



**HAL**  
open science

# Transmission Efficiency of Plasmodium falciparum Malaria Resistant Strains in the African Mosquito Vectors

Elangwe Milo Sarah-Matio

► **To cite this version:**

Elangwe Milo Sarah-Matio. Transmission Efficiency of Plasmodium falciparum Malaria Resistant Strains in the African Mosquito Vectors. Agricultural sciences. Université Montpellier, 2021. English. NNT : 2021MONTT027 . tel-03364110

**HAL Id: tel-03364110**

**<https://theses.hal.science/tel-03364110>**

Submitted on 4 Oct 2021

**HAL** is a multi-disciplinary open access archive for the deposit and dissemination of scientific research documents, whether they are published or not. The documents may come from teaching and research institutions in France or abroad, or from public or private research centers.

L'archive ouverte pluridisciplinaire **HAL**, est destinée au dépôt et à la diffusion de documents scientifiques de niveau recherche, publiés ou non, émanant des établissements d'enseignement et de recherche français ou étrangers, des laboratoires publics ou privés.

**THÈSE POUR OBTENIR LE GRADE DE DOCTEUR  
DE L'UNIVERSITÉ DE MONTPELLIER**

**EN PARASITOLOGIE**

**École doctorale CBS2**

**Unité de recherche MIVEGEC**

**TRANSMISSION EFFICIENCY OF *PLASMODIUM  
FALCIPARUM* MALARIA RESISTANT STRAINS IN  
THEIR AFRICAN MOSQUITO VECTORS**

**Présentée par Elangwe Milo SARAH-MATIO**

**Le 12 juillet 2021**

**Sous la direction de Isabelle MORLAIS**

**Devant le jury composé de**

**Catherine BOURGOUIN, DR, Institut Pasteur**

**Stéphane RANQUE, PUPH, Aiv-Marseille Université**

**Agnès AUBOUY, CR, PHARMA-DEV, IRD**

**Ahidjo AYOUBA, DR, TransVIHMI, IRD**

**Sandrine NSANGO, CC, University of Douala**

**Isabelle MORLAIS, DR, MIVEGEC - IRD**

**Président de Jury**

**Rapporteur**

**Rapporteur**

**Examineur**

**Invitée**

**Directrice de thèse**



**UNIVERSITÉ  
DE MONTPELLIER**

## Abstract

Malaria remains a public health problem in Cameroon and antimalarial drug resistance hampers proper control of the disease. Several studies have been carried out on antimalarial drug resistance but regular monitoring of mutations associated with national drug policy changes are missing. In addition, previous studies mostly focused on symptomatic patients, and very few on asymptomatic carriers despite the fact that they represent a large reservoir of parasites. In malaria hyperendemic areas such as Cameroon, malaria infections harbour multiple clones of parasites but the dynamics of transmission of the different genotypes of *P. falciparum* from humans to mosquitoes and during their development within the mosquito has received few attentions so far.

Our study updates the malaria epidemiological situation in Tibati located in the Adamawa region of Cameroon, an area of seasonal malaria transmission and Mfou, located in the central region and characterised by perennial malaria, to assess malaria prevalence and describe the trends in antimalarial resistance markers in these two epidemiologically distinct areas. Additionally, we performed next generation sequencing using high throughput Illumina Miseq in human and mosquito infections to compare the genetic diversity of parasite populations, and the carriage of mutations associated with antimalarial drug resistance between symptomatic and asymptomatic individuals and throughout the developmental stages in the mosquito. We also carried out entomological survey in Tibati where we confirmed for the first time in Cameroon, the infection of *Anopheles coluzzii* with *P. vivax*. At the individual level, we observed a drop in the *Pfprt* K76T mutation which is responsible for chloroquine resistance, even though the mutation persisted at the population level. We also observed the presence of parasites fully and super resistant to the sulphadoxine - pyrimethamine. More so, we did not observe known artemisinin resistance mutations, but observed for the first-time in the country, rare mutations such as the R255K and L258M. Using amplicon sequencing, we determined a higher number of mixed infections in asymptomatics, that showed that resistant genotypes persist at lower levels. Comparing the genetic diversity between asymptomatic and symptomatics, showed that Asymptomatics had higher MOIs, and help maintain parasite diversity. Preliminary analyses using R, on the diversity of parasites in mosquito sporozoites indicated that the mosquito has a role in the transmission of minority genotypes and also helps in maintaining parasite genetic diversity.

## Résumé

Le paludisme reste un problème de santé publique majeur au Cameroun et la résistance des parasites aux antipaludiques freine le contrôle de la maladie. Différentes études ont été menées sur la résistance aux antipaludiques, mais aucun suivi régulier des mutations associées à la résistance, en lien avec les changements de politiques nationales de traitement de la maladie, n'a encore été mis en place. De plus, les données disponibles proviennent principalement de patients symptomatiques, et très peu sur des porteurs asymptomatiques, malgré qu'ils représentent un large réservoir de parasites. Dans les zones hyper-endémiques du paludisme comme le Cameroun, les infections palustres sont complexes, elles hébergent de multiples génotypes de parasites. La dynamique de transmission des différents génotypes de *Plasmodium falciparum* de l'homme au moustique et au cours du développement chez le moustique vecteur a reçu jusqu'à présent peu d'attention. L'objectif principal de ce travail de thèse a consisté à évaluer la dynamique de transmission des différents génotypes de *P. falciparum* dans des infections mixtes naturelles, et notamment les génotypes portant des mutations de résistances aux principaux anti-malariques actuellement utilisés. Pour ce travail, nous avons réalisé des enquêtes de terrain au Cameroun dans deux sites présentant des situations épidémiologiques distinctes : à Tibati, petite ville située dans la région de l'Adamaoua au Cameroun, une zone de transmission saisonnière du paludisme, et à Mfou, ville localisée dans la région du Centre et caractérisée par un paludisme pérenne. Notre étude a permis de dresser la situation épidémiologique du paludisme actuelle sur ces deux sites, en termes de prévalence parasitaire chez des sujets symptomatiques et chez des porteurs asymptomatiques et en termes de prévalence des mutations associées à la résistance aux anti-malariques. A Tibati, nous avons également réalisé une enquête entomologique et nous avons décrit les principaux vecteurs de paludisme sur ce site. Nous avons identifié un moustique *Anopheles coluzzii* infecté par *P. vivax*, ce qui constitue la première description d'infection naturelle à *P. vivax* chez son vecteur au Cameroun. Nous avons ensuite réalisé un séquençage de nouvelle génération (NGS) avec la technologie Illumina pour caractériser les infections. Nous avons comparé la composition des infections entre les sujets symptomatiques et asymptomatiques et nous avons suivi le devenir des génotypes de parasites chez des moustiques infectés sur du sang des porteurs asymptomatiques. Nous avons effectué un séquençage ciblé, à l'aide de marqueurs de diversité et de marqueurs permettant l'identification de mutations associées à la résistance aux antipaludiques. La comparaison des infections symptomatiques et asymptomatiques a révélé



une plus grande diversité génétique chez les asymptomatiques malgré des charges parasitaires plus faibles. Nos résultats ont montré une baisse drastique des mutations associées à la résistance à la chloroquine sur le gène *Pfcr1*, en accord avec la suspension de ce médicament dans le traitement des accès palustres depuis quinze ans. Le gène *Pfdhps* qui, avec *Pfdhfr*, confère de la résistance à la sulfadoxine-pyriméthamine, s'est révélé le plus polymorphe et nous avons montré que des haplotypes super résistants circulent au Cameroun. Les analyses bio-informatiques nous ont permis de quantifier les différents génotypes dans les infections multiples et nos résultats ont montré que le génotype résistant à la chloroquine persiste dans les infections mixtes à faible densité. Les analyses préliminaires des infections chez le moustique indiquent que ces génotypes minoritaires sont efficacement transmis par le vecteur. L'ensemble de ce travail de thèse a permis de souligner la complexité des interactions entre génotypes dans les infections naturelles à *P. falciparum* et de montrer le rôle important du moustique vecteur dans le maintien de la diversité génétique.

## Acknowledgements

I will like to sincerely thank all those who helped in the accomplishment of this work.

This thesis was sponsored by the ParaFrap-Labex/IRD fellowship, and was carried out partly at the laboratoire de Maladies Infectieuses et Vecteurs et Ecologie, Génétique, Evolution et Contrôle (MIVEGEC) of l'Institut de recherche pour le développement (IRD) at Montpellier, France and the other part was carried out at Centre Pasteur Cameroon (CPC).

First, I would like to thank my thesis supervisor Isabelle Morlais for initiating and supervising this work. I have been extremely lucky to have such a dedicated and friendly supervisor during these past years. I am very grateful and appreciate all the guidance, support and counselling you gave me during this programme. Thanks to you I discovered places and cultures even in my own country that I hadn't discovered before. Thank you for assisting me in every way you could and made sure the environment was comfortable. You have been an example and a role model as a researcher, always encouraging team work and open to work with diverse persons. That I admire about you a lot.

Many thanks to Patrick Bastien, the Coordinator of the ParaFrap programme, for all the support he gave for the realisation of this work. I will also like to thank Florence Fournet for financial support through the ANT COHESION.

I will like to thank the jury members; Stéphane Ranque, Agnès Aubouy, Ahidjo Ayouba, Catherine Bourgoïn, and Sandrine Nsango who kindly accepted to be available to evaluate my thesis work.

I will also like to thank my thesis committee members; Ahidjo Ayouba, Claire Mouquet, Anna Cohuet, Luc Abate and Isabelle Morlais for all the suggestions and remarks that helped me progress in my thesis.

A big thank you to Sandrine Nsango, who was my supervisor during my stays in Yaounde. Thank you for being friendly and available for supervision. Thank you for all the stories you told me on your experiences during your PhD days, they really came in handy and was comforting. And most importantly, thank you for always emphasising on, and I quote 'You have to manage people'.

I can't thank you enough Luc Abate. Many thanks for training me during my thesis program. Thank you very much for your availability and readiness to help. For all the support and encouragement, I say 'Thank you very much indeed'.

I will also like to thank the Director of MIVEGEC, Frédéric Simard, for accommodating me in his Lab. And also, Katia Grucker, Julie Pla and Valerie Delplanque for all the administrative assistance they gave me during my stays at IRD Montpellier.

I will also like to thank the IRD representative in Cameroon Jean-Marc Hougard, for the various interventions he made at the French Embassy in Cameroon to facilitate the visa process. I will also like to thank Colette Essono at IRD for all her assistance.

I will like to say a big thank you to Lawrence Ayong, the head of the CPC Malaria Unit lab. Thank you for accepting me to work in your lab these past years, I am super grateful.

A very big thank you to Antoine Claessens, Emilie Guillochon and Thierry Lefèvre for their assistance with my bioinformatic and statistical analyses.

I will like to say a big thank you to my colleagues from CPC; Christelle Ngou, Brice Feufack, Gaelle Bouopda, Albert Ngano Bayibeki, Balotin Fongang, Sylvie Kemleu, Estelle Essangui, Christian Donkeu, Rodrigue Kemoue, Gladys Cheuteug, Ange Tchakounte. It was really a nice time working with you guys.

Thanks to all those that worked with me in the field and lab in Cameroon; Onana Etienne, Jean Pierre Agbor, Serge Soppo and Amidou.

And to my colleagues at IRD; Michelle Bengue, Edwidge Guissou, Gislain Aka, Zamblé Zamblé, Lemonde Bouafo, thank you for all the times spent together.

I will like to appreciate all my family members and friends; both living and dead, who supported and encouraged me throughout this journey. I will forever remain grateful. And most especially, I will like to thank my mother, who has been there for me, and has been my day one supporter of my dreams.

## Résumé substantiel en français

### Introduction

Le paludisme reste un problème de santé publique majeur au Cameroun et la résistance des parasites aux antipaludiques freine le contrôle de la maladie. Différentes études ont été menées sur la résistance aux antipaludiques, mais aucun suivi régulier des mutations associées à la résistance, en lien avec les changements de politiques nationales de traitement de la maladie, n'a encore été mis en place. De plus, les données disponibles proviennent principalement de patients symptomatiques, et très peu sur des porteurs asymptomatiques, malgré qu'ils représentent un large réservoir de parasites. Dans les zones hyper-endémiques du paludisme comme le Cameroun, les infections palustres sont complexes, elles hébergent de multiples génotypes de parasites. L'impact de la diversité génétique sur la symptomatologie du paludisme reste controversé. Il a été suggéré que la multiplicité d'infection protégerait des formes sévères du fait que la persistance de parasites génétiquement diverses maintiendrait une large réponse anticorps (al-Yaman et al., 1997; Beck et al., 1997; Berczky et al., 2007; Farnert et al., 1999). Il a pu être observé par ailleurs que les sujets symptomatiques n'hébergeaient pas les mêmes parasites que des porteurs asymptomatiques (Ntoumi et al. 2000) et que les sujets asymptomatiques hébergeaient un plus grand nombre de clones (Barry et al., 2021; Mercereau-Puijalon, 1996). Par ailleurs, la diversité génétique diffère selon l'intensité de la transmission, le nombre de clones circulant en zones de faible intensité étant plus réduit (Eldh et al. 2020). L'usage des médicaments anti-malariques introduit une pression sur les parasites et la diffusion des résistances aux médicaments est liée à la pression médicamenteuse. Mais, la dynamique de transmission des différents génotypes de *Plasmodium falciparum* de l'homme au moustique et au cours du développement chez le moustique vecteur a reçu jusqu'à présent peu d'attention. Le rôle du vecteur dans la diffusion ou le maintien des résistances est encore mal compris. Chez les modèles murins, des interactions compétitives entre génotypes co-infectants ont été mises en évidence et la force de ces interactions contribue à l'évolution de la résistance aux médicaments (Babiker, 2009; Hastings, 2005; Huijben; 2011; Bushman, 2018; de Roode, 2005; Bell, 2006; Wargo, 2007; Reece, 2008). Dans les infections non traitées, la présence de parasites sensibles réduit considérablement le fitness des parasites résistants, et la compétition diminue les densités de parasites résistants. Il a été montré que cette suppression compétitive augmente lorsque le parasite résistant est rare dans l'infection initiale, ce qui suggère que la suppression compétitive est la principale force empêchant l'émergence d'une résistance de novo (Huijben,

2011). Par contre, l'introduction d'une drogue permet l'élimination des parasites sensibles au médicament et entraîne une augmentation drastique, rapide, de la densité des parasites résistants. Ces phénomènes de compétition impactent également sur la transmission, les parasites montent des stratégies permettant d'optimiser leur survie et leur transmission (Reece et al., 2008; Pollitt et al., 2011). En conditions naturelles de paludisme à *P. falciparum*, les interactions compétitives, tout comme la transmission des mutations conférant des résistances aux anti-malariques sont mal connues. Pourtant les pressions de sélection qui s'opèrent chez l'homme et chez les moustiques pourraient différer, ce qui pourrait expliquer le maintien de la forte diversité génétique en zones d'hyper endémicité.

### **Objectifs**

L'objectif principal de ce travail de thèse a consisté à caractériser la diversité génétique de *P. falciparum* dans des infections naturelles, chez l'homme et chez le moustique vecteur. Les objectifs spécifiques ont été : 1) de décrire la situation épidémiologique du paludisme dans deux zones de contexte distinct, Tibati et Mfou ; 2) de quantifier et comparer la composition génétique d'infections issues de sujets symptomatiques et de porteurs asymptomatiques en utilisant des marqueurs moléculaires permettant de caractériser le polymorphisme génétique dans des gènes de forte diversité et d'identifier des mutations dans des gènes conférant une résistance aux antipaludiques ; 3) de mesurer la composition génétique dans les populations de gamétocytes et au cours du développement des parasites chez des moustiques infectés sur ces porteurs de gamétocytes ; 4) de mesurer la dynamique de transmission des différents génotypes de *P. falciparum* dans des infections mixtes naturelles, et notamment les génotypes portant des mutations de résistances aux principaux anti-malariques actuellement utilisés.

### **Procédures**

Pour ce travail, nous avons réalisé des enquêtes de terrain au Cameroun dans deux sites présentant des situations épidémiologiques distinctes : à Tibati, petite ville située dans la région de l'Adamaoua au Cameroun, une zone de transmission saisonnière du paludisme, et à Mfou, ville localisée dans la région du Centre et caractérisée par un paludisme pérenne. La diversité génétique a été étudiée par le génotypage des infections avec des marqueurs de diversité et avec des marqueurs de résistances aux principaux anti-malariques actuellement utilisés. La variabilité génétique a été mesurée dans des infections issues de prélèvements sanguins réalisés chez des sujets symptomatiques et chez des porteurs asymptomatiques, puis chez des moustiques *Anopheles* gorgés sur du sang de porteurs de gamétocytes. Les échantillons de sang

ont été filtrés sur colonnes MACs afin de séparer les stades parasitaires asexués (trophozoïtes) et sexués (gamétocytes). Par la suite, des infections expérimentales ont été réalisées au laboratoire avec la souche de moustique Ngousso. Pour les infections expérimentales, le sang de porteurs de gamétocytes est distribué dans des cellules de gorgement en verre maintenues à 37°C et des lots de femelles moustiques âgés de 3 à 5 jours sont alors infectés par gorgement à travers une membrane de parafilm. Les moustiques gorgés sont maintenus à l'insectarium, une partie est disséquée 8 jours après le repas de sang pour déterminer le niveau d'infection par comptage des oocystes au microscope et l'autre partie est conservée jusqu'à 14 jours après l'infection afin de collecter les glandes salivaires. Sur les échantillons de sang et de moustiques, nous avons réalisé un séquençage de produits d'amplification PCR, de l'« amplicon sequencing », sur séquenceur Illumina MiSeq. Nous avons effectué ce séquençage ciblé, à l'aide de marqueurs de diversité et de marqueurs permettant l'identification de mutations associées à la résistance aux antipaludiques. Nous avons suivi la procédure décrite par Lerch et al. (Lerch et al., 2017, Lerch et al., 2019) pour l'étude de la diversité génétique, et nous avons utilisé les marqueurs AMA1-D2, AMA1-D3, CSP et CPMP. Pour les marqueurs de résistance aux anti-malariques, nous avons suivi le protocole de Nag *et al.* (Nag et al. 2017). L'analyse bio-informatique des fragments a été réalisée à l'aide du package HalotypR et les analyses statistiques ont été conduites sous R à l'aide de différents logiciels, dont Vegan et SpadeR pour l'analyse de diversité.

## Résultats/Discussion

Notre étude a permis de dresser la situation épidémiologique du paludisme actuelle sur nos deux sites d'étude, en termes de prévalence parasitaire chez des sujets symptomatiques et chez des porteurs asymptomatiques et en termes de prévalence des mutations associées à la résistance aux anti-malariques. A Tibati, nous avons observé une plus forte prévalence de l'infection palustre chez les sujets asymptomatiques, et ces infections présentaient de plus faibles densités parasitaires. A Tibati, nous avons également réalisé une enquête entomologique et nous avons décrit les principaux vecteurs de paludisme sur ce site. Nous avons identifié un moustique *Anopheles coluzzii* infecté par *P. vivax*, ce qui constituait la première description d'infection naturelle à *P. vivax* chez son vecteur au Cameroun. Nous avons réalisé un génotypage par PCR nichée sur des infections asymptomatiques de Tibati et Mfou afin de déterminer les prévalences de différentes mutations associées à la résistance aux médicaments sur ces deux sites. Nous avons observé un déclin important de la mutation 76T du gène *Pfprt*, quinze ans après la cessation de la chloroquine pour le traitement des accès palustres simples au Cameroun. Le

génotype mutant IRN au niveau du gène *Pfdhfr* est presque fixé, avec des prévalences supérieures à 96%. En combinant les mutations portées sur les gènes *Pfdhps* et *Pfdhfr* et associées à la résistance à la sulfadoxine-pyriméthamine (SP), nous avons observé une forte prévalence de l'haplotype muté IRN-G, portant quatre mutations, il était présent dans près de 90% des échantillons. Nous avons également caractérisé des haplotypes *Pfdhps/Pfdhfr* « super résistants », portant sept mutations. La forte diversité génétique au niveau des mutations des gènes *Pfdhps* et *Pfdhfr* reflète la pression de la SP, qui est utilisée dans le traitement préventif intermittent de la femme enceinte.

Nous avons ensuite réalisé un séquençage de nouvelle génération (NGS) avec la technologie Illumina pour caractériser les infections. Nous avons comparé la composition des infections entre les sujets symptomatiques et asymptomatiques prélevés à Mfou et nous avons suivi le devenir des génotypes de parasites chez des moustiques infectés sur du sang des porteurs asymptomatiques. Nous avons effectué un séquençage ciblé, à l'aide de marqueurs de diversité et de marqueurs permettant l'identification de mutations associées à la résistance aux antipaludiques. Les marqueurs CPMP et CSP ont révélé une forte diversité, avec respectivement 91 et 53 génotypes distincts. L'analyse de la composition génotypique n'a pas détecté de différenciation entre les infections symptomatiques et asymptomatiques ( $G_{st} = 0.005$  (0.001) and  $G_{st} = 0.003$  (0.002) pour CPMP and CSP). La comparaison des infections symptomatiques et asymptomatiques a révélé une plus grande diversité génétique chez les sujets asymptomatiques (médiane MOI = 2 (rang de 1 à 6) chez les sujets symptomatiques et médiane MOI = 5 (rang de 1 à 15) chez les sujets asymptomatiques). Les charges parasitaires étaient significativement plus faibles chez les porteurs asymptomatiques et nous n'avons pas trouvé d'association entre la MOI et la charge parasitaire, ni chez les sujets asymptomatiques, ni chez les sujets symptomatiques. Toutefois, dans les infections mixtes, les densités relatives des différents génotypes tendaient à s'égaliser quand la MOI augmentait. Ces résultats suggèrent donc que des interactions compétitives dans les infections asymptomatiques permettent de contrôler la multiplication des parasites.

Par ailleurs, nos résultats ont confirmé la baisse drastique des mutations associées à la résistance à la chloroquine sur le gène *Pfcr1*, en accord avec la suspension de ce médicament au Cameroun dans le traitement des accès palustres depuis quinze ans. Le gène *Pfdhps* qui, avec *Pfdhfr*, confère de la résistance à la sulfadoxine-pyriméthamine, s'est révélé le plus polymorphe et nous avons montré que des haplotypes super résistants circulent au Cameroun. Les analyses bio-informatiques nous ont permis de quantifier les différents génotypes dans les infections multiples et nos résultats ont montré que le génotype résistant à la chloroquine, CVIET,

persistait dans les infections mixtes à faible densité (proportion moyenne de 12.7% (SD 20.6)). Au niveau du gène *Pfdhps*, les infections multiples étaient majoritairement constituées de mélanges de génotypes mutés, le génotype sauvage n'a été identifié que dans quatre échantillons. Aucun génotype particulier n'a dominé dans les infections mixtes. Nos résultats ont ainsi indiqué une forte diversité génétique dans les infections palustres, particulièrement importante dans les infections asymptomatiques. Les infections asymptomatiques permettent de maintenir la diversité génétique dans la population et elles représentent un large réservoir de parasites. La circulation de génotypes à faible densité dans les infections mixtes nécessite qu'ils soient transmis chez le vecteur. Nous avons alors génotypé les populations de gamétocytes et les sporozoïtes extraits des glandes salivaires de moustiques infectés sur ces mêmes porteurs de gamétocytes pour évaluer la dynamique de transmission des génotypes de *P. falciparum*.

La multiplicité d'infection dans les populations de gamétocytes étaient similaires à celle des trophozoïtes (médiane MOI = 4 (rang de 1 à 16)) mais la MOI était négativement corrélée avec la densité en gamétocytes, ce qui indique que de fortes charges en gamétocytes sont plus facilement associées à des infections monoclonales. Les analyses préliminaires des infections chez le moustique indiquent que les génotypes minoritaires sont efficacement transmis par le vecteur. En effet, malgré de faibles proportions dans les populations de gamétocytes (1%), les génotypes « rares » sont retrouvés dans les sporozoïtes avec une fréquence relative plus élevée. Nos résultats suggèrent que le moustique vecteur a un rôle dans le maintien de la diversité génétique et que les génotypes minoritaires chez l'homme ont un succès reproductif augmenté chez le moustique. Ceci doit permettre le maintien des résistances aux anti-malariques à bas bruit et leur rapide diffusion en cas de changements de politique de traitement du paludisme.

### **Conclusion/Perspectives**

Ce travail de thèse a permis de confirmer la forte dominance du génotype sensible à la chloroquine CVMNK dans les infections palustres au Cameroun. Ce phénomène, déjà décrit dans d'autres pays en Afrique (Kublin et al. 2003; Mharakurwa et al. 2021), a laissé suggérer la possibilité de réintroduire la chloroquine en association avec d'autres drogues pour le traitement et la prophylaxie du paludisme. Cependant, la pression de la chloroquine pourrait permettre une diffusion rapide du génotype muté, CVIET, puisque nous avons détecté sa présence dans les infections mixtes, même si en faible densité, et que ces génotypes minoritaires sont efficacement transmis chez le moustique vecteur. L'ensemble de ce travail de thèse a permis de souligner la complexité des interactions entre génotypes dans les infections naturelles



à *P. falciparum* et de montrer le rôle important du moustique vecteur dans le maintien de la diversité génétique.

Des études en conditions expérimentales, en utilisant différents clones isolés d'infections naturelles, pourraient permettre de mieux caractériser la dynamique des infections multiples, en contrôlant la densité et le sex ratio des différents parasites mis en mélange. Nos prochains travaux devront génotyper un plus grand nombre de marqueurs, notamment sur le gène *PfK13*, ce qui pourrait permettre de surveiller l'apparition de mutations associées à la résistance à l'artémisinine. La chloroquine et l'hydroxy-chloroquine ont été largement utilisées au Cameroun pour la prévention ou le traitement de la Covid-19 depuis le début de la pandémie en mars 2020. Cette pression médicamenteuse a pu impacter la diffusion des génotypes de *Pfcr1* et il faudrait pouvoir analyser des échantillons prélevés depuis mars 2020 pour mesurer l'émergence ou non des génotypes résistants.

## Contents

CHAPTER 1 .....	1
INTRODUCTION .....	1
1.1 Malaria Burden .....	2
1.2 Life cycle of the malaria parasite .....	2
1.2.1 Life cycle in humans .....	3
1.2.2 Life cycle in the vector .....	4
1.3 Current antimalarial drugs .....	5
1.4. Classes of antimalarial drugs and resistance mechanisms .....	6
1.5 Antimalarial drug resistance .....	7
1.5.1 Assessing antimalarial drug resistance .....	7
1.5.2 Antimalarial drug resistance markers .....	8
1.6 Transmission of <i>Plasmodium falciparum</i> .....	11
1.6.1. Mosquito malaria infection .....	11
1.6.2. Measuring gametocyte infectiousness .....	11
1.6.3. Factors influencing gametocyte infectiousness .....	13
1.7 Mosquito immunity and parasite defence .....	15
1.8 Malaria vectors and transmission .....	17
1.9 Human malaria infection .....	18
1.9.1. Parasite density .....	19
1.9.2. Age .....	20
1.9.3. Malaria Immunity .....	20
1.10 Genetic diversity of <i>Plasmodium falciparum</i> .....	23
1.10.1. Multiplicity of infection (MOI) .....	23
1.10.2. Parasite genetic variation associated with antimalarial resistance .....	24
1.11 Methods for molecular genotyping .....	24
1.12 Competitive interactions in complex infections .....	26
1.13. Malaria Epidemiology in Cameroon .....	28
1.14 Malaria vectors and control in Cameroon .....	30
Rationale of study .....	32
Objectives .....	33
Main objective of study .....	33
Specific Objectives .....	33
Description of Chapters .....	33
CHAPTER 2 .....	35
REVIEW OF ANTIMALARIAL DRUG RESISTANCE IN CAMEROON .....	35

<b>Antimalarial drug resistance in Cameroon</b> .....	36
<b>2.1 History of antimalarial drug usage in Cameroon</b> .....	36
<b>2.2. Antimalarial drug efficacy and resistance</b> .....	37
<b>2.3. Molecular studies on antimalarial drug resistance in Cameroon</b> .....	39
<b>2.3.1 Polymorphisms associated with CQ resistance</b> .....	39
<b>2.3.2 <i>Pfmdr1</i> Polymorphisms</b> .....	41
<b>2.3.3 Polymorphisms associated with SP resistance</b> .....	41
<b>2.3.4. Polymorphisms in the <i>Cytb</i> gene</b> .....	44
<b>2.3.5. Polymorphisms associated with ART resistance</b> .....	44
<b>Conclusion</b> .....	45
<b>CHAPTER 3</b> .....	47
<b>MALARIA EPIDEMIOLOGICAL AND ENTOMOLOGICAL SURVEY IN MFOU AND TIBATI, CAMEROON</b> .....	47
<b>Malaria Epidemiological and Entomological survey in Tibati and Mfou, Cameroon</b> .....	48
<b>Rationale</b> .....	48
<b>Article 1: Epidemiological and entomological studies of malaria transmission in Tibati, Adamawa region of Cameroon six years following the introduction of long-lasting insecticide nets</b> .....	48
<b>Introduction</b> .....	48
<b>Article 1: Main paper</b> .....	50
<b>Discussion and Conclusion</b> .....	64
<b>Article 2: Antimalarial Drug resistance in the Central and Adamawa regions of Cameroon: prevalence of mutations in <i>Pfcr1</i>, <i>Pfmdr1</i>, <i>Pfdhfr</i> and <i>Pfdhps</i> genes</b> .....	66
<b>Introduction</b> .....	66
<b>Article 2 Main Paper</b> .....	67
<b>Discussion and conclusion</b> .....	85
<b>CHAPTER 4</b> .....	87
<b>GENETIC DIVERSITY OF <i>PLASMODIUM FALCIPARUM</i> SYMPTOMATIC AND ASYMPTOMATIC INFECTIONS.</b> .....	87
<b>Genetic diversity of <i>Plasmodium falciparum</i> symptomatic and asymptomatic infections</b> .....	88
<b>Introduction</b> .....	88
<b>Article 3: Main paper</b> .....	89
<b>Discussion and conclusion</b> .....	120
<b>CHAPTER 5</b> .....	124
<b>TRANSMISSION EFFICIENCY OF ANTIMALARIAL DRUG RESISTANT – ASSOCIATED ALLELES BY THE ANOPHELES MOSQUITOES.</b> .....	124
<b>CONCLUSIONS AND PERSPECTIVES</b> .....	143
<b>Conclusions</b> .....	144

<b>Perspectives</b> .....	146
<b>REFERENCES</b> .....	148

## Tables and Figures

<b>Table 1:</b> Current antimalarials and their uses .....	5
<b>Table 2:</b> Summary of the major SNPs in different genes associated with antimalarial drug resistance .....	11
<b>Table 3:</b> Evolution of malaria cases and deaths in Cameroon.....	29
<b>Table 4:</b> Percentage of insecticide treated nets usage in Cameroon.....	31
<b>Table 5:</b> Antimalarial drug resistance SNPs analysed using Nested PCR and NGS .....	123
<b>Figure 1:</b> Global distribution of malaria cases, adapted from WHO World Malaria Report, 2020.....	2
<b>Figure 2:</b> Life cycle of Plasmodium falciparum in humans and mosquitoes (source: Venugopal et al. 2020).....	4
<b>Figure 3:</b> Procedure used to determine gametocyte infectiousness.....	12
<b>Figure 4:</b> Relationship between gametocyte density and mosquito infection (from Churcher et al 2013).....	14
<b>Figure 5:</b> Effect of Plasmodium falciparum genetic complexity on the outcome of infections in Anopheles gambiae (from Nsango et al., 2012).....	14
<b>Figure 6:</b> Parasite loss during development in the mosquito, with a drastic reduction of parasites observed during ookinete invasion of the midgut. Source (Stéphanie Blandin & Levashina, 2004).....	16
<b>Figure 7:</b> Map showing global prevalence of the malaria vectors (Source: (Sinka et al., 2012)). .....	18
<b>Figure 8:</b> Model of immunity to malaria (from Rodrigues-Barraques et al 2018). Anti-parasite immunity reduces the density of blood-stage infections, and anti-disease immunity reduces the temperature caused by a given parasite density. Each type of immunity varies.....	21
<b>Figure 9:</b> Links between transmission intensity, within-host dynamics, and the frequency of parasite resistance (from Bushman et al. 2018) .....	27
<b>Figure 10:</b> Climatic and administrative regions in Cameroon. Source: (Antonio-Nkondjio et al., 2019).....	28
<b>Figure 11:</b> Distribution of the five major malaria vectors in Cameroon (from Ayala et al. 2009) .....	30

## List of Abbreviations

ACTs	Artemisinin Combination Therapies
AL	Artemether + Lumefantrine
AMPSeq	Amplicon Sequencing
AQ/SP	Amodiaquine / Sulfadoxine-Pyrimethamine
ART	Artemisinin
ARTR	Artemisinin Resistance
ASAQ	Artesunate + Amodiaquine
ASMF	Artesunate + Mefloquine
ASSP	Artesunate + Sulfadoxine-Pyrimethamine
CQ	Chloroquine
CSP	circumsporozoite protein
Cytb	Cytochrome B
DHA-PP	Dihydroartemisinin + Piperaquine
Dhfr	dihydrofolate reductase
Dhps	Dihydropteroate Synthase
DMT	Drug Metabolite Transporter
ELISA	enzyme-linked immunosorbent assay
MFAs	membrane feeding assays
MQ	Mefloquine
MSPs	merozoite surface proteins
NGS	Next Generation Sequencing
PCR	Polymerase Chain Reaction
<i>PfAMA1</i>	<i>P. falciparum</i> apical membrane antigen 1
<i>Pfcr1</i>	<i>Plasmodium falciparum</i> Chloroquine Resistance Transporter,
<i>Pfmdr1</i>	<i>P. falciparum</i> multidrug resistance 1
<i>Pfmrp1</i>	<i>Plasmodium falciparum</i> multidrug resistance protein-1
<i>PfRHs</i>	<i>P. falciparum</i> reticulocyte-binding proteins
PQ	Piperaquine

SP	Sulfadoxine-pyrimethamine
SNPs	Single Nucleotide Polymorphisms
TEP1	Thioester containing protein 1

# **CHAPTER 1**

## **INTRODUCTION**



## 1.1 Malaria Burden

Globally, there has been a decline in malaria cases and deaths over the past decade, from an estimate of 238 million cases and 736000 deaths in 2000 to 229 million cases and 409,000 deaths in 2019 (World Malaria Report 2020: 20 Years of Global Progress and Challenges, 2020). However, over the past few years, there has been no significant drop in the number of estimated cases, as only 2% decline has been recorded from 2015 to 2019, as opposed to 27% from 2000 to 2015. In 2019, majority of the cases and deaths (82% and 94% respectively) were from the WHO African Region (Figure 1) (World Malaria Report 2020: 20 Years of Global Progress and Challenges, 2020). Interpreting the dynamics of malaria transmission in developing communities is complex, as the population in the WHO African Region is on the rise, from approximately 665 million in 2000 to over a billion in 2019.

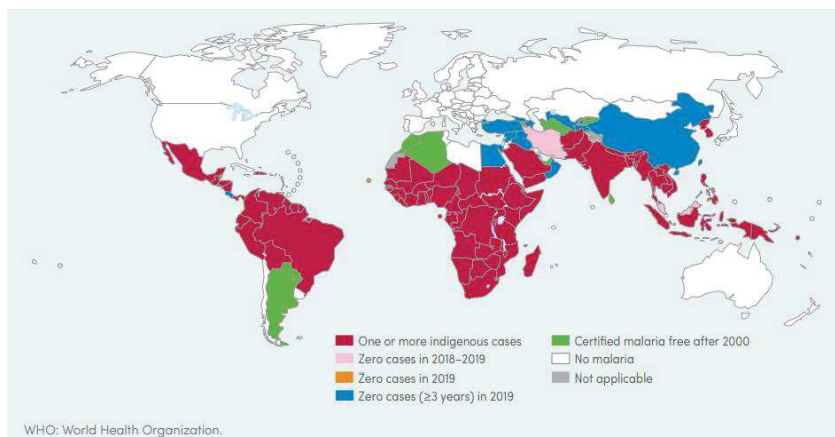

**Figure 1:** Global distribution of malaria cases, adapted from WHO World Malaria Report, 2020.

## 1.2 Life cycle of the malaria parasite

Malaria remains one of the most lethal vector-borne diseases. The disease is caused by the protozoa of the genus *Plasmodium* and is transmitted by a female *Anopheles* spp mosquito (Graumans et al., 2020). The five species of *Plasmodium* that cause malaria in humans include *P. malariae*, *P. falciparum*, *P. ovale*, *P. knowlesi* and *P. vivax*. Notably, the majority of mortality associated with malaria is due to *P. falciparum* and *P. vivax*, with *P. falciparum* being the most virulent species, mostly affecting children under 5 years (White et al., 2014).

The life cycle of the parasite involves two hosts: the human host and the mosquito vector (Figure 2). The human host is the intermediate host where takes place the asexual cycle and the mosquito vector is the definitive host in which the sexual reproduction occurs.

### **1.2.1 Life cycle in humans**

The malaria life cycle (Figure 2) in the human host begins when sporozoites, the only infectious parasite stage for the vertebrate host, are injected by a female *Anopheles* mosquito vector during a blood meal. The sporozoites migrate via blood vessels and reach the liver, then enter into hepatocytes. There starts the exo-erythrocytic cycle, parasites differentiate into schizonts in which asexual multiplication occurs, leading to thousands of merozoites. Schizonts burst and release merozoites from the hepatocytes into the blood, which marks the end of the exo-erythrocytic schizogony. This period usually takes approximately 8 days in *P. falciparum* and 15 days in *P. malariae*, *P. ovale* and *P. vivax*. For *P. ovale* and *P. vivax*, parasites can enter a period of quiescence, a state of arrested development, before their development into mature hepatic schizonts; reactivation of the quiescent forms causes relapsing infections several weeks or months after the initial infection.

Upon release from hepatocytes, the merozoites invade red blood cells and undergo the erythrocytic cycle. Merozoites form ring stages that mature in trophozoites. Mature trophozoites undergo asexual divisions to form intra erythrocytic schizonts, which mature and release between 4 to 36 merozoites for each infected RBC over a 24-72 h period, depending on *Plasmodium* species. Merozoites freshly released from RBCs commence new erythrocytic cycles by infecting healthy erythrocytes. Parasite burden is associated with the proportion of infected RBCs and lysis of numerous infected RBCs causes malaria-associated anaemia. At some point, some merozoites commit to sexual differentiation during the next erythrocytic cycle and develop into gametocytes, the sexual erythrocytic stage of the parasite and the infectious stage for the mosquito vector (van Dooren et al., 2000). Sexual differentiation results in the development of a single male or female gametocyte over the course of 10–12 days. Gametocyte development is divided into five morphologically distinct stages, immature stage I–IV gametocytes are sequestered in the bone marrow and only mature stages V circulate in peripheral blood.

## 1.2.2 Life cycle in the vector

During a blood meal on an infected individual, the female *Anopheles* mosquito ingests RBCs infected with trophozoites, schizonts and gametocytes. The trophozoites and schizonts are digested by the mosquito, and only the gametocytes continue their development cycle. The development of the parasites in the mosquito is called the sporogonic cycle. In the mosquito midgut, the matured male gametocyte, called the microgametocyte, differentiates into 1 – 8 microgametes, while the female gametocyte, called the macrogametocyte, develop into one macrogamete. While in the midgut lumen, the macro and micro gametes fuse to form zygotes which in turn develop into motile ookinetes 18 to 36 hrs later. The ookinetes cross the intestinal epithelium and then transform into oocysts on the basal side of the midgut. Numerous mitoses then take place in the oocysts, forming haploid sporozoites. The mature oocysts then burst, releasing thousands of sporozoites, which migrate via the hemolymph into the salivary glands. Sporozoites are ready to be injected during the next mosquito bite (van Dooren et al., 2000).

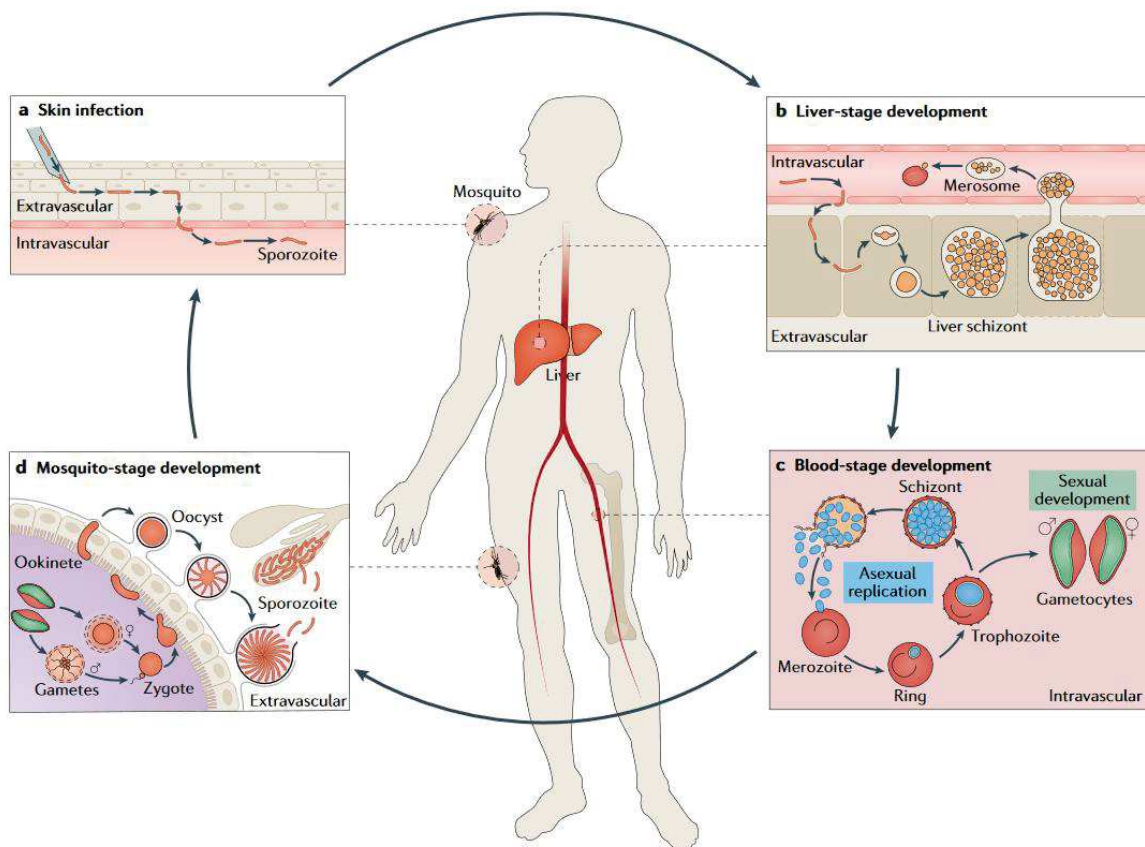

**Figure 2:** Life cycle of *Plasmodium falciparum* in humans and mosquitoes (source: Venugopal *et al.* 2020)

### 1.3 Current antimalarial drugs

Currently, the main tools for the control and elimination of malaria parasites are antimalarial drugs (Table 1). Antimalarial drugs target the erythrocytic stages of the malaria parasite. The two most frequent malaria parasites are *P. falciparum* and *P. vivax*, which both have different drug regimens: Artemisinin combination therapies (ACTs) for treating uncomplicated *P. falciparum*, and CQ (chloroquine) + PQ (piperazine) for treating *P. vivax* (Cui et al., 2015).

ACTs are made of two components: Artemisinin or its derivatives which eliminate majority of the parasites, and a partner drug which acts longer, eliminating the rest of the parasites and restricts artemisinin resistance (ARTR) selection. The ACTs commended by WHO include; artesunate + amodiaquine (ASAQ), dihydroartemisinin + piperazine (DHA-PP), artemether + lumefantrine (AL), artesunate + mefloquine (ASMF), artesunate + sulfadoxine-pyrimethamine (ASSP). It is also noted that non-falciparum parasites such as *P. ovale* and *P. malariae* are also eliminated by ACTs (Cui et al., 2015).

As reviewed by (Cui et al., 2015), several medications are used for malaria prevention; atovaquone + proguanil (malarone), doxycycline or mefloquine are recommended as chemoprophylaxis regimens to travellers to endemic settings from non-endemic areas.

Sulfadoxine-pyrimethamine (SP) is administered to pregnant women in Africa as an intermittent preventive treatment, while amodiaquine/ sulfadoxine-pyrimethamine (AQ/SP) is administered for seasonal malaria chemoprevention in regions of minimal resistance to these drugs such as the Sahel Subregion (Cui et al., 2015).

**Table 1:** Current antimalarials and their uses

Class	Drug	Use
4-Aminoquinoline	Chloroquine	Treatment of non-falciparum malaria
	Amodiaquine	Partner drug for ACT
8-Aminoquinoline	Piperazine	ACT partner drug with dihydroartemisinin as ACT
	Primaquine	Radical cure and terminal prophylaxis of <i>Plasmodium vivax</i> and <i>Plasmodium ovale</i> ; gametocytocidal drug for <i>Plasmodium falciparum</i> Radical cure of <i>P. vivax</i> and <i>P. ovale</i>
Arylamino alcohol	Quinine	Treatment of <i>P. falciparum</i> and severe malaria
	Mefloquine	Prophylaxis and partner drug for ACT for treatment of falciparum
Sesquiterpene lactone endoperoxides	Lumefantrine	Combination with artemether as ACT
	Artemether	ACT: combination with lumefantrine
Mannich base	Artesunate	ACT; treatment of severe malaria
	Dihydroartemisinin	ACT: combination with piperazine
Antifolate	Pyronaridine	Combination with artesunate as ACT
	Pyrimethamine/sulfadoxine	Treatment of some chloroquine-resistant parasites; Combination with artesunate as ACT
Naphthoquinone/antifolate	Atovaquone/proguanil	Combination for prophylaxis and treatment of <i>P. falciparum</i> (Malarone)
Antibiotic	Doxycycline	Chemoprophylaxis; treatment of <i>P. falciparum</i>
	Clindamycin	

ACT = artemisinin-based combination therapy.

Source: (Cui et al., 2015)

## 1.4. Classes of antimalarial drugs and resistance mechanisms

**1.4.1. The 4-amino-quinolines:** They include chloroquine (CQ), amodiaquine (AQ), and piperazine (PQ). All amino alcohol derivatives bind to  $\beta$ -hematin molecule and inhibit the heme detoxification in the digestive vacuole of the parasite. For several years, CQ was the reference treatment for uncomplicated malaria but due to drug resistance, it is no longer used. Even though AQ and PQ have the same mechanism of resistance as CQ, they are still efficient against parasites resistant to CQ, and used as partner drugs in ACTs (example Artesunate amodiaquine combination) (Cui et al., 2015).

**1.4.2 The 8-amino-quinolines:** An example of this class is primaquine, which is used to kill parasites in the liver, even though it can kill erythrocytic parasites. It can also target hypnozoites of *P. vivax* and lowers transmission to mosquito vectors by acting against gametocytes.

**1.4.3 Arylamino alcohols:** Antimalarials belonging to this class include; Quinine (QN), Mefloquine (MF) Lumefantrine (LF). QN is the oldest antimalarial medication, gotten from cinchona bark (Meshnick and Dobson, 2001). QN is mostly used in severe malaria cases, as it is not easily tolerated. Nevertheless, MF and LF are used in partner with ART as ACT components, for example AS/MF and artemether/LF. Resistance to QN was first reported in Brazil, and its resistance is linked to mutations in several genes (Cui et al., 2015).

**1.4.4 Antifolates:** They include sulfadoxine, which targets the parasite's dihydropteroate synthase (*dhps*) and pyrimethamine which targets the parasite's dihydrofolate reductase (*dhfr*). The benefit of SP is its single dose treatment, and they are often discussed together. However, drug resistance makes its efficacy limited. The initial use was as a monotherapy. However, resistance was observed shortly after in both *P. falciparum* and *P. vivax* (Cui et al., 2015). SP (Fansidar) was efficient against CQ - resistant parasites. However, in the late 1970s, parasites resistant to SP was observed in Asia and South America (Rumans et al., 1979).

**1.4.5 The Naphthoquinone:** An example is atovaquone that acts against the parasite's mitochondrial cytochrome bc1 complex. It is used with a DHFR inhibitor proguanil, for efficient treatment therapy, and chemoprophylaxis for falciparum malaria even though it is expensive.

**1.4.6 Antibiotics:** Examples are: doxycycline and clindamycin which have antimalarial activities, since they act against the protein synthesis machinery of the apicoplast organelles,

inhibiting protein synthesis in prokaryotes. Doxycycline in combination with QN is also used to treat falciparum malaria (Cui et al., 2015).

**1.4.7 Artemisinins:** They are considered the newest class of antimalarials. Artemisinins are derived from a plant, *Artemisia annua*, that was used in China for its antipyretic properties. Its semisynthetic derivatives artesunate, dihydroartemisinin and artemether are used in combination with partner drugs in ACTs. In combination therapy, the artemisinin derivative rapidly reduces parasitaemia and the partner drug removes residual parasites over a longer period. Combination also delays resistance to drugs. ACTs are used for the management of uncomplicated malaria as oral administration. However, in cases of severe malaria, intravenous artesunate is administered as the gold standard.

## 1.5 Antimalarial drug resistance

Drug resistance limits the efficiency of antimalarial drugs, and falciparum parasites are resistant to all antimalarials including the recent ones, even though the extent of resistance varies. Globally, *P. falciparum*, *P. vivax* and *P. malariae* have shown resistance to all available antimalarial drugs (Antony & Parija, 2016).

### 1.5.1 Assessing antimalarial drug resistance

There are different methods used to determine antimalarial drug resistance. Firstly, through clinical trials, *in vivo* studies assess the efficacy of drugs in patients and *ex vivo/in vitro* assays evaluate parasite susceptibility to the drugs. Secondly, by looking at genetic polymorphisms linked to resistance (Table 2), and lastly by checking the selective pressure of the drugs on consecutive infections. These methods have helped determined the mechanism of resistance and the severity of resistance.

There has been a wide interest in ARTR due to its crucial role in recent antimalarials. A reduced efficiency of the combination artesunate/mefloquine was observed in the Cambodia-Thailand border found in South East Asia, a focal point for antimalarial drug resistant parasite. Clinical resistance to artesunate was displayed as delayed parasite clearance in the blood after drug administration (Dondorp et al., 2009; Noedl et al., 2008; Phyo et al., 2012). Ring stage survival assays showed reduced parasite susceptibility (Witkowski, 2013). Genome wide association studies showed that delayed parasite clearance was associated with mutations in the propeller domain of the *kelch13* gene located on chromosome 13 (Ariey et al., 2014; Cheeseman et al.,



2012; Takala-Harrison et al., 2013). The delayed clearance and *K13* mutations are prevalent only in Cambodia, Myanmar, Thailand and Vietnam. Mutations including SNPs in the propeller domain are common in African parasites, but not those linked to ARTR in South East Asia (Cui et al., 2015).

## 1.5.2 Antimalarial drug resistance markers

**1.5.1.1 *Pfmdr1*:** The *P. falciparum* multidrug resistance 1 (*Pfmdr1*) is an homolog to human P-glycoproteins and a member of drug metabolite transporter (DMT) family which impacts on the sensitivity to several antimalarials (Sanchez et al., 2010). Even though the exact mechanisms underlying resistance by *P. falciparum* remain unknown, it has been shown that *Pfmdr1* encodes a transporter that localizes to the membrane of the food vacuole, the target site of several drugs, and is associated with enhanced efflux of the drugs from resistant parasites (Cowman et al., 1991). Polymorphisms in the *Pfmdr1* gene change the transportation of various drugs inside or outside of the food vacuole of the parasite. Nevertheless, these polymorphisms may lead to antagonistic effects on diverse drugs (Cui et al., 2015). In addition, increase in *Pfmdr1* copy number has been linked to the excessive use of MQ in South East Asia and mediates drug resistance (Price et al., 2004). More so, studies show how that mutations in *Pfmdr1* abate the sensitivity of drugs like QN, LF and ART (Sidhu et al., 2006).

Common mutations present at the *Pfmdr1* gene linked to resistance include: N86Y, D1246Y, S1034C, N1042D. The N86Y and D1246Y mutations have been linked to reduced sensitivity to CQ and AQ but increased sensitivity to LF, ART, and MF (Cui et al., 2015). In Africa, the mutations N86Y and D1246Y are common but not 1034C and 1042D, which are linked to reduce sensitivity to LF, ART and MQ (Sidhu et al., 2006; Viega et al 2011).

The amino quinolines PQ and AQ select the wild type alleles N86 and D1246 (Humphreys et al., 2007; Tumwebaze et al., 2015; Zongo et al., 2007). In Africa, the ACTs used (ASAQ and AL) still remain very efficient for treating uncomplicated falciparum malaria (Dorsey et al., 2007; Ménard et al., 2016; The Four Artemisinin-Based Combinations (4ABC) Study Group, 2011). Nevertheless, the frequency of polymorphisms in the *Pfmdr1* gene associated with resistance to ART derivatives may increase as a result of the drug pressure from ACTs.

**1.5.1.2 *Pfcr1*:** The *Plasmodium falciparum* Chloroquine Resistance Transporter, *Pfcr1*, encodes a membrane protein that localizes to the digestive food vacuole membrane (Martin and Kick, 2004). Its role in chloroquine resistance was demonstrated by the analysis of the progeny of

genetic cross of sensitive and resistant strains (Wellems & Pantont, 1990). The K76T point mutation is the main cause of CQR (Djimdé et al., 2001), and even though the role of the *Pfcr* is unknown (Ecker et al., 2012), the K76T mutation primarily acts by raising the exportation of CQ from the parasite's food vacuole, leading to less CQ accumulation in the parasite digestive vacuole (Fidock et al., 2010).

Other mutations associated with K76T include: C72S M74I, N75E, A220S, Q271I, N326S I356T and R371I, and carriage of different mutations determines distinct resistance phenotypes and influences the fitness of resistant parasites. More so, the mutation K76T abates parasite sensitivity to AQ but increases sensitivity to MF (Sidhu et al., 2002). As reviewed by (Antony & Parija, 2016), CQ displays cross resistance with QN and AQ as a result of the mutant 76T, while LF shows inverse cross-resistance by being susceptible when carrying this mutation. Mutations at codons 72-76 confer higher CQ resistance and medium AQ resistance in Africa and South East Asia. About 15 haplotypes have been recorded in the *Pfcr* gene, but CVMNK, the wild type haplotype, CVIET, frequent in Asia and Africa, and SVMNT, mostly found in South America, Africa and some parts of Asia, are the most common haplotypes (Niba et al., 2021).

**1.5.1.3 *Pfmrp1*:** The *Plasmodium falciparum* multidrug resistance protein-1 (*Pfmrp1*) belongs to the ABC transporter superfamily (Kavishe, 2009). Mutations in the *Pfmrp1* are associated to a decrease in QN and CQ sensitivity. The I876V and K1466R are the two mutations prevalent in African parasites even though they are not associated with parasite drug resistance. However, those found in Myanmar are linked to CQ, MF, LF and pyronaridine resistance. More so, reduced CQ growth was seen in parasites whose *Pfmrp1* gene was disrupted (Gupta et al., 2014).

**1.5.1.4 *Pfdhps/Pfdhfr*:** Sulfadoxine inhibits dihydropteroate synthase (*dhps*), a key enzyme in the biosynthesis of folate and pyrimethamine is a competitive inhibitor of dihydrofolate reductase (*dhfr*), a key enzyme in the redox cycle. Resistance to the antifolates arises from mutations in the *dhfr* and *dhps* genes (Naidoo & Roper, 2013; Plowe et al., 1997). Accumulation of several point mutations in the two genes leads to multiple genotypes with varying levels of drug resistance, the quintuple mutant N51I, C59R, S108N in *dhfr* and A437G, K540E in *dhps* being a “super resistant” genotype, increasing the risk of treatment failure with SP.



**1.5.1.5 Cytochrome B (cytb):** The electro chemical potential of the mitochondrial membrane of the parasite is disrupted by atovaquone, as it clings to the cytb ubiquinol binding site. The Y268N/S/C is the single mutation in the cytb linked to *P. falciparum* resistance to atovaquone.

**1.5.1.6 Kelch13:** Genetic linkage analysis have evidenced the link between polymorphisms in the *kelch13* gene and artemisinin resistance (Takala-Harrison et al., 2015, Miotto et al., 2015). The *kelch13* gene is located on chromosome 13 and encodes a kelch protein that comprises a C-terminal Kelch-repeat propeller domain. The K13 protein regulates haemoglobin degraded by the parasite and thus the absorption of the active drug (Birnbaum et al., 2020). Mutations in the *K13* gene inactivates K13 proteins which decreases endocytosis, thus decreasing the susceptibility to ARTs. However, the mutations do not change but reduces the function of the protein (Birnbaum et al., 2020). ART resistance is associated with mutations in the sequence encoding the Kelch 13 propeller domain (Ariey et al., 2014) and so far, approximately 200 non synonymous SNPs in the K13 gene have been identified. P574L, F446I, I543T, R539T and C580Y are the most dominant mutations in South East Asia, with the C580Y mutation in the propeller domain being the main mutation linked to ARTR (S. Menard et al., 2016; Ocan et al., 2019). Mutation A578S has the highest geographical distribution in Africa but has not been associated with ART resistance.

There are other non-synonymous polymorphisms outside of the propeller notably but their association with increased ART parasite clearance half-life has not been demonstrated. The K189T mutation has been reported in several African countries (Apinjoh et al., 2017; Ocan et al., 2019; Safeukui et al., 2017; Torrentino-Madamet et al., 2014). More recently, Rwanda and Tanzania reported the R561H mutation in the Kelch13 propeller domain (Bwire et al., 2020; Uwimana et al., 2020), this mutation has been linked with ART resistance and this finding may indicate the current emergence of resistant parasites in the African continent.

**Table 2:** Summary of the major SNPs in different genes associated with antimalarial drug resistance

Drug	Molecular marker	SNPs	Reference
Chloroquine	Crt	C72S, M74I, N75D/E, K76T	(Djimdé et al., 2001), (Fidock <i>et al.</i> , 2000)
Pyrimethamine	Dhfr	N51I, C59R, S108N, I164L	(Nzila-Mounda et al., 1998), (Basco <i>et al.</i> , 1995)
Sulfadoxine	Dhps	S436A, A437G, K540E, A581G, A613S/T	(Brooks et al., 1994),
CQ, MQ, QN, HF, LF	Mdr1	N86Y, Y184F, S1034C, N1042D, D1246Y	(Duraisingh & Cowman, 2005),
Artemisinin	K13	C580Y	(Ariey et al., 2014)
Atovaquone	Cytb	Y268S/N	(Korsinczky et al., 2000), (Vaidya & Mather, 2000)

## 1.6 Transmission of *Plasmodium falciparum*

The transmission of malaria parasites involves several factors from the parasite, the vector, the host and their environment. Measuring malaria transmission and changes in malaria transmission is key to evaluate the impact of control interventions.

### 1.6.1. Mosquito malaria infection

As earlier mentioned, gametocytes are the parasite stage that can be transmitted from humans to mosquitoes. In order for the transmission and spread of malaria infection, mature gametocytes need to be present in the blood stream and taken by an *Anopheles* female during feeding (Bousema et al., 2014). Gametocyte infectiousness is influenced by multiple factors, such as their density in the human blood, sex-ratio, immune responses from the human or mosquito hosts or antimalarial drugs.

### 1.6.2. Measuring gametocyte infectiousness

Infectiousness of *P. falciparum* gametocyte carriers to mosquitoes is estimated either by directly feeding mosquitoes on gametocyte donors or by membrane feeding assays (MFAs) where gametocyte-containing blood is dispensed in glass feeders maintained at 37° and offers

to female mosquitoes (Figure 3.A.). Fed mosquitoes are later dissected to record infection rates (Figure 3.B.). Membrane feeding assays have advantages over direct skin feeding assays that include a wider ethical and practical acceptability and are most widely used. Direct skin feeding assays are most sensitive to detect the human transmission to mosquitoes but MFAs allow good approximation of transmission potential (Bousema et al., 2013, 2014).

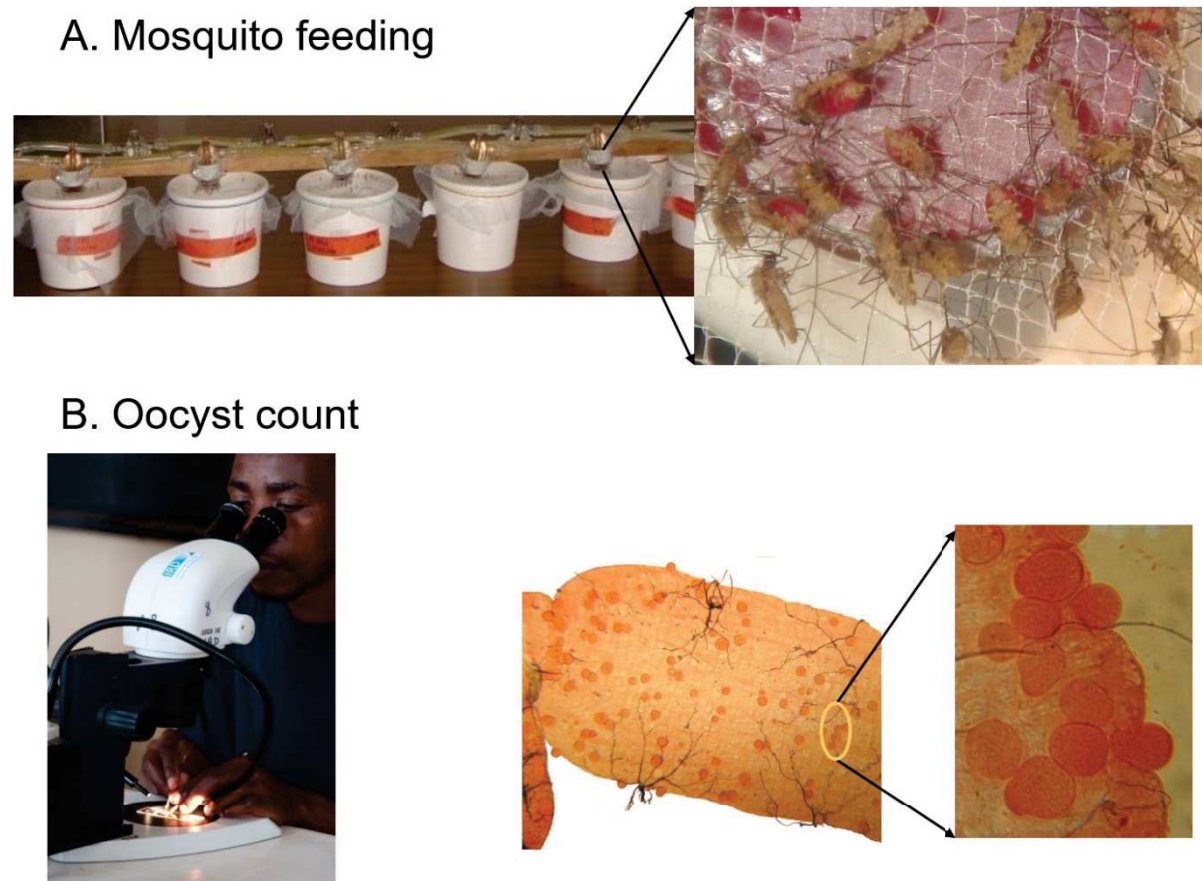

**Figure 3:** Procedure used to determine gametocyte infectiousness

### 1.6.3. Factors influencing gametocyte infectiousness

A number of studies have reported that mosquito infection increases with the number of gametocytes ingested by the mosquito (Jeffery and Eyles, 1955; Graves et al., 1980; Bousema and Drakeley, 2011; Morlais et al., 2015). However, other reports have also shown that gametocytes can infect mosquitoes at very low densities, and thus sub microscopic carriage of gametocytes represents a reservoir of parasites (Bousema et al., 2014b; Churcher et al., 2013; Schneider et al., 2007).

The mosquito needs to ingest both male and female parasites in the same blood meal and models indicate that male gametocyte density may become a limiting factor for transmission success at low gametocyte densities, as they are less represented in the human blood (Bradley et al., 2018; Reece et al., 2008).

Also, *P. falciparum* is highly multiclonal, and studies in Cameroon showed that monoclonal infections have a higher infection intensity than polyclonals (Figure 5) (Nsango et al., 2012; Morlais et al., 2015). More so, the presence of multiple clones would help parasites escape vector immunity. In multiclonal infections, there is intra-host competition in the mosquitoes, which help optimize the transmission of the most adaptable clone, which is usually the most virulent (Choisy & de Roode, 2010).

Field-based mosquito-feeding assays have revealed that host antibody responses to gametocyte proteins are associated with reduced malaria transmission efficiency from humans to mosquitoes (Dantzler et al., 2019; Stone et al., 2018). Particularly, Pfs48/45 and Pfs230 antibodies are associated with reduced transmission efficiency in natural infections. Other natural human immune responses target young gametocytes, contributing to parasite clearance.

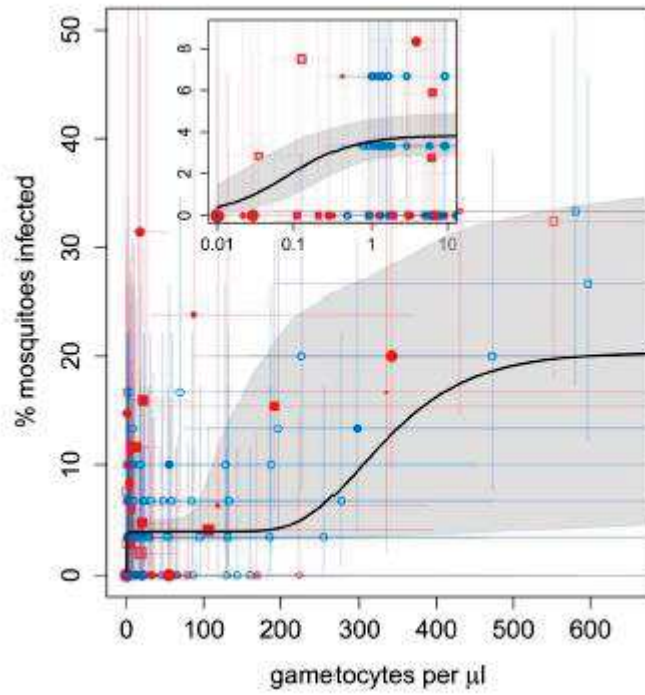

**Figure 4:** Relationship between gametocyte density and mosquito infection (from Churcher et al 2013)

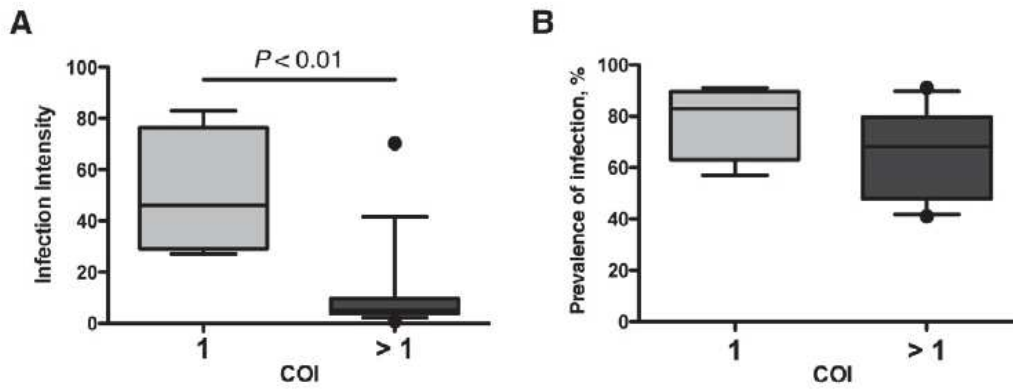

**Figure 5:** Effect of *Plasmodium falciparum* genetic complexity on the outcome of infections in *Anopheles gambiae* (from Nsango et al., 2012)

#### **1.6.4. Measurement of mosquito infection**

Different methods can be used to determine parasite infection in the mosquito vector. Mosquito infection can be confirmed by direct observation and count of oocysts and sporozoites in the midgut and salivary gland, respectively, upon dissection and microscopic examination (Graumans et al., 2020). This method remains the gold standard but is labour intensive and requires well-trained microscopists. A second method is the enzyme-linked immunosorbent assay (ELISA) that detects *Plasmodium* circumsporozoite protein (CSP). CSP is expressed in sporozoites and mature oocysts (Burkot et al. 1984, Wirtz et al. 1987). The method also required prior dissection of mosquito tissues for the specific detection of parasites in the midgut and head-thoraces, and avoid false-positive samples. Third, PCR-based detection methods have been developed more recently. PCR has a higher sensitivity with a detection limit below three to ten sporozoites in a mosquito (Arez et al., 2000; Bass et al., 2008; Boissière et al., 2013).

Intensity of malaria parasite transmission by mosquitoes in endemic areas is measured traditionally using the entomological inoculation rate (EIR) (Kilama et al., 2014). EIR estimates the level of exposure to *P. falciparum*-infected mosquitoes by calculating the number of infective bites received by an individual over a defined time period (Tusting et al., 2014). The method relies on human-landing catches, where mosquitoes are caught as they attempt to land on the exposed limbs of field workers. Other methods are using light trap catches (LTC) and pyrethrum spray catches (PSC) as alternative to human biting (Lines et al., 1991a; Mbogo et al. 1993).

#### **1.7 Mosquito immunity and parasite defence**

The interactions between the mosquito vector and malaria parasites play a vital role in malaria transmission and are also targets for control and elimination. There are two main factors that prevent mosquito infection after an infected blood meal: mosquito immune response against parasite and inadequate support nutrients required for parasite development (Blandin & Levashina, 2004).

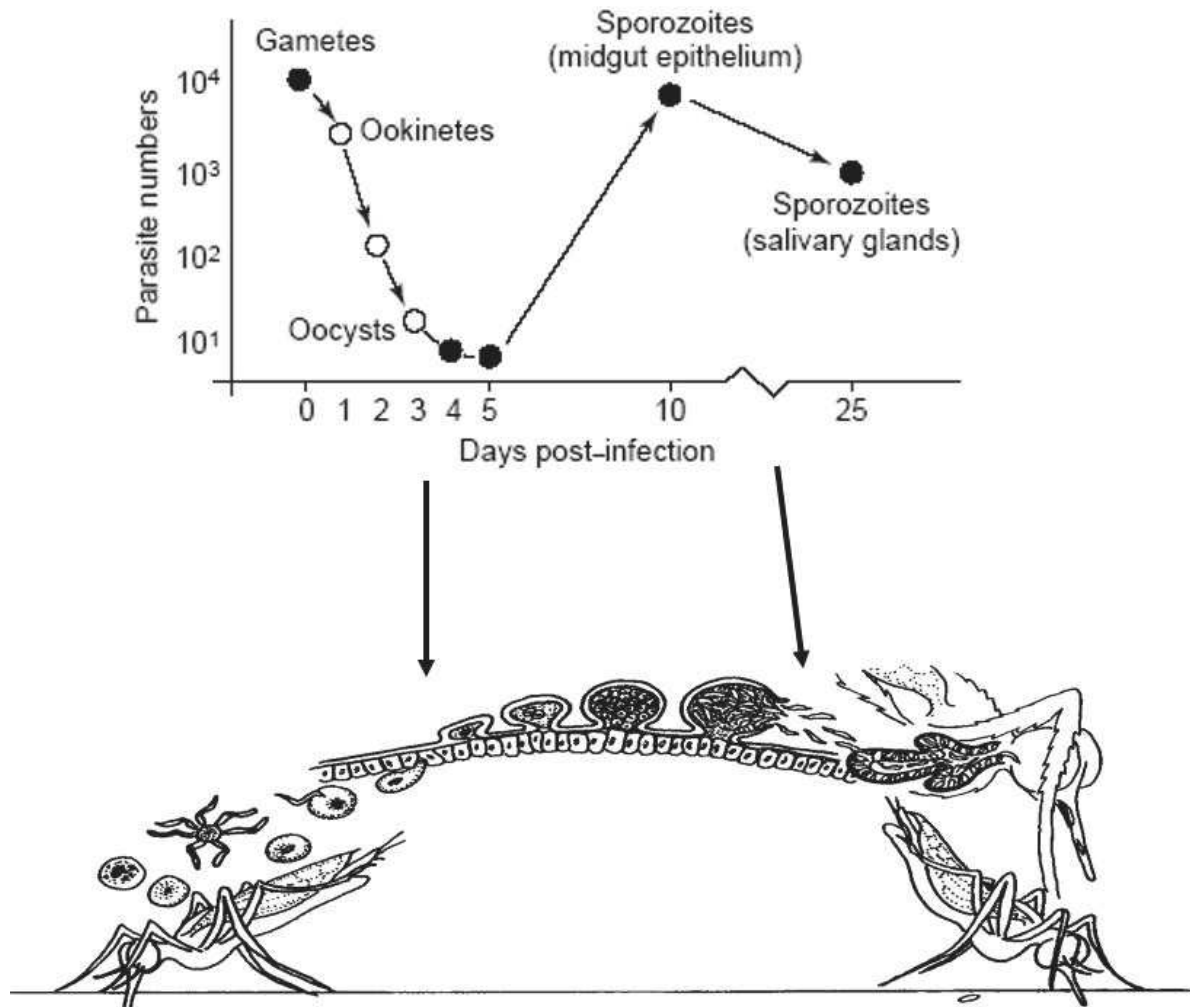

**Figure 6:** Parasite loss during development in the mosquito, with a drastic reduction of parasites observed during ookinete invasion of the midgut. Source (Blandin & Levashina, 2004).

As previously mentioned, in order to become infective to the next host, malaria parasites undergo several growth and differentiations in the mosquito. Hence most parasites can successfully develop in few mosquitoes due to complex interactions between the parasite and mosquito vector. During the malaria parasite development in mosquitoes, the parasite has to conquer 3 main major barriers to avoid development disruption; the development from gametocytes to ookinetes, ookinetes to oocysts, oocyst to midgut sporozoites and from midgut sporozoites to salivary gland sporozoites (Figure 6). This refractoriness is due to mosquito's efficient immune response, which could lead to complete refractoriness in some parasites (Blandin & Levashina, 2004).

The effective transmission of *Plasmodium* parasites occur after the parasites have overcome several barriers such as the anti-plasmodial responses targeting ookinetes and oocysts. Most



ookinetes are eliminated by the mosquito in cases where the parasite and vector are not compatible (Blandin et al., 2004). A strong epithelial nitration response is activated during invasion of the mosquito midgut by ookinetes. This causes the dispensation of hemocyte-derived micro vesicle, which stimulate complement-like activation in mosquito (Kumar et al., 2004). The activation of the *Anopheles gambiae* thioester containing protein (TEPI) causes it to bind to ookinete surface and promotes the formation of a complex that destroys the parasites (reviewed in Molina-Cruz et al., 2017). However, *P. falciparum* evades the mosquito immunity with the help of the *Pfs47* gene, a protein considered essential for malaria transmission (Molina-Cruz et al., 2017). The *Pfs47* disrupts the c-Jun N-terminal kinase which is vital in triggering epithelial nitration. The absence of nitration prevents the dispensation of hemocyte-derived micro-vesicles and the activation of TEPI and its adhering on the surface of the ookinete. Hence the parasite bypasses the mosquito immune system (Molina-Cruz et al., 2017).

## 1.8 Malaria vectors and transmission

Over 400 species of the *Anopheles* exist, and about 50 of them are unnamed. Roughly 70 of the *Anopheles* species have the ability to transmit the human malaria parasites, and 41 species are dominant vectors in malaria transmission (Figure 7). The regions with high malaria burden include: Africa, the Americas and the Asia-Pacific region. Contrarily to these regions, Europe and the Middle East are regions with little or no malaria transmission (Sinka et al., 2010).

Central America, South East Asia and the Pacific, are areas with high vector species diversity. In Africa, the vector species of major importance and dominance include, *An. gambiae*, *An. arabiensis* and *An. funestus*. Other dominant vector species (DVS) are *An. nili* and *An. moucheti*. *An. gambiae* is said to have a greater impact on malaria transmission. Nonetheless in some cases, *An. funestus* turn to have greater impact in malaria transmission and are also considered to be one of the first *Anopheles* species to be adapted to the human host (Sinka et al., 2010). In Africa, vector control efforts turn to focus on these species (Sinka et al., 2012). More so, areas with the highest EIR, disease prevalence, morbidity and mortality are in Africa, due to the presence of efficient dominant vector species (Fontenille & Simard, 2004).

Limiting human-vector contact is one of the main malaria intervention control methods (ITNs and IRS) used in Africa (Sinka et al., 2010). Other factors that control vectors include: temperature, humidity, breeding site formation and mosquito intra specific competition (Lunde



et al., 2013). Environmental changes may be favourable for malaria transmission in one area and unfavourable in for another due to varying ecology of the different vectors. Malaria parasites and their vectors respond to variation in temperatures (Lindsay & Birley, 1996).

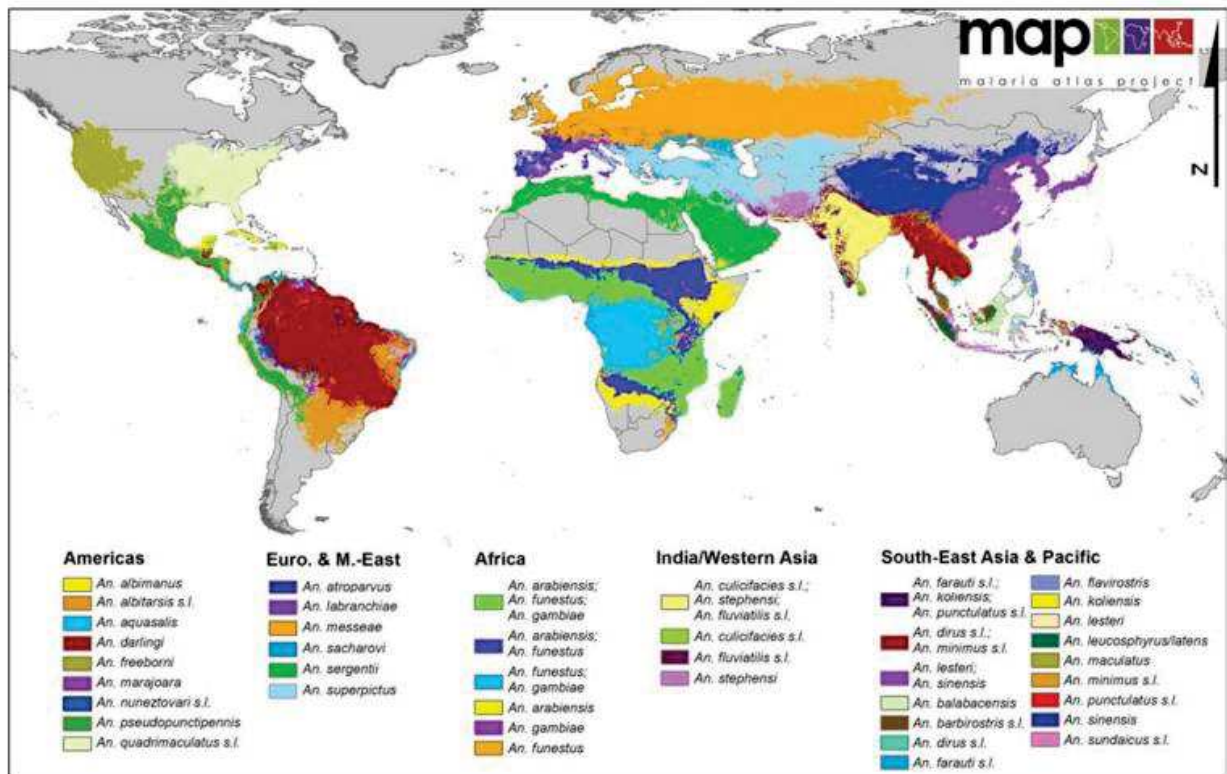

Figure 7: Map showing global prevalence of the malaria vectors (Source: (Sinka et al., 2012)).

## 1.9 Human malaria infection

The blood stage parasites are responsible for most clinical symptoms associated with the disease. Symptoms of malaria usually develop 10–15 d after being bitten. When the parasite develops in the erythrocyte, numerous known and unknown waste substances such as hemozoin pigment and other toxic factors accumulate in the infected RBCs. The periodic lysis of the infected RBCs results in the release of these toxic products, which in turn activate the immune system and cause symptoms such as chills, fatigue, pain, and fever. Erythrocytes containing more mature forms (trophozoites and schizonts) are sequestered in the post capillary venules of various organs where they adhere to endothelial cells. Cytoadherence is considered to be a major contributor to the pathogenesis of falciparum malaria. Cerebral malaria is the most severe

neurological complication of infection with *P. falciparum* malaria, resulting in long-term neuro-cognitive impairment and death.

*Plasmodium* infections that do not lead to clinical symptoms and therefore remain undetected are widespread even in low endemic regions. These asymptomatic infections, only detected through community-based surveys, represent a largely hidden reservoir of active infection that permits their persistence and eventual spread to other human hosts. Global control and elimination of malaria is being hindered due to asymptomatic carriers of *P. falciparum*. Several drug-mediated strategies target the asymptomatic parasite reservoir: mass drug administration where all the population is provided with antimalarials, mass screen and treat where all the population is screened with RDT and those infected treated, intermittent preventive therapy that consists in repeated treatment of high-risk groups with an antimalarial. Research efforts to compare the relative effectiveness of these different approaches at varying levels of malaria transmission are needed.

Different factors influence asymptomatic carriage, among them are; parasite density, age and immunity.

### **1.9.1. Parasite density**

In endemic settings, it is common to observe malaria infections that occur below detection limit using standard diagnostics such as microscopy and RDTs. These infections are often without clinical symptoms (asymptomatics). Nonetheless research shows that parasite density in an infected person fluctuates over time, implying that lower density infections may become higher density the next days (Ashley & White, 2014; Felger et al., 2012; Slater et al., 2019). Sub-patent infections are only detected by molecular methods, and can be observed irrespective of the transmission settings (Eldh et al., 2020). However, sub-patent infections are higher in low transmission areas than in high transmission areas, and in such settings, both symptomatic and asymptomatic infections act as reservoirs (Slater et al., 2019). The fraction of all infected individuals detected by PCR, microscopy and RDTs is undoubtedly lower in low transmission settings. Hence higher transmission settings turn to have a higher average parasite density than lower transmission areas (Drakeley et al., 2005; Okell et al., 2012). Nonetheless, parasite density decreases over time if no treatment is given, and it takes six months for *P. falciparum* to persist in the blood if untreated. Several factors are responsible for low parasite densities in

low transmission areas: fewer infectious bites in lower parasitaemia, control of parasites due to immunity acquired especially in cases where infection has transitioned from high to low, low genetic diversity which helps in rapid acquisition of immunity to the clones present (Bousema et al., 2014; Okell et al., 2012). Asymptomatic infections often have gametocytes, even at low densities, and usually transmit the disease. Indeed, in membrane feeding studies, asymptomatic individuals are shown to be infectious and act as reservoirs (Gonçalves et al., 2017; Ouédraogo et al., 2016).

### **1.9.2. Age**

Malaria immunity is acquired from antigenic stimulation from early childhood via repeated parasite infections (McGregor, 1987). Malaria transmission intensity affects age distribution of malaria cases. Malaria occurs in individuals of all ages in cases of low transmission. However, in high transmission areas, malaria burden and majority of deaths associated to malaria is seen in young children (Snow & Marsh, 2002). As transmission increases, children in high to moderate transmission settings develop immunity faster. However, children in low transmission settings turn to acquire a more efficient immunity than those in moderate transmission settings (Rodríguez-Barraquer et al., 2018). Higher parasite loads and clinical cases are seen in younger children in high transmission areas, while clinical cases and parasitaemia is controlled in older individuals. This is contrary to low transmission settings, where clinical cases and incidence of the disease are similar in children and adults (Marsh & Snow, 1999; Snow et al., 1997). More so, studies show that parasite prevalence decreases with age especially in high transmission areas (Roberts et al., 1999).

### **1.9.3. Malaria Immunity**

In *falciparum* malaria, frequent and multiple infections are required for the development of naturally acquired immunity. Then, naturally acquired immunity develops with host age and parasite exposure. In high transmission settings, kids are exposed to several infectious bites yearly. Hence children in such settings become immune to severe forms of the disease by 5 years (Crompton et al., 2014). Nonetheless, they continue to have uncomplicated occurrence of febrile malaria till early adolescence when they hardly have clinical malaria.

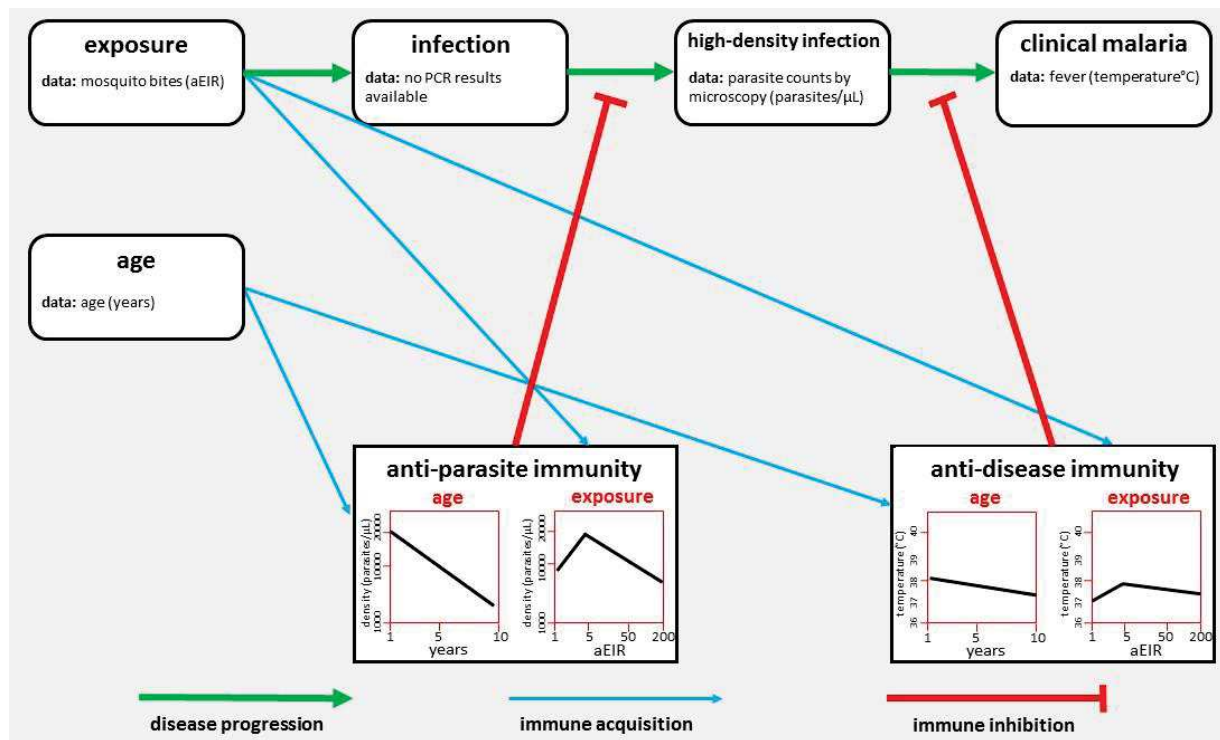

**Figure 8:** Model of immunity to malaria (from Rodrigues-Barraques et al., 2018). Anti-parasite immunity reduces the density of blood-stage infections, and anti-disease immunity reduces the temperature caused by a given parasite density. Each type of immunity varies.

Immunity comprises anti-disease immunity which protects against clinical symptoms, and anti-parasite immunity which limits blood-stage *Plasmodium* burden (Figure 8) (Doolan et al., 2009). After multiple exposure to malaria, immunity is achieved which differs widely and is dependent on the transmission intensity and location. However, immunity does not automatically prevent infection but reduces parasite density and symptoms (Tran et al., 2013). Protected individuals display only clinical immunity. Immunity against malaria parasites determine the course of the malaria infection. Immune responses against *P. falciparum* parasites are multifaceted and stage specific. Adaptive immunity against erythrocytic-stage *P. falciparum* is the most complex. Antibody-mediated immunity directed against the blood stages targets extracellular merozoites, intra-erythrocytic stages and soluble toxins. Antibody mediates cellular killing, blocks adhesion of infected RBCs to endothelium, and neutralizes parasite toxins to prevent the induction of excessive inflammation. Also, antibody responses to gametocytes interfere with parasite development within mosquitoes to reduce mosquito infection (Stone et al., 2018).

*P. falciparum* parasites have evolved immune evasion strategies to avoid killing. Immune evasion is the result of antigenic diversity and sequestration (Gomes et al., 2016). Switching in

the expression of the polymorphic proteins between blood stage generations represents an efficient mechanism for the blood stages to escape Ab-mediated recognition. Parasites switch the expression of *var* genes, leading to different *Plasmodium falciparum* erythrocyte membrane protein 1 (PfEMP1) within a single parasite population. The host immune response to the *P. falciparum* blood stages is determined mainly by recognition of variant PfEMP1 surface molecules they have already been exposed and then the switch in *var* gene enables to escape the host immunity. Other variant proteins, such as RIFINs and STEVORS, are involved in immune evasion at early trophozoite stage and mature trophozoite stage, respectively. PfEMP-1, RIFIN, and STEVOR multigene families also play a role in sequestration, a mechanism of immune evasion by which parasites leave the circulation and avoid immune clearance. STEVOR proteins were implicated in the increased deformability from young to mature gametocytes.

Merozoites are directly exposed to the immune response and evade immunity by limiting their time of exposure and through an extensive diversity (Rénia & Goh, 2016). Highly polymorphic surface proteins, the merozoite surface proteins (MSPs), the *P. falciparum* apical membrane antigen 1 (*PfAMA1*), the group of *P. falciparum* erythrocyte-binding antigens (*PfEBA*) and the *P. falciparum* reticulocyte-binding proteins (*PfRHs*) are involved in avoiding immune attack. The high polymorphism in surface proteins made them attractive vaccine candidates. The apical membrane antigen1 (AMA1) was considered as a leading blood-stage vaccine candidate but field clinical trials reported only partial strain-specific immunity (Malkin et al., 2005; Takala-Harrison et al., 2013; Thera et al., 2011). *Msp2* has been tested in different vaccine formulations, and the high antigenic diversity resulted in limited efficacy in clinical trials (Feng et al., 2018; Genton et al., 2003). The circumsporozoite protein *csp*, the major surface antigen of sporozoites and a protein required for development in the mosquito and invasion of hepatocytes, is the target of the most advanced malaria vaccine, the RTS,S/AS01, that confers partial protective efficacy in young children (RTS,S Clinical Trials Partnership 2014, 2015). The vaccine protection was shown allele-specific which explains its low efficacy in complex infections (Neafsey et al., 2015).

## 1.10 Genetic diversity of *Plasmodium falciparum*

Natural malaria infections generally harbour multiple genotypes of parasites and genetically mixed infections are more common in Africa, consistent with the high intensity of malaria transmission (Anderson et al., 2000; Färnert, 2008; MalariaGEN et al., 2021). Multiple parasites can be acquired due to superinfection (several mosquito bites), co-transmission (single mosquito bite) or both (Neafsey et al., 2015; Wong et al., 2017).

### 1.10.1. Multiplicity of infection (MOI)

Multiplicity of infection (MOI) is defined as the number of genetically distinct parasite genotypes co-infecting a host. The impact of MOI on malaria remains controversial. Indeed, epidemiological surveys report contrasting results on the clinical impact of genetically diverse infections (Contamin et al., 1996; Farnert et al., 1999; al-Yaman et al., 1997; Eldh et al., 2020, Andrade et al., 2020, Sondén et al., 2015; Portugal et al., 2017). It has been suggested that higher MOI would protect against severe malaria in high transmission settings, because persistence of genetically diverse parasites would maintain broad antibody responses, (al-Yaman et al., 1997; Beck et al., 1997; Berczky et al., 2007; Farnert et al., 1999). MOI could be influenced by parasite density and age but different studies reported different relationship (Färnert et al., 2009; Koukouikila-Koussounda et al., 2012; Ntoumi et al., 1995; Vafa et al., 2008). The effect of multiclonal infections on the risk of clinical malaria also differs with the intensity of transmission (Eldh et al., 2020). Multiple clones pose a risk of clinical malaria in children from ages 0.5 to 17 years in high transmission areas. However, this isn't the case in low transmission areas and areas of seasonal malaria transmission, as increased MOIs meant increased risk of clinical malaria especially in children with age range 0.5 to 2 years (Eldh et al., 2020).

Measuring MOI can help in understanding transmission dynamics (Tusting et al., 2014). Studies have shown a positive correlation between MOI and endemicity, and so the MOI has been used to characterise malaria transmission intensity. Several studies carried out in Africa showed high transmission areas had more infections with multiple *P. falciparum* clones, while areas with low or seasonal transmission areas had the least number of clones.



### **1.10.2. Parasite genetic variation associated with antimalarial resistance**

Malaria parasites have evolved resistance to most widely deployed antimalarial drugs. Monitoring parasite drug resistance mutations can identify the emergence of novel resistant mutants and help to implement effective malaria control strategies. Molecular markers associated with antimalarial drug resistance are highly relevant to detect and monitor the distribution of resistant parasites. Current molecular markers associated with antimalarial drug resistance include markers for resistance to chloroquine (*Pfcr*, *Pfmdr1*), sulfadoxine (*Pfdhps*), pyrimethamine (*Pfdhfr*), amodiaquine (*Pfcr*, *Pfmdr1*), quinine (*Pfcr*, *Pfmdr1*, *Pfnhe1*), and artemisinin (*PfK13*).

### **1.11 Methods for molecular genotyping**

Genotyping parasite genetic variants helps us determine drug resistance phenotypes, population structure, and infection dynamics. Different molecular markers are used for genotyping and this depends on the application used to carry out the genotyping (Koepfli et al., 2011). In cases of epidemiological studies, just one molecular marker with a high resolution is necessary, wherein individual clones are to be identified. However, molecular markers that cover several SNPs within a gene or multiple genes must be genotyped in cases where the phenotypes of drug resistance are to be determined. Several genome-wide markers are needed in cases of population genetic studies, and in these cases, the molecular markers used are unlinked to each other, and are free from selection pressure. For genotyping recrudescence in antimalarials potency trials, WHO recommends using three markers with high resolutions that are unlinked (Methods and Techniques for Clinical Trials on Antimalarial Drug Efficacy, 2008).

The amplification of the highly polymorphic *msp2* gene and then sizing by full length fragment or RFLP (Restriction fragment length polymorphism) were the early techniques used to genotype *P. falciparum* (Felger et al., 1999). The PCR-RFLP was adjusted to CE (capillary electrophoresis) in 2006, thus increasing resolution by utilizing various fluorescent labels for the 3D7 and FC27 allelic families (Owusu-Agyei et al., 2006). It is difficult to analyse the interpretation of the RFLP size patterns particularly when there is superimposition of the RFLP size patterns in several concomitant clones, hence the CE facilitates the analyses. The *msp1* (merozoite surface protein 1), *msp2* and *glurp* (glutamine rich protein) are the current markers

recommended for genotyping antimalarials by CE (*Methods and Techniques for Clinical Trials on Antimalarial Drug Efficacy*, 2008).

A mean of determining genotypes over the past years was using whole genome sequencing (WGS), but the disadvantages are high cost per sample and laborious sequence library preparations for large studies (Lerch et al., 2017). An alternative method for genotyping is the typing of numerous SNPs distributed over the entire genome. Genome-wide diversity can be determined using this multi-locus SNP-typing, and is appropriate for population studies since the selected SNPs are unlinked. Oligonucleotide ligation, or High Resolution Melting, or TaqMan are used to determine mutations of SNPs (Daniels et al., 2008). Nonetheless, a large amount of DNA template is required for SNP-typing, since each assay represents a typed SNP. In cases of mixed infections in a sample, the haplotypes will be difficult to determine if there are unlinked genotypes.

Amplicon sequencing of highly haplotypically diverse antigens has provided insight into complex infections and has been applied for surveillance of known and novel alleles at drug resistance loci (Juliano et al., 2010; Verity et al., 2020). The use of sequenced amplicons in epidemiological studies has been made possible via next generation sequencing (NGS) technologies such as Illumina. NGS permits longer sequence reads, sample multiplexing, and thus reducing cost per sample. The advantages of Amp-Seq (amplicon sequencing) genotyping are: it's highly sensitive, the proportion of different variants can be quantified, it is able to detect minor clones (low density clones) in samples having multiple clones, fitness of each parasite clone can then be studied. Notwithstanding, false allele calling due to PCR artefacts or sequencing errors can be observed due to the high sensitivity of Amp-Seq. The *msh1* and *msh2*, the length polymorphic markers, and the SNP polymorphic region of the *csp*, were the markers first used for Amp-Seq of genotyped *P. falciparum* (Bailey et al., 2012).

Amp-Seq for *P. falciparum* genotyping has been used to assess antimalarial drug efficacy (Gruenberg et al., 2019) and characterize complex infections (Lerch et al., 2017). Highly polymorphic molecular markers have been developed and validated to study the genetic diversity of *P. falciparum*. These markers often target vaccine candidate antigens, such as *csp*, *ama1*, that are under selective pressure. The availability of large sequence data allows the identification of novel genetic markers. Recently, a new highly diverse marker the *cpmp* (conserved *Plasmodium* membrane protein) has been used for Amp-Seq genotyping of *P. falciparum*. However, independent of the technique used, the accurate composition of haplotypes present in field samples is unknown, due to host dynamic factors, where by some



clones are so low that they cannot be detected (Ferreira & Hartl, 2007), and the limitation of every genotyping method to detect minority clones (Lerch et al., 2017).

## 1.12 Competitive interactions in complex infections

Evidences from animal models indicate that competitive interactions between co-infecting genotype drives the evolution of drug resistance and malaria transmission (Babiker et al., 2009; Bushman et al., 2018; de Roode et al., 2005; Hastings & Watkins, 2005; Huijben et al., 2011). Competition between resistance and sensitive parasites occurs when resistance arises in a drug-sensitive infection, or when hosts are infected with several parasites at the same time. In-host competition impacts the fitness of resistant parasites through competitive suppression or competitive release. In untreated infections, the presence of susceptible parasites substantially reduced the fitness of resistant parasites, and then competition reduced resistant parasite densities. It has been shown in *P. chabaudi* that competitive suppression increases when the resistant parasite is rare in the initial infection and then the authors postulated that competitive suppression is the major force preventing the emergence of resistance that occurs *de novo* (Huijben et al., 2011). In competitive release, removing the drug-susceptible competitors through drug treatment leads to dramatic increases in the density of resistant parasites.

In-host competition affects the transmission of individual clones (Pollitt et al., 2011; Reece et al., 2008). Investment in gametocytes is reduced when parasites experience mixed infections. In mixed infections (Figure 9), malaria parasites detect the presence of competing genotypes and respond by reducing their investment in sexual stages, they maximize their competitive ability. However, parasites use adaptive reproductive strategies and modulate asexual to sexual conversion rate according to environmental cues (Schneider et al., 2018). Increasing conversion maximises short-term transmission and reducing conversion facilitates in-host survival and thus, future transmission. Parasites can increase gametocyte investment in response to stress conditions and drastic reduction in parasite densities induces terminal investment in reproduction (Pollitt et al., 2011).

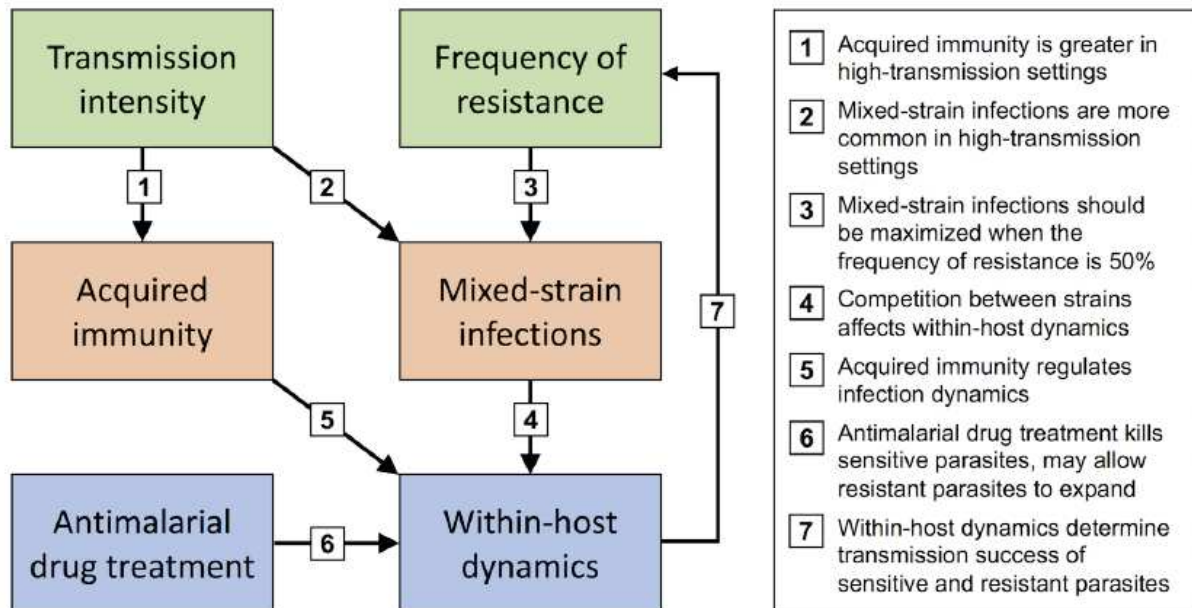
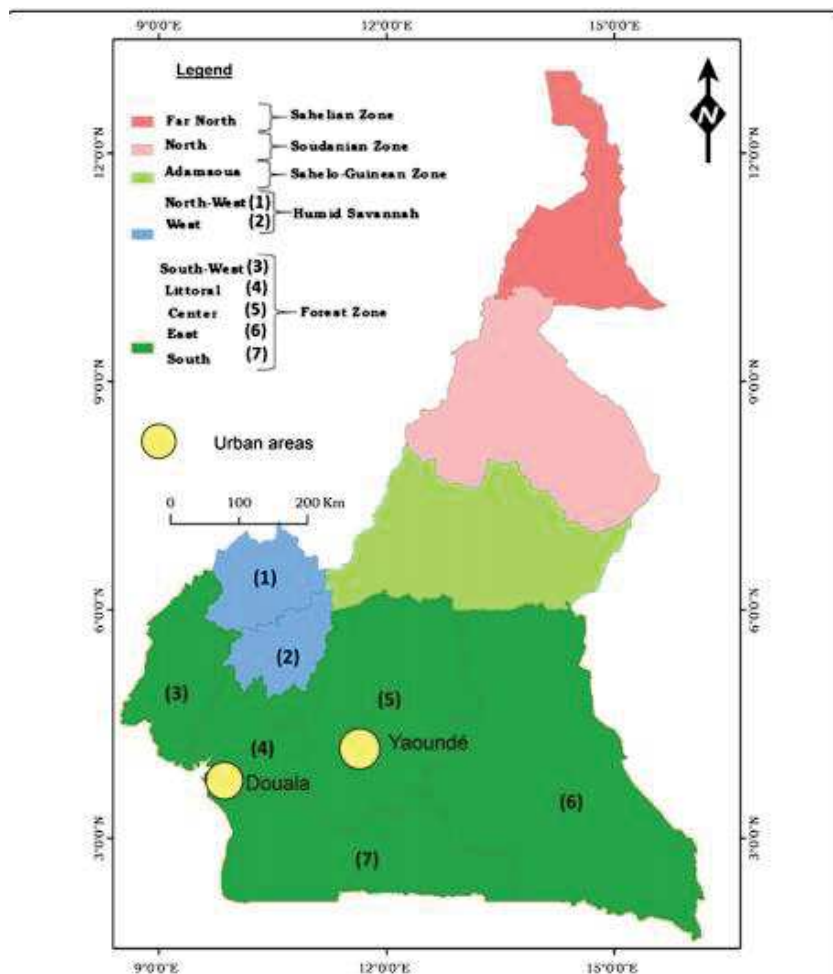

**Figure 9:** Links between transmission intensity, within-host dynamics, and the frequency of parasite resistance (from Bushman et al. 2018)

The fitness cost of resistance determines the outcome of competition between the sensitive and resistant parasite strains. If there is no fitness cost associated with a resistance mutation, then the parasite strain carrying this mutation will persist in the populations even in the absence of the drug. If fitness costs are present, selection for resistance will be reversed when the drug is absent. It has been suggested that fitness costs in mixed-strain infections may serve to prevent the fixation of resistance in the parasite population (Bushman et al., 2018). Maintenance of drug sensitive parasites would explain the recovery of drug susceptibility when an antimalarial drug is retired, which has been observed with chloroquine-sensitive *P. falciparum* after cessation of chloroquine use (Kublin et al., 2003). A previous study compared parasite genotypes in humans and mosquitoes in Zambia and found that the prevalence of mutations associated with resistance to pyrimethamine was higher in the human hosts (Mharakurwa et al., 2011). By contrast, polymorphisms associated with resistance to other drugs not used in Africa were more frequent in the mosquito. Then different selective pressure is likely to occur in humans and mosquitoes.

### 1.13. Malaria Epidemiology in Cameroon

Cameroon is located in West-Central Africa, extending from the equatorial forest in the south, to the sudano-sahelian zone in the north. Cameroon has a varying climate, with a tropical coast semi-arid and hot northern region. The country has a population of over 25 million in 2019 (Cameroon National institute of statistics projections). The country is divided into ten administrative regions that cover various ecological domains (Figure 10). The two anglophone regions share borders with Nigeria, while the rest of the country is francophone, and shares border with Equatorial Guinea, Chad, Gabon, Central African Republic and Congo. The land area of the country is 475,440km<sup>2</sup>, and all major climates and vegetation in the continent can be seen in Cameroon; mountains, desert, ocean coastland, forest, savanna and rain.



**Figure 10:** Climatic and administrative regions in Cameroon. Source: (Antonio-Nkondjio et al., 2019)

Malaria is endemic in Cameroon, and the widest spread disease and the primary cause of morbidity and mortality in the country (Table 3), especially in young children and pregnant women who are the most vulnerable group. The main parasite responsible for 95% of the malaria cases is the *P. falciparum* (Antonio-Nkondjio et al., 2019). Other parasites present include; *P. malariae*, *P. ovale*, and *P. vivax* which has been recently reported in the country (Fru-Cho et al., 2014; Ngassa Mbenda & Das, 2014; Russo et al., 2017).

The primary vector responsible for the transmission of malaria in Cameroon is the *Anopheles gambiae s.l.* Since 2017, there has been an increasing trend in the number deaths and cases associated to malaria.

**Table 3:** Evolution of malaria cases and deaths in Cameroon

	2014	2015	2016	2017	2018
<b>Number of malaria cases</b>	1,995,038	2,321,933	2,359,577	3,068,811	2,551,923
<b>Number of cases in &lt; 5 yrs old</b>	719,559	825,359	831,093	1,060,589	792,507
<b>Number of severe cases</b>	531,198	543,498	540,517	1,623,396	1,070,005
<b>Number of deaths</b>	4,398	3,440	2,639	3,195	3,263

Source: (PMI, 2020).

## 1.14 Malaria vectors and control in Cameroon

So far, 52 Anopheline species have been observed in Cameroon, wherein 16 are reported as primary and secondary vectors. However, the most efficient vectors are *An. gambiae s.s.*, *An. coluzzii*, *An. funestus*, *An. arabiensis*, *An. nili* and *An. moucheti* (Figure 11) (Ayala et al., 2009).

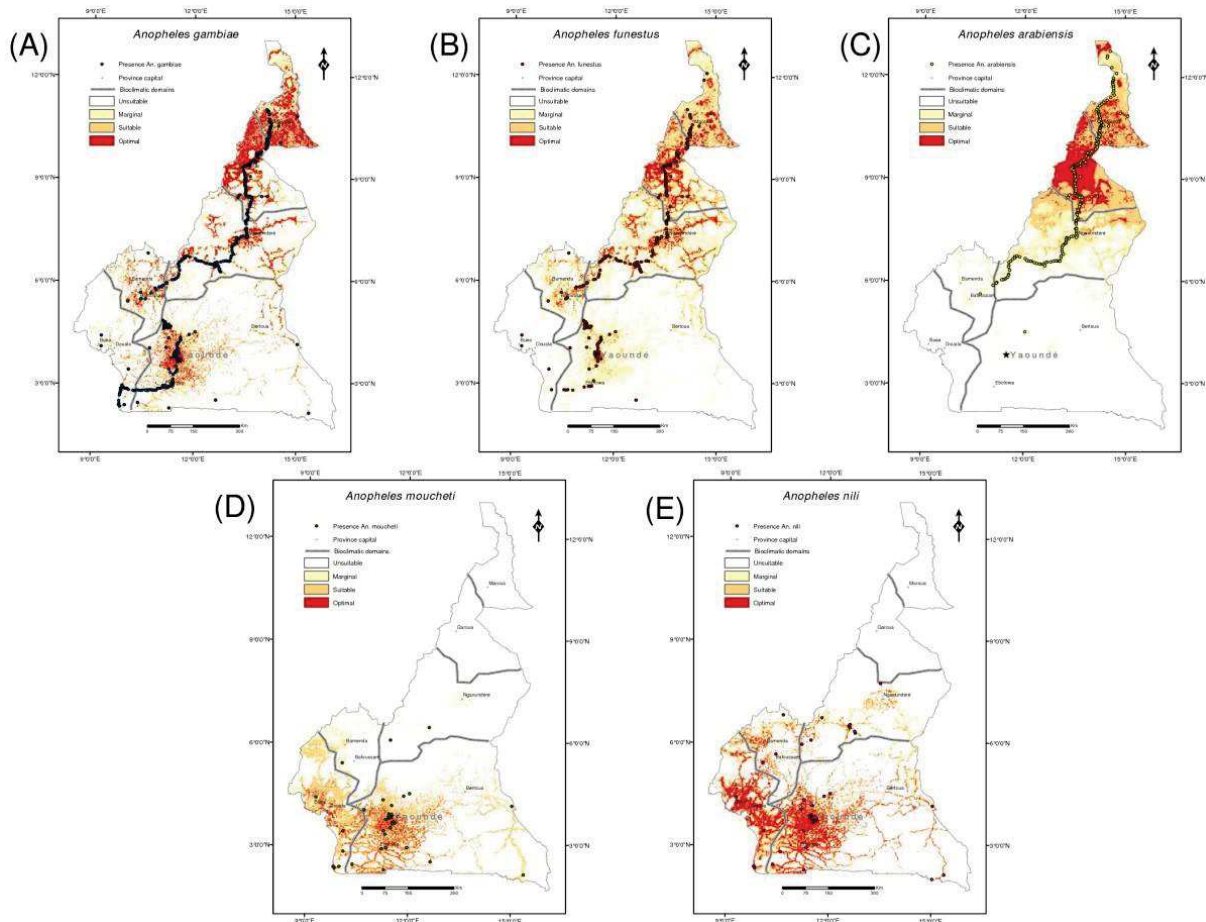

**Figure 11:** Distribution of the five major malaria vectors in Cameroon (from Ayala et al. 2009)

In the 1940s, the colonial period, hygiene and sanitation such as regular destruction of larval habitats, garbage elimination and bush clearing around houses were used to control mosquitoes in Douala and Yaounde, two cities in Cameroon. The chemicals used as insecticides at the time were; tobacco smoke, cresyl, quinoleine, phenic acid, formol and pyrethre powder (Livadas *et al.*, 1958).

In 1953, indoor residual spraying (IRS) with dieldrin, DDT and HCH as primary insecticides were used (Carnevale & Mouchet, 2001). Due to high entomological inoculation rate, several control programs have failed over the years (Antonio-Nkondjio et al., 2019). In the 1990s, large vector control programs resumed through distribution of pyrethroid treated nets to pregnant women and children less than 5 years (PNLP, 2015).

Currently, one of the country’s major components of malaria prevention and control has been vector control via the use of long-lasting insecticidal nets (LLINs). The distribution of over 20 million LLINs has led to an increase usage in bed nets over the years (Table 4) and hence vector control. It is estimated that the number of households with at least one insecticide treated net (ITN) has increased from 36% in 2011 to 73% in 2018, 59% of the population has access to ITNs and 60% of children under 5 sleeps under mosquito nets (PMI, 2020).

**Table 4:** Percentage of insecticide treated nets usage in Cameroon.

<b>Indicator</b>	<b>2011 DHS- MICS</b>	<b>2011 MIS</b>	<b>2014 MICS</b>	<b>2018 DHS KIR</b>
% Households with at least one ITN	36%	36%	71%	73%
% Households with at least one ITN for every two people	9%	n/a	37%	41%
% Population with access to an ITN	n/a	n/a	56%	59%
% Population that slept under an ITN the previous night	15%	15%	48%	54%
% Children under five who slept under an ITN the previous night	21%	21%	55%	60%

(Source: PMI, 2020)

## Rationale of study

Malaria remains a public health problem in Cameroon and drug resistance hampers proper control of the disease. Several studies have been carried out on antimalarial drug resistance but regular monitoring of mutations associated with national drug policy changes are missing (reviewed in Niba et al. 2021). In addition, most of the studies focused on symptomatic patients, and very few on asymptomatic carriers despite they represent a large reservoir of parasites. In malaria hyperendemic areas such as Cameroon, malaria infections harbour multiple clones of parasites but the dynamics of transmission of the different genotypes of *P. falciparum* from human to mosquitoes and during the development within the mosquito has received few attentions so far. Interactions between co-infecting genotypes have been mostly studied in animal models and studies have shown that co-infection influences antimalarial drug resistance, immunity and malaria transmission. However, translating results from mouse malaria to natural human infections remains challenging. So far, most studies on molecular epidemiology of malaria have used techniques such as the nPCR-RFLP to detect drug resistance mutations, and capillary electrophoresis to determine the genetic diversity of the parasites. These techniques are not able to identify new SNPs and rare alleles present in the parasite population. There is a knowledge gap on how antimalarial drug resistant parasites evolve in their mosquito vectors and how the mosquito contributes to maintain genetic diversity in natural parasite populations.

In this work, we carried out epidemiological and entomological surveys: in Tibati, in the Adamawa region of Cameroon, an area of seasonal malaria transmission, and in Mfou, located in the central region and characterised by perennial malaria, to assess the malaria prevalence and describe the trends in antimalarial resistance markers in these two epidemiologically distinct areas. Additionally, we performed next generation sequencing using high throughput Illumina Miseq in human and mosquito infections to compare the genetic diversity of parasite populations and the carriage of mutations associated with antimalarial drug resistance 1) between symptomatic and asymptomatic individuals and 2) throughout the developmental stages in the mosquito.



## Objectives

### Main objective of study

My PhD thesis aimed at determining the dynamics of *P. falciparum* mutations associated with antimalarial drugs from field isolates to their mosquito vectors.

### Specific Objectives

- 1) To describe the malaria situation in Tibati and Mfou.
- 2) To determine the genetic diversity of *Plasmodium falciparum* symptomatic and asymptomatic infections.
- 3) To determine the different *P. falciparum* clones and antimalarial drug associated alleles in different gametocyte carriers, and assess those that can be efficiently transmitted by their local mosquito vector.
- 4) Measure the transmission success of different drug resistant/sensitive genotypes in natural isolates of *P. falciparum*.

### Description of Chapters

This thesis consists of an introduction in chapter one, and four chapters. The introduction describes malaria burden, the biology of the malaria parasite and their vectors. It further looks at current antimalarial drugs and their associated drug resistance markers. More so it gives an overview of *P. falciparum* transmission, and factors responsible for parasite transmission in both the human hosts and mosquito vectors. It then looks at the genetic diversity of *falciparum* malaria, and finally the epidemiology of malaria in Cameroon.

Next, chapter two contains a review of the literature on malaria resistance in Cameroon. It describes the history of different antimalarials used in the country, the emergence of antimalarial drug resistance, and also the efficacy of these drugs in the country. It traces the prevalence of the different drug resistance molecular markers that have been studied so far.



Subsequently is Chapter three, which consists of 2 articles. The first one: **Epidemiological and entomological studies of malaria transmission in Tibati, Adamawa region of Cameroon six years following the introduction of long-lasting insecticide nets**, identifies the different malaria parasites and vectors present in Tibati, in the Adamawa region of Cameroon, an area known for seasonal malaria transmission. More so, a specific focus on this manuscript was on the detection of *P. vivax* parasite in an *An. coluzzi* mosquito. The second article: **Antimalarial Drug resistance in the Central and Adamawa regions of Cameroon: prevalence of mutations in *Pfprt*, *Pfmdr1*, *Pfdhfr* and *Pfdhps* genes**, assesses the prevalence of known mutations associated with antimalarial drug resistance in Mfou and Tibati to identify antimalarial drug resistance in two different epidemiological settings.

Chapter four constitutes an article titled: **Genetic diversity of *Plasmodium falciparum* symptomatic and asymptomatic infections**. This chapter describes and compares the genetic composition of *falciparum* infections in symptomatic and asymptomatic individuals from Mfou, in the Central Region of Cameroon, a region characterised by high malaria transmission. Molecular genotyping was performed using Amp-Seq on an Illumina MiSeq instrument and targeted gene fragments enabling simultaneously the estimation of the genetic diversity in the samples and the identification of specific mutations linked to antimalarial resistance.

Chapter five is composed of an article draft titled: **The transmission success of different drug resistant/sensitive genotypes in natural isolates of *Plasmodium falciparum***. This section assesses the transmission dynamics of co-infecting parasites from filtered blood gametocytes to oocysts in mosquito midguts and finally sporozoites in salivary glands. The same Amp-Seq procedure as in Chapter 4 was used to determine haplotypes that were efficiently transmitted through the mosquito vector.

**CHAPTER 2**  
**REVIEW OF ANTIMALARIAL**  
**DRUG RESISTANCE IN**  
**CAMEROON**

## **Antimalarial drug resistance in Cameroon**

Malaria control relies on the efficacy of antimalarial drugs and has always been hampered so far by the emergence of drug resistance. Sub-Saharan Africa endorses the largest burden of malaria, with >90% of malaria cases and deaths. The global target of reducing malaria case incidence by 75% for 2030, compared with 2015, may be seriously compromised in this African region (GTS Global technical strategy for malaria 2016–2030). Particularly as artemisinin resistance that is already widespread in South-East Asia now threatens to spread to Africa.

In Cameroon, malaria remains a serious public health problem: the entire population is at risk of malaria, with 6.84 million confirmed cases and over 12,000 deaths reported in 2018 (WHO Malaria Report, 2019). Seasonal malaria is observed in the Northern regions of Cameroon, while perennial transmission is observed in the Southern regions. The Cameroon's National Strategic Plan for malaria control (NMCP) (2019 - 2023) has as objectives to reduce malaria incidence and mortality to 60% by 2023, compared to 2015 levels, and to abate malaria transmission to a pre-elimination threshold. Activities to achieve the NMCP objectives include; prevention, case management as well as surveillance and monitoring (NMCP, 2015).

### **2.1 History of antimalarial drug usage in Cameroon**

Chloroquine has been extensively used for malaria treatment and chemoprophylaxis in Africa until late 1970s when parasite resistance to chloroquine was reported in most tropical African countries (Onori, 1984). In Cameroon, epidemiological data on malaria reported in 1957 (Languillon, 1957) from 1- to 10-year-old children indicated parasite prevalence over 50%, and 92% of malaria infections were due to *P. falciparum*. In northern Cameroon where malaria was hyperendemic, chemoprophylaxis trials were organized in 1956 by providing school children with weekly doses of a combination of chloroquine and pyrimethamine. While successful, after three months, parasite prevalence rose again and failure of the assay was attributed to pyrimethamine resistance (Schneider et al., 1958). Malaria control campaigns took place countrywide from 1964 to 1967 and consisted of weekly chloroquine chemoprophylaxis among school children. Large reductions in parasite carriage were obtained but re-infections occurred during holidays where children did not receive treatment (Abane, 1969). Chloroquine chemoprophylaxis was then extended to infants and pregnant woman until 1973, when chloroquine availability was curtailed. Chloroquine was considered effective as first-line drug and largely used until CQ resistance was reported (Laing, 1984; Sansonetti et al., 1985). Chloroquine resistance was first reported in 1985 in Limbe in two French boys who had

persistent fever 5 days after complete drug treatment with CQ (Sansone et al., 1985). CQ resistance was soon after confirmed from Cameroonian individuals and rapidly spread throughout the country (Louis et al., 1991; Oduola *et al.*, 1989; Hengy *et al.*, 1989; Mbacham et al., 2005). From the late 80s, amodiaquine and sulfadoxine-pyrimethamine (SP) were recommended as first-line and second-line drug, respectively, for uncomplicated malaria (Ringwald and Basco, 1998, 2000 part2, Basco, 2002). After few years of drug pressure with monotherapies, resistance to amodiaquine and pyrimethamine was observed with large variability from one study to another (Hengy *et al.*, 1989; Ringwald et al., 1996; Ringwald and Basco, 1998, 2000 part2; Basco, 2002; Basco and Tahar, 2006; Mbacham et al., 2005). From 2002 to 2004, the first-line drug used in Cameroon was still amodiaquine. In 2004, following the WHO policy recommendations, the National Malaria Control programme of Cameroon adopted the use of ACTs for the treatment of uncomplicated malaria: artesunate + amodiaquine (AS-AQ) for first line treatment and artemether + lumefantrine (AL) for second line, and SP for intermittent preventive treatment (IPT) during pregnancy (Figure 14). However, generic artemisinin derivatives were not available at CENAME, and until 2005 chloroquine was still the most widely used drug. Of the health care practitioners interviewed, only less than 20% were aware of ACTs and the recommended drug for treatment of malaria, AL (Quartem®), was then the most used ACT. All monotherapies were instructed by the government to be withdrawn from the market in 2006. Seasonal malaria chemoprevention (SMC) was implemented in the north parts of Cameroon by the Cameroon government (NMCP, 2016) in 2016, where by children between the ages of 3 – 59 months are yearly administered 4 doses of SP-AQ as a preventive strategy. Pregnant women are being administered SP as a preventive treatment during their second and third trimester of pregnancy. Both measures contribute to drug pressure which leads to development of *P. falciparum* resistant parasites (WHO-Cameroon Annual Report 2017).

## **2.2. Antimalarial drug efficacy and resistance**

In Cameroon, antimalarial drug efficacy was assessed by *in vivo* and *in vitro* studies in the late 80s (Hengy *et al.*, 1989; Oduola *et al.*, 1989; Louis et al., 1991 1992). Studies of therapeutic efficacy and *in vitro* assays indicated that CQ resistance had spread throughout the country, with large variations according to the epidemiological situation (Ringwald et al., 1996; Louis et al., 1991; Basco and Ringwald, 1998; Ringwald et al., 2000; Basco, 2002; Basco and Ringwald, 2000; Basco et al., 2002; Basco, 2003; Basco and Tahar, 2006). CQ resistance was lower in the northern parts where transmission is seasonal and drug pressure limited (Louis et

al., 1991; Basco and Tahar, 2006). As earlier mentioned, CQ resistance was first reported in 1985 in Limbe in two French boys who had persistent fever 5 days after complete drug treatment with CQ (Sansone et al., 1985). CQ resistance was soon after confirmed from Cameroonian individuals and rapidly spread throughout the country (Louis et al., 1991; Oduola et al., 1989; Hengy et al., 1989; Mbacham et al., 2005; Agnamey et al., 1995). Regular monitoring of clinical isolates in Yaounde showed an increase of CQ resistance from 1985 to 1991 and resistance levels then stabilized around 50 - 60% (Ringwald et al., 1996). More so, in 1992, parasites resistant to amodiaquine were reported in the South-West region with 26% therapeutic failure and 17% of in vitro resistance (Agnamey et al., 1995).

In 2007, Basco and Ringwald *et al.* (Basco & Ringwald, 2007) tried to look at the course of the response of antimalarials in Yaounde and observed that out of 482 assays for CQ sensitivity performed, 36.3% of the isolates were susceptible to CQ and 63.7% were resistant to CQ. However, their data obtained from 1996 - 1999 showed no significant difference in the number of CQ sensitive and resistant isolates. In 1996, 49% were resistant while 69% were resistant in 2004. From 2001 to 2004, of 258 isolates studied, 38.8% were CQ susceptible and 158 (61.2%) were CQ resistant. They carried out studies in Yaounde from 2000 - 2004 and noticed an increasing linear trend in the proportion of isolates that were CQ resistant. All the samples were sensitive to monodesethylamodiaquine and these drugs were stable throughout the study from 1997 to 2004.

As of 1999, sulphadoxine-pyrimethamine was the second-line drug in Cameroon and other West and Central African countries for the treatment of CQ resistant malaria. *In vitro* assays with parasites sampled 1994 and 1995 reported 37% of highly pyrimethamine resistant isolates in Yaoundé (Ringwald et al., 1996). Basco and Ringwald (Basco and Ringwald, 1999) then monitored pyrimethamine resistant isolates in Yaounde, and observed a significant increase in drug resistance from 1994 - 1995, to 1997 - 1998 and correlated the mutant type Asn-108 with the pyrimethamine resistant phenotype. At that time, it was still suggested to combine pyrimethamine and sulfadoxine as they were considered to be synergistic.

Even though AQ is a 4-aminoquinoline, it is still part of the new ACTs used to treat uncomplicated malaria in Cameroon. Interestingly there was a decrease in the prevalence of SNPs associated with 4 - aminoquinoline resistance (76T, 86Y, 184Y, and 1246Y) from 2003 to 2013. Moyeh *et al.* (Moyeh et al., 2018) showed that when *Pfmdr1* N86 increases, ASAQ

the first-line drug for uncomplicated malaria in Cameroon becomes more efficient, while at the same time being a threat to AL.

Nji *et al.* (Nji *et al.*, 2015) compared the efficacy of the different drugs used in Cameroon, ASAQ, DHAPP and AL, in children from different regions during the same period. Hence, they found that AL was not superior to ASAQ and DHAP and all ACTs can be efficiently used to treat malaria. Their study informed health policy makers that other ACTs than AL could be used for malaria treatment, AL being at the moment the recommended ACT but out of stock in distribution centres. Monitoring of ART-derivative efficacy has not reported resistance in Cameroon so far (S. Menard *et al.*, 2016; Whegang Youdom *et al.*, 2019).

Clinical efficacy studies require patient follow-up, with length depending on the drug half-life, and genotyping to discriminate reinfection from recrudescence in recurrent infections (D. Menard & Dondorp, 2017; Picot *et al.*, 2009). In vitro sensitivity assays are based on short- or long-term continuous cultures of fresh parasitized blood and required well-equipped laboratory with trained technicians (Basco & Tahar, 2007). It is in that light that led to the use of advanced molecular tools and genetic linkage analyses to determine the mechanisms involved in resistance to most used drugs.

## **2.3. Molecular studies on antimalarial drug resistance in Cameroon**

Since malaria transmission in the southern regions of Cameroon is perennial, these regions generally report a relatively higher prevalence of drug resistance markers due to continuous drug exposure in the population, compared to the northern regions. The dominant mutations associated with antimalarials in Cameroon include; the *Pfcr* K76T *Pfmdr1* N86Y, *Pfdhps* A437G, *Pfdhfr* triple mutation N51I, C59R, S108N and the *PfK13* K189T mutations (Niba *et al.*, 2021).

### **2.3.1 Polymorphisms associated with CQ resistance**

CQ has been extensively used for malaria treatment and chemoprophylaxis in Africa until the late 1970s when parasite resistance to CQ was reported in most tropical African countries (Onori, 1984; Kean, 1979). Over the past 20 years, there has been a tremendous decline in the CQR mutations (Figure 13), and the K76T mutation was the most studied. In Cameroon, the first report on molecular markers of CQR came from Basco *et al.* (Basco, 2002) who found 70

% of clinical isolates collected in 2001 carrying the mutant *Pfcr*t 76T. Mbacham *et al.* (Mbacham *et al.*, 2010) screened blood samples from children attending health care centres from 2004-6, and reported 77% of the *Pfcr*t 76T mutant allele in Yaoundé, 87% in Mutengene and 32% in Garoua. Menard *et al.* (S. Menard *et al.*, 2012a) monitored *Pfcr*t mutations 72 and 76 in asymptomatic samples from Mfou, and clinical samples from Yaounde and found prevalence of 71% and 55% *Pfcr*t 76T mutant genotype, 19% and 15% wild type K76, 10% and 30% mixed infections in Yaounde and Mfou respectively. No mutant 72S was identified. Ngassa *et al.* (Ngassa Mbenda & Das, 2014, 2016) found that, among clinical samples collected in 2012 in different cities, a global prevalence of 55% CVIET and 36% CVMNK. They also reported other CQ resistant haplotypes among them SVMNT, CVMDT, SVMET, CVMNT and CVMET. More so, The H97L mutation was also recorded in their study. Apinhoh *et al.* (Apinjoh *et al.*, 2017) reported prevalence of 47.3% CVIET, 25.3% CVMNK, and 27.4% being mixed haplotypes, among asymptomatic parasite carriers sampled along the slope of Mount Cameroon in 2013-14. Moyeh *et al.* (Moyeh *et al.*, 2018) found a decrease in the 76T mutant allele in Mutengene, with prevalence dropping from 96% in 2003 to 67% in 2013 among symptomatic children. In East of Cameroon, Ndam *et al.* (Ndam *et al.*, 2017) genotyped blood samples collected in Bertoua in 2003 among clinical cases, and in Messok in 2012 among asymptomatic individuals. They found a reduction in the mutant CVIET haplotype between the two periods of collection, from 53.0% to 25%. Then, the overall prevalence of the CQR mutants decreased in Cameroon since withdrawal of CQ and CQ sensitive parasites now remerged, as observed in most endemic areas (Ocan *et al.*, 2019). However, return to CQS is longer than described in East Africa, where prevalence of chloroquine resistance has reached undetectable levels only few years after discontinuation of CQ use (Frosch *et al.*, 2014; Kublin *et al.*, 2003; Laufer & Dzinjalama, 2006).

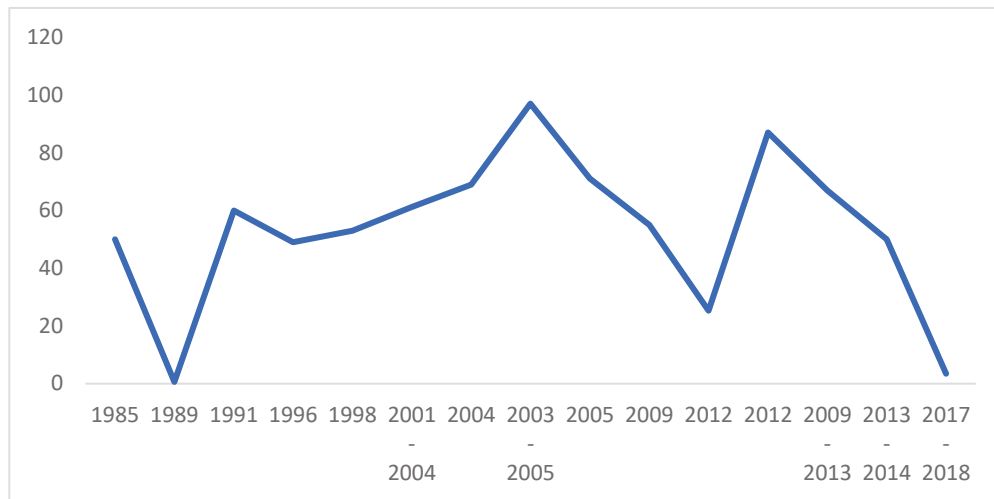

**Figure 13:** A graph showing prevalence of CQR resistance in Cameroon from 1985 to 2018. Irrespective of the method used to determine resistance, we see a steady decline in CQR resistance over the past decade.

### 2.3.2 *Pfmdr1* Polymorphisms

Menard *et al.* (S. Menard et al., 2012b) tried to establish the prevalence of *Pfmdr1* multiple copies and *Pfmdr1* 86 codons in Yaounde, Cameroon when ACT was introduced to help make comparisons in the future and to check for the development of new resistance. Their work showed 76% of the isolates had *Pfmdr1* 86Y mutant genotype in Yaounde while 84% had this mutant gene in Mfou. The wild *Pfmdr1* 86 was 10% and 4% of the isolates and mixed genotypes were 14% and 12% in Yaounde and Mfou respectively. Apinjoh *et al.* (Apinjoh et al., 2017) detected four *Pfmdr1* haplotypes with 33.1% having the wild type alleles at codons 86, 184 and 1246 (*Pfmdr1* N86Y184D1246 NYD).

### 2.3.3 Polymorphisms associated with SP resistance

Pyrimethamine-resistance of *P. falciparum* isolates was confirmed in Cameroon as soon as 1996 (Basco and Ringwald, 1998; Ringwald et al., 1996) and sequencing of the *Pfdhfr* gene correlated resistance profile with the Asn-108 mutation (Ringwald & Basco, 1999). Sequencing of the *Pfdhps* gene on fresh isolates from Yaoundé later revealed the sulfadoxine-resistant profile characterized by the double mutation: Phe-436/Ala-437/Ala-581/Ser-613 (Basco & Ringwald, 1998). Then, Basco and Ringwald (Basco & Ringwald, 2000) worked with the hypothesis that *Pfdhfr* inhibits pyrimethamine and proguanil when used as combination. After complete sequencing of the *Pfdhfr* domain in the dhfr-ts gene, they found substitutions of amino



acids at position 51, 59 and 108 and suggested these mutations were responsible for resistance in African field isolates. Additionally, they showed a gradual increase in the rate of pyrimethamine resistance and suggested this resistance was associated with the availability and number of point mutations. They didn't find the link between HB3-type single mutations and resistance to cycloguanil, and didn't observe a different genetic profile linked with cycloguanil resistance that is un-associated to pyrimethamine resistance. Thus, they confirmed the absence of cycloguanil resistance in Africa. However, they concluded that pyrimethamine resistance associated with Asn-108 and cycloguanil resistance associated with Thr-108/Val-16 wasn't applicable to their field studies.

Basco *et al.* (Basco et al., 2002) tried to characterise the *dhfr* sequence in *P. falciparum* field isolates to further comprehend the epidemiology of SP drug-resistant malaria and observed that majority of their samples had triple mutations (Ile-51 Arg-59 Asn-108). They also observed double mutations (Arg-59 and Asn-108) and single mutation Ser-to-Asn-10. They didn't observe mutant alleles Val-16, Thr-108 and Leu-164. Cys-50 reported in South America and did not identify any other new mutation in their study. Tahar and Basco, (Basco & Tahar, 2007) tried to compare clinical isolates obtained in 2004 - 2005, with their previous work on *dhfr* resistance. They observed that the continuous treatment of uncomplicated malaria in Cameroonian children with SP was no longer very effective. Their studies over time showed a growing prevalence of pyrimethamine resistance especially the triple *dhfr* mutants for a 12-year period in Yaounde and also in other parts of the country. But their study didn't show the presence of quintuple mutations (*Pfdhfr* and *Pfdhps*).

Since the epidemiology of drug-resistant *P. falciparum* can be described using molecular markers, Tahar and Basco (Basco & Tahar, 2006a) decided to conduct a descriptive molecular epidemiology of antifolate resistance at the national level. Their work showed the distribution of *Pfdhfr* alleles in Cameroon during the period 1999-2003. They notice similar mutations in the *Pfdhfr* between symptomatic and asymptomatic individuals, and suggested asymptomatic carriers are very good sources of parasites including parasites resistant to drugs. They noticed a considerable difference in antifolate resistance throughout the north-south axis of Cameroon, and observed an increase in the fraction of *Pfdhfr* mutants in Bertoua (Eastern provinces) and Garoua (Northern provinces). However, they didn't observe a difference in the proportion of *Pfdhfr* mutants in Yaounde from 1999 to 2003, even though the proportion of *Pfdhfr* mutants were high. They didn't detect the Glu-540 *Pfdhps* mutations. The prevalence of the *Pfdhfr* alleles were wild type (2.8%), double Arg-59/Asn-108 mutations (5.7%), double Ile-51/Asn-

108 mutation (0.8%), triple Ile-51/Arg-59/Asn-108 mutation (62.2%) and mixed alleles (7.6%). The *Pfdhfr* mutation that was greatest in all study sites were the triple mutations, with the northern provinces having the highest number of wild-type parasites with respect to the rest of the country (Basco & Tahar, 2006a).

Mbacham *et al.* (Mbacham et al., 2009) assessed the prevalence of molecular markers of SP resistance from samples collected in 2002 and 2003 in Limbe and Nkambe where the drug combination was no longer efficacious. Their study found a high prevalence, with 45% of the study population having the triple IRN mutant and almost 60% having the *Pfdhps* 437G mutation. They suggested that the molecular markers for monitoring the spread of SP resistance in Cameroon was 437G mutant allele as oppose to the usual 108N mutant allele of *P. falciparum*, since the mutation was associated with SP treatment failure.

Menemedengue *et al.* (Menemedengue *et al.*, 2011) analysed the mutations of *Pfdhfr* and *Pfdhps*, genes that are linked to drug resistance in *P. falciparum* isolates from children in Yaounde treated with the antimalaria artesunate-sulfadoxine-pyrimethamine, sampling having been done in 2005. No parasite had *Pfdhfr-Pfdhps* (quintuple), or *Pfdhfr* Ile164Leu mutations. However, they had quadruple mutants Asn51Ile, Cys59Arg, Ser108Asn and Ala437Gly *Pfdhps* mutation.

Chauvin *et al.* (Chauvin et al., 2015) assessed changes in the prevalence of molecular markers that are involved in SP resistance in Cameroon from isolates collected in 2010 and 2011, and showed that *Pfdhfr* N51I, C59R, S108N triple mutant was approximately 100%, but no mutations at codons 50 and 164 were detected. A437G was the most frequent *Pfdhps* mutation (76.5%) in women who were not administered SP, and was higher in pregnant women who took SP (95.9%). Even though the K540E mutation was rare, their study confirmed the mutation in Cameroon and also observed the *Pfdhps* I431V (13%), which was linked to other *Pfdhfr/Pfdhps* alleles to form an octupule mutation N51I-C59R-S108N-I431V-S436A-A437G-A581G-A613S.

Moyeh *et al.* (Moyeh et al., 2018) collected samples from Mutengene between 2003 and 2013, and observed an increasing prevalence of the CIRN haplotype, from 95.9% in 2003, to 98.8% in 2013. They concluded this was due to the SP drug pressure in Cameroon as a result of SP usage by some patients and prophylaxis for children under 5 and pregnant women adopted by the Ministry of Health in Cameroon.

Apinjoh *et al.* (Apinjoh *et al.*, 2017) conducted surveys in 2013 and 2014, and observed that the *Pfdhfr* mutant alleles present were S108N (100%), N51I and C59R found in 99% of the samples. They recorded the I431V mutation with a prevalence of 16.3%. In addition, they found the K142N mutation at a prevalence of 8.5%, and no previous studies had observed this mutation.

Finally, the triple mutant haplotype IRN of the *Pfdhfr* was the most reported in Cameroon and can be found in almost all samples in certain areas of Cameroon (Sahnouni *et al.*, 2011). The quadruple mutant haplotype IRNG associated with the *Pfdhfr* and *Pfdhps* was also found in Cameroon with a prevalence rate of 95.9% in some cases (Chauvin *et al.*, 2015). Numerous mutations are found in *dhps/dhfr* genes around the country and super resistant haplotypes, with up to 8 mutations, circulate. However, the mutations of the antifolates *Pfdhfr* and *Pfdhps* genes that confer resistance to SP should not threaten its use in Cameroon, as the prevalence rate of mutations does not exceed the WHO recommended 90% benchmark to ban the use of SP (Niba *et al.*, 2021).

#### **2.3.4. Polymorphisms in the *Cytb* gene**

In the early 2000s, there was a massive drug administration of the combination atovaquone-proguanil. This led Basco (Basco, 2003) to initiate a baseline study of *in vitro* atovaquone activity on Cameroonian clinical isolates, and analysed the sequence of cytochrome b gene and determine the chances of clinical isolates to develop atovaquone resistance which is associated with a single Tyr268Ser or Tyr261Asn substitution. They did not observe mutations associated with atovaquone resistance, possibly as the fact that the cytochrome b gene sequence is highly conserved, and hence reported the absence of atovaquone resistance in Yaounde Cameroon as of that time.

#### **2.3.5. Polymorphisms associated with ART resistance**

In 2010, it was suggested that artemisinin-based antimalarials exerted their activity by inhibiting a calcium ATPase (*Pfatp6*) and the L263E mutation would induce conformational changes leading to reduced affinity (Krishna, 2010). Menemedengue *et al.* (Menemedengue *et al.*, 2011) analyzed the mutations in the *Pfatp6* gene from children in Yaounde treated with the antimalaria artesunate-sulfadoxine-pyrimethamine. They observed wild type *Pfatp6* 263, 625,

769 alleles in all their 61 samples, with 18% having single E431K substitution (LKAS) and, E643Q, E432K, and E641Q were three other mutations detected. Tahar *et al.* (Tahar *et al.*, 2009) later investigated the *Pf*atp6 sequence polymorphisms using fresh isolates from Yaounde collected from 2001 to 2006 and compared the presence of polymorphisms with IC<sub>50</sub> of DHA. They observed two major haplotypes; the LEAs (wild-type) and LKAs (single mutant). The E432K amino acid residue was observed, even though it had never been reported. The isolates had haplotypes 263, 431, 432, 623 and 769, which were single mutant LEKAS and double mutant LKKAS. The Cameroonian isolates didn't have the West African type (E431V+Q623E) or the South American type (S769N) single mutation. However, they were able to see E431K single substitution but this substitution couldn't decrease in vitro sensitivity of DHA without a change in A623E. They concluded that the role of *Pf*atp6 mutations in ART resistance hasn't yet been proven and more research needed to be done on the candidate drug resistance genes of ARTs.

Several works reported K189T mutation in Cameroon, with a prevalence of 21% in blood samples from 2008-2009 in Bolifamba, South West region, and 36% in samples collected in 2013-2014 in surrounding areas (Apinjoh *et al.*, 2017; Safeukui *et al.*, 2017). Mutation K189T is located outside the *Pf*k13 propeller region that contains polymorphisms conferring ART resistance and has not been associated with delayed parasite clearance (Wwarn, 2019). Recently, Eboumbo Moukoko *et al.* (Eboumbou Moukoko *et al.*, 2019) sequenced the K13 gene from samples collected from Douala (2016), Yaounde (2016 - 2017) and Garoua (2014), and observed 2 non synonymous K13 mutations V589I and E612K, and 4 synonymous mutations (G625G, G453G, C469C, G449G). These mutations were completely different from those previously mentioned, implying that the K13 gene is heterogenous.

## Conclusion

Finally, so far, the potency of ART and its derivatives has remained fairly constant, and there has been a decline in the mutation K76T of the *Pf*crt and N86Y of the *Pf*mdr1, from 2008 to 2019 (Niba *et al.*, 2021). Of note, there has been the under study of antimalarial drug resistance especially in the Northern regions of Cameroon. More so, majority of the studies are on symptomatic samples, and just one study on the *Pf*dhfr mutations in asymptomatics (Basco & Tahar, 2006b). Furthermore, most studies could not identify new SNPs, since they used the nPCR-RFLP to detect drug resistance (Niba *et al.*, 2021). In conclusion, there is the need for constant monitoring of molecular markers linked to antimalarial drug resistance in Cameroon

to help determine parasite polymorphisms to know their role and influence on drug responsiveness, trends that can help change treatment policies and better comprehend the genetic diversity of drug resistant genes.

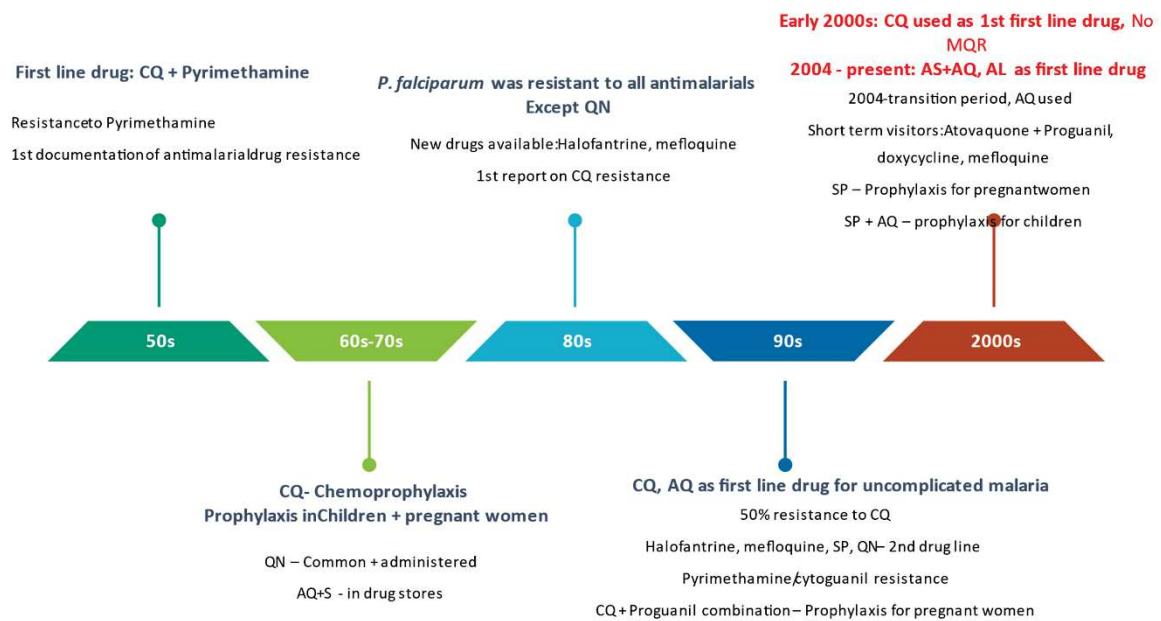

**Figure 14:** Antimalarial drug usage and resistance in Cameroon from its earliest usage to 2020

**CHAPTER 3**

**MALARIA EPIDEMIOLOGICAL  
AND ENTOMOLOGICAL SURVEY  
IN MFOU AND TIBATI,  
CAMEROON**

## **Malaria Epidemiological and Entomological survey in Tibati and Mfou, Cameroon**

Two papers are included in this section. The first paper describes the parasitological and entomological situation in Tibati, while the second characterizes SNPs associated with antimalarial drug resistance in the *Pfcr1*, *Pfmdr1*, *Pfdhps* and *Pfdhfr* genes in Tibati and Mfou. We used standard PCR methods to determine these SNPs.

**Rationale:** Malaria still remains a serious public health problem despite global efforts to fight the disease. In Cameroon, 28% and 18.3% of morbidity and deaths are respectively due to malaria (PNLP, 2020). Basic epidemiological data are lacking in many regions which makes it difficult to estimate the efficiency of disease control interventions. This malaria situation is speculated to worsen in the future due to disruption of interventions by Covid-19 (Guerra et al., 2020).

### **Article 1: Epidemiological and entomological studies of malaria transmission in Tibati, Adamawa region of Cameroon six years following the introduction of long-lasting insecticide nets**

**Introduction:** Vector control measures such as long-lasting insecticidal treated nets (LLINs) and indoor residual spraying are some of the efforts put in place for disease control. In Cameroon, 52 *Anopheles* species have been identified, of which only 16 transmit malaria to humans (Antonio-Nkondjio et al., 2006a; Wanji et al., 2003; Hervy Jean-Paul, 1998), and 6 are the most efficient vector species; *An. gambiae* ss, *An. coluzzii*, *An. arabiensis*, *An. funestus*, *An. nili* and *An. moucheti* (Fontenille et al., 2003; Fontenille & Simard, 2004).

Even though *P. falciparum* is the most prevalent and virulent *Plasmodium* species in Cameroon, other species such as *P. malariae*, *P. ovale* and *P. vivax* infect humans (Ngassa Mbenda & Das, 2014; Fru-Cho et al., 2014; Russo et al., 2017; Ngassa Mbenda & Das, 2016). *P. vivax* is widespread outside Africa in South-East Asia and the Americas. Individuals in Africa were initially considered to be refractory to the parasite due to the prevalence of the Duffy negative phenotype (Sanger et al., 1955; Miller et al., 1976). However, this has been proven otherwise as studies in Cameroon and other African countries (Ngassa Mbenda & Das, 2014; Fru-Cho et al., 2014; Russo et al., 2017; Ngassa Mbenda & Das, 2016) have observed the presence of *P. vivax* in both Duffy positive and negative individuals, even if at low frequencies. However, to the best of our knowledge, no study assessed the prevalence of *P. vivax* in their local mosquito

vector species. This work characterized malaria parasites in humans, identified the local vectors in Tibati and the prevalence of malaria parasites in the mosquito species. We investigated the presence of *P. vivax* with the aim of detecting which mosquito vector can be implicated in the transmission of *P. vivax*. in this section of the country.



RESEARCH

Open Access



# Epidemiological and entomological studies of malaria transmission in Tibati, Adamawa region of Cameroon 6 years following the introduction of long-lasting insecticide nets

Lionel Brice Feufack-Donfack<sup>1,2†</sup>, Elangwe Milo Sarah-Matio<sup>1,3†</sup>, Luc Marcel Abate<sup>3</sup>, Aline Gaelle Bouopda Tuedom<sup>1,8</sup>, Albert Ngano Bayibéki<sup>4</sup>, Christelle Maffo Ngou<sup>1,3</sup>, Jean-Claude Toto<sup>5</sup>, Maurice Marcel Sandeu<sup>6,7</sup>, Carole Else Eboumbou Moukoko<sup>1,8</sup>, Lawrence Ayong<sup>1</sup>, Parfait Awono-Ambene<sup>5</sup>, Isabelle Morlais<sup>1,3</sup> and Sandrine Eveline Nsango<sup>1,8\*</sup>

## Abstract

**Background:** Malaria remains a serious public health problem in Cameroon. Implementation of control interventions requires prior knowledge of the local epidemiological situation. Here we report the results of epidemiological and entomological surveys carried out in Tibati, Adamawa Region, Cameroon, an area where malaria transmission is seasonal, 6 years after the introduction of long-lasting insecticidal bed nets.

**Methods:** Cross-sectional studies were carried out in July 2015 and 2017 in Tibati. Thick blood smears and dried blood spots were collected from asymptomatic and symptomatic individuals in the community and at health centers, respectively, and used for the molecular diagnosis of *Plasmodium* species. Adult mosquitoes were collected by indoor residual spraying and identified morphologically and molecularly. The infection status of *Plasmodium* spp. was determined by quantitative PCR, and positivity of PCR-positive samples was confirmed by Sanger sequencing.

**Results:** Overall malaria prevalence in our study population was 55.0% (752/1367) and *Plasmodium falciparum* was the most prevalent parasite species (94.3%), followed by *P. malariae* (17.7%) and *P. ovale* (0.8%); 92 (12.7%) infections were mixed infections. Infection parameters varied according to clinical status (symptomatic/asymptomatic) and age of the sampled population and the collection sites. Infection prevalence was higher in asymptomatic carriers (60.8%), but asexual and sexual parasite densities were lower. Prevalence and intensity of infection decreased with age in both the symptomatic and asymptomatic groups. Heterogeneity in infections was observed at the neighborhood level, revealing hotspots of transmission. Among the 592 *Anopheles* mosquitoes collected, 212 (35.8%) were *An. gambiae*, 172 (29.1%) were *An. coluzzii* and 208 (35.1%) were *An. funestus* (s.s.). A total of 26 (4.39%) mosquito specimens were infected by *Plasmodium* sp. and the three *Anopheles* mosquitoes transmitted *Plasmodium* at equal efficiency.

\*Correspondence: [nsango2013@yahoo.fr](mailto:nsango2013@yahoo.fr); [nsango@pasteur-yaounde.org](mailto:nsango@pasteur-yaounde.org)

<sup>†</sup>Lionel Brice Feufack-Donfack and Elangwe Milo Sarah-Matio contributed equally to this work

<sup>1</sup>Service de Paludisme du Centre Pasteur Cameroun, BP 1274, Yaounde, Cameroon

Full list of author information is available at the end of the article



© The Author(s) 2021. This article is licensed under a Creative Commons Attribution 4.0 International License, which permits use, sharing, adaptation, distribution and reproduction in any medium or format, as long as you give appropriate credit to the original author(s) and the source, provide a link to the Creative Commons licence, and indicate if changes were made. The images or other third party material in this article are included in the article's Creative Commons licence, unless indicated otherwise in a credit line to the material. If material is not included in the article's Creative Commons licence and your intended use is not permitted by statutory regulation or exceeds the permitted use, you will need to obtain permission directly from the copyright holder. To view a copy of this licence, visit <http://creativecommons.org/licenses/by/4.0/>. The Creative Commons Public Domain Dedication waiver (<http://creativecommons.org/publicdomain/zero/1.0/>) applies to the data made available in this article, unless otherwise stated in a credit line to the data.

Surprisingly, we found an *An. coluzzii* specimen infected by *Plasmodium vivax*, which confirms circulation of this species in Cameroon. The positivity of all 26 PCR-positive *Plasmodium*-infected mosquitoes was successively confirmed by sequencing analysis.

**Conclusion:** Our study presents the baseline malaria parasite burden in Tibati, Adamawa Region, Cameroon. Our results highlight the high malaria endemicity in the area, and hotspots of disease transmission are identified. Parasitological indices suggest low bednet usage and that implementation of control interventions in the area is needed to reduce malaria burden. We also report for the first time a mosquito vector with naturally acquired *P. vivax* infection in Cameroon.

**Keywords:** Malaria, *Plasmodium vivax*, *Anopheles coluzzii*, Epidemiology, Entomology, Cameroon

## Background

Malaria remains a deadly scourge in many parts of the world, with 409,000 deaths from this disease reported globally in 2019. Over the past 10 years, a declining trend has been observed in the global incidence of cases and deaths due to malaria, 57 and 10%, respectively [1]. Disease control efforts rely at least in part on vector control measures, in particular the use of long-lasting insecticidal-treated bed nets (LLINs) and indoor residual spraying (IRS). Many countries are now adopting elimination strategies as part of their malaria operational plans, even if malaria burden has remained unchanged in some countries in sub-Saharan Africa. Unfortunately, the African region continues to account for over 90% of all malaria deaths [1].

In Cameroon, malaria remains a serious public health problem. Transmission is heterogeneous across the country, ranging from perennial transmission in the southern forested regions to seasonal and unstable transmission in the northern Sudano-savannah and Sahelian regions. Of the 52 formally recognized *Anopheles* species present in Cameroon, only 16 are able to transmit the disease to humans [2–4], and the most common and efficient vector species are *Anopheles gambiae*, *An. coluzzii*, *An. arabiensis*, *An. funestus*, *An. nili* and *An. moucheti* [5, 6]. Over the past 9 years there has been significant progress in terms of malaria control and prevention. Indeed, from 2010 to 2019, the morbidity and mortality due to malaria decreased from 36 to 28% and from 31 to 18.3%, respectively; however, the situation is not yet under control as the whole country is still at risk of disease transmission [7, 8]. These observed reductions are due to the efforts of the Government of Cameroon and international partners, with a heavy reliance on mass distribution campaigns of LLINs and the use of sulfadoxine/pyrimethamine either alone for intermittent preventive treatment in pregnant women or in combination with amodiaquine for seasonal malaria chemoprevention in children aged < 5 years. The introduction of artemisinin-based combination therapies (ACTs) for the treatment of uncomplicated malaria and of free healthcare management of severe malaria cases in

children aged < 5 years have also contributed to malaria reduction [8].

Nevertheless, the effectiveness of control measures is threatened by the rapid expansion of insecticide resistance in vector populations [9–13], changes in vector host-seeking, biting and resting behaviors [14, 15], the emergence and rapid spread of drug-resistant parasite strains [16–20] and the diversity of the vectorial system [2] and parasite species [21, 22]. In Cameroon, four *Plasmodium* species are known at the present time to cause malaria, among which *P. falciparum* is considered to be the most prevalent and virulent parasite, responsible for 82–100% of all malaria cases depending on the locality [23–26]. Other human-infecting *Plasmodium* are also present in Cameroon, including *P. malariae*, *P. ovale* and *P. vivax* [27–30]. The latter is the most geographically widespread malaria parasite that causes disease in humans outside of Africa and is especially prevalent in Southeast Asia and the Americas [31, 32]. Individuals in western, eastern and central Africa have long been considered refractory to infection by this parasite because of the high prevalence of the Duffy-negative phenotype [33, 34]. This phenotype is caused by a single nucleotide polymorphism (SNP) in the erythroid-specific promoter region of the DARC (Duffy antigen receptor for chemokines) gene [35], and individuals who are homozygous for the allele carrying this SNP lack the Duffy protein on erythrocytes. However, the dogma of “*Pv* absence in Africa” [36] began to fail a decade ago when evidence began accumulating for *P. vivax* infections in Duffy-negative individuals across Africa, and in the intervening time different studies have reported *P. vivax* infections in Mauritania [37, 38], Ethiopia [39, 40], Equatorial Guinea [41], Mali [42], Democratic Republic of Congo [43], Benin [44], Nigeria [45] and Cameroon [27–30]. In Cameroon, the association of *P. vivax* with human infections in both Duffy-positive and -negative individuals has been reported, albeit at low frequencies. However, no study has yet looked at which local malaria vector species is involved in the transmission of *P. vivax*.



In this study, we aimed to characterize malaria parasites and vectors circulating in an area of seasonal transmission in the Adamawa region. We focused on *P. vivax* detection as this species was recently reported in other parts of the country, and we conducted entomological surveys to identify its putative vector, which has not been investigated in earlier studies. Our main goal was to examine the potential risk of transmission of *P. vivax* and to determine which local malaria vector species could be implicated in its transmission in this region of Cameroon.

## Methods

### Study area

The study was conducted in the town of Tibati (6°27'57"N; 12°37'30"E), which is the capital of Djerem department in the Adamawa region of Cameroon. The population of Tibati is estimated to be 108,502 persons. The town is characterized by a predominantly wet tropical climate with two seasons, a dry season extending from November to February and a rainy season from March to October during which the intensity of transmission is high. The annual rainfall ranges from 1192 to 2023 mm, and the average annual temperature is around 23.6 °C. There is a dense hydrographic network of several rivers, such as the Djerem, Meng and Tomi rivers, in the area around Tibati [46].

The parasitological and entomological surveys were carried out from June to July 2015 and during the same period in 2017, to coincide with the rainy season during which transmission is highest. Blood samples were collected from clinical patients (symptomatic) with fever or a history of fever in 2015 and from asymptomatic individuals in the community in 2017. Patients with clinical malaria were recruited among patients in three randomly selected health facilities: the Missionary Hospital of Ngaoubela, the District Medical Center and the Integrated Medical Center located at around 7 km, 600 m and 100 m from the city center, respectively. The minimal estimated sample size of 346 participants was determined by the formula  $n = T^2 \times P(1 - P)/M^2$ , where  $n$  = sample size;  $T$  = confidence level at 95% (with value at 1.96);  $P$  = malaria prevalence in the Adamawa region (34.2%) according to the Programme National de Lutte contre le Paludisme 2019 [8]; and  $M$  = margin of error at 5% (0.05). Blood from asymptomatic carriers was collected from individuals living in randomly selected houses in the community, from eight neighborhoods within the Tibati city perimeter (Malarba, Meng, Ngaoubela, Sabongari, Tella, Wourtababa, Tomi and Yoko) (Fig. 1). Mosquito collection was performed by spraying resting female mosquitoes in randomly selected human dwellings and in houses where blood from asymptomatic

carriers was collected, with IRS with pyrethrum in 2015 and 2017, respectively.

### Blood and mosquito sampling

Blood was collected from volunteers of all ages independently of gender and ethnicity. Adults ( $\geq 18$  years old) or legal guardians were asked to provide written informed consent for underaged volunteers ( $< 18$  years old). Blood was obtained by fingerprick in volumes of 5 and 100  $\mu$ l for thick smears and dried blood spots on Whatman™ grade 1 and FTA paper (GE healthcare UK Ltd., Amersham, UK), respectively. Thick blood smears were stained with 10% Giemsa for 20 min [19] and examined under a light microscope (Leica model DM750; Leica Microsystems GmbH, Wetzlar, Germany) at 100 $\times$  magnification, oil immersion, for the detection of asexual and sexual stages of the malaria parasite. Parasitemia was estimated by counting the number of parasites against 500 white blood cells (WBCs), assuming the standard number of 8000 WBC/ $\mu$ l of blood [47]. Blood spots were dried, stored at room temperature in a desiccant container and brought to the Malaria Research Unit for further analysis. *Plasmodium*-positive patients were treated with an ACT according to the recommendations of the Ministry of Health of Cameroon (National Malaria Control Program [NMCP]).

Mosquito collections were carried out in the morning from 6:00 to 10:00 a.m., and written informed consent was obtained from household owners prior to the start of collection. A white sheet was used to cover the floor and all flat surfaces, and the pyrethrum residual (composition: permethrin, 0.25%; piperonyl butoxide, 0.34%; tethramethrin, 0.20%; D-phenothrin, 0.01%) was sprayed into all the corners of the house. After 15 min, mosquitoes that had fallen onto the sheet were collected, counted and identified at the genus or species level. *Anopheles* mosquitoes were identified using morphological identification keys [48, 49]. All female *Anopheles* specimens were dissected individually, and the carcasses and head-thoraces were stored separately in tubes containing a desiccant, archived and kept at  $-20$  °C for further molecular analysis.

### Blood and mosquito DNA extraction

DNA was isolated from blood spots collected in 2015 using the protocol provided by the manufacturer (Schleicher-Schuell BioScience GmbH, Dassel, Germany) [50]. Briefly, three 5-mm discs of a dried blood spot were cut out using a sterile paper punch and transferred to a 1.5-ml sample tube filled with 500  $\mu$ l of sterile water. The tubes were vortexed three times for at least 5 s each time and centrifuged at 2000 rpm for few seconds. Using sterile forceps, the paper discs were transferred into a

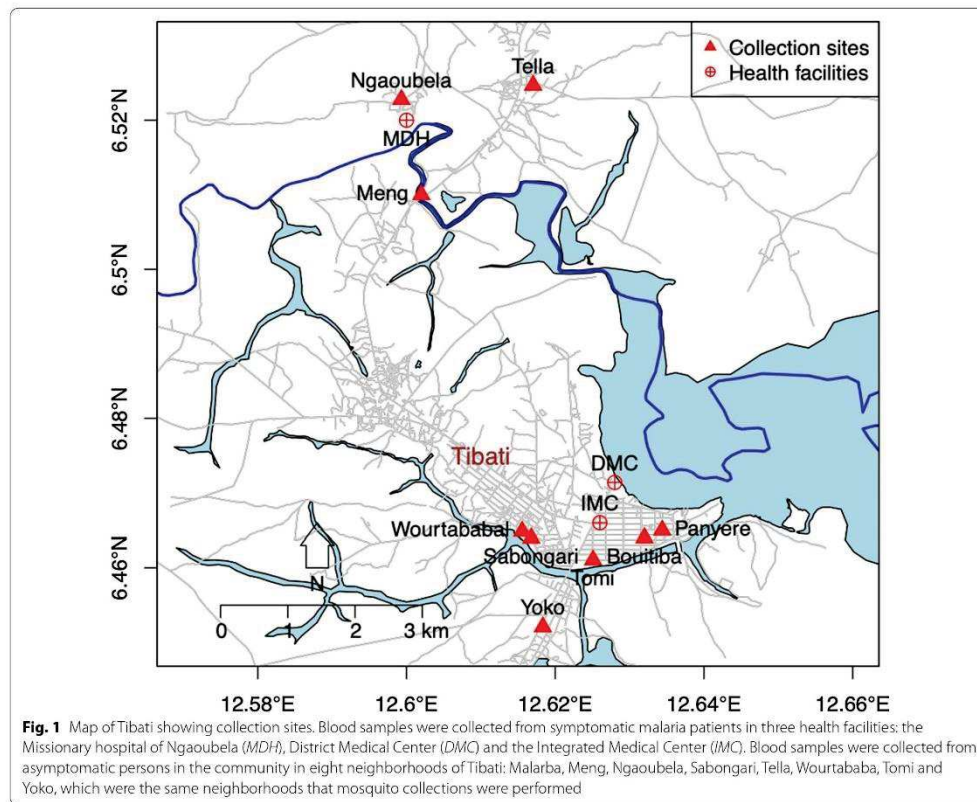

0.5-ml tube containing 120  $\mu$ l sterile water and incubated at 95  $^{\circ}$ C in a heat block for 15 min (Gene Amp<sup>®</sup>; Applied Biosystems, Foster City, CA, USA). After incubation, the tubes were centrifuged for few seconds, following which the spots were removed, and the extracted DNA was stored at  $-20^{\circ}$  C for molecular diagnosis.

To optimize the DNA extraction and allow for a better separation of DNA from some nucleases, we used the Qiagen DNeasy<sup>®</sup> Blood and Tissue Kit (Hilden, Germany) to isolate DNA from the blood samples collected in 2017, in accordance with the manufacturer's instructions, and resuspended the isolated DNA in 60  $\mu$ l elution buffer.

Genomic DNA from individual mosquito carcasses was isolated using the 2% cetyltrimethyl ammonium bromide (CTAB) method, following the protocol of Collins et al. [51]. DNA from the head-thoraces was isolated using the Qiagen DNeasy<sup>®</sup> Blood and Tissue Kit according to the

manufacturer's instructions, and resuspended in 50  $\mu$ l elution buffer.

#### Molecular identification of *Plasmodium* and *Anopheles* species

The *Plasmodium* infection status of blood collected in 2015 was determined by a multiplex PCR [52], which targets the 18S small subunit ribosomal RNA. Reaction mixtures were prepared with 5  $\mu$ l of eluted DNA and the Taq Hot Start Master mix (Qiagen), following the manufacturer's instructions, and samples were amplified as previously described [52]. The amplified products were visualized by electrophoresis in a 2% agarose gel and stained with SYBR dye (Green Nucleic Acid stain; Biotium, Hayward, CA, USA). The expected amplicon size was 276 bp for *P. falciparum*, 300 bp for *P. vivax*, 375 bp for *P. ovale* and 412 bp for *P. malariae*.

Genomic DNA from mosquito carcasses was used to identify members of the *Anopheles gambiae* complex by



PCR–restriction fragment length polymorphism (RFLP) [53] and members of *Anopheles funestus* group were identified according to the protocol of Koekemoer et al. [54]. All PCR products were analyzed in a 2% agarose gel.

A simple quantitative PCR (qPCR) was performed to identify *Plasmodium*-infected mosquitoes, as previously described [55]. Selected genes were amplified in order to discriminate between *Plasmodium* species, including the aqaglyceroporin gene (AQP, AJ413249.1) for *P. falciparum*, the enoyl-acyl carrier protein reductase gene (ECPR, AY423071.1) specific for *P. vivax*, the P25 ookinete surface protein gene (Pos25, AB074976.1) for *P. ovale* and the circumsporozoite gene (CS, S69014) targeting *P. malariae* [56]. Reaction mixtures were performed with 1 µl of template DNA in a final volume of 10 µl with EvaGreen® (5× HOT Pol EvaGreen® RT PCR Mix Plus; Euromodex, Souffelweyersheim, France) and amplified in a 7300 Real-time PCR system (Applied Biosystems). A dissociation curve was used to estimate the specific melting temperature for each reaction.

For the samples from 2017, *An. gambiae* complex and the members of *An. funestus* group were identified as described above. Detection of *Plasmodium* in blood spots and mosquito head-thoraces for these samples was achieved by multiplex qPCR in the Lightcycler 96 real-time PCR system, according to the protocol published by Mangold et al. [57], with slight modifications. The final volume of the reaction mixture was 10 µl, containing 2 µl of template DNA. The PCR conditions consisted of an initial preincubation step at 95 °C for 10 min; followed a three-step amplification of 95 °C/10 s (ramp 4.4 °C/s), 50 °C/5 s (2.2 °C/s) and 72 °C/20 s (4.4 °C/s), for 45 cycles. Amplification was directly followed by a melting program of 95 °C/120 s (2.2 °C/s), 68 °C/120 s (2.2 °C/s) and 90 °C/1 s (ramp 0.2 °C/s with 15 readings/°C), and a stepwise temperature increase of 0.03 °C/s until 95 °C. The 18S rRNA gene of the *P. falciparum* 3D7 clone was used as positive control for *Plasmodium* species differentiation.

#### Sequencing

The qPCR products of *Plasmodium*-positive mosquitoes were sequenced using the Big Dye Terminator v3.1 Sequencing Kit (Applied Biosystems) and run on an Applied Biosystems 3130xl Sequencer at the GenSeq technical facility of the Institut des Sciences de l'Evolution de Montpellier. Sequences were verified using SeqScape software (Applied Biosystems).

#### Statistical analysis

Data were stored in Microsoft Office Excel files (Microsoft Corp., Redmond, WA, USA) and transferred into GraphPad Prism 7 (GraphPad Software Inc., San Diego,

CA, USA) for statistical analyses. The Mann–Whitney test was used to compare mean parasite densities according to clinical status, for both trophozoites and gametocytes. The Chi-square test was used to compare the prevalence of *Plasmodium* infections among population age groups and mosquito species. The non-parametric Kruskal–Wallis test was used to assess differences in parasite densities between age groups. The significance threshold was set at  $\alpha=0.05$ . The relative risk (RR) was computed to estimate the protection associated with LLIN use. R software version 3.5.3 with *maptools* and *ggplot2* packages was used to generate the map and figures, respectively (R Foundation for Statistical Computing, Vienna, Austria), while melting temperatures of qPCR-positive controls were retrieved by using functional bases (without package).

## Result

### Characteristics and prevalence of malaria infections in the studied population

A total of 1367 participants were enrolled in this study, 418 through the health centers (symptomatics) and 949 at the community level (asymptomatics). The main characteristics of the participants are detailed in Table 1.

The median age of participants was 12 years (range 21 days to 85 years). The sex ratio (male/female) was 0.7 (558/809). Mean parasite densities were significantly higher in symptomatic patients from the health centers than in asymptomatic individuals recruited in the community, for both sexual ( $6199 \pm 2626$  vs  $38.75 \pm 7.85$ , Mann–Whitney  $U=1992$ ;  $P<0.0001$ ) and asexual stages ( $34,164 \pm 5332$  vs  $5964 \pm 867.8$ ; Mann–Whitney  $U=22,168$ ;  $P<0.0001$ ). The mean asexual parasite densities significantly decreased with age in blood samples from both symptomatic and asymptomatic participants (Kruskal–Wallis test,  $P<0.001$ ; Fig. 2).

Of the 1367 samples, malaria diagnostic tools revealed 752 (55.01%) infections with *Plasmodium*. The infection rate was 41.8% (175/418) in samples from symptomatic patients and 60.8% (577/949) in samples from asymptomatic individuals, which is significantly different ( $X^2=41.21$ ;  $P<0.0001$ ). *Plasmodium falciparum* was the most prevalent *Plasmodium* species collected during both collection periods and represented 98.8 and 92.9% of human infections in 2015 and 2017, respectively. *Plasmodium malariae* and *P. ovale* each accounted for 0.6% of clinical infections. In comparison, in samples from asymptomatic persons a higher prevalence was recorded for *P. malariae* (22.9%) while *P. ovale* was rare (0.9%). Mixed infections were only found in asymptomatic carriers and were mostly represented by *P. falciparum*–*P. malariae* (92/96, 95.8%). No *P. vivax* infection was detected in any blood sample.

**Table 1** Characteristics of the study population and infection parameters

Parameters	2015	2017
	Health centers (symptomatics)	Community (asymptomatics)
Sample size	418	949
Median age, years (IQR)	15 (3–30)	12 (6–23)
Infections per age group, n (%):		
< 5 years	83 (58.5)	110 (62.1)
5–15 years	40 (58.8)	310 (71.4)
> 15 years	52 (25)	157 (46.4)
Total number persons infected	175 (41.8)	577 (60.8)
<i>Plasmodium</i> infections, n (%)		
<i>P. falciparum</i>	173 (98.8)	441 (76.4)
<i>P. malariae</i>	1 (0.6)	39 (6.8)
<i>P. ovale</i>	1 (0.6)	1 (0.2)
Co-infections	0	96 (16.6)
Mean trophozoite density (/μl) (SD)	34,164 (63,541)	5964 (18,429)
Mean gametocyte density (/μl) (SD)	6199 (18,956)	38.75 (97.2)

IQR interquartile, SD standard deviation

Malaria prevalence decreased with age in both asymptomatic individuals and symptomatic patients, and individuals older than 15 years were less infected ( $\chi^2=48.39$  and  $\chi^2=49.91$  respectively;  $P<0.001$ ). Gametocyte

carriage was significantly higher in asymptomatic individuals than in symptomatic patients (16.2 vs 10.7%,  $\chi^2=6.96$ ,  $P=0.008$ ). Heterogeneity in malaria infection was observed between neighborhoods, with infection rates varying from 48.2 to 71.2% in Sabongari and Ngaoubela, respectively ( $P=0.011$ ; Table 2). A total of 53% (503/949) of asymptomatic carriers reported using LLINs and the coverage of LLINs varied from 21.1% in Yoko to 88% in Meng (Table 2). LLIN use based on self-report only conferred slight protection: malaria infection among LLIN users was only 7% less than that among non-users (non-significant difference; RR=0.89, 95% confidence interval [CI] 0.58–0.98); however, the difference varied with collection site, with up to 20% protection found in Malarba.

**Mosquito species composition**

A total of 592 *Anopheles* were collected during both study periods. According to morphological criteria, the two species complexes identified were *An. gambiae* (s.l.) and *An. funestus* (s.l.). Molecular identification of specimens of *An. gambiae* sibling species showed that this fauna was composed of two species: *An. gambiae* (212; 35.8%) and *An. coluzzii* (172; 29.1%). *Anopheles funestus* (s.s.) was the only species identified within the *An. funestus* group and represented 35.1% (208/592) of anopheline mosquitoes. The distribution of the three species according to the two

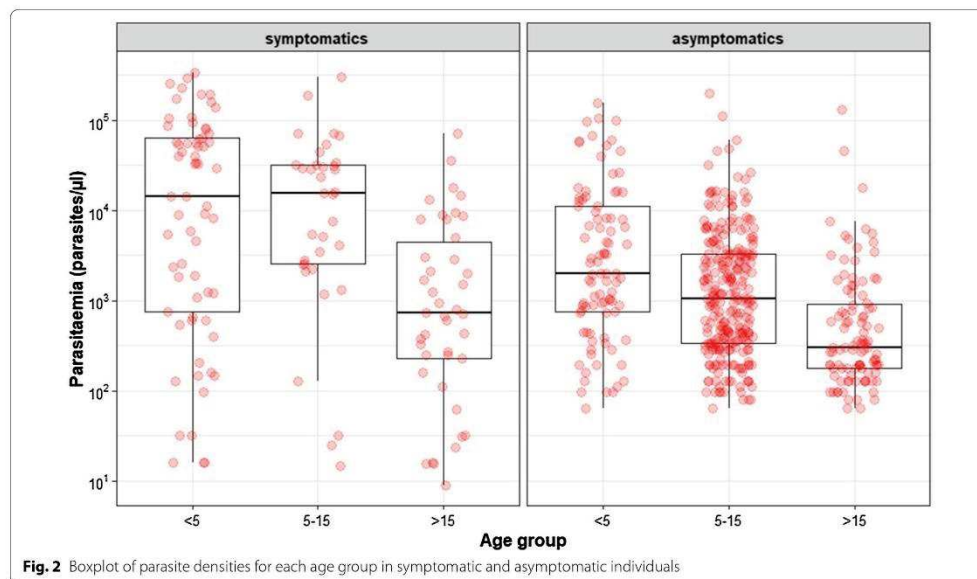

**Fig. 2** Boxplot of parasite densities for each age group in symptomatic and asymptomatic individuals

collection periods is shown in Fig. 3. No hybrid between *An. coluzzii* and *An. gambiae* mosquitoes was detected.

**Vector infection rates**

Head-thoraces of the 592 *Anopheles* were subjected to qPCR to detect infected mosquitoes. The results were obtained according to the melting temperature value given by an optical reading of the corresponding melting curve. In total, 26 (4.39%) *Anopheles* mosquitoes were infected by a *Plasmodium* sp., of which 24 could be clearly identified according to melting temperature. However, the remaining two samples (YK60 and NG239) gave a bimodal curve and were assigned as putative co-infection. YK60 was suspected to be *P. malariae*/*P. ovale* co-infection, with the main peak assigned to *P. malariae* and the minority peak to *P. ovale* (Fig. 4a). Further sequencing analysis identified the YK60 sample as a *P. malariae* mono-infection. For the NG239 sample (Fig. 4b), the melting temperature of the minority peak was assigned to *P. falciparum*, while the main peak did not match any *Plasmodium* sp. according to Mangold et al. [57]. The sequencing analysis revealed that the NG239 sample was a *P. falciparum* mono-infection.

The overall infection rate varied from 4.07 to 4.72% between mosquito species, and no significant difference was observed between species ( $\chi^2=0.046$ ,  $P=0.97$ ; Table 3). The infection rate did not differ between the two collection periods ( $\chi^2=3.049$ ,  $P=0.08$ ). Variation in mosquito infection rate was observed between neighborhoods in 2017, with Yoko (5/9) recording the highest number of infected mosquitoes (Table 3).

All *Plasmodium*-positive specimens were mono-infected, either with *P. falciparum* (61.5%), *P. malariae* (19.2%) or *P. ovale* (15.4%). A single sample was found by qPCR to be positive for *An. coluzzii* with *P. vivax*.

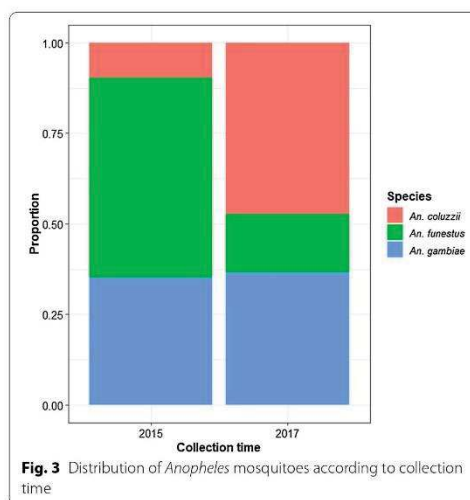

**Fig. 3** Distribution of *Anopheles* mosquitoes according to collection time

All *Plasmodium*-positive mosquitoes were processed for sequencing, and the sequence alignment of the *P. vivax* infection is presented in Fig. 5.

**Discussion**

This study was performed to assess epidemiological and entomological parameters of malaria in Tibati, a locality situated in the Adamawa region of Cameroon. At the present time, little data exist on malaria in this area.

The incidence of malaria is known to vary according to epidemiological settings, age and clinical status of the study population and season, as well as with treatment guidelines and control interventions. Malaria

**Table 2** Malaria prevalence, long-lasting insecticidal net usage and infection rate of mosquitoes according to neighborhoods in 2017

Neighborhoods	Blood samples		LLIN usage		Mosquitoes	
	N	IR (%)	Use	Frequency (%)	N	IR (%)
Malarba	150	66.0	46	30.7	40	2.5
Meng	183	61.2	161	88.0	63	1.6
Ngaoubela	111	71.2	77	69.4	78	1.3
Sabongari	83	48.2	48	57.8	3	0
Tella	100	57.0	39	39.0	0	0
Tomi	107	65.4	45	42.1	24	4.2
Wourtabbal	66	53.0	56	84.8	0	0
Yoko	147	57.1	31	21.1	96	5.2
Total	947	60.8	503	53.0	304	2.9

IR *Plasmodium* infection rate, LLIN long-lasting insecticidal nets, N number of samples collected



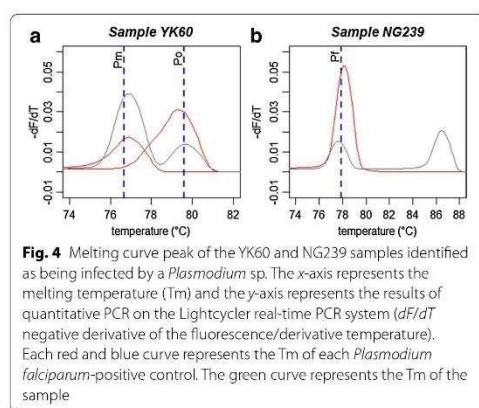

prevalence in our study area varied from 42% in symptomatic patients to 61% in asymptomatic individuals in the community. This prevalence value is 15-fold higher than that reported by Songue et al. [25] in Meidoungou, a village located within the same Adamawa region, where the authors reported a 3.6% infection rate based on microscopy studies of symptomless children aged < 10 years [25]. Other studies in Bolifamba, an area with a similar epidemiological setting, have identified an infection rate of > 50% by microscopy [58]. Malaria prevalence in studies in which malaria infections were diagnosed using PCR methodology also show large variations, with Fru-Cho et al. [28] reporting a malaria prevalence of 32% among asymptomatic carriers in the village of Bolifamba, and Russo et al. [29] reporting a 14% prevalence among febrile outpatients in Dschang, an altitudinal city in the West region. Although microscopy remains the “gold standard” tool for diagnosing malaria in the field, this approach has certain limitations, including inaccurate quality assurance and misdiagnosis of low parasitemia as the detection threshold by microscopy is about 50

parasites/ $\mu$ l. PCR-based methods are more sensitive and specific than the microscopic examination of thick blood smears, particularly in cases of low-density or mixed parasite infections that are frequent in asymptomatic carriers [59, 60]. Accordingly, 9% of the negative blood smears by microscopic examination were found to be positive upon molecular analysis in our study.

Almost half (42%) of the patients who went to the health care centers for consultation/treatment were diagnosed with malaria infection. Malaria remains the primary cause of fever in febrile patients, but other infections, such as Dengue, Chikungunya or Zika, likely also circulate in the area. Indeed, clinical symptoms of malaria are non-specific, and inter-epidemic arboviral infections are regularly reported in central Africa [61–64]. Accurate diagnosis of *Plasmodium* is therefore crucial for providing appropriate treatment regimens to patients. Determining the burden of malaria is also important for applying effective malaria control strategies in endemic settings and for determining their efficacy. In Cameroon, a nation-wide mass distribution campaign of LLINs took place in 2011, 2015 and 2019, and the NMCP reports a LLIN coverage of > 80% [65]. In our study, 53% (503/949) of asymptomatic individuals reported owning a bed net, but of these, 57.5% (289/503) were infected with malaria. It has been reported earlier that bed net coverage is not associated with asymptomatic *P. falciparum* prevalence [66]. It must also be considered that bed net coverage may be less than that acknowledged by the volunteers in our study. Barriers to mosquito net use have been described in previous studies, and a larger sensitization of households would be necessary to prevent the continuous spread of malaria [67, 68].

Asymptomatic infections represent the major reservoir of parasites [69]. In our study, we identified asymptomatic infection in 60.8% of blood samples collected from individuals at the community level, which indicates that malaria transmission is high in the area. Asymptomatic infections are associated with parasite exposure

**Table 3** Number of mosquitoes collected and of *Plasmodium*-positive mosquitoes according to quantitative PCR

<i>Anopheles</i> spp.	June 2015							July 2017					Total			
	Mosquitoes			<i>Plasmodium</i> sp.				Mosquitoes			<i>Plasmodium</i> sp.		N	N+	%	
	N	N+	%	Pf	Pm	Po	Pv	N	N+	(%)	Pf	Pm				Po
<i>An. gambiae</i>	101	7	6.93	4	3	0	0	111	3	(2.7)	2	0	1	212	10	4.72
<i>An. coluzzii</i>	28	2	7.14	1	0	0	1	144	5	(3.47)	2	1	2	172	7	4.07
<i>An. funestus</i> (s.s.)	159	8	5.03	6	1	1	0	49	1	(2.04)	1	0	0	208	9	4.33
Total	288	17	5.9	11	4	1	1	304	9	(2.96)	5	1	3	592	26	4.39

N Number of collected mosquitoes, N+ number of *Plasmodium*-positive mosquitoes, % percentage of infected mosquitoes, Pf *Plasmodium falciparum*, Pm *Plasmodium malariae*, Po *Plasmodium ovale*, Pv *Plasmodium vivax*



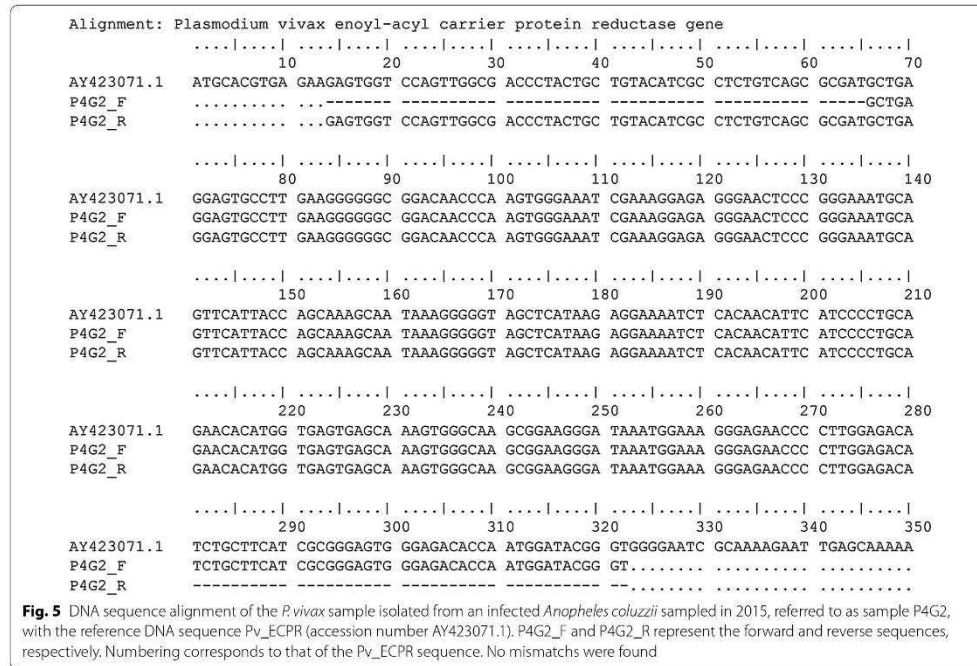

and decrease with age as prolonged exposure to malaria leads to the development of partial immunity to the disease [69, 70]. We noted that asymptomatic carriage was higher in the age group 5–15 years, which is in line with the development of acquired immunity in the older children. The lower prevalence of asymptomatic infections among individuals aged > 15 years likely represents the increased ability of older individuals to control parasite growth due to stronger anti-parasite immunity. However, some infections in this age group were certainly missed because asymptomatic infections are often low-density infections and undetectable through microscopy examination and even PCR testing [66, 69, 71]. Accordingly, parasite densities decreased with age in asymptomatic individuals. In symptomatic patients, lower parasite loads were found in the older age group (> 15 years), but densities were similar in children aged < 5 years and those aged 5–15 years, indicating that the parasite threshold to develop malaria symptoms is lower in older individuals, as previously observed [72]. Parasite burden contributes to the pathogenesis of the disease, and pyrogenic thresholds of parasitemia are often used to correlate fever with malaria, with thresholds varying with transmission intensity and age [73, 74]. Spatial heterogeneity in malaria

infections was observed in our study, with Yoko presenting the highest malaria prevalence. This finding suggests hotspots of transmission in our study area. Multiple factors can explain this heterogeneity, such as proximity to breeding sites, urbanization or housing characteristics [75–77]. It is tempting to state that such high transmission clusters should be the focus of targeted control, but past interventions targeting hotspots of transmission failed to influence malaria transmission dynamics [78].

In this study, we identified three *Plasmodium* species in human blood samples, among which *P. falciparum* was the most predominant vector species, accounting for over 95% of malaria infections. These data are consistent with previous reports in other epidemiological settings, indicating that *P. falciparum* predominates across Cameroon [29, 79, 80]. *Plasmodium malariae* and *P. ovale* were found as mono- and co-infections with *P. falciparum*, but at low prevalence and these species were rarely found in symptomatic individuals. In the present study, no *P. vivax* infection was detected either in symptomatic or asymptomatic samples. Circulation of *P. vivax* in Cameroon has been recorded since 2014 in different epidemiological settings, even though previous reports documented *P. vivax* infections only in travellers returning

from Cameroon [81, 82]. In previous reports, *P. vivax* infections in Cameroon were mostly identified at low frequencies, representing < 15% (13/269) of malaria infections in Bolifamba, southwest region [28], 6% (27/484) in Dschang, west Cameroon [29] and 4% (8/201) in five forested south parts of the country [27]. The latest study reported 23% (10/43) of *P. vivax* infections among symptomatic patients seeking medical attention at the New Bell district hospital in Douala, Littoral region [30]. Our failure to detect *P. vivax* in the present study suggests that the parasite circulates at very low frequency; as such, larger samples would be necessary to confirm this species in the area. The prevalence of *P. vivax* in Africa differs between epidemiological settings, and it has been suggested that *P. vivax* is more prevalent in areas with lower malaria burden [83].

We performed entomological surveys to identify mosquito vectors responsible for malaria transmission in Tibati. To date, six main vector species, namely *An. gambiae*, *An. coluzzii*, *An. funestus*, *An. arabiensis*, *An. nili* and *An. moucheti moucheti*, have a recognized role in *Plasmodium* transmission in Cameroon [2, 6, 84]. In the present study, three of these species were identified: *An. funestus*, *An. gambiae* and *An. coluzzii*. These data are consistent with previous reports that indicated a large distribution of these three main vectors across the country [6, 15, 85–89]. *Anopheles funestus* was more prevalent in 2015 than in 2017 (55.2 vs 16%, respectively), and the change in the density of this species is likely due to modifications of environmental cues, such as the presence of permanent breeding sites (e.g. lakes and rivers with emergent vegetation) that are favorable for the proliferation of this mosquito species [49, 90]. This observed decrease in the density of *An. funestus* mosquitoes benefited *An. coluzzii*, which represented 9.7% of collected anophelines in 2015 and 47.4% in 2017. The presence of *An. gambiae* was stable over the two collection periods. The study area is irrigated by the Meng river and is characterized by the presence of agricultural and fish farming sites that create temporary sites which are favorable for the development of *An. gambiae* (s.l.), including *An. gambiae* and *An. coluzzii* [91, 92]. *Anopheles coluzzii* has a known high capacity of adaptation in urban environments [93–95], and modifications to the habitat in Tibati (e.g. deforestation, house construction, home improvement) that occurred during the 2 years between the studies have probably contributed to the creation of breeding sites more suitable for *An. coluzzii*. Nevertheless, the use of the IRS method, which is a widely used method for sampling endophilic mosquitoes, could have favored the collection of endophilic resting *Anopheles* over other mosquito species.

We found that *Plasmodium* infection rates did not differ between *An. gambiae*, *An. coluzzii* and *An. funestus*, and thus these three species are considered to transmit malaria at equal efficiency. Sporozoite infection rates fell within the range reported in a previous study conducted in the Adamawa region [87] and in other studies conducted in different parts of the country [2, 84]. A slight decrease in the overall infection rate was observed between 2015 and 2017 (5.9 vs 4.39%;  $\chi^2=2.791$ ,  $P=0.0948$ ); this reduction, although not significant, could be due to the use of LLINs following the massive country-wide distribution campaign in 2015 [96]. The percentage of infected mosquitoes sampled in 2017 varied between neighborhoods, with the highest infection rate recorded in Yoko (5.2%), which could be explained by a high malaria prevalence and the lower LLIN coverage (21.1%) in this neighborhood.

All three mosquito species were mono-infected with *P. falciparum*, *P. ovale*, *P. malariae* and *P. vivax*. A single *An. coluzzii* mosquito was carrying *P. vivax* and the fact that only one mosquito was infected by *P. vivax* confirms the low circulation of this species in our study area. Further longitudinal studies or more in-depth sampling would increase the probability to detect *P. vivax* infections in both human and mosquito populations, but it remains that this one mosquito represents the first report of *Anopheles* infection by *P. vivax* in Cameroon. Transmission of *P. vivax* by anopheline mosquitoes has already been reported in sub-Saharan Africa, but never by *An. coluzzii*. Mosquito infections with *P. vivax* have been reported for *An. arabiensis* in Mauritania [97], Madagascar [98, 99] and Ethiopia [100], for *An. funestus* in Madagascar [98, 101], Kenya [102] and for *An. gambiae* in Kenya [102]. Also, a study conducted in Angola [41] and Equatorial Guinea identified *P. vivax* infections in mosquitoes, but identification of the vector species was not recorded [41]. Interestingly, in this latter study, the authors reported a significantly higher prevalence of *P. vivax* infection in mosquitoes (10.99%) as compared to human population (4.55%) [41]. The *P. vivax*-infected mosquito we identified was an *An. coluzzii* specimen, a species that has shown greater susceptibility to malaria infection in a study from Cameroon [55]. *Plasmodium vivax* can then be considered to circulate in the study area and may also be underestimated, as a proportion of *P. vivax* infections in humans are “hidden” since hypozoites lie dormant in the liver for several months (or years) where they are undetected.

A limitation to this study is that mosquito samples were obtained at a single collection time and, therefore, the results only provide a one-shot picture of malaria transmission in the study site. Longitudinal surveys would be necessary to follow the dynamics of malaria transmission



and, particularly, will be crucial to perform parasitological and entomological surveys before and after the implementation of control interventions, such as LLIN distribution. A second limitation is that sample sizes were small, which is possibly the reason we did not detect *P. vivax* infection in the human population. Regular monitoring of malaria infections will be necessary to assess the true circulation of *P. vivax* in the area; we cannot exclude the possibility that the *P. vivax*-positive mosquito got infected while feeding on a non-resident as Tibati is a cross-border city with a high circulation of people.

### Conclusion

We have provided a picture of the epidemiological and entomological malaria situation in Tibati, a small town in the Adamawa region of Cameroon. Malaria prevalence varied from 42% in symptomatic patients to 61% in asymptomatic individuals, and this finding highlights the high malaria endemicity in the area. Three major vectors, namely *An. funestus*, *An. gambiae* and *An. coluzzii*, were responsible for the transmission of the disease, with all three species contributing equally to *Plasmodium* transmission. Parasitological indices suggest low bednet usage and that the implementation of control interventions in the area is needed to reduce the malaria burden. We identified hotspots of disease transmission, and these sites should be the target of malaria control efforts. In addition, the presence of *P. vivax* in an *An. coluzzii* mosquito prompts for regular monitoring as the spread of this species could introduce further complexity into malaria epidemiology and control measures in this area.

### Abbreviations

CIAB: Cetyltrimethyl ammonium bromide ; IRS: Insecticide residual spraying; LLINs: Long-lasting insecticidal nets; MINSANTE: Ministère de la Santé; PCR-RFLP: PCR-restriction fragment length polymorphism; rRNA: Ribosomal ribonucleic acid .

### Acknowledgements

We are grateful to all the residents of Tibati who agreed to participate in this study and gave permission to enter their houses for mosquito collection. Our appreciation is also extended to Estelle Essangui and Balotin Fongang for their support and cooperation during data analysis. Our sincere thanks go to Rhoel Dinglasan for his contribution in reviewing the article.

### Authors' contributions

SEN and IM conceived and designed the study protocol. Lbfd, EMSM, LMA, AGBT, ANB, CMN, JCT, MMS and SEN carried out the field and laboratory assays. Lbfd, EMSM, LMA, IM and SEN analyzed, interpreted data and wrote the paper. CEEM, LA and PAA critically reviewed the manuscript. All authors read and approved the final manuscript.

### Funding

This work was carried out as part of an AUF-IRD research project granted to SEN. This research was supported by the French National Research Institute for Sustainable Development (IRD) through the JEAI-IMPALA project granted to SEN. Lbfd and EMSM were supported by a doctoral fellowship from the LabEx ParaFrap.

### Availability of data and materials

All data generated or analyzed during the current study are included in this published article.

### Declarations

#### Ethics approval and consent to participate

Our study was approved by the Cameroon National Ethics Committee (N°2015/04/579/CE/NERSH) and by the Delegate of Public Health from Adamaoua region (N°029/L/RA/DSP/SAGE/BPF/NGD/15;735/L/RA/DSP/SAGE/BPF/NGD/17) and the Health Director of the Evangelical Lutheran Church (N°004/EELC/OSEELC/SRH/15). All human volunteers were enrolled after providing written informed consent, either by the participants and/or by their legal guardians. Written informed consent were also provided by household owners prior to mosquito collection. Free malaria treatments with ACT were given to all *Plasmodium*-infected patients as recommended by the Ministry of Health (NMCP).

#### Consent for publication

Not applicable.

#### Competing interests

The authors declare that they have no competing interests.

#### Author details

<sup>1</sup>Service de Paludisme du Centre Pasteur Cameroun, BP 1274, Yaounde, Cameroon. <sup>2</sup>CNRS UPR 9022, Inserm U 963, Université de Strasbourg, 2, allée Konrad Roentgen, 67084 Strasbourg Cedex, France. <sup>3</sup>UMR MIVEGEC, IRD, CNRS, Université de Montpellier, Institut de Recherche pour le Développement, 911 avenue Agropolis, 34394 Montpellier, France. <sup>4</sup>Université Catholique d'Afrique Centrale, Yaoundé-Campus Messa, BP 1110, Yaounde, Cameroon. <sup>5</sup>Laboratoire de Recherche sur le Paludisme, Organisation de Coordination pour la lutte contre les Endémies en Afrique Centrale, BP 288, Yaounde, Cameroon. <sup>6</sup>Department of Medical Entomology, Centre for Research in Infectious Diseases, Yaounde 13591, Cameroon. <sup>7</sup>Department of Microbiology and Infectious Diseases, School of Veterinary Medicine and Sciences, University of Ngaoundere, PO Box 454, Ngaoundere, Cameroon. <sup>8</sup>Faculté de Médecine et des Sciences Pharmaceutiques de l'Université de Douala (FMSP-UD), BP 2701 Douala, Cameroon.

Received: 10 March 2021 Accepted: 23 April 2021

Published online: 08 May 2021

### References

- World Health Organization. World malaria report. Geneva: World Health Organization; 2020. <https://www.who.int/publications/i/item/9789240015791>. Accessed 03 May 2021.
- Antonio-Nkondjio C, Simard FDR, Awono-Ambene P, Chouabou M, Tchinkam TO, Fontenille D. Complexity of the malaria vectorial system in Cameroon: contribution of secondary vectors to malaria transmission. *J Med Entomol*. 2006;43:7.
- Wanji S, Tanke T, Atanga SN, Ajonina C, Nicholas T, Fontenille D. Anopheles species of the Mount Cameroon region: biting habits, feeding behaviour and entomological inoculation rates. *Trop Med Int Health*. 2003;8:643–9.
- Hervy JF, Goff G, Geoffroy B, Herve JP, Manga L, Brunhes J. Les Anophèles de la région afrotropicale. CD-ROM. Paris: ORSTOM;1998.<http://www.documentation.ird.fr/hor/fdi:010014161>. Accessed 03 May 2021.
- Fontenille D, Cohuet A, Awono-Ambene PH, Antonio-Nkondjio C, Wondji C, Kengne P, et al. Systematique et biologie des Anopheles vecteurs de Plasmodium en Afrique Données récentes. *Med Trop*. 2003;7:247–53.
- Fontenille D, Simard F. Unravelling complexities in human malaria transmission dynamics in Africa through a comprehensive knowledge of vector populations. *Comp Immunol Microbiol Infect Dis*. 2004;27:357–75.

7. Ministère de la Santé publique du Cameroun. Plan stratégique national de lutte contre le paludisme . 2011. <http://www.santetropicale.com/rapports.asp?action=lire&id=983&specialite=>. Accessed 02 May 2021.
8. PNLPL Rapport annuel du Programme de Lutte contre le Paludisme. Yaoundé Cameroun. 2020. <http://onsp.minsante.cm/fr/publication/230/rapportannuel-2019-lutte-contre-le-paludisme>. Accessed 04 May 2021.
9. Etang J, Fondjo E, Chandre F, Morlais I, Brengues C, Nwane P, et al. Short report: first report of knockdown mutation in the malaria vector *Anopheles gambiae* from Cameroon. *Am J Trop Med Hyg*. 2006;3:795–7.
10. Etang J, Mbida Mbida A, Ntonga Akono P, Binyang J, Eboumbou Moukoko CE, Lehman LG, et al. *Anopheles coluzzii* larval habitat and insecticide resistance in the island area of Manoka. *Cameroon BMC Infect Dis*. 2016;16:217.
11. Nwane P, Etang J, Chouabou M, Toto JC, Koffi A, Mimpfoundi R, et al. Multiple insecticide resistance mechanisms in *Anopheles gambiae s.l.* populations from Cameroon, Central Africa. *Parasites Vectors*. 2013;6:41.
12. Menze BD, Riveron JM, Ibrahim SS, Irving H, Antonio-Nkondjio C, Awono-Ambene PH, et al. Multiple insecticide resistance in the malaria vector *Anopheles funestus* from Northern Cameroon is mediated by metabolic resistance alongside potential target site insensitivity mutations. *PLoS ONE*. 2016;11:e0163261.
13. Ndjema HNM, Patchok A S, Atangana J, Etang J. The distribution of insecticide resistance in *Anopheles gambiae s.l.* populations from Cameroon: an update. *BMC Public Health*. 2009;12:1.
14. Ekoko WE, Awono-Ambene P, Bigoga J, Mandeng S, Piameu M, Nvondo N, et al. Patterns of anopheline feeding/resting behaviour and *Plasmodium falciparum* infections in North Cameroon, 2011–2014: implications for malaria control. *Parasites Vectors*. 2019;12:297.
15. Bamou R, Sonhaïouo-Chiana N, Mavridis K, Tchuinkam T, Wondji CS, Vontas J, et al. Status of insecticide resistance and its mechanisms in *Anopheles gambiae* and *Anopheles coluzzii* populations from forest settings in South Cameroon. *Genes*. 2019;10:741.
16. Menard S, Morlais I, Tahar R, Sayang C, Mayengue P, Iriart X, et al. Molecular monitoring of *Plasmodium falciparum* drug susceptibility at the time of the introduction of artemisinin-based combination therapy in Yaoundé, Cameroon: implications for the future. *Malar J*. 2012;11:113.
17. Chauvin P, Menard S, Iriart X, Nsango SE, Tchloffo MT, Abate L, et al. Prevalence of *Plasmodium falciparum* parasites resistant to sulfadoxine/pyrimethamine in pregnant women in Yaoundé, Cameroon: emergence of highly resistant *pfdhfr*/*pfdrhps* alleles. *J Antimicrob Chemother*. 2015;70:2566–71.
18. Apinjoh TO, Mugri RN, Miotto O, Chi HF, Tata RB, Anchang-Kimbi JK, et al. Molecular markers for artemisinin and partner drug resistance in natural *Plasmodium falciparum* populations following increased insecticide treated net coverage along the slope of Mount Cameroon: cross-sectional study. *Infect Dis Poverty*. 2017;6:136.
19. Moyeh MN, Njimoh DL, Evehe MS, Ali IM, Nji AM, Nkafu DN, et al. Effects of drug policy changes on evolution of molecular markers of *Plasmodium falciparum* resistance to chloroquine, amodiaquine, and sulphadoxine-pyrimethamine in the south west region of Cameroon. *Malar Res Treat*. 2018;2018:1–7.
20. Mbacham WF, Evehe M-SB, Netongo PM, Ateh IA, Mimche PN, Ajua A, et al. Efficacy of amodiaquine, sulphadoxine-pyrimethamine and their combination for the treatment of uncomplicated *Plasmodium falciparum* malaria in children in Cameroon at the time of policy change to artemisinin-based combination therapy. *Malar J*. 2010;9:34.
21. Anong DN, Nkuo-Akenji T, Fru-Cho J, Amambua-Ngwa A, Titanji VPK. Genetic diversity of *Plasmodium falciparum* in Bolifamba, on the slopes of Mount Cameroon: influence of MSP1 allelic variants on symptomatic malaria and anaemia. *Ann Trop Med Parasitol*. 2010;104:25–33.
22. Metoh TN, Chen J-H, Fon-Gah P, Zhou X, Moyou-Somo R, Zhou X-N. Genetic diversity of *Plasmodium falciparum* and genetic profile in children affected by uncomplicated malaria in Cameroon. *Malar J*. 2020;19:115.
23. Kwenti TE, Kwenti TDB, Njunda LA, Latz A, Tufoñ KA, Nkuo-Akenji T. Identification of the *Plasmodium* species in clinical samples from children residing in five epidemiological strata of malaria in Cameroon. *Trop Med Health*. 2017;45:14.
24. Moyeh MN, Ali IM, Njimoh DL, Nji AM, Netongo PM, Evehe MS, et al. Comparison of the accuracy of four malaria diagnostic methods in a high transmission setting in coastal Cameroon. *J Parasitol Res*. 2019;2019:1–8.
25. Songue E, Tagne C, Mbouyap P, Essomba P, Moyou R. Epidemiology of malaria in three geo-ecological zones along the Chad-Cameroon pipeline. *Am J Epidemiol Infect Dis*. 2013;13:27–33.
26. MINSANTE. Rapport d'activité 2012 du programme de lutte contre le paludisme. Yaoundé Cameroon. Ministry of health: 2013 Jul 23.
27. Ngassabenda HG, Das A. Molecular evidence of *Plasmodium vivax* mono and mixed malaria parasite infections in Duffy-negative native Cameroonians. *PLoS ONE*. 2014;9:e103262.
28. Fru-Cho J, Bumah WY, Safeukui I, Nkuo-Akenji T, Titanji VP, Haldar K. Molecular typing reveals substantial *Plasmodium vivax* infection in asymptomatic adults in a rural area of Cameroon. *Malar J*. 2014;13:170.
29. Russo G, Faggioni G, Paganotti GM, Djeunang Dongho GB, Pomponi A, De Santis R, et al. Molecular evidence of *Plasmodium vivax* infection in Duffy negative symptomatic individuals from Dschang, West Cameroon. *Malar J*. 2017;16:74.
30. Ngassa Mbenda HG, Gouado I, Das A. An additional observation of *Plasmodium vivax* malaria infection in Duffy-negative individuals from Cameroon. *J Infect Dev Ctries*. 2016;10:682–6.
31. World Health Organization. World Malaria Report. Geneva; 2019. <https://www.who.int/publications/i/item/9789241565721>. Accessed 04 May 2021.
32. Anstey NM, Guerra CA, Yeung S, Price RN, Tjitra E, White NJ. *Vivax* Malaria: neglected and not benign. *Am J Trop Med Hyg*. 2007;77:79–87.
33. Sanger R, Race RR, Jack J. The Duffy blood groups of New York negroes: the phenotype Fy(a–b–). *Br J Haematol*. 1955;1:370–4.
34. Miller LH, Mason SJ, Clyde DF, McGinniss MH. The resistance factor to *Plasmodium vivax* in blacks. The Duffy-blood-group genotype, FyFy. *N Engl J Med*. 1976;295(6):302–4.
35. Michon P, Woolley I, Wood EM, Kastens W, Zimmerman PA, Adams JH. Duffy-null promoter heterozygosity reduces DARC expression and abrogates adhesion of the *P. vivax* ligand required for blood-stage infection. *FEBS Lett*. 2001;495:111–4.
36. Rosenberg R. *Plasmodium vivax* in Africa: hidden in plain sight? *Trends Parasitol*. 2007;23:193–6.
37. Abdelraheem MH, Albsheer MMA, Mohamed HS, Amin M, Abdel Hamid MM. Transmission of *Plasmodium vivax* in Duffy-negative individuals in central Sudan. *Trans R Soc Trop Med Hyg*. 2016;110:258–60.
38. Ba H, Duffy CW, Ahouidi AD, Deh YB, Diallo MY, Tandia A, et al. Wide-spread distribution of *Plasmodium vivax* malaria in Mauritania on the interface of the Maghreb and West Africa. *Malar J*. 2016;15:80.
39. Golassa L, Baliraine FN, Enweji N, Erko B, Swedberg G, Aseffa A. Microscopic and molecular evidence of the presence of asymptomatic *Plasmodium falciparum* and *Plasmodium vivax* infections in an area with low, seasonal and unstable malaria transmission in Ethiopia. *BMC Infect Dis*. 2015;15:310.
40. Zhong D, Lo E, Wang X, Yewhalaw D, Zhou G, Atieli HE, et al. Multiplicity and molecular epidemiology of *Plasmodium vivax* and *Plasmodium falciparum* infections in East Africa. *Malar J*. 2018;17:185.
41. Mendes C, Dias F, Figueiredo J, Mora VG, Cano J, Sousa B, et al. Duffy negative antigen is no longer a barrier to *Plasmodium vivax*—molecular evidences from the African West Coast (Angola and Equatorial Guinea). *PLoS Negl Trop Dis*. 2011;5:e1192.
42. Karthigayan G, Plowe CV, Sá JM, Travassos MA, Thera MA, Laurens MB, et al. *Plasmodium vivax* Infections over 3 Years in Duffy blood group negative Malians in Bandiagara, Mali. *Am J Trop Med Hyg*. 2017;97:744–52.
43. Culleton R, Ndounga M, Zeyrek FY, Coban C, Casimiro PN, Takeo S, et al. Evidence for the transmission of *Plasmodium vivax* in the republic of the Congo West Central Africa. *J Infect Dis*. 2009;200:1465–9.
44. Poirier P, Doderer-Lang C, Atchade PS, Lemoine JP, de l'Isle MLC, Aboubacar A, et al. The hide and seek of *Plasmodium vivax* in West Africa: report from a large-scale study in Beninese asymptomatic subjects. *Malar J*. 2016;15:570.
45. Oboh MA, Badiane AS, Ntadom G, Ndiaye YD, Diongue K, Diallo MA, et al. Molecular identification of *Plasmodium* species responsible for malaria reveals *Plasmodium vivax* isolates in Duffy negative individuals from southwestern Nigeria. *Malar J*. 2018;17:439.



46. PNDP: Plan communal de développement de la commune de Tibati. 2003. <https://www.pndp.org/plan-communautaire-developpement.php?dest=plan&crcc=23>. Accessed 04 May 2021
47. Tchuinkam T, Nyih-Kong B, Fopa F, Simard F, Antonio-Nkondjio C, Awono-Ambene H-P, et al. Distribution of *Plasmodium falciparum* gametocytes and malaria-attributable fraction of fever episodes along an altitudinal transect in Western Cameroon. *Malar J.* 2015;14:96.
48. Gillies MT. A Supplement to the Anophelinae of Africa South of the Sahara. 1987;146.
49. Gillies MT, De Meillon B. The Anophelinae of Africa south of the Sahara (Ethiopian Zoogeographical Region). Johannesburg: South African Institute for Medical Research. 1968.
50. Song Y, Fahs A, Feldman C, Shah S, Gu Y, Wang Y, et al. A reliable and effective method of DNA isolation from old human blood paper cards. *Springerplus.* 2013;2:616.
51. Collins FH, Mendez MA, Rasmussen MO, Mehaieff PC, Besansky NJ, Finnerty V. A ribosomal RNA gene probe differentiates member species of the *Anopheles gambiae* complex. *Am J Trop Med Hyg.* 1987;37:37–41.
52. Padley D, Moody AH, Chiodini PL, Saldanha J. Use of a rapid, single-round, multiplex PCR to detect malarial parasites and identify the species present. *Ann Trop Med Parasites.* 2003;97:131–7.
53. Fanello C, Santolamazza F, Della TA. Simultaneous identification of species and molecular forms of the *Anopheles gambiae* complex by PCR-RFLP. *Med Vet Entomol.* 2002;16:461–4.
54. Koekemoer L, Kamau M, Hunt RH, Coetzee LL. A cocktail polymerase chain reaction assay to identify members of the *Anopheles funestus* (Diptera: Culicidae) group. *Am J Trop Med Hyg.* 2002;66:804–11.
55. Boissière A, Gimonneau G, Tchioffo MT, Abate L, Bayibeki A, Awono-Ambéné PH, et al. Application of a qPCR assay in the investigation of susceptibility to malaria infection of the M and S Molecular Forms of *An. gambiae* s.s. in Cameroon. *PLoS ONE.* 2013;8:e54820.
56. Vo TKD, Bigot P, Gazin P, Sinou V, De Pina JJ, Huynh DC, et al. Evaluation of a real-time PCR assay for malaria diagnosis in patients from Vietnam and in returned travellers. *Trans R Soc Trop Med Hyg.* 2007;101:422–8.
57. Mangold KA, Manson RJ, Koay ESC, Stephens L, Regner M, Thomson RB, et al. Real-Time PCR for detection and identification of *Plasmodium* spp. *J Clin Microbiol.* 2005;43:2435–40.
58. Nkwo Akenji TK, Ntonifor NN, Ching JK, Kimbi HK, Ndamukong KN, Anong DN, et al. Evaluating a malaria intervention strategy using knowledge, practices and coverage surveys in rural Bolifamba, south-west Cameroon. *Trans R Soc Trop Med Hyg.* 2005;99:325–32.
59. Mfuh KQ, Achonduh-Atijegbe OA, Bekindaka ON, Esemu LF, Mbakop CD, Gandhi K, et al. A comparison of thick-film microscopy, rapid diagnostic test, and polymerase chain reaction for accurate diagnosis of *Plasmodium falciparum* malaria. *Malar J.* 2019;18:73.
60. Afa Achonduh O, Ekollo Mbange AH, Atogho-Tiedeu B, Mbulli IA, Achinko D, Masube netongo P, et al. Predominance of *Plasmodium malariae-falciparum* Co-infection by molecular speciation in Bangolan, North West Region of Cameroon. *J Life Sci.* 2013;7:599–606.
61. Bouyou-Akotet NIK, Offouga CL, Mawili-Mboumba DP, Essola L, Madoungou B, Kombila M. *Falciparum* malaria as an emerging cause of fever in adults living in Gabon Central Africa. *Biol Med Res Int.* 2014;2014:1–7.
62. Leroy EM, Nkoghe D, Ollomo B, Nze-Nkogwe C, Becquart P, Grard G, et al. Concurrent Chikungunya and dengue virus infections during simultaneous outbreaks, Gabon, 2007. *Emerg Infect Dis.* 2009;15:591–3.
63. Ayorinde AF, Oyeyiga AM, Nosegbe NO, Folarin OA. A survey of malaria and some arboviral infections among suspected febrile patients visiting a health centre in Simawa, Ogun State, Nigeria. *J Infect Public Health.* 2016;9:52–9.
64. Wolfe ND, Tamoufe U, Gubler DJ, Huang CY-H, Burke DS, Mpoudi-Ngole E, et al. Seroprevalence and distribution of flaviviridae, togaviridae, and bunyaviridae arboviral infections in rural cameroonian adults. *Am J Trop Med Hyg.* 2006;74:1078–83.
65. Programme National de Lutte contre le Paludisme. Rapport d'activités du programme national de lutte contre le paludisme. Yaoundé : Ministère de la Santé publique. 2015;66.
66. Topazian HM, Gumbo A, Puerto-Meredith S, Njiko R, Mwanza A, Kayange M, et al. Asymptomatic *Plasmodium falciparum* malaria prevalence among adolescents and adults in Malawi, 2015–2016. *Sci Rep.* 2020;10:18740.
67. Pulford J, Hetzel MW, Bryant M, Siba PM, Mueller I. Reported reasons for not using a mosquito net when one is available: a review of the published literature. *Malar J.* 2011;10:83.
68. Ndo C, Menze-Djantio B, Antonio-Nkondjio C. Awareness, attitudes and prevention of malaria in the cities of Douala and Yaoundé (Cameroon). *Parasites Vectors.* 2011;4:181.
69. Bousema T, Okell L, Felger I, Drakeley C. Asymptomatic malaria infections: detectability, transmissibility and public health relevance. *Nat Rev Microbiol.* 2014;12:833–40.
70. Lindblade KA, Steinhardt L, Samuels A, Kachur SP, Slutsker L. The silent threat: asymptomatic parasitemia and malaria transmission. *Expert Rev Anti Infect Ther.* 2013;17:623–39.
71. Morlais I, Nsango SE, Toussile W, Abate L, Annan Z, Tchioffo MT, et al. *Plasmodium falciparum* mating patterns and mosquito infectivity of natural isolates of gametocytes. *PLoS ONE.* 2015;10:e0123777.
72. Mmbando BP, Lusingu JP, Vestergaard LS, Lemnge MM, Theander TG, Scheike TH. Parasite threshold associated with clinical malaria in areas of different transmission intensities in north eastern Tanzania. *BMC Med Res Methodol.* 2009;9:12.
73. Smith T, Schellenberg JA, Hayes R. Attributable fraction estimates and case definitions for malaria in endemic areas. *Stat Med.* 1994;13(22):2345–58.
74. Greenwood BM, Bradley AK, Greenwood AM, Byass P, Jammeh K, Marsh K, et al. Mortality and morbidity from malaria among children in a rural area of The Gambia, West Africa. *Trans R Soc Trop Med Hyg.* 1987;81:478–86.
75. Mogeni P. Effect of transmission intensity on hotspots and micro-epidemiology of malaria in sub-Saharan Africa. *BMC Med.* 2017;15:11.
76. Stresman GH, Mwesigwa J, Achan J, Giorgi E, Worwui A, Jawara M, et al. Do hotspots fuel malaria transmission: a village-scale spatio-temporal analysis of a 2-year cohort study in The Gambia. *BMC Med.* 2018;16:160.
77. Bousema T, Drakeley C, Gesase S, Hashim R, Magea S, Mosha F, et al. Identification of hot spots of malaria transmission for targeted malaria control. *J Infect Dis.* 2010;201:1764–74.
78. Bousema T, Stresman G, Baidjoe AY, Bradley J, Knight P, Stone W, et al. The impact of hotspot-targeted interventions on malaria transmission in Rachuonyo South District in the Western Kenyan Highlands: a cluster-randomized controlled trial. *Rogerson SJ, editor. PLOS Med.* 2016;13:e1001993.
79. Ngassa Mbenda HG, Das A. Analysis of genetic diversity in the chloroquine-resistant gene *Pfcr* in field *Plasmodium falciparum* isolates from five regions of the southern Cameroon. *Infect Genet Evol.* 2016;44:450–8.
80. Sandeu MM, Abate L, Tchioffo MT, Bayibeki AN, Awono-Ambéné PH, Nsango SE, et al. Impact of exposure to mosquito transmission-blocking antibodies on *Plasmodium falciparum* population genetic structure. *Infect Genet Evol.* 2016;45:138–44.
81. Gautret P, Legros F, Koulmann P, Rodier MH. Imported *Plasmodium vivax* malaria in France: geographical origin and report of an atypical case acquired in Central or Western Africa. *Acta Trop.* 2001;5:177–81.
82. Mangioni ED, Severini C, Menegon M, Romi R, Ruggiero G, Majori G. Case report: an unusual late relapse of *Plasmodium vivax* malaria. *Am J Trop Med Hyg.* 2003;2:159–60.
83. Twohig KA, Pfeffer DA, Baird JK, Price RN, Zimmerman PA, Hay SI, et al. Growing evidence of *Plasmodium vivax* across malaria-endemic Africa. *PLoS Negl Trop Dis.* 2019;13:e0007140.
84. Tabue RN, Awono-Ambene P, Etang J, Atangana J, Antonio-Nkondjio C, Toto JC, et al. Role of *Anopheles (Cellia) rufipes* (Gough, 1910) and other local anophelines in human malaria transmission in the northern savannah of Cameroon: a cross-sectional survey. *Parasites Vectors.* 2017;10:22.
85. Ayala D, Costantini C, Ose K, Kamdem GC, Antonio-Nkondjio C, Agbor J-P, et al. Habitat suitability and ecological niche profile of major malaria vectors in Cameroon. *Malar J.* 2009;8:307.
86. Bigoga JD, Manga L, Titanji VP, Coetzee M, Leke RG. Malaria vectors and transmission dynamics in coastal south-western Cameroon. *Malar J.* 2007;6:5.
87. Menze BD, Wondji MJ, Tchappa W, Tchoupo M, Riveron JM, Wondji CS. Bionomics and insecticides resistance profiling of malaria vectors at a selected site for experimental hut trials in central Cameroon. *Malar J.* 2018;17:317.

88. Antonio-Nkondjio C, Sonhafouo-Chiana N, Ngadjieu CS, Doumbe-Belisse P, Talipouo A, Djamouko-Djonkam L, et al. Review of the evolution of insecticide resistance in main malaria vectors in Cameroon from 1990 to 2017. *Parasites Vectors*. 2017;10:472.
89. Tchouakui M, Fossog BT, Ngannang BV, Djonabaye D, Tchappa W, Njiokou F, et al. Investigation of the influence of a glutathione S-transferase metabolic resistance to pyrethroids/DDT on mating competitiveness in males of the African malaria vector *Anopheles funestus*. *Wellcome Open Res*. 2019;4:4–13.
90. Cohuet A, Dia I, Simard F, Raymond M, Rousset F, Antonio-Nkondjio C, et al. Gene flow between chromosomal forms of the malaria vector *Anopheles funestus* in Cameroon, Central Africa, and its relevance in malaria fighting. *Genetics*. 2005;169:301–11.
91. Antonio-Nkondjio C, Fossog BT, Ndo C, Djantio BM, Togouet SZ, Awono-Ambene P, et al. *Anopheles gambiae* distribution and insecticide resistance in the cities of Douala and Yaoundé (Cameroon): influence of urban agriculture and pollution. *Malar J*. 2011;10:154.
92. Tia E, Chouaibou M, Gbalégba CNG, Boby AMO, Koné M, Kadjo AK. Distribution des espèces et de la fréquence du gène Kdr chez les populations d'*Anopheles gambiae* s.s. et d'*Anopheles coluzzii* dans cinq sites agricoles de la Côte d'Ivoire. *Bull Soc Pathol Exot*. 2017;110:130–4.
93. Kamdem C, Tene Fossog B, Simard F, Etouana J, Ndo C, Kengne P, et al. Anthropogenic habitat disturbance and ecological divergence between incipient species of the malaria mosquito *Anopheles gambiae*. *PLoS ONE*. 2012;7:e39453.
94. Simard F, Ayala D, Kamdem G, Pombi M, Etouana J, Ose K, et al. Ecological niche partitioning between *Anopheles gambiae* molecular forms in Cameroon: the ecological side of speciation. *BMC Ecol*. 2009;9:17.
95. Tene Fossog B, Kopya E, Ndo C, Menze-Djantio B, Costantini C, Njiokou F, et al. Water quality and *Anopheles gambiae* larval tolerance to pyrethroids in the cities of douala and yaoundé (Cameroon). *J Trop Med*. 2012;2012:1–10.
96. Minsanté. Xlième Journée mondiale de lutte contre le paludisme "prêt à vaincre le paludisme" Nous sommes la génération qui peut éliminer le paludisme. Cameroon tribune. 2018. <https://www.cameroon-tribune.cm/article.html/159/fr/html/extreme-nord-baisse-du-taux-de-mortalite-liee-aupaludisme>. Accessed 03 May 2021.
97. Lekweiry K, Salem M, Basco LK, Briolant S, Hafid J, Boukhary A. Malaria in Mauritania: retrospective and prospective overview. *Malar J*. 2015;14:100.
98. Zohdy S, Derfus K, Headrick EG, Andrianjaly MT, Wright PC, Gillespie TR. Small-scale land-use variability affects *Anopheles* spp. distribution and concomitant *Plasmodium* infection in humans and mosquito vectors in southeastern Madagascar. *Malar J*. 2016;15:114.
99. Rakotoarivony I, Coulanges P, Coluzzii M, Campbell GH, Fontenille D, Lepers JP. Malaria transmission and vector biology in manarintsoa, high plateaux of madagascar. *Am J Trop Med Hyg*. 1990;43:107–15.
100. Animut A, Balkew M, Gebre-Michael T, Lindtjorn B. Blood meal sources and entomological inoculation rates of anophelines along a highland altitudinal transect in south-central Ethiopia. *Malar J*. 2013;12:76.
101. Robert V, Le Goff G, Andrianavolambo L, Randimby FM, Domarlie O, Randrianarivelojosia M, et al. Moderate transmission but high prevalence of malaria in Madagascar. *Int J Parasitol*. 2006;36:1273–81.
102. Amon J, Wirtz RA, Koros J, Ryan JR, Mtalib R, Luckhart S, et al. Evidence for transmission of *Plasmodium vivax* among a Duffy antigen negative population in western Kenya. *Am J Trop Med Hyg*. 2006;75:575–81.

### Publisher's Note

Springer Nature remains neutral with regard to jurisdictional claims in published maps and institutional affiliations.

Ready to submit your research? Choose BMC and benefit from:

- fast, convenient online submission
- thorough peer review by experienced researchers in your field
- rapid publication on acceptance
- support for research data, including large and complex data types
- gold Open Access which fosters wider collaboration and increased citations
- maximum visibility for your research: over 100M website views per year

At BMC, research is always in progress.

Learn more [biomedcentral.com/submissions](https://biomedcentral.com/submissions)



**Discussion and Conclusion:** Malaria incidence varies with respect to age, season, clinical status of the population, the epidemiological setting, and control interventions. In order to provide the right treatment regimens, accurate diagnosis of *Plasmodium* species is vital. Malaria transmission was observed to be high in the area, as 60.8% of the individuals sampled in the community were asymptomatic. Additionally, asymptomatic carriage was highest within the age group 5 – 15 years old. This confirms previous observations that prolonged exposure to malaria infections helps older children develop partial anti-disease immunity (Lindblade et al., 2013; Bousema et al., 2014). Individuals over the age of 15 had lower prevalence of symptomatic infection, which is due to their stronger anti-parasite immunity. More so, in asymptomatic individuals, parasite density decreased with age, but in symptomatics, the density was similar in children less than 5 and those within 5 – 15 years. Hence older individuals better control parasitaemia (Mmbando et al., 2009).

Spatial heterogeneity was observed in malaria infections, with one location, Yoko, having the highest prevalence of malaria. This suggests that certain areas are hotspots of transmission. However, this does not imply interventions should focus solely on these hotspots, as previous interventions that target only hotspots have in the past failed to change the dynamics of malaria transmission (Bousema et al., 2016).

Three *Plasmodium* species were identified in the blood samples collected; *P. falciparum*, *P. malariae*, *P. ovale*, with *P. falciparum* accounting for 95% of malaria infections, confirming other studies that *P. falciparum* is most prevalent in Cameroon (Ngassa Mbenda & Das 2016; Sandeu et al 2016; Russo et al., 2017). *P. ovale* and *P. malariae* were observed in mono-infections and co-infections with *P. falciparum*. However, these species were rarely found in symptomatics. *P. vivax* was not observed in human samples, indicating that this species circulates at low frequency as seen in other studies (Ngassa Mbenda & Das, 2014; Fru-Cho et al., 2014; Russo et al., 2017). Other reasons for not detecting *P. vivax* could be the sample size was small, and also the fact that in Africa, *P. vivax* has been observed to be more prevalent in relatively lower transmission areas (Twohig et al., 2019).

We also identified mosquito vectors of malaria transmission, and observed the 3 main vectors that have been shown to transmit malaria in Cameroon; *An. funestus*, *An. gambiae*, and *An. coluzzii*. This finding is in line with others (Didier Fontenille & Simard, 2004; Ayala et al., 2009; Bigoga et al 2007; Menze et al., 2018; Antonio-Nkondjio et al., 2019; Tchouakui et al., 2019; Bamou et al., 2019) that these 3 main vectors are largely distributed in the country.

The prevalence of *An. funestus* was higher in 2015 than in 2017 (55.2% vs 16%), which may be due to modification of the environment, with changes which are less favourable for *funestus* (Gillies & De Meillon, 1968; Cohuet et al., 2005). The reverse was the case for *An. coluzzi*, which constituted 9.7% of the 2015 anopheline collections vs 47.4% in 2017. The prevalence of *An. gambiae ss* was relatively the same during the two collection periods. The high prevalence of *An. gambiae* could be due to the presence of fish farming sites that act as breeding sites, and favours the development of *An. gambiae* s.l (Antonio-Nkondjio et al., 2011; Tia et al., 2017).

Considering the *Plasmodium* infection rates, there was no difference in *Plasmodium* infection rate among the three vectors, hence implying that they efficiently transmit malaria. Additionally, the sporozoite infection rate was as in previous studies performed in the country (Menze et al., 2018; Tabue et al., 2017; Antonio-Nkondjio et al., 2006). However, there was a slight decrease in infection rate though not significant between 2015 and 2017. This could be due to the use of LLINs upon massive distribution in 2015 (Minsanté, 2018). It was also observed that communities with low LLIN coverage had a relatively higher prevalence of malaria. All three mosquito species were mono-infected with *P. falciparum*, *P. malariae*, *P. ovale* and *P. vivax*. One *coluzzii* mosquito sample was found infected with *P. vivax*, confirming the low circulation of *P. vivax* in that community. Hence this study reports for the first time in Cameroon, the infection of *Anopheles* with *P. vivax*. In Sub-Saharan Africa, *P. vivax* has been reported in *An. arabiensis* in Mauritania (Lekweiry et al., 2015), Madagascar (Zohdy et al., 2016; Rakotoarivony et al., 1990), Ethiopia (Animut et al., 2013), in *An. funestus* in Madagascar (Zohdy et al., 2016; Rakotoarivony et al., 1990), Kenya (Animut et al., 2013) and *An. gambiae* in Kenya (Animut et al., 2013). However, there has never been a report of *P. vivax* in *An. coluzzii*. Thus, this work provides the epidemiological and entomological malaria situation in Tibati, with 3 main vectors; *An. funestus*, *An. gambiae* and *An. coluzzii*, with each equally contributing to malaria transmission.



## **Article 2: Antimalarial Drug resistance in the Central and Adamawa regions of Cameroon: prevalence of mutations in *Pfprt*, *Pfmdr1*, *Pfdhfr* and *Pfdhps* genes**

**Introduction:** Parasite resistance to antimalarial drugs have compromised malaria controls and has led to changes in antimalarial drug policies over time. In Cameroon, ASAQ has been adapted as first line drug since 2004, and artemether lumefantrine as an alternative since 2006 (Sayang et al., 2009). SP is still used as an intermittent preventive treatment for malaria (IPTp-SP) (Chauvin et al., 2015; Moyeh et al., 2018) and combined with AQ (AQSP) for seasonal malaria chemoprevention (SMC) in the North region of Cameroon between ages 3 – 59 months.

In Cameroon, several mutations associated with antimalarial drug resistance are circulating. Compared to other African countries, relatively fewer studies on the evolution of drug resistance after ACT introduction have been carried out (Niba et al., 2021). Majority of such studies have been carried out in the Central, South East and North East regions of the country, which are all forest zones characterised by perennial malaria, and areas in the Savannah like Tibati where malaria is seasonal do not have a defined antimalarial drug resistance profile. Hence it is vital to regularly monitor the prevalence of SNPs associated with antimalarial drug resistance, to ensure national malaria treatment policies are efficient. Hence the second article aimed at determining major SNPs associated with antimalarial resistance in the *Pfprt*, *Pfmdr1*, *Pfdhfr* and *Pfdhps* genes from *P. falciparum* isolates collected in Mfou and Tibati, to identify the trends and differences of antimalarial drug resistance mutations in these two geographically and epidemiologically distinct areas of Cameroon.

## RESEARCH ARTICLE

# Antimalarial drug resistance in the Central and Adamawa regions of Cameroon: Prevalence of mutations in *P. falciparum crt*, *Pfmdr1*, *Pfdhfr* and *Pfdhps* genes

Aline Gaelle Bouopda Tuedom<sup>1,2</sup>, Elangwe Milo Sarah-Matio<sup>2,3</sup>, Carole Elise Eboumbou Moukoko<sup>1,2</sup>, Brice Lionel Feufack-Donfack<sup>2,4</sup>, Christelle Ngou Maffo<sup>2,3</sup>, Albert Ngano Bayibeki<sup>5</sup>, Hermann Parfait Awono-Ambene<sup>6</sup>, Lawrence Ayong<sup>2</sup>, Antoine Berry<sup>7</sup>, Luc Abate<sup>3</sup>, Isabelle Morlais<sup>3\*</sup>, Sandrine Eveline Nsango<sup>1,2\*</sup>



1 Department of Biological Sciences, Faculty of Medicine and Pharmaceutical Sciences, University of Douala, Douala, Cameroon, 2 Malaria Research Unit, Centre Pasteur du Cameroun, Yaoundé, Cameroon, 3 UMR MIVEGEC, IRD, CNRS, Institut de Recherche pour le Développement, Université Montpellier, Montpellier Cedex, France, 4 CNRS UPR9022, INSERM U963, Strasbourg, France, 5 Université Catholique d'Afrique Centrale, Yaoundé-Campus Messa Cameroun, Yaoundé, Cameroon, 6 Laboratoire de Recherche sur le Paludisme, Organisation de Coordination pour la lutte contre les Endémies en Afrique Centrale (OCEAC), Yaoundé, Cameroon, 7 Service de Parasitologie-Mycologie, Centre Hospitalier Universitaire de Toulouse et UMR152 UPS-IRD, Université de Toulouse, Toulouse, France

## OPEN ACCESS

**Citation:** Tuedom AGB, Sarah-Matio EM, Moukoko CEE, Feufack-Donfack BL, Maffo CN, Bayibeki AN, et al. (2021) Antimalarial drug resistance in the Central and Adamawa regions of Cameroon: Prevalence of mutations in *P. falciparum crt*, *Pfmdr1*, *Pfdhfr* and *Pfdhps* genes. PLOS ONE 16(8): e0256343. <https://doi.org/10.1371/journal.pone.0256343>

**Editor:** Jutta Marfurt, Menzies School of Health Research, AUSTRALIA

**Received:** January 30, 2021

**Accepted:** August 5, 2021

**Published:** August 19, 2021

**Copyright:** © 2021 Tuedom et al. This is an open access article distributed under the terms of the [Creative Commons Attribution License](https://creativecommons.org/licenses/by/4.0/), which permits unrestricted use, distribution, and reproduction in any medium, provided the original author and source are credited.

**Data Availability Statement:** All relevant data are within the manuscript.

**Funding:** This work was supported by the French National Research Institute for Sustainable Development (IRD) through the JEAI-IMPALA project granted to SEN (12.02.2018). The funders had no role in study design, data collection and analysis, decision to publish, or preparation of the manuscript.

☞ These authors contributed equally to this work.

\* [nsango2013@yahoo.fr](mailto:nsango2013@yahoo.fr), [nsango@pasteur-yaounde.org](mailto:nsango@pasteur-yaounde.org)

## Abstract

The spread of *Plasmodium falciparum* resistant parasites remains one of the major challenges for malaria control and elimination in Sub Saharan Africa. Monitoring of molecular markers conferring resistance to different antimalarials is important to track the spread of resistant parasites and to optimize the therapeutic lifespan of current drugs. This study aimed to evaluate the prevalence of known mutations in the drug resistance genes *Pfcr*, *Pfmdr1*, *Pfdhfr* and *Pfdhps* in two different epidemiological settings in Cameroon. Dried blood spots collected in 2018 and 2019 from asymptomatic individuals were used for DNA extraction and then the *Plasmodium* infection status was determined by PCR. Detection of SNPs was performed by nested PCR followed by allele-specific restriction analysis (ASRA). The prevalence of each genotype was compared between sites using the Chi square and Fisher's exact tests. A high prevalence of the *Pfcr* K76 wild type allele was found in both sites (88.5 and 62.29% respectively;  $P < 0.0001$ ). The prevalence of *Pfmdr1* mutations 86Y and 1246Y was respectively 55.83 and 1.45% in Mfou and 45.87 and 5.97% in Tibati, with significant difference between the studied areas ( $P < 0.0001$ ). Overall, the *Pfdhfr* triple-mutant genotype (51I/59R/108N) was highly prevalent (> 96%), however no SNP was detected at codon 164. In *Pfdhps*, the prevalence of the 437G mutation reached (90%) and was at higher frequency in Mfou ( $P < 0.0001$ ). Overall, the *Pfdhps* mutations 540E and 581G were less common (0.33 and 3.26%, respectively). The quadruple resistant genotype (*Pfdhfr* 51I/59R/108N+*Pfdhp*437G) was found almost 90% of the samples. The wild-type genotype (*Pfdhfr* N51/C59/S108/164I+*Pfdhps* A437/K540/A581) was never identified and

**Competing interests:** The authors have declared that no competing interests exist.

**Abbreviations:** ACT, Artemisinin-based combination therapy; AL, Artemether-Lumefantrine; AQ, Amodiaquine; AQ-SP, Amodiaquine-Sulphadoxine-Pyrimethamine; AS, Artesunate; AS-AQ, Artesunate-Amodiaquine; CQ, Chloroquine; HL, Halofantrine; IPTp-SP, Sulphadoxine-Pyrimethamine Intermittent preventive treatment for pregnant women; **Nested PCR**, Nested polymerase chain reaction; *Pfcr*, *Plasmodium falciparum* chloroquine resistance transporter; *Pfdhfr*, *Plasmodium falciparum* dihydrofolate reductase; *Pfdhps*, *Plasmodium falciparum* dihydropteroate synthase; *Pfmdr1*, *Plasmodium falciparum* multidrug resistance gene 1; qPCR, Quantitative polymerase chain reaction; **SMC-SP**, Sulphadoxine-Pyrimethamine Seasonal Malaria Chemoprevention; **SNP**, Single-nucleotide polymorphism; **SP**, Sulphadoxine-Pyrimethamine.

the sextuple mutant (*Pfdhfr* 511/59R/108N+*Pfdhps* 437G/540E/581G), known as super resistant appeared in two samples from Tibati. These findings demonstrate declining trends in the prevalence of mutations conferring resistance to 4-aminoquinolines, especially to chloroquine. However, a high level of mutations in *P. falciparum* genes related to SP resistance was detected and this raises concerns about the future efficacy of IPTp-SP and SMC in Cameroon.

## Background

Despite global efforts to fight against malaria, the disease remains a serious public health problem. Latest estimations from WHO reported 229 million cases of malaria and 409,000 deaths worldwide in 2019, 94% of the cases were recorded in the WHO African Region where nearly 99% of malaria cases were caused by *Plasmodium falciparum* [1]. In Cameroon, the National Malaria Control Program (NMCP) indicated that, approximately 28% of morbidity and 18.3% of deaths were due to malaria in 2019 [2]. Unfortunately, disruption of malaria interventions due to COVID-19 will likely worsen the situation in the future [3]. Malaria case management has been compromised by parasite resistance to most antimalarial drugs, leading authorities to change guidelines for the treatment of malaria over time [4]. Indeed, selection pressure of drugs delivered as monotherapy drives the emergence and spread of antimalarial drug resistance. Chloroquine (CQ) resistance in *P. falciparum* was first detected in Colombia and Cambodia-Thailand border in the late 1950s after decades of heavy use and then resistance spread worldwide, reaching Africa in the late 1970s [5]. The same scenario then happened with sulphadoxine-pyrimethamine (SP), the antifolate drug that was used after withdrawal of CQ in the late 1990s. In 2001, WHO recommended the use of artemisinin-based combination therapies (ACTs) as first line treatment for uncomplicated *P. falciparum* malaria [6].

Cameroon's authorities adopted the artesunate-amodiaquine (ASAQ) combination as first-line treatment of malaria in 2004 and artemether-lumefantrine (AL) as an alternative ACT in 2006 [7, 8]. In high malaria transmission areas, WHO recommends chemoprophylaxis as a strategy to prevent malaria, especially in risk groups [1]. Thus, SP continues to be used as an intermittent preventive treatment for prevention of malaria in pregnancy (IPTp-SP) [9, 10]. Also SP combined to amodiaquine (AQ) is used for seasonal malaria chemoprevention (SMC) in children within the age group 3–59 months in the North region of Cameroon where malaria transmission is seasonal [8]. The change in antimalarial policy has remarkably contributed to the reduction in mortality due to malaria in Cameroon [2, 11].

However, malaria case management and prevention remain highly threatened by the emergence and spread of drug resistance in *P. falciparum* parasites [12]. Presently, resistance has emerged against almost all antimalarial drugs, including the old molecules either administered as monotherapy, CQ and SP, or used as partner drugs in ACTs, amodiaquine (AQ), mefloquine (MQ) and lumefantrine (L) [13–15]. In the late 2000s, *P. falciparum* resistance to artemisinin (ART) was reported in South-East Asian regions particularly along the Cambodia–Thailand border, and this finding threatens worldwide initiatives and efforts to control malaria [16–19]. Fortunately, ART resistance has not been reported in Africa so far and treatments with ACTs remain effective [20–24]. However, polymorphisms in genes associated with resistance to partner drugs compromise the long-term efficacy of ACTs [21, 25, 26]. Moreover, resistance to ACT partner drugs emerged before that of artemisinin, thus monitoring the resistance level of partner drugs is a key element to maintain the effectiveness of ACTs [27].



Several studies have conclusively indicated a correlation between the development of anti-malarial drug resistance and the presence of single nucleotide polymorphisms (SNPs) in *P. falciparum* parasite genes determining drug effects [28, 29]. For instance, the K76T mutation in the *P. falciparum* resistance transporter (*Pfcr1*) gene confers resistance to CQ [30]. Polymorphisms in the multi-drug resistance gene of *P. falciparum* (*Pfmdr1*), especially the N86Y, Y184F and D1246Y mutations [31], are linked with resistance against CQ, AQ, L, Quinine (Q) and Halofantrine (HL) [32]. It has been well documented that polymorphisms in the *Pfcr1* and *Pfmdr1* genes are currently being driven by *P. falciparum* susceptibility to ACT partner drugs [26, 27, 33]. Indeed, the combination of *Pfcr1* 76T and the *Pfmdr1* 86Y-184Y-1246Y triplet is linked to recrudescence and reinfection after treatment with artesunate-amodiaquine AS-AQ [27, 34]. An opposite pattern has been observed for artemether-lumefantrine (AL), with a strong selection of *Pfmdr1* N86 and *Pfcr1* K76 alleles in AL-treated patients who are reinfected [35]. SNPs in the dihydrofolate reductase (*dhfr*) [30, 36, 37] and dihydropteroate synthase (*dhps*) genes [38] are associated with SP resistance. Successive accumulation of mutations in both *Pdhfr* and *Pdhps* genes confers high levels of SP resistance and clinical treatment failure in several epidemiological settings [39, 40].

According to Naidoo *et al*, three combinations of SNPs in *Pdhfr* and *Pdhps* genes are used to assess the level of SP resistance in endemic areas [41]. The quadruple mutant (*Pfdhfr* N51I, C59R and S108N + *Pfdhps* A437G) confers partial resistance [9, 42, 43]. The quintuple mutant genotype (*Pfdhfr* N51I, C59R and S108N + *Pfdhps* A437G and K540E) defined as fully-resistant parasite, is strongly linked with SP-resistance [44]. Sextuple mutant genotypes (*Pfdhfr* N51I, C59R and S108N + *Pfdhps* A437G, K540E and A581G) also referred as super-resistant parasites have been associated with clinical and parasitological failure to SP therapy [45–47]. These genotypes observed in sub-Saharan Africa, are strongly selected by the use of SP and are considered to be predictive of IPTp and IPTi failure [41, 48]. Due to the relatively high prevalence of *Pfdhps* K540E and A581G mutations, the quintuple (*Pfdhfr* N51I, C59R and S108N + *Pfdhps* A437G and K540E) and sextuple (*Pfdhfr* N51I, C59R and S108N + *Pfdhps* A437G, K540E and A581G) mutated genotypes are highly prevalent in East Africa and infections with the sextuple genotype were associated with reduced birthweight [47]. In contrast, they are present at low frequencies in West and Central Africa where the *Pfdhps* K540E mutation remains uncommon. A new *Pfdhps* mutation, at position 431 (I431V), has recently been reported in Nigeria and Cameroon [9, 12, 49]. A recent study by Oguike *et al* showed an increase in the prevalence of this mutation from 0 to 6.5% between 2003 and 2008, and up to 46% in 2010 in Enugu, Nigeria [50], suggesting that the I431V mutation is widespread throughout this part of Africa. The octal mutant genotype which combines the *Pfdhfr* N51I, C59R, S108N and *Pfdhps* I431V, S436A, A437G, A581G, A613S (IRN/VAGKGS) could be strongly associated with SP failure in Central Africa for which the efficacy of IPTp-SP may be limited [9]. However, its role in parasite resistance to SP has yet to be described [51].

Earlier studies carried out in Cameroon have reported the presence of almost all mutations described above [13, 52, 53]. However, unlike in other African countries, relatively few studies have been carried out on the evolution of drug resistance following the introduction of ACTs and chemoprevention interventions [4, 9, 10, 15, 54]. Moreover, almost all the data available are limited to forest zones (Central, South-East and North-East Regions) in Cameroon [53]. Thus, the profile of malaria resistance in savannah areas, such as in Tibati, is still unclear. To ensure efficient national malaria treatment policy and preserve the chemoprevention, it is crucial to regularly monitor the prevalence of SNPs linked to antimalarial drugs resistance across the country.

This study was designed to assess the prevalence of known drug resistance genotypes in the *Pfcr1*, *Pfmdr1*, *Pfdhfr* and *Pfdhps* genes of *P. falciparum* collected from two geographically and

epidemiologically distinct areas of Cameroon in order to identify differences in trends of anti-malarial drug resistance in Cameroon.

## Materials and methods

### Study sites and sample collection

Cross-sectional studies were conducted between June–July 2018 in Mfou (3°72'N; 11°64'E) and July–August 2019 in Tibati (6°46'N, 12°63'E), two localities in Cameroon with different epidemiological settings (Fig 1).

Mfou is a semi-urban area located in the Central region of Cameroon and characterized by Guinea-type equatorial climate. Malaria transmission is perennial with higher prevalence

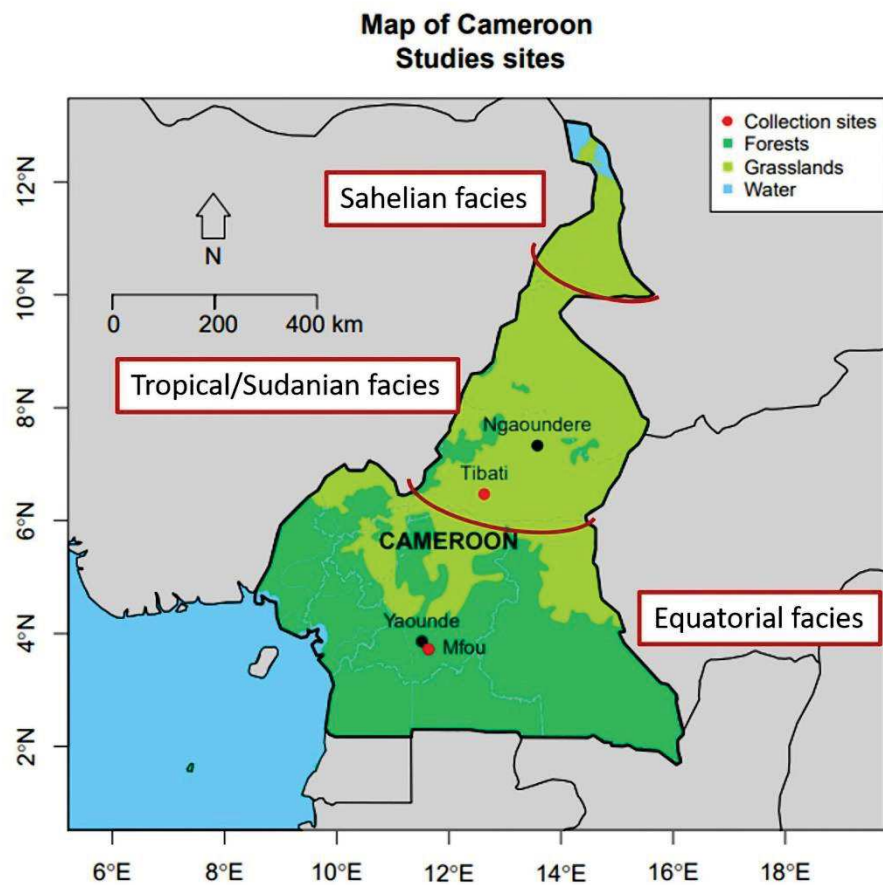

**Fig 1. Map depicting the study sites in two different epidemiological settings of Cameroon.** The map contains information from OpenStreetMap, which is made available under the Open Database License.

<https://doi.org/10.1371/journal.pone.0256343.g001>

during the rainy season from March to June and August to November. Tibati is located in the Adamawa region and characterized by humid savannah with one rainy season lasting over 6 months from March to October and seasonal transmission of malaria parasites. In both areas, *P. falciparum* is responsible for more than 90% of malaria infections, and *An. gambiae s.l* and *An. funestus* are the main malaria vectors [11].

In each study site, a simple random survey was carried out and participants were enrolled consecutively to limit selection and information bias. Prior to the survey, meetings with local authorities were organized to define suitable dates for collections in the different villages. Local populations were informed of the objectives and methods of the study during community sensitization surveys and were allowed to ask questions. Only individuals aged at least one year, with no fever (axillary temperature  $\leq 37.5^{\circ}\text{C}$ ) the previous 48h, no ongoing antimalarial treatment and who have given their consent by signing an informed consent form were enrolled in the study. For minors, only those for whom parental consent was obtained were enrolled. Participation in the study was voluntary. Study participants were recruited among asymptomatic individuals in the communities. Asymptomatic carriers were defined as individuals with malarial parasitemia of any density, absence of fever or other acute malaria symptoms, no history of recent antimalarial treatment [55]. A semi-structured questionnaire was used to collect demographic data and information on the use of antimalarial drugs. Finger-prick blood samples were collected from each participant for rapid diagnostic test (RDT, SD Bioline) and thick blood smear microscopy diagnosis. Additionally, blood samples were spotted on a Whatman<sup>®</sup> grade 17 filter paper (Whatman<sup>®</sup> Grade 17 Chr Cellulose Chromatography Paper, GE Healthcare, Chicago, USA), air-dried and stored in silica gel for further molecular analyses. The study participants who were found parasite-positive received free treatment with Artesunate Amodiaquine (ASAQ) according to the national guidelines by the National Malaria Control Program (NMCP).

#### DNA extraction and molecular identification of *Plasmodium* species

Genomic DNAs from dried blood spots were extracted using the chelex-100 method as previously described [56] and stored at  $-20^{\circ}\text{C}$  until molecular analyses. Detection and identification of *Plasmodium* spp were performed by real-time PCR according to Mangold *et al* [57]. The primer sequences target a polymorphic fragment of the small subunit 18S ribosomal RNA (18S rRNA) gene, allowing the differentiation of four plasmodial species, *P. falciparum*, *P. vivax*, *P. ovale* and *P. malariae*, upon analyses of the melting curves. Amplifications were run on a Light Cycler<sup>®</sup> 96 instrument (Roche Molecular Systems, Indianapolis, USA) using SYBR Green dye for DNA detection and quantification.

#### Single nucleotide polymorphisms (SNPs) associated with antimalarial resistance in *Pfcrt*, *Pfmdr1*, *Pfdhfr* and *Pfdhps* genes

Genotyping was performed for samples identified as *P. falciparum*-positive by real-time PCR. Nested PCR was then followed by restriction fragment length polymorphism (RFLP) analysis as described previously (University of Maryland School of Medicine. Available: <https://www.medschool.umaryland.edu/malaria/Protocols/>.) This allowed the detection of point mutations in *Pfcrt*, *Pfmdr1*, *Pfdhfr* and *Pfdhps* genes. The corresponding SNPs are detailed in Table 1.

Briefly, PCRs were carried out in a final volume of 25  $\mu\text{L}$  containing 1X Hot-Start PCR Master Mix (Thermo Scientific, Waltham, MA, USA) and 10 nM of each primer (Eurogentec, Belgium). Purified DNA from the wild type (3D7) and multi-drug resistant laboratory strains (Dd2) of *P. falciparum* (MR4, ATCC<sup>®</sup>, Manassas VA, USA) were used as controls. Each assay included the two control DNA samples of *P. falciparum*: the CQ-susceptible strain 3D7 with



Table 1. Characteristics of the primers used for PCRs and enzymes for ASRA.

Genes	Mutations	Primer names	Nucleotide sequence (5'-3')	Annealing (°C)	Fragment size (bp)	Restriction enzyme	Fragment size (bp)
<i>Pfcr</i>	K76T	76 F	ATG GCT CAC GTT TAG GTG GAG	45	192	ApoI	136 + 56
		76R	CGG ATG TTA CAA AAC TAT AGT TACC				
<i>Pfmdr1</i>	N86Y	86 F1	TTC AAC AAA AAG AGT ACC GCT G	52	450		
		86 R1	TGGTACCAATTCCTGAACCTCAC				
		86 F2	TTT ACC GTT TAA ATG TTT ACC TGC				
		86 R2	CCA TCT TGA TAA AAA ACA CTT CTT				
	D1246Y	1246 F1	ATG ACA AAT TTT CAA GAT TA	45	295		
		1246 F2	ACT AAC ACG TTT AAC ATC TT				
		1246 F2	AAT GTA AAT GAA TTT TCA AAC C				
		1246 R2	CAT CTT CTC TTC CAA ATT TGA TA				
<i>Pfdhfr</i>	S108N	108 F1	ATG ATG GAA CAA GTC TGC GAC GTT TTC GA	56	580		
		108 R1	CAC ATT CAT ATG TAC TAT TT				
		108 F2	TAA TAA CTA CAC ATT TAG AGG				
		108 R2	CTA AAA ATT CTT GAT AAA CAA CGG AAC CTC C				
	I164L	164 F1	CAGTTACAACATATGTGA	45	414		
		164 R1	CACATTCATATGCTACTATTT				
		164F2	CTAATTCTAAAAAATTACAAAATGT				
		164 R2	TTTCCTTTCTAAAAAATTCCTTGATAACAACGGAACCTCTTA				
	N511/C59R	51/59 F1	TAA TAA CTA CAC ATT TAG AGG	45	147		
		51/59 R1	ACA TCT CTT ATA TTT CAA TTT				
		51/59 F2	CTA GGA AAT AAA GGA GTA TTA CCA TGG AAA TGG A				
		51/59 R2	ATT TTT CAT ATT TTG ATT CAT TCA CAT ATG TTG TAA CTG TAC				
<i>Pfdhps</i>	A437G	437 F1	TAT TAA ATG TTA ATT ATG ATT CT	52	249		
		437 R1	TCA CAT TTA ACA ATT TTA TT				
		437 F2	TGT TCA AAG AAT GTT TGA AAT G				
		437 R2	CCA TTC TTT TTG AAA TAA TTG				
	K540E/A581G	540/581 F1	AAA CAA ATT CTA TAG TG	45	256		
		540/581 R1	TGG ATA CTC ATC ATA TA				
		540/581 F2	GTT CTA ATG CAT AAA AGA GG				
		540/581 R2	TAA GAG TTT AAT ACA TTG ATG AGC TTT CTT C				

F: Forward primer sequence; R: Reverse primer sequence.

<https://doi.org/10.1371/journal.pone.0256343.t001>

the wild-type alleles *Pfcr* K76, *Pfmdr1* N86 and D1246 and the CQ-resistant Dd2, carrying *Pfcr* 76T, *Pfmdr1* 86Y and 1246Y mutant alleles. For *Pfdhfr* and *Pfdhps* mutations, 3D7 strain known to be sulfadoxine-pyrimethamine sensitive was included as control, the strain is carrying the wild alleles *Pfdhfr* S108, I164, N51, C59 and *Pfdhps* A437, K540 and A581. Primer pairs and cycling conditions are presented in Table 1. Digestion reactions were set at a final volume of 15 µL containing 8 µL of the nested PCR product, enzyme buffer and 1 unit of the appropriate restriction enzyme (Thermo Fisher Scientific). Mixtures were digested overnight at 37°C for all the restriction enzymes, as recommended by the manufacturer. A 7 µL volume of the digested product was loaded on a 2% agarose gel containing ethidium bromide and the gel was

observed on a transilluminator with UV light. Restriction enzymes and fragment sizes for each point mutation are presented in Table 1.

### Data management and statistical analysis

Data were recorded in Microsoft Excel (Office 2010) and analyzed using the R Core Team (2020) and GraphPad Prism5 (San Diego, CA, USA) softwares. The site maps were drawn using R, mapproj and maps packages with data source from OpenStreetMap. Information from OpenStreetMap is made available under the Open Database License. Graphics were built using ggplot2 package. Alleles corresponding to the *Pfdhfr/Pfdhps* SNPs were combined for each individual and genotypes recorded. Comparison of prevalence of infection and frequency of antimalarial resistance mutations between the two study areas was computed using the Chi-square and Fisher's exact tests. The level of statistical significance was set at a value of  $P \leq 0.05$ .

The sample size was calculated by the Lorentz formula:  $n = T^2 \times P(1-P) / M^2$  [58] where  $n$  = required sample size,  $T$  = 95% confidence level (standard value is 1.96),  $P$  = estimated prevalence of malaria in the study site (47% in Central region (Mfou) and 32% in Adamawa (Tibati) [59]),  $M$  = margin of error at 5% (standard value is 0.05),  $1-P$  = adverse event.

$$\text{Mfou : } n = 1.96^2 \times 0.47(1 - 0.47) / 0.05^2 \quad n = 382.77$$

$$\text{Tibati : } n = 1.96^2 \times 0.32(1 - 0.32) / 0.05^2 \quad n = 334.37$$

The minimum sample sizes were 383 and 334 individuals in Mfou and Tibati, respectively.

### Ethics statement

This study was reviewed and approved by the Cameroon National Ethics Committee for Research on Human Health (CNERSH, No. 2018/05/1011/CE/CNERSH/SP and CNERSH, No. 2019/05/1161/CE/CNERSH/SP).

## Results

### Characteristics of study population

Overall, 2,926 asymptomatic individuals were enrolled, 1,635 (55.88%) in Mfou and 1,291 (44.12%) in Tibati (Table 2).

Out of the 2926 samples collected, 2754 (1480 from Mfou, 1274 from Tibati) were successfully used for molecular analysis. The *Plasmodium*-specific real time PCR revealed 876/1480 (59.18%) and 808/1274 (63.42%) of positive isolates in Mfou and Tibati respectively. *P. falciparum* was the most prevalent *Plasmodium* species in both sites, accounting for >98% of infections, 839/876 (95.8%) and 791/808 (98%) in Mfou and Tibati respectively. *P. malariae* infections were identified only in Mfou, in 37/876 (4.2%) of the samples and 20/37 (54%) were mixed *Pf/Pm* infections. *P. ovale* was only found in Tibati in 17/791 (2%) of blood samples and 5/17 (29.4%) were mixed *Pf/Po* infections. All the 1,655 *P. falciparum* positive blood samples (859 from Mfou, 796 from Tibati) were genotyped for all molecular markers. The distribution of *Plasmodium* infections among the age groups is presented in Fig 2. Participants  $\leq 10$  years were the most infected, the malaria prevalence closed to 70% for this age category in both sites.

### Prevalence of genotypes in *Pfcr* and *Pfmdr1* genes

Out of the 859 *P. falciparum* positive isolates from Mfou, 809 (94.18%), 827 (96.27%) and 826 (96.16%) were successfully genotyped for K76T, N86Y and D1246Y SNPs, respectively. Among the 796 *P. falciparum* positive isolates from Tibati, 762 (95.73%) for K76T, 739



Table 3. Frequency of *Pfcr*t and *Pfmdr1* genotypes in *Plasmodium falciparum* isolates from Mfou and Tibati, Cameroon.

Genes/Alleles	Number of samples (%)			P value
	Both sites	Mfou	Tibati	
<b><i>Pfcr</i>t codon 76</b>				
<i>N samples processed</i>	1571	809	762	
Wild-type K76	1244 (79.18)	716 (88.50)	528 (69.29)	< 0.0001 <sup>a</sup>
Mixed K76 and 76T	198 (12.60)	70 (8.65)	128 (16.80)	
Mutant 76T	129 (8.21)	23 (2.84)	106 (13.91)	
<b>Total mutant 76T</b>	<b>327(20.81)</b>	<b>93(11.50)</b>	<b>234(30.71)</b>	< 0.0001 <sup>b</sup>
<b><i>Pfmdr1</i> codon 86</b>				
<i>N samples processed</i>	1566	827	739	
Wild-type N86	769 (49.11)	369 (44.62)	400 (54.13)	< 0.0001 <sup>a</sup>
Mixed N86 and 86Y	605 (38.63)	381 (46.07)	224 (30.31)	
Mutant 86Y	192 (12.26)	77 (9.31)	115 (15.84)	
<b>Total mutant 86Y</b>	<b>797(50.89)</b>	<b>458(55.38)</b>	<b>339(45.87)</b>	0.0002 <sup>b</sup>
<b><i>Pfmdr1</i> codon 1246</b>				
<i>N samples processed</i>	1562	826	736	
Wild-type D1246	1501 (96.09)	809 (97.94)	692 (94.02)	< 0.0001 <sup>a</sup>
Mixed D1246 and 1246Y	49 (3.13)	8 (0.97)	41 (5.57)	
Mutant 1246Y	12 (0.77)	9 (1.09)	3 (0.46)	
<b>Total mutant 1246Y</b>	<b>61(3.91)</b>	<b>17(1.45)</b>	<b>44(5.97)</b>	< 0.0001 <sup>b</sup>

The distribution of alleles at each SNP was compared between Mfou and Tibati using a Chi square test and the P-value is indicated.

<sup>a</sup>, comparison of wild-type, mixed and mutant genotypes.

<sup>b</sup>, comparison of total mutant versus wild-type genotypes.

<https://doi.org/10.1371/journal.pone.0256343.t003>

(92.83%) for N86Y and 736 (92.46%) for D1246Y were genotyped. The prevalence of the *Pfcr*t and *Pfmdr1* genotypes are presented in Table 3.

The frequency of the *Pfcr*t K76 wild type allele was 88.50% (716/809) and 69.29% (528/762) respectively. The *Pfcr*t 76T mutant allele was observed in 23/809 (2.84%) and 106/762 (13.91%) from Mfou and Tibati, respectively. Mixed *Pfcr*t alleles were identified in 70/809 (8.65%) and 128/762 (16.80%) of the blood isolates, in Mfou and Tibati, respectively. There was a significant difference in the distribution of the alleles between the two studied sites, when we compared wild-type, mixed and mutant genotypes ( $P < 0.001$ ) as well as when mixed genotypes were classified in the mutant group ( $P < 0.001$ ). The frequencies of the wild type allele *Pfmdr1* N86 were 44.62% (369/827) and 54.13% (400/739) in Mfou and Tibati respectively. The mutant allele *Pfmdr1* 86Y was found in 77/739 (9.31%) and 115/739 (15.84%) of the samples in Mfou and Tibati, respectively. Mixed (86 N/Y) *Pfmdr1* alleles identified in 381/827 (30.31%) and 224/739 (46.07%) of the isolates in Mfou and Tibati, respectively.

Statistically significant differences were observed when comparing wild-type, mixed and mutant genotypes ( $P < 0.001$ ) and wild-type versus total mutant genotypes ( $P = 0.002$ ). The *Pfmdr1* N86 + *Pfcr*t 76K (NK) genotype, associated to a higher susceptibility to lumefantrine (L), was found in 317/827 (40.64%) and 251/739 (37.92%) isolates in Mfou and Tibati, respectively and the difference is not significant ( $\chi^2 = 3.21$ ,  $P = 0.073$ ). The *Pfmdr1* D1246 wild type allele was detected in 809/826 (97.94%) and 692/736 (94.02%) of the isolates from Mfou and Tibati, respectively. The mutant-type 1246Y was present in 9/826 (1.09%) and 3/736 (0.46%) of isolates from Mfou and Tibati, respectively. Mixed alleles (1246 D/Y) were scored in 8/826 (0.97%) samples in Mfou and 41/736 (5.6%) in Tibati.

Table 4. Frequency of *Pfdhfr* and *Pfdhps* genotypes in *Plasmodium falciparum* isolates from Mfou and Tibati, Cameroon.

Genes	Codons/alleles	Number of samples (%)			P value
		Both sites	Mfou	Tibati	
<i>Pfdhfr</i>	<b>Codon 51</b> <i>N</i> samples processed	<b>1619</b>	<b>825</b>	<b>794</b>	
	Wild-type N51	54 (3.33)	7 (0.85)	47(5.92)	<0.0001
	Mutant-type 51I	1565 (96.66)	818 (99.15)	747(94.08)	
	<b>Codon 59</b> <i>N</i> samples processed	<b>1627</b>	<b>833</b>	<b>794</b>	
	Wild-type C59	27 (1.65)	6(0.72)	21(2.64)	0.0024
	Mutant-type 59R	1600 (98.34)	827 (99.28)	773(97.36)	
	<b>Codon 108</b> <i>N</i> samples processed	<b>1604</b>	<b>821</b>	<b>783</b>	
	Wild-type S108	4 (0.23)	0(0)	4(0.51)	0.0403
	Mutant-type 108N	1600 (99.75)	821(100)	779(99.49)	
	<b>Codon 164</b> <i>N</i> samples processed	<b>1604</b>	<b>824</b>	<b>785</b>	
	Wild-type I164	1609 (100)	824(100)	785(100)	NA
	Mutant-type 164L	0 (0)	0 (0)	0(0)	
<i>Pfdhps</i>	<b>Codon 437</b> <i>N</i> samples processed	<b>1579</b>	<b>809</b>	<b>770</b>	
	Wild-type A437	147(9.31)	42(5.19)	105(13.64)	<0.0001
	Mutant-type 437G	1432(90.69)	767 (94.80)	665(86.36)	
	<b>Codon 540</b> <i>N</i> samples processed	<b>1565</b>	<b>811</b>	<b>754</b>	
	Wild-type K540	1560(99.68)	810(99.88)	750(99.47)	0.2023
	Mutant-type 540E	5 (0.32)	1(0.12)	4(0.53)	
	<b>Codon 581</b> <i>N</i> samples processed	<b>1566</b>	<b>811</b>	<b>755</b>	
	Wild-type A581	1515 (96.74)	796 (98.15)	719(95.23)	0.001
	Mutant-type 581G	51 (3.26)	15 (1.85)	36 (4.77)	

The distribution of alleles at each SNP was compared between Mfou and Tibati using a Chi square test and the P-value is indicated. NA, not applicable.

<https://doi.org/10.1371/journal.pone.0256343.t004>

### Prevalence of SNPs in *Pfdhfr* and *Pfdhps* genes

The results of the allele-specific restriction analyses for each codon are presented in Table 4. Nearly all samples contained the *Pfdhfr* mutations at codons 51, 59 and 108. The overall prevalence of the mutant allele 51I was 1565/1619 (96.66%), with the occurrence being significantly more frequent in isolates from Mfou 818/825 (99.15%) than those from Tibati 747/794 (94.08%);  $P < 0.0001$ . The frequency of the mutant allele 59R was higher in Mfou, 827/833 (99.28%) than Tibati 773/794 (97.36%), ( $P = 0.0024$ ). The 108N allele appeared in all samples from Mfou (821) and in 779/783 (99.49%) isolates from Tibati. The difference was significant ( $P = 0.0403$ ), and the overall prevalence was 1600/1604 (99.7%). For 164 codon, all parasite isolates harbored the wild type allele I164. we combined the different SNPs for the *Pfdhfr* gene, and the triple mutant 51I, 59R, 108N (IRN) was the most frequent combination, found in 763/772 (98.83%) and 674/724 (93.09%) of samples in Mfou and Tibati, respectively ( $\chi^2 = 32.49$ ,  $P < 0.0001$ ).

In the *Pfdhps* gene, the 437G mutant allele appeared in more than 90% of the total isolates analyzed. It was found in 767/809 (94.80%) of the isolates from Mfou and 667/770 (86.36%) from Tibati ( $P < 0.0001$ ). *Pfdhps* mutations K540E and A581G were present in both sites although at low frequencies. We found the mutant allele 540E in five samples, 1/811 (0.12%) in Mfou and 4/754 (0.53%) in Tibati. The prevalence of the 581G mutant allele was 15/811 (1.85%) and 36/755 (4.77%) respectively, with statistically significant difference between both areas ( $P = 0.0011$ ). The combination of the different mutations found in *Pdhfr* and *Pdhps* genes are presented in Fig 3. A total of 14 genotypes were observed and the distribution of the

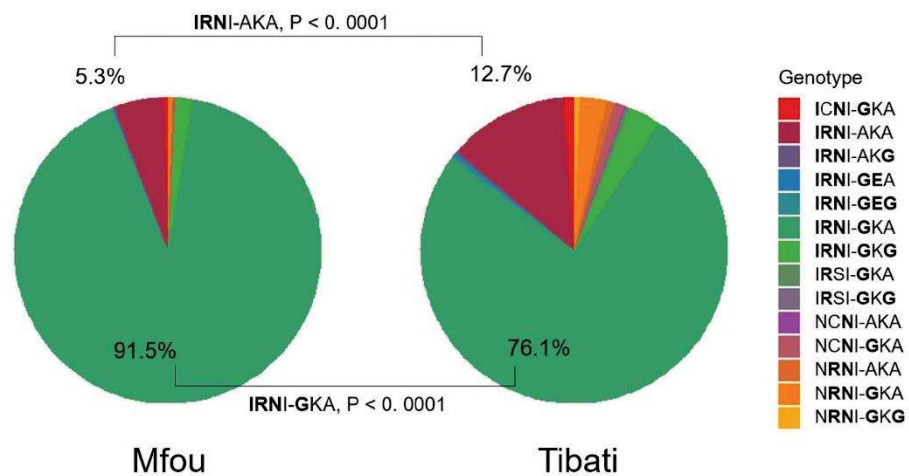

**Fig 3. Prevalence of combined *Pfdhfr*-*Pfdhps* genotypes in Mfou and Tibati.** The quadruple mutant IRNI-GKA was the most prevalent in both study sites, 706/772 (91.45%) in Mfou and 552/724 (76.24%) in Tibati, and the difference is significant ( $\chi^2 = 64.59$ ,  $P < 0.0001$ ; Fig 3). The triple mutant IRNI-AKA was more frequent in Tibati (12.7% versus 5.3% in Mfou,  $\chi^2 = 24.98$ ,  $P < 0.0001$ ; Fig 3). The wild-type genotype NCNI-AKA was never identified. The super-resistant genotype IRNI-GEG, a sextuple mutant associated to high level of SP resistance appeared in two samples from Tibati.

<https://doi.org/10.1371/journal.pone.0256343.g003>

different genotypes differed between the two study sites ( $P < 0.0001$ ). A higher diversity was observed in Tibati with 14 genotypes whereas, only 8 genotypes were recovered among samples from Mfou.

## Discussion

Antimalarial drug resistance remains a challenge for malaria control and elimination in most endemic countries. Regular surveillance of *P. falciparum* resistance is essential to monitor the efficacy of treatment guidelines. This study assessed the prevalence of antimalarial drug resistance mutations in *P. falciparum* genes, *Pfcr*, *Pfmdr1*, *Pfdhfr* and *Pfdhps*, in two different regions of Cameroon (Central and Adamawa Regions) more than 15 years after the malaria drug policy have changed from the use of CQ through AQ and SP to ACTs in 2004 [8, 53].

The present study found a high prevalence of the *Pfcr* K76 wild type genotype in our sample sets (79.18%). This finding is in line with earlier studies conducted in the Northwest Region of Cameroon [60], in the Eastern part of Cameroon [54] and in Southwest Region [12], that also reported the circulation of chloroquine-sensitive strains several years after CQ withdrawal as first-line treatment for malaria. The re-emergence of *P. falciparum* carrying the wild type allele was first observed in Malawi [61] and then in other African countries such as Tanzania [62], Kenya [63], Burkina Faso [35] and Ivory coast [64]. Despite the fact that the Cameroon government officially banned the use of chloroquine in 2002 [7], the frequency of the K76 wild type within the country was low until recently and differed between epidemiological settings [54, 65]. Indeed, the prevalence of *Pfcr* K76 wild type reported in this study is higher than the 53% reported by Ndam *et al.* [54] in samples collected in 2012 in the Eastern part of Cameroon. This suggests that the return of chloroquine sensitivity may not be similar across the



country, possibly because of different drug usage. Also, samples in Ndam's study were collected 9 years following the change in treatment policy whereas our study was carried out 15 years later. Our results then confirm that the decline in CQ resistant genotypes takes longer in West and Central Africa than in East Africa [66]. Here, we found a significantly higher proportion of the K76 wild type allele in Mfou than in Tibati (88.50% vs 69.29%,  $P < 0.0001$ ) and the difference could be due to the different use of CQ in the community. Indeed, despite the official withdrawal of CQ in 2002, the drug is still available through informal outlets, and particularly used for self-medication in some rural areas such as Tibati [15]. In 2012, a household survey conducted in Nigeria found that more than 50% of children suffering from malaria were given CQ even though the national malaria drug policy had changed to ACTs seven years ago [67, 68]. Hence, this CQ drug pressure has potentially interfered with recovery of CQ sensitive parasites in Nigeria. It is possible that CQ is also sold on local markets in Tibati because of its proximity with Nigeria or alternatively, the cross-border movements of people allow the spread [68, 69]. High level of the *Pfcr1* 76T mutant (74.6%) was observed in 2019 along the Cameroon-Nigeria border area [68], which further supports the above explanations. In addition, the use of SPAQ combination for SMC in the northern regions of Cameroon may lead to a selective pressure on the *Pfcr1* 76T mutant allele, as AQ resistance has been associated with selection of *Pfcr1* 76T and *Pfmdr1* 86Y [33]. By contrast, ACTs may be more accessible for people living in Mfou, due to its vicinity with the capital city, Yaoundé, and a larger use of AL for the treatment of uncomplicated malaria in Mfou may have contributed to the selection for the K76 allele [27].

The mutant allele 86Y in the *Pfmdr1* gene is associated with CQ resistance [70]. In the early 2000, the prevalence of *Pfmdr1* 86Y mutant allele was over 80% in several regions of Cameroon [13–15]. Our work shows a decrease in the prevalence of *Pfmdr1* 86Y mutant alleles, reaching 55.38% and 45.87% respectively in Mfou and Tibati. The results further show a low prevalence of *Pfmdr1* 1246Y mutant alleles (1.45 and 5.97%, respectively), a mutation related to CQ and quinine resistance. Our results are consistent with previous studies in Cameroon [10, 12], Gabon [71, 72], Nigeria [73], Mozambique [25] and Uganda [74, 75], showing significant reduction of *Pfmdr1* 86Y and 1246Y mutant alleles after replacement of CQ by ACTs. However, an overall similar proportion of both alleles N86 and 86Y (49.11% vs 50.89%) was observed in this study. It is plausible that the concurrent distribution of mutant and wild-type allele at codon 86 is a result of the simultaneous use of AS-AQ (first line) and AL (second line) for treatments of uncomplicated malaria in Cameroon [7]. In addition, previous studies have reported that the presence of the *Pfmdr1* N86 and 86Y alleles is currently being driven by an ACT-linked *P. falciparum* opposite selection [26, 33] and that AL and AS-AQ exerted opposite trends in selecting *Pfmdr1* N86Y and D1246Y mutations [26]. Following adoption of ACTs in many African malaria countries, some studies have shown that *Pfmdr1* 86Y and 1246Y mutant alleles are strongly selected by AS-AQ [27, 76]. Other studies indicate that the N86 and D1246 wild-type alleles are linked to a decrease of susceptibility to AL [27, 77]. In regard of these findings, it may be advantageous to use the two ACTs at the same time in the population in order to reduce the selection pressure of each treatment line and ensure the continuous effectiveness of ACTs in Cameroon.

SP was used for the treatment of uncomplicated malaria in Cameroon before its implementation for IPTp. Previous studies reported circulation of SP resistant parasites in the Central, North and South-East regions in the early 2000s [4, 14]. One of the goals of this study was to determine the prevalence of *Pfdhfr* and *Pfdhps* genotypes associated with SP resistance at present. Mutations at codons 51, 59 and 108 on the *Pfdhfr* gene were near saturation in our study. Even though high prevalences of *Pfdhfr* resistance alleles among *P. falciparum* in Cameroon were reported as early as 2000 [53], it is surprising to find high proportions nowadays

despite the adoption of ACTs for treatment of uncomplicated malaria. It is possible that the SP combination is still widely used outside the official sector for treatment of uncomplicated malaria by people who prefer to revert to SP instead of the three days daily doses of ACTs [10]. Additionally, the large-scale deployment of the IPTp and SMC interventions has certainly contributed to increase of drug pressure which has driven the spread of parasite resistance to SP [53]. The triple mutant IRN associated with high-level of pyrimethamine resistance was found in most of the samples analyzed in this study. This finding is in agreement with recent reports from Cameroon [9, 12] and in line with other studies carried out in other African countries such as Gabon (100%) [78] and Nigeria (93%) [79]. The *Pfdhfr* 164L mutant allele has been shown to be strongly associated with high pyrimethamine resistance in East Africa. In the current study, the *Pfdhfr* 164L mutant allele was not detected, and this result is consistent with previous reports in Cameroon [9, 80]. This mutation was recently detected in Equatorial Guinea although at low frequency, only two samples harboring it, which suggests that the I164L mutation is not widespread in Central Africa [81].

Considering sulphadoxine resistance, the *Pfdhps* 437G mutant allele was observed in more than 90% of analyzed samples, and was significantly more frequent in samples from Mfou than Tibati (94.80% vs 86.36%;  $P < 0.0001$ ). This prevalence was similar to that found by *Berzosa et al.* in Equatorial Guinea [81], but significantly higher than those reported few years ago in pregnant women from Yaoundé (76%) [9]. The current work showed a remarkable increase in 437G prevalence in Cameroon. It is known that the A437G mutation is strongly associated with resistance to sulfadoxine and increased risk of SP treatment failure in Africa [79]. The rising trend of the *Pfdhps* mutation underscores the need for regular monitoring in different areas of Cameroon where SP is used for malaria interventions. Although a higher prevalence of *Pfdhps* 437G mutant allele was observed in the present study. The prevalence of the *Pfdhps* mutant allele 540E was very low, detected in only 5 samples (0.33%). Hence, the prevalence of the *Pfdhps* 540E mutation in Cameroon remains low and relatively stable [9, 14]. In contrast, the *Pfdhps* 540E is common in East Africa, and its prevalence is generally high [41, 46]. This mutation is known to be less prevalent in Central Africa, which was confirmed in this study. Similar to 540E, 581G *Pfdhps* mutation has been reported to occupy the crucial position in the modulation of sulfadoxine resistance. In Cameroon, the *Pfdhps* 581G mutant allele was previously found in 5.9% of samples collected from Yaounde in 2015 [9]. Overall, this work reported a prevalence of 3.26% of the 581G allele. A meta-analysis in Africa demonstrated that IPTp efficacy was reduced when the prevalence of 581G was above 10% [82]. This threshold was not observed in this work. Although we do not report information on the *Pfdhps* I431V mutation in this study, it is important to note that this mutation is emerging in West and Central Africa, and has already been reported in Cameroon by Chauvin *et al.* and in Nigeria by Oguike *et al.* [9, 50]. Its association with other *Pfdhps* mutations such as A437G and A581G identified here could be associated with SP failure. Further work will have to determine I431V prevalence in the studied areas.

The quadruple mutant *Pfdhfr* 511/59R/108N + *Pfdhps* 437G (IRNG) conferring partial resistance to SP was most predominant in this study, with a prevalence close to 90%, and higher than reports from Equatorial Guinea (54%) [81] and Nigeria (42.6%) [79]. This high prevalence of quadruple mutants suggests high risks of SP treatment failure in IPTp and SMC. Mutations *Pfdhps* K540E and A581G are key indicators for the quintuple and sextuple mutants associated to SP failure [40, 41]. In 2015, the quintuple mutant that includes the *Pfdhps* 540E mutation was found in two samples from Yaounde in women who had taken SP in IPTp [9].

We found the *Pfdhps* 540E mutation in five samples as quintuple mutants carrying the IRNGE genotype, and this confirms the circulation of parasites fully resistant to SP in Cameroon. Another important finding of this work was the presence of the IRNGEG sextuple mutant

genotype in 2 samples from Tibati, a genotype determining super resistant parasites and associated with SP treatment failure. Even if the effectiveness of SP in IPTp and SMC seems to be preserved in Cameroon, the fact that we have identified fully and super resistant parasites raises concerns about the future efficacy of SP chemoprevention. This finding therefore warrants thorough monitoring of *Pfdhps* and *Pfdhfr* mutation prevalence in Cameroon.

However, this survey was limited to two regions of Cameroon. Additional, and more extensive studies in other geographical parts of the country will be able to provide the best mapping tool for monitoring the spread and evolution of antimalarial drug resistance. Moreover, the molecular profile of antimalarial drug resistance should also target additional SNPs lacking in this study such as the *Pfmdr1* Y184F linked to modulation of ACTs sensitivity, *Pfdhps* I431V associated to SP resistance, and the *Pfk13* SNPs related to artemisinin resistance.

## Conclusion

This work showed a high prevalence of the *Pfcr* K76, *Pfmdr1* N86 and D1246 wild-type alleles in *P. falciparum* isolates from Mfou and Tibati, Cameroon, indicating a return of the 4-aminoquinoline susceptible parasite strains, especially to CQ sensitive genotypes. This finding is in line with other reports from sub-Saharan Africa, even if return to CQ wild type parasites arose slowly in Central Africa. It has been postulated that re-emergence of CQ sensitive parasites raises the possibility of reintroducing CQ, in combination with another antimalarial drug, for malaria prevention and treatment. However, CQ drug pressure since the COVID-19 pandemic in early 2020 is likely to change the current trend of CQ resistance decline. Furthermore, we report a high prevalence of *Pfdhfr* and *Pfdhps* mutant alleles conferring resistance to SP. The prevalence of *Pfdhfr* triple mutations was nearly saturated and there was an increased prevalence in *Pfdhps* 437G mutation when compared with previous reports in Cameroon and in other endemic countries. Unfortunately, partially, fully and super resistant genotypes conferring SP failure were detected in this study and this raises concerns about efficacy and future use of IPTp and SMC in Cameroon. Here, we provided the first report on the current situation of antimalarial drug resistance in the Adamawa region of Cameroon since the change of malaria drug policy. Globally, findings from this study indicate that increased vigilance and regular monitoring of molecular markers associated with malaria drug resistance will be crucial for malaria control in Cameroon.

## Acknowledgments

We would like to thank the people who agreed to participate in this survey as well as the health staff of the districts of Mfou and Tibati, the Malaria Research Unit of Centre Pasteur of Cameroon and the UMR MIVEGEC in Montpellier, France, for their support and cooperation during the study. We also express our gratitude to the French Embassy in Cameroon who granted a 6-month fellowship to AGBT for a scientific research exchange at the UMR MIVEGEC in Montpellier.

## Author Contributions

**Conceptualization:** Aline Gaelle Bouopda Tuedom, Carole Else Eboumbou Moukoko, Isabelle Morlais, Sandrine Eveline Nsango.

**Data curation:** Aline Gaelle Bouopda Tuedom, Luc Abate, Sandrine Eveline Nsango.

**Formal analysis:** Aline Gaelle Bouopda Tuedom, Luc Abate, Sandrine Eveline Nsango.

**Funding acquisition:** Sandrine Eveline Nsango.



**Investigation:** Aline Gaelle Bouopda Tuedom, Brice Lionel Feufack-Donfack, Christelle Ngou Maffo, Albert Ngano Bayibeki, Sandrine Eveline Nsango.

**Methodology:** Aline Gaelle Bouopda Tuedom, Elangwe Milo Sarah-Matio, Brice Lionel Feufack-Donfack, Luc Abate, Sandrine Eveline Nsango.

**Project administration:** Sandrine Eveline Nsango.

**Resources:** Sandrine Eveline Nsango.

**Software:** Aline Gaelle Bouopda Tuedom, Luc Abate, Sandrine Eveline Nsango.

**Supervision:** Isabelle Morlais, Sandrine Eveline Nsango.

**Validation:** Isabelle Morlais, Sandrine Eveline Nsango.

**Visualization:** Sandrine Eveline Nsango.

**Writing – original draft:** Aline Gaelle Bouopda Tuedom, Isabelle Morlais, Sandrine Eveline Nsango.

**Writing – review & editing:** Aline Gaelle Bouopda Tuedom, Elangwe Milo Sarah-Matio, Carole Else Eboumbou Moukoko, Brice Lionel Feufack-Donfack, Christelle Ngou Maffo, Albert Ngano Bayibeki, Hermann Parfait Awono-Ambene, Lawrence Ayong, Antoine Berry, Luc Abate, Isabelle Morlais, Sandrine Eveline Nsango.

## References

1. WHO. World Malaria Report. Geneva, Switzerland: World Health Organization. 2020; <https://www.who.int/publications/item/9789240015791>
2. PNL. Rapport annuel du Programme de Lutte contre le Paludisme. Yaoundé Cameroun. 2020; <http://onsp.minsante.cm/fr/publication/230/rapportannuel-2019-lutte-contre-le-paludisme>.
3. Guerra CA, Donfack OT, Vaz LM, Niang JAM, Nchama LON, Eyono JNM, et al. Malaria vector control in sub-Saharan Africa in the time of COVID-19: no room for complacency. *BMJ Global Health*. 2020; 5: e003880. <https://doi.org/10.1136/bmjgh-2020-003880> PMID: 32938611
4. Basco LK, Ngane VF, Ndounga M, Same-Ekobo A, Youmba JC, Abodo RT, et al. Molecular epidemiology of malaria in Cameroon. XXI. baseline therapeutic efficacy of chloroquine, amodiaquine, and sulfadoxine-pyrimethamine monotherapies in children before national drug policy change. *Am J Trop Med Hyg*. 2006; 75: 388–395. <https://doi.org/10.4269/ajtmh.2006.75.388> PMID: 16968911
5. Packard RM. The Origins of Antimalarial-Drug Resistance. *N Engl J Med*. 2014; 371: 397–399. <https://doi.org/10.1056/NEJMp1403340> PMID: 25075832
6. WHO. Global report on antimalarial drug efficacy and drug resistance: 2000–2010. Geneva, Switzerland: World Health Organization. 2010; [http://whqlibdoc.who.int/publications/2010/9789241500470\\_eng.pdf](http://whqlibdoc.who.int/publications/2010/9789241500470_eng.pdf)
7. Sayang C, Gausseres M, Vernazza-Licht N, Malvy D, Bley D, Millet P. Treatment of malaria from monotherapy to artemisinin-based combination therapy by health professionals in urban health facilities in Yaoundé, central province, Cameroon. *Malar J*. 2009; 8: 176. <https://doi.org/10.1186/1475-2875-8-176> PMID: 19640292
8. FY-2020-cameroon-malaria-operational-plan.2021. <https://www.pmi.gov/docs/default-source/default-document-library/malaria-operational-plans/fy20/fy-2020-cameroon-malaria-operational-plan.pdf?sfvrsn=6>
9. Chauvin P, Menard S, Iriart X, Nsango SE, Tchioffo MT, Abate L, et al. Prevalence of Plasmodium falciparum parasites resistant to sulfadoxine/pyrimethamine in pregnant women in Yaoundé, Cameroon: emergence of highly resistant pfdhfr/pfdhps alleles. *J Antimicrob Chemother*. 2015; 70: 2566–2571. PMID: 26080363
10. Moyeh MN, Njimoh DL, Evehe MS, Ali IM, Nji AM, Nkafu DN, et al. Effects of Drug Policy Changes on Evolution of Molecular Markers of Plasmodium falciparum Resistance to Chloroquine, Amodiaquine, and Sulphadoxine-Pyrimethamine in the South West Region of Cameroon. *Malar Res Treat*. 2018; 2018. <https://doi.org/10.1155/2018/7071383> PMID: 29854394

11. Antonio-Nkondjio C, Ndo C, Njiokou F, Bigoga JD, Awono-Ambene P, Etang J, et al. Review of malaria situation in Cameroon: technical viewpoint on challenges and prospects for disease elimination. *Parasites and Vectors*. 2019; 12: 501. <https://doi.org/10.1186/s13071-019-3753-8> PMID: 31655608
12. Apinjoh TO, Mugri RN, Miotto O, Chi HF, Tata RB, Anchang-Kimbi JK, et al. Molecular markers for artemisinin and partner drug resistance in natural *Plasmodium falciparum* populations following increased insecticide treated net coverage along the slope of mount Cameroon: cross-sectional study. *Infect Dis Poverty*. 2017; 6. <https://doi.org/10.1186/s40249-017-0350-y> PMID: 29110722
13. Basco LK, Ringwald P. Molecular epidemiology of malaria in Cameroon. X. Evaluation of *Pfmdr1* mutations as genetic markers for resistance to amino alcohols and artemisinin derivatives. *Am J Trop Med Hyg*. 2002; 66: 667–671. <https://doi.org/10.4269/ajtmh.2002.66.667> PMID: 12224572
14. Mbacham WF, Evehe M-SB, Netongo PM, Ateh IA, Mimche PN, Ajua A, et al. Efficacy of amodiaquine, sulphadoxine-pyrimethamine and their combination for the treatment of uncomplicated *Plasmodium falciparum* malaria in children in Cameroon at the time of policy change to artemisinin-based combination therapy. *Malar J*. 2010; 9: 34. <https://doi.org/10.1186/1475-2875-9-34> PMID: 20105282
15. Menard S, Morlais I, Tahar R, Sayang C, Mayengue PI, Iriart X, et al. Molecular monitoring of *Plasmodium falciparum* drug susceptibility at the time of the introduction of artemisinin-based combination therapy in Yaoundé, Cameroon: Implications for the future. *Malar J*. 2012; 11: 113. <https://doi.org/10.1186/1475-2875-11-113> PMID: 22498364
16. Phyto AP, Nkhoma S, Stepniwska K, Ashley EA, Nair S, McGready R, et al. Emergence of artemisinin-resistant malaria on the western border of Thailand: a longitudinal study. *Lancet*. 2012; 379: 1960–1966. [https://doi.org/10.1016/S0140-6736\(12\)60484-X](https://doi.org/10.1016/S0140-6736(12)60484-X) PMID: 22484134
17. Hien TT, Thuy-Nhien NT, Phu NH, Boni MF, Thanh NV, Nha-Ca NT, et al. In vivo susceptibility of *Plasmodium falciparum* to artesunate in Binh Phuoc Province, Vietnam. *Malar J*. 2012; 11: 355. <https://doi.org/10.1186/1475-2875-11-355> PMID: 23101492
18. Kyaw MP, Nyunt MH, Chit K, Aye MM, Aye KH, Aye MM, et al. Reduced Susceptibility of *Plasmodium falciparum* to Artesunate in Southern Myanmar. *PLoS One*. 2013; 8: e57689. <https://doi.org/10.1371/journal.pone.0057689> PMID: 23520478
19. Talundzic E, Okoth SA, Congpuong K, Plucinski MM, Morton L, Goldman IF, et al. Selection and Spread of Artemisinin-Resistant Alleles in Thailand Prior to the Global Artemisinin Resistance Containment Campaign. *PLoS Pathog*. 2015; 11: e1004789. <https://doi.org/10.1371/journal.ppat.1004789> PMID: 25836766
20. Taylor SM, Juliano JJ. Artemisinin Combination Therapies and Malaria Parasite Drug Resistance: The Game Is Afoot. *J Infect Dis*. 2014; 210: 335–337. PMID: 24610873
21. Eboumbou Moukoko CE, Huang F, Nsango SE, Kojom Foko LP, Ebong SB, Epee Eboumbou P, et al. K-13 propeller gene polymorphisms isolated between 2014 and 2017 from Cameroonian *Plasmodium falciparum* malaria patients. *PLoS One*. 2019; 14: e0221895. <https://doi.org/10.1371/journal.pone.0221895> PMID: 31479501
22. Ogouyèmi-Hounto A, Damien G, Deme AB, Ndam NT, Assouhou C, Tchoulin D, et al. Lack of artemisinin resistance in *Plasmodium falciparum* in northwest Benin after 10 years of use of artemisinin-based combination therapy. *Parasite*. 2016; 23: 28. <https://doi.org/10.1051/parasite/2016028> PMID: 27443837
23. Okell LC, Reiter LM, Ebbe LS, Baraka V, Bisanzio D, Watson OJ, et al. Emerging implications of policies on malaria treatment: genetic changes in the *Pfmdr-1* gene affecting susceptibility to artemether–lumefantrine and artesunate–amodiaquine in Africa. *BMJ Glob Health*. 2018; 3: e000999. <https://doi.org/10.1136/bmjgh-2018-000999> PMID: 30397515
24. Whengang Youdom S, Chiabi A, Basco LK. Monitoring the Efficacy and Safety of Artemisinin-Based Combination Therapies: A Review and Network Meta-analysis of Antimalarial Therapeutic Efficacy Trials in Cameroon. *Drugs R D*. 2019; 19: 1–14. <https://doi.org/10.1007/s40268-018-0259-3> PMID: 30656608
25. Lobo E, de Sousa B, Rosa S, Figueiredo P, Lobo L, Pateira S, et al. Prevalence of *pfmdr1* alleles associated with artemether-lumefantrine tolerance/resistance in Maputo before and after the implementation of artemisinin-based combination therapy. *Malar J*. 2014; 13: 300. <https://doi.org/10.1186/1475-2875-13-300> PMID: 25098280
26. Sondo P, Derra K, Diallo Nakanabo S, Tarnagda Z, Kazienga A, Zampa O, et al. Artesunate-Amodiaquine and Artemether-Lumefantrine Therapies and Selection of *Pfprt* and *Pfmdr1* Alleles in Nanoro, Burkina Faso. *PLoS One*. 2016; 11. <https://doi.org/10.1371/journal.pone.0151565> PMID: 27031231
27. Venkatesan M, Gadalla NB, Stepniwska K, Dahal P, Nsanzabana C, Moriera C, et al. Polymorphisms in *Plasmodium falciparum* Chloroquine Resistance Transporter and Multidrug Resistance 1 Genes: Parasite Risk Factors that Affect Treatment Outcomes for *P. falciparum* Malaria after Artemether-Lumefantrine and Artesunate-Amodiaquine. *Am J Trop Med Hyg*. 2014; 91: 833–843. <https://doi.org/10.4269/ajtmh.14-0031> PMID: 25048375



28. Fidock DA, Nomura T, Talley AK, Cooper RA, Dzekunov SM, Ferdig MT, et al. Mutations in the *P. falciparum* Digestive Vacuole Transmembrane Protein PfCRT and Evidence for Their Role in Chloroquine Resistance. *Mol Cell*. 2000; 6: 861–871. [https://doi.org/10.1016/s1097-2765\(05\)00077-8](https://doi.org/10.1016/s1097-2765(05)00077-8) PMID: 11090624
29. Plowe CV. The evolution of drug-resistant malaria. *Trans R Soc Trop Med Hyg*. 2009; 103: S11–S14. PMID: 19084883
30. Djimdé A, Doumbo OK, Cortese JF, Kayentao K, Doumbo S, Diouré Y, et al. A molecular marker for chloroquine-resistant *falciparum* malaria. *N Engl J Med*. 2001; 344: 257–263. <https://doi.org/10.1056/NEJM200101253440403> PMID: 11172152
31. Foote SJ, Kyle DE, Martin RK, Oduola AM, Forsyth K, Kemp DJ, et al. Several alleles of the multidrug-resistance gene are closely linked to chloroquine resistance in *Plasmodium falciparum*. *Nature*. 1990; 345: 255–258. <https://doi.org/10.1038/345255a0> PMID: 2185424
32. Reed MB, Saliba KJ, Caruana SR, Kirk K, Cowman AF. Pgh1 modulates sensitivity and resistance to multiple antimalarials in *Plasmodium falciparum*. *Nature*. 2000; 403: 906–909. <https://doi.org/10.1038/35002615> PMID: 10706290
33. Holmgren G, Hamrin J, Svård J, Mårtensson A, Gil JP, Björkman A. Selection of *pfmdr1* mutations after amodiaquine monotherapy and amodiaquine plus artemisinin combination therapy in East Africa. *Infect Genet Evol*. 2007; 7: 562–569. <https://doi.org/10.1016/j.meegid.2007.03.005> PMID: 17467344
34. Otienoburu SD, Maiga-Ascofaré O, Schramm B, Jullien V, Jones JJ, Zolia YM, et al. Selection of *Plasmodium falciparum* *pfprt* and *pfmdr1* polymorphisms after treatment with artesunate–amodiaquine fixed dose combination or artemether–lumefantrine in Liberia. *Malar J*. 2016; 15: 452. <https://doi.org/10.1186/s12936-016-1503-3> PMID: 27596849
35. Sondo P, Derra K, Tarnagda Z, Nakanabo SD, Zampa O, Kazienga A, et al. Dynamic of *plasmodium falciparum* chloroquine resistance transporter gene *Pfprt* K76T mutation five years after withdrawal of chloroquine in Burkina Faso. *Pan Afr Med J*. 2015; 21. <https://doi.org/10.11604/pamj.2015.21.101.6437> PMID: 26516402
36. Gregson A, Plowe CV. Mechanisms of resistance of malaria parasites to antifolates. *Pharmacol Rev*. 2005; 57: 117–145. <https://doi.org/10.1124/pr.57.1.4> PMID: 15734729
37. Paget-McNicol S, Saul A. Mutation rates in the dihydrofolate reductase gene of *Plasmodium falciparum*. *Parasitology*. 2001; 122: 497–505. <https://doi.org/10.1017/s0031182001007739> PMID: 11393822
38. Kublin JG, Dzinjalama FK, Kamwendo DD, Malkin EM, Cortese JF, Martino LM, et al. Molecular Markers for Failure of Sulfadoxine–Pyrimethamine and Chlorproguanil–Dapsone Treatment of *Plasmodium falciparum* Malaria. *J Infect Dis*. 2002; 185: 380–388. PMID: 11807721
39. Mita T, Ohashi J, Venkatesan M, Marma ASP, Nakamura M, Plowe CV, et al. Ordered Accumulation of Mutations Conferring Resistance to Sulfadoxine–Pyrimethamine in the *Plasmodium falciparum* Parasite. *J Infect Dis*. 2014; 209: 130–139. PMID: 23922363
40. Anchang-Kimbi JK, Kalaji LN, Mbacham HF, Wepnje GB, Apinjoh TO, Ngole Sumbele IU, et al. Coverage and effectiveness of intermittent preventive treatment in pregnancy with sulfadoxine–pyrimethamine (IPTp-SP) on adverse pregnancy outcomes in the Mount Cameroon area, South West Cameroon. *Malar J*. 2020; 19: 100. <https://doi.org/10.1186/s12936-020-03155-2> PMID: 32122339
41. Naidoo I, Roper C. Mapping 'partially resistant', 'fully resistant', and 'super resistant' malaria. *Trends in Parasitology*. 2013; 29: 505–515. <https://doi.org/10.1016/j.pt.2013.08.002> PMID: 24028889
42. Xu C, Sun H, Wei Q, Li J, Xiao T, Kong X, et al. Mutation Profile of *pfdhfr* and *pfdhps* in *Plasmodium falciparum* among Returned Chinese Migrant Workers from Africa. *Antimicrob Agents Chemother*. 2019; 63: e01927–18. <https://doi.org/10.1128/AAC.01927-18> PMID: 30803964
43. Jiang T, Chen J, Fu H, Wu K, Yao Y, Eyi JUM, et al. High prevalence of *Pfdhfr*–*Pfdhps* quadruple mutations associated with sulfadoxine–pyrimethamine resistance in *Plasmodium falciparum* isolates from Bioko Island, Equatorial Guinea. *Malar J*. 2019; 18: 101. <https://doi.org/10.1186/s12936-019-2734-x> PMID: 30914041
44. Desai M, Gutman J, Taylor SM, Wiegand RE, Khairallah C, Kayentao K, et al. Impact of Sulfadoxine–Pyrimethamine Resistance on Effectiveness of Intermittent Preventive Therapy for Malaria in Pregnancy at Clearing Infections and Preventing Low Birth Weight. *Clin Infect Dis*. 2016; 62: 323–333. PMID: 26486699
45. Pacheco MA, Schneider KA, Cheng Q, Munde EO, Ndege C, Onyango C, et al. Changes in the frequencies of *Plasmodium falciparum* *dhps* and *dhfr* drug-resistant mutations in children from Western Kenya from 2005 to 2018: the rise of *Pfdhps* S436H. *Malar J*. 2020; 19: 378. <https://doi.org/10.1186/s12936-020-03454-8> PMID: 33092587
46. Matondo SI, Temba GS, Kavishe AA, Kauki JS, Kalinga A, van Zwetselaar M, et al. High levels of sulfadoxine–pyrimethamine resistance *Pfdhfr*–*Pfdhps* quintuple mutations: a cross sectional survey of six

- regions in Tanzania. *Malar J.* 2014; 13: 152. <https://doi.org/10.1186/1475-2875-13-152> PMID: 24751352
47. Baraka V, Ishengoma DS, Fransis F, Minja DTR, Madebe RA, Ngatunga D, et al. High-level Plasmodium falciparum sulfadoxine-pyrimethamine resistance with the concomitant occurrence of septuple haplotype in Tanzania. *Malar J.* 2015; 14: 439. <https://doi.org/10.1186/s12936-015-0977-8> PMID: 26542942
  48. Taylor SM, Antonia AL, Harrington WE, Goheen MM, Mwapasa V, Chaluluka E, et al. Independent Lineages of Highly Sulfadoxine-Resistant Plasmodium falciparum Haplotypes, Eastern Africa. *Emerg Infect Dis.* 2014; 20: 1140–1148. <https://doi.org/10.3201/eid2007.131720> PMID: 24960247
  49. Sutherland CJ, Fifer H, Pearce RJ, bin Reza F, Nicholas M, Haustein T, et al. Novel pfdhps Haplotypes among Imported Cases of Plasmodium falciparum Malaria in the United Kingdom. *Antimicrob Agents Chemother.* 2009; 53: 3405–3410. <https://doi.org/10.1128/AAC.00024-09> PMID: 19433569
  50. Oguike MC, Falade CO, Shu E, Enato IG, Watila I, Baba ES, et al. Molecular determinants of sulfadoxine-pyrimethamine resistance in Plasmodium falciparum in Nigeria and the regional emergence of dhps 431V. *Int J Parasitol Drugs Drug Resist.* 2016; 6: 220–229. <https://doi.org/10.1016/j.ijpddr.2016.08.004> PMID: 27821281
  51. Svigel SS, Adeothy A, Kpemasse A, Houngbo E, Sianou A, Saliou R, et al. Low prevalence of highly sulfadoxine-resistant dihydropteroate synthase alleles in Plasmodium falciparum isolates in Benin. *Malar J.* 2021; 20. <https://doi.org/10.1186/s12936-021-03605-5> PMID: 33546703
  52. Basco LK, Ringwald P. Analysis of the Key pfprt Point Mutation and In Vitro and In Vivo Response to Chloroquine in Yaoundé, Cameroon. *J Infect Dis.* 2001; 183: 1828–1831.
  53. Niba PTN, Nji AM, Evehe M-S, Ali IM, Netongo PM, Ngwafor R, et al. Drug resistance markers within an evolving efficacy of anti-malarial drugs in Cameroon: a systematic review and meta-analysis (1998–2020). *Malar J.* 2021; 20: 32. <https://doi.org/10.1186/s12936-020-03543-8> PMID: 33422080
  54. Ndam NT, Basco LK, Ngane VF, Ayoub A, Ngolle EM, Deloron P, et al. Reemergence of chloroquine-sensitive pfprt K76 Plasmodium falciparum genotype in southeastern Cameroon. *Malar J.* 2017; 16: 130. <https://doi.org/10.1186/s12936-017-1783-2> PMID: 28347314
  55. Lindblade KA, Steinhardt L, Samuels A, Kachur SP, Slutsker L. The silent threat: asymptomatic parasitemia and malaria transmission. *Expert Rev Anti Infect Ther.* 2013; 11: 623–639. <https://doi.org/10.1586/eri.13.45> PMID: 23750733
  56. Plowe CV, Djimde A, Bouare M, Doumbo O, Wellems TE. Pyrimethamine and proguanil resistance-conferring mutations in Plasmodium falciparum dihydrofolate reductase: polymerase chain reaction methods for surveillance in Africa. *Am J Trop Med Hyg.* 1995; 52: 565–568. <https://doi.org/10.4269/ajtmh.1995.52.565> PMID: 7611566
  57. Mangold KA, Manson RU, Koay ESC, Stephens L, Regner M, Thomson RB, et al. Real-Time PCR for Detection and Identification of Plasmodium spp. *J Clin Microbiol.* 2005; 43: 2435–2440. <https://doi.org/10.1128/JCM.43.5.2435-2440.2005> PMID: 15872277
  58. Charan J, Biswas T. How to Calculate Sample Size for Different Study Designs in Medical Research? *Indian J Psychol Med.* 2013; 35: 121–126. PMID: 24049221
  59. Cameroon Demographic and Health Survey. Yaoundé Cameroun. 2018; <https://www.dhsprogram.com/pubs/pdf/OF44/OF44.PAL.E.pdf>
  60. Achungu CR, Nkuo-Akenji T, Tobias A, Samuel W. Re-Emergence of Chloroquine Sensitive Plasmodium falciparum after Several Years of Chloroquine Withdrawal in Bamenda, North West Cameroon. *EC Microbiol.* 2018:831–6.
  61. Kublin JG, Cortese JF, Njunju EM, Mukadam RAG, Wirima JJ, Kazembe PN, et al. Reemergence of Chloroquine-Sensitive Plasmodium falciparum Malaria after Cessation of Chloroquine Use in Malawi. *J Infect Dis.* 2003; 187: 1870–1875. PMID: 12792863
  62. Bridges DJ, Molyneux M, Nkhoma S. Low level genotypic chloroquine resistance near Malawi's northern border with Tanzania. *Trop Med Int Health.* 2009; 14: 1093–1096. <https://doi.org/10.1111/j.1365-3156.2009.02340.x> PMID: 19624477
  63. Kiarie WC, Wangai L, Agola E, Kimani FT, Hungu C. Chloroquine sensitivity: diminished prevalence of chloroquine-resistant gene marker pfprt-76 13 years after cessation of chloroquine use in Msambweni, Kenya. *Malar J.* 2015; 14. <https://doi.org/10.1186/s12936-015-0850-9> PMID: 26296743
  64. Dagnogo O, Ako AB, Ouattara L, Dago ND, Coulibaly DN, Touré AO, et al. Towards a re-emergence of chloroquine sensitivity in Côte d'Ivoire? *Malar J.* 2018; 17: 413. <https://doi.org/10.1186/s12936-018-2551-7> PMID: 30404640
  65. Dossou-Yovo LR, Ntoumi F, Koukouikila-Koussounda F, Vouvougui JC, Adedjoja A, Nderu D, et al. Molecular surveillance of the Pfmdr1 N86Y allele among Congolese pregnant women with asymptomatic malaria. *Malar J.* 2020; 19: 178. <https://doi.org/10.1186/s12936-020-03246-0> PMID: 32384930



66. Mwanza S, Joshi S, Nambozi M, Chileshe J, Malunga P, Kabuya J-BB, et al. The return of chloroquine-susceptible *Plasmodium falciparum* malaria in Zambia. *Malar J.* 2016; 15: 584. <https://doi.org/10.1186/s12936-016-1637-3> PMID: 27919256
67. Brieger\_2017\_Where is chloroquine now\_Africa Health. available: [http://reprolineplus.org/system/files/resources/Brieger\\_2017\\_Where%20is%20chloroquine%20now\\_AfricaHealth.pdf](http://reprolineplus.org/system/files/resources/Brieger_2017_Where%20is%20chloroquine%20now_AfricaHealth.pdf)
68. Tientche B, Fru-Cho J, Anong DN, Nkuo-Akenji TK. Genetic Polymorphisms of Pfcrt K76T and Pfmdr1 N86Y among Asymptomatic School Children in Forest Communities of Ekondo Titi Subdivision along the Cameroon-Nigeria Border Area. *Int J Trop Dis Health.* 2019; 1–16.
69. Oladipo OO, Wellington OA, Sutherland CJ. Persistence of chloroquine-resistant haplotypes of *Plasmodium falciparum* in children with uncomplicated Malaria in Lagos, Nigeria, four years after change of chloroquine as first-line antimalarial medicine. *Diagnostic Pathology.* 2015; 10: 41. <https://doi.org/10.1186/s13000-015-0276-2> PMID: 25928117
70. Tinto H, Guekoun L, Zongo I, Guiguemdé RT, D'Alessandro U, Ouédraogo JB. Chloroquine-resistance molecular markers (Pfcrt T76 and Pfmdr-1 Y86) and amodiaquine resistance in Burkina Faso. *Trop Med Int Health.* 2008; 13: 238–240. <https://doi.org/10.1111/j.1365-3156.2007.01995.x> PMID: 18304270
71. Lekana-Douki JB, Boutamba SDD, Zatra R, Edou SEZ, Ekomy H, Bisvigou U, et al. Increased prevalence of the *Plasmodium falciparum* Pfmdr1 86N genotype among field isolates from Franceville, Gabon after replacement of chloroquine by artemether–lumefantrine and artesunate–mefloquine. *Infect Geneti Evol.* 2011; 11: 512–517. <https://doi.org/10.1016/j.meegid.2011.01.003> PMID: 21251998
72. Maghendji-Nzondo S, Kouna L-C, Mourembou G, Boundenga L, Imboumy-Limoukou R-K, Matsiegui P-B, et al. Malaria in urban, semi-urban and rural areas of southern of Gabon: comparison of the Pfmdr 1 and Pfcrt genotypes from symptomatic children. *Malar J.* 2016; 15: 420. <https://doi.org/10.1186/s12936-016-1469-1> PMID: 27538948
73. Adamu A, Jada MS, Haruna HMS, Yakubu BO, Ibrahim MA, Balogun EO, et al. *Plasmodium Falciparum* Multidrug Resistance Gene-1 N86Y-Y184F-D1246Y Polymorphisms in Northern Nigeria: Implications for the Continued Use of Artemether-Lumefantrine in the Region. 2020; 19(1):439. <https://doi.org/10.1186/s12936-020-03506-z> PMID: 33256739
74. Achol E, Ochaya S, Malinga GM, Edema H, Echodu R. High prevalence of Pfmdr-1 N86 and D1246 genotypes detected among febrile malaria outpatients attending Lira Regional Referral Hospital, Northern Uganda. *BMC Res Notes.* 2019; 12: 235. <https://doi.org/10.1186/s13104-019-4269-1> PMID: 31014391
75. Conrad MD, Staedke SG, Tappero J, Kanya M, Nankoberanyi S, Tukwasibwe S, et al. Temporal Changes in Prevalence of Molecular Markers Mediating Antimalarial Drug Resistance in a High Malaria Transmission Setting in Uganda. *Am J Trop Med Hyg.* 2014; 91: 54–61. <https://doi.org/10.4269/ajtmh.13-0647> PMID: 24799371
76. Malmberg M, Ferreira PE, Tarning J, Ursing J, Ngasala B, Björkman A, et al. *Plasmodium falciparum* Drug Resistance Phenotype as Assessed by Patient Antimalarial Drug Levels and Its Association With pfmdr1 Polymorphisms. *J Infect Dis.* 2013; 207: 842–847. PMID: 23225895
77. Sisowath C, Strömberg J, Mårtensson A, Msellem M, Obondo C, Björkman A, et al. In Vivo Selection of *Plasmodium falciparum* pfmdr1 86N Coding Alleles by Artemether-Lumefantrine (Coartem). *J Infect Dis.* 2005; 191: 1014–1017. PMID: 15717281
78. Voumbo-Matoumona DF, Kouna LC, Madamet M, Maghendji-Nzondo S, Pradines B, Lekana-Douki JB. Prevalence of *Plasmodium falciparum* antimalarial drug resistance genes in Southeastern Gabon from 2011 to 2014. *Infect Drug Resist.* 2018; 11: 1329–1338. <https://doi.org/10.2147/IDR.S160164> PMID: 30214253
79. Quan H, Igbasi U, Oyibo W, Omilabu S, Chen S-B, Shen H-M, et al. High multiple mutations of *Plasmodium falciparum*-resistant genotypes to sulphadoxine-pyrimethamine in Lagos, Nigeria. *Infect Dis Poverty.* 2020; 9: 91. <https://doi.org/10.1186/s40249-020-00712-4> PMID: 32653033
80. Tahar R, Basco LK. Molecular epidemiology of malaria in cameroon. XXII. geographic mapping and distribution of *plasmodium falciparum* dihydrofolate reductase (dhfr) mutant alleles. *Am J Trop Med Hyg.* 2006; 75: 396–401. <https://doi.org/10.4269/ajtmh.2006.75.396> PMID: 16968912
81. Berzosa P, Esteban-Cantos A, García L, González V, Navarro M, Fernández T, et al. Profile of molecular mutations in pfdhfr, pfdhps, pfmdr1, and pfcrt genes of *Plasmodium falciparum* related to resistance to different anti-malarial drugs in the Bata District (Equatorial Guinea). *Malar J.* 2017; 16: 28. <https://doi.org/10.1186/s12936-016-1672-0> PMID: 28086777
82. Okell LC, Griffin JT, Roper C. Mapping sulphadoxine-pyrimethamine-resistant *Plasmodium falciparum* malaria in infected humans and in parasite populations in Africa. *Sci Rep.* 2017; 7: 7389. <https://doi.org/10.1038/s41598-017-06708-9> PMID: 28785011

**Discussion and conclusion:** We looked at major antimalarial drug resistance mutations in the *Pfcr1*, *Pfmdr1*, *Pfdhfr* and *Pfdhps* genes of falciparum parasite in the Central and Adamawa regions of Cameroon. Overall, 79.18% of the samples had the *Pfcr1* wild type allele K76. In recent years, very few studies have been carried out on the *Pfcr1* gene, and the few available have samples collected as far back as 2012. Nonetheless, this study is in line with other studies carried out in the Northwest region (Achungu et al., 2018), Eastern part (Ndam et al., 2017) and Southwest region (Apinjoh et al., 2017) of Cameroon where CQ sensitive strains were reported. However, the prevalence of K76 mutant allele was higher in Mfou than Tibati (88.50% vs 69.29%  $P < 0.0001$ ), which could be due to the presence and use of CQ in the area via informal outlets and self-medication in the Northern regions of Cameroon (S. Menard et al., 2012b). Looking at the *Pfmdr1* gene, the prevalence of mutant allele 86Y was 55.38% and 45.8% in Mfou and Tibati respectively, and mutant allele 1246Y, which is linked to AQ and CQ resistance was low, 1.45 and 5.97% respectively. These findings are consistent with previous studies in the country (Apinjoh et al., 2017; Moyeh et al., 2018), and other African countries such as in Nigeria (Adamu et al., 2020), Gabon (Lekana-Douki et al., 2011; Maghendji-Nzondo et al., 2016), Mozambique (Lobo et al., 2014) and Uganda (Achol et al., 2019; Conrad et al., 2014). Low prevalence of mutant allele 1246Y indicates little or no presence of AQ resistance. The simultaneous use of AS-AQ as first line drug and AL as second line treatment of uncomplicated malaria in the country could be the reason for similar allele proportion of N86 and 86Y (Sayang et al., 2009), irrespective of the location.

The prevalence of triple mutant 51I/59R/108N in the *Pfdhfr* gene, which is linked to pyrimethamine resistance was present in the entire population. Nonetheless, this high prevalence have been reported since the year 2000 when SP was used for treating uncomplicated malaria (Mbacham et al., 2010). Presently, this high frequency is said to be attributed to the use of SP as an IPTp and SMC and seems to be trending in other African countries such as; Gabon where the prevalence is 100% (Voumbo-Matoumona et al., 2018) and 93% in Nigeria (Quan et al., 2020).

Considering the *Pfdhps* gene which is associated with sulphadoxine resistance, more than 90% of the samples had the 437G mutant allele, and the prevalence in Mfou was significantly higher than in Tibati (94.80% vs 86.36%;  $P < 0.0001$ ). This prevalence is significantly higher than the 76% cases reported in pregnant women from Yaounde six years ago (Chauvin et al., 2015). However, the *Pfdhps* mutant allele 540E had very low frequency (0.33%). This is in line with other studies that showed low prevalence (Chauvin et al., 2015; Mbacham et al., 2010). The

*Pfdhps* 581G mutant allele that confers resistance to sulfadoxine was present in 3.26% of the samples.

Looking at SP resistance, the quadruple mutant IRNG haplotype (*Pfdhfr* 51I/59R/108N + *Pfdhps* 437G) that confers partial resistance to SP was most prevalent in this study, with prevalence almost reaching 90%. Nevertheless, it is the quintuple (*Pfdhfr* 51I/59R/108N + *Pfdhps* 437G/540E) and sextuple mutants (*Pfdhfr* 51I/59R/108N + *Pfdhps* 437G/540E/518G), that are the main indicators of SP resistance (Anchang-Kimbi et al., 2020; Naidoo & Roper, 2013). In 2015, Cameroon first observed the quintuple mutant (*Pfdhfr* 51I/59R/108N + *Pfdhps* 437G/540E) in 2 pregnant women on SP for IPTp (Chauvin et al., 2015). In this study, 5 samples had the quintuple mutant haplotype IRNGE, confirming the presence of parasites completely resistant to SP in Cameroon. More so, the sextuple haplotype (IRNGEG) which is considered to be super resistant, was present in 2 samples from Tibati.

In conclusion, the high prevalence of the wild type *Pfprt* K76 and *Pfmdr1* D1246 alleles indicates the return of CQ sensitivity. The presence of fully and super resistant parasites to the SP warrants regular monitoring of SP drug efficacy and resistance frequency in the country.



**CHAPTER 4**

**GENETIC DIVERSITY OF**  
***PLASMODIUM FALCAPARUM***  
**SYMPTOMATIC AND**  
**ASYMPTOMATIC INFECTIONS.**

## Genetic diversity of *Plasmodium falciparum* symptomatic and asymptomatic infections

**Introduction:** In Cameroon, chloroquine (CQ) has been extensively used as first-line drug for treatment of uncomplicated malaria and chemoprophylaxis until the 80s when CQ resistance was reported and spread throughout the country (Sansone et al., 1985). From the late 80s, amodiaquine and sulfadoxine-pyrimethamine (SP) were recommended as first-line and second-line drugs, respectively, for uncomplicated malaria and resistance to AQ and SP was observed after few years of drug pressure (Basco and Ringwald, 2002; Ringwald et al., 2000). Artemisinin-based combination therapies (ACTs) for the treatment of uncomplicated malaria were implemented in 2004 following WHO recommendations. The two first-line ACT treatments are Artesunate-amodiaquine (ASAQ) and artemether-lumefantrine (AL) but dihydroartemisinin-piperaquine (DHA-PPQ) is frequently used since 2011 as an alternative to ASAQ due to its adverse side effects. No artemisinin resistance has been described so far (Menard et al., 2016a; Menard et al., 2016b; Whegang Youdom et al., 2019). Nonetheless, majority of the studies on drug resistance were carried out on symptomatic samples, and few studies have been carried on asymptomatics, the transmission reservoirs of the malaria parasite (Niba et al., 2021). More so, the techniques used for SNP detection were not able to identify new SNPs and rare genotypes. Hence this work uses an efficient technique, NGS using Illumina Miseq to determine and compare the genetic diversity present in both groups.

### Article 3: Main paper

## Genetic diversity of *Plasmodium falciparum* symptomatic and asymptomatic infections

Elangwe M. Sarah-Matio,<sup>1,2,\*</sup> Emilie Guillochon,<sup>3,\*</sup> Sandrine E. Nsango,<sup>2,4</sup> Luc Abate,<sup>1</sup> Christelle M. Ngou,<sup>1,2</sup> Gaëlle A. Bouopda,<sup>2,4</sup> Lionel B. Feufack-Donfack,<sup>4</sup> Albert N. Bayibéki,<sup>5</sup> Majoline T. Tchioffo,<sup>1,6</sup> Lawrence Ayong,<sup>2</sup> Antoine Claessens,<sup>5</sup> Thierry Lefèvre,<sup>1</sup> Antoine Berry,<sup>7,8,\*</sup> and Isabelle Morlais<sup>1,\*</sup>

1 MIVEGEC, IRD, CNRS, Univ. Montpellier, Montpellier, France

2 Malaria Research Unit, Centre Pasteur du Cameroun, Yaoundé, Cameroon

3 Université de Paris, MERIT, IRD, Paris, France

4 Department of Biological Sciences, Faculté de Médecine et des Sciences Pharmaceutiques, Université de Douala, Douala, Cameroon

5 Université Catholique d'Afrique Centrale, Yaoundé, Cameroon

6 Functional Genetics of Infectious Diseases Unit, Institut Pasteur, Paris

7 Institut Toulousain des Maladies Infectieuses et Inflammatoires (Infinity), Université Toulouse, CNRS UMR5051, INSERM UMR1291, UPS, Toulouse, France

8 Laboratoire de Pharmacocinétique et Toxicologie Clinique, Centre Hospitalier Universitaire de Toulouse, Hôpital Purpan, Toulouse, France

\* These [authors contributed equally](#) to this work

### Abstract

**Key words.** *Plasmodium falciparum*; antimalarial drug resistance; molecular genotyping; symptomatic and asymptomatic carriers; Cameroon

## Introduction

Malaria control strategy mostly relies on passive case detection which has limitations for reducing malaria burden and achieving elimination. Indeed, asymptomatic infections represent a large reservoir of parasites and contribute to malaria transmission [1, 2]. Asymptomatic infections tend to be associated with low parasite densities and are sometimes not detected by conventional diagnosis tools, microscopy and RDTs (sub microscopic). These chronic infections can persist for months but remain untreated, as they are often not detected. It is now acknowledged that active detection and treatment of asymptomatic infections will be crucial to control and eliminate malaria, and novel interventions aiming at curing the asymptomatic reservoir are being implemented at local scales according to epidemiological settings [3, 4].

In areas of high transmission intensity, malaria infections generally harbour multiple genotypes of parasites [5, 6]. The different genotypes may result from successive mosquito bites or by inoculation of genetically diverse sporozoites from a single bite. The number of co-infecting genotypes in an infection is associated with parasite exposure and the level of acquired immunity and, thus multiplicity of infection (MOI) is higher in high transmission settings [7]. The impact of MOI on the risk of clinical malaria is controversial [5, 6, 8-13] and multiple confounding factors, such as parasite density, host age, transmission intensity, likely explain discrepancies between studies. Interactions between genotypes in multiple infections likely influence disease epidemiology and evidences from animal models indicate that competitive interactions between co-infecting genotypes drive the evolution of drug resistance [14-16].

Molecular surveillance of antimalarial drug resistance markers is crucial to ensure proper prevention and treatment, as well as to monitor the emergence of resistant parasites. Point mutations in the *pfert* (*Plasmodium falciparum* chloroquine resistance transporter) gene has been associated with resistance to CQ and AQ [17, 18]. Polymorphisms in the *P. falciparum* multidrug resistance 1 gene (*pfmdr-1*) and gene copy number modulate drug sensitivities to several antimalarials [19, 20]. Resistance to antifolate drugs is determined by mutations in the dihydrofolate reductase (*dhfr*) and dihydropteroate synthase (*dhps*) genes and combination of SNPs in the two genes predicts different levels of drug resistance [21-23]. Mutations in the *P. falciparum* propeller domain of the *kelch 13* (*pfK13*) gene are key determinant of artemisinin resistance [24, 25] and specific mutant alleles in *pfK13* are associated with delayed parasite clearance [26, 27].

In this study, we aimed to investigate the genetic diversity of *falciparum* parasites in symptomatic and asymptomatic individuals from an area of high malaria transmission in Cameroon. The prevalence of point mutations in genes associated with antimalarial drug resistance and the genetic diversity of parasite populations was compared between symptomatic and asymptomatic carriers. The relative quantification of the different genotypes within multiple infections allowed to provide novel information on the importance of mixed infections on the malaria epidemiology.

## **Materials and Methods**

### **Sample collections**

Blood samples from asymptomatic individuals were collected among 5 to 14-year-old pupils attending primary schools in the Mfou district (3°43'N, 11° 38'E), Cameroon, during high transmission season (October – November) in 2017 and 2018. Venous blood was collected by venipuncture in EDTA tube for 63 children confirmed as *P. falciparum* positive upon microscopical readings of thick blood smears. A fresh blood smear was performed at the time of venipuncture for parasite quantification. Symptomatic individuals were enrolled at the Nkol-Eton health care centre (3° 52' N, 11° 31' E) in Yaoundé between October and December 2018 and participants were included upon signature of an informed consent. Venous blood samples were collected in EDTA tubes for 80 patients with malaria symptoms. Volunteers received a treatment with ACTs (dihydroartemisinin/piperaquine) according to national guidelines. Venous blood samples (1 ml) were filtered using LD columns on a QuadroMACS separator (Miltenyi Biotec, Bergisch Gladbach, Germany) according to Ribaut et al., 2006. The trophozoite fraction was resuspended in a 50 µl volume of PBS and stored at -80°C until further analyses.

### **Ethical Approval**

Ethical approval was given by National Ethical Committee for Research in Human Health (CNERSH), Yaoundé, Cameroon under agreements 2017/06/922/CE/CNERSH/SP, and 2018/09/1107/CE/CNERSH/SP. Written consent agreement was obtained from each individual or its guardian/parent in cases involving children.

### **DNA Extraction and sample selection**

DNA was extracted using the DNeasy<sup>®</sup> Blood & Tissue Kit (Qiagen, Hilden, Germany) according to the manufacturer's instructions (blood protocols). DNA extracts were eluted in a



final volume of 60 µl and stored at -20°C until further use. A real-time PCR was first performed to discriminate *Plasmodium* species present in the blood samples, according to Mangold's protocol [28]. The species-specific mean melting temperatures (T<sub>m</sub>) were determined according to curves obtained for the *Plasmodium* species controls. Only samples harbouring *P. falciparum* were kept for the following procedures. DNA from the 3D7 reference *P. falciparum* was used as control, and in triplicate.

### **Target genes and amplicon recovery**

AmpSeq genotyping was used to capture simultaneously SNPs associated with antimalarial resistance and the genetic diversity within infections. Point mutations associated with antimalarial drug resistance were screened for the five most common genes, *Pfdhfr*, *Pfdhps*, *Pfmdr1*, *Pfcr1* and *PfK13*. We followed the experimental protocol described in Nag *et al.* [29] with slight modifications. The mitochondrial fragments were excluded and only one fragment in the *pfk13* gene was amplified. Genetic diversity in the blood samples was assessed by using four known AmpSeq markers *cpmp*, *csp*, *ama1-D2* and *ama1-D3* [30]. AmpSeq primers were designed to include the amplicon-specific primers, a linker and overhang adapters. Details on target genes, AmpSeq primers are listed in Suppl. Table S1 and location of amplicon on reference genes are illustrated in Suppl. Figure 1. PCR reactions were performed using the KAPA HiFi Hot Start Ready Mix (Kapa Biosystems, USA) in a 25µl final volume with 10 µM Ampseq primers and 2µl of DNA template. Amplification reactions were run on Eppendorf® Mastercycler® ep Gradient S (Eppendorf, Germany). PCR products were visualised on a 2% agarose gel. Pools for each parasite donor were composed with 2 µl amplicons.

### **Library preparation and MiSeq sequencing**

Library preparation and sequencing were carried out by the GenSeq technical facilities of the Labex CeMEB in Montpellier. Pooled samples were purified, and a subsequent amplification was performed to incorporate sequencing adapters and multiplexing indices. Libraries were purified, then normalized and pooled. A *phiX* library was used as sequencing control. Libraries were quality checked on a Fragment Analyzer and loaded on a flow cell. The sequencing was performed with an Illumina MiSeq instrument, using paired-end method (2x 300 bp read lengths) and with the MiSeq reagent kit v3.

### **Bioinformatic analyses**

The quality of the raw sequencing data was assessed with FastQC [31] The genotypes were reconstructed using the HaplotypR package [30, 32]. Briefly, reads were de-multiplexed by

adapter and index. Reads corresponding to each marker were selected based on the primer sequences, the paired reads were trimmed based on FastQC results and joined. After, SNPs and then genotypes were called. Singletons and chimeric reads were not considered. The analysis was carried out with the default parameters proposed by the authors.

### **Statistical analysis**

Statistical analyses were performed using R and R Studio software [33, 34]. Graphics were built using ggplot2 [35]. Statistical significance was set at .05. Diversity indexes were calculated to characterize the genotype diversity and distribution among symptomatic and asymptomatic samples using the Vegan packages. Genotype accumulation curves and abundance distribution were computed to estimate the number of unseen genotypes. Richness estimators and differentiation measures between clinical status and genotype distribution at the CPMP and CSP markers were calculated using the SpadeR package. Association between variability in the relative abundance of parasite genotypes among samples, measured as the Pielou evenness index, and parasite density, clinical status or MOI was assessed using GLM models. The Pielou's evenness index measures relative evenness, the metric ranges from 0 when one or a few genotypes dominate the infection (no evenness) to 1 when all genotypes within an infection have similar densities (complete evenness). Differences in sequence reads, parasite densities or MOI was assessed using Generalized Linear Models (GLM, negative binomial errors), with clinical status and clonality (mono or poly) set as binomial variables, age and MOI as ordinal variables. Comparison of the genotype frequency at the different diversity or antimalarial resistance markers between symptomatics and asymptomatics was performed using *t-test*.

## **Results**

### **Characteristics of the study participants.**

A total of 80 individuals were included in the clinical cohort and 63 in the asymptomatic group. Asymptomatics were identified in primary schools during rainy season in late 2017 and 2018. Parasite prevalence was 55.12% (613/1112) in 2017 and 51.18% (628/1227) in 2018. Among the 63 asymptomatic children included in the study, median age is 8 years (range 4-15) and sex ratio 0.48. Parasite densities did not differ between the two consecutive surveys, 720 parasites/ $\mu$ l (IQR 224-2912) and 664 parasites/ $\mu$ l (IQR 0-1840) in 2017 and 2018, respectively (LRT  $X^2_1 = 0.9$ ,  $P = 0.35$ ). Among children of 4 to 15 years, parasitaemia were significantly

higher in symptomatic children than in symptom free children, (LRT  $X^2_1 = 46$ ,  $P < 0.001$ , Suppl Figure S2).

### **Amplicon recovery**

A total of 117 samples were processed for amplicon sequencing on an Illumina Miseq, 63 from asymptomatic individuals and 54 from symptomatics, a batch of 26 samples being lost during processing. After filtering and de-multiplexing, 11 596 861 reads were successfully assigned to targeted amplicons. For the pfdhps.4 amplicon, most reads were assigned as singletons, reflecting low quality sequences as a result of the high sequence complexity, and this amplicon was only partly included in the further analysis. Amplicons pfmdr1.7 and pfmdr1.7 did not yield polymorphism; all reads were carrying the S1034 and N1042 and D1246 wild-type codons. Mean number of reads differed between markers (LRT  $X^2_8 = 1034$ ,  $P < 0.001$ ) and negatively correlated with amplicon size (LRT  $X^2_1 = 402$ ,  $P < 0.001$ ). The CSP amplicon, the smallest fragment, recovered the highest number of reads (mean 39238, SD 25921). There was a significant marker by parasitaemia interaction on the number of reads (LRT  $X^2_8 = 40$ ,  $P < 0.001$ ). In particular, there was a positive relationship between the number of reads and parasitaemia for the 4 diversity markers (CPMP, CSP, AMA1\_D2 and AMA1\_D3, LRT  $X^2_1 = 6$ ,  $P = 0.015$ , Figure 2), while a negative relationship was observed for the 5 antimalarial resistance markers (LRT  $X^2_1 = 8$ ,  $P = 0.005$ , Figure 1).

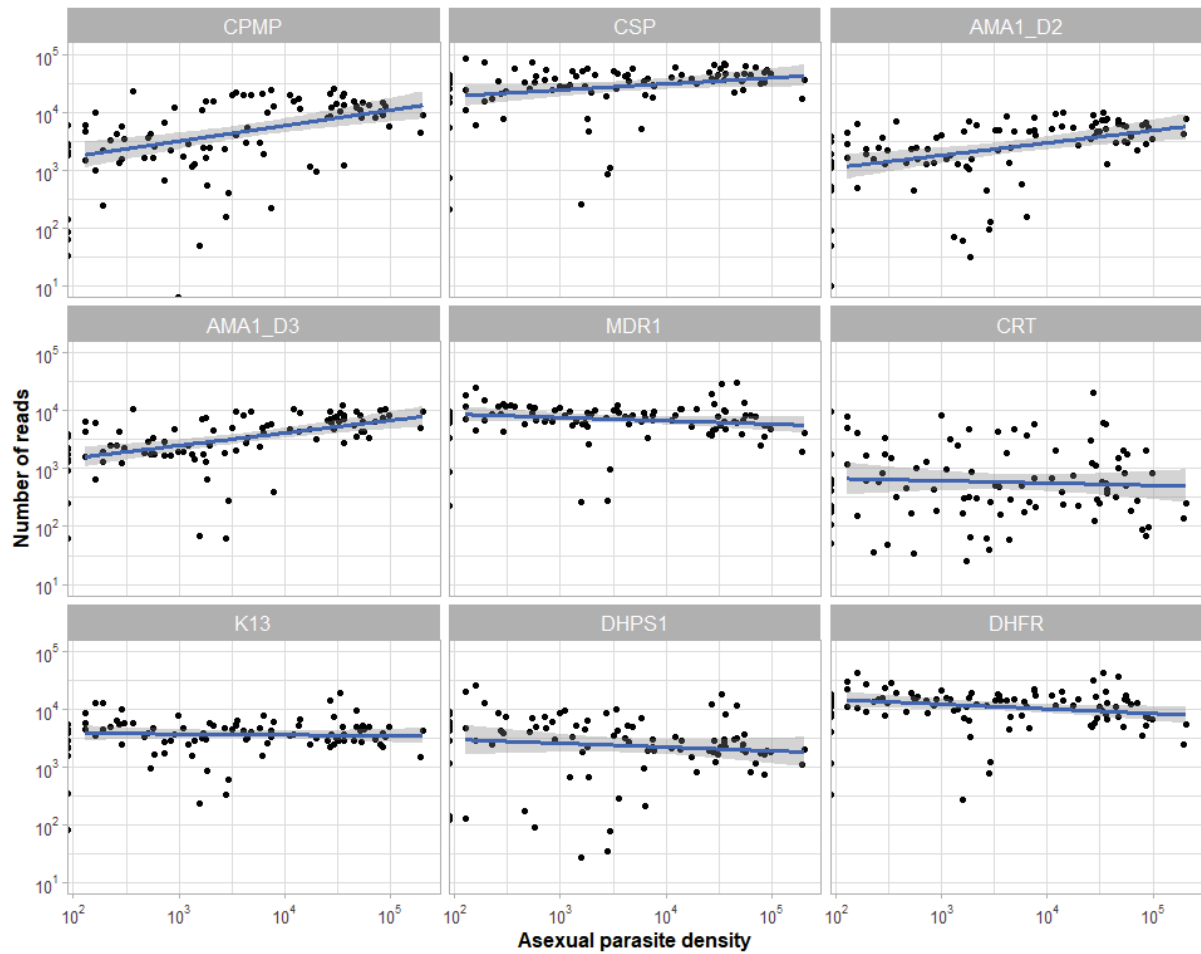

**Figure 1.** Sequenced reads according to asexual parasite density for each targeted amplicon.

### *P. falciparum* genetic diversity

The number of co-infecting clones in blood samples were determined for the four diversity markers (Suppl. Figure S3). CPMP and CSP allowed a better resolution, yielding higher mean MOI, 3.21 clones/samples (SD 2.82) and 3.23 (SD 2.5), respectively, as compared to AMA1-D2 and AMA1-D3, with 1.95 clones/samples (SD 1.1) and 1.73 (SD 0.97), respectively (ANOVA,  $F(3, 443) = 17.54$ ;  $P < 0.0001$ ). Only CPMP and CSP markers were then kept for further analysis, as combining additional markers does not increase discriminatory power (Lerch et al. 2019). Proportion of blood samples carrying a specific different clone number did not differ significantly between CPMP and CSP markers (paired  $t$ -test,  $p = 0.999$ ; Figure 2). All the 26 mono-infections carried a unique haplotype when combining CPMP and CSP genotypes, reflecting the high genetic diversity in the study area.

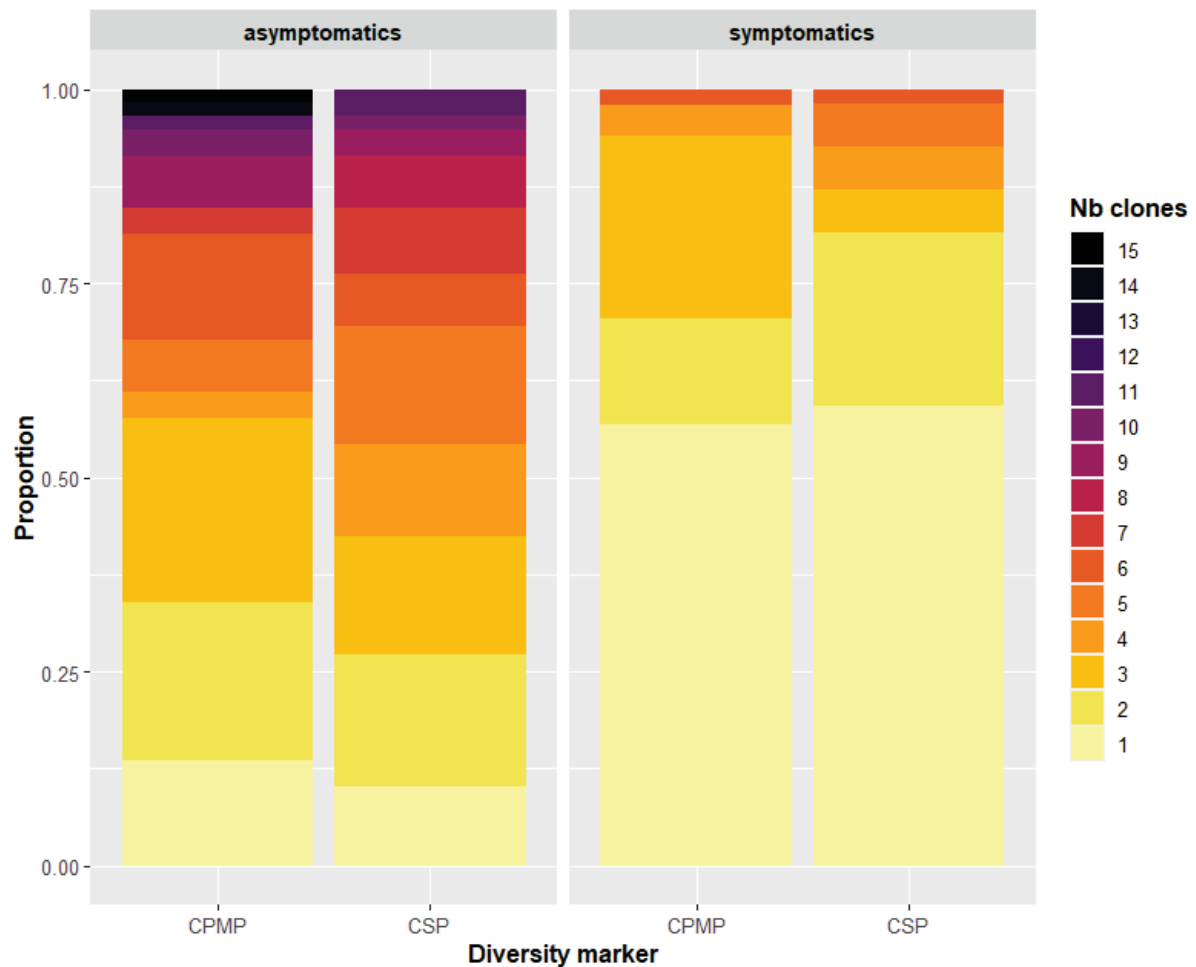
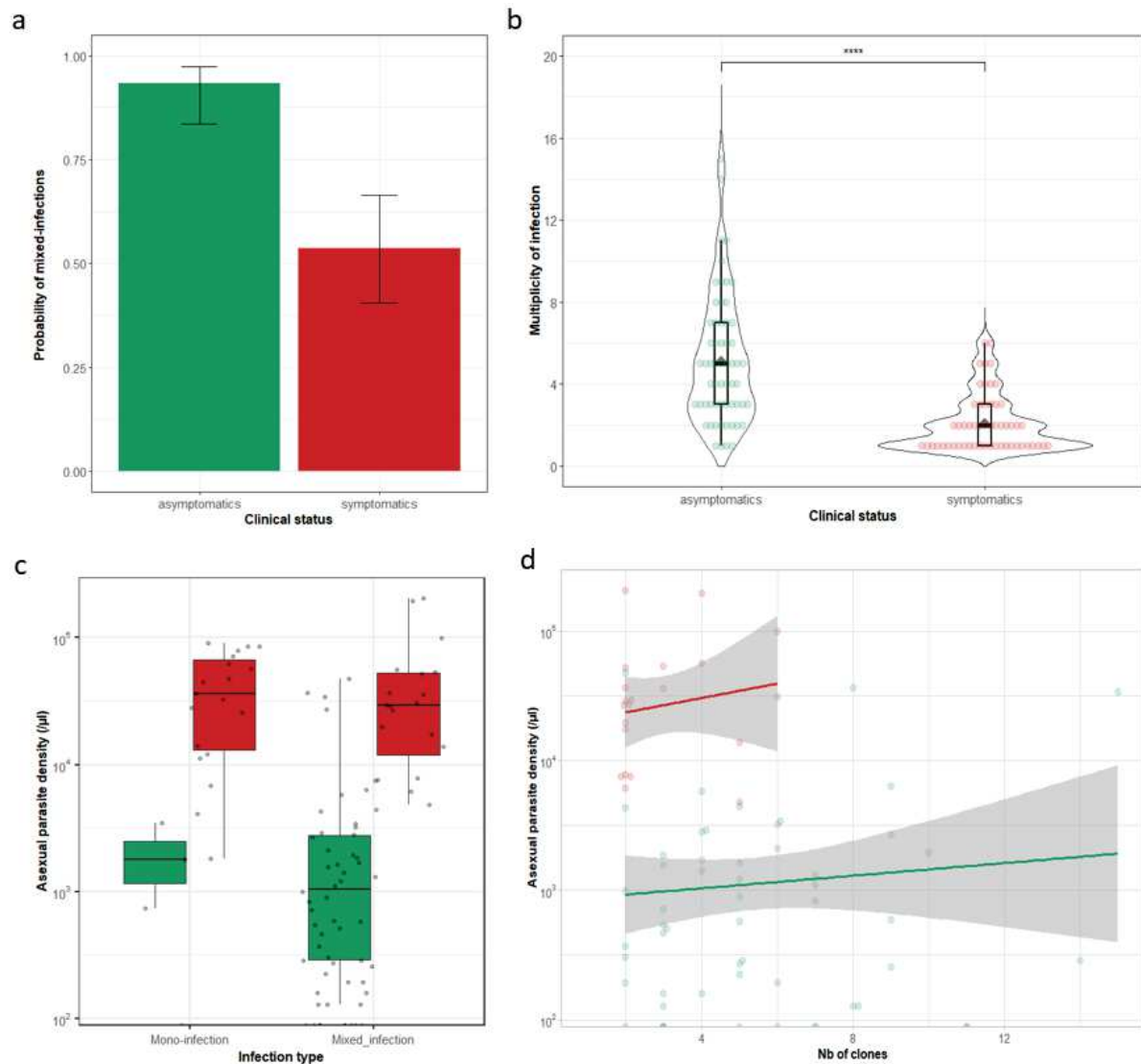

**Figure 2.** Proportion of blood samples with different clone numbers in asymptomatic and symptomatic individuals for CPMP and CSP markers.

CPMP and CSP markers distinguished 91 and 53 different genotypes, respectively (Suppl. Table S2). Mean in SNP difference between genotypes within a sample was 18.36 (SD 5.15) and 6.76 (SD 1.81) for CPMP and CSP, respectively (Suppl Figure S4). The mean ( $\pm$  SD) SNP difference between genotypes was significantly higher in asymptomatic samples than in symptomatic samples for the CPMP marker ( $19.3 \pm 4.52$  versus  $16.26 \pm 5.98$  in symptomatics,  $t=2.1$ ,  $P=0.04$ ), which could suggest higher relatedness between co-infecting genotypes in symptomatic infections, but no different was observed for the CSP marker ( $t= 0.56$ ,  $p=0.58$ ,  $6.57 \pm 1.55$  versus  $6.87 \pm 2.34$ ). We plotted genotype accumulation curves for each marker to determine whether all genotypes were detected among the sample set (Suppl. Figure S5a). Both curves commenced to plateau, indicating we provided an accurate estimation of genotype richness, which is confirmed by the Chao estimators (Suppl.Table S2). We analysed the genotype abundance distribution by fitting the Preston log-normal model (Suppl. Figure S5b)



that estimated 2.8 rare genotypes (veiled) were missed for CMP and 1.5 for CSP. Then, we compared the genotype composition between asymptomatic and symptomatic individuals for each diversity marker and pairwise differentiation measures did not indicate differentiation according to clinical status ( $G_{st} = 0.005$  (0.001) and  $G_{st} = 0.003$  (0.002) for CPMP and CSP respectively; Suppl Table S3).

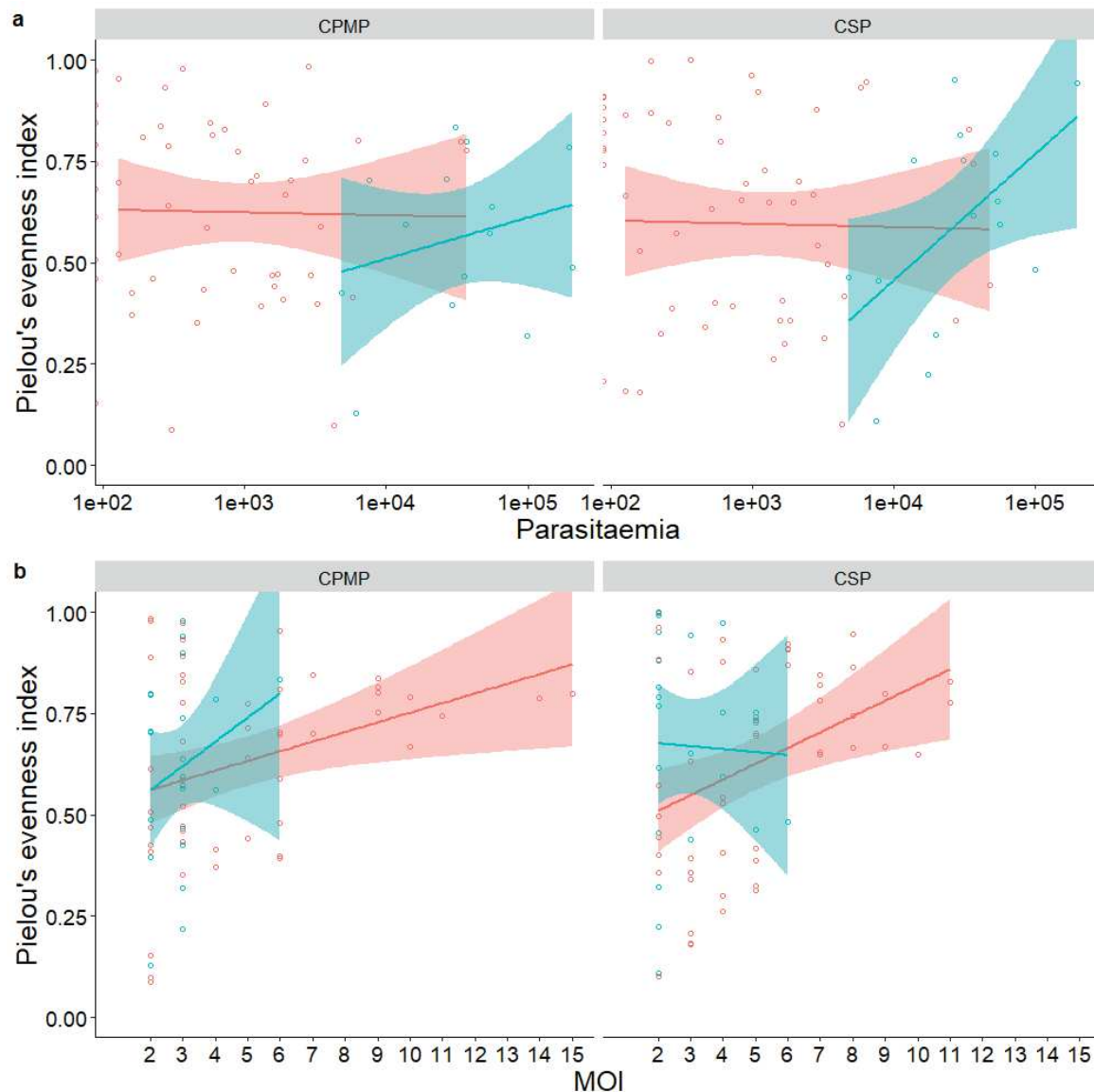

**Figure 3.** *P. falciparum* genetic diversity according to clinical status. **a.** Probability of mixed infections according to clinical status. **b.** Multiplicity of infection in symptomatic and asymptomatic individuals. **c.** Asexual parasite density according to mono or mixed infections in symptomatic and asymptomatic individuals. **d.** Association between asexual parasite density and the number of co-infecting clones according to clinical status. In red, symptomatics; in green, asymptomatics.

Multiplicity of infection was determined as the maximum number of genotypes recovered among the two diversity markers, CPMP and CSP. Symptomatic patients were less likely to

carry polyclonal infections (29/54, 53.7%) compared to asymptomatic patients (56/60, 93%) (LRT  $X^2_1 = 25$ ,  $P < 0.001$ , Figure 3a). Furthermore, symptomatic patients showed lower MOI levels (symptomatic: median MOI= 2, range= 1-6; asymptomatic: median MOI = 5, range = 1-15, LRT  $X^2_1 = 52$ ,  $P < 0.001$ , Figure 3b). Complexity of infection, *i.e.* monoclonal vs pluriclonal, and MOI were not associated with parasite density neither in symptomatic patients nor in asymptomatic carriers but parasite densities differed significantly between the clinical status, asymptomatic or symptomatic, symptomless infections carrying less parasites (LRT  $X^2_1 = 8$ ,  $P < 0.01$ , Figure 3c and 3d). Then asexual parasite densities do not correlate with the number of co-infecting clones and the lower parasite count in the more complex asymptomatic infections suggests competitive interactions between co-infecting clones to control parasite growth.

We then focused on mixed infections and quantified the relative abundance of genotypes among samples using the Pielou's evenness index. This metric ranges from 0 when one or a few genotypes dominate the infection (no evenness) to 1 when all genotypes within an infection have similar densities (complete evenness). The mean ( $\pm$  SD) evenness index of asymptomatic infections was 0.63 ( $\pm 0.23$ ) and 0.62 ( $\pm 0.25$ ) for the CPMP and the CSP marker respectively (Table S2), and 0.62 ( $\pm 0.23$ ) and 0.67 ( $\pm 0.26$ ) in symptomatic infections. Although there was an important heterogeneity in evenness among samples (min = 0.09, max = 0.99, Figure 4), the average values suggest that, overall, some parasite genotypes are more abundant than others within mixed infections. We found no significant effect of parasite density (LRT  $X^2_1 = 0.4$ ,  $P = 0.2$ ), clinical status (LRT  $X^2_1 = 0.23$ ,  $P = 0.3$ ), or interactions (LRT  $X^2_1 = 0.02$ ,  $P = 0.8$ ) on genotypic evenness (Figure 4a). However, there was a significant effect of MOI (LRT  $X^2_1 = 3.3$ ,  $P < 0.001$ ), with a levelling of the relative density of genotypes as MOI increases (Figure 5b). Marker type (CPMP vs CSP) did not influence evenness (LRT  $X^2_1 = 0.008$ ,  $P = 0.95$ ) and there was a good fit between the values derived from the CPMP or CSP marker (LRT  $X^2_1 = 6$ ,  $P < 0.001$ , Suppl. Figure S6).



**Figure 4.** Relative abundance of genotypes among samples. (a) Relative abundance of genotypes according to parasite densities. (b) Relative abundance of genotypes according to MOI.

### Multimarker haplotypes

We determined multimarker haplotypes by selecting infections that showed the same genotype at the six amplicons targeting antimalarial resistance mutations to. A total of 66 samples fit the criteria and 22 multimarker haplotypes were identified, 5 haplotypes were shared between asymptomatic and symptomatic samples and 14 haplotypes were unique. Two haplotypes were frequent, shared each between 15 samples, they were carrying *pfmdr1* N86, *pfert* CVMNK, *dhfr/dhps* IRN-ISGKAA genotypes and differed only at the *pfK13* K189T codon.

## Relative abundance of antimalarial resistance genotypes in mixed infections

The bioinformatic analysis allowed to recover the number of reads per genotype for each amplicon and we then analysed the relative abundance of the different genotypes within mixed infections. The *pfmdr1* marker presented no mixed infection and only two mixed infections were identified in the *pfdhfr* amplicon (Suppl Figure 7), which precluded any analysis for these markers. Five mixed genotype infections were found at the *pfK13* marker, all in asymptomatic carriers, and no genotype was dominant over the five mixed infections, proportion of the wild type varied from 1.2 to 97.4%. The *pfert* read assignment led to 23 mixed infections, 21 in asymptomatic individuals and 2 in asymptomatics. Strikingly, density of the wild type CVMNK genotype was significantly higher as compared to that of the resistant CVIET genotype (LRT  $\chi^2_1 = 43.1$ ,  $P < 0.0001$ ). The wild type CVMNK genotype dominated in all but one infection. The CQ resistant genotype CVIET is then present but at very low density, with a mean proportion of 12.7% (SD 20.6) (Figure 5a), and part of these mutants would probably have been missed using other detection methods such as nested-PCR or qPCR.

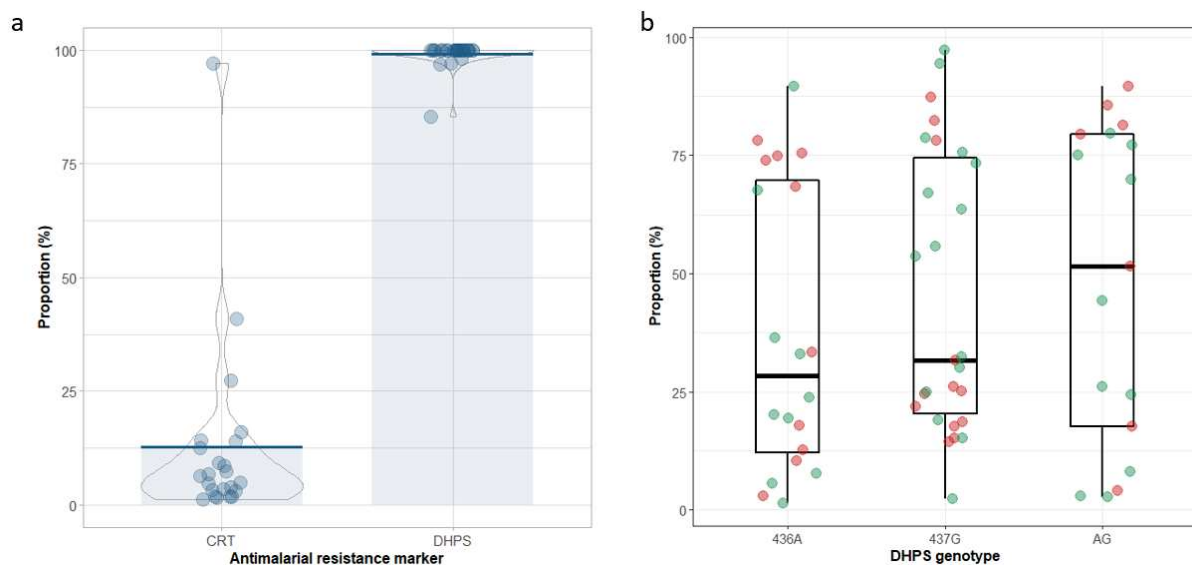

**Figure 5.** Relative proportion of resistant genotypes at *pfert* and *pfdhps* markers in mixed infections **a**, Proportion of resistant genotypes in mixed infections for the *pfert* and *pfdhps* markers. Each dot represents a blood sample. The CVIET resistant genotype in *pfert* is present at low densities while the resistant *pfdhps* genotypes are dominant. **b**, Proportion of the different

mutant *pfdhps* genotypes within mixed infections. Green dots, asymptomatic samples; red dots, symptomatics.

By contrast, among the 31 multiple infections at the *pfdhps* marker, the wild type genotype was only identified in 4 samples, from asymptomatic carriers only, and always at proportion less than 15% (Figure 5a). Mixed infections were in majority a mixture of mutant genotypes. Relative density of the different mutant genotypes did not differ significantly over all mixed infections (LRT  $\chi^2_2 = 3.9$ ,  $P = 0.144$ ) and, within each mixed infection, proportion of mutant genotypes varied greatly, from 1.4% to 97.3% (Figure 5b)) and did not differ between symptomatic and asymptomatic samples.

## Discussion

Our study clearly confirms the trend towards a return to chloroquine sensitive parasites in Cameroon, as observed in most sub-Saharan African countries few years after cessation of CQ use [36-38]. Decline in the prevalence of CQ resistant haplotypes differed between endemic areas, decline being less pronounced in West and Central Africa [39, 40]. Maintenance of CQ resistant haplotypes was explained by sustained CQ pressure, as chloroquine was still available from informal outlets several years after policy changes. Return to CQ-sensitive parasites could be due at least in part to the use of AL which selects for the CQS K76 allele [41, 42]. Indeed, AL is recommended as first-line ACT for the treatment of uncomplicated malaria in Cameroon and the rebound in the *pfmdr1* N86 allele in our study would support this hypothesis, as changes in the prevalence of this allele is an indicator of selection of parasites by AL [42, 43]. However, none of the infections were treated in this study and then the persistence of CQ resistant parasites in mixed infections, at low density, suggests genotype-genotype interactions that impede the suppression of the minority resistant parasites. Resistant parasites are less fit in absence of drug and theoretical models predict that drug-sensitive parasites competitively suppress resistant conspecifics [16, 44, 45]. Competitive suppression increases with rarity [46] and the CVIET genotype, that represents less than 15% of parasite load, would have been suppressed. Then, other interactions occur in natural infections that allow the CQ resistant parasites to persist in the population.

Here, we used polymorphic molecular markers to assess multiplicity of infection in the blood samples and compare the genetic diversity between symptomatic and asymptomatic infections.



Genotyping revealed higher genetic diversity in asymptomatic infections, which is generally reported in malaria endemic areas [47, 48][48]. However, epidemiological surveys report contrasting results on the clinical impact of genetically diverse infections. In high transmission settings, carriage of multiple genotypes reduces the risk of clinical malaria and persistence of genetically diverse parasites would maintain broad antibody responses, thus conferring higher level of protection [6, 8, 9, 49]. Also, it has been suggested that the reduced MOI in symptomatic infections reflect overgrowth of a dominant, more virulent parasite [48]. The high proportion of mono-infections among symptomatic individuals in our study may reflect the suppression of less fit parasites in former diverse infections. However, all mono-infections were unique haplotypes and we cannot interpret our data in term of parasite virulence.

Anyway, the high MOI in asymptomatic infections reflects the high malaria transmission intensity in our studied area. Indeed, infection by multiple genotypes is the result of exposure to infective mosquito bites, where parasites are inoculated successively or simultaneously [5, 50]. Evidence from animal models indicate that competitive interactions occur between co-infecting genotypes and influence transmission dynamics [15, 45, 51-54]. But determining the life history of co-infecting genotypes in natural infections is challenging. Whether genotypes were inoculated during a single mosquito bite or by sequential bites will result in different competitive interactions, because novel genotypes will experience stronger immune responses. In a recent study, it was shown that, in high transmission setting, multi-genotype infections result from parasites co-transmitted from single mosquito bites [50].

Our results support previous evidences that co-infection with multiple genotypes represent a mean to maintain genetic diversity and thereby polyclonal infections represent a reservoir of genetically diverse parasites [50, 55]. The high frequency of mixed infections carrying the wild-type CQ sensitive CVMNK genotype at low density may reflect strain-specific immunity [45, 56]. Numerically dominant parasites would shield rarer parasites from host immune responses. In this hypothesis, maintenance of minority strains within the population implies that they are transmitted to mosquitoes. Accordingly, in a previous work we followed transmission stages of parasites through its mosquito vector and showed that genotypes at sub-patent densities in the gametocyte isolates successively developed until the infectious sporozoite stage [57]. Because mixed infections lead to lower parasite burden in the mosquito, we suggested that genetic complexity was a strategy used by *P. falciparum* to survive the mosquito's immune responses [58]. A similar scenario may happen in the human host as the fitness of malaria parasites is dependent on the within-host ecology [46, 52, 59]. Indeed, malaria parasites face frequent

environmental changes, such as antimalarial drug treatment, host immune pressure and competition with co-infecting parasites, and adjust fitness traits to their changing environment [52, 54]. In absence of drug treatment, resistant parasites suffer the cost of resistance and competition with sensitive parasites reduces the density of resistant ones, they suffer competitive suppression [44]. By contrast, in a host treated with an antimalarial drug, resistant parasites out-compete their sensitive competitors and expand, a phenomenon known as competitive release [44]. Here, we propose that co-infection represents an adaptive response that facilitates the survival of genetically diverse parasites. As competitive suppression prevents the emergence of *de novo* resistant mutants in the absence of drug treatment, coexistence of multiple sensitive/resistant parasites is less detrimental at the population level for organisms living in varying environmental conditions [14, 46, 52, 55].

## **Conclusion**

Our study indicates that competitive interactions are more complex in natural infections and our results from naturally infected isolates of parasites suggest that competition-survival trade-offs probably occur to maintain parasite genetic diversity in the wild. The high frequency of CQ resistant parasites at low density supports cooperative interactions that favour coexistence of drug-sensitive and resistant parasites. Whether coexistence of diverse parasites allows a more rapid expansion of drug resistant parasites in response to drug policy changes will require further investigations. Despite WHO warnings, CQ and HCQ have been used extensively for Covid-19 prevention and treatment in Africa since the pandemic in 2020 [60]. This novel drug pressure will obviously compromise efforts to reverse CQ drug resistance, which is a prerequisite for reintroduction of CQ in combination therapy regimen.

## **Notes**

*Acknowledgements.* We thank the study participants for cooperation and the medical teams from the Nkol Eton Healthcare Centre and the Mfou Hospital for technical assistance in sample collection. We also thank the heads of the schools in the Mfou district for community mobilization. We are grateful to the technical team of the Malaria Research Unit at Centre Pasteur du Cameroun for their parasitological expertise in blood smear readings. We thank the GenSeq technical facilities at the « Institut des Sciences de l'Evolution de Montpellier » that produced the MiSeq sequencing data used in this work, the GenSeq technical facilities is

supported by the LabEx CeMEB, an ANR "Investissements d'avenir" program (ANR-10-LABX-04-01).

*Author contributions.* Conceived and designed the study: A. B. and I. M. Contributed to fieldwork: E. M. S-M., S. E. N., C. M. N., G. A. B., L. B. F-D., and A. N. B. Performed the laboratory experiments: E. M. S-M. and L.A. Analyzed the data: E. M. S-M., E. G., L. A., T. L., and I. M. Wrote the manuscript: E. M. S-M. and I.M. Critically revised the manuscript: E. G., S. E. N., L. A., T. L., A. C., and A. B. Funding acquisition: S. E. N. and I. M.

*Financial support.* This work was funded by the French National Research Institute for Sustainable Development (IRD) and through the JEAI-IMPALA project granted to SEN. E.M. S-M. and L. B. F-D. are supported by doctoral fellowships from the Labex ParaFrap.

*Potential conflicts of interest.* All authors: No reported conflicts of interest. All authors have submitted the ICMJE Form for Disclosure of Potential Conflicts of Interest. Conflicts that the editors consider relevant to the content of the manuscript have been disclosed.

## References

1. Bousema T, Okell L, Felger I, Drakeley C. Asymptomatic malaria infections: detectability, transmissibility and public health relevance. *Nat Rev Microbiol* **2014**; 12:833-40.
2. Lin JT, Saunders DL, Meshnick SR. The role of submicroscopic parasitemia in malaria transmission: what is the evidence? *Trends Parasitol* **2014**; 30:183-90.
3. Ashley EA, Poespoprodjo JR. Treatment and prevention of malaria in children. *Lancet Child Adolesc Health* **2020**; 4:775-89.
4. Sturrock HJ, Hsiang MS, Cohen JM, et al. Targeting asymptomatic malaria infections: active surveillance in control and elimination. *PLoS Med* **2013**; 10:e1001467.
5. Eldh M, Hammar U, Arnot D, et al. Multiplicity of Asymptomatic Plasmodium falciparum Infections and Risk of Clinical Malaria: A Systematic Review and Pooled Analysis of Individual Participant Data. *J Infect Dis* **2020**; 221:775-85.
6. Farnert A, Rooth I, Svensson, Snounou G, Bjorkman A. Complexity of Plasmodium falciparum infections is consistent over time and protects against clinical disease in Tanzanian children. *J Infect Dis* **1999**; 179:989-95.
7. Pinkevych M, Petravic J, Berezky S, Rooth I, Farnert A, Davenport MP. Understanding the relationship between Plasmodium falciparum growth rate and multiplicity of infection. *J Infect Dis* **2015**; 211:1121-7.
8. al-Yaman F, Genton B, Reeder JC, Anders RF, Smith T, Alpers MP. Reduced risk of clinical malaria in children infected with multiple clones of Plasmodium falciparum in a highly endemic area: a prospective community study. *Trans R Soc Trop Med Hyg* **1997**; 91:602-5.

9. Berezky S, Liljander A, Rooth I, et al. Multiclonal asymptomatic *Plasmodium falciparum* infections predict a reduced risk of malaria disease in a Tanzanian population. *Microbes Infect* **2007**; 9:103-10.
10. Earland D, Buchwald AG, Sixpence A, et al. Impact of Multiplicity of *Plasmodium falciparum* Infection on Clinical Disease in Malawi. *Am J Trop Med Hyg* **2019**; 101:412-5.
11. Liljander A, Bejon P, Mwacharo J, et al. Clearance of asymptomatic *P. falciparum* Infections Interacts with the number of clones to predict the risk of subsequent malaria in Kenyan children. *PloS one* **2011**; 6:e16940.
12. Portugal S, Tran TM, Ongoiba A, et al. Treatment of Chronic Asymptomatic *Plasmodium falciparum* Infection Does Not Increase the Risk of Clinical Malaria Upon Reinfection. *Clin Infect Dis* **2017**; 64:645-53.
13. Sondén K, Doumbo S, Hammar U, et al. Asymptomatic Multiclonal *Plasmodium falciparum* Infections Carried Through the Dry Season Predict Protection Against Subsequent Clinical Malaria. *J Infect Dis* **2015**; 212:608-16.
14. Bushman M, Morton L, Duah N, et al. Within-host competition and drug resistance in the human malaria parasite *Plasmodium falciparum*. *Proc Biol Sci* **2016**; 283:20153038.
15. de Roode JC, Helinski ME, Anwar MA, Read AF. Dynamics of multiple infection and within-host competition in genetically diverse malaria infections. *Am Nat* **2005**; 166:531-42.
16. Huijben S, Sim DG, Nelson WA, Read AF. The fitness of drug-resistant malaria parasites in a rodent model: multiplicity of infection. *J Evol Biol* **2011**; 24:2410-22.
17. Djimde A, Doumbo OK, Cortese JF, et al. A molecular marker for chloroquine-resistant *falciparum* malaria. *N Engl J Med* **2001**; 344:257-63.
18. Fidock DA, Nomura T, Talley AK, et al. Mutations in the *P. falciparum* digestive vacuole transmembrane protein PfCRT and evidence for their role in chloroquine resistance. *Mol Cell* **2000**; 6:861-71.
19. Price RN, Uhlemann AC, Brockman A, et al. Mefloquine resistance in *Plasmodium falciparum* and increased *pfmdr1* gene copy number. *Lancet* **2004**; 364:438-47.
20. Veiga MI, Dhingra SK, Henrich PP, et al. Globally prevalent PfMDR1 mutations modulate *Plasmodium falciparum* susceptibility to artemisinin-based combination therapies. *Nat Commun* **2016**; 7:11553.
21. Naidoo I, Roper C. Mapping 'partially resistant', 'fully resistant', and 'super resistant' malaria. *Trends Parasitol* **2013**; 29:505-15.
22. Peterson DS, Walliker D, Wellems TE. Evidence that a point mutation in dihydrofolate reductase-thymidylate synthase confers resistance to pyrimethamine in *falciparum* malaria. *Proc Natl Acad Sci U S A* **1988**; 85:9114-8.
23. Plowe CV, Kublin JG, Doumbo OK. *P. falciparum* dihydrofolate reductase and dihydropteroate synthase mutations: epidemiology and role in clinical resistance to antifolates. *Drug Resist Updat* **1998**; 1:389-96.
24. Dondorp AM, Nosten F, Yi P, et al. Artemisinin resistance in *Plasmodium falciparum* malaria. *N Engl J Med* **2009**; 361:455-67.
25. Noedl H, Se Y, Schaefer K, et al. Evidence of artemisinin-resistant malaria in western Cambodia. *N Engl J Med* **2008**; 359:2619-20.
26. Ariey F, Witkowski B, Amaratunga C, et al. A molecular marker of artemisinin-resistant *Plasmodium falciparum* malaria. *Nature* **2014**; 505:50-5.
27. Ménard D, Khim N, Beghain J, et al. A Worldwide Map of *Plasmodium falciparum* K13-Propeller Polymorphisms. *N Engl J Med* **2016**; 374:2453-64.

28. Mangold KA, Manson RU, Koay ES, et al. Real-time PCR for detection and identification of *Plasmodium* spp. *J Clin Microbiol* **2005**; 43:2435-40.
29. Nag S, Dalgaard MD, Kofoed PE, et al. High throughput resistance profiling of *Plasmodium falciparum* infections based on custom dual indexing and Illumina next generation sequencing-technology. *Sci Rep* **2017**; 7:2398.
30. Lerch A, Koepfli C, Hofmann NE, et al. Longitudinal tracking and quantification of individual *Plasmodium falciparum* clones in complex infections. *Sci Rep* **2019**; 9:3333.
31. Andrews S. FastQC: A Quality Control Tool for High Throughput Sequence Data. **2010**.
32. Lerch A, Koepfli C, Hofmann NE, et al. Development of amplicon deep sequencing markers and data analysis pipeline for genotyping multi-clonal malaria infections. *BMC Genomics* **2017**; 18:864.
33. R Studio Team. RStudio: Integrated Development for R.: RStudio, PBC, Boston, MA, **2020**.
34. R CoreTeam. R: A language and environment for statistical computing. R Foundation for Statistical Computing, Vienna, Austria **2020**.
35. Wickham H. ggplot2: Elegant Graphics for Data Analysis.: Springer-Verlag New York., **2016**.
36. Frosch AE, Laufer MK, Mathanga DP, et al. Return of widespread chloroquine-sensitive *Plasmodium falciparum* to Malawi. *J Infect Dis* **2014**; 210:1110-4.
37. Kublin JG, Cortese JF, Njunju EM, et al. Reemergence of chloroquine-sensitive *Plasmodium falciparum* malaria after cessation of chloroquine use in Malawi. *J Infect Dis* **2003**; 187:1870-5.
38. Laufer MK, Thesing PC, Eddington ND, et al. Return of chloroquine antimalarial efficacy in Malawi. *N Engl J Med* **2006**; 355:1959-66.
39. Mwanza S, Joshi S, Nambozi M, et al. The return of chloroquine-susceptible *Plasmodium falciparum* malaria in Zambia. *Malar J* **2016**; 15:584.
40. Ocan M, Akena D, Nsohya S, et al. Persistence of chloroquine resistance alleles in malaria endemic countries: a systematic review of burden and risk factors. *Malar J* **2019**; 18:76.
41. Baraka V, Ishengoma DS, Fransis F, et al. High-level *Plasmodium falciparum* sulfadoxine-pyrimethamine resistance with the concomitant occurrence of septuple haplotype in Tanzania. *Malar J* **2015**; 14:439.
42. Venkatesan M, Gadalla NB, Stepniewska K, et al. Polymorphisms in *Plasmodium falciparum* chloroquine resistance transporter and multidrug resistance 1 genes: parasite risk factors that affect treatment outcomes for *P. falciparum* malaria after artemether-lumefantrine and artesunate-amodiaquine. *Am J Trop Med Hyg* **2014**; 91:833-43.
43. Sisowath C, Stromberg J, Martensson A, et al. In vivo selection of *Plasmodium falciparum* pfmdr1 86N coding alleles by artemether-lumefantrine (Coartem). *J Infect Dis* **2005**; 191:1014-7.
44. de Roode JC, Culleton R, Bell AS, Read AF. Competitive release of drug resistance following drug treatment of mixed *Plasmodium chabaudi* infections. *Malar J* **2004**; 3:33.
45. Wargo AR, Huijben S, de Roode JC, Shepherd J, Read AF. Competitive release and facilitation of drug-resistant parasites after therapeutic chemotherapy in a rodent malaria model. *Proc Natl Acad Sci U S A* **2007**; 104:19914-9.
46. Huijben S, Chan BHK, Nelson WA, Read AF. The impact of within-host ecology on the fitness of a drug-resistant parasite. *Evol Med Public Health* **2018**; 2018:127-37.



47. Barry A, Bradley J, Stone W, et al. Higher gametocyte production and mosquito infectivity in chronic compared to incident *Plasmodium falciparum* infections. *Nat Commun* **2021**; 12:2443.
48. Mercereau-Puijalon O. Revisiting host/parasite interactions: molecular analysis of parasites collected during longitudinal and cross-sectional surveys in humans. *Parasite Immunol* **1996**; 18:173-80.
49. Beck HP, Felger I, Huber W, et al. Analysis of multiple *Plasmodium falciparum* infections in Tanzanian children during the phase III trial of the malaria vaccine SPf66. *J Infect Dis* **1997**; 175:921-6.
50. Nkhoma SC, Trevino SG, Gorena KM, et al. Co-transmission of Related Malaria Parasite Lineages Shapes Within-Host Parasite Diversity. *Cell Host Microbe* **2020**; 27:93-103 e4.
51. Bell AS, de Roode JC, Sim D, Read AF. Within-host competition in genetically diverse malaria infections: parasite virulence and competitive success. *Evolution* **2006**; 60:1358-71.
52. Birget PLG, Schneider P, O'Donnell AJ, Reece SE. Adaptive phenotypic plasticity in malaria parasites is not constrained by previous responses to environmental change. *Evol Med Public Health* **2019**; 2019:190-8.
53. Read AF, Taylor LH. The ecology of genetically diverse infections. *Science* **2001**; 292:1099-102.
54. Reece SE, Drew DR, Gardner A. Sex ratio adjustment and kin discrimination in malaria parasites. *Nature* **2008**; 453:609-14.
55. Bashey F. Within-host competitive interactions as a mechanism for the maintenance of parasite diversity. *Philos Trans R Soc Lond B Biol Sci* **2015**; 370.
56. de Roode JC, Culleton R, Cheesman SJ, Carter R, Read AF. Host heterogeneity is a determinant of competitive exclusion or coexistence in genetically diverse malaria infections. *Proc Biol Sci* **2004**; 271:1073-80.
57. Morlais I, Nsango SE, Toussile W, et al. *Plasmodium falciparum* mating patterns and mosquito infectivity of natural isolates of gametocytes. *PloS one* **2015**; 10:e0123777.
58. Nsango SE, Abate L, Thoma M, et al. Genetic clonality of *Plasmodium falciparum* affects the outcome of infection in *Anopheles gambiae*. *Int J Parasitol* **2012**; 42:589-95.
59. Day T, Huijben S, Read AF. Is selection relevant in the evolutionary emergence of drug resistance? *Trends Microbiol* **2015**; 23:126-33.
60. Belayneh A. Off-Label Use of Chloroquine and Hydroxychloroquine for COVID-19 Treatment in Africa Against WHO Recommendation. *Res Rep Trop Med* **2020**; 11:61-72.

## SUPPLEMENTARY MATERIAL

### Supplementary Figures

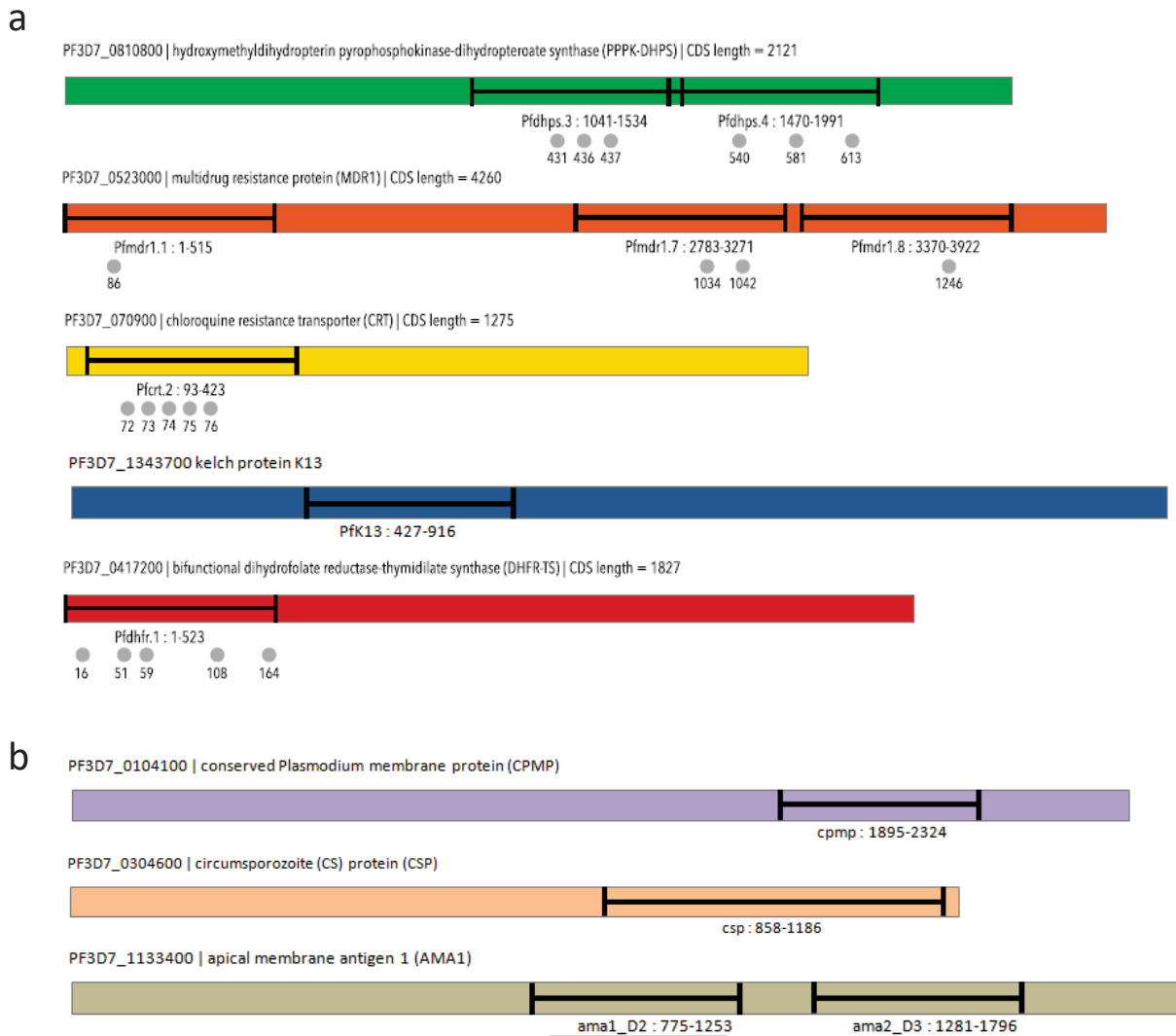

**Supplementary Figure S1.** Amplicon location in the genes associated with antimalarial drug resistance (A) and in diversity genes (B). (a) Nucleotide position of the amplicon and codon position for SNPs of interest is indicated for each gene (from Nag *et al.* 2017 [1]). (a) Nucleotide position of the targeted amplicon within the corresponding protein is indicated for each diversity marker [2, 3].

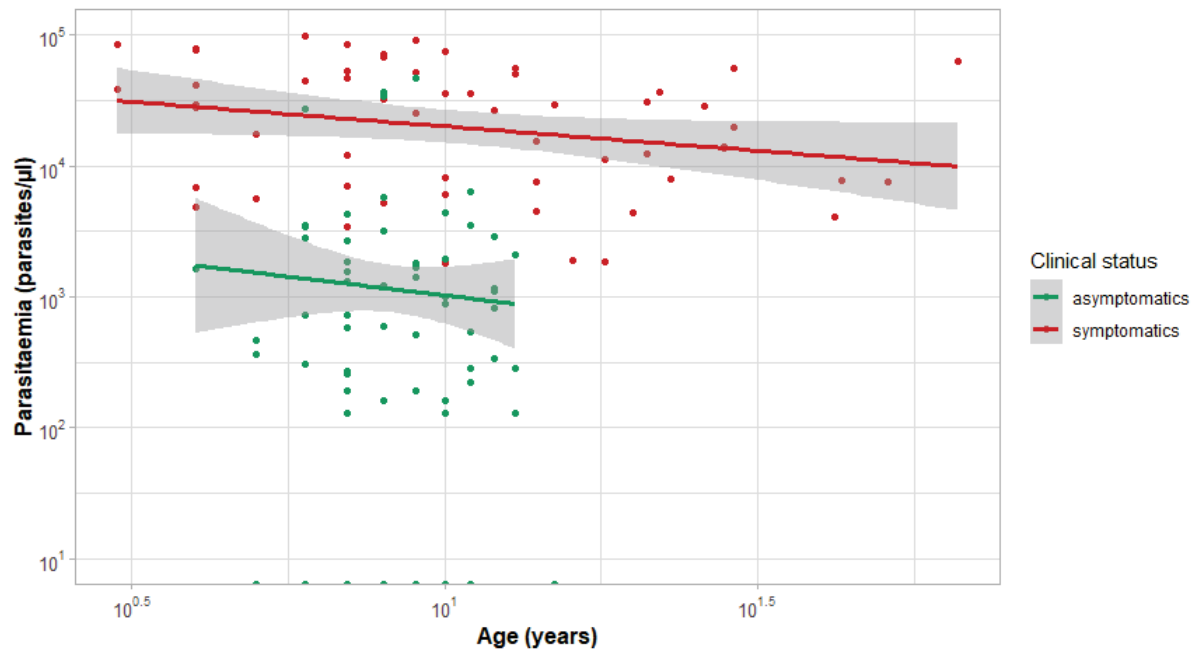

**Supplementary Figure S2.** Relation between asexual parasite density and age according to clinical status.

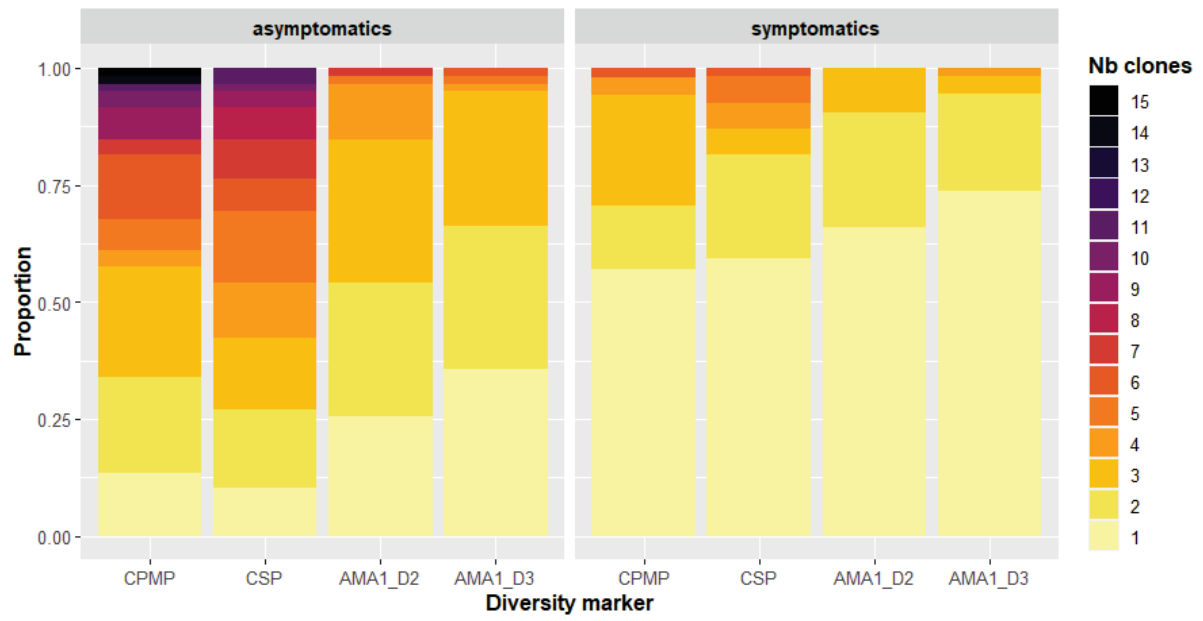

**Supplementary Figure S3.** Proportion of blood samples with different clone numbers for each diversity marker and according to clinical status.

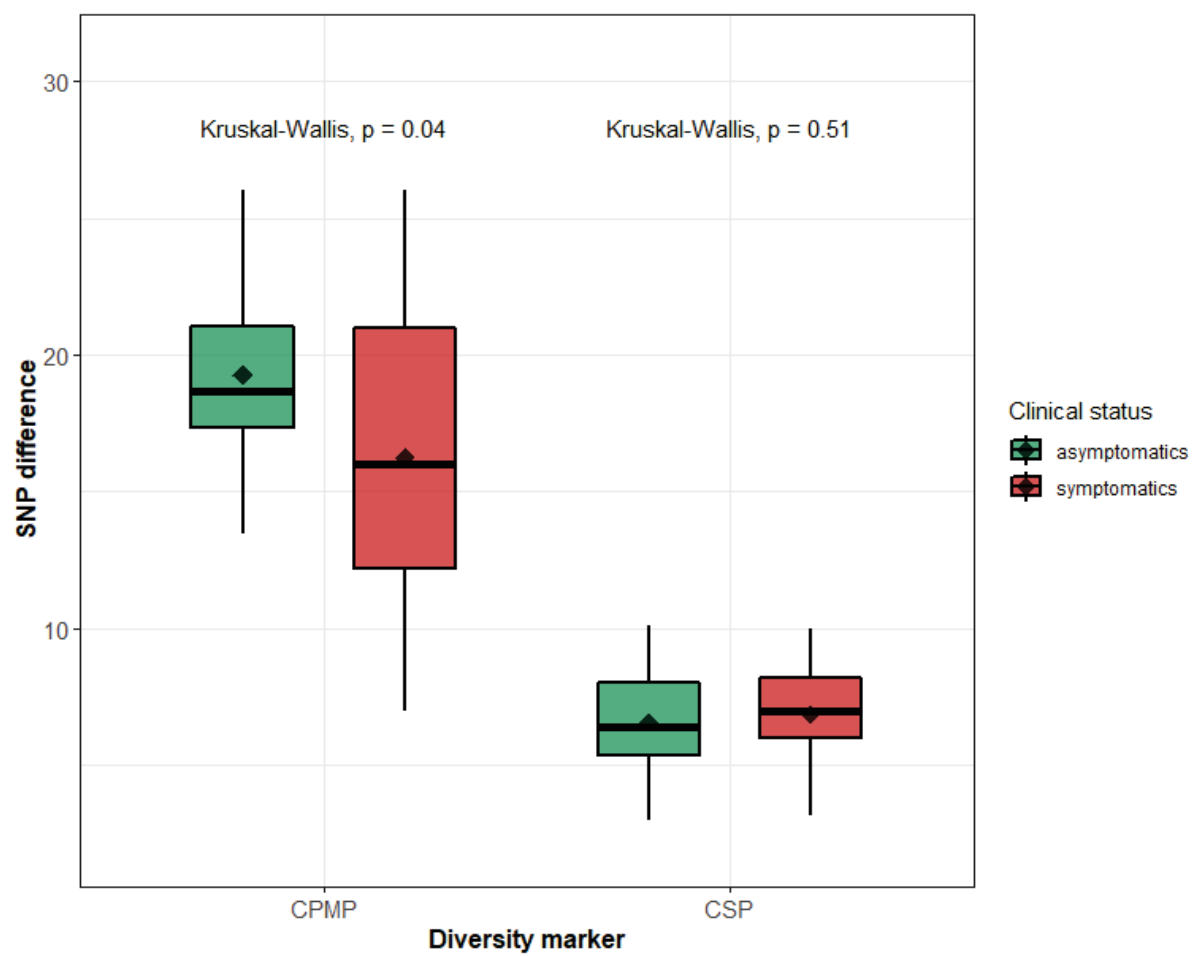

**Supplementary Figure S4.** SNP difference between genotypes identified in mixed infections from asymptomatic and symptomatic individuals with the CPMP and CSP markers.



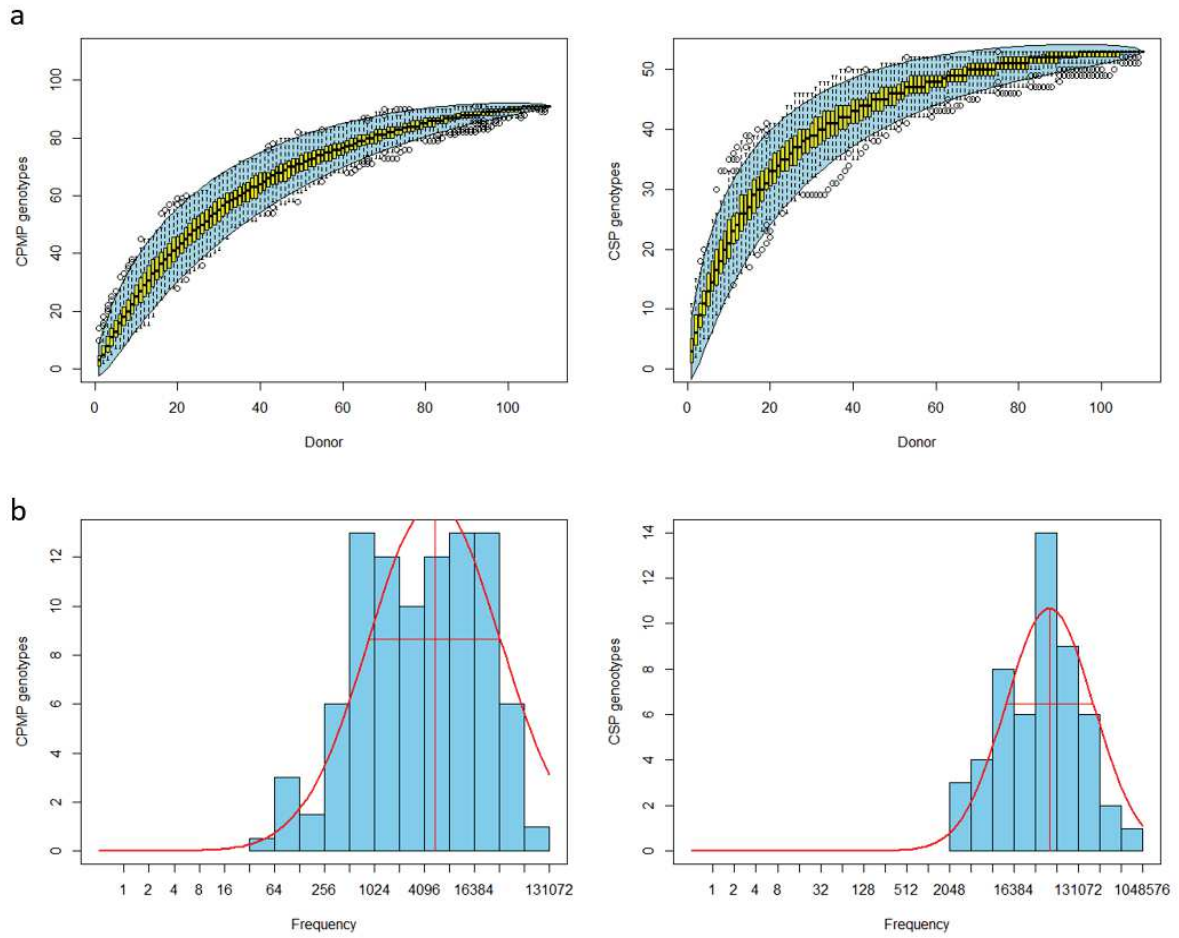

**Supplementary Figure S5.** Genotype accumulation curves (a) and genotype abundance distribution (b) for the CPMP (left) and CSP (right) markers. (a) Accumulation curves were obtained using the specaccum function in VEGAN [4] with the exact (blue) and random (yellow) models. (b) The genotype abundance distribution was plotted by fitting the Preston log-normal model that bins genotypes into frequency classes of increasing sizes. The estimated veiled genotype number using the Preston model was 2.8 for CMP and 1.5 for CSP.

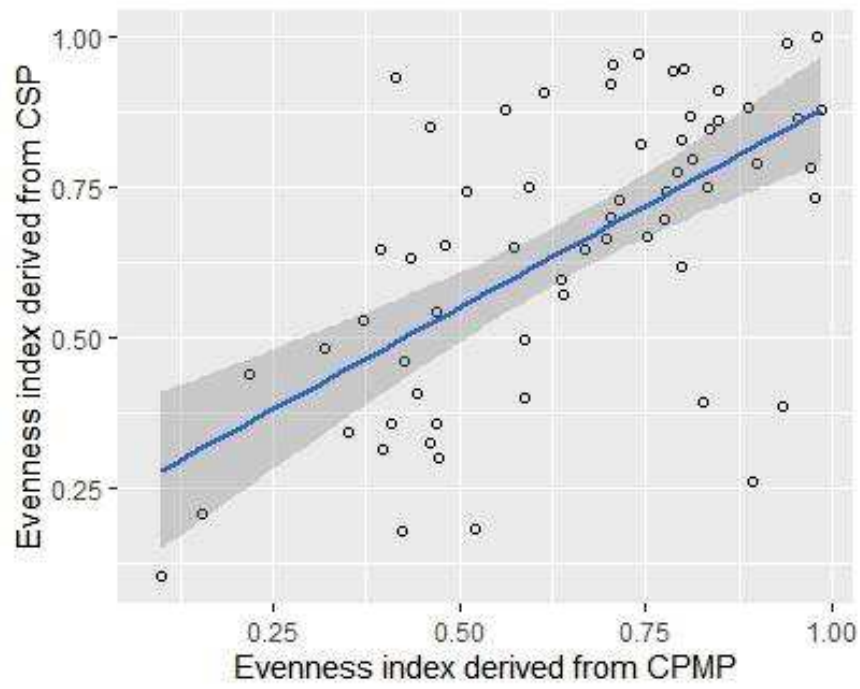

**Supplementary Figure S6.** Correlation of evenness index obtained with the two CPMP and CSP markers.

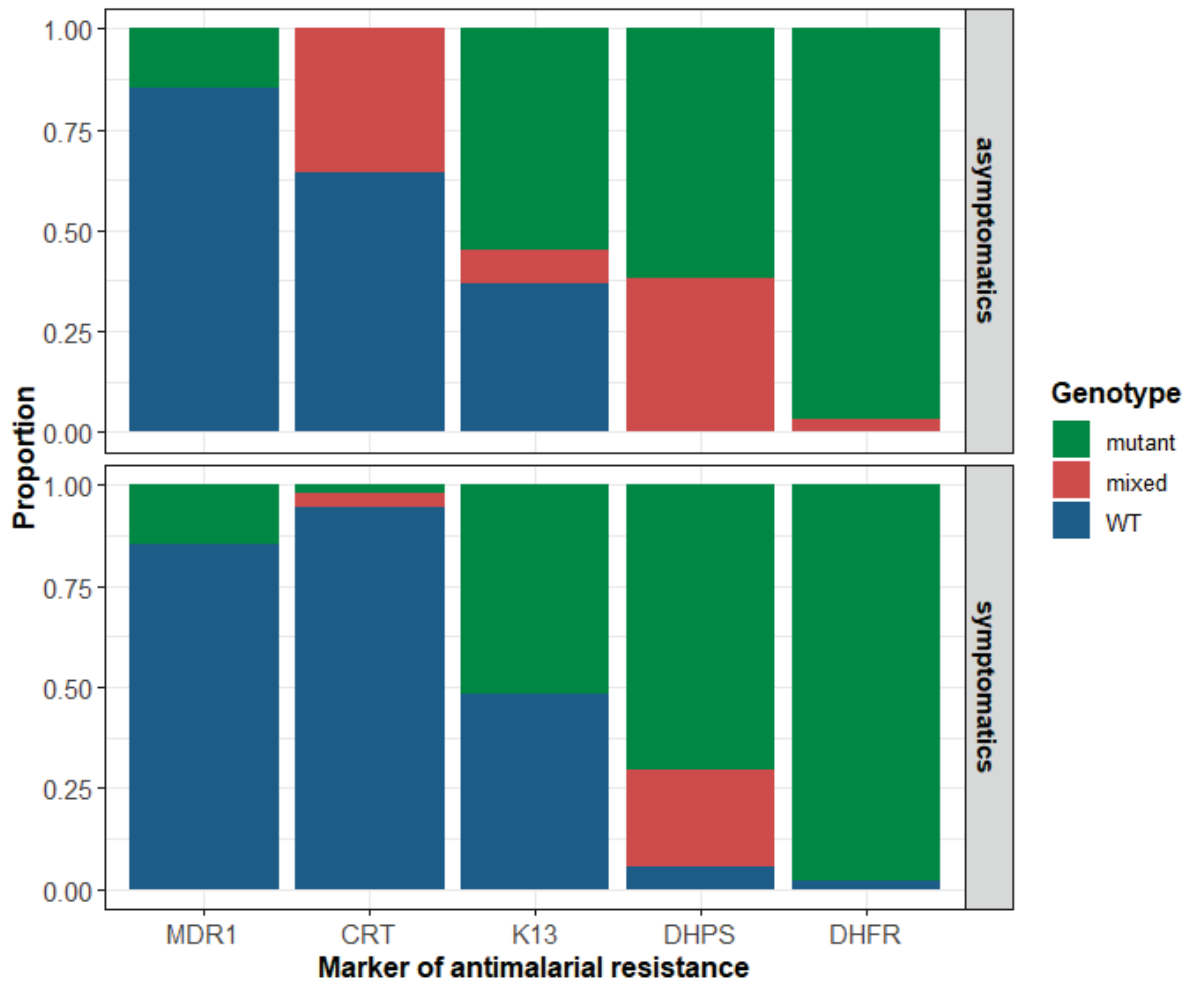

**Supplementary Figure S7.** Proportion of blood samples carrying wild-type, mutant or mixed genotypes at each antimalarial resistance marker for symptomatic and asymptomatic individuals.

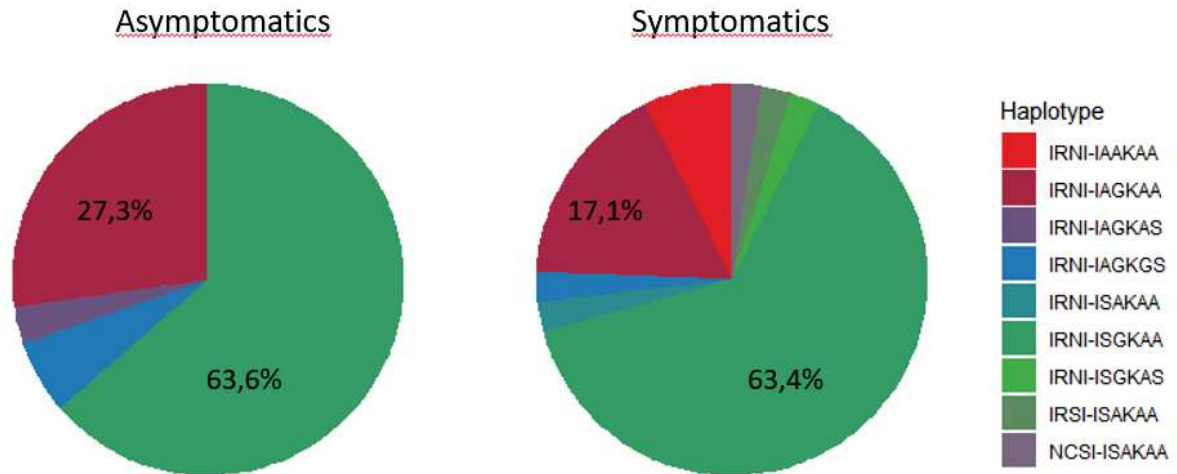

**Supplementary Figure S8.** Distribution of SP resistance haplotypes among symptomatic and asymptomatic individuals. Haplotypes were inferred by combining genotypes identified in the *dhfr* and *dhps* genes, excluding samples with mixed genotypes. For asymptomatics, 33 samples; for symptomatics, 41 samples.

## Supplementary Tables

**Supplementary Table S1.** Primers used for PCR reactions for genes associated with antimalarial resistance.

Fragment Name	Reference Gene	Primer sequence	Size (bp)
Pfdhfr.1	DHFR (PF3D7_0417200)	F. ATGATGGAACAAGTCTGCGACGTTTTTCGA R. CTA AAAAATTCTTGATAAACAACGGAACCTCC	523
Pfmdr1.1		F. ATGGGTAAAGAGCAGAAAGAGAAAAAAGATG R. GTTATAAATTCGTACCAATCCTGAACTCA	515
Pfmdr1.7	MDR1 (PF3D7_0523000)	F. TTTGTCCAATTGTTGCAGCTGTATTAAC TTT R. TGCATTTTCTGAATCTCCTTTTAAGGACATT	488
Pfmdr1.8		F. GGTA AAGTTGATATTA AAGATGTAAATTTCC R. TGGTCCAACATTTGTATCATATTTATTTGG	552
Pfcrt.2	CRT (PF3D7_0709000)	F. TGGCTCACGTTTAGGTGGAGGTTCTTG R. ACTGAACAGGCATCTAACATGGATATAGC	509
Pfdhps.3	DHPS (PF3D7_0810800)	F. ACCATCAGATGTTTATATAACAAATATGTG R. CTGGATTATTTGTACAAGCACTAATATCA	493
Pfdhps.4		F. AGAATGTGTTGATAATGATTTAGTTGATAT R. GATATAAAAGTTGATCCTTGCTTTTCCT	521
PfK13.2	K13 (PF3D7_1343700)	F. CTGACAGCAAATAATATAACTAATAATCT R. TCTTCATCAAATCGTTTCCTATGTT	488
PfCPMP	CPMP (PF3D7_0104100)	F. CATAAGTCATTA AAAATTTATGGAT R. CGTTACTATCAAGATCGTTAATATC	430
PfCSP	CSP (PF3D7_0304600)	F. AAATGACCCAAACCGAAATGT R. GGAACAAGAAGGATAATACCA	329
ama1_D2	AMA1 (PF3D7_1133400)	F. GGTCCTAGATATTGTAATAAAG R. CATGTTGGTTTGACATTA AA	479
ama1_D3		F. TACTACTGCTTTGTCCCATC R. TCAGGATCTAACATTTTCATC	516



**Supplementary Table S2.** Diversity indexes obtained for both CPMP and CSP markers. Diversity indexes were calculated using the VEGAN package (version 2.5-7) [4].

Diversity index	CPMP	CSP
	Estimate (se)	Estimate (se)
Genotype richness	91	53
Chao1	92.376 (1.479)	54.769 (2.173)
Jackknife	100.909 (3.425)	57.954 (2.625)
Shannon	0.564 (0.055)	0.598 (0.057)
Simpson	0.289 (0.026)	0.306 (0.027)
Pielou	0.627 (0.027)	0.557 (0.066)

**Supplementary Table S3.** Genotype diversity and differentiation measures between asymptomatic and symptomatic individuals for both CPMP and CSP markers. Indexes were computed using the SpadeR package [5]. s.e. estimates were obtained by 100 bootstrap replications.

Marker Status	CPMP		CSP	
	Asymptomatics	Symptomatics	Asymptomatics	Symptomatics
<i>Diversity :</i>				
Cumulated genotypes	260	93	267	98
Genotype richness	79	57	48	43
Shared genotypes	45		38	
<i>Differentiation :</i>				
Jaccard	0 (0.125)		0.918 (0.115)	
Sorensen	0 (0.176)		0.846 (0.182)	
<i>Gst</i>	0.005 (0.001)		0.003 (0.002)	
Shannon-Horn	0.092 (0.071)		0.144 (0.032)	

### Supplementary information on the prevalence of antimalarial resistance point mutations

The *pfmdr1* gene displayed low levels of polymorphism and no mixed infections were found for the 3 MDR1 amplicons. Mutation Y184F mapped outside our amplicons and was not screened here. The N86Y mutation that plays a role in CQ resistant parasites was the most frequent (16/1116, 13.8%). All parasite isolates carried the wild-type allele at positions S1034C, N1042D and D1246Y. Only positions K34R and N86Y were identified as polymorphic and mutant 34R was only observed in one symptomatic infection. Mutant genotypes represented less than 15% of infections and the frequency of mutant genotypes was not different between symptomatic and asymptomatic samples ( $p=0.964$ , Suppl. Figure S7). Mutant genotypes experienced a drastic reduction as compared to our previous study conducted between 2005 and 2009 in the same populations, in Yaoundé for symptomatics and Mfou for asymptomatics, where carriage of the 86Y mutant exceeded 90%, in overall single and mixed infections [6].

All parasite samples carried the wild type *pfprt* allele at codons C72S and V73I. Only two genotypes were recovered, the wild type CVMNK and the CQ resistant mutant CVIET. The *Pfprt* wild-type genotype CVMNK reached high prevalence in both sample sets, 94.3% (50/53) and 64.4% (38/59) in symptomatics and asymptomatics, respectively (Suppl. Figure S7). This represents a large increase as compared to our previous study [6] where prevalences of the wild-type genotype were only 19% and 15%, respectively in symptomatics and asymptomatics. The mutant CQ resistant genotype CVIET was only identified as single genotype infection in one symptomatic infection, which was a mono-infection. A total of 23 mixed CVMNK/CVIET infections were identified and mixed infections were significantly more frequent in asymptomatic samples (35.6% versus 3.8% in symptomatics,  $p < 0.0001$ ), a trend already observed in Menard et al. [6].

Three sites were polymorphic within the *pfk13* amplicon, K189T, R255K and L258M but R255K and L258M were rarely identified. Infections with mixed K13 genotypes were only found in asymptomatics and represented less than 10% (5/60) of samples (Suppl. Figure S7). Over 50% of infections (61/114) harboured mutant genotypes, mostly with the only K189T mutation. These mutations have not been associated with ART resistance.

The *pfdhfr* amplicon encompassed mutations A16V, N51I, C59R, S108N and I164L that have been associated with pyrimethamine resistance. No mutant codon was identified at positions 16 and 164. The triple IRN mutation reached almost fixation, identified in 98.3% (114/116) of the samples. All asymptomatic carriers harboured the IRN mutant genotype, two samples were

mixtures IRN + WT and IRN + S108. Symptomatic individuals were infected with a single DHFR genotype, 96.3% (52/54) with IRN and the 2 others with WT and S108N.

The *pf dhps* gene was the most polymorphic, even if no mutant codon was identified at positions 431 and 540. A total of 31.1% (34/109) of samples were mixed infections (Suppl. Figure S7). The 437G mutation reached a prevalence of 94.5% (103/109). The most prevalent genotypes were the single ISGKAA and double IAGKAA mutants, identified in 64% (48/75) and 21.3% (16/75) single infections, respectively. The wild-type ISAKAA genotype was identified in 3 (5.5%) symptomatic individuals and only as single genotype infection, while in asymptomatic carriers this genotype was present only in 4 mixed genotype infections. Prevalence of the 581G and 613S mutations reached 7.7% (9/117) and 10.3% (12/117), respectively. These two mutations that mediate enhanced SP resistance and are selected by IPTp with SP remains in the same proportion as our previous report from 20210-11 [7].

SP resistance results from the accumulation of mutations in both DHFR and DHPS genes. We inferred *dhfr/dhps* haplotypes by combining genotypes identified at each of the 3 amplicons, excluding samples with mixed genotypes (Suppl. Figure S8). The quadruple mutant IRNI/ISGKAA and the quintuple mutant IRNI/IAGKAA were the most prevalent, present in 63.5% (47/74) and 21.6% (16/74) blood samples, respectively. The sextuple mutant IRNI/IAGKGS was identified in 3 (4%) infections.

## References

1. Nag S, Dalgaard MD, Kofoed PE, et al. High throughput resistance profiling of *Plasmodium falciparum* infections based on custom dual indexing and Illumina next generation sequencing-technology. *Sci Rep* **2017**; 7:2398.
2. Lerch A, Koepfli C, Hofmann NE, et al. Longitudinal tracking and quantification of individual *Plasmodium falciparum* clones in complex infections. *Sci Rep* **2019**; 9:3333.
3. Lerch A, Koepfli C, Hofmann NE, et al. Development of amplicon deep sequencing markers and data analysis pipeline for genotyping multi-clonal malaria infections. *BMC Genomics* **2017**; 18:864.
4. Oksanen J. *Community Ecology Package.*, **2020**.
5. Chao A. *SpadeR: Species Prediction And Diversity Estimation*, **2010**.
6. Menard S, Morlais I, Tahar R, et al. Molecular monitoring of *Plasmodium falciparum* drug susceptibility at the time of the introduction of artemisinin-based combination therapy in Yaounde, Cameroon: implications for the future. *Malar J* **2012**; 11:113.
7. Chauvin P, Menard S, Iriart X, et al. Prevalence of *Plasmodium falciparum* parasites resistant to sulfadoxine/pyrimethamine in pregnant women in Yaounde, Cameroon: emergence of highly resistant *pf dhfr/pf dhps* alleles. *J Antimicrob Chemother* **2015**; 70:2566-71.

**Discussion and conclusion:** The CVMNK genotype reached a prevalence of almost 80% while the *Pfcr* CQ resistant genotype CVIET was found at low frequency, 20.5%, and mostly in mixed genotype infections. Previous works that examined *Pfcr* mutations among clinical cases in the same area reported increasing prevalence of the *Pfcr* 76T mutant until 2009, despite CQ withdrawal in the country in 2002. Prevalence of the CQR *Pfcr* 76T mutant was 70% in 2001 (Basco, 2002), reached 77% in 2004-2006 (Mbacham et al., 2010) and 81% between 2005 and 2009 (Menard et al., 2012). After 2009, reports from other regions in Cameroon indicated that proportion of the *Pfcr* 76T mutant decreased. A drop in the frequency of the mutant *Pfcr* 76T allele, from 96% in 2003-2005 to 67% in 2009-2013, was found among symptomatic children in the South-West Region of Cameroon (Moyeh et al., 2018). In East Cameroon, prevalence of the CVIET mutant switched from 72% to 46% between 2003 and 2012, even if samples were collected among distinct populations, symptomatics and asymptomatics, and in different villages, Bertoua and Messok, respectively (Ndam et al., 2017).

By contrast with the over-dominance of sensitive genotypes in *Pfcr*, the wild-type genotypes in *Pfdhfr* and *Pfdhps* genes were unfrequent. The *Pfdhfr* IRN resistant genotype approached saturation, as observed in other African countries (Mensah 2020,). The wild-type *Pfdhps* genotype was found in three monoclonal symptomatic infections and in four asymptomatics in mixed-infections, of which the infection densities of the wild-type parasites were low (less than 6%). This finding is certainly linked to SP drug pressure that maintains polymorphisms in *Pfdhfr* and *Pfdhps* genes. In Cameroon, intermittent preventive treatment in pregnancy (IPTp) with SP is used since 2004, and SP is also administrated for treatment of uncomplicated malaria because of its lower price despite its non-recommendation by national guidelines, (Chauvin et al., 2015). This drug pressure has induced changes in the prevalence of mutations associated with SP resistance and the emergence of highly resistant parasites. The *Pfdhfr/Pfdhps* quadruple mutant IRN-G remains dominant, which is consistent with other studies from West and Central Africa (Chauvin et al., 2015; Mensah et al., 2020; Moyeh et al., 2018; Narh et al., 2020; Svigel et al., 2021). The sextuple mutant IRN-AGKSG is reported here for the first time in Cameroon. Progressive accumulation of mutations in *Pfdhfr/Pfdhps* genes confers higher levels of SP resistance and further studies will be necessary to evaluate the *in vitro* and *in vivo* susceptibility to SP of this novel haplotype. Indeed, this sextuple mutant was recently found in Ghana (Mensah et al., 2020) and it may represent a new super resistant parasite.

In the *Pfkl3* gene, the K189T mutant codon was present in half of the samples and this represents an increased frequency for this mutation. Previous works reported for this mutation

a prevalence of 21% in blood samples from 2008-2009 in Bolifamba, South West region, and 36% in samples collected in 2013-2014 in surrounding areas (Apinjoh et al., 2017). Mutation K189T is located outside the *Pfk13* propeller region that contains polymorphisms conferring ART resistance and has not been associated with delayed parasite clearance (Group, 2019). Increase in the prevalence of the K189T mutation may reflect pressure from partner drugs used in ACTs, as already suggested for the C580Y mutation (Windle et al., 2020). Higher diversity in the *Pfk13* gene is observed in the African region with a low frequency of mutated codons (Ocan et al., 2019). The R255K mutation that was present in 3 of our samples has already been described in Africa (Group, 2019) and the L258M which was found in a single sample in this study may represent a novel mutation.

Comparing the genetic diversity between symptomatics and asymptomatics, we observed that asymptomatics had a higher genetic diversity, which is usually the case in malaria endemic areas (Barry et al., 2021). Lower diversity of symptomatics could be as a result of a higher prevalent of a dominant and more virulent parasite clone in asymptomatics (Mercereau-Puijalon, 1996). Higher MOI in asymptomatics implies the study area is characterised by high malaria transmission intensity. This could be due to several exposures of infective mosquito bites, or the polyclonal parasites from single mosquito bites (Eldh et al., 2020; Nkhoma et al., 2020).

Hence, we observed that the prevalence of antimalarial drug associated mutations was similar in both groups, even though mixed infections were mostly found in asymptomatics. More so, asymptomatics were more diverse, and unique clones were mostly seen in symptomatics.

We further compared the results of Mfou obtained from nested PCR with those from NGS (Table 5). For the *Pfcr1* gene, we observed a higher frequency of the wild type CQ sensitive allele K76 using nested PCR. However, NGS helped us determine the CVMNK and CVIET haplotypes present in the population that could not be determined by Nested PCR, as well as mixed infections. Looking at the *Pfmdr1* gene, majority of the samples from NGS had the WT N86 allele while half of the samples analysed using Nested PCR were either the WT N86 allele or mixed alleles. NGS further revealed that the WT alleles were present in other mutations in the *Pfmdr1* gene. More so, SNPs from the *Pfdhfr* and *Pfdhps* genes revealed similar results from Nested PCR and NGS analysed samples. Nonetheless, NGS was able to explore several SNPs associated with resistance such as the *Pfdhps* S436A and A613S which helped in determining the presence of the sextuple mutant haplotype IRN-AGKGS which is the first time being reported in Mfou. Furthermore, NGS helped us sequence the propeller region of the



*PfK13* gene, which is associated to ART, which cannot be achieved via Nested PCR. Thus, NGS helps better monitor antimalarial drug resistance, and is best to monitor antimalarial drug resistance in malaria endemic regions (Ishengoma et al., 2019).

**Table 5:** Antimalarial drug resistance SNPs analysed using Nested PCR and NGS

	Ref. allele	Alt. allele	Ref. Freq.		Alt. Freq.		Mixed Freq.		Total	
			Nested PCR	NGS	Nested PCR	NGS	Nested PCR	NGS	Nested PCR	NGS
<b>Pfcr1_72</b>	C	S	-	100% (49/49)	-	0.0% (0/49)	-	0.0% (0/49)	-	49
<b>Pfcr1_73</b>	V	-	-	100% (49/49)	-	0.0% (0/49)	-	0.0% (0)	-	49
<b>Pfcr1_74</b>	M	I	-	71.43% (35/49)	-	0.0% (0/49)	-	28.57% (14/49)	-	49
<b>Pfcr1_75</b>	N	E	-	71.43% (35/49)	-	0.0% (0/49)	-	28.57% (14/49)	-	49
<b>Pfcr1_76</b>	K	T	88.5% (716/809)	71.43% (35/49)	2.84% (23/809)	0.0% (0/49)	8.65% (70/809)	28.57% (14/49)	809	49
<b>Pfmdr1_86</b>	N	Y	44.62% (369/827)	84.62% (44/52)	9.31% (77/827)	15.39% (8/52)	46.07% (381/827)	0.0% (0/52)	827	52
<b>Pfmdr1_1034</b>	S	C	-	100% (52/52)	-	0.0% (0/52)	-	0.0% (0/52)	-	52
<b>Pfmdr1_1042</b>	N	D	-	100% (52/52)	-	0.0% (0/52)	-	0.0% (0/52)	-	52
<b>Pfmdr1_1246</b>	D	Y	97.94% (809/826)	100% (52/52)	1.09% (9/826)	0.0% (0/52)	0.97% (8/826)	0.0% (0/52)	826	52
<b>Pfdhfr_16</b>	A	V	-	100% (52/52)	-	0.0% (0/52)	-	0.0% (0/52)	-	52
<b>Pfdhfr_51</b>	N	I	0.85% (7/825)	0.0% (0/52)	99.15% (818/825)	96.15% (50/52)	0.0% (0/825)	3.85% (2/52)	825	52
<b>Pfdhfr_59</b>	C	R	0.72% (6/833)	0.0% (0/52)	99.28% (827/833)	96.15% (50/52)	0.0% (0/833)	3.85% (2/52)	833	52
<b>Pfdhfr_108</b>	S	N	0.0% (0/821)	0.0% (52/52)	100% (821/821)	96.15% (50/52)	0.0% (0/821)	3.85% (2/52)	821	52
<b>Pfdhfr_164</b>	I	L	100% (824)	100% (52)	0.0% (0/824)	0.0% (0/52)	0.0% (0/824)	0.0% (0/52)	824	52
<b>Pfdhps_436</b>	S	A	-	72% (36/50)	-	26% (13/50)	-	22% (11/50)	-	50
<b>Pfdhps_437</b>	A	G	5.19% (42/809)	20% (10/50)	94.80% (767/809)	74% (37/50)	0.0% (0/809)	26% (13/50)	809	50
<b>Pfdhps_540</b>	K	E	98.88% (810)	100% (50/50)	0.12% (1/811)	0.0% (0/50)	0.0% (0/50)	0.0% (0/50)	811	50
<b>Pfdhps_581</b>	A	G	98.15% (796)	96.15% (25/26)	1.85% (15/811)	3.85% (1/26)	0.0% (0/811)	0% (0/26)	811	26
<b>Pfdhps_613</b>	A	S	-	88.46% (23/26)	-	7.69% (2/26)	-	3.85% (1/26)	-	26
<b>PfK13_189</b>	K	T	-	57.06% (24/51)	-	52.94% (27/51)	-	8.33% (2/51)	-	51
<b>PfK13_255</b>	R	K	-	94.12% (48/51)	-	1.96% (1/51)	-	3.92% (2/51)	-	51

**CHAPTER 5**

**TRANSMISSION EFFICIENCY OF  
ANTIMALARIAL DRUG  
RESISTANT – ASSOCIATED  
ALLELES BY THE ANOPHELES  
MOSQUITOES.**

**Of note:** for this chapter, analyses are still ongoing and the results are preliminary.

### **Transmission efficiency of antimalarial drug resistant-associated alleles by the *Anopheles* mosquitoes**

Elangwe M. Sarah-Matio,<sup>1,2</sup> Luc Abate,<sup>1</sup> Emilie Guillochon,<sup>3</sup> Christelle M. Ngou,<sup>1,2</sup> Gaelle A. Bouopda,<sup>2,4</sup> Lionel B. Feufack-Donfack,<sup>4</sup> Albert N. Bayibéki,<sup>5</sup> Lawrence Ayong,<sup>2</sup> Antoine Claessens,<sup>6</sup> Antoine Berry,<sup>7,8,\*</sup> Thierry Lefèvre,<sup>1</sup> Sandrine E. Nsango,<sup>2,4</sup> and Isabelle Morlais<sup>1</sup>

1 Infectious diseases and Vectors Unit (MIVEGEC), IRD, CNRS, Univ. Montpellier, Montpellier, France

2 Malaria Research Unit, Centre Pasteur du Cameroun, Yaoundé, Cameroon

3 Université de Paris, MERIT, IRD, Paris, France

4 Department of Biological Sciences, Faculté de Médecine et des Sciences Pharmaceutiques, Université de Douala, Douala, Cameroon

5 Université Catholique d'Afrique Centrale, Yaoundé, Cameroon

6 Laboratory of Pathogen Host Interactions, Montpellier, France

7 Institut Toulousain des Maladies Infectieuses et Inflammatoires (Infinity), Université Toulouse, CNRS, INSERM, Toulouse, France

8 Laboratoire de Pharmacocinétique et Toxicologie Clinique, Centre Hospitalier Universitaire de Toulouse, Hôpital Purpan, Toulouse, France

\* These *authors contributed equally* to this work

**Key words.** *Plasmodium falciparum*; anti-malarial resistance; genetic diversity; molecular genotyping; Cameroon

### **Introduction**

The thriving of *Plasmodium falciparum* in its mosquito vector is vital for the continuous transmission of malaria. Nonetheless, the genetic diversity of the malaria parasite vary in several and different epidemiological areas (Anderson et al., 2000; Arnot, 1998). Several genotypes are mostly present in single parasite isolates, especially in malaria endemic settings, hence hindering *P. falciparum* genetic studies (Morlais et al., 2015).

Knowledge on the genetic diversity and antimalarial drug resistance haplotypes present in parasite stages developing in the mosquito, from specific gametocyte isolates will enable us better understand the dynamics of malaria transmission. Few studies have been carried out on the transmission of different haplotypes of the *P. falciparum* from gametocytes to sporozoites in single parasite isolates. (Morlais et al., 2015; Nsango et al., 2012). Thus, it is important to fathom how these parasites develop in their vector by determining which haplotypes are better transmitted by the mosquito, and in so doing give directions on malaria control strategies.

The aim of this study was to do a follow up per parasite field isolate, on the different haplotypes associated with antimalarial drug resistance and the genetic diversity of the *P. falciparum* from filtered blood gametocytes to oocysts from midgut and finally sporozoites in the salivary gland, to determine haplotypes that are efficiently transmitted by their mosquito vector.

## Results

A total of 2,339 pupils were sampled from 11 primary schools. 53% (1241/2339) were infected with trophozoites, 10.3% (241/2339) were infected with gametocytes, 9.49% (222/2339) had *P. malariae*, 82.69% (1934/2339) had *P. falciparum* and 7.82% (183/2339) had mixed *Plasmodium* infections. Of the 241 pupils infected with gametocytes, 53 of them were chosen as volunteers for mosquito experimental infections, with 86% (43/50) of the carriers being 10 years and below.

The sex ratio (M/F) was 1.11 (26/24). The average temperature was 36.95°C, the mean weight was 25.57Kg, the mean age was 8.43 years. The mean Hb was 11.63g/dl of blood. The mean gametocyte per µl of blood was 135.5, and the mean trophozoites per µl of blood was 386.1 (Table 1). 92.45% (49/53) of the gametocyte carriers said they did not sleep under mosquito nets, and 83.02% (44/53) of the donors had no recent malaria cases.

A total of 53 feedings (Table 5) was carried out of which 1,072 mosquito salivary glands were dissected 14 days post infection (P.I). DNA extraction was carried out in these samples, and qPCR tested positive for 249 (23.23%) *P. falciparum* mono infection. 210 samples were selected for AmpSeq, and 208 samples were successfully sequenced.



**Table 1:** Infection parameters of the study population.

Parameters	Mean	Range
Age (yrs)	8.434	5 – 15
Weight (Kg)	25.57	13.80 – 42.00
Temperature (°C)	36.95	36 – 37.40
Blood Hb (g/dl)	11.63	7.20 - 14.20
Gametocytes/ $\mu$ l of blood	135.5	0.0 – 2208.0
Trophozoites/ $\mu$ l of blood	386.1	0.0 – 4747.2

### Comparison of multiplicity of infection in asexual and sexual parasite stages

The parasitaemia in asexual parasites was significantly higher than those of sexuals (paired t-test,  $t=2.76$ ,  $df=49$ ,  $P=0.008$ , Table 3). Number of co-infecting clones (MOI) does not associate with parasite densities in the asexual parasite stage (LRT  $X^2_1 = 0.4$ ,  $P=0.524$ , Table 3, Figure 5a) but MOI is negatively correlated with sexual parasite density (LRT  $X^2_1 = 21$ ,  $P<0.001$ , Figure 5a), then gametocyte carriers with high parasite burden are less likely to carry complex infections. Number of co-infecting clones is not significantly different in asexual and sexual stages (LRT  $X^2_1 = 0.8$ ,  $P=0.368$ , Figure 1b) and MOI in sexual parasites correlates with that in asexuals (Figure 5c).

**Table 3.** Characteristics of parasite samples (N=50).

Parasite stage	asexual	sexual
Parasitaemia	728 [IQR152-2124]	48 [IQR 24-114]
Median MOI	5 (range 1-16)	4 (range 1-15)

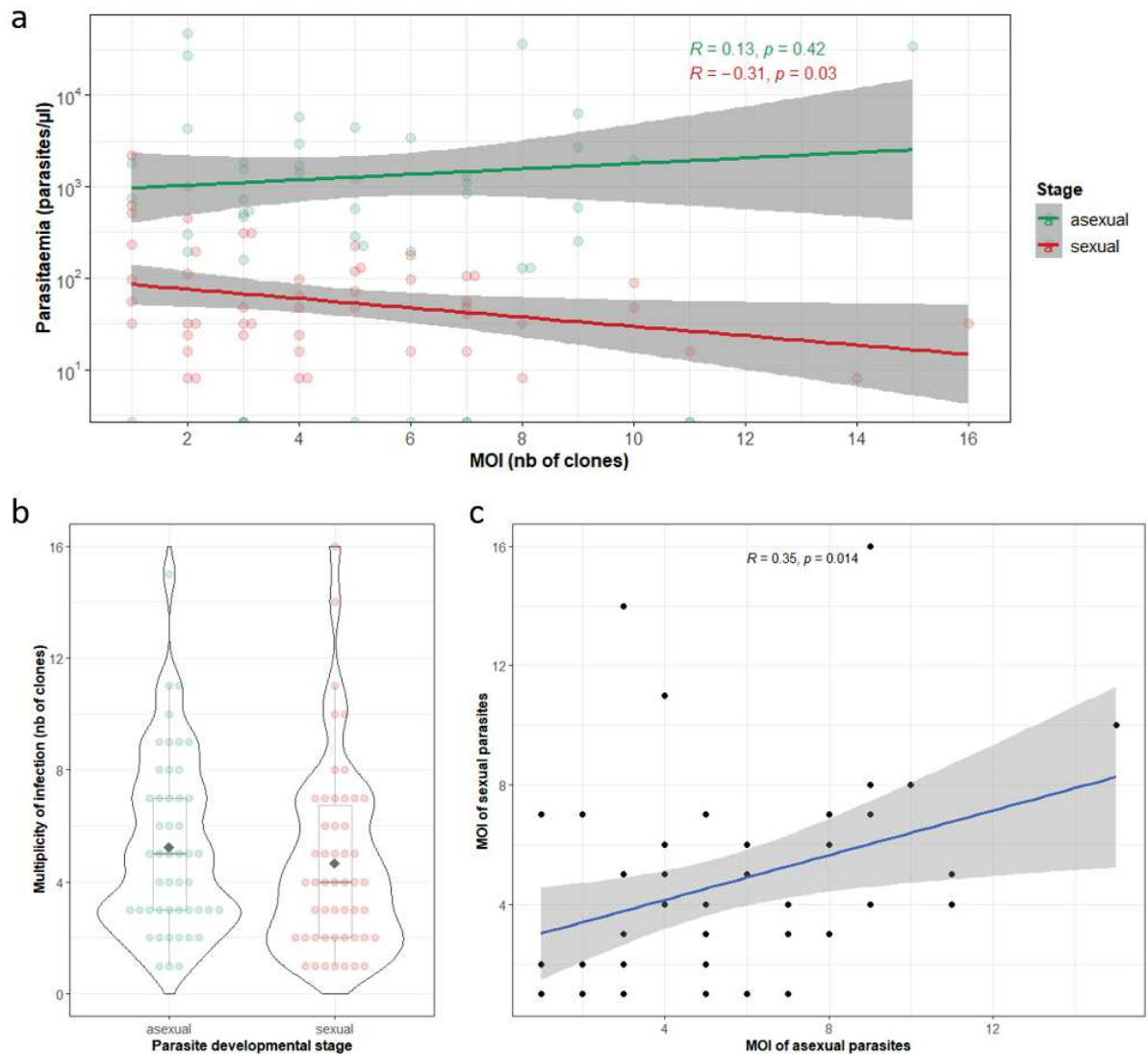

**Figure 5.** Multiplicity of infection is conserved from asexual and sexual parasite stages **a**. Association between parasite density and the number of co-infecting clones according to parasite developmental stage. **b**. Multiplicity of infection in asexual and sexual parasites. Data from 50 blood donors. **c**. Correlation of the number of co-infecting clones in asexual and sexual parasite stages. MOI, number of co-infecting clones.

### Assessment of sequence reads and MOI

We tried to assess the effect of reads on the MOI, and observed the number of reads did not influence the MOIs, irrespective of the molecular marker used (Figure 1) (X-squared = 189.95, df = 88, p-value = 1.837e-09).

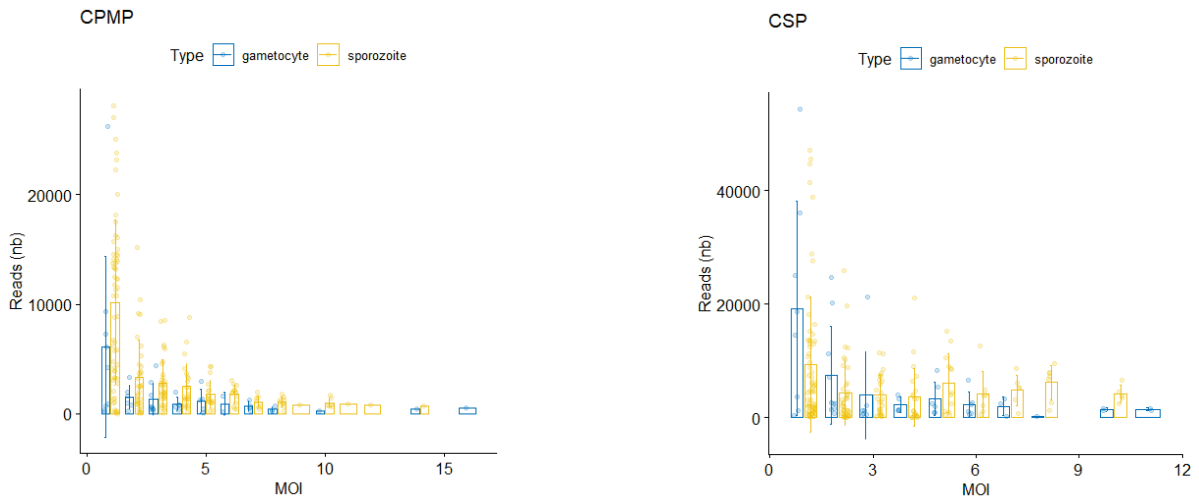

**Figure 1:** Relationship between the proportion of reads and MOI from blood gametocytes and mosquito sporozoites. Irrespective of using the molecular markers CPMP or CSP, the number of reads did not affect the MOI.

### Comparing MOIs in gametocytes and sporozoites

A total of 50 gametocytes and 208 sporozoites were used to determine the MOIs of gametocytes and sporozoites respectively. This study did not observe any significant difference in the MOIs found in gametocytes and those observed in sporozoites ( $P = 0.099$ ) (Figure 2). Notably, minor clones observed in gametocytes were major clones in sporozoites (Figure 3).

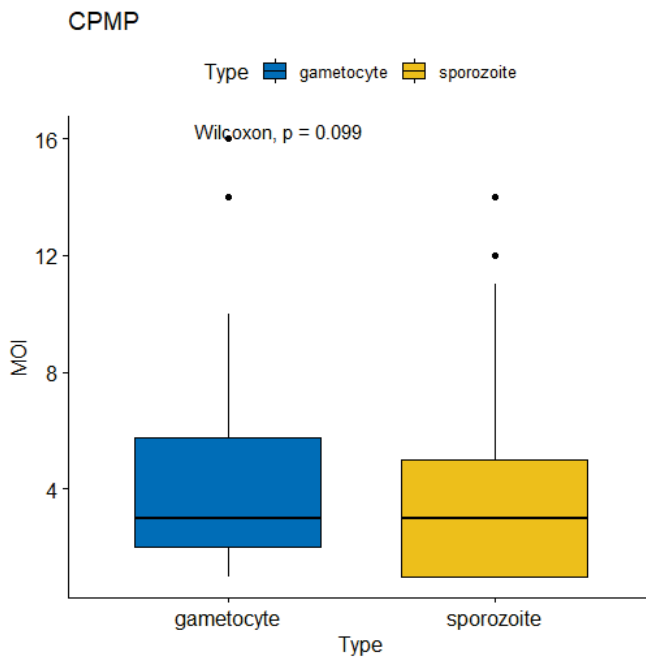

**Figure 2:** There was no significant difference in the MOI of gametocytes and sporozoites

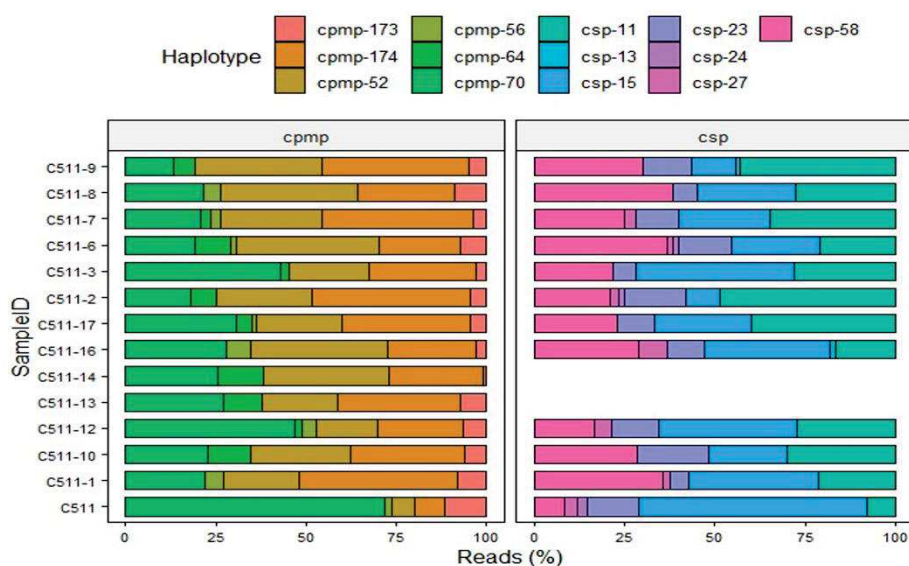

**Figure 3:** Minor clones in gametocytes were seen as major clones in sporozoites. Diagram shows an example of clones in an individual gametocyte sample C511 and the various sporozoites samples C511-1 to C511-16 obtained from mosquitoes after they blood fed from this gametocyte donor 14 days PI.

### Antimalarial drug resistance SNPs

***Pfmdr1*:** Two haplotypes were observed; the single mutant N86Y haplotype in 22.45% (11/49) gametocytes and 18.75% (39/208) sporozoites, and the wild type WT haplotype was observed in 79.59% (39/49) and 80.77% (168/208) gametocytes and sporozoites respectively. There was no significant difference in the haplotypes present in both stages ( $P = 0.95$ ) (Figure 4b).

***Pfdhps*:** Overall, there was no significant difference in the haplotypes observed in both parasite stages ( $P = 2.2e-10$ ) (Figure 4e). The *Pfdhps* was the most polymorphic gene with 5 haplotypes observed with the single mutant haplotype 437G being the most prevalent and the WT haplotype completely absent from the sporozoites (Table 2).

***Pfcrt*:** Looking at the *Pfcrt*, 2 haplotypes were seen, the wild type WT haplotype in 87.76% (43/49) and 89.9% (187/208) of gametocytes and sporozoites respectively. The M74I+N75E+K76T haplotype was observed in 28.57% (14/49) and 15.87% (33/208) in gametocytes and sporozoites ( $P < 2.2e-16$ ) (Figure 4a).

***Pfdhfr*:** 3 haplotypes were observed, the N51I+C59R+S108N triple haplotype which was observed in all gametocyte (49/49) and sporozoite (208/208) isolates. The second haplotype

was the single mutant S108N haplotype, which was present in 1 gametocyte sample and 6.25% (13/208) sporozoite samples. There was an overall significant difference in haplotypes present in gametocytes and those in sporozoites ( $P = 0.00013$ ) (Figure 4d).

***PfK13***: No known SNP associated with ARTR was observed. 3 haplotypes were seen; one with the K189T mutation, the second had the R255K mutation and the third was the wild type WT with no mutation. The K189T haplotype was observed in 48.98% (24/49) of gametocytes and 54.33% (113/208) of sporozoites. The R255K was present in 6.12% (3/49) and 1.44% (3/208) of gametocytes and sporozoites respectively. The wild type haplotype WT was present in 53.06% (26/49) and 45.19% (94/208) of the gametocytes and sporozoites respectively. Haplotypes in gametocytes were significantly slightly higher in gametocytes than sporozoites ( $P = 0.049$ ) (Figure 4c).

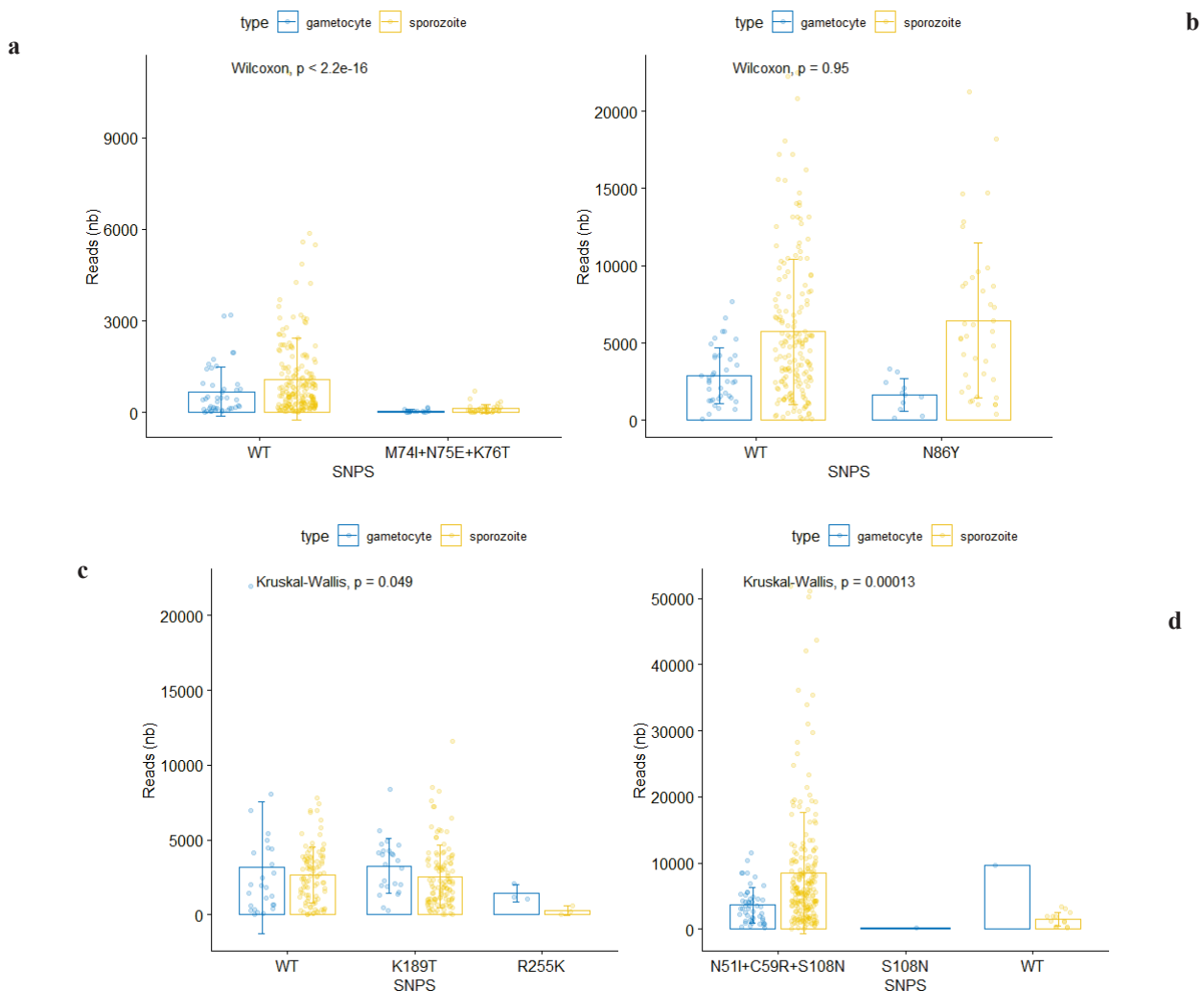

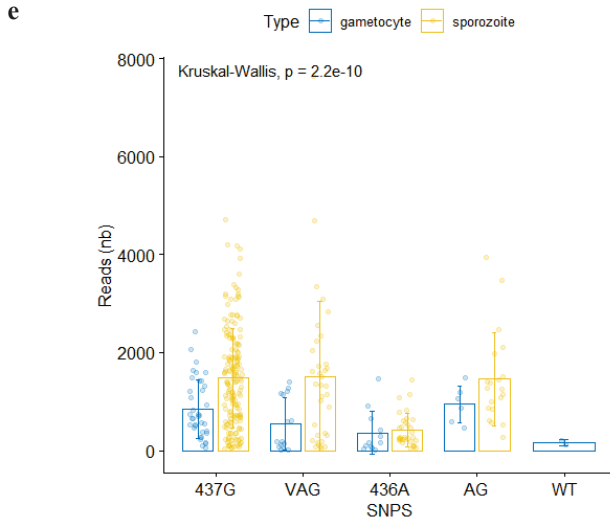

**Figure 4:** Comparing SNPs associated with antimalarial drug resistance in gametocytes and sporozoites. *Pfprt*, gene (a) and the *Pfmdr1* gene (b) didn't show any significant difference in SNPs from gametocytes and those from sporozoites. The *PfK13* gene (c) and *Pfdhfr* gene (d) observed a significant difference in the SNPs present in gametocytes and sporozoites. The *Pfdhps* gene (e) had the highest number of haplotypes, and the WT haplotype was only present in gametocytes.

**Table 2:** *Pfdhps* SNPs data from gametocyte donors and sporozoites

SNP	Gametocyte	Sporozoites
436A	24.49% (12/49)	15.39% (32/208)
437G	75.51% (37/49)	83.17% (173/208)
AG	12.25% (6/49)	9.62% (20/208)
VAG	30.61% (15 /49)	16.83% (35/208)
WT	4.08% (2 /49)	0.0% (0/208)



**Table 4:** Characteristics of gametocyte carriers and their transmission success parameters in the mosquito

Oocysts carrier	GTC/ $\mu$ l of blood	MOI	Tropho/ $\mu$ l of blood	No. of midgut dissected	Oocysts mean	Oocyst range	Oocyst prevalence (%)	No. of salivary gland dissected	No. of infected with spz
C459	16	6	25.6	53	0.6038	0 - 6	30	30	1
C460	504	1	806.4	39	1	0 - 9	37	30	2
C461	48	7	76.8	61	4.164	0 - 17	79	0	0
C462	448	2	716.8	64	17.3	0 - 79	77	0	0
C463	48	10	76.8	28	0	0	0	1	0
C464	112	2	179.2	61	5.525	0 - 56	62	0	0
C465	232	1	371.2	28	0	0	0	0	0
C466	32	8	51.2	60	1.1	0 - 6	42	3	0
C467	224	5	358.4	42	0.3571	0 - 2	26	30	0
C468	192	2	307.2	42	0.5	0 - 2	31	49	0
C469	48	3	76.8	60	1.133	0 - 10	53	30	0
C470	32	3	51.2	55	0.07273	0 - 1	7	0	0
C471	16	2	25.6	43	0.0303	0 - 1	3	0	0
C472	64	4	102.4	43	0.02326	0 - 1	2	0	0
C473	56	-	89.6	33	4.706	1 - 11	100	0	0
C474	72	5	115.2	24	2.083	0 - 6	100	1	0
C475	48	5	76.8	62	1.677	0 - 6	76	30	13
C476	32	3	51.2	44	0.4091	0 - 3	27	30	0
C477	24	4	38.4	59	1.051	0 - 5	0	30	4
C478	8	4	12.8	62	1.484	0 - 8	54	30	9
C479	120	5	192	63	9.571	0 - 27	95	30	17
C480	104	7	166.4	60	2.333	0 - 8	80	30	21
C481	128	5	204.8	58	4.69	0 - 18	76	30	18
C482	40	7	64	60	8.25	0 - 37	82	30	8
C483	24	3	38.4	60	2.683	0 - 13	75	30	9
C484	48	4	76.8	65	1.108	0 - 8	43	37	0
C485	24	2	38.4	34	1.029	0 - 6	38	30	0
C486	96	4	153.6	65	0.6769	0 - 7	29	30	0
C487	16	7	25.6	36	1.778	0 - 10	56	30	3
C488	8	8	12.8	40	0.275	0 - 1	28	30	1
C489	8	-	12.8	0	0	0	0	30	1
C490	32	1	51.2	48	3.208	0 - 14	81	30	15
C491	96	1	153.6	28	6.5	0 - 21	71	30	0
C492	32	2	51.2	18	0.3889	0 - 2	22	30	1
C493	8	4	12.8	50	2.96	0 - 13	78	30	5
C494	16	11	25.6	32	2.125	0 - 6	78	30	4

C495	32	16	51.2	44	6.159	0 - 25	75	30	12
C496	8	2	12.8	33	0.02941	0 - 1	0	30	0
C497	624	1	998.4	67	11.67	0 - 51	90	30	13
C498	0	14	0	42	1.143	0 - 7	48	30	16
C499	88	10	140.8	60	10.13	0 - 42	90	30	13
C500	0	-	0	25	0	0	0	30	0
C501	96	6	153.6	46	1.413	0 - 9	61	30	3
C502	56	7	89.6	44	1.523	0 - 10	50	30	4
C503	32	2	51.2	0	0	0	0	30	0
C504	2208	1	3532.8	45	10.03	0 - 25	93	30	0
C505	312	3	499.2	36	56.81	0 - 122	91	30	12
C506	8	2	12.8	29	0.6552	0 - 4	0	30	5
C507	16	4	25.6	0	0	0	0	30	0
C508	104	7	166.4	44	24.18	0 - 62	91	30	2
C509	56	1	89.6	57	2.281	0 - 15	54	30	3
C510	312	3	499.2	42	4.024	0 - 24	54	30	20
C511	176	6	281.6	58	13.53	0 - 31	54	30	14

SPZ: sporozoites; GTC: gametocytes; Tropho: trophozoites; MOI: multiplicity of infection

## Discussion

The aim of this study was to determine the transmission success of different *P. falciparum* strains from their blood gametocyte isolates to the sporozoite infective stage in the mosquito salivary gland. Gametocyte density was used to measure transmission rates and has been seen to correlate with the fraction of mosquitoes infected, and the parasite burden per mosquito infected (Taylor et al., 1998).

We used mosquito infection via membrane feeding assays to study the different *P. falciparum* genotypes in the field, from an area where malaria is hyperendemic and the entomological inoculation rate (EIR) is  $> 100$  (Antonio-Nkondjio et al., 2002; Bonnet et al., 2003). Based on our findings, we had the following observations;

As previously observed (Morlais et al., 2015), we confirm that transmission success was not seen in gametocyte monoclonal infections but in polyclonals. This confirms that coinfection helps in the transmission success of parasites. Thus, mosquito infection is influenced by the number of co-infecting clones in the gametocyte isolates. Minor clones in gametocytes were seen to be major clones in the sporozoite populations implying that the mosquito helps maintain the genetic diversity of the parasites, confirming previous studies (Morlais et al., 2015). Nonetheless, some studies (Ampfler et al., 2014; Campino et al., 2011; Nwakanma et al., 2008; Arez et al., 2003) hardly observed minor clones due to the molecular tools used, which were not sensitive enough to detect minor clones. Unlike us, we carried out next generation sequencing (NGS) using the Illumina Miseq which is a very sensitive tool and can detect rare and minor clones. More so, some clones that could not be detected in the gametocyte isolates were detected in sporozoites. This could be due to; inaccurate genotyping of gametocytes; the genotypes of minor clones were below PCR detection limits in gametocytes (Wampfler et al., 2014); or may be due to recombination in the midguts. This scenario was also observed over five years ago (Morlais et al., 2015).

Furthermore, transmission of parasite genotypes in the mosquito was dependent on the gametocytaemia, as there was a significant difference in the number of clones and parasitaemia. This implied that as the gametocytaemia increased, interestingly the number of clones reduced which may be due to the fact that the human host less rapidly clears multiple clone infections (Taylor et al., 1998). This is contrarily to previous studies (Taylor et al., 1998) that observed mixed clone infections had higher gametocyte density than single clones, but in line with Morlais *et al.* (Morlais et al., 2015) study conducted in the same area over 5 years ago. However,

we tried to compare this scenario with the asexual parasite stage, the trophozoites, and observed the parasite clones were independent of the parasitaemia, as there was no significant difference in the slight increase of clones with parasitaemia. This was in line with previous studies (Morlais et al., 2015; Touray et al., 2021).

Looking at the SNPs associated with antimalarial drug resistance, the local mosquitoes didn't select any antimalarial drug sensitive or resistant clones, as all strains in the blood gametocytes were also observed in the sporozoites, indicating that the vectors efficiently transmit both the resistant and sensitive strains.

## **Conclusion**

No consistent differences in infections irrespective of multiple or single clone, resistant or sensitive strains. Mosquito infection prevalence was determined by the gametocyte density and the MOI. More so, minor genotypes in blood gametocytes became major haplotypes in the mosquito sporozoites implying that the mosquitoes favour the development of minority clones. Hence the mosquito shapes the *P. falciparum* population by sporogony within the mosquito vector, hence maintaining the genetic diversity of the parasites and favours the growth of both antimalarial drug sensitive and resistant strains. Malaria transmission dynamics still remains complex. It will be interesting to determine the mechanisms in the mosquito responsible for these changes in clone dominance.

## **Materials and Methods**

**Study Population:** Sampling was carried out in primary schools (Figure 5) around Mfou, a small town 30km away from Yaounde, the capital of Cameroon. This area is characterised by perennial malaria transmission with a higher transmission intensity in the rainy season; August to November and April to June (reviewed in Nsango et al., 2012).

Sampling was among children age ranging 4 – 15 years, and those who had asymptomatic malaria and were carriers of gametocytes were used as gametocyte donors. Screening was carried out in with the help of the medical team of Mfou district hospital during the rainy season from October to November in 2017 and 2018.

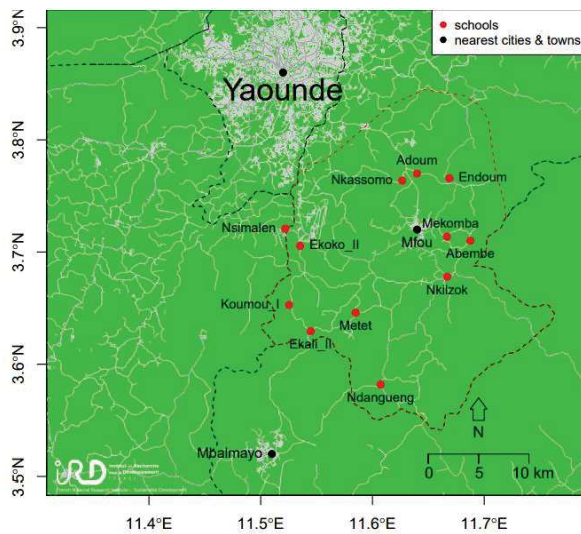

**Figure 5:** Map showing the different primary schools that were screened for gametocyte carriers.

**Gametocyte Screening:** Thick blood smear was collected voluntarily from pupils by finger pricking, stained with 20% Giemsa and examined under the light microscope (1000X) to identify sexual and asexual stages of the *Plasmodium* parasites. Children with more than 50 trophozoites per  $\mu$ l of blood and other asexual stages were treated ACTs (AS+AQ) respecting national guidelines. Gametocyte carriers were enrolled as gametocyte donors for mosquito infection after signed consent forms from parents/guardians.

**Mosquito infection:** Blood collection and mosquito infections using membrane feeding assays was performed as earlier described (Harris et al., 2012; Nsango et al., 2012). Briefly, the *Anopheles coluzzi*, which is reared (conditions:  $27 \pm 2^\circ$ ,  $85 \pm$  RH 12H light/dark) at OCEAC (Organisation de Coordination pour la Lutte contre les Endémies en Afrique Centrale) Cameroon was the mosquito species used for the experiment. 4ml of venous blood was collected in heparinized tubes from each gametocyte donor. The blood was centrifuged for 5 minutes at a temperature of  $37^\circ\text{C}$  at 2000g, and the serum of the participant was replaced by a non-immune AB serum to remove human blocking immune factors. Glass feeders were prewarmed at  $37^\circ\text{C}$ , and 500 $\mu$ l aliquot was put in each feeder. The lab mosquitoes were placed cups per gametocyte carrier and fed for about 30 minutes via a parafilm membrane. After feeding, unfed mosquitoes were discarded, while the fed ones were kept in cups, and maintained at a temperature of  $28^\circ\text{C}$  in the insectarium and daily fed with 6% sucrose solution until dissections.

**Gametocyte filtration:** For each participant, 1ml of venous blood was collected, and gametocytes were filtered using the MACs Columns as previously described (Ribaut et al 2008). The filtered gametocytes were suspended on 50µl of PBS stored in -20°C for further analyses.

**Mosquito Dissection:** After 7 days post infection (PI), mosquito midguts of all live mosquitoes in one of the two cups per carrier were dissected and observed under a light microscope (200X) after staining with 0.4% mercurochrome to enable oocysts counts. The counts were recorded per midgut dissected to determine the infection prevalence for each gametocyte carrier, which was determined by the number of mosquitoes dissected. The infection intensity was then calculated as the average number of oocysts per mosquito. The carcasses of the midgut were placed in 50µl of PBS and stored in -20°C for further analyses. Mosquito salivary glands were dissected 14 days p.i and stored in 50µl PBS for molecular analyses.

**DNA Extraction:** DNA was extracted from midguts, salivary glands and filtered gametocytes using the Qiagen blood and tissue kit, following the manufacturer's protocol and then suspended in 50µl of the of the AE buffer.

**qPCR:** The qPCR was done to; 1) confirm mono-infection of *P. falciparum* in gametocytes. 2) confirm and ensure mono-infection in oocyst positive samples. 3) identify sporozoite positive samples. The qPCR was done using the light cycler instrument following Mangold *et al.* (Mangold et al., 2005) method. The gene of target was the multicopy 18s rRNA, and the primers used were PL1473F18 [5'-TAA CgA ACg AgA TCT TAA-3'] and PL1679R18 [5'-gTT CCT CTA AgA AgC TTT-3']. Each 10µl reaction mix consisted of 2µl template DNA, 2µl of 5X EvaGreen 0.3 µl of each primer (10 µm concentration) and 5.4 µl of water. The PCR conditions were 10mins initial denaturation at 95°C, then 40 cycles of amplification of 10 secs at 95°C, 5 secs at 50°C and 20 secs at 72°C. Melting step followed, and consisted of 2 mins at 95°C, and 68°C, a stepwise temperature increase of 0.2°C/s till 90°C. At each temperature transition, fluorescence was acquisitioned. Based on values determined from the different *Plasmodium* species controls, the mean melting temperature (T<sub>m</sub>) was determined using the melting curve analyses. All positive *P. falciparum* mono-infected samples of gametocytes, oocysts and trophozoites were selected for genotyping.

**Gene Amplification PCR:** Genetic polymorphisms associated with antimalarials from five genes (*Pfcr1*, *Pfmdr1*, *Pfdhps*, *Pfdhfr*, *PfK13*) using primers from Nag *et al.* (Nag et al., 2017), and genetic diversity from four genes (CPMP, CSP, AMA1, MSP2) was assessed according to



Lerch *et al.* (Lerch et al., 2017, 2019). The same PCR protocol was used for gametocytes, oocytes and salivary glands, as previously described (Lerch et al., 2017, 2019; Nag et al., 2017). In brief, a linker and overhang adapters were added to amplicon specific primers to design the AmpSeq primers.

The KAPA HiFi Hot Start Ready Mix (KapaBioSystems, USA) was used to perform the PCR reactions in a final volume of 25 $\mu$ l, consisting of 10 $\mu$ M Ampseq primers and 2 $\mu$ l of DNA isolate. The Eppendorf® Mastercycler® ep Gradient S (Eppendorf, Germany) was used to run the amplification reactions. Visualisation of the PCR products was on a 2% agarose gel. Pooling of amplicons was done per sample for all 13 loci amplified.

**Library preparation and Miseq Illumina sequencing:** The Genseq platform of the Labex CeMED Montpellier carried out library preparation and sequencing. Purification of pooled samples followed by amplification was carried out to add adapters for sequencing and multiplexing indices. Subsequently, the libraries were normalized and pooled, with the Phix library as control sequence. The fragment Analyzer was used to assess the quality of the library, which was then loaded on the flow cell. An illumine Miseq instrument was used to run the sequencing, the Miseq reagent kit V3 using paired-end technology.

**Bioinformatic and statistical analyses:** The Fast QC was used to carryout control quality checks on the fastq files (Andrews S., 2010). The haplotype R was used to generate haplotypes (Lerch et al., 2017, 2019). In brief, based on the primer sequences, reads analogous to each marker were chosen. Subsequently, based on the FastQC results, the paired reads were trimmed and combined. Thereafter, calling of SNPs and haplotypes followed consecutively. The default parameters suggested by the authors were used to perform the analyses. Haplotypes were differentiated by observed alteration of one SNP.

The R software version 4.0.3 was used to carryout statistical analyses, with the ggplot 2 used to build graphics. 0.05 was set as the statistical significance.

**Ethical Approval:** Ethical approval was given by National Ethical Committee for Research in Human Health (CNERSH), Yaoundé, Cameroon under agreements 2017/06/922/CE/CNERSH/SP, and 2018/09/1107/CE/CNERSH/SP approved this work. Only children with written parental consent agreement were included in the study.

## **Acknowledgements**

We thank the study participants for cooperation and the medical teams from the Nkol Eton Healthcare Centre and the Mfou Hospital for technical assistance in sample collection. We also thank the heads of the schools in the Mfou district for community mobilization. We are grateful to the technical team of the Malaria Research Unit at Centre Pasteur du Cameroun for their parasitological expertise in blood smear readings. We thank the GenSeq technical facilities at the « Institut des Sciences de l'Evolution de Montpellier » that produced the MiSeq sequencing data used in this work, the GenSeq technical facilities is supported by the LabEx CeMEB, an ANR "Investissements d'avenir" program (ANR-10-LABX-04-01).

*Author contributions.* Conceived and designed the study: A. B. and I. M. Contributed to fieldwork: E. M. S-M., S. E. N., C. M. N., G. A. B., L. B. F-D., and A. N. B. Performed the laboratory experiments: E. M. S-M. and L.A. Analyzed the data: E. M. S-M., E. G., L. A., T. L., and I. M. Wrote the manuscript: E. M. S-M. and I.M. Critically revised the manuscript: E. G., S. E. N., L. A., T. L., A. C., and A. B. Funding acquisition: S. E. N. and I. M.

*Financial support.* This work was funded by the French National Research Institute for Sustainable Development (IRD) and through the JEAI-IMPALA project granted to SEN. E.M. S-M. and L. B. F-D. are supported by doctoral fellowships from the Labex ParaFrap.

*Potential conflicts of interest.* All authors: No reported conflicts of interest. All authors have submitted the ICMJE Form for Disclosure of Potential Conflicts of Interest. Conflicts that the editors consider relevant to the content of the manuscript have been disclosed.

## References

- Anderson, T. J. C., Haubold, B., Williams, J. T., Estrada-Franco, J. G., Richardson, L., Mollinedo, R., Bockarie, M., Mokili, J., Mharakurwa, S., French, N., Whitworth, J., Velez, I. D., Brockman, A. H., Nosten, F., Ferreira, M. U., & Day, K. P. (2000). Microsatellite Markers Reveal a Spectrum of Population Structures in the Malaria Parasite *Plasmodium falciparum*. *Molecular Biology and Evolution*, *17*(10), 1467–1482. <https://doi.org/10.1093/oxfordjournals.molbev.a026247>
- Andrews S. 2010. FastQC: a quality control tool for high throughput sequence data. [Accessed 14/04/2021]. <https://www.bioinformatics.babraham.ac.uk/projects/fastqc/> [Google Scholar]
- Antonio-Nkondjio, C., Awono-Ambene, P., Toto, J.-C., Meunier, J.-Y., Zebaze-Kemleu, S., Nyambam, R., Wondji, C. S., Tchuinkam, T., & Fontenille, D. (2002). High Malaria Transmission Intensity in a Village Close to Yaounde, the Capital City of Cameroon. *Journal of Medical Entomology*, *39*(2), 350–355. <https://doi.org/10.1603/0022-2585-39.2.350>
- Arez, A. P., Pinto, J., Pålsson, K., Snounou, G., Jaenson, T. G., & do Rosário, V. E. (2003). Transmission of mixed *Plasmodium* species and *Plasmodium falciparum* genotypes. *The American journal of tropical medicine and hygiene*, *68*(2), 161–168.
- Arnot, D. (1998). Clone multiplicity of *Plasmodium falciparum* infections in individuals exposed to variable levels of disease transmission. *Transactions of the Royal Society of Tropical Medicine and Hygiene*, *92*(6), 580–585. [https://doi.org/10.1016/S0035-9203\(98\)90773-8](https://doi.org/10.1016/S0035-9203(98)90773-8)
- Bonnet, S., Gouagna, L. C., Paul, R. E., Safeukui, I., Meunier, J.-Y., & Boudin, C. (2003). Estimation of malaria transmission from humans to mosquitoes in two neighbouring villages in south Cameroon: Evaluation and comparison of several indices. *Transactions of the Royal Society of Tropical Medicine and Hygiene*, *97*(1), 53–59. [https://doi.org/10.1016/S0035-9203\(03\)90022-8](https://doi.org/10.1016/S0035-9203(03)90022-8)
- Campino S, Auburn S, Kivinen K, Zongo I, Ouedraogo JB, Mangano V, Djimde A, Doumbo OK, Kiara SM, Nzila A, Borrmann S, Marsh K, Michon P, Mueller I, Siba P, Jiang H, Su XZ, Amaratunga C, Socheat D, Fairhurst RM, Imwong M, Anderson T, Nosten F, White NJ, Gwilliam R, Deloukas P, MacInnis B, Newbold CI, Rockett K, Clark TG, Kwiatkowski DP. Population genetic analysis of *Plasmodium falciparum* parasites using a customized Illumina GoldenGate genotyping assay. *PLoS One*. 2011;6(6):e20251. doi: 10.1371/journal.pone.0020251. Epub 2011 Jun 6. PMID: 21673999; PMCID: PMC3108946.
- Harris, C., Morlais, I., Churcher, T. S., Awono-Ambene, P., Gouagna, L. C., Dabire, R. K., Fontenille, D., & Cohuet, A. (2012). *Plasmodium falciparum* Produce Lower Infection Intensities in Local versus Foreign *Anopheles gambiae* Populations. *PLoS ONE*, *7*(1), e30849. <https://doi.org/10.1371/journal.pone.0030849>
- Lerch, A., Koepfli, C., Hofmann, N. E., Kattenberg, J. H., Rosanas-Urgell, A., Betuela, I., Mueller, I., & Felger, I. (2019). Longitudinal tracking and quantification of individual *Plasmodium falciparum* clones in complex infections. *Scientific Reports*, *9*(1), 3333. <https://doi.org/10.1038/s41598-019-39656-7>
- Lerch, A., Koepfli, C., Hofmann, N. E., Messerli, C., Wilcox, S., Kattenberg, J. H., Betuela, I., O'Connor, L., Mueller, I., & Felger, I. (2017). Development of amplicon deep sequencing markers and data analysis pipeline for genotyping multi-clonal malaria infections. *BMC Genomics*, *18*(1), 864. <https://doi.org/10.1186/s12864-017-4260-y>
- Mangold, K. A., Manson, R. U., Koay, E. S. C., Stephens, L., Regner, M., Thomson, R. B., Peterson, L. R., & Kaul, K. L. (2005). Real-Time PCR for Detection and

- Identification of Plasmodium spp. *Journal of Clinical Microbiology*, 43(5), 2435–2440. <https://doi.org/10.1128/JCM.43.5.2435-2440.2005>
- Morlais, I., Nsango, S. E., Toussile, W., Abate, L., Annan, Z., Tchioffo, M. T., Cohuet, A., Awono-Ambene, P. H., Fontenille, D., Rousset, F., & Berry, A. (2015). Plasmodium falciparum Mating Patterns and Mosquito Infectivity of Natural Isolates of Gametocytes. *PLOS ONE*, 10(4), e0123777. <https://doi.org/10.1371/journal.pone.0123777>
- Nag, S., Dalgaard, M. D., Kofoed, P.-E., Ursing, J., Crespo, M., Andersen, L. O., Aarestrup, F. M., Lund, O., & Alifrangis, M. (2017). High throughput resistance profiling of Plasmodium falciparum infections based on custom dual indexing and Illumina next generation sequencing-technology. *Scientific Reports*, 7(1), 2398. <https://doi.org/10.1038/s41598-017-02724-x>
- Nsango, S. E., Abate, L., Thoma, M., Pompon, J., Fraiture, M., Rademacher, A., Berry, A., Awono-Ambene, P. H., Levashina, E. A., & Morlais, I. (2012). Genetic clonality of Plasmodium falciparum affects the outcome of infection in Anopheles gambiae. *International Journal for Parasitology*, 42(6), 589–595. <https://doi.org/10.1016/j.ijpara.2012.03.008>
- Nwakanma, D., Kheir, A., Sowa, M., Dunyo, S., Jawara, M., Pinder, M., Milligan, P., Walliker, D., & Babiker, H. A. (2008). High gametocyte complexity and mosquito infectivity of Plasmodium falciparum in the Gambia. *International journal for parasitology*, 38(2), 219–227. <https://doi.org/10.1016/j.ijpara.2007.07.003>
- RStudio Team (2020). RStudio: Integrated Development for R. **RStudio**, PBC, Boston, MA URL <http://www.rstudio.com/>.
- Schneider, P., Bousema, T., Omar, S., Gouagna, L., Sawa, P., Schallig, H., & Sauerwein, R. (2006). (Sub)microscopic Plasmodium falciparum gametocytaemia in Kenyan children after treatment with sulphadoxine-pyrimethamine monotherapy or in combination with artesunate. *International journal for parasitology*, 36(4), 403–408. <https://doi.org/10.1016/j.ijpara.2006.01.002>
- Taylor, L. H., Mackinnon, M. J., & Read, A. F. (1998). VIRULENCE OF MIXED-CLONE AND SINGLE-CLONE INFECTIONS OF THE RODENT MALARIA PLASMODIUM CHABAUDI. *Evolution*, 52(2), 583–591. <https://doi.org/10.1111/j.1558-5646.1998.tb01656.x>
- Touray AO, Mobegi VA, Wamunyokoli F *et al.* Prevalence of asymptomatic *P. falciparum* gametocyte carriage among school children in Mbita, Western Kenya and assessment of the association between gametocyte density, multiplicity of infection and mosquito infection prevalence. [version 2; peer review: 1 approved, 2 approved with reservations, 1 not approved]. *Wellcome Open Res* 2021, 5:259 (<https://doi.org/10.12688/wellcomeopenres.16299.2>)
- Wampfler, R., Timinao, L., Beck, H.-P., Soulama, I., Tiono, A. B., Siba, P., Mueller, I., & Felger, I. (2014). Novel Genotyping Tools for Investigating Transmission Dynamics of Plasmodium falciparum. *The Journal of Infectious Diseases*, 210(8), 1188–1197. <https://doi.org/10.1093/infdis/jiu236>
- Wickham H (2016). *ggplot2: Elegant Graphics for Data Analysis*. Springer-Verlag New York. ISBN 978-3-319-24277-4, <https://ggplot2.tidyverse.org>.

# **CONCLUSIONS AND PERSPECTIVES**

## Conclusions

As earlier mentioned, this thesis aimed at determining the dynamics of *P. falciparum* mutations associated with antimalarial drugs from field isolates to their mosquito vectors. The specific objectives were to 1) describe the malaria situation in Tibati and Mfou; 2) determine the genetic diversity of *P. falciparum* symptomatic and asymptomatic infections; 3) determine the different *P. falciparum* clones and antimalarial drug associated alleles in different gametocyte carriers, and assess those that can be efficiently transmitted by their local mosquito vector; 4) Measure the transmission success of different drug resistant/sensitive genotypes in natural isolates of *P. falciparum*.

Our study helped us address malaria epidemiology in two different epidemiological facets in Cameroon; Tibati in the Adamawa region characterised by seasonal malaria transmission, and Mfou in the Central region of Cameroon, characterised by perennial malaria transmission. Irrespective of the locality, the infection prevalence and intensity decreased with age in both symptomatics and asymptomatics.

The malaria vectors in Tibati were characterised. The *An. gambiae*, *An. coluzzii* and *An. funestus* were the three vectors collected, with each equally considered to efficiently transmit the *Plasmodium* parasites. Considering the *Plasmodium* infection rates, there was no difference in *Plasmodium* infection rate among the three vectors. One *An. coluzzii* sample harboured the *P. vivax*. This was the first time *P. vivax* has been observed in its vector in Cameroon.

Three *Plasmodium* species were identified in the blood samples collected; *P. falciparum*, *P. malariae*, *P. ovale*, with *P. falciparum* accounting for 95% of malaria infections, confirming other studies that *P. falciparum* is most prevalent in Cameroon.

Looking at the malaria epidemiology in both study sites, the infection prevalence and intensity decreased with age in both symptomatics and asymptomatics. We genotyped asymptomatic infections from Mfou and Tibati to determine the prevalence of SNPs associated with antimalarial drug resistance using Nested PCR and NGS for samples collected in Mfou. Parasite genotyping carried out in Mfou and Tibati using nested PCR showed a high prevalence of the wild type *Pfcr* K76 and *Pfmdr1* D1246 alleles that indicate the return of CQ sensitivity in both sites. More so, the overall infection prevalence was higher in Tibati than in Mfou. We further observed that the *Pfdhfr* triple mutant IRN linked to pyrimethamine resistance was fixed, as its prevalence exceeded more than 90%. We then looked at the degree of SP resistance by



combining mutations from the *Pfdhfr* and *Pfdhps* genes to form haplotypes. We observed that the quadruple mutant IRN-E which was responsible for the partial resistance of SP was most prevalent in both sites though higher prevalence was observed in Mfou. The sextuple haplotype IRNI-GEG, which is considered the SP super resistant haplotype was observed in Tibati at low frequency. This study is the first report that characterises antimalarial drug resistance in the Adamawa region after a change in drug policy over 15 years ago.

We further determined using NGS the different SNPs associated with antimalarial drug resistance from asymptomatic and symptomatic samples collected in Mfou and Yaounde respectively, but this time in a relatively higher number of genes and SNPs in the *Pfcr1*, *Pfmdr1*, *Pfdhps*, *Pfdhfr*, *PfK13* gene, which were not included in the Nested PCR genotyping. The *Pfmdr1* gene was the least polymorphic gene.

Irrespective of the clinical status, there was a general increase in the prevalence of the CVMNK CQ sensitive *Pfcr1* haplotype, even though the prevalence was higher in symptomatics than asymptomatics, and a low prevalence of the CQ resistant haplotype CVIET, which was mostly observed in mixed asymptomatic infections. The *Pfdhps* gene was the most polymorphic gene observed, harbouring several SNPs. The partial SP resistance quadruple haplotype was most prevalent, with the sextuple haplotype observed for the first time in Mfou.

No known mutations associated to ARTR was observed, but mutations such as the R255K, L258M and K189T whose role have not yet been linked to ARTR were observed, especially the R255K and L258M mutations that were observed for the first time in Cameroon though at a very low frequency.

Looking at the genetic diversity in symptomatic samples from Yaounde and asymptomatic samples from Mfou, we compared the genotypes from the two clinical statuses. We observed that mixed falciparum infections are more prevalent in asymptomatic carriers, and mutant genotypes were independent of the clinical status, as they could be present at relatively equal proportions in both symptomatic and asymptomatics.

Using different molecular markers (CPMP, MSP2, CSP, and AMA1) to describe the genetic diversity of *P. falciparum*, we observed the CPMP marker best described the genetic diversity of *P. falciparum*. Furthermore, we observed higher genetic diversity in asymptomatics that help maintain the genetic diversity of the parasites and act as reservoirs. Rare alleles and unique genotypes were observed in symptomatics, with the proportion of single clones in symptomatics being higher than those in asymptomatics.

It was more interesting to use the Ampseq to determine the genetic diversity of the parasites, since firstly, the genotypes per sample could be quantified, minor and rare alleles could be determined, and also the fact that new and several mutations can be determined at the same time. This cannot be achieved with the nested PCR.

Looking at parasite development in the mosquito, genotyping gametocytes, and sporozoites from mosquito salivary glands infected with the same gametocyte carriers using NGS helped us evaluate the transmission dynamics of *P. falciparum*. Based on preliminary analyses of mosquito infections, we observed similar MOIs in the gametocytes and sporozoites, even though there was a negative correlation between the gametocyte density and MOI. This indicates high gametocytaemia is associated with monoclonal infections. More so, minor and rare clones present in gametocytes had higher frequencies in sporozoites. Our results suggest that the mosquito plays a major role in maintaining the genetic diversity of minor parasite clones found in humans. Looking at drug resistance haplotypes, all the haplotypes present in gametocytes were also present in the sporozoites, indicating resistant and sensitive haplotypes are efficiently transmitted by the mosquito.

Overall, this thesis highlights the complex interactions between *P. falciparum* genotype in natural infections and the role of asymptomatics and mosquito vectors in maintaining genetic diversity.

## Perspectives

Our work confirmed the high prevalence sensitive allele K76 in Tibati and the CVMNK haplotype in Mfou. It will be interesting to use the Miseq which is better tool for malaria surveillance, to determine other resistant associated SNPs, rare and minor clones in Tibati *falciparum* parasites. More so, mutations in the *PfK13* gene linked to ARTR was not assessed in Tibati. So, we look forward to determine the SNPs associated to ARTR in the area and also to sequence the whole *PfK13* gene to determine the prevalence of new SNPs.

Since the sextuple was observed in both the Central and Adamawa region, it will be interesting for us to do so in other regions, to get a better picture of SP resistance in the country.

We observed the presence of mutations R255K, L258M and K189T in the *PfK13*. Even though these mutations have not been shown to be associated with ARTR, it will be interesting to know the role of these mutations and why the prevalence K189T has increased over the years in the country.

Rare clones were observed to be more prevalent in mosquitoes than blood gametocytes. So, we will like to study the mechanisms in the mosquitoes that trigger the efficient transmission of minor, rare and sensitive parasite clones.

This work shows that competitive interactions are more complex in natural infections and our results from naturally infected isolates of parasites suggest that competition-survival trade-offs probably occur to maintain parasite genetic diversity in the wild. The high frequency of CQ resistant parasites at low density supports cooperative interactions that favour coexistence of drug-sensitive and resistant parasites. Whether coexistence of diverse parasites allows a more rapid expansion of drug resistant parasites in response to drug policy changes will require further investigations.

Despite WHO warnings, CQ and HCQ have been used extensively for Covid-19 prevention and treatment in Africa since the pandemic in 2020. We aimed at assessing the impact of CQ and HCQ usage during the pandemic, and if it affected the prevalence of CQ sensitive haplotypes in the country.

Lastly the presence of naturally occurring *P. vivax* in the mosquito indicates *P. vivax* circulation in the Adamawa and other regions of the country. So, we will like to sample larger populations to determine the frequency of this parasite the country.

## REFERENCES

- Abane, S. M. (1967). La chimioprophylaxie antipaludique dans les écoles du Cameroun oriental. *World Health Organisation*.
- Achol, E., Ochaya, S., Malinga, G. M., Edema, H., & Echodu, R. (2019). High prevalence of Pfmdr-1 N86 and D1246 genotypes detected among febrile malaria outpatients attending Lira Regional Referral Hospital, Northern Uganda. *BMC Research Notes*, *12*(1), 235. <https://doi.org/10.1186/s13104-019-4269-1>
- Achungu, C. R., Nkuo-Akenji, T., Tobias, A., & Samuel, W. (2018). Re-Emergence of Chloroquine Sensitive *Plasmodium falciparum* after Several Years of Chloroquine Withdrawal in Bamenda, North West Cameroon. 6.
- Adamu, A., Jada, M. S., Haruna, H. M. S., Yakubu, B. O., Ibrahim, M. A., Balogun, E. O., Sakura, T., Inaoka, D. K., Kita, K., Hirayama, K., Culleton, R., & Shuaibu, M. N. (2020). *Plasmodium falciparum* multidrug resistance gene-1 polymorphisms in Northern Nigeria: Implications for the continued use of artemether-lumefantrine in the region. *Malaria Journal*, *19*(1), 439. <https://doi.org/10.1186/s12936-020-03506-z>
- Agnamey, P., Leroy, G. Kouamouo, J and Brasseur, P. (1995). Sensibilité in vivo et in vitro de *Plasmodium falciparum* a la chloroquine et a l'amodiaquine a Bangangte (Quest-Cameroun). *Bull. Soc. Path. Ex*, *88*: 149-151.
- al-Yaman, F., B. Genton, J. C. Reeder, R. F. Anders, T. Smith, and M. P. Alpers. 1997. Reduced risk of clinical malaria in children infected with multiple clones of *Plasmodium falciparum* in a highly endemic area: a prospective community study. *Trans R Soc Trop Med Hyg* *91*(5):602-605. doi: 10.1016/s0035-9203(97)90046-8
- Anchang-Kimbi, J. K., Kalaji, L. N., Mbacham, H. F., Wepnje, G. B., Apinjoh, T. O., Ngole Sumbele, I. U., Dionne-Odom, J., Tita, A. T. N., & Achidi, E. A. (2020). Coverage and effectiveness of intermittent preventive treatment in pregnancy with sulfadoxine–pyrimethamine (IPTp-SP) on adverse pregnancy outcomes in the Mount Cameroon area, South West Cameroon. *Malaria Journal*, *19*(1), 100. <https://doi.org/10.1186/s12936-020-03155-2>
- Anderson, T. J. C., Haubold, B., Williams, J. T., Estrada-Franco, J. G., Richardson, L., Mollinedo, R., Bockarie, M., Mokili, J., Mharakurwa, S., French, N., Whitworth, J., Velez, I. D., Brockman, A. H., Nosten, F., Ferreira, M. U., & Day, K. P. (2000). Microsatellite Markers Reveal a Spectrum of Population Structures in the Malaria Parasite *Plasmodium falciparum*. *Molecular Biology and Evolution*, *17*(10), 1467–1482. <https://doi.org/10.1093/oxfordjournals.molbev.a026247>
- Animut, A., Balkew, M., Gebre-Michael, T., & Lindtjörn, B. (2013). Blood meal sources and entomological inoculation rates of anophelines along a highland altitudinal transect in south-central Ethiopia. *Malaria Journal*, *12*(1), 76. <https://doi.org/10.1186/1475-2875-12-76>
- Antonio-Nkondjio, C., Ndo, C., Njiokou, F., Bigoga, J. D., Awono-Ambene, P., Etang, J., Ekobo, A. S., & Wondji, C. S. (2019). Review of malaria situation in Cameroon: Technical viewpoint on challenges and prospects for disease elimination. *Parasites & Vectors*, *12*(1), 501. <https://doi.org/10.1186/s13071-019-3753-8>
- Antony, H. A., & Parija, S. C. (2016). Antimalarial drug resistance: An overview. *Tropical Parasitology*, *6*(1), 30–41. PubMed. <https://doi.org/10.4103/2229-5070.175081>
- Apinjoh, T. O., Mugri, R. N., Miotto, O., Chi, H. F., Tata, R. B., Anchang-Kimbi, J. K., Fon, E. M., Tangoh, D. A., Nyingchu, R. V., Jacob, C., Amato, R., Djimde, A., Kwiatkowski, D., Achidi, E. A., & Amambua-Ngwa, A. (2017). Molecular markers for artemisinin and partner drug resistance in natural *Plasmodium falciparum* populations following

- increased insecticide treated net coverage along the slope of mount Cameroon: Cross-sectional study. *Infectious Diseases of Poverty*, 6(1), 136. <https://doi.org/10.1186/s40249-017-0350-y>
- Arez AP, Lopes D, Pinto J, Franco AS, Snounou G, et al. (2000) *Plasmodium* sp.: optimal protocols for PCR detection of low parasite numbers from mosquito (*Anopheles* sp.) samples. *Exp Parasitol* 94: 269–272.
- Ariey, F., Witkowski, B., Amaratunga, C., Beghain, J., Langlois, A.-C., Khim, N., Kim, S., Duru, V., Bouchier, C., Ma, L., Lim, P., Leang, R., Duong, S., Sreng, S., Suon, S., Chuor, C. M., Bout, D. M., Ménard, S., Rogers, W. O., ... Ménard, D. (2014). A molecular marker of artemisinin-resistant *Plasmodium falciparum* malaria. *Nature*, 505(7481), 50–55. <https://doi.org/10.1038/nature12876>
- Ashley, E. A., & White, N. J. (2014). The duration of *Plasmodium falciparum* infections. *Malaria Journal*, 13(1), 500. <https://doi.org/10.1186/1475-2875-13-500>
- Ayala, D., Costantini, C., Ose, K., Kamdem, G. C., Antonio-Nkondjio, C., Agbor, J.-P., Awono-Ambene, P., Fontenille, D., & Simard, F. (2009). Habitat suitability and ecological niche profile of major malaria vectors in Cameroon. *Malaria Journal*, 8(1), 307. <https://doi.org/10.1186/1475-2875-8-307>
- Babiker, H. A., Hastings, I. M., & Swedberg, G. (2009). Impaired fitness of drug-resistant malaria parasites: Evidence and implication on drug-deployment policies. *Expert Review of Anti-Infective Therapy*, 7(5), 581–593. <https://doi.org/10.1586/eri.09.29>
- Bailey, J. A., Mvalo, T., Aragam, N., Weiser, M., Congdon, S., Kamwendo, D., Martinson, F., Hoffman, I., Meshnick, S. R., & Juliano, J. J. (2012). Use of Massively Parallel Pyrosequencing to Evaluate the Diversity of and Selection on *Plasmodium falciparum* csp T-Cell Epitopes in Lilongwe, Malawi. *The Journal of Infectious Diseases*, 206(4), 580–587. <https://doi.org/10.1093/infdis/jis329>
- Barry, A., Bradley, J., Stone, W., Guelbeogo, M. W., Lanke, K., Ouedraogo, A., Soulama, I., Nébié, I., Serme, S. S., Grignard, L., Patterson, C., Wu, L., Briggs, J. J., Janson, O., Awandu, S. S., Ouedraogo, M., Tarama, C. W., Kargougou, D., Zongo, S., ... Bousema, T. (2021). Higher gametocyte production and mosquito infectivity in chronic compared to incident *Plasmodium falciparum* infections. *Nature Communications*, 12(1), 2443. <https://doi.org/10.1038/s41467-021-22573-7>
- Basco, L. K. (2002). Molecular epidemiology of malaria in Cameroon. XIII. Analysis of pfcr mutations and in vitro chloroquine resistance. *The American Journal of Tropical Medicine and Hygiene*, 67(4), 388–391. <https://doi.org/10.4269/ajtmh.2002.67.388>
- Basco, L. K. (2003). Molecular Epidemiology of Malaria in Cameroon. XVII. Baseline Monitoring of Atovaquone-Resistant *Plasmodium falciparum* by in vitro drug assays and cytochrome b gene sequence analysis. *The American Journal of Tropical Medicine and Hygiene*, 69(2), 179–183. <https://doi.org/10.4269/ajtmh.2003.69.179>
- Basco, L. K., & Ringwald, P. (1998). Molecular epidemiology of malaria in Yaounde, Cameroon II. Baseline frequency of point mutations in the dihydropteroate synthase gene of *Plasmodium falciparum*. *The American Journal of Tropical Medicine and Hygiene*, 58(3), 374–377. <https://doi.org/10.4269/ajtmh.1998.58.374>
- Basco, L. K., & Ringwald, P. (2000). Molecular epidemiology of malaria in Yaounde, Cameroon. VI. Sequence variations in the *Plasmodium falciparum* dihydrofolate reductase-thymidylate synthase gene and in vitro resistance to pyrimethamine and cycloguanil. *The American Journal of Tropical Medicine and Hygiene*, 62(2), 271–276. <https://doi.org/10.4269/ajtmh.2000.62.271>
- Basco, L. K., & Ringwald, P. (2007). Molecular epidemiology of malaria in Cameroon. XXIV. Trends of in vitro antimalarial drug responses in Yaounde, Cameroon. *The American*



- Journal of Tropical Medicine and Hygiene*, 76(1), 20–26.  
<https://doi.org/10.4269/ajtmh.2007.76.20>
- Basco, L. K., Same-Ekobo, A., Ngane, V. F., Ndounga, M., Metoh, T., Ringwald, P., & Soula, G. (2002). Therapeutic efficacy of sulfadoxine–pyrimethamine, amodiaquine and the sulfadoxine–pyrimethamine–amodiaquine combination against uncomplicated *Plasmodium falciparum* malaria in young children in Cameroon. *Bulletin of the World Health Organization*, 8.
- Basco, L. K., & Tahar, R. (2006a). Molecular epidemiology of malaria in Cameroon. XXII. Geographic mapping and distribution of *Plasmodium falciparum* Dihydrofolate Reductase (DHFR) mutant alleles. *The American Journal of Tropical Medicine and Hygiene*, 75(3), 396–401. <https://doi.org/10.4269/ajtmh.2006.75.396>
- Basco, L. K., & Tahar, R. (2006b). Molecular epidemiology of malaria in Cameroon. XXII. Geographic mapping and distribution of *Plasmodium falciparum* Dihydrofolate Reductase (DHFR) mutant alleles. *The American Journal of Tropical Medicine and Hygiene*, 75(3), 396–401. <https://doi.org/10.4269/ajtmh.2006.75.396>
- Basco, L. K., & Tahar, R. (2007). Molecular Epidemiology of Malaria in Cameroon. XXVI. Twelve-Year In Vitro and Molecular Surveillance of Pyrimethamine Resistance and Experimental Studies to Modulate Pyrimethamine Resistance. *The American Journal of Tropical Medicine and Hygiene*, 77(2), 221–227. <https://doi.org/10.4269/ajtmh.2007.77.221>
- Birnbaum, J., Scharf, S., Schmidt, S., Jonscher, E., Hoeijmakers, W. A. M., Flemming, S., Toenhake, C. G., Schmitt, M., Sabitzki, R., Bergmann, B., Fröhlke, U., Mesén-Ramírez, P., Soares, A. B., Herrmann, H., Bártfai, R., & Spielmann, T. (2020). *A Kelch13-defined endocytosis pathway mediates artemisinin resistance in malaria parasites*. 10.
- Blandin, S., & Levashina, E. A. (2004). Mosquito immune responses against malaria parasites. *Current Opinion in Immunology*, 16(1), 16–20. <https://doi.org/10.1016/j.coi.2003.11.010>
- Blandin, S., Shiao, S.-H., Moita, L. F., Janse, C. J., Waters, A. P., Kafatos, F. C., & Levashina, E. A. (2004). Complement-Like Protein TEP1 Is a Determinant of Vectorial Capacity in the Malaria Vector *Anopheles gambiae*. *Cell*, 116(5), 661–670. [https://doi.org/10.1016/S0092-8674\(04\)00173-4](https://doi.org/10.1016/S0092-8674(04)00173-4)
- Bousema, T., and C. Drakeley. (2011). Epidemiology and infectivity of *Plasmodium falciparum* and *Plasmodium vivax* gametocytes in relation to malaria control and elimination. *Clin Microbiol Rev* 24(2):377-410. doi: 10.1128/CMR.00051-10
- Bousema, T., Churcher, T. S., Morlais, I., & Dinglasan, R. R. (2013). Can field-based mosquito feeding assays be used for evaluating transmission-blocking interventions? *Trends in Parasitology*, 29(2), 53–59. <https://doi.org/10.1016/j.pt.2012.11.004>
- Bousema, T., Okell, L., Felger, I., & Drakeley, C. (2014). Asymptomatic malaria infections: Detectability, transmissibility and public health relevance. *Nature Reviews Microbiology*, 12(12), 833–840. <https://doi.org/10.1038/nrmicro3364>
- Bousema, T., Stresman, G., Baidjoe, A. Y., Bradley, J., Knight, P., Stone, W., Osoti, V., Makori, E., Owaga, C., Odongo, W., China, P., Shagari, S., Doumbo, O. K., Sauerwein, R. W., Kariuki, S., Drakeley, C., Stevenson, J., & Cox, J. (2016). The Impact of Hotspot-Targeted Interventions on Malaria Transmission in Rachuonyo South District in the Western Kenyan Highlands: A Cluster-Randomized Controlled Trial. *PLOS Medicine*, 13(4), e1001993. <https://doi.org/10.1371/journal.pmed.1001993>
- Bradley, J., Stone, W., Da, D. F., Morlais, I., Dicko, A., Cohuet, A., Guelbeogo, W. M., Mahamar, A., Nsango, S., Soumaré, H. M., Diawara, H., Lanke, K., Graumans, W., Siebelink-Stoter, R., van de Vegte-Bolmer, M., Chen, I., Tiono, A., Gonçalves, B. P., Gosling, R., Bousema, T. (2018). Predicting the likelihood and intensity of mosquito



- infection from sex specific *Plasmodium falciparum* gametocyte density. *ELife*, 7, e34463. <https://doi.org/10.7554/eLife.34463>
- Brooks, D. R., Wang, P., Read, M., Watkins, W. M., Sims, P. F. G., & Hyde, J. E. (1994). Sequence Variation of the Hydroxymethyldihydropterin Pyrophosphokinase: Dihydropteroate Synthase Gene in Lines of the Human Malaria Parasite, *Plasmodium falciparum*, with Differing Resistance to Sulfadoxine. *European Journal of Biochemistry*, 224(2), 397–405. <https://doi.org/10.1111/j.1432-1033.1994.00397.x>
- Burkott R., Williams J. L. & Schneideri. Identification of *Plasmodium falciparum*-infected mosquitoes by a double anti-body enzyme-linked immunosorbent assay. (1984). *American Journal of Tropical Medicine and Hygiene*, 33(5),783-788.
- Bushman, M., Antia, R., Udhayakumar, V., & de Roode, J. C. (2018). Within-host competition can delay evolution of drug resistance in malaria. *PLOS Biology*, 16(8), e2005712. <https://doi.org/10.1371/journal.pbio.2005712>
- Bwire, G. M., Ngasala, B., Mikomangwa, W. P., Kilonzi, M., & Kamuhabwa, A. A. R. (2020). Detection of mutations associated with artemisinin resistance at k13-propeller gene and a near complete return of chloroquine susceptible falciparum malaria in Southeast of Tanzania. *Scientific Reports*, 10(1), 3500. <https://doi.org/10.1038/s41598-020-60549-7>
- Carnevale, P., & Mouchet, J. (2001). [Malaria vector control in Cameroon: Past, present, future. Reflections]. *Bulletin de la Societe de pathologie exotique (1990)*, 94(2 Pt 2), 202–209. PubMed. <http://europepmc.org/abstract/MED/16579079>
- Chauvin, P., Menard, S., Iriart, X., Nsango, S. E., Tchioffo, M. T., Abate, L., Awono-Ambéné, P. H., Morlais, I., & Berry, A. (2015). Prevalence of *Plasmodium falciparum* parasites resistant to sulfadoxine/pyrimethamine in pregnant women in Yaoundé, Cameroon: Emergence of highly resistant *pfdhfr* / *pfdhps* alleles. *Journal of Antimicrobial Chemotherapy*, 70(9), 2566–2571. <https://doi.org/10.1093/jac/dkv160>
- Cheeseman, I. H., Miller, B. A., Nair, S., Nkhoma, S., Tan, A., Tan, J. C., Al Saai, S., Physo, A. P., Moo, C. L., Lwin, K. M., McGready, R., Ashley, E., Imwong, M., Stepniewska, K., Yi, P., Dondorp, A. M., Mayxay, M., Newton, P. N., White, N. J., ... Anderson, T. J. C. (2012). A Major Genome Region Underlying Artemisinin Resistance in Malaria. *Science*, 336(6077), 79–82. <https://doi.org/10.1126/science.1215966>
- Choisy, M., & de Roode, J. C. (2010). Mixed Infections and the Evolution of Virulence: Effects of Resource Competition, Parasite Plasticity, and Impaired Host Immunity. *The American Naturalist*, 175(5), E105–E118. <https://doi.org/10.1086/651587>
- Churcher, T. S., Bousema, T., Walker, M., Drakeley, C., Schneider, P., Ouédraogo, A. L., & Basáñez, M.-G. (2013). Predicting mosquito infection from *Plasmodium falciparum* gametocyte density and estimating the reservoir of infection. *ELife*, 2, e00626. <https://doi.org/10.7554/eLife.00626>
- Conrad, M. D., Staedke, S. G., Tappero, J., Kanya, M., Nankoberanyi, S., Tukwasibwe, S., Dorsey, G., Nsohya, S. L., Arinaitwe, E., Mbogo, G. W., Baliraine, F. N., Greenhouse, B., & Rosenthal, P. J. (2014). Temporal Changes in Prevalence of Molecular Markers Mediating Antimalarial Drug Resistance in a High Malaria Transmission Setting in Uganda. *The American Journal of Tropical Medicine and Hygiene*, 91(1), 54–61. <https://doi.org/10.4269/ajtmh.13-0647>
- Cowman, A. F., Karcz, S., Galatis, D., & Culvenor, J. G. (1991). A P-glycoprotein homologue of *Plasmodium falciparum* is localized on the digestive vacuole. *Journal of Cell Biology*, 113(5), 1033–1042. <https://doi.org/10.1083/jcb.113.5.1033>
- Crompton, P. D., Moebius, J., Portugal, S., Waisberg, M., Hart, G., Garver, L. S., Miller, L. H., Barillas-Mury, C., & Pierce, S. K. (2014). Malaria Immunity in Man and Mosquito: Insights into Unsolved Mysteries of a Deadly Infectious Disease. *Annual Review of*

- Immunology*, 32(1), 157–187. <https://doi.org/10.1146/annurev-immunol-032713-120220>
- Cui, L., Mharakurwa, S., Ndiaye, D., Rathod, P. K., & Rosenthal, P. J. (2015). Antimalarial Drug Resistance: Literature Review and Activities and Findings of the ICEMR Network. *The American Journal of Tropical Medicine and Hygiene*, 93(3\_Suppl), 57–68. <https://doi.org/10.4269/ajtmh.15-0007>
- Daniels, R., Volkman, S. K., Milner, D. A., Mahesh, N., Neafsey, D. E., Park, D. J., Rosen, D., Angelino, E., Sabeti, P. C., Wirth, D. F., & Wiegand, R. C. (2008). A general SNP-based molecular barcode for *Plasmodium falciparum* identification and tracking. *Malaria Journal*, 7(1), 223. <https://doi.org/10.1186/1475-2875-7-223>
- Dantzler, K. W., Ma, S., Ngotho, P., Stone, W. J. R., Tao, D., Rijpma, S., De Niz, M., Nilsson Bark, S. K., Jore, M. M., Raaijmakers, T. K., Early, A. M., Ubaida-Mohien, C., Lemgruber, L., Campo, J. J., Teng, A. A., Le, T. Q., Walker, C. L., Hermand, P., Deterre, P., ... Marti, M. (2019). Naturally acquired immunity against immature *Plasmodium falciparum* gametocytes. *Science Translational Medicine*, 11(495), eaav3963. <https://doi.org/10.1126/scitranslmed.aav3963>
- de Roode, J. C., Helinski, M. E. H., Anwar, M. A., & Read, A. F. (2005). Dynamics of Multiple Infection and Within-Host Competition in Genetically Diverse Malaria Infections. *The American Naturalist*, 166(5), 531–542. <https://doi.org/10.1086/491659>
- Djimdé, A., Doumbo, O. K., Steketee, R. W., & Plowe, C. V. (2001). Application of a molecular marker for surveillance of chloroquine-resistant *falciparum* malaria. *The Lancet*, 358(9285), 890–891. [https://doi.org/10.1016/S0140-6736\(01\)06040-8](https://doi.org/10.1016/S0140-6736(01)06040-8)
- Dondorp, A. M., Das, D., Lwin, K. M., Lee, S. J., Imwong, M., Herdman, T., Singhasivanon, P., & Socheat, D. (2009). Artemisinin Resistance in *Plasmodium falciparum* Malaria. *The New England Journal of Medicine*, 13.
- Doolan, D. L., Dobaño, C., & Baird, J. K. (2009). Acquired Immunity to Malaria. *Clinical Microbiology Reviews*, 22(1), 13–36. <https://doi.org/10.1128/CMR.00025-08>
- Dorsey, G., Staedke, S., Clark, T. D., Njama-Meya, D., Nzarubara, B., Maiteki-Sebuguzi, C., Dokomajilar, C., Kanya, M. R., & Rosenthal, P. J. (2007). Combination Therapy for Uncomplicated *falciparum* Malaria in Ugandan Children: A Randomized Trial. *JAMA*, 297(20), 2210. <https://doi.org/10.1001/jama.297.20.2210>
- Drakeley, C. J., Corran, P. H., Coleman, P. G., Tongren, J. E., McDonald, S. L. R., Carneiro, I., Malima, R., Lusingu, J., Manjurano, A., Nkya, W. M. M., Lemnge, M. M., Cox, J., Reyburn, H., & Riley, E. M. (2005). Estimating medium- and long-term trends in malaria transmission by using serological markers of malaria exposure. *Proceedings of the National Academy of Sciences*, 102(14), 5108–5113. <https://doi.org/10.1073/pnas.0408725102>
- Duraisingh, M. T., & Cowman, A. F. (2005). Contribution of the *Pfmdr1* gene to antimalarial drug-resistance. *Acta Tropica*, 94(3), 181–190. <https://doi.org/10.1016/j.actatropica.2005.04.008>
- Eboumbou Moukoko, C. E., Huang, F., Nsango, S. E., Kojom Foko, L. P., Ebong, S. B., Epee Eboumbou, P., Yan, H., Sitchueng, L., Garke, B., & Ayong, L. (2019). K-13 propeller gene polymorphisms isolated between 2014 and 2017 from Cameroonian *Plasmodium falciparum* malaria patients. *PLOS ONE*, 14(9), e0221895. <https://doi.org/10.1371/journal.pone.0221895>
- Ecker, A., Lehane, A. M., Clain, J., & Fidock, D. A. (2012). PfCRT and its role in antimalarial drug resistance. *Trends in Parasitology*, 28(11), 504–514. <https://doi.org/10.1016/j.pt.2012.08.002>
- Eldh, M., Hammar, U., Arnot, D., Beck, H.-P., Garcia, A., Liljander, A., Mercereau-Puijalon, O., Migot-Nabias, F., Mueller, I., Ntoumi, F., Ross, A., Smith, T., Sondén, K., Vafa

- Homann, M., Yman, V., Felger, I., & Färnert, A. (2020). Multiplicity of Asymptomatic *Plasmodium falciparum* Infections and Risk of Clinical Malaria: A Systematic Review and Pooled Analysis of Individual Participant Data. *The Journal of Infectious Diseases*, 221(5), 775–785. <https://doi.org/10.1093/infdis/jiz510>
- Färnert, A. (2008). Plasmodium falciparum population dynamics: Only snapshots in time? *Trends in Parasitology*, 24(8), 340–344. <https://doi.org/10.1016/j.pt.2008.04.008>
- Färnert, A., Williams, T. N., Mwangi, T. W., Ehlin, A., Fegan, G., Macharia, A., Lowe, B. S., Montgomery, S. M., & Marsh, K. (2009). Transmission-Dependent Tolerance to Multiclonal *Plasmodium falciparum* Infection. *The Journal of Infectious Diseases*, 200(7), 1166–1175. <https://doi.org/10.1086/605652>
- Färnert, A., I. Rooth, Svensson, G. Snounou, and A. Bjorkman. (1999). Complexity of *Plasmodium falciparum* infections is consistent over time and protects against clinical disease in Tanzanian children. *J Infect Dis* 179(4):989-995. doi: 10.1086/314652
- Felger, I., Irion, A., Steiger, S., & Beck, H.-P. (1999). 2. Genotypes of merozoite surface protein 2 of Plasmodium falciparum in Tanzania. *Transactions of the Royal Society of Tropical Medicine and Hygiene*, 93, 3–9. [https://doi.org/10.1016/S0035-9203\(99\)90320-6](https://doi.org/10.1016/S0035-9203(99)90320-6)
- Felger, I., Maire, M., Bretscher, M. T., Falk, N., Tiaden, A., Sama, W., Beck, H.-P., Owusu-Agyei, S., & Smith, T. A. (2012). The Dynamics of Natural *Plasmodium falciparum* Infections. *PLoS ONE*, 7(9), e45542. <https://doi.org/10.1371/journal.pone.0045542>
- Feng, G., Boyle, M. J., Cross, N., Chan, J.-A., Reiling, L., Osier, F., Stanisic, D. I., Mueller, I., Anders, R. F., McCarthy, J. S., Richards, J. S., & Beeson, J. G. (2018). Human Immunization With a Polymorphic Malaria Vaccine Candidate Induced Antibodies to Conserved Epitopes That Promote Functional Antibodies to Multiple Parasite Strains. *The Journal of Infectious Diseases*, 218(1), 35–43. <https://doi.org/10.1093/infdis/jiy170>
- Ferreira, M. U., & Hartl, D. L. (2007). *Plasmodium falciparum*: Worldwide sequence diversity and evolution of the malaria vaccine candidate merozoite surface protein-2 (MSP-2). *Experimental Parasitology*, 115(1), 32–40. <https://doi.org/10.1016/j.exppara.2006.05.003>
- Fidock, D. A., Nomura, T., Talley, A. K., Cooper, R. A., Ferdig, M. T., Ursos, L. M. B., Deitsch, K. W., Su, X., Wootton, J. C., Roepe, P. D. (2010). Mutations in the *P. falciparum* Digestive Vacuole Transmembrane Protein PfCRT and Evidence for Their Role in Chloroquine Resistance. *Molecular Cell*, 6: (4) 861-871 [https://doi.org/10.1016/S1097-2765\(05\)00077-8](https://doi.org/10.1016/S1097-2765(05)00077-8).
- Fontenille, D., & Simard, F. (2004). Unravelling complexities in human malaria transmission dynamics in Africa through a comprehensive knowledge of vector populations. *Comparative Immunology, Microbiology and Infectious Diseases*, 27(5), 357–375. <https://doi.org/10.1016/j.cimid.2004.03.005>
- Frosch, A. E. P., Laufer, M. K., Mathanga, D. P., Takala-Harrison, S., Skarbinski, J., Claassen, C. W., Dzinjalama, F. K., & Plowe, C. V. (2014). Return of Widespread Chloroquine-Sensitive *Plasmodium falciparum* to Malawi. *The Journal of Infectious Diseases*, 210(7), 1110–1114. <https://doi.org/10.1093/infdis/jiu216>
- Fru-Cho, J., Bumah, V. V., Safeukui, I., Nkuo-Akenji, T., Titanji, V. P., & Haldar, K. (2014). Molecular typing reveals substantial *Plasmodium vivax* infection in asymptomatic adults in a rural area of Cameroon. *Malaria Journal*, 13(1), 170. <https://doi.org/10.1186/1475-2875-13-170>
- Genton, B., Al-Yaman, F., Betuela, I., Anders, R. F., Saul, A., Baea, K., Mellombo, M., Taraika, J., Brown, G. V., Pye, D., Irving, D. O., Felger, I., Beck, H.-P., Smith, T. A., & Alpers, M. P. (2003). Safety and immunogenicity of a three-component blood-stage malaria vaccine (MSP1, MSP2, RESA) against Plasmodium falciparum in Papua New Guinean children. *Vaccine*, 22(1), 30–41. [https://doi.org/10.1016/S0264-410X\(03\)00536-X](https://doi.org/10.1016/S0264-410X(03)00536-X)

- Gomes, P. S., Bhardwaj, J., Rivera-Correa, J., Freire-De-Lima, C. G., & Morrot, A. (2016). Immune Escape Strategies of Malaria Parasites. *Frontiers in Microbiology*, 7. <https://doi.org/10.3389/fmicb.2016.01617>
- Gonçalves, B. P., Kapulu, M. C., Sawa, P., Guelbéogo, W. M., Tiono, A. B., Grignard, L., Stone, W., Hellewell, J., Lanke, K., Bastiaens, G. J. H., Bradley, J., Nébié, I., Ngoi, J. M., Oriango, R., Mkabili, D., Nyaurah, M., Midega, J., Wirth, D. F., Marsh, K., ... Bousema, T. (2017). Examining the human infectious reservoir for *Plasmodium falciparum* malaria in areas of differing transmission intensity. *Nature Communications*, 8(1), 1133. <https://doi.org/10.1038/s41467-017-01270-4>
- Graumans, W., Jacobs, E., Bousema, T., & Sinnis, P. (2020). When is a Plasmodium-Infected Mosquito an Infectious Mosquito? *Trends in Parasitology*, 36(8), 705–716. <https://doi.org/10.1016/j.pt.2020.05.011>
- Graves P. M. (1980) Studies on the use of a membrane feeding technique for infecting *Anopheles gambiae* with *Plasmodium falciparum*. *Trans R Soc Trop Med Hyg* 74: 738–742.
- Gruenberg, M., Lerch, A., Beck, H.-P., & Felger, I. (2019). Amplicon deep sequencing improves *Plasmodium falciparum* genotyping in clinical trials of antimalarial drugs. *Scientific Reports*, 9(1), 17790. <https://doi.org/10.1038/s41598-019-54203-0>
- Gupta, B., Xu, S., Wang, Z., Sun, L., Miao, J., Cui, L., & Yang, Z. (2014). *Plasmodium falciparum* multidrug resistance protein 1 (Pfmpr1) gene and its association with in vitro drug susceptibility of parasite isolates from north-east Myanmar. *Journal of Antimicrobial Chemotherapy*, 69(8), 2110–2117. <https://doi.org/10.1093/jac/dku125>
- Hastings, I. M., & Watkins, W. M. (2005). Intensity of malaria transmission and the evolution of drug resistance. *Acta Tropica*, 94(3), 218–229. <https://doi.org/10.1016/j.actatropica.2005.04.003>
- Hengy, C., Garrigue, G., Abissegue, B., Ghogomu, N. A., Gazin, P., Gelas, H., Kouka-bemba, D., Le Bras, J., Jambou, R. (1989). Surveillance de la chimiosensibilité de *Plasmodium falciparum* a Yaoundé et ses environs (Cameroun). Etude in vivo et in vitro. *Bull. Soc. Path. Ex*, 82: 217-223.
- Huijben, S., Sim, D. G., Nelson, W. A., & Read, A. F. (2011). The fitness of drug-resistant malaria parasites in a rodent model: Multiplicity of infection: Drug resistance and multiplicity of infection. *Journal of Evolutionary Biology*, 24(11), 2410–2422. <https://doi.org/10.1111/j.1420-9101.2011.02369.x>
- Humphreys, G. S., Merinopoulos, I., Ahmed, J., Whitty, C. J. M., Mutabingwa, T. K., Sutherland, C. J., & Hallett, R. L. (2007). Amodiaquine and Artemether-Lumefantrine Select Distinct Alleles of the *Plasmodium falciparum* mdr1 Gene in Tanzanian Children Treated for Uncomplicated Malaria. *Antimicrobial Agents and Chemotherapy*, 51(3), 991–997. <https://doi.org/10.1128/AAC.00875-06>
- Ishengoma, D. S., Saidi, Q., Sibley, C. H., Roper, C., & Alifrangis, M. (2019). Deployment and utilization of next-generation sequencing of *Plasmodium falciparum* to guide anti-malarial drug policy decisions in sub-Saharan Africa: Opportunities and challenges. *Malaria Journal*, 18(1), 267. <https://doi.org/10.1186/s12936-019-2853-4>
- Juliano, J. J., Porter, K., Mwapasa, V., Sem, R., Rogers, W. O., Arie, F., Wongsrichanalai, C., Read, A., & Meshnick, S. R. (2010). Exposing malaria in-host diversity and estimating population diversity by capture-recapture using massively parallel pyrosequencing. *Proceedings of the National Academy of Sciences*, 107(46), 20138–20143. <https://doi.org/10.1073/pnas.1007068107>
- Kavishe, R. A., van den Heuvel, J. M. W., van de Vegte-Bolmer M., Luty, A. J. F., Russel, F. G. M., Koenderink, J. B. (2009). Localization of the ATP-binding cassette (ABC)



- transport proteins PfMRP1, PfMRP2, and PfMDR5 at the *Plasmodium falciparum* plasma membrane. *Malaria Journal*, 8: 205
- Kilama, M., Smith, D. L., Hutchinson, R., Kigozi, R., Yeka, A., Lavoy, G., Kanya, M. R., Staedke, S. G., Donnelly, M. J., Drakeley, C., Greenhouse, B., Dorsey, G., & Lindsay, S. W. (2014). Estimating the annual entomological inoculation rate for *Plasmodium falciparum* transmitted by *Anopheles gambiae* s.l. Using three sampling methods in three sites in Uganda. *Malaria Journal*, 13(1), 111. <https://doi.org/10.1186/1475-2875-13-111>
- Koepfli, C., Schoepflin, S., Bretscher, M., Lin, E., Kiniboro, B., Zimmerman, P. A., Siba, P., Smith, T. A., Mueller, I., & Felger, I. (2011). How Much Remains Undetected? Probability of Molecular Detection of Human Plasmodia in the Field. *PLoS ONE*, 6(4), e19010. <https://doi.org/10.1371/journal.pone.0019010>
- Korsinczky, M., Chen, N., Kotecka, B., Saul, A., Rieckmann, K., & Cheng, Q. (2000). Mutations in *Plasmodium falciparum* Cytochrome b That Are Associated with Atovaquone Resistance Are Located at a Putative Drug-Binding Site. *Antimicrobial Agents and Chemotherapy*, 44(8), 2100–2108. <https://doi.org/10.1128/AAC.44.8.2100-2108.2000>
- Koukouikila-Koussounda, F., Malonga, V., Mayengue, P., Ndounga, M., Vouvougui, C., & Ntoumi, F. (2012). Genetic polymorphism of merozoite surface protein 2 and prevalence of K76T pfcrt mutation in *Plasmodium falciparum* field isolates from Congolese children with asymptomatic infections. *Malaria Journal*, 11(1), 105. <https://doi.org/10.1186/1475-2875-11-105>
- Koenderink, J. B., Kavishe, R. A., B., Rijpma, B. S. R. and Russel, F. G. M. (2010). The ABCs of multidrug resistance in malaria. *Trends in Parasitology*, 26, 440–446. doi:10.1016/j.pt.2010.05.002.
- Kublin, J. G., Cortese, J. F., Njunju, E. M., Mukadam, R. A. G., Wirima, J. J., Kazembe, P. N., Djimdé, A. A., Kouriba, B., Taylor, T. E., & Plowe, C. V. (2003). Reemergence of Chloroquine-Sensitive *Plasmodium falciparum* Malaria after Cessation of Chloroquine Use in Malawi. *The Journal of Infectious Diseases*, 187(12), 1870–1875. <https://www.jstor.org/stable/30077923>
- Kumar, S., Gupta, L., Han, Y. S., & Barillas-Mury, C. (2004). Inducible Peroxidases Mediate Nitration of *Anopheles* Midgut Cells Undergoing Apoptosis in Response to *Plasmodium* Invasion. *Journal of Biological Chemistry*, 279(51), 53475–53482. <https://doi.org/10.1074/jbc.M409905200>
- Laing, A. B. G. (1984). The impact of malaria chemoprophylaxis in Africa with special reference to Madagascar, Cameroon, and Senegal. *Bulletin of the World Health Organisation*, 62 (Suppl.) 41 - 48.
- Languillon, J. (1957). Carte épidémiologique du paludisme au Cameroun. *Bulletin de la société de Pathologie exotique*, 585 - 600.
- La-situation-du-paludisme-au-cameroun.pdf. Available: <https://pnlp-cameroun.org/wp-content/uploads/2020/05/LA-SITUATION-DU-PALUDISME-AU-CAMEROUN.pdf>
- Laufer, M. K., & Dzinjalama, F. K. (2006). Return of Chloroquine Antimalarial Efficacy in Malawi. *N Engl J Med*, 8.
- Lekana-Douki, J. B., Boutamba, S. D. D., Zatra, R., Edou, S. E. Z., Ekomy, H., Bisvigou, U., & Toure-Ndouo, F. S. (2011). Increased prevalence of the *Plasmodium falciparum* Pfmdr1 86N genotype among field isolates from Franceville, Gabon after replacement of chloroquine by artemether–lumefantrine and artesunate–mefloquine. *Infection, Genetics and Evolution*, 11(2), 512–517. <https://doi.org/10.1016/j.meegid.2011.01.003>

- Lekweiry, K., Salem, M., Basco, L. K., Briolant, S., Hafid, J., & Boukhary, A. (2015). Malaria in Mauritania: Retrospective and prospective overview. *Malaria Journal*, *14*(1), 100. <https://doi.org/10.1186/s12936-015-0607-5>
- Lerch, A., Koepfli, C., Hofmann, N. E., Messerli, C., Wilcox, S., Kattenberg, J. H., Betuela, I., O'Connor, L., Mueller, I., & Felger, I. (2017). Development of amplicon deep sequencing markers and data analysis pipeline for genotyping multi-clonal malaria infections. *BMC Genomics*, *18*(1), 864. <https://doi.org/10.1186/s12864-017-4260-y>
- Lindsay, S. W., & Birley, M. H. (1996). Climate change and malaria transmission. *Annals of Tropical Medicine & Parasitology*, *90*(5), 573–588. <https://doi.org/10.1080/00034983.1996.11813087>
- Lines JD, Curtis CF, Wilkes TJ & Njunwa TJ (1991a) Monitoring human biting mosquitoes in Tanzania with light traps hung beside mosquito nets. *Bulletin of Entomological Research*, *81*,77–84
- Lobo, E., de Sousa, B., Rosa, S., Figueiredo, P., Lobo, L., Pateira, S., Fernandes, N., & Nogueira, F. (2014). Prevalence of Pfmdr1 alleles associated with artemether-lumefantrine tolerance/resistance in Maputo before and after the implementation of artemisinin-based combination therapy. *Malaria Journal*, *13*(1), 300. <https://doi.org/10.1186/1475-2875-13-300>
- Louis J. P., Gazin, P., Hengy, C., Gardon, J., Moyroud, J., Goghomu, A., Owona, R. & Trebucq, A. (1991). Surveillance de la chimiosensibilite in vivo de *Plasmodium falciparum* aux amino-4-quinoleines au Cameroun. *Ann Soc belge Méd trop*, *71*: 139 - 141.
- Louis, J. P., Hengy, C., Louis, F. J., Gazin, P., Jambou, R., Gardon, J., Fadat, G., Trebucq, A. (1992). Proposals for a new therapeutic strategy for simple *Plasmodium falciparum* malaria attacks in Cameroon. *Annals of Tropical Medicine and Parasitology*. *43*: 110 - 120.
- Lunde, T. M., Bayoh, M. N., & Lindtjorn, B. (2013). How malaria models relate temperature to malaria transmission. *Parasites & Vectors*, *6*(1), 20. <https://doi.org/10.1186/1756-3305-6-20>
- Maghendji-Nzondo, S., Kounga, L.-C., Mourembou, G., Boundenga, L., Imboumy-Limoukou, R.-K., Matsiegui, P.-B., Manego-Zoleko, R., Mbatchi, B., Raoult, D., Toure-Ndouo, F., & Lekana-Douki, J. B. (2016). Malaria in urban, semi-urban and rural areas of southern of Gabon: Comparison of the Pfmdr 1 and Pfcrt genotypes from symptomatic children. *Malaria Journal*, *15*(1), 420. <https://doi.org/10.1186/s12936-016-1469-1>
- MalariaGEN, Ahouidi, A., Ali, M., Almagro-Garcia, J., Amambua-Ngwa, A., Amaratunga, C., Amato, R., Amenga-Etego, L., Andagalu, B., Anderson, T. J. C., Andriananjaka, V., Apinjoh, T., Ariani, C., Ashley, E. A., Auburn, S., Awandare, G., Ba, H., Baraka, V., Barry, A. E., Ye, H. (2021). An open dataset of *Plasmodium falciparum* genome variation in 7,000 worldwide samples. *Wellcome Open Research*, *6*, 42. <https://doi.org/10.12688/wellcomeopenres.16168.1>
- Malkin, E. M., Diemert, D. J., McArthur, J. H., Perreault, J. R., Miles, A. P., Giersing, B. K., Mullen, G. E., Orcutt, A., Muratova, O., Awkal, M., Zhou, H., Wang, J., Stowers, A., Long, C. A., Mahanty, S., Miller, L. H., Saul, A., & Durbin, A. P. (2005). Phase 1 Clinical Trial of Apical Membrane Antigen 1: An Asexual Blood-Stage Vaccine for *Plasmodium falciparum* Malaria. *Infection and Immunity*, *73*(6), 3677–3685. <https://doi.org/10.1128/IAI.73.6.3677-3685.2005>
- Marsh, K., & Snow, R. (1999). Malaria Transmission and Morbidity. *Parassitologia*, *41*(1–3), 241–246. PubMed. <http://europepmc.org/abstract/MED/10697862>
- Mbacham, W.F., Evehe, M-S. B., Netongo, P. M., Ateh, I. A., Mimche, P. N., Ajua, A., Nji A. M., Irene, D., Echouffo-Tcheugui, J. B., Tawe, B., Hallet, R., Roper. C., Targett, G., Greenwood, B. (2010). Efficacy of amodiaquine, sulphadoxine-pyrimethamine and



- their combination for the treatment of uncomplicated *Plasmodium falciparum* malaria in children in Cameroon at the time of policy change to artemisinin-based combination therapy. *Malaria Journal* **9**, 34. <https://doi.org/10.1186/1475-2875-9-34>
- Mbogo C. N, Glass G. E, Forster D, Karibu E. W, Githure J. I, Ouma J. H, Beier J. C. (1993). Evaluation of light traps for sampling anopheline mosquitoes in Kilifi, Kenya. *Journal of American Mosquito Control Association* **9**, 260–263.
- McGregor, I. A. (1987). Malarial immunity: Current trends and prospects. *Annals of Tropical Medicine & Parasitology*, **81**(5), 647–656. <https://doi.org/10.1080/00034983.1987.11812166>
- Menard, D., & Dondorp, A. (2017). Antimalarial Drug Resistance: A Threat to Malaria Elimination. *Cold Spring Harbor Perspectives in Medicine*, **7**(7), a025619. <https://doi.org/10.1101/cshperspect.a025619>
- Ménard, D., Khim, N., Beghain, J., Adegnika, A. A., Shafiul-Alam, M., Amodu, O., Rahim-Awab, G., Barnadas, C., Berry, A., Boum, Y., Bustos, M. D., Cao, J., Chen, J.-H., Collet, L., Cui, L., Thakur, G.-D., Dieye, A., Djallé, D., Dorkenoo, M. A., Mercereau-Puijalon, O. (2016). A Worldwide Map of *Plasmodium falciparum* K13-Propeller Polymorphisms. *New England Journal of Medicine*, **374**(25), 2453–2464. <https://doi.org/10.1056/NEJMoa1513137>
- Menard, S., Morlais, I., Tahar, R., Sayang, C., Mayengue, P., Iriart, X., Benoit-Vical, F., Lemen, B., Magnaval, J.-F., Awono-Ambene, P., Basco, L. K., & Berry, A. (2012a). Molecular monitoring of *Plasmodium falciparum* drug susceptibility at the time of the introduction of artemisinin-based combination therapy in Yaoundé, Cameroon: Implications for the future. *Malaria Journal*, **11**(1), 113. <https://doi.org/10.1186/1475-2875-11-113>
- Menard, S., Morlais, I., Tahar, R., Sayang, C., Mayengue, P., Iriart, X., Benoit-Vical, F., Lemen, B., Magnaval, J.-F., Awono-Ambene, P., Basco, L. K., & Berry, A. (2012b). Molecular monitoring of *Plasmodium falciparum* drug susceptibility at the time of the introduction of artemisinin-based combination therapy in Yaoundé, Cameroon: Implications for the future. *Malaria Journal*, **11**(1), 113. <https://doi.org/10.1186/1475-2875-11-113>
- Menard, S., Tchoufack, J. N., Maffo, C. N., Nsango, S. E., Iriart, X., Abate, L., Tsapi, M. T., Awono-Ambéné, P. H., Abega Mekongo, F. A., Morlais, I., & Berry, A. (2016). Insight into k13-propeller gene polymorphism and ex vivo DHA-response profiles from Cameroonian isolates. *Malaria Journal*, **15**(1), 572. <https://doi.org/10.1186/s12936-016-1622-x>
- Mercereau-Puijalon, O. (1996). Revisiting host/parasite interactions: Molecular analysis of parasites collected during longitudinal and cross-sectional surveys in humans. *Parasite Immunology*, **18**(4), 173–180. <https://doi.org/10.1046/j.1365-3024.1996.d01-79.x>
- Meshnick S. R, Dobson M. J. (2001). The history of antimalarial drugs. Rosenthal PJ, ed. *Antimalarial Chemotherapy: Mechanisms of Action, Resistance, and New Directions in Drug Discovery*. Totowa, NJ: Humana Press, 15–25.
- World Health Organization. (2008). Methods and techniques for clinical trials on antimalarial drug efficacy: Genotyping to identify parasite populations.
- Mharakurwa, S., Kumwenda, T., Mkulama, M. A. P., Musapa, M., Chishimba, S., Shiff, C. J., Sullivan, D. J., Thuma, P. E., Liu, K., & Agre, P. (2011). Malaria antifolate resistance with contrasting *Plasmodium falciparum* dihydrofolate reductase (DHFR) polymorphisms in humans and Anopheles mosquitoes. *Proceedings of the National Academy of Sciences*, **108**(46), 18796–18801. <https://doi.org/10.1073/pnas.1116162108>

- Minsanté. (2018). Xlième Journée mondiale de lutte contre le paludisme “prêt à vaincre le paludisme” Nous sommes la génération qui peut éliminer le paludisme. *Dossier de presse*, 1–20.
- Miotto, O., R. Amato, E. A. Ashley, B. MacInnis, J. Almagro-Garcia, C. Amaratunga, P. Lim, D. Mead, S. O. Oyola, M. Dhorda, M. Imwong, C. Woodrow, M. Manske, J. Stalker, E. Drury, S. Campino, L. Amenga-Etego, T. N. Thanh, H. T. Tran, P. Ringwald, D. Bethell, F. Nosten, A. P. Phyto, S. Pukrittayakamee, K. Chotivanich, C. M. Chuor, C. Nguon, S. Suon, S. Sreng, P. N. Newton, M. Mayxay, M. Khanthavong, B. Hongvanthong, Y. Htut, K. T. Han, M. P. Kyaw, M. A. Faiz, C. I. Fanello, M. Onyamboko, O. A. Mokuolu, C. G. Jacob, S. Takala-Harrison, C. V. Plowe, N. P. Day, A. M. Dondorp, C. C. Spencer, G. McVean, R. M. Fairhurst, N. J. White, and D. P. Kwiatkowski. 2015. Genetic architecture of artemisinin-resistant *Plasmodium falciparum*. *Nat Genet* 47(3):226-234. doi: 10.1038/ng.3189
- Mmbando, B. P., Lusingu, J. P., Vestergaard, L. S., Lemnge, M. M., Theander, T. G., & Scheike, T. H. (2009). Parasite threshold associated with clinical malaria in areas of different transmission intensities in north eastern Tanzania. *BMC Medical Research Methodology*, 12.
- Molina-Cruz, A., Canepa, G. E., & Barillas-Mury, C. (2017). Plasmodium P47: A key gene for malaria transmission by mosquito vectors. *Current Opinion in Microbiology*, 40, 168–174. <https://doi.org/10.1016/j.mib.2017.11.029>
- Moyeh, M. N., Njimoh, D. L., Evehe, M. S., Ali, I. M., Nji, A. M., Nkafu, D. N., Masumbe, P. N., Barbara, A.-T., Ndikum, V. N., & Mbacham, W. F. (2018). Effects of Drug Policy Changes on Evolution of Molecular Markers of *Plasmodium falciparum* Resistance to Chloroquine, Amodiaquine, and Sulphadoxine-Pyrimethamine in the South West Region of Cameroon. *Malaria Research and Treatment*, 2018, 1–7. <https://doi.org/10.1155/2018/7071383>
- Naidoo, I., & Roper, C. (2013). Mapping ‘partially resistant’, ‘fully resistant’, and ‘super resistant’ malaria. *Trends in Parasitology*, 29(10), 505–515. <https://doi.org/10.1016/j.pt.2013.08.002>
- Ndam, N. T., Basco, L. K., Ngane, V. F., Ayoub, A., Ngolle, E. M., Deloron, P., Peeters, M., & Tahar, R. (2017). Reemergence of chloroquine-sensitive pfcr K76 *Plasmodium falciparum* genotype in southeastern Cameroon. *Malaria Journal*, 16(1), 130. <https://doi.org/10.1186/s12936-017-1783-2>
- Neafsey, D. E., Juraska, M., Bedford, T., Benkeser, D., Valim, C., Griggs, A., Lievens, M., Abdulla, S., Adjei, S., Agbenyega, T., Agnandji, S. T., Aide, P., Anderson, S., Ansong, D., Aponte, J. J., Asante, K. P., Bejon, P., Birkett, A. J., Bruls, M., ... Wirth, D. F. (2015). Genetic Diversity and Protective Efficacy of the RTS,S/AS01 Malaria Vaccine. *New England Journal of Medicine*, 373(21), 2025–2037. <https://doi.org/10.1056/NEJMoa1505819>
- Ngassa Mbenda, H. G., & Das, A. (2014). Molecular Evidence of *Plasmodium vivax* Mono and Mixed Malaria Parasite Infections in Duffy-Negative Native Cameroonians. *PLoS ONE*, 9(8), e103262. <https://doi.org/10.1371/journal.pone.0103262>
- Ngassa Mbenda, H. G., & Das, A. (2016). Analysis of genetic diversity in the chloroquine-resistant gene Pfcr in field *Plasmodium falciparum* isolates from five regions of the southern Cameroon. *Infection, Genetics and Evolution*, 44, 450–458. <https://doi.org/10.1016/j.meegid.2016.07.003>
- Niba, P. T. N., Nji, A. M., Evehe, M.-S., Ali, I. M., Netongo, P. M., Ngwafor, R., Moyeh, M. N., Ngum, L. N., Ndum, O. E., Acho, F. A., Mbu’u, C. M., Fosah, D. A., Atogho-Tiedeu, B., Achonduh-Atijegbe, O., Djokam-Dadjeu, R., Chedjou, J. P. K., Bigoga, J. D., Moukoko, C. E. E., Ajua, A., Mbacham, W. F. (2021). Drug resistance markers

- within an evolving efficacy of anti-malarial drugs in Cameroon: A systematic review and meta-analysis (1998–2020). *Malaria Journal*, 20(1), 32. <https://doi.org/10.1186/s12936-020-03543-8>
- Nji, A. M., Ali, I. M., Moyeh, M. N., Ngongang, E.-O., Ekollo, A. M., Chedjou, J.-P., Ndikum, V. N., Evehe, M. S., Froeschl, G., Heumann, C., Mansmann, U., Ogundahunsi, O., & Mbacham, W. F. (2015). Randomized non-inferiority and safety trial of dihydroartemisinin-piperaquine and artesunate-amodiaquine versus artemether-lumefantrine in the treatment of uncomplicated *Plasmodium falciparum* malaria in Cameroonian children. *Malaria Journal*, 14(1), 27. <https://doi.org/10.1186/s12936-014-0521-2>
- Nkhoma, S. C., Trevino, S. G., Gorena, K. M., Nair, S., Khoswe, S., Jett, C., Garcia, R., Daniel, B., Dia, A., Terlouw, D. J., Ward, S. A., Anderson, T. J. C., & Cheeseman, I. H. (2020). Co-transmission of Related Malaria Parasite Lineages Shapes Within-Host Parasite Diversity. *Cell Host & Microbe*, 27(1), 93-103.e4. <https://doi.org/10.1016/j.chom.2019.12.001>
- Noedl, H., Se, Y., Schaecher, K., Smith, B. L., Socheat, D., & Fukuda, M. M. (2008). Evidence of Artemisinin-Resistant Malaria in Western Cambodia. *New England Journal of Medicine*, 359(24), 2619–2620. <https://doi.org/10.1056/NEJMc0805011>
- Ntoumi, F., Contamin, H., Rogier, C., Bonnefoy, S., Trape, J.-F., & Mercereau-Puijalon, O. (1995). Age-Dependent Carriage of Multiple *Plasmodium falciparum* Merozoite Surface Antigen-2 Alleles in Asymptomatic Malaria Infections. *The American Journal of Tropical Medicine and Hygiene*, 52(1), 81–88. <https://doi.org/10.4269/ajtmh.1995.52.81>
- Nzila-Mounda, A., Mberu, E. K., Sibley, C. H., Plowe, C. V., Winstanley, P. A., & Watkins, W. M. (1998). Kenyan *Plasmodium falciparum* Field Isolates: Correlation between Pyrimethamine and Chlorocycloguanil Activity In Vitro and Point Mutations in the Dihydrofolate Reductase Domain. *Antimicrobial Agents and Chemotherapy*, 42(1), 164–169. <https://doi.org/10.1128/AAC.42.1.164>
- Ocan, M., Akena, D., Nsobya, S., Kanya, M. R., Senono, R., Kinengyere, A. A., & Obuku, E. (2019). K13-propeller gene polymorphisms in *Plasmodium falciparum* parasite population in malaria affected countries: A systematic review of prevalence and risk factors. *Malaria Journal*, 18(1), 60. <https://doi.org/10.1186/s12936-019-2701-6>
- Ocan, M., Akena, D., Nsobya, S., Kanya, M. R., Senono, R., Kinengyere, A. A., & Obuku, E. A. (2019). Persistence of chloroquine resistance alleles in malaria endemic countries: A systematic review of burden and risk factors. *Malaria Journal*, 18(1), 76. <https://doi.org/10.1186/s12936-019-2716-z>
- Oduala, A. M. J., Moyou-Somo, R. S., Kyle, D. E., Martin, S. K., Gerena, L. & Milhous, W. K. (1989). Chloroquine resistant *Plasmodium falciparum* in indigenous residents of Cameroon. *Transactions of the Royal Society of Tropical Medicine and Hygiene*, 83: 308 - 310.
- Okell, L. C., Bousema, T., Griffin, J. T., Ouédraogo, A. L., Ghani, A. C., & Drakeley, C. J. (2012). Factors determining the occurrence of submicroscopic malaria infections and their relevance for control. *Nature Communications*, 3(1), 1237. <https://doi.org/10.1038/ncomms2241>
- Onori, E. (1984). The problem of *Plasmodium falciparum* drug resistance in Africa South of the Sahara. *Bulletin of World Health Organisation*, 62(suppl.): 55-62.
- Ouédraogo, A. L., Gonçalves, B. P., Gnémé, A., Wenger, E. A., Guelbeogo, M. W., Ouédraogo, A., Gerardin, J., Bever, C. A., Lyons, H., Pitroipa, X., Verhave, J. P., Eckhoff, P. A., Drakeley, C., Sauerwein, R., Luty, A. J. F., Kouyaté, B., & Bousema, T. (2016). Dynamics of the Human Infectious Reservoir for Malaria Determined by Mosquito

- Feeding Assays and Ultrasensitive Malaria Diagnosis in Burkina Faso. *Journal of Infectious Diseases*, 213(1), 90–99. <https://doi.org/10.1093/infdis/jiv370>
- Owusu-Agyei, S., Smith, T., Falk, N., Maire, N., Beck, H.-P., Felger, I., & Sama, W. (2006). Comparison of PCR-RFLP and Gene scan–Based Genotyping for Analysing Infection Dynamics of *Plasmodium falciparum*. *The American Journal of Tropical Medicine and Hygiene*, 74(6), 944–950. <https://doi.org/10.4269/ajtmh.2006.74.944>
- Phyo, A. P., Nkhoma, S., Stepniewska, K., Ashley, E. A., Nair, S., McGready, R., ler Moo, C., Al-Saai, S., Dondorp, A. M., Lwin, K. M., Singhasivanon, P., Day, N. P., White, N. J., Anderson, T. J., & Nosten, F. (2012). Emergence of artemisinin-resistant malaria on the western border of Thailand: A longitudinal study. *The Lancet*, 379(9830), 1960–1966. [https://doi.org/10.1016/S0140-6736\(12\)60484-X](https://doi.org/10.1016/S0140-6736(12)60484-X)
- Picot, S., Olliaro, P., de Monbrison, F., Bienvenu, A.-L., Price, R. N., & Ringwald, P. (2009). A systematic review and meta-analysis of evidence for correlation between molecular markers of parasite resistance and treatment outcome in falciparum malaria. *Malaria Journal*, 8(1), 89. <https://doi.org/10.1186/1475-2875-8-89>
- PNLP. (2020) Rapport annuel du Programme de Lutte contre le Paludisme. Yaoundé Cameroun. <http://onsp.minsante.cm/fr/publication/230/rapportannuel-2019-lutte-contre-le-paludisme>. Accessed 04 May 2021.
- Plowe, C. V., Cortese, J. F., Djimde, A., Nwanyanwu, O. C., Watkins, W. M., Winstanley, P. A., Estrada-Franco, J. G., Mollinedo, R. E., Avila, J. C., Cespedes, J. L., Carter, D., & Doumbo, O. K. (1997). Mutations in *Plasmodium falciparum* Dihydrofolate Reductase and Dihydropteroate Synthase and Epidemiologic Patterns of Pyrimethamine-Sulfadoxine Use and Resistance. *The Journal of Infectious Diseases*, 176(6), 1590–1596. <https://doi.org/10.1086/514159>
- PNLP. Rapport annuel du Programme de Lutte contre le Paludisme. Yaoundé Cameroun. 2020. <http://onsp.minsante.cm/fr/publication/230/rapportannuel-2019-lutte-contre-le-paludisme>. Accessed 04 May 2021.
- Pollitt, L. C., Mideo, N., Drew, D. R., Schneider, P., Colegrave, N., & Reece, S. E. (2011). Competition and the Evolution of Reproductive Restraint in Malaria Parasites. *The American Naturalist*, 177(3), 358–367. <https://doi.org/10.1086/658175>
- Price, R. N., Uhlemann, A.-C., Brockman, A., McGready, R., Ashley, E., Phaipun, L., Patel, R., Laing, K., Looareesuwan, S., White, N. J., Nosten, F., & Krishna, S. (2004). Mefloquine resistance in *Plasmodium falciparum* and increased pfmdr1 gene copy number. *The Lancet*, 364(9432), 438–447. [https://doi.org/10.1016/S0140-6736\(04\)16767-6](https://doi.org/10.1016/S0140-6736(04)16767-6)
- Quan, H., Igbasi, U., Oyibo, W., Omilabu, S., Chen, S.-B., Shen, H.-M., Okolie, C., Chen, J.-H., & Zhou, X.-N. (2020). High multiple mutations of *Plasmodium falciparum*-resistant genotypes to sulphadoxine-pyrimethamine in Lagos, Nigeria. *Infectious Diseases of Poverty*, 9(1), 91. <https://doi.org/10.1186/s40249-020-00712-4>
- Rakotoarivony, I., Coulanges, P., Coluzzi, M., Campbell, G. H., Fontenille, D., & Lepers, J. P. (1990). Malaria Transmission and Vector Biology in Manarintsoa, High Plateaux of Madagascar. *The American Journal of Tropical Medicine and Hygiene*, 43(2), 107–115. <https://doi.org/10.4269/ajtmh.1990.43.107>
- Reece, S. E., Drew, D. R., & Gardner, A. (2008). Sex ratio adjustment and kin discrimination in malaria parasites. *Nature*, 453(7195), 609–614. <https://doi.org/10.1038/nature06954>
- Rénia, L., & Goh, Y. S. (2016). Malaria Parasites: The Great Escape. *Frontiers in Immunology*, 7. <https://doi.org/10.3389/fimmu.2016.00463>
- Ringwald, P., & Basco, L. K. (1999). Molecular epidemiology of malaria in Yaounde, Cameroon V. analysis of the omega repetitive region of the plasmodium falciparum CG2 gene and chloroquine resistance. *The American Journal of Tropical Medicine and Hygiene*, 61(5), 807–813. <https://doi.org/10.4269/ajtmh.1999.61.807>



- RTS,S Clinical Trials Partnership. 2014. Efficacy and safety of the RTS,S/AS01 malaria vaccine during 18 months after vaccination: a phase 3 randomized, controlled trial in children and young infants at 11 African sites. *PLoS Med* 11(7):e1001685. doi: 10.1371/journal.pmed.1001685
- RTS,S Clinical Trials Partnership. 2015. Efficacy and safety of RTS,S/AS01 malaria vaccine with or without a booster dose in infants and children in Africa: final results of a phase 3, individually randomised, controlled trial. *Lancet* 386(9988):31-45. doi: 10.1016/S0140-6736(15)60721-8
- RTS,S Clinical Trials Partnership. 2015. Efficacy and safety of RTS,S/AS01 malaria vaccine with or without a booster dose in infants and children in Africa: final results of a phase 3, individually randomised, controlled trial. *Lancet* 386(9988):31-45. doi: 10.1016/S0140-6736(15)60721-8
- Roberts, J. M., Nahlen, B., Lal, A., Ruebush, T. K., Oloo, A. J., Bloland, P. B., McCormick, J. B., Campbell, C. C., Boriga, D. A., & Hawley, W. (1999). Longitudinal cohort study of the epidemiology of malaria infections in an area of intense malaria transmission II. Descriptive epidemiology of malaria infection and disease among children. *The American Journal of Tropical Medicine and Hygiene*, 60(4), 641–648. <https://doi.org/10.4269/ajtmh.1999.60.641>
- Rodriguez-Barraquer, I., Arinaitwe, E., Jagannathan, P., Kanya, M. R., Rosenthal, P. J., Rek, J., Dorsey, G., Nankabirwa, J., Staedke, S. G., Kilama, M., Drakeley, C., Ssewanyana, I., Smith, D. L., & Greenhouse, B. (2018). Quantification of anti-parasite and anti-disease immunity to malaria as a function of age and exposure. *ELife*, 7, e35832. <https://doi.org/10.7554/eLife.35832>
- Rumans LW, Dennis DT, Atmosoedjono S, (1979). Fansidar resistant falciparum malaria in Indonesia. *Lancet* 2: 580–581.
- Russo, G., Faggioni, G., Paganotti, G. M., Djeunang Dongho, G. B., Pomponi, A., De Santis, R., Tebano, G., Mbida, M., Sanou Sobze, M., Vullo, V., Rezza, G., & Lista, F. R. (2017). Molecular evidence of *Plasmodium vivax* infection in Duffy negative symptomatic individuals from Dschang, West Cameroon. *Malaria Journal*, 16(1), 74. <https://doi.org/10.1186/s12936-017-1722-2>
- Safeukui, I., Fru-Cho, J., Mbengue, A., Suresh, N., Njimoh, D. L., Bumah, V. V., Nkuo-Akenji, T., Titanji, V. P., & Haldar, K. (2017). *Investigation of polymorphisms in the P. falciparum artemisinin resistance marker kelch13 in asymptomatic infections in a rural area of Cameroon* [Preprint]. Microbiology. <https://doi.org/10.1101/148999>
- Sahnouni, K., Menemedengue, V., Tahar, R., & Basco, L. (2011). Molecular Epidemiology of Malaria in Cameroon. XXX. Sequence Analysis of *Plasmodium falciparum* ATPase 6, Dihydrofolate Reductase, and Dihydropteroate Synthase Resistance Markers in Clinical Isolates from Children Treated with an Artesunate-Sulfadoxine-Pyrimethamine Combination. *The American Journal of Tropical Medicine and Hygiene*, 85(1), 22–25. <https://doi.org/10.4269/ajtmh.2011.10-0523>
- Sanchez, C. P., Dave, A., Stein, W. D., & Lanzer, M. (2010). Transporters as mediators of drug resistance in *Plasmodium falciparum*. *International Journal for Parasitology*, 40(10), 1109–1118. <https://doi.org/10.1016/j.ijpara.2010.04.001>
- Sansonetti, P. J., Lebras, C., Verdier, F., Charmot, G., Dupont, B., Lapresle, C. (1985). Chloroquine resistant *Plasmodium falciparum* in Cameroon. *The Lancet*, 1: 1154 - 1155
- Sayang, C., Gausseres, M., Vernazza-Licht, N., Malvy, D., Bley, D., & Millet, P. (2009). Treatment of malaria from monotherapy to artemisinin-based combination therapy by health professionals in urban health facilities in Yaoundé, central province, Cameroon. *Malaria Journal*, 8(1), 176. <https://doi.org/10.1186/1475-2875-8-176>

- Schneider, J., Jean Languillon, J., & Delas, A. (1958). Association chloroquine-pyriméthamine dans la chimioprophylaxie du paludisme résultats après 22 mois de traitement. *Bull. Soc. Path. exot*, 50 (2): 295.
- Schneider, P., Bousema, J. T., Gouagna, L. C., Otieno, S., Vegte-Bolmer, M. V. D., Omar, S. A., & Sauerwein, R. W. (2007). Submicroscopic *Plasmodium falciparum* gametocyte densities frequently result in mosquito infection. *The American Journal of Tropical Medicine and Hygiene Am J Trop Med Hyg*, 76(3), 470–474. <https://doi.org/10.4269/ajtmh.2007.76.470>
- Schneider, P., Greischar, M. A., Birget, P. L. G., Repton, C., Mideo, N., & Reece, S. E. (2018). Adaptive plasticity in the gametocyte conversion rate of malaria parasites. *PLOS Pathogens*, 14(11), e1007371. <https://doi.org/10.1371/journal.ppat.1007371>
- Sidhu, A. B. S., Uhlemann, A., Valderramos, S. G., Valderramos, J., Krishna, S., & Fidock, D. A. (2006). Decreasing *pfmdr1* Copy Number in *Plasmodium falciparum* Malaria Heightens Susceptibility to Mefloquine, Lumefantrine, Halofantrine, Quinine, and Artemisinin. *The Journal of Infectious Diseases*, 194(4), 528–535. <https://doi.org/10.1086/507115>
- Sidhu, A. B. S., Verdier-Pinard, D., & Fidock, D. A. (2002). Chloroquine Resistance in *Plasmodium falciparum* Malaria Parasites Conferred by *pfert* Mutations. *Science*, 298(5591), 210–213. <https://doi.org/10.1126/science.1074045>
- Sinka, M. E., Bangs, M. J., Manguin, S., Coetzee, M., Mbogo, C. M., Hemingway, J., Patil, A. P., Temperley, W. H., Gething, P. W., Kabaria, C. W., Okara, R. M., Van Boeckel, T., Godfray, H. C. J., Harbach, R. E., & Hay, S. I. (2010). The dominant Anopheles vectors of human malaria in Africa, Europe and the Middle East: Occurrence data, distribution maps and bionomic précis. *Parasites & Vectors*, 3(1), 117. <https://doi.org/10.1186/1756-3305-3-117>
- Sinka, M. E., Bangs, M. J., Manguin, S., Rubio-Palis, Y., Chareonviriyaphap, T., Coetzee, M., Mbogo, C. M., Hemingway, J., Patil, A. P., Temperley, W. H., Gething, P. W., Kabaria, C. W., Burkot, T. R., Harbach, R. E., & Hay, S. I. (2012). A global map of dominant malaria vectors. *Parasites & Vectors*, 5(1), 69. <https://doi.org/10.1186/1756-3305-5-69>
- Slater, H. C., Ross, A., Felger, I., Hofmann, N. E., Robinson, L., Cook, J., Gonçalves, B. P., Björkman, A., Ouedraogo, A. L., Morris, U., Msellem, M., Koepfli, C., Mueller, I., Tadesse, F., Gadisa, E., Das, S., Domingo, G., Kapulu, M., Midega, J., ... Okell, L. C. (2019). The temporal dynamics and infectiousness of subpatent *Plasmodium falciparum* infections in relation to parasite density. *Nature Communications*, 10(1), 1433. <https://doi.org/10.1038/s41467-019-09441-1>
- Snow, R. W., & Marsh, K. (2002). *The consequences of reducing transmission of Plasmodium falciparum in Africa* (Vol. 52, pp. 235–264). Academic Press. [https://doi.org/10.1016/S0065-308X\(02\)52013-3](https://doi.org/10.1016/S0065-308X(02)52013-3)
- Snow, R. W., Omumbo, J. A., Lowe, B., Molyneux, C. S., Obiero, J.-O., Palmer, A., Weber, M. W., Pinder, M., Nahlen, B., Obonyo, C., Newbold, C., Gupta, S., & Marsh, K. (1997). Relation between severe malaria morbidity in children and level of *Plasmodium falciparum* transmission in Africa. *The Lancet*, 349(9066), 1650–1654. [https://doi.org/10.1016/S0140-6736\(97\)02038-2](https://doi.org/10.1016/S0140-6736(97)02038-2)
- Stone, W. J. R., Campo, J. J., Ouédraogo, A. L., Meerstein-Kessel, L., Morlais, I., Da, D., Cohuet, A., Nsango, S., Sutherland, C. J., van de Vegte-Bolmer, M., Siebelink-Stoter, R., van Gemert, G.-J., Graumans, W., Lanke, K., Shandling, A. D., Pablo, J. V., Teng, A. A., Jones, S., de Jong, R. M., Jore, M. M. (2018). Unravelling the immune signature of *Plasmodium falciparum* transmission-reducing immunity. *Nature Communications*, 9(1), 558. <https://doi.org/10.1038/s41467-017-02646-2>



- Takala-Harrison, S., Clark, T. G., Jacob, C. G., Cummings, M. P., Miotto, O., Dondorp, A. M., Fukuda, M. M., Nosten, F., Noedl, H., Imwong, M., Bethell, D., Se, Y., Lon, C., Tyner, S. D., Saunders, D. L., Socheat, D., Arie, F., Phyo, A. P., Starzengruber, P., ... Plowe, C. V. (2013). Genetic loci associated with delayed clearance of *Plasmodium falciparum* following artemisinin treatment in Southeast Asia. *Proceedings of the National Academy of Sciences*, *110*(1), 240–245. <https://doi.org/10.1073/pnas.1211205110>
- Takala-Harrison, S., C. G. Jacob, C. Arze, M. P. Cummings, J. C. Silva, A. M. Dondorp, M. M. Fukuda, T. T. Hien, M. Mayxay, H. Noedl, F. Nosten, M. P. Kyaw, N. T. Nhien, M. Imwong, D. Bethell, Y. Se, C. Lon, S. D. Tyner, D. L. Saunders, F. Arie, O. Mercereau-Puijalon, D. Menard, P. N. Newton, M. Khanthavong, B. Hongvanthong, P. Starzengruber, H. P. Fuehrer, P. Swoboda, W. A. Khan, A. P. Phyo, M. M. Nyunt, M. H. Nyunt, T. S. Brown, M. Adams, C. S. Pepin, J. Bailey, J. C. Tan, M. T. Ferdig, T. G. Clark, O. Miotto, B. MacInnis, D. P. Kwiatkowski, N. J. White, P. Ringwald, and C. V. Plowe. (2015). Independent emergence of artemisinin resistance mutations among *Plasmodium falciparum* in Southeast Asia. *J Infect Dis* *211*(5):670-679. doi: 10.1093/infdis/jiu491
- The Four Artemisinin-Based Combinations (4ABC) Study Group. (2011). A Head-to-Head Comparison of Four Artemisinin-Based Combinations for Treating Uncomplicated Malaria in African Children: A Randomized Trial. *PLoS Medicine*, *8*(11), e1001119. <https://doi.org/10.1371/journal.pmed.1001119>
- Thera, M. A., Coulibaly, D., Ouattara, A., Traore, K., Diallo, D. A., Dolo, A., Sissoko, M. S., Sissoko, M., Wu, Y., Vekemans, J., Ballou, W. R., Dube, T., House, B., & Heppner, D. G. (2011). A Field Trial to Assess a Blood-Stage Malaria Vaccine. *N Engl J Med*, *10*.
- Torrentino-Madamet, M., Fall, B., Benoit, N., Camara, C., Amalvict, R., Fall, M., Dionne, P., Ba Fall, K., Nakoulima, A., Diatta, B., Diemé, Y., Ménard, D., Wade, B., & Pradines, B. (2014). Limited polymorphisms in k13 gene in *Plasmodium falciparum* isolates from Dakar, Senegal in 2012–2013. *Malaria Journal*, *13*(1), 472. <https://doi.org/10.1186/1475-2875-13-472>
- Tran, T. M., Li, S., Doumbo, S., Doumtabe, D., Huang, C.-Y., Dia, S., Bathily, A., Sangala, J., Kone, Y., Traore, A., Niangaly, M., Dara, C., Kayentao, K., Ongoiba, A., Doumbo, O. K., Traore, B., & Crompton, P. D. (2013). An Intensive Longitudinal Cohort Study of Malian Children and Adults Reveals No Evidence of Acquired Immunity to *Plasmodium falciparum* Infection. *Clinical Infectious Diseases*, *57*(1), 40–47. <https://doi.org/10.1093/cid/cit174>
- Tumwebaze, P., Conrad, M. D., Walakira, A., LeClair, N., Byaruhanga, O., Nakazibwe, C., Kozak, B., Bloome, J., Okiring, J., Kakuru, A., Bigira, V., Kapisi, J., Legac, J., Gut, J., Cooper, R. A., Kamya, M. R., Havlir, D. V., Dorsey, G., Greenhouse, B., Rosenthal, P. J. (2015). Impact of Antimalarial Treatment and Chemoprevention on the Drug Sensitivity of Malaria Parasites Isolated from Ugandan Children. *Antimicrobial Agents and Chemotherapy*, *59*(6), 3018–3030. <https://doi.org/10.1128/AAC.05141-14>
- Tusting, L. S., Bousema, T., Smith, D. L., & Drakeley, C. (2014). Chapter Three—Measuring Changes in *Plasmodium falciparum* Transmission: Precision, Accuracy and Costs of Metrics. In D. Rollinson (Ed.), *Advances in Parasitology* (Vol. 84, pp. 151–208). Academic Press. <https://doi.org/10.1016/B978-0-12-800099-1.00003-X>
- Twohig, K. A., Pfeffer, D. A., Baird, J. K., Price, R. N., Zimmerman, P. A., Hay, S. I., Gething, P. W., Battle, K. E., & Howes, R. E. (2019). Growing evidence of *Plasmodium vivax* across malaria-endemic Africa. *PLOS Neglected Tropical Diseases*, *13*(1), e0007140. <https://doi.org/10.1371/journal.pntd.0007140>

- Uwimana, A., Legrand, E., Stokes, B. H., Ndikumana, J.-L. M., Warsame, M., Umulisa, N., Ngamije, D., Munyaneza, T., Mazarati, J.-B., Munguti, K., Campagne, P., Criscuolo, A., Ariey, F., Murindahabi, M., Ringwald, P., Fidock, D. A., Mbituyumuremyi, A., & Menard, D. (2020). Emergence and clonal expansion of in vitro artemisinin-resistant *Plasmodium falciparum* kelch13 R561H mutant parasites in Rwanda. *Nature Medicine*, 26(10), 1602–1608. <https://doi.org/10.1038/s41591-020-1005-2>
- Vafa, M., Troye-Blomberg, M., Anchang, J., Garcia, A., & Migot-Nabias, F. (2008). Multiplicity of *Plasmodium falciparum* infection in asymptomatic children in Senegal: Relation to transmission, age and erythrocyte variants. *Malaria Journal*, 7(1), 17. <https://doi.org/10.1186/1475-2875-7-17>
- Vaidya, A. B., & Mather, M. W. (2000). Atovaquone resistance in malaria parasites. *Drug Resistance Updates*, 3(5), 283–287. <https://doi.org/10.1054/drup.2000.0157>
- van Dooren, G. G., Waller, R. F., McFadden, G. I., Joiner, K. A., & Roos, D. S. (2000). Traffic Jams: Protein Transport in *Plasmodium falciparum*. *Parasitology Today*, 16(10), 421–427. [https://doi.org/10.1016/S0169-4758\(00\)01792-0](https://doi.org/10.1016/S0169-4758(00)01792-0)
- Venugopal, K., Hentzschel, F., Valkiunas, G & Marti M. (2020). *Plasmodium* asexual growth and sexual development in the haematopoietic niche of the host. *Nature reviews microbiology*, 18: 177-189. <https://doi.org/10.1038/s41579-019-0306-2>
- Verity, R., Aydemir, O., Brazeau, N. F., Watson, O. J., Hathaway, N. J., Mwandagalirwa, M. K., Marsh, P. W., Thwai, K., Fulton, T., Denton, M., Morgan, A. P., Parr, J. B., Tumwebaze, P. K., Conrad, M., Rosenthal, P. J., Ishengoma, D. S., Ngondi, J., Gutman, J., Mulenga, M., Juliano, J. J. (2020). The impact of antimalarial resistance on the genetic structure of *Plasmodium falciparum* in the DRC. *Nature Communications*, 11(1), 2107. <https://doi.org/10.1038/s41467-020-15779-8>
- Voumbo-Matoumona, D. F., Kouna, L. C., Madamet, M., Maghendji-Nzondo, S., Pradines, B., & Lekana-Douki, J. B. (2018). Prevalence of *Plasmodium falciparum* antimalarial drug resistance genes in Southeastern Gabon from 2011 to 2014. *Infection and Drug Resistance*, Volume 11, 1329–1338. <https://doi.org/10.2147/IDR.S160164>
- Wargo, A. R., S. Huijben, J. C. de Roode, J. Shepherd, and A. F. Read. 2007. Competitive release and facilitation of drug-resistant parasites after therapeutic chemotherapy in a rodent malaria model. *Proceedings of the National Academy of Sciences of the United States of America* 104(50):19914-19919. doi: 10.1073/pnas.0707766104
- Wellems, T. E., & Pantont, L. J. (1990). Chloroquine resistance not linked to mdr-like genes in a *Plasmodium falciparum* cross. 345, 3.
- Whegang Youdom, S., Chiabi, A., & Basco, L. K. (2019). Monitoring the Efficacy and Safety of Artemisinin-Based Combination Therapies: A Review and Network Meta-analysis of Antimalarial Therapeutic Efficacy Trials in Cameroon. *Drugs in R&D*, 19(1), 1–14. <https://doi.org/10.1007/s40268-018-0259-3>
- White, N. J., Pukrittayakamee, S., Hien, T. T., Faiz, M. A., Mokuolu, O. A., & Dondorp, A. M. (2014). Malaria. *The Lancet*, 383(9918), 723–735. [https://doi.org/10.1016/S0140-6736\(13\)60024-0](https://doi.org/10.1016/S0140-6736(13)60024-0)
- Wirtz R. A., Zavala F., Charoenvit Y., Campbell G. H., Burkot T. R., Schneider I., Esser K. M., Beaudoin R.L. & Andre R.G. (1987) Comparative testing of monoclonal antibodies against *Plasmodium falciparum* sporozoites for ELISA development. *Bulletin of the World Health Organization*, 65(1), 39-45
- Witkowski, B. (2013). Novel phenotypic assays for the detection of artemisinin-resistant *Plasmodium falciparum* malaria in Cambodia: In-vitro and ex-vivo drug-response studies. 13, 7.
- Wong, W., Griggs, A. D., Daniels, R. F., Schaffner, S. F., Ndiaye, D., Bei, A. K., Deme, A. B., MacInnis, B., Volkman, S. K., Hartl, D. L., Neafsey, D. E., & Wirth, D. F. (2017).

Genetic relatedness analysis reveals the cotransmission of genetically related *Plasmodium falciparum* parasites in Thiès, Senegal. *Genome Medicine*, 9(1), 5. <https://doi.org/10.1186/s13073-017-0398-0>

World malaria report 2020: 20 years of global progress and challenges. (2020). 151.

Zongo, I., Dorsey, G., Rouamba, N., Tinto, H., Dokomajilar, C., Guiguemde, R. T., Rosenthal, P. J., & Ouedraogo, J. B. (2007). Artemether-lumefantrine versus amodiaquine plus sulfadoxine-pyrimethamine for uncomplicated falciparum malaria in Burkina Faso: A randomised non-inferiority trial. 369, 8.