



HAL
open science

Essays on the natural resource curse

Arsham Reisinezhad

► **To cite this version:**

Arsham Reisinezhad. Essays on the natural resource curse. Economics and Finance. Université Panthéon-Sorbonne - Paris I, 2021. English. NNT : 2021PA01E009 . tel-03374725

HAL Id: tel-03374725

<https://theses.hal.science/tel-03374725>

Submitted on 12 Oct 2021

HAL is a multi-disciplinary open access archive for the deposit and dissemination of scientific research documents, whether they are published or not. The documents may come from teaching and research institutions in France or abroad, or from public or private research centers.

L'archive ouverte pluridisciplinaire **HAL**, est destinée au dépôt et à la diffusion de documents scientifiques de niveau recherche, publiés ou non, émanant des établissements d'enseignement et de recherche français ou étrangers, des laboratoires publics ou privés.

UNIVERSITY OF PARIS 1 PANTHEON-SORBONNE

U.F.R. Economic science

PhD Thesis

Submitted for the Degree of Doctor of Philosophy in Economics

Defended on January, 2021 by

Arsham Reisinezhad

Essays on the Natural Resource Curse

Thesis Advisors:

Professor Gilles Saint Paul and Professor Jean Imbs

Jury Membres

François Bourguignon	Emeritus Professor at Paris School of Economics
Delfim Gomes Neto	Associate Researcher at NIPE-University of Minho
Baptiste Massenet	Associate Professor at Toulouse Business School
Roberta Ziparo	Assistant Professor at Aix-Marseille University

UNIVERSITÉ PARIS 1 PANTHÉON-SORBONNE

U.F.R. Sciences Économiques

THÈSE DE DOCTORAT

Pour l'obtention du grade de Docteur en Sciences Économique

Soutenue publiquement le Janvier, 2021 par

Arsham Reisinezhad

Essais sur la Malédiction des Ressources Naturelles

Directeur de Thèse:

Professeur Gilles Saint Paul and Professeur Jean Imbs

Membres du Jury

François Bourguignon	Professeur Émérite, École d'économie de Paris
Delfim Gomes Neto	Chercheur Associé, NIPE-Université du Minho
Baptiste Massenet	Maître de Conférences, École de commerce de Toulouse
Roberta Ziparo	Maître de Conférences, Aix-Marseille Université

This thesis has been carried out at

Paris-Jourdan Sciences Économiques - UMR8545,

48, Boulevard Jourdan 75014 Paris, France.

Cette thèse a été préparée à

Paris-Jourdan Sciences Économiques - UMR8545,

48, Boulevard Jourdan 75014 Paris, France.

À mes chers Parents ...

Acknowledgements

Writing this dissertation has been like learning to walk. When you are a young child, you look at your parents moving fast. Others encourage you to walk and are excited looking at your attempts, but you can't until you grow up and your muscles get stronger enough. During this process, by relying on their parents, toddler tries to learn walking with short unsteady steps. I am deeply grateful (and always will be!) for Gilles Saint Paul learned me how to walk. I fell down hard one time in the middle of this path but Gilles helped me to stand up and continue this uneven road. Now, one seems he believes that I have sufficiently learned how to walk by myself. I promise I will do my best and even to learn running!

I warmly thank the guidance of my other supervisor, Jean Imbs. He was extremely supportive, patient, and available throughout the whole process. I would also like to express my gratitude to my Co-supervisor François Bourguignon. I will never forget the first time I met him in his office. Although we didn't have any appointment together, he welcomed me and devoted a long time to listen to my words. He encouraged me to dedicate my PhD thesis to clarify the role of income inequality in natural resource-rich countries. I am immensely thankful to him for inviting me to participate in an international project at the Paris School of Economics.

My dissertation has greatly benefited from overwhelming support from Rick Van der Ploeg. I learned more from him in the short period of staying at Oxford University. For these reasons and many more, I am eternally grateful to him. I would also like to thank my committee members Delfim Gomes Neto, Baptiste Massenet, and Roberta Ziparo for giving their precious time to read this thesis and for giving very insightful comments to improve the quality of this work.

I am grateful to two wonderful people. Mahila, I am indebted for her help and friendship. Without her support and encouragement, I would not have been able to reach this stage. Mehrzad blessed me with his friendship and unfailing support and also shared many hours of his time to speak together about everything worth discussing.

I am also extremely grateful to all members of the Paris School of Economics (PSE), especially to Thomas Piketty, Carlos Winograd, Kathleen Schubert, Eric Monnet, and many of my friends and colleagues: Hamzeh Arabzadeh, Yassine Kirat, Paolo Santini, Lisa Oberländer, Li Yang, Ignacio Flores, Ilya Eryzhenskiy, Emanuele Franceschi, Jaime

Leyva, Jaime Mauricio Montana, Hector Moreno, Zeinab Elbeltagy, Can Askan Mavi, Oscar Barrera, Yajna Govind, Juan Luksic, and Sara Signorelli. I would also like to thank my students from Paris 1 and Science Po. From them, I learned many things, but mostly patience.

I finally thank my brother Arash, my sister Raha, and my brother in law Mohammad, who constantly inquired about my progress throughout this long process and support me unconditionally. Last but not most, no word can't express my sincere gratitude to my father and mother, those who were on my side from day one. They taught me the skills that enable me to be where I am today. They devoted their life to grow up us. Although I believe no time we can completely compensate for their sacrifices, I hope to repay a piece of their kindness one day.

Contents

0	Introduction - version Française	1
0.1	Les faits stylisés de la malédiction des ressources	1
0.2	Les explications de la malédiction des ressources naturelles	2
0.2.1	Problèmes économiques	3
0.2.2	Problèmes politico-économiques	6
0.3	But de l'étude	8
0.3.1	Chapitre 2: La maladie hollandaise revisitée: théorie et preuves . . .	8
0.3.2	Chapitre 3: Les inégalités de revenus alimentent-elles la maladie hollandaise?	9
0.3.3	Chapitre 4: Capacité d'absorption et malédiction des ressources naturelles	11
1	Introduction – English version	12
1.1	The stylized facts of the resource curse	12
1.2	The explanations of the natural resource curse	13
1.2.1	Economics issues	13
1.2.2	Political-economics issues	16
1.3	Purpose of the study	18
1.3.1	Chapter 2: The Dutch Disease Revisited: Theory and Evidence . . .	18
1.3.2	Chapter 3: Does income inequality feed the Dutch disease?	19
1.3.3	Chapter 4: Absorption capacity and Natural Resource Curse . . .	20
2	The Dutch Disease Revisited: Theory and Evidence	22
2.1	Introduction	23
2.2	A model of the Dutch disease	27
2.3	Theory meets empirical model	34
2.3.1	Data and Methodology	34
2.4	Econometric Results	37
2.4.1	Resource-dependence and the real exchange rate	37
2.4.2	Real exchange rate and relative sectoral output	43
2.4.3	Real exchange rate and sectoral growth	47

2.4.4	Real exchange rate and economic growth	50
2.5	Conclusion	54
2.A	Steady state response of a resource boom	56
2.B	Commodity Price index: Data Description, Sources and Methodology . . .	57
2.C	The net foreign assets and resource-dependence	58
2.D	List of Countries	59
3	Does income inequality feed the Dutch disease?	61
3.1	Introduction	62
3.2	The model	65
3.2.1	Short run analysis (static model)	70
3.2.2	Long run analysis (dynamic model)	75
3.2.3	Dutch disease dynamics	78
3.2.4	Absolute Productivity Growth	81
3.3	Empirical approach	84
3.3.1	Data and Empirical methodology	85
3.3.2	Impact of the windfall income on the real exchange rate	88
3.3.3	Income inequality response	92
3.3.4	The intensity of the Dutch disease	99
3.3.5	The sectoral growth	102
3.4	Conclusion	107
3.A	Proof of Proposition 3	108
3.B	Proof of Proposition 4	108
3.C	Proof of Proposition 7	109
3.D	List of countries included in the sample database	109
4	Absorption capacity and Natural Resource Curse	111
4.1	Introduction	112
4.2	Implication of Absorption capacity	115
4.3	Stylized Facts	119
4.4	Empirical approach	120
4.4.1	Methodology and Data	120
4.4.2	Estimation Results	123
4.4.3	Robustness Tests	128
4.5	The Model	134
4.5.1	Consumer problem	136
4.5.2	Economic response to the windfall income	138
4.5.3	Imperfect financial market and changing the demand composition .	142
4.6	Conclusion	144
4.A	Statistical cross-country estimation	145

4.B	List of countries included in the sample database	145
4.C	Windfall income and social value of wealth	147
4.D	Solution of the dynamic system	147
4.E	The real exchange rate and the capacity constraint	148
5	References	151

Chapter 0

Introduction - version Française

Le paradoxe de l'abondance, ou «la malédiction des ressources», a gagné en popularité ces 30 dernières années. Le terme a été utilisé pour la première fois par le géographe économique Richard Auty en 1993 (AUTY, AUTY et MIKESELL, 1998). La question clé du syndrome de la malédiction des ressources est de savoir pourquoi les pays dépendants des ressources naturelles n'ont généralement pas réussi à afficher de meilleures performances économiques que d'autres. En pratique, le paradoxe explique pourquoi les économies riches en ressources comme le Botswana ou la Norvège réussissent mieux alors que la Sierra Leone affichait un taux moyen en baisse de 37% entre 1971 et 1989 (HUMPHREYS, J. SACHS et STIGLITZ, 2007) et le revenu par habitant au Nigéria stagne depuis quarante ans (SALA-I-MARTIN et SUBRAMANIAN, 2013).

Pour faire la lumière sur le paradoxe de l'abondance, nous présentons d'abord dans la section 1 les faits stylisés pertinents, puis nous proposons dans la section 2 les principales hypothèses et preuves empiriques. Nous proposons enfin dans la section 3 l'objet de l'étude et présentons plus en détail la contribution, la méthodologie et les résultats de chaque chapitre.

0.1 Les faits stylisés de la malédiction des ressources

Bien que certains pays aient bien exploité leurs richesses en ressources pour développer plus rapidement leur économie, la plupart d'entre eux ont enregistré de mauvaises performances macroéconomiques. Un point de départ utile pour clarifier ce sujet est de discuter d'un exemple bien connu de pays où ils n'ont pas profité de leur richesse et d'un autre où en a bénéficié.

L'exemple le plus spectaculaire du premier groupe de pays est peut-être le Nigéria (SALA-I-MARTIN et SUBRAMANIAN, 2013). Bien que les revenus pétroliers par habitant au Nigéria aient été multipliés par 10 au cours de la période 1965-2000, le revenu par habitant stagne (autour de 1100 \$ en PPA) depuis 1960. Cela a fait grimper 2,7 fois la part de

la population des personnes qui ont survécu avec 1 \$ par jour entre 1970 et 2000. Les données montrent que les 2% les plus riches avaient la même part de revenu que les 17% les plus pauvres en 1970, alors qu'ils avaient la même part que les 55% les plus pauvres en 2000 (SALA-I-MARTIN et SUBRAMANIAN, 2013). Des données récentes montrent que le taux de croissance du PIB réel par habitant au Nigéria a baissé en moyenne de 4% entre 1965 et 2000 (source PWT90). En outre, les deux tiers de l'utilisation de la capacité dans le secteur manufacturier, qui appartient souvent au gouvernement et qui a joué un rôle principal dans la création de nouvelles possibilités d'emploi, est gaspillée. Tout cela suggèrent clairement que les classes à revenus moyens et faibles du Nigérian n'ont pas bénéficié des revenus résultant de l'exportation de pétrole (VAN DER PLOEG, 2011b). D'autres discutent d'exemples de pays ayant des expériences positives. 40% du PIB du Botswana provient des diamants, mais le Botswana a réussi à protéger son économie de la malédiction des ressources (VAN DER PLOEG, 2011b). Le deuxième pays en termes de dépenses publiques d'éducation (% du PNB) a fait du Botswana le taux de croissance le plus élevé au monde (SARRAF et JIWANJI, 2001) et le revenu par habitant a augmenté environ 20 fois (de 467 \$ à 9228 \$ en termes de PPA) en moyenne de 8,5% pendant la période 1965-2000 (source PWT90). La bonne performance économique du Botswana semble expliquer pourquoi son PIB réel par habitant qui était un dixième de celui du Nigéria en 1965 a dépassé pendant cette période de sorte qu'il est devenu environ dix fois celui du Nigéria en 2000 (source PWT90). L'expérience du Botswana est remarquable car elle a commencé son expérience postcoloniale avec un investissement minimal (VAN DER PLOEG, 2011b). Néanmoins, les données montrent que le stock de capital réel par habitant s'était accumulé en moyenne 6% par an au cours de la période (source PWT90).

0.2 Les explications de la malédiction des ressources naturelles

Les faits stylisés, discutés dans la section 1, semblent clarifier pourquoi la question selon laquelle la ressource naturelle est une malédiction ou une bénédiction pour la performance économique est toujours restée controversée. Nous représentons ici l'hypothèse principale et les preuves de l'effet des revenus exceptionnels des ressources sur la performance économique. Nous avons d'abord avancé l'hypothèse de la maladie hollandaise, puis l'effet de la volatilité des prix des matières premières sur les performances économiques pour illustrer les raisons économiques de la malédiction des ressources. Ensuite, nous abordons les questions politico-économiques pour voir dans quelle mesure la qualité des institutions, la corruption et la structure politique influencent le lien entre la dépendance aux ressources et la performance économique.

0.2.1 Problèmes économiques

La première explication durable de la malédiction des ressources renvoie à l'hypothèse de la maladie hollandaise. Le terme de la maladie hollandaise a été nommé à l'origine en 1977 par *The Economist* pour décrire les répercussions défavorables des découvertes de gaz naturel à la fin des années 1950 sur le secteur manufacturier néerlandais. L'idée sous-jacente à cette hypothèse est que les revenus exceptionnels générés par la vente de la richesse en ressources naturelles, par une appréciation du taux de change réel, diminuent la compétitivité du secteur échangé (CORDEN et NEARY, 1982). Nous pouvons le démontrer avec un petit modèle d'économie ouverte dans un cadre Salter-Swan, comme dans M. NKUSU, 2004. Supposons que les affirmations suivantes soient valables. 1) Il existe deux secteurs : les secteurs marchands (par exemple les secteurs manufacturier et agricole) et les non marchands (par exemple les services non marchands et la construction), 2) Il n'y a pas d'accumulation d'actifs et de capital et la main-d'œuvre (c'est-à-dire le capital humain) est seul facteur de production, 3) La force de travail est normalisée à l'unité pour expulser la croissance démographique, 4) La main-d'œuvre est pleinement employée par secteurs et ils peuvent se déplacer librement d'un secteur à l'autre, 5) Il y a des rendements décroissants du travail dans chaque secteur, 6) Les agents ont un goût identique et la demande de biens échangés est parfaitement élastique, 7) Le revenu exceptionnel (boom des ressources) est un don exogène constant dans le temps.

La littérature sur la maladie hollandaise met en évidence deux effets différents. Le premier est l'effet sur les dépenses. Le boom des ressources entraîne une expansion du revenu total de l'économie et augmente ainsi la demande de biens tant échangés que non échangés. Comme l'offre excédentaire de biens échangés peut être fournie par le marché mondial, le prix des biens échangés est exogène constant et la demande est donc parfaitement élastique. Cependant, l'offre intérieure ne peut pas faire face à la demande accrue de biens non échangés, ce qui conduit à l'appréciation du prix relatif des biens non échangés par rapport aux biens échangés, défini comme le taux de change réel. Le second, appelé effet de mouvement des ressources, suggère que l'appréciation relative des prix augmente le salaire réel de la main-d'œuvre travaillant dans le secteur non commercial, par rapport à ceux qui travaillent dans le secteur marchand. Cela signale à la main-d'œuvre qu'elle abandonne le secteur marchand pour se diriger vers le secteur non marchand. Par conséquent, le secteur marchand se contracte et le secteur non marchand se développe.

Pour des effets à plus long terme, il faut inclure le capital dans le cadre. Dans le modèle de Heckscher-Ohlin avec deux biens, deux secteurs, deux facteurs (c'est-à-dire le capital et le travail) et des rendements d'échelle constants dans les fonctions de production, l'appréciation du taux de change réel résultant d'un revenu exceptionnel de ressources augmente la demande de facteur utilisé de manière intensive dans le secteur non marchand par rapport à un autre facteur. Ceci, à son tour, augmente le prix relatif des facteurs (STOLPER et

SAMUELSON, 1941). Dans tous les cas, la réallocation des facteurs, passant du secteur marchand au secteur non marchand, entraîne l'expansion du secteur non marchand et la contraction du secteur marchand.

Plus tard, les chercheurs ont remis en question ce volet de la littérature et ont avancé que le secteur commercial est le moteur de la croissance. De plus, les données indiquent que le secteur commercial bénéficie davantage de l'apprentissage par la pratique à long terme (ULKU, 2004). Par conséquent, le secteur des échanges non liés aux ressources, touché par la détérioration de la compétitivité, est plus susceptible de ne pas se rétablir complètement une fois les revenus tirés des ressources épuisés (VAN DER PLOEG, 2011b). Comme première tentative, VAN WIJNBERGEN, 1984 a étudié un modèle à deux périodes et à deux secteurs dans lequel la productivité future du secteur commercial dépend de plus en plus de la production actuelle du secteur commercialisé. Plus tard, en partant du principe que seul l'emploi de la main-d'œuvre dans le secteur marchand contribue à la génération de l'apprentissage, KRUGMAN, 1987 a proposé un modèle de rendements d'échelle croissants dans le secteur commercial. Alors que J. D. SACHS et WARNER, 1995 et GYLFASSON, HERBERTSSON et ZOEGA, 1999 ont émis l'hypothèse que l'apprentissage généré par l'emploi de la main-d'œuvre dans le secteur marchand se répercute parfaitement sur le secteur non marchand. Ces derniers modèles précisent que le processus d'apprentissage induit la croissance endogène dans les deux secteurs : un boom des ressources naturelles réduit la part de l'emploi dans le secteur marchand, entrave l'apprentissage par la pratique (LBD) et ralentit ainsi la croissance économique. Dans la littérature récente, TORVIK, 2001 présente un modèle général dans lequel les deux secteurs peuvent contribuer au processus d'apprentissage et il y a des retombées d'apprentissage imparfaites entre les secteurs. Il démontre que dans un tel modèle, un boom des ressources a tendance à déprécier le taux de change réel en régime permanent, tandis que la croissance économique en régime permanent est indépendante d'un boom des ressources et que la croissance de la productivité sectorielle dépend de l'effet direct ou de retombée. est plus fort. BJØRNLAND et THORSRUD, 2016 ont proposé le modèle TORVIK, 2001 afin que la productivité se répercute entre le secteur des ressources en plein essor et d'autres secteurs nationaux. Ils montrent qu'un secteur des ressources en plein essor entraîne une dépréciation du taux de change réel sur la trajectoire de transition et une augmentation du taux de croissance de l'économie et des deux secteurs, contrairement aux modèles classiques de la maladie hollandaise.

Les œuvres influentes de J. D. SACHS et WARNER, 1995 ; J. D. SACHS et WARNER, 2001 et RODRIGUEZ et J. D. SACHS, 1999 sont des représentants d'un courant de littérature empirique montrant que la dépendance aux ressources naturelles ralentit la croissance économique. En particulier, dans un échantillon de pays entre 1970 et 1990, J. D. SACHS et WARNER, 2001 montrent qu'une augmentation de 10% du ratio des exportations de ressources naturelles (% du PIB) est associée à une baisse annuelle de 0,4 à 0,7%. Croissance

du PIB par habitant. Dans des études récentes, les chercheurs ont appliqué des données de panel plutôt qu'une approche transversale pour éviter le problème du biais des variables omises.

En ce qui concerne les études empiriques à l'appui de l'hypothèse de la maladie hollandaise, les premières preuves montrant la contraction du secteur manufacturier en raison de l'appréciation du taux de change ont été quelque peu mitigées (SALA-I-MARTIN et SUBRAMANIAN, 2013). Cependant, des travaux empiriques plus récents semblent étayer cette hypothèse. De plus amples données pour 135 pays pour la période 1975-2007 montrent qu'un revenu des ressources induit des économies d'environ 30%, réduit les exportations hors ressources de 35 à 70% et augmente les importations de produits autres que les ressources de 0 à 35% (HARDING et VENABLES, 2010). En utilisant les données annuelles de 81 secteurs manufacturiers dans 90 pays sur la période 1977-2004, ISMAIL, 2010 a avancé qu'une augmentation de 10% du prix du pétrole ralentissait, en moyenne, le taux de croissance manufacturière de 3.4%. En outre, il montre que cet effet négatif est plus fort dans les pays qui ont un marché des capitaux plus ouvert aux investissements étrangers et également dans les secteurs moins capitalistiques. Conformément aux travaux précédents, une étude récente portant sur 41 pays exportateurs de ressources sur la période 1970-2006 montre que le mouvement des prix est négativement corrélé à la valeur ajoutée manufacturière (HARDING et VENABLES, 2016). De plus, parmi quelques études limitées qui ont systématiquement étudié l'hypothèse de la maladie hollandaise, les données de 6 économies sélectionnées d'Asie du Sud-Est sur la période 1981-2007 confirment qu'un afflux d'aide étrangère conduit à une appréciation du taux de change réel, une contraction de le secteur manufacturier et une expansion du secteur des services (JAVAID et RIAZUDDIN, 2009).

Une autre explication possible qui a retenu davantage l'attention ces dernières années est l'effet destructeur de la volatilité des prix des matières premières sur les performances économiques. Au cours des années 70, lorsque les prix des produits de base étaient élevés, les pays riches en ressources utilisaient leur richesse en ressources comme garantie de leur dette, mais pendant les années 80, lorsque les prix des produits de base ont chuté de manière significative, nombre de ces pays ont été confrontés à des crises de la dette (VAN DER PLOEG et POELHEKKE, 2009). Ils soulignent en outre que les cycles d'expansion-récession induits par la volatilité des prix des matières premières, le surendettement et les contraintes de crédit sont les principaux moteurs du lien entre la rente des ressources et la croissance des ressources. En utilisant des données transnationales pour 62 pays, ils ont constaté que l'effet négatif des ressources sur la croissance est principalement dû à la volatilité des prix des produits de base, en particulier pour les ressources ponctuelles (pétrole, diamants), de sorte que l'effet négatif indirect des ressources sur la croissance de la volatilité érode tout effet positif direct des ressources sur la croissance. En outre, une partie de la littérature indique que la volatilité des prix des ressources due à l'instabilité des recettes publiques peut conduire à un boom et à un ralentissement des dépenses

publiques et ainsi saper les performances économiques (HAUSMANN et RIGOBON, 2003; EL-ANSHASY, MOHADDES et NUGENT, 2017). Dans le même ordre d'idées, AGHION et al., 2009 suggèrent que l'effet négatif de la volatilité sur la croissance économique est plus intense dans les pays dont le système financier est moins développé.

0.2.2 Problèmes politico-économiques

La deuxième explication durable de la malédiction des ressources suit les perspectives politiques et économiques. MEHLUM, MOENE et TORVIK, 2006a fournissent un cadre de recherche de rente et soutiennent qu'une institution favorable aux producteurs fait que les bénéfices des entrepreneurs sont plus importants que ceux des demandeurs de rente et incite ainsi les entrepreneurs à s'engager dans des activités productives. Par conséquent, les ressources naturelles ont tendance à faire grimper le revenu global dans les pays dotés d'institutions favorables aux producteurs. En revanche, une institution favorable aux accapareurs augmente les activités telles que la recherche de rente et réduit ainsi la tendance des entrepreneurs à s'engager dans des activités productives. Par conséquent, les ressources naturelles ont tendance à faire baisser le revenu global dans les pays dotés d'institutions favorables aux accapareurs. La qualité des institutions peut expliquer la performance des pays riches en ressources. La Norvège, le Canada, l'Australie, la Nouvelle-Zélande, l'Islande et les États-Unis sont des exemples de pays dotés d'institutions solides au moment de la découverte de leurs ressources. Alors que les pays avec des institutions faibles en place au moment de la découverte de leurs ressources sont l'Angola, le Nigéria, le Soudan, la Sierra Leone, le Libéria, le Congo et le Venezuela (ACEMOGLU, JOHNSON et ROBINSON, 2002). Dans un modèle simple de recherche de rente, TORVIK, 2002 montre que plus il y a de ressources naturelles, plus le nombre d'entrepreneurs en recherche de rente est élevé et plus le nombre d'entrepreneurs dans les entreprises productives est faible. Cela conduit donc à une baisse des revenus telle que l'augmentation des revenus de la ressource naturelle ne peut pas les compenser.

L'étude pionnière sur les données empiriques transnationales montre que la qualité des établissements n'a aucun effet sur le taux de croissance (J. D. SACHS et WARNER, 1995). Cependant, MEHLUM, MOENE et TORVIK, 2006b démontrent qu'une rente des ressources naturelles ralentit la croissance des pays dotés de mauvaises institutions et accélère la croissance des pays dotés de bonnes institutions. Des données internationales connexes suggèrent fortement que les ressources naturelles ont atteint le taux de croissance d'une économie en affaiblissant les institutions à l'intérieur de l'économie (SALA-I-MARTIN et SUBRAMANIAN, 2013). En outre, ISHAM et al., 2002 classent deux types de ressources naturelles : les ressources diffuses (plantations comme le café, le cacao, le riz) et les ressources ponctuelles (les minéraux comme le pétrole, le gaz, le charbon). La première catégorie est exploitée par plus de personnes, tandis que la seconde catégorie est détenue par quelques

propriétaires. Ils concluent que les pays fortement dépendants des ressources ponctuelles (pétrole) ont des institutions pires qui, à leur tour, conduisent à un PIB par habitant inférieur de près de 33% par rapport aux pays dotés de meilleures institutions, 25 ans après le choc pétrolier du début des années 1970s. Dans le même ordre d'idées, MAVROTAS, Syed Mansoob MURSHED et TORRES, 2011 étudient ce lien pour 56 pays en développement sur la période 1970-2000 et démontrent que les ressources ponctuelles influencent négativement les institutions et entravent ainsi la croissance.

Il y a, en outre, des preuves que la dépendance aux ressources est associée à un niveau de corruption pire qui, à son tour, est associé à une croissance plus faible (MAURO, 1995). LEITE et WEIDMANN, 1999 ont été parmi les premiers à illustrer les interrelations entre les ressources naturelles, la corruption et la croissance économique. Ils ont développé un modèle de croissance d'économie ouverte dans lequel la corruption agit comme un pot-de-vin versé par l'entreprise à l'employé du gouvernement pour obtenir l'approbation administrative des projets d'investissement. Le modèle étayé par des données transnationales pour 72 pays a montré que la corruption ralentit la croissance et que cet effet négatif est plus prononcé dans les économies moins développées. Entre autres, KHAN, 1994, SHAXSON, 2007, et VICENTE, 2010 dans une étude de cas sur le Nigeria, le golfe de Guinée et Sao Tomé-et-Principe, respectivement, confirment que les revenus pétroliers sont associés à des niveaux plus élevés de corruption. Plus de preuves sur la relation entre la corruption et la dépendance aux ressources sont présentées par BHATTACHARYYA et HODLER, 2010. Dans des témoignages de panel pour 99 pays sur la période 1980-2004, ils suggèrent que les ressources naturelles ne résultent de la corruption que dans les pays où ont eu un régime non démocratique pendant plus de 60% des années depuis 1956.

La littérature contient également des études visant à révéler la relation entre les rentes des ressources et les régimes politiques. Les preuves montrent qu'il existe une relation positive entre les régimes autoritaires et une économie dépendante de la rente des ressources (ROSS, 2004a; ROSS, 2004b). À l'exception des pays riches en ressources du Moyen-Orient, la plupart des pays non démocratiques se sont progressivement dirigés vers un système démocratique depuis les années 1970s (HUNTINGTON, 1993). Ce schéma s'observe également en Russie et dans les pays africains. Une explication possible est que la rente des ressources permet aux dictateurs d'acheter leurs rivaux politiques et ralentit donc le chemin vers la démocratie (ACEMOGLU, VERDIER et ROBINSON, 2004). Cette relation négative entre démocratie et économies dépendantes de la rente des ressources naturelles ne signifie pas nécessairement que les rentes des ressources entravent la croissance économique. (FRANKEL, 2010). COLLIER et HOFFLER, 2005 montrent qu'une démocratie faible dans les pays en développement peut conduire à des freins et contrepoids et donc nuire aux performances de l'économie. Dans la même lignée, en utilisant un échantillon cross-country de 90 pays, ANDERSEN et ASLAKSEN, 2008 constatent que la malédiction des ressources se produit dans les démocraties présidentielles et non parlementaires. Ils montrent que les systèmes

présidentiels sont moins responsables et moins représentatifs et sont donc susceptibles de fournir plus de possibilités pour les activités de recherche de rente, tandis que les systèmes parlementaires se sont avérés plus efficaces dans l'utilisation des revenus des ressources naturelles pour promouvoir la croissance.

0.3 But de l'étude

Bien que la littérature ait approfondi notre compréhension des déterminants de la performance économique des pays dépendants des ressources naturelles, de nombreuses questions restent sans réponse. Par conséquent, cette étude cherche à répondre à trois questions spécifiques suivantes :

- a) L'hypothèse de la maladie hollandaise répond-elle aux preuves empiriques et vice versa ?
- b) Le lien entre inégalités de revenu et croissance modifie-t-il la vision standard de l'hypothèse de la maladie hollandaise ?
- c) La malédiction des ressources naturelles est-elle plus intense dans les pays où la capacité d'absorption est plus limitée ?

Les sous-sections suivantes présentent plus en détail la contribution, la méthodologie et les résultats de chaque chapitre.

0.3.1 Chapitre 2 : La maladie hollandaise revisitée : théorie et preuves

Ce chapitre vise à revoir l'hypothèse de la maladie hollandaise en termes de théorie et de preuves empiriques. La littérature révèle, d'une part, qu'il existe plusieurs limites dans les théories antérieures présentées pour décrire l'hypothèse de la maladie hollandaise. Contrairement aux preuves empiriques, les modèles, tirés par Learning By Doing (*LBD*), prédisent qu'un boom des ressources tend à déprécier le taux de change réel en régime permanent et n'a aucun effet sur le taux de croissance économique à long terme. En revanche, une moindre attention a été accordée à l'analyse systématique des symptômes de la maladie hollandaise. Ces symptômes sont 1) une appréciation du taux de change réel due à un boom des ressources, et 2) une réponse asymétrique du taux de croissance des secteurs à l'appréciation du taux de change réel. Par conséquent, la première contribution de cette étude est de réviser le modèle influent de sorte à ce que ses prédictions répondent aux preuves empiriques. En outre, la deuxième contribution est de trouver un lien direct entre le boom de la rente des ressources et le taux de change réel, puis de fournir une évaluation claire de la réaction du niveau de production relatif, de la croissance sectorielle et de la croissance économique à l'appréciation du taux de change réel.

Pour atteindre les objectifs, j'ai d'abord développé un modèle à deux secteurs basé sur l'approche *LBD*. La productivité est générée à la fois dans le secteur manufacturier et

dans le secteur des services, alors qu'il y a des retombées imparfaites entre le secteur manufacturier et le secteur des services. Contrairement au modèle de TORVIK, 2001, je suppose qu'il y a un retombée technologique du secteur des ressources au secteur manufacturier. Le modèle décrit le mécanisme standard de la maladie hollandaise, le même que celui de TORVIK, 2001. Mais il montre qu'un boom des ressources apprécie conditionnellement le taux de change réel et ralentit le taux de croissance de l'économie et des deux secteurs sur le long terme, contrairement à TORVIK, 2001.

Je recueille ensuite un ensemble de données de panel déséquilibré de 132 pays de la période 1970 à 2014. En utilisant la technique de la méthode généralisée des moments (*GMM*), j'adopte une procédure d'estimation dynamique pour éviter le problème d'autocorrélation et le problème de causalité inverse entre les variables d'intérêt (problème d'endogénéité). Les symptômes de la maladie hollandaise sont étudiés en quatre étapes : 1) la réponse du taux de change réel au proxy de la dépendance aux ressources et l'impact de l'appréciation du taux de change réel, respectivement, sur 2) la productivité relative du secteur manufacturier du secteur (échangé) au secteur des services (non échangés), 3) taux de croissance du PIB sectoriel par habitant, 4) taux de croissance économique.

Les résultats empiriques, pris ensemble, ne contredisent pas le modèle présenté de l'hypothèse de la maladie hollandaise. Les principaux résultats peuvent être résumés en trois points. Premièrement, la stratégie empirique suggère un effet positif fort et statiquement significatif sur le taux de change réel d'un boom des ressources naturelles. Deuxièmement, l'appréciation du taux de change réel ralentit le taux de croissance dans les deux secteurs, de sorte que la contraction est plus importante dans le secteur manufacturier que dans le secteur des services. En conséquence, le niveau de production relatif du secteur manufacturier par rapport au secteur des services diminue et la croissance économique ralentit. Troisièmement, ces effets sont plus intenses dans les pays riches en ressources que dans les pays pauvres en ressources.

0.3.2 Chapitre 3 : Les inégalités de revenus alimentent-elles la maladie hollandaise ?

Le deuxième chapitre a pour objectif de savoir comment l'impact d'un boom des ressources sur le lien entre inégalités de revenu et croissance modifie la vision standard de la maladie hollandaise. La littérature montre que deux questions qui ont attiré de plus en plus l'attention des chercheurs sont l'impact des revenus exceptionnels sur la croissance économique et l'inégalité des revenus. Étonnamment, ces variables d'intérêt ont été étudiées isolément les unes des autres et peu d'attention a été accordée à l'étude de ces variables dans un cadre unifié. En outre, ils révèlent que la croissance économique et les inégalités de revenus sont des variables endogènes et que leurs co-mouvements affectent les forces économiques sous-jacentes auxquelles ils répondent tous les deux (TURNOVSKY, 2011). A partir de cette

prospective, ces variables d'intérêt doivent être étudiées simultanément car leur relation semble être associative et non causale (EHRlich et J. KIM, 2007). Par conséquent, la principale contribution de cet article est d'analyser comment les inégalités de revenus réagissent à un boom des ressources naturelles et comment une combinaison d'inégalités de revenus et de rentes des ressources motive l'intensité de la maladie hollandaise.

En théorie, je développe un modèle de croissance à deux secteurs dans lequel chaque secteur emploie des travailleurs qualifiés et non qualifiés. Les groupes de travailleurs attribuent différentes parts de dépenses de consommation aux biens échangés et non échangés. L'écart dans les parts des dépenses reflète la rétroaction d'un changement de l'inégalité des revenus sur la croissance économique. J'ai analysé le modèle à court terme sous une statique comparative et à long terme sous une approche dynamique pilotée par un modèle (*LBD*) d'apprentissage par la pratique.

Le modèle produit un certain nombre de résultats théoriques. Dans l'étude à court terme, une hausse permanente des revenus exceptionnels conduit respectivement à une appréciation du taux de change réel, à une réallocation des facteurs de production, à une contraction du secteur échangé et à une décélération de la croissance économique. Soit dit en passant, un changement dans les inégalités dépend de l'intensité des facteurs et de la répartition des avantages de la rente des ressources (subventions) entre les groupes de travailleurs. Les inégalités de revenus diminuent si le secteur commercial est relativement intensif en travailleurs qualifiés et si les avantages de la rente des ressources sont répartis de manière plus égale que le salaire réel entre les groupes de travailleurs. Dans l'étude à long terme, un changement de l'inégalité des revenus n'est dû qu'à un boom des ressources. En réponse à une forte hausse des revenus, l'inégalité des revenus diminue (augmente) si l'avantage relatif de la rente des ressources des travailleurs qualifiés est inférieur (supérieur) au salaire réel relatif. En outre, la baisse des inégalités de revenus aggrave la maladie hollandaise si les travailleurs qualifiés, par rapport aux travailleurs non qualifiés, allouent une part de dépenses plus importante aux biens échangés.

Conformément à la théorie, je mène une étude sur données de panel pour évaluer les prédictions théoriques. À cet égard, je collecte d'abord les données pour 79 pays sur la période 1975-2014, puis j'applique les approches GMM différenciées en premier et le système pour estimer les régressions dynamiques des données de panel. L'impact d'un boom des ressources naturelles sur le taux de change réel, puis la réponse de l'inégalité des revenus à une modification du revenu exceptionnel sont examinés. De plus, j'évalue l'effet de l'interaction entre un boom des ressources naturelles et l'inégalité des revenus sur l'intensité de la maladie hollandaise ainsi que sur le taux de croissance sectorielle. Ces études empiriques représentent des preuves claires à l'appui du rôle crucial de l'inégalité des revenus dans la performance économique des pays tributaires des ressources. Un boom des ressources naturelles réduit les inégalités de revenus et la baisse des inégalités de revenus est associée à une malédiction plus intense des ressources naturelles.

0.3.3 Chapitre 4 : Capacité d'absorption et malédiction des ressources naturelles

Le troisième chapitre cherche à présenter une réponse à la question de savoir comment les contraintes de capacité d'absorption dues à une pénurie de capitaux non échangés tels que le capital humain public et les infrastructures induisent l'intensité de la malédiction des ressources naturelles (l'effet néfaste d'un boom des ressources sur la performance économique). Les faits stylisés montrent que la malédiction des ressources naturelles s'accompagne d'un niveau inférieur de capital humain et de proxys d'infrastructure. En outre, certains types de biens d'équipement (tels que les infrastructures et le capital humain) ne peuvent pas être importés ou exportés et ils doivent être produits dans le pays, ce qui à son tour a besoin de biens d'équipement "cultivés sur place" pour fonctionner (par exemple, les routes doivent étendre les routes, les enseignants à former plus d'enseignants) (c'est-à-dire contrainte de capacité d'absorption). Par conséquent, la principale contribution de cet article est de témoigner et de clarifier l'hypothèse suivante : la malédiction des ressources naturelles est plus intense dans les pays avec plus de contraintes de capacité d'absorption (ou un niveau de biens d'équipement plus faible).

À cet égard, je présente une étude empirique. Je collecte tout d'abord des données pour 105 pays sur la période 1975-2014. Ensuite, deux indices sont construits pour identifier la capacité d'absorption transnationale (biens d'équipement) : 1) l'indice d'infrastructure, la moyenne de l'indice d'électricité normalisé et de l'indice téléphonique normalisé, et 2) l'indice d'absorption, la moyenne de l'indice de capital humain normalisé et indice d'infrastructure normalisé. En utilisant la technique $IV - 2SLS$, des preuves claires à l'appui de l'hypothèse proposée sont fondées.

De plus, motivé par VAN DER PLOEG et VENABLES, 2013, je développe un cadre simple à deux secteurs dans lequel les biens d'équipement non échangés ne sont employés que par le secteur non marchand. Cette structure capture de manière simple les caractéristiques d'une économie dans laquelle le secteur non négocié est contraint par des contraintes d'absorption. À court terme, un boom permanent des ressources conduit à une appréciation temporaire du taux de change réel et entraîne ainsi la malédiction des ressources naturelles (déindustrialisation). Alors qu'à long terme, une expansion progressive des biens d'équipement annule l'appréciation temporaire du taux de change réel et ainsi la malédiction des ressources naturelles s'atténue tant que l'écart entre l'offre et la demande du secteur non marchand disparaît. Le modèle précise également qu'une capacité d'absorption moindre (ou un niveau plus bas de biens d'équipement) augmente l'intensité de la malédiction des ressources naturelles. En outre, le modèle montre que l'intensité devient plus forte si le développement réduit le coût de financement de la production de biens d'équipement et augmente la part de consommation des biens non échangés.

Chapter 1

Introduction – English version

The paradox of plenty, or “resource curse” has gained increasing currency in recent 30 years. The term was first used by the economic geographer Richard Auty in 1993 (Auty, Auty, and Mikesell, 1998). The key question of resource curse syndrome is why natural resource-dependent countries have usually failed to show better economic performance than others. In practice, the paradox addresses why resource-rich economies such as Botswana or Norway are more successful while Sierra Leone dropped at an average rate of 37% between 1971 and 1989 (Humphreys, J. Sachs, and Stiglitz, 2007) and the income per capita in Nigeria has stagnated over forty years (Sala-i-Martin and Subramanian, 2013). To shed light on the paradox of plenty, we first present in section 1 the relevant stylized facts and then put forward in section 2 the main hypotheses and empirical evidences. We finally offer in section 3 the purpose of the study and present in more detail the contribution, the methodology, and the results of each chapter.

1.1 The stylized facts of the resource curse

Although some countries have well harnessed their resource wealth to expand their economies faster, most of them have experienced bad macroeconomic performance. A useful starting point for clarification of this subject is to discuss a well-known example of countries where have failed to benefit from their wealth and another where has benefited. The most dramatic example of the first group of countries is perhaps Nigeria (Sala-i-Martin and Subramanian, 2013). Although oil revenues per capita in Nigeria had increased 10 times over the period 1965-2000, income per capita had stagnated (around 1100 \$ in PPP terms) since 1960. It made the population share of people who survived by 1\$ per day shoot up 2.7 times during 1970-2000. Evidence shows that the top 2% had the same share of income as the bottom 17% in 1970, while they had the same share as the bottom 55% in 2000 (Sala-i-Martin and Subramanian, 2013). Recent evidence demonstrates that the real GDP per capita growth rate in Nigeria has dropped at an average of 4% between 1965

and 2000 (source PWT90). Further, two-thirds of capacity utilization in manufacturing which is often owned by the government and had a principal role in creating new job opportunities goes to waste. These suggest clearly that the middle and low-income classes of Nigerian have not benefited from revenues resulting from oil export (Van der Ploeg, 2011b).

Others discuss examples of countries having positive experiences. 40% of Botswana's GDP results from diamonds, but Botswana has succeeded to protect its economy from the resource curse (Van der Ploeg, 2011b). The second rank country in public expenditure on education (% of GNP) made Botswana enjoy the world's highest growth rate (Sarraff and Jiwanji, 2001) and income per capita increase about 20 times (from 467\$ to 9228\$ in PPP terms) on average of 8.5% during the period of 1965-2000 (source PWT90). Botswana's well economic performance seems to explain why its real GDP per capita which was one-tenth that of Nigeria in 1965 overtook during this period so that it became about ten times that of Nigeria in 2000 (source PWT90). The Botswana experience is noteworthy since it started its post-colonial experience with minimal investment (Van der Ploeg, 2011b). Nevertheless, evidence shows that the real capital stock per capita had accumulated on average 6% annually during the period (source PWT90).

1.2 The explanations of the natural resource curse

The stylized-facts, discussed in section 1, seem to clarify why the question that the natural resource is a curse or blessing for economic performance has still remained controversial. Here we represent the main hypothesis and evidence about the effect of resource windfall income on economic performance. We first put forward the Dutch disease hypothesis and then the effect of volatility in commodity price on economic performance to illustrate the economic reasons behind the resource curse. Then, we address the political-economics issues to see to what extent the quality of the institution, corruption, and political structure influence the nexus between resource dependence and economic performance.

1.2.1 Economics issues

The first enduring explanations for the resource curse refers to the Dutch disease hypothesis. The term of the Dutch disease was originally named in 1977 by *The Economist* to describe the unfavorable repercussions of natural gas discoveries in the late 1950s on the Dutch manufacturing sector. The idea behind the hypothesis is that The windfall income generated by the sale of the natural resource wealth, through an appreciation in the real exchange rate, decreases the competitiveness of the traded sector (Corden and Neary, 1982). We can demonstrated this with a small open economy model in a Salter-Swan framework, as in M. Nkusu, 2004. Let us assume the following statements hold. 1) There

are two sectors: the traded (e.g. manufacturing and agricultural sectors) and non-traded (e.g. non-traded services and construction) sectors, 2) There are no asset and capital accumulation and the labor force (i.e. Human capital) is only production factor, 3) The labor force is normalized to unity to expel the population growth, 4) The labor force is fully employed by sectors and they can move freely across sectors, 5) There are decreasing returns to labor in each sector, 6) Agents have an identical taste and there is perfectly elastic demand for traded goods, 7) The windfall income (resource boom) is a constant exogenous gift over time.

The literature on the dutch disease highlights two different effects. The first one is the spending effect. Resource boom brings about an expansion in the total income of the economy and so increases the demand for both traded and non-traded goods. Since the excess supply for traded goods can be provided by the world market, the price of traded goods is exogenously constant and so the demand is perfectly elastic. However, the domestic supply can not confront the expanded demand for non-traded goods and this drives the relative price of non-traded to traded goods, defined as the real exchange rate, to appreciate. The second one called the resource movement effect suggests that relative price appreciation increases the real wage of the labor force working in the non-trade sector, with respect to those working in the traded sector. It makes a signal for the labor force to shift away from the traded sector and into the non-traded sector. Consequently, the traded sector shrinks and the non-traded sector expands.

For longer run effects one must include capital in the framework. In the Heckscher-Ohlin model with two goods, two sectors, two factors (i.e. capital and labor) and constant returns to scale in the production functions, the real exchange rate appreciation resulting from a resource windfall income increases the demand of factor used intensively in the non-traded sector relative to another factor. This, in turn, increases the relative factor price (Stolper and Samuelson, 1941). In any case, the reallocation of factors, shifting away from the traded sector and into the non-traded sector, causes the non-traded sector to expand and the traded sector to contract.

Later on, researchers challenged this strand of the literature and put forward that the traded sector is the engine of growth. Further, evidence supports that the traded sector benefits more from learning by doing in the long-term (Ulku, 2004). Hence, the non-resource traded sector hit by worsening competitiveness is more likely to not fully recovered once the resource income runs out (Van der Ploeg, 2011b). As an initial attempt, Van Wijnbergen, 1984 studied a two-period and two-sector model in which future productivity in the traded sector depends increasingly on the current production of the traded sector. Later on, by an assumption that only labor employment in the traded sector contributes in generation of learning, Krugman, 1987 proposed a model of increasing returns to scale in the traded sector. While J. D. Sachs and Warner, 1995 and Gylfason, Herbertsson, and Zoega, 1999 made an assumption that learning generated by labor employment in the traded sector

spills over perfectly to the non-traded sector. These later models clarify that the learning process induces the endogenous growth in both sectors: a natural resource boom reduces labor employment share in the traded sector, hampers learning by doing (*LBD*) and thus decelerates economic growth. In recent literature, Torvik, 2001 presents a general model in which both sectors can contribute to the learning process and there are imperfect learning spillovers between sectors. He demonstrates that within such a model a resource boom tends to depreciate the steady-state real exchange rate, while the steady-state economic growth is independent of a resource boom and the sectoral productivity growth depends on which one of the direct or the spillover effect is stronger. Bjørnland and Thorsrud, 2016 put forward Torvik, 2001 model so that the productivity spillovers between the booming resource sector and other domestic sectors. They show that a booming resource sector leads to the real exchange rate depreciation over the transition path and increasing the rate of growth in the economy and in both sectors, contrary to standard Dutch disease models.

The influential works by J. D. Sachs and Warner, 1995; J. D. Sachs and Warner, 2001 and Rodriguez and J. D. Sachs, 1999 are representatives of a stream of empirical literature showing that natural resource dependence decelerates economic growth. In particular, in a cross-section of countries during 1970–90 J. D. Sachs and Warner, 2001 show that a 10 % increase in the ratio of natural resource exports (% of GDP) is associated with as much as 0.4–0.7 % lower annual GDP per capita growth. In recent studies, researchers have applied panel data rather than cross-section approach to avoid the problem of omitted variables bias.

Regarding the empirical studies in supporting the Dutch disease hypothesis, the early evidence to show the contraction of the manufacturing sector because of the exchange rate appreciation has been somewhat mixed (Sala-i-Martin and Subramanian, 2013). However, more recent empirical work seems to support the hypothesis. More evidence for 135 countries for the period 1975-2007 shows that a resource windfall income induces savings of about 30 %, shrinks non-resource exports by 35-70 %, and expands non-resource imports by 0-35 % (Harding and Venables, 2010). Using annual data for 81 manufacturing sectors in 90 countries over the period 1977-2004, Ismail, 2010 put forward that a 10 % increase in oil price slows down, on average, the manufacturing growth rate by 3.4 %. Further, it shows that this negative effect is stronger in countries that have a more open capital market to foreign investment and also sectors that are less capital intensive. Consistent with the former work, a recent study for 41 resource exporter countries over the period 1970-2006 shows that price movement is negatively correlated with the manufacturing value-added (Harding and Venables, 2016). Further, among a few limited studies that have systematically studied the Dutch disease hypothesis, evidence for 6 selected South-East Asian economies over the period 1981-2007 confirms that a foreign aid inflows leads to an appreciation in the real exchange rate, a contraction in the manufacturing sector and an

expansion in the service sector (Javaid and Riazuddin, 2009).

Other possible explanation that has absorbed more attention in recent years is the destructive effect of volatility in commodity price on economic performance. During the 1970s when commodity prices were high, resource-rich countries used their resource wealth as collateral for debt but during the 1980s when commodity prices fell significantly, many of those countries faced debt crises (Van der Ploeg and Poelhekke, 2009). They further point out that boom-bust cycles induced by volatile commodity prices, debt overhang, and credit constraints are the main driving forces of the resource rent-growth nexus. Using cross-country evidence for 62 countries, they found that the adverse effect of resources on growth is mainly driven by the volatility of commodity prices, especially for point-based resources (oil, diamonds), such that the indirect negative effect of resources on growth resulting from volatility erodes any direct positive effect of resources on growth. Furthermore, a strand of the literature indicates that volatility in resource price through instability in government revenue may lead to boom and bust in public spending and thus undermines economic performance (Hausmann and Rigobon, 2003; El-Anshasy, Mohaddes, and Nugent, 2017). In the same vein, Aghion et al., 2009 suggests that the adverse effect of volatility on economic growth is more intense in countries with less developed financial system.

1.2.2 Political-economics issues

The second enduring explanations for the resource curse follows political economic perspectives. Mehlum, Moene, and Torvik, 2006a provide a rent-seeking framework and argue that a producer-friendly institution makes the profits of entrepreneurs be larger than that of rent-seekers and so gives entrepreneurs the incentive to engage in productive activities. Hence, natural resources tend to push aggregate income up in countries with producer-friendly institutions. In contrast, a grabber-friendly institution makes activities such as rent-seeking increase and so reduces the tendency of entrepreneurs to engage in productive activities. Hence, natural resources tend to push aggregate income down in countries with grabber-friendly institutions. Institution quality may explain the performance of resource-rich countries. Examples of countries with strong institutions in place at the time of their resource discovery are Norway, Canada, Australia, New Zealand, Iceland, and US. While countries with weak institutions in place at the time of their resource discovery are Angola, Nigeria, Sudan, Sierra Leone, Liberia, Congo, and Venezuela (Acemoglu, Johnson, and Robinson, 2002). In a simple rent-seeking model, Torvik, 2002 shows that the greater amount of natural resources, the more the number of entrepreneurs in rent-seeking and the lower the number of entrepreneurs in productive firms. This thus leads to falling the income such that the increase in income from the natural resource can not offset it.

The pioneering study on the empirical cross-country evidence shows that institution quality

1.2. THE EXPLANATIONS OF THE NATURAL RESOURCE CURSE

does not have any effect on the growth rate (J. D. Sachs and Warner, 1995). However, Mehlum, Moene, and Torvik, 2006b demonstrates that a natural resource rent decelerates the growth of countries with bad institutions and accelerates the growth of countries with good institutions. Related cross-country evidence strongly suggests that natural resources hit the rate of growth in an economy by weakening the institutions inside the economy (Sala-i-Martin and Subramanian, 2013). Further, Isham et al., 2002 categorize two types of natural resources: diffuse resources (plantations such as coffee, cocoa, rice) and point-source resources (minerals such as oil, gas, coal). The former category is exploited by more people, while the latter type is held by a few owners. They conclude that countries with heavy dependence on point-source resources (oil) have worse institutions which, in turn, leads to having almost 33 % lower GDP per capita relative to countries with better institutions, 25 years after the oil shock of the early 1970s. In the same vein, Mavrotas, Syed Mansoob Murshed, and Torres, 2011 investigate this nexus for 56 developing countries over the period 1970–2000 and demonstrate that point-source resources influence negatively institutions and thus hampers growth.

There is, further, evidence that resource dependence is associated with a worse corruption level which, in turn, is associated with lower growth (Mauro, 1995). Leite and Weidmann, 1999 were among the first to illustrate the interrelationships between natural resources, corruption, and economic growth. They developed an open economy growth model in which corruption acts like a bribe paid by the firm to the government employee to get the administrative approval of investment projects. The model supported by cross-country evidence for 72 countries elicited that corruption decelerates growth and this negative effect is more pronounced in less developed economies. Among others, Khan, 1994, Shaxson, 2007, and Vicente, 2010 in a case study on Nigeria, The Gulf of Guinea, and Sao Tome and Principe, respectively, confirm that oil revenues are associated with higher levels of corruption. More evidence on the relationship between corruption and resource dependence is presented by Bhattacharyya and Hodler, 2010. In panel evidence for 99 countries over the period 1980-2004, they suggest that natural resources only arise corruption in countries where have had a non-democratic regime for more than 60% of the years since 1956.

The literature also contains studies seeking to reveal the relationship between resource rents and political regimes. Evidence shows that there is a positive relationship between authoritarian regimes and economic dependence on resource rent (Ross, 2004a; Ross, 2004b). Except for resource-rich countries in the Middle East, most of the non-democratic countries went gradually toward a democratic system since the 1970s (Huntington, 1993). This pattern observes also in Russia and African countries. One possible explanation is that the resource rent allows dictators to buy off political rivals and therefore makes the path toward democracy slow down (Acemoglu, Verdier, and Robinson, 2004). This negative relationship between democracy and dependency of economies on natural resources does not necessarily mean that resource rents hinder economic growth (Frankel, 2010). Collier

and Hoeffler, 2005 show that weak democracy in developing countries can lead to poor checks and balances and therefore can hamper the economy's performance. In the same vein, using a cross-country sample of 90 countries, Andersen and Aslaksen, 2008 find that the resource curse occurs in presidential, not parliamentary democracies. They show that presidential systems are less accountable and less representative and hence it is likely to provide more scope for rent-seeking activities, while parliamentary systems have shown to be more efficient in using natural resource revenues to promote growth.

1.3 Purpose of the study

Although the literature has deepened our understanding of the determinants in the economic performance of natural resource-dependence countries, many unanswered questions have still remained. Hence, this study seeks response to three specific following questions:

- a) Does the Dutch disease hypothesis meet the empirical evidence and vice versa?
- b) Does the income inequality-growth nexus modify the standard view on the Dutch disease hypothesis?
- c) Is the natural resource curse more intensive in countries with more absorption capacity constraints?

The next subsections present in more detail the contribution, the methodology, and the results of each chapter.

1.3.1 Chapter 2: The Dutch Disease Revisited: Theory and Evidence

This chapter aims to revisit the Dutch disease hypothesis in terms of theory and empirical evidence. Literature reveals, on the one hand, there are several limitations in the earlier theories presented to describe the Dutch disease hypothesis. Contrary to the empirical evidence, models, driven by Learning By Doing (*LBD*), predict that a resource boom tends to depreciate the steady-state real exchange rate and has no effect on the rate of economic growth in the long-term. On the other hand, less attention has been paid to systematically analyze the symptoms of Dutch disease. These symptoms are 1) an appreciation in the real exchange rate due to a resource boom, and 2) asymmetric response of the rate of growth in the sectors to the real exchange rate appreciation. Hence, the first contribution of this study is to revise the influential model such that its predictions meet the empirical evidence. In addition, the second contribution is to find a direct nexus between booming resource rent and the real exchange rate and then to provide a clear assessment of the response of the relative output level, sectoral growth, and economic growth to the real exchange rate appreciation.

To address the objectives, I first develop a two-sector model driven by *LBD* approach.

The productivity is generated in both manufacturing and service sectors, while there are an imperfect spillover from the manufacturing to the service sector. Different from the model of Torvik, 2001, I assume that there is a technology spillover from the resource sector to the manufacturing sector. The model describes the standard Dutch disease mechanism, the same as Torvik, 2001. But it shows that a resource boom conditionally appreciates the real exchange rate and decelerates the rate of growth in the economy and in both sectors in the long-term, contrary to Torvik, 2001.

I then collect an unbalanced panel data set of 132 countries from the period 1970 to 2014. Using the Generalized Method of Moments (*GMM*) technique, I adopt a dynamic estimation procedure to avoid the autocorrelation problem and the problem of reverse causality between variables of interest (endogeneity problem). The symptoms of the Dutch disease is investigated in four stages: 1) the response of the real exchange rate to the resource-dependence proxy and the impact of the real exchange rate appreciation, respectively, on 2) the relative productivity of the manufacturing (traded) sector to the service (non-traded) sector, 3) sectoral GDP per capita growth rate, 4) economic growth rate.

The empirical results, taken together, do not contradict the presented model of the Dutch disease hypothesis. The main findings can be summarized in three points. First, the empirical strategy suggests a strong and statically significant positive effect on the real exchange rate from a natural resource boom. Second, the real exchange rate appreciation decelerates the rate of growth in both sectors such that the shrinkage is larger in the manufacturing sector than in the service sector. Accordingly, the relative output level of the manufacturing sector to the service sector diminishes and economic growth decelerates. Third, these effects are more intensive in resource-rich countries than resource-poor countries.

1.3.2 Chapter 3: Does income inequality feed the Dutch disease?

The second chapter aims to find out how the impact of a resource boom on the link between income inequality and growth changes the standard view of Dutch disease. Literature shows that two questions that have attracted increasing attention from researchers are the impact of windfall income on economic growth and income inequality. Surprisingly these variables of interest have been studied in isolation from each other and a little attention has been paid to study these variables in a unified framework. In addition, they reveals that economic growth and income inequality are endogenous variables and their co-movements affect the underlying economic forces to which they are both responding (Turnovsky, 2011). From this prospective, these variables of interest need to be simultaneously studied since their relationship seems to be associative and not causal (Ehrlich and J. Kim, 2007).

Therefore, the main contribution of this paper is to analyze how income inequality responds to a natural resource boom and how a combination of income inequality and resource rent motivates the intensity of the Dutch disease.

In theory, I develop a two-sector growth model in which each sector employs skilled and unskilled workers. Workers' groups allocate different consumption expenditure shares on traded and non-traded goods. The gap in expenditure shares captures the feedback of a change in income inequality on economic growth. I have analyzed the model in the short-run under a comparative static and in the long-run under a dynamic approach driven by learning-by-doing (*LBD*) model.

The model yields a number of theoretical findings. In the short-run study, a permanent rise in the windfall income leads respectively to an appreciation in the real exchange rate, a reallocation in the factor inputs, a shrinkage in the traded sector and a deceleration in economic growth. By the way, a change in inequality depends on the factor intensity and the distribution of the resource rent benefits (subsidies) between workers' groups. Income inequality falls if the traded sector is relatively intensive in skilled workers and the resource rent benefits are distributed more evenly than the real wage between workers' groups. In the long-run study, a change in income inequality is only driven by a resource boom. In response to a windfall income boom, income inequality falls (rises) if the relative resource rent benefit of skilled workers is smaller (larger) than the relative real wage. In addition, falling income inequality deepens the Dutch disease if the skilled workers, with respect to unskilled workers, allocate a larger expenditure share for traded goods.

Consistently with the theory, I lead a panel data study to evaluate the theoretical predictions. In this respect, I first collect the data for 79 countries over the period 1975-2014 and then apply the first-differenced and the system GMM approaches to estimate dynamic panel data regressions. The impact of a natural resource boom on the real exchange rate and then the response of income inequality to a change in the windfall income are examined. Further, I estimate the effect of interaction between a natural resource boom and income inequality on the intensity of the Dutch disease as well as the sectoral growth rate. These empirical studies represent some clear evidence in supporting the crucial role of income inequality in economic performance of the resource-dependent countries. A natural resource boom reduces income inequality and falling income inequality is associated with a more intensive natural resource curse.

1.3.3 Chapter 4: Absorption capacity and Natural Resource Curse

The third chapter seeks to present a response to the question of how the absorption capacity constraints due to a shortage in the non-traded capital such as the public human capital and the infrastructure induce the intensity of the natural resource curse (the

1.3. PURPOSE OF THE STUDY

adverse effect of a resource boom on economic performance). The stylized facts represent that the natural resource curse is accompanied by a lower level of human capital and infrastructure proxies. Further, some sorts of capital goods (such as infrastructure and human capital) can not be imported or exported and they must be domestically produced, which in turn needs domestically produced "home-grown" capital goods to function (e.g. roads need to extend roads, teachers to educate more teachers) (i.e. absorption capacity constraint). Therefore, the main contribution of this paper is to testify and clarify the following hypothesis: the natural resource curse is more intensive in countries with more absorption capacity constraints (or a lower level of capital goods).

In this respect, I present an empirical study. I firstly collect data for 105 countries over the period 1975-2014. Then, two indexes are constructed to identify cross-country absorption capacity (capital goods): 1) Infrastructure index, the average of normalized Electricity index and normalized Telephone index, and 2) Absorption index, the average of normalized Human Capital Index and normalized Infrastructure index. Using the *IV – 2SLS* technique, clear evidence in supporting the proposed hypothesis is founded. In addition, motivated by Van der Ploeg and Venables, 2013, I develop a simple two-sector framework in which non-traded capital goods are only employed by the non-traded sector. This structure captures in a simple way the features of an economy in which the non-traded sector is constrained by absorption constraints. In the short-term, a permanent resource boom leads to a temporary appreciation in the real exchange rate and thereby arising the natural resource curse (de-industrialization). While in the long-term, a gradual expansion of capital goods reverses the temporary appreciation in the real exchange rate and so the natural resource curse moderates as long as the gap between supply and demand sides of the non-traded sector vanishes. The model also clarifies that less absorption capacity (or lower level of capital goods) increases the intensity of the natural resource curse. Further, the model shows that the intensity becomes stronger if the development reduces the cost to finance the production of capital goods and increases the consumption share for non-traded goods.

Chapter 2

The Dutch Disease Revisited: Theory and Evidence

Contrary to empirical evidence, the Dutch disease hypothesis, driven by Learning By Doing (*LBD*), does not predict the steady-state real exchange rate appreciation and economic growth deceleration due to a resource boom. To do so, I first represent a simple model to fill the theory's gap, and then adopt a dynamic panel data approach for a sample of 132 countries over the period 1970-2014 to re-evaluate both symptoms of the hypothesis in systematic analysis. The main findings are threefold. First, a resource boom appreciates the real exchange rate. Second, the real exchange rate appreciation decelerates the rate of growth in both sectors such that the shrinkage is larger in the manufacturing sector than in the service sector. This, in turn, makes the relative output level of the manufacturing sector to the service sector be smaller and economic growth be slower. Third, these effects are more intensive in resource-rich countries than in resource-poor countries.

2.1 Introduction

Why do natural resources countries tend to grow slower than countries without?, Why did Sierra Leone drop at an average rate of 37 % between 1971 and 1989 (Humphreys, J. Sachs, and Stiglitz, 2007)? and why has the income per capita in Nigeria stagnated over forty years (Sala-i-Martin and Subramanian, 2013)? A conventional interpretation that has attracted more attention of researchers refers to the Dutch disease hypothesis. The term of the Dutch disease was originally named in 1977 by *The Economist* to describe the unfavorable repercussions of natural gas discoveries in the late 1950s on the Dutch manufacturing sector. The seminal work identified by Corden and Neary, 1982 was established based on a Salter-Swan framework to provide an explanation for the process of de-industrialization. The mechanism rests on two steps: 1) a resource boom appreciates the real exchange rate, and so 2) sectoral growth responds asymmetrically to the real exchange rate appreciation. It motivates us to make the question of whether there is strong empirical evidence to support the symptoms of the Dutch disease.

A useful starting point is to address the term “natural resources”. Over the past three decades, scholars have defined “natural resources” in dozens of ways. Natural resources are generally categorized in two classes of plantations (e.g. coffee, cocoa, rice) and minerals (e.g. oil, gas, coal). Adopting the terminology defined in Woolcock, Pritchett, and Isham, 2001, the former is called diffuse resources, while the latter is called point-source resources. Considering the type of natural resources, evidence shows that point-source resources are more valuable and provide a vulnerable influence on the economy. Hence, I only address point-source resources in this study¹ (hereafter, the term "natural resource" is used to reference this specific subset of resources).

To shed light on the key question of why resource countries have usually failed to show better economic performance than others, I first clarify the mechanism of the Dutch disease. This can be illustrated in a two-sector small open economy framework², as in M. Nkusu, 2004, in which the labor force is fully employed and can move freely across sectors. The literature on the Dutch disease highlights two different effects. The first one is the spending effect. Resource boom brings about an expansion in the total income of the economy and so increases the demand for both traded and non-traded goods. Whereas the price of traded goods is determined exogenously by the international market, the relative price of non-traded to traded goods must appreciate in order to confront the expanded demand for non-traded goods. The second one is called the resource movement effect. A

¹Furthermore, given that the empirical database for the resource rent, collected from the World Bank, refers total natural resources rents to the mineral endowments, I ignore the former class of the terminology (i.e. plantation) to keep the consistency between the theory and empirical studies.

²In the standard Dutch disease model proposed by Corden and Neary, 1982, there are three sectors: the booming sector, lagging sectors producing traded goods and the non-traded sector producing services goods.

relative price appreciation will increase the real wage of labor employment in the non-trade sector, with respect to those in the traded sector. It makes a signal for labor forces to shift away from the traded sector and into the non-traded sector. Consequently, the traded sector shrinks and the non-traded sector expands (i.e. de-industrialization).

Although the framework could describe the mechanism of the Dutch disease in a short to medium-term, it would be interesting and more realistic to investigate the long-term dynamic response of a resource-dependent economy to a permanent increase in a resource rent. Evidence supports that the traded sector benefits more from learning by doing in the long-term (Ulku, 2004). Hence, the non-resource traded sector hit by worsening competitiveness is more likely to not fully recovered once the resource income runs out (Van der Ploeg, 2011b). One can be demonstrated this using a Salter-Swan model in which productivity growth is driven by learning by doing (*LBD*). As an initial attempt, Van Wijnbergen, 1984 studied a two-period and two-sector model in which future productivity in the traded sector depends increasingly on the current production of the traded sector. Later on, by an assumption that only labor employment in the traded sector contributes in generation of learning, Krugman, 1987 proposed a model of increasing returns to scale in the traded sector. While J. D. Sachs and Warner, 1995 and Gylfason, Herbertsson, and Zoega, 1999 made an assumption that learning generated by labor employment in the traded sector spills over perfectly to the non-traded sector. These later models clarify that the learning process induces the endogenous growth in both sectors: a natural resource boom reduces labor employment share in the traded sector, hampers learning by doing (*LBD*) and thus decelerates economic growth. In recent literature, Torvik, 2001 presents a general model in which both sectors can contribute to the learning process and there are imperfect learning spillovers between sectors. He demonstrates that within such a model a resource boom tends to depreciate the steady-state real exchange rate, while the steady-state economic growth is independent of a resource boom and the sectoral productivity growth depends on which one of the direct or the spillover effect is stronger. Bjørnland and Thorsrud, 2016 put forward Torvik, 2001 model so that the productivity spillovers between the booming resource sector and other domestic sectors. They show that a booming resource sector leads to the real exchange rate depreciation over the transition path and increasing the rate of growth in the economy and in both sectors, contrary to standard Dutch disease models. To investigate the empirical relevance of the theory model, they apply a Bayesian Dynamic Factor Model (*BDFM*) for Australia and Norway as representative cases studies. Their results are twofold: (1) a resource boom has significant and positive productivity spillovers on non-resource sectors, and (2) there is a two-speed transmission phase so that the non-traded sector expands faster than the traded sector. The influential works by J. D. Sachs and Warner, 1995; J. D. Sachs and Warner, 2001 and Rodriguez and J. D. Sachs, 1999 are representatives of a stream of empirical literature

showing that natural resource dependence³ decelerates economic growth. In particular, in a cross-section of countries during 1970–90 J. D. Sachs and Warner, 2001 show that a 10 % increase in the ratio of natural resource exports (% of GDP) is associated with as much as 0.4–0.7 % lower annual GDP per capita growth. In recent studies, researchers have applied panel data rather than cross-section approach to avoid the problem of omitted variables bias. A group of these studies has found that a natural resource boom retards the institutional development and this, in turn, hampers economic growth (e.g. S Mansoob Murshed, 2004; Collier and Hoeffler, 2005; Mehlum, Moene, and Torvik, 2006b). Furthermore, a study by Manzano and Rigobon, 2001 dismisses the curse once one controls for fixed effects in panel data estimation. Using annual data for 81 manufacturing sectors in 90 countries over the period 1977-2004, Ismail, 2010 put forward that a 10 % increase in oil price slows down, on average, the manufacturing growth rate by 3.4 %. Further, it shows that this negative effect is stronger in countries that have a more open capital market to foreign investment and also sectors that are less capital intensive. Consistent with the former work, a recent study for 41 resource exporter countries over the period 1970-2006 shows that price movement is negatively correlated with the manufacturing value-added (Harding and Venables, 2016). More evidence for 135 countries for the period 1975-2007 shows that a resource windfall income induces savings of about 30 %, shrinks non-resource exports by 35-70 %, and expands non-resource imports by 0-35 % (Harding and Venables, 2010). Furthermore, a number of studies (e.g. Rajan and Subramanian, 2008) consider a foreign aid rather than the resource rent and find that the aid leads to slower growth in the manufacturing sector relative to the service sector.

Out of this context, a growing number of studies examines only one of the symptoms of the Dutch disease. Strong evidence for a positive effect on the real exchange rate from commodity price appreciation (first step of the symptom) has been documented by Koranchelian, 2005 for Algeria, Zalduendo, 2006 for Venezuela, Oomes and Kalcheva, 2007 for Russia, and Beine, Bos, and Coulombe, 2012 for Canada. Furthermore, Cashin, Céspedes, and Sahay, 2004 for a panel of 58 commodity-exporting countries over the period 1980-2002, Korhonen and Juurikkala, 2009 for a panel of 12 oil-exporting countries over the period 1975-2005 and Ricci, Milesi-Ferretti, and J. Lee, 2013 for a panel of 27 developing & 21 developed countries over the period 1980-2004 report a positive correlation in the commodity prices–exchange rate nexus. In contrast, others have studied the impact of the substantial exchange rate overvaluation on growth (second step of the symptom). Empirical evidence on this subject suggests that the real exchange rate appreciation decelerates

³Two different criteria used to classify the economies depending on the natural resource are (1) resource dependence referring to the value of the natural resource as a share of GDP or total national wealth and (2) resource abundance referring to per capita value of the stock of natural resource wealth. Empirical studies across a comprehensive sample of countries show that natural resource abundance has a positive effect on economic performance (see. Brunnschweiler and Bulte, 2008; Alexeev and Conrad, 2009; Esfahani, Mohaddes, and Pesaran, 2013; Cavalcanti, Mohaddes, and Raissi, 2011).

growth. Perhaps among well-known of these studies is that of Rodrik, 2008; Aguirre and Calderón, 2005. Other studies include those of Eichengreen, 2007; Williamson, 2009; Habib, Mileva, and Stracca, 2017). In terms of the sectoral performance, Sekkat and Varoudakis, 2000 assessed this nexus for a panel of major Sub-Saharan African countries during the period 1970-1992. Their findings indicate that the real exchange rate depreciation fosters manufacturing exports' performance.

Among a few limited studies concerning both symptoms of the Dutch disease hypothesis, Javaid and Riazuddin, 2009 adopted a static and dynamic panel data technique to structurally analyze the hypothesis in a sample of 6 selected South-East Asian economies over the period 1981-2007. They first investigate the response of the real exchange rate to foreign inflows and second the impact of a change in the real exchange rate on growth rate in the manufacturing and service sectors. The findings confirm an appreciation in the real exchange rate, a contraction in the manufacturing sector and an expansion in the service sector as a foreign aid inflows.

In the same vein, Lartey, Mandelman, and Acosta, 2012 studied the Dutch disease effect of remittances under different exchange rate regimes in an unbalanced panel data set of 109 countries over the period 1990-2003. They pursued a dynamic estimation procedure to estimate a regression model in which the relative output of the traded to the non-traded sector was captured as the dependent variable and remittance (% GDP) was their explanatory variable of interest. Their findings show that an increase in remittances leads to an expansion in the share of the service sector and a shrinkage in the share of the manufacturing sector. The paper also suggests that the resource movement effect is stronger under fixed nominal exchange rate regimes.

To sum up, in the context of the natural resource curse, on the one hand, the theoretical models, as in Torvik, 2001; Bjørnland and Thorsrud, 2016, predict that the (steady-state) real exchange rate depreciates, and the rate of growth in the economy is constant or increases due to a resource boom, contrary to the empirical evidence. On the other hand, researches have estimated the impact on the real exchange rate from a commodity price rather than a resource-dependence proxy or they have studied the direct impact of a resource-dependence proxy on economic growth rather than the impact of the real exchange rate on sectoral growth. Out of the resource curse's context, the literature examines the relationship between the real exchange rate and economic growth rather than sectoral growth or they have captured this nexus in a different empirical technique and/or specification from the present paper. Hence, these reasons motivate us to fill these gaps through developing a simple dynamic theory that leads to the real exchange rate appreciation and economic growth deceleration in the long-term and also through a comprehensive systematical empirical analysis that investigates both symptoms of the Dutch disease hypothesis.

Motivated by the literature, I first develop a simple theory, driven by *LBD*, in which the

productivity is generated in both manufacturing and service sectors, while there are an imperfect spillover from the manufacturing to the service sector and a technology spillover from the resource sector to the manufacturing sector. The model describes the standard Dutch disease mechanism, the same as Torvik, 2001. While it shows that a resource boom results in a conditional appreciation in the (steady-state) real exchange rate and also an unconditional depreciation in the rate of growth in the economy, contrary to Torvik, 2001; Bjørnland and Thorsrud, 2016. I then collect an unbalanced panel data set of 132 countries from the period 1970 to 2014 to revisit the Dutch disease symptoms. Using the Generalized Method of Moments (*GMM*) technique, I adopt a dynamic estimation procedure to avoid the autocorrelation problem and the problem of reverse causality between variables of interest (endogeneity problem). Estimated results illustrate some clear evidence in supporting the positive relationship between a resource-dependence proxy and the real exchange rate. They also demonstrate that the real exchange rate appreciation causes the sectoral growth to shrink more in the manufacturing sector than in the service sector and so the economic growth to decelerate. Finally, the empirical approach suggests that these adverse effects are more intensive in resource-rich than in resource-poor countries.

The remainder of the paper is organized as follows. Section 2.2 presents a modified theory, Section 2.3 undertakes an empirical study, and Section 2.4 concludes the paper.

2.2 A model of the Dutch disease

I extend Torvik, 2001 model to make theoretical predictions consistent with empirical results. Consider a two-sector economy: manufacturing and service, indexed by M and S respectively. Assume there are no assets and capital accumulation and the labor force is the only production factor. Labor, inelastically supplied by a continuum of symmetric-identical households, can move freely across sectors. I normalize the total labor force to one:

$$L_M + L_S = 1. \quad (2.1)$$

L_M and L_S represent the labor shares in the manufacturing and service sectors, respectively. The production function in each sector operates under decreasing returns to scale, the same as in Matsuyama, 1992 and Torvik, 2001,

$$X_M = A_M L_M^\alpha \quad (2.2a)$$

$$X_S = A_S L_S^\alpha. \quad (2.2b)$$

A_J , $J = \{M, S\}$ is total factor productivity in sector J . I assume labor intensity, α , is equal in both sectors to simplify the calculations. the price of manufacturing goods is

normalized to unity. Thereby the price of service goods, denoted by P , represents the real exchange rate. In addition, the total income (Y) is the sum of the value of produced manufacturing and service goods plus the value of the resource rent,

$$Y = X_M + PX_S + A_MR. \quad (2.3)$$

An increase in R represents a natural resource boom⁴. Also, the resource rent is measured in the manufacturing goods units, as in Torvik, 2001, so as to prevent it from vanishing relative to total income as the economy grows.

On the demand side, a representative household maximizes a *CES* utility function in his consumption of manufacturing and service goods subject to his budget constraint ($PC_S + C_M = C = Y$). The utility function is given as:

$$U(C_M, C_S) = \frac{\sigma}{\sigma - 1} C_M^{\frac{\sigma-1}{\sigma}} + \frac{\sigma}{\sigma - 1} C_S^{\frac{\sigma-1}{\sigma}}. \quad (2.4)$$

Where C_M and C_S represent the consumption of manufacturing and service goods, respectively. While $\sigma > 0$ denotes the elasticity of substitution between two goods. Following the above assumptions, the demand for services is

$$C_S = \frac{Y}{P(1 + P^{\sigma-1})}. \quad (2.5)$$

Now, I compute two compositions of the real exchange rate (P) and employment share in the service sector (L_S) to determine a static equilibrium of the model. The first composition is derived from an equalization of the sectoral marginal labor productivity, representing the *LL*-curve and the second one is determined by the market-clearing condition in the service sector (i.e. $X_S = C_S$), representing the *NN*-curve. The corresponding expressions are given by

$$P = \phi \left(\frac{L_S}{1 - L_S} \right)^{1-\alpha} \quad LL - curve \quad (2.6a)$$

$$P = \phi^{\frac{1}{\sigma}} \left(\frac{(1 - L_S)^\alpha + R}{L_S^\alpha} \right)^{\frac{1}{\sigma}} \quad NN - curve \quad (2.6b)$$

where $\phi \equiv \frac{A_M}{A_S}$ is the relative productivity ratio. In a $L_S - P$ plane, the *LL*-curve is an upward sloping curve, while the *NN*-curve is a downward sloping curve.

Before moving to a description of the economy's response to a natural resource boom, it is worth investigating the long-run dynamic stability. *TFP* is driven by learning-by-doing (*LBD*). The earlier literature assumes that both sectors generate the learning but there is no spillover between them (Lucas Jr, 1988) or the productivity growth is generated in the

⁴Resource boom may refer to a windfall discovery of new resources or a technical improvement in the resource sector.

manufacturing (traded) sector with a perfect spillover on the service (non-traded) sector (J. D. Sachs and Warner, 1995). Further, Torvik, 2001 presented a more comprehensive model in which the productivity growth is generated in both sectors with an imperfect spillover between sectors. Bjørnland and Thorsrud, 2016 extend Torvik, 2001 model with technology spillover from the resource sector to both manufacturing and service sectors. Different from these models, I assume productivity is generated in both manufacturing and service sectors and there is an imperfect spillover from the manufacturing to the service sector and also an exogenous spillover from the resource sector to the manufacturing sector due to a technological improvement. This assumption results in theoretical predictions that are consistent with the empirical results.

$$\frac{\dot{A}_M}{A_M} = \delta_M L_M + \delta_R (R) \quad (2.7a)$$

$$\frac{\dot{A}_S}{A_S} = \gamma \delta_M L_M + \delta_S L_S. \quad (2.7b)$$

δ_M and δ_S denote respectively the direct effect on productivity growth of one worker employment in the manufacturing and service sectors. Furthermore, $0 < \gamma < 1$ measures the spillover intensity from the manufacturing to the service sector. An improvement in the exploitation of natural resources originated from an externality such as technology transfer from abroad is more likely to spill over productivity to the manufacturing sector. For example, complicated technical processes to exploit offshore oil or to extract oil shale could generate positive knowledge externalities that, in turn, benefit the manufacturing sector. Hence, $\delta_R (R) > 0$ represents the spillover effect from resource sector to the manufacturing sector. I assume this effect is weaker than the direct generated effect in the service sector (i.e. $\delta_R (R) < \delta_S$). This assumption prevents the model from having a corner solution. It also is reasonable to assume that a technological improvement in the resource sector shifts the resource production (i.e. resource boom). In other words, an increase in the resource production can be translated as a technological improvement. Hence more resource rent, more productivity spillover to the manufacturing sector $\delta_R' (R) > 0$.

For the purpose of dynamic analysis, let me first investigate how the static equilibrium of labor allocation reacts to a change in relative productivity. In the long run, the assumption that productivity levels in both sectors are constant is relaxed. Hence, a change in relative productivity plays a crucial role in labor allocation. Two driving forces are at work in labor allocation's response to an increase in the relative productivity ratio ϕ , as in Torvik, 2001. On the one hand, the level of labor requirement in the manufacturing sector falls while in the service sector goes up, as the relative productivity rises (Labor requirement effect). With an unchanged composition of the basket, labor shifts away from the manufacturing and into the service sector. Hence, higher relative productivity, more employment in the service sector. On the other hand, the relative price of manufacturing goods reduces

as the relative productivity increases (Substitution effect). So the relative demand for manufacturing goods expands which, in turn, induces labor to move from the service sector to the manufacturing sector. Hence, higher relative productivity, less employments in the service sector. Briefly, two driving forces push L_S in opposite directions.

The next question is which one of these driving forces is dominant. Labor requirement effect: for a given labor allocation, an increase in the relative productivity ratio leads to an expansion faster in the manufacturing sector than in the service sector. As regards manufacturing goods relative to service goods are produced cheaper than before, the real exchange rate rises to re-establish the good market equilibrium (i.e. the NN -curve shifts up and right). The vertical shift is equal to $\frac{P}{\phi\sigma}$. Substitution effect: for a given real exchange rate, the marginal productivity of labor will be less in the service sector than in the manufacturing sector as ϕ rises. Therefore, the labor force in the service sector decreases to re-establish the labor market equilibrium (i.e. the LL -curve shifts up and left). The vertical shift is equal to $\frac{P}{\phi}$. These represent that the vertical shift is larger in the NN -curve than in the LL -curve if the elasticity of substitution is less than one (i.e. $\sigma < 1$). In conclusion, if the labor requirement effect is dominant ($\sigma < 1$), the labor force in the service sector increases as the relative productivity ratio rises (i.e. $\frac{dL_S}{d\phi} > 0$).

Now, it is worth investigating the existence of a balanced growth path along which the productivity level grow equally in both sectors. The growth rate of the relative productivity ratio is,

$$\frac{\dot{\phi}}{\phi} = \frac{\dot{A}_M}{A_M} - \frac{\dot{A}_S}{A_S} = [(1 - \gamma) \delta_M + \delta_R(R)] - [(1 - \gamma) \delta_M + \delta_S] L_S(\phi, R). \quad (2.8)$$

Hence, the rate of change in relative productivity ratio will be negative if and only if $\sigma < 1$ holds. Since $\sigma < 1 \Rightarrow \frac{dL_S}{d\phi} > 0 \Rightarrow \frac{d(\dot{\phi}/\phi)}{d\phi} = -[(1 - \gamma) \delta_M + \delta_S] \frac{dL_S(\phi, R)}{d\phi} < 0$. This argument demonstrates that the dynamic stability of the system is satisfied and then there is a balanced growth path when $\sigma < 1$, as in Lucas Jr, 1988 and Torvik, 2001 ⁵.

We can now study the effect of a resource boom on the relative productivity ratio. Figure 2.1 shows the adjustment balanced growth path. The locus of relative productivity ratio is drawn as a downward-sloping line to satisfy the stability condition ⁶. In response to a natural resource boom, the relative demand for service goods increases and so the relative price (i.e. the real exchange rate, P) appreciates in order to come face to face with the expanded relative demand (i.e. Spending effect). It, in turn, leads to shifting labor away from the manufacturing sector and into the service sector (i.e. $\frac{dL_S}{dR} > 0$, Labor movement

⁵When there is a Cobb-Douglas utility function (i.e. $\sigma = 1$), the vertical shifts of both LL and NN curves are equal. Therefore, the labor share in the service sector is independent of a change in ϕ (i.e. $\frac{dL_S}{d\phi} = 0$). It suggests that there is a set of growth path rather than a unique growth path.

⁶Following Torvik, 2001, assume initially $\phi > \phi^*$. Since the labor requirement effect is dominant (i.e. $\sigma < 1$), the employment in the service sector is larger than it would be at steady-state. It results in a stronger productivity growth in the service sector with respect to that in the manufacturing sector. Consequently, the relative productivity growth falls over time until it reaches its steady-state value.

effect). The derivative of Equation 2.8 with respect to R is equal to:

$$\frac{d(\dot{\phi}/\phi)}{dR} = \delta_R'(R) - [(1-\gamma)\delta_M + \delta_S] \frac{dL_S(\phi, R)}{dR}. \quad (2.9)$$

Hence, an increase in employment share of the service sector induces the economy to jump vertically down from the solid line to the dotted line and from there moves towards a smaller equilibrium level of the relative productivity ratio ϕ_1^{**} if $\frac{dL_S}{dR} > \frac{\delta_R'(R)}{(1-\gamma)\delta_M + \delta_S} = \frac{dL_S^*}{dR} \Rightarrow \frac{d(\dot{\phi}/\phi)}{dR} < 0$. Otherwise, the economy first jumps up and then moves towards a larger equilibrium level of the relative productivity ratio ϕ_2^{**} (see Appendix A). For a special case in which there is no spillover effect from the resource sector to the manufacturing sector (i.e. $\delta_R(R) = 0$ and so $\delta_R'(R) = 0$), the same as Torvik, 2001, a resource boom leads unconditionally to decreasing the growth rate of the relative productivity ratio.

Before attention is turned to discuss the dynamic Dutch disease, it seems to be useful to

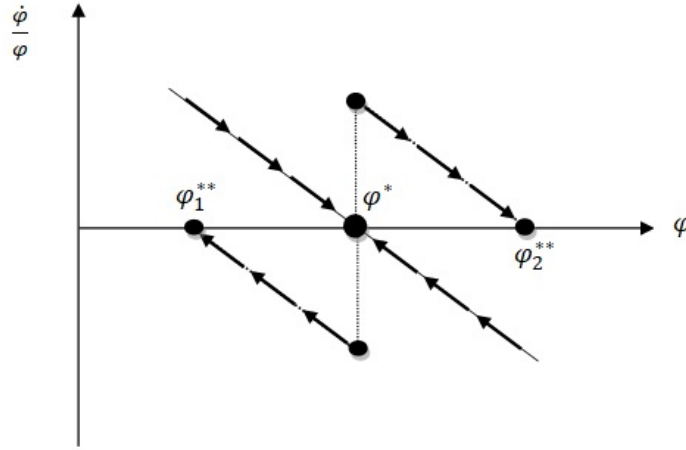

Figure 2.1: Adjustment balanced growth path

investigate the dynamic adjustment in each sector after a resource boom. Equations 2.7 verify that the productivity growth rate in the manufacturing sector decelerates as L_S increases, while the productivity growth rate in the service sector changes depending on the size of the direct and spillover effects of learning process. An increase in L_S decelerates the productivity growth in the service sector when the spillover effect is dominant (i.e. $\gamma\delta_M > \delta_S$) and it accelerates the productivity growth when the direct effect is stronger (i.e. $\gamma\delta_M < \delta_S$). In addition, Equations 2.7 indicate that a resource boom, on the one hand, tends directly to accelerate the productivity growth rate of the manufacturing sector and it, on the other hand, tends indirectly to decelerate the productivity growth rate, through making smaller the size of the labor employment share in the manufacturing sector.

To have theoretical predictions relevant to the empirical findings, I assume the direct effect of the learning process is the dominant driving force in the manufacturing sector (i.e. $\delta_M \gg \delta_R$). In addition, I make the assumption that the spillover effect from the

manufacturing to the service sector is stronger than the direct effect generated in the service sector, which in turn is larger than the spillover effect from the resource sector to the manufacturing sector (i.e. $\gamma\delta_M > \delta_S > \delta_R$).

Torvik, 2001; Bjørnland and Thorsrud, 2016 models represent that the labor shares return to their steady-state level along the transition path. However, at the present dynamic model the steady-state labor employment share in the service sector changes after a shock to R ⁷,

$$L_S^*(R) = 1 - \frac{\delta_S - \delta_R}{(1 - \gamma)\delta_M + \delta_S}. \quad (2.10)$$

As regards the assumption of $\delta_S > \delta_R(R)$, the steady-state labor share is smaller than one ($L_S^* < 1$) ⁸. Contrary to Torvik, 2001; Bjørnland and Thorsrud, 2016 models in which the labor employment share in the service sector is constant at the steady-state (i.e. $L_S^* = \frac{(1-\gamma)\delta_M}{(1-\gamma)\delta_M + \delta_S}$), Equation 2.10 reveals that a resource boom increases the labor employment share in the service sector permanently (i.e. $\frac{dL_S^*}{dR} = \frac{\delta_R'}{(1-\gamma)\delta_M + \delta_S} > 0$). To see the equilibrium output (productivity) growth rate that is directly affected by a resource boom, insert the steady-state labor employment share in the service sector into one of the two Equations 2.7. The steady-state growth rate (g^*), is given by:

$$g^* = \delta_S + \frac{(\delta_S - \gamma\delta_M)(\delta_R - \delta_S)}{(1 - \gamma)\delta_M + \delta_S} > 0. \quad (2.11)$$

At this point, a resource boom crowds out the output (productivity). Since the size of the spillover effect from the manufacturing to the service sector is larger than that of the direct effect generated in the service sector (i.e. $\gamma\delta_M > \delta_S$), $\frac{dg^*}{dR} = \frac{\delta_R'(\delta_S - \gamma\delta_M)}{(1-\gamma)\delta_M + \delta_S} < 0$. This is contrary to the standard Dutch disease model developed by Torvik, 2001 in which there is no spillover effect from the resource sector ($\delta_R = 0$) and so the steady-state growth rate is independent of a shock in R (i.e. $g^* = \frac{\delta_S\delta_M}{(1-\gamma)\delta_M + \delta_S}$). Further, this is different from the result of the model proposed by Bjørnland and Thorsrud, 2016 in which technology spillovers equally from the resource sector to other sectors and so the steady-state growth rate crowds in the sectoral output. Finally, contrary to the earlier models, the present model describes not only de-industrialization but also the slower growth rate in resource-dependent countries.

Figure 2.2 clarifies the dynamic Dutch disease and shows how the labor employment share in the service sector (L_S) and the real exchange rate (P) react in turn to a natural resource boom. The LL -curve (Equation 2.6a) and the NN -curve (Equation 2.6b) are respectively drawn as upward and downward sloping curves. These curves intersect initially at point E_0 . A resource rent through the real exchange rate appreciation shifts the labor employment away from the manufacturing sector and into the service sector (i.e. $\frac{dL_S}{dR} > 0$). Graphically

⁷Steady-state labor employment share in the manufacturing sector is $L_M^*(R) = \frac{\delta_S - \delta_R}{(1-\gamma)\delta_M + \delta_S}$.

⁸It demonstrates when $\delta_S = \delta_R(R)$, the model has a corner solution.

the NN -curve shifts up, while the LL -curve doesn't affect. The new static equilibrium is set in a higher real exchange rate and a larger labor employment share in the service sector (point E_1). Assume $\frac{dL_S}{dR} > \frac{dL_S^*}{dR} = \frac{\delta_R'(R)}{(1-\gamma)\delta_M + \delta_S}$ holds and two main assumptions are taken into account (i.e. $\gamma\delta_M > \delta_S > \delta_R$ and $\delta_M \gg \delta_R$). Since L_S is now larger relative to its steady-state value L_S^* and so the relative productivity growth is negative (i.e. $\dot{\phi} < 0$), the productivity level shrinks faster in the manufacturing sector than in the service sector. So that the relative productivity ratio declines along the transition path. Graphically, both curves shift down. As regards the NN -curve shifts faster than the LL -curve (i.e. $\sigma < 1$ holds), falling the relative productivity ratio induces a countervailing movement of labor from the service to the manufacturing sector. The movement will continue as long as the labor employment share in the service sector converges to a new steady-state value (E_1 to E_2 in Figure 2.2), which is larger than value of the initial labor employment share ⁹.

A note on the new steady-state real exchange rate P^* can come from a close graphical

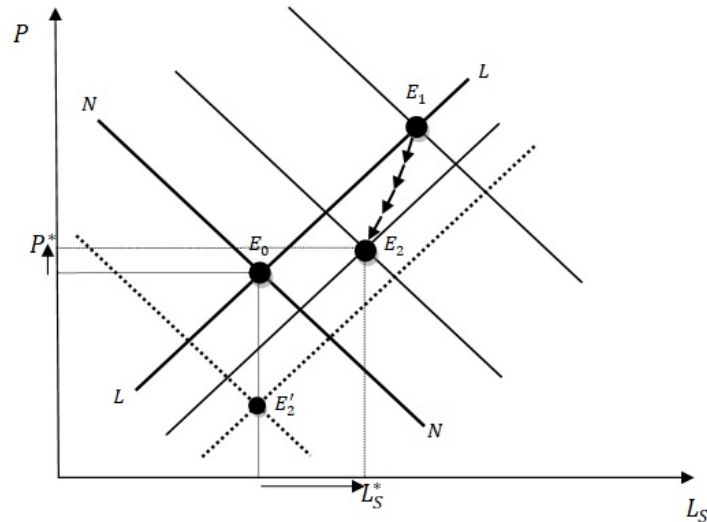

Figure 2.2: The Dutch disease mechanism

investigation of the different possible slopes in the isoclines. It observes that the steady-state of P^* relative to its initial level might set, depending on the respective magnitudes of the shifts, in a higher level if the relative productivity ratio becomes larger than a critical threshold, $0 > \frac{d\phi^*}{dR} > -\frac{(1-\alpha)\phi^*}{L_M^* L_S^*}$ (see. Appendix A). Otherwise, P^* sets in a level lower than the initial level. As opposed to those, for a case in which technology doesn't spillover to the manufacturing sector ($\delta_R = 0$), shifting the labor employment away from the service and into the manufacturing sector will continue as long as the employment shares back to their initial values (i.e. E_2' in Figure 2.2). Consequently in this case, as in Torvik, 2001, a reduction in the relative productivity ratio is accompanied by falling the real exchange rate. So that both L_S and P fall along the transition path.

⁹It suggests that the final value of the labor employment share in the manufacturing sector is smaller than its initial value.

2.3 Theory meets empirical model

I specify a panel data approach to investigate the empirical relevance of the theoretical model. The main contribution of this study is to testify the symptoms of the Dutch disease. Hence, an empirical study is discussed in four stages: 1) the response of the real exchange rate to the resource-dependence proxy and the impact of the real exchange rate appreciation, respectively, on 2) the relative productivity of the manufacturing (traded) sector to the service (non-traded) sector, 3) sectoral GDP per capita growth rate, 4) economic growth rate.

2.3.1 Data and Methodology

The dataset consists of an unbalanced panel of 132 countries and covers 5-year periods over 1970-2014¹⁰. The list of countries included in the samples presents in Appendix D. Table 4.1 reports descriptive statistics. The real effective exchange rate ($REER$) estimated by *Bruegel* (Darvas, 2012) is calculated as $REER = \frac{NEER \cdot CPI^{domestic}}{CPI^{foreign}}$, where $NEER$, the nominal effective exchange rate, is a measure of the value of a currency against a weighted average of several foreign currencies and CPI denotes the consumer price index. This proxies the relative price of service (non-traded) to manufacturing (traded) goods. Since the relative consumer price index of domestic to foreign goods implies that an increase in $REER$ tends to appreciate the relative price. I collect data of GDP per capita (Constant 2010 US *dollars*) as well as manufacturing (M) and service (S) value-added (Constant 2010 US *dollars*) from the World Bank's World Development Indicator Database (*WDI*) to construct the relative sectoral output of M to S and the natural logarithm of per capita GDP in each sector ($J = M, S$).

Following the literature, two measurements of a natural resource boom are total natural resources rents (% of GDP) (henceforth called resource-dependence index) which is sourced from *WDI* and the non-agriculture commodity export price index¹¹ which is constructed using a similar methodology to Deaton, Miller, et al., 1995, Dehn, 2000, Collier and Goderis, 2008. Whereas the former index captures the impact of both price and quantity variations on total resource rent, the latter index which is applied as a robustness check represents only price variation (See Appendix B for more detail regarding the data, sources and methodology used to construct the commodity price index).

Further, I collect data of the net foreign assets and GDP (both in local currency unit) from *WDI* to construct the explanatory variable of net foreign assets (% GDP), and this variable is used to investigate the relationship between the resource-dependence index, the

¹⁰5-year periods are: 1970-1974, 1975-79, 1980-84, 1985-89, 1990-94, 1995-99, 2000-04, 2005-09, 2010-14.

¹¹Given that total natural resource rents (% of GDP) are defined as the sum of oil, natural gas, coal, mineral, and forest rents (see. *WDI*) and so the concept of reserves does not apply to many commodities, including agricultural products, I only construct a non-agriculture commodity price for as many countries as data availability allowed.

Table 2.1: Summary Statistics

	Obs.	Mean	Std Dev.	Min	Max
Real effective exchange rate	1048	1.398	4.652	0.298	136.197
Ln (relative sectoral output of M to S)	805	3.233	0.540	1.110	5.880
Ln (per capita GDP of Manufacturing)	838	6.173	1.687	2.056	9.590
Ln (per capita GDP of Service)	865	7.489	1.679	3.917	11.307
Ln (per capita GDP)	1044	8.206	1.553	5.036	11.569
Resource-dependence index	1048	7.081	9.624	0.00005	62.897
Commodity Price index)	362	1.691	1.777	1.0002	15.352
Net foreign assets	879	8.077	18.801	-62.474	117.250
Population growth	1048	1.727	1.268	-3.674	7.126
Investment ratio	858	21.426	7.857	2.812	83.787
Human Capital index	1048	2.136	0.731	1.009	3.719
Openness index	890	66.976	45.389	4.989	456.583
Terms of trade	1048	1.071	0.792	0.124	21.272
Foreign direct investment	1048	2.508	4.078	-17.505	40.409
Government spending	855	16.371	6.666	1.253	56.456
Inflation	1048	42.484	290.698	-6.628	6945.242
Institution index	1048	-0.125	0.849	-2.069	1.989

real exchange rate and the transfer problem. Other explanatory variables of interests are Population growth ¹², Investment ratio ¹³, Human Capital Index ¹⁴, Openness ratio ¹⁵, Terms of trade ¹⁶, Foreign direct investment ¹⁷ and Government spending ¹⁸. Moreover, GDP deflator (annual %) represents inflation and the Rule of Law indicator is considered as a proxy for quality of institution (Institution index) ¹⁹.

Table 2.2 presents the correlation matrix for variables of interest. It reveals that the resource-dependence index is positively associated with the real exchange rate, while the real exchange rate, *per se*, is negatively correlated with per capita GDP level in each sector. In other words, it implies that the resource-dependence through the real exchange rate appreciation is likely to be accompanied by a contraction of GDP per capita in both

¹²The average value for the 5-year period is sourced from *WDI*.

¹³Gross fixed capital formation in the percentage of GDP (Constant 2010 US *dollars*), is used to proxy the investment ratio. Observed values as averages for the 5-year periods are derived from *WDI*.

¹⁴My measure of human capital is an index constructed by *Penn World Table*. This index is based on Barro and J. W. Lee, 2013 database for the average years of schooling and an estimated rate of return for primary, secondary, and tertiary education, introduced by Caselli, 2005.

¹⁵I collect data of trade to GDP ratio (Constant 2010 US *dollars*), a proxy for openness level, from *WDI* database. The ratio is observed as averages for 5-year periods.

¹⁶The net barter terms of trade index (2010=1) are calculated as the percentage ratio of the export unit value indexes to the import unit value indexes. The average value for the 5-year periods is derived from *WDI* database. Note that the base year of *WDI* database is 2005=1.

¹⁷It is defined as the net inflows of investment divided by *GDP*. The average value for the 5-year period is collected from *WDI*.

¹⁸It refers to General government final consumption expenditure (% of GDP) (constant 2010 US *dollars*). The data is an average value for the 5-year periods, sourced from *WDI*.

¹⁹The indicators proposed by *World Bank's Governance Indicators Project* is in the range of -2.5 (weak) to +2.5 (strong). The data are available from 1996 to 2015. For preceding periods, I assume that the indicators are equal to the earliest value.

sectors. Hence, this simple correlation matrix seems to initially clarify arising the Dutch disease and motivates us to follow the objective.

In order to verify the Dutch disease hypothesis, a dynamic panel data model is applied.

Table 2.2: Correlation Matrix

	Resource dependence index	Real eff. exchange rate	Ln (per capita GDP of Manuf.)	Ln (per capita GDP of Service)
Resource-dependence index	1			
Real effective exchange rate	0.021	1		
Ln (per capita GDP of Manuf.)	-0.248	-0.017	1	
Ln (per capita GDP of Service)	-0.246	-0.042	0.949	1

The general estimated equation is of the form:

$$y_{i,t} = \alpha + \delta y_{i,t-1} + X'_{i,t} \beta + \mu_i + \varepsilon_{i,t}. \quad (2.12)$$

where the subscripts $i = 1, \dots, N$ and $t = 1, \dots, T$ index, respectively, the countries and periods in the panel dataset. $y_{i,t}$ is the dependent variable and $X'_{i,t}$ denotes a vector of independent variables. Furthermore, α is a constant term while μ_i and $\varepsilon_{i,t}$ represent, respectively, the unobserved country-fixed effect and the error term.

The dynamic model is estimated using the first-differenced *GMM* approach suggested by Arellano and Stephen Bond, 1991 and the system *GMM* developed by Blundell and Stephen Bond, 1998. In the former method, the lagged level variables are used to instrument the explanatory variables, while in the latter method, both lagged levels and lagged differences are applied. Both estimators have been designed to address the potential econometric problems arising in the estimation of a dynamic regression model (Equation 2.12), such as a correlation between the country fixed-effect and the explanatory variables, rising autocorrelation because of including the lagged dependent variable and presence of the endogenous variables.

The valid instruments for the levels of the dependent variables and the endogenous variables are lagged two or more periods, while those for the levels of the pre-determined variables are lagged one or more periods, and for the levels of exogenous variables are simply current or lagged periods. The consistency of the *GMM* estimators depends on the assessment of the proliferation of instruments which causes overidentification in the regression model and the serial autocorrelation of errors. The proliferation of instruments is checked by the *Hansen* test of over-identifying restrictions²⁰, while the second *Arellano-Bond* test²¹ is used to verify that there is no serial autocorrelation in error term and so the lagged

²⁰*Hansen* test is adequate when the estimation considers a *heteroscedastic* weight matrix. The null hypothesis states that the instruments, as a group, are uncorrelated with the error term.

²¹The null hypothesis is that autocorrelation doesn't exist.

variables are the valid instruments. Furthermore, the rule of thumb is to keep the number of instruments less than the number of country groups to avoid an overidentification (Roodman, 2009a). Finally, the regression uses a two-step system GMM (first-differenced GMM) with Windmeijer, 2005 robust correction procedure ²².

2.4 Econometric Results

2.4.1 Resource-dependence and the real exchange rate

The aim of this section is to investigate the response of the real exchange rate (the relative price) to an increase in a resource-dependence proxy. The dependent variable of the dynamic regression model is the real effective exchange rate and the explanatory variable of interest is total natural resource rent (% of GDP) (i.e. resource-dependence index). In addition, GDP per capita, Inflation, Government spending, Terms of trade, Openness index, and Foreign direct investment are included to control the regression model. Both dependent and independent variables are log-transformed.

Table 4.9 reports the empirical results. Columns (1) and (2) represent, respectively, *OLS* and the fixed effect (*FE*) ²³ estimations of the baseline specification model. Although the results may not be informative, they still seem to be interesting as a benchmark. The core estimation of the regression model is reported in column (3). The coefficient on the resource-dependence enters with a positive sign and is significant at 1 percent. The estimation shows that a one percent increase in the resource-dependence index appreciates the real effective exchange rate by about 0.024%. It confirms the theory's prediction that an increase in the natural resource rent leads to an appreciation in the real exchange rate.

Now, it is worth discussing the impact of an increase in the resource-dependence index on the real effective exchange rate in terms of heterogeneity across resource-dependent countries. For this objective, I introduce a dummy variable for the natural resource-poor countries, equal to one when total natural resource rent is less than %5 of GDP, and an interaction between the dummy and the resource-dependence index. The significant results reported in column (4) clarify that the real exchange rate appreciation is more intensive in resource-rich countries than resource-poor countries. Precisely, the estimation implies that this positive effect in resource-rich countries is six times larger than that in resource-poor countries.

A question now arising is whether the real exchange rate depreciates along the transition path as the resource-dependence index increases. I include the second lagged dependent variable in the regression model to address this issue. Column (5) reports both short and long-run resource-dependent's effects on the real effective exchange rate. It shows that the real exchange rate appreciation is slightly moderated over time. Nevertheless, this

²²All results are estimated using *xtabond2* command proposed by Roodman, 2009b.

²³The *Hausman* test checking that the preferred model is random effects is rejected with a *p* - value of 0.000.

Table 2.3: Estimation results for the real effective exchange rate

Explanatory variable	(1)	(2)	(3)	(4)	(5)	(6)	(7)	(8)	(9)
	<i>Bruegel</i>	<i>Bruegel</i>	<i>Bruegel</i>	<i>Bruegel</i>	<i>Bruegel</i>	<i>Bruegel</i>	<i>Bruegel</i>	<i>IMF</i>	<i>Bruegel</i>
	Full Sample	Full Sample	Full Sample	Full Sample	Full Sample	Developing	Non-Europe	Full Sample	Recession
	OLS	FE	Sys. GMM	Sys. GMM	Sys. GMM	Sys. GMM	Sys. GMM	Sys. GMM	Sys. GMM
Real exchange rate (lagged)	0.631*** (0.0228)	0.485*** (0.0329)	0.576*** (0.0277)	0.534*** (0.0472)	0.672*** (0.0541)	0.458*** (0.0613)	0.459*** (0.0603)	0.477*** (0.0773)	0.570*** (0.0338)
Real exchange rate (second lagged)					-0.110** (0.0483)				
Resource-dependence (lagged)	0.00859 (0.00532)	0.00909 (0.0132)	0.0242*** (0.00894)	0.0933*** (0.0351)	0.0305*** (0.0101)	0.0278** (0.0129)	0.0315** (0.0126)	0.0223** (0.00922)	0.0359** (0.0161)
Dummy Resource Poor countries				0.180** (0.0816)					
Dummy * Resource-dependence				-0.0785** (0.0351)					
GDP per capita	0.00580 (0.00733)	0.244*** (0.0543)	0.0179 (0.0201)	0.00356 (0.00858)	0.00263 (0.0148)	-0.00327 (0.00987)	0.00279 (0.00891)	0.0229** (0.0111)	0.0444 (0.0323)
Inflation	-0.00595 (0.00804)	0.00103 (0.0124)	-0.00886 (0.0325)	-0.0115 (0.0224)	-0.00259 (0.0325)	-0.0192 (0.0230)	-0.0237 (0.0218)	-0.0282* (0.0171)	-0.0100 (0.0339)
Government spending	0.0105 (0.0216)	0.0603 (0.0521)	0.0759 (0.0524)	0.0160 (0.0427)	0.141* (0.0768)	0.00821 (0.0377)	0.0109 (0.0380)	-0.0683 (0.0624)	0.0494 (0.0915)
Terms of trade	0.114*** (0.0301)	0.182*** (0.0492)	0.198*** (0.0913)	0.162* (0.0881)	0.199* (0.107)	0.141** (0.0700)	0.138** (0.0693)	0.129* (0.0704)	0.191 (0.149)
Openness index	0.0328* (0.0170)	0.0428 (0.0417)	0.0603* (0.0310)	0.0413* (0.0219)	0.0314 (0.0434)	0.0455** (0.0223)	0.0482** (0.0215)	0.0204 (0.0179)	0.0702 (0.0489)
Foreign Direct Investment	-0.0254*** (0.00761)	-0.0367*** (0.0101)	-0.0550 (0.0403)	-0.0305** (0.0155)	-0.0419 (0.0358)	-0.0359*** (0.0116)	-0.0367*** (0.0100)	-0.0129 (0.00974)	-0.0690 (0.0484)
Time dummies	YES	YES	YES	YES	YES	YES	YES	YES	YES
Observations	719	719	719	719	628	526	572	371	486
Number of Countries	121	121	121	121	121	92	98	70	114
Arellano-Bond test for AR(2) (p-value)	-	-	0.445	0.444	0.955	0.459	0.452	0.866	0.329
Hansen OID test (p-value)	-	-	0.303	0.190	0.304	0.163	0.169	0.341	0.416
R-squared	0.606	0.419	-	-	-	-	-	-	-

Note: The dependent variable is the real effective exchange rate derived by *Bruegel*, while the dependent variable for estimation results reported in columns (8) is sourced by *IMF*. The real effective exchange rate (lagged) and the resource-dependence (lagged) are respectively instrumented by second lag and first lag levels in the first differences equation. Also, control variables are instrumented by second lag level in the first differences equation. To satisfy the rule of thumb some control variables are instrumented in columns (5)-(8).

Robust standard errors are reported in parentheses. ***, ** and * denote significance at 1, 5 and 10 percent levels.

The null hypothesis of *Arellano-Bond* test is that autocorrelation doesn't exist and the null hypothesis of *Hansen* test is that the instruments, as a group, is uncorrelated with the error term.

reduction is not to such an extent (i.e. $0.11 < 0.67$) that the long term real exchange rate is set in a level lower than the initial level ²⁴. Therefore, the result may represent more consistency of the presented theory than the Torvik, 2001 model.

Column (6) and (7) at Table 4.9 contain robustness checks of the baseline model for heterogeneity across countries. In column (6) I restrict the sample to developing countries, introduced by the International Monetary Fund's World Economic Outlook Database and in column (7) I run the regression model for sub-sample of Non-European countries to exclude the currency union's effects. The results show that the positive effect of the resource-dependence on the real exchange rate is even larger for samples of developing countries and Non-European countries so that one percent increase in the resource-dependence index leads to rising the real effective exchange rate by about 0.0278% for developing countries and 0.0315% for Non-European countries. The findings are likely to suggest that, in response to a resource boom, the relative demand for service to manufacturing goods increases more in the developing countries than others. Also, it seems to suggest that the currency union in Europe is more effective in the prevention of a resource curse.

The consistency of the results is also examined by applying a different measurement approach for the dependent variable's database. I run the baseline regression model for a database of the real effective exchange rate estimated by *IMF* ²⁵ to capture the robustness test. Column (8) shows the results. The available data for the real effective exchange rate of *IMF* database covers only 44 developing countries and 26 developed countries. The coefficient on the resource-dependence enters with a positive sign and its value is very close to what we found in estimation of the baseline database. However, the significance of the coefficient is weaker when *IMF* database is applied (i.e. significant in %5). The latter is more likely to be because of less number of countries' data included in *IMF* database than *Bruegel* database.

The global recession 2008-2013 has been the worst postwar recessions, both in terms of the decline in real World GDP per capita and the number of countries affected. A recession may associate with a depreciation in the real exchange rate because of falling the interest rate. Hence, it seems worthy to check the recession's effect on the consistency of the relationship between variables of interest. I run the regression model for a sample covering the period 1970-2004 to exclude the recession's effects. Column (9) reports the estimated results. The positive and significant coefficient on the resource-dependence index supports the finding of the real exchange rate appreciation due to a resource boom. It also suggests that the great recession's effect doesn't qualitatively bias the relationship between these variables. Further, the smaller magnitude of the coefficient for the full sample than that for the restricted sample may represent the depreciation of the real exchange rate due to the falling interest rate over the recession period.

²⁴As an alternative, it implies that there are oscillations in moving up to that long-run level of the real exchange rate.

²⁵The main difference between *Bruegel* and *IMF* databases is in the calculation of the geometrically weighted average of *CPI* indices of trading partners.

I further evaluate the sensitivity of the coefficient on the resource-dependence index to a change in sample size. Following Mihasonirina and Kangni, 2011, I run the baseline regression model (column 3 of Table 4.9) for selected randomly 98% of the observations (without replacement). This process, repeated 250 times, gives the average value and standard deviation of the coefficient on the resource rent (% GDP). The same procedure is also used for randomly 95%, 80% and 65% of the observations. The estimated value of coefficient and standard deviation for each sample size are reported in Table 3.3. The results reveal when the regression runs on 98% of the sample, the estimated coefficient remains very close to the full sample's coefficient (about 3% smaller). Nevertheless, when the regression model runs on the other samples, their coefficients reduce and their distributions widen. The latter point may state that the significance of the coefficient decreases as the sample size shrinks.

The final robustness test for the first stage of the Dutch disease's analysis is a recursive

Table 2.4: Robustness test for the sensitivity of coefficient of interest

Explanatory variable		98%	95%	80%	65%
Resource-dependence (lagged)	Coefficient	0.02343	0.02105	0.01854	0.01663
	Standard Deviation	0.00427	0.00659	0.01195	0.01435

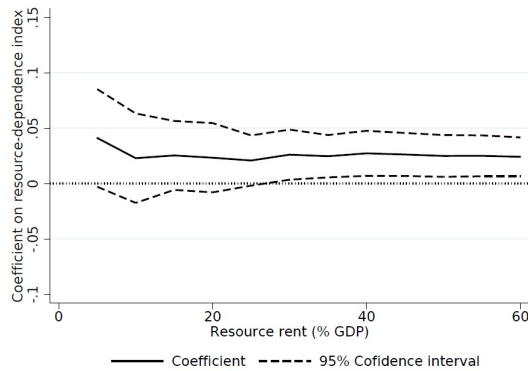

Figure 2.3: Recursive estimation on the coefficient of interest.

estimation to test the stability of the coefficient of interest for cross-country heterogeneity. I first rank the observation in increasing order of the resource rent (% GDP) (i.e. resource-dependence index) and run the regression for a sample with the lowest order of resource rent (i.e. less than 5%). In the next step, I include the subsequent observations with larger resource rent index and rerun the regression. The result, shown in Figure 2.3, remains positive and significant over the different levels of resource rent (% of GDP). It also represents that the coefficient on the resource-dependence index is approximately stable over increasing the resource-dependence index.

Before attention is turned to testify the impact of the real exchange rate appreciation on the relative sectoral output, sectoral growth, and economic growth, one seems to be interesting to discuss the response of the real exchange rate to resource price variations. In this respect, I next investigate the impact of the commodity price index rather than the resource-dependence index on the real exchange rate. Table 2.5 reports the empirical results. Columns (1) and (2) represent, respectively, *OLS* and *Sys.GMM* estimations for the sample including the commodity price index. In column (2), the insignificant and negative coefficient on the commodity price index does not support the hypothesis and is contrary to recent empirical studies (Koranchelian, 2005; Ricci, Milesi-Ferretti, and J. Lee, 2013). One might be because of the sample data set covering a shorter period and a small number of countries. An alternative may refer to heterogeneity across countries in terms of the importance of resource rent in the economy. According to the theory, a resource income boom leads to appreciating the real exchange rate. The income, in turn, depends on price and production volume. Given that the negative effect of a commodity price depreciation on the resource income may be compensated by more commodity exports, changes in commodity prices may affect the real exchange rate less intensively in resource-rich countries than in resource-poor countries. Since the commodity price presumably is the main determinant of the natural resource income in resource-poor countries where their resource productions hold constant, while the index will understate the resource income effects of the price change in resource-rich countries. To address this latter issue, I run the regression model for a sample restricted to resource-poor countries. The results are reported in column (3). The coefficient on the commodity export price index enters positive and is statistically significant at 1 percent, indicating that there is indeed a long-run real exchange rate appreciation in resource-poor countries. This contrasts with the results of the baseline model of the sample that includes the resource-dependence index (column 2 of Table 4.9) and suggests that the commodity price index may only describe the first symptom of the Dutch disease hypothesis in resource-poor countries and not all.

The impact of the natural resource on the real exchange rate seems to refer to the international transfer problem. The nexus between these variables rests on twofold. On the one hand, empirical evidence represents a positive long-run net foreign assets (of % GDP) in most natural resource countries (see. Lane and Milesi-Ferretti, 2007). In line with the evidence, I estimate the impact of the resource-dependence index on the net foreign assets for a sample including 114 countries' observations over the period 1970-2014. The results reported in Table 2.12 of Appendix C suggest that a natural resource boom leads to accumulating the net foreign assets. On the other hand, a transfer from the foreign to the home country implies an increase in global demand for home goods and hence necessitates a rise in their relative price. More precisely, in a simple Keynesian setting, countries with larger external assets, gained by exporting primary commodities (e.g. oil and gas), run a trade deficit to spend them, and achieving this trade deficit entails an appreciation in the real exchange rate. In this respect, using a database covering 64 industrial and

Table 2.5: Robustness checks for the real effective exchange rate

Explanatory variable	(1)	(2)	(3)	(4)	(5)	(6)	(7)	(8)
	<i>Bruegel</i> Full Sample OLS	<i>Bruegel</i> Full Sample Sys. GMM	<i>Bruegel</i> Resource-Poor Sys. GMM	<i>Bruegel</i> Full Sample OLS	<i>Bruegel</i> Full Sample Sys. GMM	<i>Bruegel</i> Middle Sys. GMM	<i>Bruegel</i> Low/Middle Sys. GMM	<i>Bruegel</i> High/Middle Sys. GMM
Real exchange rate (lagged)	0.326*** (0.0278)	0.363*** (0.0810)	0.390*** (0.104)	0.649*** (0.0225)	0.656*** (0.0855)	0.645*** (0.0727)	0.622*** (0.0798)	0.698*** (0.0717)
Commodity Price index (lagged)	0.00694 (0.0197)	-0.00714 (0.0286)	0.591*** (0.196)					
Net foreign assets (lagged)				0.216*** (0.0395)	0.265*** (0.0853)	0.238*** (0.0514)	0.241*** (0.0697)	0.285*** (0.0716)
GDP per capita	0.00777 (0.00718)	0.0151 (0.0128)	0.0158 (0.0221)	-0.00695 (0.00579)	-0.0187 (0.0143)	0.0108 (0.0371)	-0.0253 (0.0162)	-0.0110 (0.0179)
Inflation	-0.0299*** (0.00832)	0.0116 (0.0294)	-0.0124 (0.0193)	-0.0113 (0.00687)	0.00904 (0.0177)	0.00473 (0.0237)	0.0116 (0.0192)	0.00749 (0.0182)
Government spending	-0.0566*** (0.0248)	-0.0314 (0.0909)	0.0636 (0.131)	0.0214 (0.0171)	-0.00134 (0.0561)	-0.00922 (0.0480)	-0.0253 (0.0545)	0.0201 (0.0537)
Terms of trade	0.116*** (0.0354)	0.169* (0.0978)	0.0326 (0.232)	0.0344 (0.0230)	-0.00549 (0.0649)	0.0150 (0.0780)	-0.00922 (0.0671)	0.0669 (0.0947)
Openness index	0.0224 (0.0182)	0.000664 (0.0553)	-0.0121 (0.0468)	0.00521 (0.0135)	-0.00491 (0.0416)	0.0297 (0.0569)	0.0180 (0.0410)	0.0162 (0.0610)
Foreign Direct Investment	-0.0105 (0.00871)	-0.0288 (0.0199)	-0.000757 (0.0261)					
Time dummies	YES	YES	YES	YES	YES	YES	YES	YES
Observations	240	240	133	603	603	396	522	477
Number of Countries	66	66	41	103	103	71	90	84
Arellano-Bond test for AR(2) (p-value)	-	0.765	0.525	-	0.922	0.742	0.944	0.756
Hansen OJD test (p-value)	-	0.115	0.174	-	0.239	0.466	0.381	0.452
R-squared	0.51	-	-	0.681	-	-	-	-

Note: The dependent variable is the real effective exchange rate derived by *Bruegel*. Commodity price (lagged) is exogenous. The real effective exchange rate (lagged) and the net foreign assets (lagged) are respectively instrumented by second lag and first lag levels in the first differences equation. The net foreign assets is normalized to avoid the cancellation of the negative value of observations in Ln form. Also, control variables are instrumented by second lag level to satisfy the rule of thumb. Foreign Direct Investment is dropped in columns (4)-(8) to avoid endogeneity problem. Robust standard errors are reported in parentheses. ***, ** and * denote significance at 1, 5 and 10 percent levels. The null hypothesis of *Arellano-Bond* test is that autocorrelation doesn't exist and the null hypothesis of *Hansen* test is that the instruments, as a group, is uncorrelated with the error term.

middle-income developing countries between 1970 and 1998, Lane and Milesi-Ferretti, 2004 show that in the long run, larger net external positions should be associated with a more appreciated real exchange rate. Accordingly, these relationships may indicate the impact of the natural resource rent on the real exchange rate through the transmission channel of the international payments (i.e. the transfer problem).

The argument illustrates that the variable of the net foreign assets (% of GDP) presumably well reflects the resource-dependence index. Hence, I include the net foreign assets (% of GDP) in the base regression model (column 3 of Table 4.9), instead of the resource-dependence index, to address the transmission channel. Column (4) of Table 2.5 reports *OLS* estimation's results, while column (5) represents *Sys.GMM* estimation's results. The coefficient on the variable of interest has a positive value and is significant at 1%. In line with the literature (e.g. Lane and Milesi-Ferretti, 2004; Christopoulos, Gente, and León-Ledesma, 2012), improving net foreign assets gained by exporting primary commodities are associated with an appreciation in the real exchange rates, providing clear evidence for the existence of a powerful transfer effect. Further, according to Lane and Milesi-Ferretti, 2004, I run the regression model for the countries' subgroup, where the sample based on country size may potentially affect the magnitude of the transfer effect. In this respect, the sample is split in three groups, according to the normalized *GDP* level: *a*) low-income countries where their normalized *GDP* value is smaller than 0.25, *b*) high-income countries where their value is larger than 0.75, and *c*) middle-income countries included the rest of countries' observations. The results reported in columns (6)-(8) respectively belong to samples of middle-income, low and middle-income, and high and middle-income countries. The transfer effect remains very significant, while The coefficient magnitude in the sample including low and middle-income countries or high and middle-income countries is more intensive than the sample only including middle-income countries. This may conclude that the transfer effect is more evident in poor and rich economies.

2.4.2 Real exchange rate and relative sectoral output

In this sub-section, I examine the impact of the real exchange rate appreciation on the relative sectoral output to investigate the resource movement effect in the Dutch disease theory. Following the Torvik, 2001 model, the labor allocation is constant at steady-state (i.e. $L_S^* = \frac{(1-\gamma)\delta_M}{(1-\gamma)\delta_M + \delta_S}$). Accordingly, the relative sectoral output, at steady-state, will be a function of the steady-state relative productivity ratio ϕ^* (i.e. $\frac{X_M}{X_S} = \phi^* \left(\frac{1-L_S^*}{L_S^*}\right)^\alpha$). While, in the present theory, both increasing the steady-state labor employment share in the service sector and decreasing the steady-state relative productivity ratio tend to reduce the relative sectoral output at steady-state. Nevertheless, lack of a comprehensive dataset of sectoral productivity and also shortage data for the labor employment shares, required to estimate the productivity level in each sector, enforce us to apply another proxy that

captures the impact of a natural resource boom on the relative productivity level. One seems that the relative sectoral output is a reliable and acceptable proxy to replace the relative productivity level. Therefore, the relative per capita GDP of the manufacturing to the service sector (in constant price) ²⁶ is taken into account as the dependent variable and the real effective exchange rate will be the explanatory variable of interest. I also include per capita GDP, Investment ratio, Human capital index, Openness index, Government spending, and Institution index as the control variables. I estimate the regression model using the first-differenced *GMM*. Since the system *GMM* estimator leads to arising the unit root process.

The estimated results are shown in Table 3.7. The first and second columns respectively report the *OLS* and the fixed effect, *FE* ²⁷, estimators, while column (3) shows the results estimated by the first-differenced *GMM*. The coefficients on both the resource-dependence index and the real effective exchange rate are negative and significant at %1 percent ²⁸. These imply that an increase in the resource-dependence proxy and so the real exchange rate appreciation is associated with a decrease in the relative sectoral output. More precisely, it suggests when the real exchange rate appreciates, it is more likely that the sectoral growth shrinks faster in the manufacturing sector than in the service sector and so the relative sectoral output decrease.

The finding in column (3) confirms the theory however, the values of coefficients are small. This might be because of heterogeneity across countries in terms of dependency on resource rent. Hence, I include a dummy variable of natural resource-poor countries and interaction between the dummy and the real effective exchange rate to address this issue. The estimation results reported in column (4) represent that the coefficients on the real effective exchange rate and the interaction term enter, respectively, with negative and positive signs and are significant at 5% percent. These illustrate that falling the relative sectoral output is more intensive in resource-rich countries than in resource-poor countries. The conclusion seems to be consistent with the theory and the preceding sub-section. Since the preceding section suggested that the real exchange rate appreciation is stronger in resource-rich countries than in another group. Therefore, along the transition path the relative sectoral output level (a proxy for the relative productivity) reduces more in resource-rich countries than others to induce a stronger countervailing movement of labor from the service to the manufacturing sector.

To test the robustness of the results, I first drop the resource-dependence index to satisfy lower number of instruments than the number of country groups (i.e. the rule of thumb) and then estimate the regression model for samples of developing countries, poor-institution countries, included when the value of institution index (i.e. rule of law indicator) is smaller

²⁶Similarly, it is a relative value-added share in constant price

²⁷The *Hausman* test is rejected with a *p* – value of 0.002.

²⁸The finding in the nexus between the resource-dependence index and the relative sectoral level seems to be consistent with the empirical literature. Under the panel data model of a sample including data of 28 natural resource-rich countries for the period of 2000-2016, Amiri et al., 2019 found that the relative sectoral level decreases as the natural resource income increase.

Table 2.6: Estimation results for the relative Sectoral GDP

Explanatory variable	(1)		(2)		(3)		(4)		(5)		(6)		(7)		(8)		(9)		
	<i>Bruegel</i> Full Sample	<i>Bruegel</i> FE	<i>Bruegel</i> Full Sample	<i>Bruegel</i> Diff. GMM	<i>Bruegel</i> Full Sample	<i>Bruegel</i> Diff. GMM	<i>Bruegel</i> Full Sample	<i>Bruegel</i> Diff. GMM	<i>Bruegel</i> Developing	<i>Bruegel</i> Diff. GMM	<i>Bruegel</i> Poor-Instit	<i>Bruegel</i> Diff. GMM	<i>Bruegel</i> non-Europe	<i>Bruegel</i> Diff. GMM	<i>IMF</i> Full Sample	<i>IMF</i> Diff. GMM	<i>Bruegel</i> Recession	<i>Bruegel</i> Diff. GMM	
Relative sectoral GDP (Ln) (lagged)	0.907*** (0.0128)	0.810*** (0.0287)	0.761*** (0.0916)	0.744*** (0.0818)	0.784*** (0.0828)	0.819*** (0.106)	0.801*** (0.0901)	0.762*** (0.130)	0.635*** (0.132)										
Recourse-dependence (lagged)	0.000232 (0.000816)	0.00334* (0.00189)	-0.00925*** (0.00286)	-0.00684*** (0.00263)													-0.0107*** (0.00349)		
Real effective exchange rate (lagged)	-0.000618 (0.00115)	-0.00123 (0.00110)	-0.000989*** (0.000354)	-0.0638** (0.0305)	-0.00109*** (0.000313)	-0.00114** (0.000495)	-0.00110*** (0.000391)	-0.0299** (0.0148)									-0.000818** (0.000385)		
Dummy Recourse-Poor countries				-0.0568 (0.0425)															
Dummy * Real exchange rate (lagged)				0.0628** (0.0306)															
GDP per capita (Ln)	-0.00911 (0.00845)	-0.0603 (0.0385)	-0.0405 (0.122)	-0.0225 (0.121)	0.00389 (0.146)	0.0654 (0.160)	-0.0151 (0.125)	0.0593 (0.171)											
Investment ratio	0.00280*** (0.000931)	-0.00182 (0.00125)	-0.000450 (0.00252)	-0.00196 (0.00241)	-0.000948 (0.00266)	0.00143 (0.00282)	-0.00159 (0.00247)	-0.00759 (0.00689)									0.00114 (0.00397)		
Human capital index	0.0370** (0.0178)	0.140** (0.0656)	0.00734 (0.305)	-0.109 (0.286)	0.190 (0.374)	0.0960 (0.465)	-0.103 (0.320)	-0.424 (0.396)									0.312 (0.395)		
Openness index	-0.000003 (0.000166)	0.000233 (0.000426)	-0.000280 (0.00125)	-0.000335 (0.00107)	-0.00101 (0.00171)	-0.00227 (0.00181)	-0.00117 (0.00151)	-0.00276 (0.00206)									-0.000670 (0.00167)		
Government spending	-0.00204 (0.00127)	-0.00699*** (0.00249)	0.00147 (0.00625)	0.000100 (0.00532)	-0.000361 (0.00505)	-0.000711 (0.00701)	0.000534 (0.00548)	-0.0177 (0.0113)									0.00295 (0.00517)		
Institution index	-0.00779 (0.0122)	0.0338 (0.0265)	0.0301 (0.0415)	0.0297 (0.0414)	0.0655 (0.0745)	0.0924 (0.101)	0.0719 (0.0635)	-0.0156 (0.0482)									0.0546 (0.0512)		
Time dummies	YES	YES	YES	YES	YES	YES	YES	YES	YES	YES	YES	YES	YES	YES	YES	YES	YES	YES	YES
Observations	600	600	486	486	368	289	394	263	279	279	279	279	279	279	279	279	279	279	279
Number of Countries	114	114	104	104	76	63	81	64	87	87	87	87	87	87	87	87	87	87	87
Arellano-Bond test for AR(2) (p-value)	-	-	0.764	0.881	0.822	0.961	0.787	0.436	0.621	0.621	0.621	0.621	0.621	0.621	0.621	0.621	0.621	0.621	0.621
Hansen OID test (p-value)	-	-	0.357	0.620	0.520	0.477	0.471	0.158	0.340	0.340	0.340	0.340	0.340	0.340	0.340	0.340	0.340	0.340	0.340
R-squared	0.904	0.667	-	-	-	-	-	-	-	-	-	-	-	-	-	-	-	-	-

Note: The dependent variable is the relative GDP per capita of the manufacturing to the service sector (Ln) (in constant price). The real effective exchange rate data estimated by *Bruegel* is applied in columns (1)-(7) and (9) while the data estimated by *IMF* is used in column (8). Column (1) is regressed by *OLS* estimator, column (2) is regressed by *Fixed - Effect* estimator and other columns are regressed by first-differenced *GMM* estimator. For estimation, the relative sectoral output (lagged), the resource-dependence index (lagged) and the real effective exchange rate (lagged) are instrumented by first and second lags in the first differences equation. Also, control variables are instrumented by second lag level in first differences equation. Robust standard errors are reported in parentheses. ***, ** and * denote significance at 1, 5 and 10 percent levels. The null hypothesis of *Arellano-Bond* test is that autocorrelation doesn't exist and the null hypothesis of *Hansen* test is that the instruments, as a group, is uncorrelated with the error term.

than 1.5, and the non-European countries. The results are respectively reported in columns (5)-(7). The coefficient of interest is still negative and even their value is equal to the value estimated for the full sample (5%, at most, smaller in groups' countries than the full sample²⁹). These may suggest a negligible sensitivity of the correlation from country-group heterogeneity in terms of development level, quality of the institution, and currency union's effects.

I further regress the model for a sample of the real effective exchange rate estimated by *IMF* to investigate the dependency of the results in terms of a different measurement approach for the explanatory variable of interest. The results reported at column (8) still follow the theory's prediction, the same as the results estimated using *Bruegel* database. However, the absolute value of coefficient estimated by *IMF* database is much larger than that estimated by *Bruegel* database. To sum up, this demonstrates that empirical finding confirms the theoretical prediction, independent of measurement approaches for the real effective exchange rate³⁰.

In line with the preceding subsection, I also check the consistency of the results for a sample covering the period before the great recession. The results reported in column (9) confirm the independency of the main findings from the recession's effects. The value of the coefficient on the resource-dependence index is less negative for the full sample than for the restricted sample. Regarding the theory, it may indicate that an external real exchange depreciation due to the great recession can offset a share of the negative effect of a resource boom on the relative sectoral output through the real exchange rate appreciation.

In addition, I check the sensitivity of the coefficients on the resource-dependence index and the real exchange rate to a change in sample size the same procedure as before. The average value and standard deviation of coefficients of interest for the baseline model (i.e. column (3) in Table 3.7) are reported in Table 2.7. Although the values of both coefficients on the resource-dependence and the real exchange rate are sensitive to a shrinkage in the sample size, they keep negative signs. This may confirm that the negative correlation between the relative sectoral output and the explanatory variables of interests doesn't depend on a change in the sample size. The table further shows that the significance of the coefficient decreases along with the reduction of the sample size. Since the distribution

²⁹The value of the coefficient on the real effective exchange rate for a regression model in which the resource dependence index is excluded is equal to 0.00108.

³⁰Given that this paper aims to investigate the symptoms of the Dutch disease hypothesis systematically, I have not reported the estimated results of the impact of an increase in the commodity price index on the relative sectoral output. But the results show that the coefficient on the commodity price index is insignificant for the full sample (given data availability). This may be because of existing a sample covering a shorter period and a small number of countries. It may also refer to the fact that commodity price variation differently affects resource-groups countries depending on the importance of commodities in the economy. The estimated significant result for the sample restricted to resource-poor countries supports the latter point. This is consistent with the preceding subsection and suggests that jumping up the commodity price index through the real exchange rate appreciation and consequently the factor re-allocation only decreases the relative sectoral output level.

2.4. ECONOMETRIC RESULTS

Table 2.7: Robustness test for the sensitivity of coefficient of interest

Explanatory variable		98%	95%	80%	65%
Resource-dependence (lagged)	Coefficient	-0.00870	-0.00757	-0.00435	-0.00265
	Standard Deviation	0.00181	0.00257	0.00454	0.00515
Real effective exchange rate (lagged)	Coefficient	-0.00199	-0.00487	-0.01189	-0.01432
	Standard Deviation	0.00582	0.01149	0.02423	0.04195

of both coefficients widens as the sample size shrinks.

Following the same procedure proposed in the preceding section, I also conduct recursive

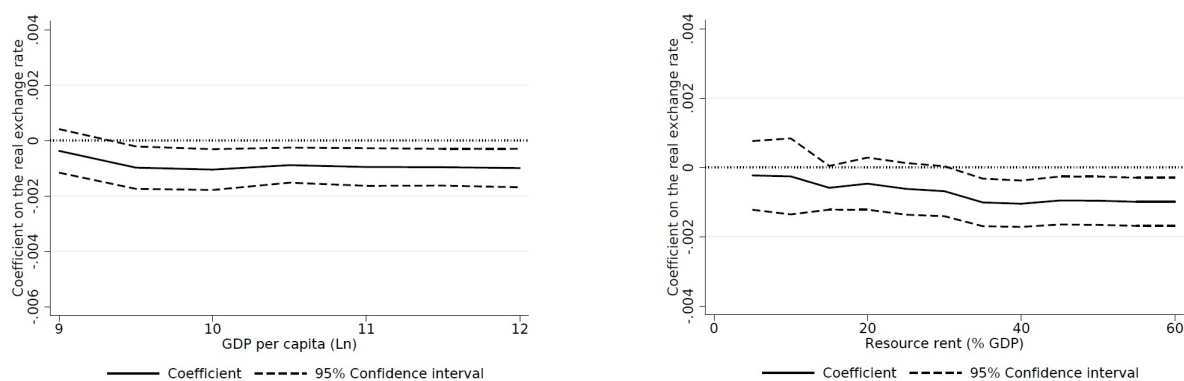

Figure 2.4: Recursive estimation on the real exchange rate.

estimations to evaluate the accuracy of the results. I estimate the coefficient on the real exchange rate for a sample of observations ranked in increasing orders of GDP per capita and resource rent share in GDP. Figure 2.4 shows the estimated results. This represents significant negative coefficients on the real exchange rate across countries and demonstrates that the value of the coefficient is approximately stable in terms of income level while it is decreasing in terms of resource rent (% GDP). The latter point is consistent with the preceding finding in column (4) of Table 3.7, suggesting that falling the relative sectoral output due to the real exchange rate appreciation is stronger in resource-rich countries than in resource-poor countries.

2.4.3 Real exchange rate and sectoral growth

So far I have analyzed the impact of the real exchange rate, appreciated by a natural resource boom, on the relative sectoral output (in constant price) as a proxy for the relative productivity ratio. But this is not the only issue of interest. It is worth conducting an investigation into the response of the sectoral economic growth, rather than the relative sectoral growth, to the real exchange rate appreciation. Sectoral GDP per capita level

(in constant price) is considered as the dependent variable and the real effective exchange rate is the explanatory variable of interest. In addition, GDP per capita (Ln), Population Growth, Investment ratio, Human capital index, Openness index, Government spending, and Institution index are included to control the regression model.

Table 3.9 contains the results for both the manufacturing and service sectors. Columns (1) and (2) represent, respectively, the estimation results of growth in the manufacturing sector using *OLS* and the first-differenced *GMM* estimators. The estimated negative and significant coefficient on the real effective exchange rate, sourced from *Bruegel*, confirms that an appreciation in the real exchange rate due to a natural resource boom shrinks the manufacturing sector, as in Sekkat and Varoudakis, 2000. Further, column (3) shows this result gets much stronger when the *IMF* database of the real exchange rate is applied instead. More precisely, a one-standard-deviation increase in the real exchange rate reduces the growth in the manufacturing sector by about 0.1% for *Bruegel* database, while it is about 4% for *IMF* database.

Columns (5) and (6) report the results of growth in the service sector. The coefficients on the real exchange rate enter with a negative sign and is significant for both *OLS* and *GMM* estimators. Also, column (7), reporting the estimation results using *IMF* database, demonstrates that the coefficient on the real exchange rate is approximately much larger than that estimated by *Bruegel* database. It shows that the growth in the service sector reduces by about 2% for *IMF* database and by about 0.1% for *Bruegel* as a one-standard-deviation increase in the real exchange rate. Further, regarding the theory, a negative coefficient on the real exchange rate seems to demonstrate that the learning generated in the manufacturing sector and spilled over to the service sector is the dominant driven force of the productivity growth in the service sector.

A comparison between the estimated coefficients reported in columns (2) and (6), on the one hand, and between columns (3) and (7), on the other hand, clarify that an increase in the real exchange rate makes the growth to be much slower in the manufacturing sector than in the service sector. A larger shrinkage in the manufacturing sector is in line with the empirical finding of the preceding sub-section. It states when the real exchange rate appreciates, the productivity level shrinks faster in the manufacturing sector than in the service sector and so the relative productivity growth (i.e. the relative sectoral output) reduces to re-establish the labor allocation among sectors.

Our findings in columns (2) and (6) also show that the values of coefficients on the variable of interest are negligible however are significant. This may reflect cross-country heterogeneity. Regarding the preceding sub-sections, I include the dummy variable of resource-poor countries and interaction between the dummy and the real effective exchange rate to address this problem. The results are reported in columns (4) and (8). The estimated coefficients of interest are significant for the manufacturing sector's regression, while they are insignificant for the service sector's regression. The estimated coefficients on the real effective exchange rate and the interaction term have negative and positive signs,

Table 2.8: Estimation results for the Sectoral Growth

Explanatory variable	(1)		(2)		(3)		(4)		(5)		(6)		(7)		(8)			
	<i>Bruegel</i>	<i>Bruegel</i>	<i>IMF</i>	<i>Bruegel</i>	<i>Bruegel</i>	<i>IMF</i>	<i>Bruegel</i>	<i>Bruegel</i>	<i>Bruegel</i>	<i>Service</i>	<i>Bruegel</i>	<i>Bruegel</i>	<i>Service</i>	<i>IMF</i>	<i>Bruegel</i>	<i>Service</i>		
	Manufacture	Manufacture	Manufacture	Manufacture	Manufacture	Manufacture	Manufacture	Manufacture	Manufacture	Service	Service	Service	Service	Service	Service	Service		
	OLS	Diff. GMM	Diff. GMM	Diff. GMM	Diff. GMM	Diff. GMM	Diff. GMM	Diff. GMM	OLS	OLS	Diff. GMM	Diff. GMM	Diff. GMM	Diff. GMM	Diff. GMM	Diff. GMM		
Sectoral GDP per capita (Ln) (lagged)	0.854*** (0.0139)	0.361*** (0.0845)	0.426*** (0.107)	0.345*** (0.0658)	0.717*** (0.0164)	0.153*** (0.0579)	0.264*** (0.0775)	0.149*** (0.0563)										
Real effective exchange rate (lagged)	-0.00249* (0.00128)	-0.00130*** (0.000395)	-0.0388*** (0.0139)	-0.106** (0.0423)	-0.00186** (0.000769)	-0.000979*** (0.000131)	-0.0176** (0.00819)	-0.00986 (0.0147)										
Dummy Resource-Poor countries				-0.0907** (0.0421)														
Dummy * Real exchange rate (lagged)				0.105** (0.0423)														
GDP per capita (Ln)	0.114*** (0.0161)	0.747*** (0.160)	0.615** (0.267)	0.779*** (0.174)	0.268*** (0.0177)	0.828*** (0.0535)	0.843*** (0.0955)	0.839*** (0.0618)										
Population Growth	-0.0333*** (0.00881)	-0.0169 (0.0138)	-0.0387** (0.0160)	-0.0242* (0.0143)	-0.0255*** (0.00516)	-0.00687 (0.00497)	-0.00725 (0.0139)	-0.00954* (0.00488)										
Investment ratio	0.00869*** (0.000992)	0.000414 (0.00402)	-0.00298 (0.00523)	-0.000181 (0.00320)	0.00366*** (0.000610)	0.00194 (0.00168)	0.00188 (0.00271)	0.00254 (0.00185)										
Human capital index	0.0418* (0.0217)	-0.190 (0.363)	-0.118 (0.365)	-0.190 (0.504)	0.0324*** (0.0123)	-0.0631 (0.149)	0.142 (0.107)	-0.0804 (0.185)										
Openness index	-0.00004 (0.000190)	-0.000420 (0.00135)	-0.00131 (0.00190)	0.000141 (0.00129)	-0.00004 (0.000103)	-0.000198 (0.000275)	-0.000356 (0.000706)	-0.000158 (0.000246)										
Government spending	-0.00429*** (0.00138)	-0.00371 (0.00491)	-0.00715 (0.01000)	-0.00311 (0.00576)	-0.00114 (0.000793)	0.000357 (0.00341)	0.0100** (0.00461)	0.00110 (0.00292)										
Institution index	0.0266** (0.0130)	-0.0125 (0.0400)	-0.0224 (0.0456)	-0.0157 (0.0425)	0.0309*** (0.00757)	-0.0296* (0.0171)	-0.0190 (0.0245)	-0.0272* (0.0157)										
Time dummies	YES	YES	YES	YES	YES	YES	YES	YES	YES	YES	YES	YES	YES	YES	YES	YES	YES	
Observations	624	509	268	509	636	519	265	519	636	636	519	265	519	636	636	519	519	
Number of Countries	115	106	64	106	121	109	64	119	121	121	109	64	119	121	121	109	119	
Arellano-Bond test for AR(2) (p-value)	-	0.899	0.990	0.911	-	0.355	0.066	0.439	-	-	0.355	0.066	0.439	-	-	-	-	
Hansen OID test (p-value)	-	0.148	0.364	0.309	-	0.177	0.395	0.218	-	-	0.177	0.395	0.218	-	-	-	-	
R-squared	0.989	-	-	-	0.996	-	-	-	-	-	-	-	-	-	-	-	-	

Note: The dependent variable is the sectoral GDP per capita level (Ln). The real effective exchange rate, used in estimation, is sourced from *Bruegel* and *IMF*. Columns (1) and (5) are regressed by *OLS*, while other columns are estimated by the first differenced *GMM* estimator. For estimation, the sectoral output level (lagged) and control variables, except Population growth and Institution index, are instrumented by second lag level, while the real effective exchange rate (lagged) is instrumented by first and prior lags in first differences equation. Robust standard errors are reported in parentheses. ***, ** and * denote significance at 1, 5 and 10 percent levels. The null hypothesis of *Arellano-Bond* test is that autocorrelation doesn't exist and the null hypothesis of *Hansen* test is that the instruments, as a group, are uncorrelated with the error term.

respectively. These suggest that the adverse effect of the real exchange rate appreciation on the sectoral growth rate is more intensive in resource-rich countries than in resource-poor countries. Regarding more appreciation of the real exchange rate and so larger reduction of the relative sectoral output level in resource-rich countries than resource-poor countries (see. preceding sub-sections and the theory), these findings seem to be plausible.

Now, I conduct a sensitivity analysis for both sectors' baseline models (i.e. columns (2)

Table 2.9: Robustness test for the sensitivity of coefficients of interest

Explanatory variable		98%	95%	80%	65%
			Manufacture		
Real effective exchange rate (lagged)	Coefficient	-0.00561	-0.00688	-0.01834	-0.01459
	Standard Deviation	0.01771	0.01803	0.02845	0.04581
			Service		
Real effective exchange rate (lagged)	Coefficient	-0.00160	-0.00237	-0.00747	-0.00913
	Standard Deviation	0.00295	0.00438	0.01174	0.01490

and (6) in Table 3.9) to a change in sample size, following the same procedure as preceding sub-sections. The coefficients of the real exchange rate for both sectoral regressions are reported in Table 2.9. They enter with negative signs independently of the sample size however, their normal distributions are widened and their tails fall along with shrinkage in the sample size. These are more likely to suggest that the significance of the coefficients decreases as the sample size shrinks.

The final robustness test is included to test the stability of coefficients on the real exchange rate for both baseline regression models. The recursive estimation on the coefficients of interest in terms of per capita GDP level and resource-dependence index are shown in Figure 2.5. The graphs demonstrate that a negative effect of the real exchange rate on the sectoral growth rate doesn't depend on heterogeneity across countries. Further, for the service sector, the value of the coefficient is stable in terms of both per capita GDP level and resource rent (% GDP), while for the manufacturing sector it is only stable in terms of per capita GDP level and decreasing in terms of resource rent (% GDP). The latter point clarifies the previous finding that a natural resource curse is more intensive in a resource-rich county than in a resource-poor country.

2.4.4 Real exchange rate and economic growth

The mechanism of the model and preceding empirical findings illustrate that a resource boom through an appreciation in the real exchange rate decelerates the growth rate of both the manufacturing and service sectors. Therefore, an economy is more likely to expand slower as the resource rent booms. This refers to the natural resource curse's hypothesis, empirically supported by J. D. Sachs and Warner, 1995; Rodriguez and J. D. Sachs, 1999; Gylfason, Herbertsson, and Zoega, 1999. Furthermore, as I mentioned before, recent

2.4. ECONOMETRIC RESULTS

studies reveal that the real exchange rate appreciation causes economic growth to become slower (e.g. Eichengreen, 2007; Rodrik, 2008; Habib, Mileva, and Stracca, 2017). These motivate us to re-investigate how the economic growth rate rather the sectoral growth rates respond to explanatory variables of interest (i.e. the real exchange rate appreciation and the resource boom) using a dynamic panel data approach.

GDP per capita level (in constant price) is considered as the dependent variable and the

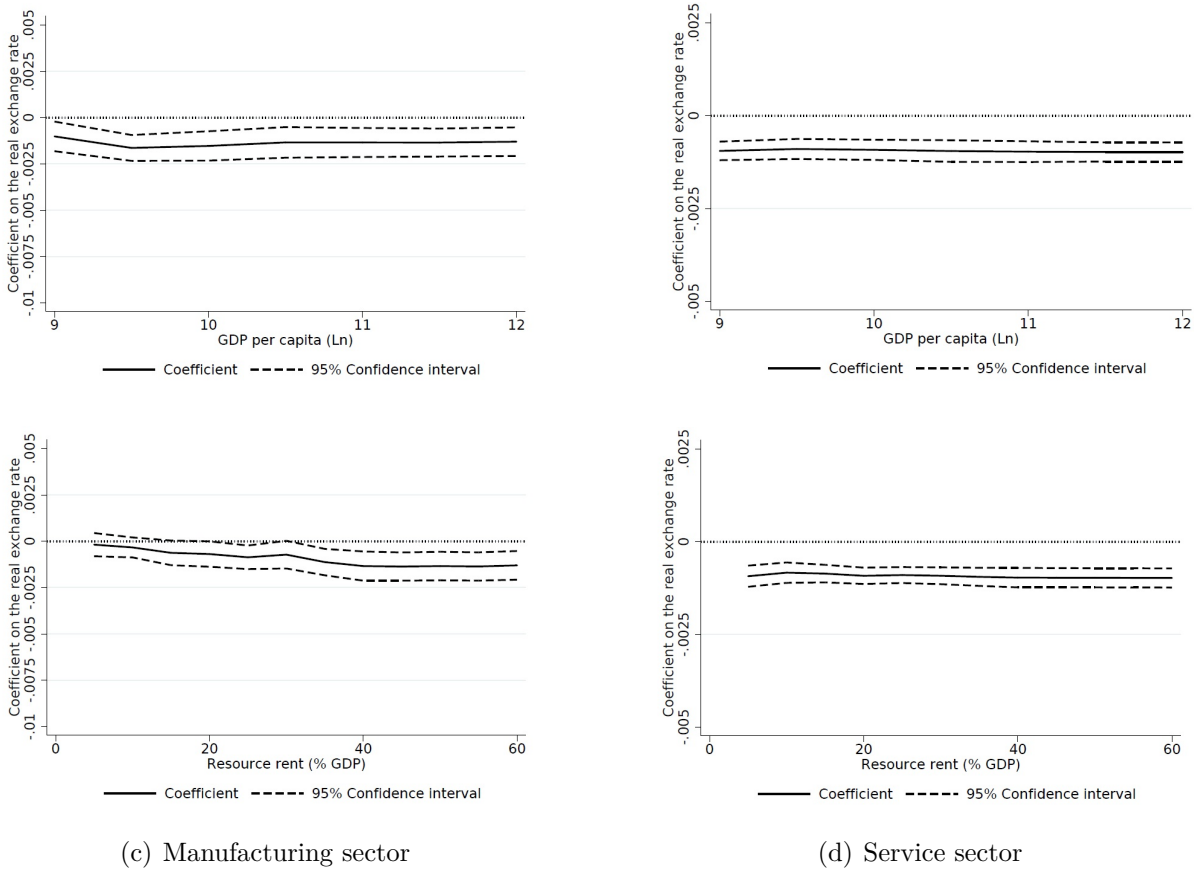

Figure 2.5: Recursive estimation on the real exchange rate.

resource-dependence index, as well as the real exchange rate, are the explanatory variables of interest. I also include Population Growth, Investment ratio, Human capital index, Openness index, Government spending, and Institution index to control the regression model. I further use the first-differenced *GMM* to estimate the regression model. Since the estimated results by the System *GMM* is suspicious to have a unit root.

Table 2.10 shows the results. *OLS* and *FE*³¹ estimations are respectively reported in Columns (1) and (2) as benchmarks. The baseline model reported in column (3) suggests that both coefficients of interest enter with negative signs and are significant at 1%. More precisely, the economic growth rate, on average, decelerates by about 0.8% as a one-standard-deviation increase in the resource-dependence index and it reduces by about 0.1% as a one-standard-deviation increase in the real exchange rate. Consistent

³¹The *Hausman* test is rejected with a *p* – value of 0.000.

Table 2.10: Estimation results for the Economic Growth

Explanatory variable	(1)	(2)	(3)	(4)	(5)	(6)	(7)	(8)	(9)
	<i>Bruegel</i>	<i>Bruegel</i>	<i>Bruegel</i>	<i>Bruegel</i>	<i>Bruegel</i>	<i>Bruegel</i>	<i>Bruegel</i>	<i>IMF</i>	<i>Bruegel</i>
	Full Sample	Full Sample	Full Sample	Full Sample	Developing	Poor-Instt	non-Europe	Full Sample	Recession
	OLS	FE	Diff. GMM	Diff. GMM	Diff. GMM	Diff. GMM	Diff. GMM	Diff. GMM	Diff. GMM
GDP per capita (Ln) (lagged)	0.962*** (0.00507)	0.763*** (0.0195)	0.752*** (0.0414)	0.798*** (0.0506)	0.734*** (0.0564)	0.784*** (0.0678)	0.732*** (0.0454)	0.627*** (0.0836)	0.761*** (0.0548)
Resource-dependence (lagged)	-0.000495 (0.000575)	-0.00207* (0.00112)	-0.00767*** (0.00289)	-0.00347** (0.00175)	-0.00701*** (0.00245)	-0.00950*** (0.00320)	-0.00763*** (0.00276)	-0.00735*** (0.00299)	-0.00581** (0.00305)
Real effective exchange rate (lagged)	-0.00237*** (0.000809)	-0.00130* (0.000734)	-0.00110*** (0.000250)	-0.0431** (0.0175)	-0.00105*** (0.000272)	-0.000724*** (0.000253)	-0.00103*** (0.000306)	-0.0187** (0.000841)	-0.00132*** (0.000331)
Dummy Resource-Poor countries				-0.0428 (0.0307)					
Dummy * Real exchange rate (lagged)				0.0420** (0.0174)					
Population Growth	-0.0260*** (0.00494)	-0.00614 (0.00681)	-0.00961 (0.0102)	-0.00921 (0.0113)	-0.00106 (0.0106)	-0.000517 (0.0107)	-0.00141 (0.0105)	0.00201 (0.0143)	-0.00729 (0.0114)
Investment ratio	0.00684*** (0.000570)	0.00663*** (0.000736)	0.0113*** (0.00232)	0.00807*** (0.00202)	0.00669*** (0.00244)	0.00836*** (0.00280)	0.00837*** (0.00276)	0.00880*** (0.00253)	0.00890*** (0.00254)
Human capital index	0.0333*** (0.0116)	-0.0144 (0.0382)	0.0490 (0.143)	-0.469* (0.239)	-0.103 (0.162)	0.0253 (0.161)	0.0135 (0.219)	0.238 (0.194)	0.0446 (0.133)
Openness index	0.000154 (0.000101)	0.000497*** (0.000177)	0.000482** (0.000220)	0.000511** (0.000247)	0.000756* (0.000422)	0.000482 (0.000294)	0.00131 (0.00105)	0.000998 (0.00119)	0.000483* (0.000249)
Government spending	-0.00318*** (0.000752)	-0.00509*** (0.00120)	-0.00396 (0.00309)	-0.00488 (0.00351)	-0.00598* (0.00346)	-0.00626* (0.00334)	-0.00548 (0.00333)	-0.00758 (0.00793)	-0.00625** (0.00258)
Institution index	0.0334*** (0.00783)	-0.0262 (0.0161)	-0.0514** (0.0247)	-0.0513* (0.0312)	0.0680 (0.0481)	0.0586 (0.0496)	0.00296 (0.0404)	-0.0388 (0.0461)	-0.00805 (0.0370)
Time dummies	YES	YES	YES	YES	YES	YES	YES	YES	YES
Observations	755	755	635	635	463	370	508	320	401
Number of Countries	120	120	120	120	91	78	97	70	106
Arellano-Bond test for AR(3) (p-value)	-	-	0.833	0.577	0.573	0.393	0.688	0.167	0.229
Hansen OJD test (p-value)	-	-	0.186	0.102	0.227	0.369	0.259	0.344	0.193
R-squared	0.995	0.892	-	-	-	-	-	-	-

Note: The dependent variable is the GDP per capita level (Ln). The real effective exchange rate is sourced from *Bruegel* and *IMF*. Columns (1) and (2) are respectively regressed by *OLS* and *FE*, while other columns are estimated by the first differenced *GMM* estimator.

For estimation, the GDP per capita level (Ln) and control variables, except Population growth and Institution index, are instrumented by second lag level, the resource-dependence index (lagged) is instrumented by second and prior lags and the real effective exchange rate (lagged) is instrumented by first and prior lags in first differences equation.

Robust standard errors are reported in parentheses. ***, ** and * denote significance at 1, 5 and 10 percent levels. The null hypothesis of *Arellano-Bond* test is that autocorrelation doesn't exist. I report AR(3) instead of AR(2) since the null hypothesis is rejected in AR(2). The null hypothesis of *Hansen* test is that the instruments, as a group, are uncorrelated with the error term.

with the main empirical studies (J. D. Sachs and Warner, 2001; Rodrik, 2008) and the present theory, these findings seem to confirm the presented model's prediction and to demonstrate both the natural resource curse hypothesis and the adverse effect of the real exchange rate on economic growth.

Following the preceding sub-sections, it seems to be worth discussing the heterogeneity across countries in terms of resource dependency. I include the dummy variable of the natural resource-poor countries and an interaction term, the same as before. The estimated result, reported in column (4), reveals that GDP per capita expands slower in natural resource-rich countries than in natural resource-poor countries as the real exchange rate appreciates. This is in following the preceding empirical findings in which appreciation in the real exchange rate, reduction in the relative sectoral output and deceleration in sectoral growth are more intensive in natural resource-rich countries than in natural resource-poor countries as the resource-dependence index increases.

As the first robustness check, I regress the baseline model (i.e. column (3)) for the developing countries, the poor-institution countries, and the non-European countries to test country-group heterogeneity. The results reported in columns (5) through (7) suggest that country-group heterogeneity doesn't affect the qualitative response of the economic growth to explanatory variables of interest. One interesting finding is that the negative effect of the resource rent on economic growth is stronger for the sample of the poor-institution countries than for the full sample. In line with Mehlum, Moene, and Torvik, 2006b, it seems to confirm that improvement in the institutional quality can moderate the adverse effect of a resource boom.

I also estimate the baseline regression model for a sample of *IMF* database to check the dependency of the results on the measurement approach for the real exchange rate. The estimated results report in column (8). Significant negative coefficients on the resource-dependence index and the real exchange rate derive the same interpretation as before and demonstrate the independence of the results from the real exchange rate databases. Further, in the last column of Table 2.10, the sample is restricted to periods before 2004 in order to check the consistency of the findings, regarding the great recession effects. The estimated results suggest that the recession may affect the response of the economic growth to both variables of interest quantitatively, not qualitatively.³²

The same as procedure proposed in preceding sub-sections, I check the sensitivity of coefficients on the resource-dependence index and the real exchange rate. The sensitivity analysis reported in Table 2.11 shows that negative relationship between the explanatory

³²Investigation on the impact of the commodity price index on economic growth does not lead to finding a significant and strong correlation neither for the full sample nor for the restricted sample of resource-poor countries. One may be because of using a sample covering a shorter period and also a small number of countries, with respect to the base sample related to the resource-dependence index. The second reason may back to the method that is used to construct the commodity price index. Although the main advantage of the measurement of the index using shares of commodities in a given year is to avoid possible endogeneity problems arising in the event of a volume response to price changes, it seems to be far from an ideal procedure. Since the index using a constant base year does not capture the effects of resource discoveries and other quantity shocks that happen after the base year.

variables of interest and the economic growth is qualitatively confirmed in different sample size, however the significance of the results decreases as the sample size shrinks.

I also conduct a recursive estimation to evaluate the accuracy of the results in terms of

Table 2.11: Robustness test for the sensitivity of coefficient of interest

Explanatory variable		98%	95%	80%	65%
Resource-dependence (lagged)	Coefficient	-0.00631	-0.00548	-0.00359	-0.00261
	Standard Deviation	0.00130	0.00189	0.00265	0.00353
Real effective exchange rate (lagged)	Coefficient	-0.00270	-0.00567	-0.01319	-0.01483
	Standard Deviation	0.00856	0.01351	0.02085	0.02773

GDP per capita level and resource-dependence level. Figure 2.4.4 illustrates the stability of a negative correlation between the real exchange rate and the economic growth in terms of GDP per capita level. While it is slightly decreasing along increasing the resource-dependence level. The latter point suggesting that the adverse effect of the real exchange rate on economic growth is more intensive in a sample of included resource-rich countries than a sample of excluded them may clarify the more deceleration of the economic growth in resource-rich countries than resource-poor countries.

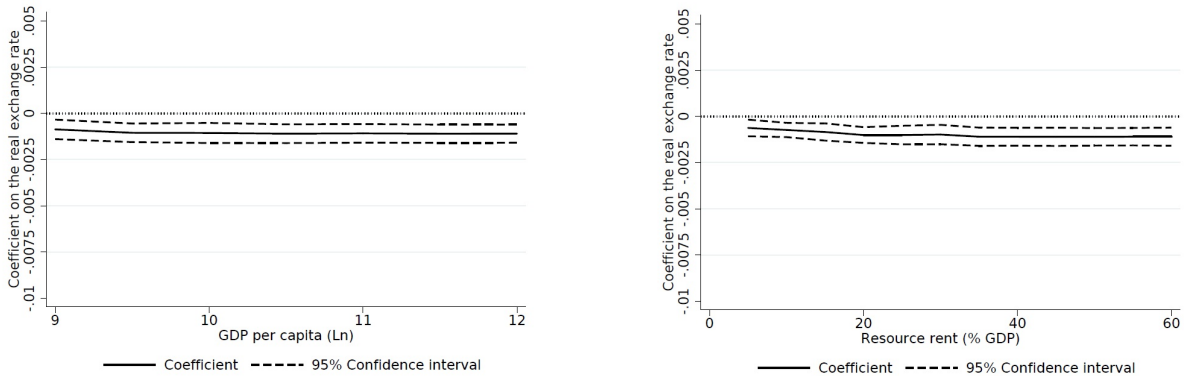

Figure 2.6: Recursive estimation on the real exchange rate.

2.5 Conclusion

In this paper, I take another look at the Dutch disease hypothesis from theoretical and also empirical perspective. Literature reveals, on the one hand, there are several limitations in the earlier theories presented to describe the Dutch disease hypothesis. Contrary to the empirical evidence, models, driven by Learning By Doing (*LBD*), predict that a resource boom tends to depreciate the steady-state real exchange rate and has no effect on the rate

of economic growth in the long-term. On the other hand, less attention has been paid to systematically analyze the symptoms of Dutch disease. Hence, the first contribution, in the context of theory, is to revise the influential model so that its predictions meet the empirical evidence. In addition, the second contribution, in the context of empirical study, is to find a direct nexus between booming resource rent and the real exchange rate and then to provide a clear assessment of the response of the relative output level, sectoral growth, and economic growth to the real exchange rate appreciation.

To address the objectives, I first develop a two-sector model in which both the manufacturing and service sectors contribute to generate productivity and there are an imperfect spillover from the manufacturing to the service sector as well as a technology spillover from the resource sector to the manufacturing sector. Contrary to Torvik, 2001; Bjørnland and Thorsrud, 2016, the model shows that the steady-state real exchange rate appreciates conditionally and the rate of growth in the economy and in both sectors decelerates.

I then collect an unbalanced panel data set of 132 countries over a sample of five-year periods from 1970 to 2014 and estimate a dynamic regression model using the *GMM* model to investigate the empirical relevance of the theory. The empirical results, taken together, do not contradict the presented model of the Dutch disease hypothesis. The main findings can be summarized in three points. First, the empirical strategy suggests a strong and statically significant positive effect on the real exchange rate from a natural resource boom. Second, the real exchange rate appreciation decelerates the rate of growth in both sectors such that the shrinkage is larger in the manufacturing sector than in the service sector. Accordingly, the relative output level of the manufacturing sector to the service sector diminishes and economic growth decelerates. Third, these effects are more intensive in resource-rich countries than resource-poor countries.

Appendix 2.A Steady state response of a resource boom

Combining Equation 2.6, we get $\phi^* \left(\frac{L_S^*}{1-L_S^*} \right)^{1-\alpha} = \phi^{*\frac{1}{\sigma}} \left(\frac{(1-L_S^*)^\alpha + R}{L_S^{*\alpha}} \right)^{\frac{1}{\sigma}}$. Therefore we have,

$$\phi^*(R) = \left[\frac{(L_S^*)^{1-\alpha} (L_S^*)^{\frac{\alpha}{\sigma}}}{(L_M^*)^{1-\alpha} ((L_M^*)^\alpha + R)^{\frac{1}{\sigma}}} \right]^{1-\sigma}$$

Replacing ϕ^* in one of Equations 2.6 gives us the steady-state value of the real exchange rate. Further, the derivative of the steady-state relative productivity ratio with respect to R is,

$$\frac{d\phi^*}{dR} = \frac{\sigma}{1-\sigma} \frac{\phi^*}{P^*} \left[\left(\frac{dP^*}{dL_S^*} \right)_{LL} - \left(\frac{dP^*}{dL_S^*} \right)_{NN} \right] \frac{dL_S^*}{dR} - \frac{\phi^*}{(1-\sigma)[(L_M^*)^\alpha + R]}.$$

Where $\left[\left(\frac{dP^*}{dL_S^*} \right)_{LL} - \left(\frac{dP^*}{dL_S^*} \right)_{NN} \right]$ denote the gap in slopes of LL and NN curves at steady-state. It represents that a resource boom reduces the relative productivity ratio, $\frac{d\phi^*}{dR} < 0$, if the following condition is satisfied.

$$\frac{dL_S^*}{dR} < \frac{\frac{P^*}{\sigma((L_M^*)^\alpha + R)}}{\left[\left(\frac{dP^*}{dL_S^*} \right)_{LL} - \left(\frac{dP^*}{dL_S^*} \right)_{NN} \right]} = \frac{L_M^* L_S^*}{\sigma[(L_M^*)^\alpha + 1 - \alpha L_S^*]}.$$

More simplification: as regards, $(L_M^*)^\alpha < 1$ and $\alpha L_S^* > 0 \Rightarrow \frac{L_M^* L_S^*}{2\sigma} < \frac{L_M^* L_S^*}{\sigma[(L_M^*)^\alpha + 1 - \alpha L_S^*]}$.

We also know that $\frac{dL_S^*}{dR} = \frac{\delta_R'(R)}{(1-\gamma)\delta_M + \delta_S}$. Therefore, $\frac{d\phi^*}{dR} < 0$ if

$$\delta_R'(R) = \frac{\delta_S - \delta_R}{2\sigma} \frac{(1-\gamma)\delta_M + \delta_S}{(1-\gamma)\delta_M + \delta_S} \Rightarrow \frac{dL_S^*}{dR} = \frac{(\delta_S - \delta_R)((1-\gamma)\delta_M + \delta_S)}{2\sigma}.$$

The derivative of Equation 2.6a with respect to R at steady-state is equal to:

$$\frac{dP^*}{dR} = \frac{P^*}{\phi^*} \frac{d\phi^*}{dR} + (1-\alpha) \frac{P^*}{L_M^* L_S^*}.$$

It demonstrates that decreasing in the relative productivity ratio is accompanied by raising the real exchange rate if $0 > \frac{d\phi^*}{dR} > -\frac{(1-\alpha)\phi^*}{L_M^* L_S^*}$. While both the relative productivity ratio and the real exchange rate decrease if $\frac{d\phi^*}{dR} < -\frac{(1-\alpha)\phi^*}{L_M^* L_S^*}$.

Appendix 2.B Commodity Price index: Data Description, Sources and Methodology

The empirical study to analyze the impact of the commodity price index on variables of interest is based on a panel dataset consisting of 73 countries over the period 1990-2014 (given data availability). To construct the composite commodity export price index, I first collect data on world prices of 16 non-agriculture commodities³³ as well as commodity export and import values. Data for commodity price indices are extracted from the *IMF – IFS* International Financial Statistics database. While, commodity export and import data for each country over the available period are collected from the *UNCTSD* (United Nations Commodity Trade Statistics Database) database³⁴. I then construct country-commodity specific weight in 1990 by dividing the individual 1990 net export values for each commodity to the total net export value of all commodities in 1990³⁵. The weights are held fixed over periods to ignore possible endogeneity problems arising in supply responses to world prices and so to construct an exogenous index. The geometrically-weighted index of commodity export prices for country i in year t (PC_{it}) is structured as follows:

$$PC_{it} = \prod_{j=1}^J PC_{jt}^{w_{j90}},$$

where PC_{jt} represents the international market prices for commodity j in year t and w_{j90} is country-commodity specific weight in 1990. Finally, to allow the effect of commodity export prices to be larger for countries with higher commodity exports, the log of the geometrically weighted index is weighted by the 1990 share of net commodity exports in a country's GDP (see. Collier and Goderis, 2008).

³³The non-agricultural commodities are aluminium, cobalt, lead, Oil crude, tin, coal, natural gas, phosphates, platinum, zinc, copper, iron ore, nickel, silver, uranium, wood. Points: 1) a normalized average prices (US dollar) of hard and soft swan-woods is given as the price of wood (2010=100), 2) a normalized average prices (US dollar) of coal for Australia and South Africa bases is given as the price of coal (2010=100), 3) a normalized average prices (US dollar) of natural gas for USA and Europe bases is given as the price of gas (2010=100), and *APSP* crude oil price that is weighted average of three crude oil spot prices (west Texas intermediate, dated Brent and Dubai Fateh) is considered as oil crude price.

³⁴It reports dollar values of exports and imports according to the *SITC1* system.

³⁵For countries with missing 1990 data for commodity export and import values, the analysis employs values available in the year closest to 1990.

Appendix 2.C The net foreign assets and resource-dependence

In this appendix, I put forward the long-run relation between the natural resource rent and the net foreign assets. The sample consists of 114 countries for the period 1970-2014. The dependent variable is the net foreign assets and the explanatory variable of interest is the resource-dependence index. I also include a number of control variables, namely the level of GDP per capita, Foreign Direct Investment, Terms of trade, Openness index, and Institution index.

Table 2.12 reports the results. Column (1) represents the results estimated by *OLS* as

Table 2.12: Estimation results for the net foreign assets

Explanatory variable	(1)	(2)	(3)	(4)	(5)
	Full Sample OLS	Full Sample Sys. GMM	Developing Sys. GMM	Resource-Poor Sys. GMM	Resource-Rich Sys. GMM
Net foreign assets (lagged)	0.736*** (0.0211)	0.699*** (0.117)	0.653*** (0.129)	0.642*** (0.198)	0.807*** (0.0837)
Resource-dependence (lagged)	0.177*** (0.0447)	0.356*** (0.112)	0.359*** (0.113)	0.997 (1.473)	0.549*** (0.196)
GDP per capita (Ln)	-0.0567 (0.388)	-0.536 (1.148)	0.557 (1.321)	-1.057 (2.826)	-2.488* (1.331)
Foreign Direct Investment	0.0396 (0.125)	-0.579 (0.371)	-0.416 (0.261)	-0.595 (0.715)	-0.185 (0.369)
Terms of trade (Ln)	-0.156 (1.082)	1.017 (2.336)	1.159 (2.299)	14.69 (16.15)	0.953 (4.702)
Openness index	0.0532*** (0.0129)	0.148*** (0.0460)	0.112*** (0.0426)	0.169** (0.0765)	0.0703 (0.0602)
Institution index	0.189 (0.675)	1.375 (1.879)	2.938 (2.384)	2.363 (4.145)	5.034 (3.488)
Time dummies	YES	YES	YES	YES	YES
Observations	763	763	682	375	313
Number of Countries	66	114	103	72	66
Arellano-Bond test for AR(2) (p-value)	-	0.136	0.199	0.178	0.585
Hansen OID test (p-value)	-	0.231	0.371	0.596	0.341
R-squared	0.727	-	-	-	-

Note: The dependent variable is the Net foreign assets. The resource-dependence (lagged) is instrumented by first lag level in the first differences equation. Also, control variables are instrumented by second lag level in the first differences equation for full and developing countries' samples, while they are instrumented by second lag level to satisfy the rule of thumb for Resource-poor and rich countries' samples.

Robust standard errors are reported in parentheses. ***, ** and * denote significance at 1, 5 and 10 percent levels. The null hypothesis of *Arellano-Bond* test is that autocorrelation doesn't exist and the null hypothesis of *Hansen* test is that the instruments, as a group, is uncorrelated with the error term.

a benchmark, while the column (2) reports the results of the baseline regression model

2.D. LIST OF COUNTRIES

estimated by *Sys.GMM*. These demonstrate that increasing the resource-dependence index is significantly associated with larger net foreign assets. The result confirms that the impact of the resource rent on the economic performance transmits more likely through the international transfer payment. Further, the control variables, except Openness index, are insignificant while qualitatively acceptable. As a robustness check I run the panel regressions for country subgroups. Columns (3)-(5) show the results for sample of developing, resource-poor and resource-rich countries, respectively. The coefficient on the resource-dependence enters with a positive sign for all samples while it remains significant only for sample of developing and resource-rich countries. The larger magnitude of the coefficient of interest for the sample of resource-rich countries than for the full sample plausibly explains why most of the natural resource-rich countries are creditors.

Appendix 2.D List of Countries

CHAPTER 2. THE DUTCH DISEASE REVISITED

Table 2.13: List of Countries

	Period	No.	Period		Period	No.	Period		Period	No.	Period
Albania	1985-2014	6	Gambia, The	1970-2014	9	Romania	1990-2014	5			
Algeria*	1970-2014	9	Germany*	1970-2014	9	Russia*	1990-2014	5			
Angola*	1980-2014	7	Ghana*	1970-2014	9	Rwanda	1970-2014	9			
Argentina*	1970-2014	9	Greece*	1970-2014	9	Saudi Arabia*	1970-2014	9			
Armenia	1990-2014	5	Guatemala*	1970-2014	9	Senegal*	1970-2014	9			
Australia*	1970-2014	9	Haiti	1970-2014	9	Sierra Leone	1970-2014	9			
Austria	1970-2014	9	Honduras*	1970-2014	9	Slovakia*	1990-2014	5			
Azerbaijan	1995-2014	4	Hungary*	1990-2014	5	Slovenia*	1995-2014	4			
Bahrain*	1980-2014	7	India*	1970-2014	9	South Africa	1970-2014	9			
Bangladesh	1970-2014	9	Indonesia*	1970-2014	9	Spain*	1970-2014	9			
Barbados	1970-2014	9	Iran*	1970-2014	9	Sri Lanka	1970-2014	9			
Belarus*	1990-2014	5	Ireland	1970-2014	9	Sudan	1970-2014	9			
Belgium	1970-2014	9	Italy	1970-2014	9	Suriname*	1970-2014	9			
Belize	1975-2014	8	Jamaica	1970-2014	9	Swaziland	1970-2014	9			
Benin*	1970-2014	9	Japan*	1970-2014	9	Switzerland*	1980-2014	7			
Bhutan	1980-2014	7	Jordan*	1975-2014	8	Sweden*	1970-2014	9			
Bolivia*	1970-2014	9	Kazakhstan*	1990-2014	5	Tajikistan	1995-2014	4			
Botswana	1970-2014	9	Kenya	1970-2014	9	Tanzania	1990-2014	5			
Brazil*	1970-2014	9	Korea south	1970-2014	9	Thailand	1970-2014	9			
Brunei*	1985-2014	6	Kuwait*	1990-2014	5	Togo*	1970-2014	9			
Bulgaria*	1980-2014	7	Kyrgyzstan*	1990-2014	5	Trinidad and Tobago*	1970-2014	9			
Burkina Faso	1970-2014	9	Lao PDR	1980-2014	7	Turkey	1970-2014	9			
Burundi	1970-2014	9	Latvia*	1995-2014	4	Tunisia*	1970-2014	9			
Cambodia	1990-2014	5	Lithuania	1995-2014	4	Ukraine*	1990-2014	5			
Cameron*	1970-2014	9	Luxembourg	1970-2014	9	Uganda	1980-2014	7			
Canada*	1970-2014	9	Madagascar	1970-2014	9	United Kingdom*	1970-2014	9			
Central Africa*	1980-2014	7	Malawi	1970-2014	9	United States*	1970-2014	9			
Chad	1970-2014	9	Malaysia*	1970-2014	9	Uruguay	1970-2014	9			
Chile*	1970-2014	9	Mali	1970-2014	9	Venezuela*	1970-2014	9			
China*	1970-2014	9	Mauritania*	1970-2014	9	Vietnam	1985-2014	6			
Colombia*	1970-2014	9	Mexico*	1970-2014	9	Yemen*	1990-2014	5			
Congo, Dem.	1970-2014	9	Moldova	1995-2014	4	Zambia*	1970-2014	9			
Congo, Rep.*	1970-2014	9	Mongolia	1990-2014	5						
Costa Rica	1970-2014	9	Morocco*	1970-2014	9						
Cote d'Ivoire	1970-2014	9	Mozambique	1980-2014	7						
Croatia	1995-2014	4	Namibia	1980-2014	7						
Cyprus	1975-2014	8	Nepal	1970-2014	9						
Czech*	1990-2014	5	Netherlands*	1970-2014	9						
Denmark*	1970-2014	9	New Zealand*	1970-2014	9						
Dominican Rep	1970-2014	9	Nicaragua*	1970-2014	9						
Ecuador*	1970-2014	9	Niger*	1970-2014	9						
Egypt*	1970-2014	9	Nigeria*	1980-2014	7						
El Salvador	1970-2014	9	Norway*	1970-2014	9						
Eritrea	1990-2014	5	Pakistan	1970-2014	9						
Estonia*	1995-2014	4	Panama	1970-2014	9						
Ethiopia	1980-2014	7	Paraguay	1970-2014	9						
Fiji*	1970-2014	9	Peru*	1970-2014	9						
Finland*	1970-2014	9	Philippine*	1970-2014	9						
France*	1970-2014	9	Poland*	1990-2014	5						
Gabon*	1970-2014	9	Portugal	1970-2014	9						

Note: countries marked by (*) are included in the sample of the commodity price index.

Chapter 3

Does income inequality feed the Dutch disease?

While much ink has been spilled over the study of income inequality and the Dutch disease in isolation from each other, little attention has been paid to the association between these subjects of interest. From this perspective, the present paper develops a two-sector growth model including two groups of workers (skilled and unskilled) with different consumption baskets. The model is induced by a relative real wage between sectors and between workers in the short-term (comparative static), while it is driven by the relative productivity growth and also a change in the relative consumption expenditure, resulting from an income inequality change, in the long-term. The main findings are twofold. First, a natural resource boom reduces income inequality if the relative real wage of skilled to unskilled workers is stronger than their relative share on windfall income benefit (subsidies). Second, falling income inequality exacerbates the intensity of the Dutch disease if skilled workers, with respect to unskilled workers, allocate a larger expenditure share for traded goods. Using the dynamic panel data approach for a sample of 79 countries over the period 1975-2014, I evaluate the theory's predictions. The empirical study represents some clear evidence in supporting the crucial role of income inequality in the economic performance of resource-dependent countries.

3.1 Introduction

Resource economies have usually failed to show better economic performance than the others (Frankel, 2010). In practice, these economies exhibit slower growth (J. D. Sachs and Warner, 1995) and higher levels of income inequality (Boyce and Ndikumana, 2012). The questions that have attracted growing attention of researchers are the impact of windfall income on economic growth and income inequality. Surprisingly, these variables of interest have been studied in isolation from each other and a little attention has been paid to study these variables in a unified framework. Literature reveals that economic growth and income inequality are endogenous variables and their co-movements affect the underlying economic forces to which they are both responding (Turnovsky, 2011)¹. Therefore, these variables of interest need to be simultaneously studied since their relationship seems to be associative and not causal (Ehrlich and J. Kim, 2007).

The main contribution of this paper stems from the question of how the impact of a resource boom on the income inequality-growth nexus modifies the standard view on the Dutch disease. In this vein, I investigate first the impact of a resource boom on income inequality, and then the feedback of a change in income inequality on sectoral growth rate (i.e. the Dutch disease), in terms of both theory and empirical evidence.

A useful starting point for our discussion is to ask why do countries with resource wealth tend to grow less rapidly? A conventional answer refers to the theory of the Dutch disease. The main idea surrounding the original theory, proposed by (Corden and Neary, 1982), rests on the following triple-step reasoning: in a comparative static, a natural resource boom, first, increases the marginal product of labor in the natural resource sector and leads to rise the relative real wage between sectors. Accordingly, labor forces move from both manufacturing and non-traded sectors to the natural resource sector (i.e. the so-called resource movement effect). Second, the windfall income raises the national income and so tends to increase the demand for imported goods and the domestic absorption for both traded and non-traded goods. Third, the real exchange rate (the relative price of non-traded to traded goods) appreciates to confront the expanded demand for non-traded goods. Consequently, labor forces shift away from the manufacturing sector and into the non-traded sector to respond the gap between supply and demand sides (i.e. the so-called spending effect). Briefly, a natural resource boom leads to worsening the competitiveness of non-resource sectors through an increase in the real exchange rate and thus shrinking

¹The possible impact of income inequality on economic growth has received more attention in recent decades. The empirical evidence for this case is inconclusive. For instance, Persson and Tabellini, 1994; Alesina and Rodrik, 1994; Castelló and Doménech, 2002; Easterly, 2007 and Assa, 2012 all suggest that income inequality has a negative impact on the growth rate, while Perotti, 1996; Li and Zou, 1998; Forbes, 2000 and Naguib, 2015 show that an increase in income inequality accelerates the rate of economic growth. In contrast, Banerjee and Duflo, 2003 show that the growth rate is an inverted U-shaped function of net changes in inequality. Grijalva, 2011 concludes that an increase in income inequality level declines the rate of economic growth, however, this effect seems to vanish over time. Further, Barro, 2000; Barro, 2008 argue that a higher level of income inequality decelerates growth rate in developing countries while it accelerates the growth rate in developed countries.

the traded sector.

Later on, J. D. Sachs and Warner, 1995; Torvik, 2001 challenged this strand of the literature by developing dynamic versions of the Dutch-Disease model in which productivity growth was driven by learning by doing (*LBD*)². This rests on the point that the traded sector benefits more from learning by doing and thus the non-resource traded sector hit by reducing competitiveness is not fully recovered once the resource income runs out (Van der Ploeg, 2011b). The hypothesis of an adverse effect of resource dependence³ on economic growth has been empirically supported by J. D. Sachs and Warner, 1995; J. D. Sachs and Warner, 2001, Rodriguez and J. D. Sachs, 1999 and Gylfason, Herbertsson, and Zoega, 1999⁴.

The second question, i.e. effect of a resource boom on inequality, has been investigated theoretically and empirically for decades. Francois Bourguignon and Morrisson, 1990 argue that the mineral resource endowment is one of the main determinants of income inequality in developing countries. According to Gylfason and Zoega, 2002, resource dependence leads to both lower growth rates and higher inequality. In a simple model, they demonstrate that education, which raises the return to work through a higher productivity level, can simultaneously enhance both equality and growth and thereby reduces the adverse effects of resource rents on these economies. Briefly, investment on education may help economic growth and reduce inequality. Goderis and Malone, 2011 propose a two-sector growth model in which two kinds of labor, skilled and unskilled, under a learning by doing model (*LBD*) drive economic growth. They suppose that the traded sector is relatively more skilled labor intensive than the non-traded sector. Changes in income inequality are driven by distribution of the resource income as well as factor reallocation across sectors. Their theoretical findings have been supported by a panel data approach on a dataset including 90 countries over the period 1965-1999. They show that income inequality falls in the short term immediately after a resource boom and then rises steadily over time until the initial impact of the resource boom disappears. In this vein, the impact of the oil rent on

²Whereas for the former, J. D. Sachs and Warner, 1995, *LBD* is generated in the traded sector with a perfect spillover to the non-traded sector, for the latter, Torvik, 2001, both traded and non-traded sectors contribute the learning process with a spillover between two sectors.

³Two different criteria are usually used to assess the economies depending on the natural resource: "resource-dependence" refers to the value of the resource as a share of GDP or total national wealth and "resource-abundance" refers to the per capita value of the stock of natural resource wealth. The literature has voided the misconception that resource abundance should be interpreted as a rule that resource-rich countries are doomed to failure (Frankel, 2010). For example, comparing Sierra Leone and Botswana as two diamond-rich countries show that Botswana has expanded at an average rate of 7 % over the recent 20 years, while the growth rate of Sierra Leone has dropped 37 % between 1971 and 1989 (Humphreys, J. Sachs, and Stiglitz, 2007). Moreover, recent empirical studies across a comprehensive sample of countries indicate that natural resource abundance plays a positive role in economic performance (see. Brunnschweiler and Bulte, 2008; Alexeev and Conrad, 2009; Esfahani, Mohaddes, and Pesaran, 2013; Cavalcanti, Mohaddes, and Raissi, 2011).

⁴The scarcity paradox may be observed in natural resource-rich countries due to keeping the energy price at a low level for a long period. In this vein, Bretschger, 2015 shows that higher energy price through lower energy use leads to a reallocation of inputs toward capital accumulation that, in turn, makes the growth rate faster.

income inequality has also been investigated by Mallaye, Timba, and U. T. Yogo, 2015. They study a dynamic panel data model on a dataset including 40 developing countries over the period 1996-2008. Their findings suggest that the oil rent reduces inequality in the short run, while this effect vanishes over time as the oil revenue increases. Using pooled *OLS* regressions on an unbalanced panel of 55 country observations for the years 1975-2008, Parceró and Papyrakis, 2016 found that oil is associated with lower income inequality for economies with moderate levels of oil dependence/abundance and greater income inequality for the very oil-dependent economies.

Although the literature has deepened our understanding of the Dutch disease and of the determinants on income inequality in the natural resource countries, surprisingly there are few serious attempts, as far as I know, to clarify how income inequality induced by a natural resource boom is associated with the economic growth⁵. Therefore, the main contribution of this paper is to clarify the role of income inequality on the standard Dutch disease theory.

In this vein, I extend the framework proposed by Goderis and Malone, 2011 which in turn is based on the model developed by Torvik, 2001. The core mechanism of the framework is learning by doing model (*LBD*) in which both sectors contribute to learning and there are learning spillovers between the sectors. My model departs from Goderis and Malone, 2011 as follows. First, I will relax the core assumption of their model in which the traded sector is relatively skilled workers intensive. Second, productivity growth is driven by the learning-by-doing of skilled workers rather than unskilled workers. Further, I capture the feedback effect of income inequality on the Dutch disease by assuming different consumption baskets between workers' groups (the novel aspect of the model).

The theory predicts that in a transition path, the effect of windfall income on income inequality depends on the difference between the relative real wage across workers' groups and their relative share on windfall income benefit (e.g. subsidies). Moreover, the impact of income inequality on the intensity of the Dutch disease depends on how workers spend their income on traded and non-traded goods. I then present a structural empirical analysis to investigate whether the theoretical predictions are consistent with the empirical findings. In this respect, a dynamic panel data regression is applied. I first collect available data for 79 countries over the period 1975-2014 and then estimate the core findings of the theory by the generalized method of moments (*GMM*). Using regressions for a sample database, I find some clear evidence in supporting the theoretical findings. Briefly, the empirical estimations demonstrate that on average income inequality reduces as a natural

⁵Scognamillo, Mele, and Sensini, 2016 present an empirical study to analyze a sample database including 43 countries over the period 1980-2012. The findings show that the resource-dependence among high-income countries is negatively correlated with the Gini coefficient and the correlation between resource dependence and per capita GDP is insignificant, while the resource-dependence among low-income countries is associated with a higher level of Gini coefficient and a lower level of per capita GDP. Further, Behzadan et al., 2017 highlight the importance of resource rent distribution in creating the Dutch disease. Their empirical analysis suggests that less equality in the distribution of natural resource rents leads to arising stronger Dutch disease effects.

resource-dependence proxy increases and also falling income inequality is associated with a larger deceleration in sectoral economic growth.

The rest of this paper is organized as follows: Section 3.2 presents the model and its analysis in the short-run (comparative static) and long-run (dynamics). Section 3.3 undertakes the empirical study to examine the theoretical predictions. Section 3.4 concludes the paper.

3.2 The model

Consider a two-sector economy: the traded and non-traded sectors, which are respectively indexed by T and N . I assume there is no asset accumulation and the windfall income R is a constant exogenous gift over time, resulting from discovery or a resource price appreciation. The model consists of two groups of households: skilled (S) and unskilled (L) workers. Each of whom, populated by a continuum of symmetric-identical households, supplies labor inelastically. Each group's labor supply is normalized to unity.

$$S_T + S_N = 1 \quad (3.1a)$$

$$L_T + L_N = 1 \quad (3.1b)$$

S_T and S_N represent the skilled labor force in the traded and non-traded sectors, respectively. Similarly, L_T and L_N denote the unskilled labor force in the traded and non-traded sectors. To put some structure on the analysis, I assume labor can move freely across sectors. Moreover, production in each sector (that is X_T and X_N) employs both skilled and unskilled labor forces and operates under constant returns to scale. For simplicity, a *Cobb-Douglas* production function is assumed in each sector.

$$X_T = A_T S_T^\beta L_T^{1-\beta} \quad (3.2a)$$

$$X_N = A_N S_N^\alpha L_N^{1-\alpha} \quad (3.2b)$$

A_J , $J = \{T, N\}$ denotes total factor productivity in sector J . The price of traded goods is normalized to unity. Thereby, the price of non-traded goods, denoted by P , is identified as the real exchange rate. The economy's total income (Y) is given by the value of produced traded and non-traded goods plus the value of windfall income.

$$Y = X_T + PX_N + A_T R \quad (3.3)$$

A windfall income boom will be considered as an increase in R . As in Torvik, 2001 and Goderis and Malone, 2011, the value of windfall income is indexed on productivity in the traded sector. This assumption allows us to prevent windfall income from vanishing relative to national income as the economy grows ⁶.

⁶Two alternatives are to measure the real value of windfall income in the productivity unit of the non-traded sector or in a given fraction of total income. However, the steady-state solution is independent

On the demand side, I make the assumption that preferences differ by groups of households. A representative household of group $i = S, L$ maximizes a *CES* utility function in his consumption of traded and non-traded goods subject to its budget constraint ($PC_N^i + C_T^i = Y^i$). The utility function is given by:

$$U^i(C_N^i, C_T^i) = \left[(1 - \theta_i)^{\frac{1}{\sigma}} (C_T^i)^{\frac{\sigma-1}{\sigma}} + (\theta_i)^{\frac{1}{\sigma}} (C_N^i)^{\frac{\sigma-1}{\sigma}} \right]^{\frac{\sigma}{\sigma-1}} \quad ; \quad i = S, L. \quad (3.4)$$

σ is the elasticity of substitution between traded and non-traded goods. θ_i represents the consumption share of non-traded goods for group $i = S, L$ and Y^i is total income for the representative household of group i . The demand for traded and non-traded goods is denoted by C_T^i and C_N^i . The aggregate price index of each group of households $e_i(P)$ is determined by the solution of consumer's problem. As in Obstfeld, Rogoff, and Wren-lewis, 1996, it is given:

$$e_i(P) = \left[(1 - \theta_i) + \theta_i P^{1-\sigma} \right]^{\frac{1}{1-\sigma}} \quad ; \quad i = S, L. \quad (3.5)$$

Households' groups allocate their total income for traded and non-traded goods according to ⁷:

$$C_N^i = \theta_i e_i^{\sigma-1} P^{-\sigma} Y_i \quad ; \quad C_T^i = (1 - \theta_i) e_i^{\sigma-1} Y_i \quad ; \quad i = S, L. \quad (3.6)$$

In contrast with Goderis and Malone, 2011 in which households have identical tastes, this model implies that the consumption distribution plays a key role in the economy's response to a resource boom. Finally, total consumption expenditure (C) equals the skilled workers' consumption expenditure (C^S) plus the unskilled workers' consumption expenditure (C^L). As regards there is no saving, the budget constraint of the entire economy is given by the equality between aggregate income and aggregate consumption expenditure (i.e. $Y = C = C^S + C^L$). To close the model, the market for non-traded goods must clear ($X_N = C_N$). The current account balance will always be in equilibrium by Walras' law.

Before moving to the description of the economy's response to an increase in the windfall income, a note about income inequality seems to be useful. There are two main sources leading to a change in income inequality between skilled and unskilled workers. The first is the relative factor intensity between sectors and the second is the relative share of windfall income benefit. Given that labor is mobile across sectors, an equalization between the sectoral marginal product of each factor gives the real wage of skilled workers (w_S) and

of these choices (Torvik, 2001).

⁷For especial case $\sigma = 1$, we have a log-linear utility function as follow:

$$U(C_N^i, C_T^i) = [\theta_i \log C_N^i + (1 - \theta_i) \log C_T^i] \quad ; \quad i = S, L.$$

The standard result is that each group of households allocates a given fraction of their total income for traded and non-traded goods. $C_T^i = (1 - \theta_i) Y^i$ $PC_N^i = \theta_i Y^i$ $i = S, L$

unskilled ones (w_L),

$$w_S = \frac{\partial X_T}{\partial S_T} = P \frac{\partial X_N}{\partial S_N} \qquad w_L = \frac{\partial X_T}{\partial L_T} = P \frac{\partial X_N}{\partial L_N}. \quad (3.7)$$

Regarding the second driver of income inequality change, I make the assumption that windfall income benefits are directly distributed between household's groups (e.g. subsidies on energy price, education, and health care services). Skilled workers appropriate a share of the windfall income benefit, equal to π , while the remaining share $1 - \pi$ accrues to unskilled workers. Therefore, income inequality which is also read as consumption expenditure inequality is defined as the ratio of skilled workers' income to total income,

$$I \equiv \frac{w_S + \pi A_T R}{Y} = \frac{C^S}{C}. \quad (3.8)$$

The income inequality definition allows to capture in a simple way the feedback of a change in income inequality on the economic performance of a resource-dependent economy. Using Equations 3.6 and 3.8, we have ⁸:

$$\frac{P^\sigma C_N}{C} = \theta_L e_L^{\sigma-1} + [\theta_S e_S^{\sigma-1} - \theta_L e_L^{\sigma-1}] I. \quad (3.9)$$

It is important to note that the composition of demand plays no role in the response of an economy to a windfall income boom if skilled and unskilled workers have identical tastes (i.e. $\theta_S = \theta_L$). If tastes differ (i.e. $\theta_S \neq \theta_L$), a change in income inequality shifts demand away from one good and into another good. For instance, if $\theta_S > \theta_L$, Equation 3.9 indicates that rising income inequality raises the expenditure share of non-traded goods. This structure of the model implies that there are three dimensions at work to analyze the economic performance of a resource-dependent country. The first one is factor intensity. The case where the traded sector is relatively skilled workers intensive ($\beta > \alpha$) seems to be consistent with countries exporting raw materials and having low value-added services or a large informal service sector. These countries are normally classified as lower-middle-income or low-income countries. Nevertheless, the case where the non-traded sector is relatively skilled workers intensive ($\beta < \alpha$) is inconclusive in resource-developed economies with high value-added services and low absorptive capacity constraints ⁹. These countries are normally classified as upper-middle-income or high-income countries. Time-series evidence in high income countries shows that labor and value-added shares in the service sector increase along the development process (Herrendorf, Rogerson, and Valentinyi, 2013). These also coincide with a well-known upward trend between the human capital

⁸For a linear utility function (i.e. $\sigma = 1$), the ratio of non-traded goods' expenditure to total expenditure is equal to $\frac{P C_N}{C} = \theta_L + (\theta_S - \theta_L) I$.

⁹The absorptive capacity refers to the declining marginal rate of return to aid (windfall income in this paper) as the value of aid increases. Given constraints on capacity such as a shortage of human capital and infrastructure (i.e. public goods), the unit cost of additional public goods and services rise and so the incremental returns to aid fall (Franois Bourguignon and Sundberg, 2006).

index and income level (Benhabib and Spiegel, 1994). Hence, the assumption that the non-traded sector is relatively more intensive in skilled workers seems to be plausible in high-income countries. But a large share of skilled-intensive services in high-income countries is export-oriented (e.g. services in finance, business, communication) and must be classified as traded goods, not as non-traded goods. To sum up, the assumption that the traded sector is relatively skilled workers intensive is more likely reliable for most of the countries. However, the other case is interesting to be discussed.

The distribution of natural resource benefits among workers' groups is the second dimension of the model. Empirical evidence states that institutional quality¹⁰ and political power may be key determinants of how windfall income is distributed between income classes. A natural resource rent is more likely distributed unevenly in a poor institution country, while it might be distributed fairly in others (e.g. Torvik, 2002 and Chaturvedi, 2016). In addition, International Energy Agency reported that major energy subsidizers are oil-exporter countries (IEA, 2019)¹¹. In the same vein, there are many evidences to confirm an unequal distribution of natural resource benefit (e.g. subsidies) between income groups. Sdravovich et al., 2014 show that the poorest quintiles of some *MENA* countries (Egypt, Jordan, Mauritania, Morocco, and Yemen) receive about 1-7% of total diesel subsidies in 2012 compared to the richest quintiles benefit of about 42-77%. Gaddah, Munro, and Quartey, 2015 also examined the incidence of public education subsidies in Ghana in 2005. They found that the poorest quintile gains less than 15% of total education benefits, while the richest quintile benefit is more than 25%. Further, the total education benefits are going less to the poor than the rich in Indonesia at 1989 and Cote d'Ivoire at 1995 (Demery, 2000), increasing from 15% for the lowest quintile to 29% for the highest quintile in Indonesia and from 13% for the lowest quintile to 35% for the highest quintile in Cote d'Ivoire. Tiongson, Davoodi, and Asawanuchit, 2003 have done a comprehensive benefit incidence analysis on education and health spending over a period of 1960-2000. Their analysis of education spending for 37 developing and transition economies represents that, on average, 27% of the benefits accrue to the richest quintile compared to 16% for the poorest quintile. Also, their analysis of health spending for 26 economies shows that about 23% of benefits accrue to the richest quintile, while the poorest quintile receives only about 17% of benefits¹².

The third dimension of the model is the gap in consumption expenditure shares for non-traded goods between workers' groups. The hypothesis suggesting that the poor with

¹⁰Mehlum, Moene, and Torvik, 2006b argue that the resource is a blessing when institutions are good and is a curse when institutions are bad.

¹¹The report reveals that Iran is the largest energy subsidizers and China, Saudi Arabia, Russia, India, Indonesia, Egypt, Algeria, Venezuela, Iraq and Kazakhstan are in the next ranks.

¹²Tiongson, Davoodi, and Asawanuchit, 2003 also suggest the analysis of public spending on education and health for five regional groups: sub-Saharan Africa, Asia, and Pacific, Western Hemisphere (excluding Canada and the United States), Middle East and North Africa, and transition economies. In all country groups, the public spending benefit on education and health is appropriated less by the poor than by the rich. Only in Western Hemisphere, the public spending benefit on health is going more to the poor than the rich.

respect to the rich spend more for the non-traded goods (e.g. housing, transportation, education, and health care) and less for the traded goods (e.g. food and clothing) seems to be consistent with stylized facts ¹³. The literature on the difference in unit price for homogeneous commodities have confirmed that the poor allocate lower unit value expenditure for good purchase (i.e. traded goods) (E. S. Leibtag, Kaufman, et al., 2003; Broda, E. Leibtag, and Weinstein, 2009). In contrast, the literature on health spending (i.e. non-traded goods) demonstrates that the poor pay a larger share of their income for health care. For example, in Thailand, the health expenditure share for the poor is 21% of their budget, whereas it is 2% for the rich (Pannarunothai and Mills, 1997). Further, expenditure share on health care in Sierra Leone is an average of 6.9%, decreasing from 25.6% for the lowest quintile to 3.7% for the highest quintile (Fabricant, Kamara, and Mills, 1999). Inequality in expenditure on health care seems to be valid even in the developed economies. A recent study for *US* economy (Ketsche et al., 2011) states that health-care spending consume more than 22% of total income for families in the lowest-income quintile, while it consumes less than 16% for families in any other income quintile.

In the same vein, literature on transportation spending and the housing expenditure share bring additional insights. In respect of the affordability of public transport, the household travel survey in *Delhi* (India) at 1994 find that the poorest quintile spends almost 15% of their income on public transport, while the highest quintile spends less than 10% of their income on public transport (Badami, Tiwari, Mohan, et al., 2004). Further, a survey, undertaken by the World Bank and the Center for Economic Studies at the Argentina Business University in 2002, shows that bottom quintile families allocate 31.6% of their income on travel to work, while top quintile families allocate 7.5% of their income on it (Carruthers, Dick, and Saurkar, 2005). In respect of the housing expenditure share, a recent study in Germany over a period of 1993-2013 demonstrates an increase in expenditure share on housing for the lowest quintile (from 27% in 1993 to 39% in 2013) and a decrease for the highest quintile (from 16% in 1993 to 14% in 2013) (Dustmann, Fitzenberger, and Zimmermann, 2018).

Briefly, the evidence suggested for the gap in consumption expenditure shares might be feasible for most of the economies. Those seem to strongly support the assumption that unskilled workers (i.e. the poor) allocate a larger expenditure share for non-traded goods than skilled workers (the rich) do (i.e. $\theta_L > \theta_S$) ¹⁴.

In what follows, I discuss the economy's response to a windfall income boom in two stages. First in the short run when the productivity levels of both sectors are constant and second in the long run when productivity levels are driven by learning-by-doing (*LBD*).

¹³According to a Consumer Expenditure Survey for the *US* economy in 2014, conducted by the Bureau of Labor Statistics, Low-income households allocated 81% of their budgets on basic needs (housing, transportation, health care, food, and clothing). While High-income households spent only 66% of their budgets on basic needs. Additionally, about 80% of their budgets on basic needs was allocated for non-traded goods (about 64% of the poor's budget and about 53% of the rich's budget).

¹⁴This assumption makes our analysis be consistent with the empirical predictions, presented in section 3.3.

3.2.1 Short run analysis (static model)

This section studies a comparative static response of an economy induced by a natural resource boom. A common assumption for this case is that productivity levels in both sectors are constant. Therefore, factor mobility across sectors will be the primary driver of the economy.

Given that the labor share of skilled workers drives the productivity levels (See. Section 3.2.2), I study the combination of the real exchange rate (P) and the labor share of skilled workers in the non-traded sector (S_N) to determine a static equilibrium of the model. The first combination of the variables of interest are found from the labor market (i.e. Equations 3.7) (henceforth LL -curve) and the second one is determined from the market-clearing condition in the non-traded sector (i.e. $X_N = C_N$) (henceforth NN -curve). Defining the ratio of productivity levels $\phi \equiv \frac{A_T}{A_N}$, the results are respectively written as:

$$P = \phi \frac{\beta}{\alpha} \left(\frac{L_T}{S_T} \right)^{1-\beta} \left(\frac{S_N}{L_N} \right)^{1-\alpha} \quad LL - curve \quad (3.10a)$$

$$P = \phi^{\frac{1}{\sigma}} \left(\frac{S_T^\beta L_T^{1-\beta} + R}{S_N^\alpha L_N^{1-\alpha}} \right)^{\frac{1}{\sigma}} [\Psi(P, I)]^{\frac{1}{\sigma}}. \quad NN - curve \quad (3.10b)$$

Where,

$$\Psi(P, I) = \left(\frac{P^\sigma C_N}{C_T} \right) = \frac{[\theta_L e_L^{\sigma-1} + (\theta_S e_S^{\sigma-1} - \theta_L e_L^{\sigma-1}) I]}{1 - P^{1-\sigma} [\theta_L e_L^{\sigma-1} + (\theta_S e_S^{\sigma-1} - \theta_L e_L^{\sigma-1}) I]}. \quad (3.11)$$

LL -curve (Equation 3.10a) is an upward sloping curve. As in Torvik, 2001, it says that for a given L_N and S_N , an increase in the real exchange rate makes the marginal productivity of skilled workers be larger in the non-traded sector than in the traded sector. Therefore, the labor share of skilled workers has to increase in the non-traded sector to re-establish the equilibrium in the labor market.

Another combination of P and S_N is NN -curve (Equation 3.10b). NN -curve is a downward sloping curve. This can be inferred as in Torvik, 2001. For a given L_N and P , an increase in S_N enlarges the supply of non-traded goods. To re-establish the equilibrium in the non-traded market, the real exchange rate depreciates to expand demand for non-traded goods.

Before attention is turned to the static response of the model, let me look closely at Equation 3.11. $\Psi(P, I)$ highlights the key role of income inequality in the response of an economy to a natural resource boom. This is in contrast to Goderis and Malone, 2011 in which $\theta_S = \theta_L$ ¹⁵. Equations 3.11 is simplified to $\Psi(I) = \frac{\theta_L + (\theta_S - \theta_L)I}{1 - [\theta_L + (\theta_S - \theta_L)I]}$ when $\sigma = 1$. Further, it indicates that the feedback of income inequality change on the real exchange

¹⁵When $\theta_S = \theta_L = \theta$, Ψ will be constant and equals to $\frac{\theta}{1-\theta}$. It implies that a change in income inequality plays no role in the economic performance

rate depends on the gap in expenditure shares between skilled and unskilled workers. When skilled workers with respect to unskilled workers allocate a larger expenditure share for traded goods (i.e. $\theta_S < \theta_L$), rising income inequality depreciates the real exchange rate by shifting demand from non-traded to traded goods ¹⁶.

An increase in windfall income (R) expands total national income (Y) and so tends to increase the demand for both traded and non-traded goods. The expanded demand for traded goods will be compensated by more imported goods. While the real exchange rate (P) must appreciate in order to confront the expanded demand for non-traded goods. Graphically NN -curve shifts up, while LL -curve is not affected by the windfall income boom. The new static equilibrium is placed at a higher level of the real exchange rate and a larger labor share of skilled workers employed by the non-traded sector.

In the economy's response to a real exchange rate appreciation, there are two conflicting forces at work. The first force refers to labor reallocation due to a change in real wage between sectors (henceforth called the spending effect). While the second force refers to labor reallocation due to a change in income level between household's groups (henceforth called the inequality effect).

Regarding the spending effect, a real exchange rate appreciation leads to increasing the real wage of both skilled and unskilled workers in the non-traded sector with respect to that in the traded sector. Hence, it signals to both workers' groups to move from the traded to the non-traded sector. Consequently, the production sector of traded goods shrinks and the production sector of non-traded goods expands (i.e. the Dutch disease). Regarding the inequality effect, I first look at the effect of a real exchange rate appreciation on the relative real wage. Figure 3.1 illustrates this effect through an Edgeworth box with skilled labor on the vertical axis and unskilled labor on the horizontal axis. Workers employed by the non-traded sector are measured as the distance from point O_N . Similarly, workers in the traded sector are measured from point O_T . The contract curve lies above the diagonal line if the non-traded sector is relatively intensive in skilled labor (see. Figure 3.1-a), while it lies below the diagonal line if the non-traded sector is relatively intensive in unskilled labor (see. Figure 3.1-b). The economy moves from point A to point B as the windfall income increases. Subscripts o and n refer to "old" and "new" equilibrium points, respectively. Although both types of workers shift away from the traded sector and into the non-traded sector, to what extent they shift depends on factor intensity between sectors.

Real exchange rate appreciation increases the relative factor price of skilled to unskilled workers (i.e. $\frac{w_S}{w_L}$) if skilled workers are used intensively in the non-traded sector. The converse occurs if skilled workers are used intensively in the traded sector. These are clarified in Figure 3.1 by a comparison between the slope line of relative real wage in point (B) and point (A). Whereas for the former case, the slope line will be flatter

¹⁶From Equations 3.10b, the effect of income inequality on the real exchange rate is: $\frac{dP}{dI} = \frac{P}{\Psi} \frac{\theta_S - \theta_L}{(1 - [\theta_L + (\theta_S - \theta_L)I])^2}$.

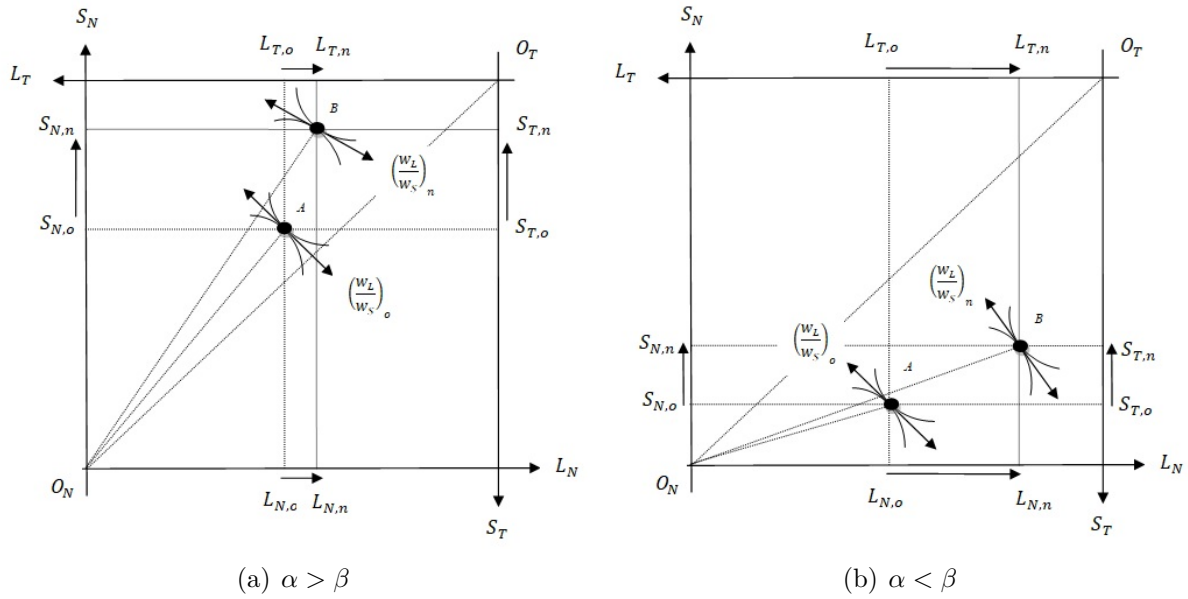

Figure 3.1: Factors movement in response to a windfall income

(see. Figure 3.1-a), for the latter case it will be steeper (see. Figure 3.1-b). These are direct results of *Stolper-Samuelson theorem* (Stolper and Samuelson, 1941). The theorem represents that the relative price appreciation increases the relative demand of factor used intensively in the non-traded sector to another factor. This, in turn, increases the relative factor price. Let $I^{NR} \equiv \frac{w_S}{w_L + w_S}$ denote the Market-based (non-resource) income inequality, I summarize the above argument as the following proposition.

Proposition 1: *In a comparative static, for any $\alpha, \beta > 0$,*

- a) *if $\alpha > \beta$, $\frac{dI^{NR}}{dR} > 0$*
- b) *if $\alpha < \beta$, $\frac{dI^{NR}}{dR} < 0$.*

Proof: The results are derived from the graphical framework (Figure1) and given that $\frac{dP}{dR} > 0$.

Now, I am interested in how the distribution of resource benefits between workers' groups affects inequality. I plausibly assume that skilled workers have more political power than unskilled ones¹⁷ and so skilled workers appropriate a larger share of resource benefit (e.g. subsidies). This assumption is not far from what is being observed in many natural resource economies. For example in most *Middle East* and low-income *sub-Saharan* countries, an elite group controls the government as well as the resource rent (Lam and Wantchekon, 2002). Further, It is more likely that a larger share of subsidies (e.g. on energy price) is received by the richest quintiles (Sdrulevich et al., 2014).

When windfall income is distributed unevenly in favor of skilled workers, two cases may

¹⁷Well-known evidence, implying that the political participation and so political voice is larger for the rich (skilled workers) than for the poor (unskilled workers), are documented by Petrocik and Shaw, 1991, and Benabou, 2000.

occur in income inequality through a windfall income boom. Whereas, for the first case in which skilled workers are used intensively in the non-traded sector income inequality will rise, for the second one in which skilled workers are used intensively in the traded sector income inequality change will be ambiguous. The results are derived from the response of the two main sources of income inequality to a resource boom. For the first case, both forces drive income inequality in the same direction. On the one hand, a larger share of windfall income is appropriated by skilled workers and on the other hand, their relative real wage increases. In conclusion, both sources of income, going to skilled workers, tends to rise income inequality. For the second case, these two forces drive income inequality in opposite directions. Windfall income is still distributed unevenly in favor of the skilled workers and so income inequality tends to go up. Nevertheless, a resource boom reduces the relative real wage of skilled workers, so that income inequality tends to go down. Consequently, the effect of a resource boom on income inequality change is ambiguous and depends on which one of these two driving forces is stronger.

To address total income inequality changes, let $y^{NR} \equiv w_L + w_S = PX_N + X_T$ and $y^R \equiv A_T R$ denote total non-resource income and total resource income, respectively. Therefore, the total income of the economy is $y = y^{NR} + y^R$. Now, the above discussion is summarized as follows,

Proposition 2: *In a comparative static, for any $\alpha, \beta > 0$ and $\pi > 0$,*

- a) $\alpha > \beta$ and $\pi > I^{NR}$ are sufficient conditions to ensure that $\frac{dI}{dR} > 0$,
- b) $\alpha < \beta$ and $\pi < I^{NR}$ are sufficient conditions to ensure that $\frac{dI}{dR} < 0$.

Proof: The results are found directly by computing $\frac{dI}{dR} = \frac{d(y^R/y)}{dR} [\pi - I^{NR}] + \left(1 - \frac{y^R}{y}\right) \frac{dI^{NR}}{dR}$ and applying Proposition 1.

The final point in the comparative static argument is how the gap in expenditure shares between skilled and unskilled workers can motivate the intensity of labor reallocation (i.e. the intensity of the Dutch disease). For this purpose, we need to know to what extent the gap in expenditure shares affects the real exchange rate appreciation. Since the larger real exchange rate appreciation, the more movement of labor from the traded to the non-traded sector.

Proposition 3: *In a comparative static, for any $\theta_S, \theta_L > 0$,*

- a) assume $\alpha > \beta$ and $\pi > I^{NR}$ holds $\Rightarrow \frac{dI}{dR} > 0$,
- 1) a natural resource boom leads to a stronger real exchange rate appreciation if skilled workers, with respect to unskilled workers, spend more on non-traded goods than if spending shares are equal \Leftrightarrow if $\theta_S > \theta_L$, $\left(\frac{dP}{dR}\right)_{\theta_S > \theta_L} > \left(\frac{dP}{dR}\right)_{\theta_S = \theta_L}$,
- 2) a natural resource boom leads to a weaker real exchange rate appreciation if skilled workers, with respect to unskilled workers, spend less on non-traded goods than if spending shares are equal \Leftrightarrow if $\theta_S < \theta_L$, $\left(\frac{dP}{dR}\right)_{\theta_S < \theta_L} < \left(\frac{dP}{dR}\right)_{\theta_S = \theta_L}$,

b) assume $\alpha < \beta$ and $\pi < I^{NR}$ holds $\Rightarrow \frac{dI}{dR} < 0$,

1) a natural resource boom leads to a weaker real exchange rate appreciation if skilled workers, with respect to unskilled workers, spend more on non-traded goods than if spending shares are equal \Leftrightarrow if $\theta_S > \theta_L$, $\left(\frac{dP}{dR}\right)_{\theta_S > \theta_L} < \left(\frac{dP}{dR}\right)_{\theta_S = \theta_L}$,

2) a natural resource boom leads to a stronger real exchange rate appreciation if skilled workers, with respect to unskilled workers, spend less on non-traded goods than if spending shares are equal \Leftrightarrow if $\theta_S < \theta_L$, $\left(\frac{dP}{dR}\right)_{\theta_S < \theta_L} > \left(\frac{dP}{dR}\right)_{\theta_S = \theta_L}$.

Proof: These results are verified by computing the vertical shift of NN -curve in response to a natural resource boom (see. Appendix A).

The proposition represents when skilled workers with respect to unskilled workers allocate a larger expenditure share for traded goods (i.e. $\theta_S < \theta_L$), falling income inequality increases the relative consumption expenditure of non-traded to traded goods. This, in turn, increases the pressure on the real exchange rate to appreciate more. Then more labor forces must be shifted away from the traded and into the non-traded sector. Briefly, this argument says that falling income inequality deepens the Dutch disease. In the same way, another case in which skilled workers with respect to unskilled workers allocate a larger expenditure share for non-traded goods (i.e. $\theta_S > \theta_L$) can be analyzed. Falling income inequality will moderate the Dutch disease through a weaker pressure on the appreciating real exchange rate, resulting from less demand for non-traded goods ¹⁸.

Before attention is turned to analyze the long-run mechanism, one seems to be useful to discuss the role of the institution's quality in the modification of the transition path. In this paper, I merely discuss one of the aspects of the role of institutions in the sustainable development of resource-dependence countries. Improving the quality of institutions can be associated with the expansion and improvement of public systems such as social security, health, education, and transportation that presumably lead to decreasing unskilled workers' expenditure shares on non-traded goods relative to skilled workers ¹⁹. Hence, a reduction in the gap in the expenditure shares between workers' groups ($\theta_L - \theta_S$) can be translated as an improvement in the quality of the institution. The real exchange rate appreciation is slightly moderated as the gap in expenditure shares decreases due to an improvement in the quality of the institution. This, in turn, leads to less intensity of falling market-based income inequality. With an unchanged distribution of the resource rent, the total income inequality level goes down less. Accordingly, less reduction in income inequality leads to less intensity of the Dutch disease. This argument concludes that the real exchange rate appreciation, falling income inequality, and the intensity of the Dutch disease are stronger

¹⁸Figure 3.3 shows the impact of a gap in expenditure shares on the magnitude of real exchange rate appreciation (i.e. the vertical movement of NN -curve) for the case $\frac{dI}{dR} < 0$.

¹⁹Improving the distribution of subsidies that can financially be provided by the resource rent is an alternative case reflecting the role of the institution's quality. But, given that the market-based (non-resource) income inequality is the main driving force of the total income inequality (regarding empirical evidence presented), I ignore the analysis of this case.

in countries with low-quality institutions than those with high-quality institutions.

3.2.2 Long run analysis (dynamic model)

In this section, we endogenize factor productivity (TFP) to discuss the long-run steady-state effects of a resource boom. TFP is driven by the learning-by-doing (LBD) model. The earlier literature assumes that LBD is only generated by the traded sector (Krugman, 1987) or both sectors generate the learning but there is no spillover between them (Lucas Jr, 1988), whereas J. D. Sachs and Warner, 1995 represent the case where only the traded sector generates the learning and there is a perfect spillover for the non-traded sector. Nevertheless, I modify Torvik, 2001 framework which covers the earlier models²⁰. I assume that productivity growth is generated by skilled workers in both sectors with an imperfect spillover between sectors.

$$\frac{\dot{A}_T}{A_T} = v S_T + \delta_N u S_N \quad (3.12a)$$

$$\frac{\dot{A}_N}{A_N} = u S_N + \delta_T v S_T \quad (3.12b)$$

u and v denote the productivity growth rate of one unit skilled worker employed respectively by the non-traded and traded sectors. The constant $0 < \delta_T < 1$ measures a fraction of the learning generated by skilled workers in the traded sector and spilled over to the non-traded sector. Similarly, $0 < \delta_N < 1$ measures a fraction of the learning generated by skilled workers in the non-traded sector and spilled over to the traded sector. In these equations, Krugman, 1987 represents the case where $u = \delta_T = 0$, while Lucas Jr, 1988 assume that $\delta_T = \delta_N = 0$. In addition, these are simplified to J. D. Sachs and Warner, 1995 model when $u = 0$ and $\delta_T = 1$.

For the purpose of the long-run analysis, I need to know how the static equilibrium of labor allocation reacts to a change in the relative productivity (i.e. $\phi \equiv \frac{A_T}{A_N}$). The response of labor allocation to an increase in the relative productivity ratio ϕ is ambiguous (Torvik, 2001). Since there are two conflicting forces at work. On the one hand, with an increase in the relative productivity, the labor requirement in the traded sector falls and that in the non-traded sector goes up (i.e. Labor requirement effect). With an unchanged composition of the basket for both groups, labor must shift away from the traded sector and into the non-traded sector. Hence, ignoring the effect on demand, an increase in the relative productivity for traded goods tends to increase employment in the non-traded sector. On the other hand, traded goods are cheaper to produce than before. So it is more likely that consumers substitute non-traded goods with traded goods (i.e. Substitution effect). Hence, shifting demand in favor of traded goods pushes both groups of labor employment to move from the non-traded sector to the traded sector. In conclusion, the two effects

²⁰The departure of my framework from those papers is that I assume there are two workers' groups rather than one group and that the workers have different identical tastes.

push S_N in opposite directions.

Now we can ask which one of these conflicting forces is dominant. On the one hand, for a given labor allocation, rising the relative productivity ratio states that the supply of the traded sector expands faster than the supply of the non-traded sector. Then the real exchange rate appreciates in order to back the good market in balance. Hence the NN -curve shifts up as ϕ increase (i.e. Labor requirement effect). The vertical shift in the NN -curve equals $\frac{P}{\phi\sigma_c}$ (i.e. $\frac{dP}{d\phi}$ in Equation 3.10b), where $\sigma_c \equiv \varepsilon_{T,P} - \varepsilon_{N,P}$ denotes the gap in the price elasticity of demand for traded and non-traded goods. On the other hand, for a given real exchange rate, the marginal productivity of labor is larger in the traded sector than in the non-traded sector as ϕ increases. Then the labor force in the non-traded sector falls to back the labor market in balance. Hence an increase in productivity level pushes the LL -curve to the left (i.e. Substitution effect). The vertical shift in the LL -curve equals $\frac{P}{\phi}$ (i.e. $\frac{dP}{d\phi}$ in Equation 3.10a). This argument represents that the vertical movement will be larger in NN -curve than in LL -curve if $\sigma_c < 1$. I summarize this argument as follows,

Summarized argument: $S_N = S_N(\phi, R)$, $\frac{dS_N}{d\phi} > 0$ if $\sigma_c < 1$ and $\frac{dS_N}{dR} > 0$.

Now I ask, is there a balanced growth path along which the productivity levels of both sectors grow at the same rate? The growth rate of the relative productivity ratio is given by:

$$\frac{\dot{\phi}}{\phi} = \frac{\dot{A}_T}{A_T} - \frac{\dot{A}_N}{A_N} = (1 - \delta_T)v - [(1 - \delta_T)v + (1 - \delta_N)u] S_N(\phi, R). \quad (3.13)$$

To prove the existence of a balanced growth path, I investigate the stability properties of the dynamic model. The rate of change in relative productivity ratio is governed by:

$$\frac{d(\dot{\phi}/\phi)}{d\phi} = -[(1 - \delta_T)v + (1 - \delta_N)u] \frac{dS_N(\phi, R)}{d\phi}. \quad (3.14)$$

Equation 3.14 states that there is a balanced growth path *iff* the skilled labor employment in the non-traded sector increases as the relative productivity ratio jumps up (i.e. $\frac{dS_N}{d\phi} > 0$). The static response of an economy to a shift in the relative productivity ratio clarifies that the stability of the dynamic steady-state depends on the gap in the price elasticity of demand ($\sigma_c \equiv \varepsilon_{T,P} - \varepsilon_{N,P}$). Regarding the summarized argument of the vertical shift in curves, the dynamic stability of the system is satisfied if $\sigma_c \leq 1$. A little gap in the price elasticity of demand (σ_c) induces the demand side to shift to the extent which is sufficient to counteract the labor movement effects.

Now let me take into account that households have identical tastes (i.e. $\theta_S = \theta_L$). This results in $\sigma_c = \sigma$. When $\sigma > 1$, the economy ends up with a specialization in one of two goods. It converges to specialization in traded (non-traded) goods if the relative productivity is larger (smaller) at initial than at steady-state. Nevertheless, $\sigma \leq 1$ is the sufficient condition to guarantee stability. There exists a unique balanced growth path

3.2. THE MODEL

for the case $\sigma < 1$, while for the case $\sigma = 1$ implying that there is a Cobb-Douglas utility function there is a set of growth path. For the latter case, the vertical shifts of the curves, moving in opposite directions, are equal. It implies that a change in ϕ has no effect on S_N (i.e. $\frac{dS_N}{d\phi} = 0$) so that the labor share of skilled workers in the non-traded sector is constant over time. Consequently, one of the goods produces faster than the other ²¹ and the relative price of the other good increases to keep the budget constraint in balance (for more information see. Lucas Jr, 1988; Torvik, 2001).

Among literature, Lucas Jr, 1988 and J. D. Sachs and Warner, 1995 have balanced productivity growth, while Krugman, 1987 is an unbalanced growth model. The case where $\theta_S = \theta_L$ is not an interesting case for us. Since a change in income inequality plays no role in the mechanism of the model. Therefore, I argue below the case $\theta_S \neq \theta_L$.

Proposition 4: *if $\theta_S < \frac{1}{1+\Psi} < \theta_L$ holds, $\sigma < 1$ is a sufficient condition to satisfy the dynamic stability of system, where $\Psi \equiv \frac{P^\sigma C_N}{C_T}$ ²².*

Proof: Regarding Equation 3.14, the stability of the dynamic system is satisfied if $\sigma_c < 1 \Rightarrow \frac{dS_N}{d\phi} > 0 \Rightarrow \frac{d(\dot{\phi}/\phi)}{d\phi} < 0$. Hence, if we find a local condition resulting in $\sigma_c < \sigma$, we can conclude that $\sigma < 1$ will be a sufficient condition to exist a balanced growth path. The computations prove that $\sigma_c < \sigma$ is satisfied if the expenditure share on non-traded goods is larger for unskilled workers than for skilled workers so that $\theta_S < \frac{1}{1+\Psi} < \theta_L$. For an analytic proof see Appendix B.

Before I turn to dynamic equilibrium, it is useful to take a closer look at the constraint of the stability condition, $\theta_S < \frac{1}{1+\Psi} < \theta_L$. The analytic computation reveals that the constraint can be rewritten as the following inequality relation: $I_N < I < I_T$, where $I_N \equiv \frac{C_N^N}{C_N^S}$ and $I_T \equiv \frac{C_T^S}{C_T^T}$ are, respectively, the consumption inequality of non-traded and traded goods (see. Appendix B). This implies when $\sigma < 1$, the dynamic system is stable *iff* the consumption distribution of non-traded goods is more evenly than the consumption distribution of total goods and the consumption distribution of traded goods is more unevenly than the consumption distribution of total goods. To make clear this argument, now let me discuss a special case in which skilled workers spend only on traded goods and unskilled workers spend only on non-traded goods (i.e. $\theta_L = 1$ and $\theta_S = 0$) ²³. The consumption inequality on traded goods equals one while the other is zero (i.e. $I_T = 1$ and $I_N = 0$). Therefore, the constraint is always satisfied (i.e. $I < I_T = 1$). As a conclusion when the expenditure share on non-traded goods is much larger for unskilled workers

²¹In a special case where $\frac{S_T}{S_N} = \frac{u(1-\delta_N)}{\nu(1-\delta_T)}$, both sectors expand at the same rate.

²²Note that there exists the other stability condition. For the case $\theta_S > \frac{1}{1+\Psi} > \theta_L$, the sufficient condition to guarantee the stability is $\sigma < 1 - (\gamma_T - \gamma_N) (\varepsilon_{N,P}^L - \varepsilon_{N,P}^S)$, where $\gamma_J \equiv \frac{C_J^L}{C_J^S}$; $J = T, N$ is the share of good J allocated to unskilled workers and $\varepsilon_{N,P}^i \equiv \frac{P}{C_N^i} \frac{\partial C_N^i}{\partial P} = - \left(\frac{\sigma(1-\theta_i) + \theta_i P^{1-\sigma}}{1-\theta_i + \theta_i P^{1-\sigma}} \right)$; $i = L, S$ is the price elasticity of non-traded goods in terms of i workers.

²³Regarding Equation 3.5, the aggregate price index or the unite expenditure is equal to P for unskilled workers while it is equal to one for skilled workers.

than for skilled workers ($\theta_S \ll \theta_L$), it is more likely that the constraint ($I_N < I < I_T$) is satisfied and so $\sigma < 1$ will be a sufficient condition to satisfy the dynamic stability of system.

When the local stability condition is satisfied, the model has a stable solution for the relative productivity ratio, denoted by ϕ^* . At such a dynamic equilibrium, the skilled and unskilled labor forces are also at their steady-state values ²⁴.

$$S_N^* = \frac{(1 - \delta_T)v}{[(1 - \delta_T)v + (1 - \delta_N)u]} \quad L_N^* = \frac{1}{1 + \left(\frac{1-\beta}{1-\alpha}\right) \left(\frac{\alpha}{\beta}\right) \left[\frac{(1-\delta_N)u}{(1-\delta_T)v}\right]}. \quad (3.15)$$

Equation 3.15 clearly implies that the steady-state labor allocation of skilled and unskilled workers are independent of the windfall income boom. It, in turn, results in a constant relative real wage at the steady-state. The steady-state value of income inequality is also given by:

$$I^* = \frac{\beta + (\eta^*)^{1-\beta} \pi R}{\beta + (1 - \beta) \eta^* + (\eta^*)^{1-\beta} R} \quad (3.16)$$

where $\eta^* \equiv \frac{S_T^*}{L_T^*}$. Equation 3.16 demonstrates that the steady-state income inequality is only driven by a natural resource boom. Therefore, factor intensity has no effect in the analysis of the balanced growth path and the distribution of windfall income between workers' groups is the only determinant of inequality change. This clarifies that a change in income inequality is a strong transmission channel in the long-run growth path. Let I^{NR*} denotes the Market-based (non-resource) income inequality at the steady-state.

Proposition 5: *At steady-state, for any $\pi > 0$,*

- a) *If resource income inequality is larger than steady-state non-resource income inequality, a natural resource boom increases total income inequality \Leftrightarrow if $\pi > I^{NR*}$, $\frac{dI^*}{dR} > 0$,*
- b) *If resource income inequality is smaller than steady-state non-resource income inequality, a natural resource boom decreases total income inequality \Leftrightarrow if $\pi < I^{NR*}$, $\frac{dI^*}{dR} < 0$.*

Proof: The results are derived through $\frac{dI^*}{dR} = \frac{d(y^R/y)}{dR} [\pi - I^{NR*}] + \left(1 - \frac{y^R}{y}\right) \frac{dI^{NR*}}{dR}$ and given that $\frac{dI^{NR*}}{dR} = 0$ at steady-state.

3.2.3 Dutch disease dynamics

The aim of this section is to study the dynamic effect of a natural resource boom on the growth rate of the relative productivity ratio. From Equation 3.13, the derivative of

²⁴ S_N^* is determined from steady-state equilibrium (i.e. $\frac{\dot{\phi}}{\phi} = 0$), while L_N^* is found by replacing S_N^* at the factor market equilibrium (i.e. $\frac{w_L}{w_S} = \frac{1-\alpha}{\alpha} \frac{S_N^*}{L_N^*} = \frac{1-\beta}{\beta} \frac{1-S_N^*}{1-L_N^*}$).

growth rate with respect to R gives:

$$\frac{d(\dot{\phi}/\phi)}{dR} = -[(1 - \delta_T)v + (1 - \delta_N)u] \frac{dS_N(\phi, R)}{dR}. \quad (3.17)$$

Given that $\frac{dS_N}{dR} > 0$, the economy throws out the steady-state equilibrium as the windfall income increases. A natural resource boom through the real exchange rate appreciation shifts the skilled labor force away from the traded sector and into the non-traded sector. Since S_N goes up relative to its steady-state value the relative productivity growth rate declines along the transition path (i.e. $\frac{\dot{\phi}}{\phi} < 0$). As a consequence, the relative productivity ratio declines to re-establish the steady-state equilibrium. This fall in ϕ induces a counter-vailing movement of labor from the non-traded to the traded sector that gradually brings back the allocation of labor to its long-run equilibrium level.

Figure 3.2 shows the adjustment balanced growth path. The locus of relative productivity ratio is a downward-sloping line in order to satisfy the stability condition (see equation 3.14)²⁵. When the windfall income increases, the economy jumps vertically down from the solid line to the dotted line and from there it moves towards the new dynamic equilibrium ϕ^{**} . This concludes whereas in the short-term, a labor reallocation between sectors brings about the Dutch disease, in the long-term a change in the relative productivity level consolidates the Dutch disease.

A useful undertaking is now to investigate the gap in expenditure shares between groups'

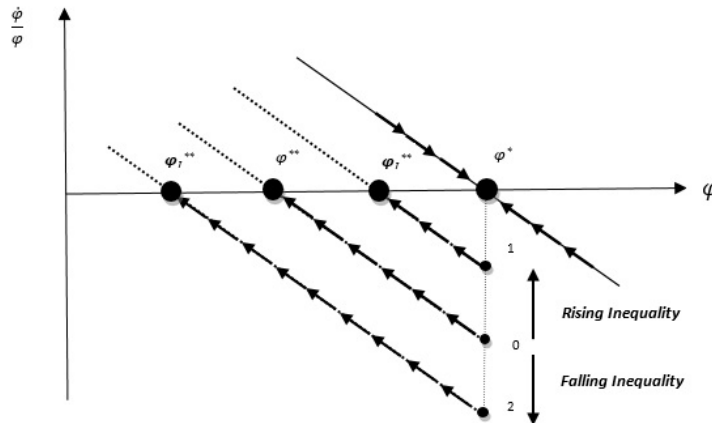

Figure 3.2: Adjustment balanced growth path for case $\theta_S < \theta_L$

workers on the intensity of the Dutch disease along the transition path. For a case in which both skilled and unskilled workers have identical tastes, the economy first jumps down from steady-state ϕ^* to point 0 and then it goes towards the new steady-state, denoted by ϕ^{**} . In this case, income inequality has no effect on the adjustment path. While

²⁵Assume initially $\phi > \phi^*$. Since the labor movement effect is stronger than the substitution effect (i.e. $\sigma < 1$), the employment in the non-traded sector is larger than it would be at steady-state. It implies that productivity growth is stronger in the non-traded sector than in the traded sector and so the relative productivity growth falls over time until it reaches its steady-state value.

for a case in which consumption baskets of skilled and unskilled workers are different, income inequality plays a key role in the adjustment path. Regarding Proposition 4, I only address the case $\theta_S < \theta_L$. If skilled workers allocate a larger expenditure share on traded goods ($\theta_S < \theta_L$), rising income inequality reduces the intensity of the real exchange rate appreciates along the transition path. This, in turn, makes the reallocation of skilled labor weaker than it would otherwise be. Thus the impact is smaller. The economy moves down to point 1 upon impact and from there, it moves towards the larger steady-state ϕ_I^{**} , compared with the former case reaching ϕ^{**} . The opposite occurs if income inequality falls. Briefly, when $\theta_S < \theta_L$, rising income inequality decreases the intensity of the Dutch disease and falling income inequality increases the intensity of the Dutch disease.

Proposition 6: *At steady-state, assume unskilled workers spend more on non-traded goods than skilled workers do $\Leftrightarrow \theta_S < \theta_L$,*

a) *rising income inequality moderates the intensity of the Dutch disease \Leftrightarrow if $\frac{dI^*}{dR} > 0$, $\phi_I^{**} > \phi^{**}$,*

b) *falling income inequality exacerbates the intensity of the Dutch disease \Leftrightarrow if $\frac{dI^*}{dR} < 0$, $\phi_I^{**} < \phi^{**}$.*

Proof: Regarding Equation 3.10a at steady-state, $\frac{dP^*}{d\phi^*} > 0$. It implies when the economy throws out the initial equilibrium, both P^* and ϕ^* shift in the same direction. Hence, the proposition can be verified by taking a derivative of the steady-state real exchange rate, rather than the steady-state productivity ratio, with respect to R , (i.e. $\frac{dP^*}{dR}$) (see. Appendix C).

Figure 3.3 shows how the labor share in the non-traded sector, S_N , and the real exchange rate, P , react in turn to an exogenous shock. LL -curve (Equation 3.10a) and NN -curve (Equation 3.10b) are drawn as upward and downward sloping curves, respectively. A natural resource boom raises the employment share in the non-traded sector, S_N . This, in turn, reduces the relative productivity ratio. Therefore, both the LL -curve and the NN -curve shift down along the transition path. Since the productivity level grows faster in the non-traded sector than in the traded sector ²⁶, this movement will continue as long as the labor share in the non-traded sector backs in its initial value. Regarding Section 3.2.2, the NN -curve shifts faster than the LL -curve, if $\sigma < 1$. Hence, both S_N and P fall along the transition process.

Now, I am interested to study the effect of the gap in expenditure shares between workers' groups on the steady-state real exchange rate. I address the case in which skilled workers spend a larger expenditure share on traded goods (i.e. $\theta_S < \theta_L$). This case is in consistent with the stability condition (Proposition 4) and in keeping with the empirical results, presented in Section 3.3.

²⁶An alternative is that the productivity level shrinks faster in the traded sector than in the non-traded sector (see. section 3.2.4). This case is consistent with the empirical evidence (see. section 3.3.4 and 3.3.5).

Proposition 7: *At steady-state,*

- a) *When resource income inequality is larger than steady-state non-resource income inequality, a natural resource boom leads to a weaker real exchange rate appreciation for case $\theta_S < \theta_L$ than for case $\theta_S = \theta_L \Leftrightarrow$ when $\pi > I^{NR*}$, $\left(\frac{dP^*}{dR}\right)_{\theta_S < \theta_L} > \left(\frac{dP^*}{dR}\right)_{\theta_S = \theta_L}$*
- b) *When resource income inequality is smaller than steady-state non-resource income inequality, a natural resource boom leads to a stronger real exchange rate appreciation for case $\theta_S < \theta_L$ than for case $\theta_S = \theta_L \Leftrightarrow$ when $\pi < I^{NR*}$, $\left(\frac{dP^*}{dR}\right)_{\theta_S < \theta_L} < \left(\frac{dP^*}{dR}\right)_{\theta_S = \theta_L}$.*

Proof: It is contained in Appendix C.

Figure 3.3 clarifies that falling income inequality increases the relative consumption expenditure of non-traded to traded goods. This, in turn, tends to shift a larger labor share away from the traded sector and into the non-traded sector. Hence, S_N is larger for the case $\theta_S < \theta_L$ than $\theta_S = \theta_L$ as a natural resource boom is accompanied by falling income inequality. This concludes that along the transition path the LL -curve and the NN -curve shift down more for the case $\theta_S < \theta_L$ than it would otherwise be. The new dynamic equilibrium is at a point such as E_2 for the case $\theta_S = \theta_L$, while it rests in a lower point such as E'_2 for the case $\theta_S < \theta_L$. Briefly, the steady-state real exchange rate depreciates more when $\theta_S < \theta_L$.

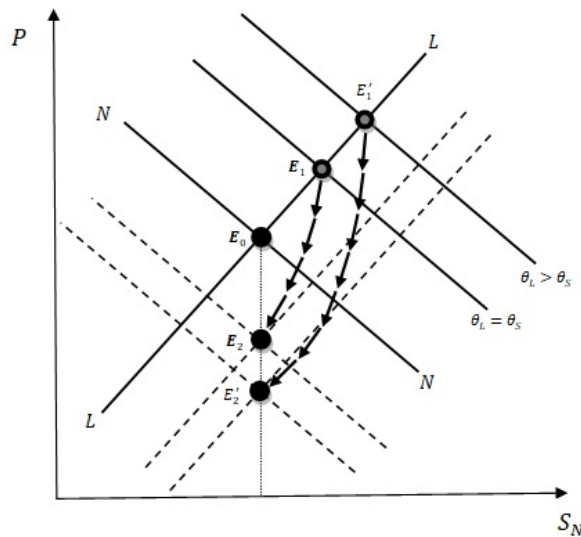

Figure 3.3: The development of comparative static when $\alpha < \beta$ and $\pi < I^{NR} \Rightarrow \frac{dI}{dR} < 0$

3.2.4 Absolute Productivity Growth

So far I have discussed how a natural resource boom affects relative productivity growth. But this is not the only issue of interest. It is worth conducting an investigation into the response of absolute productivity growth (i.e. \dot{A}_T/A_T and \dot{A}_N/A_N), rather than the

relative productivity growth (i.e. $\dot{\phi}/\phi$), to a factor reallocation.

Equations 3.12 verifies that the response of the absolute productivity level in each sector depends on the size of the direct effect of learning in each sector and the indirect effect of learning spilled over from another sector. Figure 3.4, the same as Torvik, 2001, displays this argument. In response to a natural resource boom, the labor share of skilled workers in the non-traded sector increases. Therefore, if the direct effect of learning generated by the traded sector is stronger than the spillover effect (i.e. $v > \delta_N u$), the productivity growth rate in the traded sector decelerates as S_N increases. Further, equation 3.12b verifies that an increase in S_N accelerates the productivity growth in the non-traded sector when the direct effect is dominant (i.e. $u > \delta_T v$) and it decelerates the productivity growth when the spillover effect is dominant (i.e. $u < \delta_T v$).

Proposition 8: For any $u, v > 0$ and $0 < \delta_T, \delta_N < 1$,

- a) The natural resource boom decelerates the productivity growth in the traded sector, If the direct effect of learning is stronger than the spillover effect \Leftrightarrow if $v > \delta_N u$, $\frac{d(\dot{A}_T/A_T)}{dR} < 0$,
 b) The natural resource boom decelerates the productivity growth in the non-traded sector, If the direct effect of learning is weaker than the spillover effect \Leftrightarrow if $u < \delta_T v$, $\frac{d(\dot{A}_N/A_N)}{dR} < 0$.

Proof: The results are found through the derivative of the absolute productivity growth with respect to R , $\frac{d(\dot{A}_T/A_T)}{dR} = -(v - \delta_N u) \frac{dS_N}{dR}$ & $\frac{d(\dot{A}_N/A_N)}{dR} = -(\delta_T v - u) \frac{dS_N}{dR}$, and given that $\frac{dS_N}{dR} > 0$.

The question arising now is the effect of a change in income inequality on the productivity

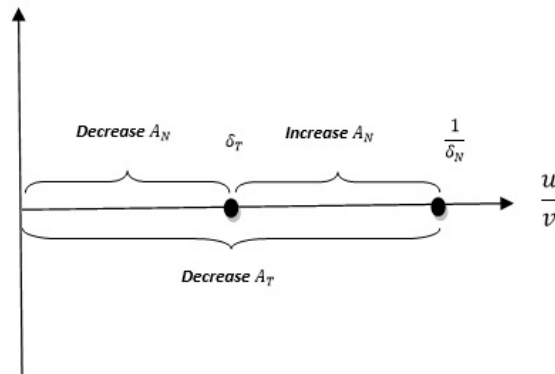

Figure 3.4: Absolute productivity growth change in response to an increase in S_N .

growth in each sector. I concentrate on the case $\theta_S < \theta_L$ which is consistent with the stability condition and the empirical evidence. On the one hand, a natural resource boom increases the labor share of skilled workers in the non-traded sector (S_N). In response, the relative productivity, ϕ , falls to shift down the LL -curve and NN -curve along the transition path. The reduction in the relative productivity ratio can be paraphrased as a faster expansion of the productivity level in the non-traded sector than in the traded

sector. But there is an alternative. It states that the productivity level shrinks faster in the traded sector than in the non-traded sector. Which one of these two states occurs depends on the gap between the direct and spillover effect for each productivity level. Regarding Proposition 8, if the direct effect of learning generated by the non-traded sector is weaker than the spillover effect (i.e. $\frac{u}{v} < \delta_T$)²⁷, the productivity level should shrink faster in the traded sector than in the non-traded sector to reduce the relative productivity level (Figure 3.4).

On the other hand, a natural resource boom can lead to falling income inequality if resource inequality is smaller than non-resource income inequality (i.e. $\pi < I^{NR}$)²⁸ and skilled workers are used intensively by the traded sector than by the non-traded sector (i.e. $\alpha < \beta$). (Proposition 3). Therefore, a natural resource boom through falling income inequality makes the real exchange rate appreciation larger for the case $\theta_S < \theta_L$ than for the case $\theta_S = \theta_L$ (see. Figure 3.3). Consequently, S_N is larger for the case $\theta_S < \theta_L$ than the case $\theta_S = \theta_L$ as a natural resource boom is accompanied by falling income inequality. This concludes as windfall income goes up, the productivity growth deceleration in both sectors is more intensive for the case $\theta_S < \theta_L$ than for the case $\theta_S = \theta_L$. The above argument is summarized as the following proposition

Proposition 9: *Assume the direct effect of learning generated by the non-traded sector is weaker than the spillover effect (i.e. $\frac{u}{v} < \delta_T$), for the case $\alpha < \beta$ and $\pi < I^{NR} \Rightarrow \frac{dI}{dR} < 0$,*

the productivity growth deceleration in both sectors is more intensive when income inequality reduces than when income inequality plays no role $\Leftrightarrow \left(\frac{d(\dot{A}_J/A_J)}{dR}\right)_{\theta_S < \theta_L} > \left(\frac{d(\dot{A}_J/A_J)}{dR}\right)_{\theta_L = \theta_S}$,
 where $J = T, N$.

Proof: We know the derivatives of the productivity growth with respect to R (Proof of Proposition 8) and given that $\left(\frac{dS_N}{dR}\right)_{\theta_S < \theta_L} > \left(\frac{dS_N}{dR}\right)_{\theta_L = \theta_S}$ (Proposition 3 and Figure 3.3). Before attention is turned to empirical evidence, It seems to be useful to discuss the steady-state growth rate. By inserting the steady-state labor share of skilled workers in the non-traded sector (S_N^* at Equations 3.15) in one of Equations 3.12, the steady-state growth rate is given :

$$g = \frac{uv(1 - \delta_T \delta_N)}{(1 - \delta_T)v + (1 - \delta_N)u}. \quad (3.18)$$

This Equation reveals that at steady-state the productivity level in each sector and total non-resource income expand equally irrespective of the natural resource (i.e. $\frac{\dot{A}_T}{A_T} = \frac{\dot{A}_N}{A_N} = \frac{\dot{X}}{X} = g$)²⁹. Also, total income grows at the same rate if R is constant over time (i.e. $\frac{\dot{Y}}{Y} = g$).

²⁷If this assumption holds, both productivity growth decelerates as S_N goes up (see. Figure 3.4).

²⁸This is equal to $\frac{\pi}{1-\pi} < \frac{w_S}{w_L}$, the relative resource rent benefit of skilled workers is smaller than the relative real wage.

²⁹The result proves as follows: $\frac{\dot{X}}{X} = \frac{X_T}{X} \frac{\dot{X}_T}{X_T} + \frac{P X_N}{X} \left[\frac{\dot{P}}{P} + \frac{\dot{X}_N}{X_N} \right]$. From Equations 4.14 we have $\frac{\dot{X}_T}{X_T} = \frac{\dot{A}_T}{A_T} = g$ and $\frac{\dot{X}_N}{X_N} = \frac{\dot{A}_N}{A_N} = g$. It also yields $\frac{\dot{P}}{P} = \frac{\dot{\phi}}{\phi} = \frac{\dot{A}_T}{A_T} - \frac{\dot{A}_N}{A_N} = 0$. Therefore, $\frac{\dot{X}}{X} = g$

3.3 Empirical approach

In this section, I present an empirical approach to find some reliable evidence in order to support the proposed theory. The main contribution is to estimate the effect of a natural resource boom on inequality, and the feedback effect of inequality on the intensity of the Dutch disease. Before moving to the description of the econometric methodology and the variables, let me briefly conclude the structural relationship of the model to bridge the gap between theory and empiric. Figure 3.5 shows the conceptual mechanism of the proposed model.

Arrow1 : The real exchange rate appreciates as the windfall income increases.

Arrow2 : The real exchange rate appreciation induces income inequality according to a sectoral factor intensity, so that the market-based income inequality rises (falls) if the non-traded sector is relatively intensive in skilled (unskilled) workers (Proposition 1).

Arrow3 : Distribution of the resource income benefits (e.g. subsidies) in participation with distribution of the market-based income changes the total income inequality (Proposition 2).

Arrow4 : In response to an increase in the real exchange rate, the relative productivity ratio reduces.

Arrow5 : On the assumption that unskilled workers with respect to skilled workers spend more on the non-traded goods, falling (rising) income inequality exacerbates (moderates) the intensity of the Dutch disease (Proposition 6).

In what follows, I estimate the structural relationship between key variables of interest in

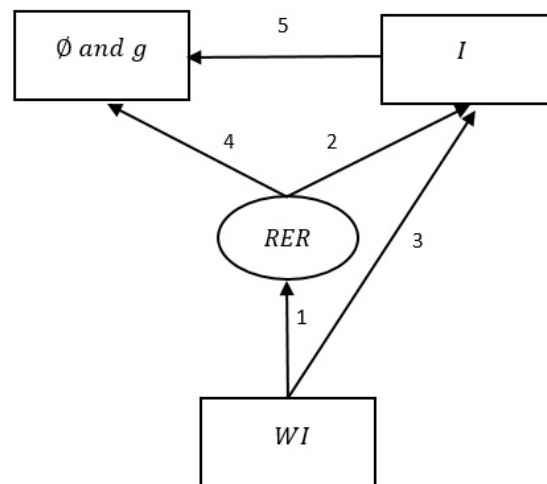

Figure 3.5: the conceptual mechanism of the model. *WI* is the windfall income (a natural resource boom). The real exchange rate and income inequality are respectively denoted by *RER* and *I*. In addition, *g* and ϕ denote the economic growth and the relative productivity ratio.

following sub-sections to clarify the conceptual mechanism of the model:

- 1) the effect of the windfall income on the real exchange rate along the transition path,
- 2) the response of income inequality to a change in the windfall income,

- 3) the combination of a natural resource boom and income inequality changes on the intensity of the Dutch disease, and
- 4) the impact of a natural resource boom on the sectoral economic growth along the transition path.

3.3.1 Data and Empirical methodology

Empirical attempts to analyze how windfall income affects economic performance have predominantly been performed using cross-sectional regression (e.g. J. D. Sachs and Warner, 1995). This procedure is unable to capture the effect of a change in our variables of interest (e.g. income inequality) on the economic performance of a natural resource-dependent economy. For this reason, I employ a panel data approach to elaborate on this problem. The unbalanced panel sample comprises 79 countries and covers non-overlapping 5-year periods of data observed from 1975 to 2014³⁰. The list of countries included in the sample database presents in Appendix D. Table 4.1 reports summary statistics. The average for 5-year periods of per capita GDP (Constant 2010 US *dollars*), and per capita manufacturing and service value-added (Constant 2010 US *dollars*) are sourced from the World Bank's World Development Indicator Database (*WDI*). Income inequality, measured by the Gini index, is gathered from the World Bank World Development Indicators (World Bank, 2013) and the University of Texas Inequality project dataset³¹. Due to the non-existence of price index for traded and non-traded goods, I use the real effective exchange rate, estimated by *Bruegel* (Darvas, 2012) as a proxy for the relative price³².

The windfall income is measured by total natural resources rents (% of GDP) collected from *WDI*. It is further proxied by the non-agriculture commodity export price index³³, constructed using a similar methodology to Deaton, Miller, et al., 1995, Dehn, 2000, Collier and Goderis, 2008. Whereas the former index captures the impact of both price and quantity variations on the windfall income, the latter one represents only price variation. To construct the composite commodity export price index, I first collect data on world prices of 16 non-agriculture commodities³⁴ as well as commodity export and import

³⁰5-year periods are: 1975-79, 1980-84, 1985-89, 1990-94, 1995-99, 2000-04, 2005-09, 2010-14. By taking into account five-year averages, I prevent the effects of short term fluctuation.

³¹The Estimated Household Income Inequality dataset (EHII) is derived from the econometric relationship between UTIP-UNIDO and the World Bank's Deininger and Squire, 1996 dataset (i.e. Galbraith and Kum, 2005).

³²The real effective exchange rate (*REER*) is calculated as $REER = \frac{NEER \cdot CPI^{domestic}}{CPI^{foreign}}$, where *NEER* is the nominal effective exchange rate of the country under study.

³³Adopting the methodology defined in *WDI*, the concept of reserves does not apply to many commodities including agricultural products. Hence, I only construct the non-agricultural commodity price for as many countries as data availability allowed to make proxies be consistent together.

³⁴The non-agricultural commodities are aluminium, cobalt, lead, Oil crude, tin, coal, natural gas, phosphates, platinum, zinc, copper, iron ore, nickel, silver, uranium, wood. Points: 1) a normalized average prices (US dollar) of hard and soft swan-woods is given as the price of wood (2010=100), 2) a normalized average prices (US dollar) of coal for Australia and South Africa bases is given as the price of coal (2010=100), 3) a normalized average prices (US dollar) of natural gas for USA and Europe bases is given as the price of gas (2010=100), and *APSP* crude oil price that is weighted average of three crude

Table 3.1: Summary Statistics

	Obs.	Mean	Std Dev.	Min	Max
Ln (per capita GDP)	479	8.69	1.37	5.12	11.41
Ln (per capita GDP of Manufacturing)	400	6.72	1.42	2.08	9.24
Ln (per capita GDP of Service)	409	8.02	1.51	3.92	10.76
Gini index	479	42.67	6.30	26.97	56.38
Real effective exchange rate (divided by 100)	474	1.13	0.77	0.33	11.95
Windfall income proxy	479	5.06	6.96	0.01	47.33
Commodity Price index	181	1.28	0.65	1.00	6.07
Population growth	479	1.32	1.05	-1.50	4.60
Investment ratio	479	23.90	6.16	4.84	54.42
Human Capital index	479	2.38	0.65	1.08	3.72
Openness index	479	63.28	31.09	9.50	205.54
Terms of trade	479	1.01	0.25	0.21	3.04
Foreign direct investment	471	2.59	3.76	-3.13	40.41
Government spending	469	15.47	5.18	4.14	46.89
Excess Money growth	389	0.09	0.26	-1.43	1.47
Rule of Law indicator	479	0.21	0.99	-1.74	1.96
Control of Corruption indicator	479	0.28	1.09	-1.37	2.51

values for available countries data over the period 1990-2014. Further, commodity export and import data for each country are collected from the *UNCTSD* (United Nations Commodity Trade Statistics Database) database ³⁵, while data for commodity price indices are sourced from the *IMF – IFS* International Financial Statistics database. Then a country-commodity specific weight for each country in 1990 is constructed by dividing the individual 1990 net export values for each commodity to the total net export value of all commodities in 1990 ³⁶. The weight is held fixed over periods to prevent the index from arising possible endogeneity problems due to supply responses to world prices. More specifically, the geometrically-weighted index of commodity export prices for country i in year t (PC_{it}) is constructed as follows:

$$PC_{it} = \prod_{j=1}^J PC_{jt}^{w_{j90}}, \quad (3.19)$$

where PC_{jt} represents the international market prices for commodity j in year t and w_{j90} is country-commodity specific weight in 1990. Finally, the log of the geometrically weighted index is weighted by the 1990 share of net commodity exports in a country's GDP (see Collier and Goderis, 2008) to allow the effect of commodity export prices to be larger for countries with higher commodity exports.

Following the recent empirical studies, I include a number of control variables in the

oil spot prices (west Texas intermediate, dated Brent and Dubai Fateh) is considered as oil crude price.

³⁵It reports dollar values of exports and imports according to the *SITC1* system.

³⁶For countries with missing 1990 data for commodity export and import values, I use the value available in the year closest to 1990.

3.3. EMPIRICAL APPROACH

regression equations. Commonly used control variables are Population growth ³⁷, Investment ratio ³⁸, Human Capital Index ³⁹, Openness ratio ⁴⁰, Terms of trade ⁴¹, Foreign direct investment ⁴² and Government spending ⁴³. Additionally, the difference between the growth rate of the Broad money ($M2$) and Economic growth is defined as Excess Money growth ⁴⁴. The average data of Rule of Law and Control of Corruption indicators ⁴⁵ are utilized to construct a normalized index, representing the quality of institution (Institution index) across countries.

In order to verify the theoretical findings, dynamic panel data models are applied. The general form of a dynamic model is specified as follow:

$$y_{i,t} = \alpha + \delta y_{i,t-1} + X'_{i,t}\beta + \mu_i + \varepsilon_{i,t}. \quad (3.20)$$

Where the subscripts $i = 1, \dots, N$ and $t = 1, \dots, T$ index the countries and periods in the panel, respectively. $y_{i,t}$ and $X'_{i,t}$ denote respectively the dependent variable and a vector of independent variables. α is a constant term, μ_i denotes the unobserved country-fixed effect and $\varepsilon_{i,t}$ is the error term.

Several econometric problems may arise in the estimation of Equations 3.20. The country-fixed effects may be correlated with the explanatory variables. Also, the inclusion of the lagged dependent variable among regressors gives rise to autocorrelation. The last problem arises when explanatory variables are predetermined or endogenous ⁴⁶ instead of strictly exogenous. In this paper, I apply first-differenced GMM estimator developed by Arellano and Stephen Bond, 1991 and the system GMM estimator proposed by Blundell and Stephen Bond, 1998 to cope with these problems. In the former method, the lagged level variables instrument the explanatory variables, while in the latter method, both

³⁷The average value for the 5-year period is sourced from *WDI*.

³⁸Gross fixed capital formation, in the percentage of GDP, is used to proxy the investment ratio. Observed values as averages for the 5-year period are derived from *WDI*.

³⁹Our measure of human capital is an index constructed by *Penn World Table*. This index is based on Barro and J. W. Lee, 2013 database for the average years of schooling and an estimated rate of return for primary, secondary, and tertiary education, introduced by Caselli, 2005. Following the recent work of Barro, 2008, I observe the human capital index at the start of each period.

⁴⁰I collect data of trade to GDP ratio, a proxy for openness level, from *WDI* database. The ratio is observed as averages for 5-year period.

⁴¹The net barter terms of trade index (2000=100) are calculated as the percentage ratio of the export unit value indexes to the import unit value indexes. The average value for the 5-year period is derived from *WDI* and *OECD* database.

⁴²It is defined as the net inflows of investment divided by *GDP*. The average value for the 5-year periods is collected from *WDI*.

⁴³It refers to general government final consumption expenditure divided by *GDP*. The data is an average value for the 5-year period, sourced from *WDI*.

⁴⁴The average growth rate of $M2$ for each period is calculated as $GM_t = \ln\left(\frac{M2_t}{M2_{t-1}}\right)$. The data source is *WDI*.

⁴⁵Both indicators proposed by *World Bank's Governance Indicators Project* are in the range of approximately -2.5 (weak) to $+2.5$ (strong). The data are available from 1996 to 2014. For preceding periods, I assume that the indicators are equal to the earliest value.

⁴⁶A predetermined variable is correlated with past observation-specific disturbance while an endogenous variable is correlated with past and current observation-specific disturbance.

lagged level and lagged differences are used.

The levels of the dependent variables and the endogenous variables are instrumented by lagged two or more periods, while those for the levels of the pre-determined variables are instrumented by lagged one or more periods. Further, the valid instruments for the levels of exogenous variables are simply current or lagged periods. The quality of the estimated dynamic models must be verified to make sure that the results are valid. The utilization of GMM estimator requires two conditions: the serial autocorrelation of errors and the proliferation of instruments which causes overidentification in the estimation model. First states that the error term must be serially uncorrelated to verify the lagged variables as valid instruments. The condition can be avoided by using the *Arellano-Bond* test. The null hypothesis of the test is that autocorrelation doesn't exist. The joint validity of full instruments is also checked by using the *Hansen* test of over-identifying restrictions⁴⁷. The null hypothesis of the test states that the instruments, as a group, are uncorrelated with the error term. Moreover, the rule of thumb is to keep the number of instruments less than the number of country groups. Therefore, I only use certain lags, instead of all available lags, as an instrument to avoid an overidentification (Roodman, 2009a). Finally, I use a two-step system GMM (first-differenced GMM) with Windmeijer, 2005 robust correction procedure⁴⁸.

3.3.2 Impact of the windfall income on the real exchange rate

The aim of this section is to evaluate the effect of a natural resource boom on the real exchange rate. Following the proposed theory and the recent study (Torvik, 2001), the real exchange rate appreciates along the transition path as the windfall income increases. Further, regarding the assumption that the unskilled workers with respect to the skilled workers allocate a larger expenditure share on non-traded goods, falling income inequality tends the real exchange rate to appreciate more (see. Figure 3.3).

The dependent variable of the dynamic panel data model is the real effective exchange rate and the explanatory variables of interest are the windfall income proxy and *Gini* index. I also include a number of control variables, namely the level of *GDP* per capita, Excess Money growth, Government spending, Terms of trade, Openness index and Foreign direct investment. Both dependent and explanatory variables are log-transformed variables.

The empirical results for regression models are reported in Table 4.9. Columns (1) and (2) represent, respectively, *OLS* and System GMM estimators for the baseline specification model. Although the *OLS* estimation results may not be informative, the results may still be interesting as a benchmark. The estimated positive and significant coefficient for the correlation between the windfall income (lagged) and the real effective exchange rate confirms the theory's prediction that a natural resource boom appreciates the real

⁴⁷*Hansen* test is adequate when the estimation considers a *heteroscedastic* weight matrix.

⁴⁸All estimations and statistical tests described in continue are carried out using *xtabond2* command proposed by Roodman, 2009b.

3.3. EMPIRICAL APPROACH

exchange rate.

I include the Gini index in the baseline model to reveal the impact of income inequality on the real exchange rate. The results are presented in column (3). The estimated coefficient is significant at 1% and enters with a negative sign. It states that falling income inequality is associated with rising the real exchange rate (the relative factor price). This supports the theory's prediction if one is assumed that the rich (skilled workers) relative to the poor (unskilled workers) spend a larger share of their income on traded goods (i.e. Proposition 3). The finding contrasts with Min, Shin, and McDonald, 2015, where under non-homothetic preferences between different income groups more inequality causes an increased demand for non-traded goods. Since the high-income group has a higher elasticity of demand for non-traded goods than does the low-income group (i.e. Engel's law). Accordingly, the relative price of non-traded goods increases and so the real exchange rate applications.

The reported small estimated coefficient on the windfall income proxy in column (3) seems to imply a heterogeneity across countries. To discuss this issue, I include an interaction term between income level and the windfall income proxy in the baseline model. Column (4) reports the results. It demonstrates that in responding to an increase in the windfall income proxy, the real exchange rate appreciates more for developing countries than for developed countries. In other words, the real exchange rate appreciation attenuates as GDP per capita increases ⁴⁹.

To test the robustness of the results, I restrict the sample to developing countries, introduced by the International Monetary Fund's World Economic Outlook Database. The results reported in column (5) show that the coefficient on the windfall income remains close to the baseline's coefficient. While the coefficient on the Gini index is less negative than the baseline's coefficient. The latter may suggest that the intensity of a change in income inequality on the real exchange rate is stronger in developed countries than in developing countries. Following the proposed theory, it may arise because the relative consumption expenditure of non-traded to traded goods for the poor is larger in developed countries than in developing countries.

The theory predicts that the real exchange rate appreciates more in low-quality-institution countries than in high-quality-institution countries. Hence, I run the regression model for a sample including countries with a normalized institution index less than 0.7, specifying poor-institution countries. I also exclude the Gini index from the regression model to prevent the real exchange rate from the indirect effect of the windfall income through income inequality change. The results reported in column (6) reveal a larger value of the coefficient on the windfall income (i.e. 0.0268) relative to the value estimated on the full sample (i.e. 0.0261). It seems to confirm the theory anticipated.

Further robustness checks are included in Column (7) and (8) to test the consistency of the results, respectively, in terms of the currency union's effects and different data sources.

⁴⁹The real exchange rate will never depreciate on the dataset. Since the largest per capita GDP (Ln) observation is equal to 11.41 and so $\frac{dP}{dR} \approx 0$.

Table 3.2: Estimation results for the real effective exchange rate

Explanatory variable	(1)	(2)	(3)	(4)	(5)	(6)	(7)	(8)	(9)	(10)
	OLS	Sys.GMM	Sys.GMM	Sys.GMM	Sys.GMM	Sys.GMM	Sys.GMM	IMF	Recession	Sys.GMM
	Full Sample Full Sample Full Sample Full Sample Developing Poor Instt Non Europe									
Real effective exchange rate (lagged)	0.574*** (0.0338)	0.483*** (0.135)	0.592*** (0.0754)	0.519*** (0.0727)	0.584*** (0.0614)	0.537*** (0.168)	0.594*** (0.0761)	0.494*** (0.128)	0.543*** (0.123)	0.499*** (0.158)
Windfall income (lagged)	0.0227*** (0.00942)	0.0261*** (0.00927)	0.0424*** (0.0150)	0.173*** (0.0777)	0.0407*** (0.0134)	0.0268*** (0.0130)	0.0331*** (0.0109)	0.0337* (0.0192)	0.0609*** (0.0223)	
Gini index			-0.950*** (0.360)	-1.017*** (0.374)	-0.888** (0.438)		-0.839** (0.375)	-1.288* (0.672)	-1.080** (0.460)	
Windfall income *GDP per capita				-0.0152* (0.00822)						
Commodity Price index (lagged)										0.108** (0.0537)
GDP per capita (lagged)	0.00407 (0.0141)	-0.00926 (0.0166)	-0.0904** (0.0414)	-0.0542 (0.0377)	-0.0594 (0.0502)	0.000497 (0.0231)	-0.0635 (0.0508)	-0.0680 (0.0414)	-0.0895* (0.0499)	-0.0242 (0.0161)
Excess Money growth (lagged)	0.0790* (0.0433)	0.0732* (0.0388)	0.122*** (0.0582)	0.114** (0.0571)	0.136*** (0.0651)	0.0918*** (0.0463)	0.118*** (0.0520)	0.100* (0.0547)	0.133*** (0.0604)	0.0651* (0.0393)
Government spending	0.0426 (0.0400)	0.0902*** (0.0376)	0.0580 (0.0574)	-0.120* (0.0614)	0.124* (0.0668)	0.0923* (0.0495)	0.0737* (0.0429)	-0.206** (0.100)	0.0528 (0.0827)	0.0484 (0.0438)
Terms of trade	0.132*** (0.0590)	0.115** (0.0576)	0.0502 (0.0657)	0.0849 (0.0672)	0.0215 (0.0726)	0.0898 (0.0594)	0.0690 (0.0503)	0.159** (0.0665)	0.111 (0.0942)	0.0180 (0.0677)
Openness index	-0.0532* (0.0278)	-0.0940 (0.0719)	-0.171*** (0.0791)	-0.153*** (0.0728)	-0.173*** (0.0836)	-0.0864 (0.0706)	-0.163*** (0.0724)	-0.0842 (0.0716)	-0.206*** (0.0891)	-0.0705*** (0.0241)
Foreign direct investment	-0.00673 (0.0105)	-0.00336 (0.0112)	0.0125 (0.0147)	0.00436 (0.0136)	0.0109 (0.0164)	0.00265 (0.0165)	0.00139 (0.0143)	-0.0205 (0.0198)	0.00683 (0.0128)	0.0220 (0.0186)
Time dummies	YES	YES	YES	YES	YES	YES	YES	YES	YES	YES
Observations	307	307	307	307	244	249	274	195	221	120
Number of Countries	63	63	63	63	52	54	54	40	62	36
Arellano-Bond test for AR(2) (p-value)	-	0.584	0.672	0.709	0.494	0.462	0.584	0.100	0.276	0.339
Hansen OID test (p-value)	-	0.422	0.187	0.501	0.290	0.529	0.377	0.661	0.342	0.313
R-squared	0.621	-	-	-	-	-	-	-	-	-

Note: The dependent variable is the real effective exchange rate derived by *Brywiel*. The Gini index is instrumented by second lag level and further in first differences equation. Robust standard errors are reported in parentheses. ***, ** and * denote significance at 1, 5 and 10 percent levels. The null hypothesis of *Arellano-Bond* test is that autocorrelation doesn't exist. The null hypothesis of *Hansen* test is that the instruments, as a group, are uncorrelated with the error term.

3.3. EMPIRICAL APPROACH

I run the baseline regression model for a sample of Non-Europe union countries and for the real effective exchange rate sourced by *IMF*⁵⁰. The estimated results reported in column (6) show that the empirical findings are still confirmed and excluding Europe union countries has no effect on our findings. Furthermore, column (7) demonstrates that these findings are independent of a database used for the real effective exchange rate, however, the coefficients are more significant in the estimation on the *Bruegel* database than on the *IMF* database.

The global recession 2008-2013 has been the worst postwar recessions, both in terms of the number of countries affected and the decline in real World GDP per capita. Given that falling the interest rate over the recession period may depreciate the real exchange rate, it seems worthy to check the consistency of the results on non-recession periods. Hence, I run the regression model for a sample including the period 1975-2004. The results presented in column (9) show that the coefficients on the variable of interests are significant and qualitatively the same as the full sample. In other words, the great recession effect affects the results only quantitatively.

The next question that seems worthy to be discussed is the response of the real exchange rate to resource price variations. In this respect, the impact of the commodity price index rather than the windfall income index on the real exchange rate is investigated. Column (10) reports the empirical results. The coefficient on the commodity price index is significant and expresses that a one percent increase in the commodity price index appreciates the real effective exchange rate by about 0.1%. It suggests that the hypothesis is confirmed in terms of both measurement approaches estimating a resource boom. The empirical finding is also in line with recent studies in the commodity prices–exchange rate nexus. Among many research, Jahan-Parvar and Mohammadi, 2011 using monthly observation data for 15 oil-exporting countries on the period 1970-2007, Bodart, Candelon, and Carpentier, 2012 using monthly observation data for 68 developing countries on the period 1980-2009⁵¹, and Ricci, Milesi-Ferretti, and J. Lee, 2013 using annual observation data for 27 developing & 21 developed countries on the period 1980-2004 confirm the existence of a long-run positive relationship between commodity prices and the real exchange rate.

I also check the sensitivity of the coefficient on the windfall income to a change in the composition of the samples. Following Mihasonirina and Kangni, 2011, I select randomly 98% of the observations (without replacement) and run the baseline regression model (column 4). This process, repeated 250 times, gives values for the coefficient on the variable of interest. I used the same procedure to select randomly 95%, 90% and 85% of observations. The mean and standard deviation of the coefficient for each selected sample are reported in Table 3.3. The test shows when the regression runs on different sample

⁵⁰The main departure of *Bruegel* database from *IMF* database is in the calculation of the geometrically weighted average of *CPI* indices of trading partners.

⁵¹They show that the dominant commodity's price affects the real exchange rate significantly in the long run when the leading commodity export share is at least 20 percent in the country's total exports of merchandises. Further their study show that the larger the share, the stronger the impact.

Table 3.3: Robustness test for the sensitivity of coefficient of interest

Explanatory variable		98%	95%	90%	85%
Windfall income (lagged)	Coefficient	0.03835	0.03606	0.03383	0.03355
	Standard Deviation	0.00435	0.00637	0.00807	0.00875

sizes, the coefficients of the windfall income don't change very much (less than 13%) while their distributions have heavier tails as the sample size shrinks. This may suggest that the coefficient becomes less significant in decreasing sample size.

Further, an additional robustness check to test the stability of the coefficient on the

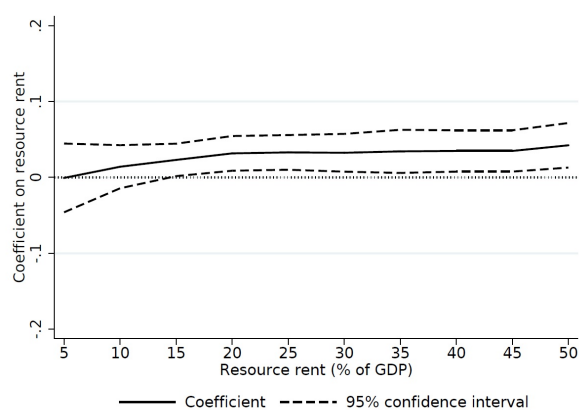

Figure 3.6: Recursive estimation on the coefficient of interest.

windfall income is conducted. I first rank the observations in increasing order of the windfall income ⁵². Then the regression is run for a sample with the lowest order of windfall income (i.e. less than 5%). In the next step, I add the subsequent observations with larger windfall income and rerun the regression. The results, shown in Figure 3.6, remain positive and significant. They also represent that the coefficient increases slightly as the share of resource rent in GDP becomes larger. It, in turn, suggests that the real exchange rate appreciation is more intense in the natural resource-rich countries than natural resource-poor countries.

3.3.3 Income inequality response

In this section, I examine the impact of the windfall income on income inequality. Gini index proxies total income inequality and so it is the dependent variable of the dynamic panel data model. The proposed theory clarifies that income inequality is affected by the distribution of resource rent benefit (subsidies) between the rich and the poor (skilled

⁵²I ranked the observations in 10 orders: less than 5%, between 5% and 10%, between 10% and 15%, and so on.

3.3. EMPIRICAL APPROACH

and unskilled workers). Furthermore, a natural resource boom induces income inequality indirectly through the real exchange rate appreciation (see. Figure 3.5). Therefore, the explanatory variables of interest are the windfall income and the real exchange rate. I also include per capita GDP (Ln), Investment ratio, Human Capital index, Openness index, and Institution index as the control variables.

Table 3.4 displays a set of results. The first column corresponds to the *OLS* estimation. The results for the indirect effect of the windfall income on the Gini index are reported at column (2). The estimated coefficient of interest is negative and significant. This implies that the real exchange rate appreciation is associated with falling income inequality. Following Proposition 1, it intuitively refers to the assumption that the traded sector is relatively more intensive in skilled workers. Since the relative price appreciation increases the factor price used intensively in the non-traded sector and decreases the other, the market-based income inequality falls if the non-traded sector is relatively unskilled worker intensive (i.e. *Stolper – Samuelson* theorem).

In order to reveal the total direct and indirect effects of a natural resource boom on income inequality, I include the windfall income index in the regression model. Column (3) reports the estimated results. The coefficient enters with a negative sign and is significant at 1 percent. It shows that a one-standard-deviation increase in the windfall income is associated with a decrease in income inequality level by about 6%. Accordingly, as in Goderis and Malone, 2011 and, D.-H. Kim and Lin, 2018⁵³, the finding suggests that a natural resource boom, on average, tends to reduce income inequality.

Now it is worth studying whether there is a difference between the response of income inequality to a resource boom in a resource-poor economy and in a resource-rich economy. To address this issue, I introduce a dummy variable for the natural resource-poor economics, equal to one when total natural resource rent is less than 5 percent of GDP. Column (4) reports the estimated coefficients of the dummy variable and the interaction between the dummy variable and the windfall. The results conclude that the correlation between the windfall income and income inequality is positive in the resource-poor economies while it is negative in other. From a theoretical viewpoint, Proposition 5 suggests when the distribution of the resource income benefit is less fairly than the distribution of the non-resource income, income inequality rises as the windfall income increases. Hence, the empirical findings seem to be consistent with the theoretical prediction. Since one is more likely that in the natural resource-poor economies, a group of elites appropriates a larger share of resource income benefits or private companies, exploiting the natural resource, distribute their income among a small group of shareholders. Thus, the assumption that, in the natural resource-poor economies, the distribution of resource income is more unevenly than the distribution of non-resource (market-based) income seems to be reliable. While in the natural resource-rich economies, direct subsidies or the spillover effects of investing

⁵³Using correlated effects pooled mean group methodology for a sample of developed and developing countries, they find that both oil abundance and oil dependence reduce income inequality.

Table 3.4: Estimation results for Gini index

Explanatory variable	(1)	(2)	(3)	(4)	(5)	(6)	(7)
	OLS Full Sample	Sys.GMM Full Sample	Sys.GMM Full Sample	Sys.GMM Full Sample	Sys.GMM Developing	Sys.GMM Poor Instit	Sys.GMM Non Europe
Gini index (lagged)	0.841*** (0.0237)	0.781*** (0.0500)	0.790*** (0.0426)	0.821*** (0.0543)	0.756*** (0.0747)	0.786*** (0.0637)	0.771*** (0.0678)
Real effective exchange rate	-0.159 (0.124)	-0.215*** (0.0551)	-0.186*** (0.0491)	-0.235*** (0.0827)	-0.249*** (0.0861)	-0.197*** (0.0754)	-0.238*** (0.0900)
Windfall income (lagged)			-0.0592*** (0.0221)	-0.177*** (0.0481)	-0.0633** (0.0264)	-0.0631*** (0.0234)	-0.0639** (0.0250)
Dummy Resource Poor countries				-2.533*** (0.656)			
Dummy* Windfall income				0.208*** (0.0573)			
GDP per capita (Ln)	-0.305** (0.137)	-0.393** (0.162)	-0.359*** (0.128)	-0.119 (0.170)	-0.169 (0.213)	-0.176 (0.147)	-0.207 (0.194)
Investment ratio	-0.0391** (0.0162)	-0.0470* (0.0279)	-0.0471 (0.0319)	0.0180 (0.0252)	-0.0656 (0.0449)	-0.0329 (0.0418)	-0.0709* (0.0417)
Human capital index	-0.417 (0.268)	-0.441 (0.298)	-0.632* (0.342)	-0.736** (0.371)	-1.033** (0.511)	-1.102** (0.437)	-1.027** (0.413)
Openness index	-0.00938*** (0.00316)	-0.0129*** (0.00482)	-0.0126** (0.00537)	-0.0143*** (0.00462)	-0.0128 (0.00929)	-0.0106 (0.00769)	-0.0114 (0.00836)
Institution index	-0.555 (0.611)	-1.035 (0.798)	-1.075 (0.819)	-0.929 (0.811)	0.484 (1.020)	-1.744 (1.105)	-0.0989 (0.770)
Time dummies	YES	YES	YES	YES	YES	YES	YES
Observations	396	396	396	396	265	286	291
Number of Countries	78	78	78	78	55	60	56
Arellano-Bond test for AR(2) (p-value)	-	0.330	0.328	0.306	0.132	0.158	0.151
Hansen ODD test (p-value)	-	0.740	0.674	0.447	0.507	0.450	0.501
R-squared	0.919	-	-	-	-	-	-

Note: The dependent variable is the Gini index of *EHHI* data set. The real effective exchange rate and windfall income (lagged) are instrumented by first lag level and second lag level in first differences equation, respectively. The control variables except the Institution index are instrumented by first lag level. Robust standard errors are reported in parentheses. ***, ** and * denote significance at 1, 5 and 10 percent levels. The null hypothesis of *Arellano-Bond* test is that autocorrelation doesn't exist. The null hypothesis of *Hansen* test is that the instruments, as a group, is uncorrelated with the error term.

3.3. EMPIRICAL APPROACH

the resource income on education, infrastructure or health care seem to make more evenly the distribution of resource income benefit than the distribution of non-resource income. Column (5) through (7) at Table 3.4 contain robustness checks of the baseline model for heterogeneity across countries. I first run the specification model for the developing economies. Further, a robustness analysis of the baseline model is examined for heterogeneity in terms of institutional quality. Given that the quality of institution is more likely to affect income inequality, I split countries with a high normalized institution index, larger than 0.7, and run the regression. For both analysis, there is a significantly negative impact on income inequality from both the real exchange rate and the windfall income, the same as the results for the baseline model (i.e. column (3)). The value of the coefficient on the windfall income is more negative in the developing economies and the poor institution countries' samples (equal -0.0633 and -0.0631 respectively) than the full sample (equal -0.0592). This may indicate a larger gap in expenditure shares in developing or poor-institution countries than others. Since, regarding the theory, a natural resource boom leads to a stronger real exchange rate appreciation in countries with a larger gap in expenditure shares (i.e. $\theta_L - \theta_S$) which, in turn, results in more falling in income inequality. In addition, column (7) represents the estimation results for non-European countries. The results are qualitatively similar to those for the full sample. It indicates currency union effects plays no role on the relationship between the variables of interest and the dependent variable. Given that the unskilled labor intensity in the non-traded sector is larger in a sample excluding European countries than in the full sample, a more negative value of the coefficient on both variables for the restricted sample seems to be explainable.

I further examine whether the estimation results are robust in terms of different income inequality databases. The first measure of the Gini coefficient is taken from the Standardized World Income Inequality Database (*SWIID*) (Solt, 2016) ⁵⁴. The results represent in column (1) of Table 3.5. Those show that the value for both explanatory variables of interest are negative, however, it is significant only for the coefficient on the windfall income. Also, the coefficient on the windfall income is more intensive when the *SWIID* database is used than when the *EHII* database is done. The second database is the World Bank's *PovcalNet* database published in the World Development Indicators *WDI*. Column (2) reports the results. Although both coefficients on the real effective exchange rate and the windfall income have negative signs, they are less significant. It may arise because *WDI* database publishes both consumption and income measures of inequality. The difference in measures would be very large and so the significance of coefficients may reduce.

Column (3) reports the results when replacing the measurement of a resource boom by the Commodity price index. The coefficient on the commodity price index enters negative and is statistically significant at 5 percent. The effect is substantial and it can be translated as a function of a country's dependence on price variation of the commodity exports.

⁵⁴I use inequality in market (pre-tax, pre-transfer) income.

Table 3.5: Robustness checks for Gini index

Explanatory variable	(1)	(2)	(3)	(4)	(5)	(6)
	Sys.GMM <i>SWIID</i>	Sys.GMM <i>WDI</i>	Sys.GMM <i>Commodity</i>	Sys.GMM <i>Commodity</i>	Sys.GMM Full sample	Sys.GMM <i>Commodity</i>
Gini index (lagged)	0.851*** (0.0443)	0.880*** (0.0454)	0.673*** (0.115)	0.630*** (0.127)	0.772*** (0.0965)	0.768*** (0.101)
Gini index (Second lagged)					-0.0310 (0.0731)	-0.0712 (0.0859)
Real effective exchange rate	-0.0990 (0.0983)	-0.575* (0.314)	-0.0675 (0.908)	0.545 (1.212)	-0.296* (0.159)	0.535 (1.087)
Windfall income (lagged)	-0.0823*** (0.0274)	-0.00250 (0.0772)			-0.0691*** (0.0196)	
Commodity Price index (lagged)			-0.574** (0.278)	-1.631*** (0.336)		-0.900** (0.454)
Dummy Resource Poor countries				-2.917*** (0.855)		
Dummy* Commodity Price				1.270* (0.656)		
GDP per capita (Ln)	0.335 (0.236)	0.468 (0.554)	-0.636 (0.390)	-0.413 (0.362)	-0.370 (0.237)	-0.358 (0.307)
Investment ratio	-0.0195 (0.0393)	-0.0278 (0.0702)	-0.0311 (0.0528)	0.00107 (0.0768)	-0.0331 (0.0359)	-0.0775 (0.0756)
Human capital index	-0.977* (0.508)	-1.501 (1.190)	-1.434** (0.568)	-1.863** (0.904)	-0.953*** (0.296)	-1.885*** (0.683)
Openness index	-0.00469 (0.00443)	0.00225 (0.00975)	-0.0177* (0.00925)	-0.0151** (0.00672)	-0.0114*** (0.00414)	-0.0141** (0.00627)
Institution index	1.378* (0.789)	0.207 (2.255)	-0.644 (1.357)	-0.918 (1.283)	-1.824* (0.978)	-0.975 (1.680)
Time dummies	YES	YES	YES	YES	YES	YES
Observations	359	211	139	139	318	130
Number of Countries	77	55	42	42	78	42
Arellano-Bond test for AR(2) (p-value)	0.487*	0.953	0.384	0.431	0.173	0.474
Hansen OID test (p-value)	0.238	0.492	0.171	0.318	0.499	0.281

Note: The dependent variables for estimation results, reported in columns (1) and (2), are the Gini index of *SWIID* database and *WDI* database, respectively. While it is the Gini index of *EHII* database in the rest of columns. The real effective exchange rate and windfall income (lagged) are instrumented by first and deeper lags level and second lag level in first differences equation, respectively. The control variables except the Institution index are instrumented by first lag level. Robust standard errors are reported in parentheses. ***, ** and * denote significance at 1, 5 and 10 percent levels.

The null hypothesis of *Arellano-Bond* test is that autocorrelation doesn't exist. The estimation results for *SWIID* dataset, marked by *, report the AR(3) instead of AR(2). The null hypothesis of *Hansen* test is that the instruments, as a group, is uncorrelated with the error term.

3.3. EMPIRICAL APPROACH

The finding shows that income inequality's response to a resource boom is qualitatively independent of how to measure this boom. Further, similar to what discussed in column (4) of Table 3.4, I check the heterogeneity between countries' groups in terms of the dependency on the commodity exports. Column (4) of Table 3.5 represents the results when adding the interaction term between the dummy for resource-poor countries and the commodity price index to the specification of column (3). This shows that an increase in the commodity price index decreases the income inequality in both groups of countries and the effect is larger in resource-rich countries than resource-poor countries. This is contrary to the previous finding, reported in column (4) of Table 3.4, that a resource revenue boom makes the income distribution be worse.

Using panel cointegration methodology for a sample of 90 countries between 1965 and 1999, Goderis and Malone, 2011 analyze the short and long-run effects of commodity prices on the *Gini* index. Their estimates show that income inequality falls in the short run immediately after a resource boom and then rises steadily over time until the initial impact of the resource boom disappears. The difference in the adopted empirical approach in this paper from their approach is to apply the five-year average of variables in order to ignore business cycle fluctuations. Although the approach applied in this paper doesn't have well efficient to capture the short-run effects of the resource measurement on the income inequality index, I address this question by including the second lagged *Gini* index in the regression model. These first and second lags of the dependent variables can be translated as the intermediate and long-run effects. The results of the regression equation including one of the proxies for the resource rent are respectively reported in columns (5) and (6). The coefficients of the resource measurement index are also similar to before. Those also show that for both resource measurement proxies the coefficients on the first and second lagged *Gini* index enter with positive and negative signs respectively but they are statically significant at 1% only for the first lagged. The statistical insignificance of the coefficients on the second-lagged dependent variables may originate from a small number of periods for each country which, in turn, may undermine the reliability of the empirical results. Nevertheless, calculations seem to confirm the long-term effects (i.e. the second lagged) is smaller than the intermediate-term (i.e. the first lagged)⁵⁵. More precisely, the intermediate and long terms effects are equal to -0.303 and -0.267 in a regression model including the windfall income index. While they are equal to -3.879 and -2.968 in a model including the commodity price index. Those may clearly reflect that falling income inequality is moderated over time, similar to Goderis and Malone, 2011 finding. I also check the sensitivity of coefficients of interest to a change in sample size the same procedure as before. The average coefficient and standard deviation for each selected sample are reported in Table 3.6. The analysis shows that reducing the random sample size has less effect on the average coefficient for the real effective exchange rate (less than 20%)

⁵⁵For the following regression model: $x_t = ax_{t-1} + bx_{t-2} + cz_t$, the intermediate and long terms effects are reflected by $\frac{dx}{dz} = \frac{c}{1-a}$ and $\frac{dx}{dz} = \frac{c}{1-(a+b)}$, respectively.

however, the base of the normal distribution widens. In contrast to this, the estimated coefficient on the windfall income weakens rapidly as the sample size shrinks. This suggests that the coefficient estimated for the baseline model (i.e. column (3) at Table 3.4) may hide significant country heterogeneity. It is partly clarified by opposite impacts of the windfall income on income inequity in the resource-poor and resource-rich economies.

An additional robustness check is a recursive estimation to test the stability of the

Table 3.6: Robustness test for the sensitivity of coefficients of interest

Explanatory variable		98%	95%	90%	85%
Real effective exchange rate	Coefficient	-0.19326	-0.19353	-0.17653	-0.15712
	Standard Deviation	0.03671	0.07515	0.14097	0.23469
Windfall income (lagged)	Coefficient	-0.05208	-0.04611	-0.03875	-0.02380
	Standard Deviation	0.01601	0.02071	0.02899	0.03603

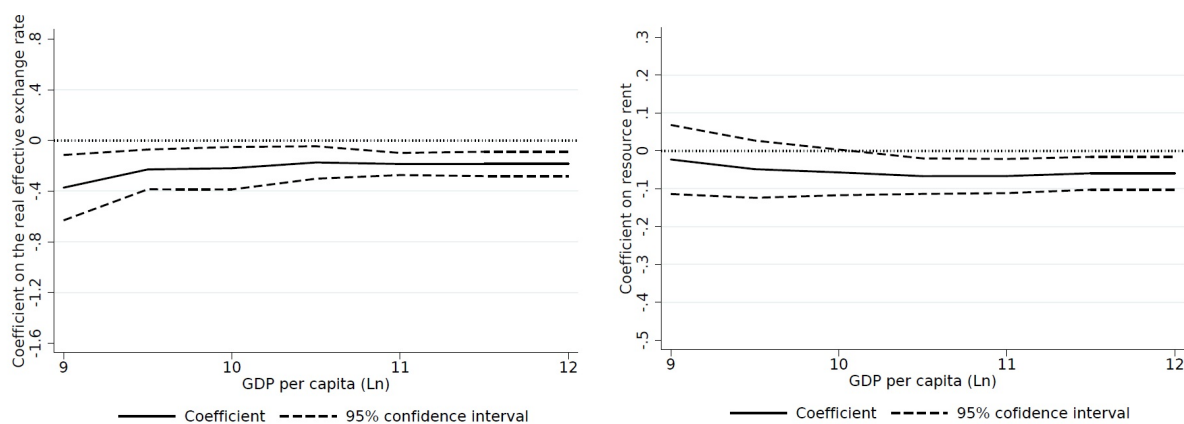

Figure 3.7: Recursive estimation on the coefficients of interest.

coefficients of interest for cross-country heterogeneity. The observations are ranked in increasing GDP per capita (Ln). The regression is run for a sample having GDP per capita (Ln) less than 9⁵⁶. Subsequent observations with larger GDP per capita are added and the regression is rerun. The same procedure is replicated as long as the full sample is covered. The results show in Figure 3.7. The coefficients on both the resource rent and the real exchange rate are negative and significant at each level of GDP per capita. This demonstrates that the negative correlation between variables of interest and income inequality is stable across country income level.

⁵⁶It covers about 50% of total observations.

3.3.4 The intensity of the Dutch disease

The third question of interest is the impact of a natural resource boom on the relative productivity ratio. The lack of enough data for the productivity level at the manufacturing and service sectors, proxies for the traded and non-traded sectors, motivates us to search a proxy for the relative productivity ratio. Following the theory, the labor allocation of skilled and unskilled workers return to their initial level along the transition path so that they would be constant at steady-state (i.e. Equation 3.15). Accordingly, the relative sectoral output, at steady-state, will be a function of the steady-state relative productivity ratio ϕ^* ⁵⁷. Hence, the relative sectoral output seems to be a reliable proxy to capture the impact of a natural resource boom on the relative productivity levels.

The income level in the manufacturing sector to that in the service sector (in constant price) is introduced as the dependent variable in the regression model. The windfall income proxy and Gini index are the explanatory variables of interest. Since the theory predicts that the resource income through the channels of income inequality can affect the relative productivity ratio. In addition, per capita GDP (Ln), Investment ratio, Human Capital index, Openness index, Government spending, and Institution index are included to control the regression model.

The estimated results are shown in Table 3.7. The results of *OLS* regression are reported in column (1) as a benchmark. Column (2) corresponds to the baseline model to test the impact of the windfall income on the dependent variable. The coefficient on the windfall income has a negative sign and is significant. The finding is consistent with the empirical literature, as in Amiri et al., 2019⁵⁸, and the theoretical prediction. A natural resource boom shifts the skilled labor force away from the traded sector and into the non-traded sector. The productivity level shrinks faster in the traded sector than in the non-traded sector⁵⁹, leading to a decrease in the relative productivity ratio, to induce a countervailing movement of labor which in turn gradually brings back the allocation of labor to a constant long-run equilibrium level.

The estimations further show that there is a negative correlation between income inequality and the relative sectoral output. More precisely, the dependent variable, on average, increases by about 2% per year as one-standard-deviation decreases in the Gini index. The finding is not following the proposed theory. Since the theory predicts that falling income inequality due to an increase in the resource rent tends to decrease more the relative productivity ratio (i.e. exacerbating the Dutch disease). This inconsistent result

⁵⁷ $\frac{X_T}{X_N} = \frac{A_T S_T^\beta L_T^{1-\beta}}{A_N S_N^\alpha L_N^{1-\alpha}} = \chi \phi^*$, where $\chi = \chi(S_N^*, L_N^*)$.

⁵⁸ They evaluate the impacts of natural resource rents on the relative sectoral output in terms of the quality of institutions. Under the panel data model of a sample including data of 28 natural resource-rich countries for the period of 2000-2016, they find that the relative output level decreases as the natural resource rents increase. Further, their estimation results show that the higher the level of institutional quality, the smaller the size of the impact.

⁵⁹ An alternative is that the productivity level grows faster in the non-traded sector than in the traded sector. Nevertheless, the empirical findings don't support this interpretation.

Table 3.7: Estimation results for the relative sectoral output

Explanatory variable	(1)		(2)		(3)		(4)		(5)		(6)		(7)		(8)			
	OLS	Full Sample	Sys.GMM	Full Sample	Sys.GMM	Full Sample	Sys.GMM	Full Sample	Sys.GMM	Developing	Sys.GMM	Poor Instit	Sys.GMM	Commodity	Sys.GMM	Commodity		
Relative sectoral output (Ln) (lagged)	0.906*** (0.0194)	0.741*** (0.0581)	0.857*** (0.0684)	0.849*** (0.0636)	0.694*** (0.107)	0.737*** (0.0608)	0.842*** (0.106)	0.996*** (0.121)										
Windfall income (lagged)	-0.00196* (0.00115)	-0.00495** (0.00203)	-0.00644 (0.0201)	-0.0134** (0.00601)	-0.00438** (0.00199)	-0.00494** (0.00220)												
Gini index	-0.00837*** (0.00217)	-0.0209*** (0.00532)	-0.0211*** (0.00618)	-0.0191*** (0.00551)	-0.0187*** (0.00684)	-0.0164*** (0.00607)	-0.0185*** (0.00691)	-0.0210** (0.00920)										
Windfall income*Gini index			0.000085 (0.000438)															
Dummy Resource Poor countries							-0.157* (0.0838)										-0.302** (0.139)	
Dummy* Resource measurement							0.0106** (0.00518)										0.159** (0.0729)	
Commodity Price index (lagged)																	-0.190*** (0.0676)	
GDP per capita (Ln) (lagged)	-0.0145 (0.0110)	-0.0385* (0.0228)	-0.0385* (0.0213)	0.000170 (0.0331)	-0.0244 (0.0252)	-0.0165 (0.0255)	-0.0338 (0.0288)	0.0655 (0.0706)										
Investment ratio	0.00212 (0.00140)	-0.000548 (0.00251)	0.00126 (0.00331)	0.00185 (0.00285)	-0.00110 (0.00313)	-0.000702 (0.00258)	-0.00117 (0.00292)	0.000112 (0.00331)										
Human capital index	-0.0222 (0.0209)	-0.0862** (0.0421)	-0.0591* (0.0317)	-0.0924** (0.0399)	-0.0776** (0.0359)	-0.0684 (0.0500)	-0.0665 (0.0589)	-0.140** (0.0688)										
Openness index	-0.000074 (0.000256)	0.000403 (0.000622)	-0.000134 (0.000643)	0.000124 (0.000571)	0.000671 (0.000525)	0.000686 (0.000582)	0.000076 (0.000569)	-0.00003 (0.00100)										
Government spending	-0.00587*** (0.00212)	-0.0158*** (0.00366)	-0.0116** (0.00475)	-0.0117*** (0.00337)	-0.0138*** (0.00394)	-0.0128*** (0.00330)	-0.0118 (0.00742)	-0.00828 (0.00851)										
Institution index	-0.0840* (0.0478)	-0.117 (0.0915)	-0.105 (0.0933)	-0.163* (0.0949)	0.000611 (0.105)	-0.128 (0.153)	-0.0717 (0.100)	-0.285* (0.0655)										
Time dummies	YES	YES	YES	YES	YES	YES	YES	YES										
Observations	313	313	313	313	213	226	128	128										
Number of Countries	68	68	68	68	46	51	40	40										
Arellano-Bond test for AR(2) (p-value)	-	0.859	0.843	0.842	0.954	0.960	0.264	0.06										
Hansen OID test (p-value)	-	0.331	0.164	0.336	0.624	0.614	0.121	0.127										
R-squared	0.914	-	-	-	-	-	-	-										

Note: The dependent variable is the relative sectoral output (in Ln forms). The windfall income (lagged) and GDP per capita (lagged) are instrumented by second lag level, while the Gini index is instrumented by first lag level in first differences equation. Robust standard errors are reported in parentheses. ***, ** and * denote significance at 1, 5 and 10 percent levels. The null hypothesis of *Arellano-Bond* test is that autocorrelation doesn't exist. The null hypothesis of *Hansen* test is that the instruments, as a group, is uncorrelated with the error term.

3.3. EMPIRICAL APPROACH

may reflect the weak efficiency of the relative sectoral output level in being a proxy of the relative productivity level. It also may arise because of country heterogeneity in terms of income equality. The latter issue is more clarified when an interaction term between variables of interest is included in the baseline model. Column (3) shows the estimated results for this regression. The coefficients on the windfall income and the interaction term are insignificant. However they, respectively, enter with negative and positive signs, meaning that falling income inequality intensifies the negative effect of the windfall income on the relative sectoral output (i.e. the relative sectoral productivity), the same as the theory's prediction.

In the preceding sub-section, I found that the response of income inequality to a natural resource boom is different in terms of the dependency on the natural resource (i.e. country heterogeneity). Hence, study the impact of a resource-dependent proxy on the relative productivity ratio would be a useful evaluation to make sure that the windfall income through the transmission channel of income inequality induces the intensity of the Dutch disease. To address this issue, like the preceding section, I include a dummy variable for the natural resource-poor economics as well as an interaction term between the dummy variable and the windfall income. Column (4) reports the results. The estimated results show that the adverse effect of the windfall income on the relative sectoral output is less intensive in the resource-poor economies. It is more likely to be because of rising income inequality in the resource-poor economies which attenuates the negative value of coefficient on the windfall income (i.e. Proposition 6).

As the first robustness check, I test the baseline model (i.e. column (2)) for developing economies and countries with low quality of the institution. The results are reported in columns (5) and (6), respectively. The main variable of interest (windfall income) enters with a negative sign and is significant, the same as the baseline model however, the coefficient is slightly smaller. This generally suggests that the correlation between the explanatory variable of interest and the dependent variable is probably robust in terms of country heterogeneity.

The results in the previous subsections imply the commodity price index being important in explaining the resource curse. Hence, I replace the windfall income with the commodity price index and run the regression models to analyze firstly the relationship between the commodity price and the relative sectoral output and secondly the effect of the resource dependency level on this nexus. The results reported in columns (7) and (8) are similar to before. Those suggest that notwithstanding the resource measurement index, a resource boom decreases the relative sectoral output level and this negative effect is less intensive in resource-poor countries than resource-rich countries.

I further evaluate the sensitivity of the variable of interest to a change in the sample size. A repeated process for randomly select of 98%, 95%, 90% and 85% of observations gives values of the coefficient on the resource rent. Table 3.8 represents the values. When the baseline model is run on different sample sizes, the values of the coefficient remain close

to full sample coefficients (reduce at most 23%), while their normal distributions have heavier tails. In other words, the significance of the coefficient weakens as the sub-sample size decreases.

Following the same procedure proposed in section 3.3.2 and 3.3.3, I also conduct a

Table 3.8: Robustness test for the sensitivity of coefficient of interest

Explanatory variable		98%	95%	90%	85%
Windfall income (lagged)	Coefficient	-0.00481	-0.00456	-0.00399	-0.00372
	Standard Deviation	0.00102	0.00147	0.00216	0.00247

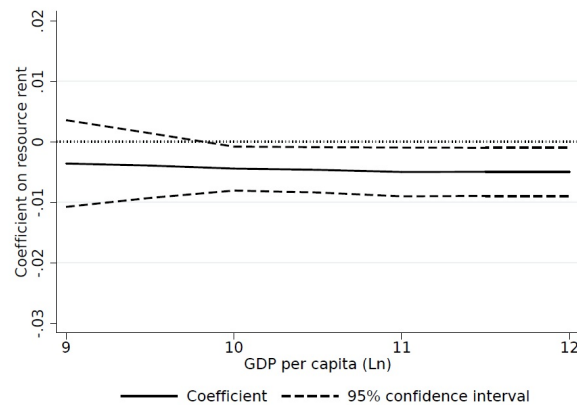

Figure 3.8: Recursive estimation on the coefficient of interest.

recursive estimation to evaluate the accuracy of the results. I estimate the coefficient on the resource rent for sample of observation ranked in increasing order of GDP per capita. Figure 3.8 shows the result. It may demonstrate the significance and stability of negative coefficients on the windfall income across countries in terms of income level.

3.3.5 The sectoral growth

The conceptual mechanism of the model (Figure 3.5) illustrates that the windfall income directly through a change in the real exchange rate induces the sectoral economic growth. It can also motivate growth indirectly through the channel of income inequality. Therefore, an evaluation of the sectoral economic growth's response to the total effects of a natural resource boom seems to be useful to figure out the mechanism of the model. Hence, the main contribution of this sub-section is to test the interaction between the windfall income and income inequality on sectoral economic growth.

Sectoral GDP per capita level in constant price is the dependent variable and the Gini index, as well as the windfall income proxy, are the explanatory variables of interest. I

3.3. EMPIRICAL APPROACH

also include Population Growth, Investment ratio, Human capital index, Openness index, Government spending and Rule of Law indicator to control the regression model. In line with Forbes, 2000, I use the difference GMM to estimate the regressions. Since the System GMM estimator yields less clear and significant results.

Table 3.9 reports the results. To save space, the results estimated by *OLS* are not reported. Columns (1) and (3) represent, respectively, the baseline specifications' results for the manufacturing and the service sectors' regression models. The estimated coefficients for the resource-dependence index enter with positive signs while those for the Gini index enter with opposite signs. Nevertheless, both are insignificant. These results are neither consistent with the recent empirical studies (e.g. J. D. Sachs and Warner, 1995, Gylfason and Zoega, 2002 and Goderis and Malone, 2011) nor the proposed theory. These may reflect a strong interaction between the variables of interest.

To address this problem, I include an interaction term between the windfall income index and the Gini index. The results for the manufacturing and service sectors are respectively reported at columns (2) and (4). For both regression models, the estimated coefficients on the windfall income and the interaction term are significant and enter with negative and positive signs, respectively. Consistently with the theory (Proposition 9), the estimations imply that the adverse effect of the windfall income on both sectoral economic growth rate attenuates as the Gini index increases. These support the theoretical finding that falling inequality intensifies the adverse effects of a natural resource boom on sectoral growth rate. Further, following Proposition 9, this may indirectly confirm the fundamental assumption that skilled workers allocate a larger expenditure share on traded goods than the unskilled workers do.

In addition, the regression coefficients on a natural resource boom indicate that the non-traded sector (proxied by the service sector) shrinks as the windfall income level goes up. It may demonstrate that the learning generated in the traded sector and spilled over to the non-traded sector is the dominant driving force of productivity growth in the non-traded sector (i.e. Proposition 8).

One more thing that seems to be worth studying is the dependency of the results in terms of the heterogeneity across the resource measurement indices. Columns (5) through (8) illustrate the estimation results when regression models include the commodity price index. The coefficients on the commodity price index are significant at 5% for both sectoral regression models, while their signs are different (see. columns (5) and (6)). The latter point indicates that resource price appreciation tends to shrink the manufacturing sector similar to the case related to the windfall income, however, it tends to expand the service sector, contrary to the case related to the windfall income. These reveal that the reaction of the service sector differs in terms of the driving forces of booming resource rent. Increasing resource dependency decelerates the expansion of the service sector while rising the resource price accelerates it. In following the theory, this may point out that productivity improvement in the service sector due to making more expensive the energy

Table 3.9: Estimation results for the sectoral growth

Explanatory variable	(1)		(2)		(3)		(4)		(5)		(6)		(7)		(8)		
	Diff.GMM	Full Sample	Diff.GMM	Full Sample	Diff.GMM	Full Sample	Diff.GMM	Full Sample	Diff.GMM	Full Sample	Diff.GMM	Full Sample	Diff.GMM	Full Sample	Diff.GMM	Full Sample	
	Manufacturing		Manufacturing		Service		Service		Manufacturing		Manufacturing		Service		Service		
Sector income level per capita (Ln) (lagged)	0.686*** (0.0994)		0.630*** (0.129)		0.506*** (0.104)		0.624*** (0.130)		0.631*** (0.106)		0.586*** (0.151)		0.653*** (0.0805)		0.648*** (0.0944)		
Windfall income (lagged)	0.00368 (0.00712)		-0.0515** (0.0215)		0.00363 (0.00617)		-0.0626*** (0.0240)		-0.0626*** (0.0240)		-0.263** (0.130)		-0.754*** (0.282)		0.133** (0.0658)		-0.225 (0.450)
Commodity Price index (lagged)																	
Gini index	-0.00859 (0.00903)		-0.0194*** (0.00738)		0.00744 (0.00823)		-0.0247** (0.0116)		-0.0153** (0.00741)		-0.0384** (0.0153)		0.00764 (0.00799)		-0.00842 (0.0156)		0.00922 (0.0147)
Resource measurement*Gini index																	
Population Growth	-0.0516* (0.0268)		-0.0246 (0.0254)		-0.00584 (0.0269)		-0.0212 (0.0237)		-0.0168 (0.0409)		-0.0486 (0.0394)		-0.0268 (0.0476)		-0.0483 (0.0509)		
Investment ratio	0.0134*** (0.00322)		0.0138*** (0.00260)		0.0104*** (0.00219)		0.00991*** (0.00294)		0.0103** (0.00465)		0.00997*** (0.00380)		0.0138*** (0.00214)		0.0141*** (0.00316)		
Human capital index	0.000926 (0.180)		-0.0162 (0.202)		0.192 (0.129)		-0.0515 (0.129)		0.0922 (0.139)		0.0663 (0.254)		0.0929 (0.127)		0.0633 (0.160)		
Openness index	0.00165 (0.00144)		0.000548 (0.00141)		-0.000027 (0.000888)		-0.00120 (0.00115)		-0.000918 (0.00277)		0.000279 (0.00164)		-0.00190 (0.00144)		-0.00161 (0.00109)		
Government spending	-0.0177 (0.0137)		-0.0267* (0.0146)		-0.0186 (0.0166)		-0.0364** (0.0146)		-0.0158 (0.0185)		-0.0247 (0.0186)		-0.0189 (0.0138)		-0.0182 (0.0183)		
Rule of Law indicator	0.0970 (0.197)		0.0479 (0.185)		0.0657 (0.0491)		0.0821 (0.0677)		-0.176 (0.125)		0.0196 (0.180)		0.0381 (0.0560)		-0.0287 (0.137)		
Time dummies	YES	YES	YES	YES	YES	YES	YES	YES	YES	YES	YES	YES	YES	YES	YES	YES	
Observations	255	255	255	258	258	258	258	258	88	88	88	88	94	94	94	94	
Number of Countries	68	68	68	69	69	69	69	69	39	39	39	39	41	41	41	41	
Arellano-Bond test for AR(2) (p-value)	0.898	0.558	0.628	0.229	0.496	0.229	0.496	0.360	0.391	0.287	0.360	0.391	0.391	0.287	0.287	0.287	
Hansen OID test (p-value)	0.332	0.579	0.146	0.261	0.372	0.261	0.372	0.232	0.376	0.124	0.232	0.376	0.376	0.124	0.124	0.124	

Note: The dependent variable is GDP per capita level in each sector (in constant price). In the estimation of the manufacturing sector regression model, the Gini index and the windfall income (lagged) are instrumented by first and second lags level in first differences equation, respectively. While to estimate the service sector regression, they are instrumented by second lags level in first differences equation. Robust standard errors are reported in parentheses. ***, ** and * denote significance at 1, 5 and 10 percent levels.

The null hypothesis of *Arellano-Bond* test is that autocorrelation doesn't exist. The null hypothesis of *Hansen* test is that the instruments, as a group, are uncorrelated with the error term.

3.3. EMPIRICAL APPROACH

price along with the commodity price appreciation, at least in resource-poor countries, may lead to being stronger the direct effect of learning generated by the non-traded sector relative to the spillover effect. Therefore, high-skilled labor reallocation due to the real exchange rate appreciation tends to expand the service sector. Nevertheless, the magnitude of the coefficient is larger for the manufacturing sector than for the service sector. Hence, an appreciation in the commodity price causes the relative sectoral output level to go down, similar to the main case and the presented theory.

Columns (6) and (8) show the effect of income inequality on the response of each sectoral level to a resource price variation. The significant results for the manufacturing sector's regression model are also similar to before. Falling income inequality exacerbates the productivity growth deceleration in the manufacturing sector. On the contrary, the results for the service sector's regression model are insignificant. Regarding Proposition 9, the latter statically insignificant result may be because of heterogeneity across countries in terms of productivity improvement in the service sector due to commodity price appreciation. The first robustness test is a sensitivity analysis of a change in the sample size. In the same procedure described in the preceding sub-sections, I estimate the values and standard-deviations of the explanatory coefficients for randomly select of 98%, 95%, 90% and 85% of observations. Table 4.6 shows the results for the selected samples. When the regressions run on 98% of the sample, the estimated coefficients remain close to the full sample coefficients. While the analysis shows when the regression runs on other sample sizes, the coefficients decrease and their distributions widen slightly. These may state less significance of the coefficients as the sample size shrinks.

The final robustness test is included to test the stability of coefficients on the direct

Table 3.10: Robustness test for the sensitivity of coefficients of interest

		Manufacturing			
Explanatory variable		98%	95%	90%	85%
Windfall income (lagged)	Coefficient	-0.05145	-0.04808	-0.04454	-0.03795
	Standard Deviation	0.0111169	0.01794	0.02438	0.03362
Windfall income*Gini	Coefficient	0.00115	0.00110	0.00103	0.00086
	Standard Deviation	0.0002508	0.00039	0.00054	0.00076
		Service			
Explanatory variable		98%	95%	90%	85%
Windfall income (lagged)	Coefficient	-0.05343	-0.04426	-0.03553	-0.02519
	Standard Deviation	0.01531	0.02106	0.02686	0.03074
Windfall income*Gini	Coefficient	0.00131	0.00111	0.00090	0.00066
	Standard Deviation	0.00033	0.00046	0.00059	0.00069

and indirect effects of the windfall income on the sectoral economic growth rates. The observations are firstly ranked in increasing order of GDP per capita (Ln). Then the process is as follows: start with a sample of low GDP per capita and run the regressions, add subsequent observation with larger GDP per capita to the sample and rerun the regression, continue the process as long as total observations are covered. The results show that the coefficients on the resource rent and the interaction term remain significant and are respectively, negative and positive in both regression models for the manufacturing and service sectors (Figure 3.9). In addition, it seems to be useful to investigate whether the direct and indirect effects of the windfall income on the sectoral economic growth rate are different in the developing and developed economies. The negative coefficient on the resource rent slightly decreases, while the positive coefficient on the interaction term slightly increases in both sectors. It states that both direct and indirect effects of a natural resource boom on sectoral growth rate are stronger in the developed economies than in the developing economies.

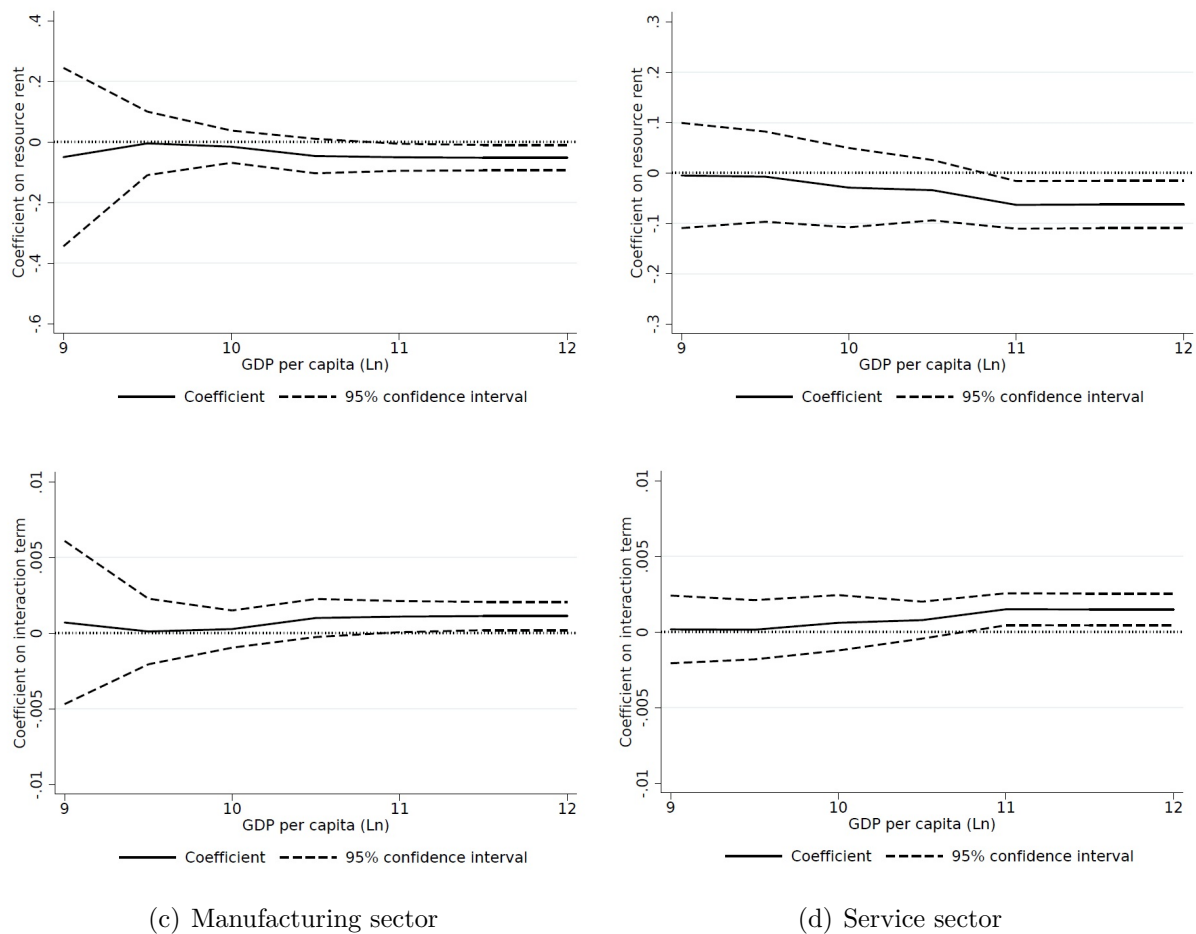

Figure 3.9: Recursive estimation on the coefficients of interest.

3.4 Conclusion

The paper acknowledges theoretically and empirically that income inequality plays a key role in the economic performance of the natural resource-dependent countries. The main contribution of this paper is to analyze how income inequality responds to a natural resource boom and how a combination of income inequality and resource rent motivates the intensity of the Dutch disease.

In theory, I develop a two-sector growth model in which each sector employs skilled and unskilled workers. Workers' groups allocate different consumption expenditure shares on traded and non-traded goods. The gap in expenditure shares captures the feedback of a change in income inequality on economic growth. I have analyzed the model in short-run under a comparative static and in long-run under a dynamic approach driven by learning-by-doing (*LBD*) model.

The present study yields a number of theoretical findings. In the short-run study, a permanent rise in the windfall income leads respectively to an appreciation in the real exchange rate, a reallocation in the factor inputs, a shrinkage in the traded sector and a deceleration in economic growth. By the way, a change in inequality depends on the factor intensity and the distribution of the resource rent benefits (subsidies) between workers' groups. Income inequality falls if the traded sector is relatively intensive in skilled workers and the resource rent benefits are distributed more evenly than the real wage between workers' groups. In the long-run study, a change in income inequality is only driven by a resource boom. In response to a windfall income boom, income inequality falls (rises) if the relative resource rent benefit of skilled workers is smaller (larger) than the relative real wage. In addition, falling income inequality deepens the Dutch disease if the skilled workers, with respect to unskilled workers, allocate a larger expenditure share for traded goods.

Consistently with the theory, I estimate a panel data study to evaluate the theoretical predictions. In this respect, the data for 79 countries over the period 1975-2014 are collected. I apply the first-differenced and the system GMM approaches to estimate dynamic panel data regressions. The impact of a natural resource boom on the real exchange rate and then the response of income inequality to a change in the windfall income are examined. Further, I estimate the effect of interaction between a natural resource boom and income inequality on the intensity of the Dutch disease as well as the sectoral economic growth. These empirical studies represent some clear evidence in supporting the crucial role of income inequality in economic performance of the resource-dependent countries. A natural resource boom reduces income inequality and falling income inequality is associated with a more intensive natural resource curse.

Appendix 3.A Proof of Proposition 3

The proposition summarizes the short-term effect of the gap in expenditure shares between workers' groups on the real exchange rate. To find the vertical shift of NN -curve, I need to compute to what extent the real exchange rate appreciates in the response of a natural resource boom, $\frac{dP}{dR}$ of Equations 3.10b. The result will be:

$$\left[1 - \frac{P}{\sigma\Psi} \frac{d\Psi}{dP}\right] \frac{dP}{dR} = \frac{P}{\sigma(S_T^\beta L_T^{1-\beta} + R)} + \frac{P}{\sigma\Psi} \frac{d\Psi}{dI} \frac{dI}{dR}. \quad A.1$$

Where $\frac{dI}{dR}$ follows the Proposition 1. In addition, $\frac{d\Psi}{dP} = \frac{\Psi}{P}(\sigma - \sigma_c)$ and $\frac{d\Psi}{dI} = \frac{\theta_S e_S^{\sigma-1} - \theta_L e_L^{\sigma-1}}{(1-\Psi)^2}$. The latter result indicates that $\frac{d\Psi}{dI} > 0$ if $\theta_S > \theta_L$ and $\frac{d\Psi}{dI} < 0$ if $\theta_S < \theta_L$. Replacing the results of $\frac{d\Psi}{dP}$ and $\frac{d\Psi}{dI}$ in Equation A.1 gives:

$$\frac{dP}{dR} = \frac{P}{\sigma_c(S_T^\beta L_T^{1-\beta} + R)} + \frac{P}{\sigma_c\Psi} \frac{\theta_S e_S^{\sigma-1} - \theta_L e_L^{\sigma-1}}{(1-\Psi)^2} \frac{dI}{dR}. \quad A.2$$

It verifies when $\theta_L = \theta_S \Rightarrow e_L = e_S$ and $\sigma_c = \sigma \Rightarrow \frac{d\Psi}{dI} = 0 \Rightarrow \left(\frac{dP}{dR}\right)_{\theta_L=\theta_S} = \frac{P}{\sigma(S_T^\beta L_T^{1-\beta} + R)}$. So the size of a vertical shift in NN -curve depends on the sign of $\frac{dI}{dR}$ and the gap in expenditure shares on non-traded goods (i.e. θ_L and θ_S).

Appendix 3.B Proof of Proposition 4

The gap in the price elasticity of demand for traded and non-traded goods is defined as: $\sigma_c \equiv \varepsilon_{T,P} - \varepsilon_{N,P} = \sigma + (\gamma_T - \gamma_N) (\varepsilon_{N,P}^L - \varepsilon_{N,P}^S)$, where $\gamma_J \equiv \frac{C_J^L}{C_J}$; $J = T, N$ is the share of good J allocated to unskilled workers and $\varepsilon_{N,P}^i \equiv \frac{P}{C_N^i} \frac{\partial C_N^i}{\partial P} = -\left(\frac{\sigma(1-\theta_i) + \theta_i P^{1-\sigma}}{1-\theta_i + \theta_i P^{1-\sigma}}\right)$; $i = L, S$ is the price elasticity of non-traded goods in terms of i workers. Thus $\sigma_c < \sigma$ if $(\gamma_T - \gamma_N) (\varepsilon_{N,P}^L - \varepsilon_{N,P}^S) < 0$.

Let me first investigate the sign of the gap in the price elasticity of non-traded goods between workers' groups (i.e. $\varepsilon_{N,P}^L - \varepsilon_{N,P}^S$). The computation reveals that $\varepsilon_{N,P}^L - \varepsilon_{N,P}^S > 0 \Leftrightarrow \sigma < 1$. To satisfy $\sigma_c < \sigma$, now I need to find a condition so that $\gamma_T - \gamma_N < 0$.

$$\gamma_T - \gamma_N < 0 \Leftrightarrow \begin{cases} a) & \frac{C_T^L}{C_T} < \frac{C_N^L}{C_N} \\ b) & \frac{C_T^S}{C_T} > \frac{C_N^S}{C_N} \end{cases} \Leftrightarrow \frac{C_N^S}{C_T^S} < \frac{C_N}{C_T} < \frac{C_N^L}{C_T^L} \Leftrightarrow \theta_S < \frac{1}{1+\Psi} < \theta_L. \quad B.1$$

Where $\Psi \equiv \frac{P^\sigma C_N}{C_T}$. By applying Equation 3.5 and 3.6, the inequality a of Equation B.1 is rewritten as:

$$\frac{P C_N}{C_T} < \frac{\theta_L P^{1-\sigma}}{1-\theta_L} \Rightarrow \frac{C - C_T}{C_T} < \frac{\theta_L P^{1-\sigma}}{1-\theta_L} \Rightarrow \frac{C}{C_T} < 1 + \frac{\theta_L P^{1-\sigma}}{1-\theta_L} \Rightarrow \frac{C_T}{C} > \frac{1-\theta_L}{1-\theta_L + \theta_L P^{1-\sigma}}.$$

It is easy to know that $\frac{1-\theta_L}{1-\theta_L + \theta_L P^{1-\sigma}} = \frac{C_T^L}{C^L}$. It gives:

$$\frac{C_T}{C} > \frac{C_T^L}{C^L} \Rightarrow \frac{C_T^L}{C} > \frac{C_T^L}{C_T} \Rightarrow \frac{C-C^S}{C} > \frac{C_T-C_T^S}{C_T} \Rightarrow \frac{C^S}{C} < \frac{C_T^S}{C_T} \Rightarrow I < I_T,$$

where $I_T \equiv \frac{C_T^S}{C_T}$ denotes the consumption inequality on traded goods. In the same way for the inequality b of Equation B.1, we have $I_N < I$, where $I_N \equiv \frac{C_N^S}{C_N}$ is the consumption inequality on non-traded goods. As a conclusion the final result derived from Equation B.1 is equal to $I_N < I < I_T$.

Appendix 3.C Proof of Proposition 7

A steady-state combination of Equation 3.10a and 3.10b gives

$$(P^*)^{1-\sigma} = M^*(R) \Psi(P^*, I^*(R)). \quad C.1$$

Where $M^*(R) \equiv \frac{\alpha}{\beta} \frac{S_T^* + \left(\frac{S_T^*}{L_T^*}\right)^{1-\beta} R}{S_N^*} \Rightarrow \frac{dM^*}{dR} > 0$. The steady-state response of the real exchange rate to increased R is then given by

$$-\left(\frac{1}{\Psi} \frac{d\Psi}{dP^*} + \frac{1-\sigma}{P^*}\right) \frac{dP^*}{dR} = \frac{1}{M^*} \frac{dM^*}{dR} + \frac{1}{\Psi} \frac{d\Psi}{dI^*} \frac{dI^*}{dR}. \quad C.2$$

We can find easily that $\frac{1}{\Psi} \frac{d\Psi}{dP^*} = \frac{\sigma-\sigma_c}{P^*}$. Thus Equation C.2 is rewritten as following.

$$\frac{dP^*}{dR} = -\frac{1}{1-\sigma_c} \frac{P^*}{M^*} \frac{dM^*}{dR} - \frac{1}{1-\sigma_c} \frac{P^*}{\Psi} \frac{d\Psi}{dI^*} \frac{dI^*}{dR}. \quad C.3$$

It indicates when $\theta_S = \theta_L$, $\sigma = \sigma_c \Rightarrow \frac{1}{\Psi} \frac{d\Psi}{dI^*} = 0$. So that the steady-state real exchange rate response to an increase in R equals $\left(\frac{dP^*}{dR}\right)_{\theta_S=\theta_L} = -\frac{1}{1-\sigma} \frac{P^*}{M^*} \frac{dM^*}{dR} < 0$. Now regarding Proposition 4, $\theta_S < \theta_L \Rightarrow \frac{1}{\Psi} \frac{d\Psi}{dI^*} < 0$ (see. Appendix A). Hence the size of $\frac{dP^*}{dR}$ depends on the steady-state income inequality response to increased R (i.e. $\frac{dI^*}{dR}$).

Appendix 3.D List of countries included in the sample database

Table 3.11: List of Countries

	Period	No.	Period		Period	No.	Period
Albania	1995-2014	4	Italy		1990-2009	4	
Algeria	1975-1999	5	Jamaica		1995-2009	3	
Argentina*	1975-2014	8	Japan*		1980-2009	6	
Australia*	1975-2014	8	Kazakhstan*		1995-2014	4	
Austria	1975-2009	7	Korea south		1975-2009	7	
Azerbaijan	1995-2009	3	Kyrgyzstan*		1995-2014	4	
Bangladesh	1975-1999	5	Latvia*		1995-2009	3	
Belgium	1995-2009	3	Malaysia*		1975-2009	7	
Bolivia*	1980-2009	6	Mexico*		1975-2014	8	
Botswana	1980-2009	6	Moldova		1995-2009	3	
Brazil*	1975-2014	8	Mongolia		1990-2009	4	
Bulgaria*	2000-2014	3	Morocco*		1980-2009	6	
Cameron*	1975-2009	7	Nepal		1985-2004	4	
Canada*	1975-2014	8	Netherlands*		1975-2009	7	
Chile*	1975-2014	8	New Zealand*		1980-2014	7	
China*	1975-2014	8	Norway*		1975-2014	8	
Colombia*	1975-2014	8	Pakistan		1975-2014	8	
Costa Rica	1985-2014	6	Paraguay		1995-2014	4	
Cote d'Ivoire	1975-1999	5	Peru*		1990-2014	5	
Croatia	1995-2009	3	Philippine*		1975-2014	8	
Cyprus	1980-2009	6	Poland*		1995-2009	3	
Czech*	1995-2009	3	Portugal		1995-2009	3	
Denmark*	1975-2009	7	Romania		1995-2014	4	
Dominican Rep.	1980-2014	7	Russia*		2000-2014	3	
Ecuador*	1975-2014	8	South Africa		1975-2014	8	
Egypt*	1975-2009	7	Spain*		1995-2009	3	
El Salvador	1975-1995	5	Sri Lanka		1980-2009	6	
Eritrea	1995-2009	3	Sweden*		1980-2004	5	
Ethiopia	1990-2009	4	Tanzania		1995-2009	3	
Finland*	1975-2009	7	Thailand		1975-2014	8	
France*	1975-2009	7	Trinidad and Tobago		1985-2004	4	
Ghana	1975-1999	5	Turkey		1975-2009	7	
Greece*	1995-2009	3	Ukraine*		1995-2014	4	
Honduras*	1975-2014	8	United Kingdom*		1990-2014	5	
Hungary*	1995-2009	3	Uruguay		1985-2009	5	
India*	1975-2009	7	Venezuela*		1975-2014	8	
Indonesia*	1990-2014	5	Yemen*		1995-2009	3	
Iran*	1975-2014	8	Zimbabwe		1975-1999	5	
Ireland	1995-2009	3					

Note: countries marked by (*) are included in the sample of the commodity price index.

Chapter 4

Absorption capacity and Natural Resource Curse

This paper investigates the impact of absorption capacity (i.e. the level of non-traded capital goods such as infrastructure and human capital) on the intensity of the natural resource curse. Using panel data for 105 countries over the period 1975-2014, I construct two indexes to proxy absorption capacity among countries. A growth regression model, estimated by *IV – 2SLS* technique, shows that the natural resource curse is more intensive in countries with more absorption capacity constraints. Furthermore, based on the idea that some sorts of capital goods (e.g. infrastructure and human capital) can not be redeployed in major countries and they must be produced domestically (i.e. absorption capacity constraints), I put forward a simple two-sector framework, in line with Van der Ploeg and Venables, 2013, to clarify the empirical finding.

4.1 Introduction

Is a natural resource a blessing or curse? This question has been attracting more attention of researchers in the literature of development economics. Conventional wisdom suggests a positive effect on economic growth from a natural resource abundance¹ (Brunnschweiler and Bulte, 2008; Alexeev and Conrad, 2009; Cavalcanti, Mohaddes, and Raissi, 2011; Esfahani, Mohaddes, and Pesaran, 2013), but a large stand of empirical researches supports that resource dependence² countries have usually failed to benefit from their natural wealth and so to grow more rapidly than others, labeled the natural resource curse (e.g. J. D. Sachs and Warner, 1995; Gylfason, Herbertsson, and Zoega, 1999; Auty et al., 2001).

The first enduring explanations for the resource curse follows political-economic perspectives. Several studies demonstrate that a natural resource rent decelerates the growth of countries with bad institutions and accelerates the growth of countries with good institutions (e.g. Mehlum, Moene, and Torvik, 2006b; Arezki and Van der Ploeg, 2011, among others). Related cross-country evidence strongly suggests that natural resources hit the rate of growth in an economy by weakening the institutions inside the economy (Sala-i-Martin and Subramanian, 2013). The literature also contains studies seeking to reveal the relationship between resource rents and political regime. The combination of a democracy and the natural resource rent seems to retard growth in developing countries (Collier and Hoeffler, 2005) and the resource curse occurs in presidential, not parliamentary democracies (Andersen and Aslaksen, 2008). Further, the argument can also be related to the notion of "petro populism", clarified by Matsen, Natvik, and Torvik, 2016. Using a rent-seeking approach, they suggest that better visibility and more information of voter may increase over-extraction and consequently economic performance is likely to be affected adversely.

The second main stream of the resource curse's explanations argue that a natural resource boom, through an appreciation in the real exchange rate, decreases the competitiveness of the traded sector, the so-called the Dutch disease hypothesis (Corden and Neary, 1982). Two features of the Dutch disease literature that have been studied in isolation from each other are described by the productivity growth with Learning by Doing (LBD) approach (J. D. Sachs and Warner, 1995; Torvik, 2001) and capital accumulation with absorptive capacity constraints (Van der Ploeg and Venables, 2013). Further, the adverse effect of the resource dependence on economic growth, the essence of the core hypothesis, has been empirically supported by scholars (e.g. J. D. Sachs and Warner, 1995; Gylfason, Herbertsson, and Zoega, 1999; Ismail, 2010).

Other possible explanation that has absorbed more attention in recent years is the destructive effect of volatility in commodity price on economic performance. Van der Ploeg and Poelhekke, 2009, using cross-country evidence for 62 countries, found that the adverse effect

¹Resource abundance refers to per capita value of the stock of natural resource wealth.

²Resource dependence refers to the value of resource as a share of GDP or total national wealth.

of resources on growth is mainly driven by the volatility of commodity prices, especially for point-based resources (oil, diamonds), such that the indirect negative effect of resources on growth resulting from volatility erodes any direct positive effect of resources on growth. Furthermore, a strand of the literature indicates that volatility in resource price through instability in government revenue may lead to boom and bust in public spending and thus undermines economic performance (Hausmann and Rigobon, 2003; El-Anshasy, Mohaddes, and Nugent, 2017). In the same vein, Aghion et al., 2009 suggests that the adverse effect of volatility on economic growth is more intense in countries with less developed financial system.

Even though these hypotheses are well understood, the effect of absorption capacity constraints on the intensity of the natural resource curse seems to have received less attention among scholars. In the present paper, the notion of the absorptive capacity constraints, used frequently in the context of international aid, refers to a shortage in non-traded (public) capital goods such as human capital and infrastructure. It suggests that the marginal rate of return to aid (natural resource rents in this paper) reduces when the rising amount of aid is associated with lack of enough non-traded capital (Franois Bourguignon and Sundberg, 2006). Since a shortage in non-traded capital goods and so facing with absorption capacity constraints leads to increasing the unit cost of an additional non-traded capital good and thus to decrease the incremental returns to aid (or resource rents). Although the literature well clarifies the positive effect of expansion in the non-traded (public) capital on economic growth (Barro, 2001; De la Fuente and Doménech, 2006; López, 2003; K. S. Sridhar and V. Sridhar, 2007), it is worth seeking the effect of resource wealth on the economic performance of a country facing with absorption capacity constraints. Therefore, the objective of this paper is to move in this direction by representing a response to the question of how the absorption capacity constraints due to a shortage in the non-traded capital induce the intensity of the natural resource curse.

In this vein, a number of papers investigate how human capital, as one of the main components of the absorption capacity, can influence the nexus between a resource boom and economic growth. A simple model, proposed by Gylfason and Zoega, 2002, argues that investment in education increases the return to work through a higher productivity level and thereby moderates the natural resource curse. Kurtz and Brooks, 2011 also find that the resource curse (or blessing) is strongly conditioned by the level of the domestic human capital. A piece of empirical evidence for major petroleum exporter countries consolidates this argument and suggests that the resource curse might arise since natural resource-rich countries neglect to invest in education (Behbudi, Mamipour, and Karami, 2010). In addition, empirical findings for supporting a two-sector growth model, proposed by Bravo-Ortega and De Gregorio, 2005, show that natural resources may lead to decelerating growth in countries with very low levels of human capital, while the adverse effects of natural resources may offset in countries with a high level of human capital. Furthermore, in a comparative analysis of Scandinavian countries versus Latin American countries, they

suggest that human capital investment, fed by natural resource rents, could play a crucial role in the difference of their economic performance.

Despite the literature seeking to understand the relationship between resource dependence and public capital investment (Bhattacharyya and Collier, 2013; Cockx and Francken, 2014), a computable general equilibrium model calibrated for Chad shows that investment in the public capital (particularly in road and irrigation infrastructure), financed by oil revenue, improves growth and household welfare (Levy, 2007). Further, using panel data for resource-rich sub-Saharan African countries over the period 1990-2013, Karimu et al., 2017 find that resource revenues increase the public capital investment which, in turn, accelerates the growth rate proportional to the level of resource rents.

The seminal theory linking the natural resource curse and absorption capacity constraints has been put forward by the models in Van der Ploeg, 2011a; Van der Ploeg and Venables, 2013. These models challenge the common belief that falling the competitiveness of the traded sector relative to the non-traded sector is the determinant driving force in shrinkage of the traded sector and expansion of the non-traded sector (e.g. J. D. Sachs and Warner, 1995; Torvik, 2001)³. Those argue if existing capital goods lead to an additional absorption capacity so that there are not any supply bottlenecks, the expanded demand for non-traded goods, a consequence of a natural resource boom, is instantaneously adjusted. Consequently, there will not be upward pressure on the relative price of non-traded goods. But in reality, some sorts of capital goods (such as infrastructure and human capital) can not be bought or sold in world markets and they must be domestically produced, which in turn needs produced "home-grown" capital goods to function (e.g. roads need to extend roads, teachers to educate more teachers). This argument intuitively states one of the essential problems of developing economies. When there is no excess capacity in the economy, the relative price sharply appreciates in the short run as a natural resource rises. But the gradual expansion of capital goods scales up the domestic spending overtime to absorb the effects of the natural resource boom.

Motivated by the literature, I present an empirical study to investigate the effect of the absorption capacity (i.e. non-traded capital goods) on the natural resource curse. In this respect, I construct two indexes to proxy cross-country non-traded capital goods and so to align the economies in terms of the absorption capacity. Using panel data for 105 countries over the period 1975-2014, I find that the natural resource curse is more intensive in countries with smaller non-traded capital indexes (more absorption capacity constraints). Furthermore, following Van der Ploeg and Venables, 2013, I develop a model to describe the economic performance of a resource-dependent country with restriction in the absorption capacity and to clarify the main empirical finding.

The remainder of this paper is structured as follows. Section 4.2 describes a framework and discusses the role of capacity constraints in the response of an economy to a resource

³The theories based on Learning by Doing (LBD) approach (J. D. Sachs and Warner, 1995; Torvik, 2001) seems to be feasible only in the short run. Since for a longer period one must allow both labor and capital move across sectors.

boom. Section 4.3 presents some stylized facts on the natural resource curse and the absorption capacity. Section 4.4 undertakes an empirical study to investigate the objective. Section 4.5 develops a dynamic model to clarify the long-term mechanism of an economy constrained by the absorptive capacity. Section 4.6 concludes.

4.2 Implication of Absorption capacity

In this paper, the notion of absorptive capacity constraints refers to a shortage in the non-traded capital such as the public human capital and the infrastructure. A useful starting point to study the role of absorptive capacity constraints on the economic performance of a resource-dependent economy is to revisit the Dutch disease theory. Following M. Nkusu, 2004, I rebuild a small open economy model in a Salter-Swan framework. The core assumptions are as follows: 1) There are two sectors: the traded and non-traded sectors ⁴, 2) There are no asset and capital accumulation and the labor force (i.e. the Human capital ⁵) is only production factor, 3) The labor force is normalized to unity to expel the population growth, 4) The labor force is fully employed by sectors and they can move freely across sectors, 5) There are decreasing returns to labor in each sector, 6) Agents have an identical taste and there is perfectly elastic demand for traded goods, 7) The windfall income (resource boom) is a constant exogenous gift over time.

Figure 4.1 illustrates the response of an economy to a natural resource boom. Markets for the traded and non-traded sectors represent, respectively, in the upper-left and -right quadrants with the price on the vertical axis and production & demand on the horizontal axis. The upward-sloping lines of ST and SNT show the supply-side of the traded and non-traded sectors, respectively. The downward-sloping line of DNT illustrates the demand-side of the non-traded sector. While, the demand for the traded sector, DT , is represented by a horizontal line. This stands for two reasons: first, a perfectly elastic demand for traded goods and second, the small open economy hypothesis. Production possibility frontier, PPF , shows in the lower-right quadrant. It represents all possible combinations of traded and non-traded goods that can be produced by employing the labor force (i.e. human capital). Also, the budget constraint (income line) and indifference curve are indexed by Y and ID , respectively.

Assume there is initially a trade balance and the price of both goods is equal. The economy produces and consumes at point B on the PPF and ID , corresponding to point C for the traded market and point M for the non-traded market. The literature on the Dutch disease highlights three different effects. The first one is the spending effect. Resource boom brings about an expansion in the total income of the economy and so increases

⁴In the standard Dutch disease model proposed by Corden and Neary, 1982, there are three sectors: the booming and lagging sectors producing traded goods and the non-traded sector producing services goods.

⁵As an alternative, we can assume the infrastructure capital good as the only factor of the production function.

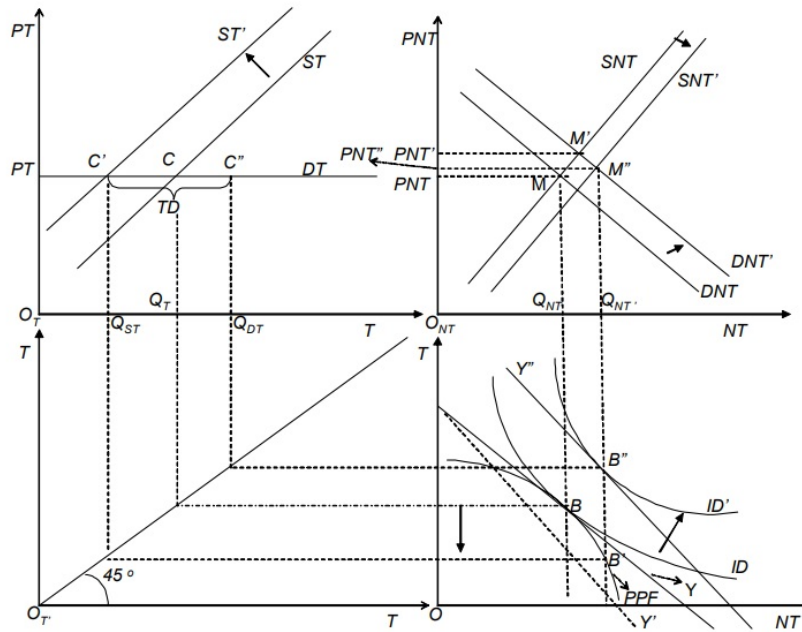

Figure 4.1: Analytical framework of the Dutch Disease Model, source: M. Nkusu, 2004.

the demand for both traded and non-traded goods. Whereas the price of traded goods is determined exogenously by the international market and so the demand is perfectly elastic, the relative price of non-traded to traded goods must appreciate in order to confront the expanded demand for non-traded goods. This is graphically represented by shifting DNT to up and left (a move from point M to M').

The second one is called the resource transfer effect. A relative price appreciation increases the real wage of the labor force working in the non-trade sector, with respect to those working in the traded sector. It makes a signal for the labor force to shift away from the traded sector and into the non-traded sector. Consequently, the traded sector shrinks and the non-traded sector expands (i.e. the Dutch disease). This effect is graphically shown by a downward shift in SNT and an upward shift in ST . Those shifts are consistent with moving from point B to B' on PPF . It because that the slope of PPF , called the marginal rate of transformation (MRT), is also the opportunity cost of producing non-traded goods in terms of traded goods and so equals the relative price of non-traded to traded goods. Therefore, relative price appreciation makes the slope be steeper in B' than in B .

The third highlighted effect in the literature is the expenditure effect. Two substitution and direct resource boom effects are coupled to move the income line Y in the lower-right quadrant. Turning clockwise of the income line, on the one hand, reflects the substitution of the traded with non-traded goods, resulting from the relative price appreciation (i.e. line Y'). On the other hand, the direct effect of the resource boom pushes up the income line, displayed by Y'' . Therefore, the economy now produces at point B' and consumes at point B'' . Whereas the former point is consistent with a lower level of the produced traded goods Q_{ST} and higher level of the produced non-traded goods $Q_{NT'}$, the latter

4.2. IMPLICATION OF ABSORPTION CAPACITY

point is associated with a higher level of consumption for both traded Q_{DT} and non-traded Q_{NT} goods. As illustrated in Figure 4.1, the expanded demand for traded goods will be substituted by more imported goods, paraphrased as the trade deficit TD .

The presented analytical framework concentrates on a prospect of the core Dutch disease under the given assumptions. The first questionable assumption is that the economy produces on its PPF . This assumption doesn't seem to be realistic (M. Nkusu, 2004). The main reason why many developing countries don't efficiently operate on its PPF comes back to observing a large amount of unused available productive resources such as high unemployment and unused lands (Verbeke, 2007). To support this assumption, M. M. Nkusu, 2004 presented the case of Uganda where available unused lands allowed the economy to increase the production of food crops without a decrease in cash crop products. Nevertheless, Brownbridge and Tumusiime-Mutebile, 2007 found less evidence of this resending and they conclude that Uganda's economy has reached its PPF after two decades. Contrary to those, the present paper is going to highlight the case in which employing the unused production factors is theoretically costless. In particular, without decreasing the production of one good to increase the production of another good, an economy can costlessly and immediately respond to externalities when its absorption capacity is not fully used. Therefore, the assumption that the economy must produce in its PPF doesn't seem to be problematic in the developing economies. Since those can not costlessly reach to their potential PPF as regards suffering structural labor and capital market constraints as well as limited infrastructure and human capital resources. Therefore, we can conclude that the actual PPF of the developing countries is matched on their potential PPF .

The other side of the coin turns to the developed economies. One of the notable features of these economies and some natural resource-rich economies is to have the spare economic capacity to absorb the windfall income. This argument rests on the fact that having reserved capacity for infrastructure and human capital or providing them from the international market let the economy respond immediately and almost costlessly to resource boom effects. Therefore, it is more realistic to take into account a production beneath the curve PPF in developed countries with a higher level of capacity (i.e. infrastructure and human capital).

The conclusion of this argument is that the structural economic problems in developing countries are more likely to enforce the economy to scarify one good to produce another good. While the spare absorption capacity in the developed economies allows them to increase the production of both goods simultaneously. Briefly, whereas the developing economies produce on the PPF curve, the developed economies operate beneath the PPF curve.

A modification framework of the core Dutch disease for economies having spare capital goods (infrastructure and human capital) is shown in Figure 4.2. In contrast with the previous analysis presented in Figure 4.1, the economy produces and consumes initially at

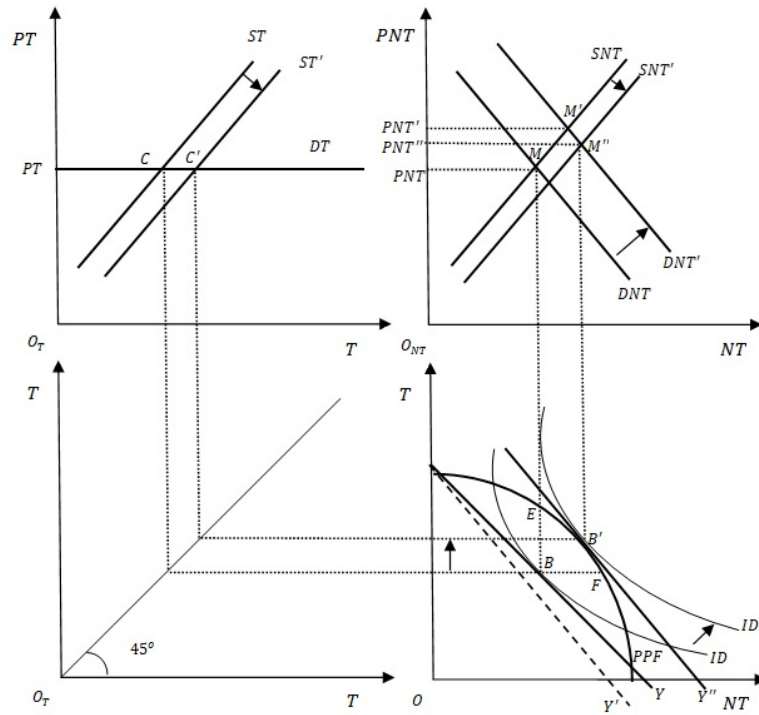

Figure 4.2: Modified analytical framework of the Dutch Disease Model: source: Author.

point B which lies within PPF (see. Figure 4.2). At point C, the demand and supply of the traded goods are equal and the demand and supply curves for the non-traded sector meet each other at point M. When the economy receives the windfall income, the demand for both goods increases. The expanded demand for the non-traded goods is reflected by an upward-shift of the demand line to DNT' which, in turn, appreciates the price of non-traded goods. While the demand line of the traded sector DT doesn't move and its price remains unchanged, in following the small open economy hypothesis. In response to the expanded demand, the economy moves its production from point B to a point on the curve $EB'F$ ⁶. Assume the economy shifts to point B' , corresponding to new market-clearing for the traded and non-traded sectors at point C' and M'' , respectively. In following this movement, the supply in the non-traded sectors expands from SNT to SNT' . While, in contrast with the previous analysis which is consistent with a developing country's situation, the supply of the traded sector expands and ST shifts down to the right to ST' . This argument states that in countries with the spare absorptive capacity none of the production sectors shrinks. Therefore, the framework shows that the resource curse arises only in countries with a limited absorptive capacity.

⁶At point E and F, the economy expands just the production of the traded and non-traded goods, respectively.

4.3. STYLIZED FACTS

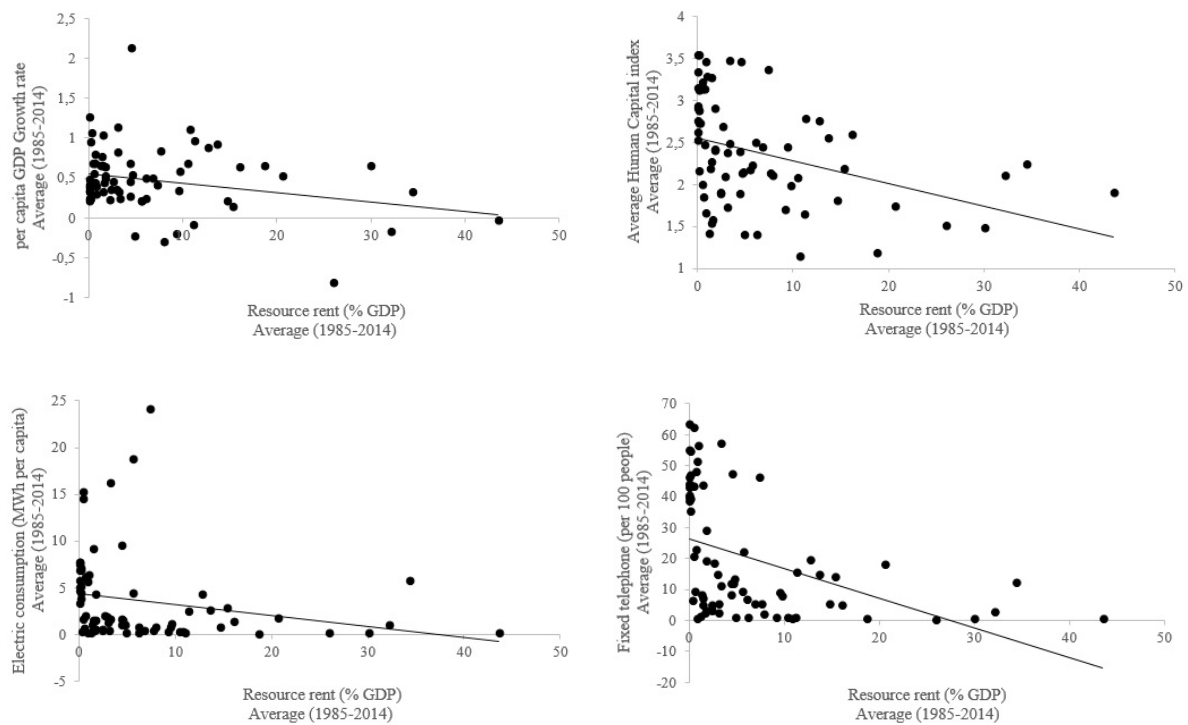

Figure 4.3: Cross-country correlation between resource rent, Growth and the absorption capacity proxies. Source: author, based on data from the World Development Indicator (*WDI*) and the Penn World Table (*PWT* 9.0).

4.3 Stylized Facts

The main objective of this section is to assess cross-country correlations between the dependence on the resource rent and the economic growth, on the one hand, and also between the dependence on the resource rent and the capital proxies, on the other hand. Figure 4.3 portrays the correlation between average of economic growth, Human capital index, Electric consumption and fixed telephone with respect to average total natural resource rents (% of GDP) as a proxy for the dependence on the resource rent (Statistical estimations are presented in Appendix A) ⁷. It shows a negative and significant correlation between the resource rent (% GDP) and per capita GDP growth rate. In line with the seminal paper applying a cross-country study to find the resource curse evidence (e.g. J. D. Sachs and Warner, 1995), this latter correlation suggests that resource-dependence countries grow slower than resource-poor countries at the long term. In addition, looking at the correlation between resource rent (% GDP) and three proxies identifying the absorption capacity: (1) Human capital index, (2) Electric power consumption (MWh per capita) and (3) Fixed telephone subscriptions (per 100 people), we can see that resource-rich countries always exhibit lower level of capacity. Briefly, the initial analysis reveals that smaller

⁷Description of data is presented in the section 4.3. Variables are approximated on average over period 1985-2014 and only countries where their time-series dataset are available on this period are covered in the cross-country study (see. Appendix B).

non-traded capital (absorption capacity) might result in the natural resource curse. This argument motivates us to investigate the impact of absorption capacity constraints (i.e. shortage in the non-traded capital goods) on the intensity of the resource curse.

4.4 Empirical approach

4.4.1 Methodology and Data

This section describes the econometric methodology to pursue the objective of the paper. In this respect, I extend the traditional economic growth regression (see. Barro, 2004) by the inclusion of a natural resource proxy, an absorption capacity proxy and an interaction term between these two variables of interest. The regression is used to test whether a larger absorption capacity index hinders the adverse effect of a natural resource-dependence on economic growth.

I utilize a panel data approach to estimate the main contribution of the empirical model. An unbalanced panel sample comprises 105 countries and covers the available data observed from 1975 to 2014. The list of countries included in the sample database presents in Appendix B. The specification model can be expressed as follow:

$$GY_{i,t} = \beta_0 + \beta_1 \ln Y_{i,t-1} + \beta_2 WI_{i,t-1} + \beta_3 NK_{i,t-1} + \beta_4 (WI_{i,t-1} * NK_{i,t-1}) + Z'_{i,t} \beta_5 + \mu_i + \epsilon_{i,t}. \quad (4.1)$$

This model allows to evaluate the overall impact of a resource-dependence proxy on economic growth and also to clarify the role the absorption capacity in economic performance⁸. In my benchmark, the subscripts $i = 1, \dots, N$ and $t = 1, \dots, T$ index, respectively, the countries and periods in the panel. GY is GDP per capita growth rate⁹ and $\ln Y$, the natural logarithm of per capita GDP, is included to estimate the hypothesis of the convergence result in the balance growth model. WI stands for the resource-dependence index and NK is a proxy for the absorption capacity in economy (e.g. human capital and/or infrastructure). Z' is the vectors of control variables that are expected to affect economic growth. Further, μ_i is a country fixed effect and $\epsilon_{i,t}$ denotes the disturbance term.

Table 4.1 reports summary statistics for 5-year average value of data variables¹⁰. The data for GDP per capita (Constant 2011 US *dollars*) is collected from the *Penn World Table* (*PWT* 9.0) and total natural resources rents (% of GDP), a proxy for resource dependence, is sourced from the *World Development Indicator* (*WDI*). Given my interested in determining the possible effect of absorption capacity (non-traded capital goods) on the

⁸The aim of this empirical procedure is not to systematically analyze both direct effect of resource rent on outcome and indirect effect, through a change in capacity index. A moderated mediation model proposed by Muller, Judd, and Yzerbyt, 2005 might be used to deal this issue.

⁹ GY_t denotes growth rate of GDP per capita and it is calculated as following: $GY_t = \left[\frac{\ln(Y_t)}{\ln(Y_{t-1})} \right]$.

¹⁰5-year periods are: 1975-79, 1980-84, 1985-89, 1990-94, 1995-99, 2000-04, 2005-09, 2010-14.

4.4. EMPIRICAL APPROACH

resource curse, I first collect data for Human Capital Index ¹¹, Electricity index ¹² and Telephone index ¹³ and then I construct two indexes to proxy cross-country capital goods and so to capture the absorption capacity.

The first one, called Infrastructure index, is defined by the average of normalized Elec-

Table 4.1: Summary Statistics

	Obs.	Mean	Std Dev.	Min	Max
Ln (per capita GDP)	699	9,03	1,15	5,80	11,35
Resource dependence index	699	7,04	9,61	0,01	51,09
Population growth	699	1,54	1,19	-1,50	7,13
Investment ratio	699	23,42	6,69	3,96	54,42
Human Capital index	699	2,28	0,69	1,06	3,72
Openness index	699	69,54	33,86	9,50	205,54
Terms of Trade	697	1.02	0.30	0.14	4.69
Real effective exchange rate (Ln)	690	4.68	0.40	3.51	9.56
Institution index	699	0,05	1,02	-2,07	1,99
Electricity index	699	2,98	4,19	0,01	24,67
Telephone index	699	16,72	18,39	0,02	73,33

tricity index and normalized Telephone index ¹⁴, while the second one, called Absorption index, is the average of normalized Human Capital Index and normalized Infrastructure index ¹⁵,

$$\text{Infrastructure index} = (\text{normalized Electricity index} + \text{normalized Telephone index})/2 \quad (4.2a)$$

$$\text{Absorption index} = (\text{normalized Human Capital index} + \text{normalized Infrastructure index})/2 \quad (4.2b)$$

Figure 4.4 represents the normalized Infrastructure and Absorption indexes with respect to income level. The plots reveal two patterns of absorption capacity constraints. First, in poor countries (GDP per capita (Ln) less than 8), Absorption index is larger than Infrastructure index. It may imply that in poor countries low level of infrastructure is the main determinant of absorption capacity constraints. Second, when GDP per capita (Ln) reaches around 10, both indexes rise sharply. Dropping the constraints corresponding to rising capital goods may suggest that the effects of a natural resource rent is adjusted faster in developed than developing countries.

¹¹This index is constructed by *Penn World Table* based on Barro and J. W. Lee, 2013 database for the average years of schooling and an estimated rate of return for primary, secondary, and tertiary education introduced by Caselli, 2005.

¹²It represents electric power consumption (MWh per capita) estimated by *WDI* database.

¹³Fixed telephone subscriptions (per 100 people) is defined as telephone index and data are collected from *WDI* database.

¹⁴Because of the lack of data for variables having long-term series and covering many countries such as the stock of buildings, rail lines, internet accessibility, the Infrastructure index restricts to these two variables.

¹⁵Normalized X is computed as $\frac{X_{i,t} - X_{min}}{X_{max} - X_{min}}$, where X_{max} and X_{min} are, respectively, maximum and minimum values of the sample dataset.

I Also include a number of control variables, namely Population Growth, Investment

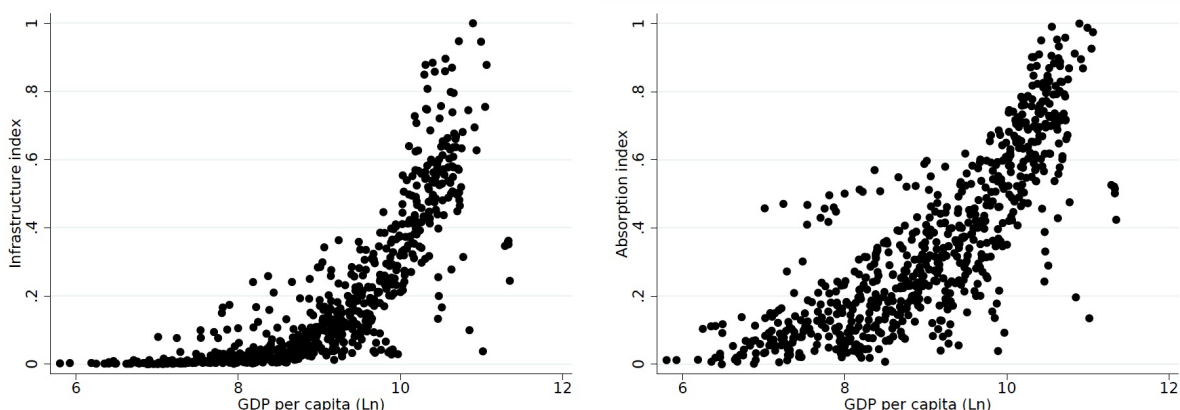

Figure 4.4: Infrastructure and Absorption indexes with respect to *GDP* per capita

ratio (i.e. Gross capital formation (of % GDP)), Openness index (i.e. Trade (of % GDP))¹⁶, Terms of trade¹⁷, and real effective exchange rate¹⁸. Further, Rule of Law indicator¹⁹ is considered as a proxy for quality of institution (Institution index).

Two econometric problems may arise in estimation of Equation 4.1: 1) inclusion of the lagged per capita GDP in regression which rises autocorrelation problem and 2) a simultaneous causality between proxies for the absorption capacity and per capita GDP, leading to the endogeneity problem. The latter problem rests on twofold. The hypothesis of non-correlation between the explanatory variables and error is relaxed if proxies observed at time t is correlated with per capita GDP and so with the error term in the same period. Therefore, I apply the lagged value of absorption capacity proxies, instead of their current value, in the regression model (see. Equations 4.1) to prevent this problem. But Figure 4.4 shows a strong correlation in each period between these two explanatory variables of interest so that dropping absorption constraints are associated with rising income level. In other words, per capita GDP could reflect as much the absorptive capacity constraint identified by two non-traded capital indexes. The standard way to deal with this type of bias is to apply the instrumental variables regression. Hence, I use *IV – 2SLS* technique to cope these problems.

Instrumental-variables approach stands on the assumption that the excluded instruments affect the dependent variable through their correlations with the endogenous variables.

¹⁶Data of these three variables are collected from *WDI*.

¹⁷The net barter terms of trade index (2005=1) are calculated as the percentage ratio of the export unit value indexes to the import unit value indexes. The average value for the 5-year periods is derived from *WDI* database.

¹⁸The index estimated by *Bruegel* is calculated as $REER = \frac{NEER \cdot CPI^{domestic}}{CPI^{foreign}}$, where *NEER*, the nominal effective exchange rate, is a measure of the value of a currency against a weighted average of several foreign currencies and *CPI* denotes the consumer price index (see. Darvas, 2012).

¹⁹The original indicator proposed by *World Bank's Governance Indicators Project* is in the range of approximately -2.5 (weak) to $+2.5$ (strong). The data are available over period 1996-2014. For preceding periods, I assume that the indicators are equal the earliest value.

The *Hansen* test of over-identifying restrictions²⁰ can be used to check this assumption. The null hypothesis is that the instruments, as a group, are distributed independently of the error process. In other words, the excluded instruments are uncorrelated with the error term and thus they are correctly excluded from the regression equation. Nevertheless, the *Hansen* test which only checks the joint validity of full instruments doesn't specify whether the instruments are correlated with the endogenous variables. The Underidentification test (*Kleibergen – Paap* rk LM statistic) addresses this question. The null hypothesis is that the regression equation is underidentified. Although a rejection of the null indicates that the model is identified, the weak identification test need to be considered as well to check whether the correlation between instruments and endogenous variables is weak or strong. Stock and M. Yogo, 2002 propose a test to check weak identification by using *Kleibergen – Paap* rk Wald F statistic²¹. Their null hypothesis is that the estimator is weakly identified. Hence, when the value of *Kleibergen – Paap* rk Wald F statistic is larger than the tabulated critical value, estimated by Stock and M. Yogo, 2002, the null hypothesis is rejected.

First-lagged of GDP per capita (Ln) and proxies for capital goods are endogenous variables. Hence, I apply second-lagged of resource-dependence index and GDP per capita (Ln) as instruments for endogenous variables to avoid the econometric problems. Further, first-lagged of Telephone index will be an instrument for endogenous variables when Infrastructure index is included²², while first-lagged of Infrastructure index and Human capital index will be instruments when Absorption index is included²³.

4.4.2 Estimation Results

In this sub-section I discuss the results of my empirical analysis²⁴. The baseline model estimates the average empirical association for pooling data of the countries included in the dataset. The presence of unobservable heterogeneity across countries that may undermine the reliability of the empirical results is evaluated by the *Hausman* test²⁵. Moreover, the estimations include *heteroskedasticity – robust* standard errors²⁶ and a

²⁰*Hansen* test is adequate when the estimation considers an *heterocedastic* weight matrix.

²¹Kleibergen and Paap, 2006

²²First-lagged of GDP per capita and Infrastructure index are functions of second-lagged of resource-dependence index and GDP per capita (Ln) as well as first-lagged of Telephone index. Note that I exclude the Electricity index as an instrument. Since the null hypothesis of the joint validity test (*Hansen* test) is rejected.

²³First-lagged of GDP per capita and Absorption index are functions of second-lagged of resource-dependence index and GDP per capita (Ln) as well as first-lagged of Infrastructure index and Human capital index.

²⁴All estimations and statistical tests reported in the following are carried out using STATA 15.1 software. The regressions are estimated by *xtivreg2* command, implemented by M. Schaffer, 2015.

²⁵The *Hausman* test checking that the preferred model is random effects is rejected with a *p – value* of 0.000 for both baseline regression models.

²⁶A test that the variance of error term is constant (*homoskedasticity*) is rejected with a *p – value* of 0.000 for both baseline regression models.

separate intercept for each time period ²⁷.

Table 4.2 summarizes the results of the regression model (Equations 4.1). *OLS* estimator for the baseline specification models are respectively reported in columns (1) and (4). Although these results may not be informative, they may still be interesting as a benchmark. Columns (2) and (5) represent the results of the baseline specification models for cases in which Infrastructure index and Absorption index are respectively included. I first evaluate the estimation results for control variables and then discuss the core independent variables. The main findings of columns are as follows. First, the income level (GDP per capita in Ln) has a significantly negative coefficient. It seems to confirm the hypothesis that low-income countries tend to grow faster than high-income countries, holding fixed other explanatory variables. Second, following *Solow* model (Solow, 1956) and empirical studies (e.g. Mankiw, Romer, and Weil, 1992; Knight, Loayza, and Villanueva, 1993), there is a negative impact on the economic growth from population growth. Third, investment ratio as well as human capital index (at column 2) enter with significantly positive signs. Consistently with the recent empirical studies (Benhabib and Spiegel, 1994; Gylfason, Herbertsson, and Zoega, 1999; Bravo-Ortega and De Gregorio, 2005; Steve Bond, Leblebicioğlu, and Schiantarelli, 2010), these findings accentuate the role of human capital in acceleration of the GDP per capita growth rate. Forth, the estimated coefficient on openness index implies that countries with higher trade shares expand faster than other countries, as in Yanikkaya, 2003. Finally, the correlation between institution index and economic growth is positive and suggests that improvement of quality of institution accelerates the economic growth. Nevertheless, the estimation results are insignificant. This may reflect that the mixture of cross-country heterogeneity has weakened the robustness of correlation.

The coefficient on the resource-dependence enters with a negative sign and is significant at 1%. It stresses that economic growth, on average, reduces by about 0.7% per year as one-standard-deviation increases in the resource-dependence. The result is consistent with the recent empirical studies (e.g. J. D. Sachs and Warner, 1995; Gylfason and Zoega, 2002) and the theory of the Dutch disease (e.g. Torvik, 2001; Van der Ploeg and Venables, 2013). Further, the coefficients on Infrastructure index (at column 2) and Absorption index (at column 5) are significantly positive. These strong findings suggest that infrastructure and human capital development lead to a faster economic expansion. In other words, falling absorption constraints are associated with rising economic growth rate.

The next interesting question which we can suggest is whether the adverse effect of the resource-dependence on economic growth is stronger in countries with a lower level of capital goods (infrastructure and human capital) and larger absorption capacity constraints? To address this question, I include an interaction term between the resource-dependence index and proxies for the absorption capacity. The results for Infrastructure index and Absorption index are respectively reported at columns (3) and (6) of Table 4.2. In both

²⁷A test that these time dummy variables are jointly equal to zero is rejected with a *p* – value of 0.006 for both baseline regression models.

4.4. EMPIRICAL APPROACH

Table 4.2: Estimation results

Explanatory variable	(1)	(2)	(3)	(4)	(5)	(6)
	OLS	IV-2SLS	IV-2SLS	OLS	IV-2SLS	IV-2SLS
	Full Sample	Full Sample	Full Sample	Full Sample	Full Sample	Full Sample
Resource dependence (lagged)	0,00133** (0,00059)	-0,00729*** (0,00168)	-0,00888*** (0,00193)	0,00133** (0,00060)	-0,00720*** (0,00168)	-0,0112*** (0,00219)
Infrastructure index (lagged)	-0,00601 (0,0421)	0,482*** (0,113)	0,443*** (0,112)			
Absorption index (lagged)				0,0987** (0,0385)	0,793*** (0,167)	0,688*** (0,164)
Infrastructure * Resource (lagged)			0,0150** (0,00630)			
Absorption * Resource (lagged)						0,0157*** (0,00522)
Ln (per capita GDP) (lagged)	-0,0714*** (0,00689)	-0,385*** (0,0435)	-0,382*** (0,0419)	-0,0722*** (0,00688)	-0,379*** (0,0436)	-0,365*** (0,0419)
Population growth	-0,0398*** (0,00608)	-0,0266** (0,0117)	-0,0229** (0,0117)	-0,0434*** (0,00568)	-0,0258** (0,0115)	-0,0232** (0,0111)
Investment ratio	0,00913*** (0,00070)	0,0144*** (0,00141)	0,0143*** (0,00139)	0,00926*** (0,00070)	0,0143*** (0,00141)	0,0140*** (0,00135)
Openness index (lagged)	0,00039*** (0,00014)	0,00172*** (0,00038)	0,00177*** (0,00039)	0,00043*** (0,00014)	0,00171*** (0,00038)	0,00175*** (0,00040)
Institution index	0,0232*** (0,00815)	0,0171 (0,0324)	0,0217 (0,0318)	0,0197** (0,00788)	0,0178 (0,0324)	0,0239 (0,0315)
Human Capital index (lagged)	0,103*** (0,0366)	0,432*** (0,146)	0,381*** (0,143)			
Country fixed effects	NO	YES	YES	NO	YES	YES
Time dummies	NO	YES	YES	NO	YES	YES
Observations	594	489	489	594	489	489
Number of Countries	105	105	105	105	105	105
R-squared	0,408	0,529	0,538	0,405	0,531	0,548
Hansen OID test (p-value)		0,136	0,203		0,307	0,307
K-P UID test (p-value)		0,000	0,000		0,000	0,000
K-P Weak ID, F statistic		122,14	126,58		130,44	131,67

Note: The dependent variable is per capita GDP growth rate. Infrastructure index (first lagged), Absorption index (first lagged) and per capita GDP (first lagged) are endogenous variables. They are instrumented by the windfall income (second lagged), per capita GDP (second lagged) and Telephone index (first lagged) in Column (2) and (3) and They are instrumented by the windfall income (second lagged), per capita GDP (second lagged), Human capital index (first lagged) and infrastructure index (first lagged) in Column (5) and (6). Robust standard errors are reported in parentheses. ***, ** and * denote significance at 1, 5 and 10 percent levels.

The null hypothesis of *Hansen* test is that the instruments, as a group, are uncorrelated with the error term. The null hypothesis of Underidentification test (K-P UID test) is that the regression equation is underidentified. The null hypothesis of weak identification test (K-P Weak ID) is that the estimator is weakly identified (Point: 5% maximal IV relative bias is 13.91).

regression models, the coefficients on the resource-dependence and the interaction term are significant and enter with a negative and positive signs, respectively. The estimations state that the natural resource curse attenuates as the absorption capacity expands. Now given the significance of the coefficient on the interaction term I investigate whether it would be feasible to change the sign of the effect of resource-dependence on economic growth. This refers to a derivative of the estimation model (i.e. Equations 4.1) with respect to the resource-dependence,

$$\frac{dGY_{i,t}}{dWI_{i,t-1}} = \beta_2 + (\beta_4 * NK_{i,t-1}). \quad (4.3)$$

Accordingly, the natural resource curse, on average, is vanished at an Infrastructure index larger than 0.6 and at an Absorption index larger than 0.7. Figure 4.5 represents the relationship between the natural resource curse and the constructed proxies. The horizontal axis shows the absorption capacity indexes (i.e. NK in Equations 4.3) and the vertical axis represents the impact on economic growth from the resource-dependence index (coefficient on resource dependence) (i.e. $\frac{dGY}{dWI}$ in Equations 4.3). The estimated results, reported in columns 4 and 6 of Table 4.2, are drawn by continues lines and dotted lines plot the 95% confidence interval. Furthermore, the circles show the average effect of the resource-dependence on economic growth with respect to the average of capital index for each country ²⁸.

A comparative study between two African countries- Ghana (*GHA*) and Cameroon (*CMR*)- can offer an example of how difference in the absorption capacity can influence the natural resource curse. A closer look at time series data shows that the average value of the resource-dependence index and per capita GDP (Ln) over 1975-2014 are approximately equal between two countries (see. Table 4.3). Nevertheless, average of Human capital index in Ghana is 1.2 times larger than that in Cameroon. Further, Electricity index and Telephone index are, respectively, 60 % and 17 % larger in Ghana. Briefly, absorption capacity constraints are less intensive in Ghana than in Cameroon. The estimation results represent that the adverse effect of a natural resource rent on economic growth is approximately 25 % less in Ghana, with respect to that in Cameroon (see. Figure 4.5).

Table 4.3: Comparative study between *Ghana to Cameroon*

Period	Resource dependence	per capita GDP (Ln)	Human capital index	Electricity index	Telephone index
1975-84	0,81	0,95	1,16	1,88	1,62
1985-94	0,68	0,94	1,23	1,51	0,86
1995-04	1,28	0,98	1,22	1,83	1,7
2005-14	1,44	1	1,22	1,17	0,52
Average	1,05	0,97	1,21	1,6	1,17

Note: relative value of variables (*Ghana to Cameroon*).

²⁸Those are estimated by $\frac{dGY_i}{dWI_i} = \beta_2 + (\beta_{4,i} * NK_i)$, where β_2 is the coefficient on the resource-dependence for full sample and $\beta_{4,i}$ is the coefficient on the interaction term for country i . Further NK_i is average of capacity index for country i over its periods.

4.4. EMPIRICAL APPROACH

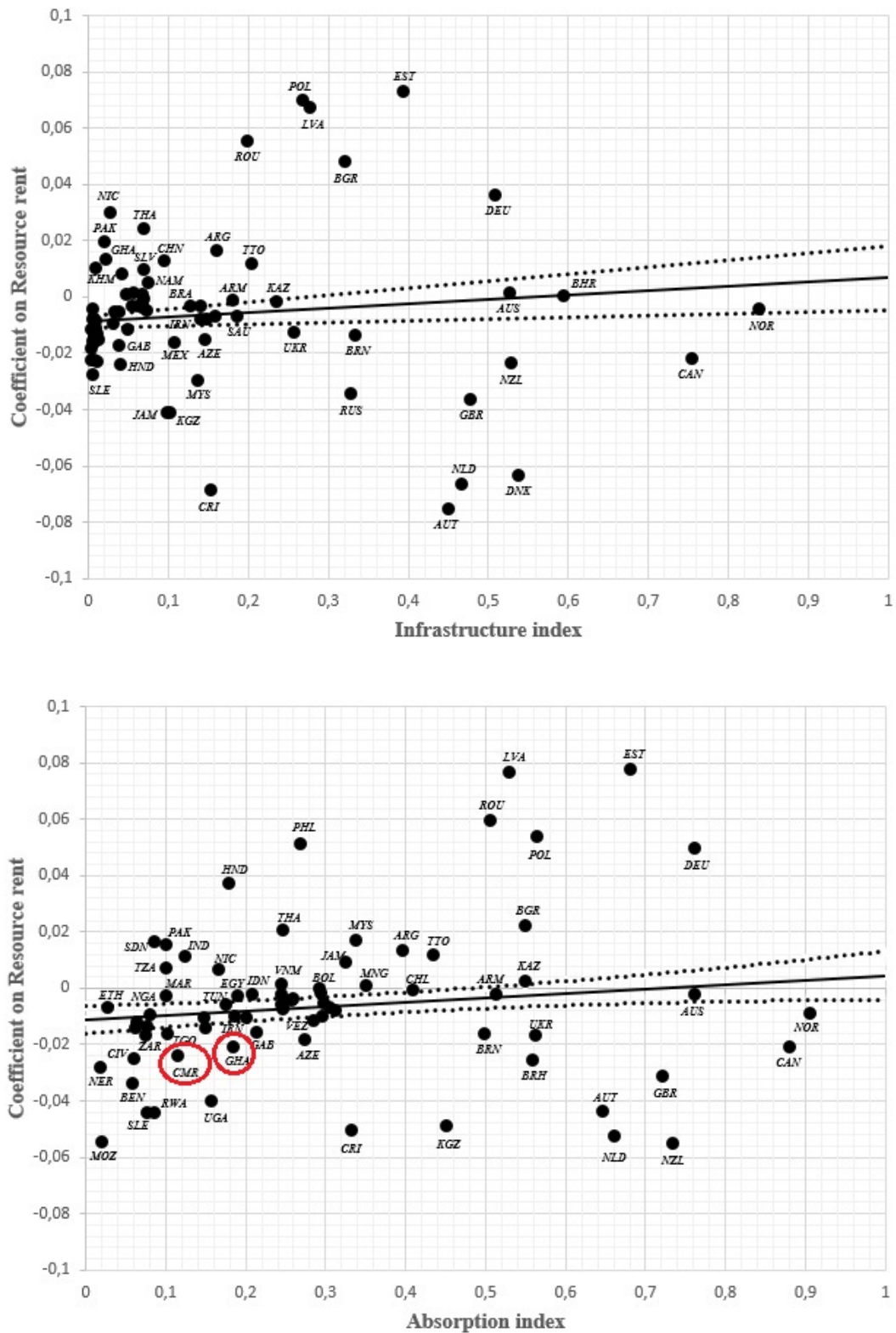

Figure 4.5: Average estimation result for coefficients on resource rent (the impact on economic growth from the resource-dependence index). Continues line: estimation results of Table 4.2 (columns 4 and 6) and dot line: 95% confidence interval. The circles: average effect of the resource-dependence rent on economic growth for each country. Only countries with an estimated coefficient larger than -0.1 and smaller than 0.1 are represented.

4.4.3 Robustness Tests

Table 4.4 represents a robustness analysis to check the results of the baseline model in terms of heterogeneity across countries, another proxy to identify the absorption capacity, and another estimation approach. Columns (1) and (2), respectively, show the results of restricted samples for developing and developed countries, introduced by the International Monetary Fund's World Economic Outlook Database. Regarding these results, the hypothesis of a positive impact on economic growth from the Absorption index is only valid in developing countries. It might be because of having a little number of observations in the sample of developed countries. In addition, the natural resource curse remains for a longer interval level of the absorption index (equal to 0.9) in the developing countries' sample than in the full sample (i.e. 0.7). It seems to confirm the more intensive resource curse in developing countries than in developed countries.

Many countries, included in the baseline sample, have small shares of the total natural resources to GDP. Further, the different quality of institutions might affect the correlation between the variables of interest. Hence, one seems to be worth studying the effect of the absorption capacity constraints on the resource curse for a sample of non-resource-poor countries, the resource-dependence index larger than 2%, and for a sample of poor-institution countries, the institution index less than one. Columns (3) and (4), reporting respectively the estimation results for non-resource-poor countries and poor-institution countries, suggest that there is a significant and positive impact on economic growth from the Absorption index, the same as the baseline results. The coefficient on the Absorption index is larger in non-resource-poor and poor institution countries' samples than the full sample. More precisely, the marginal productivity of one more unit of the absorption capacity is stronger in these two groups of countries. Further, the negative coefficient on the resource-dependence and the positive coefficient on the interaction term between variables of interest are less intensive in the restricted samples than in the full sample. These suggest that the natural resource curse remains for a longer interval of the absorption capacity's proxy when I estimate the regression model for the restricted samples (less than 0.85) than what is estimated for the full sample (less than 0.7). The latter result may state that capacity constraints which are more intense in a sample of non-resource-poor countries or low-quality-institution countries lengthen the persistence of the resource curse. In addition, in column (5), representing the estimation results of the regression model for a sample of Non-European countries, the currency union's effects are controlled. It shows when the observations for European countries are excluded, the resource curse remains in the rest of countries with each level of capacity constraint. However, less constraint tends still to moderate the resource curse.

I also estimate the regression model using *IV – GMM* to check the accuracy of the results. *IV – GMM* estimator is more comprehensive and efficient than the conventional *IV – 2SLS* estimator in the presence of arbitrary heteroskedasticity (see. Baum, M. E. Schaffer, and Stillman, 2003). The results reported in columns (6) suggest that the

4.4. EMPIRICAL APPROACH

Table 4.4: Estimation results for robustness check

Explanatory variable	(1)		(2)		(3)		(4)		(5)		(6)		(7)		(8)		
	IV-2SLS	Developing	IV-2SLS	Developed	IV-2SLS	Non-Reso	Poor	IV-2SLS	Poor	Institution	Non-European	IV-GMM	Full Sample	IV-2SLS	Full Sample	IV-2SLS	10-year period
Resource dependence (lagged)	-0.0105*** (0.00237)	-0.00143 (0.0232)	-0.0104*** (0.00245)	-0.00143 (0.0232)	-0.0104*** (0.00245)	-0.0104*** (0.00245)	-0.0111*** (0.00231)	-0.0111*** (0.00231)	-0.0104*** (0.00228)	-0.0104*** (0.00228)	-0.0103*** (0.00210)	-0.0103*** (0.00210)	-0.0112*** (0.00220)	-0.0112*** (0.00220)	-0.0112*** (0.00220)	-0.0112*** (0.00220)	-0.0112*** (0.00220)
Absorption index (lagged)	0.773*** (0.279)	0.157 (0.221)	1.001*** (0.337)	0.157 (0.221)	1.001*** (0.337)	0.723*** (0.232)	0.723*** (0.232)	0.741*** (0.200)	0.741*** (0.200)	0.610*** (0.156)	0.610*** (0.156)	0.610*** (0.156)	0.697*** (0.166)	0.697*** (0.166)	0.697*** (0.166)	0.503*** (0.187)	0.503*** (0.187)
Absorption * Resource (lagged)	0.0116** (0.00647)	-0.000550 (0.0246)	0.0121* (0.00682)	-0.000550 (0.0246)	0.0121* (0.00682)	0.0132** (0.00629)	0.0132** (0.00629)	0.0104* (0.00562)	0.0104* (0.00562)	0.0141*** (0.00511)	0.0141*** (0.00511)	0.0141*** (0.00511)	0.0157*** (0.00523)	0.0157*** (0.00523)	0.0157*** (0.00523)	0.0235*** (0.00612)	0.0235*** (0.00612)
Ln (per capita GDP) (lagged)	-0.350*** (0.0435)	-0.348*** (0.0738)	-0.326*** (0.0499)	-0.348*** (0.0738)	-0.326*** (0.0499)	-0.357*** (0.0453)	-0.357*** (0.0453)	-0.357*** (0.0419)	-0.357*** (0.0419)	-0.365*** (0.0419)	-0.365*** (0.0419)	-0.365*** (0.0419)	-0.368*** (0.0421)	-0.368*** (0.0421)	-0.368*** (0.0421)	-0.287*** (0.0611)	-0.287*** (0.0611)
Population growth	-0.0186 (0.0164)	-0.00387 (0.0175)	-0.0248 (0.0164)	-0.00387 (0.0175)	-0.0248 (0.0164)	-0.0212 (0.0153)	-0.0212 (0.0153)	-0.0203 (0.0147)	-0.0203 (0.0147)	-0.0246** (0.0111)	-0.0246** (0.0111)	-0.0246** (0.0111)	-0.0231** (0.0111)	-0.0231** (0.0111)	-0.0231** (0.0111)	-0.0272 (0.0182)	-0.0272 (0.0182)
Investment ratio	0.0130*** (0.00160)	0.00987*** (0.00199)	0.0129*** (0.00200)	0.00987*** (0.00199)	0.0129*** (0.00200)	0.0133*** (0.00157)	0.0133*** (0.00157)	0.0127*** (0.00156)	0.0127*** (0.00156)	0.0135*** (0.00131)	0.0135*** (0.00131)	0.0135*** (0.00131)	0.0140*** (0.00136)	0.0140*** (0.00136)	0.0140*** (0.00136)	0.0131*** (0.00176)	0.0131*** (0.00176)
Openness index (lagged)	0.00176*** (0.000447)	0.00110 (0.000681)	0.00169*** (0.000647)	0.00110 (0.000681)	0.00169*** (0.000647)	0.00177*** (0.000439)	0.00177*** (0.000439)	0.00179*** (0.000419)	0.00179*** (0.000419)	0.00175*** (0.000397)	0.00175*** (0.000397)	0.00175*** (0.000397)	0.00176*** (0.000400)	0.00176*** (0.000400)	0.00176*** (0.000400)	0.000750 (0.000528)	0.000750 (0.000528)
Institution index	0.0317 (0.0335)	0.118*** (0.0384)	0.0454 (0.0446)	0.118*** (0.0384)	0.0454 (0.0446)	0.0402 (0.0328)	0.0402 (0.0328)	0.0249 (0.0339)	0.0249 (0.0339)	0.0282 (0.0313)	0.0282 (0.0313)	0.0282 (0.0313)	0.0240 (0.0315)	0.0240 (0.0315)	0.0240 (0.0315)	0.0223 (0.0431)	0.0223 (0.0431)
Country fixed effects	YES	YES	YES	YES	YES	YES	YES	YES	YES	YES	YES	YES	YES	YES	YES	YES	YES
Time dummies	YES	YES	YES	YES	YES	YES	YES	YES	YES	YES	YES	YES	YES	YES	YES	YES	YES
Observations	359	130	240	130	240	372	372	378	378	489	489	489	489	489	489	223	223
Number of Countries	82	23	56	23	56	84	84	81	81	105	105	105	105	105	105	78	78
R-squared	0.564	0.782	0.516	0.782	0.516	0.565	0.565	0.543	0.543	0.547	0.547	0.547	0.547	0.547	0.547	0.540	0.540
Hansen OID test (p-value)	0.302	0.313	0.105	0.313	0.105	0.307	0.307	0.303	0.303	0.307	0.307	0.307	0.158	0.158	0.158	0.203	0.203
K-P UID test (p-value)	0.000	0.000	0.000	0.000	0.000	0.000	0.000	0.000	0.000	0.000	0.000	0.000	0.000	0.000	0.000	0.001	0.001
K-P Weak ID, F statistic	108.91	44.86	78.88	44.86	78.88	102.11	102.11	121.72	121.72	131.67	131.67	131.67	188.56	188.56	188.56	29.76	29.76

Note: The dependent variable is per capita GDP growth rate. Absorption index (first lagged) and per capita GDP (first lagged) are endogenous variables. They are instrumented by the windfall income (second lagged), per capita GDP (second lagged), Human capital index (first lagged) and infrastructure index (first lagged) in Columns (1)-(6). While, in column (7) per capita GDP (first lagged) is only endogenous variable and it is instrumented by the windfall income (second lagged) and per capita GDP (second lagged). Further, in column (8) independent variables of interest are in current period and Absorption index (current) and per capita GDP (first lagged) are instrumented by the windfall income (first lagged), per capita GDP (second lagged), Human capital index (current) and infrastructure index (current). Robust standard errors are reported in parentheses. ***, ** and * denote significance at 1, 5 and 10 percent levels. The null hypothesis of *Hansen* test is that the instruments, as a group, are uncorrelated with the error term. The null hypothesis of Underidentification test (K-P UID test) is that the regression equation is underidentified. The null hypothesis of weak identification test (K-P Weak ID) is that the estimator is weakly identified.

coefficients on the absorption proxy and the interaction term are yet significant but their values are smaller than the values estimated by $IV - 2SLS$. In general, this may reflect that the difference in estimator doesn't qualitatively bias the intensity of the natural resource curse to a change in the capital index.

The next question that may arise is whether the results depend on the specified instruments for the endogenous variables. To analyze the question, I first assume that Absorption index is exogenous and the first-lagged GDP per capita (Ln) is the only endogenous variable. I then instrument the remained endogenous variable by the second-lagged of resource-dependence index and GDP per capita (Ln). Column (7) reports the results estimated by $IV - 2SLS$ technique. It shows that the finding is independent of applying a specified regression model or taking into account the Absorption index as an endogenous variable ²⁹.

I finally consider an alternative model specification that may yield some insight into the finding that the mean years of variables is not a robust and relevant regressor in the growth model. I consider a panel dataset that has been constructed over 10-year average value of variables, instead of 5-year as in the primary sample. The reason for this is twofold. First, measurement error has a potentially weaker impact on the regression estimates as the time interval over which the data are averaged increases. So taking into account a 10-year average dataset may unearth some signs of variable relevance that may be masked by measurement error in the 5-year panel setting. Second, consideration of a 10-year averaged panel let me investigate the more long-term effect of the absorption capacity on economic growth. In column (8), I present the results of the panel including the data for 78 countries. It clearly shows that there is no difference in statistical relevance averaging the data over 10-year and 5-year intervals. In addition, the natural resource curse seems to remain for a shorter interval level of the absorption index (equal to 0.48) for the 10-years average dataset than the primary sample dataset (i.e. 0.7). The latter point may implicitly suggest that expansion of the absorption capacity over time can neutralize the adverse effect of a resource boom.

Furthermore, it can be empirically more efficient to check the accuracy and sensitivity of the main finding using a different specification model and an estimation method. Hence, following K. S. Sridhar and V. Sridhar, 2007, I use $IV - 3SLS$ to estimate a system of equations that endogenizes the absorption capacity index through being dependent on GDP per capita. Table 4.5 report the estimation results. Columns (1) shows the results of the baseline model. The presence of unobservable heterogeneity across countries is rejected using a *Breusch - Pagan Lagrange multiplier* test ³⁰. It would mean that random-effects estimators could be appropriate and so the pooled estimators, which ignore heterogeneity across individuals, could be applied. However, given the fact that country heterogeneity may undermine the reliability of the empirical results, the system of equations

²⁹Note that we will find a similar qualitative conclusion, even if we apply a deeper lagged-level for instruments.

³⁰A test for the baseline specification of economic growth has a $p - value$ of 0.000.

4.4. EMPIRICAL APPROACH

Table 4.5: Estimation results for robustness check: 3SLS

Explanatory variable	(1)	(2)	(3)	(4)	(5)	(6)
Dependent: Growth						
Resource dependence (lagged)	-0.00211** (0.00101)	-0.00452*** (0.00138)	-0.00235** (0.000977)	-0.00427*** (0.00133)	-0.00215** (0.00101)	-0.00444*** (0.00138)
Absorption index (lagged)	0.379*** (0.118)	0.324*** (0.120)	0.351*** (0.114)	0.308*** (0.116)	0.371*** (0.118)	0.321*** (0.120)
Absorption * Resource (lagged)		0.00980** (0.00382)		0.00789** (0.00369)		0.00931** (0.00381)
Ln (per capita GDP) (lagged)	-0.239*** (0.0186)	-0.235*** (0.0186)	-0.250*** (0.0184)	-0.246*** (0.0184)	-0.240*** (0.0186)	-0.236*** (0.0186)
Population growth	-0.0383*** (0.00794)	-0.0352*** (0.00800)	-0.0415*** (0.00778)	-0.0391*** (0.00784)	-0.0376*** (0.00792)	-0.0347*** (0.00798)
Investment ratio	0.0115*** (0.000790)	0.0114*** (0.000787)	0.0113*** (0.000773)	0.0112*** (0.000771)	0.0114*** (0.000788)	0.0113*** (0.000785)
Openness index (lagged)	0.00102*** (0.000276)	0.00108*** (0.000275)	0.00158*** (0.000267)	0.00159*** (0.000267)	0.00111*** (0.000275)	0.00116*** (0.000275)
Institution index	0.0210 (0.0209)	0.0233 (0.0208)	-0.00411 (0.0209)	-0.00201 (0.0209)	0.0233 (0.0208)	0.0251 (0.0207)
Constant	1.753*** (0.156)	1.737*** (0.155)	1.808*** (0.153)	1.790*** (0.153)	1.766*** (0.156)	1.749*** (0.155)
R-squared	0,720	0,722	0,729	0,731	0.720	0.722
Dependent: Absorption index						
Ln (per capita GDP)	0.0744*** (0.00636)	0.0747*** (0.00636)	0.0777*** (0.00656)	0.0780*** (0.00656)	0.0744*** (0.00636)	0.0746*** (0.00636)
Constant	-0.237*** (0.0591)	-0.239*** (0.0591)	-0.266*** (0.0609)	-0.269*** (0.0609)	-0.236*** (0.0591)	-0.238*** (0.0591)
R-squared	0,988	0,988	0,988	0.988	0.988	0,988
Dependent: Openness index						
Ln (per capita GDP)			15.48*** (2.734)	15.19*** (2.735)		
Resource dependence			0.650*** (0.151)	0.648*** (0.151)		
Ln (Real exchange rate)			-6.642*** (1.678)	-6.552*** (1.680)		
Terms of Trade			-5.612** (2.320)	-5.839** (2.324)		
Constant			-32.19 (25.61)	-29.76 (25.62)		
R-squared			0.897	0.898		
Dependent: Resource dependence						
Resource dependence (lagged)					0.402*** (0.0360)	0.402*** (0.0360)
Ln (per capita GDP)(lagged)					-3.917*** (0.592)	-3.914*** (0.592)
Openness index					0.0430*** (0.00974)	0.0427*** (0.00974)
Constant					31.99*** (5.422)	31.99*** (5.422)
R-squared					0.923	0.923
Country fixed effects	YES	YES	YES	YES	YES	YES
Time dummies	YES	YES	YES	YES	YES	YES
Observations	594	594	586	586	594	594
Number of Countries	105	105	105	105	105	105

include fixed-effects estimators³¹. The coefficients on the resource-dependence and the absorption index are significantly negative and positive, the same as the results estimated by $IV - 2SLS$. Further, the value of the coefficient on the resource-dependence is larger while that on the absorption index is smaller than those estimated by base technique. These indicate that raising the resource curse and the positive impact of dropping capacity constraints on economic growth are less intensive when $IV - 3SLS$ is used than when $IV - 2SLS$ was applied.

Column (2) presents the results of studying the intensity of the resource curse to an increase in the capacity index. This states that the natural resource curse is vanished at Absorption index larger than 0.46. It is smaller than the critical value of index found by the base method. A comparison of the results estimated by this method and the base one demonstrates that the findings are quantitatively different while qualitatively similar.

The Openness index and the resource-dependence index are more likely to be correlated with the per capita GDP. Since they are defined as a percent of GDP and also trade includes natural resource exports. Therefore, these two indexes seem to be endogenous rather than exogenous. Hence, I extend the base system of equations by adding one more equation for each of these indexes. Columns (3) and (4) represent the results for an extended system of equations in which the openness index is endogenized, while columns (5) and (6) report the results for an extended system of equations in which the resource-dependence index is endogenized. Although the values of coefficients are various, the analyzed results support the hypothesis that dropping the capacity constraints decreases the intensity of the resource curse.

Further robustness test is a sensitivity analysis of coefficients of interest to a change in the composition of the samples. Following Mihasonirina and Kangni, 2011, the baseline regression models (columns 3 and 6 of Table 4.2) are run for randomly 98% of the observations (without replacement). This process, repeated 250 times, gives us the mean and standard deviation of coefficients of interest. The same procedure is also used to run the baseline models on selected randomly 95%, 80% and 65% of observations. Table 4.6 represents the analysis. It shows when the baseline models are run on different sample sizes, the mean values of the coefficient remain close to full sample coefficient values, while their normal distributions have heavier tails. This may suggest that the coefficients become less significant as the sub-sample size shrinks.

I also conduct a recursive estimation to test the stability and accuracy of the coefficients on the absorption capacity in terms of cross-country heterogeneity. Firstly, the observations are ranked in increasing order of proxies (Infrastructure index and Absorption index). Then the regression model is run for a sample with lowest order of both indexes, less than 0.2. In the next step, the subsequent observations with larger index are added and the regression model is rerun. This procedure is replicated as long as the full sample is covered. The

³¹The *Hausman* test checking that the preferred model is random effects is rejected with a $p - value$ of 0.000 for the economic growth regression.

4.4. EMPIRICAL APPROACH

Table 4.6: Robustness test for the sensitivity of coefficients of interest

Regression for Infrastructure index					
Explanatory variable		98%	95%	80%	65%
Infrastructure index (lagged)	Coefficient	0.44758	0.44916	0.47700	0.45663
	Standard Deviation	0.04190	0.06294	0.17348	0.37443
Resource dependence (lagged)	Coefficient	-0.00894	-0.00885	-0.00873	-0.00728
	Standard Deviation	0.00078	0.00128	0.00318	0.00573
Interaction term (lagged)	Coefficient	0.01504	0.01491	0.01284	0.01187
	Standard Deviation	0.00240	0.00416	0.01315	0.02946
Regression for Absorption index					
Explanatory variable		98%	95%	80%	65%
Absorption index (lagged)	Coefficient	0.69155	0.68209	0.74709	0.79640
	Standard Deviation	0.05668	0.10473	0.25519	0.57478
Resource dependence (lagged)	Coefficient	-0.01117	-0.01097	-0.01083	-0.00925
	Standard Deviation	0.00073	0.00146	0.00318	0.00691
Interaction term (lagged)	Coefficient	0.01557	0.01535	0.013862	0.00950
	Standard Deviation	0.00185	0.00365	0.00887	0.01800

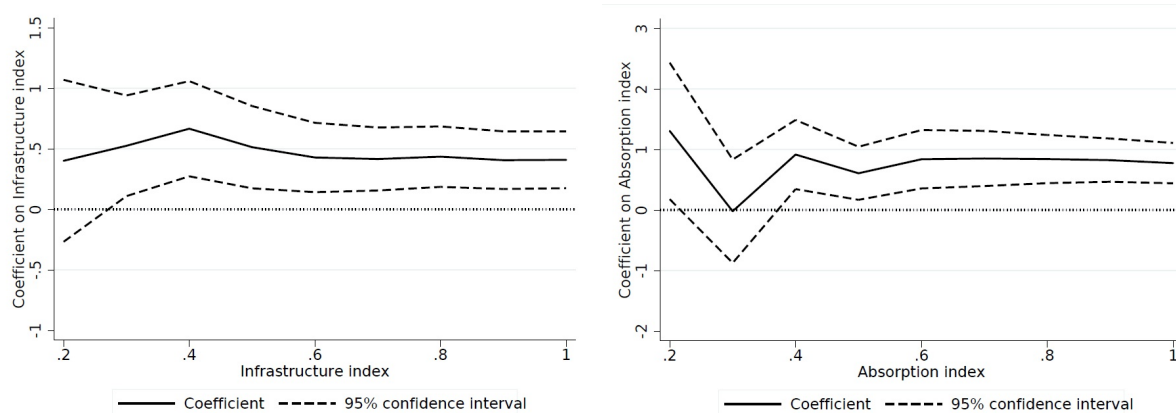

Figure 4.6: Recursive estimation on the coefficients of interest.

results show at Figure 4.6. The coefficients on both Infrastructure index and Absorption index remain positive and significant. These demonstrate that the positive correlations between variables of interest are stable across country. Further, the marginal impact of infrastructure index on economic growth is approximately constant across the sample, while the marginal impact of Absorption index on economic growth is heterogeneous. The latter point may imply that a lack of human capital intensive sectors in countries with high absorption constraints prevents to absorb the effects of expansion in the capacity.

4.5 The Model

The presented analytical framework in section 4.2 highlights the short-term prospects of the resource curse. While non-traded capital goods (i.e. infrastructure and human capital) goes a long way to enhance economic performance. In the long-term, the economy extends its production possibility frontier (*PPF*) outward so that the natural resource curse is more likely to vanish. To address this issue and also to clarify the empirical findings, I develop the framework in following the model proposed by Van der Ploeg and Venables, 2013. The model describes the dynamic mechanism of the resource curse in a developing economy constrained by the absorption capacity.

I consider a two-sector small open economy producing Traded (C_T), such as manufacturing goods, and non-Traded (C_{NT}) goods, such as services, public education and infrastructure. Price of traded goods is normalized to unity. Thereby, price of non-traded goods, denoted by P , is identified as the real exchange rate. The production technology in each sector is a homogeneous function. Assume that the non-traded sector (X_{NT}) employs labor (L_{NT}) and final capital goods (S), while the traded sector (X_T) produces goods by means of labor (L_T).

$$X_{NT} = S^\alpha (L_{NT})^{1-\alpha}, \quad (4.4a)$$

$$X_T = L_T. \quad (4.4b)$$

The labor force, inelastically supplied by households and moving freely across sectors, is normalized to unity to expel the population growth effect,

$$L_T + L_{NT} = L = 1. \quad (4.5)$$

Final capital goods (S) are normally made of the traded (such as equipment) and non-traded capital goods (such as the human capital and the infrastructure). Hence, the unit cost function for producing final capital goods can be denoted by $q(P) = P^\gamma$ in which $0 \leq \gamma \leq 1$ is a share of the non-traded capital goods used to produce one more unit of final capital goods ³². As mentioned, some sorts of the capital goods (e.g. infrastructure,

³²Bems and Carvalho Filho, 2011 found that the share of non-traded capital goods in total capital is stable across countries and over time and is in the range 0.54-0.62.

human capital) cannot normally be traded in the international capital market. Hence, the case $\gamma = 0$, meaning that the required capital goods are totally imported, doesn't seem to be a feasible assumption³³. While the case $\gamma = 1$, implying that capital goods are produced fully domestic and the resource income can not be used to import them, highlights absorption capacity constraints best. Therefore, Equation 4.4a show that an expansion in the non-traded sector (e.g. the telecommunication service) requires non-traded final capital goods (e.g. skilled workers and infrastructures). To keep the model as simple as possible, I take in to account the case $\gamma = 1$ giving $q = P$.

This kind of formulation (Equation 4.4) captures in a simple way the feature of an economy where the non-traded sector is constrained by non-traded final capital goods (i.e. absorptive capacity constraint). In response to expanded demand for education and health service (non-traded goods), the economy must educate new teachers and doctors and construct new schools and hospitals (i.e. non-traded capital goods) which, in turn, requires teachers, doctors, and skilled workers to function. More generally, skilled workers as non-traded capital goods are intensively used in infrastructure and education sectors (the non-traded sector) to produce new skilled workers (Van der Ploeg and Venables, 2013). The argument rests on the key point that non-traded capital goods must domestically be produced. Hence, Equation 4.4 can represent an economy where most skilled workers (non-traded capital goods) are employed by the non-traded sectors such as the real estate (managers), the research sector (teachers and researchers), the health system (doctors and nurses) and the infrastructure sector (engineers).

Profit maximization yields labor employment in the non-traded sector,

$$L_{NT} = S [(1 - \alpha) P]^{1/\alpha}. \quad (4.6)$$

Labor market (Equation 4.5) gives labor employment in the traded sector,

$$L_T = 1 - S [(1 - \alpha) P]^{1/\alpha}. \quad (4.7)$$

Regarding Equation 4.6 and 4.7, output in the non-traded and traded sectors are given by:

$$X_{NT} = S [(1 - \alpha) P]^{1-\alpha} \quad (4.8a)$$

$$X_T = 1 - S [(1 - \alpha) P]^{1/\alpha}. \quad (4.8b)$$

Therefore, $X = X_T + PX_{NT}$ is defined as the (non-windfall) gross national product. Moreover, $r = \frac{\partial X(P,S)}{\partial S} = \alpha (1 - \alpha)^{\frac{1-\alpha}{\alpha}} P^{\frac{1}{\alpha}}$ denotes the return on final capital goods and $w = 1$ is the real wage.

³³Note that some natural resource-rich countries, such as Persian Gulf States, can make almost all capital goods using the traded capital goods. They can provide the required human capital and infrastructure through employing, respectively, the foreign skilled and construction workers (Van der Ploeg and Venables, 2013).

Following Van der Ploeg and Venables, 2013, the windfall income ($NR(0)$) is supposed to be an exogenous flow, resulting from a discovery at initial time (t_0). The resource income can be spent to buy financial assets (B^F) or to finance capital goods over time. For simplicity, assume *Ricardian* debt neutrality held, implying that distribution of the natural resource wealth has no effect on the consumption of the economy. To capture this implication, define a foreign wealth (B) as a sum of the remaining natural resource wealth and financial asset (i.e. $B \equiv R + B^F$)³⁴. Thus the accumulated foreign wealth (B)³⁵ earns a return equal to an exogenously given world interest rate (r^*). I ignore the capital stock depreciation, then total investment (I) will be equal to capital accumulation (i.e. $I = \dot{S}$). Finally, the budget constraint of the economy is given by the following equation.

$$\begin{aligned} \dot{B} + PI &= r^* B + X_T(P, S) + PX_{NT}(P, S) - C_T - PC_{NT}, \\ S(0) &= S_0, \quad B(0) = B_0 = R(0) + B_0^F, \quad \lim_{t \rightarrow \infty} e^{-r^* t} B(t) = 0 \end{aligned} \quad (4.9)$$

Where a dot represents the time derivative (i.e. $\dot{B} \equiv \frac{dB(t)}{dt}$). Equation 4.9 displays the initial and transversality conditions³⁶. It says that total income, gained from abroad and domestic production, can be saved for investment if it exceeds the aggregate consumption. On the demand side, I make the assumption that households have identical tastes. Hence the composition of the demand plays no role in the economy's response to a natural resource boom. A representative household maximizes a log-linear utility function aggregated in his consumption of traded and non-traded goods subject to his budget constraint ($C_T + PC_{NT} = C$). The utility function is given by:

$$U(C_{NT}, C_T) = [\theta \log C_{NT} + (1 - \theta) \log C_T]. \quad (4.10)$$

θ is the consumption share of non-traded goods and C is the total consumption (expenditure). Households allocate their total income on traded and non-traded goods according to:

$$C_T = (1 - \theta) C \quad PC_{NT} = \theta C. \quad (4.11)$$

4.5.1 Consumer problem

Let me assume a benevolent social planner (e.g. Government) maximizes the utility function (Equation 4.10) subject to the budget constraint (Equation 4.9) and the capital

³⁴The present value of the natural resource wealth is: $R(t) = \int_t^\infty NR(\nu) e^{-r^*(\nu-t)} d\nu$, so $\dot{B}^F = \dot{B} - \dot{R} = \dot{B} - r^* R + NR$.

³⁵Precisely, assume the windfall income starts at time zero, so the initial foreign wealth is equal to the initial financial asset ($B_0 = B_0^F$). Furthermore, since the discovered natural resource is used to buy the costless financial assets, I can write

$$R(0) = R(t) + \Delta B^F = R(t) + B^F(t) - B_0^F = R(t) + B(t) - R(t) - B_0^F = B(t) - B_0^F \Rightarrow R(0) = \Delta B$$

³⁶The no-Ponzi condition guarantees that the foreign assets (B^F) can not grow at a rate faster than the world interest rate.

accumulation (i.e. and $I = \dot{S}$),

$$\underset{\{C_N, C_T, I\}}{Max} \int_0^{\infty} U(C_N, C_T) e^{-\rho t} dt. \quad (4.12)$$

ρ denotes the rate of discount or the agent's rate of time preference. The current value Hamiltonian for this optimization problem is:

$$H = [\theta \log C_N + (1 - \theta) \log C_T] + \mu [I - \dot{S}] + \lambda [r^* B + X_T(P, S) + P X_N(P, S) - C_T - P C_N - P I - \dot{B}], \quad (4.13)$$

where μ and λ are co-state variables. μ is the shadow value of the final capital goods and λ is defined as the social (shadow) value (marginal utility) of wealth in the form of foreign wealth (B). It is straightforward to show the optimality conditions with respect to control variables of C_T, C_{NT} and I :

$$\frac{1 - \theta}{C_T} = \lambda \quad (4.14a)$$

$$\frac{\theta}{C_{NT}} = P \lambda \quad (4.14b)$$

$$\frac{\mu}{\lambda} = P. \quad (4.14c)$$

The first pair optimal conditions are intertemporal envelop conditions and link the marginal utility of consumption to the social value of wealth. Equation 4.14c indicates when the social value of wealth is used as *numeraire*, the relative shadow value equals the unit cost to produce one more unit of the final capital good. In addition, the optimality conditions with respect to state variable of B lead to the familiar Keynes-Ramsey rule:

$$\frac{\dot{\lambda}}{\lambda} = \rho - r^* \quad (4.15)$$

This implies that marginal utility growth rate is equal to a fixed rate of return. Under a perfect international financial market, the rate of discount and the world interest rate can be assumed to be equal ($\rho = r^*$), meaning that the social value of wealth is constant over time ($\lambda = \bar{\lambda}$). This standard assumption in the small open economy's literature satisfies the existence of a nonzero finite steady-state equilibrium in a dynamic model. It allows to evaluate the response of the dynamic system to a change in the level of λ rather than a natural resource boom (see. Appendix C). Given Equation 4.14c and 4.15, the optimality condition with respect to state variable of S gives the arbitrage condition for the real exchange rate (or cost):

$$\frac{r}{P} = r^* - \frac{\dot{P}}{P}. \quad (4.16)$$

This condition represents an equality between the return on final capital goods (i.e. $r(P) = \frac{\partial X(P,S)}{\partial S}$) per unit cost of the installed capital (i.e. $q = p$) and its cost, the world rental charge minus the inflation rate (cost rate). In addition, the market-clearing condition is as follows ³⁷:

$$X_{NT}(P, S) = C_{NT}(P, \lambda) + \dot{S} \quad (4.17)$$

This intuitively indicates that additional resource spending cannot immediately be absorbed by the economy since the final capital goods must domestically be produced. Equation 4.17 clearly represents the implication of absorptive capacity constraints ³⁸ and also highlights the importance of the gradual expansion of non-traded final capital goods, as one of the significant reasons for the supply bottleneck. A permanent decline in the social value of wealth, the consequence of a natural resource discovery at time zero (see. Appendix C), induces the aggregate demand for non-traded goods to increase and subsequently the growth rate of capital goods to decrease. Therefore, this equation may demonstrate why resource-dependent economies encounter a reduction in capital accumulation growth. In other words, the resource-dependent economies neglect to invest in non-traded capital goods (such as education and infrastructure) since they see no immediate need for it (Gylfason and Zoega, 2002).

The dynamic system is eventuated as follows:

$$\dot{S} = S [(1 - \alpha) P]^{\frac{1-\alpha}{\alpha}} - \frac{\theta}{\lambda P} \quad (4.18a)$$

$$\dot{P} = Pr^* - \alpha (1 - \alpha)^{\frac{1-\alpha}{\alpha}} P^{\frac{1}{\alpha}} \quad (4.18b)$$

4.5.2 Economic response to the windfall income

When the resource rent is permanently increased, the dynamic model is thrown out of the initial steady-state equilibrium. Let me draw the linear approximation of isoclines (i.e. phase diagram) to analyze the response of the non-linear dynamic system to an externality. In fact, the slope as well as how to shift the isoclines can be determined by the implicit function theorem. More precisely, I need to compute the partial derivatives of P with respect to S along isoclines of the capital growth (i.e. $\dot{S} = 0$) and the real exchange rate

³⁷Market-clearing condition is determined by derivative of the current value Hamiltonian with respect to the real exchange rate (i.e. $\frac{\partial H}{\partial P} = 0$).

³⁸For a general case (i.e. $0 < \gamma < 1$ and $q(P) = P^\gamma$), Equation 4.17 yields: $X_{NT}(P, S) = C_{NT}(P, \lambda) + q_P(P) \dot{S}$, where $q_P(P) \equiv \frac{dq(P)}{dP}$ is the marginal cost of final capital good. Precisely, this formulation says when final capital goods only require traded capital goods to be produced ($\gamma = 0$), the unit cost function equals unity ($q = 1$) and so the marginal cost becomes zero ($q_P = 0$). Therefore, the economy will swallow the natural resource rent and is instantaneously adjusted to a new long-run structure good (i.e. $X_{NT}(P, S) = C_{NT}(P, \lambda)$).

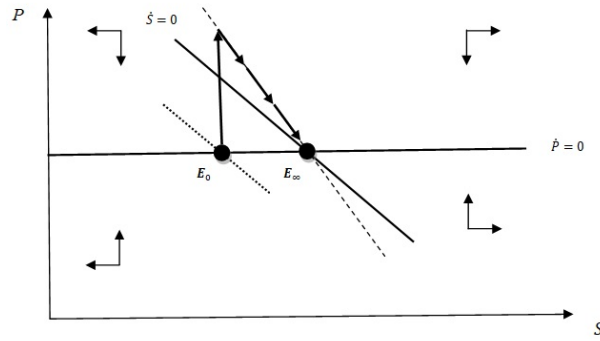

Figure 4.7: Phase Diagram and Dynamic effects of the windfall income

(i.e. $\dot{P} = 0$), respectively.

$$\left[\frac{\partial P}{\partial S} \right]_{\dot{S}=0} = - \frac{\frac{\partial \dot{S}}{\partial S} > 0}{\frac{\partial \dot{S}}{\partial P} > 0} < 0 \quad ; \quad \left[\frac{\partial P}{\partial S} \right]_{\dot{P}=0} = - \frac{\frac{\partial \dot{P}}{\partial S} = 0}{\frac{\partial \dot{P}}{\partial P} < 0} = 0 \quad (4.19)$$

It is easy to see a negatively sloped isocline for capital growth ($\dot{S} = 0$) and a horizontal isocline for the inflation locus ($\dot{P} = 0$) (see. Figure 4.7). The real exchange rate appreciation around the stationary shifts the isocline of S up to the right. Since more final capital goods are produced than consumed when the economy is above S locus. Further, rising the real exchange rate increases the return on the capital and so investment. Thereby, falling the real exchange rate above the inflation locus ($\dot{P} = 0$) is consistent to keep stationary in its place.

The saddle path will be steeper than S locus to induces the capital accumulation (i.e. $\dot{S} > 0$) (for proof see Appendix D). The isoclines cross each other at the initial steady-state equilibrium, shown by E_0 in Figure 4.7, as long as the windfall income doesn't influence the economy. For a given P , a permanent natural resource boom, through a decline in the social value of wealth (λ), increases the demand for non-traded goods and so reduces investment. Therefore, the $\dot{S} = 0$ locus shifts up to the right to re-establish the steady-state equilibrium. The real exchange rate follows the boldly directed line (see. Figure 4.7). It jumps up to saddle path along which a portion of non-traded goods is invested. This temporary appreciation moderates over time as long as the capital stock gradually increases.

To clarify the resource curse, I further do an experimental study. A log-linearized solution of dynamic system has been described in Appendix D. The time path of S and P are given by:

$$S(t) = S_0 + \Delta S [1 - \exp(-t\sigma)] \quad (4.20a)$$

$$P(t) = \bar{P} + \left[\frac{(2 - \alpha) \frac{r^*}{\alpha}}{Q_p} \right] \Delta S \exp(-t\sigma) \quad (4.20b)$$

and for the foreign wealth (B),

$$B(t) = B_0 - \left(\Delta B + \left[\frac{(2-\alpha)r^*}{Q_p} \right] \Delta S \exp(-t\sigma) \right) \quad (4.21)$$

where $\sigma = \frac{1-\alpha}{\alpha}r^* > 0$ is the adjustment speed. \bar{P} is the steady-state real exchange rate and S_0 and B_0 denote initial capital stock and foreign wealth, respectively. ΔS is the gap between steady-state and initial capital stock while ΔB is the gap between steady-state and initial foreign wealth ($\Delta B = R(0)$). $Q_p > 0$ represents the slope of the supply of non-traded goods available for use in investment (Van der Ploeg and Venables, 2013), $Q = X_{NT}(S, P) - C_{NT}(P, \lambda)$. The capital intensity α is crucial for the dynamics adjustment path. The lower the capital intensity, the faster the adjustment speed.

Figure 4.8 shows the dynamics adjustment paths. The horizontal axis can be interpreted as months. The real exchange rate (P), capital accumulation (S) and foreign wealth (B) represent in the upper-left and -right sixths, while the sectoral labor shares and the sectoral outputs with respect to their initial values are illustrated in the middle parts. Supply and demand for non-traded goods are shown in lower-left sixth and the trade balance is represented in lower-right sixth. The simulation results in Figure 4.8 set the world interest rate at 10% and the consumption share of non-traded goods at 0.6. The capital intensity equals 0.4 and the social value of wealth is assumed to be equal to 0.724, giving the balance trade (i.e. $X_T - C_T = 0$). The reported experiment is a windfall with a negative jump in the social value of wealth of 10% (i.e. $\frac{\Delta\lambda}{\lambda} = -0.1$, referring to a initial capital goods' value of 3.47 times of the initial gross national product).

Regarding the absorptive capacity constraints, there is a supply bottleneck in the non-traded sector. Therefore, in response to a permanent windfall income, the real exchange rate appreciates to confront the expanded demand for non-traded goods. While the demand for traded goods is constant (see. Equation 4.14a and 4.14b). An appreciation in the real exchange rate rises the relative real wage in terms of non-traded sector's employments and so sends a signal for the labor to shift away from the traded sector and into the non-traded sector. As a result, the traded sector shrinks and the non-traded sector expands. So that the de-industrialization is accompanied by the trade deficit (i.e. $C_T > X_T$). Further, rising the return on capital goods per unit cost ($\frac{r(P)}{P} = \frac{\partial X(P,S)}{\partial S}$) induces investment on the production of non-traded goods (i.e. $X_{NT} > C_{NT} \Rightarrow \dot{S} > 0$). The foreign wealth (B) gradually reduces to finance the capital goods (S)³⁹. More profit of production process in the non-traded sector than before⁴⁰ tends to reverse the temporary appreciation of the real exchange rate over time (X_{NT} converges to C_{NT}). In addition, a gradual real exchange rate depreciation decreases the relative real wage in terms of the non-traded

³⁹A change in the financial asset, B_F , depends on the time path of the remaining windfall income, R . For example, assume new discoveries remain the resource wealth at constant level (i.e. $R = cte \Rightarrow \dot{R} = 0$). Therefore, the financial asset follows the foreign wealth (i.e. $\dot{B} = \dot{B}_F$). As B falls to finance S so current account deficit arises and foreign debt is eventuated $\dot{B}_F < 0$.

⁴⁰Note that $\frac{\partial \frac{r(P)}{P}}{\partial P} = \frac{1-\alpha}{\alpha} \frac{r}{P^2} > 0$.

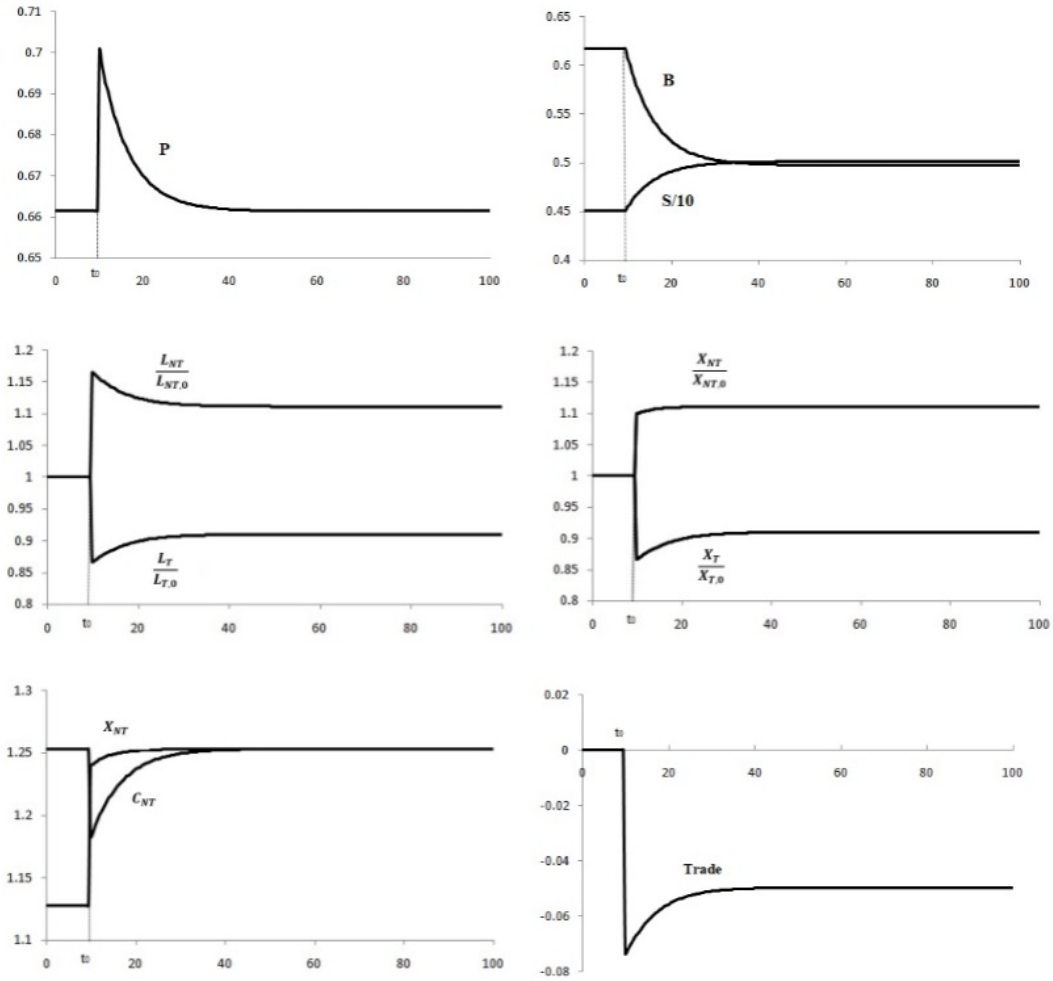

Figure 4.8: The dynamic adjustment path. Note: the dynamic path for S is divided by 10, denoted by $S/10$.

sector's employment. This, in turn, leads to a countervailing movement of labor from the non-traded to the traded sector so that a portion of reduced labor share in the traded sector is recovered. Finally, the natural resource curse (i.e. de-industrialization) and the trade balance are gradually moderated as long as the gap between the supply and the demand of the non-traded goods vanishes.

Now regarding the main empirical finding, it is worth discussing the effect of initial capital goods (i.e. the absorption capacity) on the intensity of the resource curse. In this respect, the real output is defined as: $X_r = X_T + \bar{P}X_{NT}$ ⁴¹ and the experimental responses of the gap in the real exchange rate ($\frac{dP}{P} = \frac{P-\bar{P}}{\bar{P}}$) and the gap in the real output ($\frac{dX_r}{X_r} = \frac{X_r - X_r^*}{X_r^*}$) to 10% decreases in the social value of wealth (i.e. $\frac{\Delta\lambda}{\lambda} = -0.1$) are calculated for a range of initial capital goods. Figure 4.9 displays the gaps with respect to normalized initial capital goods⁴². This represents that larger capacity, smaller appreciation in the real exchange

⁴¹An alternative is the gross national product in the nominal term (X) adjusted by the aggregate price index (P^θ) (i.e. $X_r = \frac{X}{P^\theta}$).

⁴²The maximum experimental value of initial capital goods is equal to its steady-state value.

rate and less adverse effect of a resource boom on the real output. More precisely, 1% increases in initial capital goods is approximately associated with falling 25% in the real exchange rate appreciation and improving 10% in contraction of the real output. Given the model, the real exchange rate appreciation will be smaller in higher levels of initial capital goods (see. Equation 4.20b)(see Appendix E for empirical evidence). It, in turn, can be translated to a cheaper production process (or more profit) and to less labor movement across sectors. Therefore, larger capital goods (absorption capacity) makes the natural resource curse smaller.

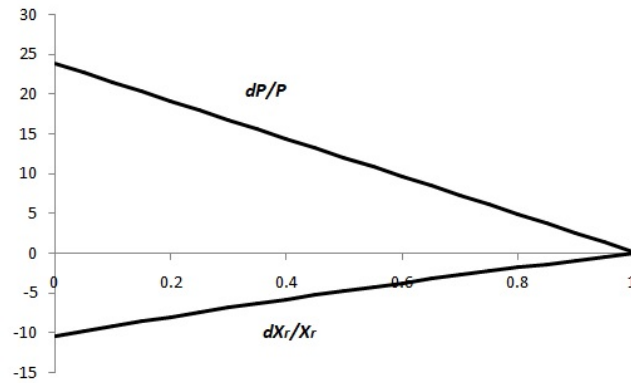

Figure 4.9: The effect of the absorption capacity on the intensity of the resource curse. The horizontal line is the normalized initial final capital stock (S_0); the original range $3 \leq S_0 \leq 5$.

4.5.3 Imperfect financial market and changing the demand composition

In the preceding subsection, I analyzed the impact of a resource boom on economic performance of a country facing with absorption capacity constraints. The analysis was based on the assumptions such as the perfect financial market and unchanged consumption shares on goods. But these assumptions don't seem to be in keeping with the development process, specifically in developing countries. For example, along with the development, improving the quality of the financial system might relax the constraints on the supply of finance for domestic production or increasing income might change the composition of the demand. Hence, it is worth combining the presented model with a financial market imperfection and changing the demand composition over time.

I don't model these two issues endogenously. I merely suppose that they change over time along with the development (i.e. expansion of the final capital (S)). Hence, I, on the one hand, assume that the domestic production sector faces interest rate $r^* + \hat{r}(I_d)$, where r^* is the interest rate prevailing internationally and $\hat{r}(I_d)$ is an interest premium, reducing along with the development (i.e. $\frac{d\hat{r}(I_d)}{dI_d} < 0$)⁴³. On the other hand, I suppose that the

⁴³Van der Ploeg and Venables, 2013 supposed that the windfall income has the effect of reducing the interest premium \hat{r} along the development path.

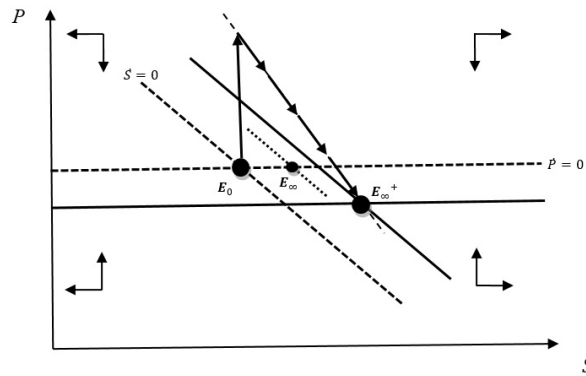

Figure 4.10: Phase Diagram of the extended model

consumption share of non-traded goods increases along with the development path (i.e. $\frac{d\theta(I_d)}{dI_d} > 0$). The modified dynamic system to capture these extensions is given as follow:

$$\dot{S} = S [(1 - \alpha) P]^{\frac{1-\alpha}{\alpha}} - \frac{\theta(I_d)}{\lambda P} \quad (4.22a)$$

$$\dot{P} = P [r^* + \hat{r}(I_d)] - \alpha (1 - \alpha)^{\frac{1-\alpha}{\alpha}} P^{\frac{1}{\alpha}} \quad (4.22b)$$

Figure 4.10 represents the dynamic effect of the extended model. The isoclines cross each other initially at E_0 . If the interest premium and the demand composition don't change along with the development, the $\dot{S} = 0$ locus and the $\dot{P} = 0$ locus intersect each other at E_{∞} , described in section 4.5.2. But if the assumptions are relaxed there are two more effects at work. The first effect comes from changing the demand composition along with the development process. The demand for non-traded goods expands more than before and so the $\dot{S} = 0$ locus shifts up to the right more. It suggests that a larger value of capital goods has to be produced over time to respond to more expansion of the demand for non-traded goods. Whereas, the second effect originates from reducing the interest premium along with the development process. The $\dot{P} = 0$ locus now shifts down. The intuition is that producing capital goods become cheaper once its cost to finance is reduced. Graphically, The initial jump in the real exchange rate P converges to a lower level. Finally, the isoclines meet each other at E_{∞}^+ , so that the quantity of the capital is larger at E_{∞}^+ than at E_{∞} , while its cost, P , is cheaper.

I further discuss the gap in the real exchange rate and in the real output once the two above constraints are ignored. Hence, I assume the consumption share of non-traded goods increases (from 0.6 to 0.7) and the interest premium decreases 1%, corresponding to a decrease of $r^* + \hat{r}(I_d)$ from 0.1 to 0.09. The experimental results represent that reducing the interest premium causes the gap in the real exchange rate to become larger to the extent of 0.75%. While increasing the consumption share on non-traded goods causes the gap in the real output to become more negative to the extent of 13%. As a conclusion, the adverse effect of a resource boom on the real output is more intensive for a case in which, along with the development, the imperfect financial market moderates and the demand

for non-traded goods expands than for a case in which the financial market is fully perfect and the composition of the demand is unchanged.

4.6 Conclusion

This paper investigates how capital goods (i.e. absorption capacity) play a role in the intensity of the natural resource curse (the adverse effect of a resource boom on economic performance). The stylized facts represent that the natural resource curse is accompanied by a lower level of human capital and infrastructure proxies. Further, some sorts of capital goods (such as infrastructure and human capital) can not be imported or exported and they must be domestically produced, which in turn needs domestically produced "home-grown" capital goods to function (e.g. roads need to extend roads, teachers to educate more teachers) (i.e. absorption capacity constraint). Therefore, the main contribution of this paper is to testify and clarify the following hypothesis: the natural resource curse is more intensive in countries with more absorption capacity constraints (or a lower level of capital goods).

In this respect, I present an empirical study. I firstly collect data for 105 countries over the period 1975-2014. Then, two indexes are constructed to identify cross-country absorption capacity (capital goods): 1) Infrastructure index, the average of normalized Electricity index and normalized Telephone index, and 2) Absorption index, the average of normalized Human Capital Index and normalized Infrastructure index. Using the *IV – 2SLS* technique, clear evidence in supporting the proposed hypothesis is founded. Motivated by Van der Ploeg and Venables, 2013, I develop a simple two-sector framework in which non-traded capital goods are only employed by the non-traded sector. This structure captures in a simple way the features of an economy in which the non-traded sector is constrained by absorption constraints. In the short-term, a permanent resource boom leads to a temporary appreciation in the real exchange rate and thereby arising the natural resource curse (de-industrialization). While in the long-term, a gradual expansion of capital goods reverses the temporary appreciation in the real exchange rate and so the natural resource curse moderates as long as the gap between supply and demand sides of the non-traded sector vanishes. The model also clarifies that less absorption capacity (or lower level of capital goods) increases the intensity of the natural resource curse. Moreover, the intensity becomes stronger if the development reduces the cost to finance the production of capital goods and increases the consumption share for non-traded goods.

Appendix 4.A Statistical cross-country estimation

OLS results for the cross-country studies are reported in Table 4.7.

Table 4.7: Cross-country estimation results

Explanatory variable	(1) GDP Growth per capita	(2) Human Capital index	(3) Fixed Telephone subscriptions	(4) Electric Power consumption
Resource rent (% GDP)	-0.0117** (0.00514)	-0.0269*** (0.00770)	-0.960*** (0.233)	-115.9* (61.05)
Constant	0.551*** (0.0567)	2.545*** (0.0848)	26.27*** (2.568)	4,317*** (672.6)
Number of Countries	73	73	73	73
R-squared	0.068	0.147	0.193	0.048

Appendix 4.B List of countries included in the sample database

Table 4.8: List of Countries

	Period	No. Period		Period	No. Period
Albania	1990-2014	5	Japan	1975-2014	8
Algeria	1975-2014	8	Kazakhstan	1995-2014	4
Angola	1995-2014	4	Korea south	1975-2014	8
Argentina	1975-2014	8	Kyrgyzstan	1995-2014	4
Armenia	1995-2014	4	Latvia	1995-2014	4
Australia	1975-2014	8	Malaysia	1975-2014	8
Austria	1975-2014	8	Mexico	1975-2014	8
Azerbaijan	1995-2014	4	Moldova	1995-2014	4
Bahrain	1985-2014	6	Mongolia	1985-2014	6
Bangladesh	1975-2014	8	Morocco	1975-2014	8
Belgium	1975-2014	8	Mozambique	1985-2014	6
Benin	1975-2014	8	Namibia	1990-2014	5
Bolivia	1980-2014	7	Nepal	1975-2014	8
Botswana	1975-2014	8	Netherlands	1975-2014	8
Brazil	1975-2014	8	New Zealand	1980-2014	7
Brunei	1990-2014	5	Nicaragua	1975-2014	8
Bulgaria	1985-2014	6	Niger	1995-2014	4
Cambodia	1995-2014	4	Nigeria	1980-2014	7
Cameron	1975-2014	8	Norway	1975-2014	8
Canada	1975-2014	8	Pakistan	1975-2014	8
Chad	1995-2014	4	Paraguay	1990-2014	5
Chile	1975-2014	8	Peru	1975-2014	8
China	1975-2014	8	Philippine	1975-2014	8
Colombia	1975-2014	8	Poland	1995-2014	4
Congo, Dem. Rep.	1975-2014	8	Portugal	1975-2014	8
Congo, Rep.	1975-2014	8	Romania	1995-2014	4
Costa Rica	1975-2014	8	Russia	1995-2014	4
Cote d'Ivoire	1975-2014	8	Rwanda	1995-2014	4
Croatia	1995-2014	4	Saudi Arabia	1975-2014	8
Cyprus	1980-2014	7	Sierra Leone	1995-2014	4
Czech	1995-2014	4	South Africa	1975-2014	8
Denmark	1975-2014	8	Spain	1975-2014	8
Dominican Rep.	1980-2014	7	Sri Lanka	1975-2014	8
Ecuador	1975-2014	8	Sudan	1995-2014	4
Egypt	1975-2014	8	Swaziland	1995-2014	4
El Salvador	1975-2014	8	Switzerland	1985-2014	6
Eritrea	1995-2014	4	Sweden	1975-2014	8
Estonia	1995-2014	4	Tajikistan	1995-2014	4
Ethiopia	1985-2014	6	Tanzania	1995-2014	4
Finland	1975-2014	8	Thailand	1975-2014	8
France	1975-2014	8	Togo	1975-2014	8
Gabon	1980-2014	7	Trinidad and Tobago	1975-2014	8
Germany	1975-2014	8	Turkey	1975-2014	8
Ghana	1975-2014	8	Tunisia	1975-2014	8
Greece	1975-2014	8	Ukraine	1995-2014	4
Honduras	1975-2014	8	Uganda	1995-2014	4
Hungary	1995-2014	4	United Kingdom	1975-2014	8
India	1975-2014	8	Uruguay	1975-2014	8
Indonesia	1975-2014	8	Venezuela	1975-2014	8
Iran	1975-2014	8	Vietnam	1990-2014	5
Ireland	1975-2014	8	Yemen	1995-2014	4
Italy	1975-2014	8	Zimbabwe	1975-2014	8
Jamaica	1975-2014	8			

Appendix 4.C Windfall income and social value of wealth

The size of the social value of wealth (λ) stimulated by a natural resource discovery (R_0) is determined using the economy's present value budget constraint and given $\rho = r^*$:

$$\int_0^\infty [C + PI] \exp(-r^*t) dt = B_0^F + R_0 + \int_0^\infty X(P, S) \exp(-r^*t) dt.$$

Where B_0^F is the initial value of the foreign asset and $B_0 = B_0^F + R_0$ represents the initial foreign wealth. By replacing $C = \frac{1}{\lambda}$ in the last equation, a sudden falling in the size of the social value of wealth, caused by a permanent jump in the natural resource discovery, can apparently be derived from the following relation:

$$\lambda = \left[\frac{\int_0^\infty \exp(-r^*t) dt}{B_0^F + R_0 + \int_0^\infty [X(P, S) - PI] \exp(-r^*t) dt} \right].$$

Appendix 4.D Solution of the dynamic system

Log-linearization of the dynamic system (Equation 4.18) gives $\dot{\tilde{y}} \approx A\tilde{y}$ where

$$\tilde{y} = \begin{bmatrix} S - S^* \\ P - \bar{P} \end{bmatrix} \quad \text{and} \quad A = \begin{bmatrix} \frac{\partial \dot{S}}{\partial P} & \frac{\partial \dot{S}}{\partial S} \\ \frac{\partial \dot{P}}{\partial S} & \frac{\partial \dot{P}}{\partial P} \end{bmatrix} = \begin{bmatrix} \frac{r^*}{\alpha} & Q_p \\ 0 & -\left(\frac{1-\alpha}{\alpha}\right) r^* \end{bmatrix}$$

Also, $S^* = \frac{\theta(1-\alpha)}{\lambda(r^*/\alpha)^{\frac{1}{1-\alpha}}}$ is the steady-state solution of capital stock, while $\bar{P} = \frac{(r^*/\alpha)^{\frac{\alpha}{1-\alpha}}}{1-\alpha}$ in the initial price level. Further, $Q_p = \frac{\theta}{\alpha\lambda P^2} = \frac{C_N(\bar{P}, \lambda)}{\alpha P}$ denotes the slope of the supply of non-traded goods available for use in investment.

Given the number of negative eigenvalues is equal to the number of pre-determined state variables (i.e. S), there is a unique optimal trajectory (saddle-path stable) and the negative eigenvalue is speed of convergence (calculation of $\det(A - \sigma I) = 0$ gives eigenvalues, $\sigma_1 = -\left(\frac{1-\alpha}{\alpha}\right) r^*$ and $\sigma_2 = \frac{r^*}{\alpha}$).

Routine calculation for a linearized dynamic system indicates that the solution for an unanticipated resource boom at time zero equals:

$$S(t) = S_0 + \Delta S [1 - \exp(-t\sigma)]$$

$$P(t) = \bar{P} + \left[\frac{(2-\alpha)r^*}{Q_p} \right] \Delta S \exp(-t\sigma).$$

Given $\Delta P = 0$ and $X_{NT}(P, S) = C_{NT}(P, \lambda)$ at steady-state, $\Delta S \equiv S^* - S_0 = -S^* \frac{\Delta\lambda}{\lambda}$ and so $S_0 = S^* \left[1 + \frac{\Delta\lambda}{\lambda} \right]$.

Furthermore, the foreign wealth equation is determined independently. Since its eigenvalue is positive r^* . The steady-state value equals $-\frac{Trade^*}{r^*}$, where $Trade^* = X_T^* - C_T^*$.

Now it is useful to prove the slope of the saddle-path is negative and it is steeper than

locus $\dot{S} = 0$. We know that $P'(S) = \frac{\partial P}{\partial S} = \frac{dP/dt}{dS/dt} = \frac{\dot{P}}{\dot{S}} = \frac{S[(1-\alpha)P]^{\frac{1-\alpha}{\alpha}} - \frac{\theta}{\lambda P}}{Pr^* - \alpha(1-\alpha)\frac{1-\alpha}{\alpha}P^{\frac{1}{\alpha}}}$. Consider slope of saddle-path at steady-state

$$P'(S^*) = \lim_{S \rightarrow S^*} P'(S) = \lim_{S \rightarrow S^*} \frac{S[(1-\alpha)P]^{\frac{1-\alpha}{\alpha}} - \frac{\theta}{\lambda P}}{Pr^* - \alpha(1-\alpha)\frac{1-\alpha}{\alpha}P^{\frac{1}{\alpha}}} = -\frac{\left(\frac{1-\alpha}{\alpha}\right)r^*}{\frac{r^*}{\alpha} + Q_p}$$

where the last equality follows L'Hopital rule. Given $\left[\frac{\partial P}{\partial S}\right]_{\dot{S}=0} = -\frac{r^*}{Q_p}$, we can conclude

$$\frac{\left[\frac{\partial P}{\partial S}\right]_{sd}}{\left[\frac{\partial P}{\partial S}\right]_{\dot{S}=0}} < 1.$$

Appendix 4.E The real exchange rate and the capacity constraint

The proposed model demonstrates that an appreciation in the real exchange rate, with respect to its steady-state level, is more intensive in countries with more absorption capacity constraints. The latter point seems to be worth supporting empirically. But to keep the main contribution of the paper that highlights the intensity of the resource curse in terms of the non-traded capital level, this question is argued in the appendix.

The regression equation is given as follow:

$$\Delta REER_{i,t} = \beta_0 + \beta_1 REER_{i,t-1} + \beta_2 WI_{i,t-1} + \beta_3 NK_{i,t-1} + \beta_4 (WI_{i,t-1} * NK_{i,t-1}) + Z'_{i,t} \beta_5 + \mu_i + \epsilon_{i,t}.$$

The dependent variable of the regression model is the change in the real effective exchange rate (i.e. $\Delta REER_{i,t} = REER_{i,t} - REER_{i,t-1}$) and the explanatory variables of interest are the resource-dependence index WI and the proxies for the absorption capacity constraints NK . Z' denoting the vectors of control variables includes the level of GDP per capita, Excess Money growth⁴⁴, Government spending⁴⁵, Terms of trade, Openness index and Foreign direct investment⁴⁶. Further, μ_i and $\epsilon_{i,t}$ are, respectively, a country fixed effect and the disturbance term. Both dependent and independent variables are log-transformed. The normalized proxies of capacity constraints are multiplied by 100 to prevent their Ln form from being made negative.

The presence of unobservable heterogeneity across countries is evaluated by the *Hausman* test⁴⁷. Further, *heteroskedasticity – robust* standard errors⁴⁸ and a separate intercept

⁴⁴The difference between the growth rate of the Broad money ($M2$) and Economic growth is defined as Excess Money growth. The average growth rate of $M2$ for each period is calculated as $GM_t = Ln\left(\frac{M2_t}{M2_{t-1}}\right)$. The data source is *WDI*.

⁴⁵It refers to general government final consumption expenditure divided by GDP . The data is an average value for the 5-year period, sourced from *WDI*.

⁴⁶It is defined as the net inflows of investment divided by GDP . The average value for the 5-year periods is collected from *WDI*.

⁴⁷The *Hausman* test checking that the preferred model is random effects is rejected with a p – value of 0.000 for both baseline regression models.

⁴⁸A test that the variance of error term is constant (*homoskedasticity*) is rejected with a p – value of 0.000 for both baseline regression models.

4.E. THE REAL EXCHANGE RATE AND THE CAPACITY CONSTRAINT

Table 4.9: Estimation results for the real exchange rate

Explanatory variable	(1)	(2)	(3)	(4)	(5)	(6)	(7)
	OLS	IV-2SLS	IV-2SLS	OLS	IV-2SLS	IV-2SLS	IV-2SLS
	<i>Bruegel</i>	<i>Bruegel</i>	<i>Bruegel</i>	<i>Bruegel</i>	<i>Bruegel</i>	<i>Bruegel</i>	<i>IMF</i>
Resource dependence (lagged)	0.0120* (0.00689)	0.0313 (0.0251)	0.0608** (0.0270)	0.0117* (0.00681)	0.0330 (0.0244)	0.0889** (0.0364)	0.0498** (0.0213)
Infrastructure index (lagged)	-0.0208 (0.0161)	-0.00254 (0.0480)	0.0245 (0.0475)				
Absorption index (lagged)				-0.0349* (0.0199)	-0.0495 (0.0666)	0.0130 (0.0731)	-0.264*** (0.0885)
Infrastructure * Resource (lagged)			-0.0170*** (0.00606)				
Absorption * Resource (lagged)						-0.0277*** (0.00989)	-0.0118* (0.00612)
Real effective exchange rate (lagged)	-0.393*** (0.0273)	-0.575*** (0.113)	-0.577*** (0.111)	-0.394*** (0.0271)	-0.581*** (0.115)	-0.581*** (0.109)	-0.822*** (0.0639)
Ln (per capita GDP)	0.0179 (0.0246)	0.285*** (0.102)	0.250*** (0.0969)	0.0138 (0.0186)	0.290*** (0.0732)	0.245*** (0.0707)	0.233*** (0.0676)
Money growth (lagged)	0.133*** (0.0335)	0.119** (0.0560)	0.120** (0.0554)	0.134*** (0.0333)	0.120** (0.0551)	0.118** (0.0541)	0.00739 (0.0414)
Government spending	0.124*** (0.0346)	0.475** (0.200)	0.464** (0.200)	0.107*** (0.0343)	0.469** (0.205)	0.460** (0.200)	0.206* (0.107)
Terms of trade	0.191*** (0.0448)	0.217** (0.100)	0.219** (0.0998)	0.190*** (0.0445)	0.214** (0.103)	0.220** (0.102)	0.00846 (0.0574)
Openness index	-0.0614** (0.0254)	-0.450*** (0.127)	-0.429*** (0.125)	-0.0570** (0.0254)	-0.453*** (0.130)	-0.400*** (0.131)	-0.289*** (0.0710)
Foreign direct investment (lagged)	0.0129 (0.00874)	0.0182 (0.0133)	0.0152 (0.0131)	0.0132 (0.00870)	0.0165 (0.0120)	0.0108 (0.0124)	-0.0167 (0.0138)
Country fixed effects	NO	YES	YES	NO	YES	YES	YES
Time dummies	NO	YES	YES	NO	YES	YES	YES
Observations	531	531	530	532	530	530	315
Number of Countries	101	101	101	101	101	101	64
R-squared	0.357	0.480	0.486	0.358	0.481	0.495	0.759
Hansen OID test (p-value)	-	0.173	0.184	-	0.286	0.307	0.088
K-P UID test (p-value)	-	0.000	0.000	-	0.000	0.000	0.000
K-P Weak ID, F statistic	-	55.14	51.12	-	165.83	164.21	88.05

Note: The dependent variable is the change in the real effective exchange rate. In Columns (2) and (3), Infrastructure index (first lagged) and per capita GDP are endogenous variables. They are instrumented by the windfall income (first and second lagged), per capita GDP (first and second lagged) and Telephone index (first lagged). While in Columns (5) and (6), Absorption index (first lagged) and per capita GDP are endogenous variables. They are instrumented by the windfall income (first and second lagged), per capita GDP (first and second lagged), Human capital index (first lagged) and infrastructure index (first lagged). Robust standard errors are reported in parentheses. ***, ** and * denote significance at 1, 5 and 10 percent levels.

The null hypothesis of *Hansen* test is that the instruments, as a group, are uncorrelated with the error term. The null hypothesis of Underidentification test (K-P UID test) is that the regression equation is underidentified. The null hypothesis of weak identification test (K-P Weak ID) is that the estimator is weakly identified (Point: 5% maximal IV relative bias is 13.97).

for each time period ⁴⁹ are included in the estimations. The estimated results are reported in Table 4.9. As benchmarks, columns (1) and (4) represent *OLS* estimations of the baseline regression models. While, the core estimations are reported in columns (2) and (5). Although the coefficients on the resource-dependence index in both specification models in terms of capacity constraints proxy are insignificant, they enter with positive signs. The latter point seems to qualitatively support the appreciation of the real exchange rate due to an increase in the resource dependency and the insignificant results might be because of an interaction between the variables of interest.

To address this problem, I include an interaction term between the resource-dependence index and proxies identifying the non-traded capital stock. In line with the literature (e.g. Cashin, Céspedes, and Sahay, 2004), the estimated results reported in columns (3) and (6) represent a positive and significant correlation between the resource-dependence index and the real effective exchange rate. Further, The coefficients on the interaction terms enter with negative signs and are significant at 1%. These results are consistent with the model's prediction and suggest that the real exchange rate appreciation attenuates as the proxies reflecting non-traded capital goods become larger. Furthermore, these represent that the appreciation vanishes at an absorption index larger than 0.25 (Point: the variables are in *Ln* form.).

The consistency of the results is examined in terms of the real exchange rate database source. The regression model is run for a database of the real effective exchange rate estimated by *IMF* ⁵⁰ to capture a robustness check. Column (7) shows the results. It demonstrates that reducing the real exchange rate appreciation along the expansion of the absorption capacity doesn't depend on measurement approaches to estimate the real exchange rate. However, the significance of the coefficient on the interaction term is weaker when *IMF* database is applied (i.e. significant in %10). The latter is more likely to be because of a smaller number of countries' data included in *IMF* database than *Bruegel* database. Further, the real exchange rate appreciation remains for a much longer interval level of the absorption index (equal to 0.68) in *IMF* sample than in *Bruegel* sample (equal to 0.25).

⁴⁹A test that these time dummy variables are jointly equal to zero is rejected with a *p* – value of about 0.015 for both baseline regression models.

⁵⁰The main difference between *Bruegel* and *IMF* databases is in the calculation of the geometrically weighted average of *CPI* indices of trading partners.

Chapter 5

References

Bibliography

- Acemoglu, Daron, Simon Johnson, and James A Robinson (2002). “Reversal of fortune: Geography and institutions in the making of the modern world income distribution”. In: *The Quarterly journal of economics* 117.4, pp. 1231–1294.
- Acemoglu, Daron, Thierry Verdier, and James A Robinson (2004). “Kleptocracy and divide-and-rule: A model of personal rule”. In: *Journal of the European Economic Association* 2.2-3, pp. 162–192.
- Aghion, Philippe et al. (2009). “Exchange rate volatility and productivity growth: The role of financial development”. In: *Journal of monetary economics* 56.4, pp. 494–513.
- Aguirre, Alvaro and César Calderón (2005). “Real exchange rate misalignments and economic performance”. In: *Documentos de Trabajo (Banco Central de Chile)* 315, pp. 1–49.
- Alesina, Alberto and Dani Rodrik (1994). “Distributive politics and economic growth”. In: *The quarterly journal of economics* 109.2, pp. 465–490.
- Alexeev, Michael and Robert Conrad (2009). “The elusive curse of oil”. In: *The Review of Economics and Statistics* 91.3, pp. 586–598.
- Amiri, Hossein et al. (2019). “Natural resource abundance, institutional quality and manufacturing development: Evidence from resource-rich countries”. In: *Resources Policy* 62, pp. 550–560.
- Andersen, Jørgen Juel and Silje Aslaksen (2008). “Constitutions and the resource curse”. In: *Journal of Development Economics* 87.2, pp. 227–246.
- El-Anshasy, Amany, Kamiar Mohaddes, and Jeffrey B Nugent (2017). “Oil, volatility and institutions: cross-country evidence from major oil producers”. In:
- Arellano, Manuel and Stephen Bond (1991). “Some tests of specification for panel data: Monte Carlo evidence and an application to employment equations”. In: *The review of economic studies* 58.2, pp. 277–297.
- Arezki, Rabah and Frederick Van der Ploeg (2011). “Do natural resources depress income per capita?” In: *Review of Development Economics* 15.3, pp. 504–521.
- Assa, Jacob (2012). “Inequality and Growth Re-Examined”. In:
- Auty, Richard M et al. (2001). *Resource abundance and economic development*. Oxford University Press.

- Auty, Richard M, Richard M Auty, and Raymond Frech Mikesell (1998). *Sustainable development in mineral economies*. Oxford University Press.
- Badami, Madhav, Geetam Tiwari, Dinesh Mohan, et al. (2004). “Access and mobility for the urban poor in India: bridging the gap between policy and needs”. In: *Forum on Urban Infrastructure and Public Service Delivery for the Urban Poor*. National Institute of Urban Affairs Delhi, India, pp. 1–20.
- Banerjee, Abhijit V and Esther Duflo (2003). “Inequality and growth: What can the data say?” In: *Journal of economic growth* 8.3, pp. 267–299.
- Barro, Robert J (2000). “Inequality and Growth in a Panel of Countries”. In: *Journal of economic growth* 5.1, pp. 5–32.
- (2001). “Human capital and growth”. In: *American economic review* 91.2, pp. 12–17.
- (2004). “Sala-i Martin X (2004) Economic Growth”. In: *Aufl. Massachusetts Institute of Technology (MIT) ISBN: 0-262-02553-1*.
- (2008). *Inequality and growth revisited*. Tech. rep. ADB Working paper series on regional economic integration.
- Barro, Robert J and Jong Wha Lee (2013). “A new data set of educational attainment in the world, 1950–2010”. In: *Journal of development economics* 104, pp. 184–198.
- Baum, Christopher F, Mark E Schaffer, and Steven Stillman (2003). “Instrumental variables and GMM: Estimation and testing”. In: *The Stata Journal* 3.1, pp. 1–31.
- Behbudi, Davood, Siab Mamipour, and Azhdar Karami (2010). “Natural resource abundance, human capital and economic growth in the petroleum exporting countries”. In: *Journal of Economic Development* 35.3, p. 81.
- Behzadan, Nazanin et al. (2017). “Does inequality drive the Dutch disease? Theory and evidence”. In: *Journal of International Economics* 106, pp. 104–118.
- Beine, Michel, Charles S Bos, and Serge Coulombe (2012). “Does the Canadian economy suffer from Dutch disease?” In: *Resource and Energy Economics* 34.4, pp. 468–492.
- Bems, Rudolfs and Irineu de Carvalho Filho (2011). “The current account and precautionary savings for exporters of exhaustible resources”. In: *Journal of International Economics* 84.1, pp. 48–64.
- Benabou, Roland (2000). “Unequal societies: Income distribution and the social contract”. In: *American Economic Review*, pp. 96–129.
- Benhabib, Jess and Mark M Spiegel (1994). “The role of human capital in economic development evidence from aggregate cross-country data”. In: *Journal of Monetary economics* 34.2, pp. 143–173.
- Bhattacharyya, Sambit and Paul Collier (2013). “Public capital in resource rich economies: Is there a curse?” In: *Oxford Economic Papers* 66.1, pp. 1–24.
- Bhattacharyya, Sambit and Roland Hodler (2010). “Natural resources, democracy and corruption”. In: *European Economic Review* 54.4, pp. 608–621.

- Bjørnland, Hilde C and Leif A Thorsrud (2016). “Boom or gloom? Examining the Dutch disease in two-speed economies”. In: *The Economic Journal* 126.598, pp. 2219–2256.
- Blundell, Richard and Stephen Bond (1998). “Initial conditions and moment restrictions in dynamic panel data models”. In: *Journal of econometrics* 87.1, pp. 115–143.
- Bodart, Vincent, Bertrand Candelon, and J-F Carpentier (2012). “Real exchanges rates in commodity producing countries: A reappraisal”. In: *Journal of International Money and Finance* 31.6, pp. 1482–1502.
- Bond, Steve, Asli Leblebicioğlu, and Fabio Schiantarelli (2010). “Capital accumulation and growth: a new look at the empirical evidence”. In: *Journal of Applied Econometrics* 25.7, pp. 1073–1099.
- Bourguignon, Francois and Christian Morrisson (1990). “Income distribution, development and foreign trade: A cross-sectional analysis”. In: *European Economic Review* 34.6, pp. 1113–1132.
- Bourguignon, Franois and Mark Sundberg (2006). “Absorptive Capacity and Achieving the MDGs”. In:
- Boyce, James K and Léonce Ndikumana (2012). “Capital Flight from Sub-Saharan African Countries: Updated Estimates, 1970-2010”. In: *PERI Working Papers*.
- Bravo-Ortega, Claudio and José De Gregorio (2005). *The relative richness of the poor? Natural resources, human capital, and economic growth*. The World Bank.
- Bretschger, Lucas (2015). “Energy prices, growth, and the channels in between: Theory and evidence”. In: *Resource and Energy Economics* 39, pp. 29–52.
- Broda, Christian, Ephraim Leibtag, and David E Weinstein (2009). “The role of prices in measuring the poor’s living standards”. In: *Journal of economic Perspectives* 23.2, pp. 77–97.
- Brownbridge, Martin and Emmanuel Tumusiime-Mutebile (2007). “Aid and fiscal deficits: lessons from Uganda on the implications for macroeconomic management and fiscal sustainability”. In: *Development Policy Review* 25.2, pp. 193–213.
- Brunnschweiler, Christa N and Erwin H Bulte (2008). “The resource curse revisited and revised: A tale of paradoxes and red herrings”. In: *Journal of environmental economics and management* 55.3, pp. 248–264.
- Carruthers, Robin, Malise Dick, and Anuja Saurkar (2005). “Affordability of public transport in developing countries”. In:
- Caselli, Francesco (2005). “Accounting for cross-country income differences”. In: *Handbook of economic growth* 1, pp. 679–741.
- Cashin, Paul, Luis F Céspedes, and Ratna Sahay (2004). “Commodity currencies and the real exchange rate”. In: *Journal of Development Economics* 75.1, pp. 239–268.
- Castelló, Amparo and Rafael Doménech (2002). “Human capital inequality and economic growth: some new evidence”. In: *The economic journal* 112.478.

- Cavalcanti, Tiago V de V, Kamiar Mohaddes, and Mehdi Raissi (2011). “Growth, development and natural resources: New evidence using a heterogeneous panel analysis”. In: *The Quarterly Review of Economics and Finance* 51.4, pp. 305–318.
- Chaturvedi, Mayuri (2016). “Rent-seeking induced inequality traps”. In:
- Christopoulos, Dimitris K, Karine Gente, and Miguel A León-Ledesma (2012). “Net foreign assets, productivity and real exchange rates in constrained economies”. In: *European Economic Review* 56.3, pp. 295–316.
- Cockx, Lara and Nathalie Francken (2014). “Extending the concept of the resource curse: Natural resources and public spending on health”. In: *Ecological Economics* 108, pp. 136–149.
- Collier, Paul and Benedikt Goderis (2008). “Commodity prices, growth, and the natural resource curse: reconciling a conundrum”. In: *Growth, and the Natural Resource Curse: Reconciling a Conundrum (June 5, 2008)*.
- Collier, Paul and Anke Hoeffler (2005). “Democracy and resource rents”. In: *GPRG Working Papers 016, Global Poverty Research Group*. Citeseer.
- Corden, W Max and J Peter Neary (1982). “Booming sector and de-industrialisation in a small open economy”. In: *The economic journal* 92.368, pp. 825–848.
- Darvas, Zsolt (2012). “Real effective exchange rates for 178 countries: a new database”. In:
- De la Fuente, Angel and Rafael Doménech (2006). “Human capital in growth regressions: how much difference does data quality make?” In: *Journal of the European Economic Association* 4.1, pp. 1–36.
- Deaton, Angus, Ronald I Miller, et al. (1995). *International commodity prices, macroeconomic performance, and politics in Sub-Saharan Africa*. International Finance Section, Department of Economics, Princeton University . . .
- Dehn, Jan (2000). *Commodity price uncertainty in developing countries*. The World Bank.
- Deininger, Klaus and Lyn Squire (1996). “A new data set measuring income inequality”. In: *The World Bank Economic Review* 10.3, pp. 565–591.
- Demery, Lionel (2000). “Benefit incidence: a practitioner’s guide”. In: *The World Bank. Washington, DC*.
- Dustmann, Christian, Bernd Fitzenberger, and Markus Zimmermann (2018). “Housing expenditures and income inequality”. In: *ZEW-Centre for European Economic Research Discussion Paper* 48.
- Easterly, William (2007). “Inequality does cause underdevelopment: Insights from a new instrument”. In: *Journal of Development Economics* 84.2, pp. 755–776.
- Ehrlich, Isaac and Jinyoung Kim (2007). “The evolution of income and fertility inequalities over the course of economic development: a human capital perspective”. In: *Journal of Human Capital* 1.1, pp. 137–174.
- Eichengreen, Barry (2007). “The real exchange rate and economic growth”. In: *Social and Economic Studies*, pp. 7–20.

- Esfahani, Hadi Salehi, Kamiar Mohaddes, and M Hashem Pesaran (2013). “Oil exports and the Iranian economy”. In: *The quarterly review of economics and finance* 53.3, pp. 221–237.
- Fabricant, Stephen J, Clifford W Kamara, and Anne Mills (1999). “Why the poor pay more: household curative expenditures in rural Sierra Leone”. In: *The International Journal of Health Planning and Management* 14.3, pp. 179–199.
- Forbes, Kristin J (2000). “A Reassessment of the Relationship between Inequality and Growth”. In: *American economic review*, pp. 869–887.
- Frankel, Jeffrey A (2010). *The natural resource curse: a survey*. Tech. rep. National Bureau of Economic Research.
- Gaddah, Mawuli, Alistair Munro, and Peter Quartey (2015). “The rich or the poor: who gains from public education spending in Ghana?” In: *International Journal of Social Economics* 42.2, pp. 112–131.
- Galbraith, James K and Hyunsub Kum (2005). “Estimating the inequality of household incomes: a statistical approach to the creation of a dense and consistent global data set”. In: *Review of Income and Wealth* 51.1, pp. 115–143.
- Goderis, Benedikt and Samuel W Malone (2011). “Natural resource booms and inequality: theory and evidence”. In: *The Scandinavian Journal of Economics* 113.2, pp. 388–417.
- Grijalva, Diego F (2011). “Inequality and Economic Growth: Bridging the Short-run and the Long-run”. In:
- Gylfason, Thorvaldur, Tryggvi Thor Herbertsson, and Gylfi Zoega (1999). “A mixed blessing”. In: *Macroeconomic dynamics* 3.2, pp. 204–225.
- Gylfason, Thorvaldur and Gylfi Zoega (2002). “Inequality and economic growth: Do natural resources matter?” In:
- Habib, Maurizio Michael, Elitza Mileva, and Livio Stracca (2017). “The real exchange rate and economic growth: Revisiting the case using external instruments”. In: *Journal of International Money and Finance* 73, pp. 386–398.
- Harding, Torfinn and Anthony J Venables (2010). “Foreign exchange windfalls, imports and exports”. In: *Unpublished. University of Oxford*.
- (2016). “The implications of natural resource exports for nonresource trade”. In: *IMF Economic Review* 64.2, pp. 268–302.
- Hausmann, Ricardo and Roberto Rigobon (2003). *An alternative interpretation of the ‘resource curse’: Theory and policy implications*. Tech. rep. National Bureau of Economic Research.
- Herrendorf, Berthold, Richard Rogerson, and Akos Valentinyi (2013). *Growth and structural transformation*. Tech. rep. National Bureau of Economic Research.
- Humphreys, Macartan, Jeffrey Sachs, and Joseph E Stiglitz (2007). *Escaping the resource curse*. Columbia University Press.

BIBLIOGRAPHY

- Huntington, Samuel P (1993). *The third wave: Democratization in the late twentieth century*. Vol. 4. University of Oklahoma press.
- IEA (2019). “World energy outlook 2006”. In: *International Energy Agency, Paris*.
- Isham, Jonathan et al. (2002). “The varieties of rentier experience: how natural resource endowments affect the political economy of economic growth”. In: *Middlebury College, Middlebury, Vt., World Bank, Washington, DC, Harvard University, Cambridge, Mass., and Yale University, New Haven, Conn. Processed*.
- Ismail, Kareem (2010). *The Structural Manifestation of the Dutch Disease’: The Case of Oil Exporting Countries*. 10-103. International Monetary Fund.
- Jahan-Parvar, Mohammad R and Hassan Mohammadi (2011). “Oil prices and real exchange rates in oil-exporting countries: a bounds testing approach”. In: *The Journal of Developing Areas*, pp. 313–322.
- Javaid, Shahid Hussain and Riaz Riazuddin (2009). *Dutch disease investigated: empirical evidence from selected South-East Asian economies*. State Bank of Pakistan.
- Karimu, Amin et al. (2017). “Natural Resource Revenues and Public Investment in Resource-rich Economies in Sub-Saharan Africa”. In: *Review of Development Economics* 21.4, e107–e130.
- Ketsche, Patricia et al. (2011). “Lower-income families pay a higher share of income toward national health care spending than higher-income families do”. In: *Health Affairs* 30.9, pp. 1637–1646.
- Khan, Sarah Ahmad (1994). *Nigeria: The political economy of oil*. Oxford University Press Oxford.
- Kim, Dong-Hyeon and Shu-Chin Lin (2018). “Oil abundance and income inequality”. In: *Environmental and Resource Economics* 71.4, pp. 825–848.
- Kleibergen, Frank and Richard Paap (2006). “Generalized reduced rank tests using the singular value decomposition”. In: *Journal of econometrics* 133.1, pp. 97–126.
- Knight, Malcolm, Norman Loayza, and Delano Villanueva (1993). “Testing the neoclassical theory of economic growth: a panel data approach”. In: *Staff papers* 40.3, pp. 512–541.
- Koranchelian, Taline (2005). *The equilibrium real exchange rate in a commodity exporting country: Algeria’s Experience*. 5-135. International Monetary Fund.
- Korhonen, Iikka and Tuuli Juurikkala (2009). “Equilibrium exchange rates in oil-exporting countries”. In: *Journal of Economics and Finance* 33.1, pp. 71–79.
- Krugman, Paul (1987). “The narrow moving band, the Dutch disease, and the competitive consequences of Mrs. Thatcher: Notes on trade in the presence of dynamic scale economies”. In: *Journal of development Economics* 27.1-2, pp. 41–55.
- Kurtz, Marcus J and Sarah M Brooks (2011). “Conditioning the “resource curse”: globalization, human capital, and growth in oil-rich nations”. In: *Comparative Political Studies* 44.6, pp. 747–770.

- Lam, Ricky and Leonard Wantchekon (2002). “Political dutch disease”. In: *Unpublished Paper 2*.
- Lane, Philip R and Gian Maria Milesi-Ferretti (2004). “The transfer problem revisited: Net foreign assets and real exchange rates”. In: *Review of Economics and Statistics* 86.4, pp. 841–857.
- (2007). “The external wealth of nations mark II: Revised and extended estimates of foreign assets and liabilities, 1970–2004”. In: *Journal of international Economics* 73.2, pp. 223–250.
- Lartey, Emmanuel KK, Federico S Mandelman, and Pablo A Acosta (2012). “Remittances, exchange rate regimes and the Dutch disease: a panel data analysis”. In: *Review of International Economics* 20.2, pp. 377–395.
- Leibtag, Ephraim S, Phillip R Kaufman, et al. (2003). *Exploring food purchase behavior of low-income households: how do they economize?* Tech. rep. United States Department of Agriculture, Economic Research Service.
- Leite, Mr Carlos and Jens Weidmann (1999). *Does mother nature corrupt: Natural resources, corruption, and economic growth*. International Monetary Fund.
- Levy, Stephanie (2007). “Public investment to reverse Dutch disease: the case of Chad”. In: *Journal of African Economies* 16.3, pp. 439–484.
- Li, Hongyi and Heng-fu Zou (1998). “Income inequality is not harmful for growth: theory and evidence”. In: *Review of development economics* 2.3, pp. 318–334.
- López, Humberto (2003). “Macroeconomics and inequality”. In: *Washington DC: The World Bank Processed*, p. 9.
- Lucas Jr, Robert E (1988). “On the mechanics of economic development”. In: *Journal of monetary economics* 22.1, pp. 3–42.
- Mallaye, Douzounet, Gaëlle Tatiana Timba, and Urbain Thierry Yogo (2015). “Oil Rent and Income Inequality in Developing Economies: Are They Friends or Foes?” In:
- Mankiw, N Gregory, David Romer, and David N Weil (1992). “A contribution to the empirics of economic growth”. In: *The quarterly journal of economics* 107.2, pp. 407–437.
- Manzano, Osmel and Roberto Rigobon (2001). *Resource curse or debt overhang?* Tech. rep. National bureau of economic research.
- Matsen, Egil, Gisle J Natvik, and Ragnar Torvik (2016). “Petro populism”. In: *Journal of Development Economics* 118, pp. 1–12.
- Matsuyama, Kiminori (1992). “Agricultural productivity, comparative advantage, and economic growth”. In: *Journal of economic theory* 58.2, pp. 317–334.
- Mauro, Paolo (1995). “Corruption and growth”. In: *The quarterly journal of economics* 110.3, pp. 681–712.

- Mavrotas, George, Syed Mansoob Murshed, and Sebastian Torres (2011). “Natural resource dependence and economic performance in the 1970–2000 period”. In: *Review of Development Economics* 15.1, pp. 124–138.
- Mehlum, Halvor, Karl Moene, and Ragnar Torvik (2006a). “Cursed by resources or institutions?” In: *World Economy* 29.8, pp. 1117–1131.
- (2006b). “Institutions and the resource curse”. In: *The economic journal* 116.508, pp. 1–20.
- Mihasonirina, A and K Kangni (2011). “ICT, financial inclusion, and growth: evidence from African countries”. In: *IMF Working Paper WP/11/73*, p. 6.
- Min, Hong-Ghi, Sang-Ook Shin, and Judith A McDonald (2015). “Income Inequality and the Real Exchange Rate: Linkages and Evidence.” In: *Annals of Economics & Finance* 16.1.
- Muller, Dominique, Charles M Judd, and Vincent Y Yzerbyt (2005). “When moderation is mediated and mediation is moderated.” In: *Journal of personality and social psychology* 89.6, p. 852.
- Murshed, S Mansoob (2004). *When does natural resource abundance lead to a resource curse?* Tech. rep.
- Naguib, Costanza (2015). *The relationship between inequality and GDP growth: An empirical approach*. Tech. rep. LIS Working Paper Series.
- Nkusu, Mrs Mwanza (2004). *Financing Uganda’s Poverty Reduction Strategy: Is Aid Causing More Pain Than Gain?(EPub)*. 4-170. International Monetary Fund.
- Nkusu, Mwanza (2004). *Aid and the Dutch disease in low-income countries: Informed diagnoses for prudent prognoses*. 2004-2049. International Monetary Fund.
- Obstfeld, Maurice, Kenneth S Rogoff, and Simon Wren-lewis (1996). *Foundations of international macroeconomics*. Vol. 30. MIT press Cambridge, MA.
- Oomes, Nienke and Katerina Kalcheva (2007). *Diagnosing Dutch disease: does Russia have the symptoms?* Vol. 7. International Monetary Fund.
- Pannarunothai, Supasit and Anne Mills (1997). “The poor pay more: health-related inequality in Thailand”. In: *Social Science & Medicine* 44.12, pp. 1781–1790.
- Parcero, Osiris J and Elissaios Papyrakis (2016). “Income inequality and the oil resource curse”. In: *Resource and Energy Economics* 45, pp. 159–177.
- Perotti, Roberto (1996). “Growth, income distribution, and democracy: What the data say”. In: *Journal of Economic growth* 1.2, pp. 149–187.
- Persson, Torsten and Guido Tabellini (1994). “Is inequality harmful for growth?” In: *The American Economic Review*, pp. 600–621.
- Petrocik, John R and Daron Shaw (1991). “Nonvoting in america: Attitudes in context”. In: *Political participation and American democracy*, pp. 67–88.

- Rajan, Raghuram G and Arvind Subramanian (2008). “Aid and growth: What does the cross-country evidence really show?” In: *The Review of Economics and Statistics* 90.4, pp. 643–665.
- Ricci, Luca Antonio, Gian Maria Milesi-Ferretti, and Jaewoo Lee (2013). “Real exchange rates and fundamentals: a cross-country perspective”. In: *Journal of Money, Credit and Banking* 45.5, pp. 845–865.
- Rodriguez, Francisco and Jeffrey D Sachs (1999). “Why do resource-abundant economies grow more slowly?” In: *Journal of Economic Growth* 4.3, pp. 277–303.
- Rodrik, Dani (2008). “The real exchange rate and economic growth”. In: *Brookings papers on economic activity* 2008.2, pp. 365–412.
- Roodman, David (2009a). “A note on the theme of too many instruments”. In: *Oxford Bulletin of Economics and statistics* 71.1, pp. 135–158.
- (2009b). “How to do xtabond2: An introduction to difference and system GMM in Stata”. In: *The Stata Journal* 9.1, pp. 86–136.
- Ross, Michael L (2004a). “Does taxation lead to representation?” In: *British journal of political science*, pp. 229–249.
- (2004b). “What do we know about natural resources and civil war?” In: *Journal of peace research* 41.3, pp. 337–356.
- Sachs, Jeffrey D and Andrew M Warner (1995). *Natural resource abundance and economic growth*. Tech. rep. National Bureau of Economic Research.
- (2001). “The curse of natural resources”. In: *European economic review* 45.4-6, pp. 827–838.
- Sala-i-Martin, Xavier and Arvind Subramanian (2013). “Addressing the natural resource curse: An illustration from Nigeria”. In: *Journal of African Economies* 22.4, pp. 570–615.
- Sarraf, Maria and Moortaza Jiwani (2001). “Beating the resource curse: the case of Botswana”. In:
- Schaffer, Mark (2015). “xtivreg2: Stata module to perform extended IV/2SLS, GMM and AC/HAC, LIML and k-class regression for panel data models”. In:
- Scognamillo, Antonio, Gianluca Mele, and Luca Sensini (2016). “Nonrenewable resources, income inequality and per capita GDP: an empirical analysis”. In:
- Sdravovich, Mr Carlo A et al. (2014). *Subsidy reform in the Middle East and North Africa: Recent progress and challenges ahead*. International Monetary Fund.
- Sekkat, Khalid and Aristomene Varoudakis (2000). “Exchange rate management and manufactured exports in Sub-Saharan Africa”. In: *Journal of Development Economics* 61.1, pp. 237–253.
- Shaxson, Nicholas (2007). “Oil, corruption and the resource curse”. In: *International Affairs* 83.6, pp. 1123–1140.

BIBLIOGRAPHY

- Solow, Robert M (1956). “A contribution to the theory of economic growth”. In: *The quarterly journal of economics* 70.1, pp. 65–94.
- Solt, Frederick (2016). “The standardized world income inequality database”. In: *Social science quarterly* 97.5, pp. 1267–1281.
- Sridhar, Kala Seetharam and Varadharajan Sridhar (2007). “Telecommunications infrastructure and economic growth: Evidence from developing countries”. In: *Applied Econometrics and International Development* 7.2.
- Stock, James H and Motohiro Yogo (2002). *Testing for weak instruments in linear IV regression*.
- Stolper, Wolfgang F and Paul A Samuelson (1941). “Protection and real wages”. In: *The Review of Economic Studies* 9.1, pp. 58–73.
- Tiongson, Mr Erwin, Mr Hamid Reza Davoodi, and Sawitree S Asawanuchit (2003). *How useful are benefit incidence analyses of public education and health spending*. 3-227. International Monetary Fund.
- Torvik, Ragnar (2001). “Learning by doing and the Dutch disease”. In: *European economic review* 45.2, pp. 285–306.
- (2002). “Natural resources, rent seeking and welfare”. In: *Journal of development economics* 67.2, pp. 455–470.
- Turnovsky, Stephen J (2011). “The accumulation of human capital and income inequality in a two-sector economy”. In: *Journal of Human Capital* 5.4, pp. 418–452.
- Ulku, Hulya (2004). *R and D, innovation, and Economic Growth: An Empirical Analysis*. 4-185. International Monetary Fund.
- Van der Ploeg, Frederick (2011a). “Fiscal policy and Dutch disease”. In: *International economics and economic policy* 8.2, pp. 121–138.
- (2011b). “Natural resources: curse or blessing?” In: *Journal of Economic literature* 49.2, pp. 366–420.
- Van der Ploeg, Frederick and Steven Poelhekke (2009). “Volatility and the natural resource curse”. In: *Oxford economic papers* 61.4, pp. 727–760.
- Van der Ploeg, Frederick and Anthony J Venables (2013). “Absorbing a windfall of foreign exchange: Dutch disease dynamics”. In: *Journal of Development Economics* 103, pp. 229–243.
- Van Wijnbergen, Sweder (1984). “The Dutch Disease’: a disease after all?” In: *The Economic Journal* 94.373, pp. 41–55.
- Verbeke, Karel (2007). “Dutch disease in aid-recipient countries: are there medicines to avoid an outbreak?” In:
- Vicente, Pedro C (2010). “Does oil corrupt? Evidence from a natural experiment in West Africa”. In: *Journal of development Economics* 92.1, pp. 28–38.
- Williamson, John (2009). “Exchange rate economics”. In: *Open Economies Review* 20.1, pp. 123–146.

- Windmeijer, Frank (2005). “A finite sample correction for the variance of linear efficient two-step GMM estimators”. In: *Journal of econometrics* 126.1, pp. 25–51.
- Woolcock, Michael, Lant Pritchett, and Jonathan Isham (2001). “The social foundations of poor economic growth in resource-rich countries”. In: *Resource Abundance and Economic Development*, Oxford University Press, Oxford.
- Yanikkaya, Halit (2003). “Trade openness and economic growth: a cross-country empirical investigation”. In: *Journal of Development economics* 72.1, pp. 57–89.
- Zalduendo, Mr Juan (2006). *Determinants of Venezuela’s equilibrium real exchange rate*. 6-74. International Monetary Fund.

Résumé en Français:

Pourquoi les pays dépendants des ressources naturelles n'ont généralement pas réussi à afficher de meilleures performances économiques que les autres? Cette question, appelée le paradoxe de l'abondance ou «malédiction des ressources», a attiré davantage l'attention des chercheurs au cours des 30 dernières années. Bien que la littérature ait approfondi notre compréhension des déterminants de la performance économique des pays dépendants des ressources naturelles, de nombreuses questions restent sans réponse.

Un point de départ utile est de revoir l'hypothèse de la maladie hollandaise. Motivé par la littérature, je développe d'abord une théorie simple, guidée par LBD, dans laquelle la productivité est générée à la fois dans les secteurs manufacturiers et des services, alors qu'il y a une retombée imparfaite du secteur manufacturier vers le secteur des services et une retombée technologique du secteur des ressources au secteur manufacturier. Le modèle décrit le mécanisme standard de la maladie hollandaise, le même que celui de Torvik, 2001. Tout en montrant qu'un boom des ressources se traduit par une appréciation conditionnelle du taux de change réel (en régime permanent) et également une dépréciation inconditionnelle du taux de croissance de l'économie, contrairement à Torvik, 2001; Bjørnland and Thorsrud, 2016. Je recueille ensuite un ensemble de données de panel déséquilibré de 132 pays de la période 1970 à 2014 pour revoir les symptômes de la maladie hollandaise. En utilisant la technique de la méthode généralisée des moments (*GMM*), j'adopte une procédure d'estimation dynamique. Les résultats estimés illustrent certaines preuves claires à l'appui de la relation positive entre un indicateur de dépendance aux ressources et le taux de change réel. Ils démontrent également que l'appréciation du taux de change réel entraîne une contraction de la croissance sectorielle davantage dans le secteur manufacturier que dans le secteur des services et donc une décélération de la croissance économique. Enfin, l'approche empirique suggère que ces effets négatifs sont plus intenses dans les pays riches en ressources que dans les pays pauvres en ressources. Le deuxième chapitre découle de la question de savoir comment l'impact d'un boom des ressources sur le lien entre inégalités de revenu et croissance modifie la vision standard du syndrome hollandais. La littérature montre que deux questions qui ont attiré de plus en plus l'attention des chercheurs sont l'impact des revenus exceptionnels sur la croissance économique et l'inégalité des revenus. Étonnamment, ces variables d'intérêt ont été étudiées isolément les unes des autres et un peu d'attention a été accordée à l'étude de ces variables

dans un cadre unifié. Dans cette perspective, je développe un modèle de croissance à deux secteurs dans lequel chaque secteur emploie des travailleurs qualifiés et non qualifiés. Les groupes de travailleurs attribuent différentes parts de dépenses de consommation aux biens échangés et non échangés. L'écart dans les parts des dépenses reflète la rétroaction d'un changement de l'inégalité des revenus sur la croissance économique. J'ai analysé le modèle à court terme sous une statique comparative et à long terme sous une approche dynamique guidée par le modèle d'apprentissage par la pratique (*LBD*). L'étude évalue également les prédictions de ma théorie en appliquant une approche dynamique de données de panel à un échantillon de base de données de 79 pays sur la période 1975-2014. Les principales conclusions sont doubles. Premièrement, un boom des ressources naturelles réduit les inégalités de revenus si le salaire réel relatif des travailleurs qualifiés par rapport aux travailleurs non qualifiés est plus élevé que leur part relative dans les bénéfices exceptionnels (subventions). Deuxièmement, la baisse des inégalités de revenus aggrave l'intensité de la malédiction hollandaise si les travailleurs qualifiés, par rapport aux travailleurs non qualifiés, allouent une plus grande part des dépenses aux biens échangés.

Le troisième numéro vise à présenter une réponse à la question de savoir comment les contraintes de capacité d'absorption dues à une pénurie de capitaux non échangés tels que le capital humain public et les infrastructures induisent l'intensité de la malédiction des ressources naturelles. À cet égard, je présente une étude empirique. Je collecte tout d'abord des données pour 105 pays sur la période 1975-2014. Ensuite, deux indices sont construits pour identifier la capacité d'absorption transnationale (biens d'équipement): 1) l'indice d'infrastructure, la moyenne de l'indice d'électricité normalisé et de l'indice téléphonique normalisé, et 2) l'indice d'absorption, la moyenne de l'indice de capital humain normalisé et de l'infrastructure normalisée indice. En utilisant la technique *IV2SLS*, des preuves claires à l'appui de l'hypothèse proposée sont fondées. De plus, motivé par Van der Ploeg and Venables, 2013, je développe un cadre simple à deux secteurs dans lequel les biens d'équipement non échangés ne sont employés que par le secteur non marchand. Cette structure capture de manière simple les caractéristiques d'une économie dans laquelle le secteur non négocié est contraint par des contraintes d'absorption. À court terme, un boom permanent des ressources conduit à une appréciation temporaire du taux de change réel et entraîne ainsi la malédiction des ressources naturelles (désindustrialisation). Alors qu'à long terme, une expansion progressive des biens d'équipement annule l'appréciation temporaire du taux de change réel et ainsi la malédiction des ressources naturelles s'atténue tant que l'écart entre l'offre et la demande du secteur non marchand disparaît. Le modèle précise également qu'une capacité d'absorption moindre (ou un niveau plus bas de biens d'équipement) augmente l'intensité de la malédiction des ressources naturelles. De plus, le modèle montre que l'intensité devient plus forte si le développement réduit le coût de financement de la production de biens d'équipement et augmente la part de consommation des biens non échangés.

Mots clés: Ressource naturelle; La maladie hollandaise; L'inégalité des revenus; Capacité d'absorption

Abstract in English:

Why natural resource-dependent countries have usually failed to show better economic performance than others? This question, called the paradox of plenty, or “resource curse”, has been attracting more attention from researchers in the recent 30 years. Although the literature has deepened our understanding of the determinants in the economic performance of natural resource-dependence countries, many unanswered questions have still remained. A useful starting point is to revisit the Dutch disease hypothesis. Motivated by the literature, I first develop a simple theory, driven by *LBD*, in which the productivity is generated in both manufacturing and service sectors, while there are an imperfect spillover from the manufacturing to the service sector and a technology spillover from the resource sector to the manufacturing sector. The model describes the standard Dutch disease mechanism, the same as Torvik, 2001. While it shows that a resource boom results in a conditional appreciation in the (steady-state) real exchange rate and also an unconditional depreciation in the rate of growth in the economy, contrary to Torvik, 2001; Bjørnland and Thorsrud, 2016. I then collect an unbalanced panel data set of 132 countries from the period 1970 to 2014 to revisit the Dutch disease symptoms. Using the Generalized Method of Moments (*GMM*) technique, I adopt a dynamic estimation procedure. Estimated results illustrate some clear evidence in supporting the positive relationship between a resource-dependence proxy and the real exchange rate. They also demonstrate that the real exchange rate appreciation causes the sectoral growth to shrink more in the manufacturing sector than in the service sector and so the economic growth to decelerate. Finally, the empirical approach suggests that these adverse effects are more intensive in resource-rich than in resource-poor countries.

The second chapter stems from a question of how the impact of a resource boom on the income inequality-growth nexus modifies the standard view on the Dutch disease. Literature shows that two questions that have attracted increasing attention from researchers are the impact of windfall income on economic growth and income inequality. Surprisingly these variables of interest have been studied in isolation from each other and a little attention has been paid to study these variables in a unified framework. From this perspective, I develop a two-sector growth model in which each sector employs skilled and unskilled workers. Workers’ groups allocate different consumption expenditure shares on traded and non-traded goods. The gap in expenditure shares captures the feedback of a change

in income inequality on economic growth. I have analyzed the model in the short-run under a comparative static and in the long-run under a dynamic approach driven by learning-by-doing (*LBD*) model. The study also evaluates the predictions of my theory by applying a dynamic panel data approach to a sample database of 79 countries over the period 1975-2014. The main findings are twofold. First, a natural resource boom reduces income inequality if the relative real wage of skilled to unskilled workers is stronger than their relative share on windfall income benefit (subsidies). Second, falling income inequality exacerbates the intensity of the Dutch disease if skilled workers, with respect to unskilled workers, allocate a larger expenditure share for traded goods.

The third issue seeks to present a response to the question of how the absorption capacity constraints due to a shortage in the non-traded capital such as the public human capital and the infrastructure induce the intensity of the natural resource curse. In this respect, I present an empirical study. I firstly collect data for 105 countries over the period 1975-2014. Then, two indexes are constructed to identify cross-country absorption capacity (capital goods): 1) Infrastructure index, the average of normalized Electricity index and normalized Telephone index, and 2) Absorption index, the average of normalized Human Capital Index and normalized Infrastructure index. Using the *IV – 2SLS* technique, clear evidence in supporting the proposed hypothesis is founded. Furthermore, motivated by Van der Ploeg and Venables, 2013, I develop a simple two-sector framework in which non-traded capital goods are only employed by the non-traded sector. This structure captures in a simple way the features of an economy in which the non-traded sector is constrained by absorption constraints. In the short-term, a permanent resource boom leads to a temporary appreciation in the real exchange rate and thereby arising the natural resource curse (de-industrialization). While in the long-term, a gradual expansion of capital goods reverses the temporary appreciation in the real exchange rate and so the natural resource curse moderates as long as the gap between supply and demand sides of the non-traded sector vanishes. The model also clarifies that less absorption capacity (or lower level of capital goods) increases the intensity of the natural resource curse. Further, the model shows that the intensity becomes stronger if the development reduces the cost to finance the production of capital goods and increases the consumption share for non-traded goods.

Keywords: Natural resource; The Dutch Disease; Income Inequality; absorption capacity