



HAL
open science

Cold anammox for energy-positive sewage treatment : impact of temperature and organic carbon on performances and microbiota

Pieter de Cocker

► **To cite this version:**

Pieter de Cocker. Cold anammox for energy-positive sewage treatment : impact of temperature and organic carbon on performances and microbiota. Other. INSA de Toulouse; UNIVERSITE DE GHENT-BELGIQUE, 2018. English. NNT : 2018ISAT0050 . tel-03396694

HAL Id: tel-03396694

<https://theses.hal.science/tel-03396694>

Submitted on 22 Oct 2021

HAL is a multi-disciplinary open access archive for the deposit and dissemination of scientific research documents, whether they are published or not. The documents may come from teaching and research institutions in France or abroad, or from public or private research centers.

L'archive ouverte pluridisciplinaire **HAL**, est destinée au dépôt et à la diffusion de documents scientifiques de niveau recherche, publiés ou non, émanant des établissements d'enseignement et de recherche français ou étrangers, des laboratoires publics ou privés.



THÈSE

En vue de l'obtention du

DOCTORAT DE L'UNIVERSITÉ DE TOULOUSE

Délivré par :

Institut National des Sciences Appliquées de Toulouse (INSA de Toulouse)

Cotutelle internationale avec l'Université de Gand, Belgique

Présentée et soutenue par :

Pieter De Cocker

le vendredi 25 mai 2018

Titre :

Cold anammox for energy-positive sewage treatment: impact of temperature and organic carbon on performance and microbiota

École doctorale et discipline ou spécialité :

ED MEGEP : Génie des procédés et de l'Environnement

Unité de recherche :

LISBP (Toulouse, France) - CMET (Gand, Belgique)

Directeur/trice(s) de Thèse :

Mathieu Sperandio - Siegfried Vlaeminck

Jury :

Prof. Dr. ir. Peter Bossier (Université de Gand, Belgique)

Prof. Dr. ir. Stijn Van Hulle (Université de Gand, Belgique)

Prof. Dr. ir. Susanne Lackner (TU Darmstadt, Allemagne)

Dr. ir. Michele Laurenzi (TU Delft, Pays-bas)

Dr. ir. Gilberte Gaval (SUEZ Groupe, France)

**Cold anammox for energy-positive sewage treatment:
impact of temperature and organic carbon on performance
and microbiota**

Pieter De Cocker

Thesis submitted in fulfillment of the requirements for the
degree of Doctor (PhD) in Applied Biological Sciences

Dissertation supervisors

Prof. Dr. Ir. Siegfried E. Vlaeminck

Center for microbial ecology and technology (CMET), Faculty of bioscience engineering, Ghent University, Belgium

Research Group of Sustainable Energy, Air and Water Technology, Department of Bioscience Engineering, University of Antwerp, Belgium

Prof. Dr. Ir. Mathieu Sperandio

LISBP, INSA de Toulouse, France

Dr. Ir. Gilberte Gaval

SUEZ Groupe, CIRSEE, Wastewater Treatment & Recovery Division, Paris, France

Members of the examination committee

Prof. Dr. Ir. Peter Bossier

Laboratory of Aquaculture & Artemia, Faculty of Bioscience Engineering, Ghent University, Belgium

Prof. Dr. Ir. Stijn Van Hulle

Department of Industrial Biological Sciences, Faculty of Bioscience Engineering, Ghent University - Campus Kortrijk, Belgium

Prof. Dr. Ir. Susanne Lackner

Department of Wastewater engineering, TU Darmstadt, GERMANY

Dr. Ir. Michele Laurenzi

Department of Biotechnology, TU Delft, The Netherlands

Dean of the faculty of Bioscience Engineering, Ghent University

Prof. dr. ir. Marc Van Meirvenne

Rector of Ghent University

Prof. dr. ir. Rik Van de Walle

Supervisor doctoral school MEGeP

Prof. dr. ir. Hélène Roux de Balman

Director of INSA Toulouse

Prof. dr. ir. Bertrand Racquet

Acknowledgements

This joint PhD project was a collaboration between SUEZ (CIRSEE, Paris), le Laboratoire d'Ingénierie des Systèmes Biologiques et des Procédés (LISBP, INSA Toulouse) and the Center for Microbial Ecology and Technology (CMET, UGent). It was partially funded by a French ANRT grant (CIFRE N° 2014/0754).

I start off by thanking the members of the jury: Prof. Dr. ir. Peter Bossier, Prof. Dr. ir. Stijn Van Hulle, Prof. Dr. ir. Susanne Lackner, Dr. ir. Michele Laurenzi for taking an interest in my research and for their highly detailed and relevant comments that have helped improve this work.

I would like to thank the people from SUEZ for haven given me the opportunity to be a part of this exciting collaborative project between industry and academia. Special thanks to Dr. ir. Samuel Martin and Dr. ir. Bruno Barillon who were the catalysts for the kick-off of this project, also to Dr. ir. Irene Mozo and Dr. ir. Gilberte Gaval for their expert input throughout this project and to Marc Caligaris from SUEZ Treatment Infrastructures for showing me how innovation is integrated in an industrial framework.

I would especially like to thank my two PhD supervisors: Prof. dr. ir. Mathieu Sperandio from the LISBP and Prof. dr. ir. Siegfried Vlaeminck from the CMET for their mentorship through these past years. I have learned so much from them and cannot thank them enough for their continuous input and support.

I would also like to thank Mathieu for always keeping his door open to me and for welcoming me in his team "Symbiose". I would also like to thank Dr. ir. Yolaine Bessière, for her valuable input and extremely detailed revisions and Dr. ir Guillermina Hernandez-Raquet and Dr. ir Lucas Auer for helping with the microbial population analyses. Thank you, Dr. ir. Myriam Mercade for granting me access to the ecology platform and Dr. Catherine Botanch for the support and advice during the FISH analyses.

Thank you to the entire team of technicians (Evrard, Delphine, Mansour, Simon and Chanta) for saving the day on many occasions. This work would also not have been possible without the hard work of the master students I have had the pleasure to work with: Manuel, Juan Sebastian and Julie. Thanks also to my all fellow PhD candidates, especially to Amaury, Longqi, Ana and Laura for their friendship and support in and out of the lab! As a wise woman once said, “there are no small victories”!

Even though my stay there was rather short, I would like to thank everyone at CMET for making me feel welcome. Thanks to the “nitrogeniuses” for the interesting discussions, thank you José, Cristina and Tom for some good talks and fun times and thank you Dries, for some great brainstorming, (pep)talking and for suffering through these final months together. Looks like we made it out of the trenches!

Finally, I would like to thank my family and friends for their love, constant support and encouragement in everything I do. Without you this would never have been possible.

To my love, Cléa. Walking this path together has been the most incredible experience. I could not begin to express how much you have touched my life these past few years, but at least I found a quote for my manuscript!

*“I think women are foolish to pretend they are equal to men, they are far superior and always have been. Whatever you give a woman, she will make greater... If you give her a house, she'll give you a home. If you give her groceries, she'll give you a meal. If you give her a smile, she'll give you her heart. She multiplies and enlarges what is given to her. So, if you give her any crap, be ready to receive a ton of sh*t!”*

By William Golding

List of Abbreviations

AerAOB	aerobic ammonium oxidizing bacteria
Anammox	anaerobic ammonium oxidation
AnAOB	anaerobic ammonium oxidizing bacteria
bCOD	biodegradable chemical oxygen demand
C	carbon
CAS	conventional activated sludge
COD	chemical oxygen demand
CSTR	continuously stirred tank reactor
DNA	Deoxyribonucleic acid
DO	dissolved oxygen
E_a	activation energy
FA	free ammonia
FNA	free nitrous acid
HB _x	heterotrophic bacteria (x = preferred functionality)
HRAS	high-rate activated sludge
IFAS	integrated fixed-film activated sludge
k_x	substrate affinity constant (x = substrate)
MBR	membrane bioreactor
N	nitrogen
N/DN	nitrification/denitrification
Nit/Dnit	nitritation/denitritation
NOB	nitrite oxidizing bacteria
OLAND	Oxygen-limited autotrophic nitrification/denitrification
OTU	operational taxonomic unit
P	phosphate
PN/A	partial nitritation anammox
qPCR	quantitative polymerase chain reaction
RNA	ribonucleic acid
r_x	rate (x = guild or substrate)
RBC	Rotating Biological Contactor
S	sulfide
SRR	specific removal rate
SBR	sequencing batch reactor
SRT	sludge retention time
STP	sewage treatment plant
t	time
TSS	total suspended solids
UASB	upflow anaerobic sludge blanket
UN	United Nations
VLR	volumetric loading rate
VRR	volumetric removal rate
VSS	volatile suspended solids
X	solids concentration
Y	yield

Abstract (English)

The intensification of human activities is resulting in an increase in reactive nitrogen circulating in the environment and wastewater where its presence (under different forms) is undesired since it is known to cause eutrophication in receiving bodies, it is toxic for aquatic life and unsuited for human consumption. To protect the environment and the humans that are part of it, governments have imposed strict discharge norms to limit nitrogen emissions. With these increasingly strict norms came the need incorporate efficient nitrogen removal techniques in wastewater treatment practices.

Conventionally Biological Nitrogen Removal (BNR) is performed via nitrification-denitrification (N/DN). These processes are very effective for the removal of pollutants from wastewater, however, there is still much room for improvement in terms of cost- and energy efficiency and overall sustainability. For example, the organic carbon present in raw wastewater has an energy potential that greatly exceeds the electricity requirements for the applied treatments but part of this organic carbon is used for denitrification when N/DN processes are used for nitrogen removal. A more efficient treatment of this carbon (for example anaerobic digestion) could greatly improve the energy balance and sustainability of the process.

Since their discovery 30 years ago, anaerobic ammonium-oxidizing or anammox bacteria (AnAOB) have been conceptually proposed as game changers for the sustainability of sewage treatment, in so-called partial nitrification/anammox (PN/A). PN/A is an autotrophic nitrogen removal process based on two consecutive conversions: aerobic ammonium-oxidizing bacteria (AerAOB) oxidize part of the ammonium aerobically to nitrite and AnAOB subsequently oxidize the residual ammonium with the formed nitrite to harmless nitrogen gas. As PN/A does not require organic carbon and significantly lowers aeration (energy) demand, it fits perfectly in a scheme for energy-autarkic treatment of municipal wastewater as secondary (N) stage, enabling a primary (C) stage to maximize carbon capture and redirection for methane

production in the sidestream. A 40-50% reduction of energy consumption has been reported for full scale applications.

The next step towards more sustainable, energy-autarkic treatment of municipal wastewater would be to introduce anammox in the mainstream or waterline of sewage treatment plants to further improve their efficiency in terms of energy consumption (and hence economics) and greenhouse gas emissions. However, some challenges need to be overcome for the successful implementation of PN/A on pretreated sewage, so-called mainstream PN/A. The main challenges are associated with the development of robust methods to suppress nitrite oxidizing bacteria (NOB) and promote the growth and activity of AnAOB under relatively low influent nitrogen concentrations (40-80 mg NH_4^+ -N/L) and non-negligible amounts of biodegradable organic carbon. The presence of organic carbon can destabilize the PN/A process efficiency by (1) suppressing AnAOB activity or (2) promoting the growth of heterotroph bacteria (HB) which can use the COD for denitrification and compete with AnAOB for nitrite and space. Furthermore, and of particular interest for regions with a temperate (or cold) climate, relatively low sewage temperatures (below 15°C, down to 10°C or even below) drastically decrease AnAOB growth rates and activity suggesting that they would be even more at disadvantage at lower temperatures.

This thesis aimed to increasing the understanding of the short and long-term impact of low temperature on AnAOB rates, -enrichment, -adaptation and their ability to compete with HB. in the presence of organic carbon.

Short term effect of decreasing temperature AnAOB activity

The short-term effect of temperature decrease on the anammox rates was evaluated in anoxic batch tests between 30-10°C. Results showed that biomass types containing the largest aggregates (>315 µm) and rich in the *Ca. Kuenenia* were less sensitive to a decrease in temperature. Differences in sensitivity were more likely attributed to the genus rather than to aggregate size. Optimization of Arrhenius modelling by splitting into two temperature intervals (rather than using one global equation) improved the overall goodness of fit (R^2) and allowed to obtain more accurate θ -values enabling realistic process rate predictions which could in term help improve modelling for process design purposes.

Long term effect of decreasing temperature on AnAOB activity and enrichment

Two anammox sequencing batch reactors (SBR) with identical inoculum were operated under anoxic conditions on synthetic influent (60 mg N/L) and compared for one year. One was kept at 30°C while temperature in the other was step-wisely decreased from 30°C to 10°C. Minimal competition and high AnAOB retention (SRTs = 168d) resulted in the formation and retention of well settling granules at both 30°C and 10°C, indicating that lowering temperature is not detrimental to granulation and can even increase granule size. The observed AnAOB enrichment and adaptation (at genus level) contributed to achieving unprecedented removal rates of 82 and 92 mg NH_4^+ -N/g VSS/d at 12.5 and 10°C respectively.

Impact of temperature and organic carbon on the competition between AnAOB and HB

The impact of low concentrations of slowly biodegradable organic carbon on the competition between anammox and denitrification and how it is impacted by temperature was assessed by adding 30 mg COD/L (90% starch and 10% acetate to mimic HRAS effluent) the influent of the above-mentioned reactors at 30°C and 10°C. With relatively low COD/nitrite removal ratios (around 0.3 in both reactors), overall nitrogen conversion ratios were close to the anammox

stoichiometry. Anammox remained the dominant N-removal pathway throughout the experiment as (1) starch hydrolysis was rate limiting for denitrification and (2) HB preferred nitrate over nitrite. Flocs developed in both reactors which transitioned from purely granular to hybrid systems. While flocs became predominant at 30°, the system at 10°C remained predominantly granular, likely due to poorer floc formation and therefore higher floc wash-out, reflected in a lower SRT at 10°C (19d) compared to 30°C (26d). AnAOB abundance decreased greatly (87 to 37%) at 30°C and to a lesser extent (91 to 74%) at 10°C. Despite the observed decrease in AnAOB abundance, removal rates remained high in both reactors and rates of up to 112 mg NH₄⁺-N/gVSS/d were reached at 10°C. Interestingly, addition of organic carbon did not impact the dominant genera which remained *Ca. Brocadia* and *Ca. Kuenenia* in SBR_{30°C} and SBR_{10°C} respectively. These findings showed how application of differential SRT (here via the imposed settling time) can help in microbial resource management for achieving mainstream PN/A.

The finding from this research project show the potential of 'cold anammox' and provide insights that can contribute to the development of a suitable microbial resource management strategy for the implementation of mainstream PN/A applications.

Samenvatting

Samenvatting

Het intensifiëren van menselijke activiteiten veroorzaakt een toename in reactieve stikstof die circuleert in het milieu en in het afvalwater dat er deel van uitmaakt. De aanwezigheid van reactieve stikstof is ongewenst daar deze eutrofiëring veroorzaakt in waterlichamen, toxisch is voor aquatisch leven en bovendien ongeschikt is voor menselijke consumptie. Zo doende het milieu en de mensen daarin te beschermen tegen deze schadelijke effecten hebben overheden steeds striktere stikstof emissienormen opgelegd waardoor de noodzaak voor efficiënte stikstofverwijdering bij afvalwaterbehandeling toenam.

Conventionele biologische stikstofverwijdering gebeurt via nitrificatie-denitrificatie (N/DN). Hoewel deze processen erg effectief zijn voor het verwijderen van pollutanten uit afvalwater is er desalniettemin nog veel ruimte voor verbetering in termen van kost- en energie-efficiëntie. Zo vertegenwoordigt de organisch koolstof in onbehandeld afvalwater bijvoorbeeld een energypotentieel dat beduidend groter is dan de elektriciteitsbehoefte voor het behandelen van dit water. Een deel van deze organische koolstof wordt echter gebruikt voor denitrificatie wanneer N/DN-processen gebruikt worden voor stikstofverwijdering. Een efficiëntere behandeling van deze koolstof (bv. Anaerobe digestie voor biogasproductie) zou de energiebalans aanzienlijk verbeteren.

Sinds hun ontdekking 30 jaar geleden worden anaerobe ammonium-oxiderende bacteria (AnAOB) naar voren geschoven als 'game changers' voor de duurzaamheid van afvalwaterbehandeling via het zogenoemde partiële nitrificatie/anammox (PN/A). PN/A is een autotroof N-verwijderingsproces waarin ammonium eerst deels geoxideerd wordt tot nitriet door aerobe ammonium-oxiderende bacteria (AerAOB). Deze wordt vervolgens met de overgebleven ammonium wordt omgezet tot schadeloos stikstofgas voor AnAOB. Daar PN/A geen organische koolstof vereist en aanzienlijk lagere beluchting (en dus energie) vereist past

dit proces perfect in een schema voor energy-autarkische behandeling van afvalwater. Deze secundaire stikstofverwijdering in een zogenaamde (N-stage) laat toe om organische koolstof maximaal te recupereren in de primaire 'C-stage'. Deze kan vervolgens omgeleid worden richting methaanproductie in de sliblijn. Reducties van 40-50% in energieverbruik zijn gerapporteerd voor full-scale toepassingen.

De volgende stap naar een nog meer hernieuwbare, energie-neutrale afvalwaterbehandeling is het implementeren van anammox in de waterlijn van afvalwaterzuiveringsinstallaties om zo de efficiëntie in termen energieconsumptie en broeikasgasemissies verder te verbeteren. Er moeten echter nog een aantal hindernissen overwonnen worden alvorens deze implementatie haalbaar wordt. Deze zijn vooral geassocieerd met het promoten van de groei en activiteit van AnAOB bij relatief lage stikstofconcentraties (40-80 mg $\text{NH}_4^+\text{-N/L}$) en niet te verwaarlozen hoeveelheden biodegradeerbare koolstof. De aanwezigheid van organische koolstof kan het PN/A proces destabiliseren door (1) AnAOB activiteit te onderdrukken of (2) het promoten van de groei van heterotrofe bacteria (HB) die deze koolstof kunnen gebruiken voor denitrificatie en hierbij in competitie treden met AnAOB voor nitriet en ruimte. Bovendien hebben de relatief koude temperaturen (15-10°C of lager) geassocieerd met mainstream processen in regio's met koude of gematigde klimaten, een nefaste invloed op de groeisnelheid en activiteit van AnAOB waardoor ze extra benadeeld zijn in geval van competitie.

Deze thesis had als doel meer inzicht te vergaren betreffende de korte- en lange-termijnimpact van lage temperatuur op AnAOB activiteit, - aanrijking, - adaptatie en op hun capaciteit om te concurreren met HB in de aanwezigheid van organische koolstof.

Korte termijn effect van lage temperatuur op AnAOB activiteit

Het korte-termijneffect van dalende temperatuur op AnAOB activiteit werd geëvalueerd tijdens anoxische batch testen tussen 30 en 10°C. De resultaten toonden dat biomassatypes met de grootste aggregaten (>315µm) en rijk aan *Ca. Kueneenia* minder gevoelig waren voor lage temperatuur en dat dit eerder te wijten was aan het anammox genus dan aan de grootte van de aggregaten. Door het optimaliseren van de Arrhenius-schatting werd de 'goodness of fit' aanzienlijk verhoogd, hierbij werden meer accurate θ -waarden bekomen. Deze waarden laten toe om processnelheden beter te schatten en dragen zo bij tot beter modelleren voor bv. ontwerpdoeleinden.

Lange termijn effect van lage temperatuur op AnAOB activiteit en aanrijking

Twee anammox sequencing batch reactoren (SBR) met identiek inoculum werden gedurende een jaar geopereerd onder anoxische omstandigheden op synthetisch influent (60 mg N/L). Eén reactor werd aan 30°C gehouden terwijl de temperatuur in de andere reactor stapsgewijs verlaagd werd van 30 naar 10°C. Conditie voor minimale competitie en maximale AnAOB retentie (SRTs=168d) resulteerden in ontwikkeling en behoud van snel bezinkende granules, zowel bij 30°C als bij 10°C. Er werd aangetoond dat lage temperatuur niet nefast is voor granulatie en zelf kan leiden tot een grotere granule-diameters. De waargenomen AnAOB aanrijking en adaptatie (op genus level) droegen ertoe bij dat ongezien hoge verwijderingssnelheden van 82 en 92 mg NH₄⁺-N/g VSS/d verwezenlijkt werden bij 12.5 and 10°C respectievelijk

Impact van temperatuur en organische koolstof op de competitie tussen AnAOB en

HB

De impact van lage concentraties traag biodegradeerbare organische koolstof op de competitie tussen anammox en denitrificatie en hoe deze beïnvloed wordt door temperatuur werd onderzocht door 30 mg COD/L (90% zetmeel en 10% acetaat om HRAS effluent te

imiteren) toe te voegen aan het influent van de hierboven vermelde reactoren aan 30°C en 10°C. Met relatief lage C/nitriet verwijderingsratio's (0.3 in beide reactoren) volgden de globale conversieratio's de anammox stoichiometrie. Gedurende de studie was anammox de dominante N-verwijderingsroute aangezien in de testcondities (1) zetmeelhydrolyse de snelheidsbepalende stap was voor denitrificatie en (2) HB nitraat verkozen over nitriet. Vlokken ontwikkelden zich in beide reactoren die overgingen van puur granulaire systemen naar hybride systemen. Terwijl vlokken dominant werden bij 30°C bleef het systeem aan 10°C hoofdzakelijk granulaire, waarschijnlijk door een verminderde vlokvorming en bijgevolg verhoogd uitwassen van vlokken, weerspiegeld in een lagere SRT bij 10°C (19d) vergeleken met 30°C (26d). Dit toonde aan hoe het opleggen van een differentiële SRT AnAOB kan helpen in hun competitie met HB voor plaats. De AnAOB abundantie daalde scherp (van 87 naar 37%) bij 30°C en in mindere mate (91 naar 74%) bij 10°C. Ondanks de geobserveerde daling in AnAOB abundantie bleven de verwijderingssnelheden hoog in beide reactoren en werden snelheden tot 112 mg NH₄⁺-N/gVSS/d bereikt bij 10°C. Het toevoegen van organische koolstof had geen impact op het dominante AnAOB genera die respectievelijk *Ca. Brocadia* en *Ca. Kueneria* bleven in SBR_{30°C} en SBR_{10°C}.

De bevindingen van dit onderzoeksproject tonen het potentieel van 'koude anammox' en geven een aantal inzichten die kunnen bijdragen tot de ontwikkeling van een geschikte strategie voor 'Microbial Resource Management' voor de implementatie van mainstream PN/A toepassingen.

Résumé

L'intensification des activités humaines a entraîné une importante augmentation d'azote réactif circulant dans les écosystèmes et dans les eaux usées ou sa présence (sous différentes formes) est indésirable car en excès il est responsable d'eutrophisation dans les milieux récepteurs, il est toxique pour la vie aquatique et inapte à la consommation humaine. Afin de rétablir l'équilibre des écosystèmes et de protéger l'environnement et les humains qui en font partie, les gouvernements ont imposé des normes de rejet strictes pour limiter les émissions d'azote. De la rigueur de ces normes découle le besoin d'intégrer des procédés efficaces d'élimination de l'azote dans le traitement des eaux usées.

Conventionnellement, l'élimination biologique de l'azote est réalisée par nitrification-dénitrification (N/DN). Cette approche est très efficace pour éliminer les polluants des eaux usées mais il reste une grande marge pour optimisation en termes de coût (énergétique) et de durabilité. Par exemple, le carbone organique présent dans les eaux usées brutes a un potentiel énergétique qui dépasse largement les besoins en électricité des traitements réalisés mais une partie de ce carbone organique est utilisée pour la dénitrification lorsque des procédés N/DN sont utilisés. L'intégration d'un traitement plus efficace de ce carbone organique (par exemple la digestion anaérobie) pourrait grandement améliorer le rendement énergétique et la durabilité du procédé.

Depuis leur découverte, il y a 20 ans, les bactéries anammox (AnAOB), qui sont capables d'oxyder l'ammonium dans des conditions anoxiques, ont été considérées très prometteuses car elles permettraient un traitement durable des eaux usées via un processus appelé la nitrification partielle/anammox (PN/A). La PN/A est un procédé autotrophe d'élimination d'azote basé sur deux conversions consécutives : les bactéries aérobies oxydant l'ammonium (AerAOB) oxydent une partie de l'ammonium en nitrite et les AnAOB oxydent ensuite l'ammonium résiduel avec le nitrite formé en azote gazeux inoffensif. Comme le PN/A ne nécessite pas de carbone organique et réduit significativement la demande d'aération (réduction du coût énergétique), il s'intègre parfaitement dans un schéma de traitement autosuffisant en énergie

des eaux usées municipales. Son implémentation comme étape secondaire (N) permettrait de maximiser la récupération du carbone dans l'étape primaire (C) afin de le rediriger vers la ligne boue (ou *sidestream*) pour une valorisation optimale (e.g. production de méthane). Une réduction de 40 à 50% de la consommation d'énergie a été rapportée pour des applications anammox à grande échelle dans *le sidestream*.

La prochaine étape vers un traitement des eaux usées municipales plus durable et auto-suffisant en énergie consisterait à introduire anammox dans la ligne eau (ou *mainstream*) des stations d'épuration afin d'améliorer davantage leur efficacité en termes de consommation énergétique et d'émissions de gaz à effet de serre. Cependant, certains défis doivent être surmontés pour réussir la mise en œuvre du PN/A *mainstream*. Les principaux défis sont associés au développement de méthodes robustes pour réprimer les bactéries oxydant les nitrites (NOB) et promouvoir la croissance et l'activité des AnAOB sur des influents avec des concentrations d'azote relativement faibles (40-80 mg NH₄⁺-N/L) et contenant des quantités non négligeables de carbone organique biodégradable. La présence de carbone organique peut déstabiliser l'efficacité du processus PN/A en (1) réprimant l'activité AnAOB ou (2) favorisant la croissance des bactéries hétérotrophes (HB) qui peuvent utiliser le carbone organique pour la dénitrification et ainsi entrer en compétition avec les AnAOB pour le nitrite et l'espace. En outre, et particulièrement relevant pour les régions tempérées (ou froides), il a été rapporté que les températures des eaux usées relativement basses (inférieures à 15°C, jusqu'à 10°C ou même inférieures) réduisent drastiquement le taux de croissance et l'activité des AnAOB ce qui suggère qu'elles seraient encore plus désavantagées à des températures plus basses.

Cette thèse vise à accroître la compréhension de l'impact à court et à long terme des températures basses sur les taux d'AnAOB, l'enrichissement, l'adaptation et sur leur capacité à concurrencer les HB en présence de carbone organique.

Effet à court terme de la diminution de la température sur l'activité AnAOB

L'effet à court terme de la diminution de la température sur l'activité des AnAOB a été évalué dans des tests batch en conditions anoxiques entre 30 et 10°C. Les résultats ont montré que les types de biomasse contenant les plus grands agrégats (> 315 µm) et riches en *Ca*. *Kuenenia* étaient moins sensibles à une baisse de température. Les différences de sensibilité étaient plus probablement attribuées au genre plutôt qu'à la taille des agrégats. L'optimisation de la modélisation Arrhenius en divisant en deux l'intervalle de température (plutôt qu'en utilisant une équation globale) a amélioré la qualité globale de l'ajustement (R^2) et permet d'obtenir des valeurs θ plus précises permettant des prévisions réalistes des vitesses d'élimination qui pourraient, à terme, améliorer la modélisation pour la conception des procédés.

Effet à long terme de la diminution de la température sur l'activité et l'enrichissement AnAOB

Deux réacteurs séquentiel discontinus (ou '*sequencing batch reactor*', SBR) avec un inoculum identique ont été opérés dans des conditions anoxiques sur un influent synthétique (60 mg N/L) et comparés pendant un an. L'un a été maintenu à 30°C tandis que la température de l'autre a été progressivement réduite de 30°C à 10°C. La minimisation de la compétition et une rétention élevée des AnAOB (âge de boue ou '*sludge retention time*', SRT = 168 d) ont entraîné la formation et la rétention de granules à 30 °C et 10 °C, indiquant que la baisse de température ne nuit pas à la granulation et peut même augmenter la taille des granules. L'enrichissement et l'adaptation des AnAOB observés (au niveau du genre) ont contribué à atteindre des taux d'élimination sans précédent de 82 et 92 mg NH₄⁺-N/g VSS/d à 12.5 et 10 °C, respectivement.

Impact de la température et du carbone organique sur la compétition entre AnAOB et HB

L'impact des faibles concentrations de carbone organique lentement biodégradable sur la compétition entre l'anammox et la dénitrification et comment elle est impactée par la température a été évalué en ajoutant 30 mg/L de carbone organique (90% d'amidon et 10% d'acétate pour imiter l'effluent HRAS) aux influents des réacteurs mentionnés ci-dessus à 30°C et 10 °C. Avec des ratios d'élimination carbone/nitrite relativement faibles (environ 0.3 dans les deux réacteurs), les taux de conversion globaux de l'azote étaient proches de ceux de la stœchiométrie anammox. La voie principale d'élimination de l'azote est restée anammox tout au long de l'expérience car (1) l'hydrolyse de l'amidon était lente et limitante pour la dénitrification et (2) HB avaient une préférence pour le nitrate sur le nitrite. Des floccs se sont développés dans les deux réacteurs qui sont passés de systèmes purement granulaires à des systèmes hybrides. Alors que les floccs sont devenus prédominants à 30°C, le système à 10°C est resté majoritairement granulaire, probablement dû à une formation de floccs plus faible et donc à un lessivage plus important des floccs, reflété dans un temps de rétention plus court à 10 °C (19d) comparé à 30°C (26d). L'abondance d'AnAOB a diminué considérablement (87 à 37%) à 30 °C et dans une moindre mesure (91 à 74%) à 10 °C. Malgré la diminution observée de l'abondance d'AnAOB, les taux d'élimination sont demeurés élevés dans les deux réacteurs avec des taux allant jusqu'à 112 mg NH₄⁺-N/g VSS/d à 10 °C. Il est intéressant de souligner que l'addition de carbone organique n'a pas eu d'impact sur les genres dominants qui sont restés *Ca. Brocadia* et *Ca. Kuenenia* à 30°C et 10°C respectivement. Ces résultats ont montré comment l'application de une âge de boue différentielle (ici via le temps de décantation imposé) peut aider la gestion des ressources microbiennes à atteindre la PN/A traditionnelle.

Les conclusions de ce projet de recherche démontrent le potentiel de « l'anammox froid » et fournissent des idées qui peuvent contribuer à l'élaboration d'une stratégie de gestion des ressources microbiennes, adaptée à la mise en œuvre d'applications du procédé PN / A.

Table of content

CHAPTER I: INTRODUCTION
1.1. INTRODUCTION.....	1
1.2. FROM WASTEWATER TREATMENT PLANT (WWTP) TO WATER RESOURCE RECOVERY FACILITY (WRR) 5	5
1.3. KEY MICROBIAL PROCESSES FOR BIOLOGICAL NITROGEN REMOVAL (BNR).....	9
1.4. MAINSTREAM PN/A: FROM ECOPHYSIOLOGY TO PROCESS TECHNOLOGY THROUGH MICROBIAL RESOURCE MANAGEMENT (MRM)	14
1.6. RESEARCH QUESTIONS AND THESIS OUTLINE	21
1.7. REFERENCES.....	24
CHAPTER II INSTANT COLD TOLERANCE IMPACTED BY ANAMMOX GENUS RATHER THAN BY AGGREGATE SIZE	32
ABSTRACT	33
2.1. INTRODUCTION.....	35
2.2 MATERIALS AND METHODS	37
2.2.1. <i>Types of biomass</i>	37
2.2.2. <i>Determination of specific ammonium removal rate (SARR)</i>	38
2.2.3. <i>Size fractionation and disaggregation treatment</i>	39
2.2.4. <i>Determination of activation energy and temperature coefficient</i>	40
2.2.5. <i>Analytical methods</i>	41
2.2.6. <i>Microbial community analysis: 16S rRNA gene amplicon sequencing</i>	41
2.3. RESULTS	42
2.3.1 <i>Biomass composition and aggregate size</i>	42
2.3.2. <i>Effect of temperature on AnAOB activity</i>	44
2.4. DISCUSSION	48
<i>Role of aggregate size</i>	50
2.5. CONCLUSIONS	54
2.6. ACKNOWLEDGEMENTS.....	55
2.7. CONFLICTS OF INTEREST	55
2.8. REFERENCES.....	56
CHAPTER III ENRICHMENT AND ADAPTATION YIELD HIGH ANAMMOX CONVERSION RATES UNDER LOW TEMPERATURES.....	60
3.1. INTRODUCTION.....	63
3.2. MATERIAL AND METHODS	65
3.2.1 <i>Set-up and operation of the reactors</i>	65
3.2.2 <i>Biomass inoculum mix</i>	67
3.2.3 <i>Anammox activity and chemical analyses</i>	67
3.2.4 <i>Particle size distribution of the biomass aggregates</i>	69
3.2.5 <i>Microbial community analyses</i>	69
3.3. RESULTS	70
3.3.1. <i>Reactor performance</i>	70
3.3.1.1. <i>Start-up of the reactors</i>	70
3.3.1.2. <i>Activity evolution at constant temperature (30°C)</i>	71
3.3.1.3. <i>Activity evolution at decreasing temperature (30°C to 10°C)</i>	72
3.2 BIOMASS AGGREGATE SIZE AND MICROBIAL COMMUNITY ANALYSIS.....	76
3.2.1 <i>Biomass particle size distribution</i>	76
3.2.2 <i>Evolutions in the microbial community</i>	77
3.4. DISCUSSION	81
3.4.1 <i>Enrichment and adaptation favoring high specific activities</i>	81
3.4.2 <i>Potential AnAOB genus niche differentiation</i>	86
3.4.3 <i>Towards implementation of partial nitrification/anammox</i>	88
3.5. CONCLUSIONS	89

3.6. ACKNOWLEDGEMENTS.....	89
3.7. REFERENCES.....	90
CHAPTER IV IMPACT OF SLOWLY BIODEGRADABLE ORGANIC CARBON ON THE COMPETITION BETWEEN ANAMMOX BACTERIA AND DENITRIFIERS AT DIFFERENT TEMPERATURES.....	94
IMPACT OF SLOWLY BIODEGRADABLE ORGANIC CARBON ON THE COMPETITION BETWEEN ANAMMOX BACTERIA AND DENITRIFIERS AT DIFFERENT TEMPERATURES.....	96
4.1. INTRODUCTION.....	97
4.2 MATERIAL AND METHODS	100
4.2.1 <i>Set-up and operation of the reactors</i>	100
4.2.3 <i>Anammox activity and chemical analyses</i>	101
4.2.4 <i>Microbial community analyses</i>	103
4.3. RESULTS	103
4.3.1. <i>Reactor performance</i>	103
4.3.1.1. Activity evolution at high temperature (30°C)	103
4.3.1.3. COD removal	108
4.3.2 <i>Biomass aggregate size and microbial community analysis</i>	109
4.3.2.1 Transition from granular system to hybrid system with flocs.....	109
4.3.2.2 Evolutions in the microbial community	110
4.4. DISCUSSION	113
4.4.1 <i>Competition between AnAOB and HB for nitrite during</i>	113
4.4.2 <i>Differential SRT favors retention of AnAOB over HB at low temperature</i>	116
4.5. CONCLUSIONS	119
4.6. ACKNOWLEDGEMENTS.....	119
4.7. REFERENCES.....	120
CHAPTER V CONCLUSIONS	124
5.1. INTRODUCTION.....	126
5.2. MAJOR FINDINGS.....	127
5.3. IMPLICATIONS FOR MICROBIAL RESOURCE MANAGEMENT	129
5.4. DESIGN CHOICES FOR MAINSTREAM PN/A SYSTEMS	130
5.5. REFERENCES.....	133
SUPPLEMENTARY INFORMATION	134
COMPILED REFERENCE LIST.....	154

Chapter I: Introduction

1.1. Introduction

A brief History of water management

It is often said that “water is life”. Indeed, water is essential to all life on earth and key for human survival on this planet, yet humanity has taken centuries to realize its importance. ‘Proper’ management of the wastewater originating from human activities, as we know it today, has had a slow development and has only been around for approximately one hundred years (Figure 1.1).

The most rudimentary drainage systems were found during early historic times in Mesopotamia, the Indus valley and Egypt. Later, the Greek started managing wastewater by redirecting it to a collection basin outside the city before conveying it to agricultural fields for irrigation and to fertilization of crops. But the first integrated water service, managing from collection to disposal and water recycling (e.g. for flushing latrines) was introduced by the Romans. After the collapse of the Roman empire, during the middle ages, the culture of water as a source of health and wellness was abandoned and water was discharged to rivers without any form of treatment, this was one of the main causes for the many spreads of disease during this period of time. Even though economic, social and institutional constraints changed water management for the better in the 19th century with the introduction of the first primary and secondary treatment technologies, the real revolution in wastewater management, environmental sciences and societal views towards pollution did not come until the 20th century. One pivotal moment was the “Eight Report of the Royal Commission on Sewage Disposal” (1912) which introduced the concept of biochemical oxygen demand (BOD) and established standardized test to be applied to sewage and sewage effluents (Lofrano & Brown, 2010).

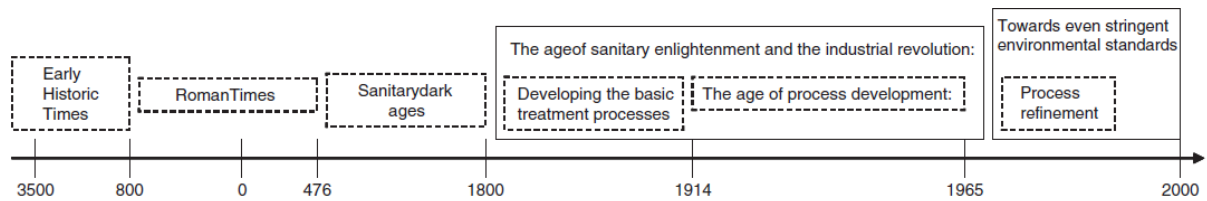

Figure 1.1 – Evolution of sanitation throughout human history (Lofrano & Brown, 2010)

Despite many technology advancements that have followed, and in light of the rapidly increasing world population, it is estimated that by 2050, at least one in four people is likely to live in a country affected by chronic or recurring shortage of fresh water if no proper action is taken (Mekonnen & Hoekstra, 2016). To address this problem, the United Nations (UN) have integrated “clean water and sanitation” in their Sustainable development goals (SDGs) for 2030. One of the set goals is to implement have “integrated water resources management at all levels, including through transboundary cooperation as appropriate” (WWAP, 2017).

There is no doubt that policy makers and researchers from both industry and academia have a big responsibility to contribute to achieving these goals and it is my opinion that collaboration is key to the success of such venture. This PhD project is just a small example of how three centers of expertise (SUEZ, LISBP and CMET) have combined efforts to help tackle the challenges that lie ahead and I am grateful to have been part of it.

Anthropogenic nitrogen flows and impacts on environment

Nitrogen is a key atom in amino acids, proteins and nucleic acids and therefore essential to life. The biggest reserve of nitrogen on earth is the unreactive dinitrogen gas in the atmosphere. Until some years ago, biological denitrification was considered the main source of dinitrogen gas in the atmosphere. However, Kuypers et al. showed that biological anoxic ammonium oxidation (anammox) could be responsible for 30 to 50% of the global dinitrogen production (Kuypers et al., 2003).

Unreactive nitrogen can be transformed into reactive nitrogen via biological nitrogen fixation as part of the nitrogen cycle and to a lesser degree by lightning strikes and combustion of fossil fuels. Biological nitrogen fixation is the process performed by specialized prokaryotes called diazotrophs which are either free-living or colonizing plant roots. About 100 years ago, when agriculture was being intensified to feed earth's growing population, the Haber-Bosch process was developed to provide the fertilizers needed for crop production. This process catalytically combines hydrogen and nitrogen gas to ammonia ($N_2 + 3 H_2 \rightarrow 2 NH_3$) under high pressure and temperature (300-550°C, 15-25 MPa, (Chagas, 2007).

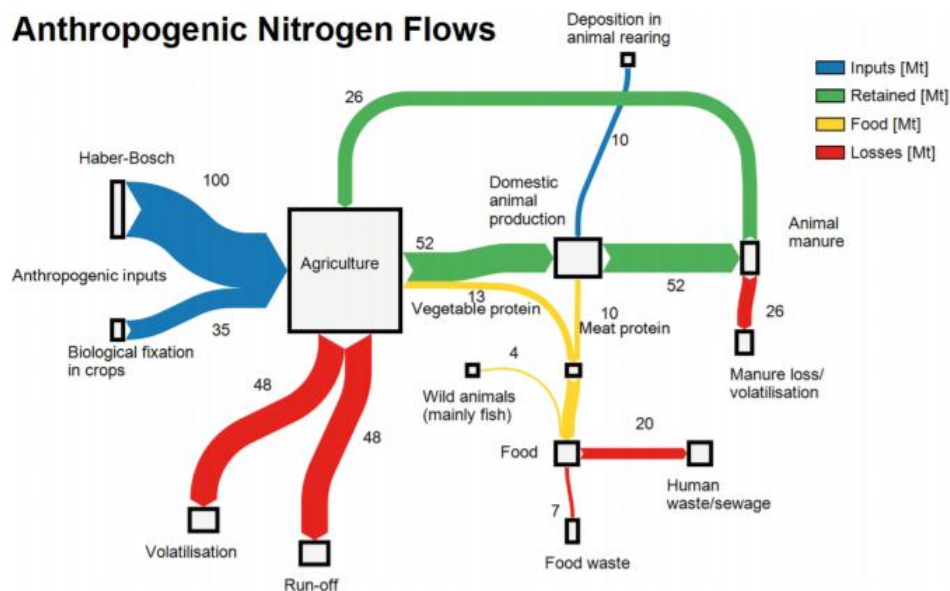

figure 1.2 - Anthropogenic nitrogen cycle proportional to current Haber-Bosch fixation (100 Mt), with a focus on industrialized agriculture (Matassa et al., 2015)

The intensification of human activities is resulting in an increase in reactive nitrogen circulating in the environment (Figure 1.2). Estimations indicate that of 135 million tons N entering the agricultural process (Haber-Bosch, Biological fixation in crops), 17% is retained in vegetable and meat protein (of which only half is actually consumed, (Coppens et al., 2016), and 15% in the urban wastewater process. The remainder is dissipated to the natural environment (Matassa et al., 2015).

Nitrogen in wastewater is commonly present as ammonium, in chemical equilibrium with ammonia which is toxic to aquatic life, even in concentrations as low as 0.25 mg NH₃ /L (Randall & Tsui, 2002). It is also known to cause eutrophication in receiving water bodies leading to oxygen depletion, a loss of biodiversity and in the case of toxic blooms, extensive fish and shellfish mortality (Conley et al., 2009). Another important issue is associated with elevated nitrite and nitrate levels in drinking and surface water. Excessive consumption can lead to accumulation of methemoglobin in the blood called methemoglobinemia (Knobeloch et al., 2000). This condition is more commonly known as “blue baby syndrome” since babies are most prone to developing it. Next to being unsuited for human consumption, nitrate and especially nitrite are also toxic in aquatic environments and harm aquatic life.

To protect the environment and the humans that are part of it, governments have imposed strict discharge norms (depending of the region and sensitivity of the receiving water bodies) to limit nitrogen emissions. For example, since 1995 Flemish regulations stipulated that waters must be treated to contain less than 2 mg NH₄⁺-N/L of ammonium, less than 1 mg NO₂⁻/L and less than 10 mg N/L of total nitrogen prior to discharge (Flemish government, 1995). With these increasingly strict norms came the need incorporate efficient nitrogen removal techniques in wastewater treatment practices.

1.2. From wastewater treatment plant (WWTP) to water resource recovery facility (WRRF)

In most WWTP operated today, pollutants are removed in what is called the “**Conventional Activated Sludge (CAS)**” process. Even though configurations may vary to meet the required capacity and local discharge limits, its basic principle is still based on the first biological sewage treatment process, then called “**activated sludge (AS)**”, developed approximately 100 years ago in Manchester, England (Ardern & Lockett, 1914) to remove organic carbon from wastewater.

After removal of debris (via screens) and well-settling (non-)biodegradable particles (in a primary settler), the incoming wastewater entered an aerated basin where micro-organisms took up oxygen to convert organic carbon into CO_2 and biomass growth, roughly 50-50. After removal of the solids (in a secondary settler) and polishing over a sand filter, the treated water was considered ready for discharge.

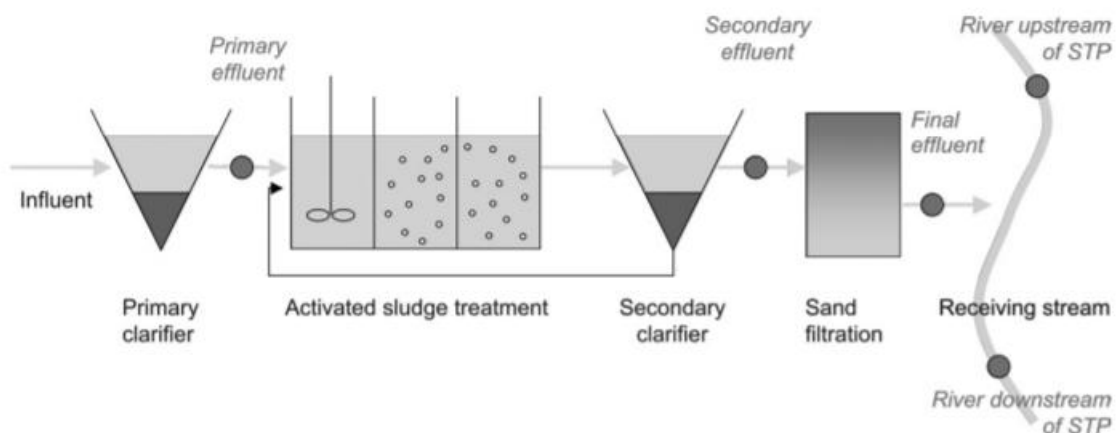

Figure 1.3 – Conventional activated sludge installation, adapted from (Escher et al., 2008)

As the understanding of the impact of wastewater on the environment grew, so did the technology. It became clear that, to avoid eutrophication in receiving water bodies, nitrogen and phosphorus also needed to be removed prior to discharge. As a result methods for biological removal of nitrogen (Ludzack & Ettinger, 1962) and phosphorus (Barnard, 1974) were being explored in the 60's and 70's respectively. To allow the different biological

conversions to take place, alternations were made between anoxic and aerobic zones. This was the beginning of the more simple CAS configurations (Figure 1.3).

The CAS approach has proven to be very effective for removing pollutants from wastewater, explaining why the technology has stood for so long. However, there is still much room for improvement in terms of cost- and energy efficiency and overall sustainability (e.g. related to reducing N₂O emissions, micro-pollutants, dosed chemicals).

Up until recently, used water was considered as a waste stream from which organic carbon, nitrogen and phosphorus needed to be removed at any cost. With the introduction of the concept of 'Circular economy', this philosophy changed and used water is gradually being considered as a resource from which energy and nutrients can be recovered. Today the use of '**Water Resource Recovery Facility (WRRF)**' is promoted over 'wastewater treatment plant (WWTP)' by the WEF (Matthew Ries, CTO of WEF during IRRC conference 2017).

Focusing on nitrogen removal

Conventionally Biological nitrogen removal (BNR) is performed via **nitrification-denitrification (N/DN)**. Nitrification is the process where ammonium is first oxidized to nitrite by aerobic ammonium oxidizing bacteria (AerAOB) and subsequently into nitrate by nitrite oxidizing bacteria (NOB). After this heterotrophic bacteria (HB) use the organic carbon present in the wastewater to reduce the produced nitrate into nitrogen gas. However, the organic carbon present in raw wastewater have an energy potential that greatly exceeds the electricity requirements for the applied treatments. When N/DN processes are used for nitrogen removal, a part of this organic matter is wasted and in that case an effective use of the contained COD is only performed when treating primary and secondary sludge, which are normally anaerobically digested and energy is recovered through methane production (Wett, 2007).

Since its discovery 30 years ago, anaerobic ammonium-oxidizing or anammox bacteria (AnAOB) have been conceptually proposed as game changers for the sustainability of sewage

treatment, in so-called **partial nitritation/anammox** (PN/A) (Jetten et al., 1997). PN/A is an autotrophic nitrogen removal process based on two consecutive conversions: AerAOB oxidize part of the ammonium aerobically to nitrite and AnAOB subsequently oxidize the residual ammonium with the formed nitrite to harmless nitrogen gas. As PN/A does not require organic carbon and significantly lowers aeration (energy) demand, it fits perfectly in a scheme for energy-autarkic treatment of municipal wastewater as secondary (N) stage, enabling a primary (C) stage to maximize carbon capture and redirection for methane production in the sidestream. Many advancements have been made, close to one hundred full scale side-stream anammox installations, usually treating digestate, landfill leachate or reject water, have seen the light of day by the end of 2013 (Lackner et al., 2014). Which helped reduce energy consumption by 40-50% (Siegrist et al., 2008). A possible WRRF configuration with sidestream PN/A can be seen below in figure 1.4a.

The next development goal is to introduce anammox in the mainstream or waterline of sewage treatment plants in order to further improve their efficiency in terms of energy consumption (and hence economics) and greenhouse gas emissions. Adaptation to mainstream could potential generate an energy production of $24 \text{ Wh pe}^{-1} \text{ d}^{-1}$ which is a big leap forward from the conventional treatment methods that conventionally consumption of $44 \text{ Wh pe}^{-1} \text{ d}^{-1}$ (Kartal et al., 2010; Morales et al., 2015). A possible WRRF configuration with PN/A integrated in the mainstream can be seen in Figure 1.4.b)

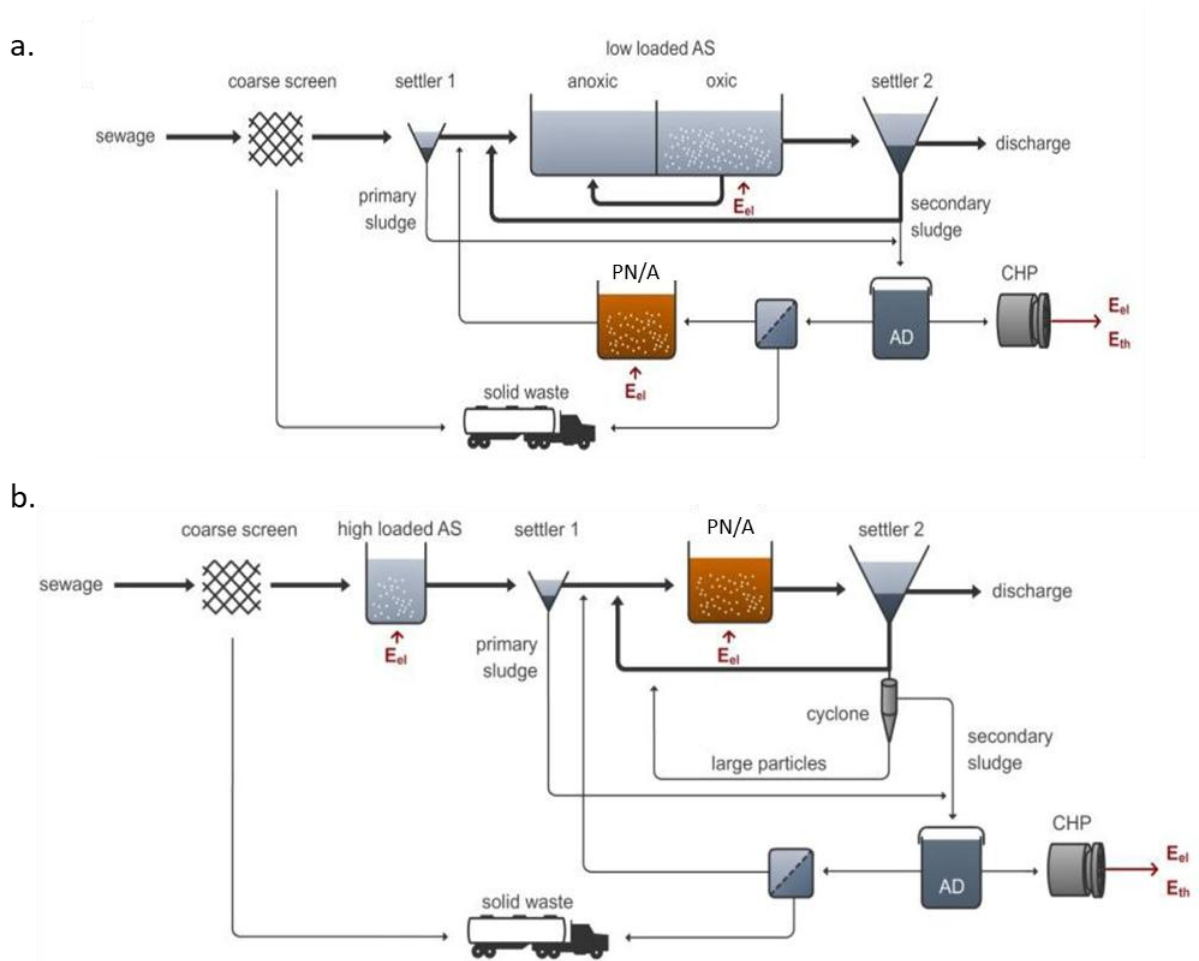

Figure 1.4 – Possible WRRF configurations with PN/A implemented on the sidestream (a) or mainstream (b) (Adapted from (Vlaeminck et al., 2012) AS: activated sludge; PN/A: partial nitritation anammox; AD: anaerobic digestion; CHP: combined heat and power; $E_{el/th}$: electrical/thermal energy)

1.3. Key microbial processes for biological nitrogen removal (BNR)

Recently, access to new molecular tools has shed some light on the heterogeneity of the microbial communities and their complex metabolic synergies occurring in the nitrogen cycle, and by extension within PN/A set-ups. These findings are of great academic value and have changed the view of the 'classical' nitrogen cycle that stood until 20 years ago. This introduction will focus on the four key microbial processes (nitrification, nitratation, heterotrophic denitrification and anammox) as well as combinations conventionally applied during biological nitrogen removal (nitrification/denitrification and partial nitrification/anammox) as shown in Figure 1.5 and Table 1.1

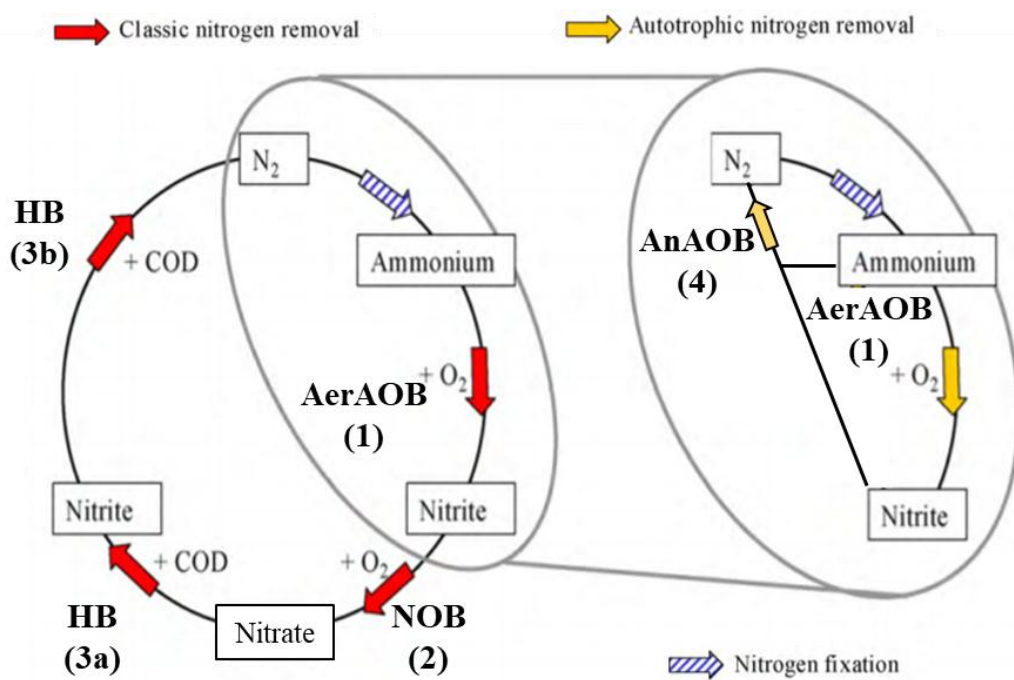

Figure 1.5. Simplified Biological Nitrogen cycle with autotrophic N-removal (adapted from (Van Hulle et al., 2010))

1.3.1. Aerobic ammonium oxidation (nitrification)

In the presence of oxygen, aerobic ammonium oxidizing bacteria catalyze the two-step oxidation of ammonium (or more correctly ammonia, NH_3) into nitrite (Figure 1.5, pathway 1). First, ammonium is converted into hydroxylamine (NH_2OH), via a membrane-bound enzyme ammonium monooxygenase (*amo*). The second step is the oxidation of hydroxylamine into nitrite by a hydroxylamine reductase (*hao*) (Kowalchuk & Stephen, 2001).

Traditionally the AerAOB found in WWTP belong to the Nitrosomonas (*N. oligotropha*, *N. europaea/eutropha* and *N. communis*) (Koops, 2001) or Nitrospira genera of the β -proteobacteria Phylum.

1.3.2. Aerobic nitrite oxidation (nitrification)

Nitrite oxidizing bacteria (NOB) use oxygen to convert the nitrite (produced by nitrification) into nitrate with a nitrite oxidoreductase (*nxr*) enzyme (Figure 1.5, pathway 2).

The most relevant NOB in WWTPs belong to the genera of *Nitrobacter* (Phylum α -proteobacteria), *Nitrospira* (Phylum Nitrospirae) or *Candidatus Nitrotoga* (Phylum β -proteobacteria). Low nitrite concentrations favor the k-strategist *Nitrospira* (high affinity for nitrite) over the r-strategist *Nitrobacter*, which, due to its higher growth rate, can outgrow the former when nitrite is not limiting (Nowka et al., 2015).

1.3.3. Heterotrophic denitrification

During Heterotrophic nitrification, a step-wise reduction of nitrate and/or nitrite into nitrogen gas is performed by heterotrophic bacteria (HB_{NO_x}) using organic carbon as an electron donor (Figure 1.5, pathway 3). Nitrate is reduced to nitrite which is subsequently reduced to NO and further into N_2O which is finally converted into nitrogen gas. The enzymes catalyzing these reactions are nitrate reductase (*nar*), nitrite reductase (*nir*), nitric oxide reductase (*nor*) and nitrous oxide reductase (*nos*) respectively (Zumft, 1997).

Heterotrophic Bacteria are abundant in all WWTPs and very diverse, often associated with the phyla of Bacteroidetes, Proteobacteria, Actinobacteria, Acidobacteria, Chlorobi, Chloroflexi (Agrawal et al., 2017a).

1.3.4. Anaerobic ammonium oxidation (anammox)

Anaerobic ammonium oxidizing bacteria (AnAOB) are known to oxidize ammonium to nitrogen gas with nitrite as electron acceptor under anoxic conditions, forming nitrate in the process (Figure 1.5, pathway 4). This transformation is done in three consecutive, coupled reactions with two intermediates, nitric oxide (NO) and hydrazine (N₂H₄). First, nitrite is reduced to NO with nitrite reductase (*nir*) which is then, as we understand, condensed with ammonium to form hydrazine, via a $\alpha\beta\gamma$ multi-enzyme complex hydrazine synthase (*HZS*) (Dietl et al., 2015). Finally, hydrazine is oxidized to dinitrogen gas by hydrazine dehydrogenase (*hdh*) (Kartal et al., 2012).

All reported AnAOB belong to the order of the Brocadiales (phylum Planctomycetes) and can be divided into five “*Candidatus*” genera. Four of these genera (*Ca. Kuenenia*, *Ca. Brocadia*, *Ca. Anammoxoglobus* and *Ca. Jettenia*) have been enriched from activated sludge (Strous, et al., 1999). The fifth (*Ca. Scalindua*) has mostly been detected in natural habitats such as marine sediments and oxygen minimum zones (Jetten, et al., 2009). Of the above-mentioned genera, *Ca. Brocadia* and *Ca. Kuenenia* are most abundant in engineered anammox systems, however a consensus is yet to be found on how key drivers such as high/low affinity for substrate, sensitivity to low temperature and/or to inhibitors etc. impact the niche differentiation between different AnAOB genera (see Chapter 3).

At first it was considered that AnAOB were obligate autotrophs and thus unable to convert organic carbon substrate. However, recent studies have reported that some AnAOB species including *Ca. Jettenia asiatica*, *Ca. anammoxoglobus propionicus*, *Ca. Brocadia fulgida* and *Ca. Kueneria stuttgartiensis* have the capacity to oxidize smaller organic electron donors such as acetate and propionate with nitrate as an electron acceptor while forming ammonium with nitrite as intermediate (Güven et al., 2005; Kartal et al., 2007; Kartal et al., 2008; Shu et al., 2016). This organotrophic capacity has advantages for wastewater treatment as it would allow to further reduce nitrate in the effluent. Also, since the oxidized organic carbon is completely oxidized to CO₂ and not incorporated into biomass, the biomass yield is reduced and less excess sludge is produced (Boran et al., 2007; Winkler et al., 2012). It is easy to imagine how this can potentially affect the competition between AnAOB and HB when organic carbon is present.

1.3.5. Other pathways

- **Autotrophic denitrification** which is the reduction of nitrate and/or nitrite to nitrogen gas using Hydrogen (produced *in situ* from fermentation) or Sulphur-compounds as electron donors. This process could potentially replenish the nitrite pool and increase the nitrogen removal by (Speth et al., 2016). This process can be an interesting approach for wastewaters with low bCOD/N since the (expensive) addition of external COD could be avoided by introducing more elegant solutions e.g. the use of packed bed reactors containing limestone (Vandekerckhove et al., 2018).
- **Complete ammonium oxidation (Comammox)** is the combined ammonium and nitrite oxidation performed by a single organism during growth via ammonium oxidation to nitrate. This process, performed by certain species of the *Nitrospira* genus, has been reported to co-exist with the anammox process under oxygen limiting conditions (Daims et al., 2015; van Kessel et al., 2015). However, given their oligotrophic lifestyle and low specific activities (Kits et al., 2017), it is unlikely that these organisms would be significantly abundant in PN/A systems.

Table 1.1 Overall stoichiometry of the 4 key microbial processes (nitrification, nitratation, denitrification and anammox) as well as combinations conventionally applied during Biological nitrogen removal (nitrification/denitrification and partial nitrification/anammox) (after Desloover, 2013; Vlaeminck, 2009).

Process	Number	Overall stoichiometry	
Nitrification (AerAOB)	1	Substrate	$\text{NH}_4^+ + 1.382 \text{ O}_2 + 0.091 \text{ HCO}_3^-$
		Products	$0.982 \text{ NO}_2^- + 1.891 \text{ H}^+ + 0.091 \text{ CH}_{1.4}\text{O}_{0.4}\text{N}_{0.2} + 1.036 \text{ H}_2\text{O}$
Nitratation (NOB)	2	Substrate	$\text{NO}_2^- + 0.488 \text{ O}_2 + 0.003 \text{ NH}_4^+ + 0.01 \text{ H}^+ + 0.013 \text{ HCO}_3^-$
		Products	$\text{NO}_3^- + 0.013 \text{ CH}_{1.4}\text{O}_{0.4}\text{N}_{0.2} + 0.008 \text{ H}_2\text{O}$
Denitrification (HB _{NOX})	3	Substrate	$\text{NO}_3^- + 1.080 \text{ CH}_3\text{OH}$
		Products	$0.467 \text{ N}_2 + \text{OH}^- + 0.760 \text{ CO}_2 + 0.325 \text{ CH}_{1.4}\text{O}_{0.4}\text{N}_{0.2} + 1.440 \text{ H}_2\text{O}$
Anammox (AnAOB)	4	Substrate	$\text{NH}_4^+ + 1.32 \text{ NO}_2^- + 0.066 \text{ HCO}_3^- + 0.13 \text{ H}^+$
		Products	$1.02 \text{ N}_2 + 0.26 \text{ NO}_3^- + 0.066 \text{ CH}_2\text{O}_{0.5}\text{N}_{0.15} + 2.03 \text{ H}_2\text{O}$
Nitrification/denitrification (N/DN)	1+2+3	Substrate	$\text{NH}_4^+ + 1.856 \text{ O}_2 + 1.058 \text{ CH}_3\text{OH}$
		Products	$0.457 \text{ N}_2 + 1.010 \text{ H}^+ + 0.641 \text{ CO}_2 + 0.421 \text{ CH}_{1.4}\text{O}_{0.4}\text{N}_{0.2} + 2.349 \text{ H}_2\text{O}$
Partial nitrification/anammox (PN/A)	1+4	Substrate	$\text{NH}_4^+ + 0.792 \text{ O}_2 + 0.080 \text{ HCO}_3^-$
		Products	$0.435 \text{ N}_2 + 1.029 \text{ H}^+ + 0.111 \text{ NO}_3^- + 0.052 \text{ CH}_{1.4}\text{O}_{0.4}\text{N}_{0.2} + 0.028 \text{ CH}_2\text{O}_{0.5}\text{N}_{0.15} + 1.460 \text{ H}_2\text{O}$

1.4. Mainstream PN/A: From ecophysiology to process technology through microbial resource management (MRM)

Compared to sidestream PN/A, on sludge reject water, it is considerably more complex to achieve sufficiently high nitrogen removal rates and efficiencies for the mainstream process (Lotti et al., 2015). Particularly winter time in colder climates challenges rates, necessitating a high AnAOB inventory and SRT. Characteristics of the pre-treated sewage impact removal efficiencies, as, besides AerAOB and AnAOB, at least four metabolic types are competing for four substrates, i.e. ammonium, oxygen, nitrite and organic carbon (Figure 1.6), and therefore also for space. Oxygen supports nitrite-oxidizing bacteria (NOB) and aerobic heterotrophs (HB_{Aer}) competing with AerAOB; and NOB and anoxic heterotrophs (HB_{NO₂⁻}) compete for nitrite with AnAOB.

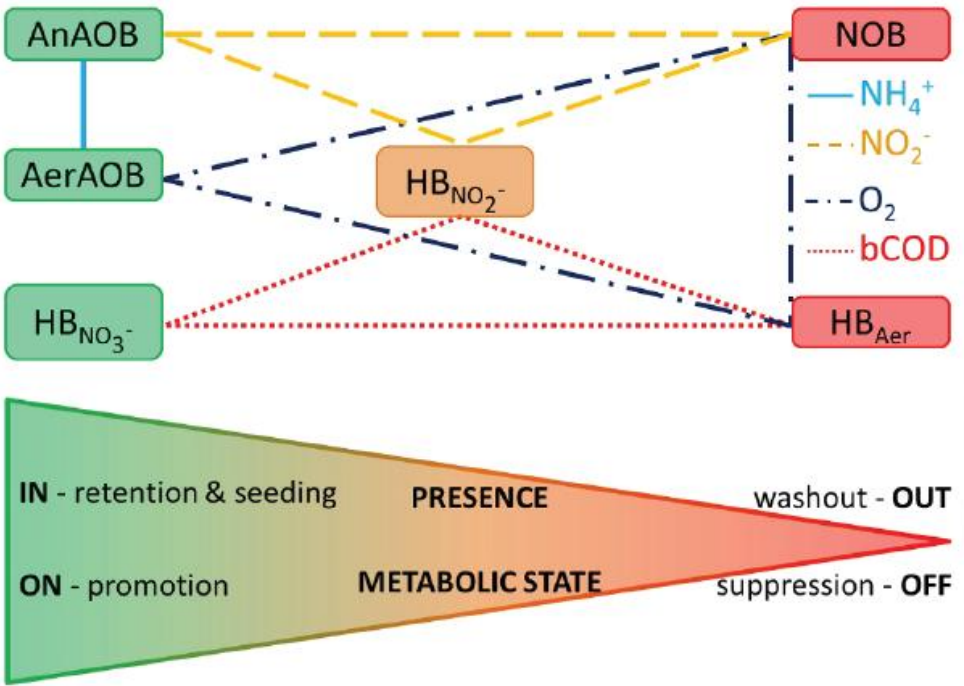

Figure 1.6 - Top: Network of competitions occurring in mainstream PN/A systems between six microbial functions for four substrates. **Bottom:** (De)Crescendo of the preferred presence and metabolic state of the six microbial function to achieve successful mainstream PN/A. An/AerAOB: Anoxic/Aerobic ammonium oxidizing bacteria; NOB: nitrite oxidizing bacteria; HB_{NO₃⁻/NO₂⁻/Aer}: Heterotrophic bacteria consuming NO₃⁻/NO₂⁻/O₂ (Agrawal et al., 2018)

Until now, several PN/A strategies have been proposed to steer microbial competition, but some are not yet reproduced and lack general consensus. These strategies aimed at (1) promoting growth and activity of AerAOB, AnAOB, and tolerating the activity of nitrite and nitrate reducing heterotrophs (HB_{NOX^-}) while suppressing the aerobic activity of NOB, we label this as “ON/OFF” control; and (2) washing-out NOB and heterotrophs from the reactors, while selectively retaining (and seeding) AerAOB and AnAOB, labelled as “IN/OUT” control (Figure 1.7).

1.4.1. ON/OFF control

Studies based on the ON/OFF control strategy implemented specific oxygen and/or substrate supply patterns or controlled exposure to certain inhibitors to steer the metabolic state of the different microbial groups in the process. Some examples of strategies are:

(a) maintaining a **residual ammonium concentration** (*i.e.* 2-4 mg N L⁻¹) for efficient NOB suppression in PN/A (Poot et al., 2016). It allows sufficient oxygen limitation in biofilms which helps obtain nitrifical granular reactors and protect AnAOB from oxygen inhibition (Lotti et al., 2015). In floccular systems, the specific growth rate of AerAOB is promoted to ensure that the dissolved oxygen (DO) is the rate limiting parameter during aeration (Isanta et al., 2015; Third et al., 2001).

(b) **aeration control** using either Continuous low DO-setpoints (< 0.2 mg O₂ L⁻¹) to minimize AnAOB oxygen inhibition, and increase their competitiveness for nitrite in the biofilm (Pérez et al., 2014; Wett et al., 2013) or Intermittent aeration or so-called “transient anoxia” to balance the periodic supply of oxygen to exploit the nitrifical lag (minimum 15-30 min. anoxic) (Laureni et al., 2016; Morales et al., 2016), complete nitrite consumption in the anoxic phase and limit AnAOB inhibition by oxygen (Gilbert et al., 2014a); Seuntjens D. et al., submitted). Typically, higher DO-setpoints (> 1.5 mg O₂ L⁻¹) are used to maximize activity of AerAOB over NOB (Han et al., 2016; Isanta et al., 2015; Kornaros et al., 2010; Third et al., 2001).

(c) exposing flocs to **inhibitors such as free ammonia (FA) and free nitrous acid (FNA)** to suppressed NOB with 80-90% nitritation in a floccular reactor (Agrawal et al., 2017b). As FA and FNA cannot reach inhibitory concentrations in the mainstream, a return-sludge treatment, that exposed thickened flocs from the clarifier, has been proposed.

1.4.2. IN/OUT control

IN/OUT control refers to selective control of the sludge retention time (SRT) of different sludge fractions. This is especially relevant under mainstream conditions where lower temperatures (10-15°C) lower the growth rates and activities of the desired organisms. Long biofilm SRT are required to retain AnAOB due to their slow growth rate, especially under low-temperature mainstream conditions (SRT =70d at 15°C, >100d at 10 °C) (Pérez et al., 2014; Yang et al., 2017). Therefore, biofilm-based reactors have been used, mainly as granule (Wett et al., 2013), or carrier material (Wang et al., 2017) configurations. In contrast, a short enough flocculent SRT to selectively washout NOB, yet retain AerAOB (Kornaros et al., 2010; Third et al., 2001; Seuntjens *et al.*, unpublished). To bring these conflicting worlds together, one-stage hybrid systems (= granule/biofilm + floc) (Lemaire et al., 2014; Pérez et al., 2014) have also been validated to achieve simultaneous, short-floc and long-biofilm SRT, allowing NOB washout from suspension and AnAOB retention in the biofilm. Another strategy might be the separation of nitritation and anammox in a two-stage approach. Special attention should also be paid to the proper control of (in)organic suspended solids (SS) entering the reactor since these SS or the flocculent used to improve their settleability in the previous stage, are reported to attach to AnAOB biomass inside the reactor, resulting in a loss of activity (Yamamoto et al., 2008).

1.4.3. IN/OUT + ON/OFF control = reactor solution

The possible combination of various strategies belonging to the “ON/OFF” and/or “IN/OUT” approaches have been advocated for NOB out-selection. For instance, in a pilot study (Third et al., 2001) based on suspended biomass, operated at 25°C, a combination of short aerobic SRT, intermittent aeration at high DO concentration and residual ammonium was successful

for NOB wash-out. In a granular biomass reactor (Malovanyy et al., 2015) operated at 15°C, shorter SRT of the flocculent fraction with continuous aeration at low DO set-point also demonstrated NOB wash-out. Intermittent aeration at a low DO set-point, and strict SRT to just retain AerAOB and wash-out NOB also worked in a hybrid reactor (suspended and carrier-based biomass, (Lawson et al., 2017).

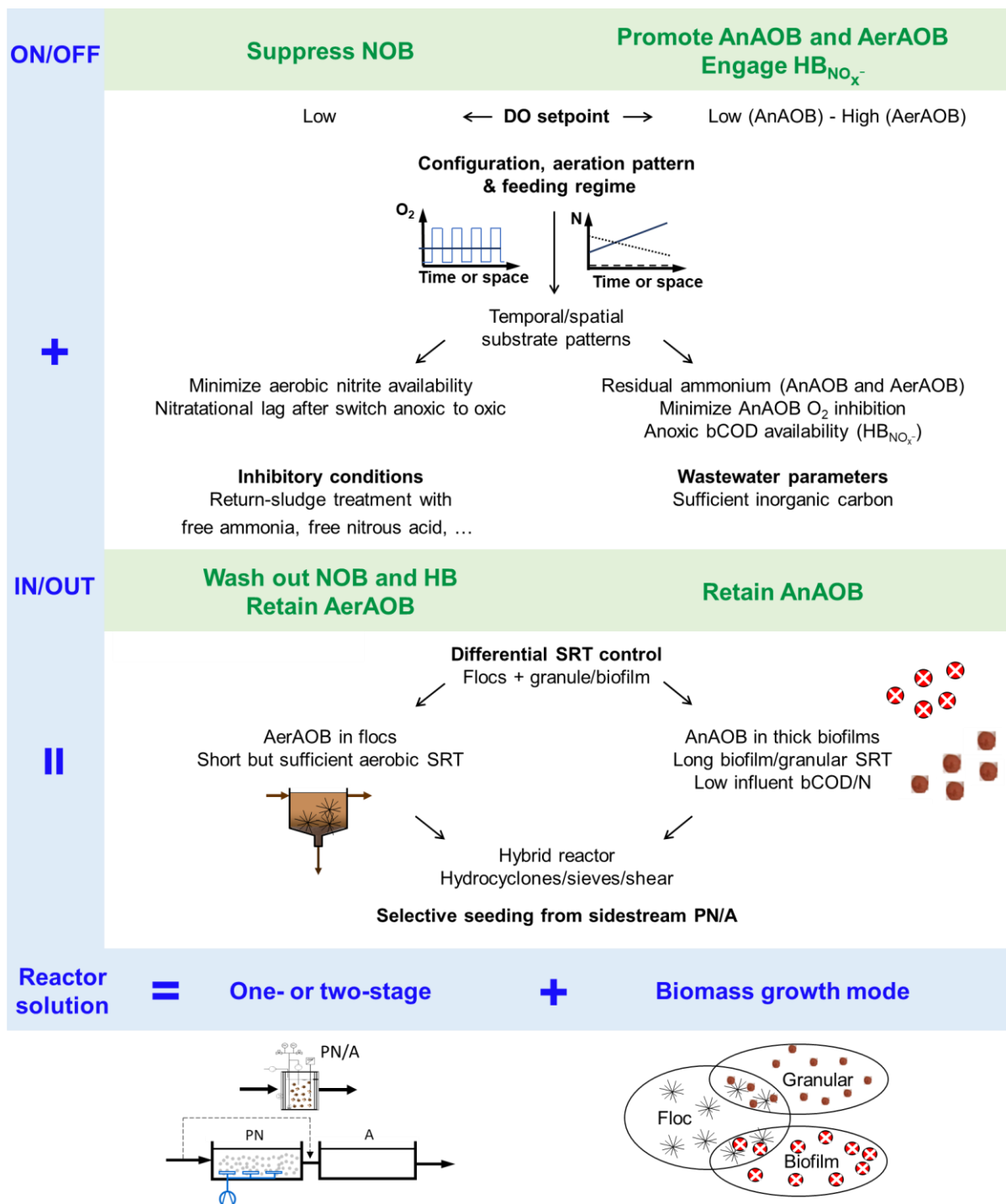

Figure 1.7 - Strategies for design and operation of a one- or two-stage partial nitrification/anammox (PN/A) reactor. NOB: Nitrite oxidizing bacteria. AerAOB: aerobic ammonium oxidizing bacteria. AnAOB: Anoxic ammonium oxidizing bacteria. HB: Heterotrophic bacteria. $HB_{NO_x^-}$: Heterotrophic bacteria reducing nitrite or nitrate. SRT: Sludge retention time. bCOD/N: biodegradable chemical oxygen demand over nitrogen (Agrawal et al., 2018).

1.4.4. Uncontrollable wastewater parameters requiring process adaptation

Residual organic carbon

Municipal wastewater has a high carbon to nitrogen ratio (around 6-10 gCOD_{tot}/gN_{tot}), because of this, a first stage aimed at maximal recovery of organic carbon (known as “C-Stage”) has been proposed in the past few years. This should also ease the implementation of mainstream PN/A (known as “N-Stage”). Nevertheless, the presence of heterotrophic bacteria is inevitable in mainstream PN/A processes (Speth et al., 2016), due to the availability of residual COD in the effluent of the C-stage or soluble metabolic products (SMP) released from AerAOB and AnAOB. This can allow fast growing HB_{NOX-} to compete with the slow growing AnAOB for nitrite and space. On the upside HB_{NOX-} can potentially (a) increase nitrogen removal efficiency by denitrifying the nitrate produced by the anammox reaction (Jenni et al., 2014) and (b) suppress NOB by reducing nitrite availability (Third et al., 2001). However, there is no consensus about the impact of organic carbon on the balance between anammox and denitrification and how it is impacted by low temperatures. Answering these questions is a key step towards successful MRM for mainstream PN/A.

Temperature

In moderate climate regions, temperature in WWTP can acutely drop down to 7°C for weeks during winter (Gilbert et al., 2014b). The growth and activity of all involved microorganisms is impacted (to a greater or lesser extent) by this drop in temperature resulting in a destabilization of the community. The already slow growing AnAOB ($\mu=0.07 \text{ d}^{-1}$ at 32°C, Strous et al., 1998) are also most sensitive making it difficult to compete for substrate and space at low temperatures, resulting in reduced removal rates and efficiencies. A better understanding of the factors influencing AnAOB cold sensitivity (e.g. aggregate size, niche differentiation etc.) and how it is impacted by long term enrichment/adaptation along with the determination of accurate temperature coefficients for modelling would allow for better design and operation of mainstream PN/A systems.

1.5. Low temperature, a major challenge for mainstream anammox

Apart from some indirect challenges associated with low temperatures, successful MRM strategies must especially be adapted to cope with the detrimental effect of low temperatures on AnAOB growth and activity, one of the main factors directly impacting performance and stability of anammox (based) processes.

This has been demonstrated in previous studies reporting Arrhenius coefficients (θ -values) between 1.09 to 1.14 (Strous, *et al.*, 1999, Dosta, *et al.*, 2008, Isaka, *et al.*, 2008, Lotti, *et al.*, 2014) obtained from batch tests over wide temperature ranges (30-10°C). Even though these obtained parameters are valuable for estimating the short-term impact of decreasing temperature, they are rather inaccurate, especially for low temperatures, e.g. below 15°C (Lotti, *et al.*, 2014). A more accurate estimation of these parameters would improve modelling for process design and microbial resource management.

Adaptation of AnAOB to low temperatures has been observed in MBBR and SBR systems, (Gilbert *et al.* 2014, Gilbert *et al.* 2015, Gustavsson *et al.* 2014, Hu *et al.* 2013). Stable anammox performance at low temperatures has previously been reported in PN/A systems on both synthetic wastewater and real wastewater (Hendrickx *et al.* 2014, Laurenzi *et al.* 2015, Laurenzi *et al.* 2016, Lotti *et al.* 2014a, Lotti *et al.* 2014b, Ma *et al.* 2013). Even though these results illustrate the adaptability of AnAOB, the conditions in these experiments (e.g. presence of oxygen/organic carbon) did not allow to evaluate the maximum potential of cold anammox.

Until today, AnAOB temperature sensitivity and adaptation has been described but some crucial links with biomass specific (e.g. AnAOB diversity, aggregate size) or operational parameters are still missing. A more comprehensive understanding of the T-impact essential for successful implementation of mainstream anammox.

1.6. Research questions and thesis outline

Implementing mainstream PN/A requires transferable operation and design strategies for the process to meet discharge requirements on a year-round basis at satisfactory conversion rates. Despite many advancements in the fields of reactor function, microbiology, and mechanistic models, there is no integrated approach to meet these requirements. A microbial resource management approach based on ON/OFF + IN/OUT strategies for steering the multitude of complex physicochemical and biological interactions occurring at different levels of mainstream PN/A was proposed (figure 7). This thesis aims to fill in some knowledge gaps in the framework by increasing the understanding of the short and long-term impact of low temperature on AnAOB rates, -enrichment, -adaptation and their ability to compete with HB_{NOX} in the presence of organic carbon. The global approach to this research project was linear and divided into 3 topics, each corresponding to a chapter of this PhD thesis as shown in figure 8 and discussed below.

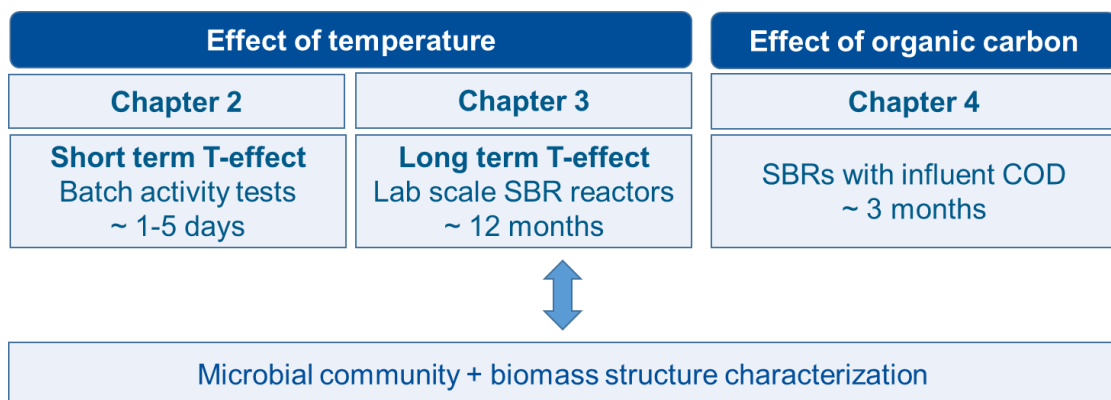

Figure 1.8 – Schematic overview of chapter content

Chapter 2 ~ Short term effect of decreasing temperature on AnAOB activity

“How will the specific anammox activities of different biomasses be affected by a decrease in temperature. Can any difference in temperature sensitivity be explained by a different composition of the bacterial population and/or different biomass structure?”

In this chapter, the impact of aggregate size and microbial community composition on the cold sensitivity of AnAOB was tested for four types of non cold-adapted biomass containing different AnAOB genera and aggregate size fractions. The short-term effect of temperature decrease on the maximum AnAOB activity was evaluated via anoxic batch tests between 30 and 10°C. A possible link between AnAOB genus and temperature sensitivity was unveiled and Arrhenius fitting was optimized to obtain more accurate temperature coefficients for improved modelling.

Chapter 3 ~ Long term effect of decreasing temperature on AnAOB activity and enrichment

“To what extent will AnAOB biomass from high strength WW at ambient T adapt during anoxic SBR operation at low T and N-concentrations? What will be the impact of low T on the growth rates of the AnAOB, on the composition of the bacterial population and on the process' removal rates? How will granulation be affected?”

This chapter aimed to reveal the maximum potential of so-called 'cold anammox'. An anammox sequencing batch reactor (SBR) operated at high temperature (30°C) was compared to one subjected to subsequent temperature drops down to 10°C for almost 1 year. Granulation occurred rapidly in both reactors and the observed AnAOB enrichment and adaptation resulted in some of the highest rates ever reported at 10°C and surprising shifts in AnAOB genus.

Chapter 4 ~ Impact of temperature and influent COD on the competition between HB and AnAOB

“To what extent is the competition between AnAOB and OHO under mainstream conditions affected by low levels of organic carbon in the influent? What is the impact of temperature (30°C vs. 10°C) on this competition?”

This study examined the long-term effect of influent COD on the competition between anammox and denitrification under anoxic conditions at both high (30°C) and low (10°C) temperature. The observed stoichiometries provided insights on the competition for substrate and, changes in aggregate type and microbial population showed that, especially at low temperature, AnAOB were able to thrive as HB were washed out resulting in very high removal rates.

Chapter 5 ~ Conclusions

In this chapter, key insights on the impact of low temperature and organic carbon on anammox rates and competition with denitrification gained from chapter 2, 3 and 4 are integrated in the proposed ON/OFF + IN/OUT approach in order to contribute to the further development of a MRM strategy for the successful implementation of mainstream PN/A.

1.7. References

- Agrawal, S., Karst, S.M., Gilbert, E.M., Horn, H., Nielsen, P.H., Lackner, S. 2017b. The role of inoculum and reactor configuration for microbial community composition and dynamics in mainstream partial nitritation anammox reactors. *MicrobiologyOpen*, **6**(4), e00456.
- Agrawal, S., Seuntjens, D., Cocker, P.D., Lackner, S., Vlaeminck, S.E. 2018. Success of mainstream partial nitritation/anammox demands integration of engineering, microbiome and modeling insights. *Current Opinion in Biotechnology*, **50**, 214-221.
- Arden, E., Lockett, W.T. 1914. Experiments on the oxidation of sewage without the aid of filters. *Journal of the Society of Chemical Industry*, **33**(10), 523-539.
- Barnard, J. 1974. *Cut P and N Without Chemicals*.
- Boran, K., M., K.M.M., Gaute, L., Jos, S., M., O.d.C.H.J., M., J.M.S., Marc, S. 2007. Anammox bacteria disguised as denitrifiers: nitrate reduction to dinitrogen gas via nitrite and ammonium. *Environmental Microbiology*, **9**(3), 635-642.
- Chagas, A.P. 2007. A síntese da amônia: alguns aspectos históricos. *Química Nova*, **30**, 240-247.
- Conley, D., Paerl, H., Howarth, R., Boesch, D., P. Seitzinger, S., Havens, K., Lancelot, C., E. Likens, G. 2009. *Controlling Eutrophication: Nitrogen and Phosphorus*.
- Coppens, J., Meers, E., Boon, N., Buysse, J., Vlaeminck, S.E. 2016. Follow the N and P road: High-resolution nutrient flow analysis of the Flanders region as precursor for sustainable resource management. *Resources, Conservation and Recycling*, **115**, 9-21.
- Daims, H., Lebedeva, E.V., Pjevac, P., Han, P., Herbold, C., Albertsen, M., Jehmlich, N., Palatinszky, M., Vierheilig, J., Bulaev, A., Kirkegaard, R.H., von Bergen, M., Rattei, T., Bendinger, B., Nielsen, P.H., Wagner, M. 2015. Complete nitrification by Nitrospira bacteria. *Nature*, **528**, 504.
- Dietl, A., Ferousi, C., Maalcke, W.J., Menzel, A., de Vries, S., Keltjens, J.T., Jetten, M.S.M., Kartal, B., Barends, T.R.M. 2015. The inner workings of the hydrazine synthase multiprotein complex. *Nature*, **527**, 394.
- Dosta, J., Fernandez, I., Vazquez-Padin, J.R., Mosquera-Corral, A., Campos, J.L., Mata-Alvarez, J. and Mendez, R. (2008) Short- and long-term effects of temperature on the Anammox process. *Journal of Hazardous Materials* 154, 688-693.

- Escher, B.I., Bramaz, N., Quayle, P., Rutishauser, S., Vermeirssen, E.L.M. 2008. Monitoring of the ecotoxicological hazard potential by polar organic micropollutants in sewage treatment plants and surface waters using a mode-of-action based test battery. *Journal of Environmental Monitoring*, **10**(5), 622-631.
- Gilbert, E.M., Agrawal, S., Brunner, F., Schwartz, T., Horn, H., Lackner, S. 2014a. Response of Different Nitrospira Species To Anoxic Periods Depends on Operational DO. *Environmental science & technology*, **48**(5), 2934-2941.
- Gilbert, E.M., Agrawal, S., Karst, S.M., Horn, H., Nielsen, P.H., Lackner, S. 2014b. Low Temperature Partial Nitritation/Anammox in a Moving Bed Biofilm Reactor Treating Low Strength Wastewater. *Environmental Science & Technology*, **48**(15), 8784-8792.
- Gustavsson, D., Persson, F. and la Cour Jansen, J. (2014) Manammox–mainstream anammox at Sjölanda WWTP. Proceedings from the IWA World Water Congress and Exhibition, September 21-26, Lisbon, Portugal (2014)
- Güven, D., Dapena, A., Kartal, B., Schmid, M.C., Maas, B., van de Pas-Schoonen, K., Sozen, S., Mendez, R., Op den Camp, H.J.M., Jetten, M.S.M., Strous, M., Schmidt, I. 2005. Propionate Oxidation by and Methanol Inhibition of Anaerobic Ammonium-Oxidizing Bacteria. *Applied and Environmental Microbiology*, **71**(2), 1066-1071.
- Han, M., De Clippeleir, H., Al-Omari, A., Wett, B., Vlaeminck, S.E., Bott, C., Murthy, S. 2016. Impact of carbon to nitrogen ratio and aeration regime on mainstream deammonification. *Water Science and Technology*, **74**(2), 375.
- Han, M., Vlaeminck, S.E., Al-Omari, A., Wett, B., Bott, C., Murthy, S. and De Clippeleir, H. (2016) Uncoupling the solids retention times of flocs and granules in mainstream deammonification: A screen as effective out-selection tool for nitrite oxidizing bacteria. *Bioresource Technology* 221, 195-204.
- Hendrickx, T.L.G., Kampman, C., Zeeman, G., Temmink, H., Hu, Z., Kartal, B. and Buisman, C.J.N. (2014) High specific activity for anammox bacteria enriched from activated sludge at 10 degrees C. *Bioresource Technology* 163, 214-221.
- Hu, Z., Lotti, T., de Kreuk, M., Kleerebezem, R., van Loosdrecht, M., Kruit, J., Jetten, M.S. and Kartal, B. (2013) Nitrogen removal by a nitritation-anammox bioreactor at low temperature. *Applied and environmental microbiology* 79, 2807-2812.
- Isaka, K., Date, Y., Kimura, Y., Sumino, T. and Tsuneda, S. (2008) Nitrogen removal performance using anaerobic ammonium oxidation at low temperatures. *Fems Microbiology Letters* 282, 32-38.

- Isanta, E., Bezerra, T., Fernández, I., Suárez-Ojeda, M.E., Pérez, J., Carrera, J. 2015. Microbial community shifts on an anammox reactor after a temperature shock using 454-pyrosequencing analysis. *Bioresource Technology*, **181**(0), 207-213.
- Jenni, S., Vlaeminck, S.E., Morgenroth, E., Udert, K.M. 2014. Successful application of nitrification/anammox to wastewater with elevated organic carbon to ammonia ratios. *Water Research*, **49**(0), 316-326.
- Jetten, M.S., Horn, S.J., van Loosdrecht, M.C. 1997. Towards a more sustainable municipal wastewater treatment system. *Water science and technology*, **35**(9), 171-180.
- Kartal, B., Kuenen, J., Van Loosdrecht, M. 2010. Sewage treatment with anammox. *Science*, **328**(5979), 702-703.
- Kartal, B., Kuypers, M.M.M., Lavik, G., Schalk, J., Op den Camp, H.J.M., Jetten, M.S.M., Strous, M. 2007. Anammox bacteria disguised as denitrifiers: nitrate reduction to dinitrogen gas via nitrite and ammonium. *Environmental Microbiology*, **9**(3), 635-642.
- Kartal, B., van Niftrik, L., Keltjens, J.T., den Camp, H.J.M.O., Jetten, M.S.M. 2012. Anammox-Growth Physiology, Cell Biology, and Metabolism. in: *Advances in Microbial Physiology*, Vol 60, (Ed.) R.K. Poole, Vol. 60, pp. 211-262.
- Kartal, B., van Niftrik, L., Rattray, J., de Vossenberg, J.L.C.M.v., Schmid, M.C., Damste, J.S.S., Jetten, M.S.M., Strous, M. 2008. Candidatus 'Brocadia fulgida': an autofluorescent anaerobic ammonium oxidizing bacterium. *Fems Microbiology Ecology*, **63**(1), 46-55.
- Kits, K.D., Sedlacek, C.J., Lebedeva, E.V., Han, P., Bulaev, A., Pjevac, P., Daebeler, A., Romano, S., Albertsen, M., Stein, L.Y., Daims, H., Wagner, M. 2017. Kinetic analysis of a complete nitrifier reveals an oligotrophic lifestyle. *Nature*, **549**, 269.
- Knobeloch, L., Salna, B., Hogan, A., Postle, J., Anderson, H. 2000. Blue babies and nitrate-contaminated well water. *Environmental Health Perspectives*, **108**(7), 675-678.
- Koops, H.P. 2001. *Distribution and ecophysiology of the nitrifying bacteria emphasizing cultured species*.
- Kornaros, M., Dokianakis, S.N., Lyberatos, G. 2010. Partial Nitrification/Denitrification Can Be Attributed to the Slow Response of Nitrite Oxidizing Bacteria to Periodic Anoxic Disturbances. *Environmental Science & Technology*, **44**(19), 7245-7253.
- Kowalchuk, G.A., Stephen, J.R. 2001. Ammonia-oxidizing bacteria: a model for molecular microbial ecology. *Annu Rev Microbiol*, **55**, 485-529.
- Kuypers, M.M., Sliemers, A.O., Lavik, G., Schmid, M., Jørgensen, B.B., Kuenen, J.G., Damsté, J.S.S., Strous, M., Jetten, M.S. 2003. Anaerobic ammonium oxidation by anammox bacteria in the Black Sea. *Nature*, **422**(6932), 608-611.

- Lackner, S., Gilbert, E.M., Vlaeminck, S.E., Joss, A., Horn, H., van Loosdrecht, M.C.M. 2014. Full-scale partial nitrification/anammox experiences - An application survey. *Water Research*, **55**, 292-303.
- Laureni, M., Weissbrodt, D.G., Szivák, I., Robin, O., Nielsen, J.L., Morgenroth, E. and Joss, A. (2015) Activity and growth of anammox biomass on aerobically pre-treated municipal wastewater. *Water Research* 80, 325-336.
- Laureni, M., Falås, P., Robin, O., Wick, A., Weissbrodt, D.G., Nielsen, J.L., Ternes, T.A., Morgenroth, E., Joss, A. 2016. Mainstream partial nitrification and anammox: long-term process stability and effluent quality at low temperatures. *Water Research*, **101**, 628-639.
- Lawson, C.E., Wu, S., Bhattacharjee, A.S., Hamilton, J.J., McMahon, K.D., Goel, R., Noguera, D.R. 2017. Metabolic network analysis reveals microbial community interactions in anammox granules. *Nature Communications*, **8**, 15416.
- Lemaire, R., Zhao, H., Thomson, C., Christensson, M., Piveteau, S., Hemmingsen, S., Veuillet, F., Zozor, P., Ochoa, J. 2014. Mainstream Deammonification with ANITA™ Mox Process. *Proceedings of the Water Environment Federation*, **2014(6)**, 2183-2197.
- Lofrano, G., Brown, J. 2010. Wastewater management through the ages: A history of mankind. *Science of The Total Environment*, **408(22)**, 5254-5264.
- Lotti, T., Kleerebezem, R., van Loosdrecht, M.C. 2015. Effect of temperature change on anammox activity. *Biotechnol Bioeng*, **112(1)**, 98-103.
- Lotti, T., Kleerebezem, R., Hu, Z., Kartal, B., Jetten, M. and van Loosdrecht, M. (2014a) Simultaneous partial nitrification and anammox at low temperature with granular sludge. *Water Research* 66, 111-121.
- Lotti, T., Kleerebezem, R., van Erp Taalman Kip, C., Hendrickx, T., Kruit, J. and Van Loosdrecht, M. (2014b) Anammox growth on pretreated municipal wastewater. *Environmental science & technology* 48,7874-80.
- Ludzack, F.J., Ettinger, M.B. 1962. Controlling Operation to Minimize Activated Sludge Effluent Nitrogen. *Journal (Water Pollution Control Federation)*, **34(9)**, 920-931.
- Ma, B., Peng, Y., Zhang, S., Wang, J., Gan, Y., Chang, J., Wang, S., Wang, S. and Zhu, G. (2013) Performance of anammox UASB reactor treating low strength wastewater under moderate and low temperatures. *Bioresource Technology* 129, 606-611.
- Malovanyy, A., Yang, J., Trela, J., Plaza, E. 2015. Combination of upflow anaerobic sludge blanket (UASB) reactor and partial nitrification/anammox moving bed biofilm reactor

- (MBBR) for municipal wastewater treatment. *Bioresource Technology*, **180**(0), 144-153.
- Matassa, S., Batstone, D.J., Hülsen, T., Schnoor, J., Verstraete, W. 2015. Can Direct Conversion of Used Nitrogen to New Feed and Protein Help Feed the World? *Environmental Science & Technology*, **49**(9), 5247-5254.
- Mekonnen, M.M., Hoekstra, A.Y. 2016. Four billion people facing severe water scarcity. *Science Advances*, **2**(2).
- Morales, N., Val del Río, Á., Vázquez-Padín, J., Méndez, R., L. Campos, J., Mosquera-Corral, A. 2016. *The granular biomass properties and the acclimation period affect the partial nitrification/anammox process stability at a low temperature and ammonium concentration.*
- Morales, N., Val del Río, Á., Vázquez-Padín, J.R., Méndez, R., Mosquera-Corral, A., Campos, J.L. 2015. Integration of the Anammox process to the rejection water and main stream lines of WWTPs. *Chemosphere*, **140**(0), 99-105.
- Nowka, B., Daims, H., Spieck, E. 2015. Comparison of Oxidation Kinetics of Nitrite-Oxidizing Bacteria: Nitrite Availability as a Key Factor in Niche Differentiation. *Applied and Environmental Microbiology*, **81**(2), 745-753.
- Pérez, J., Lotti, T., Kleerebezem, R., Picioreanu, C., van Loosdrecht, M.C. 2014. Outcompeting nitrite-oxidizing bacteria in single-stage nitrogen removal in sewage treatment plants: A model-based study. *Water research*, **66**, 208-218.
- Randall, D.J., Tsui, T.K.N. 2002. Ammonia toxicity in fish. *Marine Pollution Bulletin*, **45**(1), 17-23.
- Shu, D., He, Y., Yue, H., Gao, J., Wang, Q., Yang, S. 2016. Enhanced long-term nitrogen removal by organotrophic anammox bacteria under different C/N ratio constraints: quantitative molecular mechanism and microbial community dynamics. *RSC Advances*, **6**(90), 87593-87606.
- Siegrist, H., Salzgeber, D., Eugster, J., Joss, A. 2008. Anammox brings WWTP closer to energy autarky due to increased biogas production and reduced aeration energy for N-removal. *Water Science and Technology*, **57**(3), 383-388.
- Speth, D.R., in 't Zandt, M.H., Guerrero-Cruz, S., Dutilh, B.E., Jetten, M.S.M. 2016. Genome-based microbial ecology of anammox granules in a full-scale wastewater treatment system. *Nature Communications*, **7**, 11172.
- Strous, M., Heijnen, J.J., Kuenen, J.G., Jetten, M.S.M. 1998. The sequencing batch reactor as a powerful tool for the study of slowly growing anaerobic ammonium-oxidizing microorganisms. *Applied Microbiology and Biotechnology*, **50**(5), 589-596.

- Third, K.A., Sliemers, A.O., Kuenen, J.G., Jetten, M.S.M. 2001. The CANON System (Completely Autotrophic Nitrogen-removal Over Nitrite) under Ammonium Limitation: Interaction and Competition between Three Groups of Bacteria. *Systematic and Applied Microbiology*, **24**(4), 588-596.
- Van Hulle, S.W.H., Vandeweyer, H.J.P., Meesschaert, B.D., Vanrolleghem, P.A., Dejjans, P., Dumoulin, A. 2010. Engineering aspects and practical application of autotrophic nitrogen removal from nitrogen rich streams. *Chemical Engineering Journal*, **162**(1), 1-20.
- van Kessel, M.A.H.J., Speth, D.R., Albertsen, M., Nielsen, P.H., Op den Camp, H.J.M., Kartal, B., Jetten, M.S.M., Lücker, S. 2015. Complete nitrification by a single microorganism. *Nature*, **528**, 555.
- Vandekerckhove, T.G.L., Kobayashi, K., Janda, J., Van Nevel, S., Vlaeminck, S.E. 2018. Sulfur-based denitrification treating regeneration water from ion exchange at high performance and low cost. *Bioresource Technology*, **257**, 266-273.
- Vlaeminck, S.E., De Clippeleir, H., Verstraete, W. 2012. Microbial resource management of one-stage partial nitritation/anammox. *Microbial Biotechnology*, **5**(3), 433-448.
- Wang, Q., Duan, H., Wei, W., Ni, B.-J., Laloo, A., Yuan, Z. 2017. Achieving Stable Mainstream Nitrogen Removal via the Nitrite Pathway by Sludge Treatment Using Free Ammonia. *Environmental Science & Technology*, **51**(17), 9800-9807.
- Wett, B. 2007. Development and implementation of a robust deammonification process. *Water Science and Technology*, **56**(7), 81-88.
- Wett, B., Omari, A., Podmirseg, S.M., Han, M., Akintayo, O., Brandon, M.G., Murthy, S., Bott, C., Hell, M., Takacs, I., Nyhuis, G., O'Shaughnessy, M. 2013. Going for mainstream deammonification from bench to full scale for maximized resource efficiency. *Water Science and Technology*, **68**(2), 283-289.
- Winkler, M.K.H., Kleerebezem, R., van Loosdrecht, M.C.M. 2012. Integration of anammox into the aerobic granular sludge process for main stream wastewater treatment at ambient temperatures. *Water Research*, **46**(1), 136-144.
- Yamamoto, T., Takaki, K., Koyama, T., Furukawa, K. 2008. Long-term stability of partial nitritation of swine wastewater digester liquor and its subsequent treatment by Anammox. *Bioresource Technology*, **99**(14), 6419-6425.
- Yang, Y., Zhang, L., Cheng, J., Zhang, S., Li, B., Peng, Y. 2017. Achieve efficient nitrogen removal from real sewage in a plug-flow integrated fixed-film activated sludge (IFAS) reactor via partial nitritation/anammox pathway. *Bioresource Technology*, **239**, 294-301.

Zumft, W.G. 1997. Cell biology and molecular basis of denitrification. *Microbiology and Molecular Biology Reviews*, **61**(4), 533-616.

Chapter II

Instant cold tolerance impacted by anammox genus rather than by aggregate size

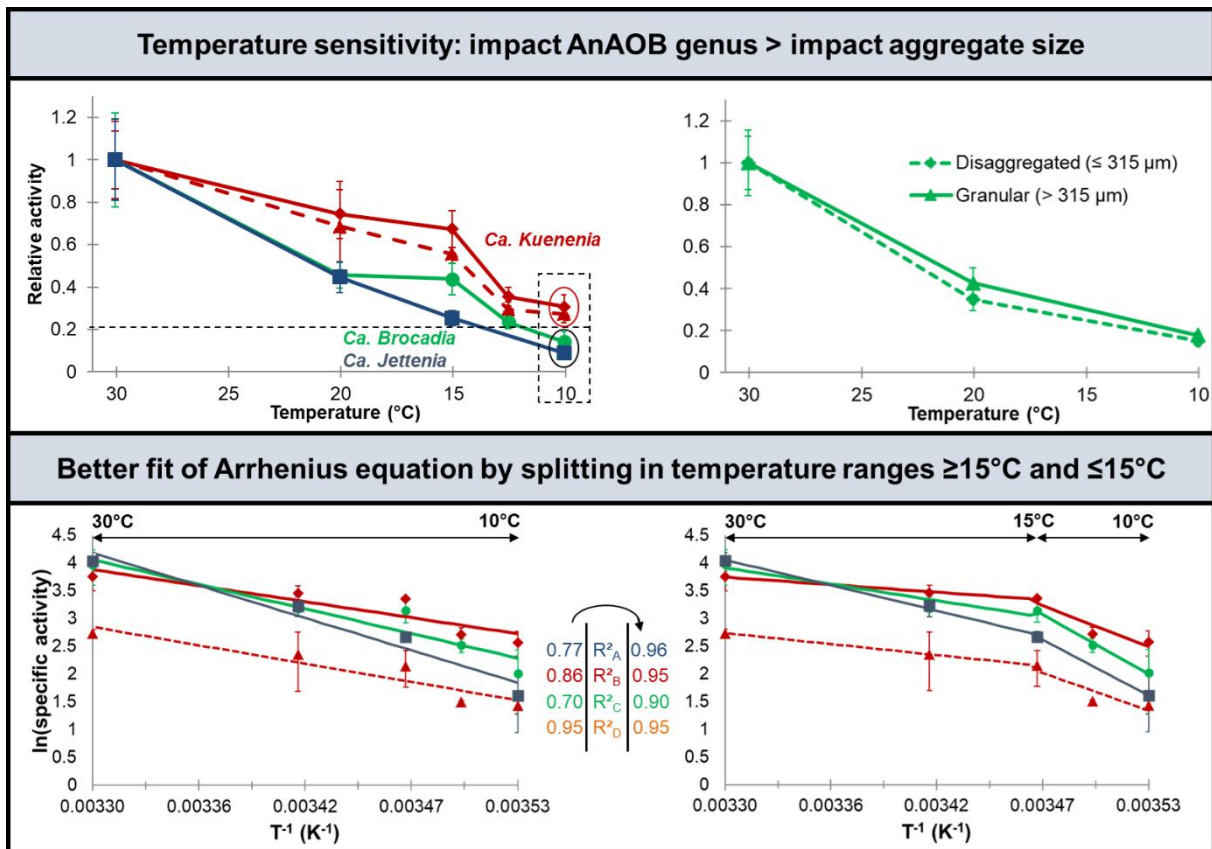

Abstract

Mainstream partial nitrification/anammox (PN/A) processes are a critical step in achieving energy-positive wastewater treatment. However, the severe impact of decreasing temperature on the growth and activity of anammox bacteria (AnAOB) hampers successful PN/A implementation in moderate climate regions. This study evaluated the short-term effect of temperature decrease on the specific ammonium removal rates (SARR) in anoxic batch tests between 10-30°C. Four types of non cold-adapted biomass were selected to study the impact of aggregate size and microbial community. Disaggregation of granules showed no direct impact of aggregate size on their temperature sensitivity. When comparing SARR at 30 and 10°C, Biomass A and B (aggregates mainly >315µm, rich in *Ca. Kueneria*) were less sensitive than biomass C and D (aggregates mainly ≤315µm, rich in *Ca. Brocadia* or *Ca. Jettenia*), suggesting a higher tolerance for decreasing temperatures by *Ca. Kueneria*. Rather than using one global Arrhenius equation, splitting into two temperature intervals improved the overall goodness of fit (R^2) from 0.70-0.95 to 0.90-0.96. For biomass A and C, cold sensitivity increased significantly below 15°C. Given the rather high θ values obtained (1.12-1.18 K⁻¹; 10-15°C), this sensitivity was potentially underestimated before, corroborating the need for accurate parameter estimations enabling realistic process rate predictions.

Instant cold tolerance impacted by anammox genus rather than by aggregate size

P. De Cocker^{1,2,3}, Y. Bessiere¹, G. Hernandez-Raquet¹, I. Mozo², G. Gaval²,
M. Caligaris⁴, B. Barillon², S.E. Vlaeminck^{3,5,§,*}, M. Sperandio^{1,§}

1. LISBP, Université de Toulouse, CNRS, INRA, INSA, Toulouse, France
2. SUEZ, CIRSEE, Le Pecq, France
3. Center for Microbial Ecology and Technology (CMET), Ghent University, Ghent, Belgium
4. SUEZ, Treatment Infrastructures, Rueil Malmaison, France
5. Research Group of Sustainable Energy, Air and Water Technology, University of Antwerp, Antwerpen, Belgium

§ equally contributed as senior authors

* corresponding author: siegfried.vlaeminck@uantwerpen.be

2.1. Introduction

Anoxic oxidation of ammonium or anammox is performed by anammox bacteria (AnAOB) using nitrite as electron acceptor. All AnAOB belong to the order of the Brocadiales and can be divided into five “*Candidatus*” genera. Four of these genera (*Ca. Kuenenia*, *Ca. Brocadia*, *Ca. Anammoxoglobus* and *Ca. Jettenia*) have been enriched from activated sludge, with reported optimal temperatures around 35-40°C (Strous, *et al.*, 1999, Isaka, *et al.*, 2008, Sobotka, *et al.*, 2016). The fifth (*Ca. Scalindua*) has mostly been detected in natural habitats such as marine sediments and oxygen minimum zones where temperatures can be much lower (below 6°C), illustrating the natural potential of this genus to thrive at low temperatures (Jetten, *et al.*, 2009).

Partial nitrification/anammox (PN/A) is an autotrophic shortcut nitrogen removal process, requiring less oxygen, abandoning the need for organic carbon, and yielding a lower sludge production compared to conventional nitrification/denitrification. It can thus present a more cost-efficient nitrogen removal process from waters low in organic carbon (Vlaeminck, *et al.*, 2012). The next development goal is to introduce anammox in the mainstream or waterline of sewage treatment plants in order to further improve their efficiency in terms of energy consumption (and hence economics) and greenhouse gas emissions (Schaubroeck, *et al.*, 2015). One of main challenges for its implementation on pretreated sewage, so-called mainstream PN/A, is linked to the detrimental effect of low temperatures on AnAOB growth and activity. This is especially relevant for regions with a temperate (or cold) climate where sewage temperatures are often below 15°C or even 10°C. Under these conditions, the already slow-growing AnAOB are even further disadvantaged and experience difficulties competing with NOB, AOB and HB for space and substrate. The resulting imbalance in the microbial consortium jeopardizes the process' performance (Vlaeminck, *et al.*, 2012, Cao, *et al.*, 2017).

Usually AnAOB temperature sensitivity is evaluated by measuring the maximum specific ammonia removal rate (SARR) at different temperatures (often ranging between 10 and 30°C). Subsequently an Arrhenius curve is fitted and from this, modelling parameters such as the temperature coefficient (also called θ value) or activation energy (E_a) are extrapolated to express temperature sensitivity quantitatively. However, these extrapolations are often inaccurate when used over wide temperature ranges (30-10°C), especially at low temperatures, e.g. below 15°C (Lotti, *et al.*, 2014). The θ values reported in literature range between 1.09 to 1.14 (Strous, *et al.*, 1999, Dosta, *et al.*, 2008, Isaka, *et al.*, 2008, Lotti, *et al.*, 2014). Note that the predicted remaining activities associated with a transition from 30 to 10°C vary with a factor 3 depending on which of the extreme value is used for modelling. A more accurate estimation of these essential parameters would increase the reliability of models for the design mainstream PN/A systems.

Previous studies have reported variable temperature sensitivities: E_a values can be as low as 27-51 kJ/mol for the higher temperature range (± 25 -30°C) and as high as 155-437 kJ/mol for the lower temperature range (± 10 -15°C) (Dosta, *et al.*, 2008, Lotti, *et al.*, 2014, Sobotka, *et al.*, 2016). So far, this variability has not been clearly linked to specific biomass characteristics such as AnAOB niche differentiation, aggregate size (distribution), or other parameters. Understanding factors influencing AnAOB cold sensitivity is required for implementation of mainstream PN/A.

In this study, the impact of aggregate size and microbial community composition on the cold sensitivity of AnAOB was tested and Arrhenius fitting was optimized to obtain accurate E_a and θ values. To this end, four types of non cold-adapted biomass containing different AnAOB genera and aggregate size fractions were selected. A disaggregation experiment was

performed to assess the direct impact of aggregate size on temperature sensitivity. The short-term effect of temperature decrease on the maximum AnAOB activity was evaluated via anoxic batch tests between 30 and 10°C.

2.2 Materials and Methods

2.2.1. Types of biomass

Four different types of biomass (A, B, C and D) were collected from stable, long-term running PN/A or anammox systems operated at rather high temperatures (26-30°C). Their characteristics are detailed in Table 2.1. Biomass A and B originated from lab-scale set-ups treating synthetic influent, while biomass C and D originated from full- and pilot-scale systems treating centrate from a sewage sludge digester. Biomass A, B and C came from PN/A systems, i.e. aerobically operated, unlike biomass D which came from an anammox reactor, i.e. an anoxic system.

Table 2.1 - Origin of the tested biomass types. PN/A: Partial Nitrification/Anammox; OLAND: Oxygen-Limited Autotrophic Nitrification/Denitrification; SBR: Sequencing Batch Reactor; RBC: Rotating Biological Contactor; CSTR: Continuous Stirred-Tank Reactor; NLR: Nitrogen Loading Rate

	A	B	C	D
Process type	PN/A	PN/A (OLAND)	PN/A (DEMON)	Anammox (DeAmmo)
Reactor type (scale)	SBR (10 L)	RBC (50 L)	CSTR (1000 m ³)	SBR (1.5 m ³)
Biomass type	Flocs + granules	Detached biofilm	Flocs + granules	Flocs + granules
Temperature (°C)	30	30	30	26
Total NLR (mg N/L/d)	70-140	~ 100	~ 500	80
Influent type	Synthetic	Synthetic	Centrate from sewage sludge digester	Centrate from sewage sludge digester

2.2.2. Determination of specific ammonium removal rate (SARR)

Batch tests to determine the maximum specific ammonium removal rate (SARR) were performed in triplicate at five different temperatures (30, 20, 15, 12.5 and 10°C) in 500 mL Schott bottles containing approximately 0.4 g VSS/L of one of the four types of biomass. One mL of a concentrated feeding solution containing ammonium and nitrite in stoichiometric ratios (1:1.32) was added to 299 mL of buffered synthetic medium to give 300 mL test medium with a total concentration of 30 mg N/L, no COD was added (Table S.II.1). At regular times, 8 mL mixed liquor samples were taken and nitrite, nitrate and ammonia levels were analyzed, typical concentration profiles can be found in Figure S1. The bottles were flushed with nitrogen gas at the beginning of the experiment and after each sampling to compensate for the change in

liquid volume and to ensure anoxic conditions throughout the entire experiment. In consequence, the ammonium removal was only attributed to AnAOB activity. To make the series of batch tests statistically representative, a systematic approach was applied to all biomass samples: the parent samples of each biomass were collected the same week in bioreactors, and then stored at 4°C. Each test was performed after an overnight reactivation step at 30°C using the before mentioned synthetic influent with extra dosed ammonia and nitrite substrate (60 mg (NH₄⁺ + NO₂⁻)-N/L). Before starting the actual batch test, biomass was recovered using a 50µm sieve and rinsed with tap water. Each biomass sample was used only once, new inoculum was used for each test. Special attention was paid to homogeneity and mixing of sample during collection. Tests at given temperature were performed in triplicate and at the same time for all four biomass types in parallel.

2.2.3. Size fractionation and disaggregation treatment

In order to have a rough estimation of the aggregate size distribution of the different types of biomass, a fractionation was done by consecutively passing them over a 315 µm and 50 µm sieve and determining the %VSS retained in each fraction. This characterization was done in duplicate and is discussed in the results section. For one series of experiments, aggregate size was reduced by blending for 3x15 seconds at 18,000 min⁻¹ with an IKA® ULTRA-TURRAX® T-18 basic equipped with S18N-19G disperser rod. This was done for a liquid volume of 300mL with 0.5 g VSS/L of granules isolated from biomass C (most biomass in stock for testing). After disaggregation, only 4% was retained post-treatment in the fraction >315 µm, indicating that disaggregation was successful.

2.2.4. Determination of activation energy and temperature coefficient

Arrhenius equation – Activation energy (E_a)

The empirical Arrhenius equation is commonly used to express the temperature dependency of (biological) reactions. It contains the following parameters: the rate constant (k , in $\text{mg NH}_4^+\text{-N/gVSS/d}$), the apparent activation energy (E_a , in kJ/mol), the temperature (T , in K), the universal gas law constant (R , in $8.314 \text{ J mol}^{-1} \text{ K}^{-1}$) and the pre-exponential factor (A , no unit). The Arrhenius equation is shown below in its linearized form (equation 1).

$$\ln k = \frac{E_a}{R \cdot T} + \ln A \quad (1)$$

Thus calculation of the activation energies for the different types of biomass and over different temperature ranges was done by plotting the natural logarithm of the reaction rate vs. the inverse of the temperature. The slope represents $-E_a/R$.

Temperature coefficient (θ)

When modelling wastewater treatment systems, θ values, also called temperature coefficients, are often used to take into account the effect temperature has on the specific growth rate of the different bacteria involved in the removal processes. Equation 2 shows the correlation between E_a and θ values. E_a represents the apparent activation energy, R the universal gas law constant and T_1 and T_2 the temperatures (in K) at which the kinetic data is obtained.

$$\theta = e^{\frac{E_a}{R \cdot T_1 \cdot T_2}} \quad (2)$$

2.2.5. Analytical methods

All the samples were filtered through 0.2µm membrane filters prior analysis. Nitrite (N-NO₂⁻) and nitrate (N-NO₃⁻) were quantified by ionic chromatography (IC25, 2003, DIONEX, USA). The concentration of ammonium (N-NH₄⁺) was measured spectrophotometrically according to the Nessler method (APHA, 1992) based in a colorimetric determination thanks to the formation of a complex with ammonium and mercury potassium iodide. Mixed liquor suspended solids (MLSS) and volatile Suspended Solids (VSS) were measured according to Standard Methods 2540D and E (APHA, 1992).

2.2.6. Microbial community analysis: 16S rRNA gene amplicon sequencing

Triplicate samples of 1.5 mL mixed liquor were taken from parent sample for microbial community analyses. After centrifugation (20 minutes at 19000 G), supernatant was removed and the remaining biomass was immediately frozen in liquid nitrogen. DNA extraction on these samples was performed using the FastDNA spinkit™ from MP biomedical following the provided Fastprep® protocol. The extracted DNA was stored at -20°C until further use.

The microbial diversity of the samples was assessed by MiSeq Illumina sequencing performed by the GenoToul Genomics and Transcriptomics facility (GeT-PlaGe, Auzeville, France). The V3-V4 hypervariable region of the 16S rRNA gene was amplified from genomic DNA samples using modified primers 343F and 784R (Lazuka, *et al.*, 2015). A detailed protocol can be found in the supporting information of chapter IV.

2.3. Results

2.3.1 Biomass composition and aggregate size

Microbial community

Figure 2.1.a shows the differences in AnAOB composition (at genus level) of the different types of biomass. It can be seen that biomass A and B, both comprised entirely of *Ca. Kuenenia*, were very different from biomass C made up entirely of *Ca. Brocadia*. Biomass D had the largest AnAOB diversity, containing *Ca. Kuenenia* (12%), *Ca. Brocadia* (19%) and *Ca. Jettenia* (69%). *Ca. Anammoxoglobus* was excluded from the graph due to its low relative AnAOB abundance (<0.4%) in each biomass.

Overall community analysis showed that, aside from AnAOB, AOB (*Nitrosomonas*), putative denitrifiers (*Hoppeia* and *Dinitratisoma*) and *SM1A02* were also present (Figure SII.2). The latter was detected in biomass A and B and is usually found in nitrifying sludge (Tian, *et al.*, 2017). Its enrichment has been reported in a CANON SBR (Chu, *et al.*, 2015) and an anammox UASB (Cao, *et al.*, 2016). Calculated Shannon (H), Simpson (D) and Chao indices can be found in Table SII.2. Both H and D are commonly used to compare the diversity of different population and are considered equivalent for a 'basic' analysis (Morris *et al.* 2014). Higher values indicate higher diversity, e.g. biomass B and D were comparable in terms of diversity which was higher than for the other biomasses. The Chao index is used to quantify the richness of a population which is correlated to the number of detected species. The higher this number, the higher the population richness and the higher the corresponding Chao index. e.g. biomass C has the highest richness of all biomass types.

Aggregate size characterization

Figure 2.1.b shows the average VSS repartition between the two size fractions (50-350 μm and >315 μm) for each biomass. The data reflect the visual observation that biomass A (mainly

granules) and B (thick detached biofilm fragments) contained a much higher fraction of bigger aggregates with respectively 85% and 82% of the aggregates retained in the 315 µm fraction compared to only 45% and 18% for the biomass C and D respectively.

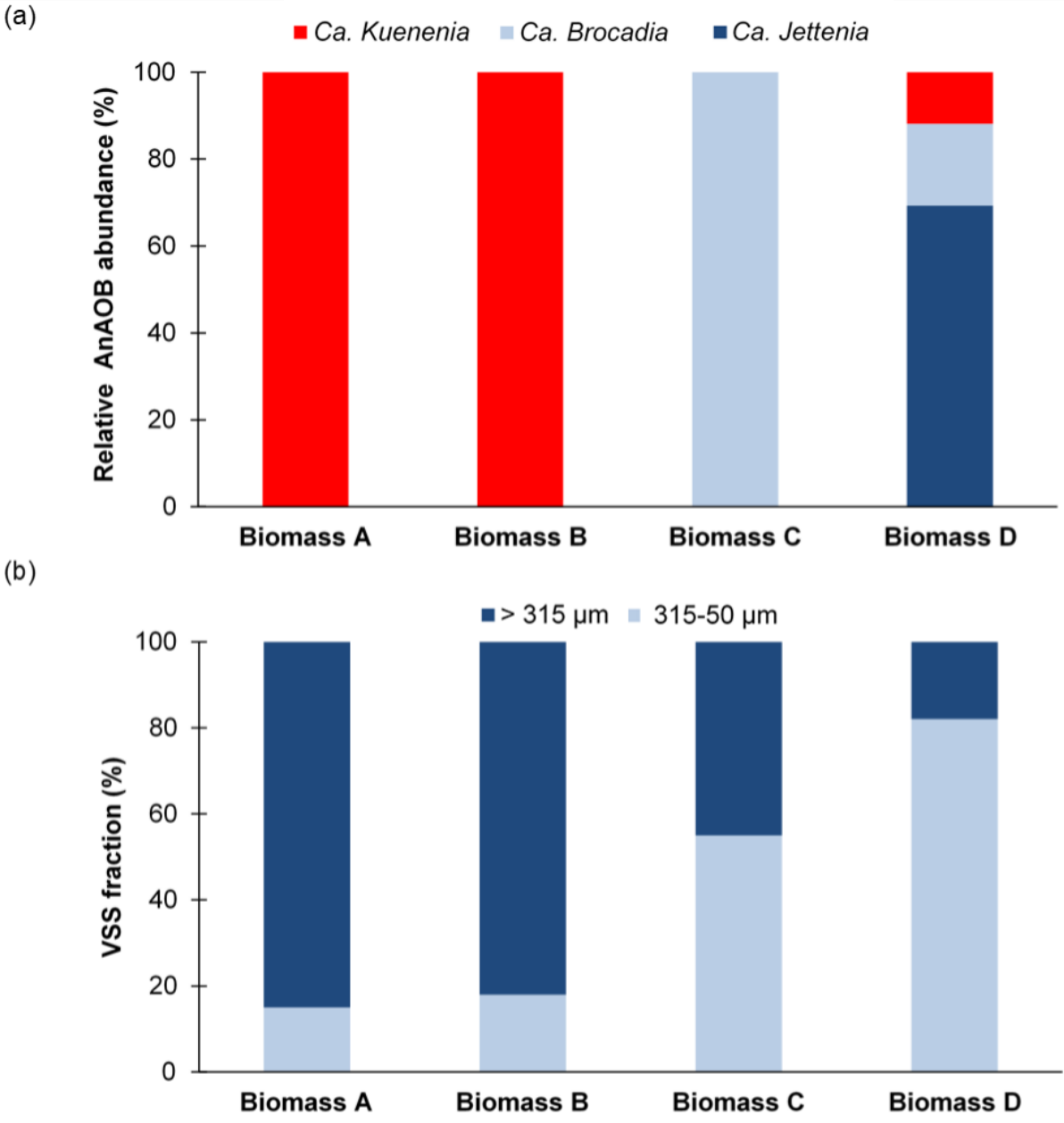

Figure 2.1 –Relative abundances of detected AnAOB genera (a) and average size fractionation (n=2) (b), for the different biomass types

2.3.2. Effect of temperature on AnAOB activity

Effect of disaggregation on temperature sensitivity

To investigate the direct impact of aggregate size on the temperature sensitivity of AnAOB biomass, granules were isolated from biomass C and half of them was disaggregated by ULTRA-TURRAX® treatment to reduce aggregate size. After disaggregation, only 4% was retained post-treatment in the fraction >315 µm, indicating that disaggregation was successful. Batch activity tests were performed in triplicate on both intact and disaggregated granules to evaluate their SARR at 30°C, 20°C and 10°C, results are shown in Figure 2.2. At each temperature, activity of the granular biomass was higher (35-66%) than the activity for the disaggregated biomass (Figure 2.2.a). For instance, at 10°C, SARR was 34.1±4.3 and 21.4±4.3 mg NH₄⁺-N/g VSS/d for granular and disaggregated biomass respectively. However, when the relative decrease of SARR was considered by comparing activity to the maximal rate at 30°C, as shown in Figure 2.2.b, the impact of granule size on the temperature sensitivity was negligible. For instance, at 10°C relative SARR was 17.8±1.3% and 15.2±1.8% for the granular and disaggregated biomass respectively.

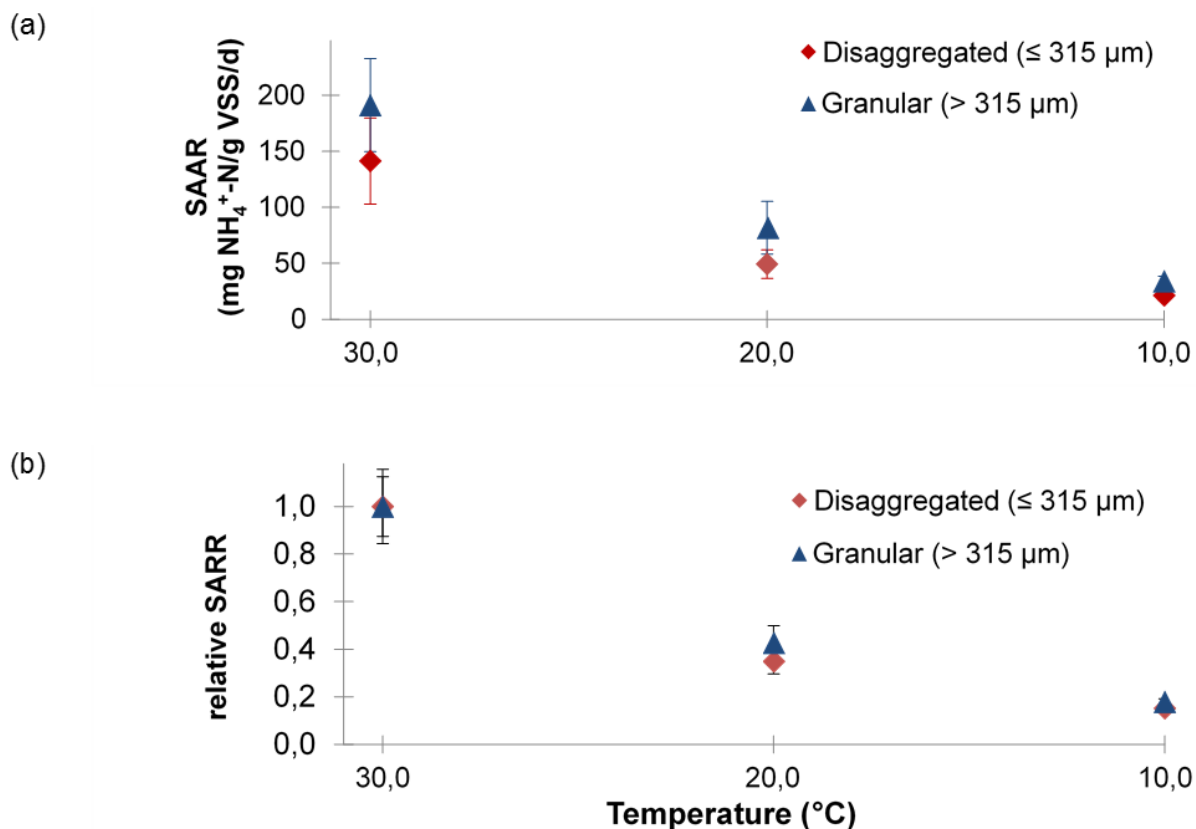

Figure 2.2 – Impact of temperature on absolute (a) and relative (b) specific ammonium removal rates (SARR) for the granules of biomass C, under intact ('granular') and disaggregated form. Error bars represent standard errors (n=3).

Effect of biomass type on temperature sensitivity

Figure 2.3.a shows the impact of temperature on the SARR values of the different biomass types. No data was available for biomass D at 12.5°C. At 30°C, most biomass types show a comparable SARR of approximately 50 mg NH₄⁺-N/g VSS/d with the exception of Biomass B which showed a significantly lower SARR, probably due to its lower abundance of AnAOB (Figure SII.2). Even at 10°C, AnAOB activity was maintained in all types of biomass, ranging from 4.2±0.6 to 13.1±2.9 mg NH₄⁺-N/g VSS/ d.

Figure 2.3.b shows the SARR calculated at each tested temperature relative to their SARR at 30°C for every biomass. In general, a decrease in SARR with decreasing temperature is observed for all four types of biomass. It can be observed that at 20°C, biomass C and D had already lost approximately 40% of their original activity while biomass A and B were impacted by this temperature drop: their relative SARR did not drop below 60% unless temperatures were lower than 15°C. The relative SARR at 10°C for biomass A and B (aggregates mainly >315µm, rich in *Ca. Kueneria*) were significantly (roughly 3 times) higher than those observed for biomass C and D (aggregates mainly ≤315µm, rich in *Ca. Brocadia* or *Ca. Jettenia*) when comparing between 30°C and 10°C, indicating a lower sensitivity to such low temperature.

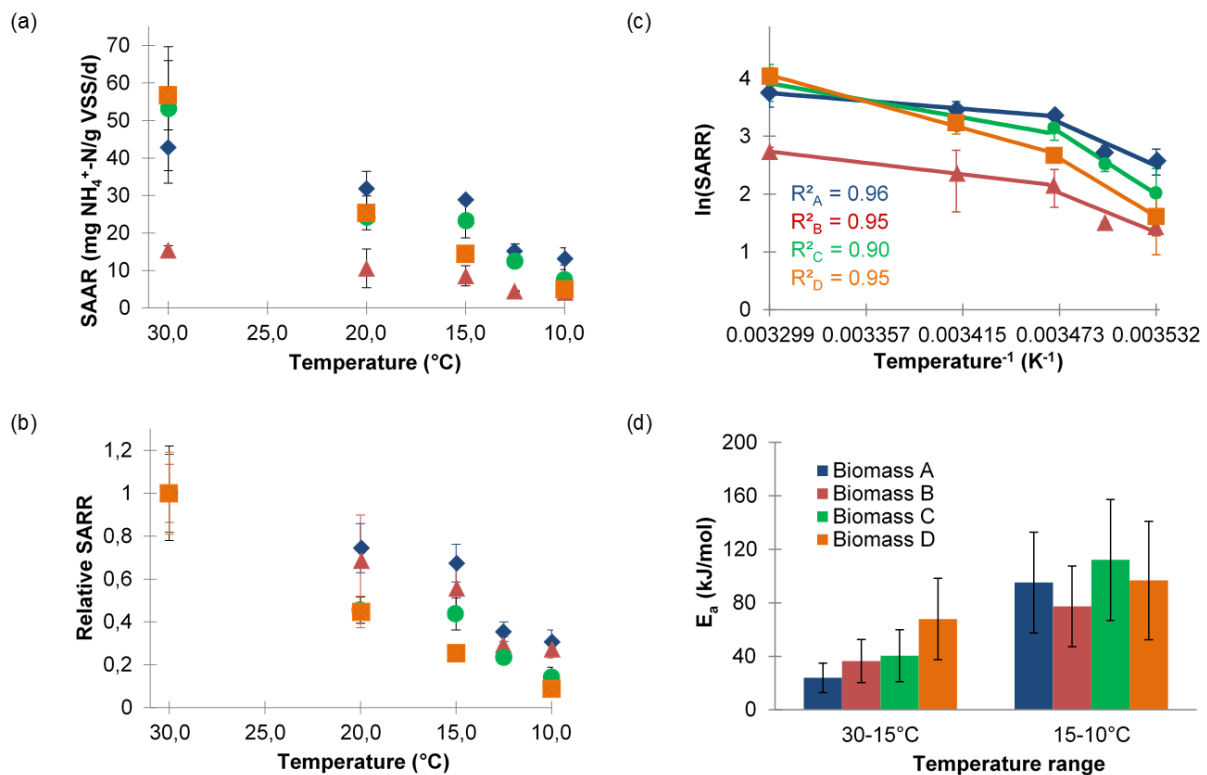

Figure 2.3 – Impact of temperature on absolute (a) and relative (b) specific ammonium removal rates (SARR), fitting to the Arrhenius equation in two temperature regions (30-15°C and 15-10°C) (c), along with derived apparent activation energies (E_a). Biomass A, B, C and D are indicated in blue (diamond), red (triangle), green (circle) and orange (square), respectively. Error bars represent standard errors ($n=3$).

Estimation of Arrhenius parameters

Fitting just one Arrhenius equation to the entire temperature range (30-10°C) resulted in a low overall goodness of fit for biomass A, B and C ($R^2=0.7-0.86$). Since temperature sensitivity was higher below 15°C for all types of biomass (Figure 2.3.b), the temperature range was split up into two zones, each with its own fitted Arrhenius curve, as proposed by Lotti *et al.*, 2014. Different scenarios where the temperature range was split at 20°C, 15°C or 12.5°C were evaluated (Table 2.2). The greatest improvement of the overall goodness of fit was observed when splitting the temperature range at 15°C, this was consistent for biomass A, B and C (average R^2 increased from 0.78 to 0.94). Since no rate was available for Biomass D at 12.5°C, the same comparison could not be made. The corresponding Arrhenius curve is show in Figure 2.3.c.

Table 2.2 - Goodness of fit (R^2) for different Arrhenius scenarios: using one or two temperature ranges.

	Scenario			
	30-10°C	30-20°C 20-10°C	30-15°C 15-10°C	30-12.5°C 12.5-10°C
Biomass A	0.77	0.89	0.96	0.93
Biomass B	0.86	0.93	0.95	0.94
Biomass C	0.70	0.83	0.90	0.84
Biomass D	0.95	0.90	0.93	n.a.

In order to quantify and compare the temperature sensitivity of the different types of biomass, their apparent activation energies were calculated between 30-15°C and 15-10°C, the same intervals that were used for the Arrhenius fitting. As can be seen in Figure 2.3.d, the E_a values calculated for the higher temperature range are much lower compared to those for the lower temperature range, situated further from the optimal temperature for AnAOB activity. Considering the mean values, this difference in E_a between the two ranges of temperature was more pronounced for biomass A, B, C than for biomass D. For the high temperature range (30-15°C), calculated E_a values are between 23.9 ± 11.1 kJ/mol, for biomass A, and 67.8 ± 30.4 kJ/mol for biomass D with biomass B and C showing intermediate E_a values. Given the

standard errors on the measurements, it was statistically only possible to show that the E_a value of biomass A was lower than that of biomass D. For the low temperature range (15-10°C), E_a values ranged between 77.3 ± 30.1 kJ/mol (biomass B) and 112 ± 45.2 kJ/mol (biomass D). A similar yet less pronounced hierarchy between the biomass types was observed as for relative SARR: the lowest average E_a value being observed for the biomass A and B could be logically associated to the lowest effect of temperature decrease. Only for biomass A and C were the E_a values between high and low temperature statistically different, indicating their temperature sensitivity is more polarized between the two intervals. This is also indicated by the biggest increase in goodness of fit when splitting the temperature range at 15°C in the Arrhenius simulations (Table 2.2).

2.4. Discussion

Quantification and modelling of the temperature effect on AnAOB activity

Since accurate modelling of the temperature effect on AnAOB activity is key for good process design, the classical approach of fitting one Arrhenius equation to a large temperature range was challenged. This was done, as previously proposed by Lotti, *et al.*, 2014, by splitting the temperature range at a certain critical temperature in order to obtain better E_a and θ estimations for each temperature interval. In support, authors had previously observed an increase in temperature sensitivity with decreasing temperature, however, critical temperatures reported in different studies varied between 28°C (*Ca. Kuenenia*, gel carriers; Isaka, *et al.*, 2008), 20-15°C (*Ca. Brocadia*, various types of biomass; Lotti, *et al.*, 2014) and 15°C (*Ca. Brocadia*, granules Sobotka, *et al.*, 2016). This study showed that the best overall goodness of fit (R^2) was achieved for a critical temperature of 15°C. This was the case for all types of biomass, except for biomass D where no data were available for 12.5°C (Table 2.2). The obtained Arrhenius plot in Figure 2.3.c shows how the slopes of the linearized curves increases below 15°C, pointing towards an increased temperature sensitivity. This illustrates the importance of using two Arrhenius equations, one for high temperatures (30-15°C) and one for low

temperatures (15-10°C). Depending on the biomass, the differences in R² between different evaluated scenarios is sometimes rather small (Table 2.2), indicating that the critical temperature slightly changes for each specific biomass, however out of all tested temperatures in this study, 15°C was most critical.

Table 2.3 show the calculated θ and corresponding E_a values together with others ones reported in literature for different types of non cold-adapted biomass. Activation energies were the lowest for biomass A and B (corresponding to a lower temperature sensitivity) but fell within the same range for all four types of biomass.

Table 2.3 - Activation energies (E_a) and corresponding theta values (Θ) reported for various non cold-adapted types of anammox biomass. AnAOB: anoxic ammonium-oxidizing bacteria; PEG: polyethylene glycol; n.a.: not available

Reference	Biomass type	AnAOB genus	Temperature (°C)	E _a (kJ/mol)	Θ (K ⁻¹)
Strous, <i>et al.</i> , 1999	Flocs	<i>Ca. Brocadia</i>	20-43	70	1.10
Dosta, <i>et al.</i> , 2008	Granules + flocs	<i>Ca. Kuenenia</i>	10-40	63	1.09
Isaka, <i>et al.</i> , 2008	PEG-gel	<i>Ca. Kuenenia</i>	6-28	93.5	1.14
	carriers	<i>Ca. Kuenenia</i>	28-37	33	1.04
Lotti, <i>et al.</i> , 2014	n.a.	<i>Ca. Brocadia</i>	15-30	65.7	1.10
This study	Biomass A	<i>Ca. Kuenenia</i>	10-15	95.1±37.6	1.15±0.06
	flocs + granules		15-30	23.9±11.1	1.03±0.02
	Biomass B	<i>Ca. Kuenenia</i>	10-15	77.3±30.1	1.12±0.05
	detached biofilm		15-30	36.5±16.1	1.05±0.02
	Biomass C	<i>Ca. Brocadia</i>	10-15	112±45.2	1.18±0.08
	flocs + granules		15-30	40.5±19.5	1.06±0.03
	Biomass D	Mainly	10-15	96.6±44.2	1.15±0.08
	flocs+ granules	<i>Ca. Jettenia</i>	15-30	67.8±30.4	1.10±0.05

As shown in Table 2.3, previous studies reported overall θ values for AnAOB in the range of 1.04-1.14. By focussing on specific temperature intervals in this study, more accurate θ values were obtained for the 30-15°C (1.03-1.10) and 15-10°C (1.12-1.18) range. Three out of four low temperature θ values reported in this study were higher than the previously reported maximum of 1.14. Using the new maximum value of 1.18 when modelling shows that only 19% of the activity is maintained when transition from 15 to 10°C (compared to 27% for $\theta = 1.14$). If used for design purposes, this could result in an 40% underestimation of the plant size. Considering the high impact of even the smallest changes in θ -values on the outcome of temperature modelling, it would be desirable to have even more accurate θ values. Future research should be focused on the 15-10°C range (or below) because of the higher associated temperature sensitivity and its relevance towards implementation of cold anammox processes. In addition, the study of long term effect (several months) would be preferable to predict the impact of seasonal temperature change.

Factors influencing temperature sensitivity

The biomass types used in this study, none of which had been previously adapted to cold temperatures, were selected to represent different aggregate sizes and AnAOB communities. The least temperature sensitive biomass types, A and B (Figure 3), were the ones that had significantly larger aggregates and AnAOB belonging to the *Ca. Kuenenia* genus (Figure 2). This is in contrast with biomass C and D, with smaller aggregates and AnAOB belonging to *Ca. Brocadia* or mainly *Ca. Jettenia* genera respectively.

Role of aggregate size

Previous studies had already suggested that thicker biofilms protected the AnAOB against the detrimental effect of decreasing temperature. Lotti and colleagues claimed this based on the

finding that the calculated E_a values of suspended biomass (83 kJ/mol) were significantly higher than for biofilms (52 kJ/mol) in his study (Lotti, *et al.*, 2014). A study comparing various low temperature (20-10°C) in PN/A reactor configurations found that nitrite accumulation started at 16°C for the suspended biomass system, whereas it occurred the latest (12-13°C) in the thickest biofilm carriers. Note that oxygen was present inside the reactor which means that temperature could also indirectly impact the activity (difference in AOB activity and hence O_2 penetration in biofilms of different thickness). However, this difference in activity was also reflected in anoxic *ex-situ* activity tests and explained partially by a larger AnAOB abundance (Gilbert, *et al.*, 2015). This is consistent with the observations in this study, where the types of biomass with the largest aggregates showed the lowest temperature sensitivity.

To further examine this claim, activity tests were performed on intact and disaggregated granules from the same biomass. On the one hand, a 26-40% drop in activity was observed after disaggregation (depending on the temperature). However, on the other hand, limited impact was observed on the relative decrease of activity when temperature decreased from 30°C to 20°C and to 10°C. Therefore, the limited impact of disaggregation on the temperature sensitivity of biomass C granules observed (Figure 3b) shows that direct effects associated with changes in mass or heat transfer (logically impacted by a reduction of the aggregate size) did not significantly impact this temperature sensitivity. This goes against the observation in another recent study where disaggregated granules from an anammox up-flow anaerobic sludge blanket reactor were more susceptible to temperature stress than the original granules (Shi, *et al.*, 2017).

Any impact of aggregate size previously reported and observed in this study was therefore most likely indirectly associated with a variability in sludge characteristics associated with

growth in thicker biofilms. For example, significant amount of extracellular polymeric substance (EPS) are generally observed in biofilm systems. Recently, it has been reported that the carbohydrate/protein-ratio of the extracellular polymeric substances (EPS) of AnAOB granules was impacted by a decrease in temperature (Shi, *et al.*, 2017), suggesting a possible relation between EPS composition and the temperature sensitivity of AnAOB bacteria. Also, it has been reported that the carbohydrate/protein ratio in the EPS of aerobic granules varied for different size fractions (Yan, *et al.*, 2015). Hence one possible hypothesis would be that the differences in EPS characteristics associated with the differences in aggregate size of the different types of biomass are responsible for the variability observed in the temperature sensitivity (e.g. lower sensitivity for biomass A and B with larger average aggregate size). Future research should aim to acquire more insights in possible correlations between temperature (sensitivity) and EPS characteristics of AnAOB.

Role of microbial community

Biomass A and B showed significantly higher relative SARR at 10°C indicating a lower sensitivity to such low temperature (Figure 2.3.b). Both were similar to each other and very different from biomass C and D in terms of both origin and AnAOB diversity. Biomass A and B originated from lab-scale set-ups treating synthetic influent as opposed to C and D, originating from full or pilot scale systems treating real influent. As the variability in temperature sensitivity of the different types of biomass could not be correlated to any difference in richness/diversity of their global communities (Table SII.2), a closer look was taken at their AnAOB diversity. Biomass A and B were the ones composed of *Ca. Kueneenia* (Figure 2.1), indicating that this genus might be less sensitive to low temperatures (below 15°C) than *Ca. Brocadia* and *Ca. Jettenia* found in biomass C and D respectively. Interestingly, during a parallel long-term reactor study in which a mix of biomass A, B, C and D was adapted by gradually decreasing temperature from 30 to 10°, a distinct switch in dominant AnOB genus from *Ca. Brocadia* to

Ca. Kueneenia was observed. In contrast, *Ca. Brocadia* was and remained the predominant genus in the reference reactor at 30°C throughout the entire experiment.

On the other hand, regarding literature, almost every other long-term study at low temperature reported that *Ca. Brocadia* was and remained the dominant genus throughout the experiments, which led to the belief that this genus has a competitive advantage over other AnAOB genera at low temperature (Hendrickx, *et al.*, 2012, Hu, *et al.*, 2013, Gilbert, *et al.*, 2014, Hendrickx, *et al.*, 2014, Lotti, *et al.*, 2014, Gilbert, *et al.*, 2015, Laureni, *et al.*, 2015, Laureni, *et al.*, 2016).

Available E_a data from previous studies do not allow to differentiate in temperature sensitivity between the before mentioned genera. E_a values of 63 kJ/mol between 10°C-40°C (Dosta, *et al.*, 2008) and 93 kJ/mol between 6°C and 22°C (Isaka, *et al.*, 2008) have been reported for *Ca. Kueneenia*. These values fall within the same range as the ones obtained for *Ca. Brocadia* (Hendrickx, *et al.*, 2014, Lotti, *et al.*, 2014). The current study found comparable E_a -values for the lower temperature range (Table 2). It should be remarked that the difference in the temperature sensitivity observed in our study was especially related to a better resistance in the range from 30 to 20°C of biomass containing *Ca. Kueneenia*. Indeed, the E_a values determined in the lower temperature range (15-10°C) were more evenly distributed. This is in accordance with our recent parallel long-term study, during which the switch from *Ca. Brocadia* to *Ca. Kueneenia* occurred in a range of temperature around 20°C.

Previously reported differences in ladderane lipid distributions in the anammoxosome of different AnAOB (Ratray, *et al.*, 2008, Ratray, *et al.*, 2010) might be correlated to differences in temperature sensitivity since changes in ladderane composition have been linked to heteroviscous adaptation of AnAOB to low temperatures (Ratray, *et al.*, 2010). However, the intricacies of AnAOB niche differentiation are still little understood and many other factors such as differences in substrate affinity (ammonia and nitrite), tolerance towards oxygen, nitrite or

presence of certain types of organic carbon and are most likely also involved, so one must remain careful when implying a causality between temperature dependency and presence of a specific AnAOB genus. One possible explanation for difference in the selection occurring in the different studies (at low temperature) is the feeding mode (continuous or batch) and the presence/absence of nitrite in the influent. Indeed, this would lead to the predominance of K_s - or μ - strategist depending on the level of substrate maintained in the reactor. Hence it is important to distinguish between the instant cold tolerance of species (based on maximal activity) and the long-term selection processes occurring at low temperature in a continuous system.

In conclusion, the factors influencing the impact of temperature on AnAOB activity are probably multiple, interlinked and can be both of direct (e.g. explored temperature range, microbial composition, adaptation) and indirect (e.g. changes in EPS structure associated with different aggregate sizes) nature. Thus explaining why the observed variability in temperature response can be poorly linked to a single parameter.

2.5. Conclusions

- Disaggregation had no significant direct impact of on temperature sensitivity, indicating that the influence of aggregate size, if any, would be indirect.
- Biomass A/B (largest aggregate size, *Ca. Kuenenia*) were less temperature sensitive than biomass C/D (smaller aggregates, *Ca. Brocadia/Ca. Jettenia*), when comparing SARR between 30 and 10°C.
- Data suggest that *Ca. Kuenenia* is less sensitive to a temperature decrease than the other present AnAOB genera.
- The use of two Arrhenius equations, between 30-15°C and between 15-10°C, is proposed to improve goodness of fit (R_{average}^2 increased from 0.70-0.95 to 0.90-0.96) and obtain more realistic modelling parameters for each temperature interval.

2.6. Acknowledgements

This study has been financially supported by the ANRT (CIFRE N° 2014/0754). The Authors are grateful to the Genotoul bioinformatics platform Toulouse Midi-Pyrenees and the Sigenae group for providing help and computing resources through to their Galaxy platform.

2.7. Conflicts of interest

No conflicts of interest are to be reported

2.8. References

- APHA, A. (1992) WPCF (American Public Health Association, American Waterworks Association, Water Pollution Control Federation)(1992) Standard methods for the examination of water and wastewater, *Standard methods for the Examination of Water and Wastewater* **17**.
- Cao, S., Du, R., Li, B., Ren, N., and Peng, Y. (2016) High-throughput profiling of microbial community structures in an ANAMMOX-UASB reactor treating high-strength wastewater, *Appl Microbiol Biotechnol* 100: 6457-6467.
- Cao, Y., van Loosdrecht, M.C.M., and Daigger, G.T. (2017) Mainstream partial nitritation–anammox in municipal wastewater treatment: status, bottlenecks, and further studies, *Appl Microbiol Biotechnol* 101: 1365-1383.
- Chu, Z.-r., Wang, K., Li, X.-k., Zhu, M.-t., Yang, L., and Zhang, J. (2015) Microbial characterization of aggregates within a one-stage nitritation–anammox system using high-throughput amplicon sequencing, *Chem Eng J* 262: 41-48.
- Dosta, J., Fernandez, I., Vazquez-Padin, J.R., Mosquera-Corral, A., Campos, J.L., Mata-Alvarez, J., and Mendez, R. (2008) Short- and long-term effects of temperature on the Anammox process, *J Hazard Mater* 154: 688-693.
- Gilbert, E.M., Agrawal, S., Karst, S.M., Horn, H., Nielsen, P.H., and Lackner, S. (2014) Low Temperature Partial Nitritation/Anammox in a Moving Bed Biofilm Reactor Treating Low Strength Wastewater, *Environ Sci Technol* 48: 8784-8792.
- Gilbert, E.M., Agrawal, S., Schwartz, T., Horn, H., and Lackner, S. (2015) Comparing different reactor configurations for Partial Nitritation/Anammox at low temperatures, *Water Res* 81: 92-100.
- Hendrickx, T.L.G., Kampman, C., Zeeman, G., Temmink, H., Hu, Z., Kartal, B., and Buisman, C.J.N. (2014) High specific activity for anammox bacteria enriched from activated sludge at 10 degrees C, *Bioresource Technol* 163: 214-221.
- Hendrickx, T.L.G., Wang, Y., Kampman, C., Zeeman, G., Temmink, H., and Buisman, C.J.N. (2012) Autotrophic nitrogen removal from low strength waste water at low temperature, *Water Res* 46: 2187-2193.
- Hu, Z., Lotti, T., de Kreuk, M., Kleerebezem, R., van Loosdrecht, M., Kruit, J., et al. (2013) Nitrogen removal by a nitritation-anammox bioreactor at low temperature, *Appl Environ Microb* 79: 2807-2812.

- Isaka, K., Date, Y., Kimura, Y., Sumino, T., and Tsuneda, S. (2008) Nitrogen removal performance using anaerobic ammonium oxidation at low temperatures, *FEMS Microbiol Lett* 282: 32-38.
- Jetten, M.S.M., van Niftrik, L., Strous, M., Kartal, B., Keltjens, J.T., and Op den Camp, H.J.M. (2009) Biochemistry and molecular biology of anammox bacteria, *Crit Rev Biochem Mol* 44: 65-84.
- Laureni, M., Falås, P., Robin, O., Wick, A., Weissbrodt, D.G., Nielsen, J.L., et al. (2016) Mainstream partial nitrification and anammox: long-term process stability and effluent quality at low temperatures, *Water Res* 101: 628-639.
- Laureni, M., Weissbrodt, D.G., Szivák, I., Robin, O., Nielsen, J.L., Morgenroth, E., and Joss, A. (2015) Activity and growth of anammox biomass on aerobically pre-treated municipal wastewater, *Water Res* 80: 325-336.
- Lazuka, A., Auer, L., Bozonnet, S., Morgavi, D.P., O'Donohue, M., and Hernandez-Raquet, G. (2015) Efficient anaerobic transformation of raw wheat straw by a robust cow rumen-derived microbial consortium, *Bioresour Technol* 196: 241-249.
- Lotti, T., Kleerebezem, R., Hu, Z., Kartal, B., Jetten, M., and van Loosdrecht, M. (2014) Simultaneous partial nitrification and anammox at low temperature with granular sludge, *Water Res* 66:111-121.
- Lotti, T., Kleerebezem, R., and van Loosdrecht, M. (2014) Effect of temperature change on anammox activity, *Biotechnol Bioeng* 112: 98-103.
- Morris EK, Caruso T, Buscot F, et al. Choosing and using diversity indices: insights for ecological applications from the German Biodiversity Exploratories. *Ecology and Evolution*. 2014;4(18):3514-3524. doi:10.1002/ece3.1155.
- Rattray, J.E., van de Vossenberg, J., Hopmans, E.C., Kartal, B., van Niftrik, L., Rijpstra, W.I.C., et al. (2008) Ladderane lipid distribution in four genera of anammox bacteria, *Arch Microbiol* 190: 51-66.
- Rattray, J.E., van de Vossenberg, J., Jaeschke, A., Hopmans, E.C., Wakeham, S.G., Lavik, G., et al. (2010) Impact of temperature on ladderane lipid distribution in anammox bacteria, *Appl Environ Microb* 76: 1596-1603.
- Schaubroeck, T., De Clippeleir, H., Weissenbacher, N., Dewulf, J., Boeckx, P., Vlaeminck, S.E., and Wett, B. (2015) Environmental sustainability of an energy self-sufficient sewage treatment plant: Improvements through DEMON and co-digestion, *Water Res* 74: 166-179.

- Shi, Z.-J., Guo, Q., Xu, Y.-Q., Wu, D., Liao, S.-M., Zhang, F.-Y., et al. (2017) Mass transfer characteristics, rheological behavior and fractal dimension of anammox granules: The roles of upflow velocity and temperature, *Bioresource Technol* 244: 117-124.
- Sobotka, D., Czerwionka, K., and Makinia, J. (2016) Influence of temperature on the activity of anammox granular biomass, *Water Sci Technol* **73**: 2518-2525.
- Strous, M., Kuenen, J.G., and Jetten, M.S. (1999) Key physiology of anaerobic ammonium oxidation, *Appl Environ Microb* 65: 3248-3250.
- Tian, S., Tian, Z., Yang, H., Yang, M., and Zhang, Y. (2017) Detection of Viable Bacteria during Sludge Ozonation by the Combination of ATP Assay with PMA-Miseq Sequencing, *Water* 9: 166.
- Vlaeminck, S.E., De Clippeleir, H., and Verstraete, W. (2012) Microbial resource management of one-stage partial nitrification/anammox, *Microb Biotechnol* 5: 433-448.
- Yan, L., Liu, Y., Wen, Y., Ren, Y., Hao, G., and Zhang, Y. (2015) Role and significance of extracellular polymeric substances from granular sludge for simultaneous removal of organic matter and ammonia nitrogen, *Bioresource Technol* 179: 460-466.

Chapter III

Enrichment and adaptation yield high anammox conversion rates under low temperatures

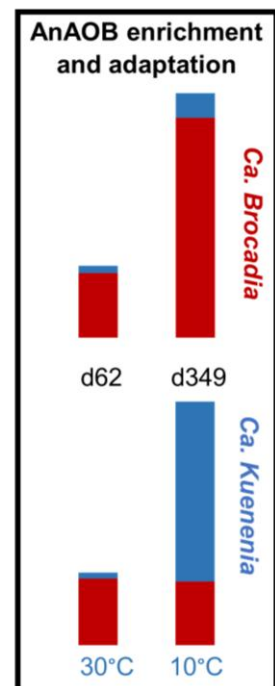
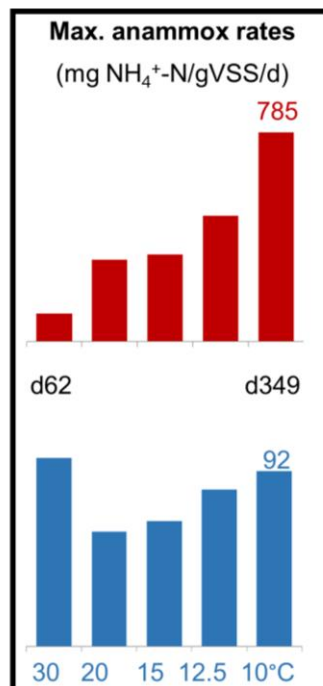
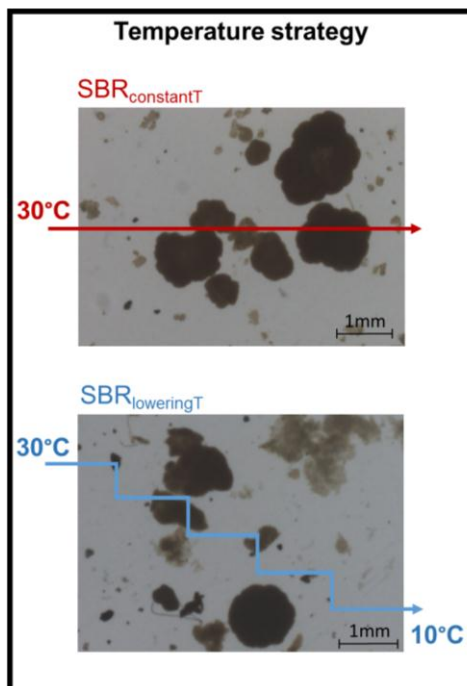

Abstract

This study compared two anammox sequencing batch reactors (SBR) for one year. $SBR_{constantT}$ was kept at 30°C while temperature in $SBR_{loweringT}$ was decreased step-wise from 30°C to 20°C and 15°C followed by over 140 days at 12.5°C and 10°C. High retention of anammox bacteria (AnAOB) and minimization of competition with AnAOB (anoxic operation, no COD) were key. 5-L anoxic reactors with the same inoculum were fed synthetic influent containing 25.9 mg NH_4^+ -N/L and 34.1 mg NO_2^- -N/L. Specific ammonium removal rates continuously increased in $SBR_{constantT}$, reaching 785 mg NH_4^+ -N/gVSS/d, and were maintained in $SBR_{loweringT}$, reaching 82.2 and 91.8 mg NH_4^+ -N/gVSS/d at 12.5 and 10°C respectively. AnAOB enrichment (increasing *hzsA* and 16S rDNA gene concentrations) and adaptation (shift from *Ca. Brocadia* to *Ca. Kueneenia* in $SBR_{loweringT}$) contributed to these high rates. Rapidly settling granules developed, with average diameters of 1.2 ($SBR_{constantT}$) and 1.6 mm ($SBR_{loweringT}$). Results reinforce the potential of anammox for mainstream applications.

Key words: biological nitrogen removal; shortcut nitrogen removal; cold anammox; microbial community structure

Enrichment and adaptation yield high anammox conversion rates under low temperatures

P. De Cocker^{1,2,3}, Y. Bessiere¹, G. Hernandez-Raquet¹, S. Dubos¹, I. Mozo², G. Gaval², M. Caligaris⁴, B. Barillon², S.E. Vlaeminck^{3,5,§}, M. Sperandio^{1,§,*}

1. LISBP, Université de Toulouse, CNRS, INRA, INSA, Toulouse, France

2. SUEZ, CIRSEE, Le Pecq, France

3. Center for Microbial Ecology and Technology (CMET), Ghent University, Ghent, Belgium

4. SUEZ, Treatment Infrastructures, Rueil Malmaison, France

5. Research Group of Sustainable Energy, Air and Water Technology, University of Antwerp, Antwerpen, Belgium

§ equally contributed as senior authors

* corresponding author: mathieu.sperandio@insa-toulouse.fr

3.1. Introduction

Partial nitritation/anammox (PN/A) is an autotrophic shortcut nitrogen removal process in which, after partial nitritation, Anammox bacteria (AnAOB) perform anoxic oxidation of ammonium with the produced nitrite as electron acceptor. This process requires less oxygen, has no need for organic carbon, and yields a lower sludge production. It can thus present a more cost-efficient treatment compared to the conventional nitrification/denitrification process (Vlaeminck et al. 2012). Many advancements have been made and by the end of 2013, close to one hundred full scale side-stream anammox installations, usually treating digestate, landfill leachate or reject water, have seen the day (Lackner et al. 2014, Mulder et al. 1995, Siegrist et al. 2008, Strous et al. 1999). The next development goal is to introduce anammox in the mainstream or waterline of sewage treatment plants in order to further improve their efficiency in terms of energy consumption (and hence economics) and greenhouse gas emissions.

The main challenges for PN/A implementation on pretreated sewage, so-called mainstream PN/A, are associated with the development of robust methods to suppress nitrite oxidizing bacteria (NOB) and promote the growth and activity of AnAOB under relatively low influent nitrogen concentrations (40-80 mg $\text{NH}_4^+\text{-N/L}$) and non-negligible amounts of biodegradable organic carbon (which allows heterotrophic bacteria (HB) to develop and compete for nitrite through denitrification). Furthermore, and of particular interest for regions with a temperate (or cold) climate, relatively low sewage temperatures (below 15°C, down to 10°C, or even below) drastically decrease AnAOB growth rates and activity (Cao et al. 2017, Vlaeminck et al. 2012). Their optimal operating temperature has been reported around 35°C - 40°C (Strous et al., 1999, Isaka et al. 2008).

Several attempts have been made to understand and model the short term impact of decreasing temperature on the specific ammonia removal rate (SARR) by calculating Arrhenius temperature coefficient (also called θ -value) or Activation Energy (E_a). These studies reported a sharp decrease in anammox activity from 15°C and down (up to 10-fold between

30 and 10°C). Maximum reported SARR values (after conversion from N₂ production to NH₄⁺ consumption based on the theoretical stoichiometry) at 10°C did not go beyond 14 mg NH₄⁺-N/gVSS/d (Lotti et al. 2014c, Dosta et al. 2008). However, short-term batch tests do not include the impact of adaptation and selection on the temperature sensitivity of the biomass, and are therefore not sufficient to assess the full potential of anammox at lower temperatures.

Several reactor strategies have been tested for anammox at lower temperature, with different types of biomass (flocs, granules or carrier-supported biofilms), and types of wastewater. Adaptation could be demonstrated through a shift in optimal temperature upon quickly or gradually decreasing temperature in Moving Bed Biofilm Reactor (MBBR) (Gilbert et al. 2014, Gustavsson et al. 2014) and Sequencing Batch Reactor (SBR) systems (Gilbert et al. 2015, Hu et al. 2013). The formation, enrichment and maintenance of anammox granules at lower temperatures has been reported on both synthetic wastewater at 10°C (Hendrickx et al. 2014, Lotti et al. 2014a) and real wastewater at 16°C (Ma et al. 2013) and 10°C (Lotti et al. 2014b). In another study where hybrid sludge (flocs + wall attached biofilm) was formed, decreasing temperature caused the SARR to drop tenfold, but the system's performance remained stable at 12°C (Laureni et al. 2015). Stable PN/A performance was also observed when decreasing the temperature to 15°C in 2 MBBRs, however a sudden drop in temperature caused a significant yet reversible drop in anammox activity (Laureni et al. 2016). Interestingly, *Brocadia* was the dominant anammox genus in all of the abovementioned studies throughout the adaptation to and operation at low temperature. It should be mentioned that all those studies at low temperature were performed in the presence of oxygen and/or organic carbon and the temperature decrease was often abrupt (big steps) and/or little time (days to a couple of months) was given to renew the slow growing AnAOB. To our knowledge, no study has been done under pure anoxic autotrophic conditions with granular sludge at low temperature.

The objective of this study was to reveal the maximum potential of so-called 'cold anammox' (for temperatures below 15°C), also monitoring potential change in the microbiological structure and the physical properties of granular sludge. In order to achieve an adapted and enriched anammox community, a long-term reactor experiment was designed in which the microbial competition was limited through using anoxic reactors, avoiding AOB and NOB activity, in the absence of organic carbon, avoiding HB. To do so, an anammox sequencing batch reactor (SBR) operated at high temperature (30°C) was compared to one subjected to subsequent temperature drops for almost 1 year. The impact of lowering the operational temperature from 30 over 20, 15 and 12.5 to 10°C on nitrogen removal performance and factors linked to biomass enrichment/adaptation and morphology was examined.

3.2. Material and Methods

3.2.1 Set-up and operation of the reactors

Two anammox SBR were operated in parallel, composed of identical, airtight, mixed, and jacketed vessels (5L), equipped with pH (H 8481 HD, SI Analytics), temperature and dissolved oxygen (DO) probes (VisifermTM, Hamilton). The SBR mode is comprised of four characteristic phases: (1) filling phase (30 minutes, inflow of 2.5L influent, hence a volumetric exchange ratio of 50%), during which oxygen was removed from the liquid through stripping with N₂ gas. For the next 30 minutes, the reactors were flushed with a mixture of N₂ and CO₂ gas to ensure anoxic conditions and set the pH back to 7.5 before starting the actual (2) reaction phase with a variable duration (between 4h and 11.3h). The length of the reaction phase was shortened (lengthened) to increase (decrease) the ammonium loading rate (ALR) when needed. After the reaction phase, mixing was stopped for 30 minutes during the (3) settling phase before starting the (4) discharge phase where 2.5L of supernatant was removed before starting the next cycle. Those operating conditions led to maintain in the system particles that have a settling velocity higher than 0.29 m/h.

One reactor, $SBR_{\text{constantT}}$, was kept at the reference temperature of 30°C throughout the entire experiment while in the second reactor, $SBR_{\text{loweringT}}$, a stepwise decrease from 30°C to 20°C, 15°C, 12.5°C and finally 10°C was imposed corresponding to phases I, II, III, IV and V respectively. The decrease of temperature was deliberately slow to let the time for the microbial community to adapt to new conditions. More specifically the temperature pattern was chosen according to the following philosophy:

- Step by step, each step being maintained for at least 2 months, until the Ammonium Removal Efficiency recovered a value of 100%, and the Volumetric Ammonium Removal Rate (VARR), i.e. the anammox conversion rate, reached steady state value;
- The temperature delta was not conservative, but progressively smaller (10°C, 5°C, 2.5°C, 2.5°C), assuming that the last temperature steps would be more detrimental to the anammox bacteria considering previous literature indicating a higher activation constant at low temperature;
- The rate of temperature decrease was linear with a slope of 2°C/day, 2°C/day, 1°C/day, 0.5°C/day for the last, again expecting that the last temperature step would be more critical for anammox bacteria.

Finally, the decrease from 30 to 10°C took 7 months. Calculations were made in order to evaluate if this time was sufficiently long to allow the renewal of most of the biomass initially contained in the reactor considering the AnAOB biomass yield and imposed nitrogen load. These calculations are given in the discussion.

The reactors were fed with the same synthetic influent which was stored at 4°C in a 150L tank. The influent contained per liter 168.0 mg of NaNO_2 , 98.8 mg of NH_4Cl , 165.0 mg of

MgSO₄•7H₂O, 143.8 mg of CaCl₂•2H₂O, 6.3 mg of EDTA-Na₂•2H₂O, 775.4 mg of NaHCO₃, 30.0 mg of KH₂PO₄, and 9.1 mg of FeSO₄•7H₂O. Hence, the total nitrogen content was 60 mg N/L, a typical value for municipal wastewater (Metcalf 2003), made up of ammonium and nitrite in a 1/1.32 ratio corresponding to the stoichiometry found by (Strous et al. 1998): 25.9 mg N-NH₄⁺/L and 34.1 mg N-NO₂⁻/L. Per liter of influent, 2 mL of a trace element solution was added, which contained per liter 430 mg of ZnSO₄•7H₂O, 240 mg of CoCl₂•6H₂O, 1.21g of MnCl₂•4H₂O, 250 mg of CuSO₄•5H₂O, 183 mg of Na₂MoO₄•2H₂O, 274.6 mg of NiSO₄•7H₂O, 50.1 mg of Na₂SeO₃•5H₂O, 60.9 mg of Na₂WO₄•2H₂O, 14 mg of H₃BO₃ and 15g of EDTA-Na₂•2H₂O.

3.2.2 Biomass inoculum mix

To provide a high microbial AnAOB diversity, four different non cold-adapted biomasses from stable, long running systems containing AnAOB and operated at rather high temperature (26-30°C) were mixed (see table S.III of the supplementary information). Half of the biomass types originated from smaller lab-scale set-ups treating synthetic influent, the others originated from full or pilot scale systems treating centrate from a sewage sludge digester. Three of the systems were PN/A (aerobically operated), the fourth system was anammox (anoxic). The resulting inoculated biomass concentration was 2.3 g VSS/L

3.2.3 Anammox activity and chemical analyses

The actual ammonium removal efficiencies were determined by measuring outlet concentrations of ammonium roughly every two days. Comparable information was obtained from nitrite measurements.

With the systems being operated in sequencing batch mode, kinetics could be followed directly during the reaction phase of the cycles. The *in situ* VARR was measured two to three times

per week. Samples of mixed liquor (8mL) were taken throughout the reaction phase of one cycle. The ammonium uptake rate was calculated by linear regression (no substrate limitation for ammonium concentration higher than 5 mgN/L for which a linear decrease was observed). Roughly every one or two months, mixed liquor samples were taken from the reactors to determine total (TSS) and volatile (VSS) suspended solids concentrations. For biomass sampling a protocol was carefully set up to collect representative samples. During sampling, the agitation speed was increased (from 50 to 100 rpm) for maximal homogenization of the reactor liquid (and at least one minute before sampling). Sampling and VSS measurements were done in duplicate, and the sample volume (2x50 mL) was chosen to obtain good reproducibility. For each phase, an average biomass concentration (g VSS/L) was calculated (two to three measurements) together with the average *in situ* VARR during the last two weeks (three to four measurements). From this, the *in situ* specific ammonium removal rate (SARR) at the end of each phase was estimated. Standard deviations were calculated for average VARR and VSS and propagated in the error bars for SARR, allowing for an objective comparison. Student tests (t-tests) were performed to compare mean SARR values between reactors and between consecutive phases within the same reactor.

All water samples were centrifuged (4°C, 2 minutes at 2,591xg) and supernatant was filtered through 0.2 µm membrane filters prior to nitrogen compounds analysis. Nitrite and nitrate were quantified using spectrophotometric methods, analyses were done automatically using the SMARTCHEM200 (AMS, Italy). Ammonium concentration was measured according to the spectrophotometric Nessler method (APHA 1992). Suspended solids (TSS and VSS) were measured in duplicate according to Standard Methods 2540D and E (APHA 1992).

3.2.4 Particle size distribution of the biomass aggregates

The particle size distribution (PSD) was determined after 354 days. Triplicate samples of mixed liquor were taken, and particles were visualized with a WILD M420x1.25 (optical zoom set at x6.4) stereomicroscope, operated using a NIKON DS-U2 control unit combined with NIS-elements F software (v.3.2). Photos were taken using a NIKON DS-Fi1 digital microscope camera. For each triplicate, 50 photos were taken. The three series of photos were combined to give one set of 150 photos per reactor for image analysis.

The first step of the image treatment consisted of a conversion to greyscale using IrfanView software (v.4.10). Next, using Visilog software (v.6.7), the pixel-scale values were converted by a scaling factor (which was calibrated for the magnification). Each grey-scale image underwent a binarization step after which the surface of each particle was quantified and used to estimate the sphere-equivalent diameter. The used script was made so that particles touching the edge of the photo or with a diameter smaller than 15 μm would not be detected (the detection limit corresponded to a minimal number of 10 pixels in the image analysis script). The obtained data was then treated in Excel with a visual basic macro to obtain the number, surface and volume weighted PSD along with additional information such as mean diameters.

3.2.5 Microbial community analyses

Triplicate samples of 1.5 mL mixed liquor were taken from each reactor, one was used for microbial community analyses, and the other two were stored as back-up. This was done on average once every two to three weeks with higher sampling density around each transition between phases. After centrifugation (20 min at 19,000xg), supernatant was removed and the remaining biomass was immediately frozen in liquid nitrogen. DNA extraction on one of these samples was performed using the FastDNA spinkit™ from MP biomedical following the provided Fastprep® protocol. The extracted DNA was stored at -20°C until further use.

In order to map AnAOB enrichment, qPCR was used to quantify the AnAOB based on phylogenetic primers (16S rRNA) and functional primers (hzsA). Also, to follow up the composition of the overall community, MiSeq Illumina sequencing was performed by the GenoToul Genomics and Transcriptomics facility (GeT-PlaGe, Auzeville, France). Sequencing data was processed using the pipeline FROGS, one of the tools proposed on Galaxy, an open web-based platform for genomic research. A more detailed protocol can be found in the supporting information of chapter IV.

3.3. Results

3.3.1. Reactor performance

3.3.1.1. Start-up of the reactors

Both reactors were started with the same seeding sludge and operated identically at 30°C for 62 days to allow for adaptation to the new incubations conditions. During this period, both reactors showed a very comparable evolution both in ammonium removal efficiency (Figure 3.1.b) and VARR, starting out around 48 mg NH₄⁺-N/L/d on day 19 and increasing to around 74.4 mg NH₄⁺-N/L/d on day 54 (Figure 3.1.a). Because of this increase in volumetric activity, the duration of the reaction time was decreased twice resulting in an increase ALR: from 40.8 mg NH₄⁺-N/L/d to 47.0 mg NH₄⁺-N/L/d (on day 24) and later to 55.4 mg NH₄⁺-N/L/d (on day 31). While a biomass concentration of 2.3 g VSS/L was initially added, levels of 0.70 and 0.76 g VSS/L, for SBR_{constantT} and SBR_{loweringT} respectively, were retrieved on day 67. This was caused by washout of the smallest aggregates during the first two months of operation, this is illustrated by the increased loss of VSS in the effluent during phase I.

Figure 3.2 shows the average *in situ* specific ammonium removal rates (SARR) at the end of each operating phase. By the end of the phase I, in which both reactors had been operated identically, they had reached very similar *in situ* SARR (103±14 and 99±26 mg NH₄⁺-N/gVSS/d for SBR_{constantT} and SBR_{loweringT} respectively). On day 62, temperature in SBR_{loweringT} was

decreased to 20°C, whereas from this point on, operating conditions in SBR_{constantT} were left unchanged for the rest of the experiment (T=30°C, ALR = 55.4 mg NH₄⁺-N/L/d).

3.3.1.2. Activity evolution at constant temperature (30°C)

For the control reactor SBR_{constantT}, as shown in Figure 3.1.a, maximal volumetric activity has continuously increased upon inoculation: at the beginning of period II, it increased slightly from 79.2 mg NH₄⁺-N/L/d on day 69 to 87.6 mg NH₄⁺-N/L/d on day 103. On this day, a leak causing a slight entrance of oxygen (0.05 mg O₂/L) in the headspace was detected. After this leak was repaired, the activity increased even more rapidly to 129.8 mg NH₄⁺-N/L/d in only three days. This increase in activity with time in SBR_{constantT} continued almost linearly during the overall study. Finally, maximal VARR reached about six times its initial value up to 336 mg NH₄⁺/L/d at the end of the experiment. At this high VARR, all of the ammonia and nitrite were consumed during the first 45 minutes of the reaction phase. The VARR was higher than the ALR, translating in a part of the reaction phase in which conditions were endogenous. The ammonium removal efficiency remained close to 100% during the entire running period (Figure 3.1.b). The average effluent concentrations were 0.6 mg NH₄⁺-N/L and 0.1 mgNO₂⁻-N/L over the entire operating period.

As VSS decreased (roughly by a factor 1.7) during the experiment, the evolution of specific activity is of particular interest: the *in situ* SARR increased by a factor 7.5 between the end of phase I (103 mg NH₄⁺-N/gVSS/d) and the end of phase V (785 mg NH₄⁺-N/gVSS/d). During this period, the relative abundance of *Ca. Brocadia* increased from 50 to 80%, suggesting enrichment and/or an adaptation of the anammox biomass; this point will be addressed in the discussion section.

3.3.1.3. Activity evolution at decreasing temperature (30°C to 10°C)

As shown in Figure 3.1.a, each temperature decrease step in $SBR_{\text{loweringT}}$ resulted in a decrease of anammox activity which temporarily affected the removal efficiency. This effect was most pronounced when switching from 30 to 20°C (beginning of phase II) and from 15°C to 12.5°C (beginning of phase IV), resulting in a 64.8% and 76.7% drop in activity respectively. However, partial recovery after the temperature drop from 30°C to 20°C, activity took 6 weeks, significantly more than the 3 days required for recovery after the drop from 15° to 10°C, which was probably the result of an adaptation and/or enrichment of the biomass during the 146 days between these events (see section 3.3.2). The effects of decreasing temperature from 20°C to 15°C and 12.5°C to 10°C were less significant, as activity loss was lower (36.3% and 28.4% respectively) and activity recovered within the month. Considering the activity measured at the end of each phase, maximal VARR decreased from 76.2 to 41.0 mg NH_4^+ -N/L/d for temperature decrease from 30°C to 20°C (phases I and II), but was relatively similar at the end of the next three phases (III, IV, V), reaching 24.0 mg NH_4^+ -N/L/d at the end the study. For this reason, it was possible to maintain the nitrogen load constant during the phases II, III, IV and V without impacting that much the ammonium removal efficiency, which remained also relatively high during the study, ranging between 57-100% for $SBR_{\text{loweringT}}$ (Figure 3.1.b). The average effluent concentrations were 2.7 mg NH_4^+ -N/L and 3.3 mg NO_2^- -N/L over the entire operating period.

In $SBR_{\text{loweringT}}$ the VSS concentration also decreased during the experiment, from 0.76 g VSS/L to 0.24 g VSS/L. When temperature was decreased to 20°C, *in situ* SARR dropped by 38% between the ends of phase I and II. During this time, the biomass concentration decreased from 0.76 g VSS/L to 0.56 g VSS/L. For the next 11 weeks, SARR remained rather stable, reaching 65.6 mg NH_4^+ -N/g VSS/d at the end of phase III while biomass concentration

decreased from 0.56 g VSS/L to 0.39 g VSS/L. Further decreases in temperature affected transiently the SARR but did not negatively impact the final SARR obtained after several weeks at the end of the temperature step. On the contrary SARR increased slightly to 82.2 mg NH₄⁺-N/g VSS/d at the end of phase IV and reached 91.8 mg NH₄⁺-N/g VSS/d at the end of phase V. This is the highest reported SARR at such low temperature. These results demonstrate a very successful adaptation and operation of the granular sludge anammox process at 10°C.

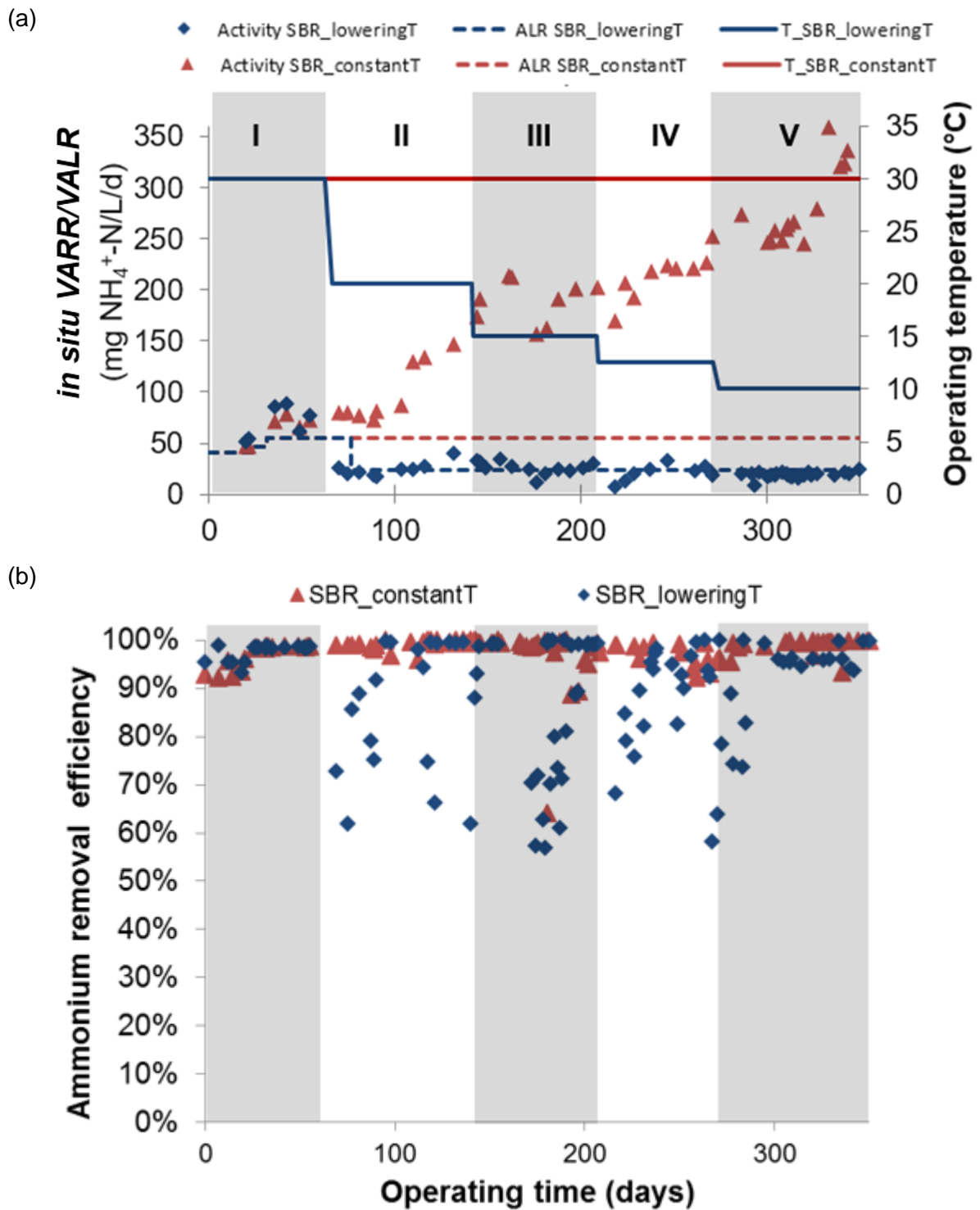

Figure 3.1 – Evolution of the operating temperature, *in situ* volumetric ammonium removal rate and volumetric ammonium loading rate (a) and ammonium removal efficiency (b) in SBR_{constantT} (red) and SBR_{loweringT} (blue).

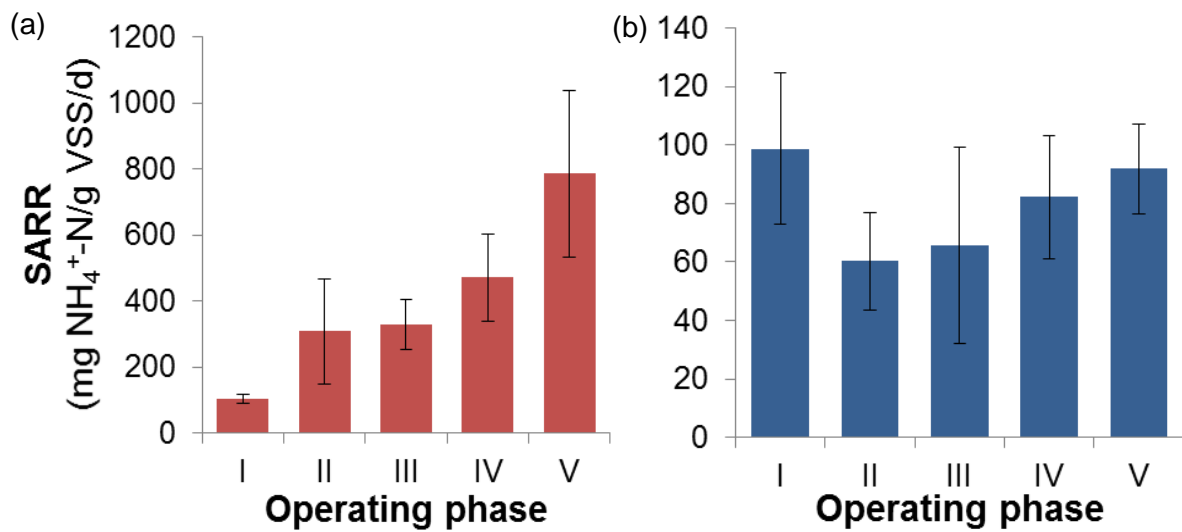

Figure 3.2 – Average *in situ* specific ammonium removal rates (SARR) at the end of each operating phase for SBR_{constantT} (a) and SBR_{loweringT} (b). The corresponding days at the end of each phase are 62 (I), 141 (II), 208 (III), 271 (IV) and 349 (V). Error bars represent standard deviations (n≥3)

Student tests (data not shown) clearly showed that the SARR in phase II, III, IV and V were significantly different between both reactors. The tests showed no significant difference between two consecutive phases in the same reactor.

3.2 Biomass aggregate size and microbial community analysis

3.2.1 Biomass particle size distribution

On day 1, both reactors contained a dark brownish and very heterogeneous hybrid sludge, made up mainly of small flocs and suspended biomass and a small number of granules, features linked to the individual constituents of the inoculum (Table SIII.1). From size fractionation of each biomass type (through sieving) and their respective contribution to the inoculum mix, it was estimated that that 59%VSS of the aggregates were smaller than 315 μm (data not shown). During the first 5 months of reactor operation, the biomass evolved to a bright red, predominantly granular sludge. During the last period of operation (phase V), even at 10°C, the granules demonstrated very good settling properties due to their size and density: To illustrate this, SVI was determined to be 34 mL/g and 26 mL/g for $\text{SBR}_{\text{constantT}}$ and $\text{SBR}_{\text{loweringT}}$ respectively on day 323. Furthermore, most of the solids were settled in less than 10 minutes during the settling phase. This corresponds to settling velocities higher than 0.88 m/h. Analysis of the particle size distribution (PSD) was performed on day 354. Results can be found in Figure SIII.1 of the supplementary information.

$\text{SBR}_{\text{loweringT}}$ displays a broader PSD, indicating more variation in granule size compared to the narrower PSD of $\text{SBR}_{\text{constantT}}$, showing a rather uniform granule size. Also, the maximum observed diameter is higher at low temperature, this is also reflected in a bigger volume median diameter: $D(0.5) = 1551\mu\text{m}$ for $\text{SBR}_{\text{loweringT}}$ vs. $D(0.5) 1215\mu\text{m}$ for $\text{SBR}_{\text{constantT}}$. Some granules around 3.3-4.4mm were detected at 10°C, but not observed at 30°C. These results showed that lowering the temperature was not detrimental to the granulation process, and can even generate bigger granules. This is likely due to the lower AnAOB growth rates at low temperatures, which resulted in stronger granules with a higher density (as illustrated by their lower SVI of 26 mL/g compared to 34 mL/g at 30°C). Consequently, granules were less susceptible to breakage, explaining why larger diameters were observed at lower temperatures.

3.2.2 Evolutions in the microbial community

16S rRNA gene sequencing showed that, right after reactor start-up (day 10), AnAOB made up 64.2% and 57.7% of the total community in SBR_{constantT} and SBR_{loweringT} respectively. By the end of phase I (day 60) the AnAOB abundances had increased to 79.2% and 80.5% respectively, enrichment was taking place. At the end phase IV abundances in SBR_{constantT} and SBR_{loweringT} were only slightly higher, 81.2% and 87.2% respectively, indicating an AnAOB enrichment that mainly occurred in phase I. The evolution of the microbial population at genus level was monitored throughout the experiment for both reactors and can be found in Figure SIII.2.

Figure 3.3 shows the evolution at genus level within the AnAOB community from 16S rRNA gene sequencing data. Both reactors started with the same inoculum, which is reflected in a very similar anammox composition at day 10 with a majority of *Ca. Brocadia* (81%), complemented with minor fractions of *Ca. Kuenenia* (8%) and *Ca. Jettenia* (11%).

As long as both reactors were operated identically (the first 60 days), they showed a comparable evolution in their AnAOB profile: an increase in *Ca. Kuenenia* abundance together with a slightly lower decrease in *Ca. Brocadia* abundance. *Ca. Jettenia* abundance dropped dramatically to 1% in both reactors, and, regardless of operational temperature, could not re-establish itself dominantly within the community. The initial changes in the AnAOB community during the first 60 days are likely the result of acclimatization to the imposed reactor operating conditions. Regarding the significant loss of suspended solids observed during the first period, a selection by selective retention during settling was likely to occur. Indeed, it was observed that the loss of *Ca. Brocadia* (-15%) and *Ca. Jettenia* (-10%), caused by washout of smaller aggregates, made the relative AnAOB abundance of *Ca. Kuenenia* increase (+25%).

In SBR_{constantT} at 30°C, there was no further major shift. *Ca. Brocadia* remained dominant, and even increased its fraction during Phase II to V, at the expense of a drop in *Ca. Kuenenia* abundance. The population repartition remained roughly unchanged and *Ca. Brocadia* made up 90% of the AnAOB community on day 293 while *Ca. Kuenenia* represented less than 10%.

In contrast, when reducing the operating temperature to 20°C in SBR_{loweringT} a remarkable evolution in the AnAOB community occurred: the *Ca. Brocadia* abundance dropped quickly (from 73 to 29%) whilst the *Ca. Kuenenia* abundance increased just as quickly (from 26 to 68%). Further operation at lower temperatures (15, 12.5 and finally 10°C) did not significantly alter the dominance with the AnAOB community, which on day 293 was comprised of 74% of *Ca. Kuenenia* and 26% *Ca. Brocadia*.

In parallel, the AnAOB enrichment in the biomass was assessed by qPCR at three moments in time. Results in Figure 3.4 indicate a considerable AnAOB enrichment occurring in both reactors, as reflected from the increase in both *hzsA* and 16S rDNA copy levels. Interestingly, in both systems most of the abundance increase occurred in the first half of the reactor operation time, by the end of Phase II, with little further enrichment over the second half. The observed trend was similar for *hzsA* and 16S rDNA copy levels expressed 'per g of biomass' or 'per ng of DNA'.

(a)

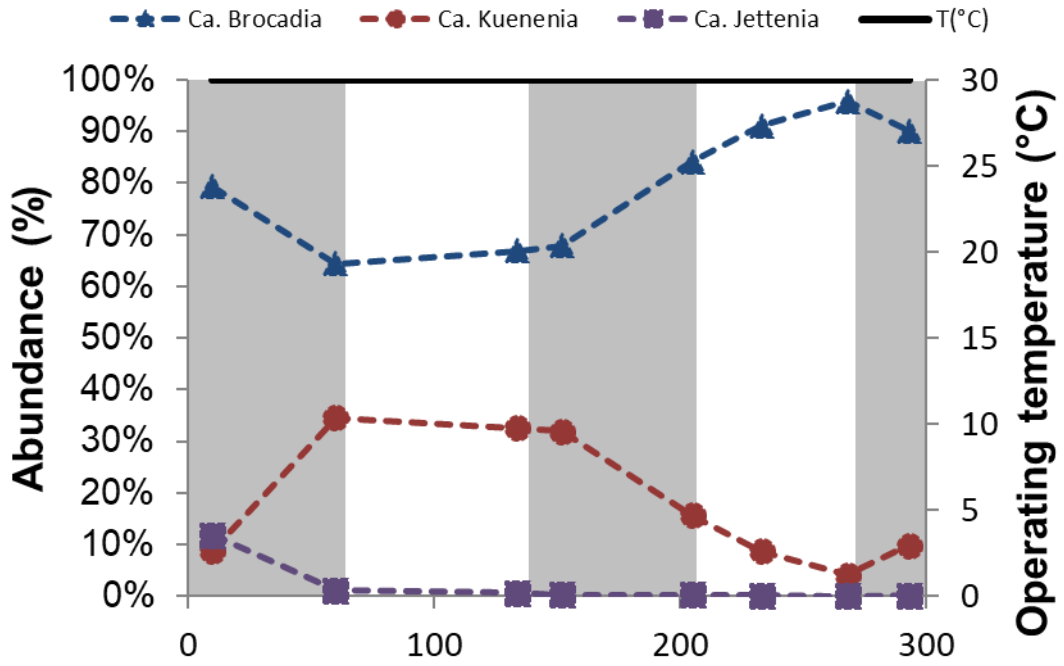

(b)

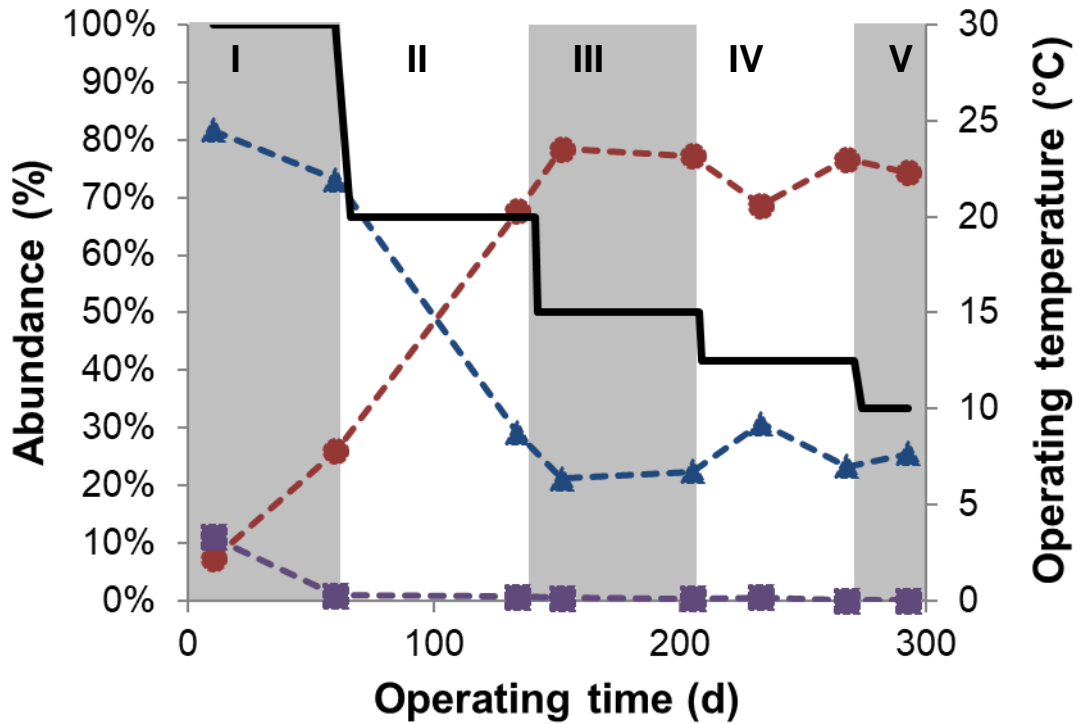

Figure 3.3 – Evolutions within the AnAOB community for $SBR_{constantT}$ (a) and $SBR_{loweringT}$ (b): relative abundances of *Ca. Brocadia*, *Ca. Kuenenia* and *Ca. Jettenia* genera, along with the operating temperature.

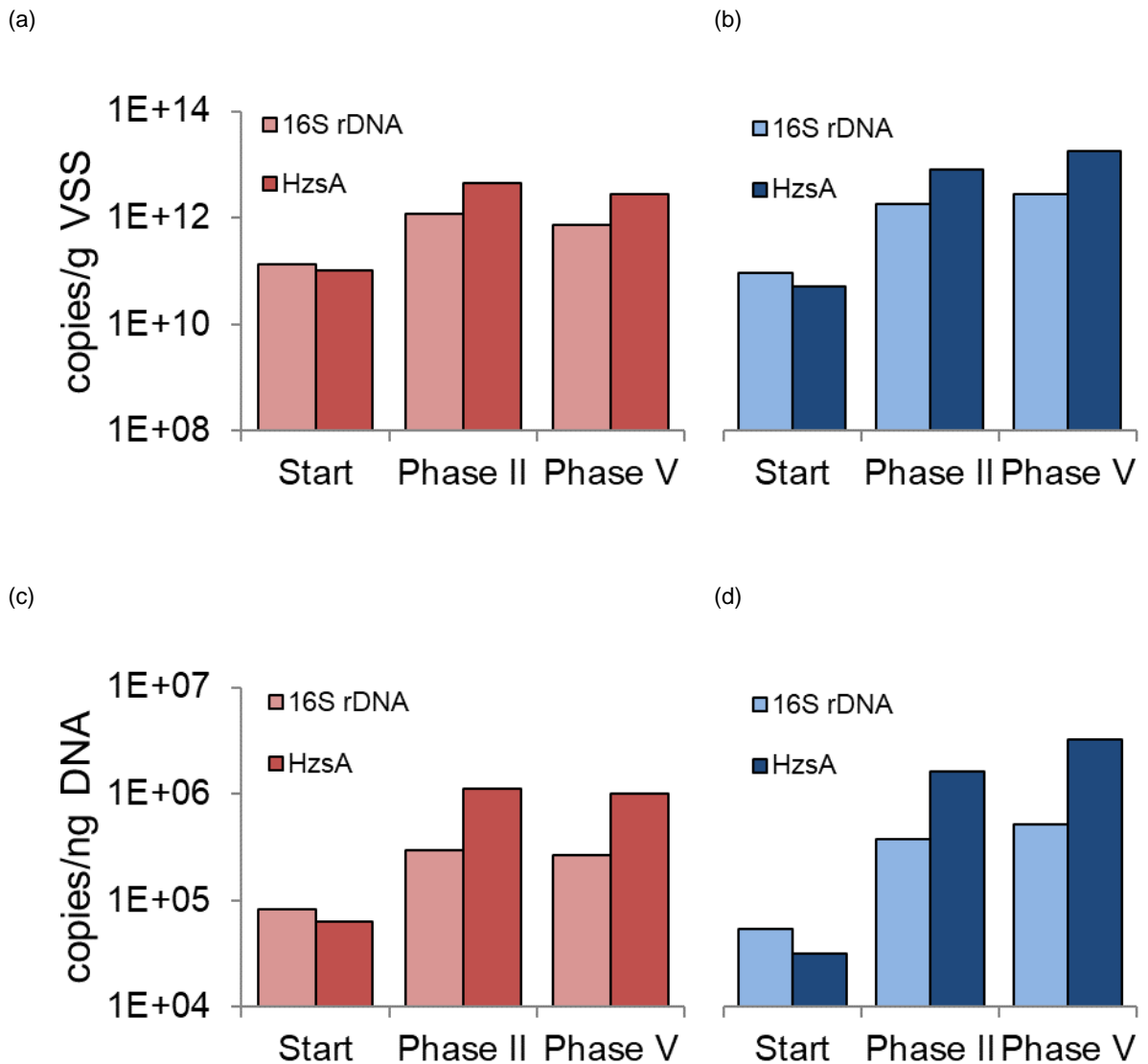

Figure 3.4 - Evolution of overall AnAOB abundance as determined by qPCR analyses based on AnAOB 16S rDNA (lighter bars) and the HzsA functional gene (darker bars). Top row shows the data expressed per g of VSS for SBR_{constantT} (a) and SBR_{loweringT} (b). Bottom rows show the same data expressed per ng of DNA for SBR_{constantT} (c) and SBR_{loweringT} (d). The corresponding sampling times for Start, Phase II and Phase V are 10, 134 and 293 days, respectively.

3.4. Discussion

3.4.1 Enrichment and adaptation favoring high specific activities

Our goal was to investigate the maximum potential of anammox at low temperatures (<15°C). After gradually decreasing from the initial temperature of 30°C in SBR_{loweringT}, the activity stabilized at 82.2 and 91.8 mg NH₄⁺-N/gVSS/d at 12.5 and 10°C, respectively. The *in situ* SARR in the reference reactor at 30°C (SBR_{constantT}) increased continuously, reaching up to 785 mg NH₄⁺-N/gVSS/d. Compared to literature, these specific removal rates at 10°C are considerably higher than previously reported values from reactor studies at low temperature, as illustrated in Table 3.1. Explanations for these differences in SARR are likely linked to differences in enrichment and/or adaptation degree, which is the consequence of a set of factors fixed in the experimental strategy. Hu *et al.* obtained a slightly higher SARR in a PN/A SBR (hence in the presence of oxygen) at after 131 days of operation 12°C compared to this study after 63 days at the same temperature. The final SARR obtained in this study after adaptation to 10°C was the same as the SARR obtained by Hu *et al.* at 12°C and significantly higher than the SARR obtained at 10°C without adaptation in that same study (Hu et al. 2013).

Table 3.1 - Specific ammonium removal rates (SARR, expressed in mg NH₄⁺-N/g VSS/d) and selected influencing factors for anammox based processes at low temperatures (<15°C) and in different reactor configurations. Moving Bed Biofilm Reactor (MBBR), Sequencing Batch Reactor (SBR), Partial Nitritation/Anammox (PN/A), Chemical oxygen demand (COD)

Process configuration; Process type	Substrates for competitors	T _{low} (°C)	Period lowering T (d)	Period at T _{low} (d)	SARR	Reference
Granular MBBR/SBR; Anammox	COD	10	-	722	13-19	Hendrickx <i>et al.</i> 2014
SBR; PN/A	O ₂	12	10 (25-12°C)	131	93	Hu <i>et al.</i> 2013
Granular upflow fluidized bed; Anammox	COD	10	127 (20-10°C)	151	35	Lotti <i>et al.</i> 2014b
Granular SBR; Anammox	O ₂	13.2	523 (30.5-13.2°C)	75	15.1	Sánchez Guillén <i>et al.</i> , 2016
Granular SBR; Anammox	-	12.5	208 (30-12.5°C)	63	82	This study
		10	257 (30-10°C)	78	92	

Maximizing space for AnAOB in the biomass is a key factor in both enrichment and adaptation, and yielded from low competition with AnAOB and high retention of AnAOB. Feeding with an autotrophic influent in anoxic conditions indeed minimized competition with AOB, NOB and

HB, the average ratio of nitrite to ammonium removal was 1.27 ± 0.19 and 1.20 ± 0.11 for $SBR_{\text{constantT}}$ and $SBR_{\text{loweringT}}$ respectively, which was close to the stoichiometry reported by Strous (Strous et al. 1998). Note that, the systems in other studies contained COD or oxygen (Table 3.1). Maximizing biomass retention enables the slow(est) growing AnAOB to stay or develop in the system. In our study, this was implemented by imposing a low minimum settling velocity, keeping solids settling at > 0.3 m/h into the system. In both reactors, regardless of operational temperature, the bacteria aggregated in rapidly settling granules, which facilitated biomass retention. Nonetheless, biomass retention was not perfect, and sampling and washout renewed an estimated 70 and 100% of the produced AnAOB biomass in $SBR_{\text{constantT}}$ and $SBR_{\text{loweringT}}$ respectively, based on the nitrogen loading and theoretical growth yield. Anoxic SRT values of 162 and 164 days, for $SBR_{\text{constantT}}$ and $SBR_{\text{loweringT}}$ respectively, were obtained, from the estimated solids balance. In other words, operating the systems for more than two times the SRT should in theory replace more than 85% of the original biomass.

Enrichment in both systems was witnessed by the increase in relative AnAOB abundance in the biomass (qPCR data; Figure 3.4) in both reactors. According to the qPCR data, most of the enrichment occurred in the first half of the experiment. In $SBR_{\text{loweringT}}$, adaptation was observed at the level of the AnAOB community, with a major shift in dominant AnAOB genus from *Ca. Brocadia* to *Ca. Kuenenia* (16S rRNA gene sequence amplicons; Figure 3.3). Even though it was not studied here, physiological adaptations within a given AnAOB species could have occurred. There is for instance evidence that AnAOB are able to alter their lipid membrane composition through 'addition synthesis' as a form of homeoviscous adaptation to changes in *in situ* temperature (Rattray et al. 2010). Such type of adaptation might also explain the shift in temperature optimum for AnAOB without significant changes in the dominant genus reported by other authors (Gilbert et al. 2014, Hu et al. 2013).

In order to assess the impact of long-term enrichment and adaptation on the AnAOB performance, a parallel study was performed to test the immediate effect of exposure to low temperatures on the anammox activity, on the four types of biomass used in the inoculum mix. Based on recalculated values from this batch test, the SARR roughly doubled after 67 days of operation at 30°C (end of Phase I; Table 3.2). After long term operation at 30°C in SBR_{constantT}, the SARR was 16 times higher than the activity of the inoculum at 30°C. Comparably, the final SARR at 12.5-10°C in SBR_{loweringT} was 8-15 times higher than the recalculated inoculum rates under these respective temperatures. As a consequence, the SARR ratios (low/high temperature) were similar in the short and long-term tests: on short term, exposure to 12.5 and 10°C yielded respectively 20 and 13% of the SARR at 30°C (see chapter II), while the respective values were 17 and 12% for the long-term reactor test (see Table 3.2).

Table 3.2 – Comparison of the short vs. long term effect of temperature decrease on SARR. Between brackets the Phase number from the long-term reactor experiment is given. For the short term test, biomass was directly exposed to lower temperatures and the data from individual biomass tests were used to calculate a weighted average, based on the different biomass contributions in the inoculum of the reactor test.

	Short term experiment	Long term experiment	
	Inoculum mix	SBR _{constantT}	SBR _{loweringT}
SARR 30°C (mg NH ₄ ⁺ -N/gVSS/d)	49.2	104 (I); 471 (IV); 785 (V)	98.7 (I)
SARR 12.5°C (mg NH ₄ ⁺ -N/gVSS/d)	9.99	-	82.2 (IV)
SARR 10°C (mg NH ₄ ⁺ -N/gVSS/d)	6.30	-	91.8 (V)
SARR ratio 12.5°C/30°C (%)	20	-	17*
SARR ratio 10°C/30°C (%)	13	-	12**

* ratio SBR_{loweringT}/SBR_{constantT} for Phase IV

** ratio SBR_{loweringT}/SBR_{constantT} for Phase V

3.4.2 Potential AnAOB genus niche differentiation

The results point towards a *Ca. Kuenenia* preference to colder temperatures (20°C and below) and a *Ca. Brocadia* preference to 30°C whereas *Ca. Jettenia* was outcompeted in both reactors. It is interesting to note that each system nonetheless maintained both genera, so the niche differentiation or competitiveness advantage was insufficiently strong to out-compete the one or the other.

In literature *Ca. Kuenenia* has been only observed as predominant in studies at relatively high temperature. A complete replacement of *Ca. Brocadia* by *Ca. Kuenenia* was observed in an anoxic anammox MBBR at 38°C (van der Star et al. 2008). The authors suggested that nitrite limitation was the main driver for this transition, based on the hypothesis that *Ca. Kuenenia* would be an affinity (K) strategist and *Ca. Brocadia* a growth rate (r) strategist. This hypothesis was challenged recently when the opposite switch was observed: *Ca. Brocadia* replaced *Ca. Kuenenia* as the dominant genus in the biofilm of two IFAS reactors operated between 24 and 29°C. The authors claimed that in this case, the tolerance towards higher and toxic nitrite levels affected the selection more than their affinity for low substrate levels (Zheng et al. 2016). *Ca. Kuenenia* has a higher reported tolerance towards nitrite than *Ca. Brocadia*: inhibition occurs for concentration of 180 mg/L and 70 mg/L respectively (Schmid et al. 2003). Neither of these hypotheses seems applicable to our study, since nitrite concentrations were too low to cause inhibition (maximum 17 mg N/L after feeding) yet were never limiting in any of the reactors (operated with rapid feeding in SBR mode). However, from Phase II onwards, the VARR in $SBR_{\text{constantT}}$ was higher than the VALR, meaning that the AnAOB were subjected to endogenous conditions during the final part of the cycle whereas the AnAOB in $SBR_{\text{loweringT}}$ knew no endogenous period since the VARR was stabilized around the VALR throughout the entire experiment. This presence or absence of an endogenous period may have also played a role in the niche differentiation between *Ca. Brocadia* to *Ca. Kuenenia*.

This is the first time a switch from *Ca. Brocadia* to *Ca. Kueneenia* is observed at low temperature. Almost every other low temperature study, reported that *Ca. Brocadia* was and remained the dominant genus throughout the experiment, suggesting that this genus had a competitive advantage over other anammox genera at low temperature (Gilbert et al. 2015, Hendrickx et al. 2014, Hendrickx et al. 2012, Hu et al. 2013, Laureni et al. 2016, Laureni et al. 2015, Lotti et al. 2014a, Sánchez Guillén et al., 2016). Note that during these studies there was always a presence of oxygen and/or organic carbon. In the study by Sánchez Guillén and colleagues the maximum DO was 0.2%, but even at such low concentration AnAOB activity can be impacted (observed in this study when a leak was detected on day 69). It is interesting to note that in the before mentioned study, average granules size decreased throughout the reactor operation. The fact that granule size increased in this study was probably due to the higher NLR and lower mixing intensity (the SBR reactor in the other study was fitted with baffles which most likely increased the shear force on the granules). Only one study reported on *Ca. Jettenia* as most dominant AnAOB genus in a PN/A Expanded Granular Sludge Bed (EGSB) reactor operated under low DO conditions (0.8 mg/L) to treating COD containing effluent of an upflow anaerobic fixed bed (UAFB) executing anaerobic digestion (AD) (Gao et al. 2015). It is possible that the absence of inhibition (in the case of oxygen) and of competition/partnerships with other bacteria (AOB, NOB and HB) played a role in the niche differentiation between *Ca. Brocadia* and *Ca. Kueneenia* observed in this study at low temperature. Available data on activation energies (E_a) do not allow to differentiate in temperature sensitivity between the two discussed genera. Two studies working with *Ca. Kueneenia* reported E_a -values of 63 kJ/mol between 10°C-40°C (Dosta et al. 2008) and 93 kJ/mol between 6°C and 22°C (Isaka et al. 2008), these values fall within the same range as the ones obtained for *Ca. Brocadia* (Hendrickx et al. 2014, Lotti et al. 2014c).

Further research should focus on understanding the influence key drivers such as high/low affinity for substrate, sensitivity to low temperature and/or to inhibitors etc. have on the niche differentiation between different AnAOB genera and if/how this affects process kinetics/stoichiometry.

3.4.3 Towards implementation of partial nitrification/anammox

The high activities obtained at low temperatures in this study reinforces the potential of anammox for mainstream application. A key strategy to obtain enrichment and adaptation was to eliminate competition and maximize retention while applying a step-wise decrease in temperature. Process design and operation will define what activity level can be reached and should therefore be aimed at maximizing the abundance of adapted AnAOB in the biomass.

In the end, the high maximal potential AnAOB activities under low temperatures provide a basis for conceiving new PN/A design solutions and associated operational strategies. If 50% of the activity at 10°C could be maintained in a full-scale process with a solids content of 3 g VSS/L, it would work at 135 g NH₄⁺-N/m³/d which corresponds to a hydraulic retention time of about 8 hours, this is a conventional value for activated sludge treating systems domestic sewage. Given the nitrite feeding and anoxic conditions in this study, a two-stage PN/A approach seems to be suitable to go as close as possible to the full potential of an enriched/adapted community, as it avoids the competition with nitrifiers, aerobic heterotrophs and with part of the anoxic heterotrophs. Selective AnAOB retention and enrichment can also be implemented in a one-stage approach, by selectively increasing the SRT of AnAOB compared to the SRT of the competitors, like in IFAS PN/A systems (Veuillet et al. 2014) or through the use of a selective screen (Han et al. 2016). Future work should verify whether equally high potential rates can be obtained when making a faster and seasonally realistic transition from higher to lower

temperatures. Five-year temperature gradient data from a WWTP in Germany showed a temperature decrease from 20°C (summer) to 10°C (winter) at a rate of 2°C per month. During the winter temperature could acutely drop down to 7°C for a several weeks (Gilbert et al. 2014). In addition, more research should be dedicated to determining any influence of low temperatures on the growth yield. One study in a PN/A SBR estimated that the growth yield lowered with decreasing temperature (Hu et al. 2013) while in another anammox granular MBBR/SBR study no such impact was observed (Hendrickx et al. 2014).

3.5. Conclusions

Minimal competition and high AnAOB retention resulted in unprecedented removal rates of 82 and 92 mg NH₄⁺-N/g VSS/d at 12.5 and 10°C respectively. AnAOB enrichment (indicated by increasing *hzsA* and 16S rRNA gene concentrations) and adaptation at genus level (indicated by a shift from *Ca. Brocadia* to *Ca. Kuenenia* in SBR_{loweringT}) contributed to this performance. Well settling granules were formed and maintained at both 30°C and 10°C, indicating that lowering temperature is not detrimental to granulation and can even increase granule size. These results provide new insights that reinforce the potential of cold anammox applications for mainstream N-removal.

3.6. Acknowledgements

This study has been financially supported by the ANRT (CIFRE N° 2014/0754). The Authors are grateful to the Genotoul bioinformatics platform Toulouse Midi-Pyrenees and the Sigenae group for providing help and computing resources through to their Galaxy platform.

3.7. References

- APHA, A. (1992) WPCF (American Public Health Association, American Waterworks Association, Water Pollution Control Federation)(1992) Standard methods for the examination of water and wastewater. Standard methods for the Examination of Water and Wastewater 17.
- Cao, Y., van Loosdrecht, M.C.M. and Daigger, G.T. (2017) Mainstream partial nitritation–anammox in municipal wastewater treatment: status, bottlenecks, and further studies. *Applied Microbiology and Biotechnology* 101, 1365-1383.
- Dosta, J., Fernandez, I., Vazquez-Padin, J.R., Mosquera-Corral, A., Campos, J.L., Mata-Alvarez, J. and Mendez, R. (2008) Short- and long-term effects of temperature on the Anammox process. *Journal of Hazardous Materials* 154, 688-693.
- Gao, D.-W., Huang, X.-L., Tao, Y., Cong, Y. and Wang, X.-I. (2015) Sewage treatment by an UAFB–EGSB biosystem with energy recovery and autotrophic nitrogen removal under different temperatures. *Bioresource Technology* 181, 26-31.
- Gilbert, E.M., Agrawal, S., Karst, S.M., Horn, H., Nielsen, P.H. and Lackner, S. (2014) Low Temperature Partial Nitritation/Anammox in a Moving Bed Biofilm Reactor Treating Low Strength Wastewater. *Environmental Science & Technology* 48, 8784-8792.
- Gilbert, E.M., Agrawal, S., Schwartz, T., Horn, H. and Lackner, S. (2015) Comparing different reactor configurations for Partial Nitritation/Anammox at low temperatures. *Water Research* 81, 92-100.
- Gustavsson, D., Persson, F. and la Cour Jansen, J. (2014) Manammox–mainstream anammox at Sjölanda WWTP. Proceedings from the IWA World Water Congress and Exhibition, September 21-26, Lisbon, Portugal (2014)
- Han, M., Vlaeminck, S.E., Al-Omari, A., Wett, B., Bott, C., Murthy, S. and De Clippeleir, H. (2016) Uncoupling the solids retention times of flocs and granules in mainstream deammonification: A screen as effective out-selection tool for nitrite oxidizing bacteria. *Bioresource Technology* 221, 195-204.
- Hendrickx, T.L.G., Kampman, C., Zeeman, G., Temmink, H., Hu, Z., Kartal, B. and Buisman, C.J.N. (2014) High specific activity for anammox bacteria enriched from activated sludge at 10 degrees C. *Bioresource Technology* 163, 214-221.
- Hendrickx, T.L.G., Wang, Y., Kampman, C., Zeeman, G., Temmink, H. and Buisman, C.J.N. (2012) Autotrophic nitrogen removal from low strength waste water at low temperature. *Water Research* 46, 2187-2193.

- Hu, Z., Lotti, T., de Kreuk, M., Kleerebezem, R., van Loosdrecht, M., Kruit, J., Jetten, M.S. and Kartal, B. (2013) Nitrogen removal by a nitrification-anammox bioreactor at low temperature. *Applied and environmental microbiology* 79, 2807-2812.
- Isaka, K., Date, Y., Kimura, Y., Sumino, T. and Tsuneda, S. (2008) Nitrogen removal performance using anaerobic ammonium oxidation at low temperatures. *Fems Microbiology Letters* 282, 32-38.
- Lackner, S., Gilbert, E.M., Vlaeminck, S.E., Joss, A., Horn, H. and van Loosdrecht, M.C.M. (2014) Full-scale partial nitrification/anammox experiences - An application survey. *Water Research* 55, 292-303.
- Laureni, M., Falås, P., Robin, O., Wick, A., Weissbrodt, D.G., Nielsen, J.L., Ternes, T.A., Morgenroth, E. and Joss, A. (2016) Mainstream partial nitrification and anammox: long-term process stability and effluent quality at low temperatures. *Water Research* 101, 628-639.
- Laureni, M., Weissbrodt, D.G., Szivák, I., Robin, O., Nielsen, J.L., Morgenroth, E. and Joss, A. (2015) Activity and growth of anammox biomass on aerobically pre-treated municipal wastewater. *Water Research* 80, 325-336.
- Lotti, T., Kleerebezem, R., Hu, Z., Kartal, B., Jetten, M. and van Loosdrecht, M. (2014a) Simultaneous partial nitrification and anammox at low temperature with granular sludge. *Water Research* 66, 111-121.
- Lotti, T., Kleerebezem, R., van Erp Taalman Kip, C., Hendrickx, T., Kruit, J. and Van Loosdrecht, M. (2014b) Anammox growth on pretreated municipal wastewater. *Environmental science & technology* 48,7874-80.
- Lotti, T., Kleerebezem, R. and van Loosdrecht, M. (2014c) Effect of temperature change on anammox activity. *Biotechnology and bioengineering* 112, 98-103.
- Ma, B., Peng, Y., Zhang, S., Wang, J., Gan, Y., Chang, J., Wang, S., Wang, S. and Zhu, G. (2013) Performance of anammox UASB reactor treating low strength wastewater under moderate and low temperatures. *Bioresource Technology* 129, 606-611.
- Metcalf, E. (2003) *Waste water engineering: treatment and reuse*, 4th edn. Revised by Tchobanoglous G, Burton FL, Stensel HD, McGraw-Hill, New York.
- Mulder, A., van de Graaf, A.A., Robertson, L.A. and Kuenen, J.G. (1995) Anaerobic ammonium oxidation discovered in a denitrifying fluidized bed reactor. *FEMS Microbiology Ecology* 16, 177-183.
- Rattray, J.E., van de Vossenberg, J., Jaeschke, A., Hopmans, E.C., Wakeham, S.G., Lavik, G., Kuypers, M.M., Strous, M., Jetten, M.S. and Schouten, S. (2010) Impact of

- temperature on ladderane lipid distribution in anammox bacteria. *Applied and environmental microbiology* 76, 1596-1603.
- Sánchez Guillén, J.A., Lopez Vazquez, C.M., de Oliveira Cruz, L.M., Brdjanovic, D., van Lier, J.B. 2016. Long-term performance of the Anammox process under low nitrogen sludge loading rate and moderate to low temperature. *Biochemical Engineering Journal*, 110, 95-106.
- Schmid, M., Walsh, K., Webb, R., Rijpstra, W.I., van de Pas-Schoonen, K., Verbruggen, M.J., Hill, T., Moffett, B., Fuerst, J., Schouten, S., Sinninghe Damsté, J.S., Harris, J., Shaw, P., Jetten, M. and Strous, M. (2003) Candidatus "*Scalindua brodae*", sp. nov., Candidatus "*Scalindua wagneri*", sp. nov., Two New Species of Anaerobic Ammonium Oxidizing Bacteria. *Systematic and Applied Microbiology* 26, 529-538.
- Siegrist, H., Salzgeber, D., Eugster, J. and Joss, A. (2008) Anammox brings WWTP closer to energy autarky due to increased biogas production and reduced aeration energy for N-removal. *Water Science and Technology* 57, 383-388.
- Strous, M., Heijnen, J.J., Kuenen, J.G. and Jetten, M.S.M. (1998) The sequencing batch reactor as a powerful tool for the study of slowly growing anaerobic ammonium-oxidizing microorganisms. *Applied Microbiology and Biotechnology* 50, 589-596.
- Strous, M., Kuenen, J.G. and Jetten, M.S. (1999) Key physiology of anaerobic ammonium oxidation. *Applied and environmental microbiology* 65, 3248-3250.
- van der Star, W.R.L., Miclea, A.I., van Dongen, U.G.J.M., Muyzer, G., Picioreanu, C. and van Loosdrecht, M.C.M. (2008) The membrane bioreactor: A novel tool to grow anammox bacteria as free cells. *Biotechnology and Bioengineering* 101, 286-294.
- Veuliet, F., Lacroix, S., Bausseron, A., Gonidec, E., Ochoa, J., Christensson, M. and Lemaire, R. (2014) Integrated fixed-film activated sludge ANITA™ Mox process—a new perspective for advanced nitrogen removal. *Water Science & Technology* 69, 915-922.
- Vlaeminck, S.E., De Clippeleir, H. and Verstraete, W. (2012) Microbial resource management of one-stage partial nitritation/anammox. *Microbial Biotechnology* 5, 433-448.
- Zheng, B., Zhang, L., Guo, J., Zhang, S., Yang, A. and Peng, Y. (2016) Suspended sludge and biofilm shaped different anammox communities in two pilot-scale one-stage anammox reactors. *Bioresource Technology* 211, 273-279.

Chapter IV

Impact of slowly biodegradable organic carbon on the competition between anammox bacteria and denitrifiers at different temperatures.

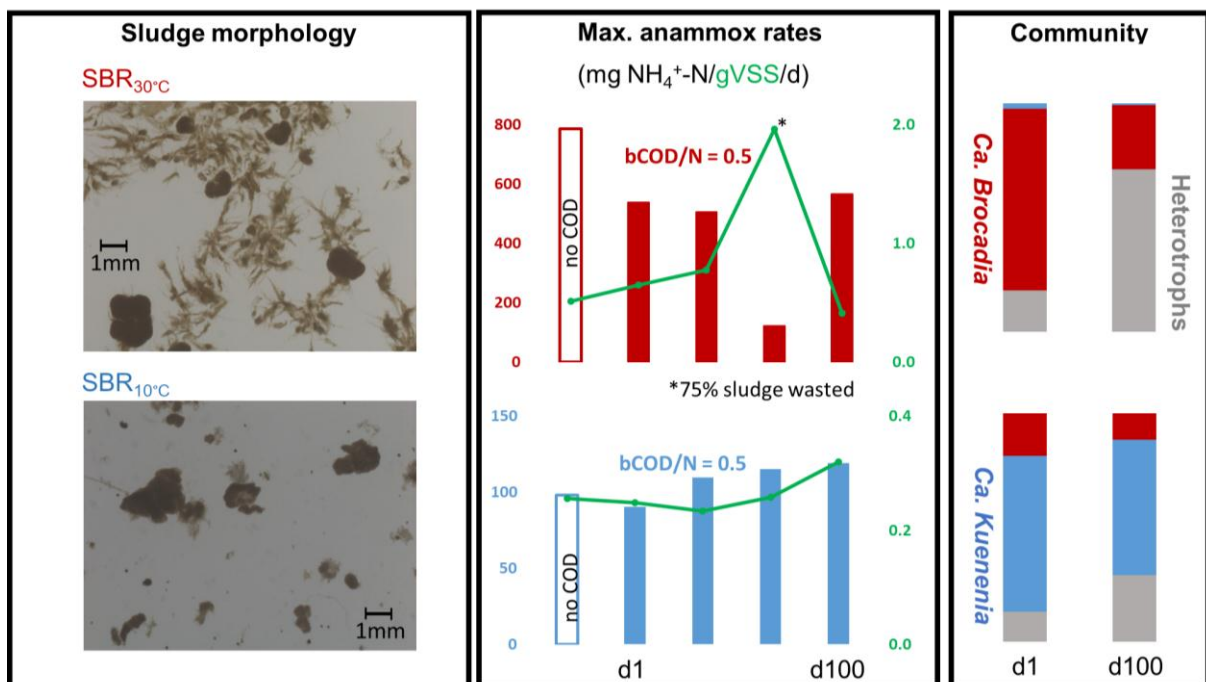

Abstract

This study evaluated the impact of low concentrations of slowly biodegradable organic carbon on the competition between anoxic ammonium-oxidizing bacteria (AnAOB) and denitrifying heterotrophic bacteria (HB) at 30°C and 10°C. Two anoxic granular sludge sequencing batch reactors, SBR_{30°C} and SBR_{10°C} had previously been operated for one year on synthetic influent containing 60 mg N/L. For this study 30 mg COD/L (90% starch, 10% acetate) was added to the influent to mimic HRAS effluent. With relatively low COD/nitrite removal ratios (around 0.3 in both reactors), overall nitrogen conversion ratios were close to the anammox stoichiometry. Flocs developed in both reactors which evolved from purely granular to hybrid systems containing granules and flocs. While flocs became predominant in SBR_{30°C}, biomass in SBR_{10°C} remained predominantly granular, likely due to poorer floc formation and therefore higher floc wash-out, reflected in a lower SRT at 10°C (19d) compared to 30°C (26d). 16S Illumina gene sequencing and qPCR analyses showed that relative AnAOB abundance decreased greatly (87 to 37%) in SBR_{30°C} and to a lesser extent in SBR_{10°C} (91 to 74%). In SBR_{30°C} maximum *in situ* specific ammonium removal rates (SARR) dropped by factor 4 as biomass concentration tripled (from 0.65 to 2 g VSS/L), during this period maximum *in situ* volumetric rates remained stable. After wasting 75% of the biomass, SARR increased to 566 mg NH₄⁺-N/gVSS/d. Despite the decrease in relative AnAOB abundance, SARR in SBR_{10°C} remained high and stable throughout the experiment, reaching up to 112 mg NH₄⁺-N/gVSS/d at the end. Interestingly, COD addition did not impact the dominant genera which remained *Ca. Brocadia* and *Ca. Kuenenia* in SBR_{30°C} and SBR_{10°C}, respectively. Results reinforce the potential of anammox for mainstream sewage treatment.

Keywords: biological nitrogen removal; shortcut nitrogen removal; cold anammox; partial nitrification/anammox

Impact of slowly biodegradable organic carbon on the competition between anammox bacteria and denitrifiers at different temperatures.

P. De Cocker^{1,2,3}, Y. Bessiere¹, G. Hernandez-Raquet¹, M. Bounouba¹, I. Mozo², G. Gaval², M. Caligaris⁴, B. Barillon², S.E. Vlaeminck^{3,5,§}, M. Sperandio^{1,§,*}

1. LISBP, Université de Toulouse, CNRS, INRA, INSA, Toulouse, France

2. SUEZ, CIRSEE, Le Pecq, France

3. Center for Microbial Ecology and Technology (CMET), Ghent University, Gent, Belgium

4. SUEZ, Treatment Infrastructures, Rueil Malmaison, France

5. Research Group of Sustainable Energy, Air and Water Technology, University of Antwerp, Antwerpen, Belgium

§ equally contributed as senior authors

* corresponding author: mathieu.sperandio@insa-toulouse.fr

4.1. Introduction

Partial nitritation/anammox (PN/A) is an autotrophic shortcut nitrogen removal process in which, after partial nitritation, Anammox bacteria (AnAOB) perform anoxic oxidation of ammonium with the produced nitrite as electron acceptor. This process requires less oxygen, abandons the need for organic carbon, and yields a lower sludge production. It can thus present a more cost-efficient treatment compared to the conventional nitrification/denitrification process (Vlaeminck et al., 2012). As the understanding of these processes increased, close to one hundred full scale side-stream anammox installations, usually treating digestate, landfill leachate or reject water, have seen the day by the end of 2013 (Kartal et al., 2012; Lackner et al., 2014; Mulder et al., 1995; Siegrist et al., 2008; Strous et al., 1999). The next development goal is to introduce anammox in the mainstream or waterline of sewage treatment plants in order to further improve their efficiency in terms of energy consumption (and hence economics) and greenhouse gas emissions.

The main challenges for PN/A implementation on pretreated sewage, so-called mainstream PN/A, are associated with the development of robust methods to suppress nitrite oxidizing bacteria (NOB) and promote the growth and activity of AnAOB under relatively low influent nitrogen concentrations (40-80 mg $\text{NH}_4^+\text{-N/L}$) and non-negligible amounts of biodegradable organic carbon (often quantified as Chemical Oxygen Demand, COD). The presence of organic carbon can destabilize the PN/A process efficiency by (1) suppressing AnAOB activity or (2) promoting the growth of heterotroph bacteria (HB) which can use the COD for denitrification and compete with AnAOB for nitrite and space (Lackner et al., 2008).

Indeed, even though certain organics such as propionate and acetate can be consumed by certain AnAOB and improve removal efficiency (Güven et al., 2005; Kartal et al., 2008), other such as alcohols (mainly methanol) are toxic to them. Dapena-Mora *et al.* reported a 70%

anammox suppression in the presence of 50mM (eq. to 2.8 g COD/L) acetate (Dapena-Mora et al., 2007), however such high concentrations will not occur under mainstream conditions.

In the case of competition between AnAOB and HB, the latter are favored in this because of their higher growth rate ($\mu=6 \text{ d}^{-1}$ at 20°C, Henze et al 2000) and yield coefficient ($Y=0.54 \text{ gCOD/gCOD}$, (Muller et al., 2003)) compared to AnAOB ($\mu=0.06 \text{ d}^{-1}$ at 32°C, (Strous et al., 1998) and $Y=0.164 \text{ gCOD/gN}$ respectively (Ni et al., 2009)). Furthermore, and of particular interest for regions with a temperate (or cold) climate, relatively low sewage temperatures (below 15°C, down to 10°C or even below) drastically decrease AnAOB growth rates and activity (Cao et al., 2017; Vlaeminck et al., 2012; Chapter 3 of this work) suggesting that they would be even more at disadvantage at lower temperatures. Some studies have reported that AnAOB have a higher substrate affinity (lower saturation constant, K_s) for nitrite than HB (Kartal et al., 2012; Wang et al., 2016) meaning they would be able to outcompete HB for nitrite. However, the apparent K_s is highly impacted by aggregate size and density. AnAOB bacteria are known to grow in granules which possibly makes them more prone to diffusion limitations compared to HB that have a tendency to prevail in flocs.

Even though it has been observed that low levels of biodegradable COD (bCOD) could improve total nitrogen removal in PN/A systems by stimulating heterotrophic denitrification of the nitrate produced during the anammox reaction (Han et al., 2016a), most of these studies also reported a negative impact on AnAOB abundance and ammonium removal performance as influent COD increased (Chen et al., 2016; Jenni et al., 2014; Li et al., 2016; Ni et al., 2012).

Some studies reported threshold COD concentration for anammox repression to be around 237-400 mg COD/L (Chamchoi et al., 2008; Chen et al., 2016; Li et al., 2016; Molinuevo et al., 2009). Rather than focusing on COD concentrations, other researchers looked to the influence of the COD/N (COD/total nitrogen) or COD/nitrite-ratio on the competition between AnAOB and HB. The reported threshold values for anammox inhibition were varying: from of 0.8-1.2 gCOD/gN (with acetate and glucose as a COD-source respectively, Sheng et al., 2018) to 3.1 gCOD/gN (non-fat dry milk, Ni et al., 2012). Reported COD/nitrite-ratio thresholds were around 1.71-2.92 gCOD/gNO₂⁻ (Tang et al., 2010; Wang et al., 2016). Nearly all of these studies used an excess (compared to need for the denitrification of produced nitrate) of rapidly biodegradable COD and were conducted at high temperature. Leal *et al.* reported the coexistence of anammox and denitrifying bacteria on pretreated municipal wastewater with high ammonium removal efficiencies (80-95%) at COD/N-ratios up to 5 (300 mg COD/L). The same study reported a decrease in anammox performance for COD concentrations above 487 mg COD/L (Leal et al., 2016). Laureni et al. reported that, despite a threefold reduction in AnAOB growth rate after switching from synthetic WW to real wastewater (containing traces of organic carbon, anammox remained the dominant N-consumption route in an PN/A SBR (Laureni et al., 2015). After long term operation of an anammox UASB operated anoxically at 11°C, Reino et al. reported that despite observed HB growth, anammox activity remained higher than heterotrophic activity, even when the synthetic influent was replaced by the nitrite-amended pre-treated real wastewater (1.3 gCOD/gN, 90 mg COD/L, Reino et al., 2018).

Even though current studies show increasing coexistence of AnAOB and HB together with increasing denitrification with increasing COD concentrations, no consensus is reached on COD or COD/N threshold values. To our knowledge, almost no information is available on this competition under COD limiting conditions (which could occur after e.g. a high performing C-removal stage followed by completely aerobic PN stage) and only few reactor studies have

examined how it is impacted by low temperatures. An improved understanding is needed to assess the feasibility of mainstream anammox at low temperatures.

This study examined the long-term effect of low levels of slowly biodegradable COD (sbCOD) on the performance, microbial community structure and aggregate size of two enriched granular anammox SBRs treating synthetic influent and operated under anoxic conditions at both high (30°C) and low (10°C) temperature.

4.2 Material and Methods

4.2.1 Set-up and operation of the reactors

Two anammox SBR were operated in parallel, composed of identical, airtight, mixed, and jacketed vessels (5L), equipped with pH (H 8481 HD, SI Analytics), temperature and dissolved oxygen (DO) probes (Visiferm™, Hamilton). The SBR mode is comprised of four characteristic phases: (1) filling phase (30 minutes, inflow of 2.5L influent, hence a volumetric exchange ratio, VER, of 50%), during which oxygen was removed from the liquid through stripping with N₂ gas. For the next 30 minutes, the reactors were flushed with a mixture of N₂ and CO₂ gas to ensure anoxic conditions and set the pH back to 7.5 before starting the actual (2) reaction phase with a variable duration (4h in SBR_{30°C} and up to 16h in SBR_{10°C}). The length of the reaction phase was shortened (lengthened) to increase (decrease) the ammonium loading rate (ALR) when needed e.g. the NLR was decreased on day 15 from 55.4 mg N_{tot}/L/d to 45 mg N_{tot}/L/d to match the observed activities. After the reaction phase, mixing was stopped for 30 minutes during the (3) settling phase before starting the (4) discharge phase where 2.5L of supernatant was removed before starting the next cycle. Those operating conditions led to maintain in the system particles that have a settling velocity higher than 0.29 m/h. Temperature was kept constant throughout the entire experiment at 30°C and 10°C in SBR_{30°C} and SBR_{10°C} respectively. After two months of operation, VSS concentration in SBR_{30°C} had quadrupled and

packed accumulation of biomass underneath the sparger was observed. To avoid mixing limitations, it was decided to remove, 75% of the biomass on day 76.

The reactors were fed with the same two synthetic influents which were both stored at 4°C, the first containing nitrogen and nutrients in a 150L tank, the second more concentrated containing the organic carbon (starch and acetate) in a 5L vessel. The first influent contained per liter 168.0 mg of NaNO₂, 98.8 mg of NH₄Cl, 165.0 mg of MgSO₄•7H₂O, 143.8 mg of CaCl₂•2H₂O, 6.3 mg of EDTA-Na₂•2H₂O, 775.4 mg of NaHCO₃, 30.0 mg of KH₂PO₄, and 9.1 mg of FeSO₄•7H₂O. The influent was prepared using tap water containing around 1 mg NO₃⁻-N/L, hence total nitrogen content was 61 mg N/L, a typical value for municipal wastewater (Metcalf, 2003), made up of ammonium and nitrite in a 1/1.32 ratio corresponding to the stoichiometry found by (Strous et al., 1998): 25.9 mg N-NH₄⁺/L and 34.1 mg N-NO₂⁻/L. Per liter of influent, 2 mL of a trace element solution was added, which contained per liter 430 mg of ZnSO₄•7H₂O, 240 mg of CoCl₂•6H₂O, 1.21g of MnCl₂•4H₂O, 250 mg of CuSO₄•5H₂O, 183 mg of Na₂MoO₄•2H₂O, 274.6 mg of NiSO₄•7H₂O, 50.1 mg of Na₂SeO₃•5H₂O, 60.9 mg of Na₂WO₄•2H₂O, 14 mg of H₃BO₃ and 15g of EDTA-Na₂•2H₂O. Also, 30 mg COD/L was fed simultaneously with the second influent from a concentrated solution (1g COD/L) stored at 4°C to avoid degradation. The solution contained 90% soluble starch (sbCOD) and 10% sodium acetate (rbCOD) in order to mimic the COD in an HRAS effluent. The influent COD/TN ratio was therefore maintained at 0.5 (Nogaj et al., 2014).

4.2.3 Anammox activity and chemical analyses

The actual ammonium removal efficiencies were determined by measuring outlet concentrations of ammonium roughly every two days. Comparable information was obtained from nitrite measurements.

With the systems being operated in sequencing batch, mode kinetics could be followed directly during the reaction phase of the cycles. The maximum *in situ* VARR was measured two to three times per week. Samples of mixed liquor (8mL) were taken throughout the reaction phase of one cycle. The ammonium uptake rate was calculated by linear regression (no substrate limitation for ammonium concentration higher than 5 mgN/L for which a linear decrease was observed). Roughly every 3-4 weeks, mixed liquor samples were taken from the reactors to determine total (TSS) and volatile (VSS) suspended solids concentrations. For biomass sampling a protocol was carefully set up to collect representative samples. During sampling, the agitation speed was increased (from 50 to 100 rpm) for maximal homogenization of the reactor liquid (and at least one minute before sampling). Sampling and VSS measurements were done in duplicate, and the sample volume (2x50 mL) was chosen to obtain good reproducibility. The maximum *in situ* SARR was calculated by combining the measured biomass concentration (g VSS/L) with the average maximum *in situ* VARR observed in during the two-three weeks around this point (three to four measurements). Standard deviations were calculated for average VARR and VSS and propagated in the error bars, allowing for an objective comparison.

All water samples were centrifuged (4°C, 2 minutes at 2,591xg) and supernatant was filtered through 0.2 µm membrane filters prior to analysis of COD and nitrogen compounds. Nitrite and nitrate were quantified using spectrophotometric methods, analyses were done automatically using the SMARTCHEM200 (AMS, Italy). Ammonium concentration was measured according to the spectrophotometric Nessler method (APHA, 1992). Suspended solids (TSS and VSS) were measured in duplicate according to Standard Methods 2540D and E (APHA, 1992). The COD concentration in the concentrated feed/ reactor samples was determined according the EPA method 410.4 (APHA, 1992) by measuring the absorbance at 620 nm/420 nm respectively after chemical oxidation with dichromate (2h at 150°C) using a spectrophotometer (Hach DR 2010).

4.2.4 Microbial community analyses

Triplicate samples of 1.5 mL mixed liquor were taken from each reactor, one was used for microbial community analyses, and the other two were stored as back-up. This was done on average once every two to three weeks. After centrifugation (20 min at 19,000xg), supernatant was removed and the remaining biomass was immediately frozen in liquid nitrogen. DNA extraction on one of these samples was performed using the FastDNA spinkit™ from MP biomedical following the provided Fastprep® protocol. The extracted DNA was stored at -20°C until further use. In order to map AnAOB enrichment, qPCR was used to quantify the AnAOB based on phylogenetic primers (16S rRNA) and functional primers (hzsA). Also, to follow up the composition of the overall community, MiSeq 16S rRNA Illumina gene sequencing was performed by the GenoToul Genomics and Transcriptomics facility (GeT-PlaGe, Auzeville, France). Sequencing data was processed using the pipeline FROGS, one of the tools proposed on Galaxy, an open web-based platform for genomic research. A detailed description of the protocol can be found in the supplementary information.

4.3. Results

4.3.1. Reactor performance

4.3.1.1. Activity evolution at high temperature (30°C)

Prior to adding COD, SBR_{30°C} displayed stable nitrogen removal and high specific ammonium removal rates of 785 mg NH₄⁺-N/g VSS/d with an average ratio of nitrite to ammonium removal of 1.27±0.19. Only limited data was available for nitrate, a single measurement performed on the last day of operation indicated that the nitrate/ammonium-ratio was slightly higher than expected from the anammox stoichiometry (see Chapter 3).

As illustrated in the left panel of Figure 4.1.a, ammonium and nitrite concentrations in the effluent remained low (respectively 1.5 ± 1.2 and 0.2 ± 0.2 on average) throughout the entire experiment and the average nitrate concentration in the effluent was 9.5 ± 4.3 mg NO_3^- -N/L.

As can be seen on the left panel of Figure 4.1.b, maximum *in situ* volumetric ammonium and nitrite removal rates at 30°C slightly increased (+20%) during the first two months of operation. VSS concentrations inside the reactor remained relatively stable at first tripled between day 40 and 76 (Figure 4.1.d) and some accumulation of packed biomass under the sparger was observed. To avoid any possible mixing problems, 75% of the biomass was removed on day 76. As a result, maximum volumetric rates initially dropped and then started to increase again until reaching 242 mg NH_4^+ -N/L/d and 258 mg NO_2^- -N/L/d on day 96 of the experiment.

The evolution of the maximum *in situ* specific ammonium and nitrite removal rates is shown in Figure 4.1d. During the first 40 days of the experiment these removal rates were relatively stable as were the VSS concentrations in the reactor. A four-fold decrease in the specific removal rates was observed between day 40 and 76, which was probably because (1) VSS concentrations tripled (likely due to the growth of HB that do not contribute to ammonium removal) and (2) some diffusion/mixing limitation occurred. After removing 75% of the biomass in the reactor on day 76, specific removal rates were the same as at the beginning of the experiment, 566 mg NH_4^+ -N/g VSS/d and 633 mg NO_2^- -N/g VSS/d on day 98.

Average $\text{nitrite}_{\text{removal}}/\text{ammonium}_{\text{removal}}$ and $\text{nitrate}_{\text{production}}/\text{ammonium}_{\text{removal}}$ ratios calculated from mass balancing were 1.36 ± 0.06 and 0.23 ± 0.09 respectively yet the average $\text{nitrite}_{\text{removal}}/\text{ammonium}_{\text{removal}}$ and $\text{nitrate}_{\text{production}}/\text{ammonium}_{\text{removal}}$ ratios calculated from the maximum *in situ* rates during the reaction phase were 1.26 ± 0.16 and -0.18 ± 0.19 respectively (Table 4.1). This discrepancy is linked to (a) nitrate production observed during the feeding phase and (b) instant consumption of the produced nitrate by HB during the reaction phase. Consequently, the average TN removal efficiency calculated from mass balancing was $81.3\pm 7\%$ which is slightly lower than the maximum 89% for anammox.

4.3.1.2. Activity evolution at low temperature (10°C)

Prior to adding COD, $\text{SBR}_{10^\circ\text{C}}$ displayed stable nitrogen removal and high specific ammonium removal rates of $92 \text{ mg NH}_4^+\text{-N/g VSS/d}$ with an average ratio of nitrite to ammonium removal of 1.20 ± 0.11 . Only limited data was available for nitrate, a single measurement performed on the last day of operation indicated that the nitrate/ammonium-ratio was slightly higher than expected from the anammox stoichiometry (see Chapter 3).

After addition of COD to the influent on day 0 and adjustment of the NLR on day 15, ammonium and nitrite concentrations in the effluent remained low (respectively 1.2 ± 0.9 and 0.5 ± 0.9 on average) and the average nitrate concentration in the effluent was $8.9\pm 2.3 \text{ mg NO}_3^-\text{-N/L}$.

The right panel of Figure 4.1.a shows the evolution of the maximum *in situ* volumetric ammonium and nitrite removal rates throughout the experiment at 10°C. During the first two weeks, removal rates were rather stable around 13 mg NH₄⁺-N/L/d and 20 mg NO₂⁻-N/L/d. During the rest of the experiment, volumetric removal rates increased continuously from 20.1 mg NH₄⁺-N/L/d and 29.4 mg NO₂⁻-N/L/d on day 16 to 38.0 mg NH₄⁺-N/L/d and 43.3 mg NO₂⁻-N/L/d on day 97.

Figure 4.1.d shows how the average specific ammonium and nitrite removal rates continuously increased throughout the experiment from 90 mg NH₄⁺-N/g VSS/d and 94 mg NO₂⁻-N/g VSS/d at the start to 119 mg NH₄⁺-N/g VSS/d and 172 mg NO₂⁻-N/g VSS/d on day 98 while VSS concentrations in the reactor slightly increased from 0.25 g/L to 0.32 g/L in the same period.

Average $\text{nitrite}_{\text{removal}}/\text{ammonium}_{\text{removal}}$ and $\text{nitrate}_{\text{production}}/\text{ammonium}_{\text{removal}}$ ratios calculated from mass balancing were 1.27 ± 0.05 and 0.26 ± 0.13 respectively, yet the average $\text{nitrite}_{\text{removal}}/\text{ammonium}_{\text{removal}}$ and $\text{nitrate}_{\text{production}}/\text{ammonium}_{\text{removal}}$ ratios calculated from the maximum *in situ* rates during the reaction phase were 1.07 ± 0.20 and 0.04 ± 0.20 respectively (Table 4.1) which is lower than expected from anammox. This discrepancy is linked to (a) nitrate production observed during the feeding phase and (b) instant consumption of the produced nitrate by HB during the reaction phase. This is further discussed in section 4.4.1. Consequently, the average TN removal efficiency was $82.3 \pm 5\%$, which is slightly lower than the maximum anammox efficiency (Strous et al., 1998).

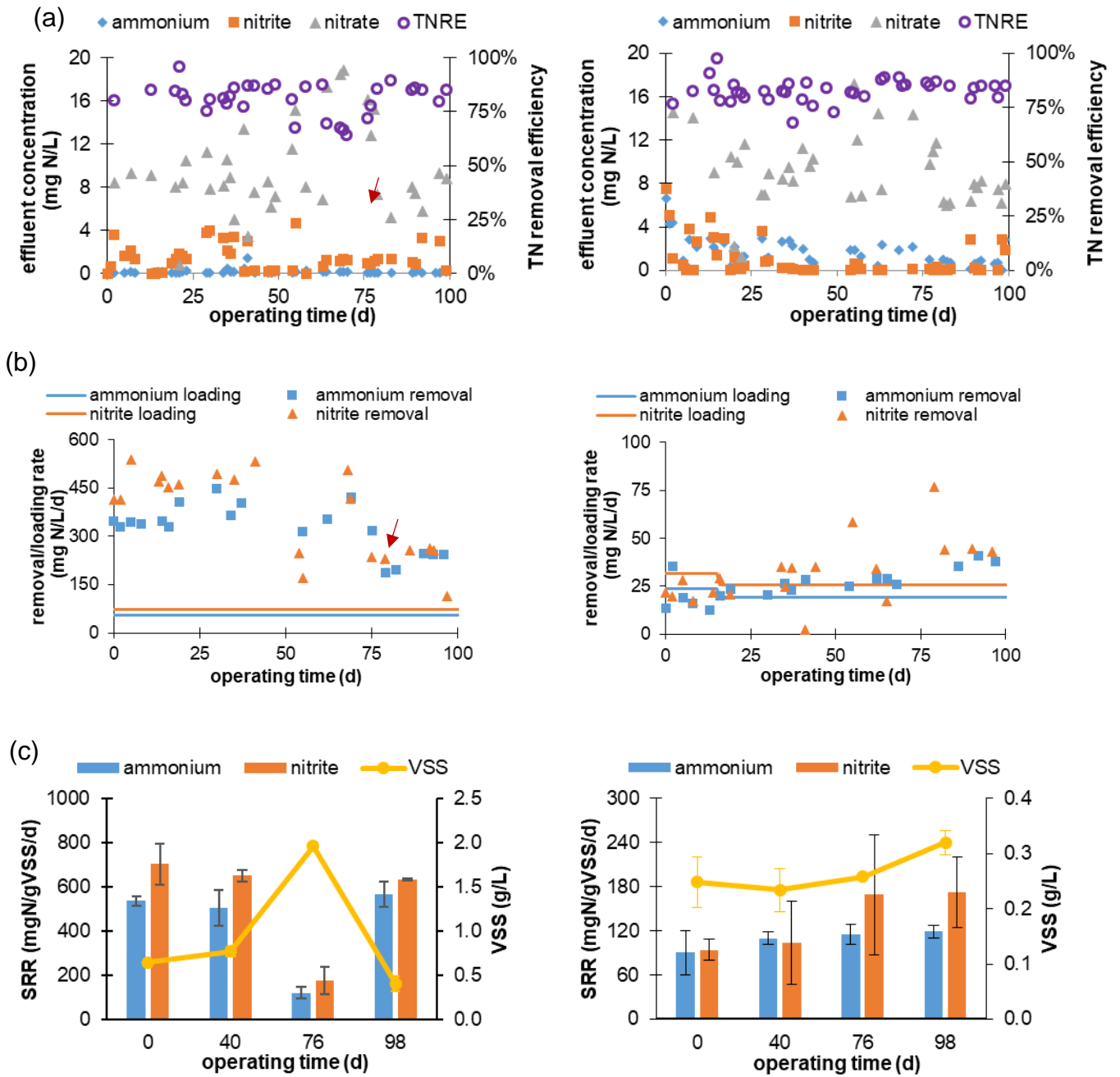

Figure 4.1 – Evolution of the performance of SBR_{30°C} (left column) and SBR_{10°C} (right column): (a) effluent quality (left axis) and total nitrogen removal efficiency, TNRE (right axis), (b) overall reactor loading rates and *in-situ* volumetric ammonium and nitrite removal, (c) specific *in-situ* ammonium and nitrite removal rates along with biomass concentrations. Red arrow on left panels of (a) and (b) represents removal of 75% biomass from SBR_{30°C}

Table 4.1 - Average stoichiometric ratios of nitrite_{removal}/ammonium_{removal} and nitrate_{production}/ammonium_{removal} calculated from *in-situ* rates and from in-out mass balance

	<i>SBR</i> _{30°C}		<i>SBR</i> _{10°C}	
	<i>mass balance</i>	<i>in-situ rates</i>	<i>mass balance</i>	<i>in-situ rates</i>
$NO_2^-_{rem}/NH_4^+_{rem}$	1.36 ± 0.06	1.26 ± 0.16	1.27 ± 0.05	1.07 ± 0.20
$NO_3^-_{prod}/NH_4^+_{rem}$	0.23 ± 0.09	-0.18 ± 0.19	0.26 ± 0.13	0.04 ± 0.20

4.3.1.3. COD removal

During the first couple of weeks close to no COD removal was observed in *SBR*_{30°C} and effluent COD concentrations were initially even slightly higher than those in the influent (30 mg COD/L), probably due to low relative HB abundance (see below). No data was available for *SBR*_{10°C} during the first two weeks as operating conditions were not yet optimized. For the rest of the experiment, both reactors showed comparable evolutions in COD removal as shown in Figure 4.2. COD removal efficiencies calculated from mass balancing gradually increased from 25 and 28% in *SBR*_{30°C} and *SBR*_{10°C} respectively (day 23) to 41% and 53% towards the end of the experiment.

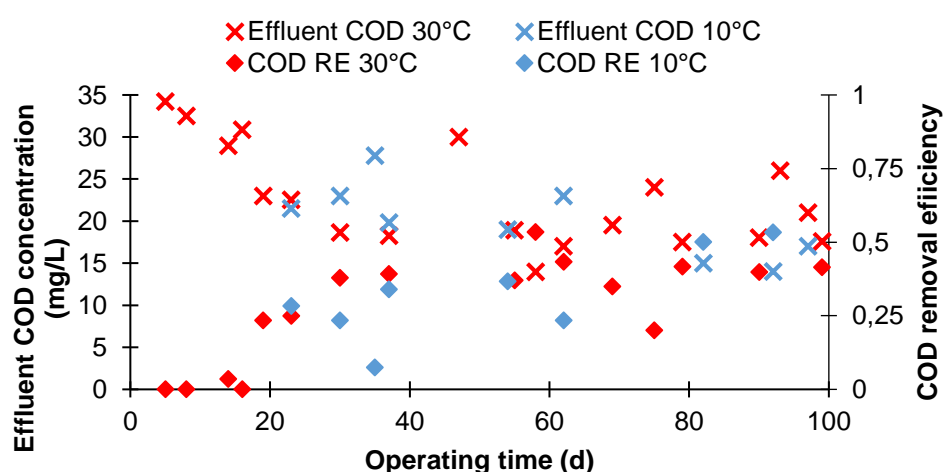

Figure 4.2 – Effluent COD concentrations (crosses) and COD removal efficiencies (diamonds) throughout the experiment in *SBR*_{30°C} (red) and *SBR*_{10°C} (blue)

4.3.2 Biomass aggregate size and microbial community analysis

4.3.2.1 Transition from granular system to hybrid system with flocs

Prior to COD addition both reactors contained bright red, well settling granules and little to no flocs were present. The maximum observed diameter was higher at low temperature, reflected in a bigger volume median diameter $D(0.5)$ of 1.6 mm for $SBR_{10^{\circ}C}$ vs. 1.2 mm for $SBR_{30^{\circ}C}$ (see Chapter 3)

After the addition of COD to the influent, flocs started to develop and a transition from a purely granular system to a hybrid system containing both granules and flocs was observed in both reactors. The flocs in $SBR_{10^{\circ}C}$ were smaller and less abundant compared to the branched growth of big flocs observed in $SBR_{30^{\circ}C}$ as illustrated in Figure 4.3 below.

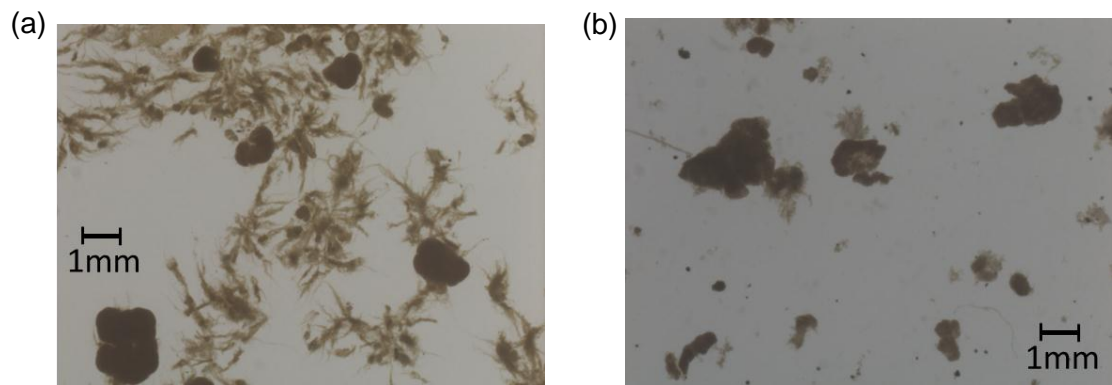

Figure 4.3 - Micrographs of mixed liquor samples taken on day 107 from (a) $SBR_{30^{\circ}C}$ and (b) $SBR_{10^{\circ}C}$

4.3.2.2 Evolutions in the microbial community

16S rRNA gene sequencing showed that, initially, AnAOB made up 87% and 91% of the total community in SBR_{30°C} and SBR_{10°C} respectively. In SBR_{30°C}, AnAOB abundance decreased linearly until it reached 37% on day 78. In SBR_{10°C}, most changes in community structure took place during the first 42 days: the relative AnAOB abundance had decreased to 75% (day 42), after which it remained stable for the rest of the experiment (74% on day 100). As can be seen in figure 4.4.b, the presence of COD did not impact the dominant genera which were *Ca. Brocadia* and *Ca. Kuenenia* in SBR_{30°C} and SBR_{10°C} respectively and remained so for the duration of the experiment. However, the relative abundance of *Ca. Brocadia* in SBR_{10°C} increased from <10% to almost 20% from day 40 to 100 as the relative abundance of Planctomycetes remained relatively stable (Figure 4.4), illustrating how slow dynamics within the AnAOB community are at this temperature. It is plausible that a steady state has not been reached after only 100 days and that dynamics would continue with prolonged operation.

In both reactors, this decrease in relative AnAOB abundance resulted from an increase in heterotroph abundance, mainly related to the development of Proteobacteria and Bacteroidetes as can be seen in Figure 4.4.a. In SBR_{10°C} the relative abundance of Bacteroides and Proteobacteria increased respectively from 2 to 14.4% and from 2.6 to 9.1%. In SBR_{30°C}, next to a remarkable increase in relative Proteobacteria (from 5.3 to 33.4%) and Bacteroidetes (from 2.7 to 13.5%) abundance, minor increases in relative Acidobacteria (3.7 to 4.6%) and Chloroflexi (2.5 to 7.2%) abundance were also observed. Firmicutes were detected only in SBR_{30°C} and remained minority and stable around 1%. Shannon and Inverse Simpson indices (see section 2.3 for more information) show a diversity increase in both reactors throughout the entire experiment. Initially both reactors had comparable diversity but as HB started to develop, diversity became and remained highest in SBR_{30°C} (Figure SIV.2). It is safe to assume that this is due to (1) the more favourable, higher temperature allowed more diverse bacteria to develop and (2) the apparent higher floc retention at 30°C compared to 10°C.

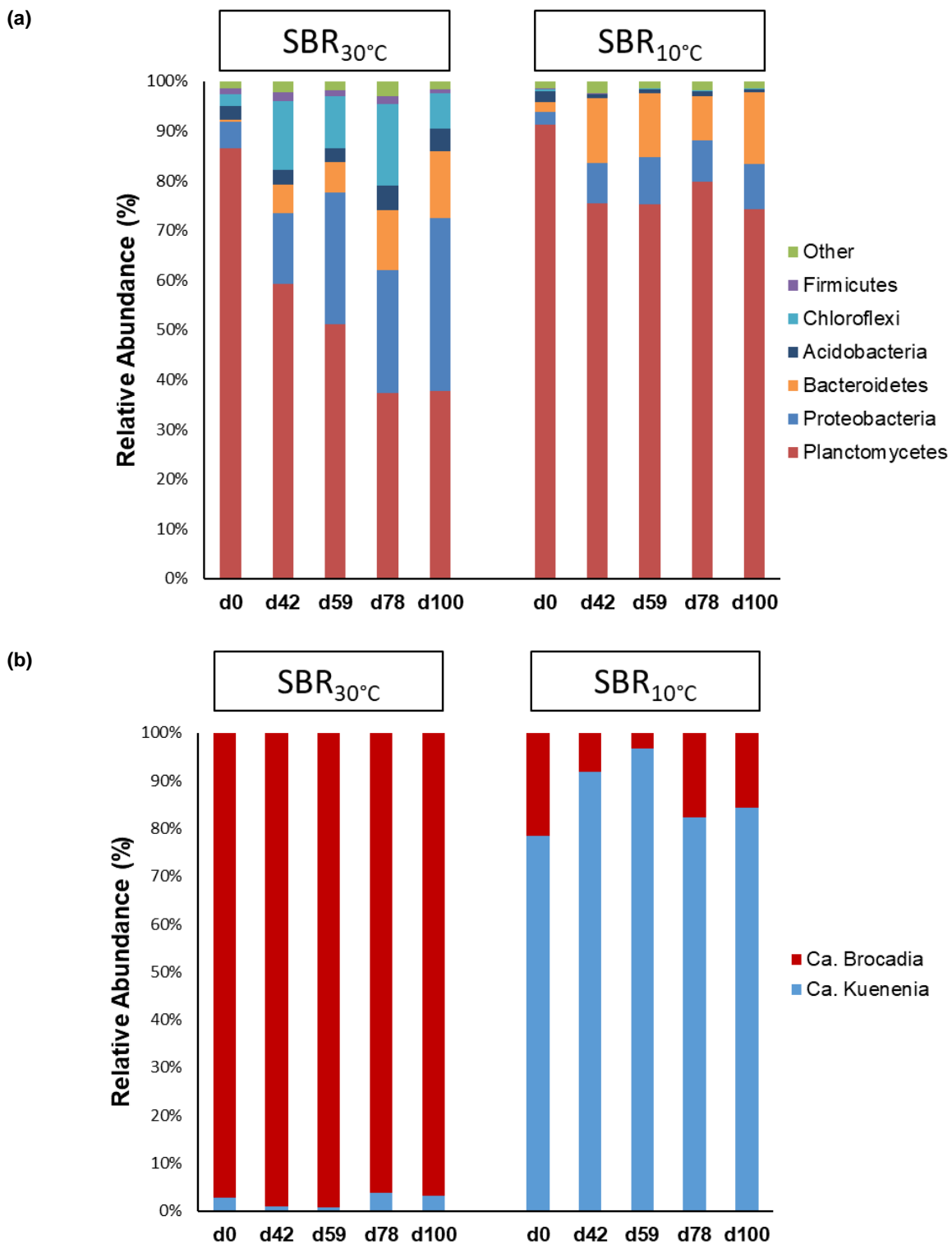

Figure 4.4 – Evolution of (a) Microbial community at Phylum level. and (b) anammox diversity at genus level throughout the experiment (abscissa represents operating days) in SBR_{30°C} (left) and SBR_{10°C} (right)

Phyla with a relative abundance below 1% are grouped in the category „Other“

In parallel, the evolution of the AnAOB abundance in the biomass was also assessed by qPCR. Results in figure 4.5 are consistent with those of the 16S rRNA amplicon sequencing, showing a much more drastic decrease in relative AnAOB abundance at 30°C compared to 10°C. The observed trends were similar for copy levels expressed ‘per g of biomass’ or ‘per ng of DNA’.

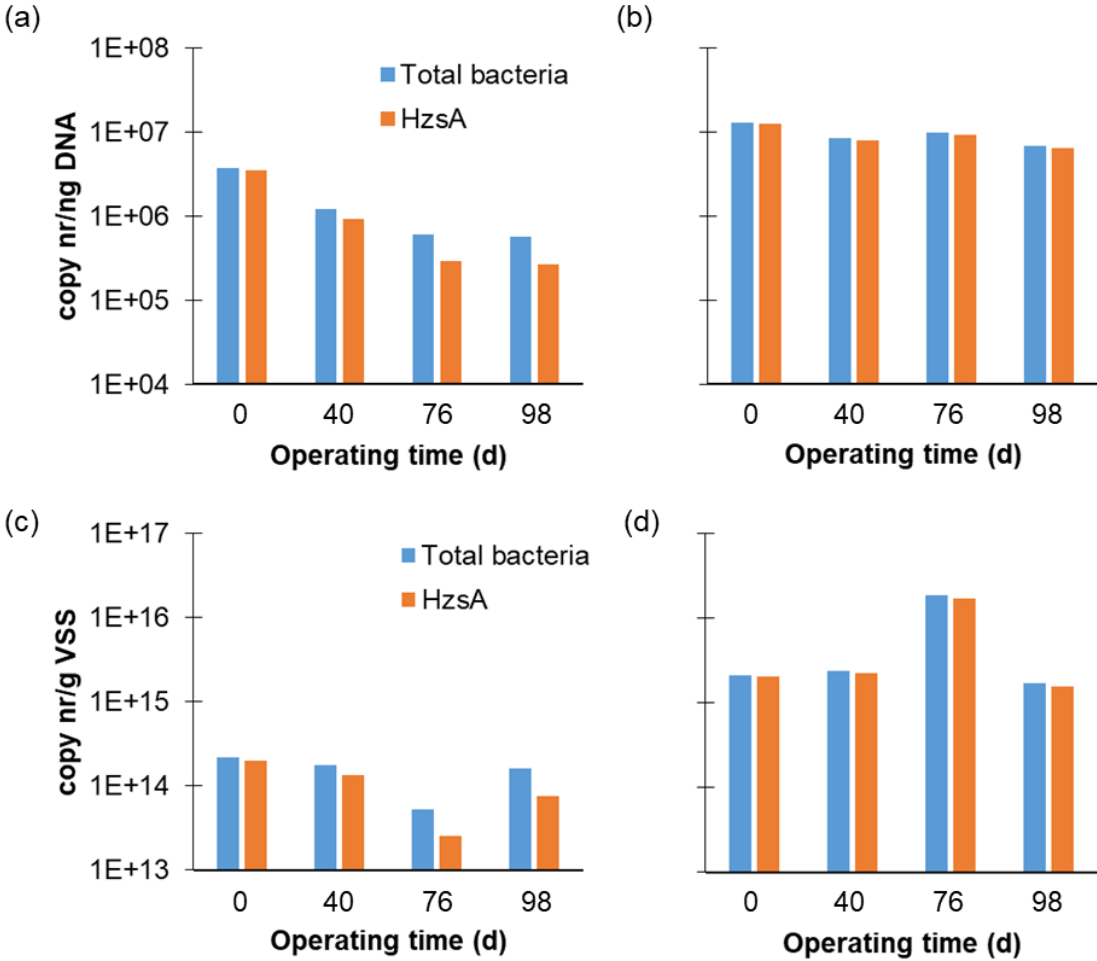

Figure 4.5 - Evolution of total bacteria and overall AnAOB abundance as determined by qPCR analyses: copy numbers of total bacteria (lighter bars) and the HzsA functional gene (darker bars) are shown. Top row shows the data expressed per g of VSS for SBR_{30°C} (a) and SBR_{10°C} (b). Bottom rows show the same data expressed per ng of DNA for SBR_{30°C} (c) and SBR_{10°C} (d).

4.4. Discussion

4.4.1 Competition between AnAOB and HB for nitrite during

It has previously been reported that the slow-growing AnAOB could be outcompeted by HB for nitrite in the presence of COD, causing a loss of anammox activity which destabilizes the process resulting in loss of N removal efficiency (Tang et al., 2010; Wang et al., 2016).

Competition during the reaction phase

Considering the observed soluble COD consumption per cycle in the range 10-15 mgCOD/L (35-50% removal) in both reactors, according to ASM, this would allow for (1) the reduction of 1.6-2.4 mg NO₃⁻-N/L and/or (2) the reduction of 2.7-4 mg NO₂⁻-N/L and/or (3) the partial reduction of 4-6 mg NO₃⁻-N/L to nitrite which would then be further consumed by AnAOB with ammonium. Note that any combination of (1), (2) and (3) would be possible.

When assessing the competition between AnAOB and HB during the anoxic reaction phase of SBR_{30°C}, the maximum *in situ* VRR $\text{nitrite}_{\text{removal}}/\text{ammonium}_{\text{removal}}$ and $\text{nitrate}_{\text{production}}/\text{ammonium}_{\text{removal}}$ ratios were 1.26 ± 0.16 and -0.18 ± 0.19 respectively (Table 4.1). This seems to be consistent with all nitrite being consumed together with ammonium in the anammox pathway and complete denitrification of nitrate by HB. Suggesting that no significant competition for nitrite occurred between AnAOB and HB at this temperature. This contradicts other studies where competition between AnAOB and HB was observed. However, these studies were performed at higher COD/N ratios and using rapidly biodegradable COD (Tang et al., 2010; Wang et al., 2016). A possible explanation is that, since neither nitrate nor nitrite were limiting during the experiment, the HB had a preference for nitrate over nitrite for denitrification since it offers a higher energy yield (proportional to the oxidation number of the nitrogen, Koike & Hattori, 1975).

When making the same assessment for SBR_{10°C}, the maximum *in situ* VRR $\text{nitrite}_{\text{removal}}/\text{ammonium}_{\text{removal}}$ and $\text{nitrate}_{\text{production}}/\text{ammonium}_{\text{removal}}$ ratios were 1.07 ± 0.20 and 0.04 ± 0.20 respectively (Table 4.1). With the available data and the uncertainty of the system, it is difficult to understand which (combination) of the of three proposed COD consumption routes is followed. e.g. assuming that all nitrite together with ammonium into nitrate by AnAOB. Complete denitrification of the produced nitrate would give rise to a higher $\text{nitrate}_{\text{production}}/\text{ammonium}_{\text{removal}}$ ratio (and not lower as observed in our experiment). A lower $\text{nitrate}_{\text{production}}/\text{ammonium}_{\text{removal}}$ ratio could be explained by partial reduction of nitrate to nitrite, but only if the produced nitrite would then be consumed together with ammonium by AnAOB. However, this is not possible because there would be no excess ammonium available (nitrite:ammonium ratio of 1.32:1 in the influent) for this conversion. This should result in the accumulation of nitrite in the effluent however this was only rarely observed. The uncertainty of the data does not allow to draw any conclusions. It is likely that a combination of the above-mentioned COD consumption routes is taking place in SBR_{10°C}.

The proposed instant (partial) denitrification of the nitrate produced by AnAOB is supported by the concentration profiles obtained during the reaction phase (Figure SIV.1) where nitrate concentrations remained rather constant and no net production or consumption of nitrate could be observed.

Conversion of the influent ammonium (25.9 mg N/L) and nitrite (34.1 mg N/L) by AnAOB would produce 6.7 mg NO₃⁻-N/L (Strous et al., 1999). As demonstrated above, the observed COD removal efficiencies (35-50%) would not allow for the (partial) denitrification of all produced nitrate (Henze et al., 2000). This suggests that soluble microbial products from decay are contributing to the soluble COD as previously proposed by Ni et al. during a modelling study (Ni et al., 2011).

Competition during the flush phase

The discrepancy between the nitrate stoichiometry calculated from *in situ rates* and that calculated from mass balancing (Table 4.1) was caused by nitrate production during the flush phase. Indeed, an average production of 4.8 and 3.6 mg NO₃⁻-N/L was observed in SBR_{30°C} and SBR_{10°C} respectively which could be explained by some AOB/NOB activity on residual oxygen present in the influent during the first 10 minutes of the flushing phase.

The residual nitrate and COD in the effluent indicates that not all influent starch had been hydrolysed and was hence not readily available for denitrification. Indeed, hydrolysis of starch needs several hours. Donosobravo et al. experimentally determined a maximum hydrolysis rate or k_h for soluble starch of 21.1d⁻¹ at 37°C (anaerobic conditions, Donoso-Bravo et al., 2009). Using an Arrhenius coefficient of 1.050 (Barker & Dold, 1997) k_h values at 30°C and 10°C are estimated at 15 d⁻¹ and 5.65 d⁻¹ respectively. These values also depend on the HB biomass concentration which was initially relatively low in both reactors and increased progressively (Figure 4.4) as did the COD removal efficiency (Figure 4.2). This indicates that hydrolysis was the rate limiting step for COD (and nitrate) removal both in SBR_{30°C} and SBR_{10°C}. This, together with the above-mentioned nitrate production during the flush phase makes that the average TN removal efficiency from mass balancing was around 82% in both reactors, which is slightly lower than the maximum TN removal efficiency of 89% of the anammox process.

In conclusion, no significant competition between AnAOB and HB for nitrite seems to be occurring during the reaction phase at 30°C, possibly because of (1) sufficiently high nitrite/nitrate concentrations to avoid limitations, (2) preference of nitrate reduction by heterotrophs and finally (3) slow COD removal controlled by hydrolysis. Finally, based on the available data, this competition cannot be excluded at 10°C

4.4.2 Differential SRT favors retention of AnAOB over HB at low temperature

It was already published that a selective separation techniques such as screens (Han et al., 2016b), hydrocyclones (Wett et al., 2013) or operation in IFAS mode with carriers (Veuillet et al., 2014) can be used to selectively retain AnAOB while washing out undesired bacteria by imposing a differential SRT in the system.

Prior to this study, both reactors had been operated for one year on autotrophic influent in anoxic conditions to minimize competition with AOB, NOB and HB while simultaneously maximizing biomass retention (by imposing a low minimum settling velocity, keeping solids settling at > 0.3 m/h into the system) by enabling the slow(est) growing AnAOB to stay or develop in the system. In both reactors, regardless of operational temperature, AnAOB enrichment occurred and bacteria aggregated in rapidly settling granules, which facilitated biomass retention, resulting in anoxic SRT values of 162 and 164 days for SBR_{30°C} and SBR_{10°C} respectively (see Chapter 3).

When adding COD to the influent, a transition from granular system with excellent biomass retention to hybrid system with granules and flocs was observed (Figure 4.3). Given the high increase in biomass production, this transition can be linked to growth of HB which tend to prevail in flocs as opposed to the slow growing AnAOB which are often found in granules.

Where biomass retention was excellent (around 1 mg VSS/L in the effluent) before addition of COD, the newly developed flocs had poorer settling properties which resulted in a more significant wash-out (23 and 26 mg VSS/L in the effluent of SBR_{30°C} and SBR_{10°C} respectively) and consequently considerably lower anoxic SRT values of 26 and 19 days for SBR_{30°C} and SBR_{10°C} respectively from the estimated solids balance after addition of COD (Table 4.2).

Table 4.2 - SRT calculations before and after adding COD to influent. The start/end of each period corresponds to VSS measurements inside the reactor

SBR_{30°C}	Period	duration (d)	Reactor mass (g VSS)	sampling (g VSS)	effluent loss (g VSS)	SRT (d)
no COD	-	349	2.78	0.364	5.62	162
	I	42	3.23	0.004	0.50	272
	II	36	3.86	0.005	8.59	16
COD	III	22	9.81	0.026	5.25	41
	IV	17	2.04	0.003	4.06	9
	total	117	4.73	0.039	18.39	26

SBR_{10°C}	Period	duration (d)	Reactor mass (g VSS)	sampling (g VSS)	effluent loss (g VSS)	SRT (d)
no COD	-	349	2.23	0.269	4.48	164
	I	42	1.24	0.002	0.28	188
	II	36	1.17	0.002	3.31	13
COD	III	22	1.29	0.003	2.02	14
	IV	17	1.60	0.002	1.56	17
	total	117	1.32	0.009	7.20	19

The observed higher SRT (Table 4.2) and VSS accumulation (Figure 4.1.d) in SBR_{30°C} compared to SBR_{10°C} are linked to (1) a higher biomass production associated with a higher COD and N loading rate and (2) better settleability of the produced biomass with a bigger aggregate size.

Indeed, the COD and N loading rate in SBR_{30°C} (64.3 mg COD/L/d, 129 mg N/L/d) were considerably higher than in SBR_{10°C} (22.8 mg COD/L/d, 45 mg N/L/d). From the observed average COD removal efficiencies of 35 and 33% in reactor SBR_{30°C} and SBR_{10°C}, an estimated 855 mgVSS/L and 218 mg VSS/L of HB would have been produced by day 76 (prior to sludge removal from SBR_{30°C}). Considering that the produced biomass was partially wash out (Table

1), these values are too low to explain the observed biomass concentrations of 2.0 g VSS/L (SBR_{30°C}) and 0.26 g VSS/L (SBR_{10°C}). However, when estimating HB biomass production associated with the observed complete denitrification of the nitrate produced by AnAOB during the reaction phase (using the rbCOD in the influent, from partial starch hydrolysis and soluble microbial products from HB decay) approximately 2.6 and 0.9 g VSS/L of HB would have accumulated in SBR_{30°C} and SBR_{10°C} respectively. By considering growth on soluble microbial products in the mass balance, the calculations approximate the observed biomass concentrations in the reactors (Table SIV.1). The deviations are likely the results of over/underestimation of the washout from SBR_{30°C} and SBR_{10°C} respectively.

The observed difference in aggregate size between SBR_{30°C} and SBR_{10°C} (Figure 4.3) translated in a difference in settleability which impacted washout and consequently the SRT. The small flocs in SBR_{10°C} settled slowly and were therefore more efficiently washed out of the reactor. In contrast, the bigger aggregated in SBR_{30°C} settled more rapidly, causing more biomass accumulation in the system.

The bigger aggregates in SBR_{30°C} are likely due to a combination of (1) faster growth rates and (2) increased floc aggregation resulting in branched growth of bigger flocs at 30°C compared to the small flocs at 10°C. From the Arrhenius equation ($\theta_{HB}=1.07$, Metcalf 2003) it can be derived that HB grow roughly 4 times slower at 10°C compared to 30°C which could be why flocs developed more slowly and were smaller in SBR_{10°C}. Secondly, whereas in SBR_{10°C} virtually no endogenous conditions occurred, the maximum *in situ* removal rates in SBR_{30°C} were significantly higher than the loading rate and most substrate was consumed during the first 40 minutes of the reaction meaning the bacteria were subjected to endogenous conditions throughout the rest of the cycle. It has previously been described how intermittent feed and endogenous periods favor floc growth and EPS production associated with biomass aggregation (Bossier & Verstraete, 1996; Krishna & Van Loosdrecht, 1999; McSwain et al., 2004). This could explain why bigger (and well settling) aggregates were found in SBR_{30°C}.

This difference in wash-out is also reflected in the microbial community dynamics. Where in SBR_{30°C} a simultaneous increase in HB abundance and steep linear decrease in AnAOB abundance is observed (abundance from 87% on day 1 to 37% on day 78), this phenomenon is much less pronounced in SBR_{10°C}. During the first 42 days AnAOB abundance decreased from 91% to 75% where it remains throughout the rest of the experiment, indication that less flocs containing HB are accumulating.

4.5. Conclusions

- Anammox remained the dominant N-removal route in both reactors.
- High maximum anammox rates were obtained in both reactors e.g. up to 119 mg NH₄⁺-N/gVSS/d at 10°C.
- Significant competition between AnAOB and HB for nitrite under anoxic conditions was not observed at 30°C but could not be excluded at 10°C.
- In SBR_{30°C}, developed flocs were retained in the mixed liquor, and heterotrophs dominated in terms of relative abundance over AnAOB. In SBR_{10°C}, developed flocs washed out, and AnAOB maintained their dominance in the community.
- For the duration of the experiment, the dominant AnAOB genus was not impacted by COD presence.
- Results are promising towards implementation of mainstream PN/A

4.6. Acknowledgements

This study has been financially supported by the ANRT (CIFRE N° 2014/0754). The Authors are grateful to the Genotoul bioinformatics platform Toulouse Midi-Pyrenees and the Sigenae group for providing help and computing resources through to their Galaxy platform.

4.7. References

- APHA, A. 1992. WPCF (American Public Health Association, American Waterworks Association, Water Pollution Control Federation)(1992) Standard methods for the examination of water and wastewater. *Standard methods for the Examination of Water and Wastewater*, **17**.
- Barker, P.S., Dold, P.L. 1997. General Model for Biological Nutrient Removal Activated-Sludge Systems: Model Application. *Water Environment Research*, **69**(5), 985-991.
- Bossier, P., Verstraete, W. 1996. *Triggers for Microbial Aggregation in Activated Sludge?*
- Cao, Y., van Loosdrecht, M.C.M., Daigger, G.T. 2017. Mainstream partial nitrification–anammox in municipal wastewater treatment: status, bottlenecks, and further studies. *Applied Microbiology and Biotechnology*, **101**(4), 1365-1383.
- Chamchoi, N., Nitorisavut, S., Schmidt, J.E. 2008. Inactivation of ANAMMOX communities under concurrent operation of anaerobic ammonium oxidation (ANAMMOX) and denitrification. *Bioresource Technology*, **99**(9), 3331-3336.
- Chen, C., Sun, F., Zhang, H., Wang, J., Shen, Y., Liang, X. 2016. Evaluation of COD effect on anammox process and microbial communities in the anaerobic baffled reactor (ABR). *Bioresource Technology*, **216**, 571-578.
- Dapena-Mora, A., Fernández, I., Campos, J.L., Mosquera-Corral, A., Méndez, R., Jetten, M.S.M. 2007. Evaluation of activity and inhibition effects on Anammox process by batch tests based on the nitrogen gas production. *Enzyme and Microbial Technology*, **40**(4), 859-865.
- De Cocker, P., Bessiere, Y., Hernandez-Raquet, G., Dubos, S., Mozo, I., Gaval, G., Caligaris, M., Barillon, B., Vlaeminck, S.E., Sperandio, M. 2018. Enrichment and adaptation yield high anammox conversion rates under low temperatures. *Bioresource Technology*, **250**, 505-512.
- Donoso-Bravo, A., Retamal, C., Carballa, M., Ruiz-Filippi, G., Chamy, R. 2009. *Influence of temperature on the hydrolysis, acidogenesis and methanogenesis in mesophilic anaerobic digestion: Parameter identification and modeling application*.
- Güven, D., Dapena, A., Kartal, B., Schmid, M.C., Maas, B., van de Pas-Schoonen, K., Sozen, S., Mendez, R., den Camp, H.J.O., Jetten, M.S. 2005. Propionate oxidation by and methanol inhibition of anaerobic ammonium-oxidizing bacteria. *Applied and environmental microbiology*, **71**(2), 1066-1071.

- Han, M., De Clippeleir, H., Al-Omari, A., Wett, B., Vlaeminck, S.E., Bott, C., Murthy, S. 2016a. Impact of carbon to nitrogen ratio and aeration regime on mainstream deammonification. *Water Science and Technology*, **74**(2), 375.
- Han, M., Vlaeminck, S.E., Al-Omari, A., Wett, B., Bott, C., Murthy, S., De Clippeleir, H. 2016b. Uncoupling the solids retention times of flocs and granules in mainstream deammonification: A screen as effective out-selection tool for nitrite oxidizing bacteria. *Bioresource Technology*, **221**, 195-204.
- Henze, M., Gujer, W., Mino, T., & Van Loosdrecht, M. C. M. (2000). Activated sludge models ASM1, ASM2, ASM2d and ASM3. IWA publishing.
- Jenni, S., Vlaeminck, S.E., Morgenroth, E., Udert, K.M. 2014. Successful application of nitrification/anammox to wastewater with elevated organic carbon to ammonia ratios. *Water Research*, **49**(0), 316-326.
- Kartal, B., van Niftrik, L., Keltjens, J.T., den Camp, H.J.M.O., Jetten, M.S.M. 2012. Anammox-Growth Physiology, Cell Biology, and Metabolism. in: *Advances in Microbial Physiology, Vol 60*, (Ed.) R.K. Poole, Vol. 60, pp. 211-262.
- Kartal, B., van Niftrik, L., Rattray, J., de Vossenberg, J.L.C.M.v., Schmid, M.C., Damste, J.S.S., Jetten, M.S.M., Strous, M. 2008. Candidatus 'Brocadia fulgida': an autofluorescent anaerobic ammonium oxidizing bacterium. *Fems Microbiology Ecology*, **63**(1), 46-55.
- KOIKE, I., HATTORI, A. 1975. Energy Yield of Denitrification: An Estimate from Growth Yield in Continuous Cultures of *Pseudomonas denitrificans* under Nitrate-, Nitrite- and Nitrous Oxide-limited Conditions. *Microbiology*, **88**(1), 11-19.
- Krishna, C., Van Loosdrecht, M.C.M. 1999. Effect of temperature on storage polymers and settleability of activated sludge. *Water Research*, **33**(10), 2374-2382.
- Lackner, S., Gilbert, E.M., Vlaeminck, S.E., Joss, A., Horn, H., van Loosdrecht, M.C.M. 2014. Full-scale partial nitrification/anammox experiences - An application survey. *Water Research*, **55**, 292-303.
- Lackner, S., Terada, A., Smets, B.F. 2008. Heterotrophic activity compromises autotrophic nitrogen removal in membrane-aerated biofilms: Results of a modeling study. *Water Research*, **42**(4-5), 1102-1112.
- Laureni, M., Weissbrodt, D.G., Szivák, I., Robin, O., Nielsen, J.L., Morgenroth, E., Joss, A. 2015. Activity and growth of anammox biomass on aerobically pre-treated municipal wastewater. *Water Research*, **80**(0), 325-336.
- Leal, C.D., Pereira, A.D., Nunes, F.T., Ferreira, L.O., Coelho, A.C.C., Bicalho, S.K., Mac Conell, E.F.A., Ribeiro, T.B., de Lemos Chernicharo, C.A., de Araújo, J.C. 2016.

- Anammox for nitrogen removal from anaerobically pre-treated municipal wastewater: Effect of COD/N ratios on process performance and bacterial community structure. *Bioresource Technology*, **211**, 257-266.
- Li, J., Qiang, Z., Yu, D., Wang, D., Zhang, P., Li, Y. 2016. Performance and microbial community of simultaneous anammox and denitrification (SAD) process in a sequencing batch reactor. *Bioresource Technology*, **218**, 1064-1072.
- McSwain, B.S., Irvine, R.L., Wilderer, P.A. 2004. The effect of intermittent feeding on aerobic granule structure. *Water Science and Technology*, **49**(11-12), 19.
- Metcalf, E. 2003. Waste water engineering: treatment and reuse, 4th edn. Revised by Tchobanoglous G, Burton FL, Stensel HD, McGraw-Hill, New York.
- Molinuevo, B., Cruz Garcia, M., Karakashev, D., Angelidaki, I. 2009. Anammox for ammonia removal from pig manure effluents: Effect of organic matter content on process performance. *Bioresource Technology*, **100**(7), 2171-2175.
- Mulder, A., van de Graaf, A.A., Robertson, L.A., Kuenen, J.G. 1995. Anaerobic ammonium oxidation discovered in a denitrifying fluidized bed reactor. *FEMS Microbiology Ecology*, **16**(3), 177-183.
- Muller, A., Wentzel, M.C., Loewenthal, R.E., Ekama, G.A. 2003. Heterotroph anoxic yield in anoxic aerobic activated sludge systems treating municipal wastewater. *Water Res*, **37**(10), 2435-41.
- Ni, B.-J., Chen, Y.-P., Liu, S.-Y., Fang, F., Xie, W.-M., Yu, H.-Q. 2009. Modeling a granule-based anaerobic ammonium oxidizing (ANAMMOX) process. *Biotechnology and Bioengineering*, **103**(3), 490-499.
- Ni, B.-J., Xie, W.-M., Chen, Y.-P., Fang, F., Liu, S.-Y., Ren, T.-T., Sheng, G.-P., Yu, H.-Q., Liu, G., Tian, Y.-C. 2011. Heterotrophs grown on the soluble microbial products (SMP) released by autotrophs are responsible for the nitrogen loss in nitrifying granular sludge. *Biotechnology and Bioengineering*, **108**(12), 2844-2852.
- Ni, S.-Q., Ni, J.-Y., Hu, D.-L., Sung, S. 2012. Effect of organic matter on the performance of granular anammox process. *Bioresource Technology*, **110**, 701-705.
- Nogaj, T.M., Randall, A.A., Jimenez, J.A., Takacs, I., Bott, C.B., Miller, M.W., Murthy, S., Wett, B. 2014. Mathematical modeling of the high rate activated sludge system: optimizing the COD: N ratio in the process effluent. *Proceedings of the Water Environment Federation*, **2014**(16), 913-926.
- Reino, C., Suárez-Ojeda, M.E., Pérez, J., Carrera, J. 2018. Stable long-term operation of an upflow anammox sludge bed reactor at mainstream conditions. *Water Research*, **128**, 331-340.

- Sheng, S., Liu, B., Hou, X., Liang, Z., Sun, X., Du, L., Wang, D. 2018. Effects of different carbon sources and C/N ratios on the simultaneous anammox and denitrification process. *International Biodeterioration & Biodegradation*, **127**, 26-34.
- Siegrist, H., Salzgeber, D., Eugster, J., Joss, A. 2008. Anammox brings WWTP closer to energy autarky due to increased biogas production and reduced aeration energy for N-removal. *Water Science and Technology*, **57**(3), 383-388.
- Strous, M., Heijnen, J.J., Kuenen, J.G., Jetten, M.S.M. 1998. The sequencing batch reactor as a powerful tool for the study of slowly growing anaerobic ammonium-oxidizing microorganisms. *Applied Microbiology and Biotechnology*, **50**(5), 589-596.
- Strous, M., Kuenen, J.G., Jetten, M.S. 1999. Key physiology of anaerobic ammonium oxidation. *Applied and environmental microbiology*, **65**(7), 3248-3250.
- Tang, C.J., Zheng, P., Wang, C.H., Mahmood, Q. 2010. Suppression of anaerobic ammonium oxidizers under high organic content in high-rate Anammox UASB reactor. *Bioresource Technology*, **101**(6), 1762-1768.
- Veuillet, F., Lacroix, S., Bausseron, A., Gonidec, E., Ochoa, J., Christensson, M., Lemaire, R. 2014. Integrated fixed-film activated sludge ANITA™ Mox process—a new perspective for advanced nitrogen removal. *Water Science & Technology*, **69**(5), 915-922.
- Vlaeminck, S.E., De Clippeleir, H., Verstraete, W. 2012. Microbial resource management of one-stage partial nitritation/anammox. *Microbial Biotechnology*, **5**(3), 433-448.
- Wang, Z., Shan, X., Li, W., Chen, H., Zhang, M., Zheng, P. 2016. Robustness of ANAMMOX granule sludge bed reactor: Effect and mechanism of organic matter interference. *Ecological Engineering*, **91**, 131-138.
- Wett, B., Omari, A., Podmirseg, S.M., Han, M., Akintayo, O., Brandon, M.G., Murthy, S., Bott, C., Hell, M., Takacs, I., Nyhuis, G., O'Shaughnessy, M. 2013. Going for mainstream deammonification from bench to full scale for maximized resource efficiency. *Water Science and Technology*, **68**(2), 283-289.

Chapter V

Conclusions

5.1. Introduction

This research project aimed to fill in some knowledge gaps highlighted in section 4 of the introduction of this thesis by increasing the understanding of the short and long-term impact of low temperature on AnAOB rates, -enrichment, -adaptation and their ability to compete with HB in the presence of organic carbon. The global approach to this research project was linear and divided into 3 topics, each corresponding to a chapter of this PhD thesis as shown in Figure 5.1. In this short chapter, the major findings of each chapter are given and their implications for microbial resource management are briefly highlighted.

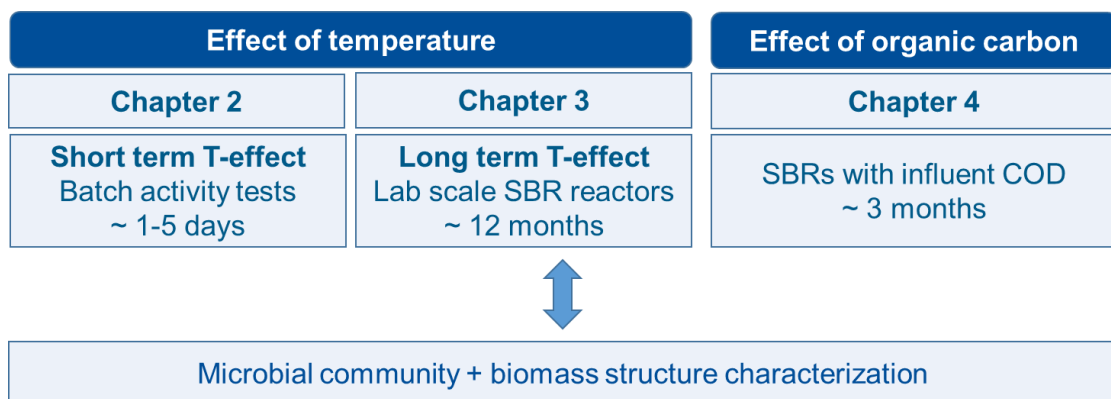

Figure 5.1 – Schematic overview of chapter content

5.2. Major findings

Chapter 2: Instant cold tolerance impacted by anammox genus rather than by aggregate size

The short-term effect of temperature decrease on the specific ammonium removal rates (SARR) was evaluated in anoxic batch tests between 30-10°C. Results showed that biomass types containing the largest aggregates (>315 µm) and rich in the AnAOB *Ca. Kueneria* were less sensitive to a decrease in temperature. A separate test showed no significant impact of aggregate size of the tested biomass' temperature sensitivity, suggesting that the observed higher tolerance for decreasing temperatures was more likely related to the difference in AnAOB genus. Optimization of Arrhenius modelling by splitting into two temperature intervals (rather than using one global equation) improved the overall goodness of fit (R^2) allowed to obtain more accurate θ -values enabling realistic process rate predictions which could in term help improve modelling for process design purposes.

Chapter 3: Enrichment and adaptation yield high anammox conversion rates under low temperatures

In this chapter, two anammox sequencing batch reactors (SBR) with identical inoculum were operated under anoxic conditions on synthetic influent (60 mg N/L) and compared for one year. One was kept at 30°C while temperature in the other was step-wisely decreased from 30°C to 10°C. Minimal competition (anoxic conditions, no COD) and high AnAOB retention (SRTs = 168d) resulted in the formation and retention of well settling granules at both 30°C and 10°C, indicating that lowering temperature is not detrimental to granulation and can even increase granule size. AnAOB enrichment (indicated by increasing *hzsA* and 16S rRNA gene concentrations) and adaptation at genus level (indicated by a shift from *Ca. Brocadia* to *Ca. Kueneria* at low temperature) contributed to achieving unprecedented removal rates of 82 and

92 mg NH₄⁺-N/g VSS/d at 12.5 and 10°C respectively. These results provided new insights that reinforce the potential of cold anammox applications for mainstream N-removal.

Chapter 4: Impact of temperature on the competition between anammox bacteria and denitrifiers under anoxic conditions

In order to evaluate the impact of low concentrations of slowly biodegradable organic carbon on the competition between anammox and denitrification and how it is impacted by temperature, 30 mg COD/L (90% starch and 10% acetate to mimic HRAS effluent) was added to the influent of the reactors at 30°C and 10°C (Chapter 3). With relatively low COD/nitrite removal ratios (around 0.3 in both reactors), overall nitrogen conversion ratios were close to the anammox stoichiometry. Significant competition between AnAOB and HB for nitrite under anoxic conditions was not observed at 30°C as (1) starch hydrolysis was rate limiting for denitrification and (2) HB preferred nitrate over nitrite. However, it could not be excluded at 10°C. Flocs developed in both reactors which transitioned from purely granular to hybrid systems. While flocs became predominant at 30°, the system at 10°C remained predominantly granular, likely due to poorer floc formation and therefore higher floc wash-out, reflected in a lower SRT at 10°C (19d) compared to 30°C (26d). 16S Illumina gene sequencing and qPCR analyses showed that AnAOB abundance decreased greatly (87 to 37%) at 30°C and to a lesser extent (91 to 74%) at 10°C. Despite the observed decrease in AnAOB abundance, removal rates remained high in both reactors and rates of up to 112 mg NH₄⁺-N/gVSS/d were reached at 10°C. Interestingly, for the duration of the experiment, COD addition did not impact the dominant genera which remained *Ca. Brocadia* and *Ca. Kuenenia* in SBR_{30°C} and SBR_{10°C}, respectively. These findings are promising and showed how application of differential SRT (here via the imposed settling time) can help microbial resource management for achieving mainstream PN/A.

5.3. Implications for microbial resource management

Dynamic characteristic of municipal wastewater (regarding composition, quantity, pH, temperature) make mainstream PN/A processes an 'open bioprocess' with high complexity. In the end, a working PN/A process needs to be predictable, i.e. its output needs to be controllable, including this dynamic variation. Despite significant research, focused on (1) reactor engineering; (2) PN/A microbial communities; (3) and modeling to understand the process, more mechanistic insights are needed to unravel the whole complexity of mainstream PN/A.

The more accurate θ -values obtained from the optimized Arrhenius fitting performed in **Chapter 2** allow to better describe the effect of temperature on anammox performance (ON/OFF) and help improve process modelling. Process modeling can play an essential role in MRM as it allows to couple engineering aspects to microbial ecology and process performance to assess different design and operational strategies.

Chapter 3 illustrated how, even at low temperatures, anammox enrichment and high removal rates could be achieved by (1) minimizing competition (ON/OFF control) and (2) maximizing the retention of anammox bacteria (IN/OUT control).

Results from **Chapter 4** showed that, even at low temperature (10°C), anammox bacteria did not significantly compete with heterotrophs for nitrite in the presence of levels of slowly biodegradable organic carbon (here starch) because the slow hydrolysis was rate limiting for denitrification. Indicating that a well performing C-stage (e.g. HRAS) is crucial for implementation of PN/A down on the water line. Even though competition for nitrite was no issue, the study did expose the possibility of competition for space occurring due to heterotroph growth if SRT is not properly controlled. Which illustrates how imposing a differential SRT (IN/OUT control) for flocs in the system can be a powerful tool for avoiding this threat.

5.4. Design choices for mainstream PN/A systems

5.4.1. Single stage PN/A vs. two-stage PN-A approach

Partial nitrification and anammox processes can be performed either in a single reactor (here referred to as PN/A) or in two sequential stages (referred to as PN-A). For sidestream applications, early stage PN/A installations were two-stage (easier control), but as full-scale experience grew, focus has shifted towards single stage systems in various implementations such as MBBR, granular sludge, SBR, RBC or activated sludge systems, often operated by controlling aeration and/or SRT (Lackner et al., 2014). From an operator point of view, some arguments can be made on the two-stage compared to a single reactor approach:

Disadvantages:

The construction of two reactors requires more available surface on site and raises the associated investment cost. Separating the two processes results in a higher nitrite accumulation inside the reactor which has been reported to cause higher N₂O emissions. Desloover et al. studied full scale 4-step N-removal process (PN-A followed by denitrification – nitrification polishing) and reported that 5.1 to 6.6% of the nitrogen load were emitted as N₂O in the PN stage and estimated that a 50% reduction of these emission was required for CO₂-neutral operation (Desloover et al., 2011). The author also suggests that high N₂O emissions might be inherent to a separate nitrification step. However, lower N₂O emission (1.8% of the nitrogen load) were observed from PN in different full scale PN-A setup where intermittent aeration was used (Kampschreur et al., 2008).

The mechanisms behind N₂O emission are highly complex and are still under investigation. More research is required to fully unravel the impact of operating conditions such as aeration control on N₂O emissions.

Advantages

Separating both processes individually facilitates control. For example (1) The competition between AnAOB and NOB for nitrite is completely removed. (2) higher DO setpoints (ON/OFF control) can be used to promote the activity of AerAOB over NOB without risk of AnAOB inhibition by oxygen. (3) Where in one-stage suspended growth systems the long SRT required for retention of the slow growing AnAOB conflicts with the short floc SRT required to wash out NOB (IN/OUT control), this not the case for two reactor systems. This is less relevant for certain processes in hybrid systems where SRT control techniques have been developed e.g. floc/granule separation by hydrocyclones in the DEMON® (Wett, 2007) process or floc/biomass carrier separation in ANITAMox™ (Lemaire et al., 2014) (4) It seems plausible that the simplified control of PN allows to further development aeration control strategies for reducing the associated N₂O emissions. The optimization of each stage individually means less compromise and allows higher maximum rates to be achieved compared to those reported for mainstream PN/A systems (Laureni et al., 2016; Lotti et al., 2014). These higher rates translate into smaller reactors which might help reduce the higher investment costs associated with their construction.

5.4.3. Proposed configuration

Given the enhanced complexity of the process control required for the successful implementation of mainstream PNA (IN/OUT and ON/OFF) as discussed in section 1.4, a separate C-removal followed by a two-stage PN-A configuration is proposed (Figure 5.2).

The **C-stage** should be robust and aimed at maximal recovery of organic carbon. This could be done via chemically enhanced primary treatment (adding flocculants/coagulants) or biologically via the implementation of e.g. high-rate activated sludge (HRAS) or high-rate contact stabilization (HiCS) (Meerburg et al., 2015). The redirection of the recovered organic

carbon towards anaerobic digestion is not only beneficial for the energy balance of the plant, it also protects the following N-stage.

As concluded in chapter 3 and 4, minimizing competition for AnAOB (anoxic conditions, no or low bCOD) and maximal AnAOB retention allowed to operate the anammox process at its maximum potential. Because of this, and to facilitate process control, the proposed **N-stage** consists of a partial nitritation SBR followed by a granular anammox SBR. NOB suppression in the PN stage could be achieved via aeration control. When choosing between continuous aeration (low DO setpoint) or intermittent aeration (high DO setpoint) the impact on operating cost, performance and N₂O emissions must be considered. Finally, an anoxic granular anammox SBR would provide optimal conditions for AnAOB growth and would allow strict SRT control for maximal AnAOB.

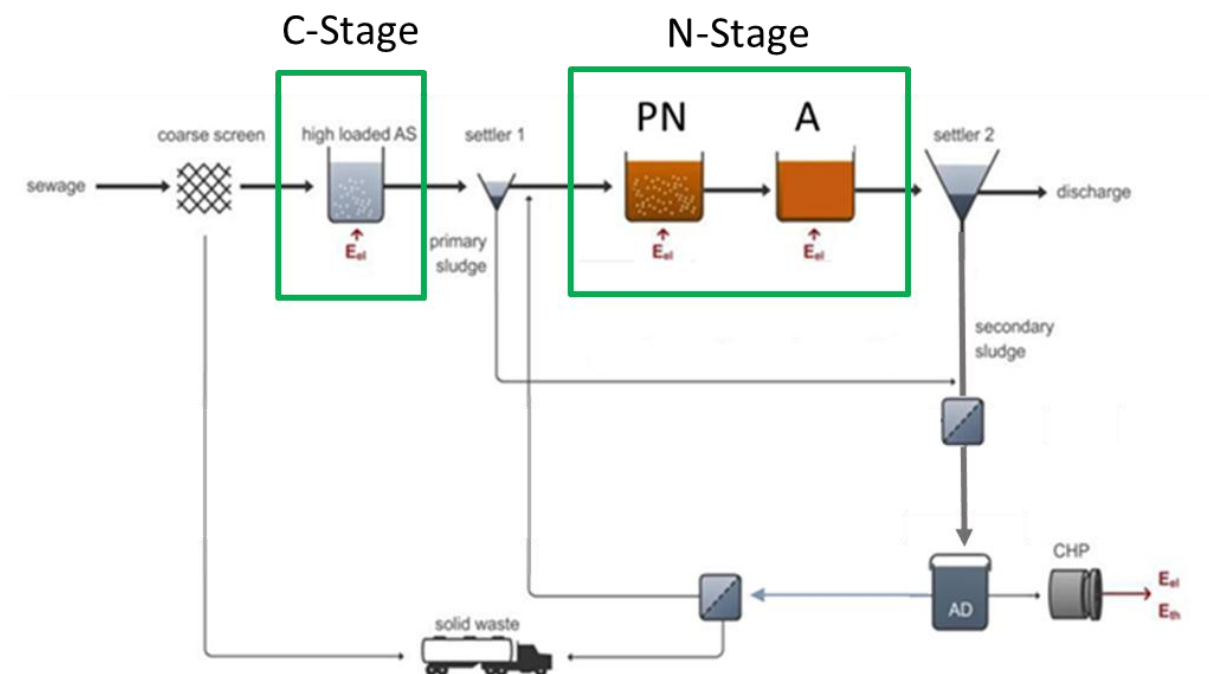

Figure 5.2 – Proposed WRRF configuration with two-stage PN-A implemented on the mainstream (Adapted from (Vlaeminck et al., 2012) AS: activated sludge; PN: partial nitritation, A: anammox; AD: anaerobic digestion; CHP: combined heat and power; $E_{el/th}$: electrical/thermal energy

5.5. References

- Desloover, J., De Clippeleir, H., Boeckx, P., Du Laing, G., Colsen, J., Verstraete, W., Vlaeminck, S.E. 2011. Floc-based sequential partial nitritation and anammox at full scale with contrasting N₂O emissions. *Water Research*, **45**(9), 2811-2821.
- Kampschreur, M.J., van der Star, W.R.L., Wielders, H.A., Mulder, J.W., Jetten, M.S.M., van Loosdrecht, M.C.M. 2008. Dynamics of nitric oxide and nitrous oxide emission during full-scale reject water treatment. *Water Research*, **42**(3), 812-826.
- Lackner, S., Gilbert, E.M., Vlaeminck, S.E., Joss, A., Horn, H., van Loosdrecht, M.C.M. 2014. Full-scale partial nitritation/anammox experiences - An application survey. *Water Research*, **55**, 292-303.
- Laureni, M., Falås, P., Robin, O., Wick, A., Weissbrodt, D.G., Nielsen, J.L., Ternes, T.A., Morgenroth, E., Joss, A. 2016. Mainstream partial nitritation and anammox: long-term process stability and effluent quality at low temperatures. *Water Research*, **101**, 628-639.
- Lemaire, R., Zhao, H., Thomson, C., Christensson, M., Piveteau, S., Hemmingsen, S., Veuillet, F., Zozor, P., Ochoa, J. 2014. Mainstream Deammonification with ANITA™ Mox Process. *Proceedings of the Water Environment Federation*, **2014**(6), 2183-2197.
- Lotti, T., Kleerebezem, R., van Erp Taalman Kip, C., Hendrickx, T., Kruit, J., Van Loosdrecht, M. 2014. Anammox growth on pretreated municipal wastewater. *Environmental science & technology*.
- Meerburg, F.A., Boon, N., Van Winckel, T., Vercamer, J.A.R., Nopens, I., Vlaeminck, S.E. 2015. Toward energy-neutral wastewater treatment: A high-rate contact stabilization process to maximally recover sewage organics. *Bioresource Technology*, **179**, 373-381.
- Vlaeminck, S.E., De Clippeleir, H., Verstraete, W. 2012. Microbial resource management of one-stage partial nitritation/anammox. *Microbial Biotechnology*, **5**(3), 433-448.
- Wett, B. 2007. Development and implementation of a robust deammonification process. *Water Science and Technology*, **56**(7), 81-88.

Supplementary information

Instant cold tolerance impacted by anammox genus rather than by aggregate size

P. De Cocker^{1,2,3}, Y. Bessiere¹, G. Hernandez-Raquet¹, I. Mozo², G. Gaval²,
M. Caligaris⁴, B. Barillon², S.E. Vlaeminck^{3,5.§,*}, M. Sperandio^{1.§}

1. LISBP, Université de Toulouse, CNRS, INRA, INSA, Toulouse, France
2. SUEZ, CIRSEE, Le Pecq, France
3. Center for Microbial Ecology and Technology (CMET), Ghent University, Ghent, Belgium
4. SUEZ, Treatment Infrastructures, Rueil Malmaison, France
5. Research Group of Sustainable Energy, Air and Water Technology, University of Antwerp, Antwerpen, Belgium

§ equally contributed as senior authors

* corresponding author: siegfried.vlaeminck@uantwerpen.be

SUPPORTING INFORMATION CHAPTER II

Table SII.1 - Medium composition

Concentrated feeding solution

NaNO ₂	2.52 g/100 mL
(NH ₄) ₂ SO ₄	1.83 g/100 mL

Buffer medium

NaHCO ₃	0.3877 g/L
KH ₂ PO ₄	0.0500 g/L
CaCl ₂ •2H ₂ O	0.2876 g/L
MgCl ₂ •6H ₂ O	0.3301 g/L
FeSO ₄ •7H ₂ O	0.0182 g/L
EDTA	0.0125 g/L
Trace element solution	2 mL/L

Trace element solution

EDTA	15 g/L
ZnSO ₄ •7H ₂ O	0.43 g/L
CoCl ₂ •6H ₂ O	0.24 g/L
MnCl ₂ •2H ₂ O	0.99 g/L
CuSO ₄ •5H ₂ O	0.25 g/L
NaMoO ₄ •2H ₂ O	0.22 g/L
NaSeO ₄ •10H ₂ O	0.21 g/L
H ₃ PO ₄	0.014 g/L
NaWO ₄ •2H ₂ O	0.05 g/L

Figure SII.1 – Typical concentration profiles obtained for nitrite (triangles), nitrate (circles) and ammonium (squares) from anammox batch tests performed in triplicate (1,2,3). The example conversions shown here are from Biomass D at 10°C.

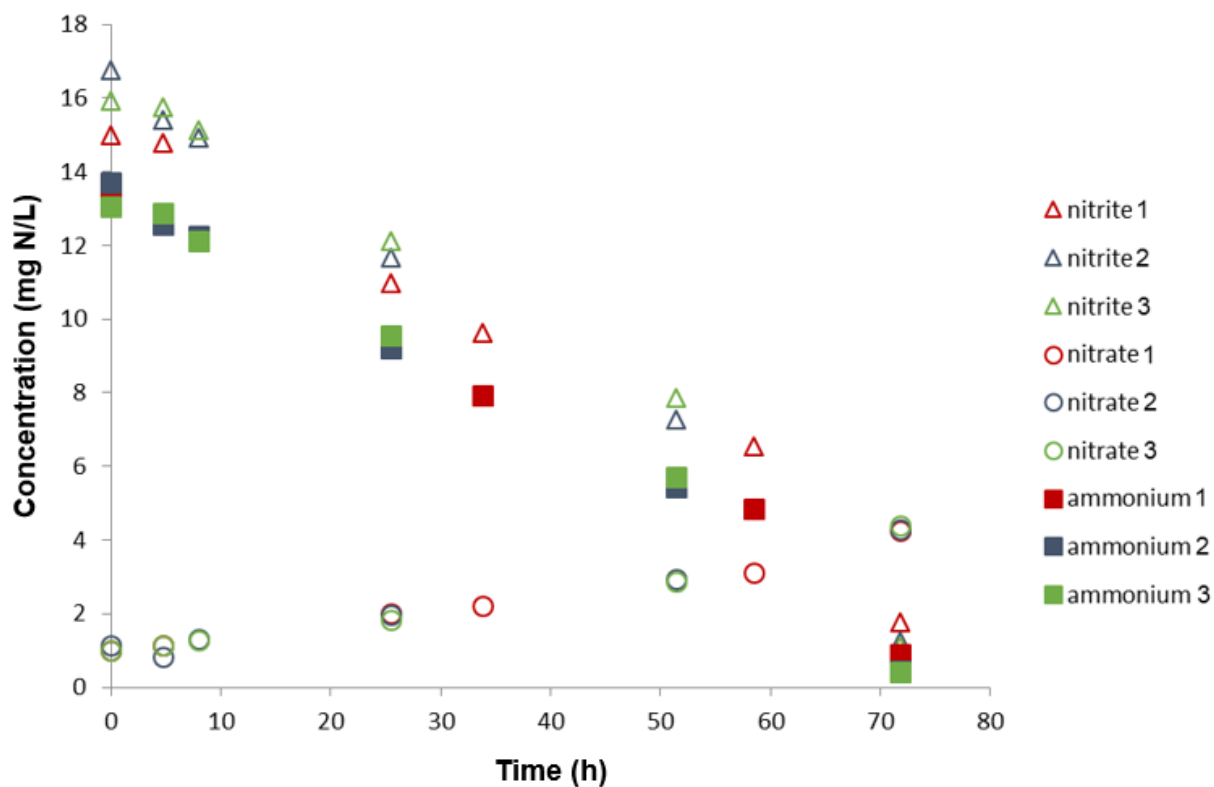

Figure SII.2 – Microbial community composition of the different biomass types (only the 9 most abundant genera are shown).

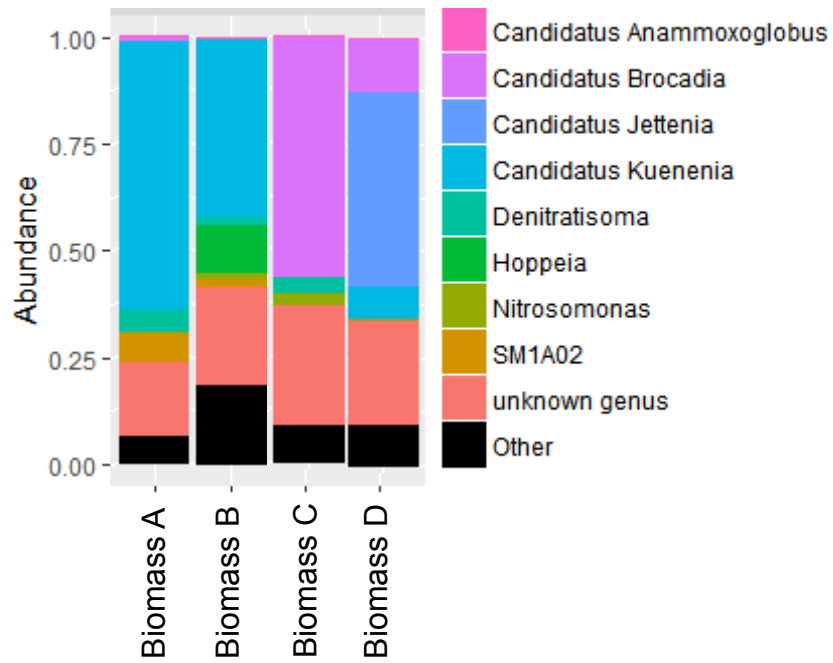

Table S.2 – Microbial richness and diversity indices for the different types of biomass

	No. of OTU	Richness		Diversity	
		Chao	Shannon (H)	Simpson (D)	
Biomass A	121	152±15	1.7719	0.5933	
Biomass B	193	246±22	2.5191	0.7957	
Biomass C	222	284±23	2.2721	0.6668	
Biomass D	193	215±11	2.5713	0.7723	

Enrichment and adaptation yield high anammox conversion rates under low temperatures

P. De Cocker^{1,2,3}, Y. Bessiere¹, G. Hernandez-Raquet¹, S. Dubos¹, I. Mozo², G.
Gaval², M. Caligaris⁴, B. Barillon², S.E. Vlaeminck^{3,5,§}, M. Sperandio^{1,§,*}

1. LISBP, Université de Toulouse, CNRS, INRA, INSA, Toulouse, France
2. SUEZ, CIRSEE, Le Pecq, France
3. Center for Microbial Ecology and Technology (CMET), Ghent University, Ghent, Belgium
4. SUEZ, Treatment Infrastructures, Rueil Malmaison, France
5. Research Group of Sustainable Energy, Air and Water Technology, University of Antwerp, Antwerpen, Belgium

§ equally contributed as senior authors

* corresponding author: mathieu.sperandio@insa-toulouse.fr

SUPPLEMENTARY INFORMATION CHAPTER III

Table SIII.1 Overview of the different biomass types included in the inoculum mix, originating from different process types: Partial Nitritation Anammox (PN/A), Oxygen-Limited Autotrophic nitrification/denitrification (OLAND), DEMON® and DeAmmo; and different reactor types: Sequencing Batch Reactor (SBR), Rotating Biological Contactor (RBC) and Continuous Stirred-Tank Reactor (CSTR)

	A	B	C	D
Process type	PN/A	PN/A (OLAND)	DEMON	Anammox (DeAmmo)
Reactor type	SBR (10 L)	RBC (50 L)	CSTR with lamella separator (1000 m ³)	SBR (1.5 m ³)
Biomass type	flocs + granules	detached biofilm	flocs + granules	flocs + granules
Temperature (°C)	30	30	30	26
Total nitrogen loading rate (mg N/L/d)	70-140	≈100	≈500	80
Influent type	Synthetic	Synthetic	Centrate from sewage sludge digester	Centrate from sewage sludge digester
Inoculum mix contribution (%VSS)	2.0	13.1	49.9	35.0

Table SIII.2 Mass balancing: calculation of SRT and theoretical AnAOB biomass production for each individual phase (I to V) and a total average in $SBR_{constantT}$ and $SBR_{loweringT}$

	Phase	Time	Reactor mass	Sampling	Effluent loss	SRT	Th. production
		(d)	(g VSS)	(g VSS)	(g VSS)	(d)	(g VSS)*
SBR_{loweringT}	I	62	3.5	0.052	2.24	95	1.36
	II	79	2.9	0.062	0.93	231	1.97
	III	67	3.05	0.122	0.79	224	1.67
	IV	63	2.35	0.047	0.74	188	1.57
	V	78	2.1	0.081	0.92	164	1.94
	total	349	2.78	0.364	5.62	162	8.51
	Phase	Time	Reactor mass	Sampling	Effluent loss	SRT	Th. production
		(d)	(g VSS)	(g VSS)	(g VSS)	(d)	(g VSS)*
SBR_{loweringT}	I	62	3.8	0.056	2.24	103	1.36
	II	79	2.8	0.060	0.70	291	1.06
	III	67	1.95	0.078	0.50	228	0.72
	IV	63	1.4	0.028	0.47	179	0.68
	V	78	1.2	0.047	0.58	150	0.84
	total	349	2.23	0.269	4.48	164	4.65

* assuming a biomass yield ($Y_{C/N}$) = 0.09 g VSS/g N-NH₄⁺

(a)

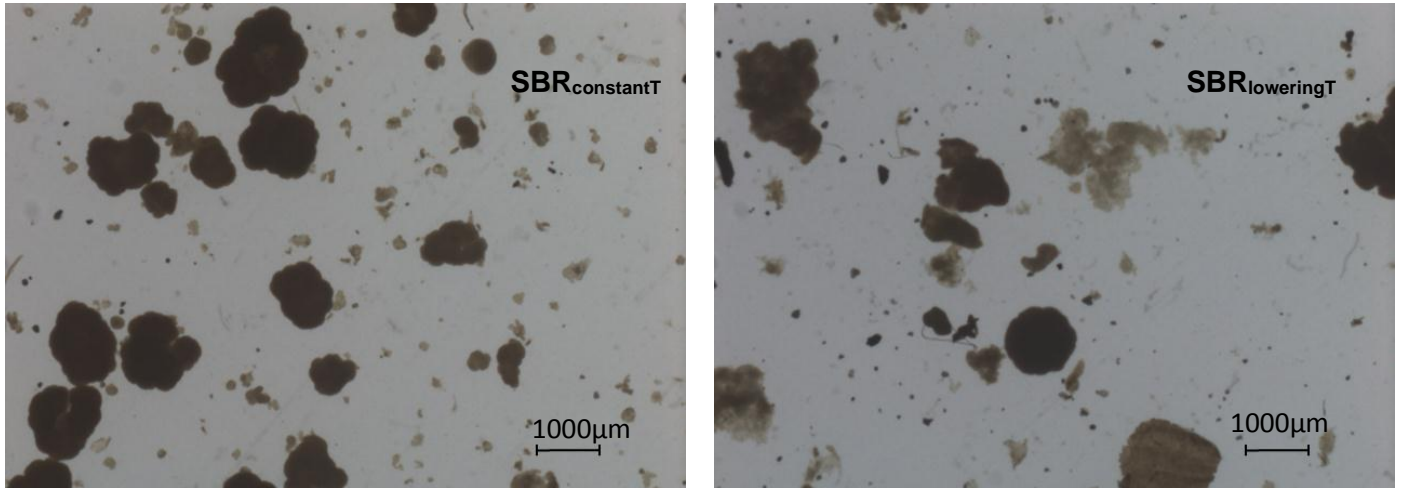

(b)

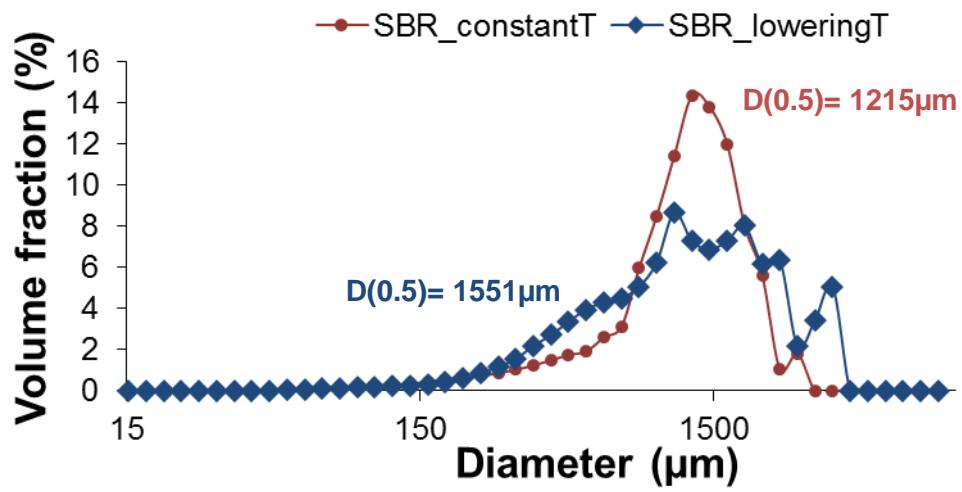

Figure SIII.1 Micrographs of mixed liquor samples taken on day 354 from $SBR_{constantT}$ and $SBR_{loweringT}$ (a) together with Volume-weighted particle size distribution in Phase V on day 354 (b)



Figure SIII.2 Evolution of microbial population at genus level in SBR_{constantT} (left) and SBR_{loweringT} (right) throughout the experiment (absciss represents operating days). Only the 10 most abundant genera are shown.

Impact of temperature on the competition between anammox bacteria and denitrifiers under anoxic conditions

P. De Cocker^{1,2,3}, Y. Bessiere¹, G. Hernandez-Raquet¹, M. Bounouba¹, I. Mozo², G.
Gaval², M. Caligaris⁴, B. Barillon², S.E. Vlaeminck^{3,5,§}, M. Sperandio^{1,§,*}

1. LISBP, Université de Toulouse, CNRS, INRA, INSA, Toulouse, France
2. SUEZ, CIRSEE, Le Pecq, France
3. Center for Microbial Ecology and Technology (CMET), Ghent University, Gent, Belgium
4. SUEZ, Treatment Infrastructures, Rueil Malmaison, France
5. Research Group of Sustainable Energy, Air and Water Technology, University of Antwerp, Antwerpen, Belgium

§ equally contributed as senior authors

* corresponding author: mathieu.sperandio@insa-toulouse.fr

SUPPORTING INFORMATION CHAPTER IV

(a)

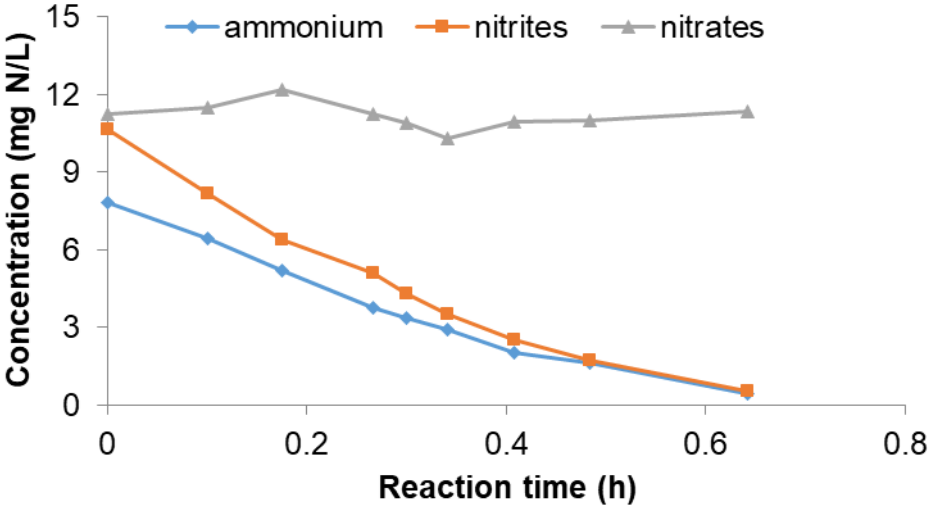

(b)

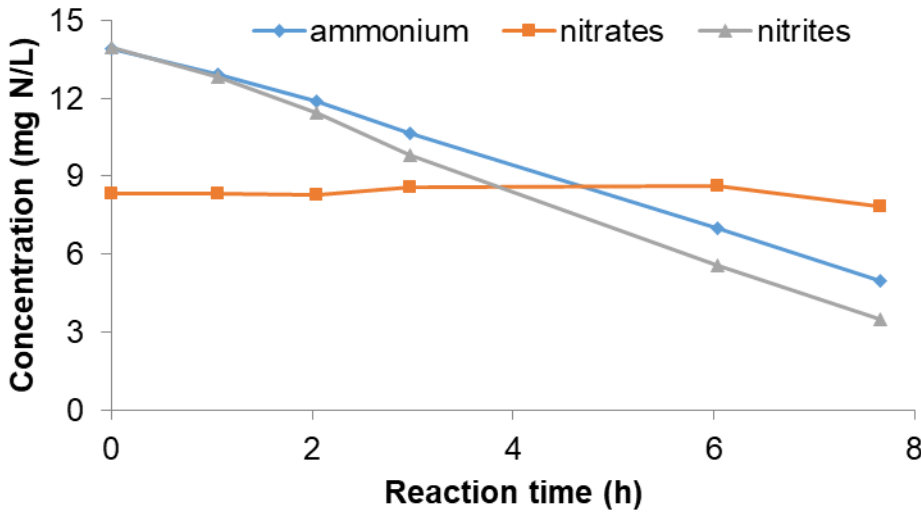

Figure SIV.1 – Typical concentration profiles obtained for nitrite (triangles), nitrate (circles) and ammonium (squares) during the reaction phase in (a) SBR_{30°C} and (b) SBR_{10°C}.

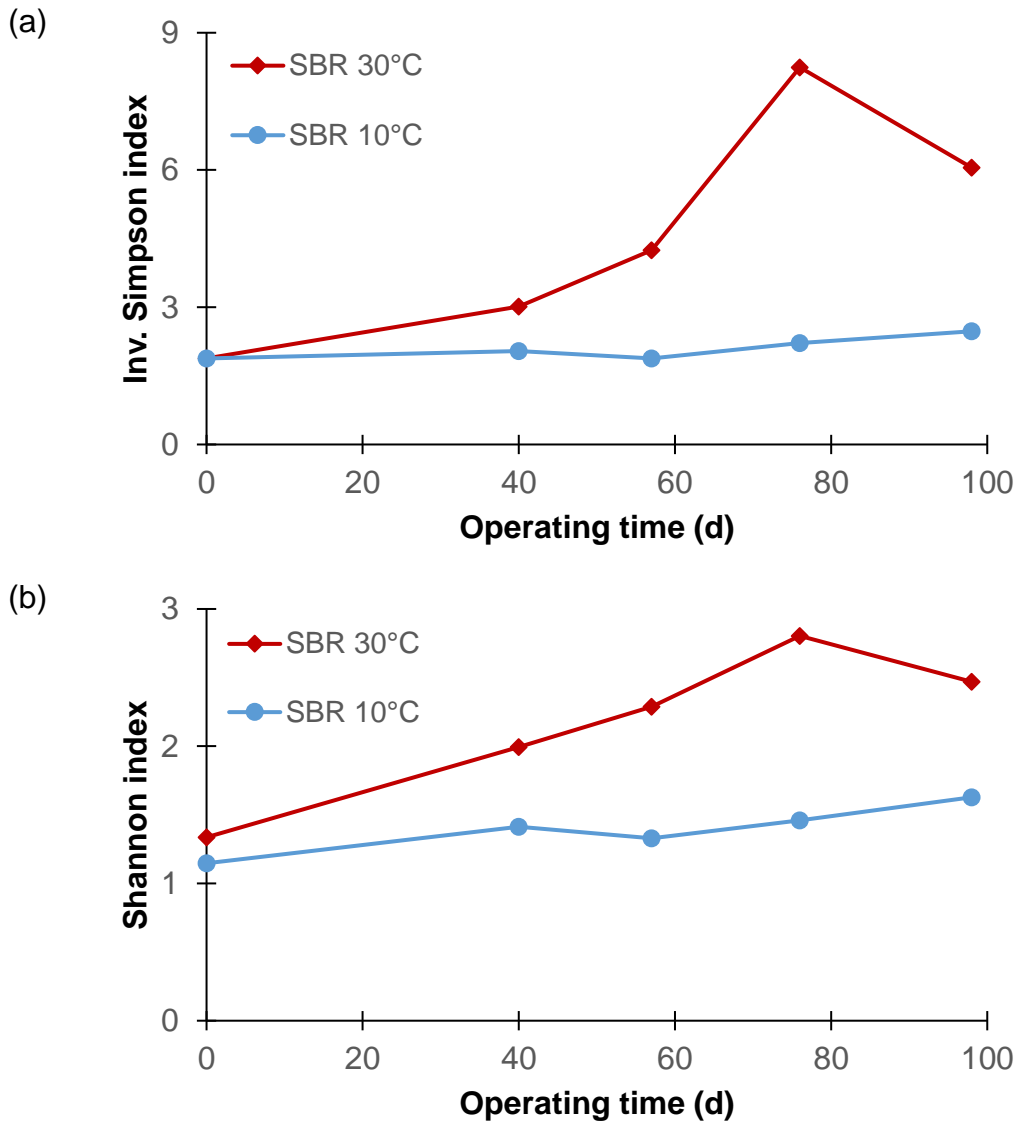

Figure SIV.2 – Evolution of Microbial (a) richness (inv. Simpson) and (b) diversity (Shannon) indices throughout the experiment in SBR_{30°C} (diamonds) and SBR_{10°C} (circles)

Table SIV.1 – Mass balance for first 76 days of operation of SBR_{30°C} and SBR_{10°C}. X is the biomass concentration expressed in g/L

	SBR _{30°C}		SBR _{10°C}	
	AnAOB	HB	AnAOB	HB
$X_{d0,measured}$	0.65		0.25	
X_{prod}^*	0.36	2.57	0.13	0.9
X_{loss}^{**}	1.82		0.72	
X_{d76}	1.76		0.56	
$X_{d76,measured}$	2		0.26	

* biomass production estimated from Ammonium removal (for AnAOB) and denitrification of associated nitrate production, considering:

$$Y_{HB} = 0.54 \text{ gCOD/gCOD}$$

$$Y_{AnAOB} = 0.122 \text{ gCOD/g NH}_4^+-\text{N}$$

$$1.42 \text{ gCOD/gVSS}$$

** values taken from table 1, loss from decay is not considered

16S rRNA gene amplicon sequencing protocol

Microbial diversity was assessed by MiSeq Illumina sequencing performed by the GenoToul Genomics and Transcriptomics facility (GeT-PlaGe, Auzeville, France). The V3-V4 hypervariable region of the 16S rRNA gene was amplified from genomic DNA samples using modified primers 343F and 784R (Lazuka, et al., 2015), degenerated as followed to ensure optimal amplification of the Planctomycetes phylum and elongated to add adaptors during the second PCR: 343modF= 5'-CTT TCC CTA CAC GAC GCT CTT CCG **ATC TAC GGR AGG CWG CAG**-3' and 784modR=5'-GGA GTT CAG ACG TGT GCT CTT CCG **ATC TTA CCR GGG TAT CTA ATC CT**-3'. The first PCR was performed in 50µL reaction mixture containing 1X PCR buffer, 2.5U MTP Taq DNA Polymerase (Sigma), 0.2 mM of each dNTP, 0.5 mM of each primer and 2 ng of extracted DNA. After 30 amplification cycles of 94°C-65°C-70°C, one minute each step, amplicons were purified using magnetic beads and quantified with a NanoDrop 1000 spectrophotometer. A second PCR was performed following the protocol developed by GeT-PlaGe to add sequencing adapters and a unique index for each sample. The PCR products were then purified once again with magnetic beads. Amplicon quality was then checked with High Sensivity DNA Analysis Kits (Agilent) and a BioAnalyzer 2100. As before, DNA concentration was measured with a NanoDrop 1000 spectrophotometer. An equimolar pool of all PCR products of all samples was prepared and loaded on a MiSeq Illumina cartridge, using reagent kit v2. MiSeq v2 reagents enabled paired 250-bp reads. Sequencing data was processed using the pipeline FROGS, one of the tools proposed on Galaxy, an open web-based platform for genomic research (Goecks, et al., 2010). Briefly, Illumina MiSeq paired-end reads were merged using Flash (Magoč and Salzberg, 2011). Sequences in which the two primers were not present were removed using Cutadapt (Martin, 2011). All sequences presenting ambiguous bases and presenting a length lower than 320bp or higher than 480bp were removed. Dereplicated high quality sequences were clustered using Swarm (Mahé, et al., 2014). Chimera detection was performed with VSARCH with the *de novo*

method (Rognes, et al., 2016). A filter keeping only Operational Taxonomic Units (OTUs) representing at least 0.005% abundance in the whole data set was applied. Sequences were rarified to 15000 sequences per sample. OTUs were taxonomically affiliated using the SILVA 16S rRNA gene database (Quast, et al., 2013).

qPCR protocol and primers

A thermocycler (Stratagene Mx3005P) was used, and the reaction mixture, with a total volume of 25 μ L, consisted of 2 μ l DNA as template (1 to 10 ng/ μ l), 1 μ l of each primer (10 μ M, Eurogentec), 12.5 μ l of SYBR Premix 2X (Promega), and 8.5 μ l of H₂O. For hzsA (hzsA-1597F/hzsA-1857R primers, Harhangi *et. al* 2012), thermal cycling conditions were as follows: 30s at 95°C, followed by 40 cycles of 5s at 95°C, 30s at 55°C at 1min30 at 72°C and 15s at 95°C, 1min at 55°C and 15s at 95°C. For AnAOB 16S rRNA gene amplification (Amx-818F/Amx-1066R primers, Tsushima *et. al* 2007), thermal cycling conditions were as follows: 30s at 95°C, followed by 40 cycles of 5s at 95°C, 1 min at 60°C and 15s at 95°C, 1min at 60°C and 15s at 95°C. Negative controls without DNA template (H₂O) were included in each amplification reaction. Standard curves were obtained using 10-fold dilutions of pBluescript II SK (+) plasmids containing respectively 16S rRNA gene sequences for Anammox (*Ca. Brocadia sinica* JPN1), or hzsA sequence from *Ca. Jettenia asiatica*. Results were interpreted with MxPro Stratagene software. Only reactions with efficiencies between 75% and 120% were accepted.

Compiled reference list

References

- Agrawal, S., Karst, S.M., Gilbert, E.M., Horn, H., Nielsen, P.H., Lackner, S. 2017b. The role of inoculum and reactor configuration for microbial community composition and dynamics in mainstream partial nitrification anammox reactors. *MicrobiologyOpen*, 6(4), e00456.
- Agrawal, S., Seuntjens, D., D Cocker, P., Lackner, S., Vlaeminck, S.E. 2018. Success of mainstream partial nitrification/anammox demands integration of engineering, microbiome and modeling insights. *Current Opinion in Biotechnology*, 50, 214-221.
- APHA, A. 1992. WPCF (American Public Health Association, American Waterworks Association, Water Pollution Control Federation)(1992) Standard methods for the examination of water and wastewater. Standard methods for the Examination of Water and Wastewater, 17.
- Ardern, E., Lockett, W.T. 1914. Experiments on the oxidation of sewage without the aid of filters. *Journal of the Society of Chemical Industry*, 33(10), 523-539.
- Barker, P.S., Dold, P.L. 1997. General Model for Biological Nutrient Removal Activated-Sludge Systems: Model Application. *Water Environment Research*, 69(5), 985-991.
- Barnard, J. 1974. Cut P and N Without Chemicals.
- Boran, K., M., K.M.M., Gaute, L., Jos, S., M., O.d.C.H.J., M., J.M.S., Marc, S. 2007. Anammox bacteria disguised as denitrifiers: nitrate reduction to dinitrogen gas via nitrite and ammonium. *Environmental Microbiology*, 9(3), 635-642.
- Bossier, P., Verstraete, W. 1996. Triggers for Microbial Aggregation in Activated Sludge? *Appl Microbiol Biotechnol* 100: 6457-6467.
- Cao, S., Du, R., Li, B., Ren, N., and Peng, Y. (2016) High-throughput profiling of microbial community structures in an ANAMMOX-UASB reactor treating high-strength wastewater, *Appl Microbiol Biotechnol* 101: 1365-1383.
- Cao, Y., van Loosdrecht, M.C.M., and Daigger, G.T. (2017) Mainstream partial nitrification–anammox in municipal wastewater treatment: status, bottlenecks, and further studies, *Appl Microbiol Biotechnol* 101: 1365-1383.
- Chagas, A.P. 2007. A síntese da amônia: alguns aspectos históricos. *Química Nova*, 30, 240-247.
- Chamchoi, N., Nitisoravut, S., Schmidt, J.E. 2008. Inactivation of ANAMMOX communities under concurrent operation of anaerobic ammonium oxidation (ANAMMOX) and denitrification. *Bioresource Technology*, 99(9), 3331-3336.
- Chen, C., Sun, F., Zhang, H., Wang, J., Shen, Y., Liang, X. 2016. Evaluation of COD effect on anammox process and microbial communities in the anaerobic baffled reactor (ABR). *Bioresource Technology*, 216, 571-578.
- Chu, Z.-r., Wang, K., Li, X.-k., Zhu, M.-t., Yang, L., and Zhang, J. (2015) Microbial characterization of aggregates within a one-stage nitrification–anammox system using high-throughput amplicon sequencing, *Chem Eng J* 262: 41-48.
- Conley, D., Paerl, H., Howarth, R., Boesch, D., P. Seitzinger, S., Havens, K., Lancelot, C., E. Likens, G. 2009. Controlling Eutrophication: Nitrogen and Phosphorus.

- Coppens, J., Meers, E., Boon, N., Buysse, J., Vlaeminck, S.E. 2016. Follow the N and P road: High-resolution nutrient flow analysis of the Flanders region as precursor for sustainable resource management. *Resources, Conservation and Recycling*, 115, 9-21.
- Daims, H., Lebedeva, E.V., Pjevac, P., Han, P., Herbold, C., Albertsen, M., Jehmlich, N., Palatinszky, M., Vierheilig, J., Bulaev, A., Kirkegaard, R.H., von Bergen, M., Rattei, T., Bendinger, B., Nielsen, P.H., Wagner, M. 2015. Complete nitrification by *Nitrospira* bacteria. *Nature*, 528, 504.
- Dapena-Mora, A., Fernández, I., Campos, J.L., Mosquera-Corral, A., Méndez, R., Jetten, M.S.M. 2007. Evaluation of activity and inhibition effects on Anammox process by batch tests based on the nitrogen gas production. *Enzyme and Microbial Technology*, 40(4), 859-865.
- Desloover, J., De Clippeleir, H., Boeckx, P., Du Laing, G., Colsen, J., Verstraete, W., Vlaeminck, S.E. 2011. Floc-based sequential partial nitritation and anammox at full scale with contrasting N₂O emissions. *Water Research*, 45(9), 2811-2821.
- Dietl, A., Ferousi, C., Maalcke, W.J., Menzel, A., de Vries, S., Keltjens, J.T., Jetten, M.S.M., Kartal, B., Barends, T.R.M. 2015. The inner workings of the hydrazine synthase multiprotein complex. *Nature*, 527, 394.
- Donoso-Bravo, A., Retamal, C., Carballa, M., Ruiz-Filippi, G., Chamy, R. 2009. Influence of temperature on the hydrolysis, acidogenesis and methanogenesis in mesophilic anaerobic digestion: Parameter identification and modeling application.
- Dosta, J., Fernandez, I., Vazquez-Padin, J.R., Mosquera-Corral, A., Campos, J.L., Mata-Alvarez, J. and Mendez, R. (2008) Short- and long-term effects of temperature on the Anammox process. *Journal of Hazardous Materials* 154, 688-693.
- Dosta, J., Fernandez, I., Vazquez-Padin, J.R., Mosquera-Corral, A., Campos, J.L., Mata-Alvarez, J., and Mendez, R. (2008) Short- and long-term effects of temperature on the Anammox process, *J Hazard Mater* 154: 688-693.
- Escher, B.I., Bramaz, N., Quayle, P., Rutishauser, S., Vermeirssen, E.L.M. 2008. Monitoring of the ecotoxicological hazard potential by polar organic micropollutants in sewage treatment plants and surface waters using a mode-of-action based test battery. *Journal of Environmental Monitoring*, 10(5), 622-631.
- Gao, D.-W., Huang, X.-L., Tao, Y., Cong, Y. and Wang, X.-I. (2015) Sewage treatment by an UAFB-EGSB biosystem with energy recovery and autotrophic nitrogen removal under different temperatures. *Bioresource Technology* 181, 26-31.
- Gilbert, E.M., Agrawal, S., Brunner, F., Schwartz, T., Horn, H., Lackner, S. 2014a. Response of Different *Nitrospira* Species To Anoxic Periods Depends on Operational DO. *Environmental science & technology*, 48(5), 2934-2941.
- Gilbert, E.M., Agrawal, S., Karst, S.M., Horn, H., Nielsen, P.H., and Lackner, S. (2014) Low Temperature Partial Nitritation/Anammox in a Moving Bed Biofilm Reactor Treating Low Strength Wastewater, *Environ Sci Technol* 48: 8784-8792.
- Gilbert, E.M., Agrawal, S., Schwartz, T., Horn, H., and Lackner, S. (2015) Comparing different reactor configurations for Partial Nitritation/Anammox at low temperatures, *Water Res* 81: 92-100.

- Gustavsson, D., Persson, F. and la Cour Jansen, J. (2014) Manamnox–mainstream anamnox at Sjölanda WWTP. Proceedings from the IWA World Water Congress and Exhibition, September 21-26, Lisbon, Portugal (2014)
- Güven, D., Dapena, A., Kartal, B., Schmid, M.C., Maas, B., van de Pas-Schoonen, K., Sozen, S., Mendez, R., den Camp, H.J.O., Jetten, M.S. 2005. Propionate oxidation by and methanol inhibition of anaerobic ammonium-oxidizing bacteria. *Applied and environmental microbiology*, 71(2), 1066-1071.
- Güven, D., Dapena, A., Kartal, B., Schmid, M.C., Maas, B., van de Pas-Schoonen, K., Sozen, S., Mendez, R., Op den Camp, H.J.M., Jetten, M.S.M., Strous, M., Schmidt, I. 2005. Propionate Oxidation by and Methanol Inhibition of Anaerobic Ammonium-Oxidizing Bacteria. *Applied and Environmental Microbiology*, 71(2), 1066-1071.
- Han, M., De Clippeleir, H., Al-Omari, A., Wett, B., Vlaeminck, S.E., Bott, C., Murthy, S. 2016. Impact of carbon to nitrogen ratio and aeration regime on mainstream deammonification. *Water Science and Technology*, 74(2), 375.
- Han, M., Vlaeminck, S.E., Al-Omari, A., Wett, B., Bott, C., Murthy, S. and De Clippeleir, H. (2016) Uncoupling the solids retention times of flocs and granules in mainstream deammonification: A screen as effective out-selection tool for nitrite oxidizing bacteria. *Bioresource Technology* 221, 195-204.
- Hendrickx, T.L.G., Kampman, C., Zeeman, G., Temmink, H., Hu, Z., Kartal, B., and Buisman, C.J.N. (2014) High specific activity for anamnox bacteria enriched from activated sludge at 10 degrees C, *Bioresource Technol* 163: 214-221.
- Hendrickx, T.L.G., Wang, Y., Kampman, C., Zeeman, G., Temmink, H., and Buisman, C.J.N. (2012) Autotrophic nitrogen removal from low strength waste water at low temperature, *Water Res* 46: 2187-2193.
- Henze, M., Gujer, W., Mino, T., & Van Loosdrecht, M. C. M. (2000). *Activated sludge models ASM1, ASM2, ASM2d and ASM3*. IWA publishing.
- Hu, Z., Lotti, T., de Kreuk, M., Kleerebezem, R., van Loosdrecht, M., Kruit, J., et al. (2013) Nitrogen removal by a nitrification-anamnox bioreactor at low temperature, *Appl Environ Microb* 79: 2807-2812.
- Isaka, K., Date, Y., Kimura, Y., Sumino, T. and Tsuneda, S. (2008) Nitrogen removal performance using anaerobic ammonium oxidation at low temperatures. *Fems Microbiology Letters* 282, 32-38.
- Isanta, E., Bezerra, T., Fernández, I., Suárez-Ojeda, M.E., Pérez, J., Carrera, J. 2015. Microbial community shifts on an anamnox reactor after a temperature shock using 454-pyrosequencing analysis. *Bioresource Technology*, 181(0), 207-213.
- Jenni, S., Vlaeminck, S.E., Morgenroth, E., Udert, K.M. 2014. Successful application of nitrification/anamnox to wastewater with elevated organic carbon to ammonia ratios. *Water Research*, 49(0), 316-326.
- Jetten, M.S., Horn, S.J., van Loosdrecht, M.C. 1997. Towards a more sustainable municipal wastewater treatment system. *Water science and technology*, 35(9), 171-180.
- Jetten, M.S.M., van Niftrik, L., Strous, M., Kartal, B., Keltjens, J.T., and Op den Camp, H.J.M. (2009) Biochemistry and molecular biology of anamnox bacteria, *Crit Rev Biochem Mol* 44: 65-84.

- Kampschreur, M.J., van der Star, W.R.L., Wienders, H.A., Mulder, J.W., Jetten, M.S.M., van Loosdrecht, M.C.M. 2008. Dynamics of nitric oxide and nitrous oxide emission during full-scale reject water treatment. *Water Research*, 42(3), 812-826.
- Kartal, B., Kuenen, J., Van Loosdrecht, M. 2010. Sewage treatment with anammox. *Science*, 328(5979), 702-703.
- Kartal, B., Kuypers, M.M.M., Lavik, G., Schalk, J., Op den Camp, H.J.M., Jetten, M.S.M., Strous, M. 2007. Anammox bacteria disguised as denitrifiers: nitrate reduction to dinitrogen gas via nitrite and ammonium. *Environmental Microbiology*, 9(3), 635-642.
- Kartal, B., van Niftrik, L., Keltjens, J.T., den Camp, H.J.M.O., Jetten, M.S.M. 2012. Anammox-Growth Physiology, Cell Biology, and Metabolism. in: *Advances in Microbial Physiology*, Vol 60, (Ed.) R.K. Poole, Vol. 60, pp. 211-262.
- Kartal, B., van Niftrik, L., Rattray, J., de Vossenberg, J.L.C.M.v., Schmid, M.C., Damste, J.S.S., Jetten, M.S.M., Strous, M. 2008. Candidatus 'Brocadia fulgida': an autofluorescent anaerobic ammonium oxidizing bacterium. *Fems Microbiology Ecology*, 63(1), 46-55.
- Kits, K.D., Sedlacek, C.J., Lebedeva, E.V., Han, P., Bulaev, A., Pjevac, P., Daebeler, A., Romano, S., Albertsen, M., Stein, L.Y., Daims, H., Wagner, M. 2017. Kinetic analysis of a complete nitrifier reveals an oligotrophic lifestyle. *Nature*, 549, 269.
- Knobeloch, L., Salna, B., Hogan, A., Postle, J., Anderson, H. 2000. Blue babies and nitrate-contaminated well water. *Environmental Health Perspectives*, 108(7), 675-678.
- KOIKE, I., HATTORI, A. 1975. Energy Yield of Denitrification: An Estimate from Growth Yield in Continuous Cultures of *Pseudomonas denitrificans* under Nitrate-, Nitrite- and Nitrous Oxide-limited Conditions. *Microbiology*, 88(1), 11-19.
- Koops, H.P. 2001. Distribution and ecophysiology of the nitrifying bacteria emphasizing cultured species.
- Kornaros, M., Dokianakis, S.N., Lyberatos, G. 2010. Partial Nitrification/Denitrification Can Be Attributed to the Slow Response of Nitrite Oxidizing Bacteria to Periodic Anoxic Disturbances. *Environmental Science & Technology*, 44(19), 7245-7253.
- Kowalchuk, G.A., Stephen, J.R. 2001. Ammonia-oxidizing bacteria: a model for molecular microbial ecology. *Annu Rev Microbiol*, 55, 485-529.
- Krishna, C., Van Loosdrecht, M.C.M. 1999. Effect of temperature on storage polymers and settleability of activated sludge. *Water Research*, 33(10), 2374-2382.
- Kuypers, M.M., Sliekers, A.O., Lavik, G., Schmid, M., Jørgensen, B.B., Kuenen, J.G., Damsté, J.S.S., Strous, M., Jetten, M.S. 2003. Anaerobic ammonium oxidation by anammox bacteria in the Black Sea. *Nature*, 422(6932), 608-611.
- Lackner, S., Gilbert, E.M., Vlaeminck, S.E., Joss, A., Horn, H., van Loosdrecht, M.C.M. 2014. Full-scale partial nitrification/anammox experiences - An application survey. *Water Research*, 55, 292-303.
- Lackner, S., Terada, A., Smets, B.F. 2008. Heterotrophic activity compromises autotrophic nitrogen removal in membrane-aerated biofilms: Results of a modeling study. *Water Research*, 42(4-5), 1102-1112.

- Laureni, M., Falås, P., Robin, O., Wick, A., Weissbrodt, D.G., Nielsen, J.L., et al. (2016) Mainstream partial nitrification and anammox: long-term process stability and effluent quality at low temperatures, *Water Res* 101: 628-639.
- Laureni, M., Falås, P., Robin, O., Wick, A., Weissbrodt, D.G., Nielsen, J.L., Ternes, T.A., Morgenroth, E. and Joss, A. (2016) Mainstream partial nitrification and anammox: long-term process stability and effluent quality at low temperatures. *Water Research* 101, 628-639.
- Laureni, M., Weissbrodt, D.G., Szivák, I., Robin, O., Nielsen, J.L., Morgenroth, E. and Joss, A. (2015) Activity and growth of anammox biomass on aerobically pre-treated municipal wastewater. *Water Research* 80, 325-336.
- Lawson, C.E., Wu, S., Bhattacharjee, A.S., Hamilton, J.J., McMahon, K.D., Goel, R., Noguera, D.R. 2017. Metabolic network analysis reveals microbial community interactions in anammox granules. *Nature Communications*, 8, 15416.
- Lazuka, A., Auer, L., Bozonnet, S., Morgavi, D.P., O'Donohue, M., and Hernandez-Raquet, G. (2015) Efficient anaerobic transformation of raw wheat straw by a robust cow rumen-derived microbial consortium, *Bioresource Technol* 196: 241-249.
- Leal, C.D., Pereira, A.D., Nunes, F.T., Ferreira, L.O., Coelho, A.C.C., Bicalho, S.K., Mac Conell, E.F.A., Ribeiro, T.B., de Lemos Chernicharo, C.A., de Araújo, J.C. 2016. Anammox for nitrogen removal from anaerobically pre-treated municipal wastewater: Effect of COD/N ratios on process performance and bacterial community structure. *Bioresource Technology*, 211, 257-266.
- Lemaire, R., Zhao, H., Thomson, C., Christensson, M., Piveteau, S., Hemmingsen, S., Veuillet, F., Zozor, P., Ochoa, J. 2014. Mainstream Deammonification with ANITA™ Mox Process. *Proceedings of the Water Environment Federation*, 2014(6), 2183-2197.
- Lemaire, R., Zhao, H., Thomson, C., Christensson, M., Piveteau, S., Hemmingsen, S., Veuillet, F., Zozor, P., Ochoa, J. 2014. Mainstream Deammonification with ANITA™ Mox Process. *Proceedings of the Water Environment Federation*, 2014(6), 2183-2197.
- Li, J., Qiang, Z., Yu, D., Wang, D., Zhang, P., Li, Y. 2016. Performance and microbial community of simultaneous anammox and denitrification (SAD) process in a sequencing batch reactor. *Bioresource Technology*, 218, 1064-1072.
- Lofrano, G., Brown, J. 2010. Wastewater management through the ages: A history of mankind. *Science of The Total Environment*, 408(22), 5254-5264.
- Lotti, T., Kleerebezem, R., and van Loosdrecht, M. (2014) Effect of temperature change on anammox activity, *Biotechnol Bioeng* 112: 98-103.
- Lotti, T., Kleerebezem, R., Hu, Z., Kartal, B., Jetten, M., and van Loosdrecht, M. (2014) Simultaneous partial nitrification and anammox at low temperature with granular sludge, *Water Res* 66:111-121.
- Lotti, T., Kleerebezem, R., van Erp Taalman Kip, C., Hendrickx, T., Kruit, J. and Van Loosdrecht, M. (2014b) Anammox growth on pretreated municipal wastewater. *Environmental science & technology* 48,7874-80.
- Lotti, T., Kleerebezem, R., van Loosdrecht, M.C. 2015. Effect of temperature change on anammox activity. *Biotechnol Bioeng*, 112(1), 98-103.
- Ludzack, F.J., Ettinger, M.B. 1962. Controlling Operation to Minimize Activated Sludge Effluent Nitrogen. *Journal (Water Pollution Control Federation)*, 34(9), 920-931.

- Ma, B., Peng, Y., Zhang, S., Wang, J., Gan, Y., Chang, J., Wang, S., Wang, S. and Zhu, G. (2013) Performance of anammox UASB reactor treating low strength wastewater under moderate and low temperatures. *Bioresource Technology* 129, 606-611.
- Malovanyy, A., Yang, J., Trela, J., Plaza, E. 2015. Combination of upflow anaerobic sludge blanket (UASB) reactor and partial nitrification/anammox moving bed biofilm reactor (MBBR) for municipal wastewater treatment. *Bioresource Technology*, 180(0), 144-153.
- Matassa, S., Batstone, D.J., Hülsen, T., Schnoor, J., Verstraete, W. 2015. Can Direct Conversion of Used Nitrogen to New Feed and Protein Help Feed the World? *Environmental Science & Technology*, 49(9), 5247-5254.
- McSwain, B.S., Irvine, R.L., Wilderer, P.A. 2004. The effect of intermittent feeding on aerobic granule structure. *Water Science and Technology*, 49(11-12), 19.
- Meerburg, F.A., Boon, N., Van Winckel, T., Vercamer, J.A.R., Nopens, I., Vlaeminck, S.E. 2015. Toward energy-neutral wastewater treatment: A high-rate contact stabilization process to maximally recover sewage organics. *Bioresource Technology*, 179, 373-381.
- Mekonnen, M.M., Hoekstra, A.Y. 2016. Four billion people facing severe water scarcity. *Science Advances*, 2(2).
- Metcalf, E. (2003) *Waste water engineering: treatment and reuse*, 4th edn. Revised by Tchobanoglous G, Burton FL, Stensel HD, McGraw-Hill, New York.
- Molinuevo, B., Cruz Garcia, M., Karakashev, D., Angelidaki, I. 2009. Anammox for ammonia removal from pig manure effluents: Effect of organic matter content on process performance. *Bioresource Technology*, 100(7), 2171-2175.
- Morales, N., Val del Río, Á., Vazquez-Padin, J., Méndez, R., L. Campos, J., Mosquera-Corral, A. 2016. The granular biomass properties and the acclimation period affect the partial nitrification/anammox process stability at a low temperature and ammonium concentration.
- Morales, N., Val del Río, Á., Vázquez-Padín, J.R., Méndez, R., Mosquera-Corral, A., Campos, J.L. 2015. Integration of the Anammox process to the rejection water and main stream lines of WWTPs. *Chemosphere*, 140(0), 99-105.
- Morris EK, Caruso T, Buscot F, et al. Choosing and using diversity indices: insights for ecological applications from the German Biodiversity Exploratories. *Ecology and Evolution*. 2014;4(18):3514-3524. doi:10.1002/ece3.1155.
- Mulder, A., van de Graaf, A.A., Robertson, L.A. and Kuenen, J.G. (1995) Anaerobic ammonium oxidation discovered in a denitrifying fluidized bed reactor. *FEMS Microbiology Ecology* 16, 177-183.
- Muller, A., Wentzel, M.C., Loewenthal, R.E., Ekama, G.A. 2003. Heterotroph anoxic yield in anoxic aerobic activated sludge systems treating municipal wastewater. *Water Res*, 37(10), 2435-41.
- Ni, B.-J., Chen, Y.-P., Liu, S.-Y., Fang, F., Xie, W.-M., Yu, H.-Q. 2009. Modeling a granule-based anaerobic ammonium oxidizing (ANAMMOX) process. *Biotechnology and Bioengineering*, 103(3), 490-499.
- Ni, B.-J., Xie, W.-M., Chen, Y.-P., Fang, F., Liu, S.-Y., Ren, T.-T., Sheng, G.-P., Yu, H.-Q., Liu, G., Tian, Y.-C. 2011. Heterotrophs grown on the soluble microbial products (SMP)

released by autotrophs are responsible for the nitrogen loss in nitrifying granular sludge. *Biotechnology and Bioengineering*, 108(12), 2844-2852.

Ni, S.-Q., Ni, J.-Y., Hu, D.-L., Sung, S. 2012. Effect of organic matter on the performance of granular anammox process. *Bioresource Technology*, 110, 701-705.

Nogaj, T.M., Randall, A.A., Jimenez, J.A., Takacs, I., Bott, C.B., Miller, M.W., Murthy, S., Wett, B. 2014. Mathematical modeling of the high rate activated sludge system: optimizing the COD: N ratio in the process effluent. *Proceedings of the Water Environment Federation*, 2014(16), 913-926.

Nowka, B., Daims, H., Spieck, E. 2015. Comparison of Oxidation Kinetics of Nitrite-Oxidizing Bacteria: Nitrite Availability as a Key Factor in Niche Differentiation. *Applied and Environmental Microbiology*, 81(2), 745-753.

Pérez, J., Lotti, T., Kleerebezem, R., Picioreanu, C., van Loosdrecht, M.C. 2014. Outcompeting nitrite-oxidizing bacteria in single-stage nitrogen removal in sewage treatment plants: A model-based study. *Water research*, 66, 208-218.

Randall, D.J., Tsui, T.K.N. 2002. Ammonia toxicity in fish. *Marine Pollution Bulletin*, 45(1), 17-23.

Rattray, J.E., van de Vossenberg, J., Hopmans, E.C., Kartal, B., van Niftrik, L., Rijpstra, W.I.C., et al. (2008) Ladderane lipid distribution in four genera of anammox bacteria, *Arch Microbiol* 190: 51-66.

Rattray, J.E., van de Vossenberg, J., Jaeschke, A., Hopmans, E.C., Wakeham, S.G., Lavik, G., et al. (2010) Impact of temperature on ladderane lipid distribution in anammox bacteria, *Appl Environ Microb* 76: 1596-1603.

Reino, C., Suárez-Ojeda, M.E., Pérez, J., Carrera, J. 2018. Stable long-term operation of an upflow anammox sludge bed reactor at mainstream conditions. *Water Research*, 128, 331-340.

Sánchez Guillén, J.A., Lopez Vazquez, C.M., de Oliveira Cruz, L.M., Brdjanovic, D., van Lier, J.B. 2016. Long-term performance of the Anammox process under low nitrogen sludge loading rate and moderate to low temperature. *Biochemical Engineering Journal*, 110, 95-106.

Schaubroeck, T., De Clippeleir, H., Weissenbacher, N., Dewulf, J., Boeckx, P., Vlaeminck, S.E., and Wett, B. (2015) Environmental sustainability of an energy self-sufficient sewage treatment plant: Improvements through DEMON and co-digestion, *Water Res* 74: 166-179.

Schmid, M., Walsh, K., Webb, R., Rijpstra, W.I., van de Pas-Schoonen, K., Verbruggen, M.J., Hill, T., Moffett, B., Fuerst, J., Schouten, S., Sinninghe Damsté, J.S., Harris, J., Shaw, P., Jetten, M. and Strous, M. (2003) *Candidatus "Scalindua brodae"*, sp. nov., *Candidatus "Scalindua wagneri"*, sp. nov., Two New Species of Anaerobic Ammonium Oxidizing Bacteria. *Systematic and Applied Microbiology* 26, 529-538.

Sheng, S., Liu, B., Hou, X., Liang, Z., Sun, X., Du, L., Wang, D. 2018. Effects of different carbon sources and C/N ratios on the simultaneous anammox and denitrification process. *International Biodeterioration & Biodegradation*, 127, 26-34.

Shi, Z.-J., Guo, Q., Xu, Y.-Q., Wu, D., Liao, S.-M., Zhang, F.-Y., et al. (2017) Mass transfer characteristics, rheological behavior and fractal dimension of anammox granules: The roles of upflow velocity and temperature, *Bioresource Technol* 244: 117-124.

Shu, D., He, Y., Yue, H., Gao, J., Wang, Q., Yang, S. 2016. Enhanced long-term nitrogen removal by organotrophic anammox bacteria under different C/N ratio constraints: quantitative molecular mechanism and microbial community dynamics. *RSC Advances*, 6(90), 87593-87606.

Siegrist, H., Salzgeber, D., Eugster, J. and Joss, A. (2008) Anammox brings WWTP closer to energy autarky due to increased biogas production and reduced aeration energy for N-removal. *Water Science and Technology* 57, 383-388.

Siegrist, H., Salzgeber, D., Eugster, J., Joss, A. 2008. Anammox brings WWTP closer to energy autarky due to increased biogas production and reduced aeration energy for N-removal. *Water Science and Technology*, 57(3), 383-388.

Sobotka, D., Czerwionka, K., and Makinia, J. (2016) Influence of temperature on the activity of anammox granular biomass, *Water Sci Technol* 73: 2518-2525.

Speth, D.R., in 't Zandt, M.H., Guerrero-Cruz, S., Dutilh, B.E., Jetten, M.S.M. 2016. Genome-based microbial ecology of anammox granules in a full-scale wastewater treatment system. *Nature Communications*, 7, 11172.

Strous, M., Heijnen, J.J., Kuenen, J.G., Jetten, M.S.M. 1998. The sequencing batch reactor as a powerful tool for the study of slowly growing anaerobic ammonium-oxidizing microorganisms. *Applied Microbiology and Biotechnology*, 50(5), 589-596.

Strous, M., Kuenen, J.G., and Jetten, M.S. (1999) Key physiology of anaerobic ammonium oxidation, *Appl Environ Microb* 65: 3248-3250.

Tang, C.J., Zheng, P., Wang, C.H., Mahmood, Q. 2010. Suppression of anaerobic ammonium oxidizers under high organic content in high-rate Anammox UASB reactor. *Bioresource Technology*, 101(6), 1762-1768.

Third, K.A., Sliemers, A.O., Kuenen, J.G., Jetten, M.S.M. 2001. The CANON System (Completely Autotrophic Nitrogen-removal Over Nitrite) under Ammonium Limitation: Interaction and Competition between Three Groups of Bacteria. *Systematic and Applied Microbiology*, 24(4), 588-596.

Tian, S., Tian, Z., Yang, H., Yang, M., and Zhang, Y. (2017) Detection of Viable Bacteria during Sludge Ozonation by the Combination of ATP Assay with PMA-Miseq Sequencing, *Water* 9: 166.

van der Star, W.R.L., Miclea, A.I., van Dongen, U.G.J.M., Muyzer, G., Picioreanu, C. and van Loosdrecht, M.C.M. (2008) The membrane bioreactor: A novel tool to grow anammox bacteria as free cells. *Biotechnology and Bioengineering* 101, 286-294.

Van Hulle, S.W.H., Vandeweyer, H.J.P., Meesschaert, B.D., Vanrolleghem, P.A., Dejana, P., Dumoulin, A. 2010. Engineering aspects and practical application of autotrophic nitrogen removal from nitrogen rich streams. *Chemical Engineering Journal*, 162(1), 1-20.

van Kessel, M.A.H.J., Speth, D.R., Albertsen, M., Nielsen, P.H., Op den Camp, H.J.M., Kartal, B., Jetten, M.S.M., Lücker, S. 2015. Complete nitrification by a single microorganism. *Nature*, 528, 555.

Vandekerckhove, T.G.L., Kobayashi, K., Janda, J., Van Nevel, S., Vlaeminck, S.E. 2018. Sulfur-based denitrification treating regeneration water from ion exchange at high performance and low cost. *Bioresource Technology*, 257, 266-273.

- Veuillet, F., Lacroix, S., Bausseron, A., Gonidec, E., Ochoa, J., Christensson, M. and Lemaire, R. (2014) Integrated fixed-film activated sludge ANITA™ Mox process—a new perspective for advanced nitrogen removal. *Water Science & Technology* 69, 915-922.
- Veuillet, F., Lacroix, S., Bausseron, A., Gonidec, E., Ochoa, J., Christensson, M., Lemaire, R. 2014. Integrated fixed-film activated sludge ANITA™ Mox process—a new perspective for advanced nitrogen removal. *Water Science & Technology*, 69(5), 915-922.
- Vlaeminck, S.E., De Clippeleir, H., and Verstraete, W. (2012) Microbial resource management of one-stage partial nitritation/anammox, *Microb Biotechnol* 5: 433-448.
- Wang, Q., Duan, H., Wei, W., Ni, B.-J., Laloo, A., Yuan, Z. 2017. Achieving Stable Mainstream Nitrogen Removal via the Nitrite Pathway by Sludge Treatment Using Free Ammonia. *Environmental Science & Technology*, 51(17), 9800-9807.
- Wang, Z., Shan, X., Li, W., Chen, H., Zhang, M., Zheng, P. 2016. Robustness of ANAMMOX granule sludge bed reactor: Effect and mechanism of organic matter interference. *Ecological Engineering*, 91, 131-138.
- Wett, B. 2007. Development and implementation of a robust deammonification process. *Water Science and Technology*, 56(7), 81-88.
- Wett, B., Omari, A., Podmirseg, S.M., Han, M., Akintayo, O., Brandon, M.G., Murthy, S., Bott, C., Hell, M., Takacs, I., Nyhuis, G., O'Shaughnessy, M. 2013. Going for mainstream deammonification from bench to full scale for maximized resource efficiency. *Water Science and Technology*, 68(2), 283-289.
- Winkler, M.K.H., Kleerebezem, R., van Loosdrecht, M.C.M. 2012. Integration of anammox into the aerobic granular sludge process for main stream wastewater treatment at ambient temperatures. *Water Research*, 46(1), 136-144.
- Yamamoto, T., Takaki, K., Koyama, T., Furukawa, K. 2008. Long-term stability of partial nitritation of swine wastewater digester liquor and its subsequent treatment by Anammox. *Bioresource Technology*, 99(14), 6419-6425.
- Yan, L., Liu, Y., Wen, Y., Ren, Y., Hao, G., and Zhang, Y. (2015) Role and significance of extracellular polymeric substances from granular sludge for simultaneous removal of organic matter and ammonia nitrogen, *Bioresource Technol* 179: 460-466.
- Yang, Y., Zhang, L., Cheng, J., Zhang, S., Li, B., Peng, Y. 2017. Achieve efficient nitrogen removal from real sewage in a plug-flow integrated fixed-film activated sludge (IFAS) reactor via partial nitritation/anammox pathway. *Bioresource Technology*, 239, 294-301.
- Zheng, B., Zhang, L., Guo, J., Zhang, S., Yang, A. and Peng, Y. (2016) Suspended sludge and biofilm shaped different anammox communities in two pilot-scale one-stage anammox reactors. *Bioresource Technology* 211, 273-279
- Zumft, W.G. 1997. Cell biology and molecular basis of denitrification. *Microbiology and Molecular Biology Reviews*, 61(4), 533-616.