



HAL
open science

Multi-scale approaches for the computation and the optimization of heterogeneous plates

Adrien Lesage

► **To cite this version:**

Adrien Lesage. Multi-scale approaches for the computation and the optimization of heterogeneous plates. Mechanics of materials [physics.class-ph]. Université Paris Est, 2020. English. NNT: . tel-03406633

HAL Id: tel-03406633

<https://theses.hal.science/tel-03406633v1>

Submitted on 28 Oct 2021

HAL is a multi-disciplinary open access archive for the deposit and dissemination of scientific research documents, whether they are published or not. The documents may come from teaching and research institutions in France or abroad, or from public or private research centers.

L'archive ouverte pluridisciplinaire **HAL**, est destinée au dépôt et à la diffusion de documents scientifiques de niveau recherche, publiés ou non, émanant des établissements d'enseignement et de recherche français ou étrangers, des laboratoires publics ou privés.

École doctorale Sciences, Ingénierie et Environnement (SIE)

THÈSE DE DOCTORAT

Discipline : Sciences de l'ingénieur

présentée par

Adrien LESAGE

Approches multi-échelles pour le calcul et l'optimisation de plaques hétérogènes

Thèse dirigée par Frédéric LEGOLL
et co-encadrée par Virginie EHRLACHER et Arthur LEBÉE
préparée au CERMICS et au Laboratoire Navier, ENPC

Soutenue 16 décembre 2020 devant un jury composé de :

| | | |
|---------------------------|--------------------|-----------------------------|
| <i>Rapporteuse</i> | Annie Raoult | Université Paris Descartes |
| <i>Rapporteur</i> | Grégoire Allaire | École Polytechnique |
| <i>Examineur</i> | Alexei Lozinski | Université de Franche-Comté |
| <i>Examineur</i> | Ludovic Chamoin | ENS Paris Saclay |
| <i>Directeur de Thèse</i> | Frédéric Legoll | École des Ponts ParisTech |
| <i>Encadrante</i> | Virginie Ehrlacher | École des Ponts ParisTech |
| <i>Encadrant</i> | Arthur Lebée | École des Ponts ParisTech |

*This is it, he thought. This is where we've
filled ourselves up with so many questions
that they're starting to overflow and
become answers.*

Terry Pratchett
(Feet of Clay)

REMERCIEMENTS

Je remercie tout d'abord Frédéric Legoll, Virginie Ehrlacher et Arthur Lebéé avec qui j'ai eu la chance de travailler pendant ces trois années. Cette période a été intense et leurs conseils, leur soutien, et leur rigueur scientifique m'ont été indispensables pour achever ce travail.

Je remercie chaleureusement Annie Raoult et Grégoire Allaire d'avoir accepté de rapporter ce travail, ainsi que Ludovic Chamoin et Alexei Lozinski d'avoir bien voulu faire partie du jury.

Au CERMICS j'ai pu faire des rencontres qui ont été enrichissantes, tant sur un plan professionnel que personnel. Ce travail doit beaucoup à l'ambiance conviviale et à l'excellence scientifique de ce laboratoire. J'ai eu la chance d'y côtoyer des doctorants dont la compagnie m'a été précieuse, et je remercie Grégoire, Pierre-Loïc, Frédéric, Laura, Marc, Ling-Ling, Sami, Rafaël, Adrien, Oumaima, Inass, Adel, Robert et les autres pour tous les moments que j'ai pu partager avec eux au quotidien. L'ensemble des chercheurs permanents du laboratoire, par leur exigence et leur ouverture m'ont fait progresser scientifiquement et je remercie chacun de ceux qui ont pris à un moment ou à un autre du temps pour échanger avec moi. En particulier, je remercie Claude Le Bris d'avoir organisé pendant que j'étais en deuxième année à l'École des Ponts un voyage à l'Université de Chicago qui m'a permis de découvrir la recherche et qui a beaucoup compté dans le choix de mon orientation. Je remercie aussi Claude Le Bris, grâce à qui lors de ma deuxième année à l'École des Ponts j'ai pu découvrir l'homogénéisation et la recherche en mathématiques. Laboratoire Navier Enfin, je remercie Isabelle Simunic pour son soutien et qui par son travail et son efficacité rend notre vie quotidienne plus facile.

Cette thèse est l'aboutissement d'un chemin commencé pour moi il y a longtemps, je profite de ce moment pour remercier l'ensemble des enseignants de mathématiques que j'ai pu avoir au long de ma scolarité, et tout particulièrement Sylvaine Chaput et Jean Voedts.

Pendant ces trois années de travail j'ai eu la chance d'être entouré d'amis qui ont été là pour moi et je veux faire part de ma reconnaissance à Thomas, Solène, Alice, Amandine, Thibaut, Cécile, Émile, Martin, Thomas, Jordy, Clément, Lucie, Pierre, Maeva, Charles, Margaux, Arthur, Caroline, Jordy, Mathilde, Diane, Ludovic, et à tout ceux avec qui j'ai pu partager des moments de joie.

Enfin je remercie ma famille, mes parents et mon frère, qui m'ont toujours soutenu et Marie, pour avoir été à mes côtés chaque jour.

LIST OF PUBLICATIONS

[AL1] *Convergence of a two-scale expansion for elastic heterogeneous plates*, in preparation (with V. Ehrlacher, A. Lebéé, and F. Legoll)

[AL2] *Multiscale Finite Element Methods for elastic heterogeneous plates*, in preparation (with V. Ehrlacher, A. Lebéé, and F. Legoll)

These two articles respectively correspond to Chapter [2](#) and Chapter [3](#) of this PhD thesis.

LIST OF TALKS

- Fifth workshop on thin structures, Naples, Italy, September 2018 (Poster presentation)
- Congrès SMAI, Société de Mathématiques Appliquées et Industrielles, Guidel Plages, France, May 2019 (Oral presentation)
- Workshop "New trends and challenges in the mathematics of optimal design", Cambridge, United Kingdom, June 2019 (Poster presentation)
- International Congress on Industrial and Applied Mathematics ICIAM 2019, Valencia, Spain, July 2019 (Oral presentation)

| | | |
|----------|--|-----------|
| 1 | Introduction | 1 |
| 1.1 | Context and motivation | 1 |
| 1.2 | Classical homogenization theory | 3 |
| 1.2.1 | Presentation of the problem | 4 |
| 1.2.2 | The one-dimensional case | 4 |
| 1.2.3 | The two scale expansion | 6 |
| 1.2.4 | The homogenization theorem | 6 |
| 1.2.5 | The strong convergence theorem | 7 |
| 1.2.6 | Non-periodic homogenization | 7 |
| 1.3 | Multi-Scale Finite Element Method | 8 |
| 1.3.1 | Motivation | 8 |
| 1.3.2 | Principle | 9 |
| 1.3.3 | Analysis of the method | 10 |
| 1.3.4 | Implementation of the MsFEM | 11 |
| 1.3.5 | Variants of MsFEM | 11 |
| 1.3.6 | Other numerical homogenization methods | 11 |
| 1.4 | Plates theory | 13 |
| 1.4.1 | Axiomatic derivation | 13 |
| 1.4.2 | Asymptotic derivation of the homogeneous plate model | 15 |
| 1.4.3 | Asymptotic derivation of the heterogeneous plate model | 22 |
| 1.4.4 | Numerical methods for homogeneous plates | 25 |
| 1.5 | Shape optimization | 26 |
| 1.5.1 | Principles of shape optimization | 26 |
| 1.5.2 | An example of shape optimization | 27 |
| 1.5.3 | Numerical methods for shape optimization | 27 |
| 1.6 | Main contributions | 28 |
| 1.6.1 | Two scale expansion of the displacement field | 29 |
| 1.6.2 | MsFEM for plates | 31 |
| 1.6.3 | Shape optimization for heterogeneous plates | 33 |
| 2 | Convergence of a two-scale expansion for elastic heterogeneous plates | 35 |
| 2.1 | Introduction | 35 |
| 2.2 | The diffusion case | 38 |
| 2.2.1 | Definition of the plate problem | 38 |
| 2.2.2 | Homogenization result: weak convergence | 40 |
| 2.2.3 | Strong convergence of the two-scale expansion | 42 |

| | | |
|----------|---|------------|
| 2.3 | The elasticity case | 50 |
| 2.3.1 | Definition of the plate problem | 50 |
| 2.3.2 | Homogenization and dimension reduction: weak convergence | 52 |
| 2.3.3 | Strong convergence result of a two-scale expansion in the membrane and bending case | 54 |
| 2.3.4 | The membrane case | 59 |
| 2.3.5 | The bending case | 63 |
| 2.3.6 | Evidence supporting Conjecture (CB) | 72 |
| 2.A | H_{div} space | 77 |
| 2.B | Korn inequalities | 78 |
| 2.C | Proofs of the homogenization results | 79 |
| 2.C.1 | Proof of Theorem 2.4 | 79 |
| 2.C.2 | Proof of Theorem 2.11 | 81 |
| 3 | Multiscale Finite Element Methods for elastic heterogeneous plates | 87 |
| 3.1 | Introduction | 87 |
| 3.2 | Presentation of the problem and former results | 89 |
| 3.2.1 | Definition of the plate problem | 90 |
| 3.2.2 | Decomposition of the problem | 92 |
| 3.2.3 | Former results | 94 |
| 3.3 | Definition and numerical analysis of the MsFEM | 97 |
| 3.3.1 | Definition of the method | 97 |
| 3.3.2 | Error estimates | 98 |
| 3.4 | Numerical results | 99 |
| 3.4.1 | Presentation of the test case | 99 |
| 3.4.2 | Meshes and alternative MsFEM variants | 101 |
| 3.4.3 | Numerical results | 104 |
| 3.5 | Conclusion | 107 |
| 3.A | Proof of the error estimates | 109 |
| 3.A.1 | Membrane case | 109 |
| 3.A.2 | Bending case | 111 |
| 4 | Shape optimization of plates | 115 |
| 4.1 | Introduction | 115 |
| 4.2 | Choice of optimization set for diffeomorphisms and reference periodic tensor | 117 |
| 4.3 | Two optimization approaches | 118 |
| 4.3.1 | Rescaled version of the plate problem | 118 |
| 4.3.2 | Homogenization approach | 120 |
| 4.3.3 | Multiscale finite element approach | 122 |
| 4.3.4 | Reduced multiscale finite element approach | 124 |
| 4.4 | Numerical results | 126 |
| 4.4.1 | Approximability properties of the reduced multiscale finite element space | 126 |
| 4.4.2 | Optimization results | 128 |

1.1 Context and motivation

A problem is said to be a "multi-scale" problem when it has different natural length-scales. Composite materials for example are heterogeneous materials made of different constituents to obtain new properties (see Figure 1.1). They are used in the industry to make cars, planes, prothesis, or sport equipment. When an object has two separate scales (see Figure 1.2), a micro-scale and a macro-scale, it is not easy to deduce its macro-properties, such as its mechanical response to external loads, from its microstructure.

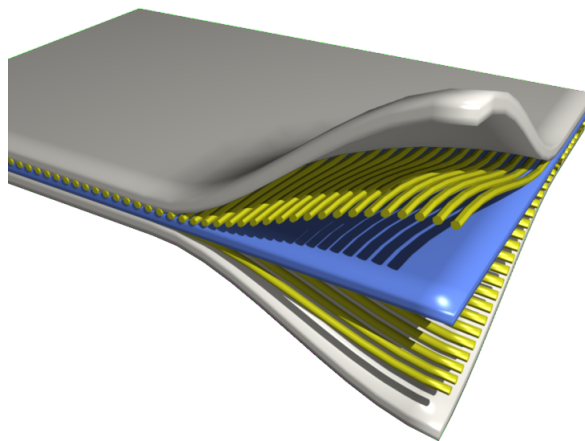

Figure 1.1: A composite material (from http://en.wikipedia.org/wiki/Composite_material)

The behaviour of a material, whether mechanical or thermal, is generally modeled by a partial differential equation (PDE). When the material has a micro-structure of size ε , the coefficient of the PDE A_ε is rapidly oscillating. Therefore, the solution of the PDE u_ε is also oscillating. One way to approximate this solution is to study the limit u_\star of the solution u_ε of the PDE when the size of the micro-structure goes to 0. This is the core of the "homogenization theory", that has been developed since the seventies (see Section 1.2). The function u_\star is itself solution to a PDE with (in general) a non-oscillating coefficient A_\star , called the "homogenized equation". The function u_\star provides an effective behaviour of the material, and A_\star can be understood as a model of a homogeneous (or slowly varying), effective material.

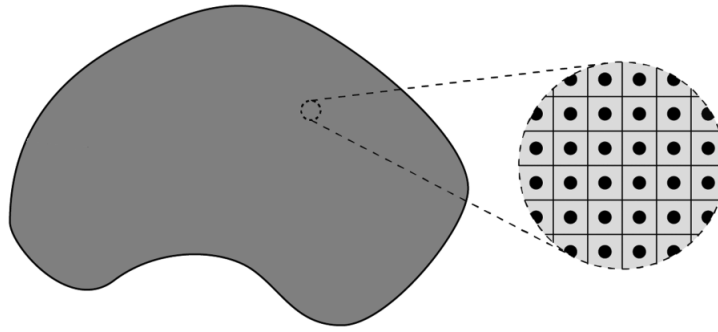

Figure 1.2: A multi-scale material (from [86])

If geometrical assumptions on the material are made, A_\star has an explicit expression and can be computed. It is the case when the micro-structure is periodic, or follows a probability law that is ergodic and stationary. When this is the case, u_\star can be computed. In the periodic case, "corrector" terms can be added to u_\star to approximate the oscillations at the micro-scale of u_ε , giving an accurate approximation of ∇u_ε . However, no real material is perfectly periodic. Even in artificial materials, defaults can appear during the manufacturing process. Without geometrical assumptions, homogenization theory ensures the existence of the homogenized problem under mild assumptions, but no practical way to compute it. In this case, u_ε has to be approached by a numerical method.

The Finite Element Method (FEM) is the most widely used numerical method to compute solutions of PDEs. It is however not adapted to multi-scale materials. Indeed, to have an accurate approximation of the solution, the problem has to be solved at the micro-scale, which can lead to high computational costs. To tackle this problem, multi-scale numerical methods have been developed in the last decades. In particular we are interested in the Multi-scale Finite Element Method (MsFEM, see Section 1.3). The MsFEM is a Galerkin method, where the basis of the approximation space is composed of oscillating functions. Those functions are defined as solutions to local PDEs, and are adapted to the problem of interest. As the oscillations of the solution are captured by the basis functions of the approximation space, there is no need to have a mesh smaller than the microstructure, hence a significant computational gain. The method consists of two steps: an "offline step", to compute the basis of the approximation space, and an "online step" to solve the Galerkin problem. For a periodic material, it is possible to prove an a priori error estimate. When the material is not periodic, there is no estimate but the method still provides accurate numerical results.

In this thesis we are in particular interested in composite plates. A composite plate is a material that is thin along one direction and has a micro-structure. Therefore, there are three scales in the problem: the size of the material, its thickness η , and the size of the micro-structure ε (see Figure 1.3). Plates have been studied as specific mechanical objects for more than two centuries. The goal of a "plate theory" is to construct 2D models that describe the behaviour of 3D plates accurately (see Section 1.4). It makes it possible to have a better understanding of plates, and helps to reduce computational costs. Originally, plate models were derived with the help of geometrical intuition. Mathematicians have also studied plate models with the tools of asymptotic analysis. This method is similar to homogenization, so this framework is particularly suited for the study of heterogeneous plates.

Our goal in this thesis is to adapt the MsFEM to the case of plates (see Chapter 3).

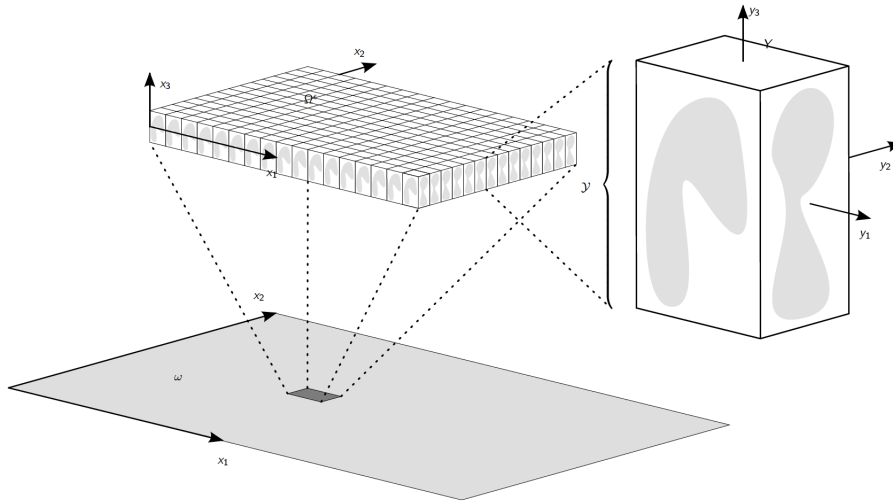

Figure 1.3: An heterogeneous plate

In order to establish error bounds for this method, we use the existing work on heterogeneous plates and prove an additional convergence result (see Section 1.6 and Chapter 2).

Another topic studied in this thesis is shape optimization, which is the study of methods that allows to find shapes that minimize a criterion while satisfying given constraints (see Section 1.5). The criterion can be the weight or the compliance of the object. The constraint can be the response to a given load. These problems are relevant for example to the aircraft industry, which needs objects that are simultaneously light and reliable. Classical computations show that the solution to a shape optimization problem is usually a composite. Shape optimization thus has a natural link with homogenization. The problem is often split in two subproblems: the optimization of the macro-behaviour of the material over a set of homogenized composites, and the definition of a real composite whose homogenized behaviour well approximates the optimal behaviour identified in the first step.

With the MsFEM it is possible to solve efficiently multi-scale problems on plates (and thus to simultaneously perform the above two steps). Our second goal is to use the MsFEM to solve a problem of shape optimization on plates, where the optimization is directly performed on a set of microstructures where the characteristic size ε of the oscillations is fixed (see Section 1.6 and Chapter 4).

1.2 Classical homogenization theory

We briefly present the classical homogenization theory for a scalar diffusion equation. Such a presentation, which is of course very classical, should be considered as a first step toward our main object of interest, namely elastic heterogeneous plates. Most of this section considers the case of materials with a periodic micro-structure. Some other cases will be mentioned in Section 1.2.6. We refer to [1], [12], [58] or [63] for a comprehensive exposition of the theory.

1.2.1 Presentation of the problem

Let Ω be an open, smooth bounded domain of \mathbb{R}^n . Let f be a function of $L^2(\Omega)$. We want to find u_ε in $H^1(\Omega)$ so that

$$\begin{cases} -\operatorname{div}(A_\varepsilon \nabla u_\varepsilon) = f & \text{on } \Omega \\ u_\varepsilon = 0 & \text{on } \partial\Omega. \end{cases} \quad (1.1)$$

For the problem to be well posed, we suppose that A_ε is elliptic in the sense that

$$\exists c_-, c_+ > 0, \quad \forall \xi \in \mathbb{R}^n, \forall x \in \Omega, \quad c_- |\xi|^2 \leq A_\varepsilon(x) \xi \cdot \xi \leq c_+ |\xi|^2. \quad (1.2)$$

We suppose that the constants c_- and c_+ are independent of ε . For the sake of simplicity, we also suppose that A_ε is a symmetric matrix.

If A_ε has oscillation at the scale ε , it is natural to suppose that u_ε will also oscillate at this scale. Homogenization is the study of the limit behaviour of u_ε . The simplest case is the case of periodic oscillations. We introduce $Y := (0, 1)^n$ and suppose that there is an application A from \mathbb{R}^n to the set of elliptic matrices that is Y -periodic, is such that

$$\exists c_-, c_+ > 0, \quad \forall \xi \in \mathbb{R}^n, \forall x \in \mathbb{R}^n, \quad c_- |\xi|^2 \leq A(x) \xi \cdot \xi \leq c_+ |\xi|^2,$$

and such that, for any $\varepsilon > 0$ and any x in Ω , $A_\varepsilon(x) = A\left(\frac{x}{\varepsilon}\right)$. In this case the problem (1.1) is to find u_ε in $H^1(\Omega)$ so that

$$\begin{cases} -\operatorname{div}\left(A\left(\frac{x}{\varepsilon}\right) \nabla u_\varepsilon\right) = f & \text{on } \Omega, \\ u_\varepsilon = 0 & \text{on } \partial\Omega. \end{cases} \quad (1.3)$$

The weak formulation of (1.3) is: find u_ε in $H_0^1(\Omega)$, such that for any v in $H_0^1(\Omega)$

$$\int_{\Omega} A\left(\frac{x}{\varepsilon}\right) \nabla u_\varepsilon \cdot \nabla v = \int_{\Omega} f v.$$

Using (1.2) and (1.3) we show that there exists $C > 0$ independent of ε so that

$$\|u_\varepsilon\|_{H^1(\Omega)} \leq C,$$

and we thus deduce that there is some u_\star in $H_0^1(\Omega)$ so that

$$u_\varepsilon \xrightarrow{\varepsilon \rightarrow 0} u_\star \quad \text{in } H^1(\Omega)$$

up to a subsequence extraction. The Figure 1.4 shows an example of such a convergence.

To identify who is u_\star , we proceed by considering the one-dimensional case first, because everything is explicit. Then we consider the multidimensional case.

1.2.2 The one-dimensional case

In the one-dimensional case, we set $\Omega = (0, 1)$ and the problem (1.3) reads as

$$-\frac{d}{dx} \left(A\left(\frac{x}{\varepsilon}\right) \frac{d}{dx} u_\varepsilon \right) = f \quad \text{on } (0, 1) \quad \text{with} \quad u_\varepsilon(0) = u_\varepsilon(1) = 0.$$

Integrating once, we get

$$A\left(\frac{x}{\varepsilon}\right) \frac{d}{dx} u_\varepsilon = -F + C_\varepsilon$$

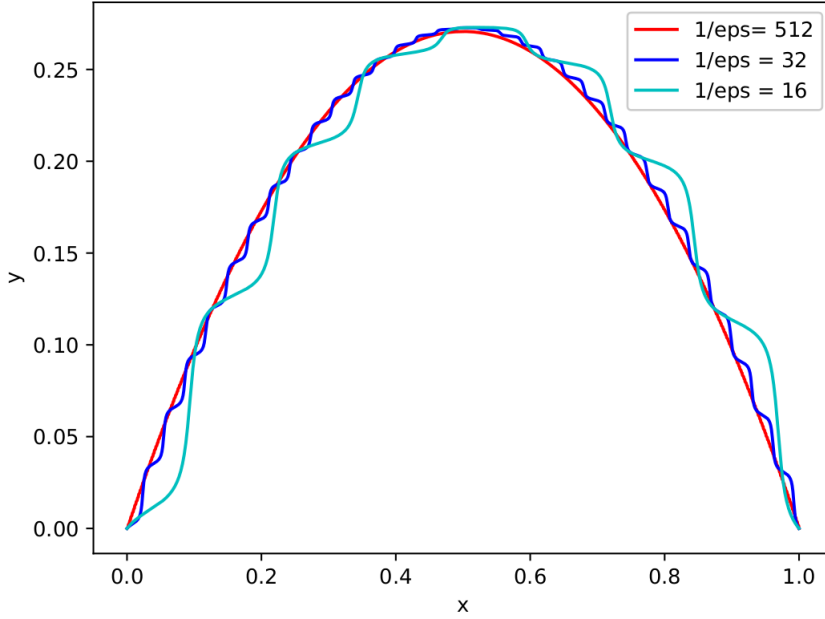

Figure 1.4: Solution of (1.3) in the one-dimensional case when $A_\varepsilon(x) = 1.1 + \sin\left(\frac{2\pi x}{\varepsilon}\right)$ (from [86])

where, for any x in $(0, 1)$, $F(x) = \int_0^x f$. Then, we get

$$u_\varepsilon(x) = - \int_0^x \frac{1}{A\left(\frac{t}{\varepsilon}\right)} F(t) dt + C_\varepsilon \int_0^x \frac{1}{A\left(\frac{t}{\varepsilon}\right)} dt. \quad (1.4)$$

Because of the condition $u_\varepsilon(1) = 0$, we compute

$$C_\varepsilon = \left(\int_0^1 \frac{1}{A\left(\frac{t}{\varepsilon}\right)} dt \right)^{-1} \int_0^1 \frac{F(t)}{A\left(\frac{t}{\varepsilon}\right)} dt.$$

To identify the limit of u_ε , we use the following lemma, written in the multidimensional context.

Lemma 1.1. *Let b in $L^\infty(\mathbb{R}^n)$ be a Y -periodic function. Then for any ϕ in $L^1(\mathbb{R}^n)$,*

$$\int_{\mathbb{R}^n} b\left(\frac{x}{\varepsilon}\right) \phi(x) dx \xrightarrow{\varepsilon \rightarrow 0} \langle b \rangle \int_{\mathbb{R}^n} \phi$$

where $\langle b \rangle := \int_Y b$.

We deduce that u_ε converges to u_\star , solution to

$$u_\star = - \left\langle \frac{1}{A} \right\rangle \int_0^x F(t) dt + x \left\langle \frac{1}{A} \right\rangle \int_0^1 F(t) dt.$$

Thus, u_\star is the solution of the following problem:

$$-\frac{d}{dx} \left(\langle A^{-1} \rangle^{-1} \frac{d}{dx} u_\star \right) = f \quad \text{on } (0, 1) \quad \text{with } u_\star(0) = u_\star(1) = 0.$$

It is important to note that for any A that is not a constant, $\langle A^{-1} \rangle^{-1} \neq \langle A \rangle$, therefore it would be a mistake to think that homogenizing a material is simply averaging it. Also, it is worth noting that u_ε and u_\star are solutions of the same type of PDE. This is not true for any homogenization problem, but is rather a specificity of (1.3).

1.2.3 The two scale expansion

We now turn to the multidimensional case. The classical way of identifying the limit problem for an oscillating problem is to suppose that the function u_ε has the form of an expansion in power of ε (see [63]), with functions that have two "scales", 1 and ε . Such an expansion reads

$$u_\varepsilon(x) = u_0\left(x, \frac{x}{\varepsilon}\right) + \varepsilon u_1\left(x, \frac{x}{\varepsilon}\right) + \varepsilon^2 u_2\left(x, \frac{x}{\varepsilon}\right) + \dots \quad (1.5)$$

where u_i ($i \geq 0$), are assumed to be periodic with respect to their second variable. The key to this formal computation is to suppose that the scales 1 and ε are sufficiently separated so that the variables x and $\frac{x}{\varepsilon}$ can be viewed as independent variables, x and y . The link between the variables is kept in the differentiation of the function:

$$\nabla_x \left[u_i\left(x, \frac{x}{\varepsilon}\right) \right] = \nabla_x u_i\left(x, \frac{x}{\varepsilon}\right) + \frac{1}{\varepsilon} \nabla_y u_i\left(x, \frac{x}{\varepsilon}\right),$$

thus ∇ is replaced by $\nabla_x + \frac{1}{\varepsilon} \nabla_y$.

Using this rule, inserting (1.5) in (1.3) yields a cascade of equations linking the u_i one to each other.

The first equation implies that $\nabla_y u_0 = 0$, i.e. the limit function is not oscillating. The second equation links u_0 and u_1 . For any x in Ω , y in Y , it yields that

$$u_1(x, y) = \sum_{i=1}^n w_i(y) \partial_i u_0(x)$$

where the w_i are called correctors. They are solutions of the following PDE:

$$\begin{cases} -\operatorname{div}(A(\nabla w_i + e_i)) = 0 & \text{on } \mathbb{R}^n \\ w_i \text{ is } Y\text{-periodic,} \end{cases} \quad (1.6)$$

where the vectors $(e_i)_i$ are the canonical basis of \mathbb{R}^n . The third equation gives the limit PDE on u_0 , that we detail in the following.

1.2.4 The homogenization theorem

The two scale expansion is a formal computation that helps to guess the homogenization theorem. We now state the rigorous theorem, whose proof can be found e.g. in [1].

Theorem 1.2 (Homogenization theorem). *Under the above assumptions on A , f and Ω , the solution u_ε to (1.3) converges weakly in $H^1(\Omega)$, strongly in $L^2(\Omega)$ to u_\star , which is the unique solution in $H_0^1(\Omega)$ of*

$$-\operatorname{div} A_\star \nabla u_\star = f \quad (1.7)$$

where the homogenized matrix A_\star is given, for $i, j = 1 \dots n$, by

$$A_\star e_i \cdot e_j = \int_Y A(\nabla w_i + e_i) \cdot (\nabla w_j + e_j). \quad (1.8)$$

Note that the whole sequence $(u_\varepsilon)_{\varepsilon>0}$ converges, and not only a subsequence.

1.2.5 The strong convergence theorem

The homogenization theorem provides a way to identify u_* , an approximation of u_ε . However, the convergence of ∇u_ε to ∇u_* is only a weak convergence. Indeed, the function ∇u_ε oscillates with a period of the order of ε and an amplitude independent of ε , whereas ∇u_* does not oscillate.

The ansatz (1.5) gives again a good intuition of the problem. A formal differentiation shows that

$$\nabla u_\varepsilon(x) \approx \nabla_x u_*(x) + \nabla_y u_1\left(x, \frac{x}{\varepsilon}\right),$$

with

$$u_1(x, y) = \sum_{i=1}^n w_i(y) \partial_i u_*(x).$$

This expression is a motivation for the name "correctors" given to the functions w_i . They "correct" the mistake made when u_ε is approximated by u_* . The proof of this can be found e.g. in [58]. Let

$$u_{\varepsilon,1} := u_* + \varepsilon \sum_{i=1}^n w_i\left(\frac{\cdot}{\varepsilon}\right) \partial_i u_*. \quad (1.9)$$

Theorem 1.3 (Strong convergence theorem). *Suppose the above assumptions on A , f and Ω holds. Suppose that $u_* \in W^{2,\infty}(\Omega)$ and that for any i , $w_i \in W^{1,\infty}(Y)$. Then,*

$$\|u_\varepsilon - u_{\varepsilon,1}\|_{H^1(\Omega)} \leq C \sqrt{\varepsilon} \|\nabla u_*\|_{W^{1,\infty}(\Omega)}$$

where C is independent of ε and u_* .

When a material has a periodic microstructure, these results give a way to compute an approximation in H^1 norm of u_ε :

- (i) solve n PDEs on Y (1.6) to compute the correctors w_i , $1 \leq i \leq n$;
- (ii) compute A_* with (1.8) and solve the homogenized PDE (1.7);
- (iii) compute $u_{\varepsilon,1}$ with (1.9).

This method however only works in the periodic case. In the Section 1.3, we present numerical methods that work for non-periodic materials. We conclude this section with general results on the homogenization of non-periodic PDEs.

1.2.6 Non-periodic homogenization

More general results have been proven by Spagnolo, and Murat and Tartar [80], who have introduced H-convergence and G-convergence. They proved that, if the coefficient A_ε is elliptic and bounded, up to a subsequence extraction the sequence of problems converges to an asymptotic problem of the form (1.7). This result does not give an explicit formula for A_* , nor a quantitative estimate on the approximation but proves that A_* is independent from f (there thus exists a homogenized material). Another method called Γ -convergence (see [27]), introduced by De Giorgi [30], gives results by treating the solution of the PDE as the minimizer of an energy that converges to the minimizer of an asymptotic energy.

In a different direction, stochastic homogenization has been developed by Jikov, Papanicolaou and Varadhan to tackle the problem of stochastic coefficients of the form $A_\varepsilon(x, \omega)$ (see [58]).

A perturbative approach by Blanc, Le Bris, Lions and Josien (see [15], [13] or [14]) tackles the problem of a coefficient which is the sum of a periodic coefficient and of defects. This model is deterministic and leads to more affordable computations than a stochastic model. In addition, it allows for a more realistic modelling of materials than the periodic setting.

1.3 Multi-Scale Finite Element Method

The homogenization theory presented in Section 1.2 provides approximations of the function u_ε and quantitative results, in the case of a periodic micro-structure. Without such geometrical assumptions on A_ε (which can be restrictive in practice) there is no such results. The only practical way of approaching u_ε is to rely on a numerical method. In this section, we motivate and explain the Multi-Scale Finite Element Method (MsFEM), a numerical method dedicated to multiscale problems. At this end of the section, we will mention some other methods addressing this problem (see Section 1.3.6).

1.3.1 Motivation

The most widely used numerical method to solve PDEs is the Finite Element Method (FEM). If we were to use it to solve (1.1) with a basis of \mathbb{P}^1 functions, the theory would give us the following error estimate (see [40]):

$$\|u_\varepsilon - u_H\|_{H^1(\Omega)} \leq CH \|u_\varepsilon\|_{H^2(\Omega)},$$

where H is the size of the mesh and u_H the FEM approximation. The Figure 1.5 shows the influence of the size of the mesh H on the error of the approximation of the Poisson problem (in blue) and a multi-scale problem (in green). It is obvious that the quality of the approximation is much worse in the latter case.

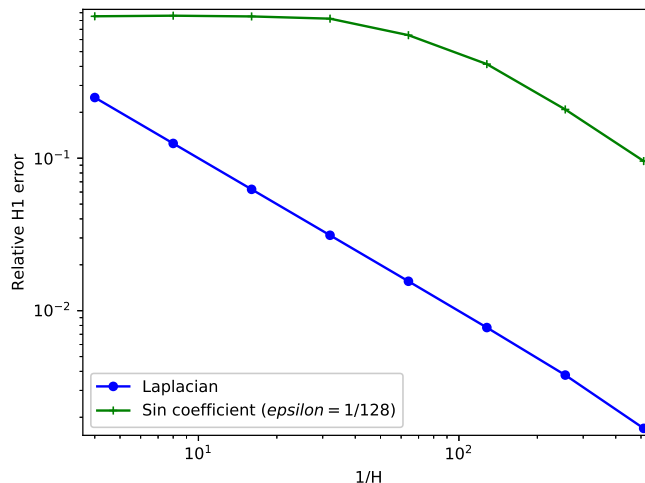

Figure 1.5: H^1 error for the 1D heterogeneous problem (in green) and Poisson problem (in blue) as a function of $\frac{1}{H}$ (from [86])

To better understand the problem it is useful to go back to the 1D case, where everything is explicit. Differentiating the function u_ε given by (1.4) twice shows that $\frac{d^2}{dx^2}u_\varepsilon = A_\varepsilon + \frac{B_\varepsilon}{\varepsilon}$ where A_ε and B_ε are two bounded functions. The error estimate of the FEM thus yields that

$$\|u_\varepsilon - u_H\|_{H^1(\Omega)} \leq C \frac{H}{\varepsilon}.$$

It means that in the case of multi-scale materials, a mesh of size $H \ll \varepsilon$ is required by the FEM in order to provide a good approximation. In the one-dimensional case, Figure 1.6 shows that if H is not small enough, the solution u_ε is not approximated by the method. As ε is supposed to be small for multi-scale materials, it can be computationally prohibitive (especially in 2D or 3D problems) to manipulate a mesh of size H smaller than ε .

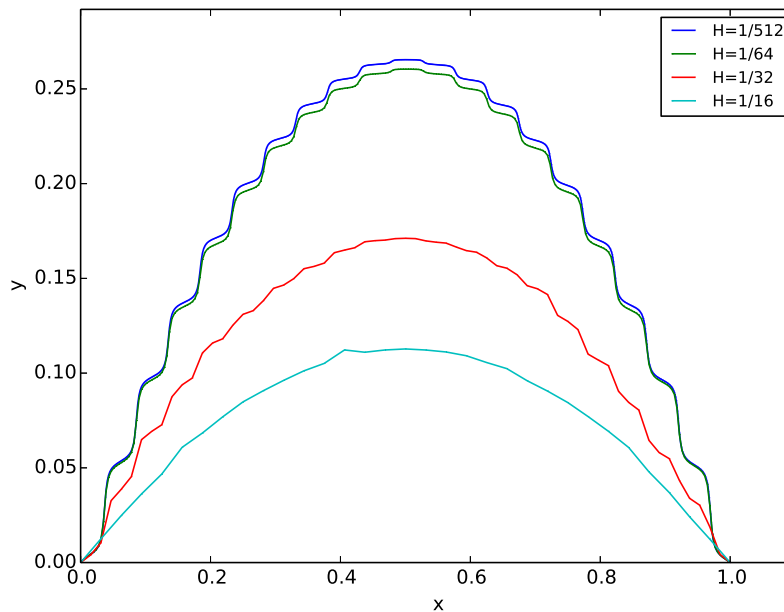

Figure 1.6: Solution of the problem (1.3) with FEM for different values of H (from [86])

1.3.2 Principle

The MsFEM has been introduced by Hou and Wu ([55], [54], see also [36]) to compute solutions of oscillating PDEs.

The MsFEM proceeds in two steps. First, a basis of oscillating functions is computed. Then, the basis is used as the approximation space in a Galerkin method to approximate u_ε .

The method relies on two meshes: a coarse mesh of size H and a fine mesh of size h of each element of the coarse mesh. The size of the fine mesh h must be small enough to capture the oscillations of the problem. The size of the coarse mesh H should be larger than ε so that the resolution of a Galerkin problem with this mesh is not too expensive. We hence consider the regime

$$h \ll \varepsilon < H.$$

The coarse mesh is used to define the basis of oscillating functions, the fine mesh is used to compute these basis functions.

1.3.3 Analysis of the method

Let \mathcal{T}_Ω^H be a conformal mesh of Ω of typical size H . Let $(\psi^i)_i$ be the canonical basis of the set of functions of $H_0^1(\Omega)$ that are affine on every element of \mathcal{T}_Ω^H . On $T \in \mathcal{T}_\Omega^H$ we define the basis function ψ_ε^i as the solution to the following PDE (see Figure 1.7):

$$\begin{cases} -\operatorname{div} A_\varepsilon \nabla \psi_\varepsilon^i = 0 & \text{in } T \\ \psi_\varepsilon^i = \psi^i & \text{on } \partial T. \end{cases} \quad (1.10)$$

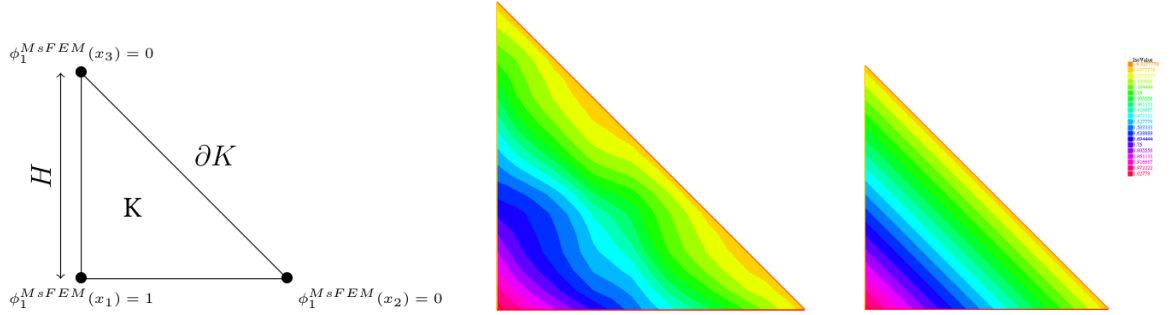

Figure 1.7: An element of the mesh K of size H , the oscillating function ψ_ε^i and the affine function ψ^i (from [86])

Let $V_H^\varepsilon := \operatorname{Span} \{\psi_i^\varepsilon\}_i$, and u_H the Galerkin's approximation of u_ε in V_H^ε . For any v in V_H^ε ,

$$\int_\Omega A_\varepsilon \nabla u_H \cdot \nabla v = \int_\Omega f v.$$

To analyse the method, we make the same assumptions as in Theorem 1.3, in particular we suppose that A_ε is periodic. Hence, the results of the previous section can be used.

Theorem 1.2 states that ψ_ε^i converges weakly in $H^1(T)$ to some ψ_\star^i which is a solution to

$$\begin{cases} -\operatorname{div} A_\star \nabla \psi_\star^i = 0 & \text{in } T \\ \psi_\star^i = \psi^i & \text{on } \partial T. \end{cases}$$

This problem is well posed, and since A_\star is constant and ψ^i is affine on T its unique solution is $\psi_\star^i = \psi^i$. Theorem 1.3 states that

$$\psi_\varepsilon^i \approx \psi^i + \varepsilon \sum_{j=1}^n w_j \left(\frac{\cdot}{\varepsilon} \right) \partial_j \psi^i.$$

The MsFEM method works because the correctors in this expression are the same as the correctors in the expression of $u_{\varepsilon,1}$:

$$u_\varepsilon \approx u_{\varepsilon,1} := u_\star + \varepsilon \sum_{j=1}^n w_j \left(\frac{\cdot}{\varepsilon} \right) \partial_j u_\star.$$

In a sense, the affine elements ψ^i capture the effective behaviour of u_ε which is u_\star , and the term $\varepsilon \sum_{j=1}^n w_j \left(\frac{\cdot}{\varepsilon} \right) \partial_j \psi^i$ captures the oscillations of u_ε .

The complete numerical analysis can be found in e.g. [36].

Theorem 1.4 (MsFEM error estimate). *Assuming that $A^\varepsilon = A\left(\frac{\cdot}{\varepsilon}\right)$ for some periodic function A and under some regularity assumptions on u_\star and the correctors, it holds that*

$$\|u_\varepsilon - u_H\|_{H^1(\Omega)} \leq C \left(H + \sqrt{\varepsilon} + \sqrt{\frac{\varepsilon}{H}} \right)$$

for a constant C independent of ε and H .

For values of ε small enough to ensure that $\sqrt{\varepsilon} + \sqrt{\frac{\varepsilon}{H}} \ll H$, the error can be roughly written as

$$\|u_\varepsilon - u_H\|_{H^1(\Omega)} \leq CH.$$

This dependence of the error with respect to the size of the mesh is similar to the FEM in the non-oscillating case.

1.3.4 Implementation of the MsFEM

The interesting feature of the MsFEM is that the problem (1.10) only depends on A_ε , but not on f . Thus, the method can be split in two steps. The first is called the "offline" step and is the most expensive:

- (i) compute the functions ψ_ε^i solutions to (1.10) (in practice using a fine mesh to discretize it);
- (ii) assemble the stiffness matrix K defined by $K_{ij} = \int_\Omega A_\varepsilon \nabla \psi_\varepsilon^i \cdot \nabla \psi_\varepsilon^j$.

The second step is the "online" step and is computationally much less expensive (recall that the number of degrees of freedom, i.e. the dimension of V_H^ε , is limited):

- (iii) assemble the vector B defined by $B_i = \int_\Omega f \cdot \psi_\varepsilon^i$;
- (iv) solve the problem $KU = B$.

1.3.5 Variants of MsFEM

Because of the boundary conditions of the problem (1.10), the oscillating basis functions ψ_ε^i are linear on the boundaries of the elements of the mesh. This is why the method we have presented in this section is called "linear MsFEM". This method is not very accurate because the numerical solution u_H is affine on the edges of the coarse mesh, whereas the actual solution u_ε is of course not.

Other choices of boundary conditions have been proposed yielding non-conformal methods such as the "oversampling MsFEM" ([55]) and "MsFEM à la Crouzeix-Raviart" ([64], [65]). A variant of the linear MsFEM where the linear boundary conditions are replaced by higher order polynomials is studied in [86].

1.3.6 Other numerical homogenization methods

There exist other numerical approaches for multi-scale problems. We present here the Heterogeneous Multi-scale Method (HMM) and the Local Orthogonal Decomposition (LOD).

HMM

The HMM was introduced by E and Engquist in [33] and analysed in [35].

In a standard Finite Element Method with a mesh of size H and a basis of \mathbb{P}^1 elements $(\psi_i)_i$ integrals of the form $\int_{\Omega} A_{\varepsilon} \nabla \psi \cdot \nabla \psi$ are numerically computed. The value of this integral is approximated by a quadrature formula on the points x_k with the weights w_k :

$$\int_{\Omega} A_{\varepsilon} \nabla \psi \cdot \nabla \psi \approx \sum_k w_k (A_{\varepsilon} \nabla \psi \cdot \nabla \psi)(x_k).$$

The core of the HMM is to replace the evaluation of $A_{\varepsilon}(x_k)$ by an effective coefficient $A_{\star}^{HMM}(x_k)$. A small patch ω_k is defined around each point x_k and meshed on a fine scale h . Then,

$$A_{\star}^{HMM}(x_k) \nabla \psi \cdot \nabla \psi \approx \frac{1}{|\omega_k|} \int_{\tau_k} A_{\varepsilon} \nabla w_k \cdot \nabla w_k$$

where the function w_k is solution to

$$\begin{cases} -\operatorname{div}(A_{\varepsilon} \nabla w_k) = 0 & \text{in } \omega_k \\ w_k = \psi & \text{on } \partial\omega_k. \end{cases}$$

The solution of the FEM where $A_{\varepsilon}(x_k)$ is replaced by $A_{\star}^{HMM}(x_k)$ is called u_{HMM} .

Theorem 1.5. *Assume that $A_{\varepsilon}(x) = A\left(\frac{x}{\varepsilon}\right)$ where A is periodic. Let u^* be the solution to (1.7) and assume that u^* is in $H^2(\Omega)$. Then, there is a constant C independent of ε and H such that*

$$\|u_{\star} - u_{HMM}\|_{H^1(\Omega)} \leq C(\varepsilon + H)$$

Note that u_{HMM} is not an approximation of the solution to (1.1). The computations on the small scale h are only done on the small patches ω_k and can be parallelized.

LOD

The LOD was introduced by Målqvist and Peterseim in [74]. Similarly to the MsFEM, the core of the LOD is the design of an approximation space to be used in a Galerkin method for the equation (1.1).

Let \mathcal{T}_H be a triangulation of Ω , and let \mathcal{I}_H be the following interpolant. For x_k a node of \mathcal{T}_H and ψ_k the \mathbb{P}^1 function associated to this node, let for any u in $H_0^1(\Omega)$

$$\mathcal{I}_H(u)(x_k) := \frac{\int_{\Omega} u \psi_k}{\int_{\Omega} \psi_k}.$$

Let $V^0 := \{f \in H_0^1(\Omega), \mathcal{I}_H(f) = 0\}$ be the kernel of the interpolant. Typically, a function that oscillates around 0 on a scale smaller than H could be in this kernel. If A_{ε} is symmetric, then the bilinear form $a_{\varepsilon} : (u, v) \mapsto \int_{\Omega} A_{\varepsilon} \nabla u \cdot \nabla v$ defines a scalar product on $H_0^1(\Omega)$. Thus we define V_{LOD}^H as the orthogonal complement of V^0 with respect to a_{ε} :

$$H_0^1(\Omega) = V^0 \oplus V_{LOD}^H.$$

We do not detail here how to construct a basis of V_{LOD}^H . We denote by u_{LOD} the solution of the Galerkin approximation of (1.1) on the approximation space V_{LOD}^H . Then the following result holds (see [74]).

Theorem 1.6. *If A_{ε} is in $L^{\infty}(\Omega)$, symmetric, bounded from above and below, then*

$$\|u_{\varepsilon} - u_{LOD}\|_{H^1(\Omega)} \leq CH \|f\|_{L^2(\Omega)}$$

where C is a constant independent of ε and H .

1.4 Plates theory

We now turn to the main object of interest in this thesis, namely heterogeneous plates. We denote by "plate" a 3D object that is thin along one dimension. The goal of plate theory is to replace a 3D model by a 2D model, while keeping a precise description of the plate.

There are two ways to find such a model. The first is axiomatic. The idea is to make ad-hoc assumptions on the 3D displacement field and separate the in-plane and out-of-plane coordinates. The second one is asymptotic. The idea is to take a 3D model with a scaling parameter ε and study what happens when ε goes to 0.

In this section we give a brief introduction to the axiomatic derivation of plate models, and review some results in the asymptotic derivation of plate models for homogeneous and heterogeneous plates. A comprehensive review can be found in [23].

In this section the computations are made for a plate in \mathbb{R}^3 . Everything would remain true for a plate in \mathbb{R}^n for $n \geq 2$, where the plate is thin along the n -th dimension.

1.4.1 Axiomatic derivation

Kirchoff-Love plate theory

The first broadly used axiomatic derivation was made by Kirchoff, and completed by Love in 1888 [72]. It is now known as the "Kirchoff-Love" theory. The assumptions made in this theory are:

- (i) the displacement of the plate is uniform through the thickness;
- (ii) the normal line to the midsurface remains normal through the transformation (see Figure 1.8).

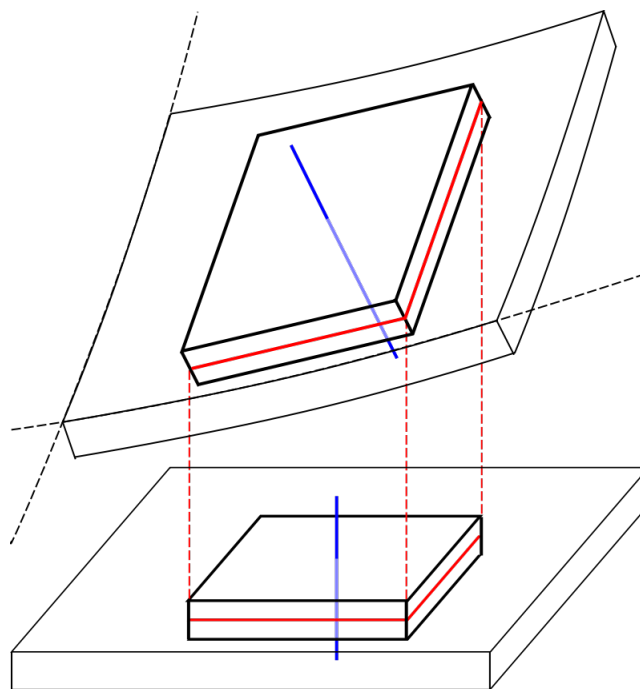

Figure 1.8: Displacement of the midsurface of a plate and of a normal line to the midsurface (from http://en.wikipedia.org/wiki/Plate_theory)

From those axioms, the displacement of the plate can be characterized. Let $u = (u_1, u_2, u_3)$ be the displacement of the plate, $x = (x_1, x_2, x_3)$ a point of the plate. Let $x = (x_1, x_2, 0)$ a point on the midsurface, and $\hat{u} = (\hat{u}_1, \hat{u}_2, \hat{u}_3)$ the displacement of the midsurface. The assumption (i) means that

$$u_3(x_1, x_2, x_3) = \hat{u}_3(x_1, x_2).$$

To use assumption (ii) let us look at the rotation of the midsurface. Let θ_1 be the rotation around the axis x_1 and θ_2 the rotation around the axis x_2 (see Figure 1.9). The displacement u can be written as

$$u(x) = \begin{pmatrix} \hat{u}_1(x_1, x_2) + x_3\theta_2(x_1, x_2) \\ \hat{u}_2(x_1, x_2) - x_3\theta_1(x_1, x_2) \\ \hat{u}_3(x_1, x_2) \end{pmatrix}.$$

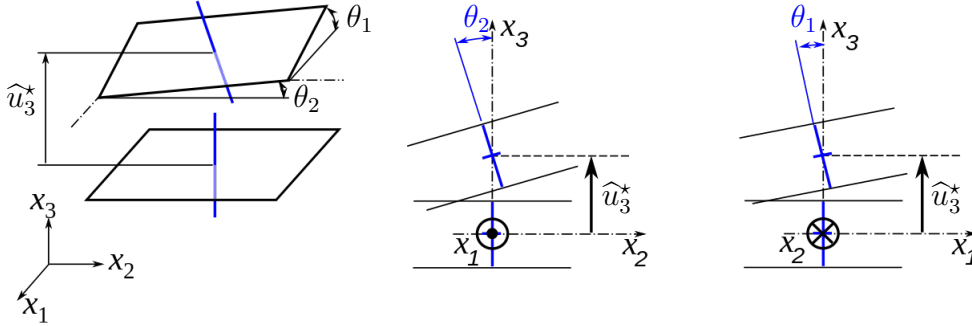

Figure 1.9: Rotation of the midsurface of a plate (from http://en.wikipedia.org/wiki/Plate_theory)

In the regime of small deformations,

$$\tan \theta_1 = \partial_2 \hat{u}_3, \quad \tan \theta_2 = -\partial_1 \hat{u}_3.$$

Also, in the regime of small deformations $\theta_1 \ll 1$ and $\theta_2 \ll 1$, thus $\tan \theta_1 \approx \theta_1$ and $\tan \theta_2 \approx \theta_2$. Then:

$$\theta_1 \approx \partial_2 \hat{u}_3, \quad \theta_2 \approx -\partial_1 \hat{u}_3.$$

The displacement can thus be written as

$$u(x) = \begin{pmatrix} \hat{u}_1(x_1, x_2) - x_3\partial_1 \hat{u}_3(x_1, x_2) \\ \hat{u}_2(x_1, x_2) + x_3\partial_2 \hat{u}_3(x_1, x_2) \\ \hat{u}_3(x_1, x_2) \end{pmatrix}.$$

The linearized strain tensor $e(u)$, where $e_{ij} = \frac{1}{2}(\partial_i u_j + \partial_j u_i)$, can also be derived from those axioms. Because of assumption (i), $e_{33}(u) = 0$, and because of assumption (ii) $e_{13}(u) = e_{23}(u) = e_{31}(u) = e_{32}(u) = 0$. This derivation of the strain tensor might be incorrect because the shear strain is neglected and the out of plane Poisson effect as well.

Reissner-Mindlin plate theory

An extension of the Kirchhoff-Love theory that addresses this problem is the Reissner-Mindlin theory. It was proposed by Reissner in 1945 [85] and by Mindlin in 1951 [77]

to relax the assumption (ii) of the Kirchoff-Love theory (and thus to better capture the shear strain and the shear stress). The idea is to suppose that the normal line to the midsurface remains straight through the transformation, but not necessarily normal to the transformed midsurface. The axioms of Mindlin are:

- (i) the transverse displacement of the plate is uniform through the thickness;
- (iii) the variation of the in-plane displacement in the thickness is linear.

From those two axioms, the displacement field u can be written as

$$u(x) = \begin{pmatrix} \widehat{u}_1(x_1, x_2) - x_3\phi_1(x_1, x_2) \\ \widehat{u}_2(x_1, x_2) - x_3\phi_2(x_1, x_2) \\ \widehat{u}_3(x_1, x_2) \end{pmatrix}.$$

The Kirchoff-Love theory is a particular case of the Reissner-Mindlin theory, where $\phi_1 = \partial_1 \widehat{u}_3$ and $\phi_2 = \partial_2 \widehat{u}_3$. The derivation of the strain tensor now shows that

$$e_{13}(u) = \frac{1}{2}(\partial_1 \widehat{u}_3 - \phi_1), \quad e_{23}(u) = \frac{1}{2}(\partial_2 \widehat{u}_3 - \phi_2).$$

The shear strain is not neglected in this theory. The Reissner-Mindlin plate theory is the most widely used plate theory for homogeneous plates.

Bending-Gradient theory

The Bending-Gradient theory has been developed by Lebée and Sab in [68] and [69]. It is an extension of the work of Reissner in [85]. The approach is axiomatic, but can be justified by formal asymptotic methods (see [70]). The Bending-Gradient theory adds degrees of freedom in the derivation of the shear stress for laminated plates, involving the gradient of the bending moment.

1.4.2 Asymptotic derivation of the homogeneous plate model

If the plate is heterogeneous, for example if the material is periodic in the in-plane directions, it is more complicated to guess the relevant axioms to derive a model. In this case, it is easier to use an asymptotic derivation [18]. The idea of an asymptotic derivation is to start from the 3D linear elasticity problem on a domain whose thickness is a small parameter ε , and make this parameter go to 0. To illustrate our arguments, we show here the calculations that lead to the model in the case of a homogeneous plate.

The plate model



Figure 1.10: The plate $\Omega^\varepsilon := \omega \times \left(-\frac{\varepsilon}{2}, \frac{\varepsilon}{2}\right)$

Let ω be the midsurface of the plate and $\Omega^\varepsilon := \omega \times \left(-\frac{\varepsilon}{2}, \frac{\varepsilon}{2}\right)$ be the plate (see Figure 1.10). Let A be the elasticity tensor, $\widetilde{u}^\varepsilon$ the displacement field, $\widetilde{\sigma}^\varepsilon$ the stress

tensor and \tilde{f}^ε be a constant external load. Then, the linear elasticity problem reads as

$$\begin{cases} -\operatorname{div} \tilde{\sigma}^\varepsilon = \tilde{f}^\varepsilon & \text{on } \Omega^\varepsilon \\ \tilde{\sigma}^\varepsilon = A : e(\tilde{u}^\varepsilon) & \text{on } \Omega^\varepsilon \\ \tilde{u}^\varepsilon = 0 & \text{on } \partial\omega \times \left(-\frac{\varepsilon}{2}, \frac{\varepsilon}{2}\right) \\ \tilde{\sigma}^\varepsilon \cdot e_3 = 0 & \text{on } \omega \times \left\{\pm\frac{\varepsilon}{2}\right\} \end{cases}$$

where $e(\tilde{u}^\varepsilon) = \frac{1}{2} (\nabla \tilde{u}^\varepsilon + (\nabla \tilde{u}^\varepsilon)^T)$ is the strain tensor. If the plate is clamped, the solution is in the space

$$V^\varepsilon := \left\{ v \in H^1(\Omega^\varepsilon)^3, \quad v = 0 \text{ on } \partial\omega \times \left(-\frac{\varepsilon}{2}, \frac{\varepsilon}{2}\right) \right\}.$$

We also suppose that A is a symmetric tensor, in the sense that for any i, j, k, l in $1, 2, 3$,

$$A_{ijkl} = A_{jikl} = A_{ijlk} = A_{klij}.$$

The weak formulation of this problem is: find \tilde{u}^ε in V^ε such that for any v in V^ε ,

$$\int_{\Omega^\varepsilon} A e(\tilde{u}^\varepsilon) : e(v) = \int_{\Omega^\varepsilon} \tilde{f}^\varepsilon \cdot v.$$

For any $\varepsilon > 0$, this problem is well posed (upon standard assumptions on A) and has a unique solution. The difficulty to study the limit behaviour when $\varepsilon \rightarrow 0$ is that the solutions \tilde{u}^ε are defined on different domains Ω^ε . It is thus convenient to rescale the problem so that we only have one domain, $\Omega := \Omega^1$. We define the functions u^ε and f , such that for any $x = (x_1, x_2, x_3)$ in Ω ,

$$u^\varepsilon(x) := \begin{pmatrix} \tilde{u}_1^\varepsilon \\ \tilde{u}_2^\varepsilon \\ \varepsilon \tilde{u}_3^\varepsilon \end{pmatrix} (x_1, x_2, \varepsilon x_3) \quad \text{and} \quad f := \begin{pmatrix} \tilde{f}_1 \\ \tilde{f}_2 \\ \varepsilon \tilde{f}_3 \end{pmatrix}.$$

Note the multiplying factor ε for the third component of u^ε and f . Recall also that we have supposed \tilde{f}^ε to be constant. We also assume from now on that f is independent of ε . We can define a rescaled symmetric gradient e^ε , such that

$$e^\varepsilon(v) = \begin{pmatrix} e_{11}(v) & e_{12}(v) & \varepsilon^{-1} e_{13}(v) \\ e_{21}(v) & e_{22}(v) & \varepsilon^{-1} e_{23}(v) \\ \varepsilon^{-1} e_{31}(v) & \varepsilon^{-1} e_{32}(v) & \varepsilon^{-2} e_{33}(v) \end{pmatrix}.$$

This definition ensures that, for any x in Ω , $e^\varepsilon(u^\varepsilon)(x) = e(\tilde{u}^\varepsilon)(x_1, x_2, \varepsilon x_3)$. Then, the weak formulation of the rescaled problem is: find u^ε in $V := V^1$ such that for any v in V ,

$$\int_{\Omega} A e^\varepsilon(u^\varepsilon) : e^\varepsilon(v) = \int_{\Omega} f \cdot v. \quad (1.11)$$

Using a Korn inequality, we deduce that $e^\varepsilon(u^\varepsilon)$ is bounded in $(L^2(\Omega))^{3 \times 3}$ (therefore $e(u^\varepsilon)$ is also bounded in $(L^2(\Omega))^{3 \times 3}$) and that u^ε is bounded in $(L^2(\Omega))^3$. This implies two results:

- (1) there exists a function u^* in $V \subset (H^1(\Omega))^3$ such that $u^\varepsilon \rightharpoonup u^*$ weakly in $(H^1(\Omega))^3$ (up to a subsequence extraction);
- (2) $e_{13}(u^\varepsilon) \xrightarrow{\varepsilon \rightarrow 0} 0$, $e_{23}(u^\varepsilon) \xrightarrow{\varepsilon \rightarrow 0} 0$, and $e_{33}(u^\varepsilon) \xrightarrow{\varepsilon \rightarrow 0} 0$ in $L^2(\Omega)$.

From those results, we deduce that $e_{13}(u^*) = e_{23}(u^*) = e_{33}(u^*) = 0$. Thus there exists some \widehat{u}^* in $(H^1(\omega))^3$ such that, for any $x = (x_1, x_2, x_3)$ in Ω ,

$$u^*(x) = \begin{pmatrix} \widehat{u}_1^*(x_1, x_2) - x_3 \partial_1 \widehat{u}_3^*(x_1, x_2) \\ \widehat{u}_2^*(x_1, x_2) - x_3 \partial_2 \widehat{u}_3^*(x_1, x_2) \\ \widehat{u}_3^*(x_1, x_2) \end{pmatrix}.$$

Note that \widehat{u}^* only depends on x_1 and x_2 and not x_3 . It is exactly the form of displacement derived by the Kirchoff-Love theory. The asymptotic analysis states that the approximation is correct (at least in the L^2 norm) for a plate that is infinitely thin, but a priori not for $\varepsilon > 0$.

We define the set of functions that are a Kirchoff-Love displacement as

$$\mathcal{V}_{KL} := \left\{ v \in (H^1(\Omega))^3, \exists \widehat{v} \in (H_0^1(\omega))^2 \times H_0^2(\omega), v = \widehat{v} - x_3 \nabla \widehat{v}_3 \right\},$$

where we note that the last component of $\nabla \widehat{v}_3$ vanishes because \widehat{v}_3 only depends on x_1 and x_2 (and therefore $v_3 = \widehat{v}_3$). For any v in \mathcal{V}_{KL} , we have

$$e(v) = \begin{pmatrix} e_{11}(\widehat{v}) & e_{12}(\widehat{v}) & 0 \\ e_{21}(\widehat{v}) & e_{22}(\widehat{v}) & 0 \\ 0 & 0 & 0 \end{pmatrix} - x_3 \begin{pmatrix} \partial_{11} \widehat{v}_3 & \partial_{12} \widehat{v}_3 & 0 \\ \partial_{21} \widehat{v}_3 & \partial_{22} \widehat{v}_3 & 0 \\ 0 & 0 & 0 \end{pmatrix}. \quad (1.12)$$

We now proceed with the computations that lead to the 2D plate model, in the case of an isotropic homogeneous 3D thin structure. There are multiple ways to present those computations, and we follow here the presentation of [47]. The isotropy hypothesis is classical and means that

$$A_{ijkl} = \lambda \delta_{ij} \delta_{kl} + \mu (\delta_{ik} \delta_{jl} + \delta_{il} \delta_{jk}),$$

where λ and μ are the Lamé coefficients.

We define the function y^ε , such that for any $x = (x_1, x_2, x_3)$ in Ω ,

$$\begin{aligned} y_1^\varepsilon(x) &:= \varepsilon^{-1} u_1^\varepsilon(x) + \int_{-\frac{1}{2}}^{x_3} \varepsilon^{-1} \partial_1 u_3^\varepsilon(x_1, x_2, t) dt - \int_{-\frac{1}{2}}^{\frac{1}{2}} \left[\varepsilon^{-1} u_1^\varepsilon(x) + \int_{-\frac{1}{2}}^{x_3} \varepsilon^{-1} u_3^\varepsilon(x_1, x_2, t) dt \right] dx_3 \\ y_2^\varepsilon(x) &:= \varepsilon^{-1} u_2^\varepsilon(x) + \int_{-\frac{1}{2}}^{x_3} \varepsilon^{-1} \partial_2 u_3^\varepsilon(x_1, x_2, t) dt - \int_{-\frac{1}{2}}^{\frac{1}{2}} \left[\varepsilon^{-1} u_2^\varepsilon(x) + \int_{-\frac{1}{2}}^{x_3} \varepsilon^{-1} \partial_2 u_3^\varepsilon(x_1, x_2, t) dt \right] dx_3 \\ y_3^\varepsilon(x) &:= \varepsilon^{-2} u_3^\varepsilon(x) - \int_{-\frac{1}{2}}^{\frac{1}{2}} \varepsilon^{-2} u_3^\varepsilon(x) dx_3. \end{aligned}$$

This definition ensures that

$$e^\varepsilon(u^\varepsilon) = \begin{pmatrix} e_{11}(u^\varepsilon) & e_{12}(u^\varepsilon) & \frac{1}{2} \partial_3 y_1^\varepsilon \\ e_{21}(u^\varepsilon) & e_{22}(u^\varepsilon) & \frac{1}{2} \partial_3 y_2^\varepsilon \\ \frac{1}{2} \partial_3 y_1^\varepsilon & \frac{1}{2} \partial_3 y_2^\varepsilon & \partial_3 y_3^\varepsilon \end{pmatrix} =: e(u^\varepsilon, y^\varepsilon). \quad (1.13)$$

In addition, for any (x_1, x_2) , the mean of $y^\varepsilon(x_1, x_2, \cdot)$ vanishes. Since $e^\varepsilon(u^\varepsilon)$ is bounded in $L^2(\Omega)^{3 \times 3}$, the function y^ε is bounded in $[L^2(\omega, H^1(-\frac{1}{2}, \frac{1}{2}))]^3$ and is such that for

any (x_1, x_2) in ω , $\int_{-\frac{1}{2}}^{\frac{1}{2}} y^\varepsilon(x_1, x_2, t) dt = 0$ therefore it weakly converges in $[L^2(\omega, H^1(-\frac{1}{2}, \frac{1}{2}))]^3$

to some y^* in $[L^2(\omega, H^1(-\frac{1}{2}, \frac{1}{2}))]^3$. It implies that

$$e^\varepsilon(u^\varepsilon) = e(u^\varepsilon, y^\varepsilon) \rightharpoonup e(u^*, y^*) \quad \text{weakly in } L^2(\Omega)^{3 \times 3}. \quad (1.14)$$

Let v be a function in \mathcal{V}_{KL} , and z a function in V . Let v^ε be defined by

$$v^\varepsilon = v + \varepsilon \begin{pmatrix} z_1 \\ z_2 \\ \varepsilon z_3 \end{pmatrix}.$$

We note that $v^\varepsilon \in V$, and that with $e(\cdot, \cdot)$ defined by (1.13),

$$e^\varepsilon(v^\varepsilon) = e(v, z) + O(\varepsilon).$$

In order to establish the limit problem solved by u^* , we take v^ε as a test function in (1.11) and we pass to the limit $\varepsilon \rightarrow 0$:

$$\int_{\Omega} Ae^\varepsilon(u^\varepsilon) : e^\varepsilon(v^\varepsilon) \xrightarrow{\varepsilon \rightarrow 0} \int_{\Omega} Ae(u^*, y^*) : e(v, z) \quad \text{and} \quad \int_{\Omega} f \cdot v^\varepsilon \xrightarrow{\varepsilon \rightarrow 0} \int_{\Omega} f \cdot v,$$

thus, for any $v \in \mathcal{V}_{KL}$ and $z \in V$,

$$\int_{\Omega} Ae(u^*, y^*) : e(v, z) = \int_{\Omega} f \cdot v. \quad (1.15)$$

Because of the assumption on the isotropy of A , the left handside reads as

$$\int_{\Omega} Ae(u^*, y^*) : e(v, z) = \int_{\Omega} \lambda(\text{tr } e(u^*) + \partial_3 y_3^*)(\text{tr } e(v) + \partial_3 z_3) + 2\mu(e(u^*) : e(v) + \partial_3 y_3^* \cdot \partial_3 z).$$

To eliminate y^* from (1.15), let $v = 0$ and $z = z_3 e_3$. Then

$$\int_{\Omega} [\lambda \text{tr } e(u^*) + (\lambda + 2\mu)\partial_3 y_3^*] \partial_3 z_3 = 0.$$

This implies that $\partial_3 y_3^* = -\frac{\lambda}{\lambda + 2\mu} \text{tr } e(u^*)$, because it is true for any z_3 in $L^2(\omega, H^1(-\frac{1}{2}, \frac{1}{2}))$.

Taking now $z = 0$ in (1.15), we get

$$\forall v \in \mathcal{V}_{KL}, \quad \int_{\Omega} \lambda(\text{tr } e(u^*) + \partial_3 y_3^*) \text{tr } e(v) + 2\mu e(u^*) : e(v) = \int_{\Omega} f \cdot v$$

and thus, using the above expression for $\partial_3 y_3^*$, we obtain

$$\forall v \in \mathcal{V}_{KL}, \quad \int_{\Omega} \lambda^* \text{tr } e(u^*) \text{tr } e(v) + 2\mu e(u^*) : e(v) = \int_{\Omega} f \cdot v \quad (1.16)$$

where

$$\lambda^* = \frac{2\lambda\mu}{\lambda + 2\mu}. \quad (1.17)$$

The problem (1.16) is well posed on \mathcal{V}_{KL} and thus completely characterizes the function u^* . We note that the whole sequence $(u^\varepsilon)_{\varepsilon > 0}$ (and not just a subsequence) therefore converges to u^* . In addition, we observe that the limit material is again isotropic (but with different Lamé coefficients).

An alternative proof with strong convergence

We now provide another proof, suggested to us by Annie Raoult, for the above results.

Using (1.11) and the Korn inequality, we see that $e^\varepsilon(u^\varepsilon)$ is bounded in $(L^2(\Omega))^{3 \times 3}$. This implies that there exists a function κ in $(L^2(\Omega))^{3 \times 3}$ such that $e^\varepsilon(u^\varepsilon) \rightharpoonup \kappa$ weakly in $(L^2(\Omega))^{3 \times 3}$ (up to a subsequence extraction).

For $v \in V$, it implies that

$$\int_{\Omega} Ae^\varepsilon(u^\varepsilon) : \varepsilon^2 e^\varepsilon(v) \xrightarrow{\varepsilon \rightarrow 0} \int_{\Omega} (A\kappa)_{33} \partial_3 v_3.$$

Thus, because of (1.11) $\int_{\Omega} (A\kappa)_{33} \partial_3 v_3 = 0$. It is true for any v_3 in $L^2(\omega, H^1(-\frac{1}{2}, \frac{1}{2}))$, thus $(A\kappa)_{33} = 0$. For $v \in V$, such that $v = (v_1, v_2, 0)$ it also implies that

$$\int_{\Omega} Ae^\varepsilon(u^\varepsilon) : \varepsilon e^\varepsilon(v) \xrightarrow{\varepsilon \rightarrow 0} \int_{\Omega} (A\kappa)_{\alpha 3} \partial_3 v_\alpha.$$

Thus, because of (1.11) it stands that $\int_{\Omega} (A\kappa)_{\alpha 3} \partial_3 v_\alpha = 0$, and for $\alpha = 1, 2$, $(A\kappa)_{\alpha 3} = 0$. Now, for $v \in \mathcal{V}_{KL}$,

$$\int_{\Omega} Ae^\varepsilon(u^\varepsilon) : e(v) \xrightarrow{\varepsilon \rightarrow 0} \int_{\Omega} (A\kappa)_{\alpha\beta} e_{\alpha\beta}(v).$$

Thus, because of (1.11) it stands that

$$\int_{\Omega} (A\kappa)_{\alpha\beta} e_{\alpha\beta}(v) = \int_{\Omega} f \cdot v. \quad (1.18)$$

For an isotropic material, we have $(A\kappa)_{33} = \lambda \kappa_{\alpha\alpha} + (\lambda + 2\mu) \kappa_{33}$, hence $\kappa_{33} = -\frac{\lambda}{\lambda + 2\mu} \kappa_{\alpha\alpha}$. Thus

$$\begin{aligned} (A\kappa)_{\alpha\beta} &= \lambda \delta_{\alpha\beta} (\kappa_{\tau\tau} + \kappa_{33}) + 2\mu \kappa_{\alpha\beta} \\ &= \lambda^* \delta_{\alpha\beta} \kappa_{\tau\tau} + 2\mu \kappa_{\alpha\beta}, \end{aligned}$$

where $\lambda^* = \frac{2\lambda\mu}{\lambda + 2\mu}$. As u^ε weakly converges in $(H^1(\Omega))^3$ to u^* , for $\alpha, \beta = 1, 2$ $\kappa_{\alpha\beta} = e_{\alpha\beta}(u^*)$. Thus, (1.18) can be written as

$$\forall v \in \mathcal{V}_{KL}, \int_{\Omega} \lambda^* \operatorname{tr} e(u^*) \operatorname{tr} e(v) + 2\mu e(u^*) : e(v) = \int_{\Omega} f \cdot v,$$

which is exactly (1.16).

We now prove a result of strong convergence. For a matrix ξ , we define the norm $\|\xi\|_A = \int_{\Omega} A\xi : \xi$. Note that (1.11) implies that $\|e^\varepsilon(u^\varepsilon)\|_A = \int_{\Omega} f \cdot u^\varepsilon$. We have already shown that for $i = 1, 2, 3$, $\kappa_{i3} = 0$, then

$$\|\kappa\|_A = \int_{\Omega} (A\kappa)_{\alpha\beta} \kappa_{\alpha\beta} = \int_{\Omega} (A\kappa)_{\alpha\beta} e_{\alpha\beta}(u^*) = \int_{\Omega} f \cdot u^*$$

The function u^ε weakly converges in $(L^2(\Omega))^3$ to u^* , then

$$\|e^\varepsilon(u^\varepsilon)\|_A = \int_{\Omega} f \cdot u^\varepsilon \xrightarrow{\varepsilon \rightarrow 0} \int_{\Omega} f \cdot u^* = \|\kappa\|_A.$$

We showed that $e^\varepsilon(u^\varepsilon) \rightharpoonup \kappa$ weakly in $(L^2(\Omega))^{3 \times 3}$ and that $\|e^\varepsilon(u^\varepsilon)\|_A \xrightarrow{\varepsilon \rightarrow 0} \|\kappa\|_A$. It implies that $\|e^\varepsilon(u^\varepsilon) - \kappa\|_A \xrightarrow{\varepsilon \rightarrow 0} 0$. It thus stands that $\|e^\varepsilon(u^\varepsilon) - \kappa\|_{(L^2(\Omega))^{3 \times 3}} \xrightarrow{\varepsilon \rightarrow 0} 0$. For

$\alpha, \beta = 1, 2$ it implies that $e_{\alpha\beta}(u^\varepsilon) \xrightarrow{\varepsilon \rightarrow 0} \kappa_{\alpha\beta} = e_{\alpha\beta}(u^*)$ in $L^2(\Omega)$. Hence, we showed that

$$u^\varepsilon \xrightarrow{\varepsilon \rightarrow 0} u^* \quad \text{strongly in } (H^1(\Omega))^3.$$

Note that we showed a result on the strong convergence of $e(u^\varepsilon)$, but not on the strong convergence $e^\varepsilon(u^\varepsilon)$.

The membrane/bending distinction

We now revisit the asymptotic process (of passing to the limit of a very thin plate) under some symmetry assumptions that are weaker than the above isotropic assumption. These symmetry assumptions enable us to split the problem in two independent problems, which are commonly called in the literature *membrane* and *bending*.

More precisely, let us define

$$\begin{aligned} \mathcal{E} &:= \left\{ v \in L^2(\Omega), \text{ s.t. for almost any } x' \in \omega, \left(-\frac{1}{2}, \frac{1}{2}\right) \ni x_3 \mapsto v(x', x_3) \text{ is even} \right\} \\ \mathcal{O} &:= \left\{ v \in L^2(\Omega), \text{ s.t. for almost any } x' \in \omega, \left(-\frac{1}{2}, \frac{1}{2}\right) \ni x_3 \mapsto v(x', x_3) \text{ is odd} \right\}. \end{aligned}$$

We point out that

$$L^2(\Omega)^3 = (\mathcal{E}^2 \times \mathcal{O}) \oplus (\mathcal{O}^2 \times \mathcal{E}).$$

This orthogonal decomposition has the following consequences: it holds that

$$\mathcal{V}_{KL} = \mathcal{V}_{KL}^{\mathcal{M}} \oplus \mathcal{V}_{KL}^{\mathcal{B}} \quad (1.19)$$

where

$$\mathcal{V}_{KL}^{\mathcal{M}} := H_0^1(\omega)^2 \times \{0\} \subset \mathcal{E}^2 \times \mathcal{O}$$

and

$$\mathcal{V}_{KL}^{\mathcal{B}} := \left\{ v \in (H^1(\Omega))^3, \exists \widehat{v}_3 \in H_0^2(\omega), v = \begin{pmatrix} -x_3 \partial_1 \widehat{v}_3 \\ -x_3 \partial_2 \widehat{v}_3 \\ \widehat{v}_3 \end{pmatrix} \right\} \subset \mathcal{O}^2 \times \mathcal{E}.$$

From now on, we make the following additional assumptions on the tensor-valued field A : for all $1 \leq \alpha, \beta, \gamma, \delta \leq 2$,

$$\begin{aligned} A_{\alpha\beta\gamma\delta}, A_{\alpha\beta 33}, A_{\alpha 3\beta 3}, A_{3333} &\in \mathcal{E}, \\ A_{\alpha 333}, A_{\alpha\beta\sigma 3} &\in \mathcal{O}. \end{aligned} \quad (1.20)$$

Remark 1.7. *In the case when the plate is composed only of isotropic phases, the assumption (1.20) amounts to assuming that the material is symmetric with respect to its medium plane.*

Remark 1.8. *In the case when the plate is homogeneous, (1.20) simply means that some of the components of A vanish: [et la, tu écris $A_{\alpha 333} = A_{\alpha\beta\sigma 3} = 0$].*

In view of (1.19), the function u^* can be decomposed as $u^* = u_{\mathcal{B}}^* + u_{\mathcal{M}}^*$ with $u_{\mathcal{B}}^*$ in $\mathcal{V}_{KL}^{\mathcal{B}}$ and $u_{\mathcal{M}}^*$ in $\mathcal{V}_{KL}^{\mathcal{M}}$. It holds that

$$u_{\mathcal{B}}^* = \begin{pmatrix} -x_3 \partial_1 \widehat{u}_3^* \\ -x_3 \partial_2 \widehat{u}_3^* \\ \widehat{u}_3^* \end{pmatrix} \quad \text{and} \quad u_{\mathcal{M}}^* = \begin{pmatrix} \widehat{u}_1^* \\ \widehat{u}_2^* \\ 0 \end{pmatrix}.$$

Recalling that the function f is constant, it can also be decomposed as $f = f_B + f_M$

$$\text{with } f_B = \begin{pmatrix} 0 \\ 0 \\ f_3 \end{pmatrix} \text{ and } f_M = \begin{pmatrix} f_1 \\ f_2 \\ 0 \end{pmatrix}.$$

For the sake of simplicity, we go back to the isotropic case, but a similar result holds for the more general case of (1.20). The equation (1.16) can then be decoupled using (1.12) into two equations, the membrane equation

$$\int_{\omega} \lambda^* \operatorname{tr} e(u_M^*) \operatorname{tr} e(v_M) + 2\mu e(u_M^*) : e(v_M) = \int_{\omega} f_M \cdot v_M, \quad (1.21)$$

and the bending equation

$$\frac{1}{12} \int_{\omega} \lambda^* \Delta \widehat{u}_3^* \Delta \widehat{v}_3 + 2\mu \nabla^2 \widehat{u}_3^* : \nabla^2 \widehat{v}_3 = \int_{\omega} f_B \cdot v_B \quad (1.22)$$

for any v_M in \mathcal{V}_{KL}^M and \widehat{v}_3 in $H_0^2(\omega)$. Note that the equations are posed on ω .

Error estimates

The derivation of plate models provides a way to characterize u^* , which is the limit of u^ε when the thickness ε of the plate goes to 0. However the convergence of u^ε to u^* is only a weak convergence in H^1 and no quantitative estimation of error is given.

In [32], Destuynder gives an error estimate for the approximation of $\sigma^\varepsilon = Ae^\varepsilon(u^\varepsilon)$ by its weak limit $\sigma^* = Ae(u^*, y^*)$ (see (1.14)) under assumption (1.20) (we recall that, in this section, A is homogeneous). It actually turns out that, in this particular homogeneous case, the convergence of σ^ε to σ^* is *strong*.

Theorem 1.9. *Under some regularity assumptions on f , there is a constant C independent of ε such that for any α, β in $\{1, 2\}$,*

$$\begin{aligned} \|\sigma_{\alpha\beta}^\varepsilon - \sigma_{\alpha\beta}^*\|_{L^2(\Omega)} &\leq C\sqrt{\varepsilon} \\ \|\sigma_{\alpha 3}^\varepsilon - \sigma_{\alpha 3}^*\|_{L^2((-\frac{1}{2}, \frac{1}{2}), H^{-1}(\omega))} &\leq C\sqrt{\varepsilon} \\ \|\sigma_{33}^\varepsilon - \sigma_{33}^*\|_{L^2((-\frac{1}{2}, \frac{1}{2}), H^{-2}(\omega))} &\leq C\sqrt{\varepsilon}. \end{aligned}$$

In [28], Dauge and Gruais give stronger results and show (with an arbitrarily small error) that the function u^ε can be approximated arbitrarily close by an expansion in power of ε similar to the expansion (1.5) of the homogenization theory.

Theorem 1.10. *Under some regularity assumptions on f ,*

$$\left\| u^\varepsilon - \sum_{i=0}^N \varepsilon^i u^i + \chi \sum_{i=1}^N \varepsilon^i w^i \right\|_{H^1(\Omega)^3} \leq C\varepsilon^{N+\frac{1}{2}}$$

The functions u_i , $i \geq 0$ are solutions to PDEs posed on Ω and the functions χ and w^i , $i \geq 0$ are functions that correct the error made on the boundary and whose definition is out of the scope of this introduction. Of course, the leading order term is $u^0 = u^*$ solution to (1.16).

In Chapter 2 we get a result somehow similar to Theorem 1.9 in the case of heterogeneous plates (see also Section 1.6). It will not be a generalization in the sense that, in the heterogeneous case we will consider there, σ^ε does not strongly converge to σ^* .

1.4.3 Asymptotic derivation of the heterogeneous plate model

If the plate is heterogenous, it is easier to use an asymptotic derivation to obtain a plate model than an axiomatic derivation, for which a good intuition may be difficult to have. The elasticity tensor A^ε of the rescaled problem (posed on Ω) now depends on ε . For the problem to be well posed, we suppose that A^ε is elliptic in the sense that

$$\exists c_-, c_+ > 0, \quad \forall \xi \in \mathbb{R}^{3 \times 3}, \quad \forall x \in \Omega, \quad c_- |\xi|^2 \leq A^\varepsilon(x) \xi : \xi \leq c_+ |\xi|^2. \quad (1.23)$$

We suppose that the constants c_- and c_+ are independent of ε . We also suppose that A^ε is a symmetric tensor, in the sense that for any i, j, k, l in $1, 2, 3$,

$$A_{ijkl}^\varepsilon = A_{jikl}^\varepsilon = A_{ijlk}^\varepsilon = A_{klij}^\varepsilon. \quad (1.24)$$

We describe here the derivation of the plate model in two cases: when the heterogeneities are "in-plane" and periodic [18] and when the heterogeneities are "out-of-plane" [47].

In-plane heterogeneities

In this section are presented results that can be found in [18] and whose proofs will be recalled in Chapter 2. The first author of [18] has performed the same work for a diffusion equation in [17].

The case of "in-plane" heterogeneities corresponds to the Figure 1.3. We introduce $Y := (0, 1)^2$, $\mathcal{Y} := Y \times \left(-\frac{1}{2}, \frac{1}{2}\right)$ and suppose that there exists an application A from \mathbb{R}^2 to the set of elliptic tensor that is periodic (of period Y) with regards to its two first variables, such that for any $x = (x_1, x_2, x_3)$,

$$A^\varepsilon(x) = A\left(\frac{x_1}{\varepsilon}, \frac{x_2}{\varepsilon}\right)$$

and

$$\exists c_-, c_+ > 0, \quad \forall \xi \in \mathbb{R}^{3 \times 3}, \quad \forall x \in \mathbb{R}^2, \quad c_- |\xi|^2 \leq A(x) \xi : \xi \leq c_+ |\xi|^2. \quad (1.25)$$

Remark 1.11. *The assumption that the size of the heterogeneities and the thickness of the plate are both of the same order of magnitude (and equal to ε) can be relaxed. In [17] and [18], the authors have studied the case of a plate of thickness μ with heterogeneities of size ε , in three different regimes: $\mu \ll \varepsilon$, $\varepsilon \ll \mu$ and $\varepsilon = \lambda \mu$ for some $\lambda > 0$.*

The derivation of the plate model in the last case is similar to the derivation when $\lambda = 1$ that we are going to describe here. The other two cases ($\varepsilon \gg \mu$ and $\varepsilon \ll \mu$) can then be obtained by taking respectively $\lambda \rightarrow \infty$ or $\lambda \rightarrow 0$ in the plate model.

Remark 1.12. *In [61] and [62] the authors have studied the case of a plate which is homogeneous but whose thickness has variations. In their study, the plate is defined by*

$$\Omega^\varepsilon := \left\{ x \in \mathbb{R}^3, (x_1, x_2) \in \omega, |x_3| < \frac{\varepsilon}{2} h\left(\frac{x_1}{\varepsilon^a}, \frac{x_2}{\varepsilon^a}\right) \right\},$$

for some periodic function h and some real positive number a . They present three limit models for variations of the thickness slower than ($a < 1$), on the order of ($a = 1$), and faster than ($a > 1$) the mean value of the thickness ε .

The weak formulation of the problem is: find u^ε in V such that for any v in V ,

$$\int_{\Omega} A\left(\frac{x_1}{\varepsilon}, \frac{x_2}{\varepsilon}\right) e^\varepsilon(u^\varepsilon) : e^\varepsilon(v) = \int_{\Omega} f \cdot v. \quad (1.26)$$

Using a Korn inequality, we deduce that $e^\varepsilon(u^\varepsilon)$ is bounded in $(L^2(\Omega))^{3 \times 3}$ (therefore $e(u^\varepsilon)$ is also bounded in $(L^2(\Omega))^{3 \times 3}$) and that u^ε is bounded in $(L^2(\Omega))^3$. This implies that there exists a function u^* in $(H^1(\Omega))^3$ such that $u^\varepsilon \rightharpoonup u^*$ weakly in $(H^1(\Omega))^3$ up to the extraction of a subsequence.

The procedure to identify the limit problem is similar to the classical periodic homogenization case (see Section 1.2). The function u^ε is supposed to have the form of an expansion in power of ε , with functions that have two scales, 1 and ε . Such an expansion reads

$$u^\varepsilon(x) = u^0\left(x, \frac{x_1}{\varepsilon}, \frac{x_2}{\varepsilon}\right) + \varepsilon u^1\left(x, \frac{x_1}{\varepsilon}, \frac{x_2}{\varepsilon}\right) + \dots \quad (1.27)$$

where the u_i functions are assumed to be periodic with respect to their last two variables. The key to this formal computation is to suppose that the scales 1 and ε are sufficiently separated so that the variables $x = (x_1, x_2, x_3)$ and $\left(\frac{x_1}{\varepsilon}, \frac{x_2}{\varepsilon}\right)$ can be viewed as independent variables. Inserting (1.27) in (1.26) yields a cascade of equations linking the u_i one to each other.

Similarly to the classical homogenization case, the procedure leads to introduce functions called "correctors". Let

$$\mathcal{W}(\mathcal{Y}) := \left\{ v \in \left(H_{loc}^1 \left(\mathbb{R}^2 \times \left(-\frac{1}{2}, \frac{1}{2} \right) \right) \right)^3, \forall z \in \left(-\frac{1}{2}, \frac{1}{2} \right), v(\cdot, z) \text{ is } Y\text{-periodic and } \int_{\mathcal{Y}} v = 0 \right\}.$$

For α, β in $\{1, 2\}$, let $w_{\mathcal{M}}^{\alpha\beta}$ be the unique solution in $\mathcal{W}(\mathcal{Y})$ to

$$\begin{cases} -\operatorname{div} A(e(w_{\mathcal{M}}^{\alpha\beta}) + e_\alpha \otimes e_\beta) = 0 \\ A(e(w_{\mathcal{M}}^{\alpha\beta}) + e_\alpha \otimes e_\beta) \cdot e_3 = 0 \text{ on } \mathcal{Y}^\pm \end{cases} \quad (1.28)$$

where $\mathcal{Y}^\pm := Y \times \{\pm \frac{1}{2}\}$ are the top and bottom faces of the cell \mathcal{Y} .

For α, β in $\{1, 2\}$, let $w_{\mathcal{B}}^{\alpha\beta}$ be the unique solution in $\mathcal{W}(\mathcal{Y})$ to

$$\begin{cases} -\operatorname{div} A(e(w_{\mathcal{B}}^{\alpha\beta}) - x_3 e_\alpha \otimes e_\beta) = 0 \\ A(e(w_{\mathcal{B}}^{\alpha\beta}) - x_3 e_\alpha \otimes e_\beta) \cdot e_3 = 0 \text{ on } \mathcal{Y}^\pm. \end{cases} \quad (1.29)$$

We recall that the spaces $\mathcal{V}_{KL}^{\mathcal{B}}$ and $\mathcal{V}_{KL}^{\mathcal{M}}$ useful in the theorem below, have been defined in (1.19). For the sake of simplicity, f is supposed to be a constant. The functions $f_{\mathcal{B}}$ and $f_{\mathcal{M}}$ are defined as $f_{\mathcal{B}} = f_3 e_3$ and $f_{\mathcal{M}} = f_1 e_1 + f_2 e_2$.

Theorem 1.13. *Under the above assumptions on A^ε (including (1.20)), f and Ω , the solution u^ε to (1.26) converges weakly in $(H^1(\Omega))^3$ to some function u^* which belongs to \mathcal{V}_{KL} . The function u^* can be decomposed as $u^* = u_{\mathcal{M}}^* + u_{\mathcal{B}}^*$, and the functions $u_{\mathcal{M}}^*$ and $u_{\mathcal{B}}^*$ are the unique solutions (respectively in $\mathcal{V}_{KL}^{\mathcal{M}}$ and $\mathcal{V}_{KL}^{\mathcal{B}}$) to*

$$\forall \phi \in \mathcal{V}_{KL}^{\mathcal{M}}, \quad \int_{\omega} A_{\mathcal{M}}^* e(u_{\mathcal{M}}^*) : e(\phi) = \int_{\omega} f_{\mathcal{M}} \cdot \phi$$

and

$$\forall \phi \in \mathcal{V}_{KL}^{\mathcal{B}}, \quad \int_{\omega} A_{\mathcal{B}}^* \nabla^2 (u_{\mathcal{B}}^*)_3 : \nabla^2 \phi_3 = \int_{\omega} f_{\mathcal{B}} \cdot \phi.$$

The homogenized tensor $A_{\mathcal{M}}^*$ and $A_{\mathcal{B}}^*$ are defined as follows: for $\alpha, \beta, \sigma, \tau$ in $\{1, 2\}$

$$\begin{aligned} A_{\mathcal{M}}^* e_\alpha \otimes e_\beta : e_\sigma \otimes e_\tau &:= \int_{\mathcal{Y}} A \left(e \left(w_{\mathcal{M}}^{\alpha\beta} \right) + e_\alpha \otimes e_\beta \right) : (e(w_{\mathcal{M}}^{\sigma\tau}) + e_\sigma \otimes e_\tau) \\ A_{\mathcal{B}}^* e_\alpha \otimes e_\beta : e_\sigma \otimes e_\tau &:= \int_{\mathcal{Y}} A \left(e \left(w_{\mathcal{B}}^{\alpha\beta} \right) - y_3 e_\alpha \otimes e_\beta \right) : (e(w_{\mathcal{B}}^{\sigma\tau}) - y_3 e_\sigma \otimes e_\tau). \end{aligned}$$

By construction, $A_{\mathcal{M}}^*$ and $A_{\mathcal{B}}^*$ are symmetric and coercive.

Note that the whole sequence $(u_\varepsilon)_\varepsilon$ converges, and not only a subsequence.

Remark 1.14. *In contrast to the classical periodic homogenization, the limit problem in the bending case does not have the same form as the original problem.*

Remark 1.15. *If A is a constant isotropic tensor, it is possible to compute the solutions of (1.28) and (1.29) analytically. For α, β in $\{1, 2\}$, we have*

$$w_{\mathcal{M}}^{\alpha\beta} = -x_3 \frac{\lambda^*}{\lambda} \delta_{\alpha\beta} e_3 \quad \text{and} \quad w_{\mathcal{B}}^{\alpha\beta} = \frac{1}{2} \left(x_3^2 - \frac{1}{12} \right) \frac{\lambda^*}{\lambda} \delta_{\alpha\beta} e_3,$$

where λ^* is given by (1.17). Then, Theorem 1.13 yields (1.21) and (1.22), that we previously obtained by a different computation. Hence, even if the material is homogeneous and isotropic, the correctors do not vanish. This implies that $e^\varepsilon ps(u^\varepsilon ps) - e^\varepsilon ps(u^*)$ does not strongly converge to 0 and hence that the Kirchoff-Love theory, which computes u^* , does not provide an accurate approximation of the heterogeneous stress.

Remark 1.16. *In the case of Remark 1.15, note that for α, β in $\{1, 2\}$,*

$$e(w_{\mathcal{B}}^{\alpha\beta}) = -x_3 e(w_{\mathcal{M}}^{\alpha\beta}).$$

Then,

$$\begin{aligned} e \left(w_{\mathcal{M}}^{\alpha\beta} \right) e_{\alpha\beta} (u_{\mathcal{M}}^*) + e \left(w_{\mathcal{B}}^{\alpha\beta} \right) \partial_{\alpha\beta} (u_{\mathcal{B}}^*)_3 &= e \left(w_{\mathcal{M}}^{\alpha\beta} \right) e_{\alpha\beta} (u_{\mathcal{M}}^*) - x_3 e \left(w_{\mathcal{M}}^{\alpha\beta} \right) \partial_{\alpha\beta} (u_{\mathcal{B}}^*)_3 \\ &= e \left(w_{\mathcal{M}}^{\alpha\beta} \right) e_{\alpha\beta} (u^*) \\ &= -\frac{\lambda^*}{\lambda} \operatorname{div} u^* e_3 \otimes e_3. \end{aligned}$$

This computation is wrong in general and allows for many simplifications in the homogeneous isotrope case.

Out-of-plane heterogeneities

In this section are presented results that can be found in [47]. The authors of [47] have performed the same work for a diffusion equation in [46].

The case of "out-of-plane" heterogeneities corresponds to the case of a stratified material. We suppose that the tensor A^ε only depends on x_3 . The computations are similar to the computations presented in Section 1.4.2 for the homogeneous case, with an additional difficulty. In the homogeneous case, the convergence of $e^\varepsilon(u^\varepsilon)$ to $e(u^*, y^*)$ implied the convergence of $Ae^\varepsilon(u^\varepsilon)$ to $Ae(u^*, y^*)$. When the tensor A^ε depends on ε , this result does not hold.

The bounds on A^ε ensure that

$$\sigma^\varepsilon := A^\varepsilon e^\varepsilon(u^\varepsilon) \rightharpoonup \sigma^* \text{ weakly in } L^2(\Omega)^{3 \times 3}.$$

The link between σ^* and $e(u^*, y^*)$ is not obvious, because the convergence of A^ε and $e^\varepsilon(u^\varepsilon)$ are weak. In [78], Murat and Tartar proved that under additional assumptions, the product of two weakly converging sequences converges to the product of the limits. We recall this result:

Theorem 1.17 (Compensated compactness). *Let Ω be an open set of \mathbb{R}^d . Let*

$$\begin{aligned} X(\Omega) &:= \{u \in L^2(\Omega)^d, \quad \operatorname{div} u \in L^2(\Omega)\} \\ Y(\Omega) &:= \{v \in L^2(\Omega)^d, \quad \operatorname{rot} v \in L^2(\Omega)^d\} \end{aligned}$$

equipped with the norms

$$\begin{aligned} \|u\|_{X(\Omega)}^2 &:= \|u\|_{L^2(\Omega)^d}^2 + \|\operatorname{div} u\|_{L^2(\Omega)}^2, \\ \|v\|_{Y(\Omega)}^2 &:= \|v\|_{L^2(\Omega)^d}^2 + \|\operatorname{rot} v\|_{L^2(\Omega)^d}^2. \end{aligned}$$

Let $(u_n)_{n \in \mathbb{N}}$ and $(v_n)_{n \in \mathbb{N}}$ be two sequences such that

$$\begin{aligned} (u_n)_{n \in \mathbb{N}} \text{ is bounded in } X(\Omega) \quad \text{and} \quad u_n &\rightharpoonup u \text{ weakly in } L^2(\Omega)^d, \\ (v_n)_{n \in \mathbb{N}} \text{ is bounded in } Y(\Omega) \quad \text{and} \quad v_n &\rightharpoonup v \text{ weakly in } L^2(\Omega)^d. \end{aligned}$$

Then it holds that

$$u_n v_n \xrightarrow{n \rightarrow \infty} uv \quad \text{in } \mathcal{D}'(\Omega)$$

In [25], Courilleau and Mossino proved a variant of this result suited for dimension reduction. This result is next used in [47] to prove that

$$\sigma^* = A^* e(u^*, y^*),$$

where A^* is analytically defined. As in the "in-plane" case, it is then possible to define a membrane problem which is a second order PDE, and a bending problem which is a fourth order PDE.

1.4.4 Numerical methods for homogeneous plates

We now return to the homogeneous plate case, and discuss its discretization. The goal is to find a numerical method to approximate the solution of (1.11). There is a rich literature on Finite Element Methods for thin plates. The most widely encountered problem is "numerical locking" which generally occurs when the convergence of the FEM depends on the small parameter ε . For a review of the problem and of the solutions that have been considered, we refer the reader to [21], [19] or [20]. In this introduction, we choose to focus on the work [84] of Paumier and Raoult, which will be relevant in Chapter 3.

The goal of the article is to approximate the solution of (1.11) by functions that have a polynomial dependency in x_3 , i.e. of the form $u^\varepsilon \approx u_0 + x_3 u_1 + x_3^2 u_2 + \dots$ where the functions u_i are independent of x_3 . Let W be a subspace of V which will be the approximation space. The Galerkin approximation of (1.11) in W is the solution to: find w^ε in W such that for any v in W ,

$$\int_{\Omega} A e^\varepsilon(w^\varepsilon) : e^\varepsilon(v) = \int_{\Omega} f \cdot v. \quad (1.30)$$

Following the same arguments as in Section 1.4.2, we know that there exists a function w^* in $H^1(\Omega)^3$ such that (up to a subsequence extraction)

$$w^\varepsilon \xrightarrow{\varepsilon \rightarrow 0} w^* \quad \text{weakly in } H^1(\Omega)^3.$$

The reduced model is said to be consistent if u^* and w^* coincide. The case where W contains functions that are polynomial in x_3 is particularly interesting for us. For any vector space $H \subset H_0^1(\omega)$, let

$$\mathcal{P}_k(H) := \left\{ w : \Omega \rightarrow \mathbb{R}, \forall x = (x_1, x_2, x_3) \in \Omega, w(x) = \sum_{j=0}^k x_3^j w_j(x_1, x_2), w_j \in H \right\}$$

and

$$\mathcal{P}_{m,n}(H) := \mathcal{P}_m(H) \times \mathcal{P}_m(H) \times \mathcal{P}_n(H).$$

Theorem 1.18. *Assume that $W = \mathcal{P}_{m,n}(H_0^1(\omega))$. Then $l(u^* - w^*) = 0$ for any linear form l in the dual space of \mathcal{V}_{KL} if and only if $m \geq 1$ and $n \geq 2$.*

Note that even though $\mathcal{V}_{KL} \subset \mathcal{P}_{1,0}(H_0^1(\omega))$, the space $\mathcal{P}_{1,0}(H_0^1(\omega))$ is "too small" (in this sense of consistency) to be a good reduced model of a plate. Solving (1.11) with a standard FEM implies the computation of three functions defined on a three dimensional domain. On the other hand, solving (1.30) with $W = \mathcal{P}_{1,2}(H_0^1(\omega))$ implies the computations of seven functions defined on a two dimensional domain, which is less expensive from a computational point of view. The next step of the discretization procedure is then classical: it consists of meshing the two-dimensional domain ω and introducing approximation spaces (e.g. finite element spaces) of $H_0^1(\omega)$.

1.5 Shape optimization

A part of the work performed during this thesis is concerned with shape optimization of thin heterogeneous structures (see Chapter 4). In this section, we present here a short introduction to shape optimization methods, largely inspired by the work of Allaire in [1] and [5]. We explain the broad principles of shape optimization, and describe some numerical methods.

1.5.1 Principles of shape optimization

A problem of shape optimization is generally defined by three specifications:

- (i) a mechanical model: we choose here to limit ourselves to linear elasticity;
- (ii) a set of admissible shapes: for example, it could be the set of connected shapes of a prescribed volume;
- (iii) an objective function which has a vocation to be optimized: for example, the compliance of an object.

Let \mathcal{U} be the set of admissible shapes, $u(\Omega)$ a physical value (for example, the displacement field of the object under some load), and J be the objective function. The problem of shape optimization is defined as

$$\min_{\Omega \in \mathcal{U}} J(u(\Omega)). \quad (1.31)$$

The choice of \mathcal{U} allows to classify shape optimization problems into three categories:

- (i) parametric shape optimization. The shapes in \mathcal{U} are defined by a few parameters.
- (ii) geometrical optimization. The admissible shapes are obtained by moving the boundary of an initial shape. The topology of the shape does not change, in particular the number of holes remains constant.
- (iii) topology optimization. It is the most general type of shape optimization.

1.5.2 An example of shape optimization

In order to understand the link between shape optimization and composite materials, we describe here a classical example of shape optimization (see [5]).

Let $\Omega := (0, 1)^2$ and χ be an indicator function defined on Ω . Let A_α and A_β be two constant elasticity tensors representing two materials with different properties. Let A_χ be the elasticity tensor representing the inclusion of the material α into the material β , such that for any x in Ω ,

$$A_\chi(x) = A_\alpha \chi(x) + A_\beta (1 - \chi(x)).$$

Let Γ be the right boundary of the square Ω , i.e. $\Gamma := \{1\} \times (0, 1)$. A constant force is applied on this part on the boundary, so that the displacement field u_χ is solution to the following problem:

$$\begin{cases} -\operatorname{div}(A_\chi e(u_\chi)) = 0 & \text{in } \Omega \\ A_\chi e(u_\chi) \cdot n = e_2 & \text{on } \Gamma \\ A_\chi e(u_\chi) \cdot n = 0 & \text{on } \partial\Omega \setminus \Gamma \end{cases} \quad (1.32)$$

The shape optimization problem consists in minimizing the compliance of the object

$$J(\chi) = \int_\Gamma u_\chi \cdot e_2$$

over the function χ , where u_χ is solution to (1.32). More precisely, the proportion of material α and β are supposed to be fixed, so the set of admissible shapes is defined by

$$\mathcal{U} = \left\{ \chi \in L^\infty(\Omega, \{0, 1\}), \int_\Omega \chi = \theta \right\}$$

for some θ in $(0, 1)$. The problem is therefore a problem of repartition of the material α in the material β . It can be written as

$$\min \{J(\chi), \chi \in \mathcal{U}\}.$$

The precise analysis of this problem is out of the scope of this introduction and is detailed in [5]. We only provide here an intuition of the problem.

The load applied on the material is horizontal, therefore the principal direction of the stress will also be horizontal. Then, the best repartition of α and β will be an alternation of horizontal inclusions of α and β . It is possible to show that, for any size of inclusions, a smaller size of inclusions lowers the objective function. Hence, the optimal material is not composed of a finite number of inclusions and cannot be represented by an indicator function, but is a composite material in the sense of a mixing of α and β in proportion θ and $1 - \theta$.

We can draw two observations from this example. First, shape optimization problems are often ill-posed, in the sense that they do not have a minimizer in \mathcal{U} . Many techniques have been developed to ensure that the solution of a shape optimization problem exists (see [51], [6] or [90]). Second, composite materials naturally appear in shape optimization problems.

1.5.3 Numerical methods for shape optimization

We briefly present four widely used methods for shape optimization: the level-set method, the SIMP method, the homogenization method and multiscale methods.

Level-set method

The level-set method has been introduced by Osher in [82]. We refer the reader to [81] for a complete overview, and to [4] for a description of the numerical implementation of the method.

In the level-set method, the shape is represented by a function ψ defined on a domain Ω . The interior of the shape corresponds to the set $\{x \in \Omega, \psi(x) < 0\}$, its exterior to the set $\{x \in \Omega, \psi(x) > 0\}$, and its boundary to the set $\{x \in \Omega, \psi(x) = 0\}$.

The optimization uses a gradient-descent method. The computation of the derivative of the cost function with respect to ψ gives a vector field defined on Ω . The boundary of the shape is moved accordingly to this vector field.

SIMP method

The Solid Isotropic Material with Penalization (SIMP) method was introduced by Bendsoe in [9]. We refer the reader to [11] for a complete overview.

The shape that is optimized is made of a material represented by a constant elasticity tensor A . The core of the method is to introduce a function θ in $L^\infty(\Omega, (0, 1))$. For an integer $p > 0$, the elasticity tensor $\theta^p A$ represent a material that lies between the "real" material ($\theta \equiv 1$) and void ($\theta \equiv 0$). The problem (1.32) is replaced by $-\operatorname{div} \theta^p A e(u_\theta) = 0$ with appropriate boundary conditions.

The cost function is optimized with respect to θ . In order to have a "real" material as a result, the values of θ that are neither 0 nor 1 are penalized. One possibility to penalize those values is to progressively increase the value of p during the optimization process.

Homogenization method

Homogenization methods for shape optimization have been introduced in [73], [79] and [60]. We refer the reader to [1] for a complete overview.

The homogenization method tackles the problem of optimizing shapes that have a microstructure. The cost of a computation involving a multi-scale material is avoided by replacing this material by its homogenized limit (see Section 1.2). The optimization is thus performed on a set of homogenized materials.

Once the optimal homogenized material is found, the difficulty is to build a "real" multi-scale material, which correspond to the homogenized material. This problem has been studied in [83], [3] and [43]. We also refer to [48] or [88].

Multi-scale methods

Multi-scale methods also tackle the optimization of shapes with a microstructure. To simplify the problem, instead of using homogenization theory, the set of admissible shapes is reduced to a set of shapes with a parametrized microstructure. We refer to [10], [94], [29] or [42] for examples. The micro-structure is either the same all over the structure [71] or varies on large length scales [59].

1.6 Main contributions

We collect here the main contributions of this thesis.

1.6.1 Two scale expansion of the displacement field

Presentation of the difficulty

Homogenization and plate theory describe what happens in the case of in-plane heterogeneities when the size of the microstructure and the thickness of the plate ε goes to 0. The displacement field of the plate u^ε can be approximated by the homogenized displacement u^* . As often the case in homogenization, the convergence of u^ε to u^* is a weak convergence in H^1 . As a consequence,

- (i) $e^\varepsilon(u^*)$ does not approximate the oscillations of $e^\varepsilon(u^\varepsilon)$;
- (ii) the shear stress is neglected: $e_{13}^\varepsilon(u^*) = e_{23}^\varepsilon(u^*) = e_{33}^\varepsilon(u^*) = 0$, whereas $e_{13}^\varepsilon(u^\varepsilon)$, $e_{23}^\varepsilon(u^\varepsilon)$ and $e_{33}^\varepsilon(u^\varepsilon)$ are a priori not small.

This problem is already present in the classical homogenization theory recalled in Section 1.2. It is addressed by considering a relevant two-scale expansion (see (1.9) and Theorem 1.3).

There is however a major difference between plate homogenization and classical homogenization. In the case of bending, that is when $f \in \mathcal{O}^2 \times \mathcal{E}$, the oscillatory problem is a vectorial second order elliptic equation on a three dimensional domain, namely

$$-\operatorname{div}^\varepsilon (A^\varepsilon e^\varepsilon(u^\varepsilon)) = f \quad \text{on } \Omega$$

whereas the homogenized equation is a scalar fourth order elliptic equation on a 2D domain:

$$\nabla^2 (A_B^* \nabla^2 \widehat{u}_3^*) = f \quad \text{on } \omega.$$

The nature of the homogenized equation is thus different from the nature of the oscillatory problem. Furthermore, in general the limit displacement u^* belongs to a space, the so-called Kirchoff-Love space \mathcal{V}_{KL} , that is not dense in $(H^1(\Omega))^3$ for the H^1 norm. In contrast to the standard proof establishing the H^1 convergence (see Theorem 1.3), we cannot take u^ε as a test function in the variational formulation of the homogenized problem. This is why new ideas are required to handle that case.

Our approach to the difficulty

For $x = (x_1, x_2, x_3)$ in Ω , let

$$u_{\mathcal{M}}^{\varepsilon,1}(x) := \begin{pmatrix} \widehat{u}_1^* \\ \widehat{u}_2^* \\ 0 \end{pmatrix} (x_1, x_2) + \varepsilon \sum_{\alpha,\beta=1}^2 \begin{pmatrix} [w_{\mathcal{M}}^{\alpha\beta}]_1 \\ [w_{\mathcal{M}}^{\alpha\beta}]_2 \\ \varepsilon [w_{\mathcal{M}}^{\alpha\beta}]_3 \end{pmatrix} \left(\frac{x_1}{\varepsilon}, \frac{x_2}{\varepsilon}, x_3 \right) e_{\alpha\beta}(\widehat{u}^*)(x_1, x_2)$$

and

$$u_{\mathcal{B}}^{\varepsilon,1}(x) := \begin{pmatrix} -x_3 \partial_1 \widehat{u}_3^* \\ -x_3 \partial_2 \widehat{u}_3^* \\ \widehat{u}_3^* \end{pmatrix} (x_1, x_2) + \varepsilon \sum_{\alpha,\beta=1}^2 \begin{pmatrix} [w_{\mathcal{B}}^{\alpha\beta}]_1 \\ [w_{\mathcal{B}}^{\alpha\beta}]_2 \\ \varepsilon [w_{\mathcal{B}}^{\alpha\beta}]_3 \end{pmatrix} \left(\frac{x_1}{\varepsilon}, \frac{x_2}{\varepsilon}, x_3 \right) \partial_{\alpha\beta} \widehat{u}_3^*(x_1, x_2).$$

Note that the correctors for the first two coordinates of the displacement are multiplied by ε , whereas it is multiplied by ε^2 in the third coordinate. It ensures that

$$e^\varepsilon(u_{\mathcal{M}}^{\varepsilon,1}) = \left(e \left(w_{\mathcal{M}}^{\alpha\beta} \right) \left(\frac{x_1}{\varepsilon}, \frac{x_2}{\varepsilon}, x_3 \right) + e_\alpha \otimes e_\beta \right) e_{\alpha\beta}(\widehat{u}^*) + O(\varepsilon) \quad (1.33)$$

and

$$e^\varepsilon(u_B^{\varepsilon,1}) = \left(e \left(w_B^{\alpha\beta} \right) \left(\frac{x_1}{\varepsilon}, \frac{x_2}{\varepsilon}, x_3 \right) - x_3 e_\alpha \otimes e_\beta \right) \partial_{\alpha\beta} \widehat{u}_3^* + O(\varepsilon). \quad (1.34)$$

The definition of $u_B^{\varepsilon,1}$ and $u_M^{\varepsilon,1}$ are deduced from the two scale formal expansion (1.27). Note that the formal expansion shows that there is some additional terms in \mathcal{V}_{KL} that are multiplied by ε . They are neglected here, because for any v in \mathcal{V}_{KL} , $e^\varepsilon(\varepsilon v) = O(\varepsilon)$. Our goal is to show that $u_B^{\varepsilon,1} + u_M^{\varepsilon,1}$ is a good approximation of u^ε .

A central ingredient of our proof is to define a homogenized-like limit problem written as a variational formulation, and for which the test function can be chosen in the whole space $(H^1(\Omega))^3$ and not only on \mathcal{V}_{KL} .

We briefly explain this here. The homogenization theorem shows that

$$\sigma^\varepsilon := A^\varepsilon e^\varepsilon(u^\varepsilon) \underset{\varepsilon \rightarrow 0}{\rightharpoonup} \sigma^* = \begin{pmatrix} \sigma_{11}^* & \sigma_{12}^* & 0 \\ \sigma_{21}^* & \sigma_{22}^* & 0 \\ 0 & 0 & 0 \end{pmatrix} \text{ weakly in } (L^2(\Omega))^{3 \times 3}.$$

The first step of our argument consists in showing that when the stress σ^ε is properly rescaled, it converges to a non-trivial limit:

$$\Sigma^\varepsilon := \begin{pmatrix} \sigma_{11}^\varepsilon & \sigma_{12}^\varepsilon & \varepsilon^{-1} \sigma_{13}^\varepsilon \\ \sigma_{21}^\varepsilon & \sigma_{22}^\varepsilon & \varepsilon^{-1} \sigma_{23}^\varepsilon \\ \varepsilon^{-1} \sigma_{31}^\varepsilon & \varepsilon^{-1} \sigma_{32}^\varepsilon & \varepsilon^{-2} \sigma_{33}^\varepsilon \end{pmatrix} \underset{\varepsilon \rightarrow 0}{\rightharpoonup} \Sigma^* := \begin{pmatrix} \Sigma_{11}^* & \Sigma_{12}^* & \Sigma_{13}^* \\ \Sigma_{21}^* & \Sigma_{22}^* & \Sigma_{23}^* \\ \Sigma_{31}^* & \Sigma_{32}^* & \Sigma_{33}^* \end{pmatrix}. \quad (1.35)$$

By construction, the oscillatory problem (1.26) yields that

$$\forall v \in V, \quad \int_\Omega \Sigma^\varepsilon : e(v) = \int_\Omega f \cdot v.$$

Using the above weak limit, we obtain that

$$\forall v \in V, \quad \int_\Omega \Sigma^* : e(v) = \int_\Omega f \cdot v$$

and therefore $\int_\Omega \Sigma^\varepsilon : e(v) = \int_\Omega \Sigma^* : e(v)$ for any v in V and any $\varepsilon > 0$. Furthermore, if v is in \mathcal{V}_{KL} ,

$$\int_\Omega \Sigma^* : e(v) = \int_\omega A_B^* \nabla^2 \widehat{u}_3^* : \nabla^2 v \quad \text{and} \quad \int_\Omega f \cdot v = \int_\omega f_3 v_3.$$

This limit problem does not define Σ^* , but is an important step in our computations. It allows us to show that

$$\int_\Omega A^\varepsilon e^\varepsilon(u^\varepsilon - u^{\varepsilon,1}) : e^\varepsilon(u^\varepsilon - u^{\varepsilon,1}) \approx \int_\Omega Z_{\alpha\beta} \left(\frac{x_1}{\varepsilon}, \frac{x_2}{\varepsilon}, x_3 \right) \partial_{\alpha\beta} \widehat{u}_3^* : e^\varepsilon(u^\varepsilon - u^{\varepsilon,1}),$$

where

$$Z_{\alpha\beta} = A \left(e \left(w_B^{\alpha\beta} \right) - x_3 e_\alpha \otimes e_\beta \right) - \int_Y A \left(e \left(w_B^{\alpha\beta} \right) - x_3 e_\alpha \otimes e_\beta \right).$$

The remainder of the proof consists in showing that $Z_{\alpha\beta} \left(\frac{x_1}{\varepsilon}, \frac{x_2}{\varepsilon}, x_3 \right)$ which is a divergence-free, Y -periodic function is small, in a relevant sense. We refer to Chapter 2 for more details.

For the theorems below, we recall that for any x in Ω , $A^\varepsilon(x) = A \left(\frac{x_1}{\varepsilon}, \frac{x_2}{\varepsilon} \right)$ where A is Y -periodic and satisfy assumptions (1.20), (1.2), and (1.24).

Theorem 1.19 (Membrane case). *Assume that $f = f_1 e_1 + f_2 e_2$ is a constant. Let us also assume that $u^* \in W^{2,\infty}(\omega)^3$ and that, for α, β in $\{1, 2\}$ we have $w_{\mathcal{M}}^{\alpha\beta} \in W^{1,\infty}(\mathbb{R}^2 \times (-\frac{1}{2}, \frac{1}{2}))^3$. Then, there exists a constant $C > 0$ independent of ε and ω such that*

$$\begin{aligned} \|e^\varepsilon(u^\varepsilon - u_{\mathcal{M}}^{\varepsilon,1})\|_{L^2(\Omega)^{3 \times 3}} &\leq C\sqrt{\varepsilon}|\omega|^{\frac{1}{2}}\|e(u^*)\|_{L^\infty(\omega)^{3 \times 3}} \\ &+ C\varepsilon\left(|\omega|^{\frac{1}{2}}\|\nabla^2 u^*\|_{L^\infty(\omega)^{3 \times 3 \times 3}} + \|f\|_{L^2(\Omega)^3}\right). \end{aligned} \quad (1.36)$$

We did not manage to give a full proof for such a two-scale strong convergence theorem in the bending case. We nevertheless managed to obtain such a result, to the price of making a conjecture which we are not able to prove, but which, we strongly believe it, should be true. We give evidence in Chapter 2, based both on theoretical and numerical arguments, why such a conjecture should hold true. This conjecture can be stated as follows:

(CB) For all $1 \leq \alpha, \beta \leq 2$,

$$\Sigma_{\alpha\beta}^* = e_\alpha \otimes e_\beta : \int_Y A(e(w_B^{\gamma\delta}) - x_d e_\gamma \otimes e_\delta) \partial_{\gamma\delta} u_d^*. \quad (1.37)$$

Theorem 1.20 (Bending case). *Assume conjecture (CB). Assume that $f = f_3 e_3$ is a constant. Let us also assume that $u^* \in W^{3,\infty}(\omega)^3$ and that, for α, β in $\{1, 2\}$ we have $w_B^{\alpha\beta} \in W^{1,\infty}(\mathbb{R}^2 \times (-\frac{1}{2}, \frac{1}{2}))^3$. Then, there exists a constant $C > 0$ independent of ε and ω such that*

$$\begin{aligned} \|e^\varepsilon(u^\varepsilon - u_B^{\varepsilon,1})\|_{L^2(\Omega)^{3 \times 3}} &\leq C\sqrt{\varepsilon}|\omega|^{\frac{1}{2}}\|e(u^*)\|_{L^\infty(\omega)^{3 \times 3}} \\ &+ C\varepsilon\left(|\omega|^{\frac{1}{2}}\|\nabla^3 u^*\|_{L^\infty(\omega)^{3 \times 3 \times 3 \times 3}} + \|\Sigma^*\|_{L^2(\Omega)}\right). \end{aligned}$$

The function Σ^* is defined in (1.35).

Remark 1.21. For $\varepsilon \ll |\omega|^{\frac{1}{2}}$, the rate of convergence of the approximation is $\sqrt{\varepsilon}$. This rate is determined by the correction of the error made on the boundary $\partial\omega \times \left(-\frac{1}{2}, \frac{1}{2}\right)$ because $u^{\varepsilon,1}$ is not in V (because it does not vanish on $\partial\omega \times \left(-\frac{1}{2}, \frac{1}{2}\right)$).

Remark 1.22. The explicit dependence in $|\omega|$ in the right hand side of the theorems above is interesting for the numerical analysis in Chapter 3.

It is important to prove the approximation results for the rescaled gradient $e^\varepsilon(u^\varepsilon)$ and not only for $e(u^\varepsilon)$. Indeed, we have $\|e^\varepsilon(u^\varepsilon)\|_{L^2(\Omega)^{3 \times 3}} = \|e(\tilde{u}^\varepsilon)\|_{L^2(\Omega^\varepsilon)^{3 \times 3}}$ and therefore the bounds of Theorem 1.19 and Theorem 1.20 directly translate as bounds on the strain in the original plate problem. For $\varepsilon \ll 1$, it would be weaker to prove a result on $\|e(u^\varepsilon)\|_{(L^2(\Omega))^{3 \times 3}}$.

1.6.2 MsFEM for plates

This section summarizes the results presented in Chapter 3. Our goal is to propose a method similar to the MsFEM presented in Section 1.3 in the case of thin materials.

The specificity of the plate problem is that it is a three dimensional PDE whose solution is close to the solution of a two dimensional PDE, in a sense explained in Section 1.4. This specificity is captured in the mesh that we use in this method. Despite

being the mesh of the 3D domain Ω , the number of elements scales as H^{-2} , where H is their typical size.

Let us assume that ω is a polyhedral, connected and bounded open subset of \mathbb{R}^2 and let \mathcal{T}_ω^H be a conforming discretization of ω . Let us now define

$$\mathcal{T}_\Omega^H = \left\{ \tau \times \left(-\frac{1}{2}, \frac{1}{2} \right), \tau \in \mathcal{T}_\omega^H \right\}.$$

Then, \mathcal{T}_Ω^H obviously defines a conforming discretization of Ω (see Figure 1.11).

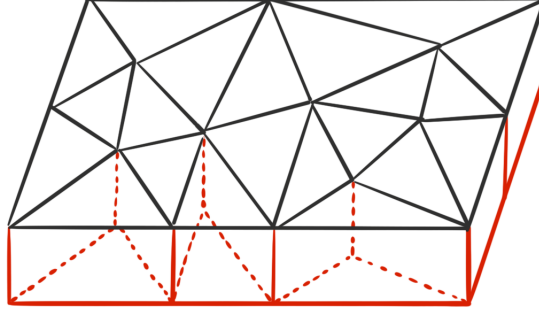

Figure 1.11: Coarse mesh \mathcal{T}_Ω^H built on the basis of a coarse mesh of ω

Similarly to the MsFEM method presented in Section 1.3, the basis functions of our approach for plates are solutions to local PDEs, and are harmonic for the operator $\operatorname{div}^\varepsilon A^\varepsilon e^\varepsilon$. The choice of the boundary conditions is dictated by the results of plate homogenization (see Section 1.4.3).

- In the membrane case, let V_H^M be the space of functions of $H_0^1(\omega)^2$ with values in \mathbb{R}^2 that are affine on every element of \mathcal{T}_ω^H , and let $(\phi_i)_i$ be its canonical base. For any ϕ_i , let $\psi_i := \begin{pmatrix} \phi_i \\ 0 \end{pmatrix}$.
- In the bending case, let V_H^B be the space of scalar valued functions of $H_0^2(\omega)$ that are cubic on every element of \mathcal{T}_ω^H , and let $(\phi_i)_i$ be its canonical base. For any ϕ_i , let $\psi_i := \begin{pmatrix} -x_3 \nabla' \phi_i \\ \phi_i \end{pmatrix}$, where $\nabla' \phi_i = \begin{pmatrix} \partial_1 \phi_i \\ \partial_2 \phi_i \end{pmatrix}$.

On any $T \in \mathcal{T}_\Omega^H$ of the form $T = \tau \times \left(-\frac{1}{2}, \frac{1}{2} \right)$, we define the oscillatory basis function ψ_i^ε associated to the single-scale basis function ψ_i as the solution to the following problem:

$$\begin{cases} -\operatorname{div}^\varepsilon A^\varepsilon e^\varepsilon(\psi_i^\varepsilon) = 0 \text{ in } T, \\ \psi_i^\varepsilon = \psi_i \text{ on } \partial\tau \times \left(-\frac{1}{2}, \frac{1}{2} \right), \\ A^\varepsilon e^\varepsilon(\psi_i^\varepsilon) \cdot e_3 = 0 \text{ on } \tau \times \left\{ \pm \frac{1}{2} \right\}. \end{cases} \quad (1.38)$$

Let $V_H^\varepsilon := \operatorname{Span}\{\psi_i^\varepsilon\}$ and u_H^ε be the Galerkin's approximation of u^ε in V_H^ε .

The results of plate homogenization (see Section 1.4.3) and Theorems 1.19 and 1.20 imply that, for $x = (x_1, x_2, x_3)$ in Ω , in the membrane case

$$e^\varepsilon(\psi_i^\varepsilon)(x) \approx \left(e \left(w_{\mathcal{M}}^{\alpha\beta} \right) \left(\frac{x_1}{\varepsilon}, \frac{x_2}{\varepsilon}, x_3 \right) + e_\alpha \otimes e_\beta \right) e_{\alpha\beta}(\phi_i)(x_1, x_2)$$

and in the bending case

$$e^\varepsilon(\psi_i^\varepsilon)(x) \approx \left(e \left(w_B^{\alpha\beta} \right) \left(\frac{x_1}{\varepsilon}, \frac{x_2}{\varepsilon}, x_3 \right) - x_3 e_\alpha \otimes e_\beta \right) \partial_{\alpha\beta} \phi_i(x_1, x_2).$$

This is similar to the values of $e^\varepsilon(u_{\mathcal{M}}^{\varepsilon,1})$ (see (1.33)) and $e^\varepsilon(u_B^{\varepsilon,1})$ (see (1.34)), and a central ingredient to the proof of the following results.

For the theorems below, we recall that for any x in Ω , $A^\varepsilon(x) = A \left(\frac{x_1}{\varepsilon}, \frac{x_2}{\varepsilon} \right)$ where A is Y -periodic and satisfies assumptions (1.20), (1.2), and (1.24).

Theorem 1.23 (Membrane case). *Assume that we are in the membrane case, namely that $f \in \mathcal{E}^2 \times \mathcal{O}$. Assume that $u^* \in (W^{2,\infty}(\omega))^3$ and that for any α, β in $\{1, 2\}$, we have $w_M^{\alpha\beta} \in (W^{1,\infty}(\mathbb{R}^3))^3$. Then*

$$\|e^\varepsilon(u^\varepsilon - u_H^\varepsilon)\|_{L^2(\Omega)^{3 \times 3}} \leq C \left(H + \sqrt{\varepsilon} + \sqrt{\frac{\varepsilon}{H}} \right) \|u_{\mathcal{M}}^*\|_{W^{2,\infty}(\omega)^3},$$

where C is a constant independent of ε and H .

Theorem 1.24 (Bending case). *Assume conjecture (CB). Assume that we are in the bending case, namely that $f \in \mathcal{O}^2 \times \mathcal{E}$. Assume that $u_3^* \in W^{4,\infty}(\omega)$ and that for any α, β in $\{1, 2\}$, we have $w_B^{\alpha\beta} \in (W^{1,\infty}(\mathbb{R}^3))^3$. Then*

$$\|e^\varepsilon(u^\varepsilon - u_H^\varepsilon)\|_{L^2(\Omega)^{3 \times 3}} \leq C \left(H^2 + \sqrt{\varepsilon} + \sqrt{\frac{\varepsilon}{H}} \right) \|\widehat{u}_3^*\|_{W^{4,\infty}(\omega)},$$

where C is a constant independent of ε and H .

The power in H in the estimation is related to the regularities of the functions u_B^* and $u_{\mathcal{M}}^*$ and to the order of the PDEs of which they are solutions, hence the difference H (in Theorem 1.23) vs H^2 (in Theorem 1.24).

1.6.3 Shape optimization for heterogeneous plates

This section summarizes the results presented in Chapter 4. Our goal is to present a shape optimization method that uses the MsFEM functions presented in Chapter 3.

The main idea is to modify equation (1.26) by replacing the periodic tensor A^ε by a tensor $A^{\varepsilon,\phi}$ defined for a function $\phi : \omega \mapsto \omega$ that is a C^1 -diffeomorphism and for $x = (x_1, x_2, x_3)$ in Ω by

$$A^{\varepsilon,\phi}(x) = A \left(\frac{\phi(x_1, x_2)}{\varepsilon}, x_3 \right).$$

The same assumptions are made on A as for (1.26). The function ϕ modulate locally the size of the oscillations of the elasticity tensor. The equation writes as

$$\forall v \in V, \quad \int_{\Omega} A \left(\frac{\phi(x_1, x_2)}{\varepsilon}, x_3 \right) e^\varepsilon(u^{\varepsilon,\phi}) : e^\varepsilon(v) = \int_{\Omega} f \cdot v. \quad (1.39)$$

In order to have bounds on the size of the oscillations of $A^{\varepsilon,\phi}$, the choice of ϕ is limited to the set

$$\mathcal{U} := \left\{ \phi : \omega \rightarrow \omega, C^1\text{-diffeomorphism}, c_- \leq \|\nabla \phi\|_{L^\infty(\omega)} \leq c_+ \right\}.$$

Then, the characteristic size of oscillations of $A^{\varepsilon, \phi}$ are between $\frac{\varepsilon}{c_+}$ and $\frac{\varepsilon}{c_-}$. The objective function is the compliance, defined by

$$F^\varepsilon(\phi) = \int_{\Omega} f \cdot u^{\varepsilon, \phi}.$$

Therefore, the optimization problem reads as

$$\inf \{ F^\varepsilon(\phi), \phi \in \mathcal{U}, u^{\varepsilon, \phi} \text{ solution of (1.39)} \}. \quad (1.40)$$

The "naive" way of solving (1.40) would be to solve (1.39) at each iteration of the minimization. It is impossible in practice because solving (1.39) is costly from a computational point of view because of the difference in scale between $|\omega|^{\frac{1}{d-1}}$ and ε , as explained in Chapter 3. This is the reason why we introduced the Multiscale Finite Element Method (MsFEM). However, it is not directly appropriate here because the basis functions of the MsFEM are solutions to PDEs that depends on $A^{\varepsilon, \phi}$, thus on ϕ . In means that the "offline" phase of the MsFEM, that is expensive, would be done at each step of the optimization.

Our strategy is to choose a family $(\phi_i)_{1 \leq i \leq N_b} \subset \mathcal{U}$ for some large N_b and compute the corresponding MsFEM basis. Then, a reduced order model method, the proper orthogonal decomposition, is used to compute a reduced subspace of approximation that will be used at each step of the minimization procedure. The obtained subspace has a dimension which is much smaller than the dimension of the vector space spanned by the reunion of the MsFEM basis for $(\phi_i)_{1 \leq i \leq N_b}$. Then, a gradient descent method is used to solve the resulting problem which approximates of (1.40).

On numerical examples made in two dimensions, we show that

- (1) the solution of the Galerkin approximation problem of (1.39) where the approximation space is computed with our reduced order model method is a good approximation of the solution of (1.39);
- (2) the compliance F^ε is noticeably reduced (by a factor of 40% on some examples) when the approximation of problem (1.40) is solved.

CHAPTER 2

CONVERGENCE OF A TWO-SCALE EXPANSION FOR ELASTIC HETEROGENEOUS PLATES

This chapter corresponds to a manuscript in preparation [AL1], co-authored with V. Ehrlacher, A. Lebé and F. Legoll.

The aim of this article is to prove strong convergence results on the difference between the solution to highly oscillatory problems posed in thin domains and its two-scale expansion. We consider the linear diffusion equation and the linear elasticity problem. While such results can be fully proved in the diffusion case, the linear elasticity case in its full generality raises challenging difficulties. Under some classical assumptions on the symmetries of the elasticity tensor, the problem can be split under two independent problems, namely the *membrane* problem the *bending* problem. The membrane case is actually quite similar to the diffusion case. However, in the bending case, the scheme of the proof used in the membrane and diffusion cases cannot be adapted straightforwardly. We show here how to obtain strong convergence results in the bending case, using different arguments, up to the price of a conjecture. We give theoretical and numerical arguments supporting our belief that this conjecture should hold true.

2.1 Introduction

In this article, we consider highly oscillatory problems posed in thin domains of \mathbb{R}^d . These problems typically read as

$$-\operatorname{div}(\mathcal{A}^\varepsilon \nabla \tilde{u}^\varepsilon) = f \quad \text{in } \Omega^\varepsilon, \quad (2.1)$$

where the matrix \mathcal{A}^ε (which is – uniformly in ε – bounded from below and from above, to ensure ellipticity of the problem and thus its well-posedness) varies at the small characteristic length-scale ε . We concurrently consider two types of PDEs: (i) the diffusion equation (2.1), where \mathcal{A}^ε is a $\mathbb{R}^{d \times d}$ matrix and \tilde{u}^ε is scalar-valued and (ii) the linear elasticity problem, which can again be written in the form (2.1) where \mathcal{A}^ε is a now a fourth-order tensor and \tilde{u}^ε is vector-valued.

The domain Ω^ε is thin, in the sense that its width ε in the d -direction is small. A typical example is when

$$\Omega^\varepsilon = \omega \times (-\varepsilon/2, \varepsilon/2), \quad (2.2)$$

where ω is a bounded open subset of \mathbb{R}^{d-1} . Note that the width of the domain Ω^ε is here equal to the characteristic length-scale of \mathcal{A}^ε . Other choices could have been made, as discussed in Remark 2.1 below. For simplicity, we have assumed in (2.1) that the right-hand side f does not depend on ε . More general cases are considered below. Of course, Problem (2.1) should be complemented by appropriate boundary conditions, that are also made precise below.

The question we consider here is to identify the limit of \tilde{u}^ε when ε go to zero. In the case when the domain Ω on which the equation is posed actually does not depend on ε , this is a very classical question of homogenization theory (see e.g. the classical textbooks [12, 58], [1, Chapter 1] and also [39, 63]). For a simple diffusive equation such as (2.1), and assuming for instance homogeneous Dirichlet boundary conditions on $\partial\Omega$ and periodicity of the matrix \mathcal{A}^ε (that is $\mathcal{A}^\varepsilon = \mathcal{A}_{\text{per}}(\cdot/\varepsilon)$ for a fixed periodic matrix \mathcal{A}_{per}), it is well-known that $\tilde{u}^\varepsilon \in H_0^1(\Omega)$ converges to some $\tilde{u}^* \in H_0^1(\Omega)$, solution to a homogenized problem of the same form with a diffusion coefficient \mathcal{A}^* which is constant. The value of \mathcal{A}^* can easily be computed using the so-called *corrector functions*, which are solutions of some auxiliary problems posed over the unit periodic cell. The convergence of \tilde{u}^ε to \tilde{u}^* is strong in $L^2(\Omega)$ and weak in $H^1(\Omega)$. It is furthermore possible to introduce a two-scale expansion $\tilde{u}^{\varepsilon,1}$, explicitly built using the homogenized solution \tilde{u}^* and the corrector functions, so that the difference $\tilde{u}^\varepsilon - \tilde{u}^{\varepsilon,1}$ strongly converges to 0 in $H^1(\Omega)$ when $\varepsilon \rightarrow 0$. Similar results have been obtained for many different equations (besides the simple diffusion equation (2.1)), and in particular for linear elasticity problems, of specific interest in this work.

In this article, we consider the situation where the domain Ω^ε on which the oscillatory problem is posed actually depends on ε and is given by (2.2). In other words, we study problems posed on plates composed of an heterogeneous medium, where the typical size of the heterogeneities is of the same order as the (small) thickness of the plate (see Figure 2.1). For such problems, the homogenized limit of (2.1)–(2.2) has been identified (both for the diffusion equation and the linear elasticity problem) in various cases, including the stratified case [46, 47, 76] (that is when \mathcal{A}^ε only depends on $x_d \in (-\varepsilon/2, \varepsilon/2)$), and the case of periodic heterogeneities in the transverse, in-plane directions [17, 18] (that is when \mathcal{A}^ε is $\varepsilon\mathbb{Z}^{d-1}$ -periodic with respect to $(x_1, \dots, x_{d-1}) \in \omega$), to name but a few. We also refer to [75, 91, 53] for recent homogenization results on plates with more general heterogeneities. Results have also been obtained for nonlinear problems: we refer e.g. to [52, 92] for nonlinear elasticity models. In all these works, the weak convergence of \tilde{u}^ε to the solution \tilde{u}^* to a homogenized problem has been established.

Following the general path of homogenization theory, the next step is to obtain a strong convergence (say in H^1), that is to build a relevant two-scale expansion $\tilde{u}^{\varepsilon,1}$ and to prove that the difference $\tilde{u}^\varepsilon - \tilde{u}^{\varepsilon,1}$ strongly converges to 0 in H^1 when $\varepsilon \rightarrow 0$ (of course, since the domain Ω^ε on which the oscillatory equation is posed depends itself on ε , the domain on which the H^1 norm is considered should be carefully chosen). Surprisingly, this question has been addressed for very few cases, at least up to our knowledge. In that direction, strong convergence results have been obtained for *homogeneous* plates in [24, 32, 28]. In this article, we focus on the case where the plate has periodic heterogeneities in its in-plane directions, which is a setting similar to the one considered in [17, 18] and for which weak convergence results have been established.

At first sight, it may be thought that such strong convergence results may easily be obtained by extending standard arguments used in the classical case (i.e. when the domain on which the equation is posed does not depend on ε). This is indeed the case for the diffusion (scalar-valued) equation. However, the analysis that we present here

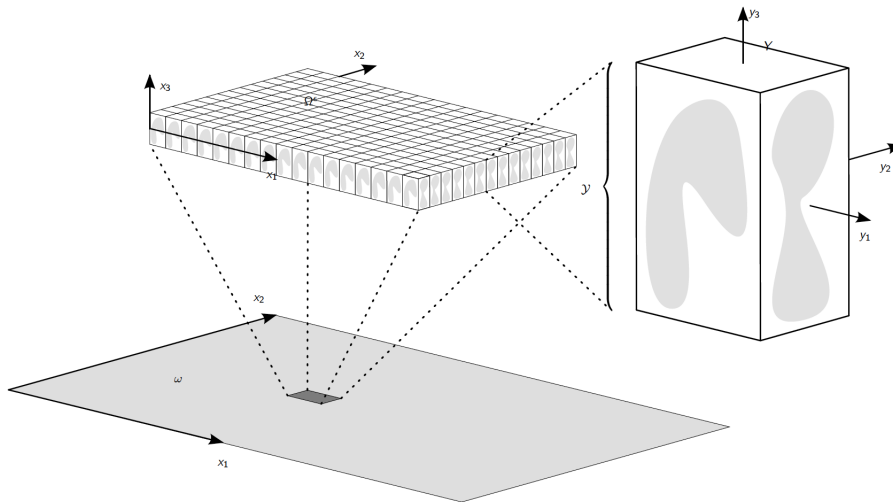

Figure 2.1: The plate and its microstructure for $d = 3$.

shows that this is not always the case for the linear elasticity (vector-valued) problem, and that additional difficulties may arise.

As the title of this article suggests, we are mainly interested in the linear elasticity problem. However, to proceed in a pedagogical manner, we first consider the case of the diffusion equation in Section 2.2. In that first case, strong convergence results (such as Theorem 2.5, our main result in that case) can indeed be obtained by using standard arguments. The situation turns out to be different in the case of linear elasticity, which we address in Section 2.3. We assume there that the mechanical composition of the heterogeneous material is symmetric with respect to its medium plane, which corresponds to assuming that the components of the elasticity tensor are either odd or even functions with respect to x_d (see (2.49) below). This assumption is classical in the literature, and is in particular satisfied by isotropic materials. Under this assumption, we distinguish two situations, depending on the symmetries of the loading (i.e. the function f in the right-hand side of the PDE) imposed on the plate: the *membrane case* and the *bending case*. The membrane case can again be analyzed using similar arguments as for diffusion problems (our main result in that case is Theorem 2.21). However, in the bending case, the standard proof does not go through. The analysis of this bending case turns out to actually require specific arguments, inspired by some ideas present in [32] to handle homogeneous plates, but the adaptation of which to the heterogeneous case is far from immediate. Actually, we were not able to obtain a complete proof of the desired result in this case, and had to rely on a conjecture stated in Section 2.3.5 (see (2.74)) to prove Theorem 2.25, our main result in the bending case. Theoretical and numerical evidence are gathered in Section 2.3.6 to support our strong belief that the conjecture should hold true.

Obtaining a strong convergence result as discussed above is of course interesting from the theoretical viewpoint, since it provides an accurate description of the solution to the oscillatory problem in its natural energy norm. It is also helpful for proving numerical analysis results. In particular, this type of results is a key ingredient to prove error bounds for the Multiscale Finite Element Method (MsFEM). This numerical approach, which is dedicated to approximating the solution to highly oscillatory problems of the type (2.1) (for a small, but not asymptotically small, scale ε), proceeds by performing a variational approximation of (2.1) using pre-computed basis func-

tions that are *adapted* to the problem (we refer to [36] and references therein). They are indeed solutions to local problems defined using the same differential operator as the problem of interest. Using these problem-specific basis functions, the MsFEM approach yields an accurate approximation of the oscillatory solution using only a limited number of degrees of freedom, in contrast to standard Finite Element approaches. In addition, the MsFEM approach is applicable in general situations, and is not limited to the case when the highly oscillatory coefficient of the equation is periodic. In our companion article [AL2], we introduce several variants of the MsFEM approach for the case of elastic heterogeneous plates, and establish error bounds for these. The strong convergence results shown here are pivotal for their numerical analysis.

2.2 The diffusion case

Let $\omega \subset \mathbb{R}^{d-1}$ be a open bounded and smooth domain and $\Omega := \omega \times \left(-\frac{1}{2}, \frac{1}{2}\right)$. For a small parameter $\varepsilon > 0$, we introduce $\Omega^\varepsilon := \omega \times \left(-\frac{\varepsilon}{2}, \frac{\varepsilon}{2}\right)$. The domain Ω^ε is called a "plate" because ε is small compared to the characteristic size of ω (see Figure 2.2). We also denote by n (respectively n^ε) the outward normal unit vector to $\partial\Omega$ (respectively $\partial\Omega^\varepsilon$).

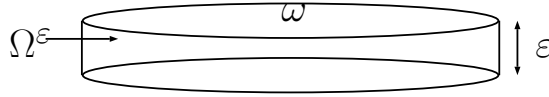

Figure 2.2: Schematic representation of the plate Ω^ε .

Let $(e_i)_{1 \leq i \leq d}$ be the canonical basis of \mathbb{R}^d . For any $x = (x_i)_{1 \leq i \leq d} \in \mathbb{R}^d$, we set $x' := (x_i)_{1 \leq i \leq d-1} \in \mathbb{R}^{d-1}$. For any $M := (M_{ij})_{1 \leq i, j \leq d} \in \mathbb{R}^{d \times d}$, we set $M' := (M_{ij})_{1 \leq i, j \leq d-1} \in \mathbb{R}^{(d-1) \times (d-1)}$. The set of $d \times d$ symmetric matrices is denoted by $\mathbb{R}_s^{d \times d}$ and $c_-, c_+ > 0$ are some fixed positive constants. We also define the periodic cells

$$Y := (0, 1)^{d-1} \quad \text{and} \quad \mathcal{Y} := Y \times \left(-\frac{1}{2}, \frac{1}{2}\right).$$

For any $f : \mathbb{R}^{d-1} \times \left(-\frac{1}{2}, \frac{1}{2}\right) \rightarrow \mathbb{R}^p$, we denote by

$$m(f)(x') := \int_{-1/2}^{+1/2} f(x', x_d) dx_d$$

the mean of f over its last variable.

Throughout the article, we use the Einstein summation convention. Latin letters are used for indices running between 1 and d and greek letters for indices running between 1 and $d - 1$.

2.2.1 Definition of the plate problem

The notations we introduce now are specific to the diffusion case (i.e. to the current Section 2.2). We refer to Section 2.3.1 for similar notations for the elasticity case. We denote by $\mathcal{M} \subset \mathbb{R}_s^{d \times d}$ the set of symmetric matrices M such that

$$\forall \xi \in \mathbb{R}^d, \quad |M\xi| \leq c_+|\xi| \quad \text{and} \quad \xi^\top M\xi \geq c_-|\xi|^2.$$

Let $A : \mathbb{R}^{d-1} \times \left(-\frac{1}{2}, \frac{1}{2}\right) \rightarrow \mathcal{M}$ be a matrix-valued field such that, for any $x_d \in \left(-\frac{1}{2}, \frac{1}{2}\right)$, the function $x' \in \mathbb{R}^{d-1} \mapsto A(x', x_d)$ is Y -periodic. For any $x \in \Omega$, we set

$$A^\varepsilon(x) = A\left(\frac{x'}{\varepsilon}, x_d\right). \quad (2.3)$$

In addition, we define \mathcal{A}^ε by

$$\forall x \in \Omega^\varepsilon, \quad \mathcal{A}^\varepsilon(x) := A^\varepsilon\left(x', \frac{x_d}{\varepsilon}\right) = A\left(\frac{x'}{\varepsilon}, \frac{x_d}{\varepsilon}\right).$$

We set

$$V^\varepsilon := \left\{ v \in H^1(\Omega^\varepsilon), \quad v = 0 \text{ on } \partial\omega \times \left(-\frac{\varepsilon}{2}, \frac{\varepsilon}{2}\right) \right\}.$$

A function in V^ε thus vanishes on the lateral boundary of Ω^ε (see Figure 2.2).

For any $\varepsilon > 0$, let $\tilde{f}^\varepsilon \in L^2(\Omega^\varepsilon)$, $g^\varepsilon \in H^1(\omega)$ and $h_\pm^\varepsilon \in L^2(\omega)$. We consider the following diffusion problem: find $\tilde{u}^\varepsilon \in V^\varepsilon$ such that

$$\begin{cases} -\operatorname{div}(\mathcal{A}^\varepsilon \nabla \tilde{u}^\varepsilon) = \tilde{f}^\varepsilon + \operatorname{div}(\mathcal{A}^\varepsilon \nabla g^\varepsilon) & \text{in } \Omega^\varepsilon, \\ \mathcal{A}^\varepsilon \nabla \tilde{u}^\varepsilon \cdot n^\varepsilon = \varepsilon h_\pm^\varepsilon - \mathcal{A}^\varepsilon \nabla g^\varepsilon \cdot n^\varepsilon & \text{on } \omega \times \left\{ \pm \frac{\varepsilon}{2} \right\}. \end{cases} \quad (2.4)$$

In (2.4), \tilde{f}^ε is the load imposed in Ω^ε . The function g^ε is inserted as a possible extension of a non-trivial Dirichlet boundary condition (so that $\tilde{u}^\varepsilon + g^\varepsilon$ does not necessarily vanish on $\partial\omega \times (-\varepsilon/2, \varepsilon/2)$). A motivation for considering this general case is the fact that we use these strong convergence results in our companion contribution [AL2] for the numerical analysis of MsFEM approaches, where such general Dirichlet boundary conditions appear. Note that g^ε does not depend on x_d . The function h_\pm^ε plays the role of a Neumann boundary condition on the top and bottom faces of the plate Ω^ε .

Remark 2.1. *As is obvious on (2.4), the thickness (denoted η in this remark) of the plate is equal to the characteristic length-scale ε of variations of \mathcal{A}^ε in the in-plane directions. As pointed out above, different regimes for η vs ε have been considered in the literature (e.g. sending η to 0 before or after sending ε to 0). We refer e.g. to [17, 46, 45] for such studies.*

Since our goal is to study the asymptotic behaviour of \tilde{u}^ε when ε goes to 0, it is convenient to rescale the problem and recast (2.4) as a problem set on Ω , a domain independent of ε . This is of course a standard step when studying plate problems.

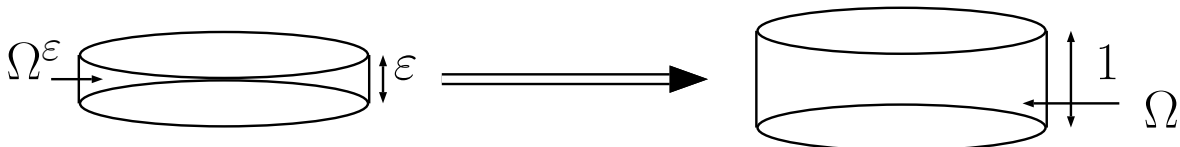

Figure 2.3: Rescaling of the domain

For any $u \in \mathcal{D}'(\mathbb{R}^d)$ and any $T \in (\mathcal{D}'(\mathbb{R}^d))^d$, we set

$$\nabla' u = \partial_\alpha u e_\alpha = \sum_{\alpha=1}^{d-1} \partial_\alpha u e_\alpha.$$

We next introduced scaled operators as

$$\nabla^\varepsilon u := \partial_\alpha u e_\alpha + \frac{1}{\varepsilon} \partial_d u e_d = \sum_{\alpha=1}^{d-1} \partial_\alpha u e_\alpha + \frac{1}{\varepsilon} \partial_d u e_d$$

and

$$\operatorname{div}^\varepsilon T := \partial_\alpha T_\alpha + \frac{1}{\varepsilon} \partial_d T_d = \sum_{\alpha=1}^{d-1} \partial_\alpha T_\alpha + \frac{1}{\varepsilon} \partial_d T_d.$$

We introduce

$$V := \left\{ v \in H^1(\Omega), \quad v = 0 \text{ on } \partial\omega \times \left(-\frac{1}{2}, \frac{1}{2} \right) \right\}. \quad (2.5)$$

It can be easily checked that problem (2.4) is equivalent to finding $u^\varepsilon \in V$ such that

$$\begin{cases} -\operatorname{div}^\varepsilon(A^\varepsilon \nabla^\varepsilon u^\varepsilon) = f^\varepsilon + \operatorname{div}^\varepsilon(A^\varepsilon \nabla^\varepsilon g^\varepsilon) & \text{in } \Omega, \\ A^\varepsilon \nabla^\varepsilon u^\varepsilon \cdot n = \varepsilon h_\pm^\varepsilon - A^\varepsilon \nabla^\varepsilon g^\varepsilon \cdot n & \text{on } \omega \times \left\{ \pm \frac{1}{2} \right\}, \end{cases} \quad (2.6)$$

where A^ε is given by (2.3) and where

$$u^\varepsilon(x) = \tilde{u}^\varepsilon(x', \varepsilon x_d) \quad \text{and} \quad f^\varepsilon(x) = \tilde{f}^\varepsilon(x', \varepsilon x_d). \quad (2.7)$$

Note that, since g^ε does not depend on x_d , the same function appears in (2.4) and (2.6).

The variational formulation of (2.6) reads as follows: find $u^\varepsilon \in V$ such that

$$\forall v \in V, \quad a^\varepsilon(u^\varepsilon, v) = b^\varepsilon(v) \quad (2.8)$$

where, for all $u, v \in V$,

$$a^\varepsilon(u, v) := \int_\Omega A^\varepsilon \nabla^\varepsilon u \cdot \nabla^\varepsilon v \quad (2.9)$$

and

$$b^\varepsilon(v) := \int_\Omega f^\varepsilon v - \int_\Omega A^\varepsilon \nabla^\varepsilon g^\varepsilon \cdot \nabla^\varepsilon v + \int_\omega h_+^\varepsilon v \left(\cdot, \frac{1}{2} \right) + \int_\omega h_-^\varepsilon v \left(\cdot, -\frac{1}{2} \right). \quad (2.10)$$

The coercivity of the bilinear form a^ε (with a constant which is uniform with respect to ε) is an easy consequence of the following Poincaré inequality and of the fact that $\|\nabla u\|_{L^2(\Omega)} \leq \|\nabla^\varepsilon u\|_{L^2(\Omega)}$ for any $u \in V$. Using the Lax-Milgram theorem, we deduce that there exists a unique solution to (2.8).

Lemma 2.2. *Let V be defined by (2.5). There exists a constant $C(\Omega) > 0$ such that*

$$\forall u \in V, \quad \|u\|_{L^2(\Omega)} \leq C(\Omega) \|\nabla u\|_{L^2(\Omega)}.$$

2.2.2 Homogenization result: weak convergence

We first establish a priori bounds on u^ε . Taking $v = u^\varepsilon$ in (2.8), using the fact that g^ε is independent of x_d (so that $\nabla^\varepsilon g = \nabla g$) for the second term and a trace inequality for the last term, we get

$$c_- \|\nabla^\varepsilon u^\varepsilon\|_{L^2(\Omega)}^2 \leq \|f^\varepsilon\|_{L^2(\Omega)} \|u^\varepsilon\|_{L^2(\Omega)} + c_+ \|g^\varepsilon\|_{H^1(\omega)} \|\nabla^\varepsilon u^\varepsilon\|_{L^2(\Omega)} + C \|h_\pm^\varepsilon\|_{L^2(\omega)} \|u^\varepsilon\|_{H^1(\Omega)}.$$

Using Lemma 2.2 and next the fact that $\|\nabla u^\varepsilon\|_{L^2(\Omega)} \leq \|\nabla^\varepsilon u^\varepsilon\|_{L^2(\Omega)}$, we deduce that

$$\begin{aligned} c_- \|\nabla^\varepsilon u^\varepsilon\|_{L^2(\Omega)}^2 &\leq C \|f^\varepsilon\|_{L^2(\Omega)} \|\nabla u^\varepsilon\|_{L^2(\Omega)} + c_+ \|g^\varepsilon\|_{H^1(\omega)} \|\nabla^\varepsilon u^\varepsilon\|_{L^2(\Omega)} + C \|h_\pm^\varepsilon\|_{L^2(\omega)} \|\nabla u^\varepsilon\|_{L^2(\Omega)} \\ &\leq C \|f^\varepsilon\|_{L^2(\Omega)} \|\nabla^\varepsilon u^\varepsilon\|_{L^2(\Omega)} + c_+ \|g^\varepsilon\|_{H^1(\omega)} \|\nabla^\varepsilon u^\varepsilon\|_{L^2(\Omega)} + C \|h_\pm^\varepsilon\|_{L^2(\omega)} \|\nabla^\varepsilon u^\varepsilon\|_{L^2(\Omega)}, \end{aligned}$$

and hence

$$\|\nabla^\varepsilon u^\varepsilon\|_{L^2(\Omega)} \leq C \left(\|f^\varepsilon\|_{L^2(\Omega)} + \|g^\varepsilon\|_{H^1(\omega)} + \|h_+^\varepsilon\|_{L^2(\omega)} + \|h_-^\varepsilon\|_{L^2(\omega)} \right), \quad (2.11)$$

for some constant C independent of ε . Using again Lemma 2.2, this implies that

$$\|u^\varepsilon\|_{H^1(\Omega)} \leq C \left(\|f^\varepsilon\|_{L^2(\Omega)} + \|g^\varepsilon\|_{H^1(\omega)} + \|h_+^\varepsilon\|_{L^2(\omega)} + \|h_-^\varepsilon\|_{L^2(\omega)} \right), \quad (2.12)$$

for some constant C independent of ε .

From now on in Section 2.2, we assume that there exist $f \in L^2(\Omega)$, $g \in H^1(\omega)$ and $h_\pm \in L^2(\omega)$ such that, for all $\varepsilon > 0$,

$$f^\varepsilon = f, \quad g^\varepsilon = g \quad \text{and} \quad h_\pm^\varepsilon = h_\pm. \quad (2.13)$$

Remark 2.3. Note that, in Theorem 2.4 below, it would be sufficient to assume that the sequence $(f^\varepsilon)_{\varepsilon>0}$ (respectively $(h_\pm^\varepsilon)_{\varepsilon>0}$) weakly converges to f (respectively h_\pm) in $L^2(\Omega)$ (respectively in $L^2(\omega)$).

Under the assumption (2.13), we infer from (2.12) that there exists $u^* \in V$ such that, up to the extraction of a subsequence,

$$u^\varepsilon \rightharpoonup u^* \text{ weakly in } H^1(\Omega).$$

The bound (2.11) will also be useful below.

We now recall the well-known homogenization result of [17]. To that aim, we introduce the corrector functions associated to the problem. Let

$$\mathcal{W}(\mathcal{Y}) := \left\{ v \in H_{\text{loc}}^1 \left(\mathbb{R}^{d-1} \times \left(-\frac{1}{2}, \frac{1}{2} \right) \right), \forall z \in \left(-\frac{1}{2}, \frac{1}{2} \right), v(\cdot, z) \text{ is } Y\text{-periodic and } \int_{\mathcal{Y}} v = 0 \right\}.$$

For all $1 \leq \alpha \leq d-1$, let $w^\alpha \in \mathcal{W}(\mathcal{Y})$ be the unique solution to the problem

$$\forall v \in \mathcal{W}(\mathcal{Y}), \quad \int_{\mathcal{Y}} A(\nabla w^\alpha + e_\alpha) \cdot \nabla v = 0. \quad (2.14)$$

Then, the function $w^\alpha \in \mathcal{W}(\mathcal{Y})$ is equivalently the unique solution in $\mathcal{W}(\mathcal{Y})$ to

$$\begin{cases} -\operatorname{div} A(\nabla w^\alpha + e_\alpha) = 0 & \text{in } \mathcal{Y}, \\ A(\nabla w^\alpha + e_\alpha) \cdot e_d = 0 & \text{on } \mathcal{Y}^+ \cup \mathcal{Y}^-, \end{cases} \quad (2.15)$$

where $\mathcal{Y}^\pm := Y \times \left\{ \pm \frac{1}{2} \right\}$ is the top (resp. bottom) face of \mathcal{Y} . We are now in position to state the homogenization theorem for the plate problem, which was proved in [17].

Theorem 2.4 (from [17]). *Under the above assumptions, the sequence $(u^\varepsilon)_{\varepsilon>0}$ solution to (2.8) weakly converges to u^* in $H^1(\Omega)$ as ε goes to 0, where the function u^* does not depend on x_d , belongs to $H_0^1(\omega)$ and is the unique solution to*

$$\forall \phi \in H_0^1(\omega), \quad \int_{\omega} A^* \nabla' u^* \cdot \nabla' \phi = \int_{\omega} (\operatorname{m}(f) + h^+ + h^-) \phi - \int_{\omega} A^* \nabla' g \cdot \nabla' \phi \quad (2.16)$$

where $A^* := (A_{\alpha\beta}^*)_{1 \leq \alpha, \beta \leq d-1}$ is the homogenized matrix defined by

$$A_{\alpha\beta}^* := \int_{\mathcal{Y}} A(\nabla w^\alpha + e_\alpha) \cdot (\nabla w^\beta + e_\beta).$$

By construction, A^* is symmetric and coercive.

For the sake of completeness, we provide a proof of this result in Appendix 2.C, using the method of the oscillating test function.

2.2.3 Strong convergence of the two-scale expansion

For any function u of $H^1(\Omega)$, we define the norm

$$\|u\|_{H_\varepsilon^1(\Omega)} := \sqrt{\|u\|_{L^2(\Omega)}^2 + \|\nabla^\varepsilon u\|_{L^2(\Omega)}^2}. \quad (2.17)$$

This is indeed the relevant energy norm for (2.8). In addition, for any u^ε defined on Ω and any \tilde{u}^ε defined on Ω^ε that are related one to each other by (2.7), we have $\|u^\varepsilon\|_{H_\varepsilon^1(\Omega)} = \|\tilde{u}^\varepsilon\|_{H^1(\Omega^\varepsilon)}$.

The aim of this section is to prove that the classical two-scale expansion, built upon the homogenized solution and the correctors, yields an approximation of u^ε which is converging in the $H_\varepsilon^1(\Omega)$ norm as ε goes to 0. More precisely, we are now in position to state our main result for the diffusion problem.

Theorem 2.5. *Let us assume that f does not depend on x_d (thus $f \in L^2(\omega)$), $g \in W^{2,\infty}(\omega)$, $u^* \in W^{2,\infty}(\omega)$ and that, for any $1 \leq \alpha \leq d-1$, we have $w^\alpha \in W^{1,\infty}(\mathbb{R}^{d-1} \times (-\frac{1}{2}, \frac{1}{2}))$. Then, introducing the two-scale expansion*

$$u^{\varepsilon,1} := u^* + \varepsilon w^\alpha \left(\frac{\cdot}{\varepsilon}, \cdot \right) \partial_\alpha (u^* + g),$$

it holds that

$$\begin{aligned} \|u^\varepsilon - u^{\varepsilon,1}\|_{H_\varepsilon^1(\Omega)} &\leq C\sqrt{\varepsilon} \left(|\omega|^{\frac{d-2}{2d-2}} \|\nabla(u^* + g)\|_{L^\infty(\omega)} \right. \\ &\quad \left. + C\sqrt{\varepsilon} |\omega|^{\frac{1}{2}} \|\nabla^2(u^* + g)\|_{L^\infty(\omega)} + \sqrt{\varepsilon} \|h_\pm\|_{L^2(\omega)} \right) \end{aligned}$$

for some constant $C > 0$ independent of ε and of the domain ω .

Tracking the dependency of the constant in the above right-hand side with respect to ω is important for our applications to MsFEM approaches considered in [AL2], where we write the above estimate for problems posed on local elements (and where $|\omega|$ is thus directly related to the size of the coarse mesh).

The rest of this section is devoted to the proof of this result, which requires some preliminary lemmas stated below. Lemma 2.6 states a Poincaré estimate and a trace result for the norm $\|\cdot\|_{H_\varepsilon^1(\Omega)}$ defined in (2.17).

Lemma 2.6. *There exist two constants $C_1 > 0$ and $C_2 > 0$ independent of ε and ω such that*

$$\forall u \in V, \quad \|u\|_{L^2(\Omega)} \leq C_1 \max \left(\varepsilon, |\omega|^{\frac{1}{d-1}} \right) \|\nabla^\varepsilon u\|_{L^2(\Omega)} \quad (2.18)$$

and

$$\forall u \in V, \quad \left\| u \left(\cdot, \pm \frac{1}{2} \right) \right\|_{L^2(\omega)} \leq C_2 \max \left(\varepsilon, |\omega|^{\frac{1}{d-1}} \right) \|\nabla^\varepsilon u\|_{L^2(\Omega)}. \quad (2.19)$$

Proof of Lemma 2.6. For any smooth bounded domain $\tilde{\omega} \subset \mathbb{R}^{d-1}$, we denote by

$$V(\tilde{\Omega}) := \left\{ v \in H^1(\tilde{\Omega}), v = 0 \text{ on } \partial\tilde{\omega} \times \left(-\frac{1}{2}, \frac{1}{2} \right) \right\}$$

where $\tilde{\Omega} := \tilde{\omega} \times \left(-\frac{1}{2}, \frac{1}{2} \right)$.

Let $\widehat{\omega} := (0, 1)^{d-1}$ and $\widehat{\Omega} := \widehat{\omega} \times \left(-\frac{1}{2}, \frac{1}{2}\right)$. Using the Poincaré inequality, there exists some constant $C_P(\widehat{\Omega})$ such that

$$\forall u \in V(\widehat{\Omega}), \quad \|u\|_{L^2(\widehat{\Omega})}^2 \leq C_P(\widehat{\Omega})^2 \|\nabla u\|_{L^2(\widehat{\Omega})}^2. \quad (2.20)$$

We next proceed by scaling. Let us introduce $\omega_K := (0, K)^{d-1}$ and $\Omega_K := \omega_K \times \left(-\frac{1}{2}, \frac{1}{2}\right)$ for some $K > 0$. For any $u \in V(\widehat{\Omega})$, the function $u_K : \omega_K \ni x \mapsto u\left(\frac{x'}{K}, x_d\right)$ belongs to $V(\Omega_K)$. A simple computation shows that

$$\begin{aligned} \|u_K\|_{L^2(\omega_K)}^2 &= K^{d-1} \|u\|_{L^2(\widehat{\omega})}^2, \\ \|\nabla' u_K\|_{L^2(\Omega_K)}^2 &= K^{d-3} \|\nabla' u\|_{L^2(\widehat{\Omega})}^2, \\ \|\varepsilon^{-1} \partial_d u_K\|_{L^2(\Omega_K)}^2 &= K^{d-1} \|\varepsilon^{-1} \partial_d u\|_{L^2(\widehat{\Omega})}^2. \end{aligned}$$

Recalling (2.20), we thus get that

$$\begin{aligned} \|u_K\|_{L^2(\Omega_K)}^2 &\leq C(\widehat{\Omega}) (K^2 \|\nabla' u_K\|_{L^2(\Omega_K)}^2 + \varepsilon^2 \|\varepsilon^{-1} \partial_d u_K\|_{L^2(\Omega_K)}^2) \\ &\leq C(\widehat{\Omega}) \max(K^2, \varepsilon^2) \|\nabla^\varepsilon u_K\|_{L^2(\Omega_K)}^2. \end{aligned}$$

Since $K = |\omega_K|^{\frac{1}{d-1}}$, we get

$$\|u_K\|_{L^2(\Omega_K)} \leq C(\widehat{\Omega}) \max\left(|\omega_K|^{\frac{1}{d-1}}, \varepsilon\right) \|\nabla^\varepsilon u_K\|_{L^2(\Omega_K)}$$

which proves (2.18) in the case $\omega = \omega_K$. In the case of a more general, shape regular domain ω , the proof can be performed using the same argument. The inequality (2.19) is proved following the same lines. This concludes the proof of Lemma 2.6. \square

We now proceed with a form a Poincaré-Wirtinger inequality.

Lemma 2.7. *Let $h \in L^2(\omega)$ and $v \in V$. Then, for any $z \in [-\frac{1}{2}, \frac{1}{2}]$, we have*

$$\left| \int_{\omega} (v(\cdot, z) - \mathfrak{m}(v)) h \right| \leq \varepsilon \|h\|_{L^2(\omega)} \|\nabla^\varepsilon v\|_{L^2(\Omega)}.$$

Proof of Lemma 2.7. Let $v \in V$ and let $(v_n)_{n \in \mathbb{N}}$ be a regularization of v such that, for all $n \in \mathbb{N}$, we have $v_n \in \mathcal{C}^\infty(\overline{\Omega})$ and $v_n \xrightarrow{n \rightarrow +\infty} v$ strongly in $H^1(\Omega)$.

For all $n \in \mathbb{N}$, the function v_n belongs to $\mathcal{C}^\infty(\overline{\Omega})$, and thus, for any $z \in [-\frac{1}{2}, \frac{1}{2}]$, we have

$$\begin{aligned} |v_n(\cdot, z) - \mathfrak{m}(v_n)| &= \left| \int_{-\frac{1}{2}}^{+\frac{1}{2}} (v_n(\cdot, z) - v_n(\cdot, t)) dt \right| \\ &= \left| \int_{-\frac{1}{2}}^{+\frac{1}{2}} \int_t^z \partial_d v_n(\cdot, s) ds dt \right| \\ &\leq \varepsilon \int_{-\frac{1}{2}}^{+\frac{1}{2}} \left| \frac{1}{\varepsilon} \partial_d v_n(\cdot, s) \right| ds. \end{aligned}$$

It follows that

$$\begin{aligned}
\|v_n(\cdot, z) - m(v_n)\|_{L^2(\omega)}^2 &= \int_{\omega} |v_n(\cdot, z) - m(v_n)|^2 \\
&\leq \varepsilon^2 \int_{\omega} \left| \int_{-\frac{1}{2}}^{+\frac{1}{2}} \frac{1}{\varepsilon} \partial_d v_n(\cdot, s) \right| ds \Big|^2 \\
&\leq \varepsilon^2 \left\| \frac{1}{\varepsilon} \partial_d v_n \right\|_{L^2(\Omega)}^2 \\
&\leq \varepsilon^2 \|\nabla^\varepsilon v_n\|_{L^2(\Omega)}^2.
\end{aligned}$$

For any $z \in [-\frac{1}{2}, \frac{1}{2}]$, we now write

$$\left| \int_{\omega} (v(\cdot, z) - m(v)) h \right| \leq \|h\|_{L^2(\omega)} \|v(\cdot, z) - m(v)\|_{L^2(\omega)}$$

and bound from above the right-hand side using that

$$\begin{aligned}
\|v(\cdot, z) - m(v)\|_{L^2(\omega)} &\leq \|v_n(\cdot, z) - m(v_n)\|_{L^2(\omega)} + \|v(\cdot, z) - v_n(\cdot, z)\|_{L^2(\omega)} \\
&\quad + \|m(v) - m(v_n)\|_{L^2(\omega)} \\
&\leq \varepsilon \|\nabla^\varepsilon v_n\|_{L^2(\Omega)} + C \|v - v_n\|_{H^1(\Omega)} + \|v - v_n\|_{L^2(\Omega)}
\end{aligned}$$

where we use the above inequality for v_n for the first term, and the trace inequality for the second term. Passing to the limit $n \rightarrow \infty$ yields the result and concludes the proof of Lemma 2.7. \square

Lemma 2.8 is an adaptation of a technical result, already present in [58, p. 27], to the case of plates.

Lemma 2.8. *Let V be defined by (2.5). Let $Z \in \left(L_{\text{loc}}^2 \left(\mathbb{R}^{d-1} \times \left(-\frac{1}{2}, \frac{1}{2} \right) \right) \right)^d$ be a vector field such that*

(i) *for almost all $z \in \left(-\frac{1}{2}, \frac{1}{2} \right)$, the function $Z(\cdot, z)$ is Y -periodic;*

(ii) $\int_Y Z = 0$;

(iii) $\text{div} Z = 0$ in $\mathcal{D}' \left(\mathbb{R}^{d-1} \times \left(-\frac{1}{2}, \frac{1}{2} \right) \right)$;

(iv) $Z \cdot e_d = 0$ on $\mathbb{R}^{d-1} \times \{-1/2\}$ and on $\mathbb{R}^{d-1} \times \{+1/2\}$.

Then, there exists some C such that

$$\forall \varphi \in W^{1,\infty}(\omega), \quad \forall v \in V, \quad \left| \int_{\Omega} \varphi Z \left(\frac{\cdot}{\varepsilon}, \cdot \right) \cdot \nabla^\varepsilon v \right| \leq C \varepsilon |\omega|^{\frac{1}{2}} \|\nabla \varphi\|_{L^\infty(\omega)} \|\nabla^\varepsilon v\|_{L^2(\Omega)}.$$

Remark 2.9. *We recall that for any function in $H_{\text{div}}(D) := \{Z \in L^2(D)^d, \text{div} Z \in L^2(D)\}$ (for any smooth domain $D \subset \mathbb{R}^d$) has a well-defined normal trace on ∂D (see Appendix 2.A for details). Assumption (iv) in Lemma 2.8 thus makes sense.*

The proof of Lemma 2.8 requires the following lemma (see [58, p. 6]). We recall that $L_{\text{per}}^2(\mathbb{R}^d) = \{f \in L_{\text{loc}}^2(\mathbb{R}^d), f \text{ is } (0, 1)^d\text{-periodic}\}$.

Lemma 2.10. *Let $p \in \{q \in (L^2_{\text{per}}(\mathbb{R}^d))^d, \text{div } q = 0 \text{ in } \mathbb{R}^d\}$. Then there exists $J \in (H^1_{\text{per}}(\mathbb{R}^d))^{d \times d}$ which is skew symmetric and such that*

$$\forall 1 \leq j \leq d, \quad p_j - \int_{(0,1)^d} p_j = \partial_i J_{ij}, \quad \int_{(0,1)^d} J_{ij} = 0.$$

Proof of Lemma 2.8. Let \bar{Z} be the periodic extension of Z in the e_d direction. We then have $\bar{Z} \in (L^2_{\text{per}}(\mathbb{R}^d))^d$. Let us prove that $\text{div } \bar{Z} = 0$ in $\mathcal{D}'(\mathbb{R}^d)$. Let $\psi \in \mathcal{D}(\mathbb{R}^d)$. There exists a compact set $K \subset \mathbb{R}^{d-1}$ and an integer $m \in \mathbb{N}^*$ such that $\text{Supp } \psi \subset K \times [-m - 1/2; m + 1/2]$. We compute

$$\begin{aligned} \langle \text{div } \bar{Z}, \psi \rangle_{\mathcal{D}'(\mathbb{R}^d), \mathcal{D}(\mathbb{R}^d)} &= - \int_{K \times (-m-1/2; m+1/2)} \bar{Z} \cdot \nabla \psi \\ &= \sum_{k=-m}^m - \int_{K \times (k-1/2; k+1/2)} \bar{Z} \cdot \nabla \psi \\ &= \sum_{k=-m}^m - \int_{K \times (-1/2; 1/2)} Z \cdot \nabla \psi(\cdot + k e_d). \end{aligned}$$

Using Assumptions (iv) and that $\psi(\cdot + k e_d) = 0$ on $\partial K \times \mathbb{R}$, we compute that

$$\int_{K \times (-1/2; 1/2)} Z \cdot \nabla \psi(\cdot + k e_d) = - \int_{K \times (-1/2; 1/2)} \psi(\cdot + k e_d) \text{div } Z.$$

Using Assumption (iii), we deduce that $\int_{K \times (-1/2; 1/2)} Z \cdot \nabla \psi(\cdot + k e_d) = 0$. We thus obtain that $\text{div } \bar{Z} = 0$ in $\mathcal{D}'(\mathbb{R}^d)$.

We are thus in position to use Lemma 2.10 for \bar{Z} . Since $\int_{\mathcal{Y}} \bar{Z} = 0$, we know that there exists a skew symmetric matrix-valued field $J \in (H^1_{\text{per}}(\mathbb{R}^d))^{d \times d}$ such that $\bar{Z}_j = \partial_i J_{ij}$.

Let $\varphi \in W^{1,\infty}(\omega)$. Denoting $J_{\cdot j} = (J_{ij})_{1 \leq i \leq d} \in \mathbb{R}^d$, we compute, for any x_d in $(-\frac{1}{2}, \frac{1}{2})$,

$$\begin{aligned} \left[Z \left(\frac{\cdot}{\varepsilon}, x_d \right) \varphi \right]_j &= \left[\bar{Z} \left(\frac{\cdot}{\varepsilon}, x_d \right) \varphi \right]_j \\ &= \partial_i J_{ij} \left(\frac{\cdot}{\varepsilon}, x_d \right) \varphi \\ &= \varepsilon \text{div}^\varepsilon \left[J_{\cdot j} \left(\frac{\cdot}{\varepsilon}, x_d \right) \right] \varphi \\ &= \varepsilon \text{div}^\varepsilon \left[J_{\cdot j} \left(\frac{\cdot}{\varepsilon}, x_d \right) \varphi \right] - \varepsilon J_{\cdot j} \left(\frac{\cdot}{\varepsilon}, x_d \right) \cdot \nabla^\varepsilon \varphi \\ &= \varepsilon \tilde{B}_j(\cdot, x_d) - \varepsilon B_j(\cdot, x_d) \end{aligned}$$

where $\tilde{B}_j(\cdot, x_d) := \text{div}^\varepsilon \left[J_{\cdot j} \left(\frac{\cdot}{\varepsilon}, x_d \right) \varphi \right]$ and $B_j(\cdot, x_d) := J_{\cdot j} \left(\frac{\cdot}{\varepsilon}, x_d \right) \cdot \nabla^\varepsilon \varphi$. Note that

$$\begin{aligned} &\text{div}^\varepsilon(\tilde{B}) \\ &= \text{div}^\varepsilon \left(\partial_\alpha \left[J_{\alpha j} \left(\frac{\cdot}{\varepsilon}, x_d \right) \varphi \right] e_j + \frac{1}{\varepsilon} \partial_d \left[J_{dj} \left(\frac{\cdot}{\varepsilon}, x_d \right) \varphi \right] e_j \right) \\ &= \partial_{\beta\alpha} \left[J_{\alpha\beta} \left(\frac{\cdot}{\varepsilon}, x_d \right) \varphi \right] + \frac{1}{\varepsilon} \left(\partial_{d\alpha} \left[J_{\alpha d} \left(\frac{\cdot}{\varepsilon}, x_d \right) \varphi \right] + \partial_{\beta d} \left[J_{d\beta} \left(\frac{\cdot}{\varepsilon}, x_d \right) \varphi \right] \right) + \frac{1}{\varepsilon^2} \partial_{dd} \left[J_{dd} \left(\frac{\cdot}{\varepsilon}, x_d \right) \varphi \right] \\ &= 0 \quad [\text{because } J \text{ is skew symmetric}]. \end{aligned} \tag{2.21}$$

We now write that, for any v in V ,

$$\int_{\Omega} \varphi Z \left(\frac{\cdot}{\varepsilon}, \cdot \right) \cdot \nabla^{\varepsilon} v = \varepsilon \int_{\Omega} \tilde{B} \cdot \nabla^{\varepsilon} v - \varepsilon \int_{\Omega} B \cdot \nabla^{\varepsilon} v. \quad (2.22)$$

We bound the first term of (2.22). By definition \tilde{B} is in $L^2(\Omega)$ and $\operatorname{div}^{\varepsilon}(\tilde{B})$ is also in $L^2(\Omega)$, in view of (2.21). We thus note that \tilde{B} has a well defined normal trace. Using (2.21) and an integration by part, we obtain

$$\int_{\Omega} \tilde{B} \cdot \nabla^{\varepsilon} v = \frac{1}{\varepsilon} \int_{\omega} \tilde{B} \left(\cdot, \frac{1}{2} \right) \cdot e_d v \left(\cdot, \frac{1}{2} \right) - \frac{1}{\varepsilon} \int_{\omega} \tilde{B} \left(\cdot, -\frac{1}{2} \right) \cdot e_d v \left(\cdot, -\frac{1}{2} \right). \quad (2.23)$$

It holds that, for any x_d in $(-\frac{1}{2}, \frac{1}{2})$,

$$\tilde{B} = \frac{1}{\varepsilon} Z \left(\frac{\cdot}{\varepsilon}, x_d \right) \varphi + J \left(\frac{\cdot}{\varepsilon}, x_d \right) \nabla^{\varepsilon} \varphi.$$

Since $\varphi \in W^{1,\infty}(\omega)$, it holds that $\nabla^{\varepsilon} \varphi = \nabla \varphi = (\nabla' \varphi, 0) \in L^{\infty}(\omega)$. Besides, since $J \in (H_{\text{per}}^1(\mathbb{R}^d))^{d \times d}$, we have

$$J \left(\frac{\cdot}{\varepsilon}, -\frac{1}{2} \right) \nabla^{\varepsilon} \varphi = J \left(\frac{\cdot}{\varepsilon}, \frac{1}{2} \right) \nabla^{\varepsilon} \varphi = J \left(\frac{\cdot}{\varepsilon}, \frac{1}{2} \right) \nabla \varphi \in L^2(\omega).$$

Assumption (iv) implies that

$$\tilde{B} \left(\cdot, \pm \frac{1}{2} \right) \cdot e_d = e_d^T J \left(\frac{\cdot}{\varepsilon}, \frac{1}{2} \right) \nabla \varphi.$$

We hence deduce from (2.23) that

$$\begin{aligned} \left| \int_{\Omega} \tilde{B} \cdot \nabla^{\varepsilon} v \right| &= \frac{1}{\varepsilon} \left| \int_{\omega} e_d^T J \left(\frac{\cdot}{\varepsilon}, \frac{1}{2} \right) \nabla \varphi \left[v \left(\cdot, \frac{1}{2} \right) - v \left(\cdot, -\frac{1}{2} \right) \right] \right| \\ &= \left| \int_{\omega} \int_{t=-1/2}^{1/2} \frac{1}{\varepsilon} \partial_d v(x', t) e_d^T J \left(\frac{x'}{\varepsilon}, \frac{1}{2} \right) \nabla \varphi(x') dt dx' \right| \\ &\leq \|\nabla^{\varepsilon} v\|_{L^2(\Omega)} \left\| J \left(\frac{\cdot}{\varepsilon}, \frac{1}{2} \right) \right\|_{L^2(\omega)} \|\nabla \varphi\|_{L^{\infty}(\omega)} \\ &\leq C|\omega|^{\frac{1}{2}} \|\nabla^{\varepsilon} v\|_{L^2(\Omega)} \left\| J \left(\cdot, \frac{1}{2} \right) \right\|_{L^2(Y)} \|\nabla \varphi\|_{L^{\infty}(\omega)} \\ &\leq C|\omega|^{\frac{1}{2}} \|\nabla^{\varepsilon} v\|_{L^2(\Omega)} \|J\|_{H^1(Y)} \|\nabla \varphi\|_{L^{\infty}(\omega)}. \end{aligned} \quad (2.24)$$

We now bound the second term of (2.22):

$$\begin{aligned} \left| \int_{\Omega} B \cdot \nabla^{\varepsilon} v \right| &= \left| \int_{\omega} \int_{-1/2}^{1/2} J \left(\frac{x'}{\varepsilon}, x_d \right) \nabla^{\varepsilon} v(x', x_d) \cdot \nabla^{\varepsilon} \varphi(x') dx' dx_d \right| \\ &\leq \|\nabla \varphi\|_{L^{\infty}(\omega)} \|\nabla^{\varepsilon} v\|_{L^2(\Omega)} \left\| J \left(\frac{\cdot}{\varepsilon}, \cdot \right) \right\|_{L^2(\Omega)} \\ &\leq C|\omega|^{\frac{1}{2}} \|\nabla \varphi\|_{L^{\infty}(\omega)} \|\nabla^{\varepsilon} v\|_{L^2(\Omega)} \|J\|_{L^2(Y)}. \end{aligned} \quad (2.25)$$

Collecting (2.22), (2.24) and (2.25), we have shown that

$$\left| \int_{\Omega} \varphi Z \left(\frac{\cdot}{\varepsilon}, \cdot \right) \cdot \nabla^{\varepsilon} v \right| \leq C\varepsilon |\omega|^{\frac{1}{2}} \|\nabla \varphi\|_{L^{\infty}(\omega)} \|\nabla^{\varepsilon} v\|_{L^2(\Omega)}.$$

This concludes the proof of Lemma 2.8. \square

We are now in position to prove Theorem 2.5.

Proof of Theorem 2.5. The proof falls in four steps. In the first step, we correct for the boundary mismatch between u^ε and its approximation $u^{\varepsilon,1}$. In Steps 2 and 3, we show that our approximation is accurate in the suitable norm inside the domain. In Step 4, we collect all the estimates to reach the conclusion.

Step 1. Let $\tau_\varepsilon \in \mathcal{D}(\omega)$ such that $0 \leq \tau_\varepsilon \leq 1$, and such that $\tau_\varepsilon(x') = 1$ for any $x' \in \omega$ such that $\text{dist}(x', \partial\omega) \geq \varepsilon$. Since ω is smooth, we can choose τ_ε such that $\varepsilon \|\nabla \tau_\varepsilon\|_{L^\infty(\omega)} \leq C$ with $C > 0$ independent of ω and ε . We define $\omega_\varepsilon := \{x' \in \omega \text{ such that } \text{dist}(x', \partial\omega) \geq \varepsilon\}$ and $\Omega_\varepsilon := \omega_\varepsilon \times (-\frac{1}{2}, \frac{1}{2})$. Note that $|\Omega \setminus \Omega_\varepsilon| \leq C\varepsilon |\omega|^{\frac{d-2}{d-1}}$.

We introduce the function $v^{\varepsilon,1}$ defined for $x \in \Omega$ by

$$v^{\varepsilon,1}(x) := u^*(x') + \varepsilon \tau_\varepsilon(x') w^\alpha \left(\frac{x'}{\varepsilon}, x_d \right) \partial_\alpha (u^*(x') + g(x')).$$

By definition of τ_ε , we have $v^{\varepsilon,1} \in V$ and $v^{\varepsilon,1} = u^{\varepsilon,1}$ in Ω_ε .

We begin with an estimation of $\|u^{\varepsilon,1} - v^{\varepsilon,1}\|_{H^1(\Omega)}$. We compute that $\nabla^\varepsilon u^{\varepsilon,1} - \nabla^\varepsilon v^{\varepsilon,1} = E_0^\varepsilon - E_1^\varepsilon + \varepsilon E_2^\varepsilon$, where

$$\begin{aligned} E_0^\varepsilon &= (1 - \tau_\varepsilon) \nabla w^\alpha \left(\frac{\cdot}{\varepsilon}, \cdot \right) \partial_\alpha (u^* + g), \\ E_1^\varepsilon &= \varepsilon \nabla^\varepsilon \tau_\varepsilon w^\alpha \left(\frac{\cdot}{\varepsilon}, \cdot \right) \partial_\alpha (u^* + g), \\ E_2^\varepsilon &= (1 - \tau_\varepsilon) w^\alpha \left(\frac{\cdot}{\varepsilon}, \cdot \right) \nabla^\varepsilon \partial_\alpha (u^* + g). \end{aligned}$$

We bound the above three terms in $L^2(\Omega)$ norm, using that $w^\alpha \in W^{1,\infty}$, $0 \leq \tau_\varepsilon \leq 1$ and that $\varepsilon \|\nabla \tau_\varepsilon\|_{L^\infty(\omega)} \leq C$. Note that by definition $\partial_d \tau_\varepsilon = 0$ therefore $\nabla^\varepsilon \tau_\varepsilon = \nabla \tau_\varepsilon$. Likewise, $\nabla^\varepsilon \partial_\alpha (u^* + g) = \nabla \partial_\alpha (u^* + g)$. We thus have

$$\begin{aligned} \|E_2^\varepsilon\|_{L^2(\Omega)}^2 &\leq C \sup_{1 \leq \alpha \leq d-1} \|w^\alpha\|_{L^\infty}^2 \|\nabla^2(u^* + g)\|_{L^2(\Omega)}^2 \\ &\leq C |\omega| (\|\nabla^2 u^*\|_{L^\infty(\omega)}^2 + \|\nabla^2 g\|_{L^\infty(\omega)}^2), \\ \|E_1^\varepsilon\|_{L^2(\Omega)}^2 &\leq C \sup_{1 \leq \alpha \leq d-1} \|w^\alpha\|_{L^\infty}^2 \|\nabla(u^* + g)\|_{L^\infty(\omega)}^2 |\Omega \setminus \Omega_\varepsilon| \\ &\leq C \varepsilon |\omega|^{\frac{d-2}{d-1}} (\|\nabla u^*\|_{L^\infty(\omega)}^2 + \|\nabla g\|_{L^\infty(\omega)}^2), \\ \|E_0^\varepsilon\|_{L^2(\Omega)}^2 &\leq C |\Omega \setminus \Omega_\varepsilon| \sup_{1 \leq \alpha \leq d-1} \|\nabla w^\alpha\|_{L^\infty}^2 \|\nabla(u^* + g)\|_{L^\infty(\omega)}^2 \\ &\leq C \varepsilon |\omega|^{\frac{d-2}{d-1}} (\|\nabla u^*\|_{L^\infty(\omega)}^2 + \|\nabla g\|_{L^\infty(\omega)}^2). \end{aligned}$$

We thus obtain

$$\|\nabla^\varepsilon v^{\varepsilon,1} - \nabla^\varepsilon u^{\varepsilon,1}\|_{L^2(\Omega)}^2 \leq C \left(\varepsilon |\omega|^{\frac{d-2}{d-1}} \|\nabla u^*\|_{L^\infty(\omega)}^2 + \varepsilon^2 |\omega| \|\nabla^2 u^*\|_{L^\infty(\omega)}^2 \right). \quad (2.26)$$

Step 2. We now bound $\bar{v}^\varepsilon := u^\varepsilon - v^{\varepsilon,1}$. Thanks to the coercivity of A , we write

$$c_- \|\nabla^\varepsilon \bar{v}^\varepsilon\|_{L^2(\Omega)}^2 \leq \int_\Omega \nabla^\varepsilon \bar{v}^\varepsilon \cdot A^\varepsilon \nabla^\varepsilon \bar{v}^\varepsilon.$$

We next split the right-hand side as

$$\int_\Omega \nabla^\varepsilon \bar{v}^\varepsilon \cdot A^\varepsilon \nabla^\varepsilon \bar{v}^\varepsilon = \int_\Omega \nabla^\varepsilon \bar{v}^\varepsilon \cdot A^\varepsilon \nabla^\varepsilon (u^\varepsilon - u^{\varepsilon,1}) + \int_\Omega \nabla^\varepsilon \bar{v}^\varepsilon \cdot A^\varepsilon \nabla^\varepsilon (u^{\varepsilon,1} - v^{\varepsilon,1}), \quad (2.27)$$

and bound the second term of (2.27) using (2.26):

$$\begin{aligned} \int_{\Omega} \nabla^{\varepsilon} \bar{v}^{\varepsilon} \cdot A^{\varepsilon} \nabla^{\varepsilon} (u^{\varepsilon,1} - v^{\varepsilon,1}) &\leq C \|\nabla^{\varepsilon} (u^{\varepsilon} - v^{\varepsilon,1})\|_{L^2(\Omega)} \|\nabla^{\varepsilon} (u^{\varepsilon,1} - v^{\varepsilon,1})\|_{L^2(\Omega)} \\ &\leq \left(\sqrt{\varepsilon} |\omega|^{\frac{d-2}{2d-2}} \|\nabla u^{\star}\|_{L^{\infty}(\omega)} \right. \\ &\quad \left. + \varepsilon |\omega|^{\frac{1}{2}} \|\nabla^2 u^{\star}\|_{L^{\infty}(\omega)} \right) \|\nabla^{\varepsilon} (u^{\varepsilon,1} - v^{\varepsilon,1})\|_{L^2(\Omega)}. \end{aligned}$$

For the first term of (2.27), we write

$$\int_{\Omega} \nabla^{\varepsilon} \bar{v}^{\varepsilon} \cdot A^{\varepsilon} \nabla^{\varepsilon} (u^{\varepsilon} - u^{\varepsilon,1}) = \int_{\Omega} A^{\varepsilon} \nabla^{\varepsilon} (u^{\varepsilon} + g) \cdot \nabla^{\varepsilon} \bar{v}^{\varepsilon} - \int_{\Omega} A^{\varepsilon} \nabla^{\varepsilon} (u^{\varepsilon,1} + g) \cdot \nabla^{\varepsilon} \bar{v}^{\varepsilon}.$$

We recast those terms as

$$\int_{\Omega} A^{\varepsilon} \nabla^{\varepsilon} (u^{\varepsilon} + g) \cdot \nabla^{\varepsilon} \bar{v}^{\varepsilon} = \int_{\Omega} \left[\int_{\mathcal{Y}} A(e_{\alpha} + \nabla w^{\alpha}) \right] \partial_{\alpha} (u^{\star} + g) \cdot \nabla^{\varepsilon} \bar{v}^{\varepsilon} + R_1^{\varepsilon} \quad (2.28)$$

and

$$\int_{\Omega} A^{\varepsilon} \nabla^{\varepsilon} (u^{\varepsilon,1} + g) \cdot \nabla^{\varepsilon} \bar{v}^{\varepsilon} = \int_{\Omega} A^{\varepsilon} \left(e_{\alpha} + \nabla w^{\alpha} \left(\frac{\cdot}{\varepsilon}, \cdot \right) \right) \partial_{\alpha} (u^{\star} + g) \cdot \nabla^{\varepsilon} \bar{v}^{\varepsilon} + R_2^{\varepsilon}. \quad (2.29)$$

where R_1^{ε} and R_2^{ε} are remainder terms precisely defined by (2.28) and (2.29). We thus have

$$\begin{aligned} &\int_{\Omega} \nabla^{\varepsilon} \bar{v}^{\varepsilon} \cdot A^{\varepsilon} \nabla^{\varepsilon} (u^{\varepsilon} - u^{\varepsilon,1}) \\ &= \int_{\Omega} \left[\int_{\mathcal{Y}} A(e_{\alpha} + \nabla w^{\alpha}) dy - A^{\varepsilon} (e_{\alpha} + \nabla w^{\alpha}) \right] \partial_{\alpha} (u^{\star} + g) \cdot \nabla^{\varepsilon} \bar{v}^{\varepsilon} + R_1^{\varepsilon} + R_2^{\varepsilon}. \end{aligned}$$

We now consider the first term of the above equation and introduce

$$Z_{\alpha} := \int_{\mathcal{Y}} A(e_{\alpha} + \nabla w^{\alpha}) - A(e_{\alpha} + \nabla w^{\alpha}).$$

Because of the definition of w^{α} solution to (2.14), Z_{α} satisfies the assumptions of Lemma 2.8. The function $\partial_{\alpha} (u^{\star} + g)$ belongs to $W^{1,\infty}(\omega)$ and $u^{\varepsilon} - v^{\varepsilon,1}$ belongs to V . We are thus in position to use Lemma 2.8. For any $1 \leq \alpha \leq d-1$, it holds that

$$\left| \int_{\Omega} Z_{\alpha} \left(\frac{\cdot}{\varepsilon}, \cdot \right) \partial_{\alpha} (u^{\star} + g) \cdot \nabla^{\varepsilon} \bar{v}^{\varepsilon} \right| \leq C \varepsilon |\omega|^{\frac{1}{2}} \|\nabla^2 (u^{\star} + g)\|_{L^{\infty}(\omega)} \|\nabla^{\varepsilon} \bar{v}^{\varepsilon}\|_{L^2(\Omega)}.$$

At this point, we have shown that

$$\|\nabla^{\varepsilon} \bar{v}^{\varepsilon}\|_{L^2(\Omega)}^2 \leq C \left(\sqrt{\varepsilon} |\omega|^{\frac{d-2}{2d-2}} \|\nabla u^{\star}\|_{L^{\infty}(\omega)} + \varepsilon |\omega|^{\frac{1}{2}} \|\nabla^2 u^{\star}\|_{L^{\infty}(\omega)} \right) \|\nabla^{\varepsilon} \bar{v}^{\varepsilon}\|_{L^2(\Omega)} + |R_1^{\varepsilon}| + |R_2^{\varepsilon}|. \quad (2.30)$$

Step 3. We now show estimates on R_1^{ε} and R_2^{ε} , defined by (2.28) and (2.29). The bound on R_2^{ε} stems from the definition of $u^{\varepsilon,1}$:

$$\begin{aligned} |R_2^{\varepsilon}| &= \left| \int_{\Omega} A^{\varepsilon} \left[\nabla^{\varepsilon} (u^{\varepsilon,1} + g) - \left(e_{\alpha} + \nabla w^{\alpha} \left(\frac{\cdot}{\varepsilon}, \cdot \right) \right) \partial_{\alpha} (u^{\star} + g) \right] \cdot \nabla^{\varepsilon} \bar{v}^{\varepsilon} \right| \\ &= \left| \int_{\Omega} A^{\varepsilon} \left[\varepsilon w^{\alpha} \left(\frac{\cdot}{\varepsilon}, \cdot \right) \nabla \partial_{\alpha} (u^{\star} + g) \right] \cdot \nabla^{\varepsilon} \bar{v}^{\varepsilon} \right| \\ &\leq C \varepsilon \|\nabla^2 (u^{\star} + g)\|_{L^2(\Omega)} \|\nabla^{\varepsilon} \bar{v}^{\varepsilon}\|_{L^2(\Omega)} \\ &\leq C \varepsilon |\omega|^{\frac{1}{2}} \|\nabla^2 (u^{\star} + g)\|_{L^{\infty}(\Omega)} \|\nabla^{\varepsilon} \bar{v}^{\varepsilon}\|_{L^2(\Omega)}. \end{aligned}$$

Let us now bound R_1^ε . We use the variational formulation (2.8) and the fact that $u^\varepsilon - v^{\varepsilon,1}$ belongs to V in order to write

$$\int_{\Omega} A^\varepsilon \nabla^\varepsilon (u^\varepsilon + g) \cdot \nabla^\varepsilon \bar{v}^\varepsilon = \int_{\Omega} f \bar{v}^\varepsilon + \int_{\Gamma^\pm} h_\pm \bar{v}^\varepsilon,$$

where $\Gamma^\pm = \omega \times \left\{ \pm \frac{1}{2} \right\}$. Since the function $\tilde{v} : \mathcal{Y} \ni y \mapsto y_d$ belongs to the space $\mathcal{W}(\mathcal{Y})$, it is an admissible test function for (2.14). Thus, we obtain that $\int_{\mathcal{Y}} A(e_\alpha + \nabla w^\alpha) \cdot e_d = 0$ for all $1 \leq \alpha \leq d-1$. We thus write

$$\begin{aligned} \int_{\Omega} \left[\int_{\mathcal{Y}} A(e_\alpha + \nabla w^\alpha) \right] \partial_\alpha (u^* + g) \cdot \nabla^\varepsilon \bar{v}^\varepsilon &= \int_{\Omega} A^* \nabla' (u^* + g) \cdot \nabla' \bar{v}^\varepsilon \\ &= \int_{\omega} A^* \nabla' (u^* + g) \cdot \nabla' m(\bar{v}^\varepsilon). \end{aligned}$$

Using the variational formulation (2.16) of the homogenized problem, the fact that $m(\bar{v}^\varepsilon)$ belongs to $H_0^1(\omega)$ (and is thus an admissible test function for (2.16)) and the fact that f does not depend on x_d yields that

$$\int_{\omega} A^* \nabla' (u^* + g) \cdot \nabla' m(\bar{v}^\varepsilon) = \int_{\omega} (f + h_\pm) m(\bar{v}^\varepsilon) = \int_{\Omega} (f + h_\pm) \bar{v}^\varepsilon.$$

Thus

$$\begin{aligned} R_1^\varepsilon &= \int_{\Omega} \left[\int_{\mathcal{Y}} A(e_\alpha + \nabla w^\alpha) \right] \partial_\alpha (u^* + g) \cdot \nabla^\varepsilon \bar{v}^\varepsilon - \int_{\Omega} A^\varepsilon \nabla^\varepsilon (u^\varepsilon + g) \cdot \nabla^\varepsilon \bar{v}^\varepsilon \\ &= \int_{\omega} h_\pm \bar{v}^\varepsilon - \int_{\Gamma^\pm} h_\pm \bar{v}^\varepsilon. \end{aligned}$$

Using Lemma 2.7, we get

$$|R_1^\varepsilon| \leq \varepsilon \|h_\pm\|_{L^2(\omega)} \|\nabla^\varepsilon \bar{v}^\varepsilon\|_{L^2(\Omega)}.$$

As a consequence,

$$|R_\varepsilon^1| + |R_\varepsilon^2| \leq C\varepsilon \left(|\omega|^{\frac{1}{2}} \|\nabla^2(u^* + g)\|_{L^\infty(\Omega)} + \|h_\pm\|_{L^2(\omega)} \right) \|\nabla^\varepsilon \bar{v}^\varepsilon\|_{L^2(\Omega)}.$$

Thus, we deduce from (2.30) that

$$\|\nabla^\varepsilon \bar{v}^\varepsilon\|_{L^2(\Omega)} \leq C \left(\sqrt{\varepsilon} |\omega|^{\frac{d-2}{2d-2}} \|\nabla(u^* + g)\|_{L^\infty(\omega)} + \varepsilon |\omega|^{\frac{1}{2}} \|\nabla^2(u^* + g)\|_{L^\infty(\omega)} + \varepsilon \|h_\pm\|_{L^2(\omega)} \right). \quad (2.31)$$

Step 4. Using (2.26) and (2.31), it holds that

$$\begin{aligned} \|\nabla^\varepsilon (u^\varepsilon - u^{\varepsilon,1})\|_{L^2(\Omega)} &\leq \|\nabla^\varepsilon (u^\varepsilon - v^{\varepsilon,1})\|_{L^2(\Omega)} + \|\nabla^\varepsilon (v^{\varepsilon,1} - u^{\varepsilon,1})\|_{L^2(\Omega)} \\ &\leq C \left(\sqrt{\varepsilon} |\omega|^{\frac{d-2}{2d-2}} \|\nabla(u^* + g)\|_{L^\infty(\omega)} + \varepsilon |\omega|^{\frac{1}{2}} \|\nabla^2(u^* + g)\|_{L^\infty(\omega)} + \varepsilon \|h_\pm\|_{L^2(\omega)} \right). \end{aligned}$$

To conclude the proof, we use the Poincaré inequality stated in Lemma 2.6, which yields that

$$\|u^\varepsilon - u^{\varepsilon,1}\|_{H_\varepsilon^1(\Omega)} \leq C\sqrt{\varepsilon} \left(|\omega|^{\frac{d-2}{2d-2}} \|\nabla(u^* + g)\|_{L^\infty(\omega)} + C\sqrt{\varepsilon} |\omega|^{\frac{1}{2}} \|\nabla^2(u^* + g)\|_{L^\infty(\omega)} + \sqrt{\varepsilon} \|h_\pm\|_{L^2(\omega)} \right).$$

This concludes the proof of Theorem 2.5. \square

2.3 The elasticity case

We now turn to the linear elasticity problem.

2.3.1 Definition of the plate problem

We use here the same notations as introduced at the beginning of Section 2.2. We furthermore introduce some notations specific to the elasticity case considered in this Section 2.3. We denote by \mathcal{M} the set of tensors $M \in \mathbb{R}^{d \times d \times d \times d}$ such that

$$\forall y \in \mathbb{R}_s^{d \times d}, \quad |My| \leq c_+ |y| \quad \text{and} \quad y^\top My \geq c_- |y|^2,$$

where we recall that $\mathbb{R}_s^{d \times d}$ is the set of symmetric matrices of size $d \times d$, and which have the following symmetries:

$$\forall 1 \leq i, j, k, l \leq d, \quad M_{ijkl} = M_{jikl} = M_{ijlk} = M_{klij}.$$

For $A, B \in \mathbb{R}^{d \times d}$ we denote by $A : B = A_{ij} B_{ij}$. Let us point out here that, in particular, for any $1 \leq i, j \leq d$ and any $A \in \mathbb{R}^{d \times d}$, $A : (e_i \otimes e_j) = e_i^T A e_j$.

Let $A : \mathbb{R}^{d-1} \times (-\frac{1}{2}, \frac{1}{2}) \rightarrow \mathcal{M}$ be such that, for any $x_d \in (-\frac{1}{2}, \frac{1}{2})$, the function $x' \mapsto A(x', x_d)$ is Y -periodic. For all $x \in \Omega$, we set

$$A^\varepsilon(x) = A \left(\frac{x'}{\varepsilon}, x_d \right).$$

In addition, we define \mathcal{A}^ε by

$$\forall x \in \Omega^\varepsilon, \quad \mathcal{A}^\varepsilon(x) := A^\varepsilon \left(x', \frac{x_d}{\varepsilon} \right) = A \left(\frac{x'}{\varepsilon}, \frac{x_d}{\varepsilon} \right).$$

We denote by

$$V^\varepsilon := \left\{ v \in (H^1(\Omega^\varepsilon))^d, \quad v = 0 \text{ on } \partial\omega \times \left(-\frac{\varepsilon}{2}, \frac{\varepsilon}{2} \right) \right\}.$$

Let $\tilde{f}^\varepsilon \in (L^2(\Omega^\varepsilon))^d$, $\tilde{g}^\varepsilon \in (H^1(\Omega))^d$ and $\tilde{h}_\pm^\varepsilon \in (L^2(\omega))^d$.

For any $u \in (H^1(\Omega))^d$, let $e(u)$ denote the symmetric gradient of u , i.e. $e(u) := \frac{1}{2} (\nabla u + \nabla u^T)$. The plate linear elasticity problem reads as follows: find $\tilde{u}^\varepsilon \in V^\varepsilon$ such that

$$\begin{cases} -\operatorname{div}(\mathcal{A}^\varepsilon e(\tilde{u}^\varepsilon)) = \tilde{f}^\varepsilon + \operatorname{div}(\mathcal{A}^\varepsilon e(\tilde{g}^\varepsilon)) & \text{in } \Omega^\varepsilon, \\ \mathcal{A}^\varepsilon e(\tilde{u}^\varepsilon) \cdot n^\varepsilon = \tilde{h}_\pm^\varepsilon - \mathcal{A}^\varepsilon e(\tilde{g}^\varepsilon) \cdot n^\varepsilon & \text{on } \omega \times \left\{ \pm \frac{\varepsilon}{2} \right\}. \end{cases} \quad (2.32)$$

Similarly as in the plate diffusion problem (2.4), \tilde{f}^ε in (2.32) is the load imposed in Ω^ε . The function \tilde{g}^ε is inserted as a possible extension of a non-trivial Dirichlet boundary condition (so that $\tilde{u}^\varepsilon + \tilde{g}^\varepsilon$ does not necessarily vanish on $\partial\omega \times (-\varepsilon/2, \varepsilon/2)$). The function $\tilde{h}_\pm^\varepsilon$ plays the role of a Neumann boundary condition (i.e. a traction boundary condition for this elasticity problem) on the top and bottom faces of the plate Ω^ε .

As already pointed out in Section 2.2, we consider the case of non-homogeneous Dirichlet boundary conditions and we track below the dependency of our estimates with respect to the size of ω since we have in mind the application of these results to the numerical analysis of MsFEM approaches (see [AL2]), where these two points are needed.

To simplify the analysis, it is classical to change the scale of the problem in the d -direction (as we did for the diffusion problem), in order to work with problems posed on a domain Ω independent of ε (recall Figure 2.3).

For any $u \in (\mathcal{D}'(\mathbb{R}^d))^d$ and $T \in (\mathcal{D}'(\mathbb{R}^d))^{d \times d}$, we define the operators e^ε and $\operatorname{div}^\varepsilon$ by

$$e_{\alpha\beta}^\varepsilon(u) := e_{\alpha\beta}(u), \quad e_{\alpha d}^\varepsilon(u) := \frac{1}{\varepsilon} e_{\alpha d}(u) \quad \text{and} \quad e_{dd}^\varepsilon(u) := \frac{1}{\varepsilon^2} e_{dd}(u)$$

and

$$\operatorname{div}^\varepsilon(T)_\alpha := \partial_\beta T_{\alpha\beta} + \frac{1}{\varepsilon} \partial_d T_{\alpha d} \quad \text{and} \quad \operatorname{div}^\varepsilon(T)_d := \frac{1}{\varepsilon} \partial_\beta T_{d\beta} + \frac{1}{\varepsilon^2} \partial_d T_{dd}$$

for any $1 \leq \alpha, \beta \leq d-1$.

We denote by

$$V := \left\{ v \in (H^1(\Omega))^d, \quad v = 0 \text{ on } \partial\omega \times \left(-\frac{1}{2}, \frac{1}{2}\right) \right\}. \quad (2.33)$$

It can then be easily seen that problem (2.32) is equivalent to finding $u^\varepsilon \in V$ such that

$$\begin{cases} -\operatorname{div}^\varepsilon(A^\varepsilon e^\varepsilon(u^\varepsilon)) = f^\varepsilon + \operatorname{div}^\varepsilon(A^\varepsilon e^\varepsilon(g^\varepsilon)) & \text{in } \Omega, \\ A^\varepsilon e^\varepsilon(u^\varepsilon) \cdot n = \begin{pmatrix} \varepsilon(h_\pm^\varepsilon)' \\ \varepsilon^2(h_\pm^\varepsilon)_d \end{pmatrix} - A^\varepsilon e^\varepsilon(g^\varepsilon) \cdot n & \text{on } \omega \times \left\{ \pm \frac{1}{2} \right\}, \end{cases} \quad (2.34)$$

with

- $u_\alpha^\varepsilon(x) = \tilde{u}_\alpha^\varepsilon(x', \varepsilon x_d)$, $u_d^\varepsilon(x) = \varepsilon \tilde{u}_d^\varepsilon(x', \varepsilon x_d)$,
- $f_\alpha^\varepsilon(x) = \tilde{f}_\alpha^\varepsilon(x', \varepsilon x_d)$, $f_d^\varepsilon(x) = \varepsilon^{-1} \tilde{f}_d^\varepsilon(x', \varepsilon x_d)$,
- $h_\alpha^\varepsilon(x') = \tilde{h}_\alpha^\varepsilon(x')$, $h_d^\varepsilon(x') = \varepsilon^{-1} \tilde{h}_d^\varepsilon(x')$,
- $g_\alpha^\varepsilon(x) = \tilde{g}_\alpha^\varepsilon(x', \varepsilon x_d)$, $g_d^\varepsilon(x) = \varepsilon \tilde{g}_d^\varepsilon(x', \varepsilon x_d)$,

where, in the third line, we have written h as a short-hand for h_\pm .

The variational formulation of (2.34) reads as:

$$\text{Find } u^\varepsilon \in V \text{ such that } \forall v \in V, \quad a^\varepsilon(u^\varepsilon, v) = b^\varepsilon(v), \quad (2.35)$$

where

$$a^\varepsilon(u^\varepsilon, v) := \int_\Omega A^\varepsilon e^\varepsilon(u^\varepsilon) : e^\varepsilon(v)$$

and

$$b^\varepsilon(v) := \int_\Omega f^\varepsilon \cdot v - \int_\Omega A^\varepsilon e^\varepsilon(g^\varepsilon) : e^\varepsilon(v) + \int_\omega h_+^\varepsilon \cdot v \left(\cdot, \frac{1}{2} \right) + \int_\omega h_-^\varepsilon \cdot v \left(\cdot, -\frac{1}{2} \right).$$

We are going to use the following Korn inequality (see [22]), a proof of which is given in Appendix 2.B (see Lemma 2.29): there exists $C(\Omega)$ such that

$$\forall u \in V, \quad \|u\|_{(H^1(\Omega))^d} \leq C(\Omega) \|e(u)\|_{(L^2(\Omega))^{d \times d}}. \quad (2.36)$$

Using this inequality and the Lax-Milgram theorem, one easily obtains that there exists a unique solution to (2.35).

We now establish a priori bounds on u^ε . Taking $v = u^\varepsilon$ in (2.35) and using a trace inequality, we get

$$\begin{aligned} c_- \|e^\varepsilon(u^\varepsilon)\|_{(L^2(\Omega))^{d \times d}}^2 &\leq \|f^\varepsilon\|_{(L^2(\Omega))^d} \|u^\varepsilon\|_{(L^2(\Omega))^d} \\ &\quad + c_+ \|e^\varepsilon(g^\varepsilon)\|_{(L^2(\Omega))^{d \times d}} \|e^\varepsilon(u^\varepsilon)\|_{(L^2(\Omega))^{d \times d}} + C \|h_\pm^\varepsilon\|_{(L^2(\omega))^d} \|u^\varepsilon\|_{(H^1(\Omega))^d}. \end{aligned}$$

Using (2.36) and next the fact that $\|e(u^\varepsilon)\|_{(L^2(\Omega))^{d \times d}} \leq \|e^\varepsilon(u^\varepsilon)\|_{(L^2(\Omega))^{d \times d}}$, we deduce that

$$\begin{aligned} c_- \|e^\varepsilon(u^\varepsilon)\|_{(L^2(\Omega))^{d \times d}}^2 &\leq C \|f^\varepsilon\|_{(L^2(\Omega))^d} \|e^\varepsilon(u^\varepsilon)\|_{(L^2(\Omega))^{d \times d}} \\ &\quad + c_+ \|e^\varepsilon(g^\varepsilon)\|_{(L^2(\Omega))^{d \times d}} \|e^\varepsilon(u^\varepsilon)\|_{(L^2(\Omega))^{d \times d}} + C \|h_\pm^\varepsilon\|_{(L^2(\omega))^d} \|e^\varepsilon(u^\varepsilon)\|_{(L^2(\Omega))^{d \times d}} \end{aligned}$$

and thus

$$\|e^\varepsilon(u^\varepsilon)\|_{(L^2(\Omega))^{d \times d}} \leq C \left(\|f^\varepsilon\|_{(L^2(\Omega))^d} + \|e^\varepsilon(g^\varepsilon)\|_{(L^2(\Omega))^{d \times d}} + \|h_\pm^\varepsilon\|_{(L^2(\omega))^d} \right) \quad (2.37)$$

for some constant $C > 0$ independent of ε . Using again (2.36), we infer that

$$\|u^\varepsilon\|_{(H^1(\Omega))^d} \leq C \left(\|f^\varepsilon\|_{(L^2(\Omega))^d} + \|e^\varepsilon(g^\varepsilon)\|_{(L^2(\Omega))^{d \times d}} + \|h_\pm^\varepsilon\|_{(L^2(\omega))^d} \right) \quad (2.38)$$

for some constant $C > 0$ independent of ε .

To obtain bounds independent of $\varepsilon > 0$ on $\left(\|u^\varepsilon\|_{(H^1(\Omega))^d} \right)_{\varepsilon > 0}$ and $\left(\|e^\varepsilon(u^\varepsilon)\|_{(L^2(\Omega))^{d \times d}} \right)_{\varepsilon > 0}$, we need to assume that the sequences $\left(\|f^\varepsilon\|_{(L^2(\Omega))^d} \right)_{\varepsilon > 0}$, $\left(\|e^\varepsilon(g^\varepsilon)\|_{(L^2(\Omega))^{d \times d}} \right)_{\varepsilon > 0}$ and $\left(\|h_\pm^\varepsilon\|_{(L^2(\omega))^d} \right)_{\varepsilon > 0}$ are bounded.

From now on in this Section 2.3, we assume that there exist $f \in (L^2(\Omega))^d$ and $h_\pm \in (L^2(\omega))^d$ such that, for all $\varepsilon > 0$,

$$f^\varepsilon = f \quad \text{and} \quad h_\pm^\varepsilon = h_\pm. \quad (2.39)$$

We postpone the precise assumption we make on the sequence $(g^\varepsilon)_{\varepsilon > 0}$ to Section 2.3.2.

Provided that the sequence $\left(\|e^\varepsilon(g^\varepsilon)\|_{(L^2(\Omega))^{d \times d}} \right)_{\varepsilon > 0}$ is bounded, we infer from (2.38) that, up to the extraction of a subsequence, there exists $u^* \in (H^1(\Omega))^d$ such that

$$u^\varepsilon \rightharpoonup u^* \text{ weakly in } (H^1(\Omega))^d.$$

The bound (2.37) is also useful in the sequel.

2.3.2 Homogenization and dimension reduction: weak convergence

The aim of this section is to recall the result of [18], where the homogenized limit of (2.35) has been identified. We introduce the set

$$\begin{aligned} \mathcal{W}(\mathcal{Y}) := &\left\{ v \in \left(H_{\text{loc}}^1 \left(\mathbb{R}^{d-1} \times \left(-\frac{1}{2}, \frac{1}{2} \right) \right) \right)^d, \right. \\ &\left. \forall z \in \left(-\frac{1}{2}, \frac{1}{2} \right), v(\cdot, z) \text{ is } Y\text{-periodic and } \int_{\mathcal{Y}} v = 0 \right\}. \end{aligned}$$

Let $w^{\alpha\beta} \in \mathcal{W}(\mathcal{Y})$ be the solution to the problem

$$\forall v \in \mathcal{W}(\mathcal{Y}), \quad \int_{\mathcal{Y}} A(e(w^{\alpha\beta}) + e_\alpha \otimes e_\beta) : e(v) = 0 \quad (2.40)$$

for any $1 \leq \alpha, \beta \leq d-1$. The function $w^{\alpha\beta}$ is equivalently the unique solution in $\mathcal{W}(\mathcal{Y})$ to

$$\begin{cases} -\operatorname{div} A(e(w^{\alpha\beta}) + e_\alpha \otimes e_\beta) = 0 \\ A(e(w^{\alpha\beta}) + e_\alpha \otimes e_\beta) \cdot e_d = 0 \text{ on } \mathcal{Y}^\pm \end{cases}$$

where $\mathcal{Y}^\pm := Y \times \left\{ \pm \frac{1}{2} \right\}$.

Let $W^{\alpha\beta} \in \mathcal{W}(\mathcal{Y})$ be the solution to the problem

$$\forall v \in \mathcal{W}(\mathcal{Y}), \quad \int_{\mathcal{Y}} A(e(W^{\alpha\beta}) - x_d e_\alpha \otimes e_\beta) : e(v) = 0 \quad (2.41)$$

for any $1 \leq \alpha, \beta \leq d-1$. The function $W^{\alpha\beta}$ is equivalently the unique solution in $\mathcal{W}(\mathcal{Y})$ to

$$\begin{cases} -\operatorname{div} A(e(W^{\alpha\beta}) - x_d e_\alpha \otimes e_\beta) = 0 \\ A(e(W^{\alpha\beta}) - x_d e_\alpha \otimes e_\beta) \cdot e_d = 0 \text{ on } \mathcal{Y}^\pm. \end{cases}$$

We define the set of the *Kirchoff-Love displacements* as follows:

$$\mathcal{V}_{KL} := \left\{ v \in (H^1(\Omega))^{d-1} \times H_0^2(\omega), \exists \widehat{v} \in (H_0^1(\omega))^{d-1} \times H_0^2(\omega), v_\alpha = \widehat{v}_\alpha - x_d \partial_\alpha \widehat{v}_d, v_d = \widehat{v}_d \right\},$$

where $H_0^2(\omega)$ is the closure of $\mathcal{D}(\Omega)$ in $H^2(\omega)$. For any $v \in \mathcal{V}_{KL}$, we use the notation \widehat{v} to denote the corresponding element of $(H_0^1(\omega))^{d-1} \times H_0^2(\omega)$.

Let us also denote by

$$\mathcal{G}_{KL} := \left\{ g \in (H^1(\Omega))^{d-1} \times H^2(\omega), \exists \widehat{g} \in (H^1(\omega))^{d-1} \times H^2(\omega), g_\alpha = \widehat{g}_\alpha - x_d \partial_\alpha \widehat{g}_d, g_d = \widehat{g}_d \right\}.$$

For all $g \in \mathcal{G}_{KL}$, we denote by \widehat{g} the corresponding element of $(H^1(\omega))^{d-1} \times H^2(\omega)$.

It then holds that $\mathcal{V}_{KL} \subset \mathcal{G}_{KL}$ and that, for any $g \in \mathcal{G}_{KL}$, the sequence $\left(\|e^\varepsilon(g)\|_{(L^2(\Omega))^{d \times d}} \right)_{\varepsilon > 0}$ is bounded. Observe indeed that

$$\forall g \in \mathcal{G}_{KL}, \quad \forall 1 \leq i \leq d, \quad e_{id}^\varepsilon(g) = 0,$$

and therefore $e^\varepsilon(g) = e(g)$ for any $g \in \mathcal{G}_{KL}$. We thus make from now on the assumption that the function g^ε appearing in the linear form b^ε of (2.35) is such that

$$\text{there exists } g \in \mathcal{G}_{KL} \text{ such that, for all } \varepsilon > 0, \text{ we have } g^\varepsilon = g. \quad (2.42)$$

We recall the following result from [18] (a proof of Theorem 2.11, using the method of the oscillating test function, is recalled in Appendix 2.C for the sake of completeness).

Theorem 2.11 (from [18]). *Under the above assumptions, the sequence $(u^\varepsilon)_{\varepsilon > 0}$ solution to (2.35) weakly converges to u^* in $(H^1(\Omega))^d$, where the function u^* belongs to \mathcal{V}_{KL} and is the unique solution to*

$$\forall \phi \in \mathcal{V}_{KL}, \quad \int_{\omega} K^* \mathcal{P} u^* : \mathcal{P} \phi = \int_{\omega} (m(f) + h_\pm) \cdot \widehat{\phi} - \int_{\omega} m(x_d f_\alpha) \partial_\alpha \widehat{\phi}_d - \int_{\omega} K^* \mathcal{P} g : \mathcal{P} \phi \quad (2.43)$$

where the homogenized tensor is given by

$$K^* := \begin{pmatrix} K_{11}^* & K_{12}^* \\ (K_{12}^*)^T & K_{22}^* \end{pmatrix},$$

where each subtensor is defined as follows: for all $1 \leq \alpha, \beta, \gamma, \delta \leq d-1$,

$$\begin{aligned} (K_{11}^*)_{\alpha\beta\gamma\delta} &:= \int_{\mathcal{Y}} A(e(w^{\alpha\beta}) + e_\alpha \otimes e_\beta) : (e(w^{\gamma\delta}) + e_\gamma \otimes e_\delta), \\ (K_{12}^*)_{\alpha\beta\gamma\delta} &:= \int_{\mathcal{Y}} A(e(w^{\alpha\beta}) + e_\alpha \otimes e_\beta) : (e(W^{\gamma\delta}) - x_d e_\gamma \otimes e_\delta), \\ (K_{22}^*)_{\alpha\beta\gamma\delta} &:= \int_{\mathcal{Y}} A(e(W^{\alpha\beta}) - x_d e_\alpha \otimes e_\beta) : (e(W^{\gamma\delta}) - x_d e_\gamma \otimes e_\delta), \\ ((K_{12}^*)^T)_{\alpha\beta\gamma\delta} &:= (K_{12}^*)_{\gamma\delta\alpha\beta}, \end{aligned} \quad (2.44)$$

and where

$$\mathcal{P} : \begin{cases} \mathcal{G}_{KL} & \rightarrow L^2 \left(\omega; \left(\mathbb{R}_s^{(d-1) \times (d-1)} \right)^2 \right) \\ v & \mapsto \begin{pmatrix} e'(\widehat{v}') \\ \nabla_{d-1}^2 \widehat{v}_d \end{pmatrix}. \end{cases}$$

By construction, K^* is symmetric and coercive.

In the definition of \mathcal{P} , let us recall that $\widehat{v} = \begin{pmatrix} \widehat{v}' \\ \widehat{v}_d \end{pmatrix}$ and that $e'(\widehat{v}')$ is a $(d-1) \times (d-1)$ symmetric matrix, with $\left[e'(\widehat{v}') \right]_{\alpha\beta} = e_{\alpha\beta}(\widehat{v})$. In addition, $\nabla_{d-1}^2 \widehat{v}_d$ is a $(d-1) \times (d-1)$ symmetric matrix, with $\left[\nabla_{d-1}^2 \widehat{v}_d \right]_{\alpha\beta} = \partial_{\alpha\beta} \widehat{v}_d$.

2.3.3 Strong convergence result of a two-scale expansion in the membrane and bending case

The aim of this section is to state some strong convergence results similar to Theorem 2.5 in the elasticity case. Let us mention here that, in the case of homogeneous plates, expansions at an arbitrary order in ε were studied in [28].

We first present some preliminary lemmas in Section 2.3.3. Then, in Section 2.3.3, we present the symmetry assumptions on the elasticity tensor A needed to state our results and present in details the membrane and bending case. We finally state our main results in Section 2.3.4 for the membrane case and in Section 2.3.5 for the bending case.

We stress here the following point: while the proof of the strong convergence result in the membrane case follows similar lines as the one in the diffusion case, the proof in the bending case is much more involved and requires a different strategy of proof. We will discuss this in more details at the beginning of Section 2.3.5.

Preliminary lemmas

The aim of this section is to prove some auxiliary lemmas which are useful in the sequel.

Lemma 2.12. *Let V be defined by (2.33). Let $Z = (Z_{ij})_{1 \leq i \leq d} \in (L_{\text{loc}}^2(\mathbb{R}^{d-1} \times (-\frac{1}{2}, \frac{1}{2})))^{d \times d}$ be a matrix field such that*

- (i) for almost all $z \in (-\frac{1}{2}, \frac{1}{2})$, $Z(\cdot, z)$ is Y -periodic;

- (ii) $\int_{\mathcal{Y}} Z = 0$;
- (iii) $\operatorname{div} Z = 0$ in $(\mathcal{D}'(\mathbb{R}^{d-1} \times (-\frac{1}{2}, \frac{1}{2})))^d$;
- (iv) $Z \cdot e_d = 0$ on $\mathbb{R}^{d-1} \times \{-1/2\}$ and on $\mathbb{R}^{d-1} \times \{+1/2\}$;
- (v) Z is symmetric in the sense that, for all $1 \leq i, j \leq d$, $Z_{ij} = Z_{ji}$.

Then, there exists some C such that

$$\forall \varphi \in W^{1,\infty}(\omega), \quad \forall v \in V, \quad \left| \int_{\Omega} \varphi Z \left(\frac{\cdot}{\varepsilon}, \cdot \right) : e^\varepsilon(v) \right| \leq C\varepsilon|\omega|^{\frac{1}{2}} \|\nabla \varphi\|_{L^\infty(\omega)} \|e^\varepsilon(v)\|_{L^2(\Omega)}.$$

Proof of Lemma 2.12.

Remark 2.13. *The jury found an error in the proof. The correct proof will be published in [AL1].*

The result is a direct consequence of Lemma 2.8. Let $v := (v_i)_{1 \leq i \leq d} \in V$. Using the symmetry of Z , and denoting by Z_i the i^{th} column of Z for $1 \leq i \leq d$, it holds that

$$\begin{aligned} & \int_{\Omega} \varphi Z \left(\frac{\cdot}{\varepsilon}, \cdot \right) : e^\varepsilon(v) \\ &= \int_{\Omega} \varphi Z_{ij} \left(\frac{\cdot}{\varepsilon}, \cdot \right) e_{ij}^\varepsilon(v) \\ &= \frac{1}{2} \int_{\Omega} \varphi Z_{\alpha\beta} \left(\frac{\cdot}{\varepsilon}, \cdot \right) (\partial_\beta v_\alpha + \partial_\alpha v_\beta) + \frac{1}{2\varepsilon} \int_{\Omega} \varphi Z_{\alpha d} \left(\frac{\cdot}{\varepsilon}, \cdot \right) (\partial_d v_\alpha + \partial_\alpha v_d) + \frac{1}{\varepsilon^2} \int_{\Omega} \varphi Z_{dd} \left(\frac{\cdot}{\varepsilon}, \cdot \right) \partial_d v_d \\ &= \int_{\Omega} \varphi Z_\alpha \left(\frac{\cdot}{\varepsilon}, \cdot \right) \cdot \nabla^\varepsilon v_\alpha + \frac{1}{\varepsilon} \int_{\Omega} \varphi Z_d \left(\frac{\cdot}{\varepsilon}, \cdot \right) \cdot \nabla^\varepsilon v_d. \end{aligned}$$

Then, applying Lemma 2.8 and using Korn inequality, we obtain the existence of a constant $C > 0$ such that

$$\begin{aligned} & \left| \int_{\Omega} \varphi Z_\alpha \left(\frac{\cdot}{\varepsilon}, \cdot \right) : \nabla^\varepsilon v_\alpha + \frac{1}{\varepsilon} \int_{\Omega} \varphi Z_d \left(\frac{\cdot}{\varepsilon}, \cdot \right) : \nabla^\varepsilon v_d \right| \\ & \leq C\varepsilon|\omega|^{\frac{1}{2}} \|\nabla \varphi\|_{L^\infty(\omega)} \left[\sum_{\alpha} \|\nabla^\varepsilon v_\alpha\|_{L^2(\Omega)} + \frac{1}{\varepsilon} \|\nabla^\varepsilon v_d\|_{L^2(\Omega)} \right] \\ & \leq C\varepsilon|\omega|^{\frac{1}{2}} \|\nabla \varphi\|_{L^\infty(\omega)} \|e^\varepsilon(v)\|_{L^2(\Omega)}. \end{aligned}$$

This concludes the proof of Lemma 2.12. \square

We also need the following lemma.

Lemma 2.14. *Let $h \in (L^2(\omega))^d$ and $v \in V$. Then, for any $z \in [-\frac{1}{2}, \frac{1}{2}]$, we have*

$$\left| \int_{\omega} h \cdot (v(\cdot, z) - m(v)) \right| \leq \varepsilon \|h\|_{L^2(\omega)} \|e^\varepsilon(v)\|_{L^2(\Omega)}.$$

The proof of Lemma 2.14 is an easy adaptation of the proof of Lemma 2.7 and we therefore skip it.

Lemma 2.15 states some estimates on the L^2 norm of the trace on $\Gamma^\pm = \omega \times \left\{ \pm \frac{1}{2} \right\}$ of a function $v \in L^2(\Omega)$ such that $\partial_d v \in L^2(\Omega)$.

Lemma 2.15. *Let $v \in L^2(\Omega)$ such that $\partial_d v \in L^2(\Omega)$. Then we have*

$$\|v\|_{L^2(\Gamma^\pm)} \leq \sqrt{2} \left(\|v\|_{L^2(\Omega)} + \|\partial_d v\|_{L^2(\Omega)} \right). \quad (2.45)$$

Proof. It holds that, for almost all $(x', z) \in (-\frac{1}{2}, \frac{1}{2}) \times \omega$, we have

$$v \left(x', \pm \frac{1}{2} \right) = v(x', z) + \int_z^{\pm \frac{1}{2}} \partial_d v(x', t) dt.$$

This implies that, for almost all $z \in (-\frac{1}{2}, \frac{1}{2})$,

$$\begin{aligned} \int_{\Gamma^\pm} |v|^2 &= \int_\omega \left| v \left(x', \pm \frac{1}{2} \right) \right|^2 dx' \\ &\leq 2 \left(\int_\omega |v(x', z)|^2 dx' + \int_\omega \left| \int_z^{\pm \frac{1}{2}} \partial_d v(x', t) dt \right|^2 dx' \right) \\ &\leq 2 \left(\int_\omega |v(x', z)|^2 dx' + \int_\omega \int_{-\frac{1}{2}}^{\frac{1}{2}} |\partial_d v(x', t)|^2 dt dx' \right) \\ &\leq 2 \left(\int_\omega |v(x', z)|^2 dx' + \int_\Omega |\partial_d v|^2 \right). \end{aligned}$$

Integrating the above inequality over z in $(-\frac{1}{2}, \frac{1}{2})$ yields that

$$\|v\|_{L^2(\Gamma^\pm)}^2 \leq 2 \left(\|v\|_{L^2(\Omega)}^2 + \|\partial_d v\|_{L^2(\Omega)}^2 \right),$$

and thus the claimed result. \square

Lastly, we need the following inequalities of Poincaré type.

Lemma 2.16. *Let V be defined by (2.33) and $z = \pm \frac{1}{2}$. Then, there exists two constants $C_1 > 0$ and $C_2 > 0$ independent of ε and ω such that, for any u in V ,*

$$\|u\|_{L^2(\Omega)} \leq C_1 \max \left(1, |\omega|^{\frac{1}{d-1}} \right) \max \left(|\omega|^{\frac{1}{d-1}}, \varepsilon^2 |\omega|^{-\frac{1}{d-1}} \right) \|e^\varepsilon(u)\|_{L^2(\Omega)}, \quad (2.46)$$

and

$$\|u(\cdot, z)\|_{L^2(\omega)} \leq C_2 \max \left(1, |\omega|^{\frac{1}{d-1}} \right) \max \left(|\omega|^{\frac{1}{d-1}}, \varepsilon^2 |\omega|^{-\frac{1}{d-1}} \right) \|e^\varepsilon(u)\|_{L^2(\Omega)}. \quad (2.47)$$

Proof of Lemma 2.16. Let $\widehat{\omega} := (0, 1)^{d-1}$ and $\widehat{\Omega} := \widehat{\omega} \times (-\frac{1}{2}, \frac{1}{2})$. Using the Korn inequality, we obtain that there exists some constant $C_K(\widehat{\Omega})$ such that

$$\forall u \in V(\widehat{\Omega}), \quad \|u\|_{L^2(\widehat{\Omega})}^2 \leq C_K(\widehat{\Omega})^2 \|e(u)\|_{L^2(\widehat{\Omega})}^2, \quad (2.48)$$

where

$$V(\widehat{\Omega}) := \left\{ v \in \left(H^1(\widehat{\Omega}) \right)^d, \quad v = 0 \text{ on } \widehat{\omega} \times \left\{ \pm \frac{1}{2} \right\} \right\}.$$

To prove (2.46), we proceed by scaling. Introduce $\omega_K := (0, K)^{d-1}$ and $\Omega_K := \omega_K \times (-\frac{1}{2}, \frac{1}{2})$ for $K > 0$. For any $u \in V(\widehat{\Omega})$, we define the function u_K so that, for x in Ω_K ,

$$u_{K,\alpha}(x) = K^{-1} u_\alpha \left(\frac{x'}{K}, x_d \right), \quad u_{K,d}(x) = u_d \left(\frac{x'}{K}, x_d \right).$$

The function u_K belongs to $V(\Omega_K) := \left\{ v \in (H^1(\Omega_K))^d, \quad v = 0 \text{ on } \omega_K \times \left\{ \pm \frac{1}{2} \right\} \right\}$. Simple computations lead to

$$\begin{aligned} \|u_K\|_{L^2(\Omega_K)}^2 &= K^{d-1} \left(K^{-2} \|u'\|_{L^2(\widehat{\Omega})}^2 + \|u_d\|_{L^2(\widehat{\Omega})}^2 \right), \\ \|e_{\alpha\beta}^\varepsilon(u_K)\|_{L^2(\Omega_K)}^2 &= K^{d-5} \|e_{\alpha\beta}(u)\|_{L^2(\widehat{\Omega})}^2, \\ \|e_{\alpha d}^\varepsilon(u_K)\|_{L^2(\Omega_K)}^2 &= K^{d-3} \varepsilon^{-2} \|e_{\alpha d}(u)\|_{L^2(\widehat{\Omega})}^2, \\ \|e_{dd}^\varepsilon(u_K)\|_{L^2(\Omega_K)}^2 &= K^{d-1} \varepsilon^{-4} \|e_{dd}(u)\|_{L^2(\widehat{\Omega})}^2. \end{aligned}$$

Recalling (2.48), we get that

$$\begin{aligned} \|u_K\|_{L^2(\omega_K)}^2 &\leq K^{d-3} \max(1, K^2) \|u\|_{L^2(\widehat{\Omega})}^2 \\ &\leq C_K(\widehat{\Omega}) K^{d-3} \max(1, K^2) \|e(u)\|_{L^2(\widehat{\Omega})}^2 \\ &\leq C_K(\widehat{\Omega}) \max(1, K^2) \max(K^2, \varepsilon^2, \varepsilon^4 K^{-2}) \|e^\varepsilon(u_K)\|_{L^2(\Omega_K)}^2 \\ &\leq C_K(\widehat{\Omega}) \max(1, K^2) \max(K^2, \varepsilon^4 K^{-2}) \|e^\varepsilon(u_K)\|_{L^2(\Omega_K)}^2, \end{aligned}$$

where we have used that, for any $\theta \in \mathbb{R}$, $\max(1, \theta^2, \theta^4) = \max(1, \theta^4)$. Using the fact that $K = |\omega_K|^{\frac{1}{d-1}}$, we finally obtain that

$$\|u_K\|_{L^2(\omega_K)} \leq C_K(\widehat{\Omega}) \max\left(1, |\omega|^{\frac{1}{d-1}}\right) \max\left(|\omega|^{\frac{1}{d-1}}, \varepsilon^2 |\omega|^{-\frac{1}{d-1}}\right) \|e^\varepsilon(u_K)\|_{L^2(\Omega)},$$

which proves the inequality (2.46) in the case when $\omega = \omega_K$. In the case of a more general, shape regular domain ω , the proof can be performed using the same argument. The inequality (2.47) is proved following the same lines. \square

Use of symmetries

In all what follows, we make additional symmetry assumptions on the problem. These symmetry assumptions enable us to split the problem into two independent problems, which are commonly called in the literature as the *membrane case* and the *bending case*.

More precisely, let us define

$$\begin{aligned} \mathcal{E} &:= \left\{ v \in L^2(\Omega) \text{ s.t., for almost any } x' \in \omega, \left(-\frac{1}{2}, \frac{1}{2}\right) \ni x_d \mapsto v(x', x_d) \text{ is even} \right\} \\ \mathcal{O} &:= \left\{ v \in L^2(\Omega) \text{ s.t., for almost any } x' \in \omega, \left(-\frac{1}{2}, \frac{1}{2}\right) \ni x_d \mapsto v(x', x_d) \text{ is odd} \right\}. \end{aligned}$$

Let us point out that

$$(L^2(\Omega))^d = (\mathcal{E}^{d-1} \times \mathcal{O}) \oplus (\mathcal{O}^{d-1} \times \mathcal{E}).$$

This orthogonal decomposition has the following consequence: it holds that

$$\mathcal{V}_{KL} = \mathcal{V}_{KL}^{\mathcal{M}} \oplus \mathcal{V}_{KL}^{\mathcal{B}}$$

where

$$\mathcal{V}_{KL}^{\mathcal{M}} := (H_0^1(\omega))^{d-1} \times \{0\} \subset \mathcal{E}^{d-1} \times \mathcal{O}$$

and

$$\mathcal{V}_{KL}^{\mathcal{B}} := \left\{ v \in (H^1(\Omega))^{d-1} \times H_0^2(\omega), \exists \widehat{v}_d \in H_0^2(\omega), v_\alpha = -x_d \partial_\alpha \widehat{v}_d, v_d = \widehat{v}_d \right\} \subset \mathcal{O}^{d-1} \times \mathcal{E}.$$

Similarly, we have

$$\mathcal{G}_{KL} = \mathcal{G}_{KL}^M \oplus \mathcal{G}_{KL}^B$$

where

$$\mathcal{G}_{KL}^M := (H^1(\omega))^{d-1} \times \{0\} \subset \mathcal{E}^{d-1} \times \mathcal{O}$$

and

$$\mathcal{G}_{KL}^B := \left\{ v \in (H^1(\Omega))^{d-1} \times H^2(\omega), \exists \widehat{v}_d \in H^2(\omega), v_\alpha = -x_d \partial_\alpha \widehat{v}_d, v_d = \widehat{v}_d \right\} \subset \mathcal{O}^{d-1} \times \mathcal{E}.$$

From now on, we make the following additional assumptions on the tensor-valued field A : for all $1 \leq \alpha, \beta, \gamma, \delta \leq d-1$,

$$\begin{aligned} A_{\alpha\beta\gamma\delta}, A_{\alpha\beta dd}, A_{\alpha d\beta d} &\in \mathcal{E}, \\ A_{\alpha d d d}, A_{\alpha\beta\sigma d} &\in \mathcal{O}. \end{aligned} \quad (2.49)$$

This is a classical assumption for plate problems (see e.g. [18, Section 7]).

Remark 2.17. *In the case when the plate is composed only of isotropic materials, the assumption (2.49) amounts to assuming that the material is symmetric with respect to its medium plane $\{x \in \Omega, x_d = 0\}$.*

We also distinguish two different sets of assumptions on the data of the problem, namely f, g, h^- and h^+ :

- Membrane case:

$$f \in \mathcal{E}^{d-1} \times \mathcal{O}, g \in \mathcal{G}_{KL}^M, h_\alpha^+ = h_\alpha^- \text{ for all } 1 \leq \alpha \leq d-1 \text{ and } h_d^+ = -h_d^-; \quad (2.50)$$

- Bending case:

$$f \in \mathcal{O}^{d-1} \times \mathcal{E}, g \in \mathcal{G}_{KL}^B, h_\alpha^+ = -h_\alpha^- \text{ for all } 1 \leq \alpha \leq d-1 \text{ and } h_d^+ = h_d^-; \quad (2.51)$$

We then have the following proposition, which states the symmetry properties of the solution u^ε to the variational problem (2.35) in the membrane or bending case.

Lemma 2.18. *Let us assume that A satisfies assumptions (2.49). Then, in the membrane case, $u^\varepsilon \in \mathcal{E}^{d-1} \times \mathcal{O}$, whereas in the bending case, $u^\varepsilon \in \mathcal{O}^{d-1} \times \mathcal{E}$.*

Proof. The result is an immediate consequence of the fact that the spaces $V \cap (\mathcal{E}^{d-1} \times \mathcal{O})$ and $V \cap (\mathcal{O}^{d-1} \times \mathcal{E})$ are orthogonal for the bilinear forms defined on V by

$$V \times V \ni (u, v) \mapsto \int_\Omega u v, \quad (u, v) \mapsto - \int_\Omega e^\varepsilon(u) : e^\varepsilon(v) \quad \text{and} \quad (u, v) \mapsto \int_{\Gamma^\pm} u v.$$

For $v \in \mathcal{O}^{d-1} \times \mathcal{E}$, we can check that $e_{\alpha\beta}(v) \in \mathcal{O}$, $e_{\alpha d}(v) \in \mathcal{E}$ and $e_{dd}(v) \in \mathcal{O}$. For $u \in \mathcal{E}^{d-1} \times \mathcal{O}$, we have $e_{\alpha\beta}(u) \in \mathcal{E}$, $e_{\alpha d}(u) \in \mathcal{O}$, and $e_{dd}(u) \in \mathcal{E}$. Using assumptions (2.49), we obtain that, for any u in $V \cap (\mathcal{E}^{d-1} \times \mathcal{O})$ and any v in $V \cap (\mathcal{O}^{d-1} \times \mathcal{E})$,

$$\int_\Omega A^\varepsilon e^\varepsilon(u) : e^\varepsilon(v) = 0.$$

Thus, the spaces $V \cap (\mathcal{E}^{d-1} \times \mathcal{O})$ and $V \cap (\mathcal{O}^{d-1} \times \mathcal{E})$ are orthogonal for the scalar product defined by a^ε . The final result is obtained using the form of the variational problem (2.35). \square

Let us mention that the assumptions made on the symmetry of A imply the following symmetry properties on the corrector functions.

Lemma 2.19. *Let us assume that A satisfies assumptions (2.49). Then, for all $1 \leq \alpha, \beta \leq d-1$, $w^{\alpha\beta} \in \mathcal{E}^{d-1} \times \mathcal{O}$ and $W^{\alpha\beta} \in \mathcal{O}^{d-1} \times \mathcal{E}$. In addition, for all $1 \leq \alpha, \beta, \gamma, \delta \leq d-1$, it holds that*

$$(K_{12}^*)_{\alpha\beta\gamma\delta} = 0$$

where the tensor K_{12}^* is defined in Theorem 2.11.

The proof of Lemma 2.19 follows similar lines as the proof of Lemma 2.18 and we omit it here for the sake of brevity.

We finally have a last lemma which characterizes the symmetry properties of the solution u^* to the homogenized problem (2.43).

Lemma 2.20. *Consider first the membrane case, when $f \in \mathcal{E}^{d-1} \times \mathcal{O}$, $g \in \mathcal{G}_{KL}^M$, $h_\alpha^+ = h_\alpha^-$ for all $1 \leq \alpha \leq d-1$ and $h_d^+ = -h_d^-$. Then $u^* = (\widehat{u}^*, 0)$ where $\widehat{u}^* \in (H_0^1(\omega))^{d-1}$ is the unique solution to*

$$\forall \widehat{v} \in (H_0^1(\omega))^{d-1}, \quad \int_{\omega} K_{11}^* e'(\widehat{u}^*) : e'(\widehat{v}) = \int_{\omega} (\text{m}(f') + (h^+)' + (h^-)') \cdot \widehat{v} - \int_{\omega} K_{11}^* e'(g) : e'(\widehat{v}). \quad (2.52)$$

We thus have that $u^* \in \mathcal{V}_{KL}^M$.

Consider next the bending case, when $f \in \mathcal{O}^{d-1} \times \mathcal{E}$, $g \in \mathcal{G}_{KL}^B$, $h_\alpha^+ = -h_\alpha^-$ for all $1 \leq \alpha \leq d-1$ and $h_d^+ = h_d^-$. Then $u^* = (-x_d \nabla' \widehat{u}_d^*, \widehat{u}_d^*)$ where $\widehat{u}_d^* \in H_0^2(\omega)$ is the unique solution to

$$\forall v_d \in H_0^2(\omega), \quad \int_{\omega} K_{22}^* \nabla^2 \widehat{u}_d^* : \nabla^2 v_d = \int_{\omega} (\text{m}(f_d) + h_d^+ + h_d^-) v_d - \int_{\omega} \text{m}(x_d f') \cdot \nabla' v_d - \int_{\omega} K_{22}^* \nabla^2 g_d : \nabla^2 v_d. \quad (2.53)$$

We thus have that $u^* \in \mathcal{V}_{KL}^B$.

For any $u \in (H^1(\Omega))^d$, we define the norm $\|u\|_{H_\varepsilon^1(\Omega)^d}$ as follows (compare with (2.17)):

$$\|u\|_{H_\varepsilon^1(\Omega)^d}^2 := \|u\|_{(L^2(\Omega))^d}^2 + \|e^\varepsilon(u)\|_{(L^2(\Omega))^{d \times d}}^2.$$

This is indeed the relevant energy norm for (2.35).

2.3.4 The membrane case

In this section, we assume that we are in the membrane case, i.e. that $f \in \mathcal{E}^{d-1} \times \mathcal{O}$, $g \in \mathcal{G}_{KL}^M$, $h_\alpha^+ = h_\alpha^-$ for all $1 \leq \alpha \leq d-1$ and $h_d^+ = -h_d^-$. The aim of this section is to prove the following strong convergence result, which is our main result in the membrane case.

Theorem 2.21. *Assume that we are in the membrane case (2.50). For any $1 \leq \gamma \leq d-1$, let*

$$u_\gamma^{\varepsilon,1} := u_\gamma^* + \varepsilon w_\gamma^{\alpha\beta} \left(\frac{\cdot}{\varepsilon}, \cdot \right) e_{\alpha\beta}(u^* + g)$$

and

$$u_d^{\varepsilon,1} := \varepsilon^2 w_d^{\alpha\beta} \left(\frac{\cdot}{\varepsilon}, \cdot \right) e_{\alpha\beta}(u^* + g).$$

We also assume that $u^*, g \in (W^{2,\infty}(\omega))^d$ and that, for any $1 \leq \alpha, \beta \leq d-1$, we have $w^{\alpha\beta} \in [W^{1,\infty}(\mathbb{R}^{d-1} \times (-\frac{1}{2}, \frac{1}{2}))]^d$. Then, there exists a constant $C > 0$ independent of ε and ω such that

$$\begin{aligned} & \|u^\varepsilon - u^{\varepsilon,1}\|_{H_\varepsilon^1(\Omega)^d} \leq C \left(1 + \max \left(1, |\omega|^{\frac{1}{d-1}} \right) \max \left(|\omega|^{\frac{1}{d-1}}, \varepsilon^2 |\omega|^{-\frac{1}{d-1}} \right) \right) \\ & \times \left(\sqrt{\varepsilon} |\omega|^{\frac{d-2}{2d-2}} \|e(u^* + g)\|_{L^\infty(\omega)} + \varepsilon |\omega|^{\frac{1}{2}} \|\nabla^2(u^* + g)\|_{L^\infty(\omega)} + \varepsilon (\|h^\pm\|_{L^2(\omega)} + \|f\|_{L^2(\Omega)}) \right). \end{aligned}$$

The proof of this result follows similar lines as the proof of Theorem 2.5. For the sake of completeness, we detail the proof below.

Proof of Theorem 2.21. The proof falls in four steps. In the first step, we correct for the boundary mismatch between u^ε and its approximation $u^{\varepsilon,1}$. In Steps 2 and 3, we show that the approximation is close to u^ε inside the domain Ω . The desired conclusion is obtained in Step 4.

Step 1. Let $\tau_\varepsilon \in \mathcal{D}(\omega)$ such that $0 \leq \tau_\varepsilon \leq 1$, and, for any $x' \in \omega$, $\tau_\varepsilon(x') = 1$ if $\text{dist}(\partial\omega, x') \geq \varepsilon$. Since ω is smooth, we can choose τ_ε such that $\varepsilon \|\nabla \tau_\varepsilon\|_{L^\infty(\omega)} \leq C$ with $C > 0$ independent of ω and ε . We define $\omega_\varepsilon := \{x' \in \omega, \text{dist}(\partial\omega, x') \geq \varepsilon\}$ and $\Omega_\varepsilon := \omega_\varepsilon \times (-\frac{1}{2}, \frac{1}{2})$. Note that $|\Omega \setminus \Omega_\varepsilon| \leq C\varepsilon |\omega|^{\frac{d-2}{d-1}}$.

For all $1 \leq \gamma \leq d-1$, let

$$\begin{aligned} v_\gamma^{\varepsilon,1} &:= u_\gamma^* + \varepsilon \tau_\varepsilon w_\gamma^{\alpha\beta} \left(\frac{\cdot}{\varepsilon}, \cdot \right) e_{\alpha\beta}(u^* + g), \\ v_d^{\varepsilon,1} &:= \varepsilon^2 \tau_\varepsilon w_d^{\alpha\beta} \left(\frac{\cdot}{\varepsilon}, \cdot \right) e_{\alpha\beta}(u^* + g). \end{aligned}$$

Then, it holds that $v^{\varepsilon,1} \in V$. In addition, we have that $e^\varepsilon(u^{\varepsilon,1} - v^{\varepsilon,1}) = E_0^\varepsilon + E_1^\varepsilon + E_2^\varepsilon$ where

$$\begin{aligned} E_0^\varepsilon &:= (1 - \tau_\varepsilon) e(w^{\alpha\beta}) \left(\frac{\cdot}{\varepsilon}, \cdot \right) e_{\alpha\beta}(u^* + g), \\ E_1^\varepsilon &:= \varepsilon \nabla \tau_\varepsilon \otimes w^{\alpha\beta} \left(\frac{\cdot}{\varepsilon}, \cdot \right) e_{\alpha\beta}(u^* + g), \\ E_2^\varepsilon &:= \varepsilon (1 - \tau_\varepsilon) w^{\alpha\beta} \left(\frac{\cdot}{\varepsilon}, \cdot \right) \otimes \nabla(e_{\alpha\beta}(u^* + g)). \end{aligned}$$

We bound the above terms in the $L^2(\Omega)$ norm, using the fact that $w^{\alpha\beta} \in [W^{1,\infty}(\mathbb{R}^{d-1} \times (-\frac{1}{2}, \frac{1}{2}))]^d$, $u^*, g \in (W^{2,\infty}(\omega))^d$, $0 \leq \tau_\varepsilon \leq 1$ and $\varepsilon \|\nabla \tau_\varepsilon\|_{L^\infty(\omega)} \leq C$. We thus obtain that

$$\begin{aligned} \|E_2^\varepsilon\|_{L^2(\Omega)}^2 &\leq C\varepsilon^2 \sup_{1 \leq \alpha, \beta \leq d-1} \|w^{\alpha\beta}\|_{L^\infty}^2 \|\nabla^2(u^* + g)\|_{L^2(\Omega)}^2 \\ &\leq C\varepsilon^2 |\omega| \|\nabla^2(u^* + g)\|_{L^\infty(\omega)}^2, \\ \|E_1^\varepsilon\|_{L^2(\Omega)}^2 &\leq C \sup_{1 \leq \alpha, \beta \leq d-1} \|w^{\alpha\beta}\|_{L^\infty}^2 \|\nabla(u^* + g)\|_{L^\infty(\omega)}^2 |\Omega \setminus \Omega_\varepsilon| \\ &\leq C\varepsilon |\omega|^{\frac{d-2}{d-1}} \|\nabla(u^* + g)\|_{L^\infty(\omega)}^2, \\ \|E_0^\varepsilon\|_{L^2(\Omega)}^2 &\leq C |\Omega \setminus \Omega_\varepsilon| \sup_{1 \leq \alpha, \beta \leq d-1} \|\nabla w^{\alpha\beta}\|_{L^\infty}^2 \|\nabla(u^* + g)\|_{L^\infty(\omega)}^2 \\ &\leq C\varepsilon |\omega|^{\frac{d-2}{d-1}} \|\nabla(u^* + g)\|_{L^\infty(\omega)}^2. \end{aligned}$$

This implies that

$$\|e^\varepsilon(v^{\varepsilon,1} - u^{\varepsilon,1})\|_{L^2(\Omega)}^2 \leq C \left(\varepsilon |\omega|^{\frac{d-2}{d-1}} \|\nabla(u^* + g)\|_{L^\infty(\omega)}^2 + \varepsilon^2 |\omega| \|\nabla^2(u^* + g)\|_{L^\infty(\omega)}^2 \right). \quad (2.54)$$

Step 2. Let us now bound $\bar{v}^\varepsilon := u^\varepsilon - v^{\varepsilon,1}$. On the one hand, using the coercivity of A^ε , we have

$$c_- \|e^\varepsilon(\bar{v}^\varepsilon)\|_{L^2(\Omega)}^2 \leq \int_{\Omega} A^\varepsilon e^\varepsilon(\bar{v}^\varepsilon) : e^\varepsilon(\bar{v}^\varepsilon).$$

On the other hand, it holds that

$$\int_{\Omega} A^\varepsilon e^\varepsilon(\bar{v}^\varepsilon) : e^\varepsilon(\bar{v}^\varepsilon) = \int_{\Omega} A^\varepsilon e^\varepsilon(u^\varepsilon - u^{\varepsilon,1}) : e^\varepsilon(\bar{v}^\varepsilon) + \int_{\Omega} A^\varepsilon e^\varepsilon(u^{\varepsilon,1} - v^{\varepsilon,1}) : e^\varepsilon(\bar{v}^\varepsilon).$$

Using (2.54), we obtain the bound

$$\begin{aligned} & \left| \int_{\Omega} A^\varepsilon e^\varepsilon(u^{\varepsilon,1} - v^{\varepsilon,1}) : e^\varepsilon(\bar{v}^\varepsilon) \right| \\ & \leq C \left(\sqrt{\varepsilon} |\omega|^{\frac{d-2}{2(d-1)}} \|\nabla(u^* + g)\|_{L^\infty(\omega)} + \varepsilon |\omega|^{1/2} \|\nabla^2(u^* + g)\|_{L^\infty(\omega)} \right) \|e^\varepsilon(\bar{v}^\varepsilon)\|_{L^2(\Omega)}. \end{aligned}$$

In addition, it holds that

$$\int_{\Omega} A^\varepsilon e^\varepsilon(u^\varepsilon - u^{\varepsilon,1}) : e^\varepsilon(\bar{v}^\varepsilon) = \int_{\Omega} A^\varepsilon e^\varepsilon(u^\varepsilon + g) : e^\varepsilon(\bar{v}^\varepsilon) - \int_{\Omega} A^\varepsilon e^\varepsilon(u^{\varepsilon,1} + g) : e^\varepsilon(\bar{v}^\varepsilon).$$

Let us now define

$$R_1^\varepsilon := \int_{\Omega} A^\varepsilon e^\varepsilon(u^\varepsilon + g) : e^\varepsilon(\bar{v}^\varepsilon) - \int_{\Omega} \int_{\mathcal{Y}} A(e_\alpha \otimes e_\beta + e(w^{\alpha\beta})) e_{\alpha\beta}(u^* + g) : e^\varepsilon(\bar{v}^\varepsilon), \quad (2.55)$$

and

$$R_2^\varepsilon := \int_{\Omega} A^\varepsilon e^\varepsilon(u^{\varepsilon,1} + g) : e^\varepsilon(\bar{v}^\varepsilon) - \int_{\Omega} A^\varepsilon \left(e_\alpha \otimes e_\beta + e(w^{\alpha\beta}) \left(\frac{\cdot}{\varepsilon}, \cdot \right) \right) e_{\alpha\beta}(u^* + g) : e^\varepsilon(\bar{v}^\varepsilon). \quad (2.56)$$

It then holds that

$$\begin{aligned} & \int_{\Omega} A^\varepsilon e^\varepsilon(u^\varepsilon - u^{\varepsilon,1}) : e^\varepsilon(\bar{v}^\varepsilon) = R_1^\varepsilon + R_2^\varepsilon \\ & + \int_{\Omega} \left[\int_{\mathcal{Y}} A(e_\alpha \otimes e_\beta + e(w^{\alpha\beta})) - A^\varepsilon \left(e_\alpha \otimes e_\beta + e(w^{\alpha\beta}) \left(\frac{\cdot}{\varepsilon}, \cdot \right) \right) \right] e_{\alpha\beta}(u^* + g) : e^\varepsilon(\bar{v}^\varepsilon). \end{aligned}$$

We now bound the first term of the above equality. In Step 3, we show that $R_1^\varepsilon + R_2^\varepsilon = O(\varepsilon)$ because of the assumptions made on the data.

Introduce

$$Z_{\alpha\beta} := \int_{\mathcal{Y}} A(e_\alpha \otimes e_\beta + e(w^{\alpha\beta})) - A(e_\alpha \otimes e_\beta + e(w^{\alpha\beta})).$$

Because of the definition of $w^{\alpha\beta}$ solution to (2.40), $Z_{\alpha\beta}$ satisfies the assumptions of Lemma 2.12. The function $e_{\alpha\beta}(u^* + g)$ belongs to $W^{1,\infty}(\omega)$ and $u^\varepsilon - v^{\varepsilon,1}$ belongs to V . We are thus in position to use Lemma 2.12. For any $1 \leq \alpha, \beta \leq d-1$, it holds that

$$\left| \int_{\Omega} Z_{\alpha\beta} \left(\frac{\cdot}{\varepsilon}, \cdot \right) e_{\alpha\beta}(u^* + g) \cdot e^\varepsilon(\bar{v}^\varepsilon) \right| \leq C \varepsilon |\omega|^{\frac{1}{2}} \|\nabla^2(u^* + g)\|_{L^\infty(\omega)} \|e^\varepsilon(\bar{v}^\varepsilon)\|_{L^2(\Omega)}.$$

This yields that

$$\begin{aligned} \|e^\varepsilon(\bar{v}^\varepsilon)\|_{L^2(\Omega)}^2 & \leq C \left(\varepsilon |\omega|^{\frac{1}{2}} \|\nabla^2(u^* + g)\|_{L^\infty(\omega)} + \sqrt{\varepsilon} |\omega|^{\frac{d-2}{2d-2}} \|\nabla(u^* + g)\|_{L^\infty(\omega)} \right) \|e^\varepsilon(\bar{v}^\varepsilon)\|_{L^2(\Omega)} \\ & \quad + |R_1^\varepsilon| + |R_2^\varepsilon|. \quad (2.57) \end{aligned}$$

Step 3. We now show estimates on R_1^ε and R_2^ε , defined by (2.55) and (2.56). The bound on R_2^ε comes from the definition of $u^{\varepsilon,1}$. We hence write

$$\begin{aligned} |R_2^\varepsilon| &:= \left| \int_{\Omega} A^\varepsilon \left[e^\varepsilon(u^{\varepsilon,1} + g) - \left(e_\alpha \otimes e_\beta + e(w^{\alpha\beta}) \left(\frac{\cdot}{\varepsilon}, \cdot \right) \right) e_{\alpha\beta}(u^* + g) \right] \cdot e^\varepsilon(\bar{v}^\varepsilon) \right| \\ &= \left| \int_{\Omega} A^\varepsilon \left[\frac{\varepsilon}{2} \left[w^{\alpha\beta} \left(\frac{\cdot}{\varepsilon}, \cdot \right) \otimes \nabla(e_{\alpha\beta}(u^* + g)) + \nabla(e_{\alpha\beta}(u^* + g)) \otimes w^{\alpha\beta} \left(\frac{\cdot}{\varepsilon}, \cdot \right) \right] \right] \cdot e^\varepsilon(\bar{v}^\varepsilon) \right| \\ &\leq C\varepsilon \|\nabla^2(u^* + g)\|_{L^2(\Omega)} \|e^\varepsilon(\bar{v}^\varepsilon)\|_{L^2(\Omega)} \\ &\leq C\varepsilon |\omega|^{\frac{1}{2}} \|\nabla^2(u^* + g)\|_{L^\infty(\Omega)} \|e^\varepsilon(\bar{v}^\varepsilon)\|_{L^2(\Omega)}. \end{aligned}$$

We now bound R_1^ε . Using the variational formulation (2.35) and the fact that $\bar{v}^\varepsilon = u^\varepsilon - v^{\varepsilon,1}$ belongs to V , we obtain

$$\int_{\Omega} A^\varepsilon e^\varepsilon(u^\varepsilon + g) \cdot e^\varepsilon(\bar{v}^\varepsilon) = \int_{\Omega} f \cdot \bar{v}^\varepsilon + \int_{\Gamma^\pm} h_\pm \cdot \bar{v}^\varepsilon.$$

For all $1 \leq i \leq d$, the function $v_i : \mathbb{R}^{d-1} \times (-\frac{1}{2}, \frac{1}{2}) \ni y \mapsto y_d e_i$ belongs to the space $\mathcal{W}(\mathcal{Y})$. The function v_i can thus be used as an admissible test function in (2.40). We therefore obtain that, for all $1 \leq \alpha, \beta \leq d-1$, $\int_{\mathcal{Y}} A(e_\alpha \otimes e_\beta + e(w^{\alpha\beta})) \cdot e_d = 0$. Thus, using the fact that $u^* \in \mathcal{V}_{KL}^M$ and that $g \in \mathcal{G}_{KL}^M$, we obtain that

$$\begin{aligned} \int_{\Omega} \left[\int_{\mathcal{Y}} A(e_\alpha \otimes e_\beta + e(w^{\alpha\beta})) \right] e_{\alpha\beta}(u^* + g) \cdot e^\varepsilon(\bar{v}^\varepsilon) &= \int_{\Omega} K_{11}^* e'(u^* + g) \cdot e'(\bar{v}^\varepsilon) \\ &= \int_{\omega} K_{11}^* e'(u^* + g) \cdot e'(m(\bar{v}^\varepsilon)). \end{aligned}$$

Using the variational formulation (2.52) of the homogenized problem, the fact that $m(\bar{v}^\varepsilon)$ belongs to $(H_0^1(\omega))^d$ (thus $m((\bar{v}^\varepsilon)')$ is an admissible test function for (2.52)), the fact that $h_d^+ = -h_d^-$ and the fact that $f_d \in \mathcal{O}$, we obtain that

$$\begin{aligned} \int_{\omega} K_{11}^* e'(u^* + g) \cdot e'(m(\bar{v}^\varepsilon)) &= \int_{\omega} (m(f') + (h^+) + (h^-)) \cdot m((\bar{v}^\varepsilon)') \\ &= \int_{\Omega} f' \cdot m((\bar{v}^\varepsilon)') + \int_{\omega} (h^+ + h^-) \cdot m(\bar{v}^\varepsilon) \\ &= \int_{\Omega} f \cdot m(\bar{v}^\varepsilon) + \int_{\omega} (h^+ + h^-) \cdot m(\bar{v}^\varepsilon). \end{aligned} \quad (2.58)$$

As a consequence,

$$\begin{aligned} R_1^\varepsilon &= \int_{\Omega} \left[\int_{\mathcal{Y}} A(e_\alpha \otimes e_\beta + e(w^{\alpha\beta})) \right] e_{\alpha\beta}(u^* + g) \cdot e^\varepsilon(\bar{v}^\varepsilon) - \int_{\Omega} A^\varepsilon e^\varepsilon(u^\varepsilon + g) \cdot e^\varepsilon(\bar{v}^\varepsilon) \\ &= - \int_{\Omega} f \cdot (\bar{v}^\varepsilon - m(\bar{v}^\varepsilon)) + \int_{\omega} (h^+ + h^-) \cdot m(\bar{v}^\varepsilon) - \int_{\Gamma^+} h^+ \cdot \bar{v}^\varepsilon - \int_{\Gamma^-} h^- \cdot \bar{v}^\varepsilon. \end{aligned}$$

Using Lemma 2.14, we get

$$\left| \int_{\omega} h^\pm \cdot m(\bar{v}^\varepsilon) - \int_{\Gamma^\pm} h^\pm \cdot \bar{v}^\varepsilon \right| \leq \varepsilon \|h^\pm\|_{L^2(\omega)} \|e^\varepsilon(\bar{v}^\varepsilon)\|_{L^2(\Omega)}.$$

In addition, using again Lemma 2.14 and the Cauchy-Schwarz inequality, we get

$$\begin{aligned} \left| \int_{\Omega} f \cdot (\bar{v}^\varepsilon - m(\bar{v}^\varepsilon)) \right| &\leq \int_{-1/2}^{1/2} \left| \int_{\omega} f(\cdot, z) \cdot (\bar{v}^\varepsilon(\cdot, z) - m(\bar{v}^\varepsilon)) \right| dz \\ &\leq \varepsilon \int_{-1/2}^{1/2} \|f(\cdot, z)\|_{L^2(\omega)} \|e^\varepsilon(\bar{v}^\varepsilon)\|_{L^2(\Omega)} dz \\ &\leq \varepsilon \|f\|_{L^2(\Omega)} \|e^\varepsilon(\bar{v}^\varepsilon)\|_{L^2(\Omega)}. \end{aligned}$$

Thus,

$$|R_\varepsilon^1| \leq \varepsilon \left(\|h^+\|_{L^2(\omega)} + \|h^-\|_{L^2(\omega)} + \|f\|_{L^2(\Omega)} \right) \|e^\varepsilon(\bar{v}^\varepsilon)\|_{L^2(\Omega)}.$$

This yields that

$$|R_\varepsilon^1| + |R_\varepsilon^2| \leq C\varepsilon \left(|\omega|^{\frac{1}{2}} \|\nabla^2(u^* + g)\|_{L^\infty(\Omega)} + \|h^+\|_{L^2(\omega)} + \|h^-\|_{L^2(\omega)} + \|f\|_{L^2(\Omega)} \right) \|e^\varepsilon(\bar{v}^\varepsilon)\|_{L^2(\Omega)}.$$

We thus deduce from (2.57) that

$$\begin{aligned} \|e^\varepsilon(\bar{v}^\varepsilon)\|_{L^2(\Omega)} &\leq C \left(\sqrt{\varepsilon} |\omega|^{\frac{d-2}{2d-2}} \|\nabla(u^* + g)\|_{L^\infty(\omega)} + \varepsilon |\omega|^{\frac{1}{2}} \|\nabla^2(u^* + g)\|_{L^\infty(\omega)} \right. \\ &\quad \left. + \varepsilon \left(\|h^+\|_{L^2(\omega)} + \|h^-\|_{L^2(\omega)} + \|f\|_{L^2(\Omega)} \right) \right). \end{aligned} \quad (2.59)$$

Step 4. Using (2.54) and (2.59), we write

$$\begin{aligned} \|e^\varepsilon(u^\varepsilon - u^{\varepsilon,1})\|_{L^2(\Omega)} &\leq \|e^\varepsilon(u^\varepsilon - v^{\varepsilon,1})\|_{L^2(\Omega)} + \|e^\varepsilon(v^{\varepsilon,1} - u^{\varepsilon,1})\|_{L^2(\Omega)} \\ &\leq C \left(\sqrt{\varepsilon} |\omega|^{\frac{d-2}{2d-2}} \|\nabla(u^* + g)\|_{L^\infty(\omega)} + \varepsilon |\omega|^{\frac{1}{2}} \|\nabla^2(u^* + g)\|_{L^\infty(\omega)} \right. \\ &\quad \left. + \varepsilon \left(\|h^\pm\|_{L^2(\omega)} + \|f\|_{L^2(\Omega)} \right) \right). \end{aligned}$$

To conclude the proof, we use the Poincaré inequality stated in Lemma 2.16, which yields that

$$\begin{aligned} \|u^\varepsilon - u^{\varepsilon,1}\|_{H_\varepsilon^1(\Omega)^d} &\leq C \left(1 + \max \left(1, |\omega|^{\frac{1}{d-1}} \right) \max \left(|\omega|^{\frac{1}{d-1}}, \varepsilon^2 |\omega|^{-\frac{1}{d-1}} \right) \right) \\ &\times \left(\sqrt{\varepsilon} |\omega|^{\frac{d-2}{2d-2}} \|e(u^* + g)\|_{L^\infty(\omega)} + \varepsilon |\omega|^{\frac{1}{2}} \|\nabla^2(u^* + g)\|_{L^\infty(\omega)} + \varepsilon \left(\|h^\pm\|_{L^2(\omega)} + \|f\|_{L^2(\Omega)} \right) \right). \end{aligned}$$

This concludes the proof of Theorem 2.21. \square

2.3.5 The bending case

Stating a similar strong convergence result in the bending case appears to be a much more intricate task than in the membrane case. We want to stress here the fact that the arguments used for the proof of Theorem 2.5 and Theorem 2.21 cannot be applied here. Indeed, notice that in the proof of Theorem 2.21, and more precisely in (2.58), we used $m((\bar{v}^\varepsilon)')$ as a test function in the variational formulation (2.52). However, in the bending case, it is not clear how to construct from \bar{v}^ε an admissible test function for problem (2.53) which would enable to proceed with the same arguments and obtain a similar two-scale strong convergence result.

We did not manage to obtain a complete proof for such a two-scale strong convergence result in the bending case. We have however managed to obtain such a result (see Theorem 2.25), by using a completely different proof strategy inspired by some arguments of [32], at the price of making a conjecture detailed below (see (2.74)). In Section 2.3.6, we provide evidence, based both on theoretical and numerical arguments, for why such a conjecture should hold true. We also mention that the complete adaptation to the heterogeneous case of the arguments of [32], which were developed for homogeneous plates, is far from being trivial.

To state the conjecture and our main result for the bending case (namely Theorem 2.25), we first need to state some intermediate results.

Let $\varepsilon > 0$ and let us define

$$\sigma^\varepsilon := A^\varepsilon e^\varepsilon(u^\varepsilon + g). \quad (2.60)$$

Using (2.39) and assumption (2.42) (which implies that $e^\varepsilon(g) = e(g)$), we infer from (2.37) that there exists a constant $C > 0$ independent of ε such that

$$\|\sigma^\varepsilon\|_{(L^2(\Omega))^{d \times d}} \leq C \left(\|f\|_{(L^2(\Omega))^d} + \|e(g)\|_{(L^2(\Omega))^{d \times d}} + \|h_\pm\|_{(L^2(\omega))^d} \right). \quad (2.61)$$

Theorem 2.11 actually provides information (in terms of u^*) about the limit of $\int_\Omega \sigma^\varepsilon : e^\varepsilon(v)$ as ε goes to 0 only when $v \in \mathcal{V}_{KL}$. To state the strong convergence theorem, we need to identify the limit of $\int_\Omega \sigma^\varepsilon : e^\varepsilon(v)$ for any $v \in V$. To this aim, we introduce the following quantities, for any $1 \leq \alpha, \beta \leq d-1$:

$$\Sigma_{\alpha\beta}^\varepsilon := \sigma_{\alpha\beta}^\varepsilon, \quad \Sigma_{\alpha d}^\varepsilon := \frac{1}{\varepsilon} \sigma_{\alpha d}^\varepsilon \quad \text{and} \quad \Sigma_{dd}^\varepsilon := \frac{1}{\varepsilon^2} \sigma_{dd}^\varepsilon. \quad (2.62)$$

Then, for all $v \in V$, we have $\int_\Omega \sigma^\varepsilon : e^\varepsilon(v) = \int_\Omega \Sigma^\varepsilon : e(v)$. The main idea of the following lemmas is to show that there exists some Σ^* regular enough such that

$$\forall v \in V, \quad \int_\Omega \Sigma^\varepsilon : e(v) = \int_\Omega \Sigma^* : e(v)$$

and to relate some components of Σ^* with u^* .

Lemma 2.22. *There exists a symmetric matrix-valued field $\Sigma^* := (\Sigma_{ij}^*)_{1 \leq i, j \leq d}$ such that, for all $1 \leq \alpha, \beta \leq d-1$, we have*

$$\Sigma_{\alpha\beta}^* \in L^2(\Omega), \quad \Sigma_{\alpha d}^* \in L^2\left(\left(-\frac{1}{2}, \frac{1}{2}\right), H^{-1}(\omega)\right) \quad \text{and} \quad \Sigma_{dd}^* \in L^2\left(\left(-\frac{1}{2}, \frac{1}{2}\right), H^{-2}(\omega)\right)$$

and such that, up to the extraction of a subsequence,

$$\Sigma_{\alpha\beta}^\varepsilon \rightharpoonup_{\varepsilon \rightarrow 0} \Sigma_{\alpha\beta}^* \text{ weakly in } L^2(\Omega), \quad (2.63)$$

$$\Sigma_{\alpha d}^\varepsilon \rightharpoonup_{\varepsilon \rightarrow 0} \Sigma_{\alpha d}^* \text{ weakly in } L^2\left(\left(-\frac{1}{2}, \frac{1}{2}\right), H^{-1}(\omega)\right), \quad (2.64)$$

$$\Sigma_{dd}^\varepsilon \rightharpoonup_{\varepsilon \rightarrow 0} \Sigma_{dd}^* \text{ weakly in } L^2\left(\left(-\frac{1}{2}, \frac{1}{2}\right), H^{-2}(\omega)\right). \quad (2.65)$$

Furthermore, for any $v := (v_i)_{1 \leq i \leq d} \in (C^\infty([-\frac{1}{2}, \frac{1}{2}], \mathcal{D}(\omega)))^d$, it holds that

$$\begin{aligned} \int_\Omega \Sigma^\varepsilon : e(v) &= \sum_{1 \leq \alpha, \beta \leq d-1} \langle \Sigma_{\alpha\beta}^*, e_{\alpha\beta}(v) \rangle_{L^2(\Omega)} \\ &+ \sum_{1 \leq \alpha \leq d-1} \langle \Sigma_{\alpha d}^*, e_{\alpha d}(v) \rangle_{L^2((-\frac{1}{2}, \frac{1}{2}), H^{-1}(\omega)), L^2((-\frac{1}{2}, \frac{1}{2}), H_0^1(\omega))} \\ &+ \langle \Sigma_{dd}^*, e_{dd}(v) \rangle_{L^2((-\frac{1}{2}, \frac{1}{2}), H^{-2}(\omega)), L^2((-\frac{1}{2}, \frac{1}{2}), H_0^2(\omega))}. \end{aligned} \quad (2.66)$$

In addition, there exists a constant $C > 0$ independent of ε and ω such that

$$\begin{aligned} \sum_{1 \leq \alpha, \beta \leq d-1} \|\Sigma_{\alpha\beta}^*\|_{L^2(\Omega)} + \sum_{1 \leq \alpha \leq d-1} \|\Sigma_{\alpha d}^*\|_{L^2((-\frac{1}{2}, \frac{1}{2}), H^{-1}(\omega))} + \|\Sigma_{dd}^*\|_{L^2((-\frac{1}{2}, \frac{1}{2}), H^{-2}(\omega))} \\ \leq C \left(\|f\|_{(L^2(\Omega))^d} + \|e(g)\|_{(L^2(\Omega))^{d \times d}} + \|h^\pm\|_{(L^2(\omega))^d} \right). \end{aligned}$$

Proof. We know from (2.61) that the sequence $(\sigma^\varepsilon)_{\varepsilon>0}$ is bounded in $(L^2(\Omega))^{d \times d}$. Thus, for all $1 \leq \alpha, \beta \leq d-1$, there exists $\Sigma_{\alpha\beta}^* \in L^2(\Omega)$ such that, up to the extraction of a subsequence,

$$\Sigma_{\alpha\beta}^\varepsilon \rightharpoonup \Sigma_{\alpha\beta}^* \text{ weakly in } L^2(\Omega).$$

Now, let us prove that the sequence $(\Sigma_{\alpha d}^\varepsilon)_{\varepsilon>0}$ is bounded in $L^2\left(\left(-\frac{1}{2}, \frac{1}{2}\right), H^{-1}(\omega)\right)$ for any $1 \leq \alpha \leq d-1$. Using (2.35), it holds that, for all $v = (v_i)_{1 \leq i \leq d} \in V$ such that $v_d = 0$,

$$\int_{\Omega} \Sigma_{\alpha d}^\varepsilon \partial_d v_\alpha = \int_{\Omega} f_\alpha v_\alpha + \int_{\Gamma^\pm} h_\alpha^\pm v_\alpha - \int_{\Omega} \sigma_{\alpha\beta}^\varepsilon e_{\alpha\beta}(v). \quad (2.67)$$

Let now $w = (w_\alpha)_{1 \leq \alpha \leq d-1} \in (L^2\left(\left(-\frac{1}{2}, \frac{1}{2}\right), H_0^1(\omega)\right))^{d-1}$. For all $1 \leq \alpha \leq d-1$, let us define v_α^w on Ω by

$$\forall (x', z) \in \omega \times \left(-\frac{1}{2}, \frac{1}{2}\right), \quad v_\alpha^w(x', z) := \int_{-1/2}^z w_\alpha(x', t) dt \quad (2.68)$$

and set $v_d^w = 0$. It then holds that $v^w = (v_i^w)_{1 \leq i \leq d}$ belongs to V , and that it can be used as a test function in (2.67). We then obtain that

$$\int_{\Omega} \Sigma_{\alpha d}^\varepsilon w_\alpha = \int_{\Omega} f_\alpha v_\alpha^w + \int_{\Gamma^\pm} h_\alpha^\pm v_\alpha^w - \int_{\Omega} \sigma_{\alpha\beta}^\varepsilon e_{\alpha\beta}(v^w). \quad (2.69)$$

Using the fact $\|v_\alpha^w\|_{L^2(\Omega)} \leq \|w_\alpha\|_{L^2(\Omega)}$ and that $\|\partial_\beta v_\alpha^w\|_{L^2(\Omega)} \leq \|\partial_\beta w_\alpha\|_{L^2(\Omega)}$ together with Lemma 2.15, we obtain that there exists a constant $C > 0$ independent of ε and ω such that

$$\begin{aligned} \left| \int_{\Omega} \Sigma_{\alpha d}^\varepsilon w_\alpha \right| &\leq \|f_\alpha\|_{L^2(\Omega)} \|v_\alpha^w\|_{L^2(\Omega)} + \|h_\alpha^+\|_{L^2(\omega)} \|v_\alpha^w\|_{L^2(\Gamma^+)} + \|h_\alpha^-\|_{L^2(\omega)} \|v_\alpha^w\|_{L^2(\Gamma^-)} \\ &+ \frac{1}{2} \sum_{1 \leq \alpha, \beta \leq d-1} \|\sigma_{\alpha\beta}^\varepsilon\|_{L^2(\Omega)} (\|\partial_\alpha v_\beta^w\|_{L^2(\Omega)} + \|\partial_\beta v_\alpha^w\|_{L^2(\Omega)}) \\ &\leq \|f_\alpha\|_{L^2(\Omega)} \|v_\alpha^w\|_{L^2(\Omega)} + \sqrt{2} (\|h_\alpha^+\|_{L^2(\omega)} + \|h_\alpha^-\|_{L^2(\omega)}) (\|v_\alpha^w\|_{L^2(\Omega)} + \|\partial_d v_\alpha^w\|_{L^2(\Omega)}) \\ &+ \frac{1}{2} \sum_{1 \leq \alpha, \beta \leq d-1} \|\sigma_{\alpha\beta}^\varepsilon\|_{L^2(\Omega)} (\|\partial_\alpha v_\beta^w\|_{L^2(\Omega)} + \|\partial_\beta v_\alpha^w\|_{L^2(\Omega)}) \\ &\leq \|f_\alpha\|_{L^2(\Omega)} \|w_\alpha\|_{L^2(\Omega)} + 2\sqrt{2} (\|h_\alpha^+\|_{L^2(\omega)} + \|h_\alpha^-\|_{L^2(\omega)}) \|w_\alpha\|_{L^2(\Omega)} \\ &+ \frac{1}{2} \sum_{1 \leq \alpha, \beta \leq d-1} \|\sigma_{\alpha\beta}^\varepsilon\|_{L^2(\Omega)} (\|\partial_\alpha w_\beta\|_{L^2(\Omega)} + \|\partial_\beta w_\alpha\|_{L^2(\Omega)}) \\ &\leq C \left(\|f\|_{(L^2(\Omega))^d} + \|e(g)\|_{(L^2(\Omega))^{d \times d}} + \|h^\pm\|_{(L^2(\omega))^d} \right) \|w\|_{L^2\left(\left(-\frac{1}{2}, \frac{1}{2}\right), H_0^1(\omega)\right)^{d-1}}. \end{aligned}$$

This implies that there exists a constant $C > 0$ independent of ε and ω such that

$$\sum_{1 \leq \alpha \leq d-1} \|\Sigma_{\alpha d}^\varepsilon\|_{L^2\left(\left(-\frac{1}{2}, \frac{1}{2}\right), H^{-1}(\omega)\right)} \leq C \left(\|f\|_{(L^2(\Omega))^d} + \|e(g)\|_{(L^2(\Omega))^{d \times d}} + \|h^\pm\|_{(L^2(\omega))^d} \right).$$

Hence, for all $1 \leq \alpha \leq d-1$, there exists $\Sigma_{\alpha d}^* \in L^2\left(\left(-\frac{1}{2}, \frac{1}{2}\right), H^{-1}(\omega)\right)$ such that, up to the extraction of a subsequence,

$$\Sigma_{\alpha d}^\varepsilon \rightharpoonup \Sigma_{\alpha d}^* \text{ weakly in } L^2\left(\left(-\frac{1}{2}, \frac{1}{2}\right), H^{-1}(\omega)\right)$$

and

$$\sum_{1 \leq \alpha \leq d-1} \|\Sigma_{\alpha d}^*\|_{L^2\left(\left(-\frac{1}{2}, \frac{1}{2}\right), H^{-1}(\omega)\right)} \leq C \left(\|f\|_{(L^2(\Omega))^d} + \|e(g)\|_{(L^2(\Omega))^{d \times d}} + \|h^\pm\|_{(L^2(\omega))^d} \right).$$

We next turn to Σ_{dd}^ε . For all $v := (v_i)_{1 \leq i \leq d} \in V$ such that $v_\alpha = 0$ for all $1 \leq \alpha \leq d - 1$, we have, using (2.35),

$$\int_{\Omega} \Sigma_{dd}^\varepsilon \partial_d v_d = \int_{\Omega} f_d v_d + \int_{\Gamma^+} h_d^+ v_d + \int_{\Gamma^-} h_d^- v_d - \int_{\Omega} \Sigma_{\alpha d}^\varepsilon \partial_\alpha v_d. \quad (2.70)$$

Let now $w_d \in L^2\left(\left(-\frac{1}{2}, \frac{1}{2}\right), H_0^2(\omega)\right)$. We define v_d^w on Ω by

$$\forall (x', z) \in \omega \times \left(-\frac{1}{2}, \frac{1}{2}\right), \quad v_d^w(x', z) := \int_{-1/2}^z w_d(x', t) dt \quad (2.71)$$

and set $v_\alpha^w = 0$ for all $1 \leq \alpha \leq d - 1$. For all $1 \leq \alpha \leq d - 1$, we have $\partial_\alpha v_d \in L^2\left(\left(-\frac{1}{2}, \frac{1}{2}\right), H_0^1(\omega)\right)$. Then, it holds that $v^w := (v_i^w)_{1 \leq i \leq d} \in V$ and can thus be used as a function test in (2.70). Following similar arguments as above, we obtain

$$\begin{aligned} \left| \int_{\Omega} \Sigma_{dd}^\varepsilon w_d \right| &\leq \|f_d\|_{L^2(\Omega)} \|v_d^w\|_{L^2(\Omega)} + \|h_d^+\|_{L^2(\omega)} \|v_d^w\|_{L^2(\Gamma^+)} + \|h_d^-\|_{L^2(\omega)} \|v_d^w\|_{L^2(\Gamma^-)} \\ &\quad + \sum_{1 \leq \alpha \leq d-1} \|\Sigma_{\alpha d}^\varepsilon\|_{L^2\left(\left(-\frac{1}{2}, \frac{1}{2}\right), H^{-1}(\omega)\right)} \|\partial_\alpha v_d^w\|_{L^2\left(\left(-\frac{1}{2}, \frac{1}{2}\right), H_0^1(\omega)\right)} \\ &\leq C \left(\|f\|_{(L^2(\Omega))^d} + \|e(g)\|_{(L^2(\Omega))^{d \times d}} + \|h^\pm\|_{(L^2(\omega))^d} \right) \|w_d\|_{L^2\left(\left(-\frac{1}{2}, \frac{1}{2}\right), H_0^2(\omega)\right)}, \end{aligned}$$

for some constant $C > 0$ independent of ω and ε . Thus, there exists $\Sigma_{dd}^* \in L^2\left(\left(-\frac{1}{2}, \frac{1}{2}\right), H^{-2}(\omega)\right)$ such that, up to the extraction of a subsequence,

$$\Sigma_{dd}^\varepsilon \xrightarrow{\varepsilon \rightarrow 0} \Sigma_{dd}^* \text{ weakly in } L^2\left(\left(-\frac{1}{2}, \frac{1}{2}\right), H^{-2}(\omega)\right)$$

and

$$\|\Sigma_{dd}^*\|_{L^2\left(\left(-\frac{1}{2}, \frac{1}{2}\right), H^{-2}(\omega)\right)} \leq C \left(\|f\|_{(L^2(\Omega))^d} + \|e(g)\|_{(L^2(\Omega))^{d \times d}} + \|h^\pm\|_{(L^2(\omega))^d} \right).$$

On the one hand, we thus obtain that, for all $v \in (\mathcal{C}^\infty\left(\left[-\frac{1}{2}, \frac{1}{2}\right], \mathcal{D}(\omega)\right))^d$,

$$\begin{aligned} \int_{\Omega} \Sigma^\varepsilon : e(v) &\xrightarrow{\varepsilon \rightarrow 0} \sum_{1 \leq \alpha, \beta \leq d-1} \langle \Sigma_{\alpha\beta}^*, e_{\alpha\beta}(v) \rangle_{L^2(\Omega)} \\ &\quad + \sum_{1 \leq \alpha \leq d-1} \langle \Sigma_{\alpha d}^*, e_{\alpha d}(v) \rangle_{L^2\left(\left(-\frac{1}{2}, \frac{1}{2}\right), H^{-1}(\omega)\right), L^2\left(\left(-\frac{1}{2}, \frac{1}{2}\right), H_0^1(\omega)\right)} \\ &\quad + \langle \Sigma_{dd}^*, e_{dd}(v) \rangle_{L^2\left(\left(-\frac{1}{2}, \frac{1}{2}\right), H^{-2}(\omega)\right), L^2\left(\left(-\frac{1}{2}, \frac{1}{2}\right), H_0^2(\omega)\right)}. \end{aligned} \quad (2.72)$$

On the other hand, since $(\mathcal{C}^\infty\left(\left[-\frac{1}{2}, \frac{1}{2}\right], \mathcal{D}(\omega)\right))^d \subset V$, we have, in view of (2.35), that

$$\int_{\Omega} \Sigma^\varepsilon : e(v) = \int_{\Omega} \sigma^\varepsilon : e^\varepsilon(v) = \int_{\Omega} f \cdot v + \int_{\Gamma^+} h^+ \cdot v + \int_{\Gamma^-} h^- \cdot v. \quad (2.73)$$

In view of (2.73), we see that the left hand side of (2.72) is actually independent of ε . We thus deduce (2.66). This concludes the proof of Lemma 2.22. \square

We now state the conjecture on which we build the proof of the strong convergence of the two-scale expansion. This conjecture reads as follows:

$$(CB) \quad \text{For all } 1 \leq \alpha, \beta \leq d - 1, \quad \Sigma_{\alpha\beta}^* = (e_\alpha \otimes e_\beta) : \left[\int_Y A(e(W^{\gamma\delta}) - x_d e_\gamma \otimes e_\delta) \right] \partial_{\gamma\delta} (u_d^* + g_d). \quad (2.74)$$

We postpone to Section 2.3.6 the discussion about the theoretical and numerical evidence supporting (2.74). Let us only mention here that one consequence of this conjecture (together with the fact that u_d^* and g_d do not depend on x_d and of (2.44)) is the identity

$$\forall 1 \leq \alpha, \beta \leq d-1, \quad m(-x_d \Sigma_{\alpha\beta}^*) = (K_{22}^*)_{\alpha\beta\gamma\delta} \partial_{\gamma\delta}(u_d^* + g_d). \quad (2.75)$$

While we are not able to prove (2.74), it turns out that we can rigorously prove (2.75), as shown in Section 2.3.6 (see Lemma 2.26). Furthermore, we also discuss in Section 2.3.6 some numerical evidence supporting (2.74).

Under some stronger regularity assumptions on A , f and g and under Conjecture (CB), the following lemma states that Σ^* is actually more regular than stated in Lemma 2.22.

Lemma 2.23. *Assume Conjecture (CB) and that*

$$(A1) \quad A \in (C^\infty(\mathbb{R}^{d-1} \times (-\frac{1}{2}, \frac{1}{2})))^{d \times d \times d \times d};$$

$$(A2) \quad f_\alpha \in L^2\left(-\frac{1}{2}, \frac{1}{2}\right), H^1(\omega) \text{ for all } 1 \leq \alpha \leq d-1 \text{ and } f_d \in L^2(\Omega);$$

$$(A3) \quad g_d \in H^4(\omega);$$

$$(A4) \quad h_\alpha^\pm \in H^1(\omega) \text{ for all } 1 \leq \alpha \leq d-1 \text{ and } h_d^\pm \in L^2(\omega).$$

Then, it holds that, for all $1 \leq \alpha, \beta \leq d-1$,

$$\Sigma_{\alpha\beta}^* \in L^2\left(\left(-\frac{1}{2}, \frac{1}{2}\right), H^2(\omega)\right), \quad \Sigma_{\alpha d}^* \in L^2\left(\left(-\frac{1}{2}, \frac{1}{2}\right), H^1(\omega)\right) \quad \text{and} \quad \Sigma_{dd}^* \in L^2(\Omega).$$

Proof. We start by proving that $u_d^* \in H^4(\omega)$. Using Lemma 2.20, it holds that

$$\nabla^2 : K_{22}^* \nabla^2 u_d^* = m(f_d) + h_d^\pm + \operatorname{div}'(m(x_d f')) - \nabla^2 : K_{22}^* \nabla^2 g_d \text{ in } \mathcal{D}'(\omega).$$

The assumptions (A2), (A3) and (A4) on f , g and h^\pm imply that

$$\nabla^2 : K_{22}^* \nabla^2 u_d^* \in L^2(\omega)$$

and we furthermore have $u_d^* \in H_0^2(\omega)$. Thus, by standard elliptic regularity, we obtain that $u_d^* \in H^4(\omega)$. In addition, we have also assumed that $g_d \in H^4(\omega)$. Using now Conjecture (CB), we deduce that $\Sigma_{\alpha\beta}^* \in L^2\left(-\frac{1}{2}, \frac{1}{2}\right), H^2(\omega)$ for all $1 \leq \alpha, \beta \leq d-1$.

We next prove that $\Sigma_{\alpha d}^* \in L^2\left(-\frac{1}{2}, \frac{1}{2}\right), H^1(\omega)$ for all $1 \leq \alpha \leq d-1$. Passing to the limit $\varepsilon \rightarrow 0$ in (2.69) and using (2.64) and (2.63), it holds that, for all $w \in (L^2\left(-\frac{1}{2}, \frac{1}{2}\right), H_0^1(\omega))^{d-1}$,

$$\begin{aligned} \int_\Omega \Sigma_{\alpha d}^* w_\alpha &= \int_\Omega f_\alpha v_\alpha^w + \int_{\Gamma^\pm} h_\alpha^\pm v_\alpha^w - \int_\Omega \Sigma_{\alpha\beta}^* e_{\alpha\beta}(v^w) \\ &= \int_\Omega f_\alpha v_\alpha^w + \int_{\Gamma^\pm} h_\alpha^\pm v_\alpha^w + \int_\Omega \partial_\beta \Sigma_{\alpha\beta}^* v_\alpha^w \quad [\text{since } v^w \text{ vanishes on } \partial\omega \times (-1/2, 1/2)] \\ &= \int_\Omega w_\alpha(x', z) \left(\int_z^{1/2} (f_\alpha(x', \cdot) + \partial_\beta \Sigma_{\alpha\beta}^*(x', \cdot)) \right) dx' dz + \int_\Omega w_\alpha(x', z) h_\alpha^+(x') dx' dz, \end{aligned}$$

where v^w is defined by (2.68) (and thus vanishes on Γ^-). This implies that

$$\Sigma_{\alpha d}^*(x', z) = h_\alpha^+(x') + \int_z^{1/2} (f_\alpha(x', \cdot) + \partial_\beta \Sigma_{\alpha\beta}^*(x', \cdot)) \quad \text{in } \mathcal{D}'(\Omega). \quad (2.76)$$

Since $\Sigma_{\alpha\beta}^* \in L^2\left(\left(-\frac{1}{2}, \frac{1}{2}\right), H^2(\omega)\right)$ for all $1 \leq \alpha, \beta \leq d-1$ and in view of the regularity (A4) on h^\pm , we infer from (2.76) that $\Sigma_{\alpha d}^* \in L^2\left(\left(-\frac{1}{2}, \frac{1}{2}\right), H^1(\omega)\right)$ for all $1 \leq \alpha \leq d-1$.

Let us finally prove that $\Sigma_{dd}^* \in L^2(\Omega)$. Let $w_d \in L^2\left(\left(-\frac{1}{2}, \frac{1}{2}\right), H_0^2(\omega)\right)$ and consider v^w defined by (2.71). Passing to the limit $\varepsilon \rightarrow 0$ in (2.70) and using (2.65) and (2.64), we obtain that

$$\begin{aligned} \int_{\Omega} \Sigma_{dd}^* w_d &= \int_{\Omega} f_d v_d^w + \int_{\Gamma^+} h_d^+ v_d^w + \int_{\Gamma^-} h_d^- v_d^w - \int_{\Omega} \Sigma_{\alpha d}^* \partial_{\alpha} v_d^w \\ &= \int_{\Omega} w_d(x', z) \left(\int_z^{1/2} (f_d(x', \cdot) + \partial_{\alpha} \Sigma_{\alpha d}^*(x', \cdot)) \right) dx' dz + \int_{\Omega} w_d(x', z) h_d^+(x') dx' dz, \end{aligned}$$

which implies that

$$\Sigma_{dd}^*(x', z) = h_d^+(x') + \int_z^{1/2} (f_d(x', \cdot) + \partial_{\alpha} \Sigma_{\alpha d}^*(x', \cdot)) \quad \text{in } \mathcal{D}'(\Omega).$$

Since $\Sigma_{\alpha d}^* \in L^2\left(\left(-\frac{1}{2}, \frac{1}{2}\right), H^1(\omega)\right)$ for all $1 \leq \alpha \leq d-1$, we deduce that $\Sigma_{dd}^* \in L^2(\Omega)$. This concludes the proof of Lemma 2.23. \square

A consequence of Lemmas 2.22 and 2.23 is the following result.

Lemma 2.24. *Under the same assumptions as in Lemma 2.23, it holds that*

$$\forall v \in V, \quad \int_{\Omega} (\Sigma^{\varepsilon} - \Sigma^*) : e(v) = 0.$$

We emphasize that this result holds without taking the limit $\varepsilon \rightarrow 0$. This is critical, since we will use that equality later on for functions v that depend on ε .

Proof. Let $\varepsilon > 0$ and $v \in V$. Since the space $(\mathcal{C}^{\infty}([-\frac{1}{2}, \frac{1}{2}], \mathcal{D}(\omega)))^d$ is dense in V , there exists a regularization of v , namely $\phi_n \in (\mathcal{C}^{\infty}([-\frac{1}{2}, \frac{1}{2}], \mathcal{D}(\omega)))^d$ such that $\|e^{\varepsilon}(v - \phi_n)\|_{(L^2(\Omega))^{d \times d}} \leq 1/n$ for any $n \in \mathbb{N}^*$.

Then, using Lemma 2.22, it holds that

$$\begin{aligned} \int_{\Omega} \Sigma^{\varepsilon} : e(v) &= \int_{\Omega} \Sigma^{\varepsilon} : e(\phi_n) + \int_{\Omega} \Sigma^{\varepsilon} : e(v - \phi_n) \\ &= \sum_{1 \leq \alpha, \beta \leq d-1} \langle \Sigma_{\alpha\beta}^*, e_{\alpha\beta}(\phi_n) \rangle_{L^2(\Omega)} \\ &\quad + \sum_{1 \leq \alpha \leq d-1} \langle \Sigma_{\alpha d}^*, e_{\alpha d}(\phi_n) \rangle_{L^2\left(\left(-\frac{1}{2}, \frac{1}{2}\right), H^{-1}(\omega)\right), L^2\left(\left(-\frac{1}{2}, \frac{1}{2}\right), H_0^1(\omega)\right)} \\ &\quad + \langle \Sigma_{dd}^*, e_{dd}(\phi_n) \rangle_{L^2\left(\left(-\frac{1}{2}, \frac{1}{2}\right), H^{-2}(\omega)\right), L^2\left(\left(-\frac{1}{2}, \frac{1}{2}\right), H_0^2(\omega)\right)} + \int_{\Omega} \Sigma^{\varepsilon} : e(v - \phi_n). \end{aligned}$$

Using now Lemma 2.23 (and hence the fact that all components of Σ^* belong to $L^2(\Omega)$), we get

$$\begin{aligned} \int_{\Omega} \Sigma^{\varepsilon} : e(v) &= \int_{\Omega} \Sigma^* : e(\phi_n) + \int_{\Omega} \Sigma^{\varepsilon} : e(v - \phi_n) \\ &= \int_{\Omega} \Sigma^* : e(v) + \int_{\Omega} \Sigma^* : e(\phi_n - v) + \int_{\Omega} \Sigma^{\varepsilon} : e(v - \phi_n). \end{aligned} \quad (2.77)$$

Moreover, it holds that

$$\left| \int_{\Omega} \Sigma^{\varepsilon} : e(v - \phi_n) \right| = \left| \int_{\Omega} \sigma^{\varepsilon} : e^{\varepsilon}(v - \phi_n) \right| \leq \frac{1}{n} \|\sigma^{\varepsilon}\|_{(L^2(\Omega))^{d \times d}}$$

and likewise

$$\left| \int_{\Omega} \Sigma^{\star} : e(\phi_n - v) \right| \leq \|\Sigma^{\star}\|_{(L^2(\Omega))^{d \times d}} \|e^{\varepsilon}(v - \phi_n)\|_{(L^2(\Omega))^{d \times d}} \leq \frac{1}{n} \|\Sigma^{\star}\|_{(L^2(\Omega))^{d \times d}}.$$

Thus, letting n go to $+\infty$ in (2.77), we obtain that

$$\int_{\Omega} \Sigma^{\varepsilon} : e(v) = \int_{\Omega} \Sigma^{\star} : e(v).$$

This concludes the proof of Lemma 2.24. \square

We are now in position to state and prove our main result.

Theorem 2.25. *Assume that we are in the bending case (2.51) and that (CB) holds together with assumptions (A1)-(A4). Assume in addition that $f_{\alpha} = 0$ for all $1 \leq \alpha \leq d-1$ and that f_d does not depend on x_d . For all $1 \leq \gamma \leq d-1$, let*

$$u_{\gamma}^{\varepsilon,1} := u_{\gamma}^{\star} + \varepsilon W_{\gamma}^{\alpha\beta} \left(\frac{\cdot}{\varepsilon}, \cdot \right) \partial_{\alpha\beta} (u_d^{\star} + g_d) = -x_d \partial_{\gamma} u_d^{\star} + \varepsilon W_{\gamma}^{\alpha\beta} \left(\frac{\cdot}{\varepsilon}, \cdot \right) \partial_{\alpha\beta} (u_d^{\star} + g_d)$$

and

$$u_d^{\varepsilon,1} := u_d^{\star} + \varepsilon^2 W_d^{\alpha\beta} \left(\frac{\cdot}{\varepsilon}, \cdot \right) \partial_{\alpha\beta} (u_d^{\star} + g_d).$$

We also assume that $u_d^{\star}, g_d \in W^{3,\infty}(\omega)$ and that, for any $1 \leq \alpha, \beta \leq d-1$, we have $W^{\alpha\beta} \in (W^{1,\infty}(\mathbb{R}^{d-1} \times (-\frac{1}{2}, \frac{1}{2})))^d$. Then, there exists a constant $C > 0$ independent of ε and ω such that

$$\begin{aligned} & \|u^{\varepsilon} - u^{\varepsilon,1}\|_{H^{\frac{1}{2}}(\Omega)^d} \leq C \max\left(1, |\omega|^{\frac{1}{d-1}}\right) \max\left(|\omega|^{\frac{1}{d-1}}, \varepsilon^2 |\omega|^{-\frac{1}{d-1}}\right) \\ & \times \left(\sqrt{\varepsilon} |\omega|^{\frac{d-2}{2(d-1)}} \|\nabla^2(u_d^{\star} + g_d)\|_{L^{\infty}(\omega)} + \varepsilon |\omega|^{1/2} \|\nabla^3(u_d^{\star} + g_d)\|_{L^{\infty}(\omega)} + \varepsilon \|\Sigma^{\star}\|_{L^2(\Omega)} \right). \end{aligned}$$

Proof. The proof falls in four steps.

Step 1: Let $\tau_{\varepsilon} \in \mathcal{D}(\omega)$ be such that $0 \leq \tau_{\varepsilon} \leq 1$, and such that $\tau_{\varepsilon}(x') = 1$ for any $x' \in \omega$ such that $\text{dist}(x', \partial\omega) \geq \varepsilon$. Since ω is a regular domain, τ_{ε} can be chosen so that $\varepsilon \|\nabla \tau_{\varepsilon}\|_{L^{\infty}(\omega)} \leq C$ for some positive constant C independent of ε and ω . We define $\omega_{\varepsilon} := \{x' \in \omega \text{ such that } \text{dist}(x', \partial\omega) \geq \varepsilon\}$ and $\Omega_{\varepsilon} := \omega_{\varepsilon} \times (-\frac{1}{2}, \frac{1}{2})$. Note that $|\Omega \setminus \Omega_{\varepsilon}| \leq C\varepsilon |\omega|^{\frac{d-2}{d-1}}$.

For all $1 \leq \gamma \leq d-1$, let

$$\begin{aligned} v_{\gamma}^{\varepsilon,1} &:= u_{\gamma}^{\star} + \varepsilon \tau_{\varepsilon} W_{\gamma}^{\alpha\beta} \left(\frac{\cdot}{\varepsilon}, \cdot \right) \partial_{\alpha\beta} (u_d^{\star} + g_d), \\ v_d^{\varepsilon,1} &:= u_d^{\star} + \varepsilon^2 \tau_{\varepsilon} W_d^{\alpha\beta} \left(\frac{\cdot}{\varepsilon}, \cdot \right) \partial_{\alpha\beta} (u_d^{\star} + g_d). \end{aligned}$$

It then holds that $v^{\varepsilon,1} \in V$. We then compute that $e^{\varepsilon}(u^{\varepsilon,1} - v^{\varepsilon,1}) = E_0^{\varepsilon} + E_1^{\varepsilon} + E_2^{\varepsilon}$ where

$$\begin{aligned} E_0^{\varepsilon} &:= (1 - \tau_{\varepsilon}) e(W^{\alpha\beta}) \left(\frac{\cdot}{\varepsilon}, \cdot \right) \partial_{\alpha\beta} (u_d^{\star} + g_d), \\ E_1^{\varepsilon} &:= \varepsilon \nabla \tau_{\varepsilon} \otimes W^{\alpha\beta} \left(\frac{\cdot}{\varepsilon}, \cdot \right) \partial_{\alpha\beta} (u_d^{\star} + g_d), \\ E_2^{\varepsilon} &:= \varepsilon (1 - \tau_{\varepsilon}) W^{\alpha\beta} \left(\frac{\cdot}{\varepsilon}, \cdot \right) \otimes \nabla (\partial_{\alpha\beta} (u_d^{\star} + g_d)). \end{aligned}$$

Using the fact that $W^{\alpha\beta} \in (W^{1,\infty}(\mathbb{R}^{d-1} \times (-\frac{1}{2}, \frac{1}{2})))^d$, that $u_d^*, g_d \in W^{3,\infty}(\omega)$, that $0 \leq \tau_\varepsilon \leq 1$ and $\varepsilon \|\nabla \tau_\varepsilon\|_{L^\infty} \leq C$, we obtain that

$$\begin{aligned} \|E_0^\varepsilon\|_{L^2(\Omega)}^2 &\leq C|\Omega \setminus \Omega_\varepsilon| \max_{1 \leq \alpha, \beta \leq d-1} \|\nabla W^{\alpha\beta}\|_{L^\infty}^2 \|\nabla^2(u_d^* + g_d)\|_{L^\infty(\omega)}^2 \\ &\leq C\varepsilon|\omega|^{\frac{d-2}{d-1}} \|\nabla^2(u_d^* + g_d)\|_{L^\infty(\omega)}^2, \\ \|E_1^\varepsilon\|_{L^2(\Omega)}^2 &\leq C \max_{1 \leq \alpha, \beta \leq d-1} \|W^{\alpha\beta}\|_{L^\infty}^2 \|\partial_{\alpha\beta}(u_d^* + g_d)\|_{L^\infty(\omega)}^2 |\Omega \setminus \Omega_\varepsilon| \\ &\leq C\varepsilon|\omega|^{\frac{d-1}{d-2}} \|\partial_{\alpha\beta}(u_d^* + g_d)\|_{L^\infty(\omega)}^2, \\ \|E_2^\varepsilon\|_{L^2(\Omega)}^2 &\leq C\varepsilon^2 \max_{1 \leq \alpha, \beta \leq d-1} \|W^{\alpha\beta}\|_{L^\infty}^2 \|\nabla^3(u_d^* + g_d)\|_{L^\infty(\omega)}^2 \\ &\leq C\varepsilon^2|\omega| \|\nabla^3(u_d^* + g_d)\|_{L^\infty(\omega)}^2. \end{aligned}$$

This implies that

$$\|e^\varepsilon(u^{\varepsilon,1} - v^{\varepsilon,1})\|_{L^2(\Omega)}^2 \leq C \left(\varepsilon^2|\omega| \|\nabla^3(u_d^* + g_d)\|_{L^\infty(\omega)}^2 + \varepsilon|\omega|^{\frac{d-2}{d-1}} \|\nabla^2(u_d^* + g_d)\|_{L^\infty(\omega)}^2 \right). \quad (2.78)$$

Step 2: Let $\bar{v}^\varepsilon := u^\varepsilon - v^{\varepsilon,1}$. On the one hand, using the coercivity of A , we have

$$c_- \|e^\varepsilon(\bar{v}^\varepsilon)\|_{L^2(\Omega)}^2 \leq \int_\Omega A^\varepsilon e^\varepsilon(\bar{v}^\varepsilon) : e^\varepsilon(\bar{v}^\varepsilon). \quad (2.79)$$

On the other hand, it holds that

$$\int_\Omega A^\varepsilon e^\varepsilon(\bar{v}^\varepsilon) : e^\varepsilon(\bar{v}^\varepsilon) = T_1 + T_2, \quad (2.80)$$

where

$$T_1 := \int_\Omega A^\varepsilon e^\varepsilon(u^\varepsilon - u^{\varepsilon,1}) : e^\varepsilon(\bar{v}^\varepsilon) \quad \text{and} \quad T_2 := \int_\Omega A^\varepsilon e^\varepsilon(u^{\varepsilon,1} - v^{\varepsilon,1}) : e^\varepsilon(\bar{v}^\varepsilon).$$

Using (2.78), we obtain that

$$|T_2| \leq C \left(\varepsilon|\omega|^{1/2} \|\nabla^3(u_d^* + g_d)\|_{L^\infty(\omega)} + \sqrt{\varepsilon}|\omega|^{\frac{d-2}{2(d-1)}} \|\nabla^2(u_d^* + g_d)\|_{L^\infty(\omega)} \right) \|e^\varepsilon(\bar{v}^\varepsilon)\|_{L^2(\Omega)}. \quad (2.81)$$

We now turn to bounding T_1 . We write

$$T_1 = \int_\Omega A^\varepsilon e^\varepsilon(u^\varepsilon + g) : e^\varepsilon(\bar{v}^\varepsilon) - \int_\Omega A^\varepsilon e^\varepsilon(u^{\varepsilon,1} + g) : e^\varepsilon(\bar{v}^\varepsilon).$$

Let $\tilde{\Sigma}^* := \left(\tilde{\Sigma}_{ij}^* \right)_{1 \leq i, j \leq d}$ be defined by

$$\tilde{\Sigma}_{\alpha\beta}^* = \Sigma_{\alpha\beta}^* \quad \text{for any } 1 \leq \alpha, \beta \leq d-1 \quad \text{and} \quad \tilde{\Sigma}_{id}^* = \tilde{\Sigma}_{di}^* = 0 \quad \text{for any } 1 \leq i \leq d.$$

Moreover, let us introduce

$$R_1^\varepsilon := \int_\Omega A^\varepsilon e^\varepsilon(u^\varepsilon + g) : e^\varepsilon(\bar{v}^\varepsilon) - \int_\Omega \tilde{\Sigma}^* : e^\varepsilon(\bar{v}^\varepsilon) \quad (2.82)$$

and

$$R_2^\varepsilon := \int_\Omega A^\varepsilon e^\varepsilon(u^{\varepsilon,1} + g) : e^\varepsilon(\bar{v}^\varepsilon) - \int_\Omega A^\varepsilon \left(-x_d e_\alpha \otimes e_\beta + e(W^{\alpha\beta}) \left(\frac{\cdot}{\varepsilon}, \cdot \right) \right) \partial_{\alpha\beta}(u_d^* + g_d) : e^\varepsilon(\bar{v}^\varepsilon). \quad (2.83)$$

It then holds that

$$T_1 = R_1^\varepsilon + R_2^\varepsilon + R_3^\varepsilon \quad (2.84)$$

with

$$R_3^\varepsilon = \int_{\Omega} \left[\tilde{\Sigma}^* - A^\varepsilon \left(-x_d e_\alpha \otimes e_\beta + e(W^{\alpha\beta}) \left(\frac{\cdot}{\varepsilon}, \cdot \right) \right) \partial_{\alpha\beta}(u_d^* + g_d) \right] : e^\varepsilon(\bar{v}^\varepsilon).$$

In Step 3, we will show that $R_1^\varepsilon + R_2^\varepsilon = \mathcal{O}(\varepsilon)$ because of the assumptions made on the data. We thus presently estimate R_3^ε .

For all $1 \leq \alpha, \beta \leq d-1$, let us define

$$Z_{\alpha\beta} := \left[e_\gamma \otimes e_\delta : \int_Y A \left(-x_d e_\alpha \otimes e_\beta + e(W^{\alpha\beta}) \right) \right] e_\gamma \otimes e_\delta - A \left(-x_d e_\alpha \otimes e_\beta + e(W^{\alpha\beta}) \right).$$

In view of Conjecture (CB), we have that

$$R_3^\varepsilon = \int_{\Omega} Z_{\alpha\beta} \left(\frac{\cdot}{\varepsilon}, \cdot \right) \partial_{\alpha\beta}(u_d^* + g_d) : e^\varepsilon(\bar{v}^\varepsilon).$$

By the definition of $W^{\alpha\beta}$ and its parity properties, it holds that $Z_{\alpha\beta}$ satisfies the assumptions of Lemma 2.12. In addition, the function $\partial_{\alpha\beta}(u_d^* + g_d)$ belongs to $W^{1,\infty}(\omega)$ and $u^\varepsilon - v^{\varepsilon,1}$ belongs to V . Thus, we obtain that, for all $1 \leq \alpha, \beta \leq d-1$,

$$|R_3^\varepsilon| = \left| \int_{\Omega} Z_{\alpha\beta} \left(\frac{\cdot}{\varepsilon}, \cdot \right) \partial_{\alpha\beta}(u_d^* + g_d) : e^\varepsilon(\bar{v}^\varepsilon) \right| \leq C\varepsilon|\omega|^{1/2} \|\nabla^3(u_d^* + g_d)\|_{L^\infty(\omega)} \|e^\varepsilon(\bar{v}^\varepsilon)\|_{L^2(\Omega)}. \quad (2.85)$$

Step 3: We now show estimates on R_1^ε and R_2^ε respectively defined by (2.82) and (2.83). The bound on R_2^ε comes from the definition of $u^{\varepsilon,1}$. We compute

$$\begin{aligned} |R_2^\varepsilon| &= \left| \int_{\Omega} A^\varepsilon \left[e^\varepsilon(u^{\varepsilon,1} + g) - \left(-x_d e_\alpha \otimes e_\beta + e(W^{\alpha\beta}) \left(\frac{\cdot}{\varepsilon}, \cdot \right) \right) \partial_{\alpha\beta}(u_d^* + g_d) \right] : e^\varepsilon(\bar{v}^\varepsilon) \right| \\ &= \left| \int_{\Omega} A^\varepsilon \left[\frac{\varepsilon}{2} \left[W^{\alpha\beta} \left(\frac{\cdot}{\varepsilon}, \cdot \right) \otimes \nabla(\partial_{\alpha\beta}(u_d^* + g_d)) + \nabla(\partial_{\alpha\beta}(u_d^* + g_d)) \otimes W^{\alpha\beta} \left(\frac{\cdot}{\varepsilon}, \cdot \right) \right] \right] : e^\varepsilon(\bar{v}^\varepsilon) \right| \\ &\leq C\varepsilon \|\nabla^3(u_d^* + g_d)\|_{L^2(\omega)} \|e^\varepsilon(\bar{v}^\varepsilon)\|_{L^2(\Omega)} \\ &\leq C\varepsilon|\omega|^{1/2} \|\nabla^3(u_d^* + g_d)\|_{L^\infty(\omega)} \|e^\varepsilon(\bar{v}^\varepsilon)\|_{L^2(\Omega)}. \end{aligned}$$

Let us now bound R_1^ε . To this aim, we use the same notation as in Lemmas 2.22, 2.23 and 2.24. Since the function \bar{v}^ε belongs to V , using Lemma 2.24, we obtain that

$$\int_{\Omega} A^\varepsilon e^\varepsilon(u^\varepsilon + g) : e^\varepsilon(\bar{v}^\varepsilon) = \int_{\Omega} \Sigma^\varepsilon : e(\bar{v}^\varepsilon) = \int_{\Omega} \Sigma^* : e(\bar{v}^\varepsilon).$$

Moreover, we easily deduce of the definition of $\tilde{\Sigma}^*$ that

$$\begin{aligned} \left| \int_{\Omega} \Sigma^* : e(\bar{v}^\varepsilon) - \int_{\Omega} \tilde{\Sigma}^* : e^\varepsilon(\bar{v}^\varepsilon) \right| &= \left| \int_{\Omega} \Sigma_{\alpha d}^* e_{\alpha d}(\bar{v}^\varepsilon) + \int_{\Omega} \Sigma_{dd}^* e_{dd}(\bar{v}^\varepsilon) \right| \\ &= \left| \varepsilon \int_{\Omega} \Sigma_{\alpha d}^* e_{\alpha d}^\varepsilon(\bar{v}^\varepsilon) + \varepsilon^2 \int_{\Omega} \Sigma_{dd}^* e_{dd}^\varepsilon(\bar{v}^\varepsilon) \right| \\ &\leq C\varepsilon \|\Sigma^*\|_{L^2(\Omega)} \|e^\varepsilon(\bar{v}^\varepsilon)\|_{L^2(\Omega)}. \end{aligned}$$

As a consequence, we obtain that

$$\begin{aligned}
|R_1^\varepsilon| &= \left| \int_{\Omega} \left(\tilde{\Sigma}^* - A^\varepsilon e^\varepsilon(u^\varepsilon + g) \right) : e^\varepsilon(\bar{v}^\varepsilon) \right| \\
&= \left| \int_{\Omega} \left(\tilde{\Sigma}^* - \Sigma^\varepsilon \right) : e^\varepsilon(\bar{v}^\varepsilon) \right| \\
&= \left| \int_{\Omega} \left(\tilde{\Sigma}^* - \Sigma^* \right) : e^\varepsilon(\bar{v}^\varepsilon) \right| \\
&\leq C\varepsilon \|\Sigma^*\|_{L^2(\Omega)} \|e^\varepsilon(\bar{v}^\varepsilon)\|_{L^2(\Omega)}.
\end{aligned}$$

We thus deduce that

$$|R_1^\varepsilon| + |R_2^\varepsilon| \leq C\varepsilon \left(|\omega|^{1/2} \|\nabla^3(u_d^* + g_d)\|_{L^\infty(\omega)} + \|\Sigma^*\|_{L^2(\Omega)} \right) \|e^\varepsilon(\bar{v}^\varepsilon)\|_{L^2(\Omega)}.$$

Collecting (2.79), (2.80), (2.81), (2.84), (2.85) and the above bound, we obtain

$$\begin{aligned}
\|e^\varepsilon(\bar{v}^\varepsilon)\|_{L^2(\Omega)} &\leq C \left(\sqrt{\varepsilon} |\omega|^{\frac{d-2}{2(d-1)}} \|\nabla^2(u_d^* + g_d)\|_{L^\infty(\omega)} \right. \\
&\quad \left. + \varepsilon |\omega|^{1/2} \|\nabla^3(u_d^* + g_d)\|_{L^\infty(\omega)} + \varepsilon \|\Sigma^*\|_{L^2(\Omega)} \right). \quad (2.86)
\end{aligned}$$

Step 4: Collecting (2.86) and (2.78), we obtain that

$$\begin{aligned}
&\|e^\varepsilon(u^\varepsilon - u^{\varepsilon,1})\|_{L^2(\Omega)} \\
&\leq \|e^\varepsilon(u^\varepsilon - v^{\varepsilon,1})\|_{L^2(\Omega)} + \|e^\varepsilon(u^{\varepsilon,1} - v^{\varepsilon,1})\|_{L^2(\Omega)} \\
&\leq C \left(\sqrt{\varepsilon} |\omega|^{\frac{d-2}{2(d-1)}} \|\nabla^2(u_d^* + g_d)\|_{L^\infty(\omega)} + \varepsilon |\omega|^{1/2} \|\nabla^3(u_d^* + g_d)\|_{L^\infty(\omega)} + \varepsilon \|\Sigma^*\|_{L^2(\Omega)} \right).
\end{aligned}$$

To conclude the proof, we make use of the Poincaré inequality stated in Lemma 2.16 to finally obtain

$$\begin{aligned}
&\|u^\varepsilon - u^{\varepsilon,1}\|_{H_\varepsilon^1(\Omega)} \leq C \max \left(1, |\omega|^{\frac{1}{d-1}} \right) \max \left(|\omega|^{\frac{1}{d-1}}, \varepsilon^2 |\omega|^{-\frac{1}{d-1}} \right) \\
&\times \left(\sqrt{\varepsilon} |\omega|^{\frac{d-2}{2(d-1)}} \|\nabla^2(u_d^* + g_d)\|_{L^\infty(\omega)} + \varepsilon |\omega|^{1/2} \|\nabla^3(u_d^* + g_d)\|_{L^\infty(\omega)} + \varepsilon \|\Sigma^*\|_{L^2(\Omega)} \right).
\end{aligned}$$

This concludes the proof of Theorem 2.25. \square

2.3.6 Evidence supporting Conjecture (CB)

The aim of this section is to present theoretical and numerical evidence supporting Conjecture (CB).

Theoretical evidence

We have pointed out above that Conjecture (CB) implies the identity (2.75) for the quantity $m(x_d \Sigma_{\alpha\beta}^*)$. It turns out that we are able to directly prove (2.75), as shown in Lemma 2.26 below. We also recall that, using the symmetries of the bending case, $\Sigma_{\alpha\beta}^*$ is known to be an odd function with respect to the d^{th} variable, and thus

$$\forall p \in \mathbb{N}, \quad m(x_d^{2p} \Sigma_{\alpha\beta}^*) = 0.$$

Lemma 2.26. *Assume that we are in the bending case, that (A1)-(A4) are satisfied, and that $W^{\alpha\beta} \in [W^{1,\infty}(\mathbb{R}^{d-1} \times (-\frac{1}{2}, \frac{1}{2}))]^d$. Assume in addition that $f_\alpha = 0$ for all $1 \leq \alpha \leq d-1$ and that f_d does not depend on x_d . Then, it holds that*

$$m(x_d \Sigma_{\alpha\beta}^*) = m\left(x_d e_\alpha \otimes e_\beta : \left[\int_Y A(e(W^{\gamma\delta}) - x_d e_\gamma \otimes e_\delta) \right] \partial_{\gamma\delta}(u_d^* + g_d)\right).$$

To prove this result, we follow a strategy inspired by the proof of homogenization using the celebrated div-curl lemma.

Proof. Since u_d^* and g_d do not depend on x_d , we first observe that the above right-hand side reads as

$$\begin{aligned} m\left(x_d e_\alpha \otimes e_\beta : \left[\int_Y A(e(W^{\gamma\delta}) - x_d e_\gamma \otimes e_\delta) \right] \partial_{\gamma\delta}(u_d^* + g_d)\right) \\ = \partial_{\gamma\delta}(u_d^* + g_d) \int_Y (x_d e_\alpha \otimes e_\beta : A(e(W^{\gamma\delta}) - x_d e_\gamma \otimes e_\delta)). \end{aligned}$$

Let p be a $d \times d$ matrix such that $p_{id} = p_{di} = 0$ for any $1 \leq i \leq d$ and let $W \in \mathcal{W}(\mathcal{Y})$ be the unique solution to the corrector problem

$$\forall v \in \mathcal{W}(\mathcal{Y}), \quad \int_Y A(e(W) - x_d p) : e(v) = 0.$$

The matrix p is a linear combination of the matrices $e_\alpha \otimes e_\beta$ (for $1 \leq \alpha, \beta \leq d-1$), and W is likewise a linear combination of the correctors $W^{\alpha\beta}$ solution to (2.41).

For all $y \in \mathcal{Y}$ and $x \in \Omega$, we define

$$T(y) = A(y)(e(W)(y) - y_d p) \quad \text{and} \quad T^\varepsilon(x) = T\left(\frac{x'}{\varepsilon}, x_d\right).$$

For any symmetric matrix $M \in \mathbb{R}^{d \times d}$, let

$$\xi^\varepsilon(M) := \begin{pmatrix} M' & \varepsilon^{-1} M_{\alpha d} \\ \varepsilon^{-1} M_{\alpha d} & \varepsilon^{-2} M_{dd} \end{pmatrix}.$$

Note that for any symmetric matrix $M \in \mathbb{R}^{d \times d}$ and any function $v \in H^1(\Omega)$, it holds that

$$M : e^\varepsilon(v) = \xi^\varepsilon(M) : e(v). \quad (2.87)$$

We recall (see (2.60)) that $\sigma^\varepsilon = A^\varepsilon e^\varepsilon(u^\varepsilon + g)$. The matrix Σ^ε defined by (2.62) satisfies $\Sigma^\varepsilon = \xi^\varepsilon(\sigma^\varepsilon)$ and we denote by $S^\varepsilon := \xi^\varepsilon(T^\varepsilon)$.

For all $x \in \Omega$, we define $\nu(x) := x^T p x / 2$. We then of course have $\nabla^2 \nu = p$. Introduce $v^\varepsilon := (v_i^\varepsilon)_{1 \leq i \leq d}$ defined by

$$\begin{aligned} v_\alpha^\varepsilon(x) &= \varepsilon W_\alpha\left(\frac{x'}{\varepsilon}, x_d\right) - x_d \partial_\alpha \nu(x) \quad \text{for all } 1 \leq \alpha \leq d-1, \\ v_d^\varepsilon(x) &= \varepsilon^2 W_d\left(\frac{x'}{\varepsilon}, x_d\right) + \nu(x). \end{aligned}$$

By construction, we have

$$e^\varepsilon(v^\varepsilon)(x) = e(W)\left(\frac{x'}{\varepsilon}, x_d\right) - x_d p.$$

Then, by definition, it holds that

$$\sigma^\varepsilon : e^\varepsilon(v^\varepsilon) = A^\varepsilon e^\varepsilon(u^\varepsilon + g) : \left[e(W) \left(\frac{x'}{\varepsilon}, x_d \right) - x_d p \right] = T^\varepsilon : e^\varepsilon(u^\varepsilon + g). \quad (2.88)$$

The sequel of the proof falls in two steps, and follows the lines of the classical proof of homogenization using the div-curl lemma. In Step 1, we identify the limit of the left-most term in the above relation (2.88). This is not simple, since both terms only weakly converge. But we are going to use that (up to some scaling) the second factor $e^\varepsilon(v^\varepsilon)$ is a symmetrized gradient, while the first factor σ^ε is divergence-free (thanks to the equation satisfied by u^ε). In Step 2, we identify the limit of the right-most term in the above relation (2.88), using again the fact that it is a product of a symmetrized gradient by a divergence-free factor (thanks to the corrector equation). The fact that the two limits are equal then yields the claimed result.

Step 1: Let $\phi \in \mathcal{D}(\omega)$. Using (2.87), we write

$$\int_{\Omega} \sigma^\varepsilon : e^\varepsilon(v^\varepsilon) \phi = \int_{\Omega} \Sigma^\varepsilon : e(v^\varepsilon) \phi = - \int_{\Omega} \Sigma^\varepsilon \nabla \phi \cdot v^\varepsilon - \int_{\Omega} \operatorname{div} \Sigma^\varepsilon \cdot v^\varepsilon \phi.$$

The boundary term in the above integration by part vanishes because ϕ vanishes on ω and because of the Neumann boundary conditions satisfied by Σ^ε on Γ^\pm . The function ϕ being independent of x_d , this leads to

$$\int_{\Omega} \sigma^\varepsilon : e^\varepsilon(v^\varepsilon) \phi = - \int_{\Omega} \sigma_{\alpha\beta}^\varepsilon \partial_\alpha \phi v_\beta^\varepsilon - \varepsilon^{-1} \int_{\Omega} \sigma_{\alpha d}^\varepsilon \partial_\alpha \phi v_d^\varepsilon - \int_{\Omega} \operatorname{div} \Sigma^\varepsilon \cdot v^\varepsilon \phi. \quad (2.89)$$

We are going to successively pass to the limit $\varepsilon \rightarrow 0$ in the three terms of the right-hand side of (2.89). Using the equation satisfied by u^ε and the assumption that $f_\alpha = 0$ for any $1 \leq \alpha \leq d-1$, we obtain for the third term that

$$- \int_{\Omega} \operatorname{div} \Sigma^\varepsilon \cdot v^\varepsilon \phi = \int_{\Omega} f \cdot v^\varepsilon \phi \xrightarrow{\varepsilon \rightarrow 0} \int_{\omega} f_d \nu \phi. \quad (2.90)$$

For the first term of (2.89), we know that, for all $1 \leq \alpha, \beta \leq d-1$, $(\sigma_{\alpha\beta}^\varepsilon)_{\varepsilon > 0}$ weakly converges in $L^2(\Omega)$ to $\Sigma_{\alpha\beta}^*$ and that $(v_\beta^\varepsilon)_{\varepsilon > 0}$ strongly converges in $L^2(\Omega)$ to $-x_d \partial_\beta \nu$. This implies that

$$- \int_{\Omega} \sigma_{\alpha\beta}^\varepsilon \partial_\alpha \phi v_\beta^\varepsilon \xrightarrow{\varepsilon \rightarrow 0} \int_{\Omega} \Sigma_{\alpha\beta}^* \partial_\alpha \phi x_d \partial_\beta \nu.$$

Using next an integration by part, we deduce that

$$\begin{aligned} \lim_{\varepsilon \rightarrow 0} - \int_{\Omega} \sigma_{\alpha\beta}^\varepsilon \partial_\alpha \phi v_\beta^\varepsilon &= - \int_{\Omega} \phi \partial_\alpha \Sigma_{\alpha\beta}^* x_d \partial_\beta \nu - \int_{\Omega} \phi \Sigma_{\alpha\beta}^* x_d \partial_\alpha \nu \\ &= - \int_{\omega} \mathfrak{m}(x_d \partial_\alpha \Sigma_{\alpha\beta}^*) \partial_\beta \nu \phi + \int_{\omega} \mathfrak{m}(-x_d \Sigma^*) : p \phi. \end{aligned} \quad (2.91)$$

We eventually turn to the second term of (2.89). By definition of v_d^ε and Σ^ε , it holds that

$$\begin{aligned} -\varepsilon^{-1} \int_{\Omega} \sigma_{\alpha d}^\varepsilon \partial_\alpha \phi v_d^\varepsilon &= -\varepsilon^{-1} \int_{\Omega} \sigma_{\alpha d}^\varepsilon \partial_\alpha \phi \nu - \varepsilon \int_{\Omega} \sigma_{\alpha d}^\varepsilon \partial_\alpha \phi W_d \left(\frac{x'}{\varepsilon}, x_d \right) \\ &= - \int_{\Omega} \Sigma_{\alpha d}^\varepsilon \partial_\alpha \phi \nu - \varepsilon \int_{\Omega} \sigma_{\alpha d}^\varepsilon \partial_\alpha \phi W_d \left(\frac{x'}{\varepsilon}, x_d \right). \end{aligned} \quad (2.92)$$

Since the function W_d is in $L^\infty(\mathcal{Y})$, we obtain that

$$\varepsilon \int_{\Omega} \sigma_{\alpha d}^\varepsilon \partial_\alpha \phi W_d \left(\frac{x'}{\varepsilon}, x_d \right) \xrightarrow{\varepsilon \rightarrow 0} 0. \quad (2.93)$$

In addition, the sequence $(\Sigma_{\alpha d}^\varepsilon)_{\varepsilon > 0}$ weakly converges in $L^2\left(\left(-\frac{1}{2}, \frac{1}{2}\right), H^{-1}(\omega)\right)$ to $\Sigma_{\alpha d}^*$. This yields that

$$\begin{aligned} \lim_{\varepsilon \rightarrow 0} - \int_{\Omega} \Sigma_{\alpha d}^\varepsilon \partial_\alpha \phi \nu &= - \langle \Sigma_{\alpha d}^*, \partial_\alpha \phi \nu \rangle_{L^2\left(\left(-\frac{1}{2}, \frac{1}{2}\right), H^{-1}(\omega)\right), L^2\left(\left(-\frac{1}{2}, \frac{1}{2}\right), H_0^1(\omega)\right)} \\ &= \langle \partial_\alpha \Sigma_{\alpha d}^*, \nu \phi \rangle_{L^2\left(\left(-\frac{1}{2}, \frac{1}{2}\right), H^{-2}(\omega)\right), L^2\left(\left(-\frac{1}{2}, \frac{1}{2}\right), H_0^2(\omega)\right)} \\ &\quad + \langle \Sigma_{\alpha d}^*, \partial_\alpha \nu \phi \rangle_{L^2\left(\left(-\frac{1}{2}, \frac{1}{2}\right), H^{-1}(\omega)\right), L^2\left(\left(-\frac{1}{2}, \frac{1}{2}\right), H_0^1(\omega)\right)} \\ &= \langle \mathfrak{m}(\partial_\alpha \Sigma_{\alpha d}^*), \nu \phi \rangle_{\mathcal{D}'(\omega), \mathcal{D}(\omega)} + \langle \mathfrak{m}(\Sigma_{\alpha d}^*), \partial_\alpha \nu \phi \rangle_{\mathcal{D}'(\omega), \mathcal{D}(\omega)}. \end{aligned} \quad (2.94)$$

Collecting (2.89), (2.90), (2.91), (2.92), (2.93) and (2.94), we have thus shown that, in the sense of distributions,

$$\mathfrak{m}(\sigma^\varepsilon : e^\varepsilon(v^\varepsilon)) \xrightarrow{\varepsilon \rightarrow 0} \mathfrak{m}(-x_d \Sigma^*) : p - \mathfrak{m}(\Sigma_{\alpha d}^* - x_d \partial_\beta \Sigma_{\alpha \beta}^*) \partial_\alpha \nu + \mathfrak{m}(\partial_\alpha \Sigma_{\alpha d}^* + f_d) \nu. \quad (2.95)$$

Let us now prove that $\mathfrak{m}(\Sigma_{\alpha d}^* - x_d \partial_\beta \Sigma_{\alpha \beta}^*) \partial_\alpha \nu$ and $\mathfrak{m}(\partial_\alpha \Sigma_{\alpha d}^* + f_d) \nu$ actually vanish. Since we know that $\operatorname{div} \Sigma^\varepsilon + f = 0$ in $\mathcal{D}'(\Omega)$, and that $\Sigma^\varepsilon \xrightarrow{\varepsilon \rightarrow 0} \Sigma^*$ in $\mathcal{D}'(\Omega)$, we obtain that $\operatorname{div} \Sigma^* + f = 0$. Then,

$$\begin{aligned} - \langle \mathfrak{m}(\partial_\alpha \Sigma_{\alpha d}^* + f_d), \nu \phi \rangle_{\mathcal{D}'(\omega), \mathcal{D}(\omega)} &= \langle \mathfrak{m}(\partial_d \Sigma_{\alpha d}^*), \nu \phi \rangle_{\mathcal{D}'(\omega), \mathcal{D}(\omega)} \quad [\text{since } \partial_i \Sigma_{di}^* + f_d = 0] \\ &= 0 \end{aligned}$$

because of the Neumann boundary conditions satisfied by Σ^* on Γ^\pm (which is reminiscent of that satisfied by Σ^ε). Similarly, since $f_\alpha = 0$ for all $1 \leq \alpha \leq d-1$, we write

$$\begin{aligned} - \langle \mathfrak{m}(\Sigma_{\alpha d}^* - x_d \partial_\alpha \Sigma_{\alpha \beta}^*), \partial_\beta \nu \phi \rangle_{\mathcal{D}'(\omega), \mathcal{D}(\omega)} &= - \langle \mathfrak{m}(\Sigma_{\alpha d}^* + x_d \partial_d \Sigma_{\alpha d}^*), \partial_\alpha \nu \phi \rangle_{\mathcal{D}'(\omega), \mathcal{D}(\omega)} \\ &= - \langle \mathfrak{m}(\partial_d(x_d \Sigma_{\alpha d}^*)), \partial_\alpha \nu \phi \rangle_{\mathcal{D}'(\omega), \mathcal{D}(\omega)} \\ &= 0. \end{aligned}$$

We thus deduce from (2.95) that, for any $\phi \in \mathcal{D}(\omega)$,

$$\int_{\Omega} \sigma^\varepsilon : e^\varepsilon(v^\varepsilon) \phi \xrightarrow{\varepsilon \rightarrow 0} \langle \mathfrak{m}(-x_d \Sigma^*) : p, \phi \rangle_{\mathcal{D}'(\omega), \mathcal{D}(\omega)}. \quad (2.96)$$

Step 2: We now study the convergence of $T^\varepsilon : e^\varepsilon(u^\varepsilon + g)$. Considering again some $\phi \in \mathcal{D}(\omega)$ (a function which, in particular, is independent of x_d), we have

$$\int_{\Omega} T^\varepsilon : e^\varepsilon(u^\varepsilon + g) \phi = \int_{\Omega} T^* : e^\varepsilon(u^\varepsilon + g) \phi + \int_{\Omega} (T^\varepsilon - T^*) : e^\varepsilon(u^\varepsilon + g) \phi, \quad (2.97)$$

where $T^*(x_d) := \int_Y T(y', x_d) dy'$ for all $x_d \in (-1/2, 1/2)$. We note that, because of the definition of the corrector W , we have $T^* e_d = 0$ and $e_d^T T^* = 0$. We know that u^ε weakly converges to u^* in $(H^1(\Omega))^d$, hence $e_{\alpha \beta}(u^\varepsilon + g)$ weakly converges in $L^2(\Omega)$ to

$e_{\alpha\beta}(u^* + g) = -x_d \partial_{\alpha\beta}(u_d^* + g_d)$, the last relation stemming from the fact that u^* and g belong to \mathcal{V}_{KL}^B . We hence obtain, for the first term of (2.97), that

$$\begin{aligned} \int_{\Omega} T^* : e^\varepsilon(u^\varepsilon + g)\phi &= \int_{\Omega} (T^*)' : e'(u^\varepsilon + g)\phi \\ &\xrightarrow{\varepsilon \rightarrow 0} \int_{\Omega} (T^*)' : (-x_d \nabla^2(u_d^* + g_d))\phi = \int_{\omega} m(-x_d(T^*)') : \nabla^2(u_d^* + g_d)\phi. \end{aligned} \quad (2.98)$$

We now prove that the second term of (2.97) tends to 0 as ε goes to 0. By definition of W , we know that

- $\operatorname{div}(T - T^*) = 0$,
- $\int_Y (T - T^*) = 0$,
- for any y_d in $\left(-\frac{1}{2}, \frac{1}{2}\right)$, the function $y' \mapsto (T - T^*)(y', y_d)$ is Y -periodic,
- $(T - T^*) \cdot e_d = 0$ on $Y \times \{\pm \frac{1}{2}\}$.

As a consequence, using Lemma 2.12, we obtain that

$$\left| \int_{\Omega} (T^\varepsilon - T^*) : e^\varepsilon(u^\varepsilon + g)\phi \right| \leq C\varepsilon \|\nabla\phi\|_{L^\infty(\omega)} \|e^\varepsilon(u^\varepsilon + g)\|_{L^2(\Omega)} \xrightarrow{\varepsilon \rightarrow 0} 0. \quad (2.99)$$

Collecting (2.97), (2.98) and (2.99), we deduce that

$$\int_{\Omega} T^\varepsilon : e^\varepsilon(u^\varepsilon + g)\phi \xrightarrow{\varepsilon \rightarrow 0} \int_{\omega} m(-x_d(T^*)') : \nabla^2(u_d^* + g_d)\phi. \quad (2.100)$$

Conclusion: Collecting (2.88), (2.96) and (2.100), we infer that

$$m(-x_d \Sigma^*) : p = m(-x_d(T^*)') : \nabla^2(u_d^* + g_d),$$

which yields the claimed result, since the matrix p is arbitrary (among $d \times d$ matrices such that $p_{id} = p_{di} = 0$). This concludes the proof of Lemma 2.26. \square

In view of this result, it is tempting to try to prove that, for all $p \in \mathbb{N}^*$,

$$m(-x_d^{2p+1} \Sigma_{\alpha\beta}^*) = m\left(-x_d^{2p+1} e_\alpha \otimes e_\beta : \left[\int_Y A(e(W^{\gamma\delta}) - x_d e_\gamma \otimes e_\delta) \right] \partial_{\gamma\delta} u_d^*\right).$$

Since a result would fully prove Conjecture (CB). Unfortunately, this appears to be a delicate task, which we did not yet achieve.

Numerical evidence

We now present some numerical evidence for Conjecture (CB). More precisely, we consider here the case when $g = 0$, and we show numerical results consistent with the fact that, under the assumptions of Theorem 2.25,

$$\|e^\varepsilon(u^\varepsilon) - e^\varepsilon(u^{\varepsilon,1})\|_{(L^2(\Omega))^{d \times d}} \xrightarrow{\varepsilon \rightarrow 0} 0. \quad (2.101)$$

If (2.101) holds true, then the proof of the conjecture (in the case $g = 0$) is straightforward. Indeed, we have

$$\sigma^\varepsilon = A^\varepsilon e^\varepsilon(u^\varepsilon) = A^\varepsilon e^\varepsilon(u^{\varepsilon,1}) + A^\varepsilon e^\varepsilon(u^\varepsilon - u^{\varepsilon,1})$$

with

$$A^\varepsilon e^\varepsilon(u^{\varepsilon,1}) \xrightarrow{\varepsilon \rightarrow 0} \left[\int_Y A(e(W^{\alpha\beta} - x_d e_\alpha \otimes e_\beta)) \right] \partial_{\alpha\beta} u_d^* \quad \text{weakly in } L^2(\Omega)^{d \times d}$$

and $A^\varepsilon e^\varepsilon(u^\varepsilon - u^{\varepsilon,1}) \xrightarrow{\varepsilon \rightarrow 0} 0$ strongly in $L^2(\Omega)^{d \times d}$. We therefore have

$$\sigma^\varepsilon \xrightarrow{\varepsilon \rightarrow 0} \left[\int_Y A(e(W^{\alpha\beta} - x_d e_\alpha \otimes e_\beta)) \right] \partial_{\alpha\beta} u_d^* \quad \text{weakly in } L^2(\Omega)^{d \times d},$$

which is exactly our conjecture (2.74).

We now present numerical tests illustrating (2.101), which have been performed using FreeFem++ [49]. We consider a problem in dimension $d = 2$, for which $\omega = (0, 1)$. The periodic elasticity tensor is defined by

$$\forall 1 \leq i, j, k, l \leq 2, \quad \forall y \in \mathcal{Y}, \quad A_{ijkl}(y) := \lambda(y) \delta_{ij} \delta_{kl} + \mu(y) (\delta_{ik} \delta_{jl} + \delta_{il} \delta_{jk}),$$

where

$$\lambda(y) := \frac{\nu E(y)}{(1 + \nu)(1 - 2\nu)} \quad \text{and} \quad \mu(y) := \frac{E(y)}{2(1 + \nu)},$$

with

$$E(y) = 4.5 \sin(2\pi y) + 5.5 \quad \text{and} \quad \nu = 0.3.$$

As mentioned above, we consider the case $g = 0$, and set $f = -e_2$ and $h_\pm = 0$.

The reference variational formulation (2.35) is discretized using a \mathbb{P}_1 finite element method with a triangular mesh where the typical diameter of each element is of the order of $h = 1/400$. We can only consider values of ε of the order of (or larger than) h , otherwise the reference problem is not accurately solved. The corrector equation (2.41) is solved on a triangular mesh whose typical size is H . The homogenized equation (2.43), which is posed on the one-dimensional domain ω , is solved by a finite difference scheme on a grid of size H . Of course, these two discretizations introduce some error related to the choice of H .

The obtained results are shown on Figure 2.4. We indeed observe that $\|e^\varepsilon(u^\varepsilon) - e^\varepsilon(u^{\varepsilon,1})\|_{(L^2(\Omega))^{d \times d}}$ decreases when ε decreases, until some plateau seems to be reached. When H takes smaller values, this plateau seems to be reached for smaller values of ε (and corresponds to a smaller value of the error), a behavior which is consistent with the fact that this plateau is reminiscent of a discretisation error related to H .

2.A H_{div} space

We recall here some results about the H_{div} space. Let $\Omega \subset \mathbb{R}^d$ be a bounded regular subdomain of \mathbb{R}^d . We define the space

$$H_{\text{div}}(\Omega) := \{v \in (L^2(\Omega))^d, \text{div } v \in L^2(\Omega)\},$$

which is a Hilbert space for the scalar product

$$\forall v, w \in H_{\text{div}}(\Omega), \quad \langle v, w \rangle = \int_\Omega v \cdot w + \int_\Omega (\text{div } v) (\text{div } w).$$

The space $(C^\infty(\overline{\Omega}))^d$ is dense in $H_{\text{div}}(\Omega)$. Let us consider the normal trace application

$$\gamma_\nu : \begin{cases} (C^\infty(\overline{\Omega}))^d & \rightarrow H^{-1/2}(\partial\Omega) \\ v & \mapsto (v \cdot \nu)|_{\partial\Omega} \end{cases},$$

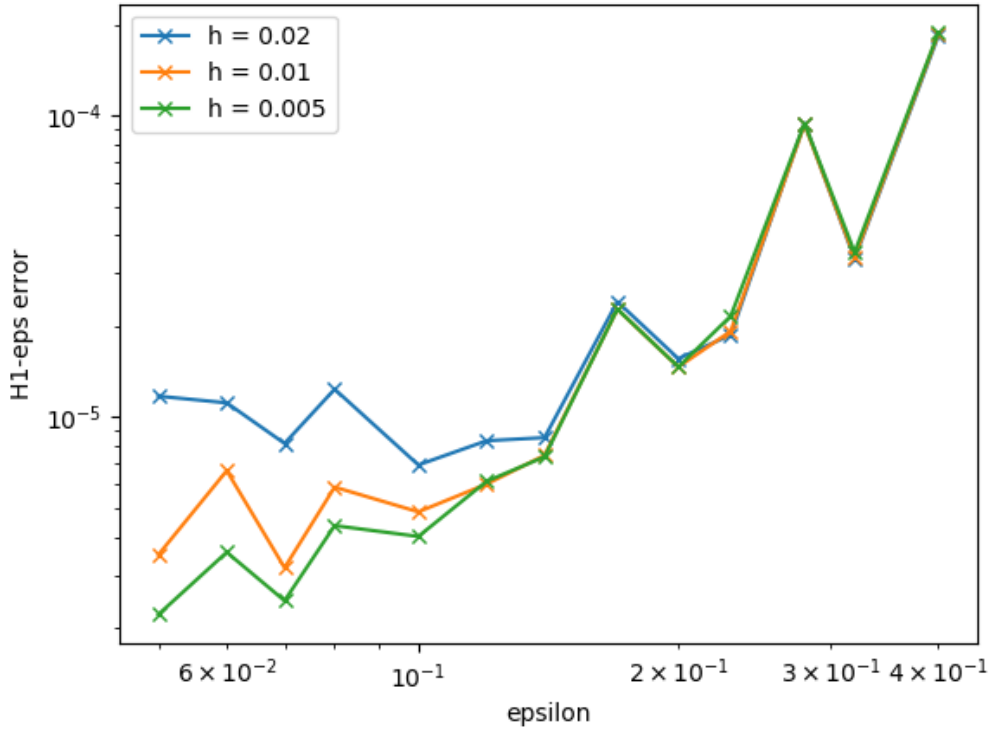

Figure 2.4: $\|e^\varepsilon(u^\varepsilon) - e^\varepsilon(u^{\varepsilon,1})\|_{(L^2(\Omega))^{d \times d}}$ as a function of ε , for different values of H .

where ν denotes the unit exterior normal vector to $\partial\Omega$. The application γ_ν can be uniquely extended as a continuous application from $H_{\text{div}}(\Omega)$ to $H^{-1/2}(\partial\Omega)$, and the following Stokes formula holds:

$$\forall v \in H_{\text{div}}(\Omega), \quad \forall w \in H^1(\Omega), \quad \int_{\Omega} v \cdot \nabla w + \int_{\Omega} w \operatorname{div} v = \langle \gamma_\nu(v), \gamma_0(w) \rangle_{H^{-1/2}(\partial\Omega), H^{1/2}(\partial\Omega)},$$

where γ_0 denotes the trace application from $H^1(\Omega)$ to $H^{1/2}(\partial\Omega)$.

2.B Korn inequalities

For the sake of completeness, we provide here a proof of the Korn inequality we have stated in (2.36). We start by recalling a well-known result:

Lemma 2.27 (Korn's inequality in H^1 , see [22]). *Let $\Omega \subset \mathbb{R}^d$ be a bounded regular domain. Then, there exists a constant $C(\Omega) > 0$ such that, for any $u \in (H^1(\Omega))^d$, we have*

$$\|u\|_{(H^1(\Omega))^d}^2 \leq C(\Omega) \left(\|u\|_{(L^2(\Omega))^d}^2 + \|e(u)\|_{(L^2(\Omega))^{d \times d}}^2 \right).$$

In the specific case of functions which vanish at the boundary, we have the following result.

Lemma 2.28 (Korn's inequality in H_0^1 , see [22]). *Let $\Omega \subset \mathbb{R}^d$ be a regular domain. For any $u \in (H_0^1(\Omega))^d$, we have*

$$\|\nabla u\|_{(L^2(\Omega))^{d \times d}} \leq \sqrt{2} \|e(u)\|_{(L^2(\Omega))^{d \times d}}.$$

In this work, we need a slightly modified version of Lemma 2.28, since we work in V and not in $(H_0^1(\Omega))^d$.

Lemma 2.29. *Let V be given by (2.33). Then, there exists a constant C such that*

$$\forall u \in V, \quad \|u\|_{(H^1(\Omega))^d} \leq C \|e(u)\|_{(L^2(\Omega))^{d \times d}}. \quad (2.102)$$

Proof. We argue by contradiction and assume that (2.102) does not hold. Then, for all $n \in \mathbb{N}^*$, there exists $u_n \in V$ such that

$$\|u_n\|_{(H^1(\Omega))^d} = 1, \quad \|e(u_n)\|_{(L^2(\Omega))^{d \times d}} \leq \frac{1}{n} \|u_n\|_{(H^1(\Omega))^d}. \quad (2.103)$$

Since u_n is bounded in $(H^1(\Omega))^d$, there exists $u \in (H^1(\Omega))^d$ such that, up to the extraction of a subsequence, $u_n \rightharpoonup u$ weakly in $(H^1(\Omega))^d$. Thus, $u_n \xrightarrow[n \rightarrow +\infty]{} u$ strongly in $(L^2(\Omega))^d$ and $e(u_n) \rightharpoonup e(u)$ weakly in $(L^2(\Omega))^{d \times d}$. The estimate (2.103) yields that $\|e(u_n)\|_{(L^2(\Omega))^{d \times d}} \xrightarrow[n \rightarrow +\infty]{} 0$, which implies that $e(u) = 0$ and thus that u is a rigid displacement. In addition, $u \in V$, and therefore $u = 0$. Using Lemma 2.27, we also deduce from (2.103) that

$$\|u_n\|_{(L^2(\Omega))^d}^2 \geq \frac{1}{C(\Omega)} - \frac{1}{n^2}.$$

Passing to the limit $n \rightarrow \infty$ and using the fact that u_n strongly converges to u in $(L^2(\Omega))^d$, we obtain that $\|u\|_{(L^2(\Omega))^d}^2 \geq 1/C(\Omega)$, which provides a contradiction with the fact that $u = 0$. \square

2.C Proofs of the homogenization results

In this section, for the sake of completeness, we provide a proof of Theorem 2.4, resp. Theorem 2.11. Note that these results were proved in [17], resp. [18]. We will use below the following well-known lemma.

Lemma 2.30. *Let B a function in $L_{\text{loc}}^2\left(\mathbb{R}^{d-1} \times \left(-\frac{1}{2}, \frac{1}{2}\right)\right)$ such that, for any $z \in \left(-\frac{1}{2}, \frac{1}{2}\right)$, the function $B(\cdot, z)$ is Y -periodic. Then, for any $z \in \left(-\frac{1}{2}, \frac{1}{2}\right)$ and any $\omega \subset \mathbb{R}^{d-1}$,*

$$B\left(\frac{\cdot}{\varepsilon}, z\right) \xrightarrow[\varepsilon \rightarrow 0]{} \frac{1}{|Y|} \int_Y B(y', z) dy' \quad \text{weakly in } L^2(\omega).$$

2.C.1 Proof of Theorem 2.4

To identify the homogenized problem, we use the oscillating test function method. Let $\phi \in \mathcal{D}(\omega)$ and $v(x) := \phi(x') + \varepsilon w^\alpha\left(\frac{x'}{\varepsilon}, x_d\right) \partial_\alpha \phi(x')$. By definition, $v \in V$ and it is thus an admissible test function in (2.8). We note that $\nabla^\varepsilon v = \nabla \phi + \nabla w^\alpha\left(\frac{\cdot}{\varepsilon}, \cdot\right) \partial_\alpha \phi + \varepsilon w^\alpha\left(\frac{\cdot}{\varepsilon}, \cdot\right) \nabla \partial_\alpha \phi$. Using this function v as test function in (2.8), we get

$$c^\varepsilon(u^\varepsilon, \phi) + r^\varepsilon(u^\varepsilon, \phi) = d^\varepsilon(\phi) + s^\varepsilon(\phi), \quad (2.104)$$

where

$$\begin{aligned} c^\varepsilon(u^\varepsilon, \phi) &:= \int_{\Omega} A^\varepsilon \nabla^\varepsilon u^\varepsilon \cdot \left(\nabla w^\alpha \left(\frac{\cdot}{\varepsilon}, \cdot \right) + e_\alpha \right) \partial_\alpha \phi, \\ r^\varepsilon(u^\varepsilon, \phi) &:= \varepsilon \int_{\Omega} w^\alpha \left(\frac{\cdot}{\varepsilon}, \cdot \right) A^\varepsilon \nabla^\varepsilon u^\varepsilon \cdot \nabla \partial_\alpha \phi, \\ d^\varepsilon(\phi) &:= b^\varepsilon(\phi) - \int_{\Omega} A^\varepsilon \nabla^\varepsilon g \cdot \nabla w^\alpha \left(\frac{\cdot}{\varepsilon}, \cdot \right) \partial_\alpha \phi, \\ s^\varepsilon(\phi) &:= \varepsilon \int_{\Omega} f w^\alpha \left(\frac{\cdot}{\varepsilon}, \cdot \right) \partial_\alpha \phi - \varepsilon \int_{\Omega} w^\alpha \left(\frac{\cdot}{\varepsilon}, \cdot \right) A^\varepsilon \nabla^\varepsilon g \cdot \nabla \partial_\alpha \phi + \varepsilon \int_{\Gamma^\pm} h_\pm w^\alpha \partial_\alpha \phi. \end{aligned}$$

The following limits are immediate in view of (2.11) (which states that $\|\nabla^\varepsilon u^\varepsilon\|_{L^2(\Omega)}$ is bounded) and of the fact that $\nabla^\varepsilon g = \nabla g$ (because g does not depend on x_d):

$$r^\varepsilon(u^\varepsilon, \phi) \xrightarrow{\varepsilon \rightarrow 0} 0 \quad \text{and} \quad s^\varepsilon(\phi) \xrightarrow{\varepsilon \rightarrow 0} 0.$$

Let us now identify the limit of $c^\varepsilon(u^\varepsilon, \phi)$. Using the Rellich theorem, it holds that, up to the extraction of a subsequence, $(u^\varepsilon)_{\varepsilon > 0}$ converges strongly in $L^2(\Omega)$ to u^* . Besides, since $\|\nabla^\varepsilon u^\varepsilon\|_{L^2(\Omega)}$ is bounded, we have that $\|\varepsilon^{-1} \partial_d u^\varepsilon\|_{L^2(\Omega)}$ is bounded, and therefore $\partial_d u^* = 0$. Since $u^* \in V$, we thus get that $u^* \in H_0^1(\omega)$. Using an integration by parts, and the fact that $\phi \in \mathcal{D}(\omega)$, we obtain that

$$\begin{aligned} c^\varepsilon(u^\varepsilon, \phi) &= \int_{\Omega} A^\varepsilon \nabla^\varepsilon u^\varepsilon \cdot \left(\nabla w^\alpha \left(\frac{\cdot}{\varepsilon}, \cdot \right) + e_\alpha \right) \partial_\alpha \phi \\ &= \int_{\Omega} \nabla^\varepsilon u^\varepsilon \cdot A^\varepsilon \left(\nabla w^\alpha \left(\frac{\cdot}{\varepsilon}, \cdot \right) + e_\alpha \right) \partial_\alpha \phi \quad [\text{since } A \text{ is symmetric}] \\ &= - \int_{\Omega} u^\varepsilon \operatorname{div}^\varepsilon \left[A^\varepsilon \left(\nabla w^\alpha \left(\frac{\cdot}{\varepsilon}, \cdot \right) + e_\alpha \right) \partial_\alpha \phi \right] + \frac{1}{\varepsilon} \int_{\Gamma^\pm} u^\varepsilon \left[A^\varepsilon \left(\nabla w^\alpha \left(\frac{\cdot}{\varepsilon}, \cdot \right) + e_\alpha \right) \partial_\alpha \phi \right] \cdot e_d \\ &= - \int_{\Omega} u^\varepsilon A^\varepsilon \left(\nabla w^\alpha \left(\frac{\cdot}{\varepsilon}, \cdot \right) + e_\alpha \right) \cdot \partial_\alpha \nabla \phi \quad [\text{by definition of } w^\alpha]. \end{aligned}$$

Thanks to Lemma 2.30 and the strong convergence of $(u^\varepsilon)_{\varepsilon > 0}$ to u^* in $L^2(\Omega)$, we deduce that

$$c^\varepsilon(u^\varepsilon, \phi) \xrightarrow{\varepsilon \rightarrow 0} c^*(u^*, \phi) := - \int_{\Omega} u^* \left[\int_Y A(y', \cdot) \left(\nabla w^\alpha(y', \cdot) + e_\alpha \right) dy' \right] \cdot \partial_\alpha \nabla \phi.$$

Using that $u^*, \phi \in H_0^1(\omega)$ yields that

$$\begin{aligned} c^*(u^*, \phi) &= - \int_{\omega} u^* \left[\int_Y A(\nabla w^\alpha + e_\alpha) \right] \cdot \partial_\alpha \nabla \phi \quad [u^* \text{ and } \phi \text{ ind. of } x_d] \\ &= \int_{\omega} \left[\int_Y A(\nabla w^\alpha + e_\alpha) \right] \partial_\alpha u^* \cdot \nabla \phi \\ &= \int_{\omega} A^* \nabla' u^* \cdot \nabla' \phi. \end{aligned}$$

The last equality stems from the fact that

$$A_{\alpha\beta}^* = \int_Y A(\nabla w^\alpha + e_\alpha) \cdot e_\beta = \int_Y A(\nabla w^\alpha + e_\alpha) \cdot (\nabla w^\beta + e_\beta).$$

We next turn to the term $d^\varepsilon(\phi)$. Using again Lemma 2.30 and similar arguments as above, it holds that

$$\begin{aligned} \lim_{\varepsilon \rightarrow 0} d^\varepsilon(\phi) &= \int_{\omega} (m(f) + h_\pm) \phi - \int_{\omega} \left[\int_Y A(\nabla w^\alpha + e_\alpha) \right] \partial_\alpha g \cdot \nabla \phi \\ &= \int_{\omega} (m(f) + h_\pm) \phi - \int_{\omega} A^* \nabla' g \cdot \nabla' \phi. \end{aligned}$$

The coercivity of A^* can be obtained by standard arguments. This proves that the homogenized problem is well-posed, and hence u^* is uniquely defined. The whole sequence u^ε (and not only a subsequence) therefore converges to u^* . This concludes the proof of Theorem 2.4.

2.C.2 Proof of Theorem 2.11

We begin by showing that u^* belongs to \mathcal{V}_{KL} . We recall (2.37), which states that $\|e^\varepsilon(u^\varepsilon)\|_{(L^2(\Omega))^{d \times d}}$ is bounded. This implies that $\|\varepsilon^{-2} \partial_d u_d^\varepsilon\|_{L^2(\Omega)} \leq C$. The function u^ε converges to u^* weakly in $(H^1(\Omega))^d$, therefore $\partial_d u_d^* = 0$.

From the bound on $\|e^\varepsilon(u^\varepsilon)\|_{(L^2(\Omega))^{d \times d}}$, we also get that $\|\partial_d u_\alpha^\varepsilon + \partial_\alpha u_d^\varepsilon\|_{L^2(\Omega)} \leq C\varepsilon$. Using again that u^ε converges to u^* weakly in $(H^1(\Omega))^d$, we deduce that $\partial_d u_\alpha^* + \partial_\alpha u_d^* = 0$. Since $\partial_d u_d^* = 0$, there exists some \tilde{u}^* in $(H^1(\omega))^d$ such that $u_\alpha^* = \tilde{u}_\alpha^* - x_d \partial_\alpha \tilde{u}_d^*$ and $u_d^* = \tilde{u}_d^*$.

The function u^ε belongs to V and converges to u^* weakly in $(H^1(\Omega))^d$. We thus obtain that $m(u^\varepsilon) \in H_0^1(\omega)^d$ and $m(u^\varepsilon) \xrightarrow{\varepsilon \rightarrow 0} m(u^*) = \tilde{u}^*$ weakly in $(H^1(\omega))^d$. We hence have $\tilde{u}^* \in H_0^1(\omega)^d$. Since $x_d \nabla \tilde{u}_d^* = \tilde{u}^* - u^*$, we have $\nabla \tilde{u}_d^* = 0$ on $\partial\omega \times (-\frac{1}{2}, \frac{1}{2})$ and $\nabla \tilde{u}_d^* \in (H_0^1(\omega))^d$. We have shown previously that $\tilde{u}_d^* \in H_0^1(\omega)$, and thus $u_d^* \in H_0^2(\omega)$. We hence have that $u^* \in \mathcal{V}_{KL}$. As for any element of \mathcal{V}_{KL} , we can associate to u^* a function $\hat{u}^* \in (H_0^1(\omega))^{d-1} \times H_0^2(\omega)$, and this element turns out to be $\hat{u}^* = \tilde{u}^*$.

To identify the homogenized limit of (2.35), we make use of the oscillating test function method. Let $\hat{\phi} \in (\mathcal{D}(\omega))^d$. By defining ϕ as $\phi_\alpha = \hat{\phi}_\alpha - x_d \partial_\alpha \hat{\phi}_d$ and $\phi_d = \hat{\phi}_d$, we get that $\phi \in \mathcal{V}_{KL}$. Let us define, for all $1 \leq \gamma \leq d-1$,

$$\begin{aligned} v_\gamma &:= \phi_\gamma + \varepsilon \left[w_\gamma^{\alpha\beta} \left(\frac{\cdot}{\varepsilon}, \cdot \right) e_{\alpha\beta}(\hat{\phi}) + W_\gamma^{\alpha\beta} \left(\frac{\cdot}{\varepsilon}, \cdot \right) \partial_{\alpha\beta} \hat{\phi}_d \right], \\ v_d &:= \phi_d + \varepsilon^2 \left[w_d^{\alpha\beta} \left(\frac{\cdot}{\varepsilon}, \cdot \right) e_{\alpha\beta}(\hat{\phi}) + W_d^{\alpha\beta} \left(\frac{\cdot}{\varepsilon}, \cdot \right) \partial_{\alpha\beta} \hat{\phi}_d \right]. \end{aligned}$$

By definition, v belongs to V and is thus an admissible test function in (2.35). We note that

$$e^\varepsilon(v) = \left[e_\alpha \otimes e_\beta + e(w^{\alpha\beta}) \left(\frac{\cdot}{\varepsilon}, \cdot \right) \right] e_{\alpha\beta}(\hat{\phi}) + \left[-x_d e_\alpha \otimes e_\beta + e(W^{\alpha\beta}) \left(\frac{\cdot}{\varepsilon}, \cdot \right) \right] \partial_{\alpha\beta} \hat{\phi}_d + \varepsilon R^\varepsilon,$$

where $\|R^\varepsilon\|_{(L^2(\Omega))^{d \times d}} \leq C$. Using v as a test function in (2.35), we get

$$c^\varepsilon(u^\varepsilon, \phi) + r^\varepsilon(u^\varepsilon, \phi) = d^\varepsilon(\phi) + s^\varepsilon(\phi), \quad (2.105)$$

where

$$\begin{aligned} c^\varepsilon(u^\varepsilon, \phi) &:= \int_\Omega A^\varepsilon e^\varepsilon(u^\varepsilon) : \left(\left[e_\alpha \otimes e_\beta + e(w^{\alpha\beta}) \left(\frac{\cdot}{\varepsilon}, \cdot \right) \right] e_{\alpha\beta}(\hat{\phi}) + \left[-x_d e_\alpha \otimes e_\beta + e(W^{\alpha\beta}) \left(\frac{\cdot}{\varepsilon}, \cdot \right) \right] \partial_{\alpha\beta} \hat{\phi}_d \right), \\ r^\varepsilon(u^\varepsilon, \phi) &:= \varepsilon \int_\Omega A^\varepsilon e^\varepsilon(u^\varepsilon) : R^\varepsilon, \end{aligned}$$

$$\begin{aligned} d^\varepsilon(\phi) &:= \int_\Omega f \cdot \phi + \int_\omega h_\pm \cdot \phi \left(\cdot, \pm \frac{1}{2} \right) \\ &- \int_\Omega A^\varepsilon e^\varepsilon(g) : \left(\left[e_\alpha \otimes e_\beta + e(w^{\alpha\beta}) \left(\frac{\cdot}{\varepsilon}, \cdot \right) \right] e_{\alpha\beta}(\hat{\phi}) + \left[-x_d e_\alpha \otimes e_\beta + e(W^{\alpha\beta}) \left(\frac{\cdot}{\varepsilon}, \cdot \right) \right] \partial_{\alpha\beta} \hat{\phi}_d \right) \end{aligned}$$

and

$$\begin{aligned}
s^\varepsilon(\phi) &:= \varepsilon \int_{\Omega} f_\gamma \left[w_\gamma^{\alpha\beta} \left(\frac{\cdot}{\varepsilon}, \cdot \right) e_{\alpha\beta}(\widehat{\phi}) + W_\gamma^{\alpha\beta} \left(\frac{\cdot}{\varepsilon}, \cdot \right) \partial_{\alpha\beta} \widehat{\phi}_d \right] \\
&\quad + \varepsilon^2 \int_{\Omega} f_d \left[w_d^{\alpha\beta} \left(\frac{\cdot}{\varepsilon}, \cdot \right) e_{\alpha\beta}(\widehat{\phi}) + W_d^{\alpha\beta} \left(\frac{\cdot}{\varepsilon}, \cdot \right) \partial_{\alpha\beta} \widehat{\phi}_d \right] \\
&\quad + \varepsilon \int_{\Gamma_\pm} (h_\pm)_\gamma \left[w_\gamma^{\alpha\beta} \left(\frac{\cdot}{\varepsilon}, \cdot \right) e_{\alpha\beta}(\widehat{\phi}) + W_\gamma^{\alpha\beta} \left(\frac{\cdot}{\varepsilon}, \cdot \right) \partial_{\alpha\beta} \widehat{\phi}_d \right] \\
&\quad + \varepsilon^2 \int_{\Gamma_\pm} (h_\pm)_d \left[w_d^{\alpha\beta} \left(\frac{\cdot}{\varepsilon}, \cdot \right) e_{\alpha\beta}(\widehat{\phi}) + W_d^{\alpha\beta} \left(\frac{\cdot}{\varepsilon}, \cdot \right) \partial_{\alpha\beta} \widehat{\phi}_d \right] \\
&\quad - \varepsilon \int_{\Omega} A^\varepsilon e^\varepsilon(g) : R^\varepsilon.
\end{aligned}$$

The following limits are immediate in view of (2.37):

$$r^\varepsilon(u^\varepsilon, \phi) \xrightarrow{\varepsilon \rightarrow 0} 0 \quad \text{and} \quad s^\varepsilon(\phi) \xrightarrow{\varepsilon \rightarrow 0} 0.$$

We now identify the limit of $c^\varepsilon(u^\varepsilon, \phi)$. Using the Rellich theorem, $(u^\varepsilon)_{\varepsilon > 0}$ converges strongly to u^* in $(L^2(\Omega))^d$. Since A is symmetric in the sense that $A_{ijkl} = A_{klij}$, we compute

$$\begin{aligned}
c^\varepsilon(u^\varepsilon, \phi) &= \int_{\Omega} A^\varepsilon e^\varepsilon(u^\varepsilon) : \left(\left[e_\alpha \otimes e_\beta + e(w^{\alpha\beta}) \left(\frac{\cdot}{\varepsilon}, \cdot \right) \right] e_{\alpha\beta}(\widehat{\phi}) + \left[-x_d e_\alpha \otimes e_\beta + e(W^{\alpha\beta}) \left(\frac{\cdot}{\varepsilon}, \cdot \right) \right] \partial_{\alpha\beta} \widehat{\phi}_d \right) \\
&= \int_{\Omega} e^\varepsilon(u^\varepsilon) : A^\varepsilon \left(\left[e_\alpha \otimes e_\beta + e(w^{\alpha\beta}) \left(\frac{\cdot}{\varepsilon}, \cdot \right) \right] e_{\alpha\beta}(\widehat{\phi}) + \left[-x_d e_\alpha \otimes e_\beta + e(W^{\alpha\beta}) \left(\frac{\cdot}{\varepsilon}, \cdot \right) \right] \partial_{\alpha\beta} \widehat{\phi}_d \right).
\end{aligned}$$

Using an integration by parts and the fact that $\widehat{\phi} \in (\mathcal{D}(\omega))^d$, we obtain

$$\begin{aligned}
c^\varepsilon(u^\varepsilon, \phi) &= - \int_{\Omega} u^\varepsilon \cdot \operatorname{div}^\varepsilon \left[A^\varepsilon \left(\left[e_\alpha \otimes e_\beta + e(w^{\alpha\beta}) \left(\frac{\cdot}{\varepsilon}, \cdot \right) \right] e_{\alpha\beta}(\widehat{\phi}) + \left[-x_d e_\alpha \otimes e_\beta + e(W^{\alpha\beta}) \left(\frac{\cdot}{\varepsilon}, \cdot \right) \right] \partial_{\alpha\beta} \widehat{\phi}_d \right) \right] \\
&\quad + \int_{\partial\omega \times (-\frac{1}{2}, \frac{1}{2})} u^\varepsilon n \cdot A^\varepsilon \left(\left[e_\alpha \otimes e_\beta + e(w^{\alpha\beta}) \left(\frac{\cdot}{\varepsilon}, \cdot \right) \right] e_{\alpha\beta}(\widehat{\phi}) + \left[-x_d e_\alpha \otimes e_\beta + e(W^{\alpha\beta}) \left(\frac{\cdot}{\varepsilon}, \cdot \right) \right] \partial_{\alpha\beta} \widehat{\phi}_d \right) \\
&\quad + \int_{\Gamma^+} u^\varepsilon e_d \cdot A^\varepsilon \left(\left[e_\alpha \otimes e_\beta + e(w^{\alpha\beta}) \left(\frac{\cdot}{\varepsilon}, \cdot \right) \right] e_{\alpha\beta}(\widehat{\phi}) + \left[-x_d e_\alpha \otimes e_\beta + e(W^{\alpha\beta}) \left(\frac{\cdot}{\varepsilon}, \cdot \right) \right] \partial_{\alpha\beta} \widehat{\phi}_d \right) \\
&\quad - \int_{\Gamma^-} u^\varepsilon e_d \cdot A^\varepsilon \left(\left[e_\alpha \otimes e_\beta + e(w^{\alpha\beta}) \left(\frac{\cdot}{\varepsilon}, \cdot \right) \right] e_{\alpha\beta}(\widehat{\phi}) + \left[-x_d e_\alpha \otimes e_\beta + e(W^{\alpha\beta}) \left(\frac{\cdot}{\varepsilon}, \cdot \right) \right] \partial_{\alpha\beta} \widehat{\phi}_d \right).
\end{aligned}$$

Since $\widehat{\phi} \in (\mathcal{D}(\omega))^d$, it holds that

$$\begin{aligned}
&\int_{\partial\omega \times (-\frac{1}{2}, \frac{1}{2})} u^\varepsilon n \cdot A^\varepsilon \left(\left[e_\alpha \otimes e_\beta + e(w^{\alpha\beta}) \left(\frac{\cdot}{\varepsilon}, \cdot \right) \right] e_{\alpha\beta}(\widehat{\phi}) + \left[-x_d e_\alpha \otimes e_\beta + e(W^{\alpha\beta}) \left(\frac{\cdot}{\varepsilon}, \cdot \right) \right] \partial_{\alpha\beta} \widehat{\phi}_d \right) \\
&= 0.
\end{aligned}$$

Besides, since for all $1 \leq \alpha, \beta \leq d-1$ we have

$$A(e(w^{\alpha\beta}) + e_\alpha \otimes e_\beta) \cdot e_d = A(e(W^{\alpha\beta}) - x_d e_\alpha \otimes e_\beta) \cdot e_d = 0 \text{ on } \mathcal{Y}^\pm,$$

we obtain that

$$e_d \cdot A^\varepsilon \left(\left[e_\alpha \otimes e_\beta + e(w^{\alpha\beta}) \left(\frac{\cdot}{\varepsilon}, \cdot \right) \right] e_{\alpha\beta}(\widehat{\phi}) + \left[-x_d e_\alpha \otimes e_\beta + e(W^{\alpha\beta}) \left(\frac{\cdot}{\varepsilon}, \cdot \right) \right] \partial_{\alpha\beta} \widehat{\phi}_d \right) = 0 \text{ on } \Gamma^\pm$$

where we recall that $\Gamma^\pm = \omega \times \left\{ \pm \frac{1}{2} \right\}$. We thus obtain that

$$\begin{aligned} & c^\varepsilon(u^\varepsilon, \phi) \\ &= - \int_{\Omega} u^\varepsilon \cdot \operatorname{div}^\varepsilon \left[A^\varepsilon \left(\left[e_\alpha \otimes e_\beta + e(w^{\alpha\beta}) \left(\frac{\cdot}{\varepsilon}, \cdot \right) \right] e_{\alpha\beta}(\widehat{\phi}) + \left[-x_d e_\alpha \otimes e_\beta + e(W^{\alpha\beta}) \left(\frac{\cdot}{\varepsilon}, \cdot \right) \right] \partial_{\alpha\beta} \widehat{\phi}_d \right) \right] \\ &= - \int_{\Omega} u^\varepsilon \cdot A^\varepsilon \left(\left[e_\alpha \otimes e_\beta + e(w^{\alpha\beta}) \left(\frac{\cdot}{\varepsilon}, \cdot \right) \right] \nabla e_{\alpha\beta}(\widehat{\phi}) + \left[-x_d e_\alpha \otimes e_\beta + e(W^{\alpha\beta}) \left(\frac{\cdot}{\varepsilon}, \cdot \right) \right] \nabla \partial_{\alpha\beta} \widehat{\phi}_d \right) \end{aligned}$$

where we have used the definitions of $w^{\alpha\beta}$ and $W^{\alpha\beta}$.

Using Lemma 2.30 and the fact that u^ε converges strongly to u^* in $(L^2(\Omega))^d$, we deduce that

$$c^\varepsilon(u^\varepsilon, \phi) \xrightarrow{\varepsilon \rightarrow 0} c^*(u^*, \phi)$$

with

$$\begin{aligned} -c^*(u^*, \phi) &= \int_{\Omega} u^* \cdot \left[\left\{ \int_Y A(\cdot, x_d) (e_\alpha \otimes e_\beta + e(w^{\alpha\beta})(\cdot, x_d)) \right\} \nabla e_{\alpha\beta}(\widehat{\phi}) \right. \\ &\quad \left. + \left\{ \int_Y A(\cdot, x_d) (-x_d e_\alpha \otimes e_\beta + e(W^{\alpha\beta})(\cdot, x_d)) \right\} \nabla \partial_{\alpha\beta} \widehat{\phi}_d \right]. \end{aligned}$$

We have shown that $u^* = \widehat{u}^* - x_d \nabla \widehat{u}_d^*$ with \widehat{u}^* independent of x_d . Using that $\widehat{\phi}$ is also independent of x_d , we deduce that

$$\begin{aligned} -c^*(u^*, \phi) &= \int_{\Omega} (\widehat{u}^* - x_d \nabla \widehat{u}_d^*) \cdot \left[\left\{ \int_Y A(\cdot, x_d) (e_\alpha \otimes e_\beta + e(w^{\alpha\beta})(\cdot, x_d)) \right\} \nabla e_{\alpha\beta}(\widehat{\phi}) \right. \\ &\quad \left. + \left\{ \int_Y A(\cdot, x_d) (-x_d e_\alpha \otimes e_\beta + e(W^{\alpha\beta})(\cdot, x_d)) \right\} \nabla \partial_{\alpha\beta} \widehat{\phi}_d \right] \\ &= \int_{\omega} (\widehat{u}^*)_\gamma \left[(k_{11}^*)_{\alpha\beta\gamma\delta} \partial_\delta e_{\alpha\beta}(\widehat{\phi}) + (k_{12}^*)_{\alpha\beta\gamma\delta} \partial_\delta \partial_{\alpha\beta} \widehat{\phi}_d \right] \\ &\quad - \partial_\gamma \widehat{u}_d^* \left[(k_{21}^*)_{\alpha\beta\gamma\delta} \partial_\delta e_{\alpha\beta}(\widehat{\phi}) + (k_{22}^*)_{\alpha\beta\gamma\delta} \partial_\delta \partial_{\alpha\beta} \widehat{\phi}_d \right] \\ &\quad + \int_{\omega} (\widehat{u}^*)_d \left[(k_{11}^*)_{\alpha\beta d\delta} \partial_\delta e_{\alpha\beta}(\widehat{\phi}) + (k_{12}^*)_{\alpha\beta d\delta} \partial_\delta \partial_{\alpha\beta} \widehat{\phi}_d \right] \end{aligned} \tag{2.106}$$

with

$$\begin{aligned} (k_{11}^*)_{\alpha\beta\gamma\delta} &:= \int_{\mathcal{Y}} e_\gamma^T \left\{ A(e(w_{\alpha\beta}) + e_\alpha \otimes e_\beta) \right\} e_\delta, \\ (k_{12}^*)_{\alpha\beta\gamma\delta} &:= \int_{\mathcal{Y}} e_\gamma^T \left\{ A(e(W_{\alpha\beta}) - x_d e_\alpha \otimes e_\beta) \right\} e_\delta, \\ (k_{22}^*)_{\alpha\beta\gamma\delta} &:= \int_{\mathcal{Y}} e_\gamma^T \left\{ A(e(W_{\alpha\beta}) - x_d e_\alpha \otimes e_\beta) \right\} x_d e_\delta, \\ (k_{21}^*)_{\alpha\beta\gamma\delta} &:= \int_{\mathcal{Y}} e_\gamma^T \left\{ A(e(w_{\alpha\beta}) + e_\alpha \otimes e_\beta) \right\} x_d e_\delta \end{aligned}$$

and likewise when γ is replaced by d .

Using (2.40), we now see (using that $w_{\gamma\delta} \in \mathcal{W}(\mathcal{Y})$) that

$$(K_{11}^*)_{\alpha\beta\gamma\delta} = \int_{\mathcal{Y}} A(e(w_{\alpha\beta}) + e_\alpha \otimes e_\beta) : e_\gamma \otimes e_\delta = (k_{11}^*)_{\alpha\beta\gamma\delta}$$

and (using that $W_{\gamma\delta} \in \mathcal{W}(\mathcal{Y})$) that

$$(K_{12}^*)_{\alpha\beta\gamma\delta} = - \int_{\mathcal{Y}} x_d A(e(w_{\alpha\beta}) + e_\alpha \otimes e_\beta) : e_\gamma \otimes e_\delta = -(k_{21}^*)_{\alpha\beta\gamma\delta}.$$

Similarly, we deduce from (2.41) (using that $W_{\gamma\delta} \in \mathcal{W}(\mathcal{Y})$) that

$$(K_{22}^*)_{\alpha\beta\gamma\delta} = - \int_{\mathcal{Y}} x_d A(e(W_{\alpha\beta}) - x_d e_\alpha \otimes e_\beta) : e_\gamma \otimes e_\delta = -(k_{22}^*)_{\alpha\beta\gamma\delta}.$$

Using that A is symmetric (i.e. $A_{ijkl} = A_{klij}$), we also write that

$$\begin{aligned} (K_{12}^*)_{\alpha\beta\gamma\delta} &= \int_{\mathcal{Y}} A(e(W_{\gamma\delta}) - x_d e_\gamma \otimes e_\delta) : (e(w_{\alpha\beta}) + e_\alpha \otimes e_\beta) \\ &= \int_{\mathcal{Y}} A(e(W_{\gamma\delta}) - x_d e_\gamma \otimes e_\delta) : e_\alpha \otimes e_\beta \\ &= (k_{12}^*)_{\gamma\delta\alpha\beta}. \end{aligned}$$

We also claim that, for any $1 \leq \alpha, \beta, \delta \leq d-1$, we have

$$(k_{11}^*)_{\alpha\beta d\delta} = (k_{12}^*)_{\alpha\beta d\delta} = 0. \quad (2.107)$$

Indeed, since $X : \mathbb{R}^d \ni x \mapsto x_d e_\delta$ is an admissible test function in (2.40), we can write

$$\begin{aligned} 0 &= \int_{\mathcal{Y}} A(e(w^{\alpha\beta}) + e_\alpha \otimes e_\beta) : e(X) \\ &= \frac{1}{2} \int_{\mathcal{Y}} A(e(w^{\alpha\beta}) + e_\alpha \otimes e_\beta) : (e_\delta \otimes e_d + e_d \otimes e_\delta) \\ &= \int_{\mathcal{Y}} A(e(w^{\alpha\beta}) + e_\alpha \otimes e_\beta) : e_d \otimes e_\delta \quad [A \text{ is symmetric: } A_{ijkl} = A_{jikl}] \\ &= \int_{\mathcal{Y}} e_d^T \left\{ A(e(w_{\alpha\beta}) + e_\alpha \otimes e_\beta) \right\} e_\delta \\ &= (k_{11}^*)_{\alpha\beta d\delta}. \end{aligned}$$

Likewise, since X is also an admissible test function in (2.41), we can write

$$\begin{aligned} 0 &= \int_{\mathcal{Y}} A(e(W^{\alpha\beta}) - x_d e_\alpha \otimes e_\beta) : e(X) \\ &= \frac{1}{2} \int_{\mathcal{Y}} A(e(W^{\alpha\beta}) - x_d e_\alpha \otimes e_\beta) : (e_\delta \otimes e_d + e_d \otimes e_\delta) \\ &= \int_{\mathcal{Y}} A(e(W^{\alpha\beta}) - x_d e_\alpha \otimes e_\beta) : e_d \otimes e_\delta \quad [A \text{ is symmetric: } A_{ijkl} = A_{jikl}] \\ &= \int_{\mathcal{Y}} e_d^T \left\{ A(e(W_{\alpha\beta}) - x_d e_\alpha \otimes e_\beta) \right\} e_\delta \\ &= (k_{12}^*)_{\alpha\beta d\delta}. \end{aligned}$$

This hence proves (2.107).

We thus infer from (2.106) that

$$\begin{aligned} -c^*(u^*, \phi) &= \int_{\omega} (\widehat{u}^*)_\gamma \left[(K_{11}^*)_{\alpha\beta\gamma\delta} \partial_\delta e_{\alpha\beta}(\widehat{\phi}) + (K_{12}^*)_{\gamma\delta\alpha\beta} \partial_\delta \partial_{\alpha\beta} \widehat{\phi}_d \right] \\ &\quad + \partial_\gamma \widehat{u}_d^* \left[(K_{12}^*)_{\alpha\beta\gamma\delta} \partial_\delta e_{\alpha\beta}(\widehat{\phi}) + (K_{22}^*)_{\alpha\beta\gamma\delta} \partial_\delta \partial_{\alpha\beta} \widehat{\phi}_d \right]. \end{aligned}$$

Using the symmetry properties of K_{11}^* and K_{22}^* (i.e. $(K_{11}^*)_{\alpha\beta\gamma\delta} = (K_{11}^*)_{\gamma\delta\alpha\beta}$), we recast the above as

$$\begin{aligned} -c^*(u^*, \phi) &= \int_{\omega} (\widehat{u}^*)_{\gamma} \left[(K_{11}^*)_{\gamma\delta\alpha\beta} \partial_{\delta} e_{\alpha\beta}(\widehat{\phi}) + (K_{12}^*)_{\gamma\delta\alpha\beta} \partial_{\delta} \partial_{\alpha\beta} \widehat{\phi}_d \right] \\ &\quad + \partial_{\gamma} \widehat{u}_d^* \left[((K_{12}^*)^T)_{\gamma\delta\alpha\beta} \partial_{\delta} e_{\alpha\beta}(\widehat{\phi}) + (K_{22}^*)_{\gamma\delta\alpha\beta} \partial_{\delta} \partial_{\alpha\beta} \widehat{\phi}_d \right]. \end{aligned} \quad (2.108)$$

We next note that, by simple tensor algebra,

$$\begin{aligned} (\widehat{u}^*)' \cdot (K_{11}^* : e_{\alpha} \otimes e_{\beta}) \nabla' e_{\alpha\beta}(\widehat{\phi}) &= (\widehat{u}^*)_{\gamma} (K_{11}^* : e_{\alpha} \otimes e_{\beta})_{\gamma\delta} \partial_{\delta} e_{\alpha\beta}(\widehat{\phi}) \\ &= (\widehat{u}^*)_{\gamma} (K_{11}^*)_{\gamma\delta\alpha\beta} \partial_{\delta} e_{\alpha\beta}(\widehat{\phi}). \end{aligned}$$

We thus deduce from (2.108) that

$$\begin{aligned} -c^*(u^*, \phi) &= \int_{\omega} (\widehat{u}^*)' \cdot \left[(K_{11}^* : e_{\alpha} \otimes e_{\beta}) \nabla' e_{\alpha\beta}(\widehat{\phi}) + (K_{12}^* : e_{\alpha} \otimes e_{\beta}) \nabla' \partial_{\alpha\beta} \widehat{\phi}_d \right] \\ &\quad + \nabla' \widehat{u}_d^* \cdot \left[((K_{12}^*)^T : e_{\alpha} \otimes e_{\beta}) \nabla' e_{\alpha\beta}(\widehat{\phi}) + (K_{22}^* : e_{\alpha} \otimes e_{\beta}) \nabla' \partial_{\alpha\beta} \widehat{\phi}_d \right]. \end{aligned}$$

Using an integration by parts and the symmetry of the matrix $K_{11}^* : e_{\alpha} \otimes e_{\beta}$, we compute

$$\begin{aligned} c^*(u^*, \phi) &= \int_{\omega} e_{\alpha\beta}(\widehat{\phi}) \left[(K_{11}^* : e_{\alpha} \otimes e_{\beta}) : \nabla'(\widehat{u}^*)' \right] + \partial_{\alpha\beta} \widehat{\phi}_d \left[(K_{12}^* : e_{\alpha} \otimes e_{\beta}) : \nabla'(\widehat{u}^*)' \right] \\ &\quad + e_{\alpha\beta}(\widehat{\phi}) \left[((K_{12}^*)^T : e_{\alpha} \otimes e_{\beta}) : \nabla_{d-1}^2 \widehat{u}_d^* \right] + \partial_{\alpha\beta} \widehat{\phi}_d \left[(K_{22}^* : e_{\alpha} \otimes e_{\beta}) : \nabla_{d-1}^2 \widehat{u}_d^* \right]. \end{aligned}$$

Note that the boundary term in the integration by parts vanishes because $\widehat{\phi} \in (\mathcal{D}(\omega))^d$. We thus deduce that

$$\begin{aligned} c^*(u^*, \phi) &= \int_{\omega} \left(K_{11}^* : e'(\widehat{\phi}') \right) : \nabla'(\widehat{u}^*)' + \left(K_{12}^* : \nabla_{d-1}^2 \widehat{\phi}_d \right) : \nabla'(\widehat{u}^*)' \\ &\quad + \left((K_{12}^*)^T : e'(\widehat{\phi}') \right) : \nabla_{d-1}^2 \widehat{u}_d^* + \left(K_{22}^* : \nabla_{d-1}^2 \widehat{\phi}_d \right) : \nabla_{d-1}^2 \widehat{u}_d^* \\ &= \int_{\omega} \left(K_{11}^* : e'(\widehat{\phi}') \right) : e'((\widehat{u}^*)') + \left(K_{12}^* : \nabla_{d-1}^2 \widehat{\phi}_d \right) : e'((\widehat{u}^*)') \\ &\quad + \left((K_{12}^*)^T : e'(\widehat{\phi}') \right) : \nabla_{d-1}^2 \widehat{u}_d^* + \left(K_{22}^* : \nabla_{d-1}^2 \widehat{\phi}_d \right) : \nabla_{d-1}^2 \widehat{u}_d^* \\ &= \int_{\omega} K^* \mathcal{P} u^* : \mathcal{P} \phi. \end{aligned}$$

Recalling (2.105), we have now identified the limit when $\varepsilon \rightarrow 0$ of the two terms on the left-hand side and of $s^{\varepsilon}(\phi)$ on the right-hand side. We are thus left with identifying the limit of

$$d^{\varepsilon}(\phi) = \int_{\Omega} f \cdot \phi + \int_{\omega} h_{\pm} \cdot \phi \left(\cdot, \pm \frac{1}{2} \right) - c^{\varepsilon}(g, \phi).$$

Use again Lemma 2.30 for the first two terms and similar computations as above, we obtain that

$$\lim_{\varepsilon \rightarrow 0} d^{\varepsilon}(\phi) = \int_{\omega} (m(f) + h_{\pm}) \cdot \widehat{\phi} - \int_{\omega} m(x_d f_{\alpha}) \partial_{\alpha} \widehat{\phi}_d - \int_{\omega} K^* \mathcal{P} g : \mathcal{P} \phi.$$

We have thus shown that, for any $\widehat{\phi} \in (\mathcal{D}(\omega))^d$, we have

$$\int_{\omega} K^* \mathcal{P} u^* : \mathcal{P} \phi = \int_{\omega} (m(f) + h_{\pm}) \cdot \widehat{\phi} - \int_{\omega} m(x_d f_{\alpha}) \partial_{\alpha} \widehat{\phi}_d - \int_{\omega} K^* \mathcal{P} g : \mathcal{P} \phi.$$

This result holds for any v in \mathcal{V}_{KL} . Indeed, for any v in \mathcal{V}_{KL} ,

$$\begin{aligned} \|\mathcal{P}\phi - \mathcal{P}v\|_{(L^2(\omega))^{(2d-2)\times(d-1)}}^2 &= \left\| e'(\widehat{\phi}') - e'(\widehat{v}') \right\|_{(L^2(\omega))^{(d-1)\times(d-1)}}^2 + \left\| \nabla^2 \widehat{\phi}_d - \nabla^2 \widehat{v}_d \right\|_{(L^2(\omega))^{(d-1)\times(d-1)}}^2 \\ &\leq \left\| \widehat{\phi}' - \widehat{v}' \right\|_{(H^1(\omega))^{d-1}}^2 + \left\| \widehat{\phi}_d - \widehat{v}_d \right\|_{H^2(\omega)}^2. \end{aligned}$$

The density of $(\mathcal{D}(\omega))^{d-1}$ in $(H^1(\omega))^{d-1}$ for the H^1 norm and of $\mathcal{D}(\omega)$ in $H^2(\omega)$ for the H^2 norm allows us to conclude.

We eventually show that K^* is coercive. Let σ and τ be in $\mathbb{R}_s^{(d-1)\times(d-1)}$. Then

$$\begin{aligned} K^* \begin{pmatrix} \sigma \\ \tau \end{pmatrix} : \begin{pmatrix} \sigma \\ \tau \end{pmatrix} &= \int_{\mathcal{Y}} A(e(w_\sigma) + \sigma + e(W^\tau) - x_d \tau) : (e(w_\sigma) + \sigma + e(W^\tau) - x_d \tau) \\ &\quad [\text{where } w^\sigma := \sigma_{\alpha\beta} w^{\alpha\beta} \text{ and } W^\tau = \tau_{\alpha\beta} W^{\alpha\beta}] \\ &= \int_{\mathcal{Y}} A\xi : \xi \quad [\text{where } \xi := e(w^\sigma) + \sigma + e(W^\tau) - x_d \tau] \\ &\geq c_- |\xi|^2. \end{aligned}$$

This shows that K^* is non-negative. We now show that $\xi = 0$ implies that $\sigma = \tau = 0$. Let $x \mapsto v(x_d)$ be in $\mathcal{D}(\mathcal{Y})$. Then

$$\begin{aligned} \int_{\mathcal{Y}} v \xi &= 0 \\ &= \int_{\mathcal{Y}} v(\sigma - x_d \tau) \quad [\text{because of the } Y\text{-periodicity of } w^\sigma \text{ and } W^\tau] \\ &= \sigma \int_{\mathcal{Y}} v - \tau \int_{\mathcal{Y}} x_d v. \end{aligned}$$

Successively taking $v = 1$ and $v = x_d$, we get $\sigma = \tau = 0$. This thus shows that K^* is coercive. As a consequence, the homogenized problem is well-posed, and thus the homogenized limit u^* is uniquely defined. This hence shows that the whole sequence u^ε (and not only a subsequence) converges to u^* . This concludes the proof of Theorem 2.11.

CHAPTER 3

MULTISCALE FINITE ELEMENT METHODS FOR ELASTIC HETEROGENEOUS PLATES

This chapter corresponds to a manuscript in preparation [AL2], co-authored with V. Ehrlacher, A. Lebé and F. Legoll.

3.1 Introduction

In this article, we consider elasticity problems posed on heterogeneous plates. These problems typically read as

$$-\operatorname{div}(\mathcal{A}^\varepsilon e(\tilde{u}^\varepsilon)) = \tilde{f}^\varepsilon \quad \text{in } \Omega^\varepsilon,$$

where $e(\tilde{u}^\varepsilon)$ is the symmetric gradient of the displacement \tilde{u}^ε , and where the elasticity tensor \mathcal{A}^ε varies at the small characteristic length-scale ε . The domain Ω^ε is thin, in the sense that its width ε in the d -direction is small. A typical example is when

$$\Omega^\varepsilon = \omega \times \left(-\frac{\varepsilon}{2}, \frac{\varepsilon}{2}\right), \quad (3.1)$$

where ω is a bounded open subset of \mathbb{R}^{d-1} (see Figure 3.2 below). The dependency of the right-hand side \tilde{f}^ε with respect to ε , as well as the choice of appropriate boundary conditions, will be made precise below. Since \mathcal{A}^ε varies at the small scale ε , standard finite element methods for plates cannot be used. They would indeed lead to prohibitive computational costs. Our aim in this article is to introduce and analyse multiscale numerical approaches, in the vein of the Multiscale Finite Element Method (MsFEM), to address this type of problems.

The principle of the MsFEM approach, originally introduced in [55] (see [36] for a comprehensive review), is to discretize the domain occupied by the heterogeneous material using a coarse mesh, where the typical size of each element, denoted H , can be chosen independently of the typical size ε of the heterogeneities. The method relies on the idea of using *specific* basis functions, which are not as generic as the standard finite element functions (like \mathbb{P}_1 finite element functions for instance), but are on the contrary well-adapted to the heterogeneities of the material. More precisely, the method proceeds in two steps. In an offline phase, some basis functions are computed as solutions to local problems defined on each element of the coarse mesh. The differential operator which is used is very similar (if not identical) to the differential operator of the global problem. It is thus expected that these basis functions appropriately encode

the oscillations of the exact solution. These basis functions are computed in parallel and independently from one another. They do not depend on the right-hand side of the problem. They are expensive to compute (because one has to use a fine mesh on each coarse element to resolve the oscillations of \mathcal{A}^ε), but this computation is local, and only performed once. These basis functions generate a discretization space of limited dimension, which is well-adapted to the problem at hand. Next, in an online phase, a global Galerkin approximation of the problem of interest is performed, on the discretization space introduced in the offline stage. Since the dimension of the discretization space is limited, the online phase is inexpensive.

Several variants of the method have been proposed, to address problems posed on domains Ω with oscillatory coefficients. These variants differ in the choice of boundary conditions for the local problems defining the oscillatory basis functions. We refer to [55, 56] for the initial variant with linear boundary conditions, to [55, 38] for the so-called oversampling variant where local problems are posed on an enlarged element, to [56] for a variant with oscillatory boundary conditions, to [64] for Crouzeix-Raviart type boundary conditions, to name but a few. MsFEM approaches have also been introduced for problems with slowly-varying coefficients posed on multiscale domains, such as perforated domains (see e.g. [65, 66]).

Our aim in this work is to introduce and analyze a MsFEM-type approach for problems posed on heterogeneous plates whose thickness is comparable to the typical size of the heterogeneities, i.e. in the case when the domain on which the problem is posed is of the form Ω^ε given by (3.1). We focus on a linear elasticity problem (rather than a more simple scalar-valued diffusion equation) because our work [AL1] has shown that this former model raises specific difficulties in the regime $\varepsilon \ll 1$, in contrast to the latter problem. In what follows, we are going to introduce a method where the dimension of the discretization space is proportional to the number of nodes of a coarse mesh of the $d - 1$ dimensional domain ω . More precisely, in the method we present here, only a few multiscale basis functions are defined on each *extruded* element of the form $\tau \times (-1/2, 1/2)$, where $\tau \subset \omega$ is an element of the coarse mesh of ω (see Figure 3.1). The computational cost is thus very limited.

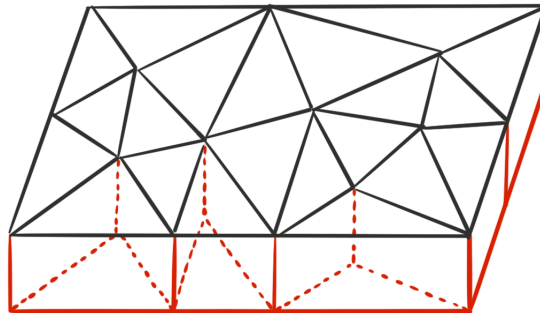

Figure 3.1: Extruded (coarse) mesh for the plate

In the case when the coefficient \mathcal{A}^ε satisfies some geometric assumptions (such as periodicity), homogenization theory for plates can of course be used. The asymptotic behavior of homogeneous plates has been studied in [24, 32, 28, 45] (for this homogeneous case, we also wish to mention [84], where the authors have studied the minimal order of polynomial functions to be used in a Galerkin approximation, so that the numerical solution remains asymptotically consistent with the asymptotic behavior of

the exact solution). In the case of heterogeneous plates, the weak convergence of the solution \tilde{u}^ε to the solution of an associated homogenized problem has been proved when the plate is stratified [46, 47, 76] or has periodic heterogeneities [17, 18]. We also refer to [75, 91, 53] for recent homogenization results on heterogeneous plates with more general heterogeneities. However, as always for homogenization, explicit expressions of the homogenized problem can only be obtained under some geometric assumptions (such as periodicity) on the oscillatory coefficient. The MsFEM approach is built in order to address problems beyond this type of assumptions: no geometric assumption is required on the coefficient \mathcal{A}^ε to put the approach in practice.

Our aim in this article is twofold. First, we numerically compare the performance of several MsFEM variants for elastic heterogeneous plates (some of these variants being inspired by the work [84] on homogeneous plates), for problems with oscillatory coefficients that are not necessarily periodic (see Section 3.4.1 for a description of our test cases). Second, we establish bounds quantifying the error in terms of the coarse mesh size H and the typical scale ε of the heterogeneities. This numerical analysis (as any numerical analysis of MsFEM approaches known to date) is performed under the assumption that heterogeneities are periodic. We cannot emphasize enough the fact that the approach can in practice be applied to more general cases (as we do in Section 3.4), and that its performances are robust. The numerical analysis is based on a triangle inequality, where we bound the error by the sum of two terms, first the difference between the exact solution and its two-scale expansion and second the difference between the two-scale expansion and the numerical solution. Homogenization results quantifying the first term are hence pivotal. In the case of elastic heterogeneous plates, we have established such results in our companion work [AL1], and we are going to use them in the numerical analysis presented here.

The article is organized as follows. In Section 3.2, we present the problem and the main theoretical results that we need. We next present the MsFEM approach in Section 3.3 and establish two error estimates, one for the so-called membrane case (Theorem 3.11) and the other one for the so-called bending case (Theorem 3.12). The proofs of these results are postponed until Appendix 3.A. Extensive numerical results comparing the different MsFEM variants are presented in Section 3.4.

3.2 Presentation of the problem and former results

Let $\omega \subset \mathbb{R}^{d-1}$ be a open, bounded and smooth domain. We set $\Omega := \omega \times \left(-\frac{1}{2}, \frac{1}{2}\right)$, choose a small parameter $\varepsilon > 0$ and set $\Omega^\varepsilon := \omega \times \left(-\frac{\varepsilon}{2}, \frac{\varepsilon}{2}\right)$. The domain Ω^ε is called a “plate” because ε is small compared to the characteristic size of ω (see Figure 3.2). We also denote by n (respectively n^ε) the outward normal unit vector to $\partial\Omega$ (respectively $\partial\Omega^\varepsilon$).



Figure 3.2: Domain Ω^ε occupied by the plate

Let $(e_i)_{1 \leq i \leq d}$ be the canonical basis of \mathbb{R}^d . For any $x = (x_i)_{1 \leq i \leq d} \in \mathbb{R}^d$, we set $x' := (x_i)_{1 \leq i \leq d-1} \in \mathbb{R}^{d-1}$. For any $M = (M_{ij})_{1 \leq i, j \leq d} \in \mathbb{R}^{d \times d}$, we set $M' := (M_{ij})_{1 \leq i, j \leq d-1} \in \mathbb{R}^{(d-1) \times (d-1)}$.

The set of $d \times d$ symmetric matrices is denoted by $\mathbb{R}_s^{d \times d}$ and $c_-, c_+ > 0$ are some fixed positive constants. We denote by \mathcal{M} the set of tensors $M \in \mathbb{R}^{d \times d \times d \times d}$ such that

$$\forall \xi \in \mathbb{R}_s^{d \times d}, \quad |M\xi| \leq c_+ |\xi| \quad \text{and} \quad \xi^T M \xi \geq c_- |\xi|^2,$$

and which have the following symmetries:

$$\forall 1 \leq i, j, k, l \leq d, \quad M_{ijkl} = M_{jikl} = M_{ijlk} = M_{klij}.$$

For $A, B \in \mathbb{R}^{d \times d}$, we set $A : B = \sum_{i,j=1}^d A_{ij} B_{ij}$. In particular, we point out that, for any $1 \leq i, j \leq d$ and any $A \in \mathbb{R}^{d \times d}$, $A : (e_i \otimes e_j) = e_i^T A e_j$.

We also define the periodic cells in dimension $d - 1$ and d by

$$Y := (0, 1)^{d-1} \quad \text{and} \quad \mathcal{Y} := Y \times \left(-\frac{1}{2}, \frac{1}{2}\right).$$

For any $f : \mathbb{R}^{d-1} \times \left(-\frac{1}{2}, \frac{1}{2}\right) \rightarrow \mathbb{R}^p$, we denote by

$$\mathfrak{m}(f)(x') := \int_{-1/2}^{+1/2} f(x', x_d) dx_d$$

the mean of f over its last variable. For any vector-valued function u , let $e(u)$ denote the symmetric gradient of u , namely $e(u) := \frac{1}{2} (\nabla u + \nabla u^T)$.

Throughout the article, we use the Einstein summation convention. Latin letters are used for indices running between 1 and d and greek letters for indices running between 1 and $d - 1$.

3.2.1 Definition of the plate problem

The original problem

Let $A^\varepsilon : \omega \times \left(-\frac{1}{2}, \frac{1}{2}\right) \rightarrow \mathcal{M}$ be a tensor-valued field such that, for any $x_d \in \left(-\frac{1}{2}, \frac{1}{2}\right)$, the function $x' \in \omega \mapsto A^\varepsilon(x', x_d)$ is thought to be heterogeneous and have a characteristic scale of variation of the order of ε . For instance, one could think (but the method carries over to more general cases) that $A^\varepsilon(x) = A\left(\frac{x'}{\varepsilon}, x_d\right)$ for some fixed function A which is \mathbb{Z}^{d-1} periodic with respect to its first argument. In addition, we define the tensor \mathcal{A}^ε on Ω^ε by

$$\forall x \in \Omega^\varepsilon, \quad \mathcal{A}^\varepsilon(x) := A^\varepsilon\left(x', \frac{x_d}{\varepsilon}\right).$$

We introduce

$$V^\varepsilon := \left\{ v \in (H^1(\Omega^\varepsilon))^d, \quad v = 0 \text{ on } \partial\omega \times \left(-\frac{\varepsilon}{2}, \frac{\varepsilon}{2}\right) \right\}.$$

A function in V^ε thus vanishes on the lateral boundary of Ω^ε (see Figure 3.2).

For any $\varepsilon > 0$, let $\tilde{f}^\varepsilon \in (L^2(\Omega^\varepsilon))^d$, $\tilde{g}^\varepsilon \in (W^{2,\infty}(\Omega))^d$ and $\tilde{h}_\pm^\varepsilon \in (L^2(\omega))^d$. We consider the following linear elasticity problem, posed on the plate Ω^ε : find $\tilde{u}^\varepsilon \in V^\varepsilon$ such that

$$\begin{cases} -\operatorname{div}(\mathcal{A}^\varepsilon e(\tilde{u}^\varepsilon)) = \tilde{f}^\varepsilon + \operatorname{div}(\mathcal{A}^\varepsilon e(\tilde{g}^\varepsilon)) & \text{in } \Omega^\varepsilon, \\ \mathcal{A}^\varepsilon e(\tilde{u}^\varepsilon) \cdot n^\varepsilon = \tilde{h}_\pm^\varepsilon - \mathcal{A}^\varepsilon e(\tilde{g}^\varepsilon) \cdot n^\varepsilon & \text{on } \omega \times \left\{ \pm \frac{\varepsilon}{2} \right\}. \end{cases} \quad (3.2)$$

In (3.2), \tilde{f}^ε is the load imposed in Ω^ε . The function \tilde{g}^ε is inserted as a possible extension of a non-trivial Dirichlet boundary condition (so that $\tilde{u}^\varepsilon + \tilde{g}^\varepsilon$ does not necessarily vanish on $\partial\omega \times (-\varepsilon/2, \varepsilon/2)$). The function $\tilde{h}_\pm^\varepsilon$ plays the role of a Neumann boundary condition (i.e. a traction boundary condition for this elasticity problem) on the top and bottom faces of the plate Ω^ε .

The rescaled problem

To simplify the analysis, it is classical to change the scale of the problem in the d -direction, in order to work with problems posed on a domain Ω independent of ε (see Figure 3.3). We thus introduce

$$V := \left\{ v \in (H^1(\Omega))^d, \quad v = 0 \text{ on } \partial\omega \times \left(-\frac{1}{2}, \frac{1}{2} \right) \right\}. \quad (3.3)$$

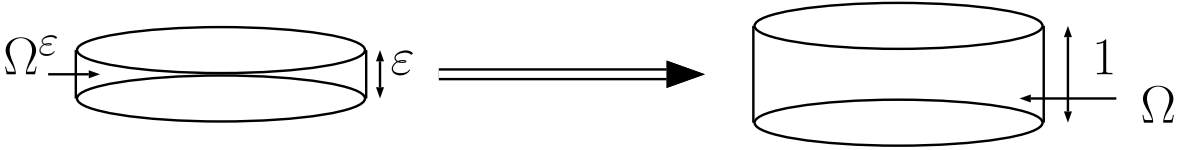

Figure 3.3: Rescaling of the domain

For any $u \in (\mathcal{D}'(\mathbb{R}^d))^d$ and $T \in (\mathcal{D}'(\mathbb{R}^d))^{d \times d}$, we define the operator e^ε by

$$e_{\alpha\beta}^\varepsilon(u) := e_{\alpha\beta}(u), \quad e_{\alpha d}^\varepsilon(u) := \frac{1}{\varepsilon} e_{\alpha d}(u) \quad \text{and} \quad e_{dd}^\varepsilon(u) := \frac{1}{\varepsilon^2} e_{dd}(u),$$

and the operator $\operatorname{div}^\varepsilon$ by

$$\operatorname{div}^\varepsilon(T)_\alpha := \partial_\beta T_{\alpha\beta} + \frac{1}{\varepsilon} \partial_d T_{\alpha d} \quad \text{and} \quad \operatorname{div}^\varepsilon(T)_d := \frac{1}{\varepsilon} \partial_\beta T_{d\beta} + \frac{1}{\varepsilon^2} \partial_d T_{dd},$$

for any $1 \leq \alpha, \beta \leq d-1$.

It can then be easily checked that problem (3.2) is equivalent to finding $u^\varepsilon \in V$ such that

$$\begin{cases} -\operatorname{div}^\varepsilon(A^\varepsilon e^\varepsilon(u^\varepsilon)) = f^\varepsilon + \operatorname{div}^\varepsilon(A^\varepsilon e^\varepsilon(g^\varepsilon)) & \text{in } \Omega, \\ A^\varepsilon e^\varepsilon(u^\varepsilon) \cdot n = \left(\frac{\varepsilon(h_\pm^\varepsilon)'}{\varepsilon^2(h_\pm^\varepsilon)_d} \right) - A^\varepsilon e^\varepsilon(g^\varepsilon) \cdot n & \text{on } \omega \times \left\{ \pm \frac{1}{2} \right\}, \end{cases} \quad (3.4)$$

with, for any $1 \leq \alpha \leq d-1$,

$$\begin{aligned} u_\alpha^\varepsilon(x) &= \tilde{u}_\alpha^\varepsilon(x', \varepsilon x_d), & u_d^\varepsilon(x) &= \varepsilon \tilde{u}_d^\varepsilon(x', \varepsilon x_d), \\ f_\alpha^\varepsilon(x) &= \tilde{f}_\alpha^\varepsilon(x', \varepsilon x_d), & f_d^\varepsilon(x) &= \varepsilon^{-1} \tilde{f}_d^\varepsilon(x', \varepsilon x_d), \\ h_\alpha^\varepsilon(x') &= \tilde{h}_\alpha^\varepsilon(x'), & h_d^\varepsilon(x') &= \varepsilon^{-1} \tilde{h}_d^\varepsilon(x'), \\ g_\alpha^\varepsilon(x) &= \tilde{g}_\alpha^\varepsilon(x', \varepsilon x_d), & g_d^\varepsilon(x) &= \varepsilon \tilde{g}_d^\varepsilon(x', \varepsilon x_d), \end{aligned}$$

where, in the third line, we have written h as a short-hand for h_{\pm} . Note the rescaling factor ε on the d -th components of the various vectors.

We assume that, after this rescaling, the functions f^{ε} , h_{\pm}^{ε} and g^{ε} are all independent of ε . We thus have, for any $\varepsilon > 0$, that

$$f^{\varepsilon} = f \in (L^2(\Omega))^d, \quad g^{\varepsilon} = g \in (W^{2,\infty}(\Omega))^d, \quad h_{\pm}^{\varepsilon} = h_{\pm} \in (L^2(\omega))^d.$$

The variational formulation of (3.4) reads as

$$\text{Find } u^{\varepsilon} \in V \text{ such that, for any } v \in V, \quad a^{\varepsilon}(u^{\varepsilon}, v) = b^{\varepsilon}(v) \quad (3.5)$$

where

$$a^{\varepsilon}(u^{\varepsilon}, v) := \int_{\Omega} A^{\varepsilon} e^{\varepsilon}(u^{\varepsilon}) : e^{\varepsilon}(v)$$

and

$$b^{\varepsilon}(v) := \int_{\Omega} f \cdot v - \int_{\Omega} A^{\varepsilon} e^{\varepsilon}(g) : e^{\varepsilon}(v) + \int_{\Gamma^{\pm}} h_{\pm} \cdot v,$$

where $\Gamma^{\pm} = \omega \times \{\pm 1/2\}$. Using the Lax-Milgram theorem and the Korn inequality (see e.g. [22]), we obtain that there exists a unique solution to (3.5).

Taking $v = u^{\varepsilon}$ in (3.5), we get (we refer to [AL1, Section 3.1] for details) that

$$\|e^{\varepsilon}(u^{\varepsilon})\|_{(L^2(\Omega))^{d \times d}} \leq C \left(\|f\|_{(L^2(\Omega))^d} + \|e^{\varepsilon}(g)\|_{(L^2(\Omega))^{d \times d}} + \|h_{\pm}\|_{(L^2(\omega))^d} \right) \quad (3.6)$$

and hence

$$\|u^{\varepsilon}\|_{(H^1(\Omega))^d} \leq C \left(\|f\|_{(L^2(\Omega))^d} + \|e^{\varepsilon}(g)\|_{(L^2(\Omega))^{d \times d}} + \|h_{\pm}\|_{(L^2(\omega))^d} \right) \quad (3.7)$$

for some constant C independent of ε . Provided that the sequence $\left(\|e^{\varepsilon}(g)\|_{(L^2(\Omega))^{d \times d}} \right)_{\varepsilon > 0}$ is bounded (in Section 3.2.2 below, we will make an assumption (3.8) on g that directly implies this bound), we infer from (3.7) that, up to the extraction of a subsequence, there exists $u^{\star} \in (H^1(\Omega))^d$ such that

$$u^{\varepsilon} \rightharpoonup u^{\star} \text{ weakly in } (H^1(\Omega))^d.$$

The bound (3.6) is also useful in the sequel.

3.2.2 Decomposition of the problem

Kirchoff-Love displacements

To describe u^{\star} , we define the set of the *Kirchoff-Love displacements* as follows:

$$\mathcal{V}_{KL} := \left\{ v \in (H^1(\Omega))^{d-1} \times H_0^2(\omega), \exists \widehat{v} \in (H_0^1(\omega))^{d-1} \times H_0^2(\omega) \text{ s.t. } v_{\alpha} = \widehat{v}_{\alpha} - x_d \partial_{\alpha} \widehat{v}_d, v_d = \widehat{v}_d \right\},$$

where $H_0^2(\omega)$ is the closure of $\mathcal{D}(\Omega)$ in $H^2(\omega)$. For any $v \in \mathcal{V}_{KL}$, we now use the notation \widehat{v} to denote the corresponding element of $(H_0^1(\omega))^{d-1} \times H_0^2(\omega)$.

Let us also denote by

$$\mathcal{G}_{KL} := \left\{ g \in (H^1(\Omega))^{d-1} \times H^2(\omega), \exists \widehat{g} \in (H^1(\omega))^{d-1} \times H^2(\omega) \text{ s.t. } g_{\alpha} = \widehat{g}_{\alpha} - x_d \partial_{\alpha} \widehat{g}_d, g_d = \widehat{g}_d \right\}.$$

For any $g \in \mathcal{G}_{KL}$, we denote by \widehat{g} the corresponding element of $(H^1(\omega))^{d-1} \times H^2(\omega)$.

It holds that $\mathcal{V}_{KL} \subset \mathcal{G}_{KL}$ and that, for any $g \in \mathcal{G}_{KL}$, the sequence $\left(\|e^\varepsilon(g)\|_{(L^2(\Omega))^{d \times d}} \right)_{\varepsilon > 0}$ is bounded. We assume throughout this article that the function g which appears in the linear form b^ε of (3.5) belongs to \mathcal{G}_{KL} :

$$g \in \mathcal{G}_{KL}. \quad (3.8)$$

We recall the following result from [18] (see also [AL1, Theorem 3.1]).

Proposition 3.1. *Under the above assumptions, the homogenized limit u^* of Problem (3.5) belongs to \mathcal{V}_{KL} .*

To better understand elements in \mathcal{V}_{KL} , we note that any $v \in \mathcal{V}_{KL}$ is the sum of two contributions, first the function

$$(x', x_d) \mapsto \begin{pmatrix} \widehat{v}'(x') \\ 0 \end{pmatrix},$$

which is a lateral displacement independent of x_d , and second the function

$$(x', x_d) \mapsto \begin{pmatrix} -x_d \nabla' \widehat{v}_d(x') \\ v_d(x') \end{pmatrix}$$

which is a vertical displacement coupled with a rotation of the normal vector to $\omega \times \{0\}$.

Symmetries of the problem

In the above section, we have introduced the Kirchoff-Love displacements, and explained how they could be “split” in two independent parts. We now explain that, under some symmetry assumptions on the elasticity tensor, we can decompose the problem into two simpler and independent problems.

Let us define the spaces

$$\begin{aligned} \mathcal{E} &:= \{v \in L^2(\Omega) \text{ s.t., for almost any } x' \in \omega, \text{ the function } x_d \mapsto v(x', x_d) \text{ is even}\} \\ \mathcal{O} &:= \{v \in L^2(\Omega) \text{ s.t., for almost any } x' \in \omega, \text{ the function } x_d \mapsto v(x', x_d) \text{ is odd}\}. \end{aligned}$$

We suppose hereafter that the elasticity tensor A^ε satisfies

$$\begin{aligned} A_{\alpha\beta\sigma\tau}^\varepsilon, A_{\alpha\beta dd}^\varepsilon, A_{\alpha d\beta d}^\varepsilon &\in \mathcal{E}, \\ A_{\alpha d d d}^\varepsilon, A_{\alpha\beta\sigma d}^\varepsilon &\in \mathcal{O}. \end{aligned} \quad (3.9)$$

This assumption is classical in the literature for plate problems (see e.g. [18, Section 7]). It is for instance satisfied by any material that is isotropic and admits $x_d = 0$ as a plane of symmetry.

In the sequel, we split the plate problem into two problems, the *membrane* problem and the *bending* problem, using the fact that

$$(L^2(\Omega))^d = (\mathcal{E}^{d-1} \times \mathcal{O}) \oplus (\mathcal{O}^{d-1} \times \mathcal{E}).$$

We write the same decomposition for the Kirchoff-Love space:

$$\mathcal{V}_{KL} = \mathcal{V}_{KL}^{\mathcal{M}} \oplus \mathcal{V}_{KL}^{\mathcal{B}}$$

where

$$\mathcal{V}_{KL}^{\mathcal{M}} := (H_0^1(\omega))^{d-1} \times \{0\} \subset \mathcal{E}^{d-1} \times \mathcal{O}$$

and

$$\mathcal{V}_{KL}^{\mathcal{B}} := \left\{ v \in (H^1(\Omega))^{d-1} \times H_0^2(\omega), \exists \widehat{v}_d \in H_0^2(\omega), v_\alpha = -x_d \partial_\alpha \widehat{v}_d, v_d = \widehat{v}_d \right\} \subset \mathcal{O}^{d-1} \times \mathcal{E}.$$

The membrane and the bending problems are defined as follows.

Proposition-Definition 3.2. *If $f, g \in \mathcal{E}^{d-1} \times \mathcal{O}$ and $h_\alpha^+ = h_\alpha^-$, $h_d^+ = -h_d^-$, then the solution u^ε to (3.5) belongs to $\mathcal{E}^{d-1} \times \mathcal{O}$, its homogenized limit u^* belongs to \mathcal{V}_{KL}^M and the problem is said to be a membrane problem.*

If $f, g \in \mathcal{O}^{d-1} \times \mathcal{E}$ and $h_\alpha^+ = -h_\alpha^-$, $h_d^+ = h_d^-$, then the solution u^ε to (3.5) belongs to $\mathcal{O}^{d-1} \times \mathcal{E}$, its homogenized limit u^ belongs to \mathcal{V}_{KL}^B and the problem is said to be a bending problem.*

The proof derives directly from a computation of (3.5) taking into account the symmetries and can be found e.g. in [AL1, Section 3.3.2].

Rescaled norm and Poincaré inequality

We started our analysis by rescaling the problem, going from an equation posed on $\Omega^\varepsilon = \omega \times \left(-\frac{\varepsilon}{2}, \frac{\varepsilon}{2}\right)$ to an equation posed on $\Omega = \omega \times \left(-\frac{1}{2}, \frac{1}{2}\right)$. In the same spirit, we replace the H^1 norm by a norm that gives a different ponderation to the d -th derivative and d -th coordinate, and which is the natural energy norm for (3.5).

Definition 3.3. *For any function $u \in (H^1(\Omega))^d$, let*

$$\|u\|_{H_\varepsilon^1(\Omega)^d}^2 := \|u\|_{(L^2(\Omega))^d}^2 + \|e^\varepsilon(u)\|_{(L^2(\Omega))^{d \times d}}^2.$$

The following Poincaré inequality is useful below, where we keep explicit the dependence of the constant with respect to ω and ε (see [AL1, Lemma 3.5]).

Lemma 3.4. *Let V be defined by (3.3). There exists some constant $C > 0$ independent of ε and ω such that*

$$\forall u \in V, \quad \|u\|_{(L^2(\Omega))^d} \leq C \max\left(1, |\omega|^{\frac{1}{d-1}}\right) \max\left(|\omega|^{\frac{1}{d-1}}, \varepsilon^2 |\omega|^{-\frac{1}{d-1}}\right) \|e^\varepsilon(u)\|_{(L^2(\Omega))^{d \times d}}. \quad (3.10)$$

3.2.3 Former results

We now recall the homogenization theorems established in [18] and the strong convergence results shown in [AL1] in the periodic case, that is when the elasticity tensor A^ε in (3.4) is given by

$$A^\varepsilon(x) = A\left(\frac{x'}{\varepsilon}, x_d\right) \quad (3.11)$$

for some fixed function A which is \mathbb{Z}^{d-1} periodic with respect to its first argument, i.e. such that the function $x' \in \mathbb{R}^{d-1} \mapsto A(x', x_d)$ is Y -periodic for any $x_d \in (-1/2, 1/2)$.

Definition of the correctors

We first define two families of correctors functions, which all belong to the space

$$\mathcal{W}(\mathcal{Y}) := \left\{ v \in \left(H_{\text{loc}}^1 \left(\mathbb{R}^{d-1} \times \left(-\frac{1}{2}, \frac{1}{2} \right) \right) \right)^d, \right. \\ \left. \forall z \in \left(-\frac{1}{2}, \frac{1}{2} \right), v(\cdot, z) \text{ is } Y\text{-periodic and } \int_{\mathcal{Y}} v = 0 \right\}.$$

Lemma 3.5 (Membrane correctors). *Let $w_{\mathcal{M}}^{\alpha\beta} \in \mathcal{W}(\mathcal{Y})$ be the solution to the problem*

$$\forall v \in \mathcal{W}(\mathcal{Y}), \quad \int_{\mathcal{Y}} A(e(w_{\mathcal{M}}^{\alpha\beta}) + e_\alpha \otimes e_\beta) : e(v) = 0 \quad (3.12)$$

for any $1 \leq \alpha, \beta \leq d-1$. The function $w_{\mathcal{M}}^{\alpha\beta}$ is equivalently the unique solution in $\mathcal{W}(\mathcal{Y})$ to

$$\begin{cases} -\operatorname{div} A(e(w_{\mathcal{M}}^{\alpha\beta}) + e_{\alpha} \otimes e_{\beta}) = 0, \\ A(e(w_{\mathcal{M}}^{\alpha\beta}) + e_{\alpha} \otimes e_{\beta}) \cdot e_d = 0 \text{ on } \mathcal{Y}^{\pm}, \end{cases}$$

where $\mathcal{Y}^{\pm} := Y \times \{\pm \frac{1}{2}\}$. In addition, we have

$$w_{\mathcal{M}}^{\alpha\beta} \in \mathcal{E}^{d-1} \times \mathcal{O}.$$

Lemma 3.6 (Bending correctors). *Let $w_{\mathcal{B}}^{\alpha\beta} \in \mathcal{W}(\mathcal{Y})$ be the solution to the problem*

$$\forall v \in \mathcal{W}(\mathcal{Y}), \quad \int_{\mathcal{Y}} A(e(w_{\mathcal{B}}^{\alpha\beta}) - x_d e_{\alpha} \otimes e_{\beta}) : e(v) = 0 \quad (3.13)$$

for any $1 \leq \alpha, \beta \leq d-1$. The function $w_{\mathcal{B}}^{\alpha\beta}$ is equivalently the unique solution in $\mathcal{W}(\mathcal{Y})$ to

$$\begin{cases} -\operatorname{div} A(e(w_{\mathcal{B}}^{\alpha\beta}) - x_d e_{\alpha} \otimes e_{\beta}) = 0, \\ A(e(w_{\mathcal{B}}^{\alpha\beta}) - x_d e_{\alpha} \otimes e_{\beta}) \cdot e_d = 0 \text{ on } \mathcal{Y}^{\pm}, \end{cases}$$

where again $\mathcal{Y}^{\pm} := Y \times \{\pm \frac{1}{2}\}$. In addition, we have

$$w_{\mathcal{B}}^{\alpha\beta} \in \mathcal{O}^{d-1} \times \mathcal{E}.$$

Homogenization theorems

We now recall the homogenized limit of (3.5), considering first the membrane case (for which the homogenized problem is again a second order PDE) and second the bending case (for which the homogenized problem turns out to be a fourth order PDE). We recall from Proposition 3.1 that $u^* \in \mathcal{V}_{KL}$. There thus exists some $\widehat{u}^* \in (H_0^1(\omega))^{d-1} \times H_0^2(\omega)$ such that $u_{\alpha}^* = \widehat{u}_{\alpha}^* - x_d \partial_{\alpha} \widehat{u}_d^*$ and $u_d^* = \widehat{u}_d^*$.

Theorem 3.7 (Homogenized limit, the membrane case). *Assume that we are in the membrane case in the sense of Definition 3.2. Under the above assumptions, the homogenized limit u^* does not depend on x_d , is such that $u_d^* = 0$ and $u^* = (\widehat{u}^*, 0)$ where \widehat{u}^* is the unique solution in $(H_0^1(\omega))^{d-1}$ to*

$$\forall \phi \in (H_0^1(\omega))^{d-1}, \quad \int_{\omega} A_{\mathcal{M}}^* e'(\widehat{u}^*) : e'(\phi) = \int_{\omega} (m(f') + h'_{\pm}) \cdot \phi - \int_{\omega} A_{\mathcal{M}}^* e'(g) : e'(\phi) \quad (3.14)$$

where

$$(A_{\mathcal{M}}^*)_{\alpha\beta\sigma\tau} := \int_{\mathcal{Y}} A(e(w_{\mathcal{M}}^{\alpha\beta}) + e_{\alpha} \otimes e_{\beta}) : (e(w_{\mathcal{M}}^{\sigma\tau}) + e_{\sigma} \otimes e_{\tau}).$$

Theorem 3.8 (Homogenized limit, the bending case). *Assume that we are in the bending case in the sense of Definition 3.2. Under the above assumptions, we have $u^* = (-x_d \nabla' \widehat{u}_d^*, \widehat{u}_d^*)$ where \widehat{u}_d^* is the unique solution in $H_0^2(\omega)$ to*

$$\forall \phi \in H_0^2(\omega), \quad \int_{\omega} A_{\mathcal{B}}^* \nabla^2 \widehat{u}_d^* : \nabla^2 \phi = \int_{\omega} (m(f_d) + h_d^{\pm}) \phi - \int_{\omega} m(x_d f') \cdot \nabla' \phi - \int_{\omega} A_{\mathcal{B}}^* \nabla^2 g_d : \nabla^2 \phi \quad (3.15)$$

where

$$(A_{\mathcal{B}}^*)_{\alpha\beta\sigma\tau} := \int_{\mathcal{Y}} A(e(w_{\mathcal{B}}^{\alpha\beta}) - y_d e_{\alpha} \otimes e_{\beta}) : (e(w_{\mathcal{B}}^{\sigma\tau}) - y_d e_{\sigma} \otimes e_{\tau}).$$

Strong convergence theorem

To perform the numerical analysis of the MsFEM approach we introduce below, we need a stronger result, namely an estimate in the H^1 norm of the difference between u^ε and its corresponding two-scale expansion. This strong convergence result is stated in the following theorem for the membrane case (see [AL1, Theorem 3.10]).

Theorem 3.9 (Strong convergence result, the membrane case). *Assume that we are in the membrane case. Let*

$$\begin{aligned} u_\sigma^{\varepsilon,1} &:= \widehat{u}_\sigma^* + \varepsilon e_\sigma \cdot w_{\mathcal{M}}^{\alpha\beta} \left(\frac{\cdot}{\varepsilon}, \cdot \right) e_{\alpha\beta}(\widehat{u}^* + g), \\ u_d^{\varepsilon,1} &:= \varepsilon^2 e_d \cdot w_{\mathcal{M}}^{\alpha\beta} \left(\frac{\cdot}{\varepsilon}, \cdot \right) e_{\alpha\beta}(\widehat{u}^* + g). \end{aligned}$$

Assume that $u^* \in (W^{2,\infty}(\omega))^d$ and that $w_{\mathcal{M}}^{\alpha\beta} \in [W^{1,\infty}(\mathbb{R}^{d-1} \times (-\frac{1}{2}, \frac{1}{2}))]^d$ for any $1 \leq \alpha \leq d-1$. Then

$$\begin{aligned} \|u^\varepsilon - u^{\varepsilon,1}\|_{H_\varepsilon^1(\Omega)^d} &\leq C \left(1 + \max \left(1, |\omega|^{\frac{1}{d-1}} \right) \max \left(|\omega|^{\frac{1}{d-1}}, \varepsilon^2 |\omega|^{-\frac{1}{d-1}} \right) \right) \\ &\times \left(\sqrt{\varepsilon} |\omega|^{\frac{d-2}{2d-2}} \|e(u^* + g)\|_{L^\infty(\omega)} + \varepsilon |\omega|^{\frac{1}{2}} \|\nabla^2(u^* + g)\|_{L^\infty(\omega)} + \varepsilon (\|h^\pm\|_{L^2(\omega)} + \|f\|_{L^2(\Omega)}) \right) \end{aligned}$$

for some $C > 0$ independent of ε and ω .

In the bending case, the situation is slightly more delicate. We introduce

$$\sigma^\varepsilon := A^\varepsilon e^\varepsilon(u^\varepsilon + g). \quad (3.16)$$

Using assumption (3.8) (which implies that $e^\varepsilon(g) = e(g)$), we infer from (3.6) that σ^ε is bounded in $(L^2(\Omega))^{d \times d}$. We next introduce the matrix Σ^ε defined by, for any $1 \leq \alpha, \beta \leq d-1$,

$$\Sigma_{\alpha\beta}^\varepsilon := \sigma_{\alpha\beta}^\varepsilon, \quad \Sigma_{\alpha d}^\varepsilon := \frac{1}{\varepsilon} \sigma_{\alpha d}^\varepsilon \quad \text{and} \quad \Sigma_{dd}^\varepsilon := \frac{1}{\varepsilon^2} \sigma_{dd}^\varepsilon. \quad (3.17)$$

It can be shown (see [AL1, Lemma 3.11]) that $\Sigma_{\alpha\beta}^\varepsilon$, $\Sigma_{\alpha d}^\varepsilon$ and Σ_{dd}^ε are bounded in (respectively) $L^2(\Omega)$, $L^2((-\frac{1}{2}, \frac{1}{2}), H^{-1}(\omega))$ and $L^2((-\frac{1}{2}, \frac{1}{2}), H^{-2}(\omega))$, and therefore weakly converge (up to a subsequence extraction) to some $\Sigma_{\alpha\beta}^*$, $\Sigma_{\alpha d}^*$ and Σ_{dd}^* . In the sequel, we make the following assumption, which is comprehensively discussed in [AL1]:

$$\text{(CB)} \quad \text{For all } 1 \leq \alpha, \beta \leq d-1, \quad \Sigma_{\alpha\beta}^* = (e_\alpha \otimes e_\beta) : \left[\int_Y A(e(w_B^{\gamma\delta}) - x_d e_\gamma \otimes e_\delta) \right] \partial_{\gamma\delta}(u_d^* + g_d). \quad (3.18)$$

This assumption in particular implies that the whole $d \times d$ matrix Σ^* belongs to $(L^2(\Omega))^{d \times d}$. We are now in position to state a strong convergence result in the bending case (see [AL1, Theorem 3.14]).

Theorem 3.10 (Strong convergence result, the bending case). *Assume that we are in the bending case. Let*

$$\begin{aligned} u_\sigma^{\varepsilon,1} &:= -x_d \partial_\sigma u_d^* + \varepsilon e_\sigma \cdot w_B^{\alpha\beta} \left(\frac{\cdot}{\varepsilon}, \cdot \right) \partial_{\alpha\beta}(u_d^* + g_d), \\ u_d^{\varepsilon,1} &:= u_d^* + \varepsilon^2 e_d \cdot w_B^{\alpha\beta} \left(\frac{\cdot}{\varepsilon}, \cdot \right) \partial_{\alpha\beta}(u_d^* + g_d). \end{aligned}$$

Assume that $u_d^*, g_d \in W^{3,\infty}(\omega)$ and that $w_B^{\alpha\beta} \in [W^{1,\infty}(\mathbb{R}^{d-1} \times (-\frac{1}{2}, \frac{1}{2}))]^d$ for any $1 \leq \alpha \leq d-1$. We also assume that A, f, g and h_{\pm} are sufficiently regular, and that Assumption (CB) holds. Then

$$\begin{aligned} & \|u^\varepsilon - u^{\varepsilon,1}\|_{H^1_\varepsilon(\Omega)^d} \leq C \max\left(1, |\omega|^{\frac{1}{d-1}}\right) \max\left(|\omega|^{\frac{1}{d-1}}, \varepsilon^2 |\omega|^{-\frac{1}{d-1}}\right) \\ & \times \left(\sqrt{\varepsilon} |\omega|^{\frac{d-2}{2(d-1)}} \|\nabla^2(u_d^* + g_d)\|_{L^\infty(\omega)} + \varepsilon |\omega|^{1/2} \|\nabla^3(u_d^* + g_d)\|_{L^\infty(\omega)} + \varepsilon \|\Sigma^*\|_{L^2(\Omega)}\right) \end{aligned}$$

for some $C > 0$ independent of ε and ω .

3.3 Definition and numerical analysis of the MsFEM

The MsFEM approach has been introduced by Hou and Wu in [55] as a discretization method for oscillatory elliptic PDEs. Instead of using for example a FEM discretization approach with generic (say \mathbb{P}^1) basis functions (see Figure 3.4), the idea of MsFEM is to introduce oscillatory basis functions which are well adapted to the problem of interest (see Figure 3.5).

The oscillating functions are solutions to local PDEs posed on the elements of the coarse mesh. They are precomputed during an offline phase (by using in practice a fine mesh of each coarse element). These basis functions only depend on the elasticity tensor A^ε , and not on the right-hand side f or the boundary conditions imposed on the problem of interest. During the online phase, a Galerkin approximation of the global problem is introduced, where the discretization space is the one spanned by the precomputed oscillating basis functions. Whenever the functions f, g and h_{\pm} change, the offline phase does not have to be repeated, hence a computational gain in a multi-query context.

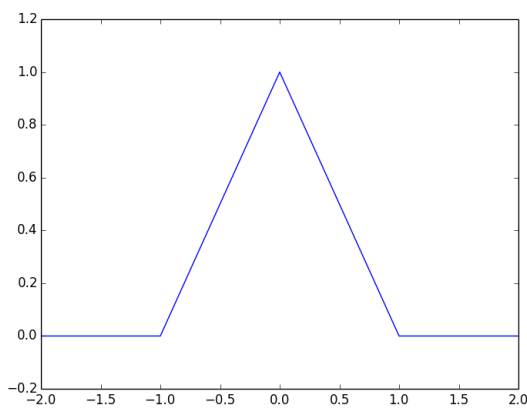

Figure 3.4: A \mathbb{P}^1 element in 1D

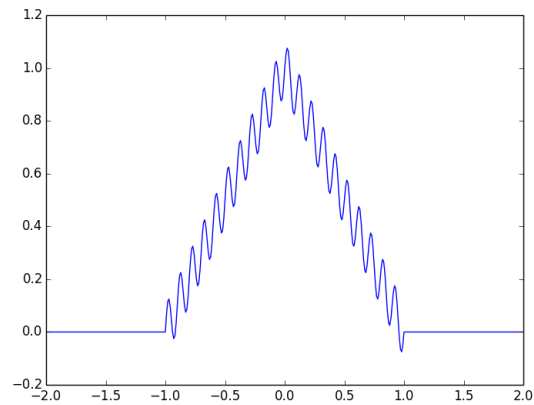

Figure 3.5: An oscillating basis function in 1D

3.3.1 Definition of the method

Let us assume that ω is a polyhedral, connected and bounded open subset of \mathbb{R}^{d-1} and let \mathcal{T}_ω^H be a conforming discretization of ω . Let us now define

$$\mathcal{T}_\Omega^H = \left\{ \tau \times \left(-\frac{1}{2}, \frac{1}{2}\right), \tau \in \mathcal{T}_\omega^H \right\}.$$

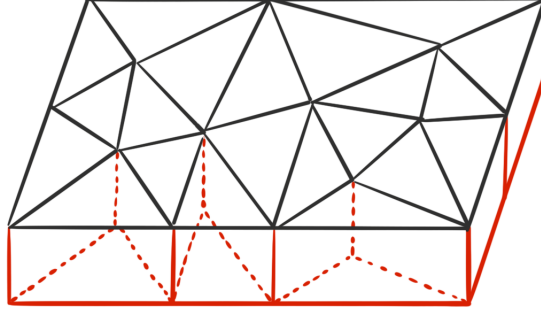

Figure 3.6: Coarse mesh \mathcal{T}_Ω^H of Ω obtained by extrusion of a coarse mesh \mathcal{T}_ω^H of ω .

Then, \mathcal{T}_Ω^H obviously defines a conforming discretization of Ω (see Figure 3.6).

To define the multiscale basis functions, we consider either the membrane or the bending case:

- in the membrane case, let V_H^M be the space of functions which belong to $(H_0^1(\omega))^{d-1}$ and which are piecewise affine on each element of \mathcal{T}_ω^H . We denote $(\phi_i)_i$ the canonical basis of V_H^M . For any ϕ_i , let $\psi_i := \begin{pmatrix} \phi_i \\ 0 \end{pmatrix}$. We observe that $\psi_i \in \mathcal{V}_{KL}^M$.
- in the bending case, let V_H^B be the space of functions which belong to $H_0^2(\omega)$ and which are piecewise cubic on each element of \mathcal{T}_ω^H . We denote $(\phi_i)_i$ the canonical basis of V_H^B . For any ϕ_i , let $\psi_i := \begin{pmatrix} -x_d \nabla' \phi_i \\ \phi_i \end{pmatrix}$. We observe that $\psi_i \in \mathcal{V}_{KL}^B$.

On any element $T = \tau \times \left(-\frac{1}{2}, \frac{1}{2}\right)$ of the coarse mesh \mathcal{T}_Ω^H of Ω , we define the oscillatory basis function ψ_i^ε associated to the single-scale basis function ψ_i as the solution to the following problem:

$$\begin{cases} -\operatorname{div}^\varepsilon A^\varepsilon e^\varepsilon(\psi_i^\varepsilon) = 0 & \text{in } T, \\ \psi_i^\varepsilon = \psi_i & \text{on } \partial\tau \times \left(-\frac{1}{2}, \frac{1}{2}\right), \\ A^\varepsilon e^\varepsilon(\psi_i^\varepsilon) \cdot e_d = 0 & \text{on } \tau \times \left\{\pm\frac{1}{2}\right\}. \end{cases} \quad (3.19)$$

We then introduce the MsFEM discretization space as $V_H^\varepsilon := \operatorname{Span}\{\psi_i^\varepsilon\}$ and let u_H^ε be the Galerkin's approximation of u^ε in V_H^ε . It is the unique solution in V_H^ε to the following variational formulation, which is the Galerkin approximation of (3.5):

$$\text{Find } u_H^\varepsilon \in V_H^\varepsilon \text{ such that, for any } v \in V_H^\varepsilon, \quad a^\varepsilon(u_H^\varepsilon, v) = b^\varepsilon(v).$$

3.3.2 Error estimates

As pointed out above, the MsFEM approach can be put in action for a large variety of heterogeneous materials. Its numerical analysis is however, to date, restricted to the periodic case (3.11). We have the following error estimate:

Theorem 3.11 (Membrane case). *Assume that we are in the membrane case. Under the assumptions of Theorem 3.9, we have*

$$\|u^\varepsilon - u_H^\varepsilon\|_{H_\varepsilon^1(\Omega)} \leq C \left(H + \sqrt{\varepsilon} + \sqrt{\frac{\varepsilon}{H}} \right) \|u^*\|_{H^2(\omega)}$$

where C is a constant independent of ε and H .

Theorem 3.12 (Bending case). *Assume that we are in the bending case. Under the assumptions of Theorem 3.10 and the additional assumption that $u_d^* \in H^4(\omega)$, we have*

$$\|u^\varepsilon - u_H^\varepsilon\|_{H_\varepsilon^1(\Omega)} \leq C \left(H^2 + \sqrt{\varepsilon} + \sqrt{\frac{\varepsilon}{H}} \right) \|u_d^*\|_{H^4(\omega)}$$

where C is a constant independent of ε and H .

The proofs of Theorems 3.11 and 3.12 are based on Theorems 3.9 and 3.10. They are postponed until Appendix 3.A.

3.4 Numerical results

The numerical tests of the MsFEM has two goals. First, we wish to check that our MsFEM approach provides accurate results. Second, we wish to check if the assumptions on the regularity of A^ε can be relaxed. Indeed, real materials are not smooth, and we would like our method to be able to tackle them. The numerical tests reported on below have been performed using FreeFEM++ [49].

3.4.1 Presentation of the test case

The numerical tests have been performed in dimension $d = 2$, with $\omega = (0, 1)$ and $\Omega = (0, 1) \times (-\frac{1}{2}, \frac{1}{2})$. The periodic cells are thus $Y := (0, 1)$ and $\mathcal{Y} = (0, 1) \times (-\frac{1}{2}, \frac{1}{2})$. We consider four periodic isotropic elasticity tensors and two non periodic ones. For $0 \leq q \leq 3$, we define $A_{\text{per},q}$ on \mathcal{Y} by: for any y in \mathcal{Y} ,

$$A_{\text{per},q}(y) := E_{\text{per},q}(y) \left(\frac{\nu}{(1+\nu)(1-2\nu)} \delta_{ij} \delta_{kl} + \frac{1}{2(1+\nu)} (\delta_{ik} \delta_{jl} + \delta_{il} \delta_{jk}) \right) e_i \otimes e_j \otimes e_k \otimes e_l.$$

Each of these four elasticity tensors has a constant Poisson coefficient $\nu = 0.3$ (which is e.g. close to the value of the Poisson coefficient of stainless steel). The different tensors are then characterized by their Young modulus. The four cases are

- a homogeneous tensor with $E_{\text{per},0}(y) := 1$;
- a smooth periodic tensor with $E_{\text{per},1}(y) := 4.5 \cos(2\pi y_1) + 5.5$ (see Figure 3.7); note that this is a lamellar case;
- a discontinuous periodic tensor with $E_{\text{per},2}(y) := 10 \mathbb{1}_{Y_1}(y_1) + \mathbb{1}_{Y_2}(y_1)$ where $Y_1 := [0, \frac{1}{4}] \cup [\frac{3}{4}, 1]$ and $Y_2 := [\frac{1}{4}, \frac{3}{4}]$ (see Figure 3.8); note that this is again a lamellar case;
- a second discontinuous and periodic tensor given by $E_{\text{per},3}(y) := 10 \mathbb{1}_{\mathcal{Y}_1}(y) + \mathbb{1}_{\mathcal{Y}_2}(y)$ where $\mathcal{Y}_2 := [\frac{1}{4}, \frac{3}{4}] \times [\frac{1}{4}, \frac{3}{4}]$ and $\mathcal{Y}_1 := \mathcal{Y} \setminus \mathcal{Y}_2$ (see Figure 3.9); in contrast to $E_{\text{per},2}$, this case is *not* a lamellar case.

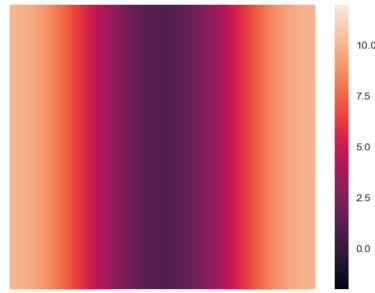

Figure 3.7: Plot of $y \mapsto E_{\text{per},1}(y)$



Figure 3.8: Plot of $y \mapsto E_{\text{per},2}(y)$

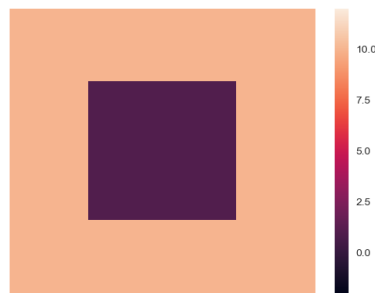

Figure 3.9: Plot of $y \mapsto E_{\text{per},3}(y)$

In addition, we consider two non periodic tensors which are given by

$$A_q(y) := E_q(y) \left(\frac{\nu}{(1+\nu)(1-2\nu)} \delta_{ij} \delta_{kl} + \frac{1}{2(1+\nu)} (\delta_{ik} \delta_{jl} + \delta_{il} \delta_{jk}) \right) e_i \otimes e_j \otimes e_k \otimes e_l$$

with two possible choices for the Young modulus, namely E_2 and E_3 . The non periodic case E_2 (resp. E_3) is obtained as a modification of the discontinuous and periodic case $E_{\text{per},2}$ (resp. $E_{\text{per},3}$). In each periodic cell of the material, we draw a random number $\theta \sim \mathcal{U}([-0.2, 0.2])$ (independently from one cell to another) and define E_i in that cell as $E_i(y) = E_{\text{per},i}(y_1 - \theta, y_2)$.

The elasticity tensor A^ε of (3.4) is then given by $A^\varepsilon(x) = A(x'/\varepsilon, x_d)$, where A is either of the six above choices.

The elasticity tensors $A_{\text{per},0}$ and $A_{\text{per},1}$ satisfy the assumptions of Theorems 3.9 and 3.10. The other tensors do not. We show below that, in the latter case, our MsFEM approach provides qualitative results similar to those of the former case, although of lower accuracy.

We choose two simple loads for the tests:

- $f_0 : x \mapsto e_1 \in \mathcal{E} \times \mathcal{O}$ for the membrane case;
- $f_1 : x \mapsto e_2 \in \mathcal{O} \times \mathcal{E}$ for the bending case.

3.4.2 Meshes and alternative MsFEM variants

The coarse mesh has been described in Section 3.3.1. In 2D, the coarse mesh is simple. We choose some $H > 0$, and

$$\mathcal{T}_\Omega^H := \left\{ T_i := \tau_i \times \left(-\frac{1}{2}, \frac{1}{2} \right), \tau_i := (iH, (i+1)H) \right\}.$$

Every element of the coarse mesh is next meshed with a fine triangular mesh of typical size $h \ll H$.

In order to get some intuition on the MsFEM approach introduced in Section 3.3.1, we momentarily consider the following test case. The plate is assumed to be of thickness $\varepsilon = 1$, to occupy the domain $\Omega = \Omega^\varepsilon = \omega \times \left(-\frac{1}{2}, \frac{1}{2} \right)$ with $\omega = (0, 10)$, to be modelled by the homogeneous elasticity tensor $A_{\text{per},0}$ and to be submitted to the load f_0 (thus corresponding to a membrane test case). We mesh $\omega = (0, 10)$ by 11 coarse elements of identical size, which yields the mesh \mathcal{T}_Ω^H of Ω . An appropriate fine mesh of each coarse element is introduced.

On Figure 3.10 (resp. Figure 3.11), we plot the reference solution (resp. the MsFEM solution) for that problem, in the sense that we represent the action of $\Omega \ni x \mapsto x + \begin{pmatrix} u_1^\varepsilon \\ 5 \times u_2^\varepsilon \end{pmatrix} (x)$ on the mesh to highlight qualitatively the differences between the two solutions. Significant qualitative errors can be observed, which are due to the fact that, in the membrane case, the exact displacement in the d -direction is small (of the order of ε^2 in the $L^2(\Omega)$ norm, see Theorem 3.9) but does not vanish. In contrast, in the numerical solution, it identically vanishes on the edges of each coarse element. Such a mismatch thus introduces numerical errors close to the boundaries of each coarse element. In order to address this problem, we consider two alternative MsFEM variants, an enriched variant and a non-conform variant.

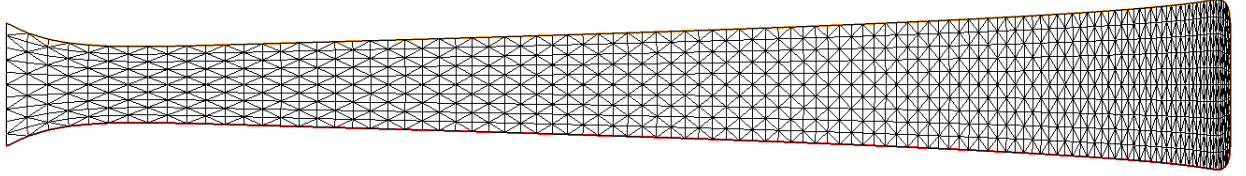

Figure 3.10: Reference solution.

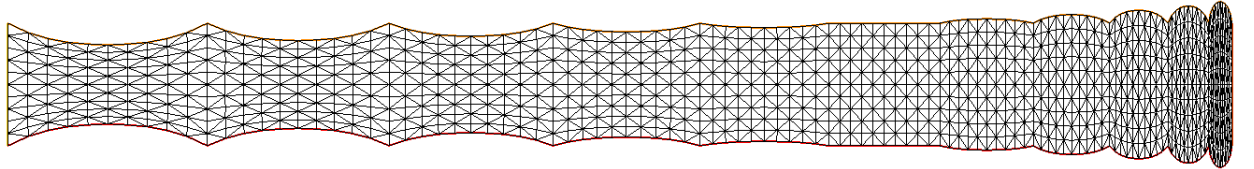

Figure 3.11: Numerical solution with the MsFEM approach of Section 3.3.1.

Enriched MsFEM variant

The first idea is to keep the MsFEM basis functions defined by (3.19) and to enrich the discretization space with new basis functions. This strategy is inspired by [84], where the authors approximate the coordinates of the displacement vector (for an elasticity problem posed in an isotropic and homogeneous plate) by functions of the form $w(x) = \sum_{i=0}^N (x_d)^i w^i(x')$, where the functions w^i are independent of x_d and chosen in relevant functional spaces. The article [84] states that, if one wants the approximation to be consistent (in a sense defined in the article), then the degree of the polynomial function in x_d has to be $N = 1$ for the $d - 1$ first coordinates of the displacement vector and $N = 2$ for the d -th coordinate. Due to the symmetries of the membrane case, this implies that the $d - 1$ first coordinates of the displacement should be approximated by functions independent of x_d , while the d -th coordinate should be approximated by a function which is linear in x_d .

The motivation of the MsFEM approach is of course to address heterogeneous problem, but we want the method to also be adequate for homogeneous cases. In the isotropic and homogeneous case, the solution to (3.19) is not independent of x_d because of the Neumann conditions on $\tau \times \{\pm \frac{1}{2}\}$. However, if we only look close enough to the boundary of each element, the function appears to be almost independent of x_d because of the Dirichlet conditions on $\partial\tau \times (-\frac{1}{2}, \frac{1}{2})$. This motivates us to add basis functions (in the MsFEM discretization space) whose d -th coordinate is linear with respect to x_d close to the boundary of the coarse elements.

For the same reason, in the bending case, we should add functions whose d -th coordinate is quadratic in x_d close to the boundary.

We thus introduce a so-called *enriched MsFEM* variant, where the discretization space is spanned by basis functions defined by (3.19) and by the additional basis functions $\{\psi_i^\varepsilon\}_i$ we define now as follows, in the two-dimensional case.

Additional basis function (Enriched MsFEM, membrane case): The function ψ_i^ε is supported in $T_i \cup T_{i+1}$, where we recall that $T_j = \tau_j \times (-\frac{1}{2}, \frac{1}{2})$ and $\tau_j = (jH, (j +$

1) H) for any j . It satisfies the following local problems:

$$\left\{ \begin{array}{l} -\operatorname{div}^\varepsilon A^\varepsilon e^\varepsilon(\psi_i^\varepsilon) = 0 \text{ in } T_i, \\ \psi_i^\varepsilon(iH, x_2) = 0, \\ \psi_i^\varepsilon((i+1)H, x_2) = x_2 e_2, \\ A^\varepsilon e^\varepsilon(\psi_i^\varepsilon) \cdot e_2 = 0 \text{ on } \tau_i \times \left\{ \pm \frac{1}{2} \right\} \end{array} \right. \quad \text{and} \quad \left\{ \begin{array}{l} -\operatorname{div}^\varepsilon A^\varepsilon e^\varepsilon(\psi_i^\varepsilon) = 0 \text{ in } T_{i+1}, \\ \psi_i^\varepsilon((i+1)H, x_2) = x_2 e_2, \\ \psi_i^\varepsilon((i+2)H, x_2) = 0, \\ A^\varepsilon e^\varepsilon(\psi_i^\varepsilon) \cdot e_2 = 0 \text{ on } \tau_{i+1} \times \left\{ \pm \frac{1}{2} \right\}. \end{array} \right. \quad (3.20)$$

Additional basis function (Enriched MsFEM, bending case)

$$\left\{ \begin{array}{l} -\operatorname{div}^\varepsilon A^\varepsilon e^\varepsilon(\psi_i^\varepsilon) = 0 \text{ in } T_i, \\ \psi_i^\varepsilon(iH, x_2) = 0, \\ \psi_i^\varepsilon((i+1)H, x_2) = x_2^2 e_2, \\ A^\varepsilon e^\varepsilon(\psi_i^\varepsilon) \cdot e_2 = 0 \text{ on } \tau_i \times \left\{ \pm \frac{1}{2} \right\} \end{array} \right. \quad \text{and} \quad \left\{ \begin{array}{l} -\operatorname{div}^\varepsilon A^\varepsilon e^\varepsilon(\psi_i^\varepsilon) = 0 \text{ in } T_{i+1}, \\ \psi_i^\varepsilon((i+1)H, x_2) = x_2^2 e_2, \\ \psi_i^\varepsilon((i+2)H, x_2) = 0, \\ A^\varepsilon e^\varepsilon(\psi_i^\varepsilon) \cdot e_2 = 0 \text{ on } \tau_{i+1} \times \left\{ \pm \frac{1}{2} \right\}. \end{array} \right. \quad (3.21)$$

The numerical analysis we made for the MsFEM method introduced in Section 3.3.1 uses the fact that the boundary conditions imposed in (3.19) are Kirchoff-Love displacements. We are thus in position to use Theorems 3.9 and 3.10, where we recall that the function g (which stands for possible non-homogeneous Dirichlet boundary conditions) belongs to \mathcal{G}_{KL} (see assumption (3.8)). The situation is different for the additional basis functions defined by (3.20) and (3.21). In particular, there is no function in \mathcal{V}_{KL} whose d -th coordinate has a trace on $\partial\tau \times \left(-\frac{1}{2}, \frac{1}{2}\right)$ which is a linear function of x_d . We thus cannot use Theorems 3.9 and 3.10 to identify the homogenized limit of (3.20) and (3.21). The numerical analysis of this enriched MsFEM variant is thus challenging. At least, since we are enlarging the discretization space (in comparison to that of the MsFEM method introduced in Section 3.3.1) and since the approximation remains conform, the estimates of Theorems 3.11 and 3.12 are still valid, although maybe not sharp.

To get some intuition on that enriched MsFEM variant, we again perform the test (for a homogeneous plate) described at the beginning of Section 3.4.2. The result for the enriched MsFEM variant is shown on Figure 3.12 (we recall that the reference solution is shown on Figure 3.10 and that the numerical solution obtained by the MsFEM approach is shown on Figure 3.11). We observe that adding those basis functions allows (at least in the membrane considered here) to significantly reduce the error at the boundaries of the coarse elements (compare e.g. Figures 3.12 and 3.11).

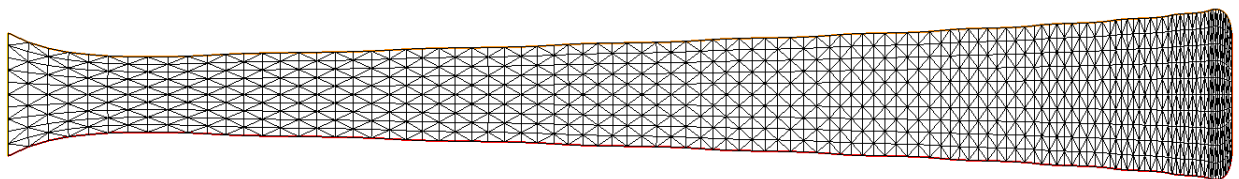

Figure 3.12: Numerical solution with the enriched MsFEM approach of Section 3.4.2.

Non-conform MsFEM variant

The second idea is to change the definition of the MsFEM basis functions, and hence to not consider at all the functions defined by (3.19). The boundary errors arise because of the homogeneous Dirichlet boundary condition on the d -th component of ψ_i^ε . It is therefore natural to consider a problem similar to (3.19), but where the boundary condition is somewhat relaxed. More precisely, the d -th component of ψ_i^ε remains free on $\partial\tau \times (-\frac{1}{2}, \frac{1}{2})$, and the Dirichlet boundary condition is replaced by a homogeneous Neumann boundary condition. The resulting basis functions do not belong to $H^1(\Omega)$, hence yielding a non conforming approach that we call the *non-conform MsFEM* variant in the sequel.

In dimension $d = 2$, and for the membrane case, the basis functions ψ_i^ε are supported in $T_i \cup T_{i+1}$, and are solutions to the following local problem on T_i :

$$\left\{ \begin{array}{l} -\operatorname{div}^\varepsilon A^\varepsilon e^\varepsilon(\psi_i^\varepsilon) = 0 \text{ in } T_i, \\ \psi_i^\varepsilon \cdot e_1 = \phi_i \cdot e_1 \text{ on } \partial\tau_i \times \left(-\frac{1}{2}, \frac{1}{2}\right), \\ A^\varepsilon e^\varepsilon(\psi_i^\varepsilon) : (e_2 \otimes e_2) = 0 \text{ on } \partial\tau_i \times \left(-\frac{1}{2}, \frac{1}{2}\right), \\ A^\varepsilon e^\varepsilon(\psi_i^\varepsilon) \cdot e_2 = 0 \text{ on } \tau_i \times \left\{\pm\frac{1}{2}\right\} \end{array} \right. \quad (3.22)$$

and, on T_{i+1} ,

$$\left\{ \begin{array}{l} -\operatorname{div}^\varepsilon A^\varepsilon e^\varepsilon(\psi_i^\varepsilon) = 0 \text{ in } T_{i+1}, \\ \psi_i^\varepsilon \cdot e_1 = \phi_i \cdot e_1 \text{ on } \partial\tau_{i+1} \times \left(-\frac{1}{2}, \frac{1}{2}\right), \\ A^\varepsilon e^\varepsilon(\psi_i^\varepsilon) : (e_2 \otimes e_2) = 0 \text{ on } \partial\tau_{i+1} \times \left(-\frac{1}{2}, \frac{1}{2}\right), \\ A^\varepsilon e^\varepsilon(\psi_i^\varepsilon) \cdot e_2 = 0 \text{ on } \tau_{i+1} \times \left\{\pm\frac{1}{2}\right\}. \end{array} \right. \quad (3.23)$$

Recall that the functions ϕ_i form a basis for the space V_H^M of functions which belong to $(H_0^1(\omega))^{d-1}$ and which are piecewise affine on each element of \mathcal{T}_ω^H .

We have not found a meaningful equivalent of these basis functions for the bending case.

We again perform the test (for a homogeneous plate) described at the beginning of Section 3.4.2. The result for the non-conform MsFEM variant is shown on Figure 3.13 (we recall that the reference solution is shown on Figure 3.10, that the numerical solution obtained by the MsFEM approach is shown on Figure 3.11 and that the numerical solution obtained by the enriched MsFEM approach is shown on Figure 3.12). We observe that this non-conform variant yields a numerical solution with small errors at the boundaries of the coarse elements.

3.4.3 Numerical results

There are three regimes for MsFEM approaches, depending on the relative values of ε and H . When $H \gg \varepsilon$, we can recast Theorem 3.11 for the membrane case as

$$\|u^\varepsilon - u_H^\varepsilon\|_{H_\varepsilon^1(\Omega)} \leq CH \|u_1^*\|_{H^2(\omega)}$$

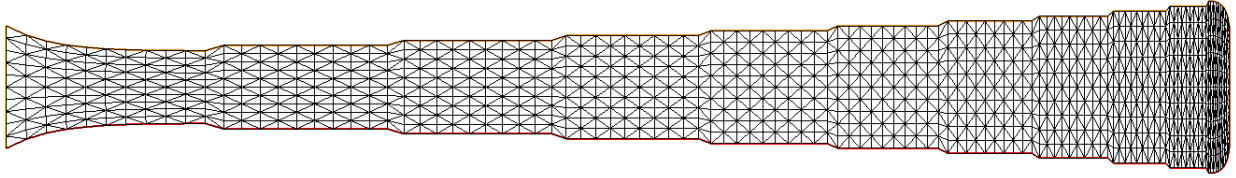

Figure 3.13: Numerical solution with the non-conform MsFEM approach of Section 3.4.2.

and Theorem 3.12 for the bending case as

$$\|u^\varepsilon - u_H^\varepsilon\|_{H_\varepsilon^1(\Omega)} \leq CH^2 \|u_2^*\|_{H^4(\omega)}.$$

When $H \approx \varepsilon$, MsFEM approaches often show a plateau in the convergence plot. The last regime is when $H \ll \varepsilon$, a regime we do not consider since it leads in practice to prohibitively expensive computations.

Convergence of the error when H varies

We begin our numerical investigations by fixing the value of ε and varying the coarse mesh size H . The values of H we consider range from values much larger than ε to values slightly smaller than ε . We successively discuss the behavior of the error for the various elastic materials described in Section 3.4.1.

Homogeneous and smooth periodic cases. Figures 3.14 and 3.15 show the H_ε^1 relative error in the homogeneous case and in the smooth periodic case. Those are the cases where the hypothesis of Theorems 3.11 and 3.12 are met.

In the regime $H \gg \varepsilon$, we observe for the MsFEM approach that the error varies with respect to H as predicted by our theoretical estimate, i.e. essentially in a linear manner. This is also the case for the two variants we have next introduced, which give results very close to the MsFEM. We also note that the threshold value of H (below which the behavior changes) is larger in the bending case than in the membrane case.

When H is close to ε , the error of the MsFEM method does not decrease anymore when H decreases. A plateau seems to be reached. The enriched variant performs much better than the original approach. In the membrane case, it yields an error which remains linear in terms of H , even in the regime $H \approx \varepsilon$. This could mean that the boundary error identified on Figure 3.11 has been successfully corrected. In the bending case, the behavior of the enriched MsFEM (although better than the MsFEM approach) is not as good as in the membrane case. It is unclear to us whether there could be other simple ways to enrich the MsFEM in the bending case in order to remove the plateau. Except for the very specific case of a homogeneous plate, the non-conform MsFEM method performs similarly to the MsFEM.

Discontinuous periodic cases and non periodic cases. Figures 3.16 and 3.17 show the H_ε^1 relative error in the periodic discontinuous cases, and in the non periodic cases. Those cases do not meet the hypothesis of Theorems 3.11 and 3.12, but they may be more realistic from an engineering point of view. The behavior of MsFEM and its variants is essentially the same in these cases as in the previous cases. In particular, in the membrane case, the enriched variant outperforms the two other approaches. In the bending case, this is not the case, and the enriched variant performances are very close to those of MsFEM.

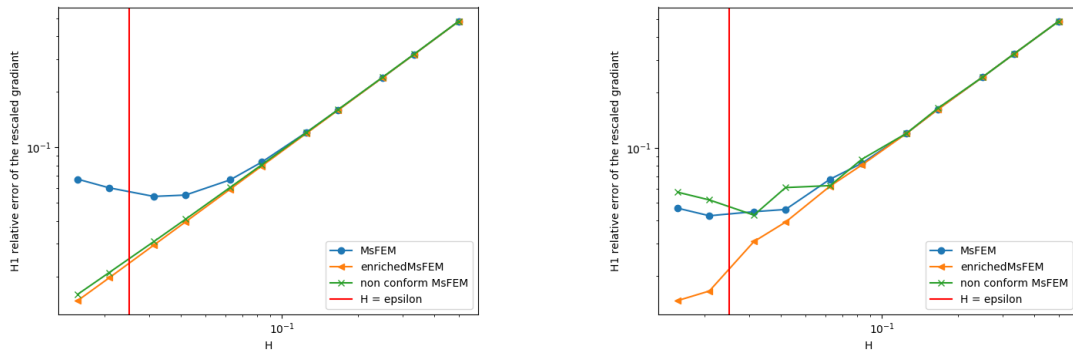

Figure 3.14: H_ϵ^1 relative error in log-log scale, for $\epsilon = 1/40$, $h = 1/768$, $f = f_0$ (membrane case), $A^\epsilon = A_{\text{per},0}(\cdot/\epsilon, \cdot)$ (left) and $A^\epsilon = A_{\text{per},1}(\cdot/\epsilon, \cdot)$ (right)

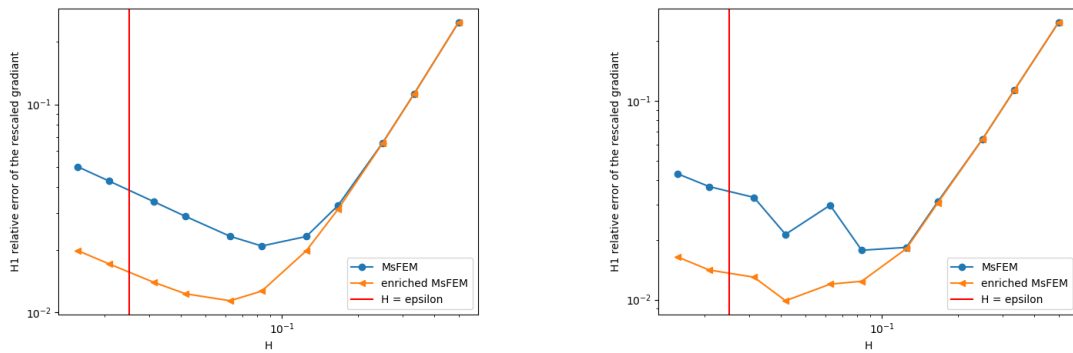

Figure 3.15: H_ϵ^1 relative error in log-log scale, for $\epsilon = 1/40$, $h = 1/768$, $f = f_1$ (bending case), $A^\epsilon = A_{\text{per},0}(\cdot/\epsilon, \cdot)$ (left) and $A^\epsilon = A_{\text{per},1}(\cdot/\epsilon, \cdot)$ (right)

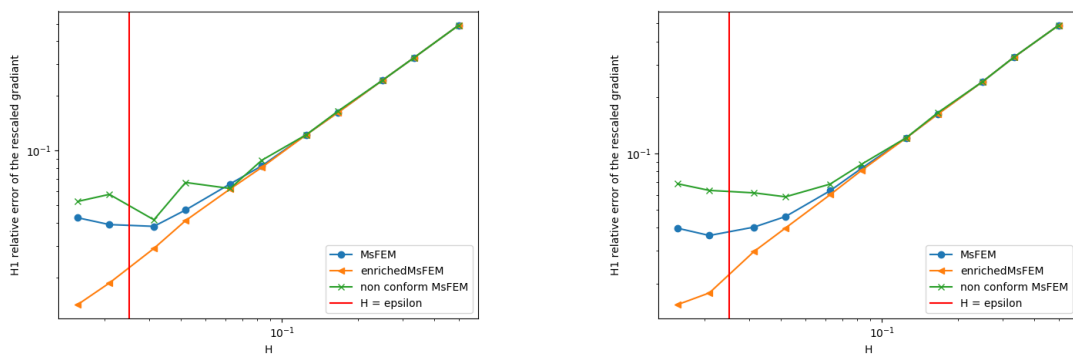

Figure 3.16: H_ϵ^1 relative error in log-log scale, for $\epsilon = 1/40$, $h = 1/768$, $f = f_0$ (membrane case), $A^\epsilon = A_{\text{per},2}(\cdot/\epsilon, \cdot)$ (left) and $A^\epsilon = A_2(\cdot/\epsilon, \cdot)$ (right)

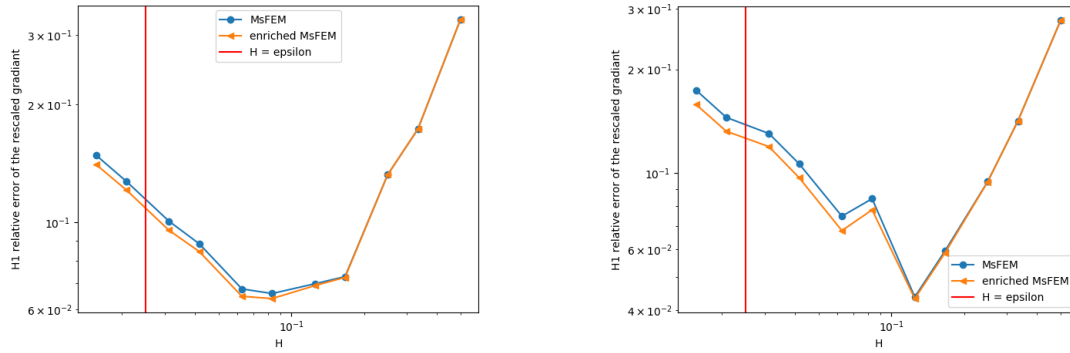

Figure 3.17: H_ϵ^1 relative error in log-log scale, for $\varepsilon = 1/40$, $h = 1/768$, $f = f_1$ (bending case), $A^\varepsilon = A_{\text{per},3}(\cdot/\varepsilon, \cdot)$ (left) and $A^\varepsilon = A_3(\cdot/\varepsilon, \cdot)$ (right)

Robustness of the error when ε varies

In this section, we fix the coarse mesh size, and we investigate the behavior of the approaches when ε varies. Results are shown on Figures 3.18, 3.19, 3.20 and 3.21. Our first observation is that the error does not blow up when ε goes to 0 (in sharp contrast with what would happen for a standard Finite Element approach). Our second observation is that the enriched variant performances are always similar (if not better) than those of the two other variants. These superior performances are observed irrespectively of the material (should it be periodic or not, smooth or not) and of the loading type (membrane or bending).

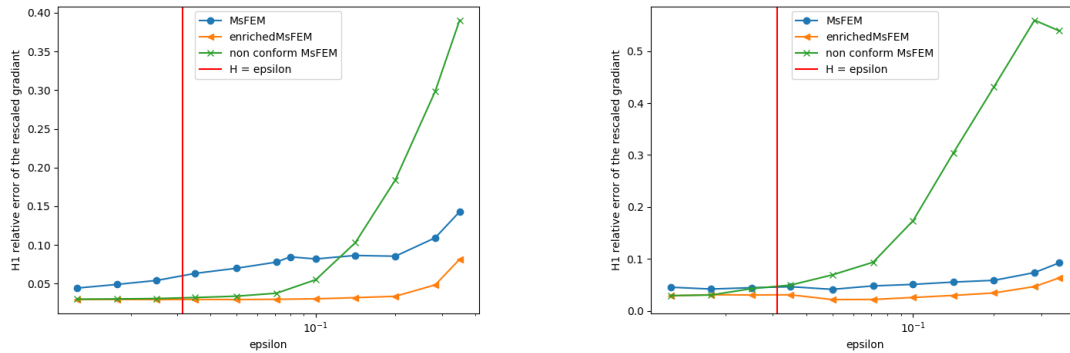

Figure 3.18: H_ϵ^1 relative error in log scale, for $H = 1/32$, $h = 1/768$, $f = f_0$ (membrane case), $A^\varepsilon = A_{\text{per},0}(\cdot/\varepsilon, \cdot)$ (left) and $A^\varepsilon = A_{\text{per},1}(\cdot/\varepsilon, \cdot)$ (right)

3.5 Conclusion

In this article, we have introduced several MsFEM approaches to approximate the solution of elasticity problems posed on thin plates. We have also established error estimates for one of these approaches. The performances of these approaches have been investigated on several two-dimensional test cases. We have observed that, in the practically relevant regime when $\varepsilon \ll 1$ and $\varepsilon < H$, the rate of convergence of the error estimate is sharp. The enriched variant, motivated by heuristic observations of some shortcomings for the original MsFEM approach, appears to be a competitive method, which performs very well in the bending case, and extremely well in the membrane case. The performances of all the approaches seem to be very robust with respect to

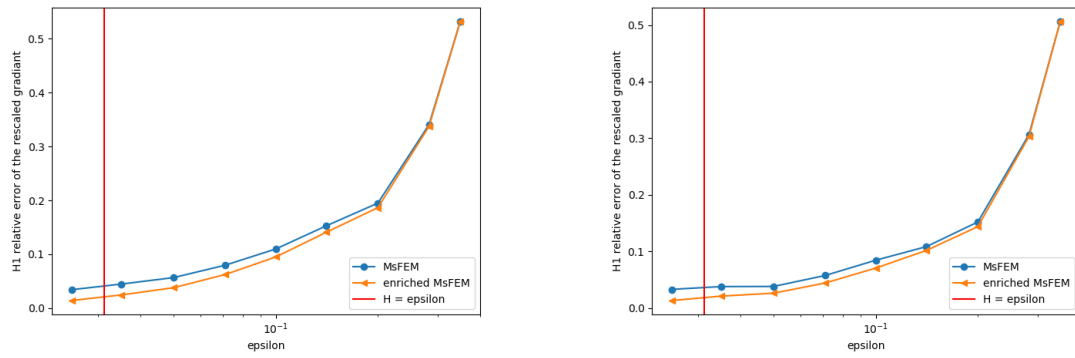

Figure 3.19: H_ε^1 relative error in log scale, for $H = 1/32$, $h = 1/768$, $f = f_1$ (bending case), $A^\varepsilon = A_{\text{per},0}(\cdot/\varepsilon, \cdot)$ (left) and $A^\varepsilon = A_{\text{per},1}(\cdot/\varepsilon, \cdot)$ (right)

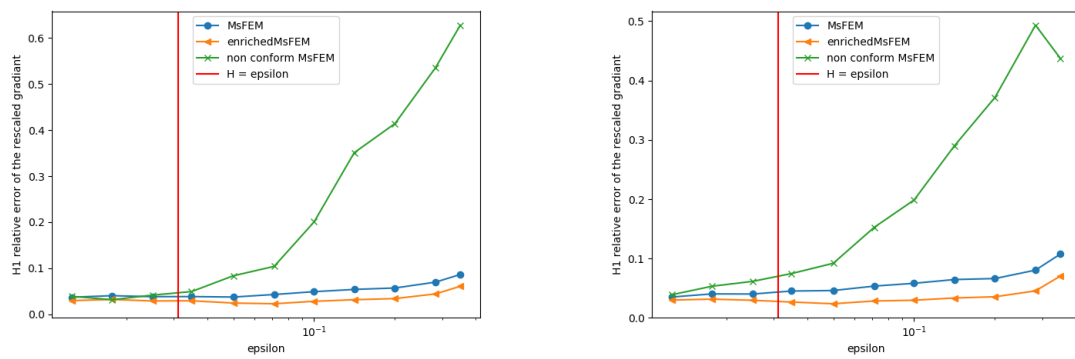

Figure 3.20: H_ε^1 relative error in log scale, for $H = 1/32$, $h = 1/768$, $f = f_0$ (membrane case), $A^\varepsilon = A_{\text{per},2}(\cdot/\varepsilon, \cdot)$ (left) and $A^\varepsilon = A_2(\cdot/\varepsilon, \cdot)$ (right)

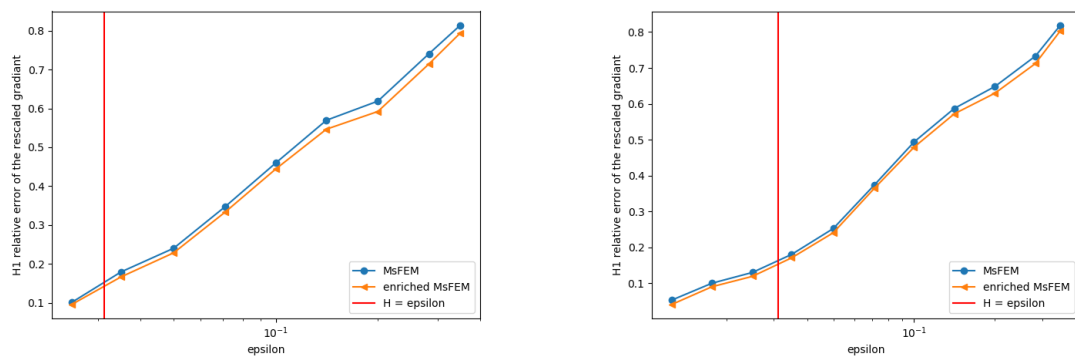

Figure 3.21: H_ε^1 relative error in log scale, for $H = 1/32$, $h = 1/768$, $f = f_0$ (membrane case), $A^\varepsilon = A_{\text{per},3}(\cdot/\varepsilon, \cdot)$ (left) and $A^\varepsilon = A_3(\cdot/\varepsilon, \cdot)$ (right)

the possible lack of periodicity of the microstructure, and possible discontinuities in the coefficients.

3.A Proof of the error estimates

We collect here the proofs of Theorems 3.11 and 3.12.

3.A.1 Membrane case

Before giving the proof of Theorem 3.11, we prove the following lemma.

Lemma 3.13. *Let ψ_i^ε be defined by (3.19). Then, for any $T \in \mathcal{T}_\Omega^H$, we have $\psi_i^\varepsilon \xrightarrow{\varepsilon \rightarrow 0} \psi_i$ in $H^1(T)$.*

Proof. Using Theorem 3.7, we know that $\psi_i^\varepsilon \xrightarrow{\varepsilon \rightarrow 0} \psi_i^*$ in $H^1(T)$ where ψ_i^* is the solution to

$$\begin{cases} -\operatorname{div} A_{\mathcal{M}}^* e(\psi_i^*) = 0 & \text{in } \tau, \\ \psi_i^* = \psi_i & \text{on } \partial\tau. \end{cases}$$

The problem is well posed and has a unique solution which is ψ_i . \square

Proof of Theorem 3.11. The proof falls in three steps.

Step 1. Let $H := |\tau|^{\frac{1}{d-1}}$. We have assumed that $u^* \in W^{2,\infty}(\omega)$. It is thus possible to approximate u^* using elements of $\mathbb{P}^1(\omega)$ (see e.g. [89]):

$$\exists (\alpha_i)_{i < N}, \|u^* - \alpha_i \psi_i\|_{H^1(\omega)} \leq CH \|u^*\|_{H^2(\omega)}$$

where C is independent of ε and H . The functions u^* and ψ_i are in \mathcal{V}_{KL} , thus it is equivalent to write

$$\|u^* - \alpha_i \psi_i\|_{H_\varepsilon^1(\Omega)} \leq CH \|u^*\|_{H^2(\omega)}. \quad (3.24)$$

Let $(\psi_i^\varepsilon)_i$ be the set of functions defined by (3.19). Because of Lemma 3.13 and Theorem 3.10 we know that

$$\psi_i^\varepsilon = \psi_i + \varepsilon w_{\alpha\beta} \left(\frac{\cdot}{\varepsilon}, \cdot \right) e_{\alpha\beta}(\psi_i) + \theta_i^\varepsilon,$$

and thus

$$\begin{cases} \psi_i^\varepsilon \cdot e_\sigma = \psi_i \cdot e_\sigma + \varepsilon w_{\alpha\beta} \left(\frac{\cdot}{\varepsilon}, \cdot \right) \cdot e_\sigma e_{\alpha\beta}(\psi_i) + \theta_i^\varepsilon \cdot e_\sigma, \\ \psi_i^\varepsilon \cdot e_d = \varepsilon^2 w_{\alpha\beta} \left(\frac{\cdot}{\varepsilon}, \cdot \right) \cdot e_d e_{\alpha\beta}(\psi_i) + \theta_i^\varepsilon \cdot e_d, \end{cases}$$

with

$$\|\theta_i\|_{H_\varepsilon^1(T)} \leq C\sqrt{\varepsilon} H^{\frac{d-2}{2}} \|e(\psi_i)\|_{L^2(\tau)} + C\varepsilon H^{\frac{d-1}{2}} \|\nabla^2 \psi_i\|_{L^2(\tau)}.$$

In the sequel we assume that $\sqrt{H\varepsilon} \ll 1$, thus

$$\|\theta_i\|_{H_\varepsilon^1(T)} \leq C\sqrt{\varepsilon} H^{\frac{d-2}{2}} \|e(\psi_i)\|_{L^2(T)}.$$

Let u_H^ε be the Galerkin approximation of u^ε in V_H^ε . Let $v^\varepsilon := \alpha_i \psi_i^\varepsilon$. By definition, $v^\varepsilon \in V_H^\varepsilon$. Then, using C ea's lemma, we have

$$\begin{aligned} \|u^\varepsilon - u_H^\varepsilon\|_{H_\varepsilon^1(\Omega)} &\leq C \|u^\varepsilon - v^\varepsilon\|_{H_\varepsilon^1(\Omega)} \\ &\leq C \|u^\varepsilon - u^{\varepsilon,1}\|_{H_\varepsilon^1(\Omega)} + C \|u^{\varepsilon,1} - v^\varepsilon\|_{H_\varepsilon^1(\Omega)}. \end{aligned} \quad (3.25)$$

The first term is bounded with Theorem 3.10:

$$\|u^\varepsilon - u^{\varepsilon,1}\|_{H_\varepsilon^1(\Omega)} \leq C\sqrt{\varepsilon}\|\nabla u^*\|_{L^2(\omega)}. \quad (3.26)$$

Step 2. We now bound the second term of (3.25). Let $\Theta^\varepsilon := \alpha_i \theta_i^\varepsilon$. By definition of $u^{\varepsilon,1}$ and v^ε ,

$$u^{\varepsilon,1} - v^\varepsilon = u^* - \alpha_i \psi_i + \varepsilon w_{\alpha\beta} \left(\frac{\cdot}{\varepsilon}, \cdot \right) (e_{\alpha\beta}(u^*) - \alpha_i e_{\alpha\beta}(\psi_i)) - \Theta^\varepsilon$$

and

$$\begin{aligned} e^\varepsilon(u^{\varepsilon,1} - v^\varepsilon) &= \left(e_\alpha \otimes e_\beta + e(w_{\alpha\beta}) \left(\frac{\cdot}{\varepsilon}, \cdot \right) \right) (e_{\alpha\beta}(u^*) - \alpha_i e_{\alpha\beta}(\psi_i)) \\ &\quad + \varepsilon w_{\alpha\beta} \left(\frac{\cdot}{\varepsilon}, \cdot \right) e(e_{\alpha\beta}(u^*) - \alpha_i e_{\alpha\beta}(\psi_i)) - e^\varepsilon(\Theta^\varepsilon). \end{aligned}$$

The functions $(\psi_i^\varepsilon)_i$ are defined as solutions to a PDE posed on each element of the mesh. We will then use the results of the asymptotic analysis on each element:

$$\|e^\varepsilon(u^{\varepsilon,1} - v^\varepsilon)\|_{L^2(\Omega)}^2 = \sum_{T \in \mathcal{T}_\Omega^H} \|e^\varepsilon(u^{\varepsilon,1} - v^\varepsilon)\|_{L^2(T)}^2. \quad (3.27)$$

First, we split this term in three parts that we will tackle separately:

$$\begin{aligned} \|e^\varepsilon(u^{\varepsilon,1} - v^\varepsilon)\|_{L^2(T)} &\leq \left\| \left(e_\alpha \otimes e_\beta + e(w_{\alpha\beta}) \left(\frac{\cdot}{\varepsilon}, \cdot \right) \right) (e_{\alpha\beta}(u^*) - \alpha_i e_{\alpha\beta}(\psi_i)) \right\|_{L^2(T)} \\ &\quad + \varepsilon \left\| w_{\alpha\beta} \left(\frac{\cdot}{\varepsilon}, \cdot \right) e(e_{\alpha\beta}(u^*) - \alpha_i e_{\alpha\beta}(\psi_i)) \right\|_{L^2(T)} + \|e^\varepsilon(\Theta^\varepsilon)\|_{L^2(T)}. \end{aligned} \quad (3.28)$$

The first term of (3.28) is bounded because of (3.24) and of the regularity of the correctors, which are supposed to be in $W^{1,\infty}(\mathbb{R}^{d-1} \times (-\frac{1}{2}, \frac{1}{2}))$:

$$\begin{aligned} \left\| \left(e_\alpha \otimes e_\beta + e(w_{\alpha\beta}) \left(\frac{\cdot}{\varepsilon}, \cdot \right) \right) (e_{\alpha\beta}(u^*) - \alpha_i e_{\alpha\beta}(\psi_i)) \right\|_{L^2(T)}^2 &\leq C \|e'(u^*) - \alpha_i e'(\psi_i)\|_{L^2(T)}^2 \\ &\leq CH^2 \|u^*\|_{H^2(T)}. \end{aligned} \quad (3.29)$$

We also use the regularity of the correctors to bound the second term of (3.28):

$$\begin{aligned} \varepsilon^2 \left\| w_{\alpha\beta} \left(\frac{\cdot}{\varepsilon}, \cdot \right) e(e_{\alpha\beta}(u^*) - \alpha_i e_{\alpha\beta}(\psi_i)) \right\|_{L^2(T)}^2 &\leq C\varepsilon^2 \|\nabla^2 u^* - \alpha_i \nabla^2 \psi_i\|_{L^2(T)}^2 \\ &= C\varepsilon^2 \|\nabla^2 u^*\|_{L^2(T)}^2, \end{aligned} \quad (3.30)$$

where the last equality comes from the fact that the ψ_i are affine.

We have to be careful with the remaining term. Indeed it is possible to bound separately the θ_i^ε , but α_i are dependent of H . We note that on each T , v^ε is solution to

$$\begin{cases} -\operatorname{div}^\varepsilon A^\varepsilon e^\varepsilon(v^\varepsilon) = 0 & \text{in } T, \\ v^\varepsilon = \alpha_i \psi_i & \text{on } \partial\tau \times \left(-\frac{1}{2}, \frac{1}{2}\right), \\ A^\varepsilon e^\varepsilon(v^\varepsilon) \cdot e_d = 0 & \text{on } \tau \times \left\{\pm \frac{1}{2}\right\}. \end{cases}$$

Because of Theorem 3.10, we know that

$$\begin{aligned} \|\Theta^\varepsilon\|_{H_\varepsilon^1(T)} &= \left\| v^\varepsilon - \alpha_i \psi_i - \varepsilon \begin{pmatrix} w'_{\alpha\beta} \\ \varepsilon w_{\alpha\beta} \cdot e_d \end{pmatrix} \left(\frac{\cdot}{\varepsilon}, \cdot \right) e_{\alpha\beta}(\alpha_i \psi_i) \right\|_{H_\varepsilon^1(T)} \\ &\leq C\sqrt{\varepsilon}|T|^{\frac{d-2}{2d-2}} \|\alpha_i e(\psi_i)\|_{W^{1,\infty}(\tau)}. \end{aligned}$$

The ψ_i are affine functions, therefore $\|\alpha_i e(\psi_i)\|_{W^{1,\infty}(\tau)} = \frac{1}{|\tau|^{\frac{1}{2}}} \|\alpha_i e(\psi_i)\|_{L^2(\tau)}$. Then

$$\|\Theta^\varepsilon\|_{H_\varepsilon^1(T)} \leq C\sqrt{\varepsilon}|\tau|^{-\frac{1}{2d-2}} \|\alpha_i e(\psi_i)\|_{L^2(\tau)}.$$

Yet $|\tau| = H^{d-1}$ then $|\tau|^{-\frac{1}{2d-2}} = \frac{1}{\sqrt{H}}$, thus

$$\|\Theta^\varepsilon\|_{H_\varepsilon^1(T)} \leq C\sqrt{\frac{\varepsilon}{H}} \|\alpha_i e(\psi_i)\|_{L^2(\tau)}.$$

We use (3.24) to recast this term as

$$\begin{aligned} \|\alpha_i e(\psi_i)\|_{L^2(\tau)} &\leq \|\alpha_i e'(\psi_i) - e'(u^*)\|_{L^2(\tau)} + \|e'(u^*)\|_{L^2(\tau)} \\ &\leq CH + \|u^*\|_{H^1(\tau)} \\ &\leq \|u^*\|_{H^1(\tau)} \quad \text{for } H \text{ small enough,} \end{aligned}$$

and thus

$$\|\Theta^\varepsilon\|_{H^1(T)} \leq C\sqrt{\frac{\varepsilon}{H}} \|u^*\|_{H^1(\tau)}. \quad (3.31)$$

Collecting (3.27), (3.26), (3.28), (3.29), (3.30) and (3.31),

$$\begin{aligned} \|e^\varepsilon(u^{\varepsilon,1} - v^\varepsilon)\|_{L^2(\Omega)}^2 &\leq C \left(H^2 + \varepsilon^2 + \frac{\varepsilon}{H} \right) \sum_{\tau \in \mathcal{T}_\omega^H} \|u^*\|_{H^2(\tau)}^2 \\ &\leq C \left(H^2 + \varepsilon^2 + \frac{\varepsilon}{H} \right) \|u^*\|_{H^2(\omega)}^2 \end{aligned}$$

because we supposed that $u^* \in W^{2,\infty}(\omega) \subset H^2(\omega)$. We use the Poincaré inequality of Lemma 3.4 to write

$$\|u^{\varepsilon,1} - v^\varepsilon\|_{H_\varepsilon^1(\Omega)} \leq C \left(H + \varepsilon + \sqrt{\frac{\varepsilon}{H}} \right) \|u^*\|_{H^2(\omega)}. \quad (3.32)$$

Step 3. Using (3.25), (3.32) and Theorem 3.9, we have shown that

$$\|u^{\varepsilon,1} - u_H^\varepsilon\|_{H_\varepsilon^1(\Omega)} \leq C \left(H + \sqrt{\varepsilon} + \sqrt{\frac{\varepsilon}{H}} \right) \|u^*\|_{H^2(\omega)}.$$

This concludes the proof of Theorem 3.11. \square

3.A.2 Bending case

Before giving the proof of Theorem 3.12, we prove the following lemma.

Lemma 3.14. *For any $T \in \mathcal{T}_\Omega^H$, we have $\psi_i^\varepsilon \xrightarrow{\varepsilon \rightarrow 0} \psi_i$ in $H^1(T)$.*

Proof. Using Theorem 3.8, we know that $\psi_i^\varepsilon \xrightarrow{\varepsilon \rightarrow 0} \psi_i^*$ in $H^1(T)$, where ψ_i^* is the solution to

$$\begin{cases} \nabla^2 A_B^* \nabla^2(\psi_i^*)_d = 0 & \text{in } \tau, \\ (\psi_i^*)_d = (\psi_i)_d & \text{on } \partial\tau, \\ \nabla(\psi_i^*)_d = \nabla(\psi_i)_d & \text{on } \partial\tau. \end{cases}$$

The problem is well posed and has a unique solution which is $(\psi_i)_d$. \square

Proof of Theorem 3.12. The proof falls in three steps.

Step 1. Let $H := |\tau|^{\frac{1}{d-1}}$. We have assumed that $u_d^* \in W^{3,\infty}(\omega)$. It is thus possible to approximate u_d^* using elements of $\mathbb{P}^3(\omega)$ (see e.g. [89]):

$$\exists(\alpha_i)_{i < N}, \|u_d^* - \alpha_i(\psi_i)_d\|_{H^2(\omega)} \leq CH^2 \|u^*\|_{H^4(\omega)},$$

where C is independent of ε and H . The functions u^* and ψ_i are in \mathcal{V}_{KL}^B , thus it implies that

$$\|e^\varepsilon(u^* - \alpha_i\phi_i)\|_{L^2(\omega)} = \frac{1}{12} \|\nabla^2(u_d^* - \alpha_i(\phi_i)_d)\|_{L^2(\omega)}^2 \leq CH^2 \|u^*\|_{H^4(\omega)}$$

and that

$$\|u^* - \alpha_i\phi_i\|_{H_\varepsilon^1(\Omega)} \leq CH^2 \|u^*\|_{H^4(\omega)}. \quad (3.33)$$

Let $(\psi_i^\varepsilon)_i$ be the set of functions defined by (3.19). Because of Lemma 3.14 and Theorem 3.10 we know that

$$\begin{cases} \psi_i^\varepsilon \cdot e_\sigma = \psi_i \cdot e_\sigma + \varepsilon w_B^{\alpha\beta} \left(\frac{\cdot}{\varepsilon}, \cdot \right) \cdot e_\sigma e_{\alpha\beta}(\psi_i) + \theta_i^\varepsilon \cdot e_\sigma, \\ \psi_i^\varepsilon \cdot e_d = \psi_i \cdot e_d + \varepsilon^2 w_B^{\alpha\beta} \left(\frac{\cdot}{\varepsilon}, \cdot \right) \cdot e_d e_{\alpha\beta}(\psi_i) + \theta_i^\varepsilon \cdot e_d, \end{cases}$$

with

$$\|\theta_i\|_{H_\varepsilon^1(T)} \leq C\sqrt{\varepsilon}H^{\frac{d-2}{2}} \|e(\psi_i)\|_{L^2(T)} + C\varepsilon H^{\frac{d-1}{2}} \|\nabla^2\psi_i\|_{L^2(T)}.$$

In the sequel we assume that $\sqrt{H\varepsilon} \ll 1$, thus

$$\|\theta_i\|_{H_\varepsilon^1(T)} \leq C\sqrt{\varepsilon}H^{\frac{d-2}{2}} \|e(\psi_i)\|_{L^2(T)}.$$

Let u_H^ε be the Galerkin approximation of u^ε in V_H^ε . Let $v^\varepsilon := \alpha_i\psi_i^\varepsilon$. By definition, $v^\varepsilon \in V_H^\varepsilon$. Then, using Céa's lemma, we have

$$\begin{aligned} \|u^\varepsilon - u_H^\varepsilon\|_{H_\varepsilon^1(\Omega)} &\leq C\|u^\varepsilon - v^\varepsilon\|_{H_\varepsilon^1(\Omega)} \\ &\leq C\|u^\varepsilon - u^{\varepsilon,1}\|_{H_\varepsilon^1(\Omega)} + C\|u^{\varepsilon,1} - v^\varepsilon\|_{H_\varepsilon^1(\Omega)}. \end{aligned} \quad (3.34)$$

The first term is bounded with Theorem 3.10:

$$\|u^\varepsilon - u^{\varepsilon,1}\|_{H_\varepsilon^1(\Omega)} \leq C\sqrt{\varepsilon}\|\nabla u^*\|_{L^2(\omega)}. \quad (3.35)$$

Step 2. We now bound the second term of (3.34). Let $\Theta^\varepsilon := \alpha_i\theta_i^\varepsilon$. By definition of $u^{\varepsilon,1}$ and v^ε ,

$$\begin{aligned} e^\varepsilon(u^{\varepsilon,1} - v^\varepsilon) &= \left(-x_d e_\alpha \otimes e_\beta + e(w_B^{\alpha\beta}) \left(\frac{\cdot}{\varepsilon}, \cdot \right) \right) (\partial_{\alpha\beta}(u_d^*) - \alpha_i \partial_{\alpha\beta}(\psi_i)_d) \\ &\quad + \varepsilon w_B^{\alpha\beta} \left(\frac{\cdot}{\varepsilon}, \cdot \right) e(\partial_{\alpha\beta}(u_d^*) - \alpha_i \partial_{\alpha\beta}(\psi_i)_d) - e^\varepsilon(\Theta^\varepsilon). \end{aligned}$$

The functions $(\psi_i^\varepsilon)_i$ are defined as solutions to a PDE posed on each element of the mesh. We will then use the results of the asymptotic analysis on each element:

$$\|e^\varepsilon(u^{\varepsilon,1} - v^\varepsilon)\|_{L^2(\Omega)}^2 = \sum_{T \in \mathcal{T}_\Omega^H} \|e^\varepsilon(u^{\varepsilon,1} - v^\varepsilon)\|_{L^2(T)}^2. \quad (3.36)$$

First, we split this term in three parts that we will tackle separately:

$$\begin{aligned} \|e^\varepsilon(u^{\varepsilon,1} - v^\varepsilon)\|_{L^2(T)} &\leq \left\| \left(-x_d e_\alpha \otimes e_\beta + e(w_B^{\alpha\beta}) \left(\frac{\cdot}{\varepsilon}, \cdot \right) \right) (\partial_{\alpha\beta}(u_d^*) - \alpha_i \partial_{\alpha\beta}(\psi_i)_d) \right\|_{L^2(T)} \\ &\quad + \varepsilon \left\| w_B^{\alpha\beta} \left(\frac{\cdot}{\varepsilon}, \cdot \right) e(\partial_{\alpha\beta}(u_d^*) - \alpha_i \partial_{\alpha\beta}(\psi_i)_d) \right\|_{L^2(T)} + \|e^\varepsilon(\Theta^\varepsilon)\|_{L^2(T)}. \end{aligned} \quad (3.37)$$

The first term of (3.37) is bounded because of (3.33) and of the regularity of the correctors, which are supposed to be in $W^{1,\infty}(\mathbb{R}^{d-1} \times (-\frac{1}{2}, \frac{1}{2}))$:

$$\begin{aligned} \left\| \left(-x_d e_\alpha \otimes e_\beta + e(w_{\mathcal{B}}^{\alpha\beta}) \left(\frac{\cdot}{\varepsilon}, \cdot \right) \right) (\partial_{\alpha\beta}(u^*)_d - \alpha_i \partial_{\alpha\beta}(\psi_i)_d) \right\|_{L^2(T)}^2 &\leq C \|\nabla^2 u_d^* - \alpha_i \nabla^2(\psi_i)_d\|_{L^2(T)}^2 \\ &\leq CH^4 \|u_d^*\|_{H^4(T)}. \end{aligned} \quad (3.38)$$

We also use the regularity of the correctors to bound the second term of (3.37):

$$\begin{aligned} \varepsilon^2 \left\| w_{\mathcal{B}}^{\alpha\beta} \left(\frac{\cdot}{\varepsilon}, \cdot \right) e(\partial_{\alpha\beta}(u^*)_d - \alpha_i \partial_{\alpha\beta}(\psi_i)_d) \right\|_{L^2(T)}^2 &\leq C\varepsilon^2 \|\nabla^3 u^* - \alpha_i \nabla^3 \psi_i\|_{L^2(T)}^2 \\ &= C\varepsilon^2 \|\nabla^3 u^*\|_{L^2(T)}^2 \end{aligned} \quad (3.39)$$

where the last equality stems from the fact that the functions ψ_i are cubic.

We have to be careful with the remaining term. Indeed it is possible to bound separately the θ_i^ε , but α_i are dependent of H . We note that on each T , v^ε is solution to

$$\begin{cases} -\operatorname{div}^\varepsilon A^\varepsilon e^\varepsilon(v^\varepsilon) = 0 & \text{in } T, \\ v^\varepsilon = \alpha_i \psi_i & \text{on } \partial\tau \times \left(-\frac{1}{2}, \frac{1}{2}\right), \\ A^\varepsilon e^\varepsilon(v^\varepsilon) \cdot e_d = 0 & \text{on } \tau \times \left\{\pm\frac{1}{2}\right\}. \end{cases}$$

Because of Theorem 3.10, we know that

$$\begin{aligned} \|\Theta^\varepsilon\|_{H_\varepsilon^1(T)} &= \left\| v^\varepsilon - \alpha_i \psi_i - \varepsilon \left(\frac{(w_{\mathcal{B}}^{\alpha\beta})'}{\varepsilon w_{\mathcal{B}}^{\alpha\beta}} \cdot e_d \right) \left(\frac{\cdot}{\varepsilon}, \cdot \right) \partial_{\alpha\beta}(\alpha_i \psi_i)_d \right\|_{H_\varepsilon^1(T)} \\ &\leq C\sqrt{\varepsilon} |T|^{\frac{d-2}{2d-2}} \|\alpha_i \nabla^2(\psi_i)_d\|_{W^{1,\infty}(\tau)}. \end{aligned}$$

The functions ψ_i are cubic, therefore $\|\alpha_i \nabla^2(\psi_i)_d\|_{W^{1,\infty}(\tau)} = \frac{1}{2|\tau|^{\frac{1}{2}}} \|\alpha_i \nabla^2(\psi_i)_d\|_{L^2(\tau)}$.

Then

$$\|\Theta^\varepsilon\|_{H_\varepsilon^1(T)} \leq C\sqrt{\varepsilon} |\tau|^{-\frac{1}{2d-2}} \|\alpha_i \nabla^2(\psi_i)_d\|_{L^2(\tau)}.$$

Yet $|\tau| = H^{d-1}$ then $|\tau|^{-\frac{1}{2d-2}} = \frac{1}{\sqrt{H}}$, thus

$$\|\Theta^\varepsilon\|_{H_\varepsilon^1(T)} \leq C\sqrt{\frac{\varepsilon}{H}} \|\alpha_i \nabla^2(\psi_i)_d\|_{L^2(\tau)}.$$

We use (3.33) to bound this term as

$$\begin{aligned} \|\alpha_i \nabla^2(\psi_i)_d\|_{L^2(\tau)} &\leq \|\alpha_i \nabla^2(\psi_i)_d - \nabla^2 u_d^*\|_{L^2(\tau)} + \|\nabla^2 u_d^*\|_{L^2(\tau)} \\ &\leq CH + \|u_d^*\|_{H^2(\tau)} \\ &\leq C\|u_d^*\|_{H^2(\tau)} \quad \text{for } H \text{ small enough,} \end{aligned}$$

which implies that

$$\|\Theta^\varepsilon\|_{H_\varepsilon^1(T)} \leq C\sqrt{\frac{\varepsilon}{H}} \|u_d^*\|_{H^2(\tau)}. \quad (3.40)$$

Collecting (3.36), (3.35), (3.37), (3.38), (3.39) and (3.40), we deduce that

$$\begin{aligned} \|e^\varepsilon(u^{\varepsilon,1} - v^\varepsilon)\|_{L^2(\Omega)}^2 &\leq C \left(H^4 + \varepsilon^2 + \frac{\varepsilon}{H} \right) \sum_{\tau \in \mathcal{T}_\omega^H} \|u_d^*\|_{H^4(\tau)}^2 \\ &\leq C \left(H^4 + \varepsilon^2 + \frac{\varepsilon}{H} \right) \|u_d^*\|_{H^4(\omega)}^2, \end{aligned}$$

because we have supposed that $u_d^* \in W^{4,\infty}(\omega) \subset H^4(\omega)$. We use the Poincaré inequality of Lemma 3.4 to write

$$\|u^{\varepsilon,1} - v^\varepsilon\|_{H_\varepsilon^1(\Omega)} \leq C \left(H^2 + \varepsilon + \sqrt{\frac{\varepsilon}{H}} \right) \|u_d^*\|_{H^3(\omega)}. \quad (3.41)$$

Step 3. Using (3.34), (3.35), (3.41) and Theorem 3.10, we have shown that

$$\|u^{\varepsilon,1} - u_H^\varepsilon\|_{H_\varepsilon^1(\Omega)} \leq C \left(H^2 + \sqrt{\varepsilon} + \sqrt{\frac{\varepsilon}{H}} \right) \|u_d^*\|_{H^3(\omega)}.$$

This concludes the proof of Theorem 3.12. □

CHAPTER 4

SHAPE OPTIMIZATION OF PLATES

4.1 Introduction

The aim of this chapter is to present a shape optimization method in order to optimize the microstructure of an heterogeneous thin plate together with preliminary numerical results.

The principle of the method is the following. Let us consider a microstructured plate, composed of a mixture of linear elastic materials, the thickness of which is order ε , for some fixed value of $\varepsilon > 0$. Let $d = 2$ or 3 and let us assume that this plate occupies a physical domain $\Omega^\varepsilon := \omega \times (-\varepsilon/2, \varepsilon/2)$ for some bounded regular subdomain of \mathbb{R}^{d-1} .

We denote by \mathcal{M} the set of tensors $M \in \mathbb{R}^{d \times d \times d \times d}$ such that

$$\forall y \in \mathbb{R}_s^{d \times d}, \quad |My| \leq c_+ |y| \quad \text{and} \quad y^\top My \geq c_- |y|^2,$$

where $\mathbb{R}_s^{d \times d}$ denotes the set of symmetric matrices, and which have the following symmetries:

$$\forall 1 \leq i, j, k, l \leq d, \quad M_{ijkl} = M_{jikl} = M_{ijlk} = M_{klij}.$$

For $A, B \in \mathbb{R}^{d \times d}$ we denote by $A : B = A_{ij}B_{ij}$. Let us point out here that, in particular, for any $1 \leq i, j \leq d$ and any $A \in \mathbb{R}^{d \times d}$, $A : e_i \otimes e_j = e_i^T A e_j$. We also define

$$Y := (0, 1)^{d-1} \quad \text{and} \quad \mathcal{Y} := Y \times \left(-\frac{1}{2}, \frac{1}{2}\right).$$

Let us assume in addition that the typical size of the microstructures in the transverse direction is also of order ε . Let us denote by $\mathcal{A}^\varepsilon : \Omega^\varepsilon \rightarrow \mathcal{M}$ the application which associates to all $x \in \Omega^\varepsilon$ the value of the linear elastic tensor $\mathcal{A}^\varepsilon(x) \in \mathcal{M}$ of the plate at point x .

If the plate is composed of a periodic microstructured material, as in the preceding chapters, there exists an application $A : \mathbb{R}^{d-1} \times \left(-\frac{1}{2}, \frac{1}{2}\right) \rightarrow \mathcal{M}$ such for any $x_d \in \left(-\frac{1}{2}, \frac{1}{2}\right)$, the function $x' \mapsto A(x', x_d)$ is Y -periodic, and such that

$$\mathcal{A}^\varepsilon(x) = A\left(\frac{x'}{\varepsilon}, \frac{x_d}{\varepsilon}\right), \quad \forall x = (x', x_d) \in \Omega^\varepsilon = \omega \times (-\varepsilon/2, \varepsilon/2).$$

The shape optimization problem we consider here consists in optimizing some given objective functional over the set of microstructured thin plates whose linear elastic tensor can be written under the form

$$\mathcal{A}^{\psi,\varepsilon}(x) = A \left(\frac{\psi(x')}{\varepsilon}, \frac{x_d}{\varepsilon} \right),$$

for some fixed reference periodic tensor-valued application A , some fixed value of ε , and for some regular diffeomorphism $\psi : \omega \rightarrow \omega$ which has the vocation to be optimized. In other words, the set of admissible microstructures we are considering here can be seen as *macroscopic deformations* of a reference periodic microstructure.

In addition, let

$$V^\varepsilon := \left\{ v \in H^1(\Omega^\varepsilon)^d, v = 0 \text{ on } \partial\omega \times \left(-\frac{\varepsilon}{2}, \frac{\varepsilon}{2} \right) \right\}.$$

We consider here a compliance optimization problem which may be written as follows. Let $\tilde{f}^\varepsilon \in L^2(\Omega)^d$ and, for any regular diffeomorphism $\psi : \omega \rightarrow \omega$, consider $\tilde{u}^{\psi,\varepsilon} \in V^\varepsilon$ the unique solution to the linear elastic problem

$$\begin{cases} -\operatorname{div} \mathcal{A}^{\psi,\varepsilon} e(\tilde{u}^{\psi,\varepsilon}) = \tilde{f}^\varepsilon & \text{in } \Omega^\varepsilon, \\ \mathcal{A}^{\psi,\varepsilon} e(\tilde{u}^{\psi,\varepsilon}) \cdot n = 0 & \text{on } \omega \times \left\{ \pm \frac{1}{2} \right\}, \end{cases} \quad (4.1)$$

where $e(u)$ denotes the symmetric gradient of a vector field $u \in H^1(\Omega)^d$ and n denotes the unit outward normal vector to Ω^ε .

Our aim in this chapter is to propose some numerical methods in order to approximately solve an optimization problem of the form

$$\inf_{\psi \in \mathcal{U}} \tilde{\mathcal{J}}^\varepsilon(\psi), \quad (4.2)$$

where \mathcal{U} is a given set of regular diffeomorphisms from ω to ω , to be precised later, and where

$$\tilde{\mathcal{J}}^\varepsilon(\psi) := \int_{\Omega^\varepsilon} \tilde{f}^\varepsilon \cdot \tilde{u}^{\psi,\varepsilon}.$$

We are left at this point with two difficulties. The first difficulty lies in the characterization of a set of regular diffeomorphisms \mathcal{U} which enables to consider a large enough set of microstructures *and* can lead to computable numerical scheme. Such a question is definitely not trivial in the case when $d = 3$ since ω is then a subset of \mathbb{R}^2 . In the preliminary study presented in this chapter, we leave this important question aside for future research work and focus our attention on the more simple case where $d = 2$, so that ω is simply a subinterval of \mathbb{R} , which we fix to be equal to $(0, 1)$. The precise choice of optimization set \mathcal{U} is detailed in Section 4.2, together with the choice of the reference periodic tensor-valued application A .

In addition, since the value of ε has the vocation to be small, the cost of the numerical resolution of problem 4.1 for any $\psi \in \mathcal{U}$ is extremely high if standard finite element methods are used. To circumvent this bottleneck, we study and compare two alternatives. The first approach consists by replacing problem 4.1 by its homogenized limit obtained as ε goes to 0, and optimize the compliance of the homogenized problem. The second alternative consists in approximating the solution of 4.1 using multiscale finite element methods to alleviate the computational burden. However, the optimization procedure would require in principle to recompute at each stage of the optimization

process to recompute the MsFEM basis for each new value of $\psi \in \mathcal{U}$, which would still lead to very costly simulations. Here again, we consider an approach in order to reduce the computational cost where the multiscale finite element functions are chosen to be approximated in a reduced approximation space, obtained by the mean of an appropriate Proper Orthogonal Decomposition (POD) method. We present the two resulting optimization procedures in full details in Section 4.3.

Numerical results obtained on different test cases illustrate the comparison between these two approaches in Section 4.4.

4.2 Choice of optimization set for diffeomorphisms and reference periodic tensor

As mentioned in the introduction, in this preliminary study, we restrict ourselves to the more simple situation where $d = 2$ and $\omega = (0, 1)$. We introduce a uniform discretization grid of the interval $(0, 1)$ where the typical size of the subintervals is equal to $H_{\text{diff}} = \frac{1}{N_{\text{diff}}}$ for some $N_{\text{diff}} \in \mathbb{N}^*$ and define

$$\mathcal{U}^{H_{\text{diff}}} := \left\{ \begin{array}{l} \psi : (0, 1) \rightarrow (0, 1), \quad \text{continuous, increasing and piecewise affine} \\ \text{on each subinterval } (iH_{\text{diff}}, (i+1)H_{\text{diff}}) \text{ for all } 0 \leq i \leq N_{\text{diff}} - 1 \end{array} \right\}. \quad (4.3)$$

For all $0 \leq i \leq N_{\text{diff}}$, let us denote by $x_i := iH_{\text{diff}}$ and by $\psi_i : (0, 1) \rightarrow \mathbb{R}$ the standard hat element function centered on the point x_i , i.e. defined such that

$$\forall x \in (0, 1), \quad \psi_i(x) := \begin{cases} 1 - \frac{|x-x_i|}{H_{\text{diff}}} & \text{if } x \in (x_i - H_{\text{diff}}, x_i + H_{\text{diff}}), \\ 0 & \text{otherwise.} \end{cases}$$

Then, it holds that the set $\mathcal{U}^{H_{\text{diff}}}$ can be equivalently characterized as

$$\mathcal{U}^{H_{\text{diff}}} = \left\{ \psi = \sum_{i=0}^{N_{\text{diff}}} a_i \psi_i, (a_i)_{0 \leq i \leq N_{\text{diff}}} \subset [0, 1], a_0 = 0 < a_1 < \dots < a_{N_{\text{diff}}-1} < a_{N_{\text{diff}}} = 1 \right\}.$$

The strict inequalities which appear in the definition of the set $\mathcal{U}^{H_{\text{diff}}}$ are not easy to handle from a numerical point of view when it comes to optimizing an objective functional over the set $\mathcal{U}_{H_{\text{diff}}}$. To this aim, for $1 > \eta > 0$ we introduce the subset $\mathcal{U}^{H_{\text{diff}}, \eta} \subset \mathcal{U}^{H_{\text{diff}}}$ defined by

$$\mathcal{U}^{H_{\text{diff}}, \eta} := \left\{ \psi = \sum_{i=0}^{N_{\text{diff}}} a_i \psi_i, (a_i)_{0 \leq i \leq N_{\text{diff}}} \subset [0, 1], a_0 = 0 < a_1 < \dots < a_{N_{\text{diff}}-1} < a_{N_{\text{diff}}} = 1, \frac{1}{\eta} \geq \frac{a_{i+1} - a_i}{H_{\text{diff}}} \geq \eta, \forall 0 \leq i \leq N_{\text{diff}} - 1 \right\}. \quad (4.4)$$

The set $\mathcal{U}^{H_{\text{diff}}, \eta}$ is then a closed convex subset, and is the set of diffeomorphisms ψ we are going to consider to define the shape optimization problem. The smaller the value of the parameter η , the larger the set $\mathcal{U}^{H_{\text{diff}}, \eta}$ since $\mathcal{U}^{H_{\text{diff}}, \eta_1} \subset \mathcal{U}^{H_{\text{diff}}, \eta_2}$ for all $0 < \eta_2 \leq \eta_1 < 1$. Thus, the parameter η has the vocation to be small in practice. The precise values of η and H_{diff} chosen in our numerical tests are precised in Section 4.4.

In practice, in the numerical tests presented in Section 4.4, the reference periodic tensor-valued application A is chosen so that for all $(x', x_d) \in \mathbb{R}^{d-1} \times (-\frac{1}{2}, \frac{1}{2})$, $A(x', x_d)$ is an isotropic linear tensor, i.e. for all $1 \leq i, j, k, l \leq d$,

$$A_{ijkl}(x', x_d) = \lambda(x', x_d) \delta_{ij} \delta_{kl} + \mu(x', x_d) (\delta_{ik} \delta_{jl} + \delta_{il} \delta_{jk}),$$

where λ and μ are the values the Lamé coefficients of the material, that are supposed to be of the form We suppose that the is constant, thus only the Young modulus E is a function of $x \in \Omega$. It means that for any x in Ω ,

$$\lambda(x', x_d) = \frac{\nu E(x', x_d)}{(1 + \nu)(1 - 2\nu)} \quad \text{and} \quad \mu(x', x_d) = \frac{E(x', x_d)}{2(1 + \nu)}$$

for a fixed value of the Poisson coefficient ν and a varying Young modulus function $E : \mathbb{R}^{d-1} \times \left(-\frac{1}{2}, \frac{1}{2}\right) \rightarrow \mathbb{R}$ such that for all $x_d \in \left(-\frac{1}{2}, \frac{1}{2}\right)$, $\mathbb{R}^{d-1} \ni x' \mapsto E(x', x_d)$ is Y -periodic.

Let us denote by the function $E^{\psi, \varepsilon}$ defined such that for all $(x', x_d) \in \omega \times \left(-\frac{1}{2}, \frac{1}{2}\right)$

$$E^{\psi, \varepsilon}(x', x_d) := E\left(\frac{\psi(x')}{\varepsilon}, x_d\right).$$

The objective of Figure 4.1 is to illustrate the values of $E^{\psi, \varepsilon}$ when $\omega = (0, 1)$ (hence $d = 2$), for different choices of $\psi \in \mathcal{U}^{H_{\text{diff}}}$ for $H_{\text{diff}} = \frac{1}{8}$, where $\varepsilon = \frac{1}{10}$ and

$$E(x', x_d) = \begin{cases} 1 & \text{if } 0.25 \leq x' - [x'] < 0.75, \\ 10 & \text{otherwise,} \end{cases}$$

where for all $x' \in \mathbb{R}$, $[x']$ denotes the integer part of x' .

4.3 Two optimization approaches

In this section, we present the two optimization procedures we propose, based on homogenization theory and multiscale finite element methods, for the approximative resolution of problem 4.2. Here, and in all the sequel, we keep the notation \mathcal{U} to denote the chosen of optimization set of diffeomorphisms of ω . We remind the reader that in practice, in the case when $d = 2$, the set \mathcal{U} will be chosen as $\mathcal{U}^{H_{\text{diff}}, \eta}$ defined in (4.4) for some positive values of H_{diff} and η .

4.3.1 Rescaled version of the plate problem

In this section, we introduce a rescaled version of problem (4.1) and problem (4.2), defined on a domain independent of $\varepsilon > 0$, which are more convenient to handle in the sequel. Let $\Omega := \omega \times \left(-\frac{1}{2}, \frac{1}{2}\right)$ and let

$$V := \left\{ v \in H^1(\Omega), v = 0 \text{ on } \partial\omega \times \left(-\frac{1}{2}, \frac{1}{2}\right) \right\}^d. \quad (4.5)$$

For all $\psi \in \mathcal{U}$, let us introduce $u^{\psi, \varepsilon} \in V$ and $f^\varepsilon \in L^2(\Omega)^d$ defined such that for all $(x', x_d) \in \omega \times \left(-\frac{1}{2}, \frac{1}{2}\right)$ and all $1 \leq \alpha \leq d - 1$,

- $u_\alpha^{\psi, \varepsilon}(x) = \tilde{u}_\alpha^{\psi, \varepsilon}(x', \varepsilon x_d)$, $u_d^{\psi, \varepsilon}(x) = \varepsilon \tilde{u}_d^{\psi, \varepsilon}(x', \varepsilon x_d)$;
- $f_\alpha^\varepsilon(x) = \tilde{f}_\alpha^\varepsilon(x', \varepsilon x_d)$, $f_d^\varepsilon(x) = \varepsilon^{-1} \tilde{f}_d^\varepsilon(x', \varepsilon x_d)$.

For any $u \in \mathcal{D}'(\mathbb{R}^d)^d$ and $T \in \mathcal{D}'(\mathbb{R}^d)^{d \times d}$, we define the operators e^ε and div^ε by

$$e_{\alpha\beta}^\varepsilon(u) := e_{\alpha\beta}(u), \quad e_{\alpha d}^\varepsilon(u) := \frac{1}{\varepsilon} e_{\alpha d}(u) \quad \text{and} \quad e_{dd}^\varepsilon(u) := \frac{1}{\varepsilon^2} e_{dd}(u)$$

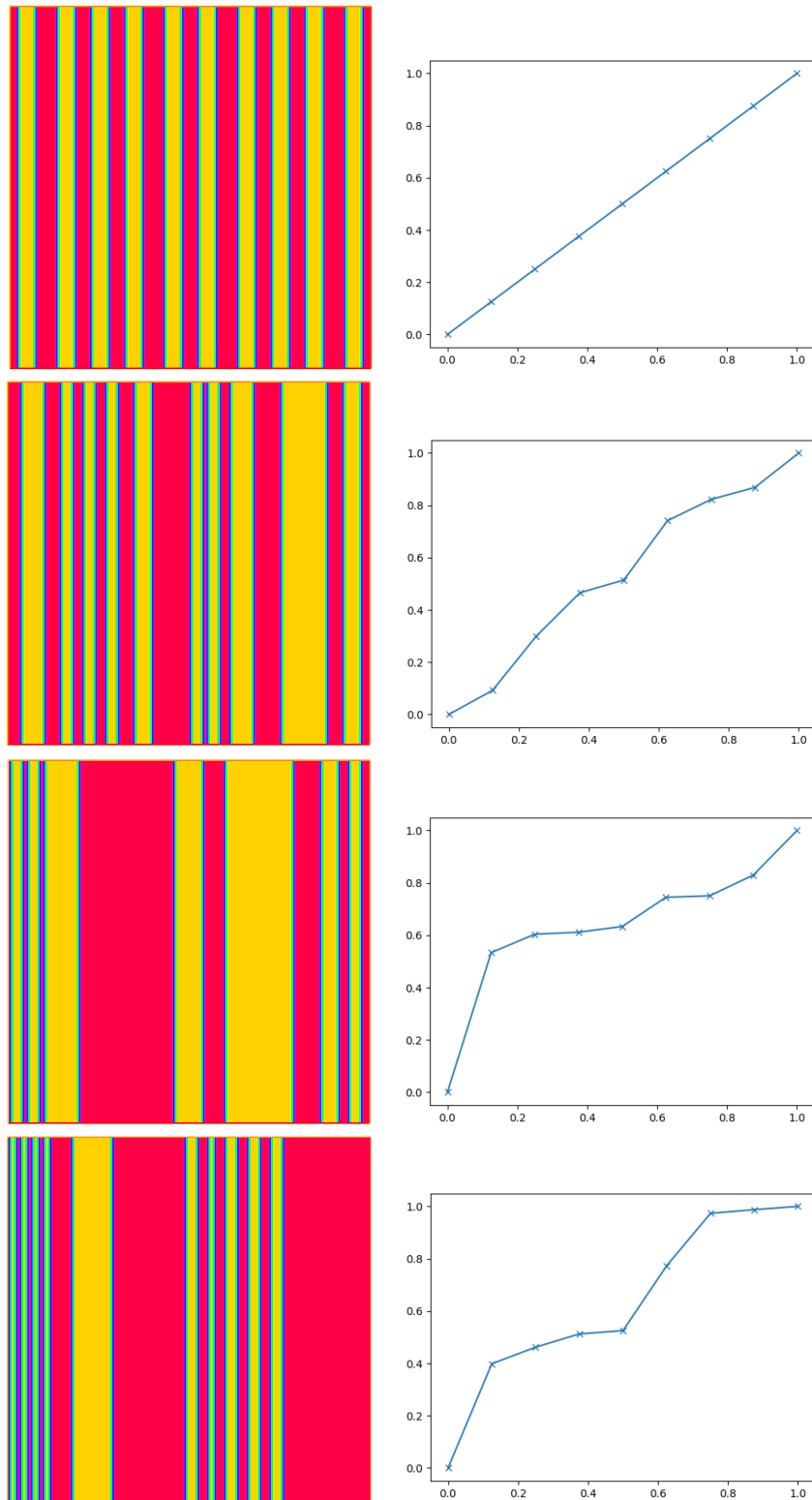

Figure 4.1: Plots of $E^{\psi,\varepsilon}$ and ψ for different functions ψ in $\mathcal{U}^{H_{\text{diff}}}$.

and

$$\operatorname{div}^\varepsilon(T)_\alpha := \partial_\beta T_{\alpha\beta} + \frac{1}{\varepsilon} \partial_d T_{\alpha d} \quad \text{and} \quad \operatorname{div}^\varepsilon(T)_d := \frac{1}{\varepsilon} \partial_\beta T_{d\beta} + \frac{1}{\varepsilon^2} \partial_d T_{dd}$$

for any $1 \leq \alpha, \beta \leq d-1$.

Then $u^{\psi, \varepsilon}$ is the unique solution in V to

$$\begin{cases} -\operatorname{div}^\varepsilon(A^{\psi, \varepsilon} e^\varepsilon(u^{\psi, \varepsilon})) = f^\varepsilon \text{ in } \Omega \\ A^{\psi, \varepsilon} e^\varepsilon(u^{\psi, \varepsilon}) \cdot n = 0 \text{ on } \omega \times \left\{ \pm \frac{1}{2} \right\}, \end{cases} \quad (4.6)$$

where for all $(x', x_d) \in \omega \times \left(-\frac{1}{2}, \frac{1}{2}\right)$,

$$A^{\psi, \varepsilon}(x', x_d) := A\left(\frac{\psi(x')}{\varepsilon}, x_d\right). \quad (4.7)$$

The variational formulation of (4.6) reads:

$$\text{Find } u^{\psi, \varepsilon} \in V \text{ such that } \forall v \in V, a^{\psi, \varepsilon}(u^{\psi, \varepsilon}, v) = b^\varepsilon(v) \quad (4.8)$$

where

$$a^{\psi, \varepsilon}(u^{\psi, \varepsilon}, v) := \int_\Omega A^{\psi, \varepsilon} e^\varepsilon(u^{\psi, \varepsilon}) : e^\varepsilon(v)$$

and

$$b^\varepsilon(v) := \int_\Omega f^\varepsilon \cdot v.$$

Let us then remark that for all $\psi \in \mathcal{U}$, $\tilde{\mathcal{J}}^\varepsilon(\psi) = \varepsilon \mathcal{J}^\varepsilon(\psi)$ where $\mathcal{J}^\varepsilon(\psi) := \int_\Omega u^{\psi, \varepsilon} \cdot f^\varepsilon$. This implies that problem (4.2) is equivalent to the optimization problem

$$\inf_{\psi \in \mathcal{U}} \mathcal{J}^\varepsilon(\psi). \quad (4.9)$$

4.3.2 Homogenization approach

In this section and the rest of the chapter, we are going to assume that there exists a function $f \in L^2(\Omega)^d$ such that $f^\varepsilon = f$ independently of ε .

We begin by introducing the homogenized problem associated to (4.6). We define the set of the *Kirchoff-Love displacements* as follows:

$$\mathcal{V}_{KL} := \left\{ v \in (H^1(\Omega))^{d-1} \times H_0^2(\omega), \exists \hat{v} \in (H_0^1(\omega))^{d-1} \times H_0^2(\omega), v_\alpha = \hat{v}_\alpha - x_d \partial_\alpha \hat{v}_d, v_d = \hat{v}_d \right\},$$

where $H_0^2(\omega)$ is the closure of $\mathcal{D}(\Omega)$ in $H^2(\omega)$. For $v \in \mathcal{V}_{KL}$, we now use the notation \hat{v} to denote the corresponding element of $(H_0^1(\omega))^{d-1} \times H_0^2(\omega)$ entering in the above definition. We also introduce the set

$$\begin{aligned} \mathcal{W}(\mathcal{Y}) := & \left\{ v \in \left(H_{\text{loc}}^1 \left(\mathbb{R}^{d-1} \times \left(-\frac{1}{2}, \frac{1}{2} \right) \right) \right)^d, \right. \\ & \left. \forall z \in \left(-\frac{1}{2}, \frac{1}{2} \right), v(\cdot, z) \text{ is } Y\text{-periodic and } \int_Y v = 0 \right\}. \end{aligned}$$

For any $g \in L^2(\Omega)$, we also define for all $x' \in \omega$,

$$m(g)(x') := \int_{x_d = -\frac{1}{2}}^{\frac{1}{2}} g(x', x_d) dx_d.$$

For any u in $(\mathcal{D}'(\mathbb{R}^d))^d$ and any invertible matrix $G \in \mathbb{R}^{(d-1) \times (d-1)}$, we define the quantity $e^G(u)$ as follows: for all $y \in \mathbb{R}^d$,

$$e^G(u)(x', x_d) := \frac{1}{2} \left[\begin{pmatrix} G & 0 \\ 0 & 1 \end{pmatrix} \nabla u(y) + \left(\begin{pmatrix} G & 0 \\ 0 & 1 \end{pmatrix} \nabla u(y) \right)^T \right].$$

For any invertible matrix $G \in \mathbb{R}^{(d-1) \times (d-1)}$ and $1 \leq \alpha, \beta \leq d-1$, we introduce $w^{\alpha\beta, G} \in \mathcal{W}(\mathcal{Y})$ the unique solution to the corrector problem

$$\forall v \in \mathcal{W}(\mathcal{Y}), \quad \int_{\mathcal{Y}} A(e^G(w^{\alpha\beta, G}) + e_\alpha \otimes e_\beta) : e^G(v) = 0 \quad (4.10)$$

for any $1 \leq \alpha, \beta \leq d-1$. We also introduce $W^{\alpha\beta, G} \in \mathcal{W}(\mathcal{Y})$ the unique solution to the problem

$$\forall v \in \mathcal{W}(\mathcal{Y}), \quad \int_{\mathcal{Y}} A(e^G(W^{\alpha\beta, G}) - x_d e_\alpha \otimes e_\beta) : e^G(v) = 0 \quad (4.11)$$

for any $1 \leq \alpha, \beta \leq d-1$.

We then define for all $1 \leq \alpha, \beta, \gamma, \delta \leq d-1$,

$$\begin{aligned} (K_{11}^{*,G})_{\alpha\beta\gamma\delta} &:= \int_{\mathcal{Y}} A(e^G(w^{\alpha\beta, G}) + e_\alpha \otimes e_\beta) : (e^G(w^{\gamma\delta, G}) + e_\gamma \otimes e_\delta), \\ (K_{12}^{*,G})_{\alpha\beta\gamma\delta} &:= \int_{\mathcal{Y}} A(e^G(w^{\alpha\beta, G}) + e_\alpha \otimes e_\beta) : (e^G(W^{\gamma\delta, G}) - x_d e_\gamma \otimes e_\delta), \\ (K_{22}^{*,G})_{\alpha\beta\gamma\delta} &:= \int_{\mathcal{Y}} A(e^G(W^{\alpha\beta, G}) - x_d e_\alpha \otimes e_\beta) : (e^G(W^{\gamma\delta, G}) - x_d e_\gamma \otimes e_\delta), \\ ((K_{12}^{*,G})^T)_{\alpha\beta\gamma\delta} &:= (K_{12}^{*,G})_{\gamma\delta\alpha\beta}, \end{aligned}$$

Let $\psi : \omega \rightarrow \omega$ be a \mathcal{C}^1 -diffeomorphism. Under appropriate assumptions on ψ , which we do not detail here, it can be proved that the family $(u^{\psi, \varepsilon})_{\varepsilon > 0}$ weakly converges to a limit $u^{\psi, *}$ in \mathcal{V}_{KL} which is the unique solution of the following homogenized problem:

$$\forall v \in \mathcal{V}_{KL}, \quad \int_{\omega} K^* \mathcal{P} u^{\psi, *} : \mathcal{P} v = \int_{\omega} m(f) \cdot \widehat{v} - \int_{\omega} m(x_d f_\alpha) \partial_\alpha \widehat{v}_d, \quad (4.12)$$

where for all $x' \in \omega$,

$$K^*(x') := \begin{pmatrix} K_{11}^{*, \nabla \psi(x')} & K_{12}^{*, \nabla \psi(x')} \\ (K_{12}^{*, \nabla \psi(x')})^T & K_{22}^{*, \nabla \psi(x')} \end{pmatrix}, \quad (4.13)$$

and where

$$\mathcal{P} : \begin{cases} \mathcal{V}_{KL} & \rightarrow L^2 \left(\omega; \left(\mathbb{R}_s^{(d-1) \times (d-1)} \right)^2 \right) \\ v & \mapsto \begin{pmatrix} e'(\widehat{v}') \\ \nabla_{d-1}^2 \widehat{v}_d \end{pmatrix} \end{cases}. \quad (4.14)$$

We do not give the detailed proof of this convergence result here for the sake of brevity, since the main focus of this chapter is to propose numerical methods for shape optimization problems. Note that if $\psi \in \mathcal{U}^{H_{\text{diff}}}$ for some $H_{\text{diff}} > 0$, with $\mathcal{U}^{H_{\text{diff}}}$ defined

by (4.3), there always exists a unique solution $u^{\psi,*} \in \mathcal{V}_{KL}$ to problem (4.12), even though ψ may not satisfy all the necessary assumptions for the convergence of the family $(u^{\psi,\varepsilon})_{\varepsilon>0}$ to $u^{\psi,*}$ to hold weakly in $H^1(\Omega)^d$ (in particular, any element $\psi \in \mathcal{U}^{H_{\text{diff}}}$ may not be \mathcal{C}^1).

Nevertheless, the first approach we propose in order to approximate optimization problem (4.9) is to consider an optimization problem where the homogenized problem (4.12) is solved instead of problem (4.6). More precisely, we consider the optimization problem

$$\inf_{\psi \in \mathcal{U}} \mathcal{J}^*(\psi), \quad (4.15)$$

where

$$\mathcal{J}^*(\psi) := \int_{\Omega} f \cdot u^{\psi,*}.$$

In practice, in the case where $d = 2$, $\omega = (0, 1)$, (4.12) is solved using a standard Galerkin method where for all $1 \leq \alpha \leq d_1$, $\widehat{u}_{\alpha}^{\psi,*}$ belongs to the space of \mathbb{P}_1 finite element functions and $\widehat{u}_d^{\psi,*}$ belongs to the space of cubic spline functions associated to a uniform discretization grid of $(0, 1)$ of typical mesh size denoted by H_{homog} . In addition, the corrector problems (4.10) and (4.11) are solved using a \mathbb{P}_1 finite element mesh the typical mesh size of which is denoted by H_{corr} .

4.3.3 Multiscale finite element approach

The aim of this section is to introduce a second approach to effectively compute a numerical approximation of a solution to (4.9) relying on the use of Multiscale Finite Element methods, similar to the one introduced in the preceding chapter of this manuscript.

The principle of the MsFEM approach, originally introduced in [55] (see [36] for a comprehensive review), is to discretize the domain occupied by the heterogeneous material using a coarse mesh, where the typical size of each element, denoted H , can be chosen independently of the typical size ε of the heterogeneities. The method relies on the idea of using *specific* basis functions, which are not as generic as the standard finite element functions (like \mathbb{P}_1 finite element functions for instance), but are on the contrary well-adapted to the heterogeneities of the material.

More precisely, the method usually proceeds in two steps. In an offline phase, some basis functions are computed as solutions to local problems defined on each element of the coarse mesh. The differential operator which is used is very similar (if not identical) to the differential operator of the global problem. It is thus expected that these basis functions appropriately encode the oscillations of the exact solution. These basis functions are computed in parallel and independently from one another. They do not depend on the right-hand side of the problem. They are expensive to compute (because one has to use a fine mesh of each coarse element to resolve the oscillations of $\mathcal{A}^{\psi,\varepsilon}$), but this computation is local, and only performed once. These basis functions generate a discretization space of limited dimension, which is well-adapted to the problem at hand. Next, in an online phase, a global Galerkin approximation of the problem of interest is performed, on the discretization space introduced in the offline stage. Since the dimension of the discretization space is limited, the online phase is inexpensive.

In our specific context, the MsFEM method works as follows. Let us assume that ω is a polyhedral, connected and bounded open subset of \mathbb{R}^{d-1} and let \mathcal{T}_{ω}^H be a con-

Figure 4.2: A \mathbb{P}^1 element in 1D

Figure 4.3: An oscillating basis function in 1D

forming discretization of ω . Let us now define

$$\mathcal{T}_\Omega^H = \left\{ \tau \times \left(-\frac{1}{2}, \frac{1}{2} \right), \tau \in \mathcal{T}_\omega^H \right\}.$$

Then, \mathcal{T}_Ω^H obviously defines a conforming discretization of Ω (see Figure 4.4).

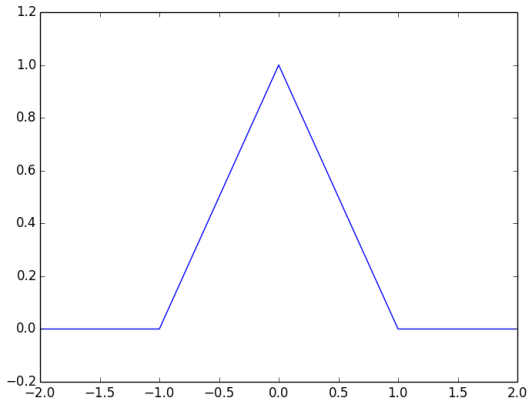
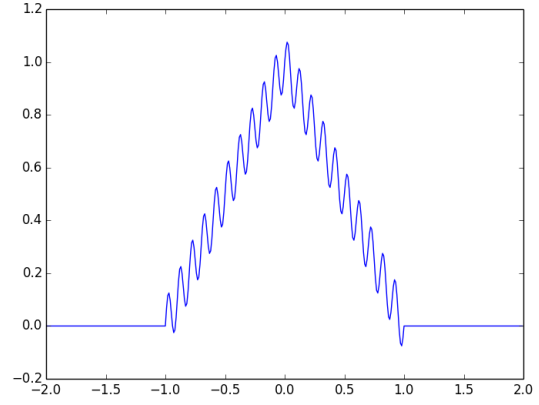
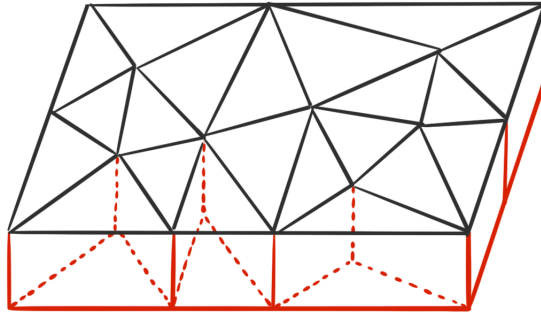
Figure 4.4: Coarse mesh \mathcal{T}_Ω^H

To define the multiscale basis functions, we consider two different discretizations spaces, which we call hereafter the *membrane space* and the *bending space*.

Membrane space: Let V_H^M be the space of functions of $H_0^1(\omega)^{d-1}$ that are piecewise affine on every element of \mathcal{T}_ω^H , let N_H^M be its dimension and let $(\phi_i^M)_{1 \leq i \leq N_H^M}$ be its canonical base. For any $1 \leq i \leq N_H^M$, let $\varphi_i^M := \begin{pmatrix} \phi_i^M \\ 0 \end{pmatrix} \in \mathcal{V}^{KL}$.

Bending space: Let V_H^B be the space of functions of $H_0^2(\omega)$ that are piecewise cubic on every element of \mathcal{T}_ω^H , and let N_H^B be its dimension and let $(\phi_j^B)_{1 \leq j \leq N_H^B}$ be its canonical base. For any $1 \leq j \leq N_H^B$, let $\varphi_j^B := \begin{pmatrix} -x_d \nabla \phi_j^B \\ \phi_j^B \end{pmatrix}$.

For all $\psi \in \mathcal{U}$, on any $T \in \mathcal{T}_\Omega^H$ of the form $T = \tau \times \left(-\frac{1}{2}, \frac{1}{2} \right)$, we define the membrane oscillatory basis function $\varphi_i^{\psi, \varepsilon, M}$ for all $1 \leq i \leq N_H^M$ as the solution of the

following problem

$$\begin{cases} -\operatorname{div}^\varepsilon A^{\psi,\varepsilon} e^\varepsilon \left(\varphi_i^{\psi,\varepsilon,\mathcal{M}} \right) = 0 \text{ in } T, \\ \varphi_i^{\psi,\varepsilon,\mathcal{M}} = \varphi_i^\mathcal{M} \text{ on } \partial\tau \times \left(-\frac{1}{2}, \frac{1}{2} \right), \\ A^{\psi,\varepsilon} e^\varepsilon \left(\varphi_i^{\psi,\varepsilon,\mathcal{M}} \right) \cdot e_d = 0 \text{ on } \tau \times \left\{ \pm \frac{1}{2} \right\}, \end{cases} \quad (4.16)$$

where $A^{\psi,\varepsilon}$ is defined in (4.7). Similarly, we define the bending oscillatory basis function $\varphi_j^{\psi,\varepsilon,\mathcal{B}}$ for all $1 \leq j \leq N_H^\mathcal{B}$ as the solution of the following problem

$$\begin{cases} -\operatorname{div}^\varepsilon A^{\psi,\varepsilon} e^\varepsilon \left(\varphi_j^{\psi,\varepsilon,\mathcal{B}} \right) = 0 \text{ in } T, \\ \varphi_j^{\psi,\varepsilon,\mathcal{B}} = \varphi_j^\mathcal{B} \text{ on } \partial\tau \times \left(-\frac{1}{2}, \frac{1}{2} \right), \\ A^{\psi,\varepsilon} e^\varepsilon \left(\varphi_j^{\psi,\varepsilon,\mathcal{B}} \right) \cdot e_d = 0 \text{ on } \tau \times \left\{ \pm \frac{1}{2} \right\}. \end{cases} \quad (4.17)$$

We then define the multiscale finite element space associated to $\psi \in \mathcal{U}$ as follows

$$V_H^{\psi,\varepsilon} := \operatorname{Span}\{\varphi_i^{\psi,\varepsilon,\mathcal{M}}, \varphi_j^{\psi,\varepsilon,\mathcal{B}}, 1 \leq i \leq N_H^\mathcal{M}, 1 \leq j \leq N_H^\mathcal{B}\}.$$

and denote by $u_H^{\psi,\varepsilon}$ be the Galerkin's approximation of $u^{\psi,\varepsilon}$ in the discretization space V_H^ε . In practice, problems (4.16) and (4.17) are solved using a \mathbb{P}_1 finite element method associated to a triangular mesh with typical mesh size $h \ll H$.

A first version of the multiscale finite element approach for the approximation of problem (4.9) is to consider the following alternative optimization problem

$$\inf_{\psi \in \mathcal{U}} \mathcal{J}^{\varepsilon,H}(\psi), \quad (4.18)$$

where

$$\mathcal{J}^{\varepsilon,H}(\psi) := \int_{\Omega} f \cdot u_H^{\psi,\varepsilon}.$$

The main advantage of such a method over the homogenized approach presented in Section 4.3.2 is that the approximation $u_H^{\psi,\varepsilon}$ of $u^{\psi,\varepsilon}$ obtained by the multiscale finite element method is in principle more accurate than its homogenized approximation $u^{\psi,*}$. Thus, there is good hope that considering (4.18) instead of (4.15) should provide better diffeomorphisms $\psi \in \mathcal{U}$ in the sense of the original optimization problem (4.9).

However, solving an optimization problem of the form (4.18) would require to compute, at each step of the optimization procedure, the solution of the $N_H^\mathcal{M} + N_H^\mathcal{B}$ MsFEM problems (4.16) and (4.17) for each new value of $\psi \in \mathcal{U}$, which would lead to very heavy computational costs. Hence, we rather consider an approach where we compute a *global reduced multiscale finite element space* obtained via the Proper Orthogonal Decomposition of basis functions of $V_H^{\psi,\varepsilon}$ for randomly selected values of $\psi \in \mathcal{U}$.

We detail this *reduced multiscale finite element method* in the next section.

4.3.4 Reduced multiscale finite element approach

The reduced multiscale finite element we propose works as follows. Assume that we randomly select $M \in \mathbb{N}^*$ elements \mathcal{U} , which are denoted hereafter by $(\psi_m)_{1 \leq m \leq M}$.

In a first step, for all $1 \leq m \leq M$, the multiscale basis functions $\varphi_i^{\psi_m, \varepsilon, \mathcal{M}}$ and $\varphi_j^{\psi_m, \varepsilon, \mathcal{B}}$ are computed for all $1 \leq i \leq N_H^{\mathcal{M}}$ and $1 \leq j \leq N_H^{\mathcal{B}}$.

In a second step, the Proper Orthogonal decomposition of the family of functions $(\varphi_i^{\psi_m, \varepsilon, \mathcal{M}})_{1 \leq m \leq M, 1 \leq i \leq N_H^{\mathcal{M}}}$ (respectively $(\varphi_j^{\psi_m, \varepsilon, \mathcal{B}})_{1 \leq m \leq M, 1 \leq j \leq N_H^{\mathcal{B}}}$) is computed. The resulting singular values are denoted (in decreasing order) by $(\sigma_k^{\mathcal{M}})_{1 \leq k \leq K^{\mathcal{M}}}$ (respectively $(\sigma_k^{\mathcal{B}})_{1 \leq k \leq K^{\mathcal{B}}}$) and the corresponding POD modes by $(\xi_k^{\mathcal{M}})_{1 \leq k \leq K^{\mathcal{M}}}$ (respectively $(\xi_k^{\mathcal{B}})_{1 \leq k \leq K^{\mathcal{B}}}$) where $K^{\mathcal{M}} := MN_H^{\mathcal{M}}$ (respectively $K^{\mathcal{B}} := MN_H^{\mathcal{B}}$). Note that the POD decompositions are computed with respect to the scalar product $\langle \cdot, \cdot \rangle_V$ on V defined by

$$\forall v, w \in V, \quad \langle v, w \rangle_V = \int_{\Omega} e(v) : e(w).$$

The associated norm is denoted hereafter by $\| \cdot \|_V$.

In a third step, an integer N_r is chosen so that $N_r \ll \max(K^{\mathcal{M}}, K^{\mathcal{B}})$, and a *reduced multiscale finite element space* $V_{H, N_r}^{\varepsilon, \text{red}}$ is constructed as follows:

$$V_{H, N_r}^{\varepsilon, \text{red}} := \{ \xi_k^{\mathcal{M}}, \xi_k^{\mathcal{B}}, 1 \leq k \leq N_r \}.$$

The motivation for considering such a reduced space stems from the optimal approximability properties of the POD decomposition. For all finite-dimensional subspace $X \subset V$, let us denote by Π_X^V the orthogonal projection of V onto X . Then, it holds that the family $(\xi_k^{\mathcal{M}})_{1 \leq k \leq N_r}$ is a minimizer to the optimization problem

$$\min_{(\xi_k)_{1 \leq k \leq N_r} \in V} \sum_{i=1}^{N_H^{\mathcal{M}}} \sum_{m=1}^M \left\| \varphi_i^{\psi_m, \varepsilon, \mathcal{M}} - \Pi_{\text{Span}\{(\xi_k)_{1 \leq k \leq N_r}\}}^V \varphi_i^{\psi_m, \varepsilon, \mathcal{M}} \right\|_V^2.$$

In other words, the vectorial space spanned by the POD modes $(\xi_k^{\mathcal{M}})_{1 \leq k \leq N_r}$ is one of the best N_r -dimensional vector space which approximates the family of functions $(\varphi_i^{\psi_m, \varepsilon, \mathcal{M}})_{1 \leq m \leq M, 1 \leq i \leq N_H^{\mathcal{M}}}$ over all N_r -dimensional subspace $X \subset V$ in the sense of the average error

$$\sum_{i=1}^{N_H^{\mathcal{M}}} \sum_{m=1}^M \left\| \varphi_i^{\psi_m, \varepsilon, \mathcal{M}} - \Pi_X^V \varphi_i^{\psi_m, \varepsilon, \mathcal{M}} \right\|_V^2.$$

Naturally, similar approximability properties hold for the family of functions $(\xi_k^{\mathcal{B}})_{1 \leq k \leq N_r}$.

For all $\psi \in \mathcal{U}$, we then denote by $u_{H, N_r}^{\psi, \varepsilon, \text{red}}$ the Galerkin approximation of $u^{\psi, \varepsilon}$ in the discretization space $V_{H, N_r}^{\varepsilon, \text{red}}$. The reduced multiscale finite element optimization approach to problem (4.9) we suggest consists in considering the optimization problem

$$\inf_{\psi \in \mathcal{U}} \mathcal{J}^{\text{red}, N_r}(\psi), \quad (4.19)$$

where

$$\mathcal{J}^{\text{red}, N_r}(\psi) := \int_{\Omega} f \cdot u_{H, N_r}^{\psi, \varepsilon, \text{red}}.$$

Let us detail here the precise random selection procedure of the set of functions $(\psi_m)_{1 \leq m \leq M}$ that we use in practice in the case where $d = 2$, $\omega = (0, 1)$ and $\mathcal{U} = \mathcal{U}^{H_{\text{diff}}, \eta}$ for some η , $H_{\text{diff}} > 0$.

Each function $\psi \in U^{H_{\text{diff}}, \eta}$ is randomly drawn following the following procedure. A family of $N_{H_{\text{diff}}} - 1$ random independent numbers are drawn according to a uniform

distribution law and then ordered in order to form a family of non-decreasing numbers $(a_i)_{1 \leq i \leq N_{H_{\text{diff}}} - 1}$. If this family satisfies the property

$$\forall 0 \leq i \leq N_{H_{\text{diff}}} - 1, \quad \frac{1}{\eta} \geq \frac{a_{i+1} - a_i}{H_{\text{diff}}} \geq \eta, \quad (4.20)$$

with $a_0 = 0$ and $a_{N_{\text{diff}}} = 1$, then an element ψ is built as

$$\psi = \sum_{i=0}^{N_{\text{diff}}} a_i \psi_i.$$

Otherwise, a new family of random numbers is chosen and the procedure is iterated until the property (4.20) is satisfied.

4.4 Numerical results

In this section, we present some numerical results illustrating the different approaches we propose. We recall that we stick here to cases where $d = 2$, $\omega = (0, 1)$ and the set \mathcal{U} is chosen to be equal to $\mathcal{U}^{H_{\text{diff}}, \eta}$ for some values $H_{\text{diff}, \eta} > 0$. In all the presented test cases, we only consider loading cases where

$$f(x', x_2) = \begin{cases} 0 & \text{if } x' < \frac{1}{2} \\ -e_2 & \text{if } x' \geq \frac{1}{2} \end{cases},$$

and where the Young modulus function $E(x', x_2)$ is even with respect to the x_2 variable. Hence, all the numerical results presented here are obtained in purely bending cases. As a consequence, in the multiscale finite element approach described in Section 4.3.3 and Section 4.3.4, only bending multiscale finite element functions are computed.

4.4.1 Approximability properties of the reduced multiscale finite element space

Our first set of numerical results concerns the approximability properties of the reduced space $V_{H, N_r}^{\varepsilon, \text{red}}$ defined in Section 4.3.4.

In this test, we fix two cases:

- (a) $\varepsilon = \frac{1}{10}$, $H = \frac{1}{8}$, $H_{\text{diff}} = \frac{1}{8}$, $h = \frac{1}{64}$, $\eta = \frac{1}{10}$ and $M = 100$;
- (b) $\varepsilon = \frac{1}{20}$, $H = \frac{1}{16}$, $H_{\text{diff}} = \frac{1}{16}$, $h = \frac{1}{128}$, $\eta = \frac{1}{10}$ and $M = 100$.

The value of the Young modulus function E is chosen to be equal to

$$E(x', x_2) = 4.5 \cos(2\pi x') + 5.5.$$

Figure 4.5 illustrates the decay rate of the singular values $(\sigma_k^{\mathcal{B}})_{1 \leq k \leq K^{\mathcal{B}}}$ in two cases corresponding (a) and (b). Figure 4.5 shows that the decrease of the singular values is almost exponential with respect to k in both cases. For example, we see that

$$\frac{\sigma_0^{\mathcal{B}}}{\sigma_{10}^{\mathcal{B}}} \approx 10^2 \quad \text{and} \quad \frac{\sigma_0^{\mathcal{B}}}{\sigma_{20}^{\mathcal{B}}} \approx 10^4.$$

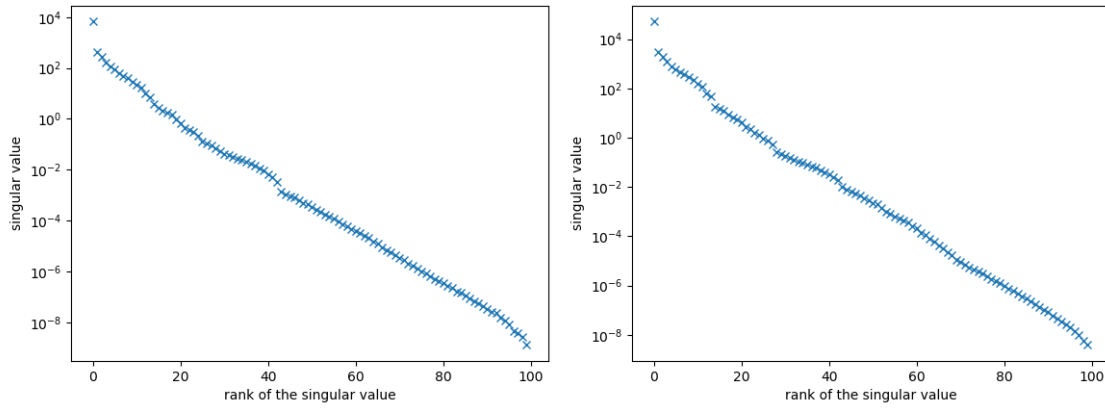

Figure 4.5: Decay of the singular value $\sigma_k^{\mathcal{B}}$ as a function of k in case (a) (left) and case (b) (right).

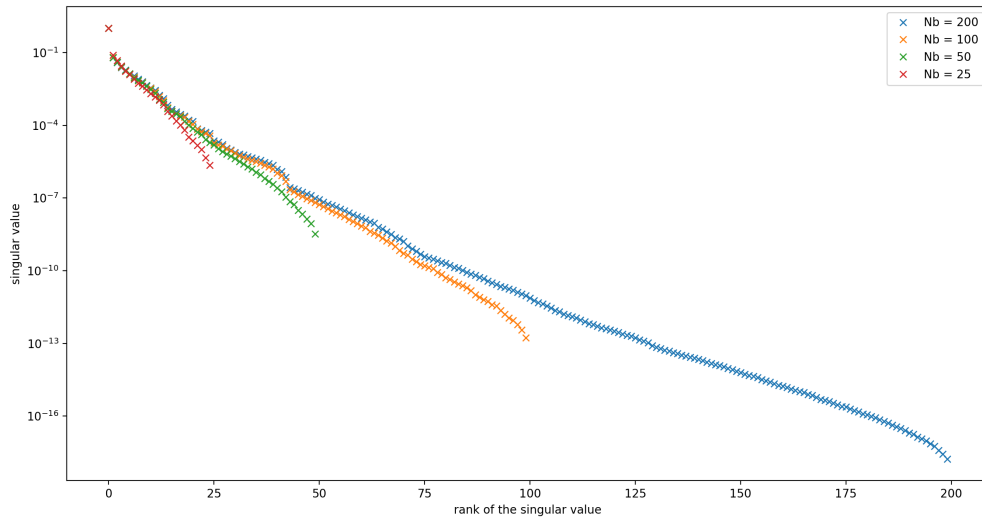

Figure 4.6: Decay of the singular value $\sigma_k^{\mathcal{B}}$ as a function of k in case (a) for different values of N_b .

Of course, these numerical results do not enable to conclude the decrease of the singular values would decay at the same rate for any smooth Young modulus function E , but it shows the relevance of the approach in this particular situation. Figure 4.6 shows the influence of the choice of N_b on the decrease of the singular values in case (a).

These numerical results lead us to think that, at least in this particular example, the vector-valued function $u_{H,N_r}^{\psi,\varepsilon,\text{red}}$ should be a reasonably good approximation of $u^{\psi,\varepsilon}$ for any $\psi \in \mathcal{U}^{H_{\text{diff}},\eta}$ for small values of N_r . To this aim, we randomly draw an element $\psi \in \mathcal{U}^{H_{\text{diff}},\eta}$ according to the random selection procedure detailed at the end of Section 4.3.4 so that $\psi \notin \{\psi_m, 1 \leq m \leq M\}$. In other words, ψ does not belong to the set of diffeomorphisms which have been used to compute the POD modes $(\xi_k)_{1 \leq k \leq N_r}$. In Figure 4.7 are plotted the relative errors in compliance $\left| \frac{\mathcal{J}^\varepsilon(\psi) - \mathcal{J}^{\text{red},N_r}(\psi)}{\mathcal{J}^\varepsilon(\psi)} \right|$ as a function of N_r in cases (a) and (b). We observe in these cases that this relative error is lower than 10^{-2} as soon as N_r is greater than 10. The approximation of the solution $u^{\psi,\varepsilon}$ to

problem (4.6) is computed using a standard \mathbb{P}_1 finite element method associated to a fine discretization mesh whose typical mesh size is chosen to be equal to $h_{\text{ref}} = \frac{1}{64}$ in case (a) and $h_{\text{ref}} = \frac{1}{128}$ in case (b).

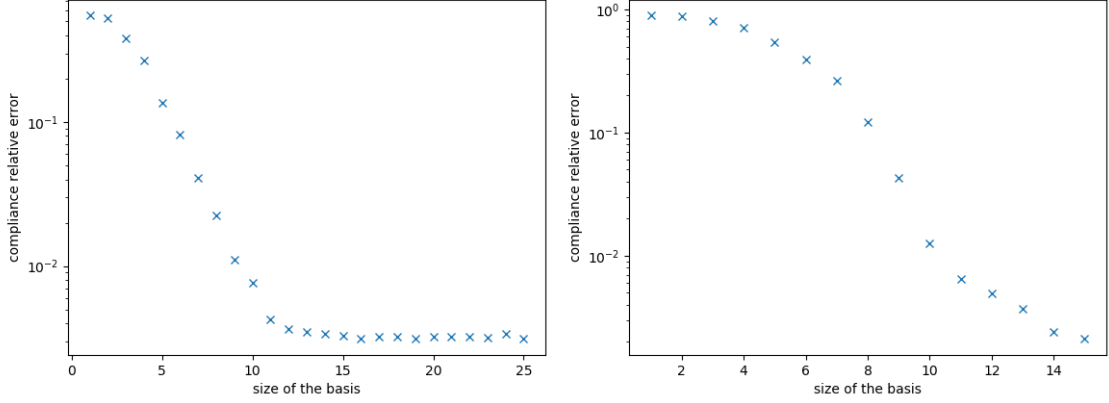

Figure 4.7: Relative error $\left| \frac{\mathcal{J}^\varepsilon(\psi) - \mathcal{J}^{\text{red}, N_r}(\psi)}{\mathcal{J}^\varepsilon(\psi)} \right|$ as a function of N_r in case (a) (left) and (b) (right)

4.4.2 Optimization results

The aim of this section is to illustrate the different optimization approaches introduced in Section 4.3. The different optimization problems were solved using standard projected gradient descent algorithms. In the tests of this section, we fix two cases: In this test, we fix two cases:

- (a) $\varepsilon = \frac{1}{10}$, $H = \frac{1}{8}$, $H_{\text{diff}} = \frac{1}{8}$, $h = \frac{1}{64}$, $\eta = \frac{1}{10}$, $M = 100$ and $N_r = 8$;
- (b) $\varepsilon = \frac{1}{20}$, $H = \frac{1}{16}$, $H_{\text{diff}} = \frac{1}{16}$, $h = \frac{1}{128}$, $\eta = \frac{1}{10}$, $M = 100$ and $N_r = 8$.

The value of the Young modulus function E is chosen to be equal to

$$E(x', x_2) = 4.5 \cos(2\pi x') + 5.5.$$

The reference values of the compliance $\mathcal{J}^\varepsilon(\psi)$ for any $\psi \in \mathcal{U}^{H_{\text{diff}}, \eta}$ are computed using a \mathbb{P}_1 finite element method for the resolution of problem 4.6 associated to a fine discretization mesh, the typical mesh size of which is given by $h_{\text{ref}} = \frac{1}{64}$ in case (a) and $h_{\text{ref}} = \frac{1}{128}$ in case (b).

We are plotting in Figures 4.8 and 4.9 different values of compliances as a function of the iterations of different optimization procedures.

We first consider the numerical resolution of the homogenized optimization problem (4.15) starting from the initial choice $\psi_{\text{init}} = \text{Id}$ (see Figures 4.10 and 4.11). The blue dots represents the evolution of $\mathcal{J}^*(\psi)$ as a function of the number of iterations of the optimization procedure. For the sake of comparison, for each value of ψ given by this optimization procedure, we compute the reference value of the compliance $\mathcal{J}^\varepsilon(\psi)$ in green triangles. We denote by ψ_{opt}^* the optimized value of ψ obtained at the end of this numerical procedure. In this test case, we obtain in case (a) that

$$\mathcal{J}^*(\psi_{\text{opt}}^*) = 1.78 \times 10^{-4} \quad \text{and} \quad \mathcal{J}^\varepsilon(\psi_{\text{opt}}^*) = 1.42 \times 10^{-4},$$

and in case (b) that

$$\mathcal{J}^*(\psi_{\text{opt}}^*) = 1.81 \times 10^{-4} \quad \text{and} \quad \mathcal{J}^\varepsilon(\psi_{\text{opt}}^*) = 1.57 \times 10^{-4}.$$

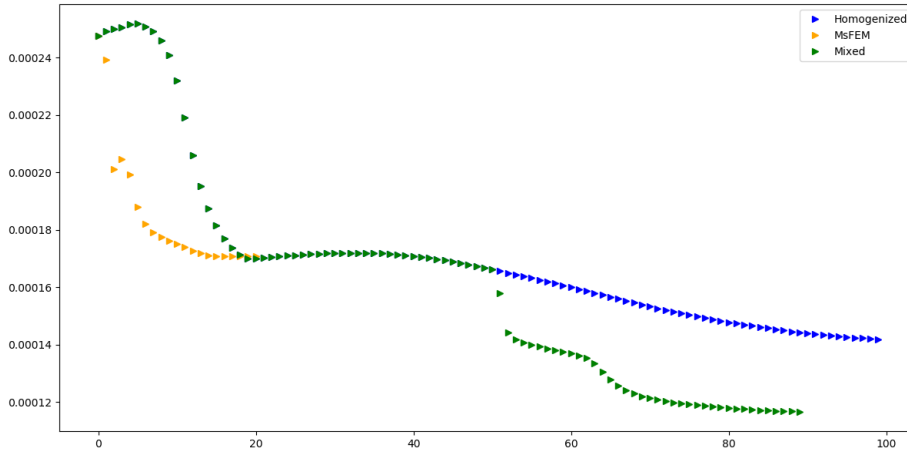

Figure 4.8: Evolution in case (a) of $\mathcal{J}^\varepsilon(\psi)$ with the homogenized optimization problem (4.15) starting from the initial choice $\psi_{\text{init}} = \text{Id}$ (blue triangles, mixed up with the green triangles until iteration 50), with the reduced multiscale optimization problem (4.19) starting from the initial choice $\psi_{\text{init}} = \text{Id}$ (red triangles, stopping at iteration 20), and with the reduced multiscale optimization problem (4.19) starting from the initial choice $\psi_{\text{init}} = \psi_{\text{opt}}^*$ (green triangles).

Let us also mention here that the reference value of the compliance for a perfectly periodic material is equal in case (a) to

$$\mathcal{J}^\varepsilon(\text{Id}) = 2.48 \times 10^{-4}.$$

and in case (b) to

$$\mathcal{J}^\varepsilon(\text{Id}) = 2.23 \times 10^{-4}.$$

We then consider the numerical resolution of the reduced multiscale optimization problem (4.19) starting from the initial choice $\psi_{\text{init}} = \text{Id}$ (see Figure 4.12 and 4.13). The red crosses represents the evolution of $\mathcal{J}^{\text{red},N_r}(\psi)$ as a function of the number of iterations of the optimization procedure. For the sake of comparison, for each value of ψ given by this optimization procedure, we compute the reference value of the compliance $\mathcal{J}^\varepsilon(\psi)$ in red triangles. We denote by $\psi_{\text{opt}}^{\text{red},1}$ the optimized value of ψ obtained at the end of this numerical procedure. In this test case, we obtain that in case (a)

$$\mathcal{J}^{\text{red},N_r}(\psi_{\text{opt}}^{\text{red},1}) = 1,65 \times 10^{-4} \quad \text{and} \quad \mathcal{J}^\varepsilon(\psi_{\text{opt}}^{\text{red},1}) = 1,71 \times 10^{-4},$$

and in case (b)

$$\mathcal{J}^{\text{red},N_r}(\psi_{\text{opt}}^{\text{red},1}) = 1,37 \times 10^{-4} \quad \text{and} \quad \mathcal{J}^\varepsilon(\psi_{\text{opt}}^{\text{red},1}) = 1,53 \times 10^{-4},$$

We finally consider the numerical resolution of the reduced multiscale optimization problem (4.19) starting from the initial choice $\psi_{\text{init}} = \psi_{\text{opt}}^*$ (see Figures 4.14 and 4.15). The blue dots represent the evolution of $J^*(\psi)$ and the orange crosses represents the evolution of $\mathcal{J}^{\text{red},N_r}(\psi)$ as a function of the number of iterations of the optimization procedure. For the sake of comparison, for each value of ψ given by this optimization procedure, we compute the reference value of the compliance $\mathcal{J}^\varepsilon(\psi)$ in green triangles.

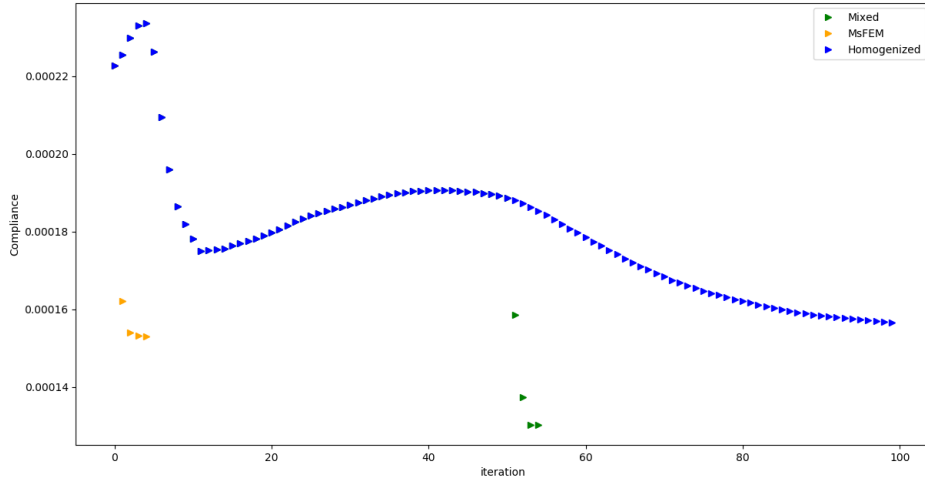

Figure 4.9: Evolution in case (b) of $\mathcal{J}^\varepsilon(\psi)$ with the homogenized optimization problem (4.15) starting from the initial choice $\psi_{\text{init}} = \text{Id}$ (blue triangles), with the reduced multiscale optimization problem (4.19) starting from the initial choice $\psi_{\text{init}} = \text{Id}$ (red triangles, stopping at iteration 5), and with the reduced multiscale optimization problem (4.19) starting from the initial choice $\psi_{\text{init}} = \psi_{\text{opt}}^*$ (green triangles, mixed up with the blue triangles until iteration 50).

We denote by $\psi_{\text{opt}}^{\text{red},2}$ the optimized value of ψ obtained at the end of this numerical procedure. In this test case, we obtain in case (a) that

$$\mathcal{J}^{\text{red},N_r}(\psi_{\text{opt}}^{\text{red},2}) = 1,13 \times 10^{-4} \quad \text{and} \quad \mathcal{J}^\varepsilon(\psi_{\text{opt}}^{\text{red},2}) = 1,16 \times 10^{-4},$$

and in case (b) that

$$\mathcal{J}^{\text{red},N_r}(\psi_{\text{opt}}^{\text{red},2}) = 1,20 \times 10^{-4} \quad \text{and} \quad \mathcal{J}^\varepsilon(\psi_{\text{opt}}^{\text{red},2}) = 1,30 \times 10^{-4}.$$

We thus obtain the following compliance reduction for the three different optimization procedures in case a:

$$\begin{aligned} \frac{\mathcal{J}^\varepsilon(\text{Id}) - \mathcal{J}^\varepsilon(\psi_{\text{opt}}^*)}{\mathcal{J}^\varepsilon(\text{Id})} &= 0.42, \\ \frac{\mathcal{J}^\varepsilon(\text{Id}) - \mathcal{J}^\varepsilon(\psi_{\text{opt}}^{\text{red},1})}{\mathcal{J}^\varepsilon(\text{Id})} &= 0.31, \\ \frac{\mathcal{J}^\varepsilon(\text{Id}) - \mathcal{J}^\varepsilon(\psi_{\text{opt}}^{\text{red},2})}{\mathcal{J}^\varepsilon(\text{Id})} &= 0.53; \end{aligned}$$

and in case (b):

$$\begin{aligned} \frac{\mathcal{J}^\varepsilon(\text{Id}) - \mathcal{J}^\varepsilon(\psi_{\text{opt}}^*)}{\mathcal{J}^\varepsilon(\text{Id})} &= 0.30, \\ \frac{\mathcal{J}^\varepsilon(\text{Id}) - \mathcal{J}^\varepsilon(\psi_{\text{opt}}^{\text{red},1})}{\mathcal{J}^\varepsilon(\text{Id})} &= 0.31, \\ \frac{\mathcal{J}^\varepsilon(\text{Id}) - \mathcal{J}^\varepsilon(\psi_{\text{opt}}^{\text{red},2})}{\mathcal{J}^\varepsilon(\text{Id})} &= 0.42; \end{aligned}$$

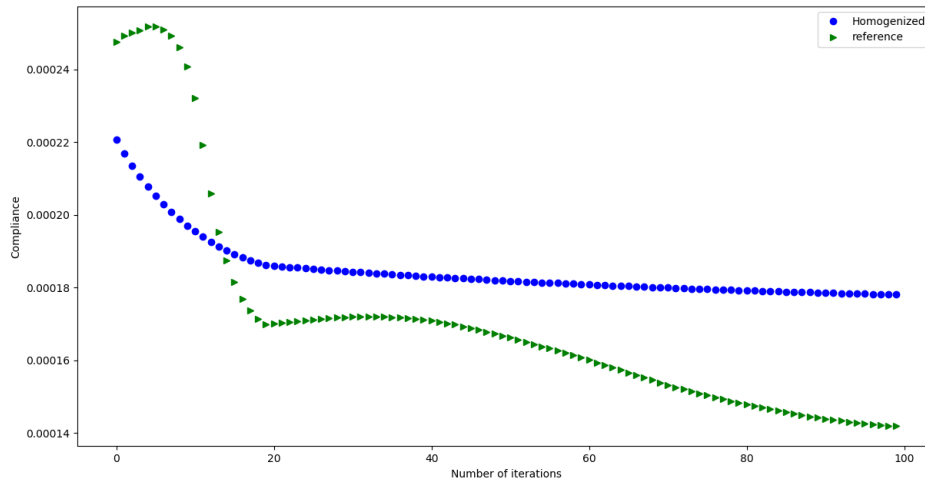

Figure 4.10: Evolution in case (a) of $\mathcal{J}^*(\psi)$ (blue dots) and $\mathcal{J}^\varepsilon(\psi)$ (green triangles) as a function of the number of iterations of the optimization procedure during the resolution of the homogenized optimization problem (4.15) starting from the initial choice $\psi_{\text{init}} = \text{Id}$.

On these plots, we observe that, along the iterations of the optimization procedures, the approximated values of the compliance given by the reduced multiscale approach $\mathcal{J}^{\text{red}, N_r}(\psi)$ are closer to the corresponding reference values $\mathcal{J}^\varepsilon(\psi)$ than the approximation $\mathcal{J}^*(\psi)$ obtained with a homogenized model. Hence, the proposed reduced multiscale finite element approach seems to yield more faithful approximations of the compliance of the actual material than a homogenized model.

In addition, we observe that the reference compliance of $\mathcal{J}^\varepsilon(\psi_{\text{opt}}^{\text{red}, 2})$ is lower than $\mathcal{J}^\varepsilon(\psi_{\text{opt}}^{\text{red}, 1})$ or $\mathcal{J}^\varepsilon(\psi_{\text{opt}}^*)$. This numerical observation leads us to think that the general strategy which consists in first solving the homogenized optimization problem, and use the obtained optimal diffeomorphism as a starting guess for the resolution of the reduced multiscale optimization problem yields to actual materials the reference compliance of which is significantly lower than what would have been obtained with the only use of a homogenized model.

In Figures 4.16 and 4.17 are plotted the functions ψ_{opt}^* , $\psi_{\text{opt}}^{\text{red}, 1}$ and $\psi_{\text{opt}}^{\text{red}, 2}$. The values of $\frac{\nu}{(1+\nu)(1-2\nu)} E^{\psi_{\text{opt}}^*, \varepsilon}$, $\frac{\nu}{(1+\nu)(1-2\nu)} E^{\psi_{\text{opt}}^{\text{red}, 1}, \varepsilon}$ and $\frac{\nu}{(1+\nu)(1-2\nu)} E^{\psi_{\text{opt}}^{\text{red}, 2}, \varepsilon}$ are plotted in Figures 4.18 and 4.19.

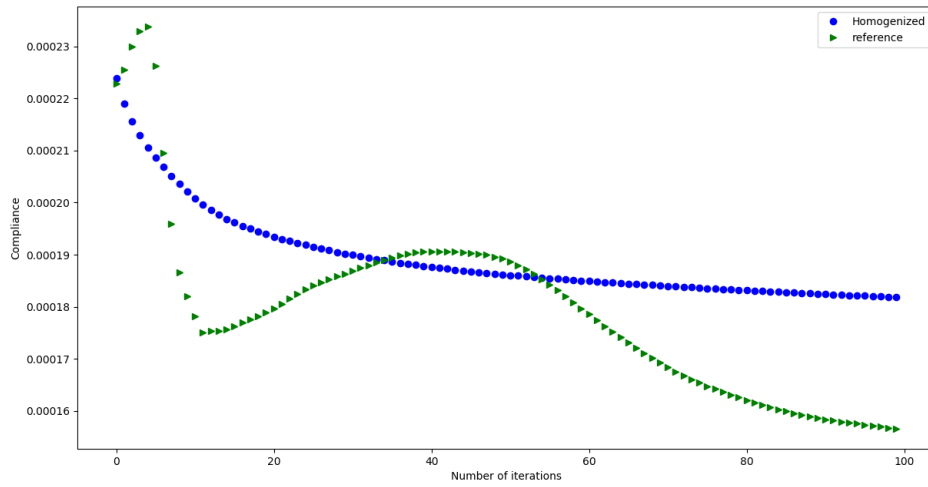

Figure 4.11: Evolution in case (b) of $\mathcal{J}^*(\psi)$ (blue dots) and $J^\varepsilon(\psi)$ (green triangles) as a function of the number of iterations of the optimization procedure during the resolution of the homogenized optimization problem (4.15) starting from the initial choice $\psi_{\text{init}} = \text{Id}$.

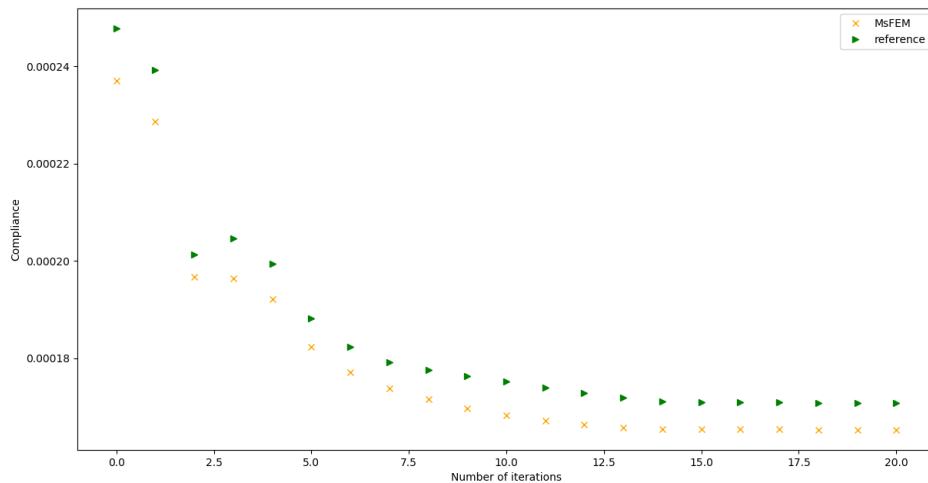

Figure 4.12: Evolution in case (a) of $\mathcal{J}^{\text{red}, N_r}(\psi)$ (red crosses) and $J^\varepsilon(\psi)$ (green triangles) as a function of the number of iterations of the optimization procedure during the resolution of the reduced multiscale optimization problem (4.19) starting from the initial choice $\psi_{\text{init}} = \text{Id}$.

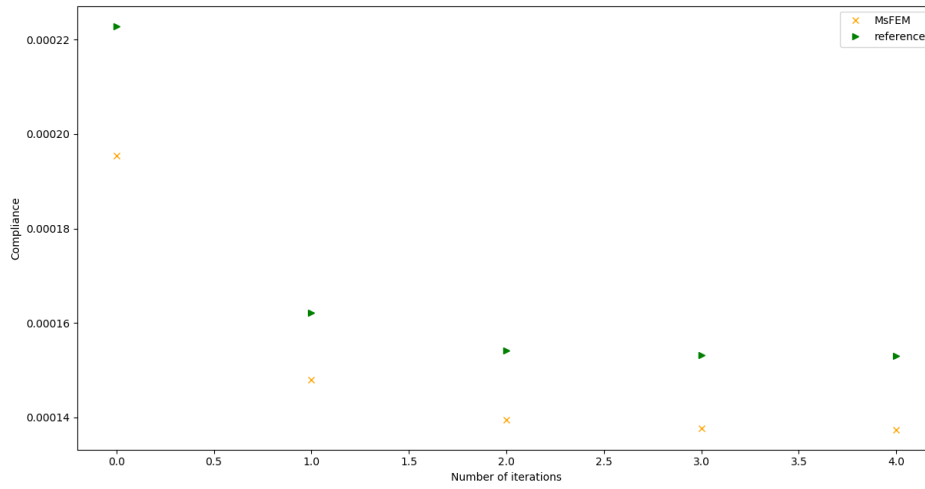

Figure 4.13: Evolution in case (b) of $\mathcal{J}^{\text{red},N_r}(\psi)$ (red crosses) and $J^\varepsilon(\psi)$ (green triangles) as a function of the number of iterations of the optimization procedure during the resolution of the reduced multiscale optimization problem (4.19) starting from the initial choice $\psi_{\text{init}} = \text{Id}$.

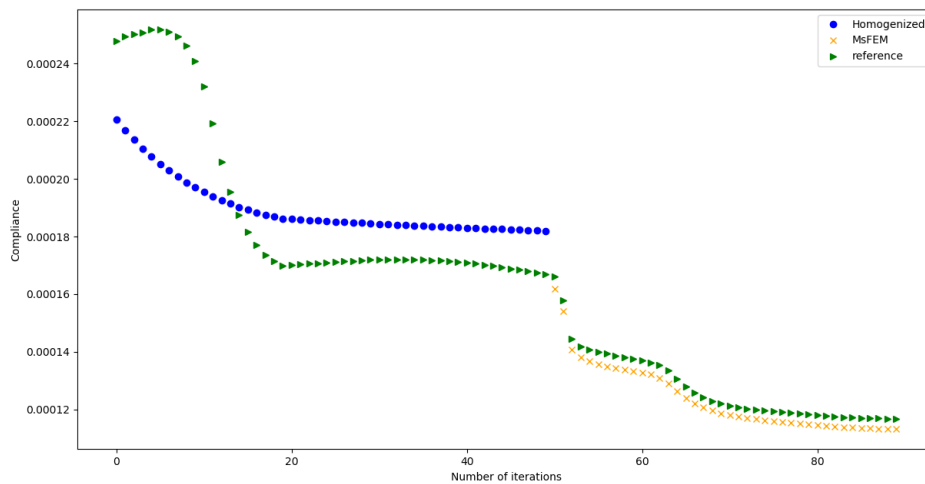

Figure 4.14: Evolution in case (a) of $\mathcal{J}^*(\psi)$ (blue dots) and $J^\varepsilon(\psi)$ (green triangles) as a function of the number of iterations of the optimization procedure during the resolution of the homogenized optimization problem starting from the initial choice $\psi_{\text{init}} = \text{Id}$, then of $\mathcal{J}^{\text{red},N_r}(\psi)$ (red crosses) and $J^\varepsilon(\psi)$ (green triangles) as a function of the number of iterations of the optimization procedure during the resolution of the reduced multiscale optimization problem (4.19) starting from the initial choice $\psi_{\text{init}} = \psi_{\text{opt}}^*$.

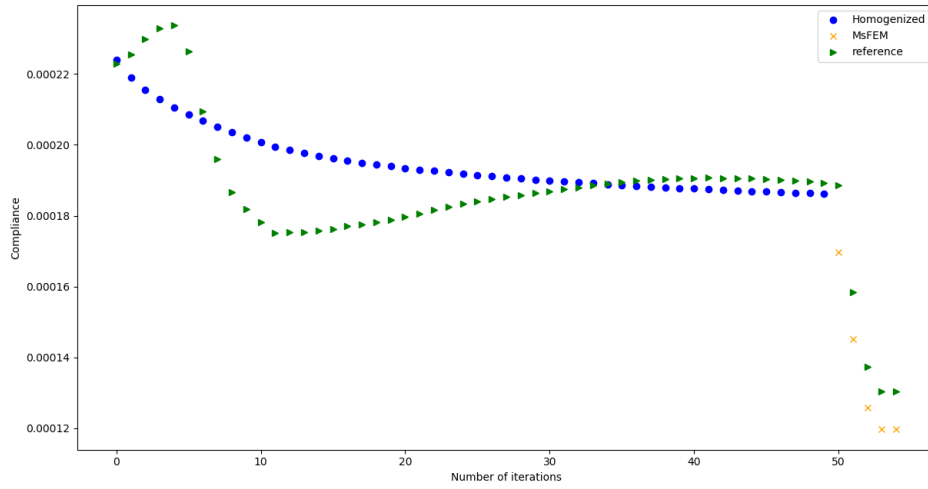

Figure 4.15: Evolution in case (b) of $\mathcal{J}^*(\psi)$ (blue dots) and $J^\varepsilon(\psi)$ (green triangles) as a function of the number of iterations of the optimization procedure during the resolution of the homogenized optimization problem starting from the initial choice $\psi_{\text{init}} = \text{Id}$, then of $\mathcal{J}^{\text{red}, N_r}(\psi)$ (red crosses) and $J^\varepsilon(\psi)$ (green triangles) as a function of the number of iterations of the optimization procedure during the resolution of the reduced multiscale optimization problem (4.19) starting from the initial choice $\psi_{\text{init}} = \psi_{\text{opt}}^*$.

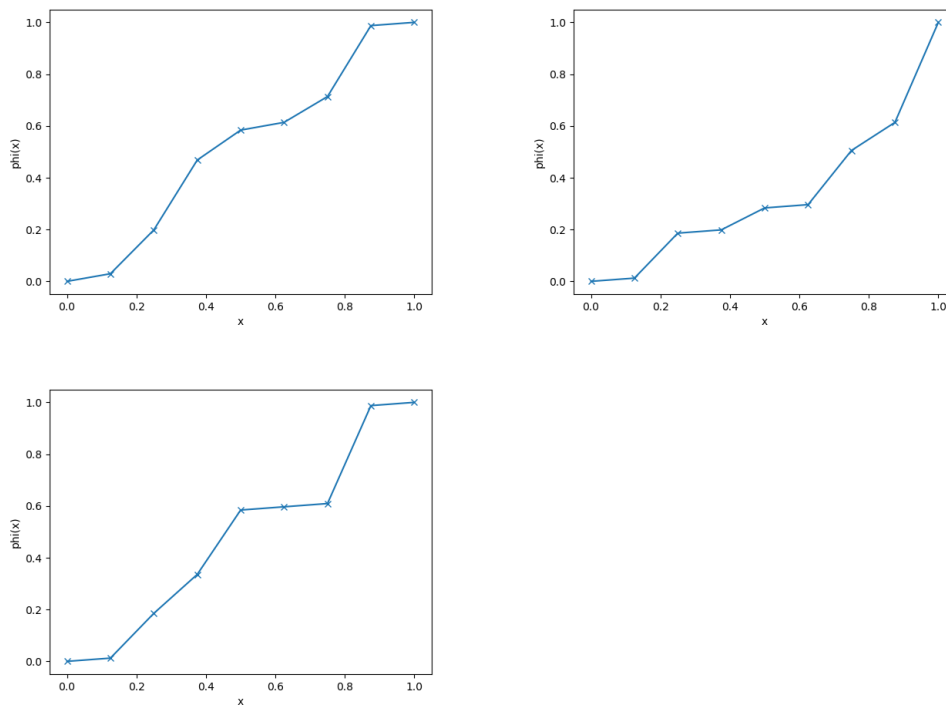

Figure 4.16: Plots of the functions ψ_{opt}^* , $\psi_{\text{opt}}^{\text{red},1}$ and $\psi_{\text{opt}}^{\text{red},2}$ in case (a)

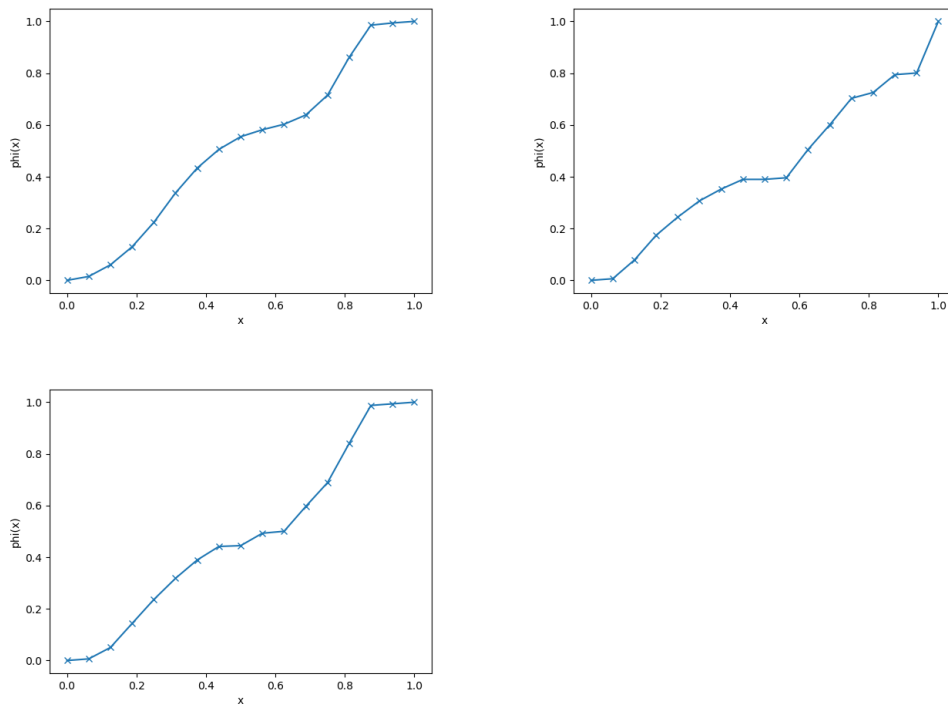

Figure 4.17: Plots of the functions ψ_{opt}^* , $\psi_{\text{opt}}^{\text{red},1}$ and $\psi_{\text{opt}}^{\text{red},2}$ in case (b)



Figure 4.18: Plots of the function $\frac{\nu}{(1+\nu)(1-2\nu)} E^{\psi_{\text{opt}}^*, \varepsilon}$, $\frac{\nu}{(1+\nu)(1-2\nu)} E^{\psi_{\text{opt}}^{\text{red},1}, \varepsilon}$ and $\frac{\nu}{(1+\nu)(1-2\nu)} E^{\psi_{\text{opt}}^{\text{red},2}, \varepsilon}$ in case (a)



Figure 4.19: Plots of the function $\frac{\nu}{(1+\nu)(1-2\nu)} E \psi_{\text{opt};\varepsilon}^*$, $\frac{\nu}{(1+\nu)(1-2\nu)} E \psi_{\text{opt}}^{\text{red},1}$ and $\frac{\nu}{(1+\nu)(1-2\nu)} E \psi_{\text{opt}}^{\text{red},2}$ in case (b)

BIBLIOGRAPHY

- [1] G. Allaire. *Shape optimization by the homogenization method*, volume 146. Springer Science & Business Media, 2012.
- [2] G. Allaire, E. Bonnetier, G. Francfort, and F. Jouve. Shape optimization by the homogenization method. *Numerische Mathematik*, 76(1):27–68, 1997.
- [3] G. Allaire, P. Geoffroy-Donders, and O. Pantz. Topology optimization of modulated and oriented periodic microstructures by the homogenization method. *Computers & Mathematics with Applications*, 78(7):2197–2229, 2019.
- [4] G. Allaire, F. Jouve, and A. Toader. A level-set method for shape optimization. *Comptes Rendus Mathématique*, 334(12):1125–1130, 2002.
- [5] G. Allaire and M. Schoenauer. *Conception optimale de structures*, volume 58. Springer, 2007.
- [6] L. Ambrosio and G. Buttazzo. An optimal design problem with perimeter penalization. *Calculus of variations and partial differential equations*, 1(1):55–69, 1993.
- [7] N. S. Bakhvalov and G. Panasenko. *Homogenisation: averaging processes in periodic media: mathematical problems in the mechanics of composite materials*, volume 36. Springer Science & Business Media, 2012.
- [8] K. Bell. A refined triangular plate bending finite element. *International journal for numerical methods in engineering*, 1(1):101–122, 1969.
- [9] M. P. Bendsøe. Optimal shape design as a material distribution problem. *Structural optimization*, 1(4):193–202, 1989.
- [10] M. P. Bendsøe and N. Kikuchi. Generating optimal topologies in structural design using a homogenization method. *Computer methods in applied mechanics and engineering*, 71(2):197–224, 1988.
- [11] M. P. Bendsøe and O. Sigmund. *Topology Optimization: Theory, Methods, and Applications*. Springer Science & Business Media, 2003.
- [12] A. Bensoussan, J-L. Lions, and G. Papanicolaou. *Asymptotic analysis for periodic structures*, volume 374. American Mathematical Soc., 2011.
- [13] X. Blanc, M. Josien, and C. Le Bris. Approximation locale précisée dans des problèmes multi-échelles avec défauts localisés. *Comptes Rendus Mathématique*, 357(2):167–174, 2019.

- [14] X. Blanc, M. Josien, and C. Le Bris. Precised approximations in elliptic homogenization beyond the periodic setting. *Asymptotic Analysis*, 116(2):93–137, 2020.
- [15] X. Blanc, C. Le Bris, and P-L. Lions. On correctors for linear elliptic homogenization in the presence of local defects. *Communications in Partial Differential Equations*, 43(6):965–997, 2018.
- [16] H. Brezis. *Analyse fonctionnelle: théorie et applications*, volume 91. Dunod Paris, 1999.
- [17] D. Caillerie. Homogénéisation des équations de la diffusion stationnaire dans les domaines cylindriques aplatis. *ESAIM: Mathematical Modelling and Numerical Analysis*, 15(4):295–319, 1981.
- [18] D. Caillerie and J. C. Nedelec. Thin elastic and periodic plates. *Mathematical Methods in the Applied Sciences*, 6(1):159–191, 1984.
- [19] D. Chapelle. *Etude des phénomènes de verrouillage numérique pour les problèmes de coques minces*. PhD thesis, Paris 6, 1996.
- [20] D. Chapelle and K.-J. Bathe. Fundamental considerations for the finite element analysis of shell structures. *Computers & Structures*, 66(1):19–36, 1998.
- [21] D. Chenais and J-C. Paumier. On the locking phenomenon for a class of elliptic problems. *Numerische Mathematik*, 67(4):427–440, 1994.
- [22] P. G. Ciarlet. *Mathematical Elasticity: Volume I: three-dimensional elasticity*. North-Holland, 1988.
- [23] P. G. Ciarlet. *Mathematical Elasticity: Volume II: Theory of Plates*. Elsevier, 1997.
- [24] P. G. Ciarlet and P. Destuynder. Justification of the two-dimensional linear plate model. *J Mec*, 18(2):315–344, 1979.
- [25] P. Courilleau and J. Mossino. Compensated compactness for nonlinear homogenization and reduction of dimension. *Calculus of Variations and Partial Differential Equations*, 20(1):65–91, 2004.
- [26] G. R. Cowper, E. Kosko, G. M. Lindberg, and M. D. Olson. Static and dynamic applications of a high-precision triangular plate bending element. *AIAA Journal*, 7(10):1957–1965, 1969.
- [27] G. Dal Maso. *An introduction to Γ -convergence*, volume 8. Springer Science & Business Media, 2012.
- [28] M. Dauge and I. Gruais. Asymptotics of arbitrary order for a thin elastic clamped plate, I. Optimal error estimates. *Asymptotic Analysis*, 13(2):167–197, 1996.
- [29] S. Daynes, S. Feih, W. F. Lu, and J. Wei. Optimisation of functionally graded lattice structures using isostatic lines. *Materials & Design*, 127:215–223, 2017.
- [30] E. De Giorgi. Sulla convergenza di alcune successioni d’integrali del tipo dell’area. *Bollettino dell’Unione Matematica Italiana*, 8(4):391–411, 1973.
- [31] B. F. De Veubeke. A conforming finite element for plate bending. *International Journal of Solids and Structures*, 4(1):95–108, 1968.

- [32] P. Destuynder. Comparaison entre les modèles tridimensionnels et bidimensionnels de plaques en élasticité. *RAIRO. Analyse numérique*, 15(4):331–369, 1981.
- [33] W. E and B. Engquist. The Heterogeneous Multiscale Methods. *Communications in Mathematical Sciences*, 1(1):87–132, 2003.
- [34] W. E, B. Engquist, X. Li, W. Ren, and E. Vanden-Eijnden. Heterogeneous multiscale methods: a review. *Communications in computational physics*, 2(3):367–450, 2007.
- [35] W. E, P. Ming, and P. Zhang. Analysis of the heterogeneous multiscale method for elliptic homogenization problems. *Journal of the American Mathematical Society*, 18(1):121–156, 2005.
- [36] Y. Efendiev and T. Y. Hou. *Multiscale finite element methods: theory and applications*, volume 4. Springer Science & Business Media, 2009.
- [37] Y. R Efendiev. *The Multiscale Finite Element Method (MsFEM) and its Applications*. PhD thesis, California Institute of Technology, 1999.
- [38] Y.R. Efendiev, T.Y. Hou, and X.-H. Wu. Convergence of a nonconforming multiscale finite element method. *SIAM J. Num. Anal.*, 37(3):888–910, 2000.
- [39] B. Engquist and P. E. Souganidis. Asymptotic and numerical homogenization. *Acta Numerica*, 17:147–190, 2008.
- [40] A. Ern and J-L. Guermond. *Theory and practice of Finite Elements*, volume 36. Springer Science & Business Media, 2002.
- [41] F. Feyel and J-L. Chaboche. FE2 multiscale approach for modelling the elastoviscoplastic behaviour of long fibre sic/ti composite materials. *Computer methods in applied mechanics and engineering*, 183(3-4):309–330, 2000.
- [42] B. Geihe, M. Lenz, M. Rumpf, and R. Schultz. Risk averse elastic shape optimization with parametrized fine scale geometry. *Mathematical Programming*, 141(1-2):383–403, 2013.
- [43] P. Geoffroy-Donders. *Homogenization method for topology optimization of structures built with lattice materials*. PhD thesis, Université Paris-Saclay, 2018.
- [44] A. Gloria, S. Neukamm, and F. Otto. Quantification of ergodicity in stochastic homogenization: optimal bounds via spectral gap on Glauber dynamics. *Inventiones mathematicae*, 199(2):455–515, 2015.
- [45] G. Griso and B. Miara. Homogenization of periodically heterogeneous thin beams. *Chinese Annals of Mathematics, Series B*, 39(3):397–426, 2018.
- [46] B. Gustafsson and J. Mossino. Non-periodic explicit homogenization and reduction of dimension: the linear case. *IMA Journal of Applied Mathematics*, 68(3):269–298, 2003.
- [47] B. Gustafsson and J. Mossino. Compensated compactness for homogenization and reduction of dimension: the case of elastic laminates. *Asymptotic Analysis*, 47(1, 2):139–169, 2006.

- [48] J. Haslinger, M. Kočvara, G. Leugering, and M. Stingl. Multidisciplinary free material optimization. *SIAM Journal on Applied Mathematics*, 70(7):2709–2728, 2010.
- [49] F. Hecht. New development in FreeFem++. *J. Numer. Math.*, 20(3-4):251–265, 2012.
- [50] P. Henning and D. Peterseim. Oversampling for the multiscale finite element method. *Multiscale Modeling & Simulation*, 11(4):1149–1175, 2013.
- [51] A. Henrot and M. Pierre. *Variation et optimisation de formes: une analyse géométrique*, volume 48. Springer Science & Business Media, 2006.
- [52] P. Hornung, S. Neukamm, and I. Velčić. Derivation of a homogenized nonlinear plate theory from 3d elasticity. *Calculus of variations and partial differential equations*, 51(3-4):677–699, 2014.
- [53] P. Hornung, M. Pawelczyk, and I. Velčić. Stochastic homogenization of the bending plate model. *Journal of Mathematical Analysis and Applications*, 458(2):1236–1273, 2018.
- [54] T. Hou, X-H. Wu, and Z. Cai. Convergence of a multiscale finite element method for elliptic problems with rapidly oscillating coefficients. *Mathematics of computation*, 68(227):913–943, 1999.
- [55] T. Y. Hou and X. Wu. A multiscale finite element method for elliptic problems in composite materials and porous media. *Journal of computational physics*, 134(1):169–189, 1997.
- [56] T.Y. Hou, X.-H. Wu, and Z. Cai. Convergence of a multiscale finite element method for elliptic problems with rapidly oscillating coefficients. *Maths. of Comp.*, 68(227):913–943, 1999.
- [57] T. J. R. Hughes, G. R. Feijóo, L. Mazzei, and J.-B. Quincy. The variational multiscale method—a paradigm for computational mechanics. *Computer methods in applied mechanics and engineering*, 166(1-2):3–24, 1998.
- [58] V. V. Jikov, S. M. Kozlov, and O. A. Oleinik. *Homogenization of differential operators and integral functionals*. Springer-Verlag, 1994.
- [59] Y. Y. Kim and G. H. Yoon. Multi-resolution multi-scale topology optimization—a new paradigm. *International Journal of Solids and Structures*, 37(39):5529–5559, 2000.
- [60] R. V. Kohn and G. Strang. Optimal design and relaxation of variational problems, I. *Communications on pure and applied mathematics*, 39(1):113–137, 1986.
- [61] R. V. Kohn and M. Vogelius. A new model for thin plates with rapidly varying thickness. *International Journal of Solids and Structures*, 20(4):333–350, 1984.
- [62] R. V. Kohn and M. Vogelius. A new model for thin plates with rapidly varying thickness. II. A convergence proof. *Quarterly of applied mathematics*, 43(1):1–22, 1985.
- [63] C. Le Bris. *Systèmes multi-échelles: modélisation et simulation*, volume 47. Springer Science & Business Media, 2005.

- [64] C. Le Bris, F. Legoll, and A. Lozinski. MsFEM à la Crouzeix-Raviart for highly oscillatory elliptic problems. *Chinese Annals of Mathematics, Series B*, 34(1):113–138, 2013.
- [65] C. Le Bris, F. Legoll, and A. Lozinski. An MsFEM type approach for perforated domains. *Multiscale Modeling & Simulation*, 12(3):1046–1077, 2014.
- [66] C. Le Bris, F. Legoll, and F. Madiot. Multiscale Finite Element methods for advection-dominated problems in perforated domains. *Multiscale Modeling & Simulation*, 17(2):773–825, 2019.
- [67] C. Le Bris, F. Legoll, and W. Minvielle. Special quasirandom structures: a selection approach for stochastic homogenization. *Monte Carlo Methods and Applications*, 22(1):25–54, 2016.
- [68] A. Lebée and K. Sab. A bending-gradient model for thick plates. Part I: Theory. *International Journal of Solids and Structures*, 48(20):2878–2888, 2011.
- [69] A. Lebée and K. Sab. A Bending-Gradient model for thick plates, Part II: Closed-form solutions for cylindrical bending of laminates. *International Journal of Solids and Structures*, 48(20):2889–2901, 2011.
- [70] A. Lebée and K. Sab. Justification of the bending-gradient theory through asymptotic expansions. In *Generalized continua as models for materials*, pages 217–236. Springer, 2013.
- [71] L. Liu, J. Yan, and G. Cheng. Optimum structure with homogeneous optimum truss-like material. *Computers & Structures*, 86(13-14):1417–1425, 2008.
- [72] A. E. H. Love. The small free vibrations and deformation of a thin elastic shell. *Philosophical Transactions of the Royal Society of London.(A.)*, 179:491–546, 1888.
- [73] K. A. Lurie, A. V. Cherkaev, and A. V. Fedorov. Regularization of optimal design problems for bars and plates, Part 1. *Journal of Optimization Theory and Applications*, 37(4):499–522, 1982.
- [74] A. Målqvist and D. Peterseim. Localization of elliptic multiscale problems. *Mathematics of Computation*, 83(290):2583–2603, 2014.
- [75] M. Marohnić and I. Velčić. Homogenization of bending theory for plates; the case of oscillations in the direction of thickness. *Communications on Pure & Applied Analysis*, 14(6):2151, 2015.
- [76] M. Marohnić and I. Velčić. Non-periodic homogenization of bending–torsion theory for inextensible rods from 3d elasticity. *Annali di Matematica Pura ed Applicata (1923-)*, 195(4):1055–1079, 2016.
- [77] R. D. Mindlin. Influence of rotatory inertia and shear on flexural motions of isotropic, elastic plates. *J. Appl. Mech.*, 18:31–38, 1951.
- [78] F. Murat. Compacité par compensation. *Annali della Scuola Normale Superiore di Pisa-Classe di Scienze*, 5(3):489–507, 1978.
- [79] F. Murat. Calcul des variations et homogénéisation. *Les Méthodes de l’Homogénéisation: Théorie et Applications en Physique, Coll. de la Dir, des Etudes et Recherches de Electricite*, pages 319–370, 1985.

- [80] F. Murat and L. Tartar. H-convergence. In *Topics in the mathematical modelling of composite materials*, pages 21–43. Springer, 2018.
- [81] S. Osher and R. P. Fedkiw. Level set methods: an overview and some recent results. *Journal of Computational physics*, 169(2):463–502, 2001.
- [82] S. Osher and J. A. Sethian. Fronts propagating with curvature-dependent speed: algorithms based on Hamilton-Jacobi formulations. *Journal of computational physics*, 79(1):12–49, 1988.
- [83] O. Pantz and K. Trabelsi. A post-treatment of the homogenization method for shape optimization. *SIAM Journal on Control and Optimization*, 47(3):1380–1398, 2008.
- [84] J. Paumier and A. Raoult. Asymptotic consistency of the polynomial approximation in the linearized plate theory. *ESAIM: Proceedings*, 2:203–213, 1997.
- [85] E. Reissner. The effect of transverse shear deformation on the bending of elastic plates. *J. appl. Mech.*, 12:A68–A77, 1945.
- [86] P-L. Rothé. *Méthodes numériques pour l'estimation des fluctuations dans les matériaux multi-échelles et problèmes reliés*. PhD thesis, Université Paris Est, 2019.
- [87] K. Sab and A. Lebé. *Homogenization of heterogeneous thin and thick plates*. John Wiley & Sons, 2015.
- [88] F. Schury, M. Stingl, and F. Wein. Slope constrained material design. *Structural and Multidisciplinary Optimization*, 46(6):813–827, 2012.
- [89] G. Strang and G. J. Fix. *An analysis of the finite element method*, volume 212. Prentice-hall Englewood Cliffs, NJ, 1973.
- [90] V. Šverák. On optimal shape design. *Journal de mathématiques pures et appliquées*, 72(6):537–551, 1993.
- [91] L. Tomasz and T. J. Joachim. *Plates, laminates and shells: asymptotic analysis and homogenization*, volume 52. World Scientific, 2000.
- [92] I. Velčić. On the derivation of homogenized bending plate model. *Calculus of variations and partial differential equations*, 53(3-4):561–586, 2015.
- [93] F. Zara. *Modèle mécanique d'une plaque mince*. Habilitation à diriger des recherches (HDR), Université Lyon 1, 2017.
- [94] P. Zhang, J. Toman, Y. Yu, E. Biyikli, M. Kirca, M. Chmielus, and A. C. To. Efficient design-optimization of variable-density hexagonal cellular structure by additive manufacturing: theory and validation. *Journal of Manufacturing Science and Engineering*, 137(2), 2015.
- [95] O. Zienkiewicz. *The finite element methods in engineering science*. McGraw-Hill, 1971.