



**HAL**  
open science

# Role of the endocannabinoid system in exercise motivation

Bastien Redon

► **To cite this version:**

Bastien Redon. Role of the endocannabinoid system in exercise motivation. Neuroscience. Université de Bordeaux, 2021. English. NNT : 2021BORD0034 . tel-03411513

**HAL Id: tel-03411513**

**<https://theses.hal.science/tel-03411513>**

Submitted on 2 Nov 2021

**HAL** is a multi-disciplinary open access archive for the deposit and dissemination of scientific research documents, whether they are published or not. The documents may come from teaching and research institutions in France or abroad, or from public or private research centers.

L'archive ouverte pluridisciplinaire **HAL**, est destinée au dépôt et à la diffusion de documents scientifiques de niveau recherche, publiés ou non, émanant des établissements d'enseignement et de recherche français ou étrangers, des laboratoires publics ou privés.

THÈSE PRÉSENTÉE  
POUR OBTENIR LE GRADE DE

**DOCTEUR DE L'UNIVERSITÉ DE BORDEAUX**

École Doctorale des Sciences de la Vie et de la Santé

Spécialité - Neurosciences

**Par Bastien REDON**

# **ROLE OF THE ENDOCANNABINOID SYSTEM IN EXERCISE MOTIVATION**

Sous la direction de : Francis CHAOULOFF

Soutenue le 08 février 2021

## **Membres du jury :**

CADOR Martine, Dr  
BELLONE Camilla, Pr  
BARIK Jacques, Dr  
PARKES Shauna, Dr  
AHMED Serge, Dr  
SOLINAS Marcelo, Dr  
CHAOULOFF Francis, Dr  
MARSICANO Giovanni, Dr

Université de Bordeaux, France  
Université de Genève, Suisse  
Université Côte d'Azur, France  
Université de Bordeaux, France  
Université de Bordeaux, France  
Université de Poitiers, France  
Université de Bordeaux, France  
Université de Bordeaux, France

Président  
Rapporteur  
Rapporteur  
Examineur  
Examineur  
Examineur  
Invité  
Invité



# ROLE DU SYSTEME ENDOCANNABINOÏDE DANS LA MOTIVATION POUR L'EXERCICE

La sédentarité est un problème majeur de santé publique qui s'explique principalement par un déséquilibre de la balance énergétique. Il résulte (i) d'une prise alimentaire abondante et (ii) d'une absence de motivation pour l'exercice. Malheureusement, les bases neurobiologiques de la motivation pour l'exercice sont encore méconnues. Des travaux du laboratoire avaient montré l'implication du système endocannabinoïde (SEC) dans le contrôle des performances de course chez la souris. Ce contrôle s'effectue *via* les récepteurs aux cannabinoïdes de type 1 (CB1) localisés sur les terminaisons GABAergiques de l'aire tegmentale ventrale (ATV), cette région cérébrale jouant un rôle clef dans les processus de motivation pour les récompenses. Cependant, les performances de course ne permettent pas de distinguer la motivation pour l'exercice du plaisir de courir. L'objectif de ce travail était d'étudier l'implication des récepteurs CB1 dans la régulation spécifique de la motivation pour l'exercice chez la souris (i) en caractérisant la(les) population(s) de récepteurs participant à celle-ci, puis (ii) en évaluant leur implication dans le choix entre l'exercice et la nourriture palatable, et enfin (iii) en mesurant l'effet de leur stimulation sur la motivation pour l'exercice. Cette étude repose sur l'utilisation du conditionnement opérant (unique moyen d'étude de la motivation chez l'animal) associé à des approches génétiques (mutants des récepteurs CB1) et pharmacologiques (agonistes et antagonistes de ces récepteurs).

La première partie de ce travail a permis de développer un protocole de conditionnement opérant permettant de distinguer (i) la motivation pour l'exercice, celle-ci étant corrélée à l'activité des neurones dopaminergiques de l'ATV, (ii) du plaisir de courir. Cette étude a montré que les récepteurs CB1 qui contrôlent la motivation pour l'exercice sont localisées dans l'ATV. Nous avons ensuite démontré le rôle tonique nécessaire et suffisant des récepteurs CB1 des neurones GABAergiques (GABA-CB1) dans la motivation pour l'exercice, mais pas dans le plaisir de courir. Les résultats obtenus ont soulevé la question de la spécificité du contrôle de la motivation pour la course par ces récepteurs. Nous avons alors confirmé l'implication du SEC

dans la motivation pour la nourriture palatable avant de montrer que les récepteurs GABA-CB1 n'étaient pas impliqués dans celle-ci.

La deuxième partie visait à étudier l'implication du récepteur CB1 dans le choix entre l'exercice et la nourriture palatable lorsque ces deux récompenses sont mises en concurrence. En effet, humains et animaux sont confrontés quotidiennement à plusieurs récompenses simultanées, leur choix étant basé sur leurs motivations respectives pour chacune d'elles. Dans ce but, nous avons développé un protocole de choix en conditionnement opérant permettant d'étudier la préférence de l'animal entre ces deux récompenses. Ainsi, après avoir démontré l'importance du SEC dans le choix entre ces deux récompenses, nous avons montré que la délétion des récepteurs GABA-CB1 a diminué la préférence pour l'exercice au profit de la nourriture palatable. Cette étude identifie donc un potentiel mécanisme neurobiologique participant à la sédentarité.

La troisième partie de ce travail avait pour but d'évaluer la possibilité de moduler la motivation pour l'exercice via le SEC. En effet, le contrôle tonique exercé par les récepteurs GABA-CB1 sur la motivation pour courir soulevait la question de l'impact d'une stimulation de ces récepteurs sur cette motivation. Les résultats ont indiqué que la stimulation des récepteurs CB1 par des agonistes directs et indirects de ces récepteurs n'était pas en mesure d'augmenter la motivation pour l'exercice.

En conclusion, ce travail démontre le rôle majeur des récepteurs CB1 des neurones GABAergiques dans la motivation pour l'exercice physique.

**Mots clés** : Récepteurs CB1, Exercice, Motivation, Conditionnement opérant

# **ROLE OF THE ENDOCANNABINOID SYSTEM IN EXERCISE MOTIVATION**

Sedentariness is a major public health issue. It is mainly explained by a lack of exercise motivation, resulting in an energy imbalance in favor of food intake. However, the neurobiological bases of exercise motivation remain poorly described. Previous works in the laboratory have demonstrated the role of the endocannabinoid system (ECS) in the control of running performances in mice. This role is exerted by type-1 cannabinoid receptors (CB1) located on GABAergic terminals in the ventral tegmental area (VTA). This brain region has been shown to play a key role in reward processes. Because the evaluation of running performances does not distinguish between running motivation and pleasure, we aimed at studying the role of CB1 receptors in the regulation of exercise motivation in mice. Using operant conditioning protocols (which allow to specifically study motivation in animals), this work characterized (i) the subpopulation(s) of receptors participating in this regulation, (ii) their potential involvement in the choice between exercise and palatable food, and (iii) the consequences of a selective stimulation of these receptors on exercise motivation. This work combined genetic (mouse mutants for CB1 receptors) and pharmacological (CB1 receptor agonists and antagonists) approaches.

The first set of experiments aimed at developing an operant conditioning protocol that allow to distinguish exercise motivation from exercise pleasure, the former but not the latter being positively linked to the activity of VTA dopaminergic neurons. Our results showed that CB1 receptors control exercise motivation through an action in the VTA. Moreover, we demonstrated that CB1 receptors located on GABAergic neurons (GABA-CB1) are necessary and sufficient for the tonic control of exercise motivation. Conversely, exercise pleasure, as assessed by running performance, proved independent from this receptor population. Because previous studies demonstrated the key role exerted by CB1 receptors in motivation for other (than exercise) rewards, we questioned the specificity of the control of running motivation exerted by GABA-CB1 receptors. Indeed, after having confirmed the involvement of the ECS in palatable food motivation, we provided evidence against a role for GABA-CB1 receptors in feeding motivation, hence indicating their reward-specific control.

The second set of experiments aimed at evaluating the involvement of CB1 receptors in the choice between exercise and palatable food when both rewards were made concurrent. Indeed, humans and animals are permanently confronted with reward choices, these being dictated by their respective motivation for these alternatives. To this aim, we developed an operant conditioning protocol allowing the study of the animal preference between exercise and palatable food presented simultaneously but being mutually exclusive. By this means, we demonstrated the crucial importance of CB1 receptors in this choice. Moreover, we showed that the lack of GABA-CB1 receptors decreased the mouse preference for exercise in favor of palatable food. This work thus identifies a potential neurobiological mechanism underlying sedentariness.

The third set of experiments aimed at evaluating the possibility to stimulate exercise motivation. The tonic control exerted by GABA-CB1 receptors on exercise raises the question of the impact of their stimulation. Indeed, stimulation of CB1 receptors by direct and indirect agonists proved inefficient in altering running motivation.

In conclusion, besides providing a paradigm allowing to study exercise motivation in mice, this work provides direct evidence for a specific role of CB1 receptors located on GABAergic neurons on motivation for exercise.

**KEYWORDS:** CB1 receptors, Exercise, Motivation, Operant Conditioning

## LONG RESUME

La sédentarité est un problème majeur de santé publique, avec une mortalité d'environ 9% et un fardeau économique pour nos sociétés qui s'élève à 50 milliards de dollars. Des études longitudinales menées aux Etats-Unis ont montré que le manque d'activité physique, plutôt que l'augmentation des apports caloriques, était associée à l'augmentation de l'obésité abdominale. Cette observation met donc en exergue le rôle primordial de l'inactivité physique dans les causes métaboliques (mais également cardiovasculaires) de la sédentarité. Il a été montré que le manque de motivation à initier l'exercice ainsi que le manque de plaisir à adhérer sur le long-terme à des programmes d'exercice constituaient les causes majeures de l'inactivité physique. Malgré cette reconnaissance, les bases neurobiologiques de la motivation pour l'exercice physique restent méconnues. Le modèle animal d'activité physique le plus utilisé est la course sur une roue d'exercice, et ce par son aspect volontaire et hautement récompensant, deux caractéristiques propres à l'exercice chez l'humain. Les études menées avec la roue d'exercice ont permis d'identifier certains régulateurs neurobiologiques de la performance d'exercice, tels que la leptine et les opioïdes endogènes. De précédents travaux au laboratoire ont montré l'implication d'un autre système neurobiologique, le système endocannabinoïde (SEC), dans le contrôle des performances de course chez la souris. Ce contrôle s'effectue *via* des récepteurs aux cannabinoïdes de type 1 (CB1) localisés sur des terminaisons GABAergiques de l'aire tegmentale ventrale (ATV). Cette dernière structure est étroitement liée aux processus de motivation pour les récompenses, qu'elles soient naturelles ou pas (e.g. drogues d'abus). Cependant, les performances de course ne permettent pas de distinguer la motivation pour l'exercice du plaisir de courir. Cette distinction est pourtant essentielle. En effet, la motivation correspond à l'effort maximal qu'un individu accepte de fournir lors de la recherche d'une récompense pour y accéder, alors que le plaisir correspond aux comportements « consommatoires » liés aux propriétés hédoniques de la récompense une fois atteinte. Cette distinction est d'autant plus cruciale que ces deux aspects reposent sur des substrats neurobiologiques distincts, la motivation étant dépendante de la transmission dopaminergique au sein du système mésocorticolimbique (principalement l'ATV), contrairement au plaisir.



L'objectif de ce travail était d'étudier l'implication des récepteurs CB1 dans la régulation de la motivation et/ou du plaisir pour l'exercice physique chez la souris (i) en caractérisant la(les) population(s) de récepteurs participant à ces processus, puis (ii) en évaluant leur potentielle implication dans le choix entre l'exercice physique et la nourriture palatable, et enfin (iii) en mesurant l'effet de leur stimulation sur la motivation pour l'exercice. Cette étude repose sur l'utilisation de différents protocoles de conditionnement opérant, dont le principe consiste à apprendre à l'animal à réaliser un effort préalable afin d'obtenir une récompense (i.e. un temps limité d'accès à une roue d'exercice). Cet effort, e.g. l'introduction du museau à travers un dispositif un nombre de fois fixe ("fixed ratio"; FR) puis progressif ("progressive ratio"; PR) permet de quantifier l'effort maximal que l'animal accepte de fournir dans un temps imparti (1 heure) pour accéder à l'exercice physique. Afin d'étudier l'implication des récepteurs CB1, ces protocoles de conditionnement opérants ont été combinés à des approches génétiques (mutants constitutifs et conditionnels des récepteurs CB1) et pharmacologiques (agonistes et antagonistes de ces récepteurs).

La première partie de ce travail a donc permis de développer un protocole de conditionnement opérant chez la souris permettant de distinguer la motivation pour l'exercice physique du plaisir de courir. Ainsi, après avoir été conditionnées pendant plusieurs sessions quotidiennes en FR1 (une introduction de museau = un accès à la roue) puis en FR3 (trois introductions de museau = un accès à la roue), les souris ont été soumises à un test de motivation dans lequel le nombre d'introductions pour accéder à la roue était augmenté de 3 unités (3, 6, 9...etc) au sein d'une session unique (PR). La mesure du niveau maximal d'introductions atteint définit de manière quantitative la motivation pour l'exercice. Nous avons tout d'abord démontré qu'un antagoniste des récepteurs dopaminergiques D2 diminuait de manière dose-dépendante la motivation pour courir alors que le temps de course (i.e. le plaisir) restait inchangé. De plus, nous avons observé que l'effort maximal fourni par nos animaux corrélait avec l'activité des neurones dopaminergiques de l'ATV, validant par la même la capacité de notre protocole à discriminer les différentes dimensions de l'exercice physique.

Par l'injection systémique d'antagonistes des récepteurs CB1 ainsi que par l'utilisation de mutants constitutifs pour ces récepteurs, cette étude a démontré que les récepteurs CB1 contrôlaient la motivation, mais pas le plaisir, pour l'exercice physique. Afin de

déterminer quelle population de récepteurs était responsable de ce contrôle, nous avons ensuite utilisé une autre approche génétique. Ainsi, l'utilisation de (i) mutants conditionnels pour les récepteurs CB1 des neurones GABAergiques (GABA-CB1) et de (ii) mutants conditionnels délétés pour les récepteurs CB1 totaux chez lesquels ont été réexprimés les récepteurs GABA-CB1, a permis de montrer le rôle nécessaire et suffisant des récepteurs GABA-CB1 dans la motivation pour l'exercice physique (contrôle tonique positif), mais pas dans le plaisir de courir. Au contraire, l'utilisation de mutants conditionnels pour les récepteurs CB1 des neurones glutamatergiques (Glu-CB1) a permis de montrer que ces récepteurs exercent un contrôle tonique négatif sur le plaisir de courir mais ne sont pas impliqués dans la motivation pour l'exercice. Des travaux complémentaires, qui ont également utilisé des mutants conditionnels, ont permis de montrer que les récepteurs CB1 portés par (i) les neurones exprimant Sim1 (i.e. principalement les neurones du noyau paraventriculaire de l'hypothalamus et les neurones de l'amygdale) ou (ii) les neurones sérotoninergiques ne jouent pas de rôle significatif dans la modulation de la motivation pour l'exercice ou du plaisir qu'il engendre.

Afin de caractériser au niveau anatomique le contrôle exercé par les récepteurs CB1 sur la motivation pour l'exercice physique, un antagoniste de ces récepteurs a été infusé dans l'ATV. Cette infusion a eu un effet similaire à celui produit par son injection systémique, suggérant que ce sont des récepteurs CB1 localisés dans cette région qui exercent un contrôle de la motivation pour l'exercice. Compte tenu (i) du rôle majeur, sinon unique, des récepteurs GABA-CB1 dans la motivation pour l'exercice, et (ii) de la localisation principalement présynaptique de ces récepteurs, nous avons émis deux hypothèses quant à la population neuronale GABAergique exprimant ces récepteurs : (i) intrinsèque au sein de l'ATV (interneurones), ou bien (ii) extrinsèques et projetant sur l'ATV. Pour tester la première hypothèse, nous avons croisé une lignée reportrice (marqueur fluorescent Ai6) avec les souris portant la construction génétique (cre recombinase) utilisée pour générer nos mutants conditionnels pour les récepteurs GABA-CB1. Bien que préliminaires, nos résultats suggèrent que les récepteurs GABA-CB1 contrôlant la motivation pour l'exercice physique ne sont pas localisés sur des neurones intrinsèques de l'ATV.

De nombreux travaux ont montré l'implication des récepteurs CB1 dans la motivation pour diverses récompenses telles que certaines drogues d'abus ou des récompenses

naturelles. Cette implication, médiée par une régulation du système mésocorticolimbique au niveau de l'ATV, questionne la spécificité du contrôle des récepteurs GABA-CB1 sur la motivation pour l'exercice physique. Afin de répondre à cette question, nous avons étendu nos recherches à la motivation pour une autre récompense, la nourriture palatable. Nous avons d'abord confirmé l'implication du SEC dans la motivation pour la nourriture palatable avant de montrer que les récepteurs GABA-CB1 et Glu-CB1 n'étaient pas impliqués dans cette motivation, indiquant donc que leur rôle dépend strictement de la nature de la récompense.

La deuxième partie de cette étude visait à étudier l'implication du récepteur CB1 dans le choix entre l'exercice physique et la nourriture palatable lorsque ces deux récompenses sont mises en concurrence. En effet, humains et animaux sont quotidiennement confrontés à plusieurs récompenses proposées de manière simultanée, leur choix étant basé sur leurs motivations respectives pour ces alternatives. Dans ce but, nous avons développé un protocole de conditionnement opérant permettant d'étudier la préférence de l'animal entre ces deux récompenses proposées de manière mutuellement exclusive (i.e. choisir une récompense annule le choix pour l'autre pendant une durée fixe). Par l'utilisation de nos mutants constitutifs, nous avons montré l'importance des récepteurs CB1 dans le choix entre ces deux récompenses. De manière intéressante, contrairement aux récepteurs Glu-CB1 dont la délétion n'a pas eu d'effet significatif sur le choix de l'animal, la délétion des récepteurs GABA-CB1 a diminué la préférence pour l'exercice physique au profit de la nourriture palatable. Par l'observation du rôle primordial des récepteurs GABA-CB1 dans la motivation pour l'exercice physique mais pas pour la nourriture palatable, la présente étude identifie un mécanisme neurobiologique contribuant à la sédentarité.

La troisième partie de ce travail avait pour but d'évaluer la possibilité de moduler positivement la motivation pour l'exercice. Le contrôle tonique positif exercé par les récepteurs GABA-CB1 soulève la question de l'impact d'une stimulation de ces récepteurs sur la motivation pour l'exercice. Nous avons donc évalué l'impact d'une stimulation aiguë des récepteurs CB1 par l'utilisation d'agonistes directs/indirects de ces récepteurs. Bien qu'augmentant la motivation pour la nourriture palatable, ces stimulations n'ont pas été en mesure d'augmenter la motivation pour l'exercice physique.

En conclusion, par le développement de protocoles de conditionnement opérant permettant la distinction entre (i) la motivation pour l'exercice physique et le plaisir de courir, ainsi qu'entre (ii) les motivations pour l'exercice physique et la nourriture palatable, la présente étude démontre le rôle spécifique joué par les récepteurs CB1 exprimés par les neurones GABAergiques sur la motivation pour l'exercice. De plus, nos résultats suggèrent que ce contrôle aurait lieu dans l'ATV. Cependant, l'identité de la population neuronale GABAergique exprimant ces récepteurs reste à caractériser. Les résultats préliminaires de cette étude suggèrent que cette population pourrait être des neurones extrinsèques projetant sur l'ATV, bien que l'origine de ceux-ci reste à caractériser. Cette étude fournit donc un cadre permettant l'étude de désordres motivationnels entre l'exercice physique et la prise alimentaire qui pourrait s'avérer utile pour le développement de modèles animaux d'obésité et d'anorexie nerveuse.

## **UNITE DE RECHERCHE**

Université de Bordeaux

Neurocentre Magendie – Inserm U1215

Equipe « Endocannabinoïdes et NeuroAdaptation »

146 Rue Léo Saignat

33077 Bordeaux

France

## **FINANCEMENT**

Ce travail a été soutenu par :

- Une bourse du Ministère de l'Enseignement Supérieur et de la Recherche de 2016 à 2019
- Une bourse de fin de thèse de la « Fondation pour la Recherche Médicale » (FDT201904008109)

ACKNOWLEDGMENTS .....	17
LIST OF PUBLICATIONS.....	21
LIST OF COMMUNICATIONS.....	22
LIST OF FIGURES .....	23
LIST OF ABBREVIATIONS .....	25
INTRODUCTION .....	28
1. The Endocannabinoid System .....	28
1.1. History .....	28
1.2. Description.....	30
1.2.1. The cannabinoid receptors .....	30
1.2.1.1. CB1 receptors .....	30
1.2.1.2. CB2 receptors .....	33
1.2.1.3. Other relevant receptors? .....	33
1.2.2. The endogenous ligands: the endocannabinoids .....	34
1.2.2.1. Synthesis of endocannabinoids.....	36
1.2.2.2. Transport of endocannabinoids.....	37
1.2.2.3. Degradation of endocannabinoids.....	38
1.3. CB1 receptor signaling & neuronal plasticity .....	39
1.3.1. CB1 receptor intracellular signaling pathways.....	39
1.3.2. CB1 receptor modulation of neurotransmitter release .....	40
1.3.3. Short-term plasticity.....	41
1.3.4. Long-term plasticity .....	42
2. Motivation, reinforcement & reward .....	44
2.1. Historical of the concepts and definitions.....	45
2.2. Neurobiology of motivated behaviors.....	48
2.2.1. Anatomical considerations.....	48
2.2.2. Is dopamine crucial?.....	50
2.2.3. Other cellular types in VTA & motivated behaviors .....	57
3. CB1 receptors & reward processing .....	58
3.1. CB1 receptors & VTA dopaminergic neurons .....	58
3.2. CB1 receptors & dopamine release .....	61
3.3. CB1 receptors & motivated behavior .....	63
4. Physical activity: from humans to animal models.....	68
4.1. Why studying physical activity? .....	69

4.2.	Physical activity as a natural reward.....	71
4.3.	Physical activity in eating disorders: the case of anorexia nervosa .....	73
4.4.	Motivation for physical activity – a common feature of food-related disorders?.....	76
4.5.	Animal models of physical activity .....	76
4.6.	Regulators of wheel-running .....	77
4.7.	CB1 receptors & wheel-running .....	79
OBJECTIVES .....		83
	Chapter 1 – Development of an operant conditioning paradigm to study wheel-running motivation.....	83
	Chapter 2 – Role of CB1 receptors in motivation for wheel-running .....	84
	Chapter 3 – Modulation of wheel-running motivation.....	85
	Chapter 4 – On-going experiments.....	87
MATERIALS & METHODS.....		89
1.	Animals .....	89
2.	Post-weaning social isolation rearing.....	91
3.	Operant conditioning paradigm.....	91
3.1.	Wheel-running protocol.....	92
3.2.	Palatable food.....	94
3.3.	Choice between wheel-running and palatable food .....	96
3.4.	Behavioral readouts.....	98
4.	Local intra-VTA drug infusion.....	99
4.1.	Surgery .....	99
4.2.	Drug infusion.....	99
4.3.	Analysis of canulae placements.....	99
5.	Local deletion of CB1 receptors in the lateral hypothalamus (LH) .....	100
5.1.	Animals and viruses.....	100
5.2.	Surgery .....	100
5.3.	Analysis of the injection sites and viral expression .....	100
6.	Drugs .....	101
7.	Statistics .....	102

RESULTS .....	103
Chapter 1 – Development of an operant conditioning paradigm to study wheel-running motivation.....	103
Chapter 2 – Role of CB1 receptors in motivation for wheel-running .....	105
Objective 1 – Pharmacological findings.....	105
Objective 2 – Genetic findings.....	105
Objective 3 – Specificity of the role of the endocannabinoid system in wheel-running motivation: comparison with palatable food motivation.....	115
Objective 4 – Role of CB1 receptors in a wheel-running/palatable food choice paradigm .....	119
Chapter 3 – Modulation of wheel-running motivation .....	122
Objective 1 – CB1 receptor stimulation and wheel-running motivation.....	122
Objective 2 – Doping agents and wheel-running motivation: the example of glucocorticoids.....	123
Objective 3 – Illustration of the limits of free wheel-running paradigms for the study of human pathologies: the ABA model.....	124
Chapter 4 – On-going experiments .....	126
<i>Objective 1</i> – CB1 receptors and wheel-running motivation: where are they? .....	126
<i>Objective 2</i> – Evaluating VGAT as a new promoter to study the role of CB1 receptors on GABAergic neurons in running motivation .....	133
 GENERAL DISCUSSION .....	 142
1. Wheel-running is a potent reinforcer in mice.....	142
2. CB1 receptors control wheel-running reinforcing properties .....	144
2.1. CB1 receptors control wheel-running motivation .....	144
2.2. GABA-CB1 receptors are necessary and sufficient for wheel-running motivation .....	145
2.3. Glu-CB1 receptors control wheel-running performances .....	147
2.4. Are other CB1 receptor populations involved in wheel-running? .....	147
2.5. Anatomical location of CB1 receptor control over wheel-running motivation .....	149
2.6. VGAT cre-expressing mice as a complementary genetic approach .....	152
2.7. CB1 receptor stimulation does not impact wheel-running motivation/performance .....	153
3. Separate CB1 receptor populations control wheel-running and palatable food motivations.....	154
4. CB1 receptors control the choice for wheel-running over palatable food.....	155



5. Increasing exercise motivation.....	158
5.1. Glucocorticoid ergogenic effects do not involve increased exercise motivation .....	158
5.2. ABA phenotype is not accounted for by increased exercise motivation	159
 CONCLUSION.....	 161
 REFERENCES.....	 162
 ANNEXES .....	 216

# ACKNOWLEDGMENTS

En premier lieu, je tiens à remercier **Dr Martine Cador** d'avoir accepté de présider ce jury de thèse, ainsi que **Dr. Camilla Bellone** et **Dr. Jacques Barik** d'avoir accepté de juger mon travail de thèse en tant que rapporteurs. Mes remerciements vont également aux **Dr. Shauna Parkes**, **Dr. Serge Ahmed** et **Dr. Marcelo Solinas** pour leur participation à ce jury. Par ces quelques lignes je tiens à vous exprimer ma gratitude pour votre participation.

Je tiens également à remercier **Dr François Georges** et **Dr Giulia Fois** pour leur collaboration précieuse à ce projet et pour les discussions et conseils constructifs.

Mes remerciements vont également à mon directeur de thèse, **Francis Chaouloff**. Si je n'ai pas mis le titre devant le nom, c'est parce que ces lignes ne s'adressent pas qu'au scientifique. J'ai bien conscience du traitement de faveur que j'ai eu, de travailler avec Francis (j'insiste sur le mot « avec »), je garde en tête toutes ses leçons, même si leur application nécessitera un travail quotidien. Si se lancer dans une thèse implique de se « [préparer] à des nuits blanches, des migraines, des *nervousses brékdones* comme on dit de nos jours », le faire sous sa direction est un privilège permettant d'apprendre, de penser et de proposer des idées librement (quitte à se laisser entendre qu'elles sont mauvaises, mais toujours avec pédagogie... ou une blague) mais également d'apprendre à valoriser chaque expérience même si elle paraît, au premier abord, vraiment décevante. Et tout cela avec un soutien inconditionnel faisant toujours passer l'aspect humain avant tout. J'espère faire honneur à tout ce qu'il m'a appris, par ce travail mais également dans le futur. Ma plus grande fierté restera de n'avoir jamais été mis en défaut par une référence cinématographique ou musicale, ainsi que de n'avoir jamais démerité aux concours de jeux de mots. Merci

Obviously, my acknowledgments go to The Marsicano Team, with capital letter to every word, starting with our charismatic Master & Commander, **Giovanni Marsicano**. Thank you for giving me the opportunity to be part of your team, for your support and advice in difficult time, for the trust and confidence you give to all members of this group, and for creating such an amazing atmosphere in and around the lab.

This atmosphere started right in our beloved I4 office with: **Arnau Busquets-Garcia**, gràcies per portar-me en aquesta aventura, gràcies per tots els teus consells, el teu

suport, les sortides de "running" o cervesa, no crec que calgui recordar l'admiració que tinc per tu; **José Cruz**, gostaria de ter citado Quim, no entanto, dada a admiração que tenho por ti, prefiro agradecer-lhe por estes momentos passados e pelas suas palavras inspiradoras... e o "memes"... desde que dure; **Edgar Soria-Gomez**, gracias hermano, por estos momentos pasados, por tus consejos y tu estímulo en la mayor de las calamidades, por todas estas "grandes cañas"... y por tu silla de oficina ; **Christina « Chrichri » Ionannidou**, ευχαριστώ Chrichri, πρώτα απ 'όλα που κατάφερα να επιβιώσω από τα αστεία μου, και ειδικά για τα απόλαυσα. Σημειώνω ότι δεν ήταν τυχαίο που ήμασταν μαζί στη Μαδρίτη: η φίλια μας "marche très bien". Because the I4 office is a spirit, I want to thank also past/present members: the sweet **Maria Carmen Medrano**, probably the best public for my jokes I ever had by my side, **GianLuca Lavanco**, "Jean-Luc Lavanque" the most surprising office mate and **Ana Covelo**, often locked in ephy room to escape my jokes. Thank you all for everything.

Je ne peux que dédier un paragraphe à celle qui m'a accompagné et soutenu pendant toutes ces années, une personne exceptionnelle et surprenante... et sans qui je n'aurais jamais su quand m'alimenter, **Marjorie Varilh**, merci pour tout (inférieur à 3).

Don't be fooled, other offices are also great. I want to thank **Geoffrey Terral**, pour toutes ces aventures ici ou ailleurs (LA, Bilbao...); **Antonio Pagano Zottola**, grazie Toto per tutti questi momenti, pettegolezzi, aneddoti e il tuo buon umore, tu sei grandissimo; **Astrid Cannich**, endlich eine Gelegenheit, Ihnen die immense Bewunderung zu zeigen, die ich für Sie habe, ein wahres Vorbild; **Roman Serrat**, for this magic trick "playing-cards appearance" and his intemporal French accent; **Su Melser**, the Calm incarnated; **Laurie Robin**, pour nos discussions, parfois franches et directes, mais toujours affectueuses; **Zhe Zhao**, 谢谢你的一切·我的朋; **Luigi Bellocchio**, l'unica persona le cui battute sono peggiori delle mie ; **Virginie Morales**, merci pour ton soutien toutes ces années.

Now that I thank the people that welcomed me, let's thank people that I welcomed: **Emma Mesguich**, si la vie était une soudure, tu en serais le flux; **Imane Hurel**, merci d'avoir eu un esprit critique sur mon repertoire musical et mon humour; **Yamuna Mariani**, grazie per i duetti di Laura Pausini e Roma Roma attraverso il laboratorio; **Christopher Stevens**, in your language you say "Ní neart go cur le chéile" and I think it's beautiful (no); **Paula Sotres Gomez**, gracias por los rasguños, no olvidamos, no

perdonamos; **Urszula Skupio**, dziękuję za bycie moim jedynym towarzyszem żartów i kultury słowiańskiej; **Abel Eraso**, no oblidgeu mai l'anècdota del pebrot i el clavell, ens trobarem al "virage sud" amic meu ; **Alex Fletcher-Jones**, thanks for staying so calm when we repeatedly massacre your mother language; **Ignacio Fernandez**, sólo me arrepiento de una cosa: no haber podido ver cómo te cortaste el pelo en una noche loca, como le prometiste; **Francisca Julio**, gracias por el curso avanzado de chileno, no olvidaré "pololo".

Some stayed shortly in the lab, but much longer in the heart: **Carol "bambolina" Stella**, grazie per tutte le lunghe conversazioni, le situazioni improbabili e tutte le birre, qui o in qualsiasi paese, non si fermerà tanto presto; **Violeta "Vivi" Araque**, gracias por todos los tiempos locos hermanita; **Justine Daniault**, je pense que l'anecdote japonaise se suffit à elle-même.

Merci à la clique de Bordeaux, **Geoffrey, Thomas, Eva, Marie, Tifenn, Camille, Dylan, Julien** et tous ceux qui gravitaient autour de ce noyau dur. Malgré votre mépris pour mon club de cœur qui m'a valu des quolibets récurrents, parfois blessants, je vous apprécie. On a ri, pensé, philosophé... on a bien profité de la vie quoi. Merci vraiment du fond du cœur !

Bien évidemment mes remerciements vont à **Chris, Alex, Greg, Charlène, Diane, Clémence, Mathias** et tous ceux que j'oublie qui ont rythmé toutes ces années. Ah ça quand t'aime rigoler et bourlinguer, t'aime rigoler et bourlinguer. Merci pour tous ces moments si particuliers autour de quelques verres, assortis de pas de dance impeccables et d'un comportement toujours empathique, ces rencontres toujours inattendues (Mathieu, Yaya). Je ne pense pas prendre de risque en disant que tout ça restera durablement gravé, et se poursuivra ici ou ailleurs.

Je tiens à remercier mes muses **Alice, Céline, Manon**, des bons moments passés, un soutien indéfectible et une amitié qui dure depuis les premiers moments sur les bancs de la fac. Pour rester dans la team clermontoise, je remercie **Maxime, Lucas, Julien** qui ont transformé chaque retour au pays, mais également chaque pays, en aventures.

Merci à toute ma famille, mes parents **Marie-Paule et Michel**, ma sœur **Marion, Julien** et le petit nouveau **Hyacinthe**, ainsi qu'à **Anne-Marie, Florence, Sandra, Vincent, Philippe, Catherine**. Et tous les autres que je n'ai pas la place de citer mais qui sont,

et ont toujours été là. Evidemment une pensée à tous ceux qui sont partis et qui ne liront pas ces mots. Je ne vais pas faire l'arbre généalogique évidemment, mais je veux par ces quelques lignes exprimer ma gratitude à tout le monde parce que la famille c'est la chose la plus importante que l'on puisse avoir. La mienne restera la base grâce à laquelle j'ai pu me construire. Merci

Enfin je ne pouvais terminer ces remerciements sans citer deux personnes/entités qui ont rendu mon quotidien vivable, mes samedis et dimanches après-midis au labo presque euphoriques, et qui m'ont permis d'atteindre le nirvana, le pinacle de l'extase par deux fois. Il s'agit évidemment de **Didier Deschamps** pour cette deuxième étoile le 15 juillet 2018. Et enfin.... **L'ASM Clermont Auvergne**, représentée par son fidèle guerrier Aurélien Rougerie, et l'infatigable Morgan Parra, qui gratta ce dernier ballon le 4 juin 2017.

Merci...

## LIST OF PUBLICATIONS

Busquets-Garcia, A., Soria-Gómez, E., **REDON, B.**, Mackenbach, Y., Vallée, M., Chaouloff, F., Varilh, M., Ferreira, G., Piazza, P.-V., and Marsicano, G. (2017). **Pregnenolone blocks cannabinoid-induced acute psychotic-like states in mice.** *Molecular Psychiatry* 22, 1594–1603.

Busquets-Garcia, A., Cruz, J.F. da, Terral, G., Zottola, A.C., Soria-Gómez, E., Contini, A., Martin, H., **REDON, B.**, Varilh, M., Ioannidou, C., et al. (2018). **Hippocampal CB1 Receptors Control Incidental Associations.** *Neuron* 99, 1247-1259.e7.

Muguruza\* C., **REDON\* B.**, Fois GR., Hurel I., Scocard A., Nguyen C., Stevens C., Soria-Gomez E., Varilh M., Cannich A., Danialt J., Busquets-Garcia A., Pelliccia T., Caillé S., Georges F., Marsicano G., and Chaouloff F. (2019). **The motivation for exercise over palatable food is dictated by cannabinoid type-1 receptors.** *JCI Insight* 4, e126190.

**REDON, B.**, Hurel, I., Marsicano, G., and Chaouloff, F. (2019). **An Operant Conditioning Task to Assess the Choice between Wheel Running and Palatable Food in Mice.** *Bio-protocol*, 9(19): e3381

**REDON, B.**, Violleau, C., Georges, F., Marsicano, G., and Chaouloff, F. (2019). **The ergogenic impact of the glucocorticoid prednisolone does not translate into increased running motivation in mice.** *Psychoneuroendocrinology* 111, 104489.

Hurel\*, I., **REDON\*, B.**, Scocard, A., Malezieux, M., Marsicano, G., and Chaouloff, F. (2019). **Beyond the Activity-Based Anorexia Model: Reinforcing Values of Exercise and Feeding Examined in Stressed Adolescent Male and Female Mice.** *Frontiers in Pharmacology* 10, 587.

Medrano\*, M., Hurel\*, I., Mesguich, E., **REDON, B.**, Stevens, C., Georges, F., Melis, M., Marsicano, G., and Chaouloff, F. (2020). **Exercise craving potentiates excitatory inputs to ventral tegmental area dopaminergic neurons.** *Addiction Biology* e12967.

Hurel\*, I., Muguruza\*, C., **REDON, B.**, Marsicano, G., and Chaouloff, F. (2021). **Cannabis and exercise: Effects of  $\Delta 9$ -tetrahydrocannabinol on preference and motivation for wheel-running in mice.** *Progress in Neuro-Psychopharmacology & Biological Psychiatry* 105, 110117.

\*share first authorship

# LIST OF COMMUNICATIONS

## ORAL COMMUNICATION

*Symposium NutriNeuro, Bordeaux, France (2018):*

Feeding, running, how motivated are you? A role for the endocannabinoid system

## POSTERS

*Symposium Neurocentre Magendie, Bordeaux, France (2018) :*

Motivation for exercise and food intake: role of the endocannabinoid system.  
**REDON B.**, Daniault J., Hurel I., Scocard A., Varilh M., Medrano MC., Marsicano G., Chaouloff F.

*Society for Neurosciences, San Diego, USA (2018):*

Role of the endocannabinoid system in wheel-running preference/motivation.  
**REDON B.**, Muguruza C., Marsicano G., Chaouloff F.

*International meeting NeuroFrance 2019, Marseille, France (2019):*

Cannabinoid type-1 receptors on GABAergic neurons are necessary and sufficient for running motivation, **REDON B.**, Hurel I., Muguruza C., Marsicano G., Chaouloff F.

*6<sup>th</sup> Bordeaux Neurocampus conference, Normal and pathological reward processing, Bordeaux, France (2019):*

Cannabinoid type-1 receptors on GABAergic neurons are necessary and sufficient for running motivation, **REDON B.**, Hurel I., Muguruza C., Marsicano G., Chaouloff F.

*FENS Virtual Forum (2020):*

Effects of cannabinoid receptor type-1 stimulation on mouse motivation and craving for wheel-running, **REDON B.**, Hurel I., Muguruza C., Mesguich E., Marsicano G., Chaouloff F.

## LIST OF FIGURES

Figure 1 - Distribution of CB1 receptors throughout the mouse brain.....	31
Figure 2 - Endogenous cannabinoids .....	35
Figure 3 - Endogenous allosteric modulators of CB1 receptors.....	35
Figure 4 - Synthesis and degradation of the two main endocannabinoids AEA and 2-AG .....	37
Figure 5 - Dopaminergic neurons encode reward prediction error (RPE).....	51
Figure 6 - DA concentration in the nucleus accumbens core reflects the value of working for a reward.....	56
Figure 7 - Operant chamber configuration for wheel-running protocol.....	92
Figure 8 - Operant chamber configuration for palatable food .....	94
Figure 9 - Operant chamber configuration for the choice between wheel- running and palatable food .....	96
Figure 10 - Logigram of the choice between wheel-running and palatable food.....	98
Figure 11 - Wheel-running reinforcing properties were not altered in mice expressing the Cre recombinase under the Dlx5/6 promoter.....	109
Figure 12 - The deletion of CB1 receptors from Sim1-positive neurons did not alter wheel-running reinforcing properties under FR schedules.....	111
Figure 13 - The deletion of CB1 receptors from Sim1-positive neurons altered neither running motivation nor running performance .....	112
Figure 14 - The deletion of CB1 receptors from TPH2-expressing neurons did not affect wheel-running under FR schedules.....	113
Figure 15 - Effects of CB1 receptor deletion from TPH2-positive neurons on wheel-running under PR schedule.....	114
Figure 16 - Mice with cre recombinase expression under the Dlx5/6 promoter display no alteration in palatable food motivation .....	118
Figure 17 - Expression of the Dlx promoter, as assessed by the cre- dependent expression of an Ai6 fluorescent reporter (green) in the ventral tegmental area .....	129



Figure 18 - Deletion of CB1 receptors from the lateral hypothalamus did not impact operant responses and running performances under FR schedules.....	131
Figure 19 - Deletion of CB1 receptors from lateral hypothalamic neurons increased running motivation but not performance.....	132
Figure 20 - Deletion of CB1 receptors from VGAT-positive neurons decreases wheel-running motivation but not performance .....	134
Figure 21 - Wheel-running reinforcing properties are decreased in mice expressing a Cre recombinase under the VGAT promoter on agouti background .....	136
Figure 22 - VGAT-CB1-KO mice and VGAT-Cre (+) mice do not display alterations in palatable food motivation, compared to their WT littermates. ....	138
Figure 23 - Wheel-running reinforcing properties were not altered in mice expressing the Cre recombinase under the VGAT promoter on a C57Bl/6J genetic background.....	141

## LIST OF ABBREVIATIONS

2-AG	2-arachidonoylglycerol
6-OH-DA	6-hydroxydopamine
ABA	Activity-Based Anorexia
ABDH4	$\alpha/\beta$ -hydrolase domain type 4
ABDH6	$\alpha/\beta$ -hydrolase domain type 6
ABDH12	$\alpha/\beta$ -hydrolase domain type 12
AC	Adenylate Cyclase
Ach	Acetylcholine
AEA	Anandamide
AN	Anorexia Nervosa
ATP	Adenosine Triphosphate
BDNF	Brain-Derived Neurotrophic Factor
BNST	Bed Nucleus of the Stria Terminalis
CA3	Cornu Ammonis 3
cAMP	Cyclic Adenosine Monophosphate
CB1 receptors	Cannabinoid type-1 receptors
CB2 receptors	Cannabinoid type-2 receptors
CCK	Cholecystokinin
ChAT	Choline Acetyltransferase
CIN	Cholinergic Interneuron
CNS	Central Nervous System
COX2	Cyclooxygenase 2
CPA	Conditioned Place Aversion
CPP	Conditioned Place Preference
CS	Conditioned Stimulus
D1R	Dopamine D1 receptors
D2R	Dopamine D2 receptors
D3R	Dopamine D3 receptors
DA	Dopamine
DAG	Diacylglycerol
DAT	Dopamine Transporter
DGL	Diacylglycerol Lipase
DIG	Digoxigenin
DOR	Delta Opioid Receptor
DRN	Dorsal Raphe Nucleus
DSE	Depolarization-Induced Suppression of Excitation
DSI	Depolarization-Induced Suppression of Inhibition
DSM-5	Diagnostic and Statistical Manual of Mental Disorders 5
ECS	Endocannabinoid System
EPSC	Excitatory Postsynaptic Current
ER	Estrogen Receptor
ERK1/2	Extracellular-regulated Kinases 1/2

ES	Embryonic Stem (cells)
FAA	Food-Anticipatory Activity
FAAH	Fatty Acid Amide Hydrolase
FABPs	Fatty Acid Binding Proteins
FR	Fixed Ratio
FSCV	Fast-Scan Cyclic Voltammetry
GABA	$\gamma$ Aminobutyric Acid
GAD	Glutamate Decarboxylase
GDE1	Glycerophosphodiesterase 1
GFP	Green Fluorescent Protein
GIRK	G Protein-Coupled Inwardly Rectifying Potassium Channel
GPCR	G Protein-Coupled Receptors
GPR55	G Protein Coupled Receptor 55
GR	Glucocorticoid Receptor
HRP	Horseradish Peroxidase
HSP70	Heat Shock Protein 70
HVR	High Voluntary Running
ICSS	Intracranial Self-Stimulation
IGF1	Insulin-Like Growth Factor 1
i.p.	Intraperitoneal
IP3	Inositol Triphosphate
IPSC	Inhibitory Postsynaptic Current
LEA	Linoleoylethanolamide
LH	Lateral Hypothalamus
LOX	Lipoxygenase
LTD	Long-Term Depression
LTP	Long-Term Potentiation
LVR	Low Voluntary Running
M1	Type 1 Acetylcholine Metabotropic Receptors
M3	Type 3 Acetylcholine Metabotropic Receptors
MAPK	Mitogen-Activated Protein Kinases
MGL	Monoacylglycerol Lipase
mGluR1/5	Type-1/5 Metabotropic Glutamate Receptor
MOR	$\mu$ Opioid Receptor
MSN	Medium Spiny Neurons
NAc	Nucleus Accumbens
NAPE	N-arachidonoyl phosphatidylethanolamine
NAPE-PLD	N-acylphosphatidylethanolamine-hydrolyzing phospholipase D
NAT	N-acyltransferase
NP	Nose Poke
NS	Non Significant
NTS1	Neurotensin Receptor 1
OEA	Oleoylethanolamide
OX1	Orexin Receptor 1

PCR	Polymerase Chain Reaction
PEA	Palmitoylethanolamide
PET	Positron Emission Topography
PFC	Prefrontal Cortex
PKA	Protein Kinase A
PLC $\beta$	Phospholipase C $\beta$
PR	Progressive Ratio
PTPN22	Protein Tyrosine Phosphatase N22
PVN	Paraventricular Nucleus of The Hypothalamus
PWIR	Post-Weaning Social Isolation Rearing
RMTg	Rostromedial Tegmental Nucleus
RNA	Ribonucleic Acid
RPE	Reward Prediction Error
Sim1	Single-Minded 1
SN	Substantia Nigra
SON	Supraoptic Nucleus of The Hypothalamus
STAT3	Signal Transducer and Activator of Transcription 3
THC	$\Delta^9$ -tetrahydrocannabinol
TH	Tyrosine Hydroxylase
TPH2	Tryptophane Hydroxylase 2
TRPV1	Transient Receptor Potential Vanilloid Type 1
TSA	Tyramide Signal Amplification
US	Unconditioned Stimulus
VEGF	Vascular Endothelial Growth Factor
VGAT	Vesicular GABA Transporter
VGCCs	Voltage-Gated Calcium Channels
VGLUT-2	Vesicular Glutamate Transporter 2
VMAT2	Vesicular Monoamine Transporter 2
VP	Ventral Pallidum
VR	Variable Ratio
VTA	Ventral Tegmental Area
WT	Wild type

# INTRODUCTION

## 1. The Endocannabinoid System

### 1.1. History

Already hypothesized in the mid-20<sup>th</sup> century before being characterized in the early 90's, the endocannabinoid system is a neuromodulatory system that has been named after the plant *Cannabis sativa L.* and its components, the cannabinoids. In order to understand how this system was brought to light, one must trace back the history of cannabis use.

Cannabis has been cultivated in China as early as 4000 years B.C. for the plant fiber. Its first use for medical and psychoactive properties is documented in the world oldest pharmacopeia, the *Pen-tsao Ching* based on oral tradition dated around 2,700 BC in China, and also in the Atharva Veda, a collection of sacred texts from the region of India (Zuardi, 2006). Cannabis was thus used to treat several afflictions such as pain, digestive disorders, and inflammation, as well as for religious purposes. Interestingly, its psychoactive action was also described in the *Pen-tsao Ching*: "the fruit, if taken in excess, will produce visions of devils... over a long term, it makes one communicate with spirits". Progressively, the use of cannabis spread to the Middle East, Africa and, by means of the Atlantic slave trade, to America.

Cannabis use in most of Western countries finds its roots in the 19<sup>th</sup> and 20<sup>th</sup> centuries, with the initial work and findings of two physicians: William O'Shaughnessy and Jacques-Joseph Moreau. The former served in India where he wrote a seminal work "On the preparation of the Indian hemp, or gunjah" when the latter was a psychiatrist that travelled to Middle East and was more interested in the psychotropic effect of the plant with the aim to fight mental diseases (O'Shaughnessy, 1843). Following this introduction in western use, cannabis has been extensively studied for diseases lacking therapeutic solutions. In the early 20<sup>th</sup> century, cannabis extracts were used for sedative/hypnotic, analgesic, or appetitive/digestive purposes whilst cannabis recreational use started.

This period saw numbers of new cannabis-derived therapeutics options arising in conjunction with innovation in pharmacology, immunology, and medical technics. However, lack of consent on the true therapeutic properties of cannabis and the

growing awareness on the addictive properties of cannabis use led to a decrease in the medical interest for cannabis products. More recently, with the expanding use of cannabis for its hedonic impact and hence the observation of its positive consequences in several pain-associated illnesses, there has been a recent surge of interest for its clinical use as a pain killer and its anti-vomiting properties in patients undergoing chemotherapy.

In the 60's, the chemical structure of the main psychoactive component of *Cannabis sativa L.*, namely the  $\Delta^9$ -tetrahydrocannabinol (THC) was discovered by Gaoni and Mechoulam (Gaoni and Mechoulam, 1964). This discovery drove intense research on the effect of THC and especially in an attempt to elucidate its mechanism of action. Because of its lipidic nature, THC was first thought to putatively act through a nonspecific mechanism by interacting with hydrophobic membranes (Mechoulam et al., 2014). However, the 80's were a period of intense research and receptor description, especially in the homology domain, and it was observed by Howlett and colleagues that THC altered the functioning of an enzyme linked to receptor-associated G protein intracellular transmission, namely the adenylate cyclase (AC; Howlett and Fleming, 1984). This effect was sensitive to pertussis toxin (Howlett et al., 1986), thus demonstrating that THC was acting at a G protein-coupled receptor (GPCR). The pharmacological displacement of a highly potent synthetic analogue firmly demonstrated the existence of cannabinoid type-1 (CB1) receptors in the brain (Devane et al., 1988), later cloned thus revealing its structure (Matsuda et al., 1990). This discovery suggested the existence of endogenous ligands for these receptors. Indeed, some years after CB1 receptor discovery, the first endogenous ligand was isolated, namely N-arachidonyl ethanolamine, which was then called anandamide (AEA) after the Sanskrit word *ananda* ("bliss" or "joy"; Devane et al., 1992). Still in the 90's, a second cannabinoid receptor was described in peripheral organs (but see below), thus named cannabinoid type-2 (CB2) receptors (Munro et al., 1993). Research was striving to investigate the role of CB1 receptors in multiple physiological processes as well as in THC effects; however, the lack of antagonist(s) for these receptors impeded firm conclusions on the specificity of the phenotypes observed. The discovery of the first CB1 receptor antagonist, namely SR141716A or rimonabant (Rinaldi-Carmona et al., 1996), expanded the characterization of the endocannabinoid system. During this intensive research period, a second endogenous ligand was

described and isolated, i.e. 2-arachidonoylglycerol (2-AG; Mechoulam et al., 1995; Sugiura et al., 1995). Since then, several other endogenous ligands were characterized with specificities differing from those of AEA and 2-AG; however, these are currently much less described (Mechoulam et al., 2014). The discovery of the endocannabinoid system rose the question of its role. Twenty years ago, it was discovered that endogenous cannabinoids act through retrograde signaling (Wilson and Nicoll, 2001) and mediate activity-dependent synaptic plasticities (Kano et al., 2009).

## 1.2. Description

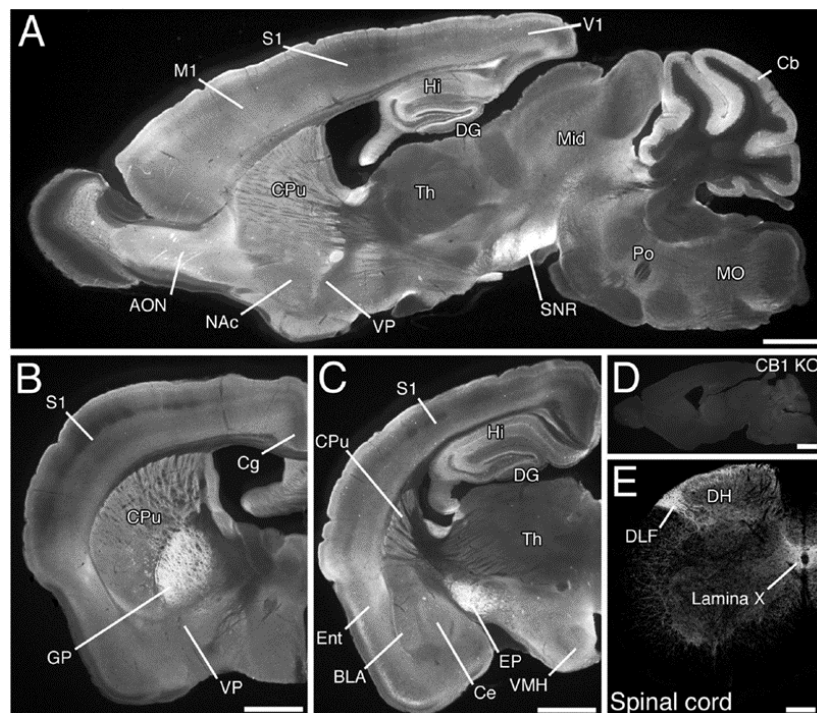
The endocannabinoid system comprises four main elements with (i) the receptors, (ii) their ligands (the so-called endocannabinoids), and the machineries for their (iii) synthesis and (iv) degradation. One of the major characteristics of this system is retrograde signaling whereby endocannabinoids are produced “on-demand” (no storage in vesicles) postsynaptically to travel backward within the synaptic cleft and exert their effects mainly (but not exclusively) through binding at presynaptic CB1 receptors. In this section, I will describe the different components of the system as well as their characteristics and distribution before addressing the role of CB1 receptors in synaptic plasticity.

### 1.2.1. *The cannabinoid receptors*

#### 1.2.1.1. CB1 receptors

These receptors are the main mediators of endogenous (i.e. AEA and 2-AG) and exogenous (e.g.  $\Delta^9$ -THC) cannabinoids in the central nervous system (CNS). In the early 90's, the use of the radio-labeled cannabinoid analogue [ $^3$ H]CP55,940 initiated the characterization of CB1 receptors in rat brain membranes and suggested their coupling to a G protein (Devane et al., 1988). Later, its molecular identity was firmly assessed by receptor cloning (Matsuda et al., 1990). Further studies next evidenced coupling of the receptor to  $G_{i/o}$  proteins (Devane et al., 1988; Howlett, 2002; Howlett et al., 1986; Pertwee, 1997). Its structure consists in seven transmembrane domains linked by 3 intracellular and 3 extracellular loops, its extracellular N-terminal domain bearing posttranslational modification sites (Shim, 2010), whose influences are not fully characterized. Recently, CB1 receptors were crystalized (Hua et al., 2016, 2017;

Shao et al., 2016), allowing a fine investigation of the site of action of their ligands. In addition to its monomeric form, dimerization of CB1 receptors has been observed (Wager-Miller et al., 2002), including within heteromers where it is associated with CB2 receptors (Callén et al., 2012), dopamine D2 receptors (D2R) or opioid receptors (Mackie, 2005). However, the functional relevance of such complexes is still unknown. [<sup>3</sup>H]CP55,940 binding studies (Devane et al., 1988; Herkenham et al., 1990) unraveled CB1 receptor distribution across the CNS, revealing that it can be considered the most expressed GPCR in the brain (Herkenham et al., 1990). As reviewed by Kano et al. (Kano et al., 2009), the highest levels of CB1 receptor binding were observed in the olfactory bulb, the hippocampus (especially in the regions of the dentate gyrus and the CA3), the lateral striatum, the globus pallidus, the entopeduncular nucleus, the substantia nigra (SN) pars reticulata and the cerebellar molecular layer. Moderate levels were observed in the cerebral cortex (mostly in the frontal, parietal, and cingulate regions), the septum, the amygdala, the hypothalamus (mostly in the ventromedial hypothalamus), the lateral subnucleus of interpeduncular nucleus, the parabrachial nucleus, the nucleus of the solitary tract and the spinal dorsal horn. Finally, low levels of CB1 receptor binding were observed in the thalamus and in brain stem nuclei.



**Figure 1 - Distribution of CB1 receptors throughout the mouse brain.** (A) Sagittal slice (B) Coronal slice at the level of the striatum (C) Coronal slice (D) Sagittal slice of a CB1-KO mouse brain (E) Spinal cord (adapted from Kano et al. 2009).



CB1 receptors are mainly located at presynaptic terminals (Freund et al., 2003), but studies have indicated that it might also be located postsynaptically where, in keeping with the postsynaptic location of endocannabinoid synthesis/release, it might play an autocrine role (Bacci et al., 2004). This consideration is of prime importance, especially for projection neurons, considering that for a given brain area the mRNA expression might be quantitatively important when CB1 receptor immunolabelling might be scarce because of its restricted location to the terminal region. One of the best illustrations for this dichotomy is provided by the medium spiny neurons (MSN) of the ventral striatum (Kano et al., 2009). As neuromodulators, CB1 receptors modulate synaptic transmission (detailed in the following sections) of a wide variety of neurotransmitters, including GABA, glutamate, serotonin, acetylcholine (ACh), or cholecystinin (CCK) among others (Cohen et al., 2019). Accordingly, CB1 receptors are found on presynaptic terminals of GABAergic and glutamatergic neurons (Katona et al., 2006; Mátyás et al., 2008), with a higher density on the former terminals than in the latter terminals within several brain regions (Kawamura et al., 2006). This observation could explain the biphasic effects of cannabinoids drugs on several behaviors such as food intake (Bellocchio et al., 2010), locomotion (Sañudo-Peña et al., 2000) and anxiety (Rey et al., 2012). However, [ $S^{35}$ ]GTP $\gamma$ S experiments have indicated that differences in CB1 receptor densities between inhibitory and excitatory terminals are counterbalanced by differences in CB1 receptor coupling efficiencies (i.e. CB1 receptors on excitatory terminals are more strongly coupled to G protein signaling than receptors on inhibitory terminals: Steindel et al., 2013).

Even though mainly expressed on neurons, CB1 receptors are also present on glial cells such as astrocytes (Gutiérrez-Rodríguez et al., 2018; Han et al., 2012; Stella, 2010). Therein, CB1 receptor stimulation induces an increase in intracellular calcium through coupling to  $G_{q/11}$  protein (Navarrete and Araque, 2008, 2010) thereby triggering gliotransmission (Cruz et al., 2016; Robin et al., 2018). Moreover, as suggested from the lipidic nature of their ligands, CB1 receptors are also found in subcellular compartments, especially in association to mitochondria (Bénard et al., 2012; Hebert-Chatelain et al., 2014, 2016; Koch et al., 2015), their activation regulating negatively mitochondrial respiration, and hence, affecting higher brain functions such as memory (Hebert-Chatelain et al., 2016).

### 1.2.1.2. CB2 receptors

The second main cannabinoid receptor, the CB2 receptor, was discovered few years after CB1 receptors in immune cells within human spleen (Munro et al., 1993). This receptor is also a 7-transmembrane domain GPCR, mainly coupled to G proteins of the  $G_{i/o}$  type; however, besides being encoded by separate genes (*Cnr1* for CB1 receptors, *Cnr2* for CB2 receptors), they only share 44% of homology (Pertwee, 1997). Even though it was first referred to as a “peripheral” cannabinoid receptor because of its discovery in the immune system (Munro et al., 1993), the CB2 receptor was also observed in brain, bearing long-neglected effects. Indeed, CB2 receptors are found (i) in microglia wherein their expression is induced by inflammation (Maresz et al., 2005), but also (ii) in neurons and glial cells (Brusco et al., 2008; Jordan and Xi, 2019; Onaivi et al., 2006), although at a much lower level than CB1 receptors. These discoveries, allowed by new technics such as the RNAscope for high sensitivity fluorescent *in situ* hybridization, fueled the interest for their central effects. Indeed, central CB2 receptors were shown to be involved in cannabinoid-induced analgesia and catalepsy (Wang et al., 2020), two behavioral readouts of the so-called cannabinoid "tetrad". Recently, the group of Zheng-Xiong Xi showed that central CB2 receptors were involved in the aversive effect of high doses of cannabinoids (Spiller et al., 2019), and proposed that this effect might involve their expression in ventral tegmental area (VTA) dopaminergic neurons (Han et al., 2017; Zhang et al., 2017, 2014).

### 1.2.1.3. Other relevant receptors?

Although most effects of cannabinoid drugs are due to their actions on CB1 and/or CB2 receptors, several of their pharmacological effects could not be linked to either receptor, thus suggesting other targets, among which the transient receptor potential vanilloid type 1 (TRPV1) and a deorphanized GPCR, the G protein coupled receptor 55 (GPR55; Brown, 2007).

TRPV1 is extensively described in sensory neurons where it mediates noxious thermal and chemical stimuli, - including those triggered by capsaicin (found in red-hot chili pepper) - thus activating such neurons to convey the pain message to the brain (Caterina et al., 1997). However, this receptor is also targeted by endogenous lipids (Petrocellis and Marzo, 2005), among which AEA (Ross, 2003). Furthermore, TRPV1

was found to be expressed in brain, more precisely in neurons (postsynaptic location), astrocytes and pericytes (Menigoz and Boudes, 2011; Tóth et al., 2005), thus suggesting a potential involvement in central non-CB1/CB2 cannabinoid receptor effects. Indeed, TRPV1 activation by AEA induces a CB1 receptor-independent form of long-term depression (LTD) of excitatory synapses (Chávez et al., 2010) thus demonstrating that endocannabinoids can induce synaptic plasticity through these receptors.

The orphanized GPCR, GPR55, was primarily described in the human striatum (Sawzdargo et al., 1999). Even though this receptor displays a poor (around 14 %) amino-acid homology with CB1 and CB2 receptors (Yang et al., 2016), several endocannabinoids, among which AEA and 2-AG, were described as GPR55 ligands (Ryberg et al., 2007). Their affinity for GPR55 however depends on the cell type considered (Sharir and Abood, 2010). Although much progress has been made with respect to this receptor, its functional significance and information on its activation by endocannabinoids remain to be described (Marichal-Cancino et al., 2017).

### 1.2.2. *The endogenous ligands: the endocannabinoids*

The discovery of cannabinoid receptors suggested the existence of endogenous ligands. The observation that the first cannabinoids which were discovered, such as THC, are of lipidic nature raised the hypothesis that endogenous cannabinoids, i.e. endocannabinoids, would be lipidic as well. Indeed, the two main endocannabinoids discovered in the 90's, namely AEA, (Devane et al., 1992) and 2-AG, (Mechoulam et al., 1995; Sugiura et al., 1995) were of lipidic nature, being derivatives of arachidonic acid (Figure 2; Piomelli, 2003). More recently, several other endogenous ligands were discovered, e.g. 2-arachidonoylglycerol ether (noladin ether; Hanuš et al., 2001), O-arachidonylethanolamine (virhodamine; Porter et al., 2002) and N-arachidonoyldopamine (Huang and Walker, 2006). However, these molecules are far less investigated and for the sake of clarity, I will thus only focus on AEA and 2-AG in the following section.

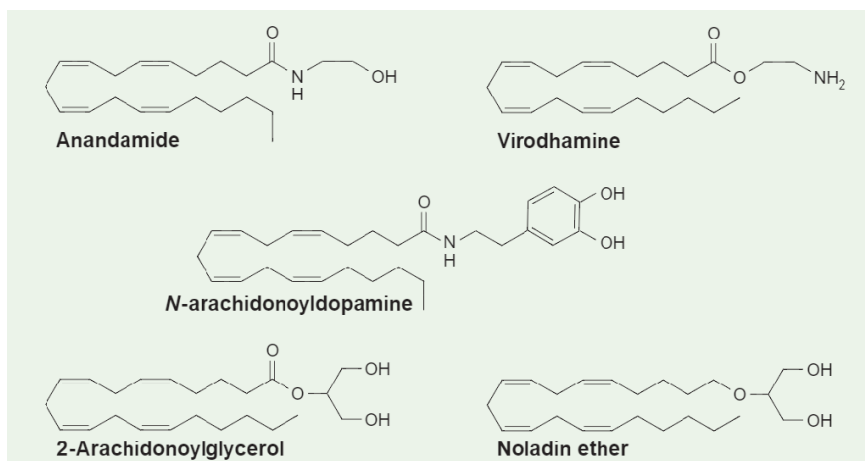


Figure 2 - **Endogenous cannabinoids** (Adapted from Piomelli 2003)

Of note, beside the previously cited endogenous ligands which act as orthosteric agonists, several endogenous allosteric modulators of CB1 receptors have been described (Morales et al., 2016; Figure 3): lipoxin-A4, an anti-inflammatory derivative of arachidonic acid (Pamplona et al., 2012), pregnenolone (Vallée et al., 2014) which decreases THC-induced extracellular-regulated kinase 1/2 (ERK1/2) pathway activation and blocks the psychotic-like effect of THC *in vivo* (Busquets-Garcia et al., 2017), and pepcan-12 (Bauer et al., 2012), a derivative of hemopressin. The latter is supposedly exerting an allosteric modulation of CB1 receptor agonist-mediated alteration of the cyclic adenosine monophosphate (cAMP) intracellular pathway.

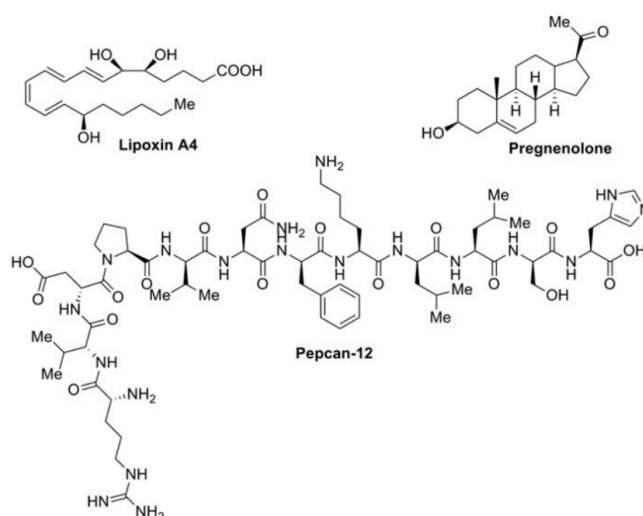


Figure 3 - **Endogenous allosteric modulators of CB1 receptors** (adapted from Morales et al. 2016)

As above-mentioned, oppositely to classical neurotransmitters, endocannabinoids are fast acting neuromodulators that are not stored in vesicles but rather produced “on-demand” following neuronal activation (Piomelli, 2003). It should be noted however that this dogma has been debated in several publications (see Belluomo et al., 2015; Min et al., 2010). Following, their release and their stimulation of CB1 receptors, they are rapidly taken up and degraded by specific enzymes which are detailed below (1.2.2.3.).

#### 1.2.2.1. Synthesis of endocannabinoids

As previously mentioned, the term “endocannabinoid” generally refers to the two main endocannabinoids namely AEA and 2-AG which respectively belong to the N-acylethanolamine and monoacylglycerol families and derive from poly unsaturated fatty acids such as arachidonic acid. As yet mentioned, AEA and 2-AG are mainly produced postsynaptically after neuronal activation to act either (i) in a paracrine manner traveling backward across the synapse to activate CB1 receptors, or (ii) in an autocrine manner activating CB1 receptors locally (Bacci et al., 2004; Kano et al., 2009). However, as indicated below, the syntheses of endocannabinoids are accompanied by syntheses of other lipidic molecules which have CB receptor-independent functional effects.

The first endocannabinoid described, AEA, is synthesized after an increase in postsynaptic calcium (Piomelli, 2003). The first step of this synthesis requires the generation of N-arachidonoyl phosphatidylethanolamine (NAPE) from membrane phospholipids via N-acyltransferase (NAT; Marzo et al., 1994; Figure 4). The second step leading to AEA can be either (i) direct through the enzyme N-acylphosphatidylethanolamine-hydrolyzing phospholipase D (NAPE-PLD), or (ii) indirect through  $\alpha/\beta$ -hydrolase domain type 4 (ABDH4) activity followed by glycerophosphodiesterase 1 (GDE1) action or through the recruitment of protein tyrosine phosphatase N22 (PTPN22; Iannotti et al., 2016). However, as previously mentioned, AEA is not the sole lipid generated from the NAPE precursor. Indeed, palmitoylethanolamide (PEA), oleoylethanolamide (OEA), and linoleoylethanolamide (LEA), among others, are also generated. All three are worth mentioning here given their ability to bind TRPV1 and GPR55, and hence bear functional effects in a CB1 receptor-independent manner (Cristino et al., 2020).

The synthesis of 2-AG (Figure 4), either triggered by depolarization or stimulation of G<sub>q</sub>-coupled receptors (e.g. mGluR1/5), requires diacylglycerol (DAG) that can be obtained from phosphatidic acid through phosphatase action or from membrane phospholipids through phospholipase C $\beta$  (PLC $\beta$ ). In turn, diacylglycerol lipase (DGL) catalyzes the conversion of 2-AG from DAG (Bisogno et al., 2003; Iannotti et al., 2016). However, as for AEA, the biosynthetic pathway leading to 2-AG generates other lipids, such as monoacylglycerol which can act on several non-CB receptors, thereby participating to the multiplicity of actions resulting from the synthesis of endocannabinoids (Cristino et al., 2020).

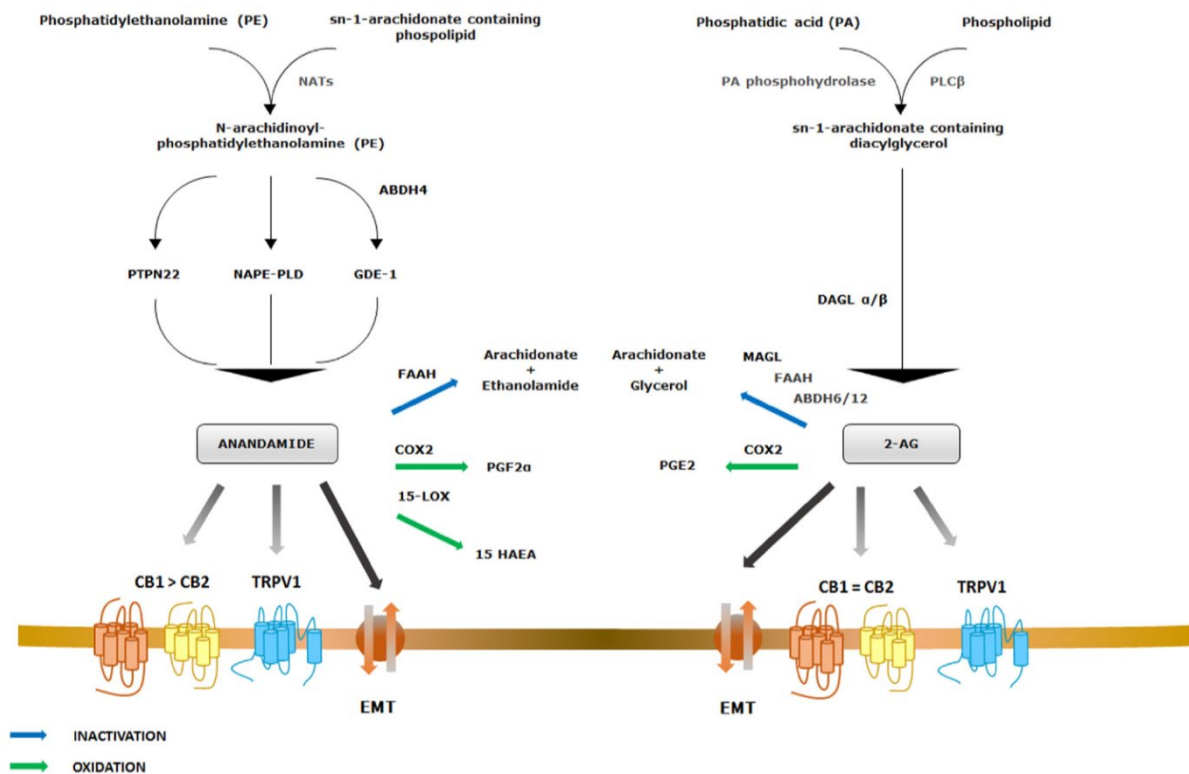


Figure 4 - **Synthesis and degradation of the two main endocannabinoids AEA and 2-AG** (adapted from Iannotti et al., 2016)

#### 1.2.2.2. Transport of endocannabinoids

Classical neurotransmitters are stored in vesicles at the presynaptic terminal, released into the synaptic cleft upon depolarization-induced calcium entry before reaching their postsynaptic targets. As indicated, endocannabinoids differ from classical neurotransmitters in (i) their postsynaptic synthesis and (ii) their lipidic nature, thus raising the question: how do endocannabinoids cross the aqueous synaptic cleft to

reach their target receptors? To date, the underlying mechanism remains poorly documented.

Few studies have addressed this question. These described a putative binding of AEA to carrier proteins for intracellular (and thus, possibly cross-synaptic) trafficking, such as the heat shock protein 70 (HSP70; Oddi et al., 2009), albumin (Oddi et al., 2009), and the fatty acid binding proteins (FABPs) 5 and 7 (Kaczocha et al., 2009). Regarding synaptic transport, recent investigations reported a possible involvement of microvesicles, as opposed to carrier proteins, for both AEA (Gabrielli et al., 2015) and 2-AG (Nakamura et al., 2019).

#### 1.2.2.3. Degradation of endocannabinoids

The degradation of endocannabinoids is essential to limit their actions both spatially and temporarily. Adding to the already mentioned complexity of the endocannabinoid system, the degradation of the main endocannabinoids relies on several enzymes which also degrade the non-endocannabinoid molecules mentioned above. However, two main degradation pathways can be described, the most important being through hydrolysis and the second being through oxidation (Figure 4).

The two main hydrolases responsible for the degradation of the endocannabinoids are respectively the fatty acid amide hydrolase (FAAH) for AEA (Cravatt et al., 1996) and the monoacylglycerol lipase (MGL) for 2-AG (Dinh et al., 2002). Whereas FAAH can nearly account for the full degradation of AEA, as demonstrated by the lack of AEA-degrading activity in FAAH-knock out animals (Cravatt et al., 2001), 2-AG degradation is far more complex, involving several enzymes. Even though most of 2-AG degradation at near physiological pH is accounted for by MGL activity (85%),  $\alpha/\beta$ -hydrolase domain type 12 (ABDH12) and 6 (ABDH6) also degrade this endocannabinoid (respectively 9 % and 4% of the whole degradation process) as well as, in a smaller proportion, FAAH (less than 1% of that process; Blankman et al., 2007; Iannotti et al., 2016). Moreover, AEA and 2-AG are not the sole substrates for those hydrolases. Indeed, FAAH degrades other molecules from the N-acylethanolamine group and MGL hydrolyzes other monoacylglycerols (Cristino et al., 2020), an observation which is worth mentioning when evaluating the effects of drugs altering

endocannabinoid degradation (as to enhance endocannabinoid levels and thus potentiate their actions).

As indicated above, the second type of degradation corresponds to endocannabinoid oxidation. Both AEA and 2-AG can be processed through multiple steps by either cyclooxygenase-2 (COX2; Rouzer and Marnett, 2008) or lipoxygenase (LOX), leading to several prostaglandins that will, in turn, bear functional effects on their own (Cristino et al., 2020; Iannotti et al., 2016).

### 1.3. CB1 receptor signaling & neuronal plasticity

The relative abundance and the ubiquity of the endocannabinoid system throughout the CNS, associated with its location in both inhibitory and excitatory neurons as well as other cell types (e.g. astrocytes), confer to this system an ideal position to finely tune neuronal circuits and regulate synaptic plasticity. Several forms of neuronal plasticity have been attributed to the endocannabinoids, these being observed either (i) in the short-term, such as the depolarization-induced suppression of inhibition or excitation (DSI or DSE) and the metabotropic-induced short-term plasticity, or (ii) in the long-term, mainly LTD.

#### 1.3.1. *CB1 receptor intracellular signaling pathways*

Activation of CB1 receptors induces several intracellular signaling cascades encompassing the modulation of second messengers, ion channels and mitogen-activated protein kinases (MAPK), the latter exerting longer lasting effects through actions at the level of transcription factors (Turu and Hunyady, 2010).

CB1 receptor-dependent inhibition of AC was the first intracellular pathway described for cannabinoids (Howlett and Fleming, 1984; Howlett et al., 1986), and was found to be pertussis toxin-sensitive, indicating the involvement of  $G_{i/o}$  proteins. Such an inhibition downregulates the second messenger cAMP, which regulates gene expression through the ERK/ cAMP response element-binding protein (ERK/CREB) pathway by activation of protein kinase A (PKA; Davis et al., 2003). Moreover, the stimulation of CB1 receptors modulates several ion channels. It has been shown that CB1 receptor stimulation activates both G protein-coupled inwardly rectifying



potassium channels (GIRK) through the aforementioned involvement of  $G_{i/o}$  proteins (Mackie et al., 1995) and A-type potassium channels through modulation of PKA activity (Hampson et al., 1995). Oppositely, CB1 receptor stimulation inhibits voltage-gated calcium channels (VGCCs) such as (i) N-type calcium channels (Brown et al., 2004; Pan et al., 1996), an action which has been suggested to account for the presynaptic inhibition that follows retrograde signaling by endocannabinoids and CB1 receptor stimulation (Freund et al., 2003), (ii) L-type calcium channels (Endoh, 2006), and (iii) P/Q-type calcium channels (Fisyunov et al., 2006; Mackie et al., 1995). In addition to the rapid impact of the inhibition of AC and its modulation of ion channels, CB1 receptor stimulation can induce longer-lasting effects through regulation of nuclear transcription factors by favoring the phosphorylation of ERK1/2, p42/p44 MAPK, p38 MAPK and Jun N-terminal kinase (Howlett, 2005; Turu and Hunyady, 2010).

### 1.3.2. *CB1 receptor modulation of neurotransmitter release*

The intracellular pathways modulated by CB1 receptors participate to the hyperpolarization of the presynaptic neuron, leading to the inhibition of neurotransmitter release (Schlicker and Kathmann, 2001). Indeed, CB1 receptor agonists decrease excitatory postsynaptic currents (EPSCs) both *in vitro* in rat hippocampal cultures (Shen et al., 1996) and *ex vivo* in mouse hippocampal slices (Misner and Sullivan, 1999) hence promoting an increased coefficient of variation and an increased paired-pulse facilitation (i.e. a decreased probability of neurotransmitter release), later found in cerebellum and striatum (Schlicker and Kathmann, 2001). These agonists also decrease inhibitory postsynaptic currents (IPSCs) *ex vivo* in the striatum (Szabo et al., 1998) and SN (Chan et al., 1998) without affecting the modulation of postsynaptic currents induced by GABA application, hence suggesting a presynaptic mechanism. Moreover, these effects were blocked by CB1 receptor antagonists (Misner and Sullivan, 1999; Szabo et al., 1998). In addition, CB1 receptor agonists decrease extracellular glutamate and GABA recovered from striatal synaptosomes (Köfalvi et al., 2005) or measured by *in vivo* microdialysis in striatum (Polissidis et al., 2014) and prefrontal cortex (PFC; Pistis et al., 2002), these effects being also blocked by CB1 receptor antagonists. Thus, pharmacological and electrophysiological data indicate that cannabinoids induce a presynaptic CB1

receptor-dependent decrease in glutamate and GABA release. The release of several other neurotransmitters is similarly negatively regulated by CB1 receptors, encompassing Ach (Gifford and Ashby, 1996), noradrenaline (Ishac et al., 1996), dopamine (Cadogan et al., 1997), serotonin (Nakazi et al., 2000) and CCK (Beinfeld and Connolly, 2001).

However, the mechanisms leading to the suppression of neurotransmitter release once CB1 receptors are activated depend on the cell type considered and/or the brain region investigated. For instance, VGCC inhibition was shown to underlie the inhibition of GABA release in hippocampus (Hoffman and Lupica, 2000), and of glutamate release at corticostriatal synapses (Huang et al., 2001), whereas potassium channel activation was found to mediate the inhibition of glutamate release in the nucleus accumbens (NAc; Robbe et al., 2001).

The intrinsic activity of presynaptic neurons also influences the impact of CB1 receptor stimulation on neurotransmitter release. Indeed, WIN55,212-2-elicited stimulation of CB1 receptors in CCK-positive GABAergic interneurons suppressed IPSCs on the postsynaptic pyramidal cell in CA1 region of the hippocampus when the presynaptic cell was firing at low frequency (Földy et al., 2006). However, when this firing activity was increased, the inhibition of GABA release induced by WIN55,212-2 was weaker and shorter-lasting, indicating that presynaptic activity yet modulates CB1 receptor-mediated effects of (endo)cannabinoids on neurotransmitter release. With respect to that issue, it has been proposed (Földy et al., 2006) that such a mechanism could underlie the differences in the self-reported effects of cannabis due to different users' expectation or context (Földy et al., 2006; Iversen, 1999).

### 1.3.3. *Short-term plasticity*

In the 90's, the hypothesis of a short-term plasticity mediated by a retrograde messenger was formulated based on the observation of a short suppression of GABA release (< 1 minute), as assessed by decreased IPSCs, after a brief postsynaptic stimulation in cerebellum (Llano et al., 1991) and in the hippocampus (Pitler and Alger, 1992). This phenomenon was termed depolarization-induced suppression of inhibition or DSI (Alger and Pitler, 1995). Later, endocannabinoids were shown to be the retrograde messengers mediating DSI in hippocampus (Wilson and Nicoll, 2001) and

in primary cultures (Ohno-Shosaku et al., 2001). The same year, independent groups unraveled a similar form of short-term plasticity by endocannabinoids, that plasticity taking however place at excitatory glutamatergic synapses in cerebellum (Kreitzer and Regehr, 2001; Maejima et al., 2001). In line with the reference to DSI, this phenomenon was termed depolarization-induced suppression of excitation or DSE. Later, endocannabinoid-mediated DSI and DSE plasticities were observed in several other brain regions e.g. hypothalamus, neocortex, VTA, amygdala, and basal ganglia among others (reviewed in Kano et al., 2009).

DSI and DSE can be initiated through two main mechanisms involving either (i) postsynaptic intracellular calcium increases or (ii) activation of postsynaptic  $G_{q/11}$  coupled receptors (see below). The first mechanism was evidenced by the abolition of DSI after application of calcium chelators in the postsynapse (Llano et al., 1991; Ohno-Shosaku et al., 2001; Pitler and Alger, 1992). Moreover, exogenous application of calcium to the postsynaptic element was sufficient to induce this short-term plasticity (Wilson and Nicoll, 2001). The second mechanism involves the activation of postsynaptic metabotropic  $G_{q/11}$ -coupled receptors. Indeed, activation of type 1/5 metabotropic glutamate receptors (mGluR1/5) in cerebellum (Maejima et al., 2001), hippocampus (Varma et al., 2001), striatum (Brown et al., 2003) and VTA (Melis et al., 2004a) or the activation of type 1/3 acetylcholine metabotropic receptors (M1/M3) in the hippocampus (Ohno-Shosaku et al., 2003), were sufficient to produce endocannabinoid-mediated short term plasticities. The stimulation of  $G_{q/11}$ -coupled receptors, which activates  $PLC\beta$ , thus favoring the production of inositol-triphosphate (IP3) and then calcium release from intracellular compartments, increases DAG, the precursor of 2-AG. Moreover, DSI was abolished in mice bearing a genetic deletion of  $DGL\alpha$ , the synthesis enzyme of 2-AG, in hippocampus (Gao et al., 2010) and cerebellum (Tanimura et al., 2010), hence indicating that this form of endocannabinoid-mediated synaptic plasticity is mainly mediated by 2-AG.

#### 1.3.4. *Long-term plasticity*

The second type of synaptic plasticity induced by endocannabinoids relates to a longer suppression of neurotransmission following sustained neuronal activation. First described at excitatory synapses of the dorsal striatum (Gerdeman et al., 2002) and

the NAc (Robbe et al., 2002), this endocannabinoid-mediated form of plasticity involves a suppression of neurotransmission for a prolonged duration, lasting at least 30 minutes (*versus* < 1 min for DSI/DSE) and was thus called endocannabinoid-mediated long-term depression (abbreviated ecb-LTD). Later, this form of plasticity was observed in amygdala (Azad et al., 2004; Chevaleyre et al., 2007; Marsicano et al., 2002), hippocampus (Chevaleyre and Castillo, 2003; Chevaleyre et al., 2007), visual cortex (Sjöström et al., 2004), PFC (Lafourcade et al., 2007) and VTA (Pan et al., 2008) [see Heifets and Castillo, 2009 for review]. The general mechanism involved in ecb-LTD requires an increase in postsynaptic calcium followed by a massive endocannabinoid mobilization and a sustained retrograde activation of CB1 receptors at the presynapse.

The investigations on ecb-LTD in different brain regions/synapses suggest that several mechanisms might underlie the endocannabinoid mobilization required to induce ecb-LTD. Indeed, investigators consistently found that the activation of mGluR1/5 is necessary to induce ecb-LTD in several brain regions (Azad et al., 2004; Chevaleyre and Castillo, 2003; Lafourcade et al., 2007; Pan et al., 2008; Robbe et al., 2002). However, whereas the rise in postsynaptic intracellular calcium is necessary in some brain regions, such as the NAc (Robbe et al., 2002), the neocortex (Sjöström et al., 2003), the somatosensory cortex (Bender et al., 2006) and the PFC (Lafourcade et al., 2007), it seems dispensable in some others e.g. hippocampus and VTA (Chevaleyre and Castillo, 2003; Pan et al., 2008). Moreover, the inhibition of PLC $\beta$  abolished ecb-LTD in hippocampus, PFC and VTA (Chevaleyre and Castillo, 2003; Lafourcade et al., 2007; Pan et al., 2008) thus suggesting another possible pathway leading to endocannabinoid mobilization.

The induction of ecb-LTD also requires a prolonged activation of CB1 receptors. Indeed, if the CB1 receptor antagonist rimonabant is applied 1 or 3 minutes after the induction protocol, the ecb-LTD is found to be respectively abolished or strongly reduced, indicating that the induction requires a prolonged (over 1 min) stimulation of CB1 receptors (Chevaleyre and Castillo, 2003; Ronesi et al., 2004). As opposed to the induction, CB1 receptors are dispensable for ecb-LTD expression, as demonstrated by the inability of CB1 receptor antagonists to reverse LTD once established (Chevaleyre and Castillo, 2003; Ronesi et al., 2004; Sjöström et al., 2003). However, CB1 receptor stimulation is not sufficient, as attested by the inability of the sole

application of an exogenous agonist to induce an ecb-LTD (Ronesi et al., 2004; Singla et al., 2007; Sjöström et al., 2003). Thus, one crucial feature of the ecb-LTD induction is the need for presynaptic neuronal activity in addition to CB1 receptor activation, as demonstrated in the hippocampus by the absence of LTD if the presynaptic neuron is maintained silent (Heifets et al., 2008). This observation indicates that this process is an afferent-specific mechanism. Moreover, presynaptic calcium increases (Heifets et al., 2008; Singla et al., 2007) and activation of the calcium-sensitive phosphatase calcineurin (Heifets et al., 2008) are also required for ecb-LTD. As indicated above, after stimulation of CB1 receptors, activation of the  $G\alpha_{i/o}$  subunit, and hence inhibition of the AC/PKA pathway, takes place. This mechanism was demonstrated by the blockade of LTD by a PKA inhibitor or cAMP potentiation (Chevaleyre et al., 2007). Furthermore, the use of RIM1 $\alpha$ -knock out animals demonstrated the necessity for this active zone protein, which is associated to the release machinery (Chevaleyre et al., 2007).

## **2. Motivation, reinforcement & reward**

The term “motivation” engulfs a wide array of concepts, initially stemmed from philosophy and early psychology to become nowadays the matter of an intense neuroscientific interest with the aim to describe reward-related behaviors. As the deciphering went by, several theories trying to reconcile neurobiology and psychology emerged, and with it, many different terms and concepts. As an illustration, the term “rewarding”, although extensively used in this field, has progressively lost accuracy, being used to designate the incentive/appetitive as well as the hedonic properties of a reinforcer although their respective neurobiological substrates are partly separated (see below).

In this section, I will first provide a brief historic of definitions and concepts regarding motivation with the aim to provide clarity as concerns its terminology. Then, the neurobiology underlying motivational processes will be discussed, with special emphasis on the involvement of the neurotransmitter dopamine (DA) and the mesocorticolimbic pathway.

### 2.1. Historical of the concepts and definitions

Although being used daily in a wide variety of contexts, the meaning of the term motivation can be hard to seize and is most often intricately linked to the idea of reward.

The general definition of motivation is as simple as “the reasons for acting or behaving in a particular way”. Historically, as it is the case with many concepts in neuroscience and psychology, the concept of motivation comes from philosophy. It was the matter of intense thinking and debate as early as Plato or Socrates, and the concept could be summarized by the following question: why an individual acts, behave, and thinks the way he does? Later, the philosopher Schopenhauer formulated the motivation as the way organisms will be able to “choose, seize, and even seek out the means of satisfaction” (Schopenhauer, 1999).

In psychology, the roots of the modern concept of motivation can be traced back to the 19<sup>th</sup> century, when Thorndike formulated the “Law of Effect”. He observed that when animals were locked in a cage equipped with a device allowing its opening, placing a piece of food outside of the cage promoted intense investigations of different strategies to open the cage and reach the food (Thorndike, 1898). On subsequent trials, the latency to escape then quickly dropped to become close to null by performing the most efficient strategy right away. By designating the food as a “satisfier”, Thorndike enounced his “Law of Effect” wherein an action leading to satisfaction has an increased probability of happening again, whilst conversely, an action leading to an unpleasant outcome will be abandoned. However, in this task, the focus was made on a given strategy and its outcome rather than on motivation for this particular outcome.

The psychology field of the 19<sup>th</sup> century was highly influenced by behaviorism, and conditioning was of privileged interest to explain human and animal behavior. Indeed, the seminal work of Ivan Pavlov led to the description of pavlovian conditioning, also called classical conditioning, designating the observation that an individual will react to a previously neutral stimulus (called the conditioned stimulus or CS) if repeatedly paired with an appetitive stimulus (called the unconditioned stimulus or US; Denny-Brown, 1928). Individuals are described as respondents in the sense that this conditioning leads to an involuntary response, called “reflex” by Pavlov at that time.

Several decades later, the seminal work of Skinner expanded Thorndike’s “Law of Effect”, leading to what is nowadays called operant conditioning (Skinner, 1938). He

designed an apparatus, known as an operant chamber, which could house an animal and display a discriminative stimulus (e.g. a lever) that the animal could interact with, this interaction being called an instrumental or an operant response. When the animal exerted this operant response, a piece of food was dispensed, this in turn increasing the probability that the animal repeated this action, the food thus being called a reinforcer. This increase was then called positive reinforcement. The crucial point of this approach relies on the fact that Skinner focused on the relation between the response elicited and the reinforcer, but also on the effect of the latter on the former. Even though Skinner was more interested in the fact that the reinforcer was indeed reinforcing than on the question *why* it was, operant conditioning and the principle of reinforcement grounded future works of psychologists, psychiatrists, and neuroscientists on motivation.

Several theories then emerged to explain the motivation concept; however, as elegantly reviewed by Berridge (Berridge, 2004), the modern idea of the concept of incentive motivation finds its origin in the work of three investigators: Bolles, Bindra and Toates. After years of predominance of the “need or drive reduction” theory (depletion states drive animal behavior to replenish defective needs), Bolles proposed that classical conditioning leads to incentive expectancies (Bolles, 1972). Indeed, after repeated US-CS pairings, part of the hedonic properties of the US are transferred to the CS, thereby providing the CS with incentive expectancies. However, this scheme did not fully explain why these expectancies are linked to motivation. Accordingly, Bindra completed this framework, suggesting that the CS would not only cause expectancies, but rather evoke a similar incentive motivational state to that of the US after conditioning (Bindra, 1978). Finally, this framework was completed by Toates. He considered the physiological state of the animal as an important regulator of the incentive properties of a stimulus (Toates, 1986). Indeed, he suggested that a physiological depletion would impact the hedonic properties of a stimulus, and thereby, modulate the incentive properties of that stimulus.

From this framework, it is thus suggested that classical conditioning transfers incentive/hedonic properties from the US to the CS. However, these properties should not be considered as pertaining to a single unique behavioral dimension. Berridge and Robinson proposed to discriminate between the incentive and the hedonic dimensions of reward-related behaviors since their underlying brain mechanisms are separated

(as discussed in the next section). Indeed, this conceptual view proposes a segregation between the motivational incentive properties of a reinforcer, called incentive salience or “wanting”, and the essential hedonic reaction evoked by the reinforcer, called “liking” (Berridge and Robinson, 1998). This distinction relies on the former description of well-conserved hedonic reactions to pleasant tastes in human infants and several animal species (Steiner, 1973). These orofacial taste reactions, which represent an objective way to assess pleasure in humans and animals, paved the way to the description of the neurobiology of “liking”, which then provided a clear separation between the “wanting” and “liking” components of motivated behaviors.

A further subdivision was proposed by Salamone and colleagues based on the plethora of works which focused on the impacts of manipulations of dopaminergic activity on reinforcement and motivation (Salamone and Correa, 2002). They demonstrated that the “wanting” dimension of motivated behavior was not a unitary entity but rather could be subdivided into (i) a directional aspect of the behavior, referring to the “appetite” to reach a specific stimulus, and (ii) an activational aspect, that could be defined as the allocation of energy to that task.

The current motivation concept refers to a set of behavioral and sensory components centered on a target stimulus (i.e. the reinforcer). It comprises incentive aspects, i.e. the “wanting” for this stimulus with both directional (the will to reach this specific stimulus) and activational (how much energy should be allocated) components, and reward-linked hedonic properties, i.e. the “liking” of the stimulus, referring to the reaction of pleasure linked to its consumption. As outlined in this section, several fields of investigation studied the concept of motivation, hence leading to the use of different terms defining the same behavioral dimension. In conclusion, the term “*reward*” designates a stimulus with incentive properties (“Wanting” component), triggering hedonic reactions (“Liking” component), and which is able to reinforce a given behavior associated to its receipt (Learning component). The tight relation between reward and motivation can lead to ambiguity in neurobiological studies, and several authors in the field now plead for a careful use of the term “reward”.



## 2.2. Neurobiology of motivated behaviors

### 2.2.1. *Anatomical considerations*

As outlined in the previous section, motivation involves a complex set of behaviors and thus, a wide array of neurobiological processes. Herein, I will focus the discussion on one crucial neurobiological substrate of motivated behaviors, namely the mesocorticolimbic dopaminergic system.

Classically, the mesocorticolimbic dopaminergic system refers to A10 cells originating in midbrain VTA (Hillarp et al., 1966) and projecting to (i) the ventral striatum, especially the NAc, and to (ii) cortical structures, especially the PFC. Besides these major projections, VTA dopaminergic cells also send important projections to the amygdala, the ventral pallidum (VP) and hypothalamic nuclei, but also to other cortical areas such as the anterior cingulate cortex (German and Manaye, 1993; Haber and Fudge, 1997; Ikemoto, 2007; Lammel et al., 2008, 2014; Morales and Margolis, 2017). This system has been long referred to as the “reward circuit” based on several observations. Indeed, early studies using electrical self-stimulation demonstrated that the dopaminergic pathway was one of the best targets for such a self-stimulation of operant responding (Alcaro and Panksepp, 2011; Ikemoto, 2010; Phillips et al., 1975). In addition, most drugs of abuse, e.g. cocaine, amphetamine, cannabinoids, opiates, alcohol (Koob and Nestler, 1997; Koob and Volkow, 2010; Lüscher, 2015; Wise and Rompre, 1989), and nondrug rewards, e.g. food, social interaction, sex (Alcaro et al., 2007; Bariselli et al., 2018; Gunaydin et al., 2014; Melis and Argiolas, 1995; Prevost-Solie et al., 2020; Spanagel et al., 1999) evoke DA release. Furthermore, altering dopaminergic transmission through pharmacological or genetic approaches impairs the seeking of such reward (Chiara, 1999). I will discuss later in this chapter the more complex relationship between DA and reward-related processes (see below).

Dopaminergic neurons represent the majority of VTA cells (around 60-65%), followed by GABAergic neurons (25-30%) and glutamatergic neurons (5-10%; Nair-Roberts et al., 2008). Dopaminergic and GABAergic neurons are distributed throughout the VTA whereas most glutamatergic neurons are found closer to the midline (Morales and Margolis, 2017; Yamaguchi et al., 2011). Similar to dopaminergic neurons, VTA GABAergic neurons can establish local connections (Johnson and North, 1992) and also project to several brain areas, among which reward-relevant regions such as the

NAC (Bockstaele and Pickel, 1995) and PFC (Carr and Sesack, 2000). More recently, similar observations were reported for VTA glutamatergic neurons that can impinge locally onto dopaminergic- and GABAergic neurons within VTA (Dobi et al., 2010; Yamaguchi et al., 2011) but can also project extrinsically (Yamaguchi et al., 2011). The canonical identification of dopaminergic neurons relies on tyrosine hydroxylase (TH) expression, the rate-limiting enzyme of DA synthesis (Morales and Margolis, 2017). GABAergic neurons are mostly identified by glutamate decarboxylase 1 or 2 (GAD1/GAD2 also known as GAD67/GAD65 respectively), that synthesize GABA, and by vesicular GABA transporter (VGAT) packing the neurotransmitter into vesicles (Margolis et al., 2012; Morales and Margolis, 2017), whereas glutamatergic neurons are mostly identified by the vesicular glutamate transporter 2 (VGLUT-2; Morales and Margolis, 2017; Yamaguchi et al., 2007). However, the discrimination of VTA neuronal populations is far more complex, and the characterization of their molecular identities and hence behavioral functions only begins to be revealed (Morales and Margolis, 2017). Indeed, most TH-expressing neurons also express the proteins necessary for dopaminergic transmission such as the vesicular monoamine transporter 2 (VMAT2), DA transporter (DAT) and the D2R. However, some TH-positive neurons, especially in the VTA midline, lack expression for these proteins in rat (Li et al., 2013) and mouse (Lammel et al., 2008; Stamatakis et al., 2013), thus questioning their ability to use DA as a neurotransmitter. Pharmacological and electrophysiological heterogeneities are also observed among VTA GABAergic neurons with a fraction displaying similar electrophysiological features as compared to TH-positive neurons, i.e. hyperpolarization-activated cation current  $I_h$ , long duration action potential and slow spontaneous firing rates (Margolis et al., 2012; Ungless and Grace, 2012). Furthermore, only a fraction responds to the opioid receptor agonist DAMGO whereas none of them are sensitive to GABA<sub>B</sub> challenge (Margolis et al., 2012). In addition to this heterogeneity, several types of combinatorial neurons were described within the VTA, co-expressing DA and GABA (Stamatakis et al., 2013), DA and glutamate (Yamaguchi et al., 2015) or GABA and glutamate (Root et al., 2014). Although representing a tiny percentage of VTA neurons, these combinatorial neurons also bear heterogeneity. For example, some DA/GABA or DA/glutamate neurons do not express VMAT2 and DAT, which are necessary for dopaminergic neurotransmission (Morales and Margolis, 2017). The consideration of molecular and anatomical heterogeneity of VTA neuronal populations is not trivial since a plethora of studies investigating the

involvement of VTA neurons in reward-related processes are based on loxP-cre recombinase genetic approaches. As an example, the effects observed after modulation of TH-positive neurons in TH-cre animals can be interpreted as being accounted for by alterations in dopaminergic transmission whereas some TH-positive neurons might not express the required machinery to store and release DA (see above). Another illustration was provided by a recent study from Morales' group in which they demonstrate that VTA glutamate-expressing only neurons (VTA-Glu), GABA-expressing only neurons (VTA-GABA) and dual glutamate-GABA-expressing neurons (VTA-Glu/GABA) have a unique signaling pattern: VTA-Glu neurons are activated by reward-predicting cues whilst VTA-GABA neurons signal the cues that are predictive of reward omission and, surprisingly, VTA-Glu/GABA neurons are not activated by learned cues, but react to positive or negative outcomes even though they express the same markers than the other two populations (Root et al., 2020).

### 2.2.2. *Is dopamine crucial?*

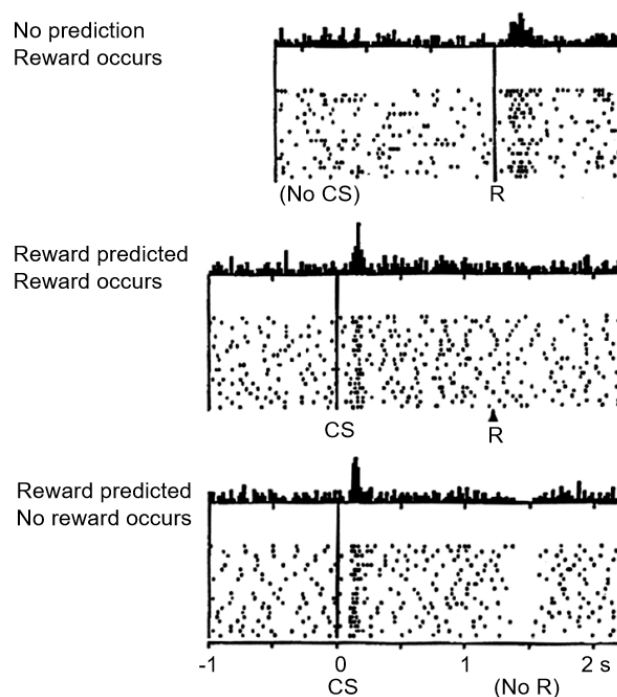
The mesocorticolimbic dopaminergic system is of crucial importance for reward-related and motivated behaviors. However, as previously mentioned, such behaviors involve separated processes. In this section, I will discuss the involvement of dopaminergic systems in several dimensions of motivated behaviors.

#### ***Dopamine & Reward Prediction Errors (RPE)***

The majority of VTA and SN dopaminergic neurons present a characteristic pattern of activity comprising (i) a slow “tonic” firing rate (2-10 Hz) which can contain (ii) bursts described as a series of 2-10 spikes decreasing in amplitude, referred to as “phasic” activity (Grace, 1991; Ungless and Grace, 2012). Interestingly, *in vivo* recordings of these neurons revealed that phasic activation was observed after encountering unexpected rewarding stimuli (e.g. food, liquids directly to the mouth) and at presentation of reward-predictive cues after pavlovian conditioning without discrimination regarding the type of stimulus (Schultz et al., 1993). Moreover, dopaminergic neurons discriminate between reward and non-reward objects (Schultz and Romo, 1990), suggesting that phasic activation is sensitive to the stimulus salience. However, pioneering works on learning theory and on midbrain dopaminergic

physiology grounded the discovery that phasic activation of dopaminergic neurons encodes reward-prediction errors (RPEs; Berke, 2018; Schultz, 2016; Schultz et al., 1997).

In an initial experiment where monkeys learned that pressing a lever associated with a visual cue led to fruit juice presentation, DA neurons displayed a phasic increase in their activity when the reward was encountered (Schultz et al., 1993, 1997). However, after training (several cue-reward pairings), this phasic activity was not observed anymore at reward delivery but was rather shifted to the cue which predicted reward delivery (Figure 5). As conceptually proposed (see above section), this observation fits with the idea that conditioning transfers motivational properties from the US to the CS as pairings go on. Interestingly, this phasic activity bears also quantitative meanings. Schultz et al. observed that not only did dopaminergic firing signals expectation of reward delivery, but also that firing updated this expectation either positively, through an increased firing when the reward was larger than expected, or negatively, when the reward was not present anymore at the expected delivery time (Figure 5). These experiments thus indicated that dopaminergic neurons encode the so-called RPE (Schultz, 1998, 2016; Schultz et al., 1997).



**Figure 5 - Dopaminergic neurons encode reward prediction error (RPE)** – (Top) Positive RPE: unexpected reward encounter induces phasic activation of dopaminergic neurons at reward delivery. (Middle) No RPE: reward predicted from a conditioned stimulus (CS) does not elicit phasic activation at

*reward delivery, but rather at the time of the CS. (Bottom) Negative RPE: reward omission engenders a pause in dopaminergic firing activity at the predicted reward delivery time, reflecting a difference between the prediction and the outcome (adapted from Schultz et al., 1997). R: reward.*

Such a mechanism has been characterized in monkeys (Bayer and Glimcher, 2005; Schultz et al., 1997), in rodents (Cohen et al., 2012) as well as in humans (D'Ardenne et al., 2008). Optogenetic tagging experiments confirmed that TH-positive VTA-DA neurons provided a major neural substrate for such RPEs during conditioning (Cohen et al., 2012). However, these might not be the unique substrates for RPEs as GABAergic neurons also encode reward expectancy (see below).

In conclusion, dopaminergic neuronal activity encodes and updates information about rewarding stimuli in the environment, doing so through RPEs. By signaling the discrepancy between expected/predicted events and actual outcomes, dopaminergic neurons are of crucial importance for reinforcement learning.

### ***Dopamine & activational aspects of motivated behaviors***

Experiments suggest the involvement of the neurotransmitter DA in the “wanting” part of motivated behavior, represented by actions performed by the animal to access the targeted reinforcer. However, a set of experiments (Salamone, 1986; Salamone et al., 1991, 1994a, 1994b) demonstrates that this phase of motivated behavior can be subdivided into separated but interacting entities such as the directional and activational dimensions of “wanting”, as indicated above. Several experimental evidences demonstrate that DA, especially in the NAc, is of crucial importance for the activational dimension of the “wanting” process.

Studies giving the animal a choice between a large/preferred reinforcer (i.e. palatable food or a high amount of food) and a small/least preferred reinforcer (i.e. normal chow or a small amount of food) helped to decipher the involvement of dopaminergic neurotransmission in the activational dimension of motivated behavior. Salamone and colleagues used such a procedure by means of a concurrent choice between palatable food obtained through lever pressing under a fixed ratio (FR) 5 schedule of reinforcement (wherein 5 lever-presses are required to access one reinforcer) and freely available standard lab chow. Rats submitted to this procedure and treated

systemically with DA receptor antagonists, such as SCH-23390 (D1R antagonist) and haloperidol (D2R antagonist), decreased lever pressing for palatable food whilst increasing their free chow consumption (Correa et al., 2002; Salamone et al., 1991, 2002), doing so without changing the natural preference of the animal for the former. Such a phenotype could not be explained by an alteration of the primary motivation for the reinforcer as devaluation, by means of pre-feeding (Randall et al., 2012; Salamone et al., 1991) or appetite-suppressant drugs such as fenfluramine (Salamone et al., 2002) or the CB1 receptor antagonist rimonabant (Randall et al., 2012; Sink et al., 2008), decreased both lever-pressing for palatable food and free chow consumption. Interestingly, the phenotype observed after systemic treatment with DA receptor antagonists was also observed after microinjection of haloperidol into the NAc (Salamone et al., 1991). Moreover, DA release in this nucleus, as assessed by microdialysis, increased when animal lever pressed at high rate but not when they consumed free laboratory chow (Salamone et al., 1994b).

T-maze experiments strengthened this hypothesis that DA is involved in the will to allocate efforts for a preferred reward. The T-maze is made of three arms, (i) one arm containing the large/preferred reinforcer (i.e. high amount of food or palatable food) and being obstructed by a physical barrier that the animal has to climb, (ii) a second arm which contains a small/least preferred reinforcer (i.e small amount of food or normal chow) freely accessible, and (iii) the last being the starting arm. Systemic pretreatment with D1R or D2R antagonists or NAc DA depletion (using local microinjection of 6-hydroxydopamine; 6-OH-DA) biased the animal choice as it chooses the least effortful option whilst leaving intact the initial preference for the highly reinforced arm (Bardgett et al., 2009; Salamone et al., 1994a).

In conclusion, DA transmission in the NAc regulates the effort allocation for a given reinforcer without altering the primary motivation for it. It thus regulates the activational dimension of motivated behavior but not its hedonic value (see below).

### ***Dopamine & hedonic reactions or “liking”***

Even though DA is often referred to as the neurotransmitter of pleasure, the hedonic dimension of motivated behavior is one of the least DA-dependent processes. We refer here to hedonic properties of a reward as the conscious pleasure evoked through its

“consumption” (“liking”). The dopaminergic system was initially viewed as a neuronal substrate for pleasure, as illustrated by the “dopamine anhedonia hypothesis” (Wise, 1982). However, dopaminergic systems turn out to be neither necessary nor sufficient for the hedonic impact of rewards (Berridge and Robinson, 2003). A first intuitive hint for this indication comes from RPE signals encoded by dopaminergic neurons: indeed, these neurons stop firing at reward delivery when it is fully expected although their consumption remains pleasurable. Moreover, human patients treated with DA receptor antagonists do not evoke any alteration in their self-reported “liking” feelings for either methamphetamine (Wachtel et al., 2002b) or cigarettes (Brauer et al., 2001).

Pleasure and hedonic reactions are considered as subjective experiences, difficult to scientifically assess through other means than self-reports. However, the description of well-conserved hedonic reactions which are easily observable and objective in human infants and several animal species rendered pleasure investigations accessible to scientists (Steiner, 1973). Indeed, near complete lesions of dopaminergic neurons through 6-OHDA, which rendered the animals amotivational and drastically aphagic, surprisingly failed to affect “liking” reactions to food (Berridge and Robinson, 1998). Moreover, systemic or intra-accumbal administration of DA receptor blockers did not alter “liking” for rewards (e.g. sucrose or ethanol: Kaczmarek and Kiefer, 2000; Peciña et al., 1997). In addition, activation or potentiation of DA transmission through either intra-accumbal injection of amphetamine (Wyvell and Berridge, 2000) or the genetic deletion of DAT (thus rendering animals “hyperdopaminergic”, Peciña et al., 2003) increased motivation to work for the rewards (“wanting”) but failed to alter “liking” for these rewards.

Finally, “liking” reactions were found to be altered when specific locations, called hedonic hotspots, were manipulated. These hotspots were observed in the NAc shell (Peciña and Berridge, 2005) and the VP (Smith and Berridge, 2005), these alterations in “liking” being both brain region- and neurotransmitter-dependent. Indeed, microinjection of either the  $\mu$ -opioid receptor (MOR) agonist DAMGO (Peciña and Berridge, 2005) or AEA (Mahler et al., 2007) into these hotspots drastically increased taste “liking” reactions for sucrose whereas the same injection next to the hotspots failed to alter hedonic reactions. It remains to be determined whether these observations hold true for other rewarding stimuli.

In conclusion, even though DA was initially labelled as the "pleasure" neurotransmitter, the hedonic properties of reward, and hence its "liking" dimension, are not encoded by the dopaminergic system although it involves one of its major target regions, namely the NAc.

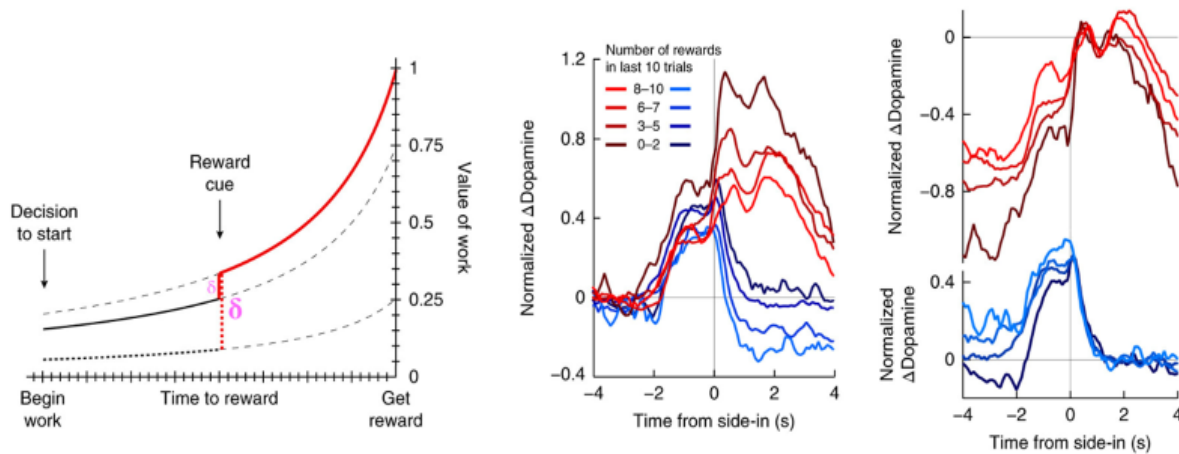
### ***Reconciling learning and activational properties of dopamine?***

Activity of DA neurons in the VTA conveys, through RPEs, learning signals whilst dopaminergic transmission in the NAc core bears activational properties. These findings question how the seemingly same circuit/transmitter can influence both present (activational) and future (learning) behaviors?

The answer to this question has been proposed to rely on different time scales, with the tonic (slow) activity of VTA dopaminergic neurons conveying motivational signals whilst their phasic (fast) activity (either bursts or pauses) is translated into a learning signal updating expectations (Schultz, 2007). Recent studies help to go a step further regarding this issue. By combining a decision-making paradigm with (i) real-time recording of the activity of VTA dopaminergic neurons and (ii) measurement of extracellular DA concentrations at target sites by microdialysis or fast-scan cyclic voltammetry (FSCV), Berke's group demonstrated that NAc core DA concentrations encode the value of working for a reward. This encoding was independent from the firing activity of VTA dopaminergic neurons, the latter being rather involved in RPEs (Hamid et al., 2015; Mohebi et al., 2019).

Several researchers described DA ramps as the animal gets closer to the reward (either in time or space; Hamid et al., 2015; Howe et al., 2013; Roitman et al., 2004; Wassum et al., 2012) suggesting that it could reflect animals' motivation for the reward. By using a decision-making paradigm requiring a series of actions from the animal to get (or not) rewarded (the experimenter varying the probability of delivery), Hamid and colleagues demonstrated that DA concentration ([DA]) in the NAc core correlated with the level of the working engagement for the reward (Figure 6), i.e. the moment-by-moment level of reward expectation (Hamid et al., 2015).





**Figure 6 - DA concentration in the nucleus accumbens core reflects the value of working for a reward.** (Left) When an animal works for a high-probability reward delivery (e.g., 75% chance to be rewarded: 0.75 trajectory), the value of work increased as the animal gets closer to the reward, and stimuli indicating the certainty of the delivery (value of work = 1) induce only a small change ( $\delta$ ) in work value. In contrast, if the reward delivery has a low probability of occurrence (e.g., 75% chance to be rewarded: 0.75 trajectory), reward-predictive stimuli induce a massive increase in the value of working for it. Therefore,  $\delta$  represents RPE, whereas the theoretical lines indicate the moment-by-moment reward expectation. (Middle) DA concentrations in NAc core normalized to baseline. Reward expectations (represented by the number of reward deliveries in the last 10 trials) influence the DA surge at the reward-predictive cue. (Right) However, consecutive fast-scan cyclic voltammetry measures revealed that rather than modulating peak values, reward expectations altered baseline DA concentration as seen after normalization to the peak value. (Adapted from Berke, 2018)

Indeed, baseline [DA] is higher if reward expectation is almost certain (e.g. 90% of the previous trials rewarded) than if the reward delivery is highly unlikely. Interestingly, fast DA fluctuations are consistent with RPE, as with high reward expectation reward delivery induces a fast surge in DA that is quantitatively lower than if the expectation is very low (Figure 6). However, the reward expectation, and thus baseline NAc core [DA], does not correlate with the tonic activity of DA neurons whilst their phasic activity does correlate with fast DA fluctuations (Mohebi et al., 2019). This suggests a dissociation between neuronal firing activity and DA release, consistent with several reports of local modulation of NAc DA release (Cachope et al., 2012; Threlfell et al., 2012; see below).

### 2.2.3. *Other cellular types in VTA & motivated behaviors*

As previously mentioned, in addition to dopaminergic neurons, the VTA is also composed of non-dopaminergic cells, mainly GABAergic (30-35% of cells) and glutamatergic (5-10% of cells) neurons (Margolis et al., 2012; Nair-Roberts et al., 2008; Yamaguchi et al., 2011).

VTA GABAergic terminals can arise from local interneurons or from long-range projection neurons (Bariselli et al., 2016; Morales and Margolis, 2017; Soden et al., 2020). Interestingly, several drugs of abuse are documented to negatively interact with these neurons, including cannabinoids (Friend et al., 2017; Szabo et al., 2002), cocaine (Bocklisch et al., 2013) and benzodiazepines (Tan et al., 2010), hence disinhibiting VTA dopaminergic neurons. It is thought that such a disinhibition contributes to their reinforcing properties (Lüscher and Malenka, 2011). Besides, VTA GABAergic neurons are intrinsically involved in RPEs. Indeed, after several pairings between a liquid reward and its predictive cue, optogenetically tagged VGAT-positive VTA GABAergic neurons displayed a sustained increase in their firing activity between the predictive cue and reward delivery (Cohen et al., 2012). These are thought to code an expectation of reward magnitude, but which differs from that promoted by RPE-coding VTA-DA neurons by their insensitivity to reward delivery or omission (Cohen et al., 2012). Optogenetic activation of local VTA GABAergic neurons during the US presentation disrupted the consumption of a liquid reward, doing so by inhibiting VTA dopaminergic neurons (van Zessen et al., 2012; Wakabayashi et al., 2019), but not when this activation occurred during CS presentation. The involvement of VTA GABAergic neurons is however not restricted to positive experiences. Indeed, these neurons were also activated by unconditioned aversive stimuli, such as air puffs (Cohen et al., 2012). Moreover, their stimulation by optogenetic means inhibited the firing activity of DA neurons upon which they synapse, thereby triggering conditioned place aversion (Tan et al., 2012). In addition, VTA GABAergic neurons projecting onto NAc cholinergic interneurons (CINs) are thought to be involved in associative learning. Thus, optogenetic stimulation of these GABAergic neurons induced brief pauses of CINs and improved the learning of the stimulus-outcome in an aversive conditioning paradigm (Brown et al., 2012). A recent study confirmed the involvement of CINs in motivational cue processing as their activation led to a decreased pavlovian-to-instrumental transfer whilst their inhibition increased it (Collins et al., 2019). Altogether,

the above observations raise the hypothesis that the VTA GABAergic projecting neurons modulating the activity of CINs play a role in the above-mentioned dissociation between the motivational and the learning roles of DA (Berke, 2018). Finally, bed nucleus of the stria terminalis (BNST) inputs onto VTA GABAergic neurons can also modulate conditioning. Indeed, activation of BNST glutamatergic inputs onto VTA GABAergic neurons induces CPA and anxiety-like behavior, whilst activation of BNST GABAergic inputs induces conditioned place preference (CPP) and promotes anxiolysis (Jennings et al., 2013). Considered altogether, these findings underline the crucial role of VTA non-DA neurons, suggesting a close collaboration of these different cell-types in motivated behaviors.

### 3. CB1 receptors & reward processing

The mesocorticolimbic DA system is thus a crucial neural substrate for reward processing and motivation. Given its prime importance in animals' survival, this system is highly regulated through a plethora of neurobiological mechanisms. By its "on demand" neuromodulatory role, the endocannabinoid system can finely tune DA transmission, doing so at several levels in a crucial way for reward processing and motivation.

#### 3.1. CB1 receptors & VTA dopaminergic neurons

A prerequisite for the involvement of CB1 receptors in reward processing and motivation lies in their presence in reward-regulating brain regions, especially the VTA. Ultrastructural observations provided evidence for the presence of both the 2-AG synthesizing enzyme, DGL $\alpha$ , and CB1 receptors in the VTA (Mátyás et al., 2008). Interestingly, the precise location of both components fits with an endocannabinoidergic neuromodulation of dopaminergic afferences, with DGL $\alpha$  being expressed on the dendritic membrane of DA neurons, facing CB1 receptor-expressing GABAergic and glutamatergic afferences onto these VTA dopaminergic neurons. Electrophysiological evidences strengthen this hypothesis. Indeed, when dopaminergic neurons activity was increased *in vitro* through application of apamine

(a blocker of calcium-sensitive potassium channels), the CB1 receptor antagonist AM251 increased both GABA<sub>B</sub> receptor-mediated IPSCs and AMPA receptor-mediated EPSCs (Riegel and Lupica, 2004), hence demonstrating an endocannabinoid release onto these GABAergic and glutamatergic presynaptic neurons. Moreover, it has been shown that GABA<sub>B</sub> receptor-mediated currents were related to extrinsic GABAergic afferences whilst GABA<sub>A</sub> receptor-mediated currents were observed in synapses with local interneurons (Edwards et al., 2017; Johnson and North, 1992; Riegel and Lupica, 2004). In line with this discrimination, past studies demonstrated that CB1 receptor agonists increased the activity of VTA dopaminergic neurons (Cheer et al., 2000) whilst decreasing their GABA<sub>A</sub> receptor-mediated IPSCs (Szabo et al., 2002). These effects were prevented by CB1 receptor antagonists and GABA<sub>A</sub> receptor agonists (Cheer et al., 2000; Szabo et al., 2002) suggesting that in addition to extrinsic GABAergic afferences, CB1 receptors could exert a neuromodulatory impact on VTA dopaminergic neurons through intrinsic GABAergic interneurons. As indicated above, endocannabinoids also modulate the activity of glutamatergic afferences onto VTA dopaminergic neurons. Indeed, short-term endocannabinoid plasticity at these glutamatergic afferences, namely DSE (see above), has been observed *in vitro* (Melis et al., 2004b, 2004a). In addition, the activation of VTA dopaminergic neurons which resulted from the stimulation of prefrontocortical glutamatergic afferences was found to be respectively amplified and diminished by CB1 receptor antagonists and agonists *in vivo* (Melis et al., 2004a).

Taken together, these observations demonstrate the involvement of the endocannabinoid system in the modulation of the activity of VTA dopaminergic neurons, doing so through extrinsic (Riegel and Lupica, 2004) and intrinsic (Cheer et al., 2000; Szabo et al., 2002) GABAergic afferences on the one hand, and glutamatergic afferences on the other hand (Melis et al., 2004b, 2004a).

However, given their ability to modulate both inhibitory and excitatory afferences to VTA dopaminergic neurons, it is conceivable that the net effect of the stimulation of CB1 receptors would be null if endocannabinoids released from VTA dopaminergic neurons reach indistinctively these CB1 receptor-expressing GABAergic and glutamatergic presynapses. Even though an apamine-mediated increase in the activity of the latter neurons suggested an endocannabinoid release onto CB1 receptors located on both inhibitory and excitatory afferences (Riegel and Lupica, 2004) this

situation is hardly conceivable under physiological conditions. Interestingly, systemic administration of CB1 receptor agonists, such as THC or WIN55,212-2, increased the firing rate of VTA dopaminergic neurons, doing so through increases in the percentage of action potentials contained in bursts (French, 1997; Gessa et al., 1998; Wu and French, 2000). This effect, which was blocked by rimonabant (French, 1997; Gessa et al., 1998), thus indicates that CB1 receptor agonists acted solely on GABAergic afferences (Lupica and Riegel, 2005). Indeed, *in vitro* studies further suggested a tonic positive control of VTA dopaminergic activity through these GABAergic afferences. Accordingly, CB1 receptor antagonists increased GABA receptor-mediated IPSCs (Buczynski et al., 2016; Wang et al., 2015), although contrasting results were also reported (Cheer et al., 2003; Gessa et al., 1998; Riegel and Lupica, 2004). Strikingly, this effect was prevented by pretreatment with tetrahydrolipstatin, a DGL $\alpha$  inhibitor, but increased by JZL184, a MGL inhibitor which increases extracellular levels of 2-AG (see above) (Wang et al., 2015).

As previously mentioned, endocannabinoid synthesis can arise from depolarization-induced increases in intracellular calcium, but also from activation of G $_q$  protein-associated receptors (e.g. mGluR1/5 receptors), hence converging into an activation of PLC $\beta$  and, thus, production of 2-AG. Interestingly, several groups reported a CB1 receptor-mediated control of the activity of VTA dopaminergic neurons consecutive to the stimulation of these G $_q$  protein-associated receptors. Indeed, the stimulation of  $\alpha$ -1 adrenergic receptors (Wang et al., 2015), mGluR1/5 receptors (Pan et al., 2008), or orexinergic OX1 receptors (Tung et al., 2016) all increased VTA dopaminergic activity by (i) prior production of 2-AG from dopaminergic neurons, leading to (ii) a CB1 receptor-mediated decrease in the activity of GABAergic inputs onto these neurons. Conversely, a decrease in the EPSCs recorded in dopaminergic neurons could be observed after stimulation of NTS1 neurotensin receptors, this observation resulting from a 2-AG-mediated stimulation of CB1 receptors on excitatory inputs to dopaminergic neurons (Kortleven et al., 2012).

In summary, CB1 receptor activation is well suited to finely tune the activity of the mesocorticolimbic dopaminergic pathway. The above data suggest that their depolarization and/or the stimulation of G $_q$  protein-associated receptors on their membranes does not induce a wide and blind production and release of endocannabinoids. Rather, it seems that such a release is targeted to modulate a

specific type of afference. The observation that DGL $\alpha$  is expressed following a “punctate pattern” at the vicinity of afferences (Mátyás et al., 2008) strengthens such a hypothesis.

### 3.2. CB1 receptors & dopamine release

The endocannabinoid system, and specifically CB1 receptors, also regulate the release of DA in its target areas. This is especially true in the NAc.

Stimulating CB1 receptors through the systemic administration of THC (Chen et al., 1991), WIN55,212-2 (Cheer et al., 2004; Sperlágh et al., 2009) or AEA (Solinas et al., 2006) increases NAc DA release. This effect is potentiated by an inhibitor of FAAH (URB597), and blocked by rimonabant, hence demonstrating the specific involvement of CB1 receptors. In contrast, blocking CB1 receptors using antagonists does not alter *per se* DA release, suggesting a lack of tonic endocannabinoid release under control conditions (Cheer et al., 2004, 2007). Although tightly linked to dopaminergic activity, the release of DA within target areas, and especially the NAc, is also locally controlled by CB1 receptors. In the striatum, CB1 receptors are expressed following a dorsolateral-ventromedial gradient, the highest expression being in the dorsal regions whereas the NAc expresses only few CB1 receptors (Herkenham et al., 1990; Hohmann and Herkenham, 2000). However, these receptors bear a profound influence on local DA release, and hence motivated behaviors. Interestingly, CB1 receptors are not expressed by dopaminergic neurons (Matsuda et al., 1993; Mátyás et al., 2008) ruling out any direct influence of cannabinoids on dopaminergic terminals, further confirmed by the absence of effect of cannabinoid agonists or antagonists on DA release evoked by a single electrical pulse (Sidló et al., 2008; Szabo et al., 1999). As indicated above, although representing a small proportion of striatal neurons, another important reward-related neuronal population within the NAc is the CINs whose activity increases the release of DA independently from VTA dopaminergic neuronal firing tone (Cachope et al., 2012; Threlfell et al., 2012). This recently discovered mechanism is of crucial importance for motivated behaviors as the pattern of burst-and-pauses displayed by CINs coincides with dopaminergic activity during salient cue presentation (Cragg, 2006). Although Ach release from CINs favors the endocannabinoid production by the MSNs (Narushima et al., 2007), CINs are devoid of CB1 receptors

(Hohmann and Herkenham, 2000; Mateo et al., 2017). In contrast, CB1 receptors were observed on both GABAergic (interneurons, mostly fast-spiking parvalbumin-positive interneurons, and MSNs, displaying collaterals impinging onto NAc neurons) and glutamatergic terminals within the NAc (Uchigashima et al., 2007) even though at differential level, i.e. highly expressed in the former but not in the latter. Interestingly, cannabinoid agonists decrease CIN-induced DA release through stimulation of CB1 receptors located on cortical glutamatergic terminals in the NAc (Mateo et al., 2017). Importantly, MSNs were found to express the machinery necessary for endocannabinoid synthesis, allowing local endocannabinoid signalization (Uchigashima et al., 2007). However, the exact locus of the CB1 receptor-mediated control of DA release has been proven difficult to assess. Indeed, it was observed that electrically evoked DA concentrations in the NAc were decreased by the administration of CB1 receptor agonists (Cheer et al., 2004; Sidló et al., 2008). The mechanism involves (i) a decreased GABA<sub>A</sub>-related inhibition, (ii) the increase in production of the diffusible messenger H<sub>2</sub>O<sub>2</sub> that in turn (iii) triggers the opening of ATP-sensitive potassium channels leading to (iv) a decreased release of DA (Sidló et al., 2008). Altogether, these observations indicate that CB1 receptor activity could be involved in the integration of motivationally-relevant information and action selection by participating in the regulation of the afferent messengers impinging onto NAc.

Modulation of CB1 receptors also alters DA release in response to several drug and nondrug rewards. Indeed, CB1 receptor antagonists decrease cocaine-induced DA transients within the NAc (Cheer et al., 2007), and this holds also true for nicotine (Cheer et al., 2007; Cohen et al., 2002), ethanol (Cheer et al., 2007; Cohen et al., 2002; Hungund et al., 2003) and amphetamine (Kleijn et al., 2012). These pharmacological findings were confirmed using CB1-KO animals, whether ethanol (Hungund et al., 2003), cocaine (Li et al., 2008), or morphine (Mascia et al., 1999) are concerned. Nondrug rewards such as palatable food have been shown to elicit DA release within the NAc in a CB1 receptor-dependent manner (Melis et al., 2007). Thus, despite the variety of mechanisms through which drug and nondrug rewards promote DA release, CB1 receptor blockade proved efficient at modulating such a release, hence providing an illustration of the neuromodulatory role of the ECS on terminal dopaminergic transmission.

### 3.3. CB1 receptors & motivated behavior

In the previous sections, I described several mechanisms through which CB1 receptors regulate dopaminergic transmission. This description raises the issue of the net impact on motivated behaviors of CB1 receptor stimulation on the one hand, and CB1 receptor blockade/deletion on the other hand. However, such considerations cannot account for the net behavioral outcome induced by modulation of CB1 receptors under physiological conditions, or through pharmacological or genetic manipulations on one hand, and the involvement of CB1 receptors in the effects of drug of abuse.

Intracranial self-stimulation (ICSS) experiments have been extensively used to investigate the neurobiological underpinnings of reward-related processes and of the reinforcing properties of drugs of abuse (Carlezon and Chartoff, 2007). Animals voluntarily and repeatedly self-stimulate through an electrode located in key brain areas exerting a stimulatory control of the mesocorticolimbic pathway. THC displays a biphasic effect with low doses decreasing ICSS thresholds, demonstrating an increased rewarding efficacy of the electrical stimuli, whereas higher doses increase this threshold, both effects being antagonized by rimonabant (Katsidoni et al., 2013; Vlachou et al., 2007). This is consistent with the ability of THC to be self-administered, especially when locally administered within the VTA or the NAc, this ability being prevented by either rimonabant or the genetic deletion of CB1 receptors (Justinova et al., 2003; Ledent et al., 1999; Zangen et al., 2006). Confirmingly, a similar biphasic effect of THC can be observed in conditioned place experiments, low and high doses promoting respectively CPP and CPA, both being blocked by rimonabant although the latter is devoid of intrinsic effect (Braida et al., 2004; Chaperon et al., 1998; Valjent and Maldonado, 2000). Recent findings suggest that the aversive effect of cannabinoids could be due to the stimulation of CB1 receptors located on VTA VGLUT-2-expressing glutamatergic neurons (Han et al., 2017).

In addition to their role in mediating cannabinoid rewarding effects, CB1 receptors modulate the reinforcing properties of several drugs of abuse (Parsons and Hurd, 2015). This is true for opiates. Thus, CB1 receptors and opiate (especially  $\mu$ ) receptors are closely interacting with consequences on reward-related processes (Solinas and Goldberg, 2005). Indeed, CB1 receptor antagonists block heroin and morphine self-administrations (Caillé and Parsons, 2003, 2006; Navarro et al., 2001). Furthermore, CB1-KO mice display decreased morphine self-administration (Ledent et al., 1999),



lack of CPP for morphine (Martin et al., 2000) and do not show morphine-induced NAc DA release (Mascia et al., 1999). In a similar way, alterations in CB1 receptor activity affect the reinforcing properties of ethanol. Indeed, antagonism of these receptors decreases ethanol consumption (Arnone et al., 1997), blunts the preference over water in a two-bottle test (Thanos et al., 2005) and decreases self-administration when rimonabant is injected systemically (Economidou et al., 2006; Freedland et al., 2001) or infused in the NAc or the VTA (Alvarez-Jaimes et al., 2009; Caillé et al., 2007). In confirmation, CB1-KO animals do not express CPP for ethanol (Thanos et al., 2005). Although eliciting different behavioral effects from those elicited by opiates or ethanol, the reinforcing properties of psychostimulants, such as cocaine, are also sensitive to manipulations of CB1 receptor activity. Blockade or genetic deletion of CB1 receptors decreased cocaine self-administration, but only when reinforcement schedules are high, such as during a progressive ratio (PR; Soria et al., 2005; Vries et al., 2001; Xi et al., 2008). The use of conditional CB1 receptor mutants (identical to those used in this Thesis; see “Results”) revealed that CB1 receptors located on forebrain GABAergic neurons control the sensitivity to cocaine whereas those located on cortical glutamatergic neurons control the learning processes involved in cocaine seeking (Martín-García et al., 2016). Surprisingly, the CB1 receptor agonist WIN55,212-2 also decreases cocaine self-administration (Fattore et al., 1999) whilst CB1-KO animals display no alteration in cocaine-induced CPP (Martin et al., 2000; Tung et al., 2016) indicating that the relationship between CB1 receptors and cocaine reinforcing properties are more complex than initially thought. As compared to the above-mentioned drugs, the relationship between CB1 receptors and nicotine reinforcement has been less characterized. Antagonism of CB1 receptors, especially those located in the VTA, decreases nicotine self-administration (Cohen et al., 2002; Simonnet et al., 2013) whilst, surprisingly, no alteration in nicotine self-administration is observed in CB1-KO animals (Cossu et al., 2001). Similarly, CB1 receptor blockade in the VTA decreases CPP for nicotine (Azizi et al., 2018) but no phenotype is observed in the same behavioral task when CB1-KO animals are tested (Castañé et al., 2002). Finally, modulation of CB1 receptors impacts the reinstatement of drug-seeking after a period of extinction, an animal model of relapse (Shaham et al., 2003). Indeed, CB1 receptor agonists reinstate THC- (Justinova et al., 2008), heroin- (Vries et al., 2003), ethanol- (López-Moreno et al., 2004), cocaine- (Vries et al., 2001) and nicotine-seeking (Gamaledin et al., 2012). On the other hand, CB1 receptor blockade decreases cue-

and drug-induced reinstatement for such drugs (Economidou et al., 2006; Gamaledin et al., 2012; Justinova et al., 2008; Vries et al., 2001, 2003).

Besides drugs of abuse, examination of the interactions between CB1 receptors and natural rewards have greatly helped to document the role of the endocannabinoid system in reward processes (Fattore et al., 2010; Solinas et al., 2008). This is especially true for food intake, whether examined at the consummatory level or at the motivation level. Cannabis has been described for centuries as exerting an orexigenic effects in human (Abel, 1975), an effect later attributed to THC. Indeed, administration of THC (Koch, 2001; Williams and Kirkham, 2002; Williams et al., 1998) or AEA (Jamshidi and Taylor, 2001; Soria-Gómez et al., 2007; Williams and Kirkham, 1999) in satiated animals induces a dose-dependent hyperphagia and increases the intake of sweet solutions (Gallate et al., 1999), i.e. effects which are blocked by rimonabant (Gallate and McGregor, 1999; Williams and Kirkham, 1999, 2002). Interestingly, in 24-h fasted animals, THC exerts a biphasic effect during refeeding, with (i) low doses inducing hyperphagia, whilst (ii) higher doses promote hypophagia, this differential effect of THC being mediated by different subsets of CB1 receptors located on cortical glutamatergic and NAc-D1R-expressing MSNs, respectively (Bellocchio et al., 2010). Hyperphagia elicited by THC has been then shown to be modulated by olfactory processes (Soria-Gómez et al., 2014). Moreover, CB1 receptor antagonists on their own decrease food intake in food-restricted animals (Chambers et al., 2004; McLaughlin et al., 2003, 2006). Under control conditions (*ad libitum* feeding), CB1-KO mice display a lean and hypophagic phenotype (Cota et al., 2003), indicating that, beside their role under fasting and restricted feeding conditions, CB1 receptors are also involved in homeostatic food intake.

However, as mentioned earlier, free consumption does not reflect the appetitive motivation for food. Researchers have thus investigated the involvement of CB1 receptors in food-maintained reinforcement in animals as to understand whether and how these receptors regulate motivation for food. Interestingly, THC and other CB1 receptor agonists increase operant responding for standard food or palatable food/nutritional liquid under FR schedules (Barbano et al., 2009) or PR schedules of reinforcement, an effect blocked by CB1 receptor antagonists (Solinas and Goldberg, 2005; Ward and Dykstra, 2005). As observed with the consumption under free access conditions, CB1 receptor antagonists decrease operant responding for food under FR

(Freedland et al., 2000; McLaughlin et al., 2003; Thornton-Jones et al., 2005) and PR (Solinas and Goldberg, 2005; Ward and Dykstra, 2005) reinforcement schedules. These pharmacological findings were confirmed by the use of CB1-KO mice exerting decreased operant responding for food and sweet solutions (Guegan et al., 2013; Mancino et al., 2015; Sanchis-Segura et al., 2004). Together with the ability of CB1 receptor antagonists to decrease food-induced DA release (Melis et al., 2007) without affecting the ability to feed (forepaw usage during feeding; McLaughlin et al., 2005), these last observations are consistent with a role for CB1 receptors in the appetitive motivation for food. However, the phenotype observed after injection of CB1 receptor antagonists before being tested in the aforementioned procedures where animals have the choice between lever pressing for a preferred diet or free consumption of a chow diet (*paragraph 2.2.2*; Randall et al., 2012; Sink et al., 2008) is closer to a pre-feeding impact (satiation characterized by a decrease in both lever pressing for the preferred food and in the consumption of freely accessible chow) than to an activational impact reflecting dopaminergic transmission alterations (i.e. concurrent decreases in lever pressing with increases in chow consumption). This suggests that altering CB1 receptor transmission decreases appetite rather than it disrupts the activational dimension of feeding behavior. In addition to the positive impact of CB1 receptor stimulation on food-maintained reinforcement, past studies using taste reactivity tests (aimed at evaluating the hedonic dimension of reinforcer) have demonstrated that THC increases the hedonic reactions to sucrose and decreases the aversiveness of the bitter compound quinine (Jarrett et al., 2005, 2007). Conversely, CB1 receptor antagonists blocked these effects beside promoting opposite effects on their own (Jarrett et al., 2005, 2007). Moreover, Mahler et al. (Mahler et al., 2007) described a hedonic hotspot in which injection of AEA increased drastically hedonic reactions to sucrose without altering quinine aversiveness. In conclusion, CB1 receptors control food intake through multiple mechanisms within food-relevant brain areas including modulation of food motivation through alteration of appetitive and hedonic properties of the food. Note that for the sake of clarity and due to controversies on the specificity of so-called peripheral CB1 receptor antagonists, the putative impacts of peripheral CB1 receptors on the aforementioned feeding behaviors after CB1 receptor stimulation/blockade will not be addressed in the present document.

In addition to food, social interaction is another strong nondrug reward in both humans and laboratory animals, although its underlying neurobiology appears far more complex. The reinforcing value of social interactions was shown in monkeys who were proposed two levers for either highly palatable food or social play: in half of the trials, the animals would choose social play over food, even when rendered hungry (Mason et al., 1963). This was later confirmed in laboratory rodents using discrimination tests in a T-maze (Ikemoto and Panksepp, 1992), in a three-chamber apparatus (Nadler et al., 2004) and in CPP trials (Trezza and Vanderschuren, 2009). Social reward is regulated by the mesolimbic dopaminergic system, especially through activation of VTA dopaminergic neurons projecting to the NAc (Bariselli et al., 2018; Gunaydin et al., 2014; Prevost-Solie et al., 2020). Besides DA, oxytocin and serotonin interactions within the target area (NAc) have been shown to mediate the rewarding properties of social behaviors (Dölen et al., 2013). In keeping with the data provided in the present chapter, it is not surprising that the ECS also modulates social interactions (Fattore et al., 2010). The characterization of its involvement in social interactions traces back to the 70's when investigations revealed a pro-social effect in human cannabis smokers *versus* nonsmoking individuals (Georgotas and Zeidenberg, 1979; Tart, 1970). On the other hand, THC decreases agonistic interactions in several animal species, an observation which might be accounted for by the high doses used (Miczek, 1978). Although preclinical studies repeatedly demonstrated that CB1 receptor agonists such as THC and WIN55,212 decrease social interactions and social play (Busquets-Garcia et al., 2017; Trezza and Vanderschuren, 2008a, 2008b), likely through mitochondrial-associated CB1 receptors in astrocytes (Jimenez-Blasco et al., 2020), the increase in AEA levels following the inhibition of its degrading enzyme proved effective at increasing social play, an effect blocked by rimonabant and the non-selective DA receptor antagonist flupenthixol (Trezza and Vanderschuren, 2008a, 2008b). These data thus strengthen the hypothesis of an endocannabinoid control of the reinforcing properties of social interactions. Confirmingly, mutant mice lacking the AEA degrading enzyme (FAAH-KO mice) proved more social than their controls (Cassano et al., 2011) whilst CB1-KO mice displayed decreased social interactions (Haller et al., 2004). More specifically, Wei and colleagues (Wei et al., 2015) used a CPP paradigm to better characterize the involvement of endocannabinoids in the rewarding properties of social interactions. Interestingly, social encountering and isolation were observed to respectively increase and decrease AEA mobilization within the NAc. They further

demonstrated that this AEA mobilization was driven by the "prosocial" neuropeptide oxytocin in this brain region, and that this mechanism was both necessary and sufficient for the rewarding properties of social interaction (Wei et al., 2015, 2017). Similar observations were made while investigating social play in juvenile rats: social play increases AEA mobilization in NAc and amygdala, an effect amplified by inhibiting AEA degradation in either brain region (Trezza and Vanderschuren, 2008a; Trezza et al., 2012).

Another nondrug reward has been the interest of investigations in the past decades, namely physical activity. As we will see in the next chapter, several modulators of physical activity have been described. I will show that several findings point to a major role played by the endocannabinoids in the reinforcing property of physical activity.

#### **4. Physical activity: from humans to animal models**

From physicians of ancient China and Greece to modern public health communication, exercise practice is promoted and encouraged all over the world. Several decades of investigations revealed multiple positive effects of physical activity, giving scientific ground to the roman adage "*mens sana in corpore sano*" ("a healthy mind in a healthy body"). Physical exercise bears reinforcing properties and is pleasurable, and as such, is considered a natural reward. Then, it might seem paradoxical that most of the people engaging in exercising programs to tackle overweight or obesity drop-out before reaching their therapeutic goals. At the other side of the spectrum, excessive exercise is a core feature of several psychiatric disorders, including exercise addiction and anorexia nervosa. In the latter, excessive exercise is considered a life-threatening activity because it worsens the catabolic imbalance yet promoted by food restriction. It has been recently proposed that one common feature of these excesses in exercise practice find their roots at the motivation level. However, the neurobiological underpinnings of human exercise motivation have been loosely described as these mainly rely on imaging studies, thus rendering animal models of physical activity of prime importance. As detailed below, these models have outlined the key role of the ECS, and especially CB1 receptors, in exercise motivation.

#### 4.1. Why studying physical activity?

Physical activity corresponds to “any bodily movement produced by skeletal muscles that results in energy expenditure” (Caspersen et al., 1985) whilst physical exercise adds to the latter criteria the planning of that activity and its intentional bases (e.g. health-directed, record-directed...). Physical activity/exercise is a crucial component of the energy balance, representing most of the caloric expenses in humans and animals, as opposed to caloric storage which is mainly accounted for by food intake. Nowadays, our industrialized societies are overwhelmed by tasty and energy-dense foods on the one hand – and which might have enduring consequences throughout life (Naneix et al., 2018; Tantot et al., 2017; Vendruscolo et al., 2010)-, and technological progresses (e.g. transportation, information technologies) which facilitate sedentary activities on the other hand. This leads to an imbalance which is alarming considering its burden for our societies in terms of public health and economy. Indeed, a North American longitudinal study indicated that the prevalence of obesity which increased between 1988 and 2010 was mostly explained by a deficit in physical activity rather than by an increase in caloric intake (Ladabaum et al., 2014). Around 6 % of coronary heart diseases, 7% of type-2 diabetes, 10% of breast cancers and 10% of colon cancers were estimated to be attributable to physical inactivity; furthermore, 9 % of premature deaths worldwide in 2008 were accounted for by sedentariness (Lee and Paffenbarger, 2000; Lee et al., 2012; Warburton et al., 2006). From an economic point of view, the worldwide burden was estimated around 54 billion dollars in 2013 (Ding et al., 2016). In line with these observations, decades of epidemiological research demonstrated the health benefits of exercise, whether these concerned preventions or adjunct therapy (Warburton et al., 2006).

The central effects of physical activity have been of particular interest for psychiatric therapies as epidemiological studies reported an association between exercise and a lower risk of mental disorders (Goodwin, 2003; Harvey et al., 2010; Have et al., 2011). Confirmingly, exercise was shown as beneficial as a first line treatment in mild to moderate depression forms and provided synergistic benefit when added to classical pharmacotherapies in more severe cases (Carek et al., 2011; Cooney et al., 2013; Schuch et al., 2016). Besides, acute and chronic anxiolytic properties of exercise have been recognized since the 80's (Greist et al., 1979; Martinsen, 2009; Martinsen et al., 1985), and are proposed as an efficient prevention and/or as adjunct to therapy against

anxiety disorders (Carek et al., 2011; Kandola et al., 2018; Martinsen, 2009; Zschucke et al., 2013).

Several neurobiological hypotheses intended to explain the positive central effects of physical activity through structural and functional changes (Voss et al., 2013). Exercise increases monoamine (DA, serotonin, noradrenaline) synthesis and/or release in several brain areas relevant to the modulation of mood (Chaouloff, 1989, 1997; Dunn and Dishman, 1991). However, such findings lacked experimental evidence for a causal link between these exercise-induced monoamine changes and mood modulation. Several pieces of evidence pinpoint the opioid system as acute exercise increases circulating  $\beta$ -endorphin in humans (Carr et al., 1981; Gambert et al., 1981) and both peripheral and central  $\beta$ -endorphin in rodents (Hoffmann et al., 1990).  $\beta$ -endorphins are agonists at the MOR, whose activation is crucial for the euphoric effects of opioids; and, blocking MORs decreased the mood-improving effects of physical exercise in humans in some studies (Järvekülg and Viru, 2002) whilst reported as ineffective in other (Markoff et al., 1982, but see for review Dishman and O'Connor, 2009). Despite being very well impregnated in the wide audience, the endorphinergic hypothesis of physical exercise bears however several caveats, among which the consideration that even a slight activation of MORs induces noticeable physiological effects (e.g. respiratory depression) obviously incompatible with exercise performances. More recent work focused on another candidate, namely the growth factor "brain-derived neurotrophic factor" (BDNF), which belongs to the neurotrophins family. This factor, expressed at high levels in the brain, is of crucial importance for the development and maturation of neurons, and for higher cognitive functions such as learning and memory (Lu et al., 2014). It was observed that short-term (i.e. days: Neeper et al., 1995) and long-term (i.e. months: Kobilov et al., 2011) exercise increase human circulating and rodent hippocampal BDNF in a durable manner (Ferris et al., 2007; Gold et al., 2003). Indeed, other trophic factors are also upregulated in brain by exercise, albeit to a lesser extent than BDNF: this includes the insulin-like growth factor 1 (IGF1; Carro et al., 2000) or the vascular endothelial growth factor (VEGF; Tang et al., 2010). Interestingly, peripherally blocking these trophic factors precluded the exercise-induced neurogenic effects (Fabel et al., 2003; Trejo et al., 2001). Even though the underlying mechanisms are not fully characterized, BDNF, IGF1 and VEGF

mediate part of the beneficial effects of exercise on brain health and functions through their actions on neurogenesis and plasticity (Cotman et al., 2007).

To conclude, physical activity bears multiple beneficial effects on the whole body, including the brain, and represents a crucial therapeutic tool, alone or in association, to tackle a wide range of pathological conditions. Based on these observations, exercise was integrated in therapeutic programs aimed at normalizing body weight in overweight and obese patients. However, half of the participants dropped out of the long-term program before reaching the therapeutic goals; indeed, self-reports indicated that a lack of motivation for and/or pleasure from exercise was the main reason for such a drop out (Ekkekakis et al., 2008). This observation illustrates the need to identify the mechanisms supporting exercise motivation as this is a prerequisite for the use of exercise for therapeutic aims.

#### 4.2. Physical activity as a natural reward

Physical activity is a powerful nondrug reward that can lead to euphoric states, such as the so-called “runner’s high”, i.e. a positive emotional state (“well-being”) associated with anxiolysis, analgesia and ultimately sedation often reported by endurance runners (Dietrich and McDaniel, 2004). However, the evidence for the rewarding effect of physical activity mostly relies on self-reports of feelings during or after exercising (Ekkekakis et al., 2008); whilst physical activity bears cultural positive biases, especially within industrialized countries (the fashionable need to run) which impedes an objective assessment of the rewarding impact of exercise in humans.

The rewarding properties of physical activity have thus been investigated in laboratory animals and especially in rodents. Placing an animal in a discriminative context after undergoing either an acute (Belke and Wagner, 2005; Lett et al., 2000) or a chronic (Greenwood et al., 2011) exercise induces a CPP, hence demonstrating the pleasurable dimension of exercising after-effects. However, besides measuring exercise after-effects rather than exercise actual effects, this assessment relies on a preference test which provides an indirect measurement of the reinforcing properties of physical activity. Several investigations, which rendered wheel-running contingent to a prior work (e.g. lever pressing) in operant conditioning protocols, robustly demonstrated that animals are willing to work to get access to exercise (Belke, 1997;



Collier and Hirsch, 1971; Iversen, 1993; Kagan and Berkun, 1954) even when the access consisted in noticeably short bouts of running (as short as 4-second bouts, Iversen, 1993). It might be opposed to these findings that wheel-running rather reflects boredom or stereotypical behavior of laboratory animals living in an impoverished environment (a living condition different from the one surrounding human beings). Then, animals could grant high salience to the opportunity to run as a mere artefact of the captivity conditions. However, Meijer et al. (Meijer and Robbers, 2014), by placing a running wheel equipped with a camera in a natural and open environment, demonstrated that wild mice actually perform wheel-running, their bouts of running being comparable to those of laboratory mice.

At the neurobiological level, the use of laboratory animals revealed that wheel-running affected the mesolimbic dopaminergic system (Novak et al., 2012). Indeed, an acute running session increased NAc DA release in rats (Wilson and Marsden, 1995), a key feature of rewarding stimuli (see above). Chronic wheel-running was found to increase TH mRNA in the VTA (Greenwood et al., 2011), indicating an upregulation of DA synthesis. Moreover, as opposed to novel environment exploration and forced activity, wheel-running increased the immediate early gene *c-fos*, a widely used marker of neuronal activation, doing so specifically within the NAc core (Vargas-Pérez et al., 2003). In addition, an increase in  $\Delta$ Fos-B was observed in the NAc following 4-6 weeks access to wheel-running (Greenwood et al., 2011; Werme et al., 2002). Similar observations were reported following exposure to drugs of abuse (Nestler et al., 1999) suggesting common neuronal circuits. In line with such an assumption, several studies reported a mechanism of substitution between wheel-running and drugs of abuse (Lynch et al., 2013; Novak et al., 2012; Zhou et al., 2016) as observed with other nondrug rewards such as sucrose (Ahmed, 2018; Cantin et al., 2010). Indeed, the denial of ethanol to mice chronically exposed to both wheel-running and ethanol induced an increase in running (Ozburn et al., 2008). Moreover, wheel-running was reported to decrease self-administration rates of other drugs of abuse, including cocaine (Cosgrove et al., 2002; Smith et al., 2008) and amphetamine (Kanarek et al., 1995). These observations extend to nondrug rewards such as food and sucrose. Indeed, when wheel access is granted on alternate days, standard food and sucrose intake are significantly decreased on the wheel-access day in favor of running (Mueller et al., 1997; Satvat and Eikelboom, 2006).

#### 4.3. Physical activity in eating disorders: the case of anorexia nervosa

As previously mentioned, physical activity bears beneficial effects and rewarding properties. However, excessive exercise is also observed in pathological conditions, one of which being anorexia nervosa.

##### ***A brief overview of anorexia nervosa***

Anorexia nervosa (AN) is an eating disorder representing a set of feeding behaviors with restricting and bingeing/purging subtypes (Treasure et al., 2020) and is one of the deadliest psychiatric pathologies with a mortality rate estimated at 5.1 per 1000 person-years (Arcelus et al., 2011). Although its lifetime prevalence is relatively low, AN affects 1% of women and 0.5% of men (Smink et al., 2012), with a peak incidence during adolescence at around 15 year-old (Javaras et al., 2015; Zipfel et al., 2015). Anorexic patients display an impaired drive for food intake characterized by an ego-syntonic chronic food refusal associated with an intense fear of weight gain and an altered perception of one's body, hence leading to a life-threatening weight loss (Kaye, 2008; Kaye et al., 2009; Treasure et al., 2020). This is especially true because the estimated latency between the initial trouble and the first treatment is circa 29.9 months (Treasure et al., 2020). The popular opinion that current physical standards of beauty in western societies and hence cultural pressure could account for anorexia is very unlikely given that (i) similar pathological cases were already described a century ago (Gull, 1888; Laségue, 1997) and (ii) the lifetime prevalence is low in high incomes western societies in which people are highly exposed to ideal of thinness through media (Smink et al., 2012) (iii) the latter prevalence being comparable in non-western societies (Smink et al., 2012). Even though AN etiology remains loosely defined (Clarke et al., 2017), the common risk factors are the female gender, past eating or gastrointestinal problems, childhood trauma (sexual abuse, neglect, violence) and general psychiatric morbidities such as anxiety, depression, obsessive-compulsive disorders (Jacobi et al., 2004). Given the rarity of the disorder, the investigation of heritability and the role of genetic in AN etiology is challenging. Although no specific locus was described in genome-wide association studies, the risk of developing AN is significantly higher for patient relatives, especially if from the female sex (Bulik et al., 2015; Initiative et al., 2019; Zipfel et al., 2015). Moreover, in a recent genome-wide association study in anorexic

patients, it was observed that genetic risk loci for AN were closely associated with several phenotypic variables, among which the propensity to exercise (Initiative et al., 2019).

### ***Anorexia nervosa & physical activity***

Although the prime disturbance observed in anorexic patients corresponds to food-related behavior and drastic loss of weight, excessive physical activity, which is not considered in the DSM-5 diagnostic manual, has recently been proposed to be considered as a core feature of AN (Zipfel et al., 2015). Indeed, excessive exercising is displayed by up to 80% of AN patient (Davis et al., 1997; Hebebrand et al., 2003). Longitudinal studies indicate that higher physical activity, which can be observed in individuals before the initiation of dieting and weight loss, is associated with a heavier clinical outcome (Casper and Jabine, 1996; Strober et al., 1997). Furthermore, female athletes are at higher risk of developing eating disorders, especially AN, than sedentary females (Martinsen and Sundgot-Borgen, 2013). However, a lack of consensus on the means to measure activity and thus define “excessive” activity has led to discrepancies in the literature; accordingly, some studies did report a higher level of activity in anorexic patients (e.g. Davis et al., 1997), whilst an absence of difference was observed in others (e.g. Bouten et al., 1996). Interestingly, Cook and Hausenblas (Cook and Hausenblas, 2008) showed that rather than the total activity exerted by the individuals, it is the motivation and the potential dependence upon exercise which might mediate the eating pathology. Confirmingly, the “drive” for physical activity was found to be strongly associated with the severity of the pathology (Sternheim et al., 2015). In line with such findings, a therapeutic approach of AN that displays the best positive outcome to date with 75% remission rates at 1-year and 10% relapse rates at 5-year follow-ups of 1428 patients, includes the restriction of physical activity in complement of the normalization of eating behavior pattern (Bergh et al., 2002, 2013).

Physical activity is thus a core feature of AN which often precedes alteration in feeding behavior, and which mediates the maintenance and the outcome of the pathology. Moreover, data suggest that the high physical activity reported in AN resides at the motivation level (Cook and Hausenblas, 2008; Sternheim et al., 2015). This hypothesis is strengthened by the observations that (i) exercise is primarily performed for body

weight/shape reasons, and (ii) an intense feeling of guilt accompanies the postponement of exercise in anorexic patients (Mond and Calogero, 2008). Taken together, these data indicate the need to consider exercise at the motivation level, rather than at the consumption level (considering intrinsic exercise performance as a consumption of that natural reward).

### ***Anorexia nervosa & alteration of reward processing***

Anorexic patients display an increased sensitivity to rewards other than food, as assessed by self-report questionnaires (Glashouwer et al., 2014; Jappe et al., 2011) and bear difficulties to distinguish between positive and negative outcomes in a disease-unrelated monetary game, (Bischoff-Grethe et al., 2013; Wagner et al., 2007). This last observation was associated with a non-discriminative activity in the striatum (Bischoff-Grethe et al., 2013; Wagner et al., 2007). In addition, a D2R polymorphism affecting its transcription efficiency and its transcript stability was associated with AN diagnosis in patients as compared to controls individuals (Bergen et al., 2005), and an increase in striatal D2R and D3R binding was observed using positron emission topography (PET) in women that have recovered from AN (Frank et al., 2005). In contrast to disease-unrelated stimuli, such as money in the monetary game mentioned above, a disease-related stimulus, such as an image of under- or normal- weight women, evokes opposite activities in the ventral striatum of patients and healthy controls, the greater activity being observed at the sight of underweight individuals in anorexic patients (Fladung et al., 2010).

Few studies have investigated reward-processing with specific regard to physical activity in anorexic patients. As mentioned earlier, standardized interviews for the exercise drive demonstrated that the latter was strongly associated with the clinical severity and was predictive of the eating pathology (Sternheim et al., 2015). In line with such observations, Gianini et al. (Gianini et al., 2016) investigated the motivation for exercise in low weight or recovered anorexic patients using a PR task wherein subjects had to repeatedly press a keyboard button to access either physical activity, leisure time, or money. Interestingly, low weight patients performed a higher PR for exercise than the recovered individual, thus showing a higher exercise motivation. Moreover, compared to healthy athletes or non-athletes, anorexic patients display an attentional

bias toward hyperactivity-related stimuli (Giel et al., 2013), suggesting an altered motivational value compared to both control groups.

#### 4.4. Motivation for physical activity – a common feature of food-related disorders?

Even though overweight/obesity and anorexia are phenotypically at opposite extremities of food-related disorders, both conditions share an alteration in physical activity (sedentariness *versus* hyperactivity, respectively). Moreover, in both pathologies, the alteration in physical activity co-occurs with an alteration of reward processes linked to exercise-related stimuli.

This indicates the crucial need for a better characterization of the neurobiological underpinnings of exercise motivation as to pave the way for more effective therapeutic approaches to tackle such debilitating conditions.

#### 4.5. Animal models of physical activity

Animal models of physical activity have been thoroughly used in the past decades. The two most prominent models consist in treadmill running and wheel-running. The treadmill is a moving platform with a motorized conveyor belt allowing the animal to run on it. The advantage of such an apparatus resides in the possibility for the experimenter to set the running characteristics (e.g. running duration and/or speed), thereby allowing to investigate the impact of different intensities of exercise in rodents with reproducible volumes of physical activity. For example, rat treadmill running has allowed to reach sufficient exercise intensities as to observe an up-regulation of proteins bearing cardioprotective properties, such as the heat-shock protein 72 which are not usually observed after voluntary wheel-running (Noble et al., 1999). However, treadmill running is not voluntary. Indeed, forced running is accounted for by the avoidance of an electric grid delivering shocks. This last point raises the concern that stress might interfere. Confirmingly, animal forced to exercise on a treadmill exerted a significant increase in circulating corticosterone after days (Brown et al., 2007) or weeks of running (Hayes et al., 2008), whereas voluntary runners in wheels did not differ from controls (Hayes et al., 2008). Although some rats do run immediately without

the need to dispense shocks, treadmill running should rather be considered as a negative reinforcer (i.e. running is a behavior aimed at avoiding a negative stimulus).

On the other hand, wheel-running is a spontaneous and voluntary behavior in laboratory and wild rodents (Meijer and Robbers, 2014; Sherwin, 1998). By allowing the animal to choose when, how, and for how much time he wants to run, wheel-running resembles human exercise. Moreover, the physiological consequences of wheel-running are similar to those measured in exercising humans (Novak et al., 2012; Voss et al., 2013). However, voluntary wheel-running cannot distinguish between the different reinforcing properties of exercise. Indeed, as mentioned earlier, motivation for and “consumption” of rewards are separate entities which involve distinct neurobiological mechanisms (Berridge, 2007; Salamone and Correa, 2012). To be able to distinguish between both dimensions, one must be able to quantify the amount of effort the animal will accept to perform as to access (or unlock in our studies) the running wheel.

I discussed the rewarding properties of physical activity above. Indeed, wheel-running reinforces operant responding (e.g. lever pressing or nose poking) under FR, PR or variable ratio reinforcement schedules (Belke, 1997; Collier and Hirsch, 1971; Iversen, 1993), as observed with other primary reinforcing stimuli. The use of operant conditioning paradigms allows to dissect out wheel-running reinforcing properties by distinguishing the motivation for exercise, as assessed by e.g. a PR task, from exercise “consumption”, as assessed by the running performance when the wheel is accessed.

#### 4.6. Regulators of wheel-running

In the past decades, several regulators of wheel-running have been described, among which the opioid system and leptin signaling, both of which exert this role by interacting with the mesolimbic dopaminergic system.

As previously mentioned, endogenous opioids are increased during exercise in humans and animals, thus suggesting a role for opioid system in physical activity. In female hamsters, a MOR antagonist, naltrexone, decreased night-time wheel-running (Potter et al., 1983). Moreover, in a 1-hour free wheel-running paradigm during the dark phase, nonfood-restricted rats injected with naloxone (another MOR antagonist)

displayed a dose-dependent decrease in wheel-running (Sisti and Lewis, 2001). The MOR agonist morphine decreased wheel-running in the first hour post-injection but then increased the running for the remaining 5 hours of a 6-hour free wheel-running paradigm (Sisti and Lewis, 2001). These observations indicate that stimulation of opioid receptors is necessary for wheel-running. The use of rats bred for either high- or low voluntary wheel-running (HVR and LVR, respectively) helped to decipher which could be the genetic component influencing physical activity. Interestingly, HVR rats displayed a higher level of MOR mRNA within the NAc (Ruegsegger et al., 2016), a brain region crucial for reward-processing (see above). In the same rat group, injection of naltrexone dose-dependently decreased wheel-running, VTA TH mRNA levels, and mRNA levels of fos and of the dopamine receptor 5 (a nonsignificant decrease was also observed for D1R and D2R; Ruegsegger et al., 2016). These results further suggest a modulation of dopaminergic transmission through the opioid system that could account for higher voluntary wheel-running. Furthermore, the CPP induced by wheel-running after-effects (see above) was blocked by systemic naloxone pretreatment (i.e. 10 minutes before the CPP test; Lett et al., 2001), indicating that in addition to their role in wheel-running performance, endogenous opioids bear a role in the hedonic after-effects of exercise. As already mentioned, the use of operant conditioning for wheel-running allows to isolate the appetitive dimension of running from its consummatory dimension. This is especially true during PR tests. Thus, Rasmussen et al. (Rasmussen and Hillman, 2011) used this experimental approach and demonstrated that injection of naloxone before the session decreases the consummatory running behavior, leaving unaffected the appetitive running seeking. This points toward a potential role for the endogenous opioid system in the consummatory dimension part of exercise without any role in appetitive motivation for running. It should be noted however that such a change in running consumption in naloxone-treated rats tested during a PR task was not observed in naloxone-treated mice (although this naloxone dose proved efficient against fasting-induced feeding; unpublished observations from our laboratory).

Another endogenous regulator of exercise is leptin. Leptin is a peripheral hormone produced in the adipose tissue whose concentration is related to the fat mass (Maffei et al., 1995). Whilst fasting increases wheel-running (Pierce et al., 1986), it also decreases plasmatic concentrations of leptin (Ahima et al., 1996). Interestingly, the

effects of leptin on wheel-running depend on the nutritional status of the animal. Indeed, leptin decreases fasting-induced wheel-running whereas no effect was observed upon leptin administration in fed animals (Exner et al., 2000; Morton et al., 2011). The use of leptin-deficient mice (*ob/ob* mice) helped deciphering its role in energy balance, and hence wheel-running. These mice display a lower level of wheel-running as compared to wild-type (WT) mice, and leptin replacement in fed conditions increases wheel-running (Morton et al., 2011). In addition to its tonic control of wheel-running, leptin decreases the motivation for sucrose in operant conditioning (Figlewicz et al., 2006) and increases ICSS thresholds (thus decreasing its rewarding efficacy (Fulton et al., 2000). Interestingly, leptin receptors are found within VTA dopaminergic neurons (Figlewicz et al., 2003) and leptin administration (i) increases the signaling (through phosphorylation) of the signal transducer and activator of transcription 3 (STAT3) in these neurons, and (ii) decreases DA release in the NAc (Fulton et al., 2006), thus indicating that leptin negatively modulates the mesolimbic dopaminergic system. Furthermore, mice lacking STAT3 signaling specifically in VTA dopaminergic neurons (STAT3-DAT-KO) display a higher level of wheel-running and an increased running-induced CPP, the latter effect being abolished by intra-VTA leptin administration in control mice, but not in the STAT3-DAT-KO mice (Fernandes et al., 2015). Therefore, leptin central action negatively influences wheel-running performance and its rewarding after-effects, doing so through a direct action on the mesolimbic dopaminergic system. However, the impact of leptin on motivation for wheel-running has never been assessed to date.

#### 4.7. CB1 receptors & wheel-running

In addition to opioid and leptin systems, the ECS emerges as a crucial regulator of exercise.

Human studies revealed that physical exercise, i.e. prolonged running and cycling, enhanced circulating AEA levels (Sparling et al., 2003), this observation extending to other cursorial species such as dogs and mice but not in non-cursorial animals such as ferrets (Fuss et al., 2015; Raichlen et al., 2012). Thus, this suggests that endocannabinoids might not be released in response to the mere movements exerted during exercise but might relate to processes involved in the regulation of such an



activity. Even though the site of production of AEA is not characterized and its circulating levels cannot account for its brain concentrations, endocannabinoids can readily cross the blood-brain-barrier owing to their lipidic nature and hence bear central effects. Voluntary wheel-running in rats modulate AEA concentration in a region-specific manner, e.g. increased in the hippocampus, but not in the PFC, without any change in 2-AG (Hill et al., 2010). Moreover, AEA circulating levels measured after exercise positively correlate with positive affect in humans (Raichlen et al., 2012). With respect to the aforementioned "runner's high" feeling, it has been proposed that endocannabinoids might contribute to it. In keeping with the observation that CB1 receptor stimulation triggers anxiolysis, well-being, sedation, and analgesia, it is not surprising that some features of the runner's high (anxiolysis and analgesia but not post-exercise sedation) were found to be CB1 receptor-dependent in a mouse model of wheel-running, whereas post-exercise sedation was not (Fuss et al., 2015). Beside these observations, wheel-running was shown to increase the number of progenitor cells in the dentate gyrus in a CB1 receptor-dependent manner (Hill et al., 2010), a finding contradicted by another study (Dubreucq et al., 2010). In addition, wheel-running specifically potentiates the cannabinoid-induced inhibition of striatal GABAergic synapses without affecting the glutamatergic ones (Chiara et al., 2010) whilst it prevents social defeat-elicited anxiety (Chiara et al., 2010). Interestingly, all these effects are blocked or prevented by CB1 receptor antagonism, suggesting that CB1 receptors are involved in the beneficial anxiolytic effects of wheel-running. The use of mouse lines selected for their spontaneous physical activity level (high- *versus* low runners) helped to determine whether CB1 receptors could be a determinant of such a behavioral trait. Keeney and colleagues (Keeney et al., 2008) investigated the effects of CB1 receptor blockade using rimonabant in high- *versus* low runners in both sexes. Even though rimonabant decreases wheel-running in all animals, the drug affects differentially (i) males and females, and (ii) high and low runners, with high runner females displaying the strongest reduction in wheel-running whereas no difference is observed in either male genotypes. This suggests that CB1 receptors might be a key determinant of the running performance. The use of operant conditioning in rats also helped deciphering which aspect(s) of wheel-running was dependent on CB1 receptors. Indeed, Rasmussen and colleagues (Rasmussen and Hillman, 2011) demonstrated that CB1 receptor antagonism impacts specifically the appetitive behavior linked to the wheel (i.e. the maximal effort exerted by the animal to

run, namely the breakpoint, and the response rate) but not its consummatory counterpart (i.e. wheel revolutions once the wheel was accessed). However, it should be noted that (i) extremely high doses of rimonabant were used, and (ii) this study used obese animals, thus questioning the generalization of these observations to control rats and mice.

Previous works in our laboratory aimed at disentangling the role of CB1 receptors in wheel-running, doing so using genetic and pharmacological approaches. Wheel-running was studied by allowing free access to the wheels in mouse home cages, this access being either unlimited (Dubreucq et al., 2010) or restricted to 3 h (as to get closer to the human situation; Dubreucq et al., 2013). These works demonstrated that mice bearing a lifelong deletion of CB1 receptors (CB1-KO) displayed a lower level of voluntary wheel-running (Dubreucq et al., 2010, 2013), and a similar phenotype was observed after systemic CB1 receptor blockade with rimonabant (Dubreucq et al., 2013). Interestingly, the conditional deletion of CB1 receptors from (Cam kinase 2-expressing) principal neurons, serotonergic neurons, cortical glutamatergic neurons, D1R-expressing neurons, or astrocytes did not impact wheel-running whereas a deletion from forebrain GABAergic neurons (GABA-CB1-KO) recapitulated the phenotype observed in CB1-KO animals. Moreover, rimonabant was devoid of impact on wheel-running in CB1-KO animals and in GABA-CB1-KO animals, indicating that CB1 receptors on GABAergic neurons account for the CB1 receptor-mediated control of voluntary wheel-running (Dubreucq et al., 2013). Importantly, this impact of CB1 receptor was specific to wheel-running, leaving intact ambulatory locomotion, hence strengthening the specific link between the ECS and exercise (Dubreucq et al., 2010, 2013). Interestingly, local administration of CB1 receptor antagonists within the VTA did recapitulate the phenotype observed after their systemic administration in WT animals whilst these proved ineffective in GABA-CB1-KO mice (Dubreucq et al., 2013). This work demonstrated that CB1 receptors located on VTA GABAergic terminals exert a permissive effect on voluntary wheel-running. In addition, electrophysiological recordings of VTA dopaminergic neurons in anaesthetized mice shortly after running indicated that acute and repeated wheel-running decreases the activity of these neurons in GABA-CB1-KO mice only, their WT littermates showing no change. This observation indicates that the permissive effect of CB1 receptors on wheel-running involves a modulation of the VTA dopaminergic activity.

In conclusion, a growing body of evidence demonstrates the crucial involvement of CB1 receptors in wheel-running, and previous works in our laboratory provided evidence for the specific involvement of CB1 receptors located on GABAergic terminals within VTA in the control of voluntary wheel-running. However, as indicated above, the appetitive and consummatory dimensions of wheel-running are intermingled when using free access (i.e. "no cost conditions") to the wheel. Accordingly, the only means to distinguish the drive for running from running performance is to render the wheel access contingent to a quantifiable effort. The aim of the present work was thus to study the respective involvement of CB1 receptors in running motivation and performance, extending this aim to a choice paradigm wherein running is in concurrence with another reward, namely palatable feeding.

## OBJECTIVES

As mentioned in the Introduction, the ECS, by means of CB1 receptors, is involved in reward-related processes. Previous works in the laboratory demonstrated the crucial role of CB1 receptors located in the VTA in the tonic control of "free" wheel-running (i.e. in the home cages). However, free wheel-running is not suitable for the discrimination between wheel-running motivation and "consumption". The aim of the present work was thus to study if CB1 receptors regulate either or both of these components. To do so, we first aimed at developing an operant conditioning paradigm to allow the assessment of wheel-running motivation (**Chapter 1**). Once developed and validated, we used this paradigm in combination with pharmacological and genetic approaches to decipher the involvement of CB1 receptors in wheel-running motivation, the wheel being provided alone or in a concurrent choice with palatable food (**Chapter 2**). Using our operant conditioning protocol, we next investigated whether wheel-running motivation could be further enhanced by pharmacological (THC, prednisolone) or environmental (adolescent stress) means (**Chapter 3**). Finally, we aimed at describing the anatomical localization of the CB1 receptors controlling wheel-running motivation (**Chapter 4**).

### **Chapter 1 – Development of an operant conditioning paradigm to study wheel-running motivation**

The first aim of the present work was to develop and validate an effort-based wheel-running protocol. Previous studies demonstrated the possibility to maintain operant responding with wheel-running as a reinforcer (Belke, 1997; Iversen, 1993), but these mainly used rats. The first objective was thus to develop a conditioned running model suitable for mice as to extend its use to our CB1 receptor mutant lines. To do so, male C57Bl/6N mice were used. Additional experiments then aimed at validating our protocol by evaluating the relationships between running motivation and dopaminergic activity, including in the VTA.

The results indicated that (i) our model allows to specifically measure running motivation (as assessed under PR schedules) and running seeking (as assessed by cue-induced reinstatement sessions) independently from running performance, and (ii)

## OBJECTIVES

running motivation scores in PR sessions are sensitive to D2R blockade and correlate with subsequent VTA dopaminergic firing rates (albeit in anesthetized animals).

[Annex 1](#) : Muguruza\*, Redon\* et al., (2019) *JCI insight*

## Chapter 2 – Role of CB1 receptors in motivation for wheel-running

**Objective 1: to assess the role of CB1 receptors through pharmacological means.** This set of experiments used CB1 receptor (inverse or neutral) antagonists, namely rimonabant and O-2050, and examined their respective effects on running motivation. The results showed that CB1 receptors exert a tonic control of wheel-running motivation.

[Annex 1](#) : Muguruza\*, Redon\* et al., (2019) *JCI insight*

**Objective 2: to assess the role of CB1 receptors through genetic means.** After having verified that the removal of CB1 receptors from the whole body (CB1-KO mice) impacted negatively running motivation, this part of the study examined whether removing CB1 receptors from (i) forebrain GABAergic neurons (GABA-CB1-KO mice), (ii) cortical glutamatergic neurons (Glu-CB1-KO mice), (iii) Sim1-expressing neurons (Sim-CB1-KO mice), or (iv) serotonergic neurons (TPH2-CB1-KO mice) recapitulated the behavior of CB1-KO mice. Because CB1 receptors on GABAergic neurons were found to be necessary for wheel-running motivation, we then aimed at evaluating whether these receptors are also sufficient for running motivation. To do so, we specifically re-expressed this CB1 receptor subpopulation in mice bearing a silencing of CB1 receptor expression. The results indicated that CB1 receptors located on GABAergic neurons are both necessary and sufficient for wheel-running motivation.

[Annex 1](#) : Muguruza\*, Redon\* et al., (2019) *JCI insight*

**Objective 3: to assess whether the CB1 receptor-mediated control of running motivation extends to palatable feeding motivation.** The above-mentioned results raised the issue of the reward specificity of the control of running motivation by CB1 receptors on GABAergic neurons. We thus wondered whether this

## OBJECTIVES

receptor population also controls the motivation for another reward, namely palatable food, for which CB1 receptors have been shown to be essential (see “Introduction”). Using an operant conditioning protocol, we followed a similar experimental plan as described under *objective 2*: (i) estimation of the impact of the pharmacological blockade of CB1 receptors on palatable feeding, and (ii) evaluation of palatable food reinforcing properties in constitutive and conditional CB1 receptor mutants. The results, which confirmed the involvement of CB1 receptors in palatable food motivation, indicated that such an involvement was independent from CB1 receptors located on GABAergic neurons.

[Annex 1](#) : Muguruza\*, Redon\* et al., (2019) *JCI insight*

**Objective 4: to assess whether CB1 receptors on GABAergic neurons control motivation for running when the latter is made concurrent with palatable food.** Evaluating the respective drives for two rewards provided alone cannot account for the preference for one over the other in a concurrent choice situation (Cantin et al., 2010). Accordingly, the first task was to develop a novel operant conditioning paradigm allowing the investigation of the choice between running and palatable feeding in an effort-based setting ([Annex 2](#)). Once validated, constitutive and conditional mutants for CB1 receptors were conditioned and their operant responding scores in this choice context were then evaluated. The results demonstrate that CB1 receptors on GABAergic neurons control the preference for wheel-running over palatable food.

[Annex 1](#): Muguruza\*, Redon\* et al, (2019) *JCI insight*

[Annex 2](#): Redon et al., (2019) *Bioprotocol*

## Chapter 3 – Modulation of wheel-running motivation

**Objective 1: to evaluate the impact of acute CB1 receptor stimulation on wheel-running motivation.** As mentioned in the Introduction, the stimulation of CB1 receptors, e.g. by THC or through inhibition of endocannabinoid degradation, increases the motivation for natural rewards such as food (Barbano et al., 2009; Oleson et al., 2012; Solinas and Goldberg, 2005; Ward and Dykstra, 2005). We thus aimed at evaluating whether this observation extends to wheel-running motivation. To do so, we

## OBJECTIVES

stimulated CB1 receptors with THC or JZL184 (an inhibitor of 2-AG degradation; see “Introduction”) and measured their impacts on wheel-running motivation and performance (PR tests). The results show that stimulation of CB1 receptors affects none of these variables.

[Annex 3](#) : Hurel\*, Muguruza\* et al., (2021) *Progress in Neuropsychopharmacology & Biological Psychiatry*

**Objective 2: to evaluate whether the ergogenic impact of glucocorticoids is mediated by their modulation of exercise motivation.** Even though the ergogenic (i.e. doping) impact of glucocorticoids is proposed to be mainly accounted for by their peripheral effects (mainly muscles), their receptors are also found in the brain. Therein, they have been shown to modulate reward processes. We thus wondered whether repeated treatment with ergogenic doses of a glucocorticoid, namely prednisolone, would also stimulate running motivation. The results indicate that the ergogenic effects of glucocorticoids might be independent from any action on motivation processes.

[Annex 4](#) : Redon et al., (2019) *Psychoneuroendocrinology*

**Objective 3: to evaluate the construct validity of the activity-based anorexia model.** Activity-based anorexia (ABA), which consists in exposing mice or rats to a running wheel under food-restricted conditions, is a widely used animal model of AN (Méquinion et al., 2015; Scheurink et al., 2010). Even though AN etiology and neurobiology are still poorly documented, increased motivation for exercise is considered a core feature of the pathology (see “Introduction”). We thus evaluated in male and/or female mice whether the running hyperactivity observed in the ABA model finds its roots at the motivation level. Moreover, because childhood traumas have been identified as potential etiological factors for AN, we measured whether an early-life stress (post-weaning isolation rearing, PWIR) would stimulate running motivation at the expense of feeding motivation, and if so, whether this would obey gender-dependent rules. The results demonstrated that, even though PWIR accentuated the ABA-induced phenotype, neither this early-life stress nor food restriction affected running motivation.

[Annex 5](#) : Hurel\*, Redon\* et al., (2019) *Frontiers in Pharmacology*

## Chapter 4 – On-going experiments

**Objective 1: to characterize the anatomical localization of CB1 receptors controlling wheel-running motivation.** Data gathered under Chapter 2 underline the prominent role of GABA-CB1 receptors in the control of wheel-running motivation. However, the genetic approaches which were used impede any conclusion regarding their anatomical location. The first set of experiments addressed the impact of a local infusion of a CB1 receptor antagonist in the VTA prior to a PR session of wheel-running. The results strongly suggest that CB1 receptors located on VTA terminals control wheel-running motivation. Because CB1 receptors on GABAergic neurons play a major, if not unique, role therein, it is tempting to suggest that these receptors are located at the terminals of (i) intrinsic VTA GABAergic interneurons or (ii) extrinsic GABAergic projections impinging onto VTA dopaminergic neurons. To test the former hypothesis, we crossed the *Dlx5/6-Cre* mice (used to generate the GABA-CB1-KO mutants) with mice bearing a fluorescent reporter (*Ai6*). Even though preliminary, the results suggest that VTA neurons from *Dlx-Ai6* mice lack expression of the reporter, an observation which favors the second hypothesis. I thus began to test the second hypothesis, doing so by deleting CB1 receptors from the lateral hypothalamus (LH) neurons. The preliminary results surprisingly indicate that this deletion increased wheel-running motivation.

[Annex 1](#) : Muguruza\*, Redon\* et al., (2019) *JCI insight*

**Objective 2: to evaluate whether VGAT (*Slc32a1*) is a useful promoter for the study of the CB1 receptor-mediated control of running motivation.** As mentioned in the previous chapters, the genetic construct used to generate our GABA-CB1 mutants is based on the *Dlx5/6* promoter. However, this promoter is thought to be mainly expressed in the forebrain, but several observations suggest that it might also be expressed in midbrain (see Dubreucq et al., 2013). In order (i) to confirm that CB1 receptors on GABAergic neurons control running motivation, and (ii) examine whether removing CB1 receptors from all GABAergic (i.e. VGAT-expressing) neurons decreases running motivation, we crossed VGAT-Cre mice (agouti background, Vong et al., 2011) with our CB1-floxed mice and observed that VGAT-CB1-KO mice behaved as expected with regard to running and palatable feeding motivation. The second set



## OBJECTIVES

of experiments aimed, by means of VGAT-Cre (+) and VGAT-Cre (-) mice, at ensuring that the decreased running motivation observed in VGAT-CB1-KO mice was not due to the VGAT-Cre recombinase. While no effect was observed for palatable food, VGAT-Cre expressing mice displayed to our surprise a decrease in wheel-running motivation. We thus tested another VGAT-cre expressing mouse line (C57Bl/6J background) in operant conditioning for wheel-running. The results demonstrated that this genetic construct did not alter wheel-running reinforcing properties, making it a suitable mouse line for our research. Accordingly, crosses between these VGAT-Cre expressing mice and our CB1-floxed mice are now in progress.

## MATERIALS & METHODS

### 1. Animals

The experiments reported in this document used C57Bl/6N mice (Elevage Janvier, Le Genet Saint Isle, France) and constitutive/conditional mutant mice for the CB1 receptor with their respective WT littermates, all bred in the animal facility of the Neurocentre Magendie. All animals were housed - at least one week before the beginning of the experiments - in a room adjacent to the experimental one, with controlled temperature ( $20 \pm 2^\circ\text{C}$ ), hygrometry ( $40 \pm 10\%$ ) and light intensity. All animals were provided food and water *ad libitum* in their home cages, unless indicated otherwise. Excepted from one study ([Annex 5: Hurel\\*, Redon\\* et al., \(2019\) \*Frontiers in Pharmacology\*](#)), all other studies involved male mice aged 8-12 weeks old.

The constitutive mutants, i.e. CB1-KO mice bearing a life-long deletion of CB1 receptors, and their control littermates (CB1-WT) were all obtained from heterozygous crossings (Marsicano et al., 2002, 2003). Conditional mutants were all obtained by crossing (i) female mice bearing a genetic construction wherein the CB1 receptor gene is flanked by two loxP sites, namely CB1<sup>fl/fl</sup> (CB1-floxed) mice, with (ii) male mice expressing a Cre recombinase under the control of regulatory sequences of specific genes from the cell-type of interest. This strategy allowed to generate conditional mutant mice bearing specific deletions of CB1 receptors from forebrain GABAergic neurons (CB1<sup>fl/fl, Dlx5/6-Cre</sup> called GABA-CB1-KO), cortical glutamatergic neurons (CB1<sup>fl/fl, Nex-Cre</sup>, called Glu-CB1-KO; Monory et al., 2006), serotonergic neurons (CB1<sup>fl/fl, TPH2-CreERT2</sup>, called TPH2-CB1-KO, this deletion being inducible through tamoxifen administration; see below) or from neurons expressing the transcription factor single-minded 1 (Sim1) mainly observed in the paraventricular nucleus (PVN) and the supraoptic nucleus of the hypothalamus (SON; CB1<sup>fl/fl, Sim1-Cre</sup>, called Sim1-CB1-KO; Cardinal et al., 2015; Dubreucq et al., 2012). To further investigate the role of CB1 receptors in GABAergic neurons, male mice expressing the Cre recombinase under the promoter of the VGAT under an Agouti background (*Slc32a1<sup>tm2(cre)</sup>Lowl* knock-in mice obtained from Jackson laboratory #016962, referred to as VGAT-cre hereafter; Vong et al., 2011) were crossed with female CB1-floxed mice, as to generate VGAT-CB1-WT and VGAT-CB1-KO (CB1<sup>fl/fl, VGAT-cre</sup>) mice. Given the phenotype observed in VGAT-cre mice (see “Results”), I used another mouse line wherein multiple

## MATERIALS & METHODS

backcrossings allowed to obtain the expression of the Cre recombinase in a C57Bl/6J background (B6J.129S6(FVB)-Slc32a1<sup>tm2(cre)Lowl/MwarJ</sup> obtained from Jackson Laboratory #028862, referred to as VGAT\*B6-cre hereafter). Only the influence of the Cre recombinase was investigated as crossings between these mice (males) and CB1-floxed mice (females) began in November 2020.

For the study of the consequences of a selective rescue (re-expression) of CB1 receptors in GABAergic neurons in mice bearing a silenced CB1 receptor gene expression, (i) mice carrying a CB1 receptor gene silenced by the insertion of a loxP-flanked STOP cassette in the CB1 receptor Start codon, called Stop-CB1 mice (Ruehle et al., 2013) were crossed with (ii) mice expressing the Dlx5/6-Cre recombinase in GABAergic neurons, to obtain - through a selective removal of the Stop cassette from GABAergic neurons - a rescue of CB1 receptor expression only in GABAergic neurons (called GABA-CB1-rescue), and their control Stop-CB1 littermates.

To characterize the pattern of expression of the Dlx5/6 promoter (used to generate our GABA-CB1-KO and GABA-CB1-rescue mouse lines), Dlx5/6-cre (+) mice were crossed with Ai6 reporter-expressing mice (Gt(ROSA)26Sor<sup>tm6(CAG-ZsGreen1)Hze</sup> obtained from Jackson Laboratory #007906) bearing a loxP-flanked STOP cassette preventing the expression of an enhanced green fluorescent protein variant (ZsGreen1). The resulting mouse pups (Dlx-Ai6) thus display green, fluorescent Dlx5/6-expressing neurons, but not elsewhere, allowing the assessment of their locations.

The expression of the cre recombinase (and thus the deletion of CB1 receptors) was inducible in TPH2-CB1-KO animals: this enzyme was fused to the interacting site of the human estrogen receptor (ER). This modified enzyme (called Cre<sup>ERT2</sup>) is activated by one daily intraperitoneal (i.p.) injection of tamoxifen (2 mg) for 5 consecutive days when mice were 7-8 weeks old. The excision of CB1 receptors is obtained within 3 weeks post-treatment. This inducible approach thus avoids any developmental impact of the deletion of CB1 receptors from serotonergic neurons.

All animals were genotyped (through PCR assays by the Genotyping Platform, Neurocentre Magendie) at (i) post-natal day 10 and (ii) at the end of the experiments. All of these included both mutants and their WT littermates.

## MATERIALS & METHODS

### **2. Post-weaning social isolation rearing**

To evaluate the impact of stress on (i) wheel-running motivation and performance, and (ii) the choice between wheel-running and palatable feeding, we used post-weaning social isolation rearing (PWIR), a model of early life stress which induces long-lasting behavioral and neurochemical effects (Fone and Porkess, 2008; Walker et al., 2019). Briefly, C57Bl/6N male and female mice arrived in our facility at 3 weeks of age and were immediately assigned to either of two groups: (i) separated, singly housed in an individual cage or (ii) group-housed in a collective cage (by 3). PWIR impedes social play and social interactions at early age, which are crucial for development. Animals were then kept under these housing conditions until testing in adulthood.

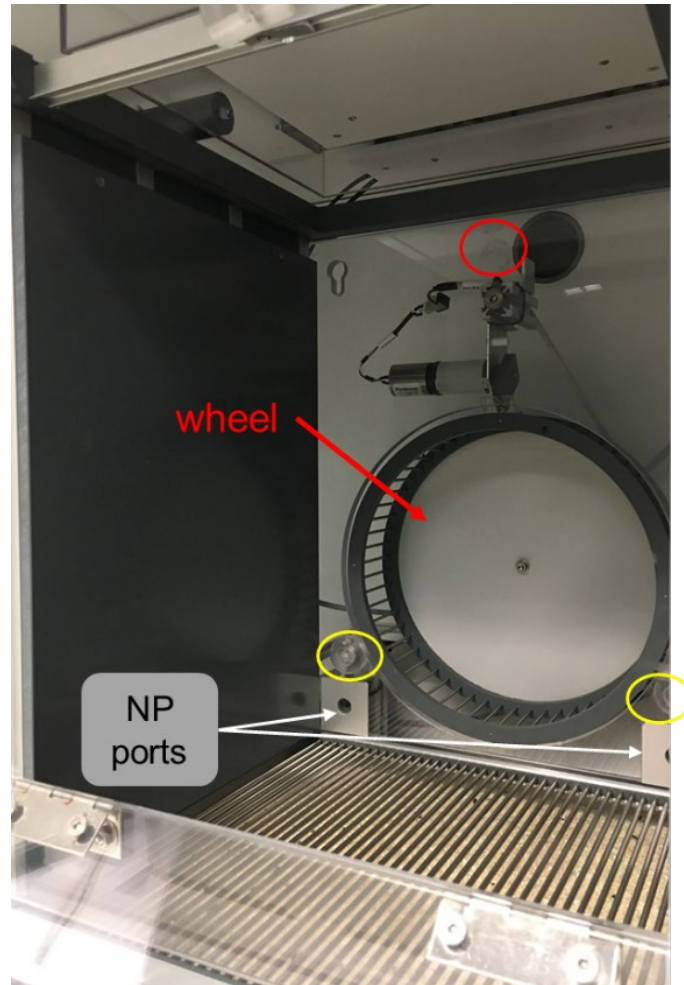
### **3. Operant conditioning paradigm**

All our behavioral protocols were performed during the active phase of the animal cycle, thus during the dark phase of the light/dark cycle (12:12, light off at 10AM) in a room adjacent to the housing facility. The operant conditioning chambers (Imetronic, Pessac, France) were individual chambers (28 cm long x 26 cm wide x 38 cm high) placed in wooden cases (60 cm long x 62 cm wide x 49 cm high) ventilated to ensure air circulation and background noise. The rear side has a 20-cm diameter wheel mounted at the center, surrounded by two nose poke (NP) ports, with a brake pad on top of it to allow the locking/unlocking. The left panel has a food tray placed at the center surrounded by two NP ports. Both panels (rear and left) can be hidden using grey Perspex depending on the task (see below). To facilitate learning of the task and indicate reward availability, cue lights are associated with (i) the rewards (on top of the wheel and the food tray) and (ii) the active NP ports. The floor consists of a grid above a drawer filled with litter (same litter as the animal home cage). Each cage is connected to a computer through an interface to (i) set the contingency and the duration of each protocol and (ii) record the animal responses in each session.

Within a given protocol, a NP can be either “active” (leading to reinforcer access) or “inactive” (no consequence). The left/right allocation of active/inactive NP ports was counterbalanced between animals.

## MATERIALS & METHODS

### 3.1. Wheel-running protocol



*Figure 7 - **Operant chamber configuration for wheel-running protocol** – A wheel mounted on the rear side surrounded by two NP ports associated with light cues (yellow circles) that can be paired with another light cue (red circle) on the top of the wheel (the left panel being covered by gray Perspex). The floor is a metal grid placed over a litter drawer.*

The operant conditioning protocol for wheel-running was divided in three consecutive steps: (i) habituation, (ii) conditioning under fixed-ratio (FR) schedules of reinforcement and either (iiia) tests under a progressive ratio (PR) schedule, or (iiib) extinction sessions followed by a cue-induced reinstatement test (one set of experiments). Each mouse underwent one daily 60-min session through the protocol duration.

## MATERIALS & METHODS

### Habituation

Mice were placed in the operant chamber with the wheel unlocked and its associated cue illuminated all session long as to habituate the mice to the context of the chamber, the wheel and the cue indicating wheel unlocking. The NP ports were covered by metal pieces to render them inaccessible.

### Conditioning

In the conditioning phase, the metal pieces covering the NP ports were removed, rendering them accessible for wheel unlocking. Mice were conditioned under FR schedules of reinforcement wherein a fixed number of operant responses was required to access the wheel. Under FR1 conditions, a single active NP led to 10-second illumination of the active port-associated cue and 60-second wheel unlocking together with the illumination of its associated cue, whereas poking through the inactive port had no consequence. After 60 seconds, the brake applied, and the mouse was required to perform another active NP to unlock the wheel again. After 6 sessions under this schedule of reinforcement, mice were placed under FR3 conditions, 3 active NP being required to unlock the wheel. All animals were required to exert a discrimination index ( $\text{number of active NP} / \text{total number of NP} * 100$ ) over 75%, and a variation of operant responses (number of active NP/session) under 20% over the last two FR3 sessions to be included.

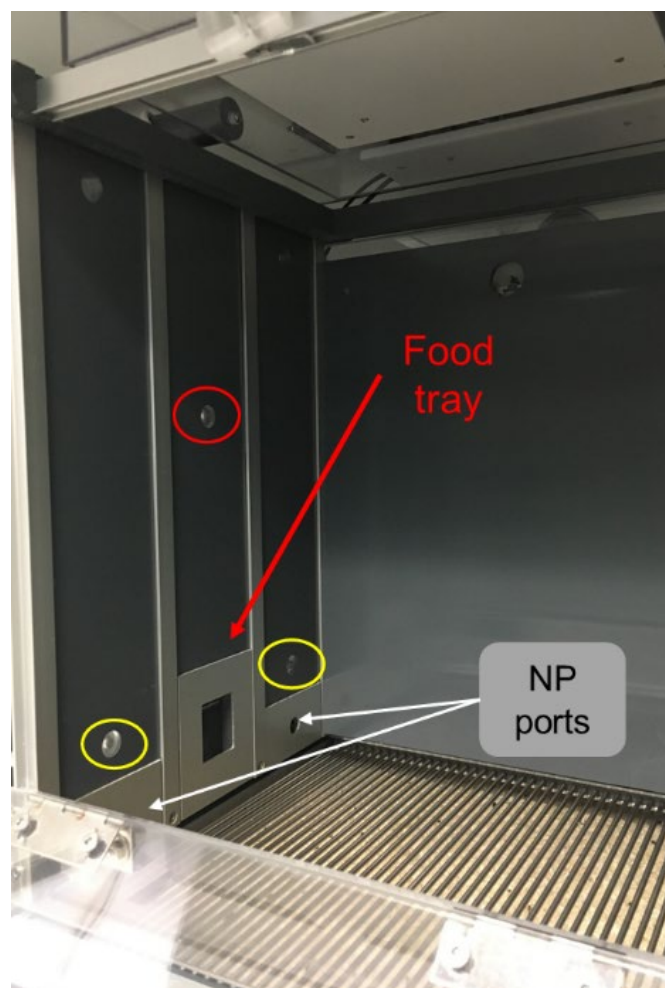
The day after the last FR3 session, the motivation for wheel-running was assessed by testing mice under a linear PR schedule of reinforcement where the number of active NP required to unlock the wheel was incremented by 3 between each rewarded sequence (3, then 6, then 9... etc corresponding to a PR3 schedule of reinforcement), and with a 15-minute time limit between two steps.

For the set of experiments aimed at assessing cue-induced reinstatement of wheel-running seeking, mice entered an extinction phase after their last FR3 session. During this extinction period, mice were placed once daily in the operant chambers but neither active/inactive NP ports nor cue lights were functional, the wheel thus remaining locked throughout the sessions. When stable operant responses were observed over three consecutive sessions (indicating the extinction of wheel-running seeking), a

## MATERIALS & METHODS

reinstatement session was performed. Reinstatement was initiated 30 seconds after the session onset by illuminating the active port-associated cue light for 10 seconds. Following this non-contingent cue illumination, if the animal performed an active NP, the cue light illuminated once again for 10 seconds (FR1 condition). Then, 3 active NP were required for subsequent 10-second cue illumination (FR3 condition). However, the wheel and its associated cue remained off all the time during this session.

### 3.2. Palatable food



*Figure 8 - Operant chamber configuration for palatable food - A food tray located on the left panel is surrounded by two NP ports associated with light cues (yellow circle) that can be paired with another light cue (red circle) on the top of the food tray (the rear side covered by gray Perspex). The floor is made of a metal grid over a litter drawer.*

## MATERIALS & METHODS

As for wheel-running, the operant conditioning protocol for palatable food consisted in three consecutive phases: (i) habituation, (ii) conditioning and (iii) test. Daily food intakes and body weights were recorded along a week before initiating a mild food restriction protocol. This involved a daily delivery of an amount of food calculated to maintain the animals at 90% of their free feeding body weights. The beginning of the operant conditioning protocol coincides with an effective food-restriction and stable body weights (90%). This amount of food was always given in their home cage, at least 60-90 minutes after the completion of the daily sessions to avoid any conflict with the operant behavior. Before starting the experiment, mice were habituated to the palatable food used as reinforcer (20-mg chocolate-flavored dustless precision pellet, F05301, Bioserv, USA) by providing them with 5 pellets per day for the three days which preceded the operant protocol. As opposed to wheel-running, and to avoid satiety, the operant sessions lasted only 30 minutes.

Mice were then placed in the operant chamber where the food tray-associated cue remained illuminated all session long, thereby signaling the availability of 17 food pellets dispensed in a non-contingent manner at the session onset (NP ports remaining covered by metal pieces). This session aimed at habituating the mice to the context of the chamber, the food tray, and the availability of food pellets.

The conditioning followed the same scheme as the wheel-running protocol. After a single active NP in the FR1 condition (NP ports being uncovered from their metal pieces), the active port-associated cue illuminated and a food pellet was dispensed in the food tray hence initiating a 15-second timeout period during which active NP remained inefficient (no pellet delivered, but NP were counted). Mice were then conditioned under FR3 schedules, i.e. 3 active NP were required to obtain one food pellet. To allow the comparison with the wheel-running protocol, 6 FR3 sessions followed 6 FR1 sessions. The same criteria of inclusion were used: discrimination index over 75%, and operant response variations below 20% on the last two sessions.

The day after the last FR3 session, mice were tested under a PR3 schedule of reinforcement as described for wheel-running. However, no time limit was set in keeping with the short duration of the session.



## MATERIALS & METHODS

### 3.3. Choice between wheel-running and palatable food



*Figure 9 - Operant chamber configuration for the choice between wheel-running and palatable food – The access to both rewards is allowed through the removal of the Perspex panels used in the two previous configurations. Thus, mice have access to the feeder and its respective NP ports on the left panel, or to the wheel and its respective NP ports on the rear side. The floor is made of a metal grid over a litter drawer.*

The operant conditioning protocol for the choice between wheel-running and palatable food is described with experimental and technical details in a publication provided in [Annex 2 \(Redon et al., \(2019\) Bioprotocol\)](#). Briefly, the protocol consisted in two consecutive steps: (i) conditioning for wheel-running and palatable food presented

## MATERIALS & METHODS

separately, followed by (ii) choice sessions, both rewards being presented simultaneously to the animal.

For the first step, mice were placed in operant chambers for two consecutive 30-minute sessions per day, one for wheel-running the other for palatable food, the order of which was counterbalanced between days to avoid the influence of one reward over the other. The sessions occurred under FR1 conditions for 5 sessions, before moving to FR3 conditions for 5 more sessions. However, the rewarded sequences (reward receipt) were slightly different as compared to individual protocols described above: the performance of a single (FR1 condition) or 3 consecutive (FR3 condition) active NP triggered a simultaneous illumination of (i) the active port-associated cue for 5 seconds, together with (ii) wheel- or food tray- associated cue for 20 seconds or 15 seconds, respectively. The same criteria of inclusion were used: discrimination index over 75%, and operant responses variation below 20% on the last two sessions.

For the next step, mice were given the opportunity to work for either reward (wheel or palatable food) in 1-hour daily sessions. The grey Perspex panels were removed to render the wheel, the food tray, and their associated NP ports accessible for choice sessions. The sessions occurred under FR3 conditions (detailed in Figure 10). The performance of 3 active NP initiated a rewarded sequence: wheel unlocking or 1 pellet dispensed, and illumination of the active port- and reward-associated cues. However, the choice was mutually exclusive, meaning that choosing one reward rendered the other inaccessible for a given time (the timeout period). This was indicated to the mice by illuminating a green ceiling light for an additional 5-second period at the end of the rewarded sequence, whichever reward was chosen. After 5 sessions under these experimental conditions (which were sufficient to stabilize operant responses), mice were mildly food restricted, as previously described to maintain them at 90% of their free-feeding body weights, for 2-5 additional sessions.

## MATERIALS & METHODS

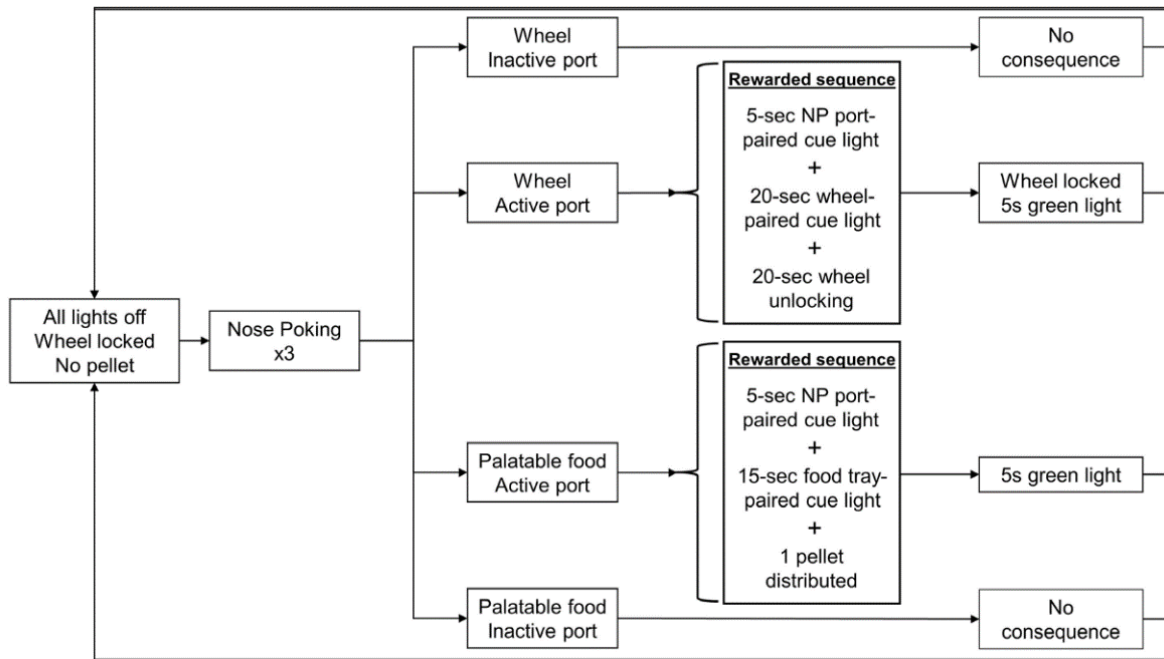


Figure 10 - **Logigram of the choice between wheel-running and palatable food.** Nose poking gives access to one reward, but the choice is mutually exclusive, i.e. choosing one reward excludes the possibility to obtain the other reward for a given time period (from [Annex 2: Redon et al., \(2019\) Bioprotocol](#)).

### 3.4. Behavioral readouts

The following readouts were computed and analyzed:

- operant responses: active/inactive NP
- running performances: assessed through two indices
  - *Running duration per sequence*: mean time spent running at each wheel access in a given session
  - *Running distance per sequence*: mean distance ran at each wheel access in a given session
- Pellet consumption: percentage of the number of pellets consumed over the number of pellets earned
- Preference ratio: ratio of the number of operant responses for wheel-running over the total operant responses in each choice session, expressed as a percentage. Ratios above and below 50% indicate a preference for wheel-running and palatable food, respectively.

## MATERIALS & METHODS

### 4. Local intra-VTA drug infusion

#### 4.1. Surgery

To locally block CB1 receptors within the VTA, C57Bl/6N were implanted with bilateral canulae. Mice were thus anesthetized by an i.p. injection of a mixture of ketamine/xylazine, shaved, and locally disinfected before being placed in a stereotaxic frame (David Kopf Instruments), the head being maintained with atraumatic maxillary bars. After craniotomy, bilateral 2.7-mm stainless canulae were implanted above the VTA using the following coordinates: anteroposterior:  $-3.0$  mm; lateral:  $\pm 0.5$  mm; dorsoventral:  $-4.7$ mm (Franklin and Paxinos, 2013). After being lowered to these coordinates, canulae were secured with dental cement. At the end of the surgery, the animal was placed in a ventilated cage maintained at  $28^{\circ}\text{C}$ . When normal locomotion and feeding were observed, the animal was placed back in its home cage and monitored for a week post-surgery during which analgesics were administered and the body weight recorded to ensure full recovery.

#### 4.2. Drug infusion

The CB1 receptor antagonist AM251 was infused before the PR test for wheel-running motivation estimates. AM251 ( $1\ \mu\text{g}/\text{side}$ ) or its vehicle were bilaterally infused, using 4.7-mm-long injectors connected through polyethylene tubing to a Hamilton syringe ( $10\text{-}\mu\text{l}$  volumes), at a rate of  $250\ \text{nl}/\text{min}$  for 2 minutes. The injectors were left in place for 1 minute to allow diffusion within the tissue and avoid capillarity during their removal. After the infusion, mice were returned to their home cages for 15-20 minutes before entering the operant chambers for the tests.

#### 4.3. Analysis of canulae placements

At the end of the experiment, mice were bilaterally injected with Sky Blue through the canulae before being sacrificed. Brains were rapidly removed, frozen on dry ice, and stored at  $-80^{\circ}\text{C}$  before being sliced ( $40\ \mu\text{m}$ -width) using a cryostat. A Neutral Red staining was then performed before slices were visualized under an Olympus SZX10 stereomicroscope (Olympus) to assess canulae placements.

## MATERIALS & METHODS

### **5. Local deletion of CB1 receptors in the lateral hypothalamus (LH)**

#### 5.1. Animals and viruses

To delete CB1 receptors from LH neurons, a viral construct bearing a coding sequence for the Cre recombinase was injected in 8-week-old CB1-floxed mice. The viruses were (i) an AAV-CAG-CRE-GFP allowing the expression of the Cre recombinase in infected neurons, and (ii) a control virus (AAV-CAG-GFP), both being tagged with a green fluorescent protein (GFP) to enable the post-hoc assessment of the sites of injections and viral infections.

#### 5.2. Surgery

Adult mice were anesthetized with isoflurane 5% (v/v in oxygen) before being shaved, locally disinfected, and placed on the stereotaxic frame (David Kopf Instruments), the head being maintained by atraumatic maxillary bars. The anesthesia was maintained with a mask continuously diffusing 1-2% isoflurane during all the surgery process. Before incision, saline was injected subcutaneously to avoid any dehydration during anesthesia, and lidocaine was applied at the incision site. After craniotomy, a glass pipette containing the virus was lowered to the following coordinates: anteroposterior: -1.55 mm, mediolateral:  $\pm 1.10$  mm and dorsoventral: -5.2 mm to target the anterior LH (Franklin and Paxinos, 2013). Using the Nanojet pump system, 40 nL of virus were infused bilaterally at 1 nl/second. The glass pipette was maintained for 5 minutes after the end of the injection process to allow the diffusion of the volume injected into the tissue and avoid capillarity. At the end of the surgery, the animal was placed in a ventilated cage maintained at 28°C. When normal locomotion and feeding were observed, the animal was placed back in its home cage and monitored for a week post-surgery, a period during which analgesics were administered and the body weight recorded to ensure full recovery.

#### 5.3. Analysis of the injection sites and viral expression

After the experiment, all mice were sacrificed and transcardially perfused with paraformaldehyde to fix tissues. After the extractions, brains were frozen in isopentane solution and sliced (30- $\mu$ m width) with a cryostat. Digoxigenin (DIG)-labeled riboprobes

## MATERIALS & METHODS

against mouse CB1 receptor RNA transcripts were prepared as previously described (Marsicano and Lutz, 1999). Anti-DIG antibodies conjugated to horseradish peroxidase (HRP; Roche; 1:2000) were applied 2 hours at room temperature. The signal for CB1 receptor hybridization was revealed by a Tyramide Signal Amplification (TSA) reaction using Cyanine 3-labeled tyramide (Perkin Elmer; 1:80 for 12 minutes). Then, the slices were incubated overnight at 4°C with a rabbit polyclonal antibody against GFP (1:1000; Fisher Scientific). After several washes, slices were incubated for 2 hours with a secondary anti-rabbit antibody conjugated to Alexa Fluor 488 (1:500; Fisher Scientific). Finally, free-floating sections were incubated in 4',6-diamidino-2-phenylindole (DAPI; 1:20 000; Fisher Scientific) to visualize cell nuclei and were then washed, mounted, cover-slipped and imaged with an epifluorescence Leica DM6000 microscope (Leica, Germany).

### 6. Drugs

Haloperidol, tamoxifen and hemisuccinate prednisolone were obtained from Sigma (France), rimonabant (SR141716A) from Interchim (France), and 0-2050 and AM251 from Tocris (England). All the drugs used in the present work were prepared extemporaneously before their use, except for tamoxifen and prednisolone which were made fresh every 2-3 days. Haloperidol (0.15 and 0.3 mg/kg injected i.p. 30 minutes beforehand) was dissolved in 0.9% of NaCl; rimonabant (3 mg/kg injected i.p. 30 minutes beforehand) and 0-2050 (0.5 mg/kg injected i.p. 30 minutes beforehand) or their vehicles (DMSO at a final concentration of 1.25% in a drop of Tween 80 and 0.9% NaCl injected 30 minutes beforehand). For local infusions, AM251 (1 µg/side) or its vehicle (DMSO, final concentration 10%) were diluted in cremophore (final concentration 10%) and then in 0.9% NaCl, before being administered 20-30 minutes beforehand. Prednisolone was added to drinking water to reach final concentrations of 5 and 15 µg/ml in the bottles. Finally, tamoxifen (2 mg i.p.) was dissolved in 10% absolute ethanol and 90% sesame oil.

## MATERIALS & METHODS

### 7. Statistics

Statistical analyses were performed with GB-Stat software (version 10; Dynamic Microsystems Inc., Silver Spring) and GraphPad Prism (version 8, GraphPad, San Diego), with *P* values less than 0.05 being considered significant. Genotype or treatment differences in operant responses, running durations per sequence, running distances per sequence and pellet consumptions during conditioning (FR1 and FR3 schedules), and free wheel-running were all assessed by 2-way analyses of variance (ANOVA) with a repeated design (time). Note that for Stop-CB1 and GABA-CB1-rescue mice a repeated design could not be applied as some mice did not run during several sessions (see “Results”). Homogeneity of the variances was achieved by prior logarithmic transformation of the data, if necessary. Post-hoc group comparisons (Tukey’s test) were performed only if the genotype/treatment x time interactions were found significant. Two-group (genotype or treatment) comparisons of the PR data were achieved by means of 2-tailed Student’s *t* tests. For the choice sessions, the preference ratios were compared with non-preference (50 % preference for wheel-running) by 1-tailed Student’s *t* tests.

## RESULTS

### Chapter 1 – Development of an operant conditioning paradigm to study wheel-running motivation

#### Annex 1 : Muguruza\*, Redon\* et al., (2019) *JCI insight*

The first objective of our experimental work consisted in the development and the validation of an operant conditioning task for wheel-running in mice that would have allowed pharmacogenetic investigations on its reinforcing properties. This goal first required to assess whether wheel-running could reinforce NP responding under FR and PR schedules of reinforcement (detailed in “Materials & Methods”) and, if so, its potential modulation by dopaminergic transmission (see “Introduction”). Second, we aimed at evaluating whether wheel-running was reinforcing enough as to observe a cue-induced reinstatement of running seeking after an extinction period (Shaham et al., 2003). Through a collaboration with Dr François Georges and Dr Giulia Fois (CNRS UMR 5287, Bordeaux), we next measured whether running motivation and running performance, as assessed during a PR session, are respectively associated (or not) with changes on the activity of VTA dopaminergic neurons (albeit in anaesthetized mice).

Early studies showed that wheel-running reinforces operant responses under FR or variable ratio (VR) reinforcement schedules (Belke, 1997; Iversen, 1993). However, these studies were mostly performed in rats, questioning their transferability to mice, our privileged animal model for the study of the ECS. We first showed that standard (i.e. C57Bl/6N) mice exert strong operant responses under FR and PR reinforcement schedules, demonstrating the high reinforcing properties of wheel-running in rodents. Pretreatment with either of two non-cataleptic doses of D2R antagonist haloperidol (0.15 and 0.3 mg/kg) decreased in a dose-dependent manner the numbers of NP (and the breakpoint) performed during a PR session. Interestingly, the running durations per sequence remained unaffected by haloperidol, confirming that reward consumption, as opposed to reward motivation, is independent from mesocorticolimbic dopaminergic activity (Salamone and Correa, 2012).

As indicated above, we next focused on wheel-running seeking after an extinction period. Seeking a reward after either extinction or abstinence, a hallmark of numerous



natural and drug reinforcers, is thought to model human craving (Shaham et al., 2003). As opposed to abstinence wherein the subjects are not confronted to reward-associated contexts, extinction corresponds to a reversal learning during which the operant response is no longer reinforced, thus progressively extinguishing reinforcer seeking. In our experiment, mice performed NP (in the formerly active port) during the first extinction session, doing so at a significantly higher level than that measured in the last FR sessions (fitting with the extinction “burst” commonly observed). However, this behavior rapidly weakened to reach stable close-to-zero NP scores after 8-10 sessions. Thereafter, exposure to the cue triggered reinstatement of wheel-running seeking although the wheel remained locked all session long.

In order to further characterize our conditioned running paradigm, we aimed at evaluating the relationships between running motivation on the one hand, and running performance on the other hand, and VTA dopaminergic activity. To this end, three experimental mouse groups were designed (for details see “Materials & Methods”): (i) “*operant*” mice, whose wheel-running access was rendered contingent to operant responses; (ii) “*yoked*” mice, which had access to the unlocked wheel only when an “*operant*” congener (in an adjacent chamber) unlocked its own wheel, and (iii) “*control*” mice, which were transferred to an “inactive” operant chamber for a similar number of sessions as the two preceding groups. *In vivo* electrophysiological recordings of VTA dopaminergic neurons were performed in mice anaesthetized 2 h after the end of PR sessions. Recordings from operant mice showed a significant positive correlation between (i) the number of NP performed during the PR sessions and (ii) the firing rates of VTA dopaminergic neurons. Conversely, recordings in yoked mice did not yield any correlation between running duration and the firing rates of dopaminergic neurons. Thus, VTA dopaminergic activity was positively correlated to wheel-running seeking but not to wheel-running duration (i.e. running performance), reflecting the discrimination between running motivation and performance at the neuronal level.

**Chapter 2 – Role of CB1 receptors in motivation for wheel-running**

Past studies from the laboratory have indicated that CB1 receptors located on VTA GABAergic nerve terminals exert a tonic control on "free" wheel-running in mice housed with running wheels (Dubreucq et al., 2013). Whether such an observation is accounted for by a selective CB1 receptor-dependent control of running motivation is a question we wished to answer by means of an appropriate paradigm. Having developed such a paradigm, we then investigated through pharmacological and genetic means the role of the ECS in wheel-running motivation.

Objective 1 – Pharmacological findings[Annex 1: Muguruza\\*, Redon\\* et al., \(2019\) JCI insight](#)

In a first series of experiments, we investigated the impact of a pretreatment (30 minutes beforehand) with a selective CB1 receptor antagonist, namely rimonabant, on NP performance during a PR session. The results brought evidence that CB1 receptors control running motivation but not running performance (as assessed by the running duration per rewarded sequence). The results were not accounted for by the inverse agonist properties of rimonabant because pretreatment with O-2050, a neutral CB1 receptor antagonist, provided similar results to those measured with the former antagonist.

The finding that CB1 receptors control running motivation, but not intrinsic running performance, confirms the suggestion based on *in vivo* electrophysiological recordings that these are two independent reward dimensions.

Objective 2 – Genetic findings[Annex 1: Muguruza\\*, Redon\\* et al., \(2019\) JCI insight](#)

In this second set of experiments, we aimed at (i) confirming through genetics the above pharmacological findings, and (ii) investigating which CB1 receptor subpopulation(s) control(s) wheel-running motivation.

***Effects of the constitutive deletion of CB1 receptors***

We first evaluated the effects of a constitutive deletion of CB1 receptors (i.e. CB1-KO mice) on wheel-running reinforcing properties. Interestingly, a decreased level of response was already observed during the conditioning phase under FR schedules, even though mice still displayed learning and operant responses that met our criteria of inclusion. However, the mutants' wheel-running performances, as assessed by the mean running duration per sequence, was indistinguishable from those reached by their wild-type (CB1-WT) littermates. These results extended to the PR reinforcement schedule, with a striking decrease in wheel-running motivation ( $79 \pm 11\%$  reduction in the number of NP) as compared to CB1-WT mice. Again, the two genotypes did not differ with respect to the running duration per rewarded sequence.

Taken together, these genetic findings confirmed the above-mentioned pharmacological observations, i.e. CB1 receptors control running motivation but not running performance under conditioned settings. However, the global approaches used so far (i.p. injections and constitutive genetic deletions) did not allow us to determine through which means CB1 receptors exert their control over motivation for wheel-running. Our first quest was to determine the identity of the cell hosting the CB1 receptor populations involved in this control. To address this issue, we took advantage of our conditional mutant mouse lines bearing genetic deletions of CB1 receptors in specific neuronal populations (e.g. GABAergic, glutamatergic...etc).

***The conditional deletion of CB1 receptors in GABAergic neurons decreases wheel-running motivation***

In keeping with the prime importance of CB1 receptors located on VTA GABAergic terminals in voluntary wheel-running performance (Dubreucq et al., 2013), we first investigated if this role was accounted for by a control of wheel-running motivation. To do so, we used the Dlx5/6-CB1 line wherein littermates are deleted for their CB1 receptors on GABAergic neurons (called from now on GABA-CB1-KO mice for the sake of clarity) or not (GABA-CB1-WT mice). Interestingly, during conditioning, GABA-CB1-KO mice displayed decreased levels of operant responses, as compared to their GABA-CB1-WT littermates; on the other hand, the running duration per rewarded sequence remained unaffected by the mutation. As for the differences between CB1-

KO and CB1-WT mice, these decreases in operant responses under FR schedules extended to PR schedules, with GABA-CB1-KO mice displaying an important decrease in maximal responding rates ( $57 \pm 9\%$  reduction) even though their running duration per sequence did not differ from that of GABA-CB1-WT mice.

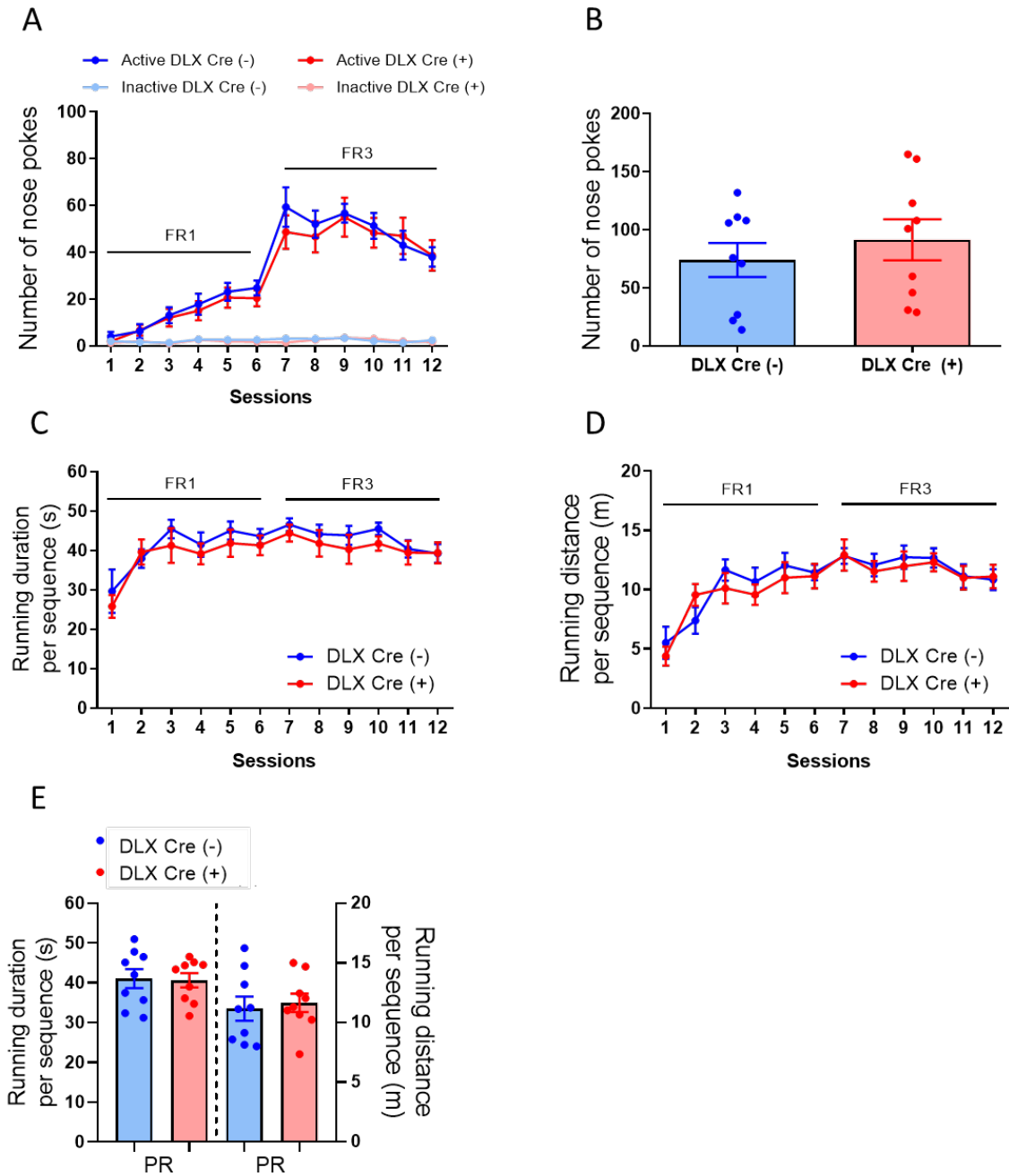
This experiment suggested that CB1 receptors located on GABAergic neurons are necessary for wheel-running motivation. This suggestion opened the possibility that these receptors might also be sufficient for running motivation. To address this issue, we then used another genetic approach based on a selective re-expression of CB1 receptors in GABAergic neurons in mice devoid of CB1 receptor expression (for details see “Materials & Methods”), hereafter called GABA-CB1-rescue mutant mice. During conditioning, mice devoid of CB1 receptor expression (hereafter called Stop-CB1 mice) - through insertion of Stop cassettes which flank the CB1 receptor gene - displayed (as expected) a low level of responding under FR reinforcement schedules which was comparable to that of CB1-KO mice. However, rescuing CB1 receptors in GABAergic neurons in Stop-CB1 mice was sufficient to substantially increase NP responses. Even though a 2-way ANOVA revealed a significant genotype effect on the running duration per sequence, this effect was accounted for by the first sessions when Stop-CB1 mice were responding at a close-to-zero level, a phenotype which was no longer observable at the end of the conditioning when mice met our inclusion criteria (in accordance with our observations in CB1-KO mice). Of note was the final observation that the GABA-CB1 re-expression significantly increased the maximal responding under a PR schedule, as compared to Stop-CB1 mice, doing so without affecting running performances (albeit the low number of successful Stop-CB1 mice impedes definitive conclusions).

This set of experiment demonstrated that (i) CB1 receptor deletion in GABAergic neurons negatively impacts wheel-running motivation without affecting (conditioned) running performance, and (ii) the selective re-expression of this subset of receptors (in mice lacking CB1 receptor expression) is sufficient to restore the motivation for this reinforcer. We thus concluded that CB1 receptors located on GABAergic neurons are both necessary and sufficient for wheel-running motivation but not performance.

***The Dlx5/6-Cre recombinase: a control for the genetic construct of the GABA-CB1 mouse line***

As indicated in “Materials & Methods”, the GABA-CB1 line results from the crossings between (i) CB1-floxed females and (ii) males harboring a Cre recombinase under the control of Dlx5/6 promoters (Bellocchio et al., 2010; Dubreucq et al., 2013; Monory et al., 2006) thought to be specific for forebrain GABAergic neurons (but see Dubreucq et al., 2013 for the possibility that such a specificity extends to midbrain GABAergic neurons). To ensure that the above-mentioned decrease in running motivation in GABA-CB1-KO mice was due to CB1 receptor deletion and not to the presence of the Dlx5/6-Cre recombinase, mice harboring (Dlx-cre (+)) or not (Dlx-cre (-)) that Cre recombinase (abbreviated Dlx-cre) were both tested in our operant conditioning protocol (n=9/genotype; Figure 11). A similar approach was previously used under free wheel-running conditions, demonstrating that the Dlx5/6-Cre recombinase lacked intrinsic influence (Dubreucq et al., 2013). Here, mice were conditioned, as previously described, under FR1 and FR3 schedules of reinforcement. All animals learned how to perform the operant responses in a comparable manner, and no genotype difference appeared throughout these sessions (2-way ANOVA,  $F(1,16) = 0.2203$ ;  $p = \text{NS}$ ; Figure 11A). Further, Dlx-cre (+) did not differ from their WT littermates when tested under a PR schedule of reinforcement (t-test,  $t = 0.7628$ ,  $df = 16$ ,  $p = \text{NS}$ ; Figure 11B). In addition, to ensure that the genetic construct would not alter wheel-running performances along the protocol, running durations and distances per sequences were assessed. Extending the above-mentioned observations under free wheel-running conditions (Dubreucq et al., 2013), no difference was observed between Dlx-cre (+) and Dlx-cre (-) during FR schedules, whether running durations per sequence (2-way ANOVA,  $F(1,16) = 0.7350$ ;  $p = \text{NS}$ ; Figure 11C) or running distances per sequence (2-way ANOVA,  $F(1,16) = 0.1352$ ;  $p = \text{NS}$ ; Figure 11D) were concerned. These observations extended respectively (t-tests,  $t = 0.1382$ ,  $df = 16$ ,  $p = \text{NS}$  and  $t = 0.3802$ ,  $df = 16$ ,  $p = \text{NS}$ ) to the performances measured during the PR session (Figure 11E).

These data strengthen our initial suggestion that it is the absence of CB1 receptors in GABAergic neurons which weakens wheel-running motivation.



**Figure 11 - Wheel-running reinforcing properties were not altered in mice expressing the Cre recombinase under the *Dlx5/6* promoter.** Number of NP under (A) FR and (B) PR schedules were not different between *Dlx-cre* (+) ( $n = 9$ ) and their *Dlx-cre* (-) littermates ( $n = 9$ ). Wheel-running performances, as assessed through (C) running durations and (D) running distances per sequence did not show difference between genotypes, a trend also observed under (E) PR schedules. Data represent mean  $\pm$  SEM.

***Conditional deletion of CB1 receptors on glutamatergic neurons: involvement in wheel-running performances***

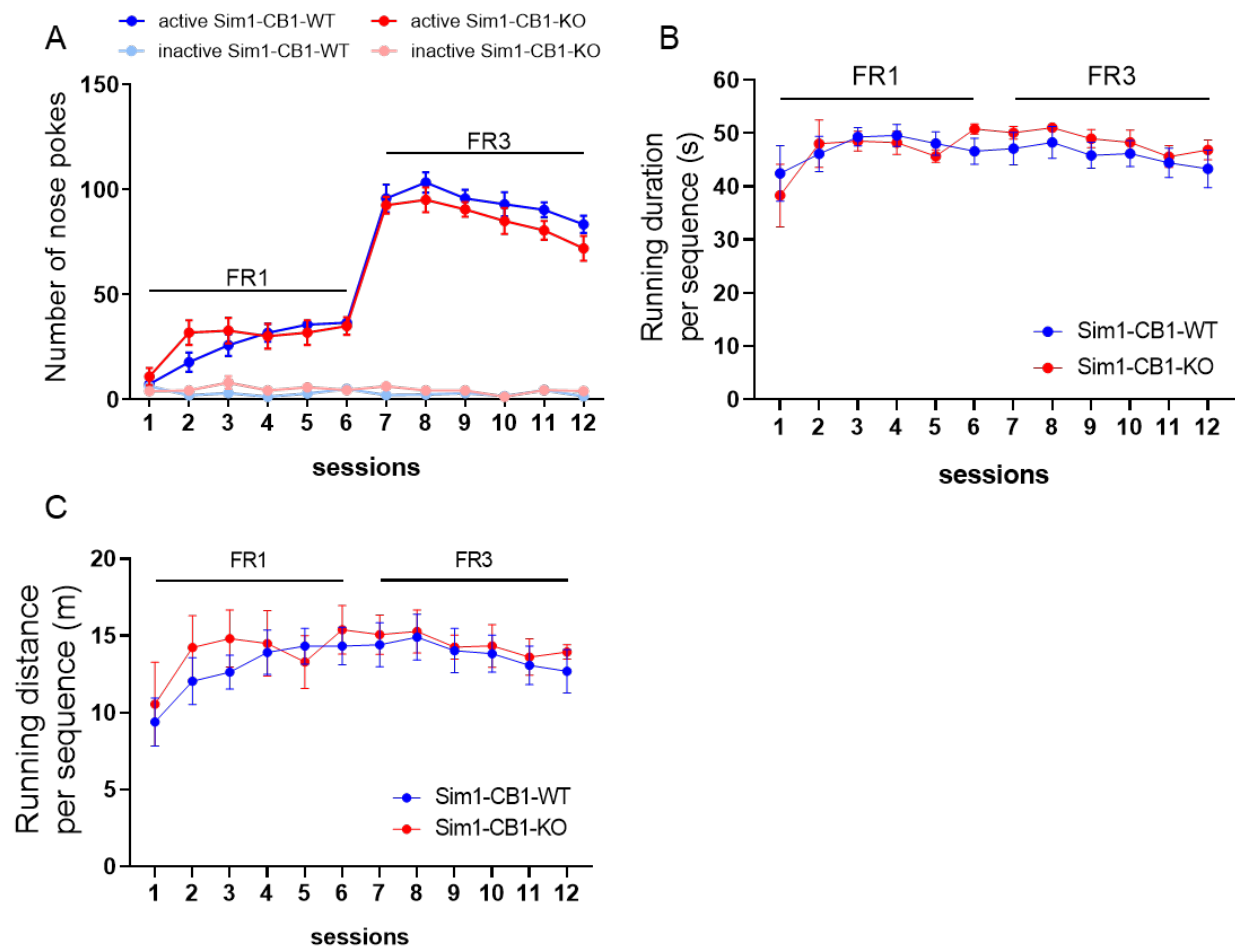
Previous studies demonstrated opposite functional consequences of CB1 receptor deletions in GABAergic *versus* glutamatergic neurons (Bellocchio et al., 2010; Martín-García et al., 2016). Thus, we extended our investigation to the impact of CB1 receptor deletion in cortical glutamatergic neurons (Glu-CB1-KO mice, as opposed to Glu-CB1-WT mice) on wheel-running motivation. In contrast to GABA-CB1-KO mice, Glu-CB1-KO mice performed as well as their WT littermates regarding the numbers of NP under FR and PR reinforcement schedules. On the other hand, these mutants displayed a significant increase in the running duration per rewarded sequence during the last FR sessions, a finding which extended to the PR session.

It was concluded that CB1 receptors located on cortical glutamatergic neurons are not involved in the control of wheel-running motivation. On the other hand, this subset of receptors bears a role in wheel-running performance. This role is however limited to conditioned running conditions because Glu-CB1-KO mice do not differ from their WT littermates under free wheel-running conditions (Dubreucq et al., 2013).

***Conditional deletion of CB1 receptors in Sim1-positive neurons***

The hypothalamus is of prime importance for the regulation of energy balance, a function accounted for by its ability to integrate a variety of internal and external signals (Morton et al., 2006). Interestingly, hypothalamic CB1 receptors are particularly involved in this regulation. Indeed, removal of these receptors from this brain area leads to a resistance to weight gain accompanied by an increased energy expenditure without changes in total food intake (Cardinal et al., 2012). Interestingly, these phenotypes were also observed in Sim1-CB1-KO mice, mice in which CB1 receptors are deleted from Sim1-positive neurons, meaning virtually all neurons from the paraventricular nucleus of the hypothalamus (PVN; Cardinal et al., 2015). The observation that Sim-CB1-KO mice display increased energy expenditure compared to their WT littermates led us to investigate whether the reinforcing value of wheel-running is altered in these mutants (FR sessions) so that they would display increased motivation for wheel-running (PR sessions). To test this hypothesis, we exposed the Sim1-CB1 mouse line to our operant conditioning protocol (Sim-CB1-WT: n = 9; Sim-

CB1-KO:  $n = 6$ ). The deletion of CB1 receptors did not affect either the learning or the operant responses during the conditioning phase under FR schedules (2-way ANOVA:  $F(1,13) = 0.2210$ ;  $p = \text{NS}$ ; Figure 12). This lack of influence extended to wheel-running performances, whether the running duration per sequence (2-way ANOVA:  $F(1,13) = 0.1278$ ;  $p = \text{NS}$ ; Figure 12B) or the running distance per sequence (2-way ANOVA:  $F(1,13) = 0.2409$ ;  $p = \text{NS}$ ; Figure 12C) were concerned.



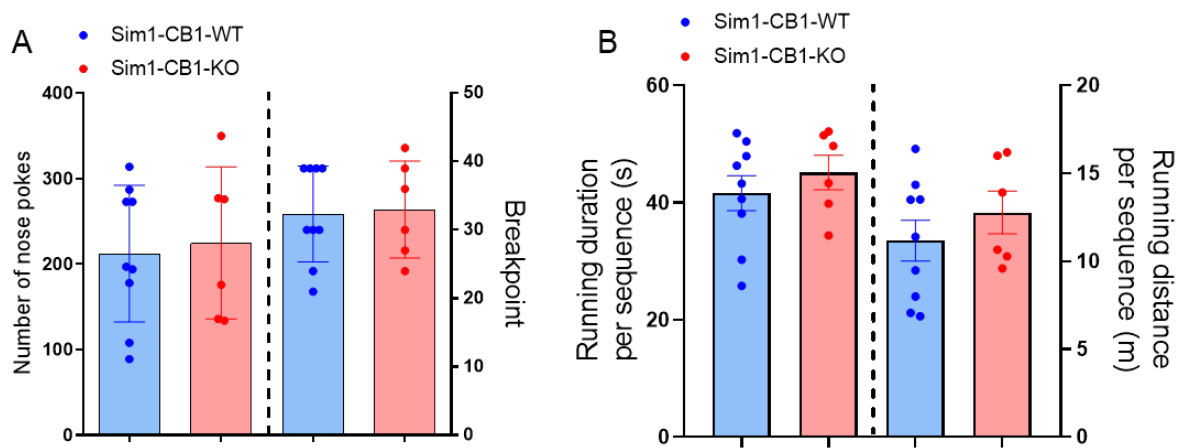
**Figure 12 - The deletion of CB1 receptors from Sim1-positive neurons did not alter wheel-running reinforcing properties under FR schedules.** (A) Number of NP under FR schedules were similar for both Sim1-CB1-KO ( $n = 6$ ) and their WT littermates ( $n = 9$ ). (B, C) Performance of wheel-running assessed through (B) running duration and (C) running distance per sequence. Data represent mean  $\pm$  SEM.

Similar observations were made under the PR schedule of reinforcement. Thus, Sim1-CB1-KO mice did not display significant differences in the number of NP performed (t-



test:  $t = 0.2790$ ,  $df = 13$ ,  $p = \text{NS}$ ; Figure 13A left) or in the breakpoint reached (t-test:  $t = 0.1797$ ,  $df = 13$ ,  $p = \text{NS}$ ; Figure 13A right) as compared to their Sim1-CB1-WT littermates. As observed during the conditioning, wheel-running performances were genotype-insensitive (t-tests, running duration per sequence:  $t = 0.8039$ ,  $df = 13$ ,  $p = \text{NS}$ ; Figure 13B left, and running distance per sequence:  $t = 0.9234$ ,  $df = 13$ ,  $p = \text{NS}$ ; Figure 13B right).

Taken together, these results suggest that CB1 receptors in Sim1-positive neurons do not control wheel-running motivation or performance.

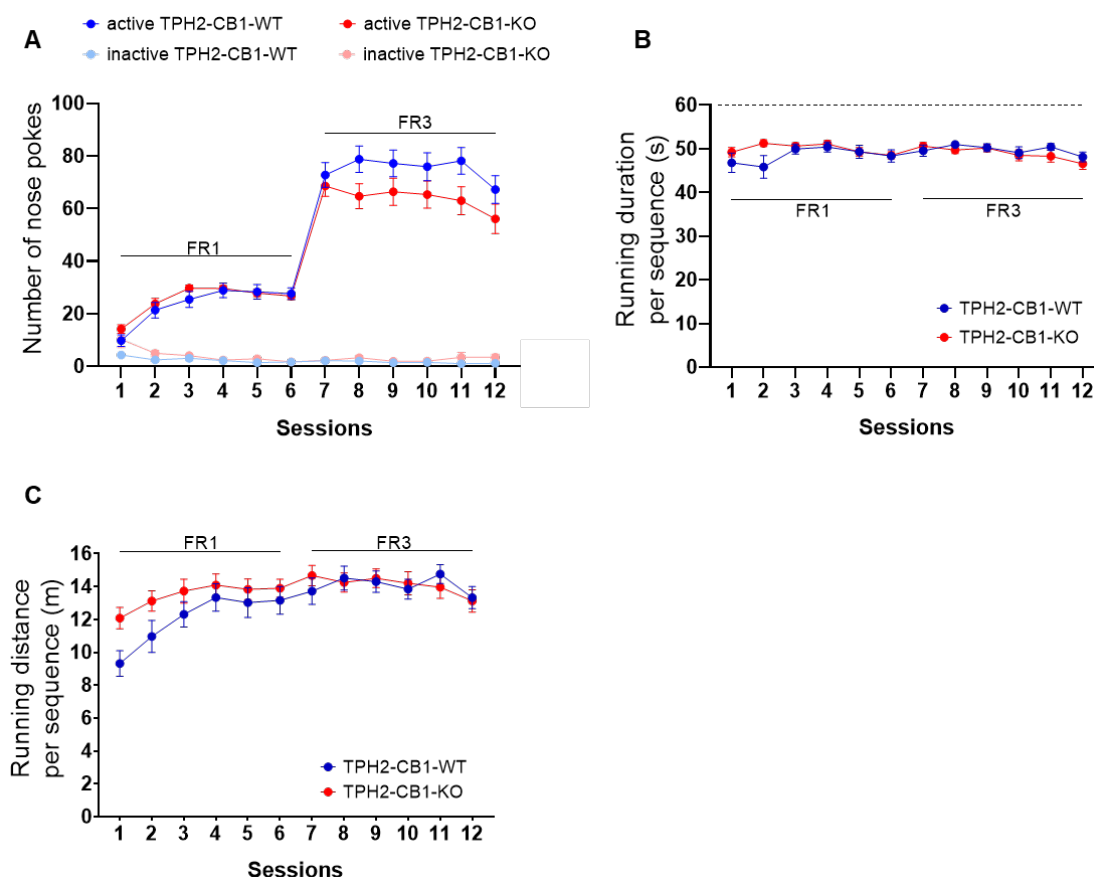


**Figure 13 - The deletion of CB1 receptors from Sim1-positive neurons altered neither running motivation nor running performance.** (A) Operant responding of Sim-CB1 mice under PR schedule expressed as (left) numbers of NP and (right) breakpoints. (B) Running performances of Sim-CB1 mice under PR schedule, as assessed through (left) running duration and (right) running distance per sequence. Data represent mean  $\pm$  SEM.

### **Conditional deletion of CB1 receptors on TPH2-positive neurons**

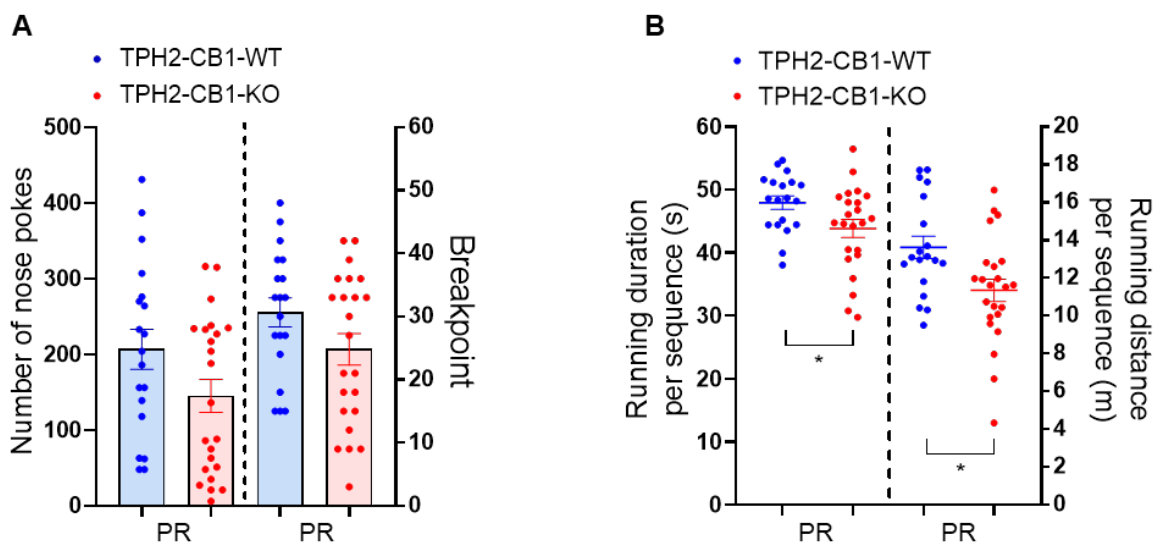
In keeping with the role of serotonergic transmission in reward-related processes (Fischer and Ullsperger, 2017; Liu et al., 2014), and especially the involvement of serotonergic projections from dorsal raphe nucleus (DRN) onto VTA dopaminergic neurons (Li et al., 2016; Wang et al., 2019), we investigated the effects of the CB1 receptor deletion from serotonergic neurons on wheel-running reinforcing properties and motivation. To this end, we used a TPH2-Cre<sup>ERT2</sup>-CB1 mouse line (Dubreucq et al., 2013), in which CB1 receptors are deleted (TPH2-CB1-KO,  $n = 23$ ) or not (TPH2-CB1-WT,  $n = 19$ ) from neurons expressing the rate-limiting enzyme in serotonin synthesis, namely tryptophane hydroxylase 2 (TPH2). As opposed to the other lines

tested during the Thesis, the genetic construct of this line allows the post-developmental deletion of CB1 receptors through tamoxifen treatment. The animals entered our operant conditioning protocol 3 weeks after the induction treatment (for details see “Materials & Methods”) to ensure that CB1 receptors were deleted all along the protocol. As it can be observed in Figure 14, TPH2-CB1-KO did not significantly differ from their WT littermates (2-way ANOVA:  $F(1,40) = 1.328$ ,  $p = \text{NS}$ ; Figure 14A) even though a tendency for a lower level of response could be noted under FR3 schedules (see “Discussion”). Regarding performances during conditioning, even though TPH2-CB1-KO performed an increased running distance during the first sessions, both running durations per sequence (2-way ANOVA:  $F(1,40) = 0.1151$ ;  $p = \text{NS}$ ; Figure 14B) and distances per sequence (2-way ANOVA:  $F(1,40) = 0.9311$ ,  $p = \text{NS}$ ; Figure 14C) were similar between genotypes.



**Figure 14 - The deletion of CB1 receptors from TPH2-expressing neurons did not affect wheel-running under FR schedules.** (A) Number of NP performed under FR schedules were similar between TPH2-CB1-KO mice ( $n = 23$ ) and their WT littermates ( $n = 19$ ). (B,C) Wheel-running performances, as assessed by (B) the running duration per sequence and (C) the running distance per sequence were similar between genotypes. Data represent mean  $\pm$  SEM.

Under a PR schedule of reinforcement, we observed a tendency for a decrease in the maximal responding in TPH2-CB1-KO mice, although not significant (t-tests:  $t = 1.825$ ,  $df = 40$ ,  $p = \text{NS}$  for the number of NP, and  $t = 1.687$ ,  $df = 40$ ,  $p = \text{NS}$  for the breakpoint; Figure 15A). Interestingly, the observation of this last panel suggests the presence of two populations of TPH2-CB1-KO mice during this session even though CB1 receptor deletion was ascertained in all animals afterwards (see “Discussion”). Besides, TPH2-CB1-KO displayed lower running durations per sequence (t-test:  $t = 2.234$ ,  $df = 40$ ,  $p = 0.0311$ ) and running distances per sequence (t-test:  $t = 2.696$ ,  $df = 40$ ,  $p = 0.0102$ ) than their TPH2-CB1-WT littermates during the PR session (Figure 15B).



**Figure 15 - Effects of CB1 receptor deletion from TPH2-positive neurons on wheel-running under PR schedule.** (A) Operant responses, expressed as (left) number of NP and (right) breakpoint, revealed two populations in the TPH2-CB1-KO group and an overall nonsignificant decreased operant response versus their WT. (B) Wheel-running performances were negatively affected in TPH2-CB1-KO as assessed by a decreased (left) running duration- and (right) distance- per sequence. Data represent mean  $\pm$  SEM. \* $p < 0.05$  for 2-group comparisons by Student's t-test.

No firm conclusion can be drawn regarding the potential influence of CB1 receptors on TPH2-expressing neurons on wheel-running motivation. Indeed, when compared to their TPH2-CB1-WT littermates, TPH2-CB1-KO mice tended to display a lower level of responding during both the conditioning and the PR sessions. However, two populations were observed in TPH2-CB1-KO mice exposed to a PR reinforcement schedule, questioning the origin of such a subdivision (see “Discussion”). In contrast, wheel-running performances were homogeneously decreased in TPH2-CB1-KO.

***Conclusions raised by the genetic findings:***

Using genetic approaches, we demonstrated that CB1 receptors located on **forebrain GABAergic neurons** are necessary and sufficient for wheel-running motivation whereas CB1 receptors located on **cortical glutamatergic neurons** are involved in wheel-running performances. In contrast, CB1 receptors located on **Sim1-positive neurons** are dispensable for wheel-running motivation and performances. Finally, CB1 receptors located on **serotonergic neurons** bear a role in wheel-running performance.

Objective 3 – Specificity of the role of the endocannabinoid system in wheel-running motivation: comparison with palatable food motivation

***Annex 1: Muguruza\*, Redon\* et al., (2019) JCI insight***

In this section, we aimed at evaluating whether the role of CB1 receptors on wheel-running motivation could extend to the motivation for another natural reward, namely palatable food. Indeed, it has been shown that CB1 receptors control feeding, with different receptor subsets exerting opposite effects (Bellocchio et al., 2010). After having developed an operant conditioning protocol for the study of palatable food motivation in food-restricted mice (see “Materials & Methods”), we went through pharmacological and genetic approaches to further delineate the role of different CB1 receptor populations, as performed for wheel-running motivation.

***Pharmacological findings***

As we did for wheel-running, the first approach consisted in the acute blockade of CB1 receptors before the PR session in trained C57Bl/6N mice. We thus injected rimonabant according to conditions (3 mg/kg i.p., 30 minutes beforehand) shown to be effective against running motivation. As already described in the literature, this pretreatment decreased the maximal number of NP performed for palatable food under a PR schedule of reinforcement ( $54 \pm 7\%$ ), confirming that CB1 receptors are involved in the regulation of motivation for palatable food, including in our experimental setting.

***Constitutive deletion of CB1 receptors***

To further confirm this observation, we used mice bearing a constitutive deletion of CB1 receptors. As observed for wheel-running motivation, CB1-KO animals displayed decreased levels of operant responses for palatable food under FR and PR schedules of reinforcement. These changes were associated with concomitant decreases in food consumption. Of note is the observation that in CB1-KO mice the reduction in the maximal number of NP performed under the PR schedule ( $36 \pm 5\%$ ) was lower than that measured during wheel-running motivation tests ( $79\% \pm 11\%$ ), thus suggesting the involvement of other regulatory systems in palatable feeding motivation.

***Conditional deletion of CB1 receptors in GABAergic neurons***

The major role exerted by CB1 receptors located on (forebrain) GABAergic neurons on wheel-running motivation was found to be specific to the latter reward (at least compared to palatable feeding). Thus, when tested for palatable food motivation, GABA-CB1-KO mice did not differ from their WT littermates when compared for their respective behaviors during FR and PR sessions.

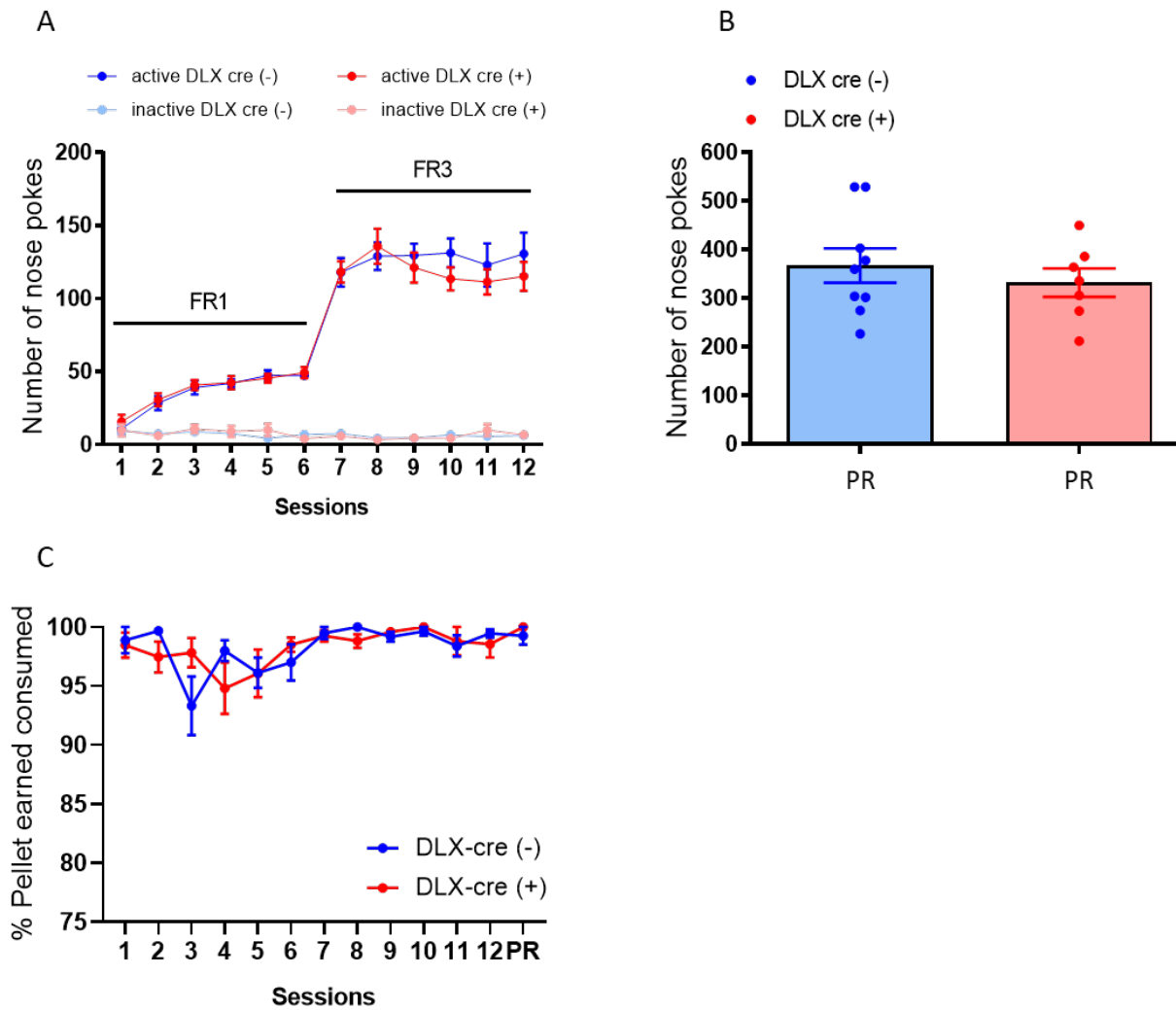
***Conditional deletion of CB1 receptors in glutamatergic neurons***

To further dissect which CB1 receptor subpopulation is involved in the above-mentioned control of palatable food motivation by CB1 receptors, we next evaluated the effects of the conditional deletion of CB1 receptors in cortical glutamatergic neurons (Glu-CB1-KO). As observed with the GABA-CB1 mouse line, Glu-CB1-KO mice did not differ from their WT littermates for their respective operant responses (NP) and food consumption rates during FR and PR sessions.

***DLX5/6-Cre recombinase***

The previous sets of experiments provided evidence for a differential role of CB1 receptors located on Dlx5/6-expressing neurons on running motivation and palatable feeding motivation (this subset of CB1 receptors being dispensable for the latter). However, to ensure that such a conclusion was valid, we aimed at evaluating the

intrinsic effect of the Dlx5/6-Cre recombinase (Dlx-Cre) on feeding motivation as we did for running motivation. To do so, the reinforcing values of palatable feeding were measured in DLX-cre (+) ( $n = 7$ ) and their WT littermates ( $n = 9$ ), i.e. DLX-cre (-). After habituation sessions, mice were conditioned under FR1 and then FR3 schedules of reinforcement learning. This learning step was achieved without genotype differences (as assessed by discrimination ratios between active and inactive NP ports; data not shown). As expected, genotypes did not differ with respect to their operant responding scores (2-way ANOVA:  $F(1,14) = 0.1471$ ;  $p = \text{NS}$ ; Figure 16A). This observation extended to operant responding scores under PR schedules, as the mean maximal number of NP performed by DLX-cre (+) was indistinguishable from that of their DLX-cre (-) littermates (t-test:  $t = 0.7279$ ,  $df = 14$ ;  $p = \text{NS}$ ; Figure 16B). To ensure that the pellets earned through operant responding were really consumed after their delivery, the percentages of pellet effectively eaten after being earned were measured in both genotypes. These measures revealed consumption rates  $> 90\%$ , with no difference between the two genotypes under both FR and PR schedules of reinforcement (2-way ANOVA:  $F(1,14) = 0.0001$ ;  $p = \text{NS}$ ; Figure 16C).



**Figure 16 - Mice with cre recombinase expression under the *Dlx5/6* promoter display no alteration in palatable food motivation.** (A) Numbers of NP under FR schedules were similar in DLX cre (+) mice ( $n = 7$ ) and their cre (-) littermates ( $n = 9$ ). (B) Maximal numbers of NP performed under PR schedules were similar between genotypes. (C) The percentages of pellets earned and effectively consumed (under both FR and PR schedules), were above 90% without differences between genotypes. Data represent mean  $\pm$  SEM.

In conclusion, the genetic construct used to generate our GABA-CB1 mouse line does not alter *per se* the level of operant responding and the motivation for palatable food. In turn, this result clearly indicates that CB1 receptors on *Dlx5/6*-positive GABAergic neurons do not control palatable food motivation, as opposed to wheel-running motivation.

**Conclusion of objective 3**

This set of experiment suggests that even though CB1 receptors are involved in the motivation for palatable food (and other drug and nondrug rewards; see “Introduction”), CB1 receptors expressed in GABAergic neurons control motivation in a reward-specific manner. However, both experiments were conducted in separate groups of animals, each having access to only one reward, either wheel-running or palatable food. At a translational level, these experiments are thus prone to criticisms. Indeed, in their daily lives, humans and animals have to choose between concurrent rewards. We thus aimed to decipher the role of CB1 receptors in the choice between wheel-running and palatable food, doing so at the motivation level. The relevant experiments are thus described in the following section.

Objective 4 – Role of CB1 receptors in a wheel-running/palatable food choice paradigm

Annex 1: Muguruza\*, Redon\* et al., (2019) *JCI insight*

In this set of experiments, mice were exposed to our recently developed choice protocol between wheel-running and palatable food (see Annex 2: Redon et al., (2019) *Bio-protocol* for an extensive description of the protocol). As mentioned above (see “Materials & Methods”), the animals are first daily conditioned for each reward proposed alone (reward order counterbalanced each day to dampen the influence of one reward over another). This conditioning is slightly different from the protocols used in the previous sections in that it consists in two 30-min sessions (as opposed to 1 hour in the operant conditioning protocol for wheel-running studies) and all animals are fed *ad libitum* in their home cages (*versus* food-restriction in the operant conditioning protocol for palatable feeding studies). Once conditioned, the subjects are exposed once daily to both rewards made concurrent. Indeed, preference for one reward excludes the possibility to obtain the other one for a given time (time-out period of 5 seconds after the rewarded sequence) rendering wheel-running and palatable food mutually exclusive. At the end of this phase, the animals undergo several sessions of choice under food restriction to strengthen the drive for food and we analyze its consequences on running motivation. Using this protocol, we investigated the role of



CB1 receptors by means of our constitutive (CB1-KO) and conditional (GABA-CB1-KO and Glu-CB1-KO) mutant mice.

In the first step of the protocol, when rewards were presented daily in independent sessions under *ad libitum* feeding conditions, we confirmed the above results when wheel-running or palatable food were proposed alone. Thus, CB1-KO mice and GABA-CB1-KO mice displayed lower levels of operant responses for wheel-running whereas no difference was observed in Glu-CB1-KO animals, compared to their respective WT littermates. Furthermore, CB1-KO mice, but neither GABA-CB1-KO mice nor Glu-CB1-KO mice, responded less than their WT counterparts for palatable food. However, we noticed a slight decrease in operant responses for palatable food in Glu-CB1-KO mutants. This contrasts with the observation made when animals were food-restricted before being proposed palatable food (see above), a metabolic status which might underlie such a trend.

In addition to these findings, we also compared the respective levels of operant responses for each reward proposed alone in all genotypes ([Annex 1: Muguruza\\*, Redon\\* et al., \(2019\) JCI Insight, supplementary figures](#)). Whatever the line under scrutiny, WT animals always displayed higher levels of operant responding for wheel-running than for palatable food, a phenotype also observed in Glu-CB1-KO mice. However, this observation did not extend to CB1-KO and GABA-CB1-KO which displayed similar levels of operant response for either reward.

Once conditioning was completed, animals underwent a daily 1-hour session during which both rewards were made concurrent and mutually exclusive (for details see “Materials & Methods”). The animals were kept under *ad libitum* feeding conditions in their home cages for the first 5 sessions whilst sessions 6 and 7 were performed under food restriction (as to reach 85-90 % of their initial body weight). Interestingly, both CB1-KO and GABA-CB1-KO animals showed lower levels of operant responses for wheel-running, as compared to their WT littermates, and these levels remained unchanged throughout the protocol (including under food restriction). In contrast, the levels of responses of Glu-CB1-KO mice were not different from Glu-CB1-WT animals.

When both rewards are considered concurrently, we observed that WT animals of all lines had significantly higher levels of responses for wheel-running over palatable food, and this was reverted under food restriction. However, it is interesting to note that even

though the levels of responses for palatable food drastically increased under food restriction, the response for wheel-running either remained unchanged or only slightly decreased, strengthening that wheel-running is a highly reinforcing reward in mice. To be able to compare the respective wheel-running preferences in each genotype, we calculated a preference ratio based on the level of operant responses for wheel-running over the total operant responses (wheel-running + food). Interestingly, CB1-KO and GABA-CB1-KO displayed higher levels of responses for palatable food all along the protocol, as reflected by a significantly lower preference ratio than their respective WT. In contrast, Glu-CB1-KO animal displayed a pattern of responding similar to that of their Glu-CB1-WT littermates, and no difference was observed regarding the preference ratio in both genotypes.

#### ***Conclusion of objective 4***

This set of experiments indicates that the crucial role exerted by CB1 receptors in GABAergic neurons on wheel-running motivation extends to a situation wherein the latter is in concurrence with another natural reward, namely palatable food.

**Chapter 3 – Modulation of wheel-running motivation**

The previous chapter focused on the tonic control exerted by CB1 receptors on wheel-running motivation, including in a running/feeding choice paradigm. The present chapter is aimed at evaluating whether wheel-running motivation might be further increased by directly/indirectly stimulating CB1 receptors. We also asked whether drugs endowed with ergogenic properties (i.e. doping agents) act on wheel-running motivation. Finally, we wondered whether the widely used ABA model recapitulates one core feature observed in some of anorexic patients, i.e. increased exercise motivation.

Objective 1 – CB1 receptor stimulation and wheel-running motivation

*Annex 3: Hurel\*, Muguruza\* et al., (2021) Prog. Neuropsychopharmacol. Biol. Psychiatry*

Recent self-reports indicate a link between cannabis and exercise. Sport practitioners in states where cannabis is legalized and anecdotal reports from athletes revealed that cannabis might be taken before and/or after exercising with the aim to improve motivation, performance, or pleasure, and/or to alleviate post-exercise fatigue and pain (Nguyen, 2019; YorkWilliams et al., 2019). Collectively, these observations have driven interest to characterize the scientific grounds of these potential links. Together with the results of Chapter 1 and 2, these observations question the possibility to indeed increase exercise motivation by further stimulating CB1 receptors. To address this question, we measured the effects of direct (i.e. THC) or indirect (i.e. JZL184, an inhibitor of MGL) CB1 receptor stimulation on running motivation. The results indicate first that direct activation of CB1 receptors did not affect exercise motivation or performance although it proved efficient at increasing motivation for another natural reward, namely palatable food. Furthermore, indirect stimulation (potentiation) of CB1 receptors through blockade of 2-AG degradation proved also inefficient on wheel-running motivation and performance (motivation for palatable food was not tested). These results indicate that stimulation of CB1 receptors does not increase exercise motivation or performance, even though limitations preclude firm conclusions (see “Discussion”).

Objective 2 – Doping agents and wheel-running motivation: the example of glucocorticoids

Annex 4: Redon et al., (2019) *Psychoneuroendocrinology*

The ergogenic effects of glucocorticoids are thought to be mainly accounted for by their peripheral effects. However, glucocorticoids, through their receptors (GRs) present in numerous brain areas (Kloet et al., 2005; McEwen et al., 1986), exert central effects. As an illustration, GRs are present in the mesocorticolimbic system where they mediate the stimulating effects of glucocorticoids on seeking drugs of abuse (cocaine, amphetamine: Ambroggi et al., 2009; Parnaudeau et al., 2014; Piazza and Moal, 1997). The latter findings thus indicate that glucocorticoids might stimulate motivation for exercise, hence suggesting that their doping properties might also be accounted for by their central effects. To test this hypothesis, mice repeatedly treated with a synthetic glucocorticoid, namely prednisolone, were tested in operant conditioning under FR and PR schedules as to assess wheel-running motivation and performances. Indeed, none of the doses tested (5 and 15 µg/ml in drinking water) impacted operant responses for wheel-running during conditioning; conversely, they significantly decreased wheel-running performance, as assessed by the distance ran per sequence. On the other hand, the lowest dose of prednisolone decreased wheel-running motivation and performance under a PR schedule of reinforcement. To ensure that our treatments were ergogenic, muscular resistance was measured by means of wire grid-hanging tests. Individual analyses revealed that muscular performance scores in this test were independent from wheel-running motivation, i.e. mice in which the ergogenic impact of prednisolone was the highest were not those displaying the highest level of running motivation. Given the negative impact of prednisolone on wheel-running performances, which suggested an inhibitory effect on reward “consumption”, another group of mice was tested under a “free” wheel-running paradigm allowing a non-contingent access to the running wheels in their home cages. Indeed, both doses of prednisolone were devoid of effects on wheel-running performances in this test, even though the ergogenic impact of these treatments were once again assessed through the wire grid-hanging test.

Accordingly, by the use of free and cost-based access to wheel-running, the present work suggests that the ergogenic effects of glucocorticoids do not involve a stimulation of exercise motivation.

Objective 3 – Illustration of the limits of free wheel-running paradigms for the study of human pathologies: the ABA model

Annex 5: Hurel\*, Redon\* et al., (2019) *Frontiers in Pharmacology*

The ABA model, wherein food restricted mice given daily a constant amount of food increase their running activities at the expense of feeding, is widely used to investigate the neurobiology underlying AN (Boakes, 2007; Kim, 2012; Méquinion et al., 2015; Scheurink et al., 2010). We aimed at evaluating the construct validity of this model by asking whether (i) early-life stress, thought to be an etiological determinant of AN (Canetti et al., 2008; Leung et al., 2000; Pike et al., 2008; Romans et al., 2001), would amplify running activity at the expense of feeding, and whether (ii) such an imbalance finds its roots at the motivation level. In the present study, post-weaning isolation rearing (PWIR) was used as a model of early trauma (Fone and Porkess, 2008).

As a first approach, female C57Bl/6N, either PWIR or control (grouped by 3), were exposed to an ABA protocol; as expected, all mice displayed a drastic decrease in body weight, the latter being more important in PWIR mice. Interestingly, PWIR mice displayed significantly higher food-anticipatory activity (FAA) compared to control mice. To understand whether increased FAA was reflective of an alteration at the motivation level, we used our operant conditioning protocols to evaluate (i) the impact of food-restriction on wheel-running motivation before (ii) assessing the impact of PWIR in the motivation for palatable food and wheel-running, and (iii) the preference when both are concurrent. Even though no difference was observed under FR schedules, responding under PR schedules yielded a clear sex-dependent difference, with food-restricted males displaying an increased motivation for wheel-running compared to *ad libitum* fed littermates whereas females remained insensitive. The next question was thus whether PWIR was inducing an alteration in motivation that could account for the amplification of the phenotype observed in the ABA protocol. Interestingly, when males were tested under PR schedules of reinforcement, statistical analyses revealed a reward x housing interaction mainly explained by an increased motivation for palatable food in the PWIR group. In contrast, females remained unaffected by PWIR, displaying similar responding between groups. When both rewards were made concurrent, a clear preference for wheel-running was observed in grouped males fed *ad libitum*. This preference then shifted to palatable food under mild food restriction conditions whilst PWIR males had no preference for either reward under *ad libitum* condition but a

preference for palatable food when food restricted. In contrast, females' preference remained unaffected by PWIR, hence displaying a preference for wheel-running when *ad libitum* fed which then shifted to palatable food under mild food restriction.

Taken together, these results demonstrate that changes in “free” (costless) running activity observed in females exposed to the ABA model reflect neither motivational changes for the respective rewards (running *versus* feeding) nor the reward preference. This study thus questions the translational value of such an animal model to decipher the neurobiological grounds of AN.

**Chapter 4 – On-going experiments**Objective 1 – CB1 receptors and wheel-running motivation: where are they?

The aim of this objective was to characterize the anatomical location of the CB1 receptor population responsible for the above-mentioned control of wheel-running motivation. We have provided evidence for the presence of these receptors on GABAergic neurons (see Chapter 2). However, the use of mutant mice wherein CB1 receptors are deleted from Dlx5/6-positive GABAergic neurons precludes the identification of (i) the location of the terminals expressing these receptors and (ii) the brain region where these neurons originate from. Indeed, our past study with free wheel-running settings indicated that the GABAergic terminals wherein CB1 receptors control running performance are located in the VTA where they possibly disinhibit dopaminergic neurons (Dubreucq et al., 2013). Moreover, as indicated above, *in vivo* electrophysiological studies led with Dr François Georges and Dr Giulia Fois have indicated that the motivation for wheel-running is positively correlated with VTA dopaminergic neuronal activity (see Chapter 2). We thus hypothesized that the CB1 receptor population controlling free running performance is also the one controlling wheel-running motivation. To address this hypothesis, intra-VTA perfusions of CB1 receptor antagonist were performed before the PR session. In a second series of experiments, we aimed at assessing whether CB1 receptors are present on local (intra-VTA) GABAergic neurons. As indicated earlier, the Dlx5/6 promoter used to remove CB1 receptors from GABAergic neurons is thought to be specific for forebrain GABAergic neurons, which might exclude the VTA (and hence interneurons). Confirmingly, a detailed anatomical study of MOR and  $\delta$  opioid receptor (DOR) expression in Dlx5/6-Cre (+) and Cre (-) mice failed to detect receptor binding differences in the VTA (as opposed to forebrain regions; Charbogne et al., 2017; Chung et al., 2015). However, the hypothesis of a forebrain-specific expression of Dlx5/6 is still debated (see Dubreucq et al., 2013). Because CB1 receptor expression in the VTA is extremely low (Herkenham et al., 1990; Mátyás et al., 2008), hence impeding decreases, if any, to be quantified in GABA-CB1-KO mice, we crossed our Dlx5/6-Cre mice with an Ai6-fluorescent reporter mouse line. I also initiated the evaluation of a CB1 receptor deletion from brain regions displaying major inputs to VTA dopaminergic neurons, starting with LH neurons. The latter two experiments are still on-going and will however require the use of more specific viruses before conclusions

can be drawn. The last set of experiments aimed at assessing the possibility to use a mouse line expressing the Cre recombinase under the VGAT promoter as to delete CB1 receptors from a wider population of GABAergic neurons (as compared to our current GABA-CB1 mouse line).

### ***Effect of the intra-VTA CB1 receptor blockade on wheel-running motivation***

#### ***Annex 1: Muguruza\*, Redon\* et al., (2019) JCI insight***

As previously mentioned, we hypothesized that CB1 receptors control wheel-running motivation by means of a local action within the VTA. To test this hypothesis, we locally infused the CB1 receptor antagonist AM251 in the VTA through surgically implanted canulae. C57Bl/6N were thus trained under FR1 schedule of reinforcement for 4 sessions before undergoing surgical implantation of bilateral canulae in the VTA. After a recovery period of 7 days during which the animals were daily monitored to ensure the absence of post-surgery infection and pain, mice were trained under an additional FR1 session before being daily exposed to FR3 schedule of reinforcement. All animals displayed levels of operant responding comparable to those of C57Bl/6N used in our other pharmacological studies and displayed stable responding at the end of the conditioning. Mice were then divided into two groups based on equal responding during the last FR3 session.

Before performing the PR test, the animals were infused 15 to 20 minutes beforehand with AM251 (1 µg per side) or its vehicle using Hamilton syringes. Although vehicle-perfused animals showed low levels of motivation (possibly due to the DMSO contained in the vehicle solution and the light animal restraint for infusion purposes), the CB1 receptor antagonist AM251 decreased by  $70 \pm 14$  % the number of NP performed in PR, doing so without affecting running performances. This decrease in PR responding was comparable to the one observed in CB1-KO animals, suggesting a major, if not unique, role of VTA CB1 receptors in the control of wheel-running motivation.

In conclusion, the local blockade of VTA CB1 receptors markedly reduced running motivation whilst leaving unaffected the running performances. Taken with our genetic findings, these data indicate that the control of wheel-running motivation is mainly

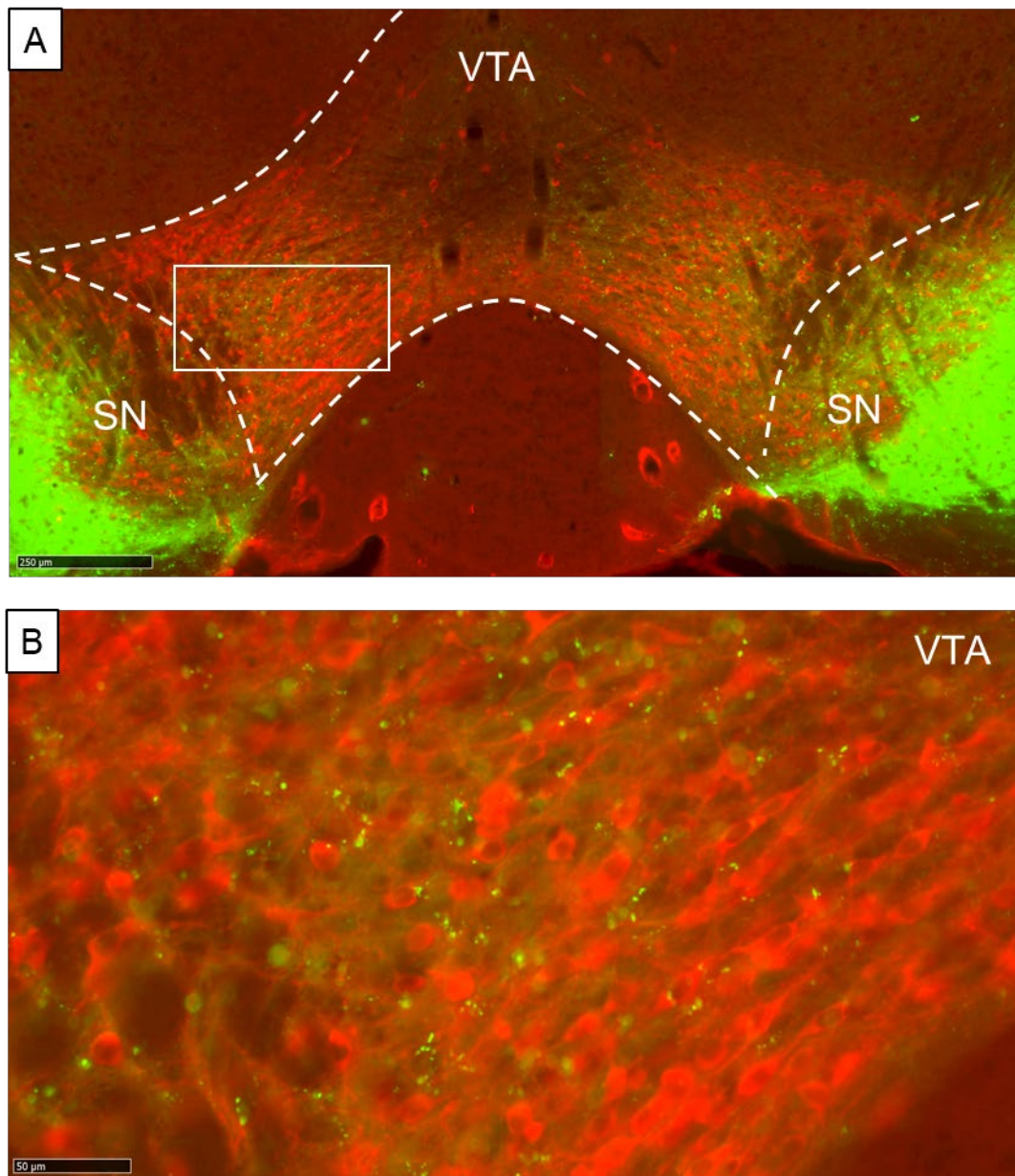


exerted by CB1 receptors located on Dlx5/6-positive GABAergic terminals in the VTA. However, as mentioned in “Introduction”, such GABAergic terminals could arise from (i) local GABAergic interneurons within the VTA, and/or (ii) GABAergic long-range projection from other brain regions (e.g. LH, NAc, VP; Morales and Margolis, 2017; Soden et al., 2020).

### ***Characterization of the Dlx promoter-expression using Dlx-Ai6 mice***

As indicated above, the key issue that needed to be addressed relates to the origin of the CB1 receptor-expressing GABAergic neurons which control running motivation. Accordingly, we first tested whether the Dlx5/6 promoter is expressed in the VTA. To do so, we aimed at evaluating the spatial expression of the Dlx5/6 promoter within the mouse brain by crossing (i) the Dlx-cre mouse line, used to generate our GABA-CB1-KO animals, with (ii) an Ai6-reporter mouse line, expressing a cre-dependent fluorescent reporter. After generation of this new line, namely Dlx<sup>\*</sup>Ai6, 7-9 weeks old male mice were perfused, and their brains extracted. By encoding a green fluorescent reporter, Ai6 can be visualized in brain slices without further amplification. However, to delineate the VTA, an immunocytochemistry was performed to stain TH (the rate-limiting enzyme in dopamine and noradrenaline synthesis) and hence label dopaminergic neurons. Once the slices were mounted on glass slides, pictures were taken using the Nanozoomer (BIC platform) to obtain a mapping of Dlx promoter expression in the whole brain (experiment in progress).

As it can be observed in Figure 17A, the VTA, delineated by the red staining of TH<sup>+</sup> neurons, displayed a low/close-to-zero expression of the Ai6 reporter, as compared to other brain regions such as the neighboring substantia nigra. A higher magnification (Figure 17B) confirms such an observation, further revealing that the green staining did not display a classical cell body-shaped signal as expected from a fluorescent reporter expressed at high intensity in the cytoplasm.



**Figure 17 - Expression of the *Dlx* promoter, as assessed by the cre-dependent expression of an *Ai6* fluorescent reporter (green) in the ventral tegmental area (delineated using tyrosine hydroxylase staining, in red) in (A) x5 and (B) x10 magnification (of the white square in A). VTA: Ventral tegmental Area; SN: Substantia Nigra.**

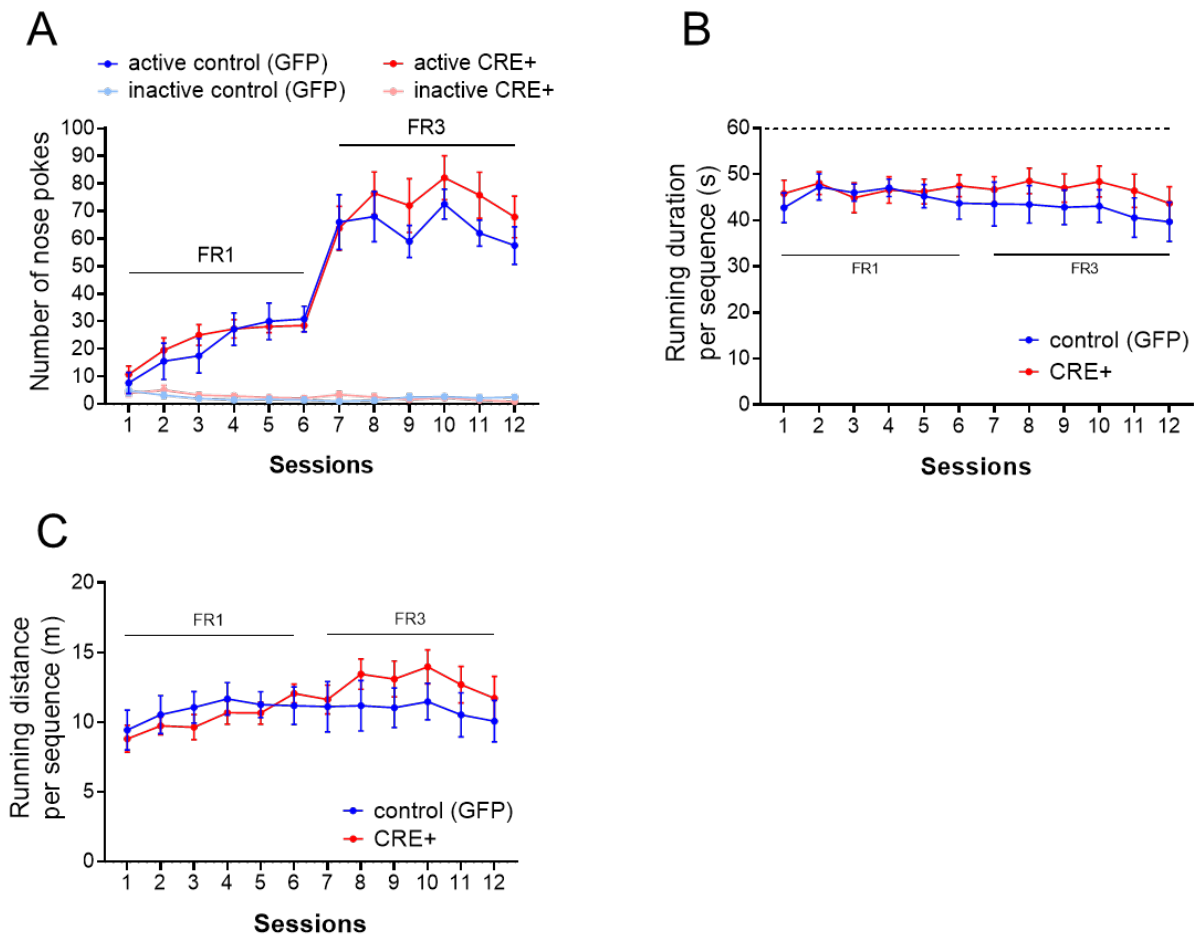
Although a firm conclusion awaits the addition of other animals, this experiment suggests that *Dlx5/6* expression is weak if not absent in VTA neurons. Accordingly, even though it cannot be excluded that a small proportion of VTA GABAergic neurons expresses the *Dlx5/6* promoter, it seems unlikely that the population of CB1 receptors controlling wheel-running motivation is expressed by local GABAergic interneurons in the VTA.

***Effects of the CB1 receptor deletion from LH neurons on wheel-running motivation***

If CB1 receptors are not located on local GABAergic neurons (to be confirmed), then CB1 receptors controlling running motivation need to be located on the VTA terminals of extrinsic GABAergic neurons. LH neurons are among the most numerous GABAergic inputs onto VTA dopaminergic neurons (Godfrey and Borgland, 2019; Morales and Margolis, 2017; Watabe-Uchida et al., 2012) and bear an important role in reward processing (Godfrey and Borgland, 2019; Nieh et al., 2015, 2016; Tyree and Lecea, 2017). Accordingly, we first tested the effects of a general deletion of CB1 receptors from LH neurons on wheel-running motivation and performance. This investigation was considered a first step before performing CB1 receptor deletions from (i) all LH GABAergic neurons or (ii) the ones specifically targeting VTA (retroviral approaches) but... another viral approach (the coronavirus pandemic) did not allow us to pursue this quest!

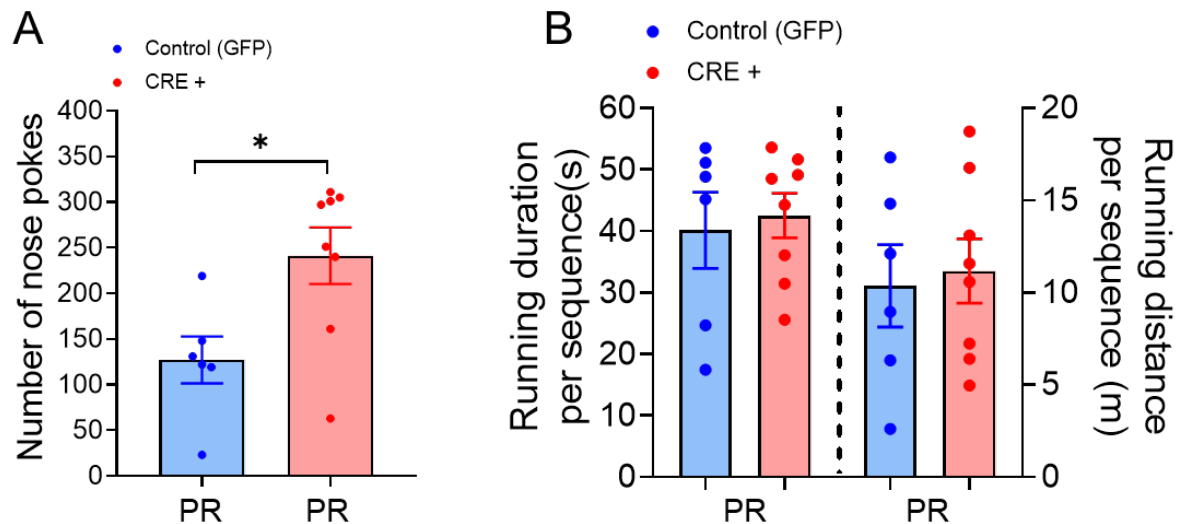
To do so, I performed bilateral stereotaxic injections of viral vectors bearing a Cre recombinase within the LH of CB1-floxed mice. Two groups of animals were designed, with the Cre-expressing group injected with a CAG-cre-GFP virus (n = 8) and the control group being injected with a CAG-hr-GFP virus (n = 6), respectively abbreviated hereafter "CRE +" and "control (GFP)". The site of injection corresponds to the anterior part of the LH at the following stereotaxic coordinates: anteroposterior: -1.55 mm, mediolateral:  $\pm 1.10$  mm and dorsoventral: -5.2 mm. Three weeks after the surgery, ensuring both the recovery of the animals and an effective expression of the virus, mice entered the operant conditioning protocol.

Following a habituation period (see above), mice were conditioned under FR1 and FR3 schedules of reinforcement (Figure 18). Interestingly, both groups of animals displayed comparable levels of operant responses during conditioning (2-way ANOVA:  $F(1,12) = 0.6298$ ;  $p = \text{NS}$ ; Figure 18A) with stable responding over sessions. Their absolute levels were equal to those reached by naive CB1-floxed mice that had been tested in previous experiments, showing that the surgery did not alter operant behavior. Wheel-running performances were similar in both groups of animals whether running duration (2-way ANOVA:  $F(1,12) = 0.6285$ ;  $p = \text{NS}$ ; Figure 18B) or running distance (2-way ANOVA:  $F(1,12) = 0.2545$ ;  $p = \text{NS}$ ; Figure 18C) per sequence were considered.



**Figure 18 - Deletion of CB1 receptors from the lateral hypothalamus did not impact operant responses and running performances under FR schedules.** (A) Number of NP under FR schedules were not different between CRE+ mice ( $n = 8$ ) and their controls (GFP) ( $n = 6$ ). (B,C) Performances of wheel-running were similar between groups whether (B) running durations or (C) running distances per sequence were considered. Data represent mean  $\pm$  SEM.

Surprisingly, when these mice were tested under PR schedules of reinforcement (Figure 19), a higher maximal number of NP was measured in CRE + mice ( $241.1 \pm 31.03$  NP), compared to their control littermates ( $127.0 \pm 25.71$  NP; t-test,  $t = 2.696$ ,  $df = 12$ ,  $p = 0.0195$ ), indicating that CB1 receptor deletion in the LH increases wheel-running motivation (Figure 19A). Even though a great variability could be observed under PR schedules, the performances of wheel-running were not altered in CRE + animals, whether running durations (t-test,  $t = 0.3550$ ,  $df = 12$ ,  $p = \text{NS}$ ) or distances (t-test,  $t = 0.2913$ ,  $df = 12$ ;  $p = \text{NS}$ ) per sequence were considered (Figure 19B).



**Figure 19 - Deletion of CB1 receptors from lateral hypothalamic neurons increased running motivation but not performance.** (A) Increased maximal number of NP in PR session in CRE + mice ( $n=8$ ) as compared to control animals ( $n=6$ ). (B) In contrast, the performances of wheel-running as assessed by (left) running durations and (right) running distances per sequence were not different between groups. Data represent mean  $\pm$  SEM.  $*p<0.05$  for 2-group comparisons by Student's  $t$ -test.

In conclusion, even though operant responses and wheel-running performances were not altered under FR schedules, LH CB1 receptor deletion increased wheel-running motivation but not performance. To our knowledge, this is the first observation of an increased motivation for running after deletion of a CB1 receptor subpopulation. However, several limits must be taken into consideration before drawing any conclusion. First, the results presented here derive from a unique batch of animal; thus, an independent series of experiment is further needed to confirm such observations. The second limit resides in the general deletion induced by this approach. Indeed, CB1 receptors were deleted from all LH neurons, hence rendering difficult the precise characterization of the circuit involved in such an effect. This needs consideration given the wide pattern of projection of LH neurons, including those targeting other reward-related brain regions such as the NAc (Bonnavion et al., 2016).

### Summary of results

We demonstrated that VTA CB1 receptor blockade drastically decreased wheel-running motivation, recapitulating the phenotype observed in CB1-KO and GABA-CB1-

KO animals. The preliminary results presented here suggest that Dlx5/6 promoter expression is low/close-to-null within the VTA, thus arguing for an extrinsic (to VTA) origin of the GABAergic neurons controlling - through CB1 receptors - running motivation. Given their prominent projections onto VTA neurons, especially dopaminergic, and their role in reward-related behavior, LH neurons are likely candidates. Surprisingly, this deletion increased wheel-running motivation, leaving running performances unaffected.

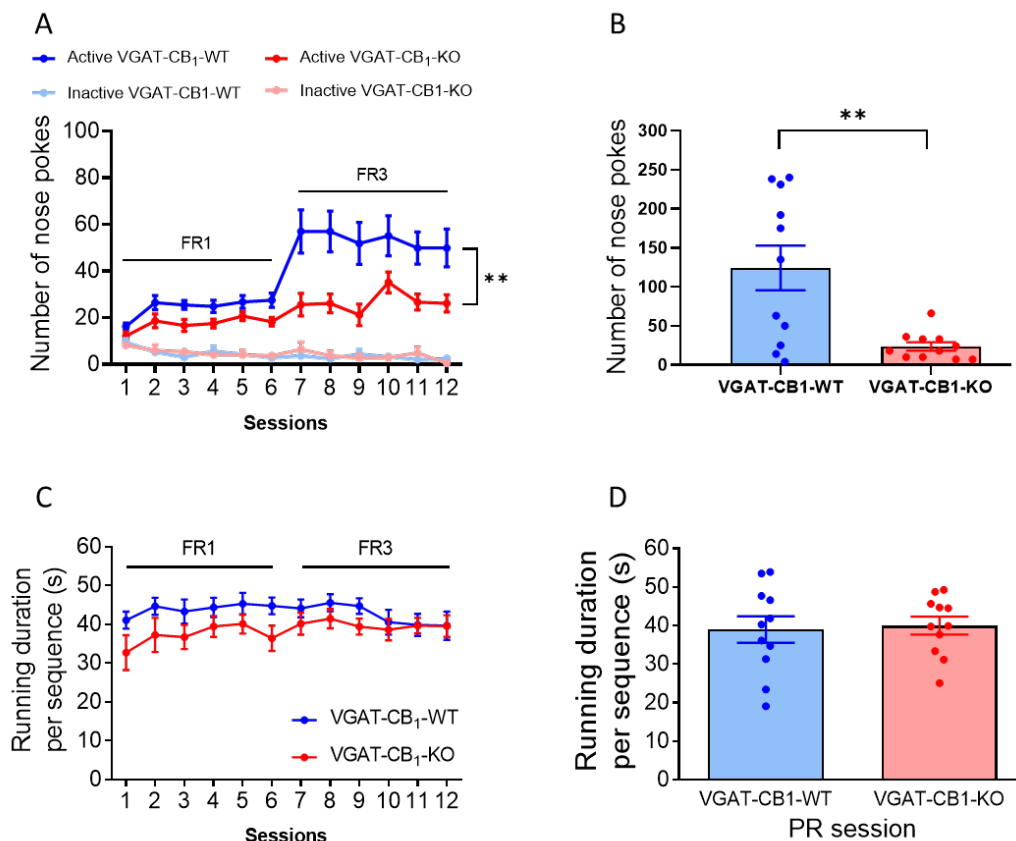
*Objective 2* – Evaluating VGAT as a new promoter to study the role of CB1 receptors on GABAergic neurons in running motivation

As indicated above, there is uncertainty regarding the expression of Dlx5/6 in midbrain. In keeping with this uncertainty, we wished to use another Cre recombinase-associated promoter to delete CB1 receptors from GABAergic neurons. To this aim, we chose to use the promoter of the vesicular GABA transporter (*Vgat* or *Slc32a1*). To do so, a VGAT-CB1 mouse line was generated using the VGAT-Cre mouse line from Jackson Laboratory (Vong et al., 2011) and our CB1-floxed mice. We then studied the respective behaviors of VGAT-CB1-KO and VGAT-CB1-WT mice.

***VGAT-CB1 mice & wheel-running motivation***

Once this new mouse line was generated, both VGAT-CB1-KO (n = 11) and their VGAT-CB1-WT littermates (n = 11) were investigated in our operant conditioning protocol for wheel-running. As observed in Dlx5/6-CB1 animals, the VGAT-CB1-KO displayed a significantly lower level of operant responses under FR1, a difference further amplified under the FR3 schedule (2-way ANOVA:  $F(1,20) = 11.12$ ;  $p = 0.0033$ ; Figure 20A). This difference in operant responses extended to the maximal number of NP performed under PR schedules of reinforcement with VGAT-CB1-KO animals reaching a lower level than their VGAT-CB1-WT littermates (t-test:  $t = 3.439$ ,  $df = 20$ ;  $p = 0.0026$ ; Figure 20B). This indicated a decreased motivation for wheel-running in the mutants. Conversely, the running durations per sequence under FR schedules of reinforcement proved similar in both genotypes (2-way ANOVA:  $F(1,20) = 3.282$ ;  $p = \text{NS}$ ; Figure 20C) and this similarity extended to PR schedules (t-test:  $t = 0.2474$ ,  $df =$

20;  $p = \text{NS}$ ; Figure 20D), suggesting that the performances of VGAT-CB1-KO mice were not altered.



**Figure 20 - Deletion of CB1 receptors from VGAT-positive neurons decreases wheel-running motivation but not performance.** (A) The decreased numbers of NP under FR schedules for VGAT-CB1-KO ( $n=11$ ), as compared to their WT littermates ( $n=11$ ), extended to (B) PR schedules, thus demonstrating decreased wheel-running motivation. (C,D) Performances of wheel-running were not different between genotypes, as assessed by running durations per sequence under (C) FR and (D) PR schedules. Data represent mean  $\pm$  SEM.  $**p < 0.01$  for main genotype significance in the 2-way ANOVA (A) and for 2-group comparison by Student's  $t$ -test (B).

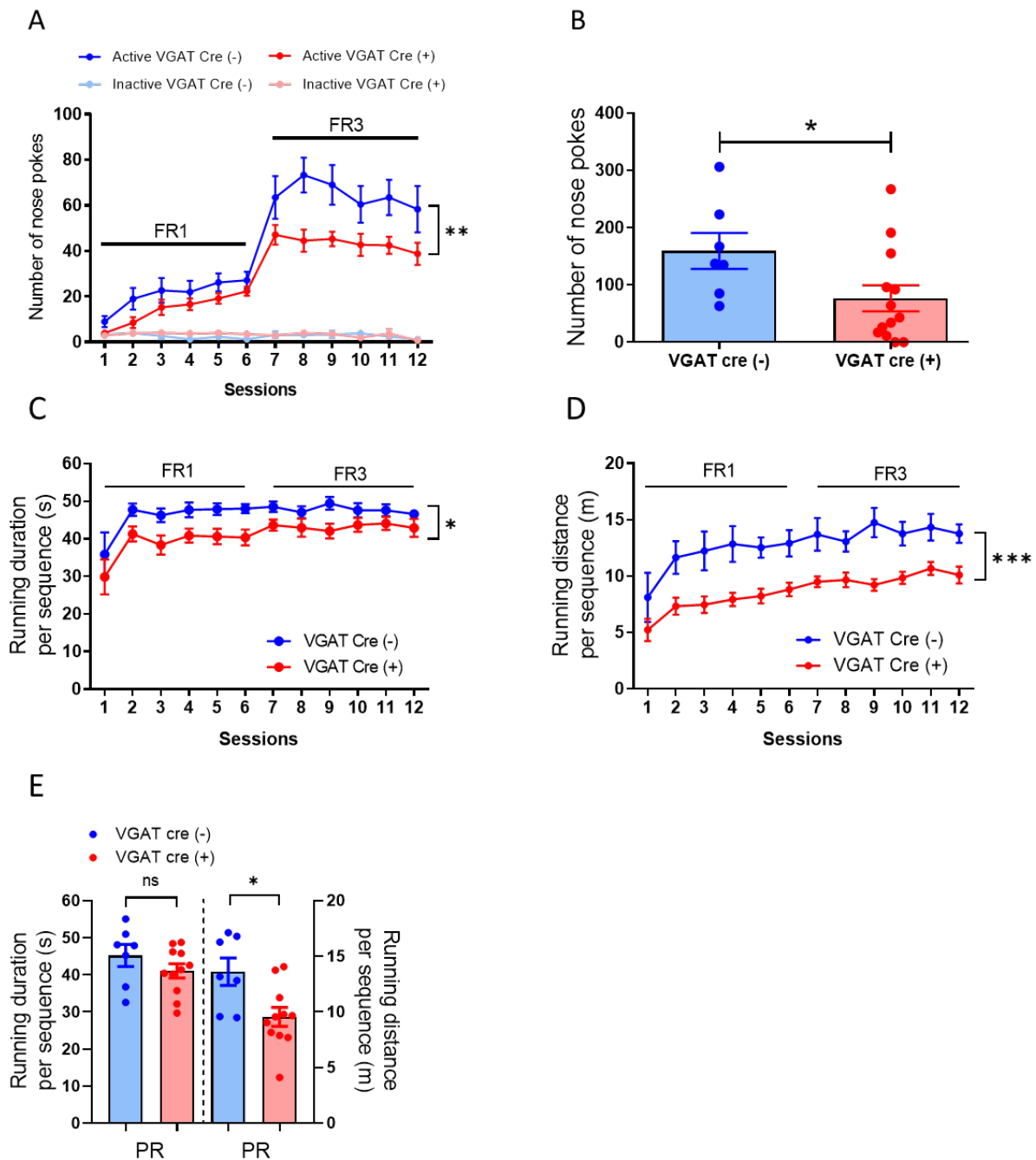
In conclusion, the phenotype of VGAT-CB1 mice was similar to that observed in mutants from the *Dlx5/6*-CB1 line, i.e. decreased operant responding under FR and PR schedules but running performances similar to those of their WT littermates.

### **VGAT-cre mice (Agouti background) & wheel-running motivation**

In keeping with the above-mentioned differences in the VGAT-CB1 line, I next wanted to make sure that these differences were not accounted for by the presence of the

VGAT-Cre recombinase. As performed with the *Dlx5/6-Cre* line, I thus tested the VGAT-Cre line, wherein mice harbored (Cre (+) mice) or not (Cre (-) mice) the Cre recombinase, used to generate the VGAT-CB1 line (see above). I thus compared VGAT-cre (+) ( $n = 13$ ) to their VGAT-cre (-) littermates ( $n = 7$ ) in our operant conditioning protocol for wheel-running. Surprisingly, VGAT-cre (+) displayed a significantly lower level of operant responding under FR1 and FR3 schedules, the difference being further amplified in the latter schedule, compared to their VGAT-Cre (-) littermates (2-way ANOVA:  $F(1,18) = 9.143$ ;  $p = 0.0073$ ; Figure 21A). This difference extended to the PR reinforcement schedules (t-test:  $t = 2.138$ ,  $df = 18$ ;  $p = 0.0465$ ; Figure 21B), indicating a decreased wheel-running motivation in mice harboring the VGAT-Cre recombinase. In addition, VGAT-cre (+) displayed lower running durations (2-way ANOVA:  $F(1,18) = 7.669$ ;  $p = 0.0126$ ; Figure 21C) and running distances (2-way ANOVA:  $F(1,18) = 22.65$ ;  $p = 0.0002$ ; Figure 21D) per sequence under FR schedules. This observation extended to the running distance, but not the running duration, performed under PR schedules (t-tests, running distance:  $t = 2.816$ ,  $df = 16$ ,  $p = 0.0124$ ; running duration:  $t = 1.240$ ,  $df = 16$ ,  $p = \text{NS}$ ; Figure 21E).





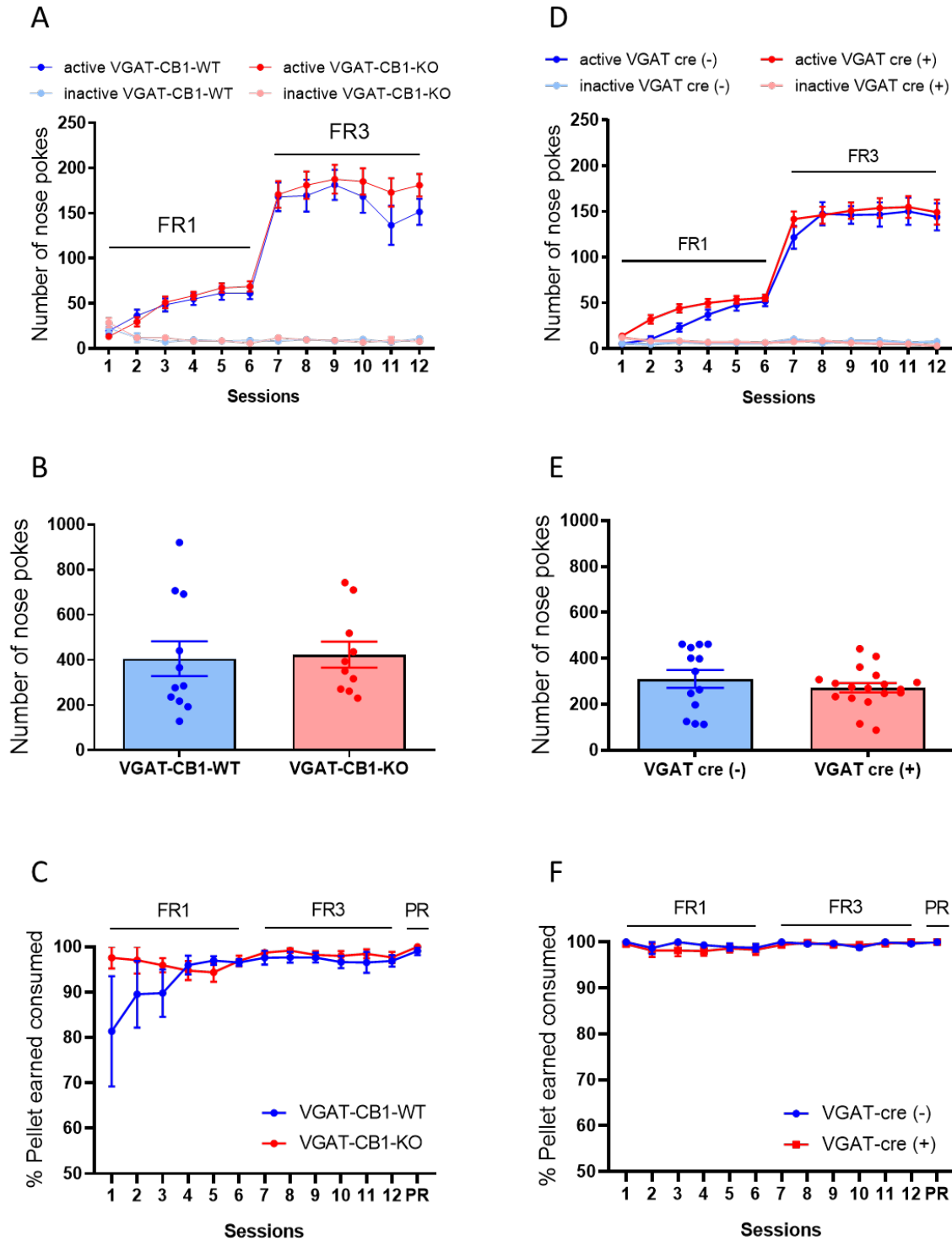
**Figure 21 - Wheel-running reinforcing properties are decreased in mice expressing a Cre recombinase under the VGAT promoter on agouti background.** (A) Decreased number of NP under FR schedules in VGAT cre (+) ( $n = 13$ ) versus their cre (-) littermates ( $n = 7$ ) that extend to (B) the maximal number of NP under PR schedules, hence demonstrating decreased motivation for wheel-running. (C,D) Decreased wheel-running performances in VGAT cre (+) whether (C) running durations or (D) running distances per sequence were considered. (E) Performances of wheel-running under PR schedules were differentially affected with (left) running durations being similar between genotypes whilst (right) running distances were decreased in cre-expressing mice. Data represent mean  $\pm$  SEM. \* $p < 0.05$ , \*\* $p < 0.01$ , \*\*\* $p < 0.001$  for the main genotype significance in the 2-way ANOVA (A,C,D), and for 2-group comparisons by Student's  $t$ -tests (B,E).

***VGAT-CB1 mice, VGAT-cre mice & motivation for palatable food***

Given the above observations in VGAT-Cre (+) mice exposed to wheel-running motivation tests, I aimed at evaluating whether the impairment in reward-processing would be observed with another reinforcer, namely palatable food. Accordingly, I evaluated palatable food motivation, first in VGAT-CB1 mice and then in VGAT-cre mice, using our previously described operant conditioning protocol for palatable food.

After habituation sessions, VGAT-CB1 mice were conditioned under FR1 and FR3 schedules: indeed, no difference between the VGAT-CB1-KO (n = 10) and their WT littermates (n = 11) was observed (2-way ANOVA:  $F(1,19) = 0.5294$ ;  $p = \text{NS}$ ; Figure 22A). This lack of difference extended to responding under a PR schedule, as assessed by the absence of difference in the maximal number of NP performed (t-test:  $t = 0.1795$ ,  $df = 19$ ;  $p = \text{NS}$ ; Figure 22B), hence indicating similar palatable food motivation. To ensure that the pellets earned through operant responding were effectively consumed by mice, the percentages of pellet effectively consumed were calculated. Even though a great variability could be observed in the first sessions of the conditioning, owing to one animal which did not consume the pellets earned, the mean percentages in both genotypes were over 90% all along the protocol without any difference between genotypes (2-way ANOVA:  $F(1,19) = 1.024$ ;  $p = \text{NS}$ ; Figure 22C).

As observed with VGAT-CB1 mice, no difference was observed between VGAT-cre (+) (n = 18) and their VGAT-cre (-) littermates (n = 13) in the level of operant responding under FR1 and FR3 schedules (2-way ANOVA:  $F(1,29) = 1.019$ ;  $p = \text{NS}$ ; Figure 22D). This lack of genotype difference extended to the maximal number of NP under a PR schedule (t-test:  $t = 0.9423$ ,  $df = 29$ ;  $p = \text{NS}$ ; Figure 22E), indicating a lack of alteration in palatable food motivation. The percentages of pellets earned effectively consumed were over 95% all along the protocol without differences between genotypes (2-way ANOVA:  $F(1,29) = 0.4056$ ;  $p = \text{NS}$ ; Figure 22F).



**Figure 22 - VGAT-CB1-KO mice and VGAT-Cre (+) mice do not display alterations in palatable food motivation, compared to their WT littermates.** (A) Numbers of NP under FR schedules were similar between VGAT-CB1-KO ( $n = 10$ ) and their WT littermates ( $n = 11$ ), a similarity which extended to (B) the maximal numbers of NP under PR schedules. (C) The percentages of pellets earned which were effectively consumed ( $> 90\%$ ) were not different between genotypes. (D) Numbers of NP under FR schedules were similar between VGAT-cre (+) ( $n = 18$ ) and their cre (-) littermates ( $n = 13$ ), as were (E) the maximal numbers of NP under PR schedules. (F) The percentages of pellets earned which were effectively consumed ( $> 95\%$ ) were not different between genotypes. Data represent mean  $\pm$  SEM.

These experiments show that palatable food motivation was affected neither by the deletion of CB1 receptors from VGAT-expressing neurons nor by the presence of the VGAT-Cre recombinase (and/or the DNA portion between the *Vgat* and *non-agouti* genes; see below and “Discussion”). The latter observation further indicates that the control of reward motivation by the VGAT-Cre insertion is indeed reward-dependent.

In conclusion, the results presented in this objective strengthen the need to investigate the intrinsic impact of the Cre recombinase and/or the genomic alterations it might promote when such a construct is used. The difference in wheel-running motivation (which did not extend to palatable food motivation) observed in VGAT-CB1-KO mice, compared to their WT littermates, might have been fully accounted for by the presence of the Cre recombinase used to generate the VGAT-CB1 line (i.e. VGAT-Cre recombinase). However, another explanation lies in the observation that both VGAT-CB1-KO mice and VGAT-Cre (+) mice have an "agouti" fur (the fur color of the mice of the 129S6 line from which the initial ES cells were used to create the VGAT-Cre line Vong et al., 2011). This observation is accounted for by the close vicinity of the *Vgat* gene and the *non-agouti* locus. In turn, this suggests that it is not the VGAT-Cre recombinase which is responsible for the above-mentioned observations but rather the piece of DNA genome between *Vgat* and *non-agouti* genes which might harbor genes involved in reward motivation. To examine this possibility, we next used another VGAT-Cre line which was established in a full C57Bl/6J background (see below).

#### ***VGAT-cre mouse line (C57Bl/6J background) & wheel-running motivation***

Mice issued from this line bearing (VGAT\*B6 cre (+); n = 9) or not (VGAT\*B6 cre (-); n = 6) the cre recombinase under the VGAT promoter were trained in our operant conditioning protocol for wheel-running (Figure 23). Thus, after habituation sessions, mice were conditioned under FR1 and FR3 schedules. Unlike VGAT-cre (on an Agouti background; see above), VGAT\*B6 cre (+) did not differ from their cre (-) littermates under FR (2-way ANOVA:  $F(1,13) = 0.01063$ ;  $p = \text{NS}$ ; Figure 23A) and PR (t-test :  $t = 1.453$ ,  $df = 13$ ;  $p = \text{NS}$ ; Figure 23B) schedules. Furthermore, wheel-running performances were equally unaltered in cre-expressing animals, compared to their controls, whether running durations (2-way ANOVA:  $F(1,13) = 1.965$ ,  $p = \text{NS}$ ; Figure

23C) or running distances (2-way ANOVA :  $F(1,13) = 0.004035$ ;  $p = \text{NS}$ ; Figure 23D) per sequence under FR schedules were considered. This also hold true for both running durations (t-test:  $t = 0.4601$ ,  $df = 13$ ;  $p = \text{NS}$ ; Figure 23E left) and running distances (t-test:  $t = 0.2621$ ,  $df = 13$ ;  $p = \text{NS}$ ; Figure 23E right) under PR schedules.

In conclusion, the expression of cre recombinase under the VGAT promoter on a C57Bl/6J genetic background did not alter wheel-running reinforcing properties, therefore making it a suitable mouse line to study the impact of CB1 receptor deletion from whole brain GABAergic neurons.

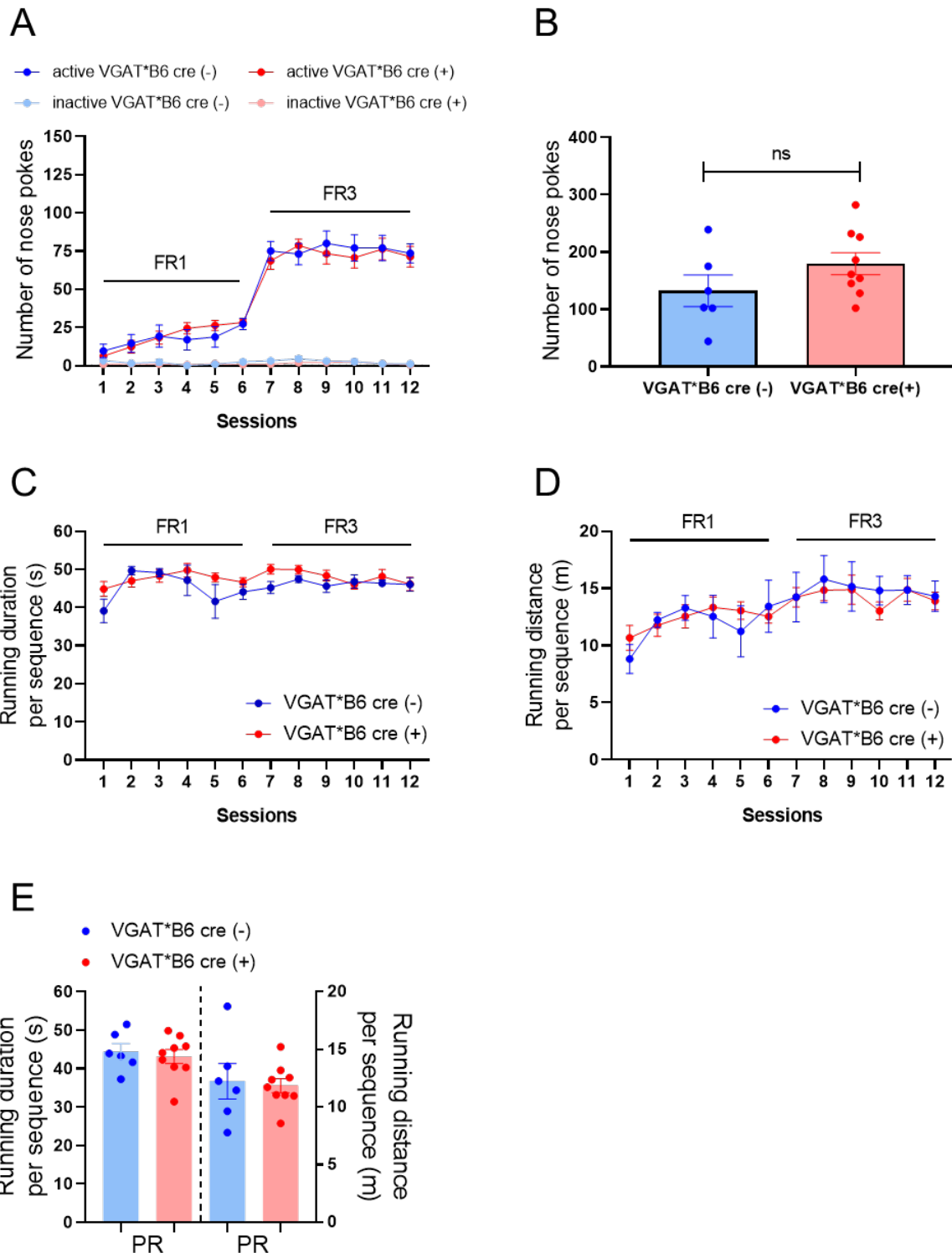


Figure 23 - **Wheel-running reinforcing properties were not altered in mice expressing the Cre recombinase under the VGAT promoter on a C57Bl/6J genetic background.** (A) Number of NP under FR schedules were similar between VGAT\*B6 cre (+) (n = 9) and their cre (-) littermates (n = 6) and that extend to (B) the maximal number of NP performed under PR schedule. (C,D) Performances of wheel-running were similar between genotypes under both FR and PR schedules whether (C, E left) running durations- or (D, E right) running distances per sequence were considered. Data represent mean  $\pm$  SEM.

## GENERAL DISCUSSION

### 1. Wheel-running is a potent reinforcer in mice

The first aim of the present work was to develop and validate a suitable behavioral paradigm to investigate the role of CB1 receptors in exercise motivation (discussed below). Several investigators previously demonstrated that wheel-running could maintain operant responding (Belke, 1997; Belke and Pierce, 2016; Collier and Hirsch, 1971; Iversen, 1993). However, except from one study (Belke and Garland, 2007), most studies were performed in rats, questioning the transferability of operant wheel-running to mice. This was an important issue as mice are our privileged animal models for the study of the ECS. The second important issue related to this paradigm was the ability to discriminate between wheel-running motivation and performance. Therefore, we designed an operant conditioning protocol wherein training was led under FR schedules of reinforcement, based on decades of self-administration literature showing that these schedules allow the fastest learning and yield stable responding (Richardson and Roberts, 1996). These FR sessions were followed by a single PR reinforcement schedule session, the only means to estimate the maximal efforts the animal accept to perform to gain access to the wheel i.e. its motivation (Hodos, 1961). As extensively described in the Introduction, appetitive and consummatory behavior rely on separate neurobiological grounds, and especially the former, but not the latter, is DA-dependent (Berridge, 2007; Salamone and Correa, 2012). Using a standard line (C57Bl/6N), we demonstrated the reinforcing properties of wheel-running in mice by means of our operant conditioning protocol. Moreover, the administration of two non-cataleptic doses of haloperidol, a D2R antagonist, dose-dependently decreased maximal responding under PR schedules whilst performances of wheel-running remained unaffected. These results confirmed the ability of our protocol to efficiently separate running motivation from performance. One limit of these experiments however lies in the systemic administration of haloperidol, hence questioning the involvement of VTA dopaminergic neurons in running motivation. Indeed, (i) Wang et al. described burst firing of VTA dopaminergic neurons both at onsets and offsets of wheel-running episodes (Wang and Tsien, 2011), (ii) Greenwood and colleagues reported increased TH mRNA within VTA after chronic wheel-running (Greenwood et al., 2011), and (iii) Wilson et al. observed increased NAc extracellular DA levels after

acute bout of treadmill running (Wilson and Marsden, 1995). These results, which at first glance suggest an involvement of VTA dopaminergic neurons in running motivation derived from “free” wheel/treadmill running protocols wherein running motivation and performance are intermingled. Although we do not yet have evidence for a causal relationship between the activity of VTA dopaminergic neurons and running motivation – experiments which are now on-going by means of *in vivo* electrophysiology in conscious animals – our electrophysiology experiments in anaesthetized mice indicate a relationship between these two variables but not between VTA dopaminergic activity and running performance.

One hallmark of the reinforcing properties of a rewarding stimulus consists in the reinstatement of its seeking after extinction or abstinence periods (Shaham et al., 2003). Reinstatement of extinguished reward-seeking is considered an animal model of craving and relapse; thus, stimuli inducing the reinstatement in animals also trigger craving and/or relapse in humans, e.g. reward-associated cues or context, stress, unexpected exposure to the reward, even though the parallel with humans remains difficult (Sanchis-Segura and Spanagel, 2006; Shaham et al., 2003). In our hands, mice conditioned under FR schedules reinstate wheel-running seeking after a period of extinction, strengthening the observation that wheel-running acts as a highly potent reinforcer in mice. Additionally, a recent work in the lab provided evidence that conditioned wheel-running under FR schedules strengthens excitatory transmission onto VTA DA neurons (as assessed by an increased ratio of AMPA receptor-mediated EPSCs to NMDA receptor-mediated EPSCs; Medrano et al., 2020). Furthermore, this increased ratio, which did not correlate with performances of wheel-running, was also observed during a “craving” session for wheel running after an extinction period (Medrano et al., 2020). Finally, it is noteworthy that all wheel-running experiments mentioned in this Thesis (except when specifically mentioned) were performed without the need to use food-restriction, a procedure commonly used in operant conditioning protocols to facilitate learning and hence responding for drug and natural rewards.



## 2. CB1 receptors control wheel-running reinforcing properties

The pharmacological and genetic approaches used in the present work demonstrate that CB1 receptors exert a positive tonic control over wheel-running motivation in mice. Indeed, pharmacological blockade and constitutive genetic deletion both decreased the maximal effort displayed by mice under PR schedules whilst performances remained unaffected. The additional use of conditional mutants helped to refine the respective involvement of different CB1 receptors populations. Mutants lacking CB1 receptors on GABAergic neurons (Dlx5/6-positive) in the forebrain – but see below - recapitulate the phenotype observed in constitutive mutants with a decreased motivation for, but similar performances of, wheel running (as compared to their WT littermates). In addition, specific re-expression of this receptor population in mice whose CB1 receptor gene expression is silenced increased wheel-running motivation, as compared to mice lacking such a re-expression. Thus, CB1 receptors located on forebrain GABAergic neurons are both necessary and sufficient for wheel-running motivation. At the opposite, mutant mice lacking CB1 receptors on cortical glutamatergic (Nex-positive) neurons display a negative tonic control over wheel-running performance, as indicated by their increased running performances under FR and PR schedules, compared to their WT littermates. In contrast, CB1 receptors located in Sim1-positive neurons (mostly located in the hypothalamic PVN) proved dispensable for wheel-reinforcing properties. Finally, our results suggest that CB1 receptors located on serotonergic neurons (TPH2-positive) bear a role in wheel-running performances only when the effort pre-requisite was high (PR schedules; but see below).

### 2.1. CB1 receptors control wheel-running motivation

Only one study investigated the involvement of CB1 receptors in operant wheel-running in rats and demonstrated that the acute blockade of CB1 receptors through rimonabant decreased operant responding (breakpoint) whilst leaving wheel revolutions unaffected (Rasmussen and Hillman, 2011). However, this study was led in food-restricted obese rats, thus questioning the transferability to *ad libitum* fed mice. In addition, only high (10 mg/kg) but not low/moderate doses (1-3 mg/kg) of rimonabant were exerting significant effects, thus questioning the specificity of the ECS. Similar

behavioral observations are reported in the present work using a low dose of rimonabant (3 mg/kg) injected before the PR session. Indeed, we observed decreased PR scores as compared to vehicle-treated animals, whilst performances remained unaffected. In addition, the use of a second CB1 receptor antagonist thought to be neutral, namely O-2050 (Wiley et al., 2011), yielded similar observations, hence discarding the potential impact of rimonabant inverse agonist properties. As indicated above, these results provide an illustration of one mechanism through which reward motivation is controlled by, doing so independently from its mere consumption (assuming that running performance is an index of such a consumption). The use of our constitutive CB1-KO mutants confirmed our pharmacological findings. The analyses of the discrimination indices (> 75 %) indicated that the genotype differences under FR and PR schedules were not accounted for by learning/memory biases although CB1-KO mice are documented for their deficiencies in these processes (Busquets-Garcia et al., 2015). The finding that CB1 receptors are necessary for wheel-running motivation is in keeping with the crucial role of these receptors in both drug (Parsons and Hurd, 2015) and nondrug “natural” rewards (e.g. food: Solinas and Goldberg, 2005; social: Trezza et al., 2012; see Fattore et al., 2010; Melis et al., 2012; Solinas et al., 2008 for review) as described in the Introduction.

## 2.2. GABA-CB1 receptors are necessary and sufficient for wheel-running motivation

The phenotype observed in CB1-KO mice was recapitulated in GABA-CB1-KO mice. We discarded any intrinsic impact of the genetic construct *per se* as Dlx-cre (+) mice did not differ from their cre (-) littermates. Interestingly, the decrease in PR scores of GABA-CB1-KO mice (*versus* their WT littermates: 57% ± 9%) did not significantly differ from the one observed in CB1-KO mice (*versus* their WT littermates: 79% ± 11%). This result suggests that among CB1 receptor populations, only that located on GABAergic neurons controls running motivation. If we assume that the control of “free” wheel-running by GABA-CB1 receptors (Dubreucq et al., 2013) is exerted at the motivation level, the observation that pretreatment with CB1 receptor antagonists did not further decrease running in GABA-CB1-KO mice (Dubreucq et al., 2013) supports such a hypothesis. Although at the present stage we cannot exclude the involvement of other

CB1 receptor populations, these should play a minor role. Not only do CB1 receptors on GABAergic neurons play a necessary role in running motivation, but these are also sufficient to establish, albeit partly, such a motivation. Noteworthy is the observation that mice displaying CB1 receptor expression silencing (Stop-CB1 mice) behaved worse than CB1-KO animals. Indeed, whilst the constitutive mutants are bred with a heterozygous (CB1<sup>+/-</sup>) mother, Stop-CB1 mice are bred from mothers wherein the CB1 receptor gene is silenced. Because the lack of CB1 receptors may have negative impacts on maternal care (Schechter et al., 2012), and then on the mesolimbic dopaminergic pathway (Hasselt et al., 2012; Peña et al., 2014), this maternal difference might explain our results as well as the observation that Stop-CB1 mice are particularly sensitive to stress, as compared to CB1-KO mice (personal observations).

Taken together, these results demonstrate that GABA-CB1 receptors are both necessary and sufficient for wheel-running motivation. If we assume that most of the CB1 receptor control over wheel-running motivation is exerted by this population (see above), it can thus be hypothesized that the mechanism of action involves CB1 receptors localized on GABAergic terminals within the VTA (see below for anatomical considerations). This framework is consistent with the disinhibition model of dopaminergic neurons proposed to underlie the rewarding effects of THC (Lupica and Riegel, 2005; Riegel and Lupica, 2004) as well as other drugs of abuse (e.g. benzodiazepines: Tan et al., 2010). Indeed, disinhibition of dopaminergic neurones generates high-frequency bursts in these neurones (Lobb et al., 2010), hence allowing reward processing (Corre et al., 2018; van Zessen et al., 2012). In contrast, lack of CB1 receptors on GABAergic neurons precludes this mechanism, VTA DA neurons remaining under tonic GABAergic inhibition, and hence amotivation. These mechanisms in turn suggest a tonic release of endocannabinoids from dopaminergic neurons, thus questioning their targets in GABA-CB1-KO mice. Would the lack of CB1 receptors on GABAergic neurons shift these targets to other CB1 receptor-expressing neurons? Even though such a hypothesis cannot be discarded, (i) the “punctate” patterns of expression of the enzymes involved in endocannabinoid syntheses machinery within VTA DA neurons, hence facing CB1 receptor-expressing afferences (Mátyás et al., 2008) and (ii) the rapid inactivation by the degrading enzymes (Piomelli, 2003) suggest precise loci of action rather than a blind volume distribution of extracellular endocannabinoids.

### 2.3. Glu-CB1 receptors control wheel-running performances

The above data suggest that CB1 receptors on GABAergic neurons fully mediate the control of running motivation by CB1 receptors. On the other hand, we could not exclude that other CB1 receptor populations played opposite roles. Indeed, CB1 receptor populations on GABAergic and cortical glutamatergic neurons have been shown to exert opposite controls over (i) feeding in fasted mice (Bellocchio et al., 2010) or (ii) the reinforcing value of cocaine self-administration (Martín-García et al., 2016). The use of Glu-CB1-KO mice allowed to reject this hypothesis. On the other hand, these mice were found to perform better than their WT, thus suggesting a negative tonic control of wheel-running performance by Glu-CB1 receptors. This observation further demonstrate that effort-based protocols are the unique means to discriminate between running motivation and performance. Confirmingly, such a genotype difference could not be observed when wheel-running was set "free" in the home cages (Dubreucq et al., 2013). A previous study by Wotjak's group using the Glu-CB1 line showed that male Glu-CB1-KO mice displayed a decreased interest for social interaction with females, compared to their WT controls (Terzian et al., 2014). Taken with the aforementioned feeding and cocaine intake studies, this indicates the need to consider endocannabinoid-reward interactions in a reward-specific manner.

### 2.4. Are other CB1 receptor populations involved in wheel-running?

Previous work from Cota's group demonstrated that deletion of CB1 receptors from Sim1-positive neurons, mainly expressed in the PVN of the hypothalamus and the mediobasal amygdala (Cardinal et al., 2015; Dubreucq et al., 2012), yield to a significant increase in energy expenditure under high-fat diet despite normal under lab chow feeding (as compared to their WT) whereas no change in food intake was observed (Cardinal et al., 2015). Moreover, such a deletion promotes ambulatory hyperactivity whilst lacking influence in a passive sucrose/water choice test (Dubreucq et al., 2012). In our hands, CB1 receptors located on Sim1-positive neurons proved dispensable for wheel-running in mice.

DRN serotonergic neurons send projections to several reward-regulating areas such as the VTA, the NAc and the mPFC (Waselus et al., 2011; Watabe-Uchida et al., 2012). Recently, direct evidence for a link between DRN serotonergic neurons and reward-

processing has been documented. Indeed, optogenetic activation of these neurons proved able to reinforce self-stimulation in mice (Liu et al., 2014), and calcium-imaging experiments demonstrated that several rewards (i.e. sucrose solution and social interactions) actually increase their activity (Li et al., 2016). Because CB1 receptors were described in DRN serotonergic neurons (Häring et al., 2007), we tested conditional mutants for CB1 receptors on TPH2-positive serotonergic neurons (TPH2-CB1) in our operant conditioning protocol for wheel-running. Although these mutants did not prove significantly different from their WT littermates for running motivation (as opposed to running performances) in PR sessions, it seems that TPH2-CB1-KO mice could be segregated in two subpopulations. The first was accounted for by low responders (< 100 NP) whilst the second included high responders (> 100 NP). Interestingly, retrospective analyses of these two populations indicate that despite equal performances under FR1 schedules, the significant difference between high and low responders could already be observed under FR3 schedules. An inefficiency of the tamoxifen treatment can be excluded inasmuch as each mouse deletion was ensured post-hoc. Indeed, the inducibility of the deletion during late adolescence could suggest a role of environmental factors in the phenotypes observed. As previously mentioned, the quality of maternal care in rodent can affect offspring behavior on the long term (Schechter et al., 2012), and more precisely, even within a single litter, differential maternal care can affect offspring adolescent social play, which depends on mesolimbic dopaminergic pathway (Hasselt et al., 2012). Then, if mesolimbic dopaminergic systems are differentially affected by early-life events, it could be hypothesized that the additional deletion of CB1 receptors at adulthood may differentially affects individuals.

In keeping with a previous work which reported no alteration in "free" wheel running in TPH2-CB1-KO mice (Dubreucq et al., 2013), the present results indicate that under low effort requirements (i.e. FR1 schedule), KO mice do not differ from their WT littermates. However, the mechanism(s) underlying (i) decreased wheel-running performances and (ii) decreased operant responding in a subpopulation of TPH2-CB1-KO animals remain to be characterized. Indeed, CB1 receptors are only expressed in a subset (circa 20 %) of TPH2-positive neurons (Häring et al., 2007). Moreover, most serotonergic cells co-express glutamate, some are serotonergic only, and an even fewer proportion co-expresses serotonin and GABA (Calizo et al., 2011; Li et al., 2016).

The molecular identity of the serotonergic neurons bearing CB1 receptors remains thus to be determined. The latter point is of crucial importance as recent evidence indicates that within the VTA, serotonergic-only neurons mainly make symmetric synapses onto nondopaminergic neurons whereas serotonin/glutamate-expressing neurons are found to make asymmetric synapses onto dopaminergic neurons (Wang et al., 2019).

### 2.5. Anatomical location of CB1 receptor control over wheel-running motivation

Previous works revealed that the CB1 receptor population controlling "free" wheel-running is located on lateral VTA GABAergic terminals (Dubreucq et al., 2013). To evaluate whether this CB1 receptor population could account for the control of wheel-running motivation, a CB1 receptor antagonist was infused in the lateral VTA. This infusion reduced running motivation to a similar extent (circa 70 %) to that promoted by the constitutive (CB1-KO) or the conditional (GABA-CB1-KO) deletion of CB1 receptors. These results indicate that most, if not all, of the CB1 receptor-mediated control of wheel-running motivation is locally exerted within the VTA, even though a minor role at dopaminergic terminals cannot be discarded (Covey et al., 2017). Such a finding is in keeping with the role of VTA endocannabinoid transmission, especially through 2-AG, in reward-seeking (i.e. sucrose; Oleson et al., 2012). However, these results raise questions regarding the neuronal population bearing the CB1 receptors of interest. Indeed, two hypotheses can be formulated, i.e. (i) intrinsic GABAergic neurons (interneurons) located within the VTA, and (ii) extrinsic GABAergic projections impinging onto VTA DA neurons. Regarding the first hypothesis, VTA GABAergic neurons have been shown to preferentially synapse with dendrites, rather than the soma, of VTA DA neurons, hence favoring a fine-tuning of VTA dopaminergic activity (Omelchenko and Sesack, 2009).

The former hypothesis is based on the literature describing (i) the ability of intrinsic VTA GABAergic neurons to synapse onto neighboring dopaminergic neurons, (ii) their stimulation effectively inhibiting VTA DA neurons, and (iii) their role in motivated behavior (Cohen et al., 2012; Tan et al., 2010, 2012; van Zessen et al., 2012). Although the characterization of CB1 receptor deletion in GABA-CB1-KO mice suggests that it mainly affects forebrain GABAergic neurons (Monory et al., 2006), the low expression of CB1 receptors in midbrain (Herkenham et al., 1990) could render any decrease in

that expression difficult to quantify. To gain direct evidence for this hypothesis, we crossed our *Dlx5/6-cre* mice (used to generate our GABA-CB1-KO) with a reporter mouse line *Ai6* and analyzed VTA *Dlx5/6* expression. Even though this experiment needs to be completed, the preliminary results suggest that VTA neurons do not express *Dlx5/6*. It is thus unlikely that CB1 receptors controlling wheel-running motivation are located on intrinsic VTA GABAergic neurons. Such observations are in line with studies from Kieffer's group investigating the conditional deletion of opioid receptors ( $\mu$ - and  $\delta$ - opioid receptors, MOR and DOR respectively) from *Dlx5/6*-positive neurons (Charbogne et al., 2017; Chung et al., 2015). Indeed, decreased receptor mRNA levels and binding characteristics for their specific ligands were observed in NAc and dorsal striatum of *Dlx5/6*-MOR (Charbogne et al., 2017) and *Dlx5/6*-DOR (Chung et al., 2015) mice whilst receptor mRNA levels and binding remained unaffected in VTA and more posterior structures (e.g. DRN, brain stem and spinal cord).

The second hypothesis is substantiated by recent viral studies indicating that VTA dopaminergic neurons receive dense GABAergic projections from several brain regions such as the NAc, the hypothalamus, and the ventral pallidum (Bariselli et al., 2016; Morales and Margolis, 2017; Soden et al., 2020; Watabe-Uchida et al., 2012). Unpublished results from the lab suggest however that CB1 receptors located on D1R-expressing neurons (thus encompassing NAc MSNs directly projecting to the VTA, e.g. from the median shell of the NAc: Yang et al., 2018) do not control motivation for wheel-running, at least under our experimental conditions (in preparation). Another region of interest is the LH, from which GABAergic projections were identified to impinge on both dopaminergic and nondopaminergic neurons in the VTA (Nieh et al., 2015) and have been identified as a key pathway for the regulation of motivated behaviors (Bonnayon et al., 2016; Nieh et al., 2015, 2016). Although currently in progress, our investigation in this brain region was initiated by deleting CB1 receptors from LH neurons. During conditioning, no difference was observed between groups. However, under PR schedules, mice bearing CB1 receptor deletions in the LH displayed a significant increase in wheel-running motivation without affecting running performance. This is the first observation of a CB1 receptor-driven manipulation allowing an increase in wheel-running motivation. Obviously, a major limit of these experiment is the non-specific CB1 receptor deletion from all neuronal populations within the LH, thus precluding an

identification of the mechanisms (circuit, cell type) through which running motivation was amplified. This quest is indeed rendered complex by the neuronal heterogeneity of the LH (Godfrey and Borgland, 2019; Mickelsen et al., 2019). However, our results are in line with recent findings based on specific targeting of the GABAergic neurons which project from the LH to the VTA (Stuber and Wise, 2016). Indeed, whilst the activation of LH glutamatergic projections promotes aversion, activation of LH-to-VTA GABAergic neurons reinforces nose-poking, induces real-time CPP (Nieh et al., 2016) and drives feeding (Barbano et al., 2016; Jennings et al., 2015; Schiffino et al., 2019). Rather than a direct control over dopaminergic neurons, LH GABA projections are thought to impinge onto VTA GABAergic neurons, thus disinhibiting their neighboring DA neurons and inducing pro-reward behaviors (Nieh et al., 2015, 2016). Noteworthy is the report by Charbogne and colleagues (Charbogne et al., 2017) of unaltered MOR mRNA levels in the LH of their *Dlx5/6*-MOR mice, as compared to their controls. This suggests that our *Dlx5/6*-CB1-KO (i.e. GABA-CB1-KO) mice did not bear CB1 receptor deletions from LH GABA neurons, even though direct evidence is lacking. A hypothetical mechanism for the phenotype of GABA-CB1-KO mice may involve a similar neurocircuit wherein (i) the CB1 receptor deletion from LH GABAergic neurons inhibits intrinsic VTA GABA interneurons, thus disinhibiting their neighboring dopaminergic neurons, hence favoring wheel-running motivation. However, definitive conclusions require the use of more specific viral strategies.

Even though our results are preliminary and need to be confirmed, GABA-CB1 receptors controlling wheel-running might be located on extrinsic GABAergic projections to the VTA. These are most likely different from D1R-expressing and LH GABAergic neurons. Other major GABAergic inputs to the VTA are projections from the rostromedial tegmental nucleus (RMTg), a major mediator of the acute rewarding effects of morphine (Jalabert et al., 2011; Matsui et al., 2014). As previously mentioned, the prominent involvement of VP in motivated behaviors renders VP GABAergic projections another potential candidate (Root et al., 2015; Watabe-Uchida et al., 2012) inasmuch as these neurons project to, and inhibit, VTA dopaminergic neurons (Hjelmstad et al., 2013).



## 2.6. VGAT cre-expressing mice as a complementary genetic approach

As discussed above, using a cre recombinase driven by *Dlx5/6* to delete CB1 receptors from GABAergic neurons might limit this deletion to the forebrain. With the aims to confirm that CB1 receptors on GABAergic neurons control running motivation and to evaluate the impact of a wider deletion of CB1 receptors from GABAergic neurons, we used a mouse line wherein the cre recombinase is driven by the *Vgat* gene promoter (*Slc32a1<sup>tm2(cre)Lowl</sup>*; Vong et al., 2011). Besides showing that VGAT-CB1-KO mice and GABA-CB1-KO mice resembled each other with respect to running and palatable feeding motivation, control experiments revealed that the VGAT cre recombinase might have had an intrinsic influence on running motivation. Additionally, because VGAT-cre (+) and VGAT-CB1-KO were agouti-coated whilst VGAT-cre (-) and VGAT-CB1-WT were dark-coated, we wondered whether this last observation could also explain our results. Indeed, the *Slc32a1* gene (which encodes the VGAT protein) is located 1.9 cM from the nonagouti locus ([http://genome.ucsc.edu/cgi-bin/hgTracks?db=mm10&lastVirtModeType=default&lastVirtModeExtraState=&virtModeType=default&virtMode=0&nonVirtPosition=&position=chr2%3A152784128%2D164379351&hgid=972723991\\_pfgsMTAY7YEJ6dQiKokvJUtrlEXJ](http://genome.ucsc.edu/cgi-bin/hgTracks?db=mm10&lastVirtModeType=default&lastVirtModeExtraState=&virtModeType=default&virtMode=0&nonVirtPosition=&position=chr2%3A152784128%2D164379351&hgid=972723991_pfgsMTAY7YEJ6dQiKokvJUtrlEXJ)), which explains why both characters cannot be dissociated. Accordingly, genes included in this DNA portion, and possibly beyond, might also be involved in the regulation of running motivation. To solve this issue, we used another VGAT-cre line (i.e. the B6J.129S6(FVB)-*Slc32a1<sup>tm2(cre)Lowl/MwarJ</sup>* line, called VGAT\*B6 hereafter) wherein multiple backcrosses in a C57Bl/6J genetic background allowed to selectively assess the impact of the VGAT-cre. The results show that the VGAT-cre is devoid of intrinsic effects on running motivation, hence allowing on-going breedings between VGAT-cre males and CB1-floxed females.

However, these observations underline the need to control for the intrinsic impact of the cre recombinase constructs used to perform conditional gene deletion/expression. Confirmingly, *Dlx5/6*-cre mice, although lacking changes in running or palatable feeding motivation, were shown to be hypersensitive to the pro-convulsant drug pentylenetetrazol (Kim et al., 2013). Another illustration of that need is provided by the observation that choline acetyltransferase (ChAT) cre-expressing mice display deficits in locomotion, operant food training and nicotine effects (Chen et al., 2018).

### 2.7. CB1 receptor stimulation does not impact wheel-running motivation/performance

Self-reports from sport practitioners using cannabis (i) prior to exercise to increase exercise pleasure and performance, and/or (ii) after exercising to alleviate post-exercise fatigue (Nguyen, 2019; YorkWilliams et al., 2019) drove scientific interest into the relationships between cannabis use and exercise. However, despite anecdotal and self-report data, there is a lack of scientific evidence for a link between cannabis use and exercise performance/recovery. Even though cannabis plants contain hundreds of molecules (Andre et al., 2016), the psychotropic properties of THC are thought to underlie cannabis effects on exercise (Wachtel et al., 2002a). Together with the results discussed above describing the positive tonic control exerted by CB1 receptors on wheel-running (likely through VTA), we hypothesized that CB1 receptor stimulation increases exercise motivation. The results gathered with THC and the inhibitor of the 2-AG-degrading enzyme, JZL184, argue against this hypothesis. The inability of these treatments to affect running motivation was not accounted for by the treatment protocols as (i) these proved effective in the past (Bellocchio et al., 2010; Busquets-Garcia et al., 2011; Gianessi et al., 2020), and (ii) THC increased palatable food motivation (hence confirming previous reports: Barbano et al., 2009; Solinas and Goldberg, 2005), albeit in food-restricted mice (see above). These results thus suggest that CB1 receptor stimulation does not increase wheel-running motivation/performance, an observation in line with previous results in the lab showing the inability of THC to alter voluntary wheel-running in a dose range from 0.1 to 1 mg/kg (Dubreucq et al., 2013). We acknowledge that the putative beneficial effect of THC on motivation (through e.g. GABA-CB1 receptor stimulation) might have been hampered by its aversive effects at (i) CB1 receptors on VTA glutamatergic neurons (Han et al., 2017) or at (ii) CB2 receptors on VTA dopaminergic neurons (Zhang et al., 2014). However, the former study suggests that THC at doses lower than 3 mg/kg does not target this subset of CB1 receptors (Han et al., 2017). Regarding its putative actions at CB2 receptors, previous works exclude any impact of CB2 receptor stimulation/blockade on wheel-running, at least under "free" running conditions (Dubreucq et al., 2013). Taken together, these results provide another illustration of the specificity of the interactions between the ECS and reward processes. It should be however noted that we evaluated the impact of an acute non-contingent injection of

THC whereas the human situation most likely implies voluntary chronic exposition (YorkWilliams et al., 2019). However, few studies evaluating the rewarding effects of the chronic administration of THC in rodents reported either no effect (Lewis and Brett, 2010) or decreased performances (Scherma et al., 2017), suggesting that chronic treatment regimen would likely lead to similar observations as reported above. Regarding the contingency, we acknowledge that voluntary drug self-administration (Chen et al., 2008) or, as we recently demonstrate, operant wheel-running (Medrano et al., 2020), involve longer-lasting synaptic plasticity changes in reward-relevant areas than those observed using noncontingent drug injection or “free” wheel-running respectively. However, self-administration of THC proved difficult to maintain in laboratory rodents (in part due to the route of administration, Melis et al., 2017), precluding its use. Recently, a study in rats reported the ability of vaporized THC to reinforce operant responding under both FR and PR schedules (Freels et al., 2020), paving the way for future studies on the link between cannabis and exercise.

### **3. Separate CB1 receptor populations control wheel-running and palatable food motivations**

In keeping with the above-mentioned role of CB1 receptors on motivation for several drug and nondrug rewards (Lupica and Riegel, 2005; Melis et al., 2012; Parsons and Hurd, 2015; Riegel and Lupica, 2004; Solinas and Goldberg, 2005; Solinas et al., 2008), we wondered whether the control of running motivation by CB1 receptors on GABAergic neurons was reward-specific. We thus analyzed the role of CB1 receptors in the motivation for another natural reward, i.e. palatable food. We first confirmed that CB1 receptors control food motivation (Hernandez and Cheer, 2012; Sanchis-Segura et al., 2004; Solinas and Goldberg, 2005). The analysis of the respective drops in running and feeding motivation (- 79% and - 36%, respectively) in CB1-KO animals indicates that CB1 receptors exert a stronger control on running motivation. This difference might have been underestimated as mild food-restricted conditions were used for the estimation of palatable feeding motivation. In addition, the latter was insensitive to the conditional deletions of CB1 receptors from GABAergic or glutamatergic neurons. This observation indicates that the control exerted by CB1 receptors on GABAergic neurons on reward motivation is reward-specific. Thus, GABA-CB1-KO animals are less motivated for running, more motivated for cocaine

self-administration (Martín-García et al., 2016) or as motivated as their WT littermates for palatable food. Regarding Glu-CB1 receptors, we cannot exclude an involvement in the pleasure for palatable food, even though the consumption of the pellet earned did not differ between KO and WT (either in the percentage of pellet earned or in the number of pellets consumed by session). Indeed, our experimental set-up precludes the assessment of taste reactivities to the chocolate-flavored reward consumed, a widely accepted means to evaluate the hedonic reactions to ingestive rewards (Berridge, 2000; Steiner, 1973). Moreover, a recent study suggested that Glu-CB1 receptors tonically control palatable food motivation (Domingo-Rodríguez et al., 2020). The discrepancy between our observations and the latter study may be accounted for by their use of fed mice and/or the duration of their conditioning sessions (5-h, as opposed to 1-h herein). Therefore, it might be hypothesized that, in addition to *ad libitum* feeding, a potential impact of this CB1 receptor deletion on hedonia might decrease the reinforcing value of palatable food and underlie their tonic regulation of it.

It has been proposed that the role of the dopaminergic system is to regulate energy expenditure, doing so along two axes (i) conserve/expend energy and (ii) exploit/explore the environment, by integrating internal and external inputs (Beeler et al., 2012). According to such a framework, increasing dopaminergic activity would favor energy expenditure and exploration, hence two processes that might depend on running motivation (Atalayer and Rowland, 2011). This suggests that GABA-CB1 receptors, through their regulation of the activity of VTA dopaminergic neurons, might be a potential mechanism in the regulation of energy expenditure, doing so in a resource-dependent manner. In favor of this hypothesis is the observation that such an activity did not differ between GABA-CB1-KO and their WT littermates during rest, but not after "free" wheel-running (Dubreucq et al., 2013). Thus, this receptor population might regulate the impact of the environment on mesolimbic dopaminergic neurons, e.g. favoring energy expenditure by controlling running motivation.

#### **4. CB1 receptors control the choice for wheel-running over palatable food**

The results presented above relied on experiments wherein running motivation and palatable feeding motivation were assessed separately. This differs from real-life

situation where individuals constantly face multiple reward alternatives, i.e. should I run or should I eat? Even though a complete ethological approach cannot be led in laboratory (but see below), recent studies showed that the lack of an alternative when assessing the motivation for a reward can be misleading (Ahmed, 2018; Ahmed et al., 2013). Indeed, animals presented separately with cocaine and sucrose display higher breakpoints for the former whilst the latter is preferred when both are made concurrent in a choice setting (Cantin et al., 2010). Recent analyses indicate that such a choice is actually dictated by the kinetics of the respective effects of each reward on mesocorticolimbic dopaminergic neurons (Canchy et al., 2021). We thus developed and validated an operant conditioning protocol presenting both rewards separately before rendering them concurrent in a choice setting. Such a development indicates that the crucial control of running motivation by GABA-CB1 receptors extends to a choice situation. Moreover, within-session analyses of the kinetics of operant responding revealed that the preference for palatable food over wheel-running remained almost constant over the course of the session in CB1-KO and GABA-CB1-KO, discarding a potential “first eat and then run” pattern that would bias the preference analyses due to the restricted time (1-h) sessions during which these analyses were performed. In addition, an hypophagic impact of wheel-running on palatable food intake could be discarded, confirming that wheel-running increases, rather than decreases, food intake in mice (as to compensate for running-elicited energy expenditure: Dubreucq et al., 2010). Temporal studies of operant food intake in animals housed with a running wheel bring evidence for an intercalation of caloric intakes between running bouts (Rowland et al., 2017), a possible explanation for such intercalated events being accounted for by a decreased risk for mice to be predated (Atalayer and Rowland, 2012). Even though of short duration, we acknowledge that the mild food restriction employed early in the protocol to facilitate learning might alter palatable food responding (Parkes et al., 2017). However, (i) this impact would over-estimate, rather than under-estimate, palatable food responding and (ii) our results clearly demonstrate that GABA-CB1 receptors impact wheel-running whilst leaving unaffected palatable food responding.

As mentioned above, the limited time length during which choices were proposed might limit our conclusion on the role of GABA-CB1 receptors. Although daily choice sessions occurred during the active phase of the light/dark cycle, the role exerted by these

receptors might not extend to the whole active phase. A second limit relates to the use of palatable food, as opposed to "standard" food. Although this kind of food allows a parallel with the choice between exercising and snacking, we acknowledge that the present results account for "exostatic", but not "homeostatic" eating, i.e. conditions during which the ECS plays differential roles (Piazza et al., 2017). A third limit is accounted for by the fact that mice are offered running in the operant chambers only, as opposed to feeding which also occurs in the home cage in *ad libitum* choice sessions. Then, it might be argued that the experimental conditions increase the salience of the running wheel at the expense of feeding. One last limit relates to the exclusive use of male mice, questioning the role of GABA-CB1 receptors in females. Besides the observation that pathologies, such as AN, wherein imbalances between feeding and running occur, are mostly observed in women (see "Introduction"), females might have differential regulatory mechanisms of energy balance, whether basal metabolic rate or coping reactions to body weight loss are concerned (Rowland et al., 2017).

One way to circumvent these limits consists in hosting mice in closed-economy settings wherein they need to nose poke (according to different reinforcement schedules; see below) to get access to standard food (3 x 20-mg pellets) and wheel-running (1 minute). This further allows (i) to evaluate the circadian pattern of running and feeding (ii) in effort-based conditions (iii) with the possibility to modulate the effort required for each reinforcer access. Note that this paradigm has been already developed for food intake (Atalayer and Rowland, 2012; Rowland et al., 2017, 2018). For this closed economy protocol, mice are first trained to nose poke (under FR1 reinforcement schedules in 30-60 min sessions) for food and for running, these rewards being proposed alone and then in concurrence (as indicated above). Thereafter, they are placed in the operant chambers (displaying a 12:12 light/dark cycle similar to our normal hosting conditions, see "Materials & Methods") with small shelters, nesting material, and free access to water bottles, the grids being replaced by drawers filled with sawdust. This protocol lasts 12 days, mice being placed under progressing FR schedules (FR1, FR3, FR10, FR30) with each schedule lasting 3 days. These progressing "prices" allow to calculate the so-called "essential values" (i.e. elasticity of the demand) for each reward (Hursh and Silberberg, 2008). On-going experiments yet indicate that (i) the essential value for feeding logically exceeds that for running, and (ii) the essential value for exercise,

but not that for food, is markedly decreased in both male and female GABA-CB1-KO mice, compared to their respective WT littermates in keeping with the deletion of CB1 receptors from GABAergic neurons. These observations thus strengthen our hypothesis that GABA-CB1 receptors play a key role in running motivation, and hence energy expenditure.

## 5. Increasing exercise motivation

### 5.1. Glucocorticoid ergogenic effects do not involve increased exercise motivation

Glucocorticoids, such as prednisolone, bear ergogenic properties that led to their ban from sport competition (WADA, 2020). These effects are mainly accounted for by peripheral impacts on metabolism increasing the energy provided to organs, and their anti-inflammatory role facilitating breathing and joint pain associated with sport practice (Adcock and Mumby, 2016; Magomedova and Cummins, 2015). However, the corticoids receptors (glucocorticoid receptors and mineralocorticoid receptors, GRs and MRs respectively) are also present in the brain (McEwen et al., 1986). Interestingly, GRs present in the mesolimbic system tonically control drug self-administration, such as cocaine and amphetamine (Parnaudeau et al., 2014; Piazza and Moal, 1997) whereas they have been shown to be dispensable for the motivation for food (Parnaudeau et al., 2014). Furthermore, the phasic effects of glucocorticoids modulate drug- and natural reward acquisition, albeit in opposite directions (Gourley et al., 2008; Piazza and Moal, 1997) whilst corticosterone is self-administered in rats (Deroche et al., 1993). Altogether, these data suggest an interaction between GRs signaling and motivational processes, thus questioning their impact on another natural reward, namely exercise. Indeed, even though DA transmission is a common endpoint of drugs of abuse, GRs differentially regulate mechanistically different drug classes, e.g. cocaine versus morphine (Barik et al., 2010). Even though previous research suggested a tonic control of glucocorticoids on wheel-running performances (Duclos et al., 2009; Ebada et al., 2016), such observation cannot account for a potential impact on motivation (Belke, 1997). To address this question, we evaluated the effect of chronic prednisolone, the most studied ergogenic glucocorticoid in humans (Collomp et al., 2016), on wheel-running motivation and performance through operant conditioning and free wheel-running. Additionally, we evaluated the ergogenic impact

of our treatment through the wire-grid hanging test, proved to be sensitive to glucocorticoids ergogenic effects (Morrison-Nozik et al., 2015). Even though body weight decrease assesses the effectiveness of our treatment (due to early catabolic effects, Karatsoreos et al., 2010), prednisolone proved inefficient on running motivation. A major limit of this set of experiment is the muscle waste induced by our treatment (assessed by decreased body weight) that is unlikely to reflect a human performance-enhancing situation. In line with the latter point, the ergogenic and muscle atrophy effects of glucocorticoids involve separate pathways (Morrison-Nozik et al., 2015). Moreover, it has been observed that the ergogenic effects in humans are mainly reported in endurance-based sports (Collomp et al., 2016), substantiated by pre-clinical data reporting an increased time to exhaustion in treadmill running (Morrison-Nozik et al., 2015). Whilst the latter observation questions the paradigm used in the present work, the treadmill running paradigm required to attain exhaustion in running animals involves trainings with electric shocks or air puffs, both of which are stressful manipulations rendering the discrimination between positive and negative reinforcements of running difficult.

### 5.2. ABA phenotype is not accounted for by increased exercise motivation

As above mentioned, although being one of the deadliest psychiatric conditions, the etiology and neurobiology of AN remain poorly described, in part due to a lack of suitable animal model (see “Introduction” and “Results – Chapter 3”). The present work evaluates the construct validity of the most accepted animal model of AN, namely the ABA model (Kim, 2012; Méquinion et al., 2015). Our strategy evaluated whether (i) known risk factors, such as female sex and childhood trauma (the latter modeled by PWIR, proved to bear long-term behavioral consequences relevant to psychiatric diseases, Fone and Porkess, 2008) would amplify the ABA phenotype, and whether (ii) the latter phenotype would model a core feature of AN, namely an imbalance between running and feeding drives. Except for our demonstration that the ABA model does not specifically capture these drives, this study proved negative regarding the initial hypotheses. One limit of our protocol involved the use of palatable food, which renders any strict parallel with the feeding behavior of anorexic patients limited. This is especially true considering that standard food and palatable food do not recruit the same neurobiological circuits (Fulton, 2010). However, the use of standard food in our



operant conditioning protocol would have required to maintain animals under mild food-restriction as to maintain operant responding, a condition incompatible with our initial aim. Another limit is linked to the use of female mice inasmuch as one study reported that the amplitude of the motivation for cocaine self-administration varies with the phase of the estrous cycle (Calipari et al., 2017). It should be noted however that the total duration of ABA and operant protocols under FR3 schedules encompassed the duration of a complete estrus cycle. Obviously, one means to deal with these limits is to examine the impacts of gender and early trauma in mice placed under the above-mentioned closed economy conditions. This is one experimental investigation we would like to pursue in the near future.

# CONCLUSION

Through the development of an operant conditioning protocol allowing to discriminate (i) wheel-running motivation from performance, and (ii) wheel-running motivation from palatable feeding motivation, the present work demonstrates the specific role played by CB1 receptors located on GABAergic neuron on running motivation. Our results suggest that this control is likely exerted within the VTA. However, the identity of the GABAergic neuronal population expressing these receptors remains to be characterized. The preliminary results presented here suggest that this GABAergic population might represent extrinsic projection neurons impinging onto the VTA, even though the origin of such a projection remains to be determined.

The present work also investigates means to positively modulate wheel-running motivation. As opposed to their tonic role on running motivation, stimulation of CB1 receptors proved ineffective to augment motivation for running. In addition, whilst glucocorticoids modulate reward-processing, our results suggest that their ergogenic effects are not accounted for by a stimulation of exercise motivation. Finally, the present work suggests that the ABA paradigm, a widely used animal model of AN, does not lead to exercise hyper-motivation, one core feature of this pathology.

In conclusion, the present work provides a frame allowing to study motivation imbalances between exercise and feeding which should prove helpful for the development of obesity and AN models. By unraveling the crucial role of CB1 receptors on exercise motivation, we provide a potential neurobiological mechanism underlying sedentariness. Future studies under closed-economy conditions will greatly help to further dissect this role under conditions with closer translational relevance

## REFERENCES

- Abel, E.L. (1975). Cannabis: Effects on hunger and thirst. *Behav Biol* 15, 255–281.
- Adcock, I.M., and Mumby, S. (2016). Pharmacology and Therapeutics of Asthma and COPD. *Handb Exp Pharmacol* 171–196.
- Ahima, R.S., Prabakaran, D., Mantzoros, C., Qu, D., Lowell, B., Maratos-Flier, E., and Flier, J.S. (1996). Role of leptin in the neuroendocrine response to fasting. *Nature* 382, 250–252.
- Ahmed, S.H. (2018). Trying to make sense of rodents' drug choice behavior. *Progress in Neuro-Psychopharmacology and Biological Psychiatry* 87, 3–10.
- Ahmed, S.H., Lenoir, M., and Guillem, K. (2013). Neurobiology of addiction versus drug use driven by lack of choice. *Curr Opin Neurobiol* 23, 581–587.
- Alcaro, A., and Panksepp, J. (2011). The SEEKING mind: Primal neuro-affective substrates for appetitive incentive states and their pathological dynamics in addictions and depression. *Neuroscience & Biobehavioral Reviews* 35, 1805–1820.
- Alcaro, A., Huber, R., and Panksepp, J. (2007). Behavioral functions of the mesolimbic dopaminergic system: An affective neuroethological perspective. *Brain Research Reviews* 56, 283–321.
- Alger, B.E., and Pitler, T.A. (1995). Retrograde signaling at GABAA-receptor synapses in the mammalian CNS. *Trends Neurosci* 18, 333–340.
- Alvarez-Jaimes, L., Polis, I., and Parsons, L.H. (2009). Regional Influence of Cannabinoid CB1 Receptors in the Regulation of Ethanol Self-Administration by Wistar Rats. *Open Neuropsychopharmacol J* 2, 77–85.
- Ambroggi, F., Turiault, M., Milet, A., Deroche-Gamonet, V., Parnaudeau, S., Balado, E., Barik, J., Veen, R. van der, Maroteaux, G., Lemberger, T., et al. (2009). Stress and addiction: glucocorticoid receptor in dopaminergic neurons facilitates cocaine seeking. *Nat Neurosci* 12, 247–249.
- Andre, C.M., Hausman, J.-F., and Guerriero, G. (2016). Cannabis sativa: The Plant of the Thousand and One Molecules. *Front Plant Sci* 7, 19.
- Arcelus, J., Mitchell, A.J., Wales, J., and Nielsen, S. (2011). Mortality Rates in Patients With Anorexia Nervosa and Other Eating Disorders: A Meta-analysis of 36 Studies. *Arch Gen Psychiat* 68, 724–731.

- Arnone, M., Maruani, J., Chaperon, F., Thiébot, M.-H., Poncelet, M., Soubrié, P., and Fur, G.L. (1997). Selective inhibition of sucrose and ethanol intake by SR 141716, an antagonist of central cannabinoid (CB1) receptors. *Psychopharmacology* 132, 104–106.
- Atalayer, D., and Rowland, N.E. (2011). Comparison of voluntary and foraging running wheel activity on food demand in mice. *Physiology & Behavior* 102, 22–29.
- Atalayer, D., and Rowland, N.E. (2012). Effects of meal frequency and snacking on food demand in mice. *Appetite* 58, 117–123.
- Azad, S.C., Monory, K., Marsicano, G., Cravatt, B.F., Lutz, B., Zieglgänsberger, W., and Rammes, G. (2004). Circuitry for Associative Plasticity in the Amygdala Involves Endocannabinoid Signaling. *The Journal of Neuroscience* 24, 9953–9961.
- Azizi, F., Fartootzadeh, R., Alaei, H., and Reisi, P. (2018). Effects of concurrent blockade of OX2 and CB1 receptors in the ventral tegmental area on nicotine-induced place preference in rats. *Neurosci Lett* 684, 121–126.
- Bacci, A., Huguenard, J.R., and Prince, D.A. (2004). Long-lasting self-inhibition of neocortical interneurons mediated by endocannabinoids. *Nature* 431, 312–316.
- Barbano, F.M., Wang, H.-L., Morales, M., and Wise, R.A. (2016). Feeding and Reward Are Differentially Induced by Activating GABAergic Lateral Hypothalamic Projections to VTA. *The Journal of Neuroscience* 36, 2975–2985.
- Barbano, M.F., Castañé, A., Martín-García, E., and Maldonado, R. (2009). Delta-9-tetrahydrocannabinol enhances food reinforcement in a mouse operant conflict test. *Psychopharmacology* 205, 475–487.
- Bardgett, M.E., Depenbrock, M., Downs, N., Points, M., and Green, L. (2009). Dopamine Modulates Effort-Based Decision Making in Rats. *Behav Neurosci* 123, 242–251.
- Barik, J., Parnaudeau, S., Amaux, A.L.S., Guiard, B.P., Dzib, J.F.G., Bocquet, O., Bailly, A., Benecke, A., and Tronche, F. (2010). Glucocorticoid Receptors in Dopaminergic Neurons, Key for Cocaine, Are Dispensable for Molecular and Behavioral Morphine Responses. *Biol Psychiat* 68, 231–239.
- Bariselli, S., Glangetas, C., Tzanoulinou, S., and Bellone, C. (2016). Ventral tegmental area subcircuits process rewarding and aversive experiences. *J Neurochem* 139, 1071–1080.

- Bariselli, S., Hörnberg, H., Prévost-Solié, C., Musardo, S., Hatstatt-Burklé, L., Scheiffele, P., and Bellone, C. (2018). Role of VTA dopamine neurons and neuregulin 3 in sociability traits related to nonfamiliar conspecific interaction. *Nat Commun* 9, 3173.
- Bauer, M., Chicca, A., Tamborrini, M., Eisen, D., Lerner, R., Lutz, B., Poetz, O., Pluschke, G., and Gertsch, J. (2012). Identification and Quantification of a New Family of Peptide Endocannabinoids (Pepcans) Showing Negative Allosteric Modulation at CB1 Receptors. *J Biol Chem* 287, 36944–36967.
- Bayer, H.M., and Glimcher, P.W. (2005). Midbrain Dopamine Neurons Encode a Quantitative Reward Prediction Error Signal. *Neuron* 47, 129–141.
- Beeler, J.A., Frazier, C.R., and Zhuang, X. (2012). Putting desire on a budget: dopamine and energy expenditure, reconciling reward and resources. *Frontiers in Integrative Neuroscience* 6.
- Beinfeld, M.C., and Connolly, K. (2001). Activation of CB1 cannabinoid receptors in rat hippocampal slices inhibits potassium-evoked cholecystinin release, a possible mechanism contributing to the spatial memory defects produced by cannabinoids. *Neurosci Lett* 301, 69–71.
- Belke, T.W. (1997). Running and responding reinforced by the opportunity to run: effect of reinforcer duration. *Journal of the Experimental Analysis of Behavior* 67, 337–351.
- Belke, T.W., and Garland, T. (2007). A brief opportunity to run does not function as a reinforcer for mice selected for high daily wheel-running rates. *J Exp Anal Behav* 88, 199–213.
- Belke, T.W., and Pierce, D.W. (2016). Wheel-running reinforcement in free-feeding and food-deprived rats. *Behavioural Processes* 124, 1–9.
- Belke, T.W., and Wagner, J.P. (2005). The reinforcing property and the rewarding aftereffect of wheel running in rats: a combination of two paradigms. *Behavioural Processes* 68, 165–172.
- Bellocchio, L., Lafenêtre, P., Cannich, A., Cota, D., Puente, N., Grandes, P., Chaouloff, F., Piazza, P., and Marsicano, G. (2010). Bimodal control of stimulated food intake by the endocannabinoid system. *Nature Neuroscience* 13, 281–283.
- Belluomo, I., Matias, I., Pernègre, C., Marsicano, G., and Chaouloff, F. (2015). Opposite control of frontocortical 2-arachidonoylglycerol turnover rate by cannabinoid type-1 receptors located on glutamatergic neurons and on astrocytes. *J Neurochem* 133, 26–37.

- Bénard, G., Massa, F., Puente, N., Lourenço, J., Bellocchio, L., Soria-Gómez, E., Matias, I., Delamarre, A., Metna-Laurent, M., Cannich, A., et al. (2012). Mitochondrial CB1 receptors regulate neuronal energy metabolism. *Nat Neurosci* 15, 558–564.
- Bender, V.A., Bender, K.J., Brasier, D.J., and Feldman, D.E. (2006). Two Coincidence Detectors for Spike Timing-Dependent Plasticity in Somatosensory Cortex. *J Neurosci* 26, 4166–4177.
- Bergen, A.W., Yeager, M., Welch, R.A., Haque, K., Ganjei, J.K., Bree, M.B.M. van den, Mazzanti, C., Nardi, I., Fichter, M.M., Halmi, K.A., et al. (2005). Association of Multiple DRD2 Polymorphisms with Anorexia Nervosa. *Neuropsychopharmacol* 30, 1703–1710.
- Bergh, C., Brodin, U., Lindberg, G., and Södersten, P. (2002). Randomized controlled trial of a treatment for anorexia and bulimia nervosa. *Proc National Acad Sci* 99, 9486–9491.
- Bergh, C., Callmar, M., Danemar, S., Hölcke, M., Isberg, S., Leon, M., Lindgren, J., Lundqvist, Å., Niinimaa, M., Olofsson, B., et al. (2013). Effective treatment of eating disorders: Results at multiple sites. *Behavioral Neuroscience* 127, 878–889.
- Berke, J.D. (2018). What does dopamine mean? *Nature Neuroscience* 21, 787–793.
- Berridge, K.C. (2000). Measuring hedonic impact in animals and infants: microstructure of affective taste reactivity patterns. *Neurosci Biobehav Rev* 24, 173–198.
- Berridge, K.C. (2004). Motivation concepts in behavioral neuroscience. *Physiology & Behavior* 81, 179–209.
- Berridge, K.C. (2007). The debate over dopamine's role in reward: the case for incentive salience. *Psychopharmacology* 191, 391–431.
- Berridge, K.C., and Robinson, T.E. (1998). What is the role of dopamine in reward: hedonic impact, reward learning, or incentive salience? *Brain Res Rev* 28, 309–369.
- Berridge, K.C., and Robinson, T.E. (2003). Parsing reward. *Trends in Neurosciences* 26, 507–513.
- Bindra, D. (1978). How adaptive behavior is produced: a perceptual-motivational alternative to response reinforcements. *Behav Brain Sci* 1, 41–52.

- Bischoff-Grethe, A., McCurdy, D., Grenesko-Stevens, E., Irvine, L.E. (Zoe), Wagner, A., Yau, W.-Y.W., Fennema-Notestine, C., Wierenga, C.E., Fudge, J.L., Delgado, M.R., et al. (2013). Altered brain response to reward and punishment in adolescents with Anorexia nervosa. *Psychiatry Res Neuroimaging* 214, 331–340.
- Bisogno, T., Howell, F., Williams, G., Minassi, A., Cascio, M.G., Ligresti, A., Matias, I., Schiano-Moriello, A., Paul, P., Williams, E.-J., et al. (2003). Cloning of the first sn1-DAG lipases points to the spatial and temporal regulation of endocannabinoid signaling in the brain. *J Cell Biology* 163, 463–468.
- Blankman, J.L., Simon, G.M., and Cravatt, B.F. (2007). A Comprehensive Profile of Brain Enzymes that Hydrolyze the Endocannabinoid 2-Arachidonoylglycerol. *Chem Biol* 14, 1347–1356.
- Boakes, R.A. (2007). Self-Starvation in the Rat: Running versus Eating. *Span J Psychology* 10, 251–257.
- Bocklisch, C., Pascoli, V., Wong, J.C., House, D.R., Yvon, C., Roo, M. de, Tan, K.R., and Lüscher, C. (2013). Cocaine Disinhibits Dopamine Neurons by Potentiation of GABA Transmission in the Ventral Tegmental Area. *Science* 341, 1521–1525.
- Bockstaele, E.J.V., and Pickel, V.M. (1995). GABA-containing neurons in the ventral tegmental area project to the nucleus accumbens in rat brain. *Brain Res* 682, 215–221.
- Bolles, R.C. (1972). Reinforcement, expectancy, and learning. *Psychol Rev* 79, 394–409.
- Bonnavion, P., Mickelsen, L.E., Fujita, A., Lecea, L. de, and Jackson, A.C. (2016). Hubs and spokes of the lateral hypothalamus: cell types, circuits and behaviour. *J Physiology* 594, 6443–6462.
- Bouten, C.V., Lichtenbelt, W.D.V.M., and Westerterp, K.R. (1996). Body mass index and daily physical activity in anorexia nervosa. *Medicine & Science in Sports & Exercise* 28.
- Braida, D., Iosué, S., Pegorini, S., and Sala, M. (2004).  $\Delta$ 9-Tetrahydrocannabinol-induced conditioned place preference and intracerebroventricular self-administration in rats. *Eur J Pharmacol* 506, 63–69.
- Brauer, L.H., Cramblett, M.J., Paxton, D.A., and Rose, J.E. (2001). Haloperidol reduces smoking of both nicotine-containing and denicotinized cigarettes. *Psychopharmacology* 159, 31–37.

- Brown, A.J. (2007). Novel cannabinoid receptors. *Brit J Pharmacol* 152, 567–575.
- Brown, D.A., Johnson, M.S., Armstrong, C.J., Lynch, J.M., Caruso, N.M., Ehlers, L.B., Fleshner, M., Spencer, R.L., and Moore, R.L. (2007). Short-term treadmill running in the rat: what kind of stressor is it? *J Appl Physiol* 103, 1979–1985.
- Brown, M.T.C., Tan, K.R., O'Connor, E.C., Nikonenko, I., Muller, D., and Lüscher, C. (2012). Ventral tegmental area GABA projections pause accumbal cholinergic interneurons to enhance associative learning. *Nature* 492, 452–456.
- Brown, S.P., Safo, P.K., and Regehr, W.G. (2004). Endocannabinoids Inhibit Transmission at Granule Cell to Purkinje Cell Synapses by Modulating Three Types of Presynaptic Calcium Channels. *J Neurosci* 24, 5623–5631.
- Brown, T.M., Brotchie, J.M., and Fitzjohn, S.M. (2003). Cannabinoids Decrease Corticostriatal Synaptic Transmission via an Effect on Glutamate Uptake. *J Neurosci* 23, 11073–11077.
- Brusco, A., Tagliaferro, P.A., Saez, T., and Onaivi, E.S. (2008). Ultrastructural Localization of Neuronal Brain CB2 Cannabinoid Receptors. *Ann Ny Acad Sci* 1139, 450–457.
- Buczynski, M.W., Herman, M.A., Hsu, K.-L., Natividad, L.A., Irimia, C., Polis, I.Y., Pugh, H., Chang, J.W., Niphakis, M.J., Cravatt, B.F., et al. (2016). Diacylglycerol lipase disinhibits VTA dopamine neurons during chronic nicotine exposure. *Proc National Acad Sci* 113, 1086–1091.
- Bulik, C., Yilmaz, Z., and HArday, A. (2015). Genetics and epigenetics of eating disorders. *Adv Genom Genetics Volume* 5, 131–150.
- Busquets-Garcia, A., Puighermanal, E., Pastor, A., Torre, R. de la, Maldonado, R., and Ozaita, A. (2011). Differential Role of Anandamide and 2-Arachidonoylglycerol in Memory and Anxiety-like Responses. *Biol Psychiat* 70, 479–486.
- Busquets-Garcia, A., Desprez, T., Metna-Laurent, M., Bellocchio, L., Marsicano, G., and Soria-Gomez, E. (2015). Dissecting the cannabinergic control of behavior: The where matters. *BioEssays* 37, 1215–1225.
- Busquets-Garcia, A., Soria-Gómez, E., Redon, B., Mackenbach, Y., Vallée, M., Chaouloff, F., Varilh, M., Ferreira, G., Piazza, P.-V., and Marsicano, G. (2017). Pregnenolone blocks cannabinoid-induced acute psychotic-like states in mice. *Molecular Psychiatry* 22, 1594–1603.
- Cachope, R., Mateo, Y., Mathur, B.N., Irving, J., Wang, H.-L., Morales, M., Lovinger, D.M., and Cheer, J.F. (2012). Selective Activation of Cholinergic Interneurons



Enhances Accumbal Phasic Dopamine Release: Setting the Tone for Reward Processing. *Cell Reports* 2, 33–41.

- Cadogan, A., Alexander, S.P.H., Boyd, E.A., and Kendall, D.A. (1997). Influence of Cannabinoids on Electrically Evoked Dopamine Release and Cyclic AMP Generation in the Rat Striatum. *J Neurochem* 69, 1131–1137.
- Caillé, S., and Parsons, L.H. (2003). SR141716A reduces the reinforcing properties of heroin but not heroin-induced increases in nucleus accumbens dopamine in rats. *Eur J Neurosci* 18, 3145–3149.
- Caillé, S., and Parsons, L.H. (2006). Cannabinoid Modulation of Opiate Reinforcement through the Ventral Striatopallidal Pathway. *Neuropsychopharmacol* 31, 804–813.
- Caillé, S., Alvarez-Jaimes, L., Polis, I., Stouffer, D.G., and Parsons, L.H. (2007). Specific Alterations of Extracellular Endocannabinoid Levels in the Nucleus Accumbens by Ethanol, Heroin, and Cocaine Self-Administration. *J Neurosci* 27, 3695–3702.
- Calipari, E.S., Juarez, B., Morel, C., Walker, D.M., Cahill, M.E., Ribeiro, E., Roman-Ortiz, C., Ramakrishnan, C., Deisseroth, K., Han, M.-H., et al. (2017). Dopaminergic dynamics underlying sex-specific cocaine reward. *Nature Communications* 8, 13877.
- Calizo, L.H., Akanwa, A., Ma, X., Pan, Y., Lemos, J.C., Craige, C., Heemstra, L.A., and Beck, S.G. (2011). Raphe serotonin neurons are not homogenous: Electrophysiological, morphological and neurochemical evidence. *Neuropharmacology* 61, 524–543.
- Callén, L., Moreno, E., Barroso-Chinea, P., Moreno-Delgado, D., Cortés, A., Mallol, J., Casadó, V., Lanciego, J.L., Franco, R., Lluís, C., et al. (2012). Cannabinoid Receptors CB1 and CB2 Form Functional Heteromers in Brain. *J Biol Chem* 287, 20851–20865.
- Canchy, L., Girardeau, P., Durand, A., Vouillac-Mendoza, C., and Ahmed, S.H. (2021). Pharmacokinetics trumps pharmacodynamics during cocaine choice: a reconciliation with the dopamine hypothesis of addiction. *Neuropsychopharmacol* 46, 288–296.
- Canetti, L., Kanyas, K., Lerer, B., Latzer, Y., and Bachar, E. (2008). Anorexia nervosa and parental bonding: the contribution of parent–grandparent relationships to eating disorder psychopathology. *J Clin Psychol* 64, 703–716.

- Cantin, L., Lenoir, M., Augier, E., Vanhille, N., Dubreucq, S., Serre, F., Vouillac, C., and Ahmed, S.H. (2010). Cocaine Is Low on the Value Ladder of Rats: Possible Evidence for Resilience to Addiction. *Plos One* 5, e11592.
- Cardinal, P., Bellocchio, L., Clark, S., Cannich, A., Klugmann, M., Lutz, B., Marsicano, G., and Cota, D. (2012). Hypothalamic CB1 Cannabinoid Receptors Regulate Energy Balance in Mice. *Endocrinology* 153, 4136–4143.
- Cardinal, P., Bellocchio, L., Guzmán-Quevedo, O., André, C., Clark, S., Elie, M., Leste-Lasserre, T., Gonzales, D., Cannich, A., Marsicano, G., et al. (2015). Cannabinoid Type 1 (CB 1 ) Receptors on Sim1-Expressing Neurons Regulate Energy Expenditure in Male Mice. *Endocrinology* 156, 411–418.
- Carek, P.J., Laibstain, S.E., and Carek, S.M. (2011). Exercise for the Treatment of Depression and Anxiety. *Int J Psychiatry Medicine* 41, 15–28.
- Carlezon, W.A., and Chartoff, E.H. (2007). Intracranial self-stimulation (ICSS) in rodents to study the neurobiology of motivation. *Nat Protoc* 2, 2987–2995.
- Carr, D.B., and Sesack, S.R. (2000). GABA-containing neurons in the rat ventral tegmental area project to the prefrontal cortex. *Synapse* 38, 114–123.
- Carr, D.B., Bullen, B.A., Skrinar, G.S., Arnold, M.A., Rosenblatt, M., Beitins, I.Z., Martin, J.B., and McArthur, J.W. (1981). Physical Conditioning Facilitates the Exercise-Induced Secretion of Beta-Endorphin and Beta-Lipotropin in Women. *New Engl J Medicine* 305, 560–563.
- Carro, E., Nuñez, A., Busiguina, S., and Torres-Aleman, I. (2000). Circulating Insulin-Like Growth Factor I Mediates Effects of Exercise on the Brain. *J Neurosci* 20, 2926–2933.
- Casper, R.C., and Jabine, L.N. (1996). An eight-year follow-up: Outcome from adolescent compared to adult onset anorexia nervosa. *J Youth Adolescence* 25, 499–517.
- Caspersen, C.J., Powell, K.E., and Christenson, G.M. (1985). Physical activity, exercise, and physical fitness: definitions and distinctions for health-related research. *Public Heal Reports Wash D C* 1974 100, 126–131.
- Cassano, T., Gaetani, S., Macheda, T., Laconca, L., Romano, A., Morgese, M.G., Cimmino, C.S., Chiarotti, F., Bambico, F.R., Gobbi, G., et al. (2011). Evaluation of the emotional phenotype and serotonergic neurotransmission of fatty acid amide hydrolase-deficient mice. *Psychopharmacology* 214, 465–476.

- Castañé, A., Valjent, E., Ledent, C., Parmentier, M., Maldonado, R., and Valverde, O. (2002). Lack of CB1 cannabinoid receptors modifies nicotine behavioural responses, but not nicotine abstinence. *Neuropharmacology* *43*, 857–867.
- Caterina, M.J., Schumacher, M.A., Tominaga, M., Rosen, T.A., Levine, J.D., and Julius, D. (1997). The capsaicin receptor: a heat-activated ion channel in the pain pathway. *Nature* *389*, 816–824.
- Chambers, A.P., Sharkey, K.A., and Koopmans, H.S. (2004). Cannabinoid (CB)1 receptor antagonist, AM 251, causes a sustained reduction of daily food intake in the rat. *Physiol Behav* *82*, 863–869.
- Chan, P.K.Y., Chan, S.C.Y., and Yung, W. (1998). Presynaptic inhibition of GABAergic inputs to rat substantia nigra pars reticulata neurones by a cannabinoid agonist. *NeuroReport* *9*.
- Chaouloff, F. (1989). Physical exercise and brain monoamines: a review. *Acta Physiol Scand* *137*, 1–13.
- Chaouloff, F. (1997). Effects of acute physical exercise on central serotonergic systems. *Medicine Sci Sports Exerc* *29*, 58–62.
- Chaperon, F., Soubrié, P., Puech, A.J., and Thiébot, M.-H. (1998). Involvement of central cannabinoid (CB1) receptors in the establishment of place conditioning in rats. *Psychopharmacology* *135*, 324–332.
- Charbogne, P., Gardon, O., Martín-García, E., Keyworth, H.L., Matsui, A., Mechling, A.E., Bienert, T., Nasseef, T., Robé, A., Moquin, L., et al. (2017). Mu Opioid Receptors in Gamma-Aminobutyric Acidergic Forebrain Neurons Moderate Motivation for Heroin and Palatable Food. *Biological Psychiatry* *81*, 778–788.
- Chávez, A.E., Chiu, C.Q., and Castillo, P.E. (2010). TRPV1 activation by endogenous anandamide triggers postsynaptic long-term depression in dentate gyrus. *Nat Neurosci* *13*, 1511–1518.
- Cheer, J.F., Marsden, C.A., Kendall, D.A., and Mason, R. (2000). Lack of response suppression follows repeated ventral tegmental cannabinoid administration: an in vitro electrophysiological study. *Neuroscience* *99*, 661–667.
- Cheer, J.F., Kendall, D.A., Mason, R., and Marsden, C.A. (2003). Differential cannabinoid-induced electrophysiological effects in rat ventral tegmentum. *Neuropharmacology* *44*, 633–641.

- Cheer, J.F., Wassum, K.M., Heien, M.L.A.V., Phillips, P.E.M., and Wightman, R.M. (2004). Cannabinoids Enhance Subsecond Dopamine Release in the Nucleus Accumbens of Awake Rats. *J Neurosci* 24, 4393–4400.
- Cheer, J.F., Wassum, K.M., Sombers, L.A., Heien, M.L.A.V., Ariansen, J.L., Aragona, B.J., Phillips, P.E.M., and Wightman, R.M. (2007). Phasic Dopamine Release Evoked by Abused Substances Requires Cannabinoid Receptor Activation. *J Neurosci* 27, 791–795.
- Chen, B.T., Bowers, M.S., Martin, M., Hopf, F.W., Guillory, A.M., Carelli, R.M., Chou, J.K., and Bonci, A. (2008). Cocaine but Not Natural Reward Self-Administration nor Passive Cocaine Infusion Produces Persistent LTP in the VTA. *Neuron* 59, 288–297.
- Chen, E., Lallai, V., Sherafat, Y., Grimes, N.P., Pushkin, A.N., Fowler, J., and Fowler, C.D. (2018). Altered Baseline and Nicotine-Mediated Behavioral and Cholinergic Profiles in ChAT-Cre Mouse Lines. *J Neurosci* 38, 2177–2188.
- Chen, J., Paredes, W., Lowinson, J.H., and Gardner, E.L. (1991). Strain-specific facilitation of dopamine efflux by  $\Delta^9$ -tetrahydrocannabinol in the nucleus accumbens of rat: An in vivo microdialysis study. *Neurosci Lett* 129, 136–140.
- Chevaleyre, V., and Castillo, P.E. (2003). Heterosynaptic LTD of Hippocampal GABAergic Synapses A Novel Role of Endocannabinoids in Regulating Excitability. *Neuron* 38, 461–472.
- Chevaleyre, V., Heifets, B.D., Kaeser, P.S., Südhof, T.C., and Castillo, P.E. (2007). Endocannabinoid-Mediated Long-Term Plasticity Requires cAMP/PKA Signaling and RIM1 $\alpha$ . *Neuron* 54, 801–812.
- Chiara, G.D. (1999). Drug addiction as dopamine-dependent associative learning disorder. *Eur J Pharmacol* 375, 13–30.
- Chiara, V.D., Errico, F., Musella, A., Rossi, S., Mataluni, G., Sacchetti, L., Siracusano, A., Castelli, M., Cavasinni, F., Bernardi, G., et al. (2010). Voluntary Exercise and Sucrose Consumption Enhance Cannabinoid CB1 Receptor Sensitivity in the Striatum. *Neuropsychopharmacol* 35, 374–387.
- Chung, P.C.S., Keyworth, H.L., Martin-Garcia, E., Charbogne, P., Darcq, E., Bailey, A., Filliol, D., Matifas, A., Scherrer, G., Ouagazzal, A.-M., et al. (2015). A Novel Anxiogenic Role for the Delta Opioid Receptor Expressed in GABAergic Forebrain Neurons. *Biol Psychiat* 77, 404–415.
- Clarke, T.K., Weiss, A.R.D., and Berrettini, W.H. (2017). The Genetics of Anorexia Nervosa. *Clin Pharmacol Ther* 91, 181–188.

- Cohen, C., Perrault, G., Voltz, C., Steinberg, R., and Soubrié, P. (2002). SR141716, a central cannabinoid (CB1) receptor antagonist, blocks the motivational and dopamine-releasing effects of nicotine in rats. *Behav Pharmacol* 13, 451–463.
- Cohen, J.Y., Haesler, S., Vong, L., Lowell, B.B., and Uchida, N. (2012). Neuron-type-specific signals for reward and punishment in the ventral tegmental area. *Nature* 482, 85–88.
- Cohen, K., Weizman, A., and Weinstein, A. (2019). Modulatory effects of cannabinoids on brain neurotransmission. *Eur J Neurosci* 50, 2322–2345.
- Collier, G., and Hirsch, E. (1971). Reinforcing properties of spontaneous activity in the rat. *J Comp Physiol Psych* 77, 155–160.
- Collins, A.L., Aitken, T.J., Huang, I.-W., Shieh, C., Greenfield, V.Y., Monbouquette, H.G., Ostlund, S.B., and Wassum, Kate.M. (2019). Nucleus accumbens cholinergic interneurons oppose cue-motivated behavior. *Biological Psychiatry*.
- Collomp, K., Arlettaz, A., Buisson, C., Lecoq, A.-M., and Mongongu, C. (2016). Glucocorticoid administration in athletes: Performance, metabolism and detection. *Steroids* 115, 193–202.
- Cook, B.J., and Hausenblas, H.A. (2008). The Role of Exercise Dependence for the Relationship between Exercise Behavior and Eating Pathology. *J Health Psychol* 13, 495–502.
- Cooney, G.M., Dwan, K., Greig, C.A., Lawlor, D.A., Rimer, J., Waugh, F.R., McMurdo, M., and Mead, G.E. (2013). Exercise for depression. *Cochrane Db Syst Rev* 9, CD004366.
- Corre, J., Zessen, R. van, Loureiro, M., Patriarchi, T., Tian, L., Pascoli, V., and Lüscher, C. (2018). Dopamine neurons projecting to medial shell of the nucleus accumbens drive heroin reinforcement. *Elife* 7, e39945.
- Correa, M., Carlson, B.B., Wisniecki, A., and Salamone, J.D. (2002). Nucleus accumbens dopamine and work requirements on interval schedules. *Behavioural Brain Research* 137, 179–187.
- Cosgrove, K.P., Hunter, R.G., and Carroll, M.E. (2002). Wheel-running attenuates intravenous cocaine self-administration in rats Sex differences. *Pharmacol Biochem Be* 73, 663–671.
- Cossu, G., Ledent, C., Fattore, L., Imperato, A., Böhme, G.A., Parmentier, M., and Fratta, W. (2001). Cannabinoid CB1 receptor knockout mice fail to self-

- administer morphine but not other drugs of abuse. *Behav Brain Res* 118, 61–65.
- Cota, D., Marsicano, G., Tschöp, M., Grübler, Y., Flachskamm, C., Schubert, M., Auer, D., Yassouridis, A., Thöne-Reineke, C., Ortman, S., et al. (2003). The endogenous cannabinoid system affects energy balance via central orexigenic drive and peripheral lipogenesis. *Journal of Clinical Investigation* 112, 423–431.
- Cotman, C.W., Berchtold, N.C., and Christie, L.-A. (2007). Exercise builds brain health: key roles of growth factor cascades and inflammation. *Trends Neurosci* 30, 464–472.
- Covey, D.P., Mateo, Y., Sulzer, D., Cheer, J.F., and Lovinger, D.M. (2017). Endocannabinoid modulation of dopamine neurotransmission. *Neuropharmacology* 124, 52–61.
- Cragg, S.J. (2006). Meaningful silences: how dopamine listens to the ACh pause. *Trends Neurosci* 29, 125–131.
- Cravatt, B.F., Giang, D.K., Mayfield, S.P., Boger, D.L., Lerner, R.A., and Gilula, N.B. (1996). Molecular characterization of an enzyme that degrades neuromodulatory fatty-acid amides. *Nature* 384, 83–87.
- Cravatt, B.F., Demarest, K., Patricelli, M.P., Bracey, M.H., Giang, D.K., Martin, B.R., and Lichtman, A.H. (2001). Supersensitivity to anandamide and enhanced endogenous cannabinoid signaling in mice lacking fatty acid amide hydrolase. *Proc National Acad Sci* 98, 9371–9376.
- Cristino, L., Bisogno, T., and Marzo, V.D. (2020). Cannabinoids and the expanded endocannabinoid system in neurological disorders. *Nat Rev Neurol* 16, 9–29.
- Cruz, J.F.O. da, Robin, L.M., Drago, F., Marsicano, G., and Metna-Laurent, M. (2016). Astroglial type-1 cannabinoid receptor (CB1): A new player in the tripartite synapse. *Neuroscience* 323, 35–42.
- D’Ardenne, K., McClure, S.M., Nystrom, L.E., and Cohen, J.D. (2008). BOLD Responses Reflecting Dopaminergic Signals in the Human Ventral Tegmental Area. *Science* 319, 1264–1267.
- Davis, C., Katzman, D.K., Kaptein, S., Kirsh, C., Brewer, H., Kalmbach, K., Olmsted, M.F., Woodside, D.B., and Kaplan, A.S. (1997). The prevalence of high-level exercise in the eating disorders: Etiological implications. *Compr Psychiat* 38, 321–326.

- Davis, M.I., Ronesi, J., and Lovinger, D.M. (2003). A Predominant Role for Inhibition of the Adenylate Cyclase/Protein Kinase A Pathway in ERK Activation by Cannabinoid Receptor 1 in N1E-115 Neuroblastoma Cells. *J Biol Chem* 278, 48973–48980.
- Denny-Brown, D. (1928). Conditioned Reflexes: an Investigation of the Physiological Activity of the Cerebral Cortex. *Nature* 121, 662–664.
- Deroche, V., Piazza, P.V., Deminie`re, J.-M., Moal, M.L., and Simon, H. (1993). Rats orally self-administer corticosterone. *Brain Res* 622, 315–320.
- Devane, W., Hanus, L., Breuer, A., Pertwee, R., Stevenson, L., Griffin, G., Gibson, D., Mandelbaum, A., Etinger, A., and Mechoulam, R. (1992). Isolation and structure of a brain constituent that binds to the cannabinoid receptor. *Science* 258, 1946–1949.
- Devane, W.A., Dysarz, F.A., Johnson, M.R., Melvin, L.S., and Howlett, A.C. (1988). Determination and characterization of a cannabinoid receptor in rat brain. *Mol Pharmacol* 34, 605–613.
- Dietrich, A., and McDaniel, W.F. (2004). Endocannabinoids and exercise. *British Journal of Sports Medicine* 38, 536.
- Ding, D., Lawson, K.D., Kolbe-Alexander, T.L., Finkelstein, E.A., Katzmarzyk, P.T., Mechelen, W. van, Pratt, M., and Committee, L.P.A.S. 2 E. (2016). The economic burden of physical inactivity: a global analysis of major non-communicable diseases. *Lancet* 388, 1311–1324.
- Dinh, T.P., Freund, T.F., and Piomelli, D. (2002). A role for monoglyceride lipase in 2-arachidonoylglycerol inactivation. *Chem Phys Lipids* 121, 149–158.
- Dishman, R.K., and O'Connor, P.J. (2009). Lessons in exercise neurobiology: The case of endorphins. *Ment Health Phys Act* 2, 4–9.
- Dobi, A., Margolis, E.B., Wang, H.-L., Harvey, B.K., and Morales, M. (2010). Glutamatergic and Nonglutamatergic Neurons of the Ventral Tegmental Area Establish Local Synaptic Contacts with Dopaminergic and Nondopaminergic Neurons. *J Neurosci* 30, 218–229.
- Dölen, G., Darvishzadeh, A., Huang, K., and Malenka, R.C. (2013). Social reward requires coordinated activity of nucleus accumbens oxytocin and serotonin. *Nature* 501, 179–184.
- Domingo-Rodriguez, L., Azua, I.R. de, Dominguez, E., Senabre, E., Serra, I., Kummer, S., Navandar, M., Baddenhausen, S., Hofmann, C., Andero, R., et al. (2020).

A specific prelimbic-nucleus accumbens pathway controls resilience versus vulnerability to food addiction. *Nat Commun* 11, 782.

- Dubreucq, S., Koehl, M., Abrous, D.N., Marsicano, G., and Chaouloff, F. (2010). CB1 receptor deficiency decreases wheel-running activity: Consequences on emotional behaviours and hippocampal neurogenesis. *Exp Neurol* 224, 106–113.
- Dubreucq, S., Kambire, S., Conforzi, M., Metna-Laurent, M., Cannich, A., Soria-Gomez, E., Richard, E., Marsicano, G., and Chaouloff, F. (2012). Cannabinoid type 1 receptors located on single-minded 1-expressing neurons control emotional behaviors. *Neuroscience* 204, 230–244.
- Dubreucq, S., Durand, A., Matias, I., Bénard, G., Richard, E., Soria-Gomez, E., Glangetas, C., Groc, L., Wadleigh, A., Massa, F., et al. (2013). Ventral Tegmental Area Cannabinoid Type-1 Receptors Control Voluntary Exercise Performance. *Biological Psychiatry* 73, 895–903.
- Duclos, M., Gatti, C., Bessièrre, B., and Mormède, P. (2009). Tonic and phasic effects of corticosterone on food restriction-induced hyperactivity in rats. *Psychoneuroendocrino* 34, 436–445.
- Dunn, A.L., and Dishman, R.K. (1991). Exercise and the Neurobiology of Depression. *Exercise Sport Sci R* 19, 41.
- Ebada, M.E., Kendall, D.A., and Pardon, M.-C. (2016). Corticosterone and dopamine D2/D3 receptors mediate the motivation for voluntary wheel running in C57BL/6J mice. *Behav Brain Res* 311, 228–238.
- Economidou, D., Mattioli, L., Cifani, C., Perfumi, M., Massi, M., Cuomo, V., Trabace, L., and Ciccocioppo, R. (2006). Effect of the cannabinoid CB1 receptor antagonist SR-141716A on ethanol self-administration and ethanol-seeking behaviour in rats. *Psychopharmacology* 183, 394–403.
- Edwards, N.J., Tejada, H.A., Pignatelli, M., Zhang, S., McDevitt, R.A., Wu, J., Bass, C.E., Bettler, B., Morales, M., and Bonci, A. (2017). Circuit specificity in the inhibitory architecture of the VTA regulates cocaine-induced behavior. *Nature Neuroscience* 20, 438–448.
- Ekkekakis, P., Hall, E.E., and Petruzzello, S.J. (2008). The Relationship Between Exercise Intensity and Affective Responses Demystified: To Crack the 40-Year-Old Nut, Replace the 40-Year-Old Nutcracker! *Ann Behav Med* 35, 136–149.



- Endoh, T. (2006). Pharmacological characterization of inhibitory effects of postsynaptic opioid and cannabinoid receptors on calcium currents in neonatal rat nucleus tractus solitarius. *Brit J Pharmacol* 147, 391–401.
- Exner, C., Hebebrand, J., Remschmidt, H., Wewetzer, C., Ziegler, A., Herpertz, S., Schweiger, U., Blum, W.F., Preibisch, G., Heldmaier, G., et al. (2000). Leptin suppresses semi-starvation induced hyperactivity in rats: implications for anorexia nervosa. *Mol Psychiatr* 5, 476–481.
- Fabel, K., Fabel, K., Tam, B., Kaufer, D., Baiker, A., Simmons, N., Kuo, C.J., and Palmer, T.D. (2003). VEGF is necessary for exercise-induced adult hippocampal neurogenesis. *Eur J Neurosci* 18, 2803–2812.
- Fattore, L., Martellotta, M.C., Cossu, G., Mascia, M.S., and Fratta, W. (1999). CB1 cannabinoid receptor agonist WIN 55, 212-2 decreases intravenous cocaine self-administration in rats. *Behav Brain Res* 104, 141–146.
- Fattore, L., Melis, M., Fadda, P., Pistis, M., and Fratta, W. (2010). The endocannabinoid system and nondrug rewarding behaviours. *Exp Neurol* 224, 23–36.
- Fernandes, M.F.A., Matthys, D., Hryhorczuk, C., Sharma, S., Mogra, S., Alquier, T., and Fulton, S. (2015). Leptin Suppresses the Rewarding Effects of Running via STAT3 Signaling in Dopamine Neurons. *Cell Metabolism* 22, 741–749.
- Ferris, L.T., Williams, J.S., and Shen, C.-L. (2007). The Effect of Acute Exercise on Serum Brain-Derived Neurotrophic Factor Levels and Cognitive Function. *Medicine Sci Sports Exerc* 39, 728–734.
- Figlewicz, D.P., Evans, S.B., Murphy, J., Hoen, M., and Baskin, D.G. (2003). Expression of receptors for insulin and leptin in the ventral tegmental area/substantia nigra (VTA/SN) of the rat. *Brain Res* 964, 107–115.
- Figlewicz, D.P., Bennett, J.L., Naleid, A.M., Davis, C., and Grimm, J.W. (2006). Intraventricular insulin and leptin decrease sucrose self-administration in rats. *Physiol Behav* 89, 611–616.
- Fischer, A.G., and Ullsperger, M. (2017). An Update on the Role of Serotonin and its Interplay with Dopamine for Reward. *Front Hum Neurosci* 11, 484.
- Fisyunov, A., Tsintsadze, V., Min, R., Burnashev, N., and Lozovaya, N. (2006). Cannabinoids Modulate the P-Type High-Voltage-Activated Calcium Currents in Purkinje Neurons. *J Neurophysiol* 96, 1267–1277.

- Fladung, A.-K., Grön, G., Grammer, K., Herrnberger, B., Schilly, E., Grasteit, S., Wolf, R.C., Walter, H., and Wietersheim, J. von (2010). A Neural Signature of Anorexia Nervosa in the Ventral Striatal Reward System. *American Journal of Psychiatry* 167, 206–212.
- Földy, C., Neu, A., Jones, M.V., and Soltesz, I. (2006). Presynaptic, Activity-Dependent Modulation of Cannabinoid Type 1 Receptor-Mediated Inhibition of GABA Release. *J Neurosci* 26, 1465–1469.
- Fone, K.C.F., and Porkess, M.V. (2008). Behavioural and neurochemical effects of post-weaning social isolation in rodents—Relevance to developmental neuropsychiatric disorders. *Neurosci Biobehav Rev* 32, 1087–1102.
- Frank, G.K., Bailer, U.F., Henry, S.E., Drevets, W., Meltzer, C.C., Price, J.C., Mathis, C.A., Wagner, A., Hoge, J., Ziolkowski, S., et al. (2005). Increased Dopamine D2/D3 Receptor Binding After Recovery from Anorexia Nervosa Measured by Positron Emission Tomography and [<sup>11</sup>C]Raclopride. *Biol Psychiat* 58, 908–912.
- Franklin, Keith B. J., and Paxinos, George (2013). Paxinos and Franklin's The mouse brain in stereotaxic coordinates.
- Freedland, C.S., Poston, J.S., and Porrino, L.J. (2000). Effects of SR141716A, a central cannabinoid receptor antagonist, on food-maintained responding. *Pharmacology Biochemistry and Behavior* 67, 265–270.
- Freedland, C.S., Sharpe, A.L., Samson, H.H., and Porrino, L.J. (2001). Effects of SR141716A on Ethanol and Sucrose Self-Administration. *Alcohol Clin Exp Res* 25, 277–282.
- Freels, T.G., Baxter-Potter, L.N., Lugo, J.M., Glodosky, N.C., Wright, H.R., Baglot, S.L., Petrie, G.N., Yu, Z., Clowers, B.H., Cuttler, C., et al. (2020). Vaporized Cannabis Extracts Have Reinforcing Properties and Support Conditioned Drug-Seeking Behavior in Rats. *J Neurosci* 40, 1897–1908.
- French, E.D. (1997).  $\Delta^9$ -Tetrahydrocannabinol excites rat VTA dopamine neurons through activation of cannabinoid CB1 but not opioid receptors. *Neurosci Lett* 226, 159–162.
- Freund, T.F., Katona, I., and Piomelli, D. (2003). Role of Endogenous Cannabinoids in Synaptic Signaling. *Physiol Rev* 83, 1017–1066.
- Friend, L., Weed, J., Sandoval, P., Nufer, T., Ostlund, I., and Edwards, J.G. (2017). CB1-Dependent Long-Term Depression in Ventral Tegmental Area GABA

- Neurons: A Novel Target for Marijuana. *Journal of Neuroscience* 37, 10943–10954.
- Fulton, S. (2010). Appetite and reward. *Front Neuroendocrin* 31, 85–103.
- Fulton, S., Woodside, B., and Shizgal, P. (2000). Modulation of Brain Reward Circuitry by Leptin. *Science* 287, 125–128.
- Fulton, S., Pissios, P., Manchon, R.P., Stiles, L., Frank, L., Pothos, E.N., Maratos-Flier, E., and Flier, J.S. (2006). Leptin Regulation of the Mesoaccumbens Dopamine Pathway. *Neuron* 51, 811–822.
- Fuss, J., Steinle, J., Bindila, L., Auer, M.K., Kirchherr, H., Lutz, B., and Gass, P. (2015). A runner's high depends on cannabinoid receptors in mice. *Proceedings of the National Academy of Sciences* 112, 13105–13108.
- Gabrielli, M., Battista, N., Riganti, L., Prada, I., Antonucci, F., Cantone, L., Matteoli, M., Maccarrone, M., and Verderio, C. (2015). Active endocannabinoids are secreted on extracellular membrane vesicles. *Embo Rep* 16, 213–220.
- Gallate, J.E., and McGregor, I.S. (1999). The motivation for beer in rats: effects of ritanserin, naloxone and SR 141716. *Psychopharmacology* 142, 302–308.
- Gallate, J.E., Saharov, T., Mallet, P.E., and McGregor, I.S. (1999). Increased motivation for beer in rats following administration of a cannabinoid CB1 receptor agonist. *Eur J Pharmacol* 370, 233–240.
- Gamaledin, I., Wertheim, C., Zhu, A.Z.X., Coen, K.M., Vemuri, K., Makryannis, A., Goldberg, S.R., and Foll, B.L. (2012). Cannabinoid receptor stimulation increases motivation for nicotine and nicotine seeking. *Addict Biol* 17, 47–61.
- Gambert, S.R., Garthwaite, T.L., Pontzer, C.H., Cook, E.E., Tristani, F.E., Duthie, E.H., Martinson, D.R., Hagen, T.C., and McCarty, D.J. (1981). Running Elevates Plasma  $\beta$ -Endorphin Immunoreactivity and ACTH in Untrained Human Subjects. *P Soc Exp Biol Med* 168, 1–4.
- Gao, Y., Vasilyev, D.V., Goncalves, M.B., Howell, F.V., Hobbs, C., Reisenberg, M., Shen, R., Zhang, M.-Y., Strassle, B.W., Lu, P., et al. (2010). Loss of Retrograde Endocannabinoid Signaling and Reduced Adult Neurogenesis in Diacylglycerol Lipase Knock-out Mice. *J Neurosci* 30, 2017–2024.
- Gaoni, Y., and Mechoulam, R. (1964). Isolation, Structure, and Partial Synthesis of an Active Constituent of Hashish. *J Am Chem Soc* 86, 1646–1647.

- Georgotas, A., and Zeidenberg, P. (1979). Observations on the effects of four weeks of heavy marihuana smoking on group interaction and individual behavior. *Compr Psychiat* 20, 427–432.
- Gerdeman, G.L., Ronesi, J., and Lovinger, D.M. (2002). Postsynaptic endocannabinoid release is critical to long-term depression in the striatum. *Nature Neuroscience* 5, 446–451.
- German, D.C., and Manaye, K.F. (1993). Midbrain dopaminergic neurons (nuclei A8, A9, and A10): Three-dimensional reconstruction in the rat. *J Comp Neurol* 331, 297–309.
- Gessa, G., Melis, M., Muntoni, A., and Diana, M. (1998). Cannabinoids activate mesolimbic dopamine neurons by an action on cannabinoid CB1 receptors. *Eur J Pharmacol* 341, 39–44.
- Gianessi, C.A., Groman, S.M., Thompson, S.L., Jiang, M., Stelt, M., and Taylor, J.R. (2020). Endocannabinoid contributions to alcohol habits and motivation: Relevance to treatment. *Addict Biol* 25, e12768.
- Gianini, L.M., Klein, D.A., Call, C., Mayer, L., Foltin, R.W., Walsh, B.T., Wang, Y., Wu, P., and Attia, E. (2016). The reinforcing effect of exercise in anorexia nervosa: Clinical correlates and relationship to outcome. *Eat Disord* 24, 1–12.
- Giel, K.E., Kullmann, S., Preißl, H., Bischoff, S.C., Thiel, A., Schmidt, U., Zipfel, S., and Teufel, M. (2013). Understanding the reward system functioning in anorexia nervosa: Crucial role of physical activity. *Biol Psychol* 94, 575–581.
- Gifford, A.N., and Ashby, C.R. (1996). Electrically evoked acetylcholine release from hippocampal slices is inhibited by the cannabinoid receptor agonist, WIN 55212-2, and is potentiated by the cannabinoid antagonist, SR 141716A. *J Pharmacol Exp Ther* 277, 1431–1436.
- Glashouwer, K.A., Bloot, L., Veenstra, E.M., Franken, I.H.A., and Jong, P.J. de (2014). Heightened sensitivity to punishment and reward in anorexia nervosa. *Appetite* 75, 97–102.
- Godfrey, N., and Borgland, S.L. (2019). Diversity in the Lateral Hypothalamic input to the Ventral Tegmental Area. *Neuropharmacology* 154, 4–12.
- Gold, S.M., Schulz, K.-H., Hartmann, S., Mladek, M., Lang, U.E., Hellweg, R., Reer, R., Braumann, K.-M., and Heesen, C. (2003). Basal serum levels and reactivity of nerve growth factor and brain-derived neurotrophic factor to standardized acute exercise in multiple sclerosis and controls. *J Neuroimmunol* 138, 99–105.

- Goodwin, R.D. (2003). Association between physical activity and mental disorders among adults in the United States. *Prev Med* 36, 698–703.
- Gourley, S.L., Kiraly, D.D., Howell, J.L., Olausson, P., and Taylor, J.R. (2008). Acute Hippocampal Brain-Derived Neurotrophic Factor Restores Motivational and Forced Swim Performance After Corticosterone. *Biol Psychiat* 64, 884–890.
- Grace, A.A. (1991). Phasic versus tonic dopamine release and the modulation of dopamine system responsivity: a hypothesis for the etiology of schizophrenia. *Neuroscience* 41, 1–24.
- Greenwood, B.N., Foley, T.E., Le, T.V., Strong, P.V., Loughridge, A.B., Day, H.E.W., and Fleshner, M. (2011). Long-term voluntary wheel running is rewarding and produces plasticity in the mesolimbic reward pathway. *Behav Brain Res* 217, 354–362.
- Greist, J.H., Klein, M.H., Eischens, R.R., Faris, J., Gurman, A.S., and Morgan, W.P. (1979). Running as treatment for depression. *Compr Psychiat* 20, 41–54.
- Guegan, T., Cutando, L., Ayuso, E., Santini, E., Fisone, G., Bosch, F., Martinez, A., Valjent, E., Maldonado, R., and Martin, M. (2013). Operant behavior to obtain palatable food modifies neuronal plasticity in the brain reward circuit. *European Neuropsychopharmacology* 23, 146–159.
- Gull, W. (1888). Anorexia Nervosa. *Lancet* 131, 516–517.
- Gunaydin, L.A., Grosenick, L., Finkelstein, J.C., Kauvar, I.V., Fenno, L.E., Adhikari, A., Lammel, S., Mirzabekov, J.J., Airan, R.D., Zalocusky, K.A., et al. (2014). Natural Neural Projection Dynamics Underlying Social Behavior. *Cell* 157, 1535–1551.
- Gutiérrez-Rodríguez, A., Río, I.B., Puente, N., Gómez-Urquijo, S.M., Fontaine, C.J., Egaña-Huguet, J., Elezgarai, I., Ruehle, S., Lutz, B., Robin, L.M., et al. (2018). Localization of the cannabinoid type-1 receptor in subcellular astrocyte compartments of mutant mouse hippocampus. *Glia* 66, 1417–1431.
- Haber, S.N., and Fudge, J.L. (1997). The Primate Substantia Nigra and VTA: Integrative Circuitry and Function. *Crit Rev Neurobiol* 11, 323–342.
- Haller, J., Varga, B., Ledent, C., Barna, I., and Freund, T.F. (2004). Context-dependent effects of CB1 cannabinoid gene disruption on anxiety-like and social behaviour in mice. *Eur J Neurosci* 19, 1906–1912.

- Hamid, A.A., Pettibone, J.R., Mabrouk, O.S., Hetrick, V.L., Schmidt, R., Weele, C.M., Kennedy, R.T., Aragona, B.J., and Berke, J.D. (2015). Mesolimbic dopamine signals the value of work. *Nat Neurosci* 19, 117–126.
- Hampson, R.E., Evans, G.J.O., Mu, J., Zhuang, S., King, V.C., Childers, S.R., and Deadwyler, S.A. (1995). Role of cyclic amp dependent protein kinase in cannabinoid receptor modulation of potassium “A-current” in cultured rat hippocampal neurons. *Life Sci* 56, 2081–2088.
- Han, J., Kesner, P., Metna-Laurent, M., Duan, T., Xu, L., Georges, F., Koehl, M., Abrous, D.N., Mendizabal-Zubiaga, J., Grandes, P., et al. (2012). Acute Cannabinoids Impair Working Memory through Astroglial CB1 Receptor Modulation of Hippocampal LTD. *Cell* 148, 1039–1050.
- Han, X., He, Y., Bi, G.-H., Zhang, H.-Y., Song, R., Liu, Q.-R., Egan, J.M., Gardner, E.L., Li, J., and Xi, Z.-X. (2017). CB1 Receptor Activation on VgluT2-Expressing Glutamatergic Neurons Underlies  $\Delta$ 9-Tetrahydrocannabinol ( $\Delta$ 9-THC)-Induced Aversive Effects in Mice. *Scientific Reports* 7, 12315.
- Hanuš, L., Abu-Lafi, S., Fride, E., Breuer, A., Vogel, Z., Shalev, D.E., Kustanovich, I., and Mechoulam, R. (2001). 2-Arachidonyl glyceryl ether, an endogenous agonist of the cannabinoid CB1 receptor. *Proc National Acad Sci* 98, 3662–3665.
- Häring, M., Marsicano, G., Lutz, B., and Monory, K. (2007). Identification of the cannabinoid receptor type 1 in serotonergic cells of raphe nuclei in mice. *Neuroscience* 146, 1212–1219.
- Harvey, S.B., Hotopf, M., Øverland, S., and Mykletun, A. (2010). Physical activity and common mental disorders. *Brit J Psychiat* 197, 357–364.
- Hasselt, F.N. van, Tieskens, J.M., Trezza, V., Krugers, H.J., Vanderschuren, L.J.M.J., and Joëls, M. (2012). Within-litter variation in maternal care received by individual pups correlates with adolescent social play behavior in male rats. *Physiol Behav* 106, 701–706.
- Have, M. ten, Graaf, R. de, and Monshouwer, K. (2011). Physical exercise in adults and mental health status Findings from the Netherlands Mental Health Survey and Incidence Study (NEMESIS). *J Psychosom Res* 71, 342–348.
- Hayes, K., Sprague, S., Guo, M., Davis, W., Friedman, A., Kumar, A., Jimenez, D.F., and Ding, Y. (2008). Forced, not voluntary, exercise effectively induces neuroprotection in stroke. *Acta Neuropathol* 115, 289–296.

- Hebebrand, J., Exner, C., Hebebrand, K., Holtkamp, C., Casper, R.C., Remschmidt, H., Herpertz-Dahlmann, B., and Klingenspor, M. (2003). Hyperactivity in patients with anorexia nervosa and in semistarved rats: evidence for a pivotal role of hypoleptinemia. *Physiol Behav* 79, 25–37.
- Hebert-Chatelain, E., Reguero, L., Puente, N., Lutz, B., Chaouloff, F., Rossignol, R., Piazza, P.-V., Benard, G., Grandes, P., and Marsicano, G. (2014). Cannabinoid control of brain bioenergetics: Exploring the subcellular localization of the CB1 receptor. *Mol Metab* 3, 495–504.
- Hebert-Chatelain, E., Desprez, T., Serrat, R., Bellocchio, L., Soria-Gomez, E., Busquets-Garcia, A., Zottola, A.C.P., Delamarre, A., Cannich, A., Vincent, P., et al. (2016). A cannabinoid link between mitochondria and memory. *Nature* 539, 555–559.
- Heifets, B.D., and Castillo, P.E. (2009). Endocannabinoid Signaling and Long-Term Synaptic Plasticity. *Annu Rev Physiol* 71, 283–306.
- Heifets, B.D., Chevaleyre, V., and Castillo, P.E. (2008). Interneuron activity controls endocannabinoid-mediated presynaptic plasticity through calcineurin. *Proc National Acad Sci* 105, 10250–10255.
- Herkenham, M., Lynn, A.B., Little, M.D., Johnson, M.R., Melvin, L.S., Costa, B.R. de, and Rice, K.C. (1990). Cannabinoid receptor localization in brain. *Proc National Acad Sci* 87, 1932–1936.
- Hernandez, G., and Cheer, J.F. (2012). Effect of CB1 Receptor Blockade on Food-Reinforced Responding and Associated Nucleus Accumbens Neuronal Activity in Rats. *The Journal of Neuroscience* 32, 11467–11477.
- Hill, M.N., Titterness, A.K., Morrish, A.C., Carrier, E.J., Lee, T.T. -Y., Gil-Mohapel, J., Gorzalka, B.B., Hillard, C.J., and Christie, B.R. (2010). Endogenous cannabinoid signaling is required for voluntary exercise-induced enhancement of progenitor cell proliferation in the hippocampus. *Hippocampus* 20, 513–523.
- Hillarp, N.A., Fuxe, K., and Dahlström, A. (1966). Demonstration and mapping of central neurons containing dopamine, noradrenaline, and 5-hydroxytryptamine and their reactions to psychopharmaca. *Pharmacol Rev* 18, 727–741.
- Hjelmstad, G.O., Xia, Y., Margolis, E.B., and Fields, H.L. (2013). Opioid Modulation of Ventral Pallidal Afferents to Ventral Tegmental Area Neurons. *J Neurosci* 33, 6454–6459.
- Hodos, W. (1961). Progressive Ratio as a Measure of Reward Strength. *Science* 134, 943–944.

- Hoffman, A.F., and Lupica, C.R. (2000). Mechanisms of Cannabinoid Inhibition of GABAergic Synaptic Transmission in the Hippocampus. *J Neurosci* 20, 2470–2479.
- Hoffmann, P., Terenius, L., and Thorén, P. (1990). Cerebrospinal fluid immunoreactive  $\beta$ -endorphin concentration is increased by voluntary exercise in the spontaneously hypertensive rat. *Regul Peptides* 28, 233–239.
- Hohmann, A.G., and Herkenham, M. (2000). Localization of cannabinoid CB1 receptor mRNA in neuronal subpopulations of rat striatum: A double-label in situ hybridization study. *Synapse* 37, 71–80.
- Howe, M.W., Tierney, P.L., Sandberg, S.G., Phillips, P.E.M., and Graybiel, A.M. (2013). Prolonged dopamine signalling in striatum signals proximity and value of distant rewards. *Nature* 500, 575–579.
- Howlett, A.C. (2002). The cannabinoid receptors. *Prostaglandin and Lipid Mediators* 68, 619–631.
- Howlett, A.C. (2005). Cannabinoids. *Handbook of Experimental Pharmacology* 53–79.
- Howlett, A.C., and Fleming, R.M. (1984). Cannabinoid inhibition of adenylate cyclase. Pharmacology of the response in neuroblastoma cell membranes. *Molecular Pharmacology* 26, 532–538.
- Howlett, A.C., Qualy, J.M., and Khachatrian, L.L. (1986). Involvement of  $G_i$  in the inhibition of adenylate cyclase by cannabimimetic drugs. *Molecular Pharmacology* 29, 307.
- Hua, T., Vemuri, K., Pu, M., Qu, L., Han, G.W., Wu, Y., Zhao, S., Shui, W., Li, S., Korde, A., et al. (2016). Crystal Structure of the Human Cannabinoid Receptor CB1. *Cell* 167, 750–762.e14.
- Hua, T., Vemuri, K., Nikas, S.P., Laprairie, R.B., Wu, Y., Qu, L., Pu, M., Korde, A., Jiang, S., Ho, J.-H., et al. (2017). Crystal structures of agonist-bound human cannabinoid receptor CB1. *Nature* 547, 468–471.
- Huang, S.M., and Walker, J.M. (2006). Enhancement of Spontaneous and Heat-Evoked Activity in Spinal Nociceptive Neurons by the Endovanilloid/Endocannabinoid N-Arachidonoyldopamine (NADA). *J Neurophysiol* 95, 1207–1212.
- Huang, C., Lo, S., and Hsu, K. (2001). Presynaptic mechanisms underlying cannabinoid inhibition of excitatory synaptic transmission in rat striatal neurons. *J Physiology* 532, 731–748.



- Hungund, B.L., Szakall, I., Adam, A., Basavarajappa, B.S., and Vadasz, C. (2003). Cannabinoid CB1 receptor knockout mice exhibit markedly reduced voluntary alcohol consumption and lack alcohol-induced dopamine release in the nucleus accumbens. *J Neurochem* *84*, 698–704.
- Hursh, S.R., and Silberberg, A. (2008). Economic Demand and Essential Value. *Psychol Rev* *115*, 186–198.
- Iannotti, F.A., Marzo, V.D., and Petrosino, S. (2016). Endocannabinoids and endocannabinoid-related mediators: Targets, metabolism and role in neurological disorders. *Prog Lipid Res* *62*, 107–128.
- Ikemoto, S. (2007). Dopamine reward circuitry: Two projection systems from the ventral midbrain to the nucleus accumbens–olfactory tubercle complex. *Brain Res Rev* *56*, 27–78.
- Ikemoto, S. (2010). Brain reward circuitry beyond the mesolimbic dopamine system: A neurobiological theory. *Neurosci Biobehav Rev* *35*, 129–150.
- Ikemoto, S., and Panksepp, J. (1992). The effects of early social isolation on the motivation for social play in juvenile rats. *Dev Psychobiol* *25*, 261–274.
- Initiative, A.N.G., Consortium, E.D.W.G. of the P.G., Watson, H.J., Yilmaz, Z., Thornton, L.M., Hübel, C., Coleman, J.R.I., Gaspar, H.A., Bryois, J., Hinney, A., et al. (2019). Genome-wide association study identifies eight risk loci and implicates metabo-psychiatric origins for anorexia nervosa. *Nat Genet* *51*, 1207–1214.
- Ishac, E.J.N., Jiang, L., Lake, K.D., Varga, K., Abood, M.E., and Kunos, G. (1996). Inhibition of exocytotic noradrenaline release by presynaptic cannabinoid CB1 receptors on peripheral sympathetic nerves. *Brit J Pharmacol* *118*, 2023–2028.
- Iversen, I.H. (1993). Techniques for establishing schedules with wheel running as reinforcement in rats. *Journal of the Experimental Analysis of Behavior* *60*, 219–238.
- Iversen, L. (1999). High times for cannabis research. *Proc National Acad Sci* *96*, 5338–5339.
- Jacobi, C., Hayward, C., Zwaan, M. de, Kraemer, H.C., and Agras, W.S. (2004). Coming to Terms With Risk Factors for Eating Disorders: Application of Risk Terminology and Suggestions for a General Taxonomy. *Psychol Bull* *130*, 19–65.

- Jalabert, M., Bourdy, R., Courtin, J., Veinante, P., Manzoni, O.J., Barrot, M., and Georges, F. (2011). Neuronal circuits underlying acute morphine action on dopamine neurons. *Proc National Acad Sci* *108*, 16446–16450.
- Jamshidi, N., and Taylor, D.A. (2001). Anandamide administration into the ventromedial hypothalamus stimulates appetite in rats. *Brit J Pharmacol* *134*, 1151–1154.
- Jappe, L.M., Frank, G.K.W., Shott, M.E., Rollin, M.D.H., Pryor, T., Hagman, J.O., Yang, T.T., and Davis, E. (2011). Heightened sensitivity to reward and punishment in anorexia nervosa. *Int J Eat Disorder* *44*, 317–324.
- Jarrett, M.M., Limebeer, C.L., and Parker, L.A. (2005). Effect of  $\Delta^9$ -tetrahydrocannabinol on sucrose palatability as measured by the taste reactivity test. *Physiol Behav* *86*, 475–479.
- Jarrett, M.M., Scantlebury, J., and Parker, L.A. (2007). Effect of  $\Delta^9$ -tetrahydrocannabinol on quinine palatability and AM251 on sucrose and quinine palatability using the taste reactivity test. *Physiol Behav* *90*, 425–430.
- Järvekülg, A., and Viru, A. (2002). Opioid Receptor Blockade Eliminates Mood Effects of Aerobic Gymnastics. *Int J Sports Med* *23*, 155–157.
- Javaras, K.N., Runfola, C.D., Thornton, L.M., Agerbo, E., Birgegård, A., Norring, C., Yao, S., Råstam, M., Larsson, H., Lichtenstein, P., et al. (2015). Sex- and age-specific incidence of healthcare-register-recorded eating disorders in the complete swedish 1979–2001 birth cohort. *Int J Eat Disorder* *48*, 1070–1081.
- Jennings, J.H., Sparta, D.R., Stamatakis, A.M., Ung, R.L., Pleil, K.E., Kash, T.L., and Stuber, G.D. (2013). Distinct extended amygdala circuits for divergent motivational states. *Nature* *496*, 224–228.
- Jennings, J.H., Ung, R.L., Resendez, S.L., Stamatakis, A.M., Taylor, J.G., Huang, J., Veleta, K., Katak, P.A., Aita, M., Shilling-Scriver, K., et al. (2015). Visualizing Hypothalamic Network Dynamics for Appetitive and Consummatory Behaviors. *Cell* *160*, 516–527.
- Jimenez-Blasco, D., Busquets-Garcia, A., Hebert-Chatelain, E., Serrat, R., Vicente-Gutierrez, C., Ioannidou, C., Gómez-Sotres, P., Lopez-Fabuel, I., Resch-Beusher, M., Resel, E., et al. (2020). Glucose metabolism links astroglial mitochondria to cannabinoid effects. *Nature* *583*, 603–608.
- Johnson, S.W., and North, R.A. (1992). Two types of neurone in the rat ventral tegmental area and their synaptic inputs. *J Physiology* *450*, 455–468.

- Jordan, C.J., and Xi, Z.-X. (2019). Progress in Brain Cannabinoid CB2 Receptor Research: From Genes to Behavior. *Neurosci Biobehav Rev* 98, 208–220.
- Justinova, Z., Tanda, G., Redhi, G.H., and Goldberg, S.R. (2003). Self-administration of  $\Delta$ 9-tetrahydrocannabinol (THC) by drug naive squirrel monkeys. *Psychopharmacology* 169, 135–140.
- Justinova, Z., Munzar, P., Panlilio, L.V., Yasar, S., Redhi, G.H., Tanda, G., and Goldberg, S.R. (2008). Blockade of THC-Seeking Behavior and Relapse in Monkeys by the Cannabinoid CB1-Receptor Antagonist Rimonabant. *Neuropsychopharmacol* 33, 2870–2877.
- Kaczmarek, H.J., and Kiefer, S.W. (2000). Microinjections of Dopaminergic Agents in the Nucleus Accumbens Affect Ethanol Consumption But Not Palatability. *Pharmacol Biochem Be* 66, 307–312.
- Kaczocha, M., Glaser, S.T., and Deutsch, D.G. (2009). Identification of intracellular carriers for the endocannabinoid anandamide. *Proc National Acad Sci* 106, 6375–6380.
- Kagan, J., and Berkun, M. (1954). The reward value of running activity. *J Comp Physiol Psych* 47, 108–108.
- Kanarek, R.B., Marks-Kaufman, R., D'Anci, K.E., and Przypek, J. (1995). Exercise attenuates oral intake of amphetamine in rats. *Pharmacol Biochem Be* 51, 725–729.
- Kandola, A., Vancampfort, D., Herring, M., Rebar, A., Hallgren, M., Firth, J., and Stubbs, B. (2018). Moving to Beat Anxiety: Epidemiology and Therapeutic Issues with Physical Activity for Anxiety. *Curr Psychiat Rep* 20, 63.
- Kano, M., Ohno-Shosaku, T., Hashimotodani, Y., Uchigashima, M., and Watanabe, M. (2009). Endocannabinoid-Mediated Control of Synaptic Transmission. *Physiol Rev* 89, 309–380.
- Karatsoreos, I.N., Bhagat, S.M., Bowles, N.P., Weil, Z.M., Pfaff, D.W., and McEwen, B.S. (2010). Endocrine and Physiological Changes in Response to Chronic Corticosterone: A Potential Model of the Metabolic Syndrome in Mouse. *Endocrinology* 151, 2117–2127.
- Katona, I., Urbán, G.M., Wallace, M., Ledent, C., Jung, K.-M., Piomelli, D., Mackie, K., and Freund, T.F. (2006). Molecular Composition of the Endocannabinoid System at Glutamatergic Synapses. *The Journal of Neuroscience* 26, 5628–5637.

- Katsidoni, V., Kastellakis, A., and Panagis, G. (2013). Biphasic effects of  $\Delta^9$ -tetrahydrocannabinol on brain stimulation reward and motor activity. *International Journal of Neuropsychopharmacology* 16, 2273–2284.
- Kawamura, Y., Fukaya, M., Maejima, T., Yoshida, T., Miura, E., Watanabe, M., Ohno-Shosaku, T., and Kano, M. (2006). The CB1 Cannabinoid Receptor Is the Major Cannabinoid Receptor at Excitatory Presynaptic Sites in the Hippocampus and Cerebellum. *J Neurosci* 26, 2991–3001.
- Kaye, W. (2008). Neurobiology of anorexia and bulimia nervosa. *Physiol Behav* 94, 121–135.
- Kaye, W.H., Fudge, J.L., and Paulus, M. (2009). New insights into symptoms and neurocircuit function of anorexia nervosa. *Nat Rev Neurosci* 10, 573–584.
- Keeney, B.K., Raichlen, D.A., Meek, T.H., Wijeratne, R.S., Middleton, K.M., Gerdeman, G.L., and Garland, T. (2008). Differential response to a selective cannabinoid receptor antagonist (SR141716; rimonabant) in female mice from lines selectively bred for high voluntary wheel-running behaviour. *Behav Pharmacol* 19, 812–820.
- Kim, S.F. (2012). Animal models of eating disorders. *Neuroscience* 211, 2–12.
- Kim, T.H., Richards, K., Heng, J., Petrou, S., and Reid, C.A. (2013). Two lines of transgenic mice expressing cre-recombinase exhibit increased seizure susceptibility. *Epilepsy Res* 104, 11–16.
- Kleijn, J., Wiskerke, J., Cremers, T.I.F.H., Schoffelmeer, A.N.M., Westerink, B.H.C., and Pattij, T. (2012). Effects of amphetamine on dopamine release in the rat nucleus accumbens shell region depend on cannabinoid CB1 receptor activation. *Neurochem Int* 60, 791–798.
- Kloet, E.R. de, Joëls, M., and Holsboer, F. (2005). Stress and the brain: from adaptation to disease. *Nat Rev Neurosci* 6, 463–475.
- Kobilo, T., Liu, Q.-R., Gandhi, K., Mughal, M., Shaham, Y., and Praag, H. van (2011). Running is the neurogenic and neurotrophic stimulus in environmental enrichment. *Learn Memory* 18, 605–609.
- Koch, J.E. (2001).  $\Delta^9$ -THC stimulates food intake in Lewis rats: effects on chow, high-fat and sweet high-fat diets. *Pharmacol Biochem Be* 68, 539–543.
- Koch, M., Varela, L., Kim, J.G., Kim, J.D., Hernández-Nuño, F., Simonds, S.E., Castorena, C.M., Vianna, C.R., Elmquist, J.K., Morozov, Y.M., et al. (2015).

- Hypothalamic POMC neurons promote cannabinoid-induced feeding. *Nature* 519, 45–50.
- Köfalvi, A., Rodrigues, R.J., Ledent, C., Mackie, K., Vizi, E.S., Cunha, R.A., and Sperlágh, B. (2005). Involvement of Cannabinoid Receptors in the Regulation of Neurotransmitter Release in the Rodent Striatum: A Combined Immunochemical and Pharmacological Analysis. *J Neurosci* 25, 2874–2884.
- Koob, G.F., and Nestler, E.J. (1997). The neurobiology of drug addiction. *J Neuropsychiatry Clin Neurosci* 9, 482–497.
- Koob, G.F., and Volkow, N.D. (2010). Neurocircuitry of Addiction. *Neuropsychopharmacology* 35, 217–238.
- Kortleven, C., Bruneau, L.C., and Trudeau, L.-E. (2012). Neurotensin inhibits glutamate-mediated synaptic inputs onto ventral tegmental area dopamine neurons through the release of the endocannabinoid 2-AG. *Neuropharmacology* 63, 983–991.
- Kreitzer, A.C., and Regehr, W.G. (2001). Retrograde Inhibition of Presynaptic Calcium Influx by Endogenous Cannabinoids at Excitatory Synapses onto Purkinje Cells. *Neuron* 29, 717–727.
- Ladabaum, U., Mannalithara, A., Myer, P.A., and Singh, G. (2014). Obesity, Abdominal Obesity, Physical Activity, and Caloric Intake in US Adults: 1988 to 2010. *Am J Medicine* 127, 717-727.e12.
- Lafourcade, M., Elezgarai, I., Mato, S., Bakiri, Y., Grandes, P., and Manzoni, O.J. (2007). Molecular Components and Functions of the Endocannabinoid System in Mouse Prefrontal Cortex. *Plos One* 2, e709.
- Lammel, S., Hetzel, A., Häckel, O., Jones, I., Liss, B., and Roeper, J. (2008). Unique Properties of Mesoprefrontal Neurons within a Dual Mesocorticolimbic Dopamine System. *Neuron* 57, 760–773.
- Lammel, S., Lim, B., and Malenka, R.C. (2014). Reward and aversion in a heterogeneous midbrain dopamine system. *Neuropharmacology* 76, 351–359.
- Laségue, Dr. (1997). On Hysterical Anorexia. *Obesity Research* 5, 492–497.
- Ledent, C., Valverde, O., Cossu, G., Petitet, F., Aubert, J.-F., Beslot, F., Böhme, G.A., Imperato, A., Pedrazzini, T., Roques, B.P., et al. (1999). Unresponsiveness to Cannabinoids and Reduced Addictive Effects of Opiates in CB1 Receptor Knockout Mice. *Science* 283, 401–404.

- Lee, I.-M., and Paffenbarger, R.S. (2000). Associations of Light, Moderate, and Vigorous Intensity Physical Activity with Longevity The Harvard Alumni Health Study. *Am J Epidemiol* 151, 293–299.
- Lee, I.-M., Shiroma, E.J., Lobelo, F., Puska, P., Blair, S.N., Katzmarzyk, P.T., and Group, for the L.P.A.S.W. (2012). Effect of physical inactivity on major non-communicable diseases worldwide: an analysis of burden of disease and life expectancy. *Lancet* 380, 219–229.
- Lett, B.T., Grant, V.L., Byrne, M.J., and Koh, M.T. (2000). Pairings of a distinctive chamber with the aftereffect of wheel running produce conditioned place preference. *Appetite* 34, 87–94.
- Lett, B.T., Grant, V.L., and Koh, M.T. (2001). Naloxone attenuates the conditioned place preference induced by wheel running in rats. *Physiology & Behavior* 72, 355–358.
- Leung, N., Thomas, G., and Waller, G. (2000). The relationship between parental bonding and core beliefs in anorexic and bulimic women. *Brit J Clin Psychol* 39, 205–213.
- Lewis, D.Y., and Brett, R.R. (2010). Activity-based anorexia in C57/BL6 mice: Effects of the phytocannabinoid,  $\Delta^9$ -tetrahydrocannabinol (THC) and the anandamide analogue, OMDM-2. *Eur Neuropsychopharm* 20, 622–631.
- Li, X., Hoffman, A.F., Peng, X.-Q., Lupica, C.R., Gardner, E.L., and Xi, Z.-X. (2008). Attenuation of basal and cocaine-enhanced locomotion and nucleus accumbens dopamine in cannabinoid CB1-receptor-knockout mice. *Psychopharmacology* 204, 1.
- Li, X., Qi, J., Yamaguchi, T., Wang, H.-L., and Morales, M. (2013). Heterogeneous composition of dopamine neurons of the rat A10 region: molecular evidence for diverse signaling properties. *Brain Struct Funct* 218, 1159–1176.
- Li, Y., Zhong, W., Wang, D., Feng, Q., Liu, Z., Zhou, J., Jia, C., Hu, F., Zeng, J., Guo, Q., et al. (2016). Serotonin neurons in the dorsal raphe nucleus encode reward signals. *Nature Communications* 7, 10503.
- Liu, Z., Zhou, J., Li, Y., Hu, F., Lu, Y., Ma, M., Feng, Q., Zhang, J., Wang, D., Zeng, J., et al. (2014). Dorsal Raphe Neurons Signal Reward through 5-HT and Glutamate. *Neuron* 81, 1360–1374.
- Llano, I., Leresche, N., and Marty, A. (1991). Calcium entry increases the sensitivity of cerebellar Purkinje cells to applied GABA and decreases inhibitory synaptic currents. *Neuron* 6, 565–574.

- Lobb, C.J., Wilson, C.J., and Paladini, C.A. (2010). A Dynamic Role for GABA Receptors on the Firing Pattern of Midbrain Dopaminergic Neurons. *J Neurophysiol* 104, 403–413.
- López-Moreno, J.A., González-Cuevas, G., Fonseca, F.R. de, and Navarro, M. (2004). Long-Lasting Increase of Alcohol Relapse by the Cannabinoid Receptor Agonist WIN 55,212-2 during Alcohol Deprivation. *J Neurosci* 24, 8245–8252.
- Lu, B., Nagappan, G., and Lu, Y. (2014). Neurotrophic Factors. *Handb Exp Pharmacol* 220, 223–250.
- Lupica, C.R., and Riegel, A.C. (2005). Endocannabinoid release from midbrain dopamine neurons: a potential substrate for cannabinoid receptor antagonist treatment of addiction. *Neuropharmacology* 48, 1105–1116.
- Lüscher, C. (2015). The Emergence of a Circuit Model for Addiction. *Annu Rev Neurosci* 39, 1–20.
- Lüscher, C., and Malenka, R.C. (2011). Drug-Evoked Synaptic Plasticity in Addiction: From Molecular Changes to Circuit Remodeling. *Neuron* 69, 650–663.
- Lynch, W.J., Peterson, A.B., Sanchez, V., Abel, J., and Smith, M.A. (2013). Exercise as a novel treatment for drug addiction: A neurobiological and stage-dependent hypothesis. *Neurosci Biobehav Rev* 37, 1622–1644.
- Mackie, K. (2005). Cannabinoid receptor homo- and heterodimerization. *Life Sci* 77, 1667–1673.
- Mackie, K., Lai, Y., Westenbroek, R., and Mitchell, R. (1995). Cannabinoids activate an inwardly rectifying potassium conductance and inhibit Q-type calcium currents in AtT20 cells transfected with rat brain cannabinoid receptor. *J Neurosci* 15, 6552–6561.
- Maejima, T., Ohno-Shosaku, T., and Kano, M. (2001). Endogenous cannabinoid as a retrograde messenger from depolarized postsynaptic neurons to presynaptic terminals. *Neurosci Res* 40, 205–210.
- Maffei, M., Halaas, J., Ravussin, E., Pratley, R.E., Lee, G.H., Zhang, Y., Fei, H., Kim, S., Lallone, R., Ranganathan, S., et al. (1995). Leptin levels in human and rodent: Measurement of plasma leptin and ob RNA in obese and weight-reduced subjects. *Nat Med* 1, 1155–1161.
- Magomedova, L., and Cummins, C.L. (2015). Metabolic Control. *Handb Exp Pharmacol* 233, 73–93.

- Mahler, S.V., Smith, K.S., and Berridge, K.C. (2007). Endocannabinoid Hedonic Hotspot for Sensory Pleasure: Anandamide in Nucleus Accumbens Shell Enhances 'Liking' of a Sweet Reward. *Neuropsychopharmacology* 32, 2267–2278.
- Mancino, S., Burokas, A., Gutiérrez-Cuesta, J., Gutiérrez-Martos, M., Martín-García, E., Pucci, M., Falconi, A., D'Addario, C., Maccarrone, M., and Maldonado, R. (2015). Epigenetic and Proteomic Expression Changes Promoted by Eating Addictive-Like Behavior. *Neuropsychopharmacol* 40, 2788–2800.
- Maresz, K., Carrier, E.J., Ponomarev, E.D., Hillard, C.J., and Dittel, B.N. (2005). Modulation of the cannabinoid CB2 receptor in microglial cells in response to inflammatory stimuli. *J Neurochem* 95, 437–445.
- Margolis, E.B., Toy, B., Himmels, P., Morales, M., and Fields, H.L. (2012). Identification of Rat Ventral Tegmental Area GABAergic Neurons. *Plos One* 7, e42365.
- Marichal-Cancino, B.A., Fajardo-Valdez, A., Ruiz-Contreras, A.E., Mendez-Díaz, M., and Prospero-García, O. (2017). Advances in the Physiology of GPR55 in the Central Nervous System. *Curr Neuropharmacol* 15.
- Markoff, R.A., Ryan, P., and Young, T. (1982). Endorphins and mood changes in long-distance running. *Medicine Sci Sports Exerc* 14, 11.
- Marsicano, G., and Lutz, B. (1999). Expression of the cannabinoid receptor CB1 in distinct neuronal subpopulations in the adult mouse forebrain. *Eur J Neurosci* 11, 4213–4225.
- Marsicano, G., Wotjak, C.T., Azad, S.C., Bisogno, T., Rammes, G., Cascio, M.G., Hermann, H., Tang, J., Hofmann, C., Zieglgänsberger, W., et al. (2002). The endogenous cannabinoid system controls extinction of aversive memories. *Nature* 418, 530–534.
- Marsicano, G., Goodenough, S., Monory, K., Hermann, H., Eder, M., Cannich, A., Azad, S.C., Cascio, M.G., Gutiérrez, S.O., Stelt, M. van der, et al. (2003). CB1 Cannabinoid Receptors and On-Demand Defense Against Excitotoxicity. *Science* 302, 84–88.
- Martin, M., Ledent, C., Parmentier, M., Maldonado, R., and Valverde, O. (2000). Cocaine, but not morphine, induces conditioned place preference and sensitization to locomotor responses in CB1 knockout mice. *Eur J Neurosci* 12, 4038–4046.
- Martín-García, E., Bourgoin, L., Cathala, A., Kasanetz, F., Mondesir, M., Gutiérrez-Rodríguez, A., Reguero, L., Fiancette, J.-F., Grandes, P., Spampinato, U., et



- al. (2016). Differential Control of Cocaine Self-Administration by GABAergic and Glutamatergic CB1 Cannabinoid Receptors. *Neuropsychopharmacology* 41, 2192–2205.
- Martinsen, E.W. (2009). Physical activity in the prevention and treatment of anxiety and depression. *Nord J Psychiat* 62, 25–29.
- Martinsen, M., and Sundgot-Borgen, J. (2013). Higher Prevalence of Eating Disorders among Adolescent Elite Athletes than Controls. *Medicine Sci Sports Exerc* 45, 1188–1197.
- Martinsen, E.W., Medhus, A., and Sandvik, L. (1985). Effects of aerobic exercise on depression: a controlled study. *Br Medical J Clin Res Ed* 291, 109.
- Marzo, V.D., Fontana, A., Cadas, H., Schinelli, S., Cimino, G., Schwartz, J.-C., and Piomelli, D. (1994). Formation and inactivation of endogenous cannabinoid anandamide in central neurons. *Nature* 372, 686–691.
- Mascia, M.S., Obinu, M.C., Ledent, C., Parmentier, M., Böhme, G.A., Imperato, A., and Fratta, W. (1999). Lack of morphine-induced dopamine release in the nucleus accumbens of cannabinoid CB1 receptor knockout mice. *Eur J Pharmacol* 383, R1–R2.
- Mason, W.A., Saxon, S.V., and Sharpe, L.G. (1963). Preferential responses of young chimpanzees to food and social rewards. *Psychological Rec* 13, 341–345.
- Mateo, Y., Johnson, K.A., Covey, D.P., Atwood, B.K., Wang, H.-L., Zhang, S., Gildish, I., Cachope, R., Bellocchio, L., Guzmán, M., et al. (2017). Endocannabinoid Actions on Cortical Terminals Orchestrate Local Modulation of Dopamine Release in the Nucleus Accumbens. *Neuron* 96, 1112-1126.e5.
- Matsuda, L.A., Lolait, S.J., Brownstein, M.J., Young, A.C., and Bonner, T.I. (1990). Structure of a cannabinoid receptor and functional expression of the cloned cDNA. *Nature* 346, 561–564.
- Matsuda, L.A., Bonner, T.I., and Lolait, S.J. (1993). Localization of cannabinoid receptor mRNA in rat brain. *J Comp Neurol* 327, 535–550.
- Matsui, A., Jarvie, B.C., Robinson, B.G., Hentges, S.T., and Williams, J.T. (2014). Separate GABA Afferents to Dopamine Neurons Mediate Acute Action of Opioids, Development of Tolerance, and Expression of Withdrawal. *Neuron* 82, 1346–1356.
- Mátyás, F., Urbán, G.M., Watanabe, M., Mackie, K., Zimmer, A., Freund, T.F., and Katona, I. (2008). Identification of the sites of 2-arachidonoylglycerol synthesis

and action imply retrograde endocannabinoid signaling at both GABAergic and glutamatergic synapses in the ventral tegmental area. *Neuropharmacology* 54, 95–107.

McEwen, B.S., Kloet, E.R.D., and Rostene, W. (1986). Adrenal steroid receptors and actions in the nervous system. *Physiol Rev* 66, 1121–1188.

McLaughlin, P.J., Winston, K., Swezey, L., Wisniecki, A., Aberman, J., Tardif, D.J., Betz, A.J., Ishiwari, K., Makriyannis, A., and Salamone, J.D. (2003). The cannabinoid CB1 antagonists SR 141716A and AM 251 suppress food intake and food-reinforced behavior in a variety of tasks in rats. *Behavioural Pharmacology* 14, 583–588.

McLaughlin, P.J., Winston, K.M., Limebeer, C.L., Parker, L.A., Makriyannis, A., and Salamone, J.D. (2005). The cannabinoid CB1 antagonist AM 251 produces food avoidance and behaviors associated with nausea but does not impair feeding efficiency in rats. *Psychopharmacology* 180, 286–293.

McLaughlin, P.J., Qian, L., Wood, J.T., Wisniecki, A., Winston, K.M., Swezey, L.A., Ishiwari, K., Betz, A.J., Pandarinathan, L., Xu, W., et al. (2006). Suppression of food intake and food-reinforced behavior produced by the novel CB1 receptor antagonist/inverse agonist AM 1387. *Pharmacol Biochem Be* 83, 396–402.

Mechoulam, R., Ben-Shabat, S., Hanus, L., Ligumsky, M., Kaminski, N.E., Schatz, A.R., Gopher, A., Almog, S., Martin, B.R., Compton, D.R., et al. (1995). Identification of an endogenous 2-monoglyceride, present in canine gut, that binds to cannabinoid receptors. *Biochem Pharmacol* 50, 83–90.

Mechoulam, R., Hanuš, L.O., Pertwee, R., and Howlett, A.C. (2014). Early phytocannabinoid chemistry to endocannabinoids and beyond. *Nat Rev Neurosci* 15, 757–764.

Medrano, M., Hurel, I., Mesguich, E., Redon, B., Stevens, C., Georges, F., Melis, M., Marsicano, G., and Chaouloff, F. (2020). Exercise craving potentiates excitatory inputs to ventral tegmental area dopaminergic neurons. *Addict Biol* e12967.

Meijer, J.H., and Robbers, Y. (2014). Wheel running in the wild. *Proceedings of the Royal Society B: Biological Sciences* 281, 20140210.

Melis, M.R., and Argiolas, A. (1995). Dopamine and sexual behavior. *Neurosci Biobehav Rev* 19, 19–38.

- Melis, M., Perra, S., Muntoni, A.L., Pillolla, G., Lutz, B., Marsicano, G., Marzo, V.D., Gessa, G.L., and Pistis, M. (2004a). Prefrontal Cortex Stimulation Induces 2-Arachidonoyl-Glycerol-Mediated Suppression of Excitation in Dopamine Neurons. *J Neurosci* 24, 10707–10715.
- Melis, M., Pistis, M., Perra, S., Muntoni, A.L., Pillolla, G., and Gessa, G.L. (2004b). Endocannabinoids Mediate Presynaptic Inhibition of Glutamatergic Transmission in Rat Ventral Tegmental Area Dopamine Neurons through Activation of CB1 Receptors. *J Neurosci* 24, 53–62.
- Melis, M., Muntoni, A.L., and Pistis, M. (2012). Endocannabinoids and the Processing of Value-Related Signals. *Front Pharmacol* 3, 7.
- Melis, M., Frau, R., Kalivas, P.W., Spencer, S., Chioma, V., Zamberletti, E., Rubino, T., and Parolaro, D. (2017). New vistas on cannabis use disorder. *Neuropharmacology* 124, 62–72.
- Melis, T., Succu, S., Sanna, F., Boi, A., Argiolas, A., and Melis, M.R. (2007). The cannabinoid antagonist SR 141716A (Rimonabant) reduces the increase of extra-cellular dopamine release in the rat nucleus accumbens induced by a novel high palatable food. *Neurosci Lett* 419, 231–235.
- Menigoz, A., and Boudes, M. (2011). The Expression Pattern of TRPV1 in Brain. *J Neurosci* 31, 13025–13027.
- Méquinion, M., Chauveau, C., and Viltart, O. (2015). The Use of Animal Models to Decipher Physiological and Neurobiological Alterations of Anorexia Nervosa Patients. *Front Endocrinol* 6, 68.
- Mickelsen, L.E., Bolisetty, M., Chimileski, B.R., Fujita, A., Beltrami, E.J., Costanzo, J.T., Naparstek, J.R., Robson, P., and Jackson, A.C. (2019). Single-cell transcriptomic analysis of the lateral hypothalamic area reveals molecularly distinct populations of inhibitory and excitatory neurons. *Nat Neurosci* 22, 642–656.
- Miczek, K. (1978). delta9-tetrahydrocannabinol: antiaggressive effects in mice, rats, and squirrel monkeys. *Science* 199, 1459–1461.
- Min, R., Marzo, V.D., and Mansvelder, H.D. (2010). DAG Lipase Involvement in Depolarization-Induced Suppression of Inhibition: Does Endocannabinoid Biosynthesis Always Meet the Demand? *Neurosci* 16, 608–613.
- Misner, D.L., and Sullivan, J.M. (1999). Mechanism of Cannabinoid Effects on Long-Term Potentiation and Depression in Hippocampal CA1 Neurons. *J Neurosci* 19, 6795–6805.

- Mohebi, A., Pettibone, J.R., Hamid, A.A., Wong, J.-M.T., Vinson, L.T., Patriarchi, T., Tian, L., Kennedy, R.T., and Berke, J.D. (2019). Dissociable dopamine dynamics for learning and motivation. *Nature* 570, 65–70.
- Mond, J.M., and Calogero, R.M. (2008). Excessive Exercise in Eating Disorder Patients and in Healthy Women. *Aust Nz J Psychiat* 43, 227–234.
- Monory, K., Massa, F., Egertová, M., Eder, M., Blaudzun, H., Westenbroek, R., Kelsch, W., Jacob, W., Marsch, R., Ekker, M., et al. (2006). The Endocannabinoid System Controls Key Epileptogenic Circuits in the Hippocampus. *Neuron* 51, 455–466.
- Morales, M., and Margolis, E.B. (2017). Ventral tegmental area: cellular heterogeneity, connectivity and behaviour. *Nature Reviews Neuroscience* 18, 73–85.
- Morales, P., Goya, P., Jagerovic, N., and Hernandez-Folgado, L. (2016). Allosteric Modulators of the CB1 Cannabinoid Receptor: A Structural Update Review. *Cannabis Cannabinoid Res* 1, 22–30.
- Morrison-Nozik, A., Anand, P., Zhu, H., Duan, Q., Sabeh, M., Prosdocimo, D.A., Lemieux, M.E., Nordsborg, N., Russell, A.P., MacRae, C.A., et al. (2015). Glucocorticoids enhance muscle endurance and ameliorate Duchenne muscular dystrophy through a defined metabolic program. *Proc National Acad Sci* 112, E6780–E6789.
- Morton, G.J., Cummings, D.E., Baskin, D.G., Barsh, G.S., and Schwartz, M.W. (2006). Central nervous system control of food intake and body weight. *Nature* 443, 289–295.
- Morton, G.J., Kaiyala, K.J., Fisher, J.D., Ogimoto, K., Schwartz, M.W., and Wisse, B.E. (2011). Identification of a physiological role for leptin in the regulation of ambulatory activity and wheel running in mice. *Am J Physiol-Endoc M* 300, E392–E401.
- Mueller, D.T., Loft, A., and Eikelboom, R. (1997). Alternate-Day Wheel Access Effects on Feeding, Body Weight, and Running. This research was supported by funds from the WLU Office of Research to R. E. *Physiol Behav* 62, 905–908.
- Munro, S., Thomas, K.L., and Abu-Shaar, M. (1993). Molecular characterization of a peripheral receptor for cannabinoids. *Nature* 365, 61–65.
- Nadler, J.J., Moy, S.S., Dold, G., Simmons, N., Perez, A., Young, N.B., Barbaro, R.P., Piven, J., Magnuson, T.R., and Crawley, J.N. (2004). Automated apparatus for quantitation of social approach behaviors in mice. *Genes Brain Behav* 3, 303–314.

- Nair-Roberts, R., Chatelain-Badie, S., and Neuroscience, B.-E. (2008). Stereological estimates of dopaminergic, GABAergic and glutamatergic neurons in the ventral tegmental area, substantia nigra and retrorubral field in the rat.
- Nakamura, Y., Dryanovski, D.I., Kimura, Y., Jackson, S.N., Woods, A.S., Yasui, Y., Tsai, S.-Y., Patel, S., Covey, D.P., Su, T.-P., et al. (2019). Cocaine-induced endocannabinoid signaling mediated by sigma-1 receptors and extracellular vesicle secretion. *Elife* 8, e47209.
- Nakazi, M., Bauer, U., Nickel, T., Kathmann, M., and Schlicker, E. (2000). Inhibition of serotonin release in the mouse brain via presynaptic cannabinoid CB1 receptors. *Naunyn-Schmiedeberg's Archives Pharmacol* 361, 19–24.
- Naneix, F., Darlot, F., Smedt-Peyrusse, V.D., Pape, J.-R., Coutureau, E., and Cador, M. (2018). Protracted motivational dopamine-related deficits following adolescence sugar overconsumption. *Neuropharmacology* 129, 16–25.
- Narushima, M., Uchigashima, M., Fukaya, M., Matsui, M., Manabe, T., Hashimoto, K., Watanabe, M., and Kano, M. (2007). Tonic Enhancement of Endocannabinoid-Mediated Retrograde Suppression of Inhibition by Cholinergic Interneuron Activity in the Striatum. *J Neurosci* 27, 496–506.
- Navarrete, M., and Araque, A. (2008). Endocannabinoids Mediate Neuron-Astrocyte Communication. *Neuron* 57, 883–893.
- Navarrete, M., and Araque, A. (2010). Endocannabinoids Potentiate Synaptic Transmission through Stimulation of Astrocytes. *Neuron* 68, 113–126.
- Navarro, M., Carrera, M.R.A., Fratta, W., Valverde, O., Cossu, G., Fattore, L., Chowen, J.A., Gómez, R., Arco, I. del, Villanúa, M.A., et al. (2001). Functional Interaction between Opioid and Cannabinoid Receptors in Drug Self-Administration. *J Neurosci* 21, 5344–5350.
- Neeper, S.A., Góaucomez-Pinilla, F., Choi, J., and Cotman, C. (1995). Exercise and brain neurotrophins. *Nature* 373, 109–109.
- Nestler, E.J., Kelz, M.B., and Chen, J. (1999).  $\Delta$ FosB: a molecular mediator of long-term neural and behavioral plasticity1Published on the World Wide Web on 27 November 1998.1. *Brain Res* 835, 10–17.
- Nguyen, T. (2019). Working out with weed. *Nature* 572, S14–S15.
- Nieh, E.H., Matthews, G.A., Allsop, S.A., Presbrey, K.N., Leppla, C.A., Wichmann, R., Neve, R., Wildes, C.P., and Tye, K.M. (2015). Decoding Neural Circuits that Control Compulsive Sucrose Seeking. *Cell* 160, 528–541.

- Nieh, E.H., Vander Weele, C.M., Matthews, G.A., Presbrey, K.N., Wichmann, R., Leppla, C.A., Izadmehr, E.M., and Tye, K.M. (2016). Inhibitory Input from the Lateral Hypothalamus to the Ventral Tegmental Area Disinhibits Dopamine Neurons and Promotes Behavioral Activation. *Neuron* 90, 1286–1298.
- Noble, E.G., Moraska, A., Mazzeo, R.S., Roth, D.A., Olsson, M.C., Moore, R.L., and Fleshner, M. (1999). Differential expression of stress proteins in rat myocardium after free wheel or treadmill run training. *J Appl Physiol* 86, 1696–1701.
- Novak, C.M., Burghardt, P.R., and Levine, J.A. (2012). The use of a running wheel to measure activity in rodents: Relationship to energy balance, general activity, and reward. *Neurosci Biobehav Rev* 36, 1001–1014.
- Oddi, S., Fezza, F., Pasquariello, N., D’Agostino, A., Catanzaro, G., Simone, C.D., Rapino, C., Finazzi-Agrò, A., and Maccarrone, M. (2009). Molecular Identification of Albumin and Hsp70 as Cytosolic Anandamide-Binding Proteins. *Chem Biol* 16, 624–632.
- Ohno-Shosaku, T., Maejima, T., and Kano, M. (2001). Endogenous Cannabinoids Mediate Retrograde Signals from Depolarized Postsynaptic Neurons to Presynaptic Terminals. *Neuron* 29, 729–738.
- Ohno-Shosaku, T., Matsui, M., Fukudome, Y., Shosaku, J., Tsubokawa, H., Taketo, M.M., Manabe, T., and Kano, M. (2003). Postsynaptic M1 and M3 receptors are responsible for the muscarinic enhancement of retrograde endocannabinoid signalling in the hippocampus. *Eur J Neurosci* 18, 109–116.
- Oleson, E.B., Beckert, M.V., Morra, J.T., Lansink, C.S., Cachope, R., Abdullah, R.A., Loriaux, A.L., Schetters, D., Pattij, T., Roitman, M.F., et al. (2012). Endocannabinoids Shape Accumbal Encoding of Cue-Motivated Behavior via CB1 Receptor Activation in the Ventral Tegmentum. *Neuron* 73, 360–373.
- Omelchenko, N., and Sesack, S.R. (2009). Ultrastructural analysis of local collaterals of rat ventral tegmental area neurons: GABA phenotype and synapses onto dopamine and GABA cells. *Synapse* 63, 895–906.
- Onaivi, E.S., Ishiguro, H., Gong, J., Patel, S., Perchuk, A., Meozzi, P.A., Myers, L., Mora, Z., Tagliaferro, P., Gardner, E., et al. (2006). Discovery of the Presence and Functional Expression of Cannabinoid CB2 Receptors in Brain. *Annals of the New York Academy of Sciences* 1074, 514–536.
- O’Shaughnessy, W.B. (1843). On the Preparations of the Indian Hemp, or Gunjah. *Prov Medical Surg J* 5, 343–347.

- Ozburn, A.R., Harris, R.A., and Blednov, Y.A. (2008). Wheel running, voluntary ethanol consumption, and hedonic substitution. *Alcohol* 42, 417–424.
- Pamplona, F.A., Ferreira, J., Lima, O.M. de, Duarte, F.S., Bento, A.F., Forner, S., Villarinho, J.G., Bellocchio, L., Bellochio, L., Wotjak, C.T., et al. (2012). Anti-inflammatory lipoxin A4 is an endogenous allosteric enhancer of CB1 cannabinoid receptor. *Proc National Acad Sci* 109, 21134–21139.
- Pan, B., Hillard, C.J., and Liu, Q. (2008). Endocannabinoid Signaling Mediates Cocaine-Induced Inhibitory Synaptic Plasticity in Midbrain Dopamine Neurons. *J Neurosci* 28, 1385–1397.
- Pan, X., Ikeda, S.R., and Lewis, D.L. (1996). Rat brain cannabinoid receptor modulates N-type Ca<sup>2+</sup> channels in a neuronal expression system. *Mol Pharmacol* 49, 707–714.
- Parkes, S.L., Furlong, T.M., Black, A.D., and Balleine, B.W. (2017). Intermittent feeding alters sensitivity to changes in reward value. *Appetite* 113, 1–6.
- Parnaudeau, S., Dongelmans, M., Turiault, M., Ambroggi, F., Delbes, A.-S., Cansell, C., Luquet, S., Piazza, P.-V., Tronche, F., and Barik, J. (2014). Glucocorticoid receptor gene inactivation in dopamine-innervated areas selectively decreases behavioral responses to amphetamine. *Front Behav Neurosci* 8, 35.
- Parsons, L.H., and Hurd, Y.L. (2015). Endocannabinoid signalling in reward and addiction. *Nat Rev Neurosci* 16, 579–594.
- Peciña, S., and Berridge, K.C. (2005). Hedonic Hot Spot in Nucleus Accumbens Shell: Where Do  $\mu$ -Opioids Cause Increased Hedonic Impact of Sweetness? *J Neurosci* 25, 11777–11786.
- Peciña, S., Berridge, K.C., and Parker, L.A. (1997). Pimozide Does Not Shift Palatability: Separation of Anhedonia from Sensorimotor Suppression by Taste Reactivity. *Pharmacol Biochem Be* 58, 801–811.
- Peciña, S., Cagniard, B., Berridge, K.C., Aldridge, J.W., and Zhuang, X. (2003). Hyperdopaminergic Mutant Mice Have Higher “Wanting” But Not “Liking” for Sweet Rewards. *J Neurosci* 23, 9395–9402.
- Peña, C.J., Neugut, Y.D., Calarco, C.A., and Champagne, F.A. (2014). Effects of maternal care on the development of midbrain dopamine pathways and reward-directed behavior in female offspring. *Eur J Neurosci* 39, 946–956.
- Pertwee, R.G. (1997). Pharmacology of cannabinoid CB1 and CB2 receptors. *Pharmacol Therapeut* 74, 129–180.

- Petrocellis, L.D., and Marzo, V.D. (2005). Lipids as regulators of the activity of transient receptor potential type V1 (TRPV1) channels. *Life Sci* 77, 1651–1666.
- Phillips, A.G., Brooke, S.M., and Fibiger, H.C. (1975). Effects of amphetamine isomers and neuroleptics on self-stimulation from the nucleus accumbens and dorsal nor-adrenergic bundle. *Brain Res* 85, 13–22.
- Piazza, P.V., and Moal, M.L. (1997). Glucocorticoids as a biological substrate of reward: physiological and pathophysiological implications. *Brain Res Rev* 25, 359–372.
- Piazza, P.V., Cota, D., and Marsicano, G. (2017). The CB1 Receptor as the Cornerstone of Exostasis. *Neuron* 93, 1252–1274.
- Pierce, W.D., Epling, W.F., and Boer, D.P. (1986). Deprivation and satiation: the interrelations between food and wheel running. *J Exp Anal Behav* 46, 199–210.
- Pike, K.M., Hilbert, A., Wilfley, D.E., Fairburn, C.G., Dohm, F.-A., Walsh, B.T., and Striegel-Moore, R. (2008). Toward an understanding of risk factors for anorexia nervosa: a case-control study. *Psychol Med* 38, 1443–1453.
- Piomelli, D. (2003). The molecular logic of endocannabinoid signalling. *Nat Rev Neurosci* 4, 873–884.
- Pistis, M., Ferraro, L., Pira, L., Flore, G., Tanganelli, S., Gessa, G.L., and Devoto, P. (2002).  $\Delta^9$ -Tetrahydrocannabinol decreases extracellular GABA and increases extracellular glutamate and dopamine levels in the rat prefrontal cortex: an in vivo microdialysis study. *Brain Res* 948, 155–158.
- Pitler, T., and Alger, B. (1992). Postsynaptic spike firing reduces synaptic GABA<sub>A</sub> responses in hippocampal pyramidal cells. *J Neurosci* 12, 4122–4132.
- Polissidis, A., Chouliara, O., Galanopoulos, A., Naxakis, G., Papahatjis, D., Papadopoulou-Daifoti, Z., and Antoniou, K. (2014). Cannabinoids negatively modulate striatal glutamate and dopamine release and behavioural output of acute d-amphetamine. *Behav Brain Res* 270, 261–269.
- Porter, A.C., Sauer, J.-M., Knierman, M.D., Becker, G.W., Berna, M.J., Bao, J., Nomikos, G.G., Carter, P., Bymaster, F.P., Leese, A.B., et al. (2002). Characterization of a Novel Endocannabinoid, Virodhamine, with Antagonist Activity at the CB1 Receptor. *J Pharmacol Exp Ther* 301, 1020–1024.



- Potter, C.D., Borer, K.T., and Katz, R.J. (1983). Opiate-receptor blockade reduces voluntary running but not self-stimulation in hamsters. *Pharmacol Biochem Be* 18, 217–223.
- Prevost-Solie, C., Girard, B., Righetti, B., Tapparel, M., and Bellone, C. (2020). Dopamine neurons of the VTA encode active conspecific interaction and promote social learning through social reward prediction error. *Biorxiv* 2020.05.27.118851.
- Raichlen, D.A., Foster, A.D., Gerdeman, G.L., Seillier, A., and Giuffrida, A. (2012). Wired to run: exercise-induced endocannabinoid signaling in humans and cursorial mammals with implications for the ‘runner’s high.’ *The Journal of Experimental Biology* 215, 1331–1336.
- Randall, P.A., Pardo, M., Nunes, E.J., Cruz, L., Vemuri, K.V., Makriyannis, A., Baqi, Y., Müller, C.E., Correa, M., and Salamone, J.D. (2012). Dopaminergic Modulation of Effort-Related Choice Behavior as Assessed by a Progressive Ratio Chow Feeding Choice Task: Pharmacological Studies and the Role of Individual Differences. *PLoS ONE* 7, e47934.
- Rasmussen, E.B., and Hillman, C. (2011). Naloxone and rimonabant reduce the reinforcing properties of exercise in rats. *Experimental and Clinical Psychopharmacology* 19, 389.
- Rey, A.A., Purrio, M., Viveros, M.-P., and Lutz, B. (2012). Biphasic Effects of Cannabinoids in Anxiety Responses: CB1 and GABAB Receptors in the Balance of GABAergic and Glutamatergic Neurotransmission. *Neuropsychopharmacol* 37, 2624–2634.
- Richardson, N.R., and Roberts, D.C.S. (1996). Progressive ratio schedules in drug self-administration studies in rats: a method to evaluate reinforcing efficacy. *J Neurosci Meth* 66, 1–11.
- Riegel, A.C., and Lupica, C.R. (2004). Independent Presynaptic and Postsynaptic Mechanisms Regulate Endocannabinoid Signaling at Multiple Synapses in the Ventral Tegmental Area. *J Neurosci* 24, 11070–11078.
- Rinaldi-Carmona, M., Pialot, F., Congy, C., Redon, E., Barth, F., Bachy, A., Brelière, J.-C., Soubrié, P., and Fur, G.L. (1996). Characterization and distribution of binding sites for [3H]-SR 141716A, a selective brain (CB1) cannabinoid receptor antagonist, in rodent brain. *Life Sci* 58, 1239–1247.
- Robbe, D., Alonso, G., Duchamp, F., Bockaert, J., and Manzoni, O.J. (2001). Localization and Mechanisms of Action of Cannabinoid Receptors at the

- Glutamatergic Synapses of the Mouse Nucleus Accumbens. *J Neurosci* 21, 109–116.
- Robbe, D., Kopf, M., Remaury, A., Bockaert, J., and Manzoni, O.J. (2002). Endogenous cannabinoids mediate long-term synaptic depression in the nucleus accumbens. *Proceedings of the National Academy of Sciences* 99, 8384–8388.
- Robin, L.M., Cruz, J.F.O. da, Langlais, V.C., Martin-Fernandez, M., Metna-Laurent, M., Busquets-Garcia, A., Bellocchio, L., Soria-Gomez, E., Papouin, T., Varilh, M., et al. (2018). Astroglial CB1 Receptors Determine Synaptic D-Serine Availability to Enable Recognition Memory. *Neuron* 98, 935-944.e5.
- Roitman, M.F., Stuber, G.D., Phillips, P.E.M., Wightman, R.M., and Carelli, R.M. (2004). Dopamine Operates as a Subsecond Modulator of Food Seeking. *J Neurosci* 24, 1265–1271.
- Romans, S.E., Gendall, K.A., Martin, J.L., and Mullen, P.E. (2001). Child sexual abuse and later disordered eating: A New Zealand epidemiological study. *Int J Eat Disorder* 29, 380–392.
- Ronesi, J., Gerdeman, G.L., and Lovinger, D.M. (2004). Disruption of Endocannabinoid Release and Striatal Long-Term Depression by Postsynaptic Blockade of Endocannabinoid Membrane Transport. *J Neurosci* 24, 1673–1679.
- Root, D.H., Mejias-Aponte, C.A., Zhang, S., Wang, H.-L., Hoffman, A.F., Lupica, C.R., and Morales, M. (2014). Single rodent mesohabenular axons release glutamate and GABA. *Nat Neurosci* 17, 1543–1551.
- Root, D.H., Melendez, R.I., Zaborszky, L., and Napier, C.T. (2015). The ventral pallidum: Subregion-specific functional anatomy and roles in motivated behaviors. *Prog Neurobiol* 130, 29–70.
- Root, D.H., Barker, D.J., Estrin, D.J., Miranda-Barrientos, J.A., Liu, B., Zhang, S., Wang, H.-L., Vautier, F., Ramakrishnan, C., Kim, Y.S., et al. (2020). Distinct Signaling by Ventral Tegmental Area Glutamate, GABA, and Combinatorial Glutamate-GABA Neurons in Motivated Behavior. *Cell Reports* 32, 108094.
- Ross, R.A. (2003). Anandamide and vanilloid TRPV1 receptors. *Brit J Pharmacol* 140, 790–801.
- Rouzer, C.A., and Marnett, L.J. (2008). Non-redundant Functions of Cyclooxygenases: Oxygenation of Endocannabinoids. *J Biol Chem* 283, 8065–8069.

- Rowland, N.E., Cervantez, M.R., and Robertson, K.L. (2017). Temporal relationships between food acquisition and voluntary exercise in mice. *Behav Process* 145, 37–43.
- Rowland, N.E., Atalayer, D., Cervantez, M.R., Minaya, D.M., and Splane, E.C. (2018). Cost-based anorexia: A novel framework to model anorexia nervosa. *Appetite* 130, 50–58.
- Ruegsegger, G.N., Brown, J.D., Kovarik, M.C., Miller, D.K., and Booth, F.W. (2016). Mu-opioid receptor inhibition decreases voluntary wheel running in a dopamine-dependent manner in rats bred for high voluntary running. *Neuroscience* 339, 525–537.
- Ruehle, S., Remmers, F., Romo-Parra, H., Massa, F., Wickert, M., Wörtge, S., Häring, M., Kaiser, N., Marsicano, G., Pape, H.-C., et al. (2013). Cannabinoid CB1 Receptor in Dorsal Telencephalic Glutamatergic Neurons: Distinctive Sufficiency for Hippocampus-Dependent and Amygdala-Dependent Synaptic and Behavioral Functions. *J Neurosci* 33, 10264–10277.
- Ryberg, E., Larsson, N., Sjögren, S., Hjorth, S., Hermansson, N., Leonova, J., Elebring, T., Nilsson, K., Drmota, T., and Greasley, P.J. (2007). The orphan receptor GPR55 is a novel cannabinoid receptor. *Brit J Pharmacol* 152, 1092–1101.
- Salamone, J.D. (1986). Different effects of haloperidol and extinction on instrumental behaviours. *Psychopharmacology* 88, 18–23.
- Salamone, J.D., and Correa, M. (2002). Motivational views of reinforcement: implications for understanding the behavioral functions of nucleus accumbens dopamine. *Behav Brain Res* 137, 3–25.
- Salamone, J.D., and Correa, M. (2012). The mysterious motivational functions of mesolimbic dopamine. *Neuron* 76, 470–485.
- Salamone, J., Steinpreis, R., McCullough, L., Smith, P., Grebel, D., and Mahan, K. (1991). Haloperidol and nucleus accumbens dopamine depletion suppress lever pressing for food but increase free food consumption in a novel food choice procedure. *Psychopharmacology* 104, 515–521.
- Salamone, J., Arizzi, M., Sandoval, M., Cervone, K., and Aberman, J. (2002). Dopamine antagonists alter response allocation but do not suppress appetite for food in rats: contrast between the effects of SKF 83566, raclopride, and fenfluramine on a concurrent choice task. *Psychopharmacology* 160, 371–380.
- Salamone, J.D., Cousins, M.S., and Bucher, S. (1994a). Anhedonia or anergia? Effects of haloperidol and nucleus accumbens dopamine depletion on instrumental

- response selection in a T-maze cost/benefit procedure. *Behav Brain Res* 65, 221–229.
- Salamone, J.D., Cousins, M.S., McCullough, L.D., Carriero, D.L., and Berkowitz, R.J. (1994b). Nucleus accumbens dopamine release increases during instrumental lever pressing for food but not free food consumption. *Pharmacol Biochem Behav* 49, 25–31.
- Sanchis-Segura, C., and Spanagel, R. (2006). REVIEW: Behavioural assessment of drug reinforcement and addictive features in rodents: an overview. *Addict Biol* 11, 2–38.
- Sanchis-Segura, C., Cline, B.H., Marsicano, G., Lutz, B., and Spanagel, R. (2004). Reduced sensitivity to reward in CB1 knockout mice. *Psychopharmacology* 176, 223–232.
- Sañudo-Peña, M.C., Romero, J., Seale, G.E., Fernandez-Ruiz, J.J., and Walker, J.M. (2000). Activational role of cannabinoids on movement. *Eur J Pharmacol* 391, 269–274.
- Satvat, E., and Eikelboom, R. (2006). Dissociation of conditioned and unconditioned factors in the running-induced feeding suppression. *Physiol Behav* 89, 428–437.
- Sawzdargo, M., Nguyen, T., Lee, D.K., Lynch, K.R., Cheng, R., Heng, H.H.Q., George, S.R., and O'Dowd, B.F. (1999). Identification and cloning of three novel human G protein-coupled receptor genes GPR52,  $\Psi$ GPR53 and GPR55: GPR55 is extensively expressed in human brain<sup>1</sup>Sequence data from this article have been deposited with the GenBank Data Library under Accession Nos. AF096784-AF096786, AF100789.1. *Mol Brain Res* 64, 193–198.
- Schechter, M., Pinhasov, A., Weller, A., and Fride, E. (2012). Blocking the postpartum mouse dam's CB1 receptors impairs maternal behavior as well as offspring development and their adult social–emotional behavior. *Behav Brain Res* 226, 481–492.
- Scherma, M., Satta, V., Collu, R., Boi, M.F., Usai, P., Fratta, W., and Fadda, P. (2017). Cannabinoid CB1/CB2 receptor agonists attenuate hyperactivity and body weight loss in a rat model of activity-based anorexia. *British Journal of Pharmacology* 174, 2682–2695.
- Scheurink, A.J.W., Boersma, G.J., Nergårdh, R., and Södersten, P. (2010). Neurobiology of hyperactivity and reward: Agreeable restlessness in Anorexia Nervosa. *Physiol Behav* 100, 490–495.

- Schiffino, F.L., Siemian, J.N., Petrella, M., Laing, B.T., Sarsfield, S., Borja, C.B., Gajendiran, A., Zuccoli, M.L., and Aponte, Y. (2019). Activation of a lateral hypothalamic-ventral tegmental circuit gates motivation. *PLOS ONE* 14, e0219522.
- Schlicker, E., and Kathmann, M. (2001). Modulation of transmitter release via presynaptic cannabinoid receptors. *Trends Pharmacol Sci* 22, 565–572.
- Schopenhauer, A. (1999). *Prize Essay on the Freedom of the Will* (Cambridge University Press).
- Schuch, F.B., Vancampfort, D., Richards, J., Rosenbaum, S., Ward, P.B., and Stubbs, B. (2016). Exercise as a treatment for depression: A meta-analysis adjusting for publication bias. *J Psychiatr Res* 77, 42–51.
- Schultz, W. (1998). Predictive Reward Signal of Dopamine Neurons. *J Neurophysiol* 80, 1–27.
- Schultz, W. (2007). Multiple Dopamine Functions at Different Time Courses. *Annu Rev Neurosci* 30, 259–288.
- Schultz, W. (2016). Dopamine reward prediction error coding. *Dialogues Clin Neurosci* 18, 23–32.
- Schultz, W., and Romo, R. (1990). Dopamine neurons of the monkey midbrain: contingencies of responses to stimuli eliciting immediate behavioral reactions. *J Neurophysiol* 63, 607–624.
- Schultz, W., Apicella, P., and Ljungberg, T. (1993). Responses of monkey dopamine neurons to reward and conditioned stimuli during successive steps of learning a delayed response task. *J Neurosci* 13, 900–913.
- Schultz, W., Dayan, P., and Montague, P.R. (1997). A Neural Substrate of Prediction and Reward. *Science* 275, 1593–1599.
- Shaham, Y., Shalev, U., Lu, L., Wit, H. de, and Stewart, J. (2003). The reinstatement model of drug relapse: history, methodology and major findings. *Psychopharmacology* 168, 3–20.
- Shao, Z., Yin, J., Chapman, K., Grzemska, M., Clark, L., Wang, J., and Rosenbaum, D.M. (2016). High-resolution crystal structure of the human CB1 cannabinoid receptor. *Nature* 540, 602–606.
- Sharir, H., and Abood, M.E. (2010). Pharmacological characterization of GPR55, a putative cannabinoid receptor. *Pharmacol Therapeut* 126, 301–313.

- Shen, M., Piser, T.M., Seybold, V.S., and Thayer, S.A. (1996). Cannabinoid Receptor Agonists Inhibit Glutamatergic Synaptic Transmission in Rat Hippocampal Cultures. *J Neurosci* 16, 4322–4334.
- Sherwin, C.M. (1998). Voluntary wheel running: a review and novel interpretation. *Anim Behav* 56, 11–27.
- Shim, J.-Y. (2010). Understanding Functional Residues of the Cannabinoid CB1 Receptor for Drug Discovery. *Curr Top Med Chem* 10, 779–798.
- Sidló, Z., Reggio, P.H., and Rice, M.E. (2008). Inhibition of striatal dopamine release by CB1 receptor activation requires nonsynaptic communication involving GABA, H<sub>2</sub>O<sub>2</sub>, and KATP channels. *Neurochem Int* 52, 80–88.
- Simonnet, A., Cador, M., and Caille, S. (2013). Nicotine reinforcement is reduced by cannabinoid CB1 receptor blockade in the ventral tegmental area. *Addict Biol* 18, 930–936.
- Singla, S., Kreitzer, A.C., and Malenka, R.C. (2007). Mechanisms for Synapse Specificity during Striatal Long-Term Depression. *J Neurosci* 27, 5260–5264.
- Sink, K.S., Vemuri, V.K., Olszewska, T., Makriyannis, A., and Salamone, J.D. (2008). Cannabinoid CB1 antagonists and dopamine antagonists produce different effects on a task involving response allocation and effort-related choice in food-seeking behavior. *Psychopharmacology* 196, 565–574.
- Sisti, H.M., and Lewis, M.J. (2001). Naloxone suppression and morphine enhancement of voluntary wheel-running activity in rats. *Pharmacol Biochem Be* 70, 359–365.
- Sjöström, P.J., Turrigiano, G.G., and Nelson, S.B. (2003). Neocortical LTD via Coincident Activation of Presynaptic NMDA and Cannabinoid Receptors. *Neuron* 39, 641–654.
- Sjöström, P.J., Turrigiano, G.G., and Nelson, S.B. (2004). Endocannabinoid-Dependent Neocortical Layer-5 LTD in the Absence of Postsynaptic Spiking. *J Neurophysiol* 92, 3338–3343.
- Skinner, B.F. (1938). *The behavior of organisms: an experimental analysis.* (Oxford, England: Appleton-Century).
- Smink, F.R.E., Hoeken, D. van, and Hoek, H.W. (2012). Epidemiology of Eating Disorders: Incidence, Prevalence and Mortality Rates. *Curr Psychiat Rep* 14, 406–414.

- Smith, K.S., and Berridge, K.C. (2005). The Ventral Pallidum and Hedonic Reward: Neurochemical Maps of Sucrose “Liking” and Food Intake. *J Neurosci* 25, 8637–8649.
- Smith, M.A., Schmidt, K.T., Iordanou, J.C., and Mustroph, M.L. (2008). Aerobic exercise decreases the positive-reinforcing effects of cocaine. *Drug Alcohol Depen* 98, 129–135.
- Soden, M.E., Chung, A.S., Cuevas, B., Resnick, J.M., Awatramani, R., and Zweifel, L.S. (2020). Anatomic resolution of neurotransmitter-specific projections to the VTA reveals diversity of GABAergic inputs. *Nat Neurosci* 23, 968–980.
- Solinas, M., and Goldberg, S.R. (2005). Motivational Effects of Cannabinoids and Opioids on Food Reinforcement Depend on Simultaneous Activation of Cannabinoid and Opioid Systems. *Neuropsychopharmacology* 30, 2035–2045.
- Solinas, M., Justinova, Z., Goldberg, S.R., and Tanda, G. (2006). Anandamide administration alone and after inhibition of fatty acid amide hydrolase (FAAH) increases dopamine levels in the nucleus accumbens shell in rats. *J Neurochem* 98, 408–419.
- Solinas, M., Goldberg, S.R., and Piomelli, D. (2008). The endocannabinoid system in brain reward processes. *Brit J Pharmacol* 154, 369–383.
- Soria, G., Mendizábal, V., Touriño, C., Robledo, P., Ledent, C., Parmentier, M., Maldonado, R., and Valverde, O. (2005). Lack of CB1 Cannabinoid Receptor Impairs Cocaine Self-Administration. *Neuropsychopharmacol* 30, 1670–1680.
- Soria-Gómez, E., Matias, I., Rueda-Orozco, P., Cisneros, M., Petrosino, S., Navarro, L., Marzo, D.V., and Prospéro-García, O. (2007). Pharmacological enhancement of the endocannabinoid system in the nucleus accumbens shell stimulates food intake and increases c-Fos expression in the hypothalamus. *Brit J Pharmacol* 151, 1109–1116.
- Soria-Gómez, E., Bellocchio, L., Reguero, L., Lepousez, G., Martin, C., Bendahmane, M., Ruehle, S., Remmers, F., Desprez, T., Matias, I., et al. (2014). The endocannabinoid system controls food intake via olfactory processes. *Nature Neuroscience* 17, 407–415.
- Spanagel, R., Weiss, F., Spanagel, R., and Weiss, F. (1999). The dopamine hypothesis of reward: past and current status. *Trends Neurosci* 22, 521–527.
- Sparling, P.B., Giuffrida, A., Piomelli, D., Rosskopf, L., and Dietrich, A. (2003). Exercise activates the endocannabinoid system. *NeuroReport* 14, 2209–2211.

- Sperlágh, B., Windisch, K., Andó, R.D., and Vizi, E.S. (2009). Neurochemical evidence that stimulation of CB1 cannabinoid receptors on GABAergic nerve terminals activates the dopaminergic reward system by increasing dopamine release in the rat nucleus accumbens. *Neurochem Int* 54, 452–457.
- Spiller, K.J., Bi, G., He, Y., Galaj, E., Gardner, E.L., and Xi, Z. (2019). Cannabinoid CB1 and CB2 receptor mechanisms underlie cannabis reward and aversion in rats. *British Journal of Pharmacology* 176, 1268–1281.
- Stamatakis, A.M., Jennings, J.H., Ung, R.L., Blair, G.A., Weinberg, R.J., Neve, R.L., Boyce, F., Mattis, J., Ramakrishnan, C., Deisseroth, K., et al. (2013). A Unique Population of Ventral Tegmental Area Neurons Inhibits the Lateral Habenula to Promote Reward. *Neuron* 80, 1039–1053.
- Steindel, F., Lerner, R., Häring, M., Ruehle, S., Marsicano, G., Lutz, B., and Monory, K. (2013). Neuron-type specific cannabinoid-mediated G protein signalling in mouse hippocampus. *J Neurochem* 124, 795–807.
- Steiner, J.E. (1973). The gustofacial response: observation on normal and anencephalic newborn infants. *Symposium Oral Sensation Percept* 254–278.
- Stella, N. (2010). Cannabinoid and cannabinoid-like receptors in microglia, astrocytes, and astrocytomas. *Glia* 58, 1017–1030.
- Sternheim, L., Danner, U., Adan, R., and Elburg, A. (2015). Drive for activity in patients with anorexia nervosa. *Int J Eat Disorder* 48, 42–45.
- Strober, M., Freeman, R., and Morrell, W. (1997). The long-term course of severe anorexia nervosa in adolescents: Survival analysis of recovery, relapse, and outcome predictors over 10–15 years in a prospective study. *Int J Eat Disorder* 22, 339–360.
- Stuber, G.D., and Wise, R.A. (2016). Lateral hypothalamic circuits for feeding and reward. *Nature Neuroscience* 19, 198–205.
- Sugiura, T., Kondo, S., Sukagawa, A., Nakane, S., Shinoda, A., Itoh, K., Yamashita, A., and Waku, K. (1995). 2-Arachidonoylglycerol: A Possible Endogenous Cannabinoid Receptor Ligand in Brain. *Biochem Biophys Res Commun* 215, 89–97.
- Szabo, B., Dörner, L., Pfreundtner, C., Nörenberg, W., and Starke, K. (1998). Inhibition of GABAergic inhibitory postsynaptic currents by cannabinoids in rat corpus striatum. *Neuroscience* 85, 395–403.



- Szabo, B., Müller, T., and Koch, H. (1999). Effects of Cannabinoids on Dopamine Release in the Corpus Striatum and the Nucleus Accumbens In Vitro. *J Neurochem* 73, 1084–1089.
- Szabo, B., Siemes, S., and Wallmichrath, I. (2002). SHORT COMMUNICATION Inhibition of GABAergic neurotransmission in the ventral tegmental area by cannabinoids. *European Journal of Neuroscience* 15, 2057–2061.
- Tan, K.R., Brown, M., Labouèbe, G., Yvon, C., Creton, C., Fritschy, J.-M., Rudolph, U., and Lüscher, C. (2010). Neural bases for addictive properties of benzodiazepines. *Nature* 463, 769–774.
- Tan, K.R., Yvon, C., Turiault, M., Mirzabekov, J.J., Doehner, J., Labouèbe, G., Deisseroth, K., Tye, K.M., and Lüscher, C. (2012). GABA Neurons of the VTA Drive Conditioned Place Aversion. *Neuron* 73, 1173–1183.
- Tang, K., Xia, F.C., Wagner, P.D., and Breen, E.C. (2010). Exercise-induced VEGF transcriptional activation in brain, lung and skeletal muscle. *Resp Physiol Neurobi* 170, 16–22.
- Tanimura, A., Yamazaki, M., Hashimoto, Y., Uchigashima, M., Kawata, S., Abe, M., Kita, Y., Hashimoto, K., Shimizu, T., Watanabe, M., et al. (2010). The Endocannabinoid 2-Arachidonoylglycerol Produced by Diacylglycerol Lipase  $\alpha$  Mediates Retrograde Suppression of Synaptic Transmission. *Neuron* 65, 320–327.
- Tantot, F., Parkes, S.L., Marchand, A.R., Boitard, C., Naneix, F., Layé, S., Trifilieff, P., Coutureau, E., and Ferreira, G. (2017). The effect of high-fat diet consumption on appetitive instrumental behavior in rats. *Appetite* 108, 203–211.
- Tart, C.T. (1970). Marijuana Intoxication: Common Experiences. *Nature* 226, 701–704.
- Terzian, A.B., Micale, V., and Wotjak, C.T. (2014). Cannabinoid receptor type 1 receptors on GABAergic vs. glutamatergic neurons differentially gate sex-dependent social interest in mice. *European Journal of Neuroscience* 40, 2293–2298.
- Thanos, P.K., Dimitrakakis, E.S., Rice, O., Gifford, A., and Volkow, N.D. (2005). Ethanol self-administration and ethanol conditioned place preference are reduced in mice lacking cannabinoid CB1 receptors. *Behav Brain Res* 164, 206–213.
- Thorndike, E. (1898). Some experiments on animal intelligence. *Science* 7, 818–824.

- Thornton-Jones, Z.D., Vickers, S.P., and Clifton, P.G. (2005). The cannabinoid CB1 receptor antagonist SR141716A reduces appetitive and consummatory responses for food. *Psychopharmacology* 179, 452–460.
- Threlfell, S., Lalic, T., Platt, N.J., Jennings, K.A., Deisseroth, K., and Cragg, S.J. (2012). Striatal Dopamine Release Is Triggered by Synchronized Activity in Cholinergic Interneurons. *Neuron* 75, 58–64.
- Toates, F.M. (1986). *Motivational systems* (CUP Archive).
- Tóth, A., Boczán, J., Kedei, N., Lizanecz, E., Bagi, Z., Papp, Z., Édes, I., Csiba, L., and Blumberg, P.M. (2005). Expression and distribution of vanilloid receptor 1 (TRPV1) in the adult rat brain. *Mol Brain Res* 135, 162–168.
- Treasure, J., Duarte, T.A., and Schmidt, U. (2020). Eating disorders. *Lancet* 395, 899–911.
- Trejo, J.L., Carro, E., and Torres-Alemán, I. (2001). Circulating Insulin-Like Growth Factor I Mediates Exercise-Induced Increases in the Number of New Neurons in the Adult Hippocampus. *J Neurosci* 21, 1628–1634.
- Trezza, V., and Vanderschuren, L.J.M.J. (2008a). Bidirectional cannabinoid modulation of social behavior in adolescent rats. *Psychopharmacology* 197, 217–227.
- Trezza, V., and Vanderschuren, L.J.M.J. (2008b). Cannabinoid and opioid modulation of social play behavior in adolescent rats: Differential behavioral mechanisms. *Eur Neuropsychopharm* 18, 519–530.
- Trezza, V., and Vanderschuren, L.J.M.J. (2009). Divergent Effects of Anandamide Transporter Inhibitors with Different Target Selectivity on Social Play Behavior in Adolescent Rats. *J Pharmacol Exp Ther* 328, 343–350.
- Trezza, V., Damsteegt, R., Manduca, A., Petrosino, S., Kerkhof, L.W.M.V., Pasterkamp, R.J., Zhou, Y., Campolongo, P., Cuomo, V., Marzo, V.D., et al. (2012). Endocannabinoids in Amygdala and Nucleus Accumbens Mediate Social Play Reward in Adolescent Rats. *The Journal of Neuroscience* 32, 14899–14908.
- Tung, L.-W., Lu, G.-L., Lee, Y.-H., Yu, L., Lee, H.-J., Leishman, E., Bradshaw, H., Hwang, L.-L., Hung, M.-S., Mackie, K., et al. (2016). Orexins contribute to restraint stress-induced cocaine relapse by endocannabinoid-mediated disinhibition of dopaminergic neurons. *Nat Commun* 7, 12199.

- Turu, G., and Hunyady, L. (2010). Signal transduction of the CB1 cannabinoid receptor. *J Mol Endocrinol* 44, 75–85.
- Tyree, S.M., and Lecea, L. de (2017). Lateral Hypothalamic Control of the Ventral Tegmental Area: Reward Evaluation and the Driving of Motivated Behavior. *Frontiers in Systems Neuroscience* 11, 50.
- Uchigashima, M., Narushima, M., Fukaya, M., Katona, I., Kano, M., and Watanabe, M. (2007). Subcellular Arrangement of Molecules for 2-Arachidonoyl-Glycerol-Mediated Retrograde Signaling and Its Physiological Contribution to Synaptic Modulation in the Striatum. *J Neurosci* 27, 3663–3676.
- UCSC (2020). University of California - Santa Cruz - UCSC Genome Browser - [http://genome.ucsc.edu/cgi-bin/hgTracks?db=mm10&lastVirtModeType=default&lastVirtModeExtraState=&virtModeType=default&virtMode=0&nonVirtPosition=&position=chr2%3A152784128%2D164379351&hgsid=972723991\\_pfgsMTAY7YEJ6dQiKokvJUtrIEXJ](http://genome.ucsc.edu/cgi-bin/hgTracks?db=mm10&lastVirtModeType=default&lastVirtModeExtraState=&virtModeType=default&virtMode=0&nonVirtPosition=&position=chr2%3A152784128%2D164379351&hgsid=972723991_pfgsMTAY7YEJ6dQiKokvJUtrIEXJ).
- Ungless, M.A., and Grace, A.A. (2012). Are you or aren't you? Challenges associated with physiologically identifying dopamine neurons. *Trends in Neurosciences* 35, 422–430.
- Valjent, E., and Maldonado, R. (2000). A behavioural model to reveal place preference to  $\Delta$ 9-tetrahydrocannabinol in mice. *Psychopharmacology* 147, 436–438.
- Vallée, M., Vitiello, S., Bellocchio, L., Hébert-Chatelain, E., Monlezun, S., Martin-Garcia, E., Kasanetz, F., Baillie, G.L., Panin, F., Cathala, A., et al. (2014). Pregnenolone Can Protect the Brain from Cannabis Intoxication. *Science* 343, 94–98.
- van Zessen, R., Phillips, J.L., Budygin, E.A., and Stuber, G.D. (2012). Activation of VTA GABA Neurons Disrupts Reward Consumption. *Neuron* 73, 1184–1194.
- Vargas-Pérez, H., Mena-Segovia, J., Giordano, M., and Díaz, J.-L. (2003). Induction of c-fos in nucleus accumbens in naive male Balb/c mice after wheel running. *Neurosci Lett* 352, 81–84.
- Varma, N., Carlson, G.C., Ledent, C., and Alger, B.E. (2001). Metabotropic Glutamate Receptors Drive the Endocannabinoid System in Hippocampus. *J Neurosci* 21, RC188–RC188.
- Vendruscolo, L.F., Gueye, A.B., Darnaudéry, M., Ahmed, S.H., and Cador, M. (2010). Sugar Overconsumption during Adolescence Selectively Alters Motivation and Reward Function in Adult Rats. *Plos One* 5, e9296.

- Vlachou, S., Nomikos, G.G., Stephens, D.N., and Panagis, G. (2007). Lack of evidence for appetitive effects of  $\Delta$ 9-tetrahydrocannabinol in the intracranial self-stimulation and conditioned place preference procedures in rodents. *Behavioural Pharmacology* 18.
- Vong, L., Ye, C., Yang, Z., Choi, B., Chua, S., and Lowell, B.B. (2011). Leptin Action on GABAergic Neurons Prevents Obesity and Reduces Inhibitory Tone to POMC Neurons. *Neuron* 71, 142–154.
- Voss, M.W., Vivar, C., Kramer, A.F., and Praag, H. van (2013). Bridging animal and human models of exercise-induced brain plasticity. *Trends Cogn Sci* 17, 525–544.
- Vries, T.J.D., Shaham, Y., Homberg, J.R., Crombag, H., Schuurman, K., Dieben, J., Vanderschuren, L.J.M.J., and Schoffelmeer, A.N.M. (2001). A cannabinoid mechanism in relapse to cocaine seeking. *Nat Med* 7, 1151–1154.
- Vries, T.J.D., Homberg, J.R., Binnekade, R., Raasø, H., and Schoffelmeer, A.N.M. (2003). Cannabinoid modulation of the reinforcing and motivational properties of heroin and heroin-associated cues in rats. *Psychopharmacology* 168, 164–169.
- Wachtel, S., ElSohly, M., Ross, S., Ambre, J., and Wit, H. de (2002a). Comparison of the subjective effects of  $\Delta$ 9-tetrahydrocannabinol and marijuana in humans. *Psychopharmacology* 161, 331–339.
- Wachtel, S.R., Ortengren, A., and Wit, H. de (2002b). The effects of acute haloperidol or risperidone on subjective responses to methamphetamine in healthy volunteers. *Drug Alcohol Depen* 68, 23–33.
- WADA (2020). What is prohibited - World Anti-Doping Agency - <https://www.wada-ama.org/en/content/what-is-prohibited>.
- Wager-Miller, J., Westenbroek, R., and Mackie, K. (2002). Dimerization of G protein-coupled receptors: CB1 cannabinoid receptors as an example. *Chem Phys Lipids* 121, 83–89.
- Wagner, A., Aizenstein, H., Venkatraman, V.K., Fudge, J., May, J.C., Mazurkewicz, L., Frank, G.K., Bailer, U.F., Fischer, L., Nguyen, V., et al. (2007). Altered Reward Processing in Women Recovered From Anorexia Nervosa. *Am J Psychiat* 164, 1842–1849.
- Wakabayashi, K.T., Feja, M., Baidur, A.N., Bruno, M.J., Bhimani, R.V., Park, J., Hausknecht, K., Shen, R.-Y., Haj-Dahmane, S., and Bass, C.E. (2019). Chemogenetic activation of ventral tegmental area GABA neurons, but not

mesoaccumbal GABA terminals, disrupts responding to reward-predictive cues. *Neuropsychopharmacol* 44, 372–380.

- Walker, D.M., Cunningham, A.M., Gregory, J.K., and Nestler, E.J. (2019). Long-Term Behavioral Effects of Post-weaning Social Isolation in Males and Females. *Front Behav Neurosci* 13, 66.
- Wang, D.V., and Tsien, J.Z. (2011). Conjunctive Processing of Locomotor Signals by the Ventral Tegmental Area Neuronal Population. *Plos One* 6, e16528.
- Wang, H., Treadway, T., Covey, D.P., Cheer, J.F., and Lupica, C.R. (2015). Cocaine-Induced Endocannabinoid Mobilization in the Ventral Tegmental Area. *Cell Reports* 12, 1997–2008.
- Wang, H.-L., Zhang, S., Qi, J., Wang, H., Cachope, R., Mejias-Aponte, C.A., Gomez, J.A., Mateo-Semidey, G.E., Beaudoin, G.M.J., Paladini, C.A., et al. (2019). Dorsal Raphe Dual Serotonin-Glutamate Neurons Drive Reward by Establishing Excitatory Synapses on VTA Mesoaccumbens Dopamine Neurons. *Cell Reports* 26, 1128-1142.e7.
- Wang, X., Galaj, E., Bi, G., Zhang, C., He, Y., Zhan, J., Bauman, M.H., Gardner, E.L., and Xi, Z. (2020). Different receptor mechanisms underlying phytocannabinoid- versus synthetic cannabinoid-induced tetrad effects: Opposite roles of CB1/CB2 versus GPR55 receptors. *Brit J Pharmacol* 177, 1865–1880.
- Warburton, D.E.R., Nicol, C.W., and Bredin, S.S.D. (2006). Health benefits of physical activity: the evidence. *Can Med Assoc J* 174, 801–809.
- Ward, S.J., and Dykstra, L.A. (2005). The role of CB1 receptors in sweet versus fat reinforcement: effect of CB1 receptor deletion, CB1 receptor antagonism (SR141716A) and CB1 receptor agonism (CP-55940). *Behavioural Pharmacology* 16, 381–388.
- Waselus, M., Valentino, R.J., and Bockstaele, E.J.V. (2011). Collateralized dorsal raphe nucleus projections: A mechanism for the integration of diverse functions during stress. *J Chem Neuroanat* 41, 266–280.
- Wassum, K.M., Ostlund, S.B., and Maidment, N.T. (2012). Phasic Mesolimbic Dopamine Signaling Precedes and Predicts Performance of a Self-Initiated Action Sequence Task. *Biol Psychiat* 71, 846–854.
- Watabe-Uchida, M., Zhu, L., Ogawa, S.K., Vamanrao, A., and Uchida, N. (2012). Whole-Brain Mapping of Direct Inputs to Midbrain Dopamine Neurons. *Neuron* 74, 858–873.

- Wei, D., Lee, D., Cox, C.D., Karsten, C.A., Peñagarikano, O., Geschwind, D.H., Gall, C.M., and Piomelli, D. (2015). Endocannabinoid signaling mediates oxytocin-driven social reward. *Proceedings of the National Academy of Sciences of the United States of America* *112*, 14084–14089.
- Wei, D., Allsop, S., Tye, K., and Piomelli, D. (2017). Endocannabinoid Signaling in the Control of Social Behavior. *Trends Neurosci* *40*, 385–396.
- Werme, M., Messer, C., Olson, L., Gilden, L., Thorén, P., Nestler, E.J., and Brené, S. (2002).  $\Delta$ FosB Regulates Wheel Running. *J Neurosci* *22*, 8133–8138.
- Wiley, J.L., Breivogel, C.S., Mahadevan, A., Pertwee, R.G., Cascio, M.G., Bolognini, D., Huffman, J.W., Walentiny, D.M., Vann, R.E., Razdan, R.K., et al. (2011). Structural and pharmacological analysis of O-2050, a putative neutral cannabinoid CB1 receptor antagonist. *Eur J Pharmacol* *651*, 96–105.
- Williams, C.M., and Kirkham, T.C. (1999). Anandamide induces overeating: mediation by central cannabinoid (CB1) receptors. *Psychopharmacology* *143*, 315–317.
- Williams, C.M., and Kirkham, T.C. (2002). Reversal of  $\Delta$ 9-THC hyperphagia by SR141716 and naloxone but not dexfenfluramine. *Pharmacology Biochemistry and Behavior* *71*, 333–340.
- Williams, C.M., Rogers, P.J., and Kirkham, T.C. (1998). Hyperphagia in pre-fed rats following oral  $\delta$ 9-THC. *Physiol Behav* *65*, 343–346.
- Wilson, R.I., and Nicoll, R.A. (2001). Endogenous cannabinoids mediate retrograde signalling at hippocampal synapses. *Nature* *410*, 588–592.
- Wilson, W.M., and Marsden, C.A. (1995). Extracellular dopamine in the nucleus accumbens of the rat during treadmill running. *Acta Physiol Scand* *155*, 465–466.
- Wise, R.A. (1982). Neuroleptics and operant behavior: The anhedonia hypothesis. *Behav Brain Sci* *5*, 39–53.
- Wise, R.A., and Rompre, P.P. (1989). Brain Dopamine and Reward. *Annu Rev Psychol* *40*, 191–225.
- Wu, X., and French, E.D. (2000). Effects of chronic  $\Delta$ 9-tetrahydrocannabinol on rat midbrain dopamine neurons: an electrophysiological assessment. *Neuropharmacology* *39*, 391–398.
- Wyvell, C.L., and Berridge, K.C. (2000). Intra-Accumbens Amphetamine Increases the Conditioned Incentive Salience of Sucrose Reward: Enhancement of Reward

- “Wanting” without Enhanced “Liking” or Response Reinforcement. *J Neurosci* 20, 8122–8130.
- Xi, Z.-X., Spiller, K., Pak, A.C., Gilbert, J., Dillon, C., Li, X., Peng, X.-Q., and Gardner, E.L. (2008). Cannabinoid CB1 Receptor Antagonists Attenuate Cocaine’s Rewarding Effects: Experiments with Self-Administration and Brain-Stimulation Reward in Rats. *Neuropsychopharmacol* 33, 1735–1745.
- Yamaguchi, T., Sheen, W., and Morales, M. (2007). Glutamatergic neurons are present in the rat ventral tegmental area. *Eur J Neurosci* 25, 106–118.
- Yamaguchi, T., Wang, H.-L., Li, X., Ng, T.H., and Morales, M. (2011). Mesocorticolimbic Glutamatergic Pathway. *J Neurosci* 31, 8476–8490.
- Yamaguchi, T., Qi, J., Wang, H., Zhang, S., and Morales, M. (2015). Glutamatergic and dopaminergic neurons in the mouse ventral tegmental area. *Eur J Neurosci* 41, 760–772.
- Yang, H., Zhou, J., and Lehmann, C. (2016). GPR55 – a putative “type 3” cannabinoid receptor in inflammation. *J Basic Clin Physiology Pharmacol* 27, 297–302.
- Yang, H., Jong, J.W. de, Tak, Y., Peck, J., Bateup, H.S., and Lammel, S. (2018). Nucleus Accumbens Subnuclei Regulate Motivated Behavior via Direct Inhibition and Disinhibition of VTA Dopamine Subpopulations. *Neuron* 97, 434-449.e4.
- YorkWilliams, S.L., Gust, C.J., Mueller, R., Bidwell, L.C., Hutchison, K.E., Gillman, A.S., and Bryan, A.D. (2019). The New Runner’s High? Examining Relationships Between Cannabis Use and Exercise Behavior in States With Legalized Cannabis. *Frontiers Public Heal* 7, 99.
- Zangen, A., Solinas, M., Ikemoto, S., Goldberg, S.R., and Wise, R.A. (2006). Two Brain Sites for Cannabinoid Reward. *J Neurosci* 26, 4901–4907.
- Zhang, H., Gao, M., Shen, H., Bi, G., Yang, H., Liu, Q., Wu, J., Gardner, E.L., Bonci, A., and Xi, Z. (2017). Expression of functional cannabinoid CB2 receptor in VTA dopamine neurons in rats. *Addict Biol* 22, 752–765.
- Zhang, H.-Y., Gao, M., Liu, Q.-R., Bi, G.-H., Li, X., Yang, H.-J., Gardner, E.L., Wu, J., and Xi, Z.-X. (2014). Cannabinoid CB2 receptors modulate midbrain dopamine neuronal activity and dopamine-related behavior in mice. *Proc National Acad Sci* 111, E5007–E5015.

- Zhou, Y., Zhao, M., Zhou, C., and Li, R. (2016). Sex differences in drug addiction and response to exercise intervention: From human to animal studies. *Front Neuroendocrin* 40, 24–41.
- Zipfel, S., Giel, K.E., Bulik, C.M., Hay, P., and Schmidt, U. (2015). Anorexia nervosa: aetiology, assessment, and treatment. *Lancet Psychiatry* 2, 1099–1111.
- Zschucke, E., Gaudlitz, K., and Ströhle, A. (2013). Exercise and Physical Activity in Mental Disorders: Clinical and Experimental Evidence. *J Prev Medicine Public Heal* 46, S12–S21.
- Zuardi, A.W. (2006). History of cannabis as a medicine: a review. *Rev Bras Psiquiatr* 28, 153–157.



# ANNEXES

## Annex 1:

Muguruza\* C., **Redon\*** B., Fois GR., Hurel I., Scocard A., Nguyen C., Stevens C., Soria-Gomez E., Varilh M., Cannich A., Daniault J., Busquets-Garcia A., Pelliccia T., Caillé S., Georges F., Marsicano G., and Chaouloff F. (2019). **The motivation for exercise over palatable food is dictated by cannabinoid type-1 receptors.** *JCI Insight* 2019;4(5):e126190.

## Annex 2:

**Redon B.**, Hurel I., Marsicano G. and Chaouloff F. (2019). **An operant conditioning task to assess the choice between wheel running and palatable food in mice.** *Bio-protocol*, 9(19): e3381.

## Annex 3:

Hurel\* I., Muguruza\* C., **Redon B.**, Marsicano G., Chaouloff F. (2021). **Cannabis and exercise: Effects of  $\Delta^9$ -tetrahydrocannabinol on preference and motivation for wheel-running in mice.** *Progress in Neuropsychopharmacology & Biological Psychiatry*, 2021;105:110117.

## Annex 4:

**Redon B.**, Violleau C., Georges F., Marsicano G., Chaouloff F. (2019). **The ergogenic impact of the glucocorticoid prednisolone does not translate into increased running motivation in mice.** *Psychoneuroendocrinology*, 2019;111:104489

## Annex 5:

Hurel\* I., **Redon\*** B., Scocard A., Malezieux M., Marsicano G. and Chaouloff F. (2019). **Beyond the Activity-Based Anorexia Model: Reinforcing Values of Exercise and Feeding Examined in Stressed Adolescent Male and Female Mice.** *Frontiers in Pharmacology*, 2019;10:587.

\*Share first authorship

# ANNEX 1

The motivation for exercise over palatable food is dictated by cannabinoid type-1 receptors.

JCI Insight 2019;4(5):e126190.

Carolina Muguruza\*, **Bastien Redon**\*, Giulia R. Fois, Imane Hurel, Amandine Scocard, Claire Nguyen, Christopher Stevens, Edgar Soria-Gomez, Marjorie Varilh, Astrid Cannich, Justine Daniault, Arnau Busquets-Garcia, Teresa Pelliccia, Stéphanie Caillé, François Georges, Giovanni Marsicano, and Francis Chaouloff

\*Share first authorship



# The motivation for exercise over palatable food is dictated by cannabinoid type-1 receptors

Carolina Muguruza, ... , Giovanni Marsicano, Francis Chaouloff

*JCI Insight*. 2019;4(5):e126190. <https://doi.org/10.1172/jci.insight.126190>.

Research Article

Neuroscience

The lack of intrinsic motivation to engage in, and adhere to, physical exercise has major health consequences. However, the neurobiological bases of exercise motivation are still unknown. This study aimed at examining whether the endocannabinoid system (ECS) is involved in this process. To do so, we developed an operant conditioning paradigm wherein mice unlocked a running wheel with nose pokes. Using pharmacological tools and conditional mutants for cannabinoid type-1 (CB<sub>1</sub>) receptors, we provide evidence that CB<sub>1</sub> receptors located on GABAergic neurons are both necessary and sufficient to positively control running motivation. Conversely, this receptor population proved dispensable for the modulation of running duration per rewarded sequence. Although the ECS mediated the motivation for another reward, namely palatable food, such a regulation was independent from CB<sub>1</sub> receptors on GABAergic neurons. In addition, we report that the lack of CB<sub>1</sub> receptors on GABAergic neurons decreases the preference for running over palatable food when mice were proposed an exclusive choice between the two rewards. Beyond providing a paradigm that enables motivation processes for exercise to be dissected either singly or in concurrence, this study is the first to our knowledge to identify a neurobiological mechanism that might contribute to sedentary behavior.

**Find the latest version:**

<http://jci.me/126190/pdf>



# The motivation for exercise over palatable food is dictated by cannabinoid type-1 receptors

Carolina Muguruza,<sup>1,2,3,4</sup> Bastien Redon,<sup>1,2</sup> Giulia R. Fois,<sup>2,5</sup> Imane Hurel,<sup>1,2</sup> Amandine Scocard,<sup>1,2</sup> Claire Nguyen,<sup>1,2,6</sup> Christopher Stevens,<sup>1,2</sup> Edgar Soria-Gomez,<sup>1,2,7</sup> Marjorie Varilh,<sup>1,2</sup> Astrid Cannich,<sup>1,2</sup> Justine Daniault,<sup>1,2</sup> Arnau Busquets-Garcia,<sup>1,2</sup> Teresa Pelliccia,<sup>1,2,8</sup> Stéphanie Caillé,<sup>2,9</sup> François Georges,<sup>2,5</sup> Giovanni Marsicano,<sup>1,2</sup> and Francis Chauloff<sup>1,2</sup>

<sup>1</sup>Endocannabinoids and NeuroAdaptation, NeuroCentre INSERM U1215, Bordeaux, France. <sup>2</sup>Université de Bordeaux, Bordeaux, France. <sup>3</sup>Department of Pharmacology, University of the Basque Country, Leioa, Bizkaia, Spain. <sup>4</sup>Centro de Investigación Biomédica en Red de Salud Mental (CIBERSAM), Madrid, Spain. <sup>5</sup>Neurodegenerative Diseases Institute, CNRS UMR 5293, Bordeaux, France. <sup>6</sup>Neurosciences Paris Seine, CNRS UMR 8246, Paris, France. <sup>7</sup>IKERBASQUE Foundation, University of the Basque Country, Achucarro Basque Center for Neuroscience, Leioa, Bizkaia, Spain. <sup>8</sup>Dipartimento di Medicina Molecolare e dello Sviluppo, Università di Siena, Siena, Italy. <sup>9</sup>Institut de Neurosciences Cognitives et Intégratives d'Aquitaine, CNRS UMR 5287, Bordeaux, France.

The lack of intrinsic motivation to engage in, and adhere to, physical exercise has major health consequences. However, the neurobiological bases of exercise motivation are still unknown. This study aimed at examining whether the endocannabinoid system (ECS) is involved in this process. To do so, we developed an operant conditioning paradigm wherein mice unlocked a running wheel with nose pokes. Using pharmacological tools and conditional mutants for cannabinoid type-1 (CB<sub>1</sub>) receptors, we provide evidence that CB<sub>1</sub> receptors located on GABAergic neurons are both necessary and sufficient to positively control running motivation. Conversely, this receptor population proved dispensable for the modulation of running duration per rewarded sequence. Although the ECS mediated the motivation for another reward, namely palatable food, such a regulation was independent from CB<sub>1</sub> receptors on GABAergic neurons. In addition, we report that the lack of CB<sub>1</sub> receptors on GABAergic neurons decreases the preference for running over palatable food when mice were proposed an exclusive choice between the two rewards. Beyond providing a paradigm that enables motivation processes for exercise to be dissected either singly or in concurrence, this study is the first to our knowledge to identify a neurobiological mechanism that might contribute to sedentary behavior.

## Introduction

Physical inactivity is a global pandemic, with a mean mortality rate reaching 9% worldwide (1) and an annual economic burden exceeding 50 billion dollars (2). One illustration of the negative health consequences of physical inactivity is provided by a 20-year survey of US adults, indicating that physical inactivity, rather than caloric intake, associates with abdominal obesity (3). The lack of intrinsic motivation (as opposed to the extrinsic motivation, which finds its roots externally; ref. 4) to initiate exercise and the lack of pleasure to adhere in the long-term to exercise programs are the major causes of physical inactivity (5). Hence, these observations render crucial the identification of the neurobiological mechanisms controlling the motivation to run. Due to its volitional and highly rewarding properties, the use of wheel running has been privileged as an animal model of human exercise (6). Several neurobiological candidates (e.g., leptin, opiates) have been proposed as regulators of intrinsic running motivation (7, 8), but these proposals rely on after-running conditioned preference tests, which bear two limits of interpretation. The first is linked to the evidence that running motivation and the motivation consecutive to running are independent processes (9). The second lies into the inability of preference tests to discriminate between reward motivation and consumption. This distinction is essential because (a) appetitive motivation (i.e., “wanting”) finds its roots in the relationship between the incentive value of the reward and the maximal effort achieved to access that reward, while (b)

**Authorship note:** CM and BR are co-first authors.

**Conflict of interest:** The authors have declared that no conflict of interest exists.

**License:** Copyright 2019, American Society for Clinical Investigation.

**Submitted:** November 14, 2018

**Accepted:** January 29, 2019

**Published:** March 7, 2019

**Reference information:**

*JCI Insight.* 2019;4(5):e126190.

<https://doi.org/10.1172/jci.insight.126190>.

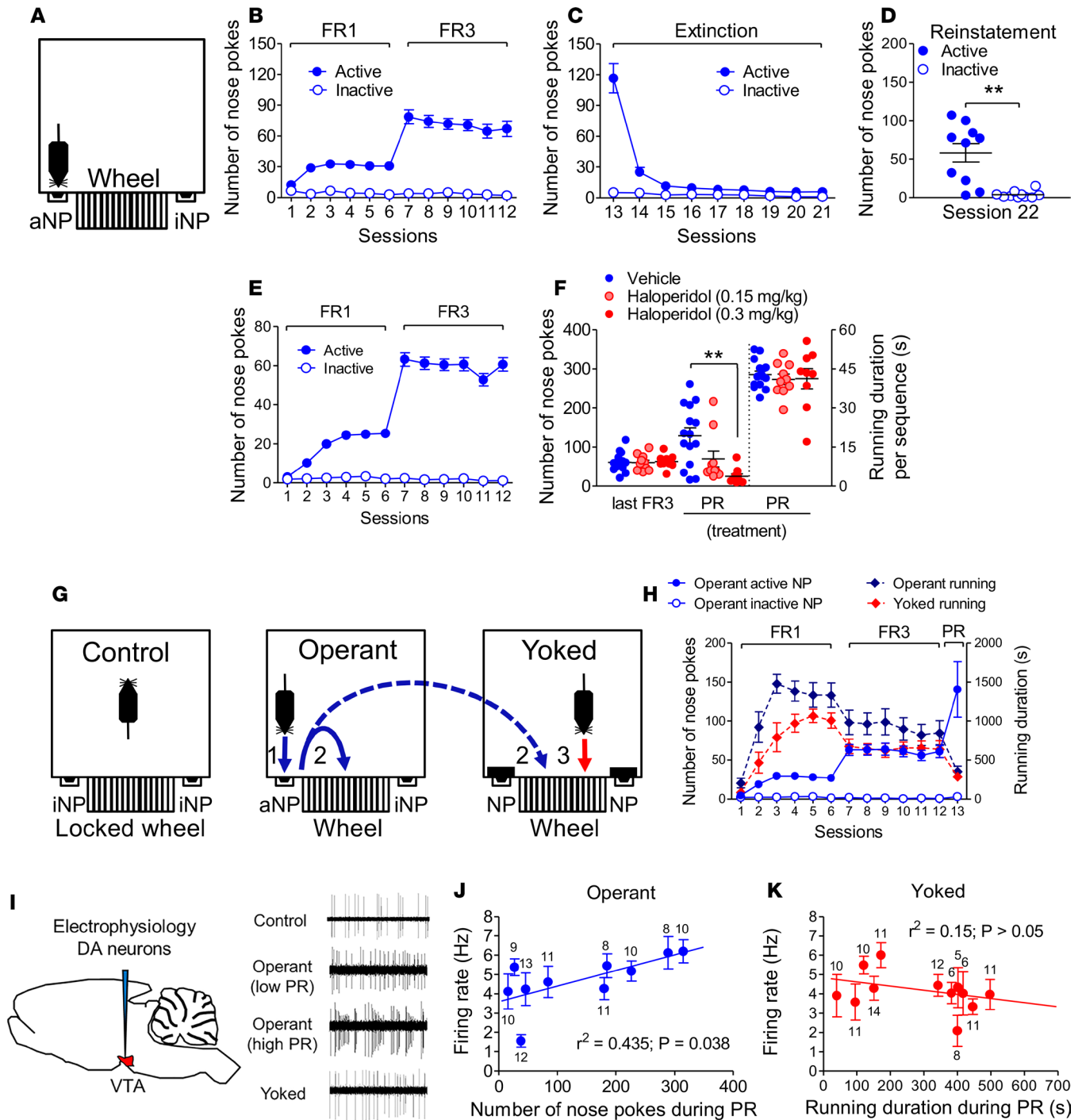
insight.126190.

the consummatory process is linked to the perceived hedonic properties of the reward (10, 11). Actually, the former, but not the latter, process is dependent on mesolimbic dopaminergic activity (10, 11), a major component of the reward circuitry (12, 13).

In addition to leptin and opioids, the endocannabinoid system (ECS) might play a role in setting the rewarding properties of rodent wheel running and hence human exercise. Pharmacological blockade or genetic deletion of the main cannabinoid receptor in the brain, namely the cannabinoid type-1 ( $CB_1$ ) receptor (14), inhibits mouse voluntary running (15, 16). As  $CB_1$  receptors located on GABAergic terminals are involved therein (ref. 16, but see ref. 17), this receptor subpopulation might control running motivation. However, because the estimation of reward motivation requires the measurement of the efforts that an individual accepts to pay for reward access (11, 18), free wheel-running performance might not document on motivation. This hypothesis is reinforced by the findings that rat (19) or mouse (20) wheel-running performance was found not to be predictive of the amount of efforts (i.e., motivation) the animals afforded to access the wheel under costly conditions. With access to a reward — provided alone or within a choice — dictated by an effort (e.g., lever pressing, nose poking) imposed by the experimenter, operant conditioning is an ideal paradigm to measure motivation (11). Although operant procedures have been used to uncover the rewarding property of wheel running in rats (19, 21, 22), its neurobiological bases are still unidentified. Here, we first developed a mouse operant procedure to dissect the role of the ECS in running motivation through pharmacologic and genetic tools. We next adapted that procedure to examine the effect of the ECS on the choice between exercise and palatable food. This study reports that  $CB_1$  receptors on GABAergic neurons positively control the motivation for running but not for palatable feeding when these rewards are made concurrent, hence identifying a neurobiological process that might be involved in sedentary behavior.

## Results

*$CB_1$  receptors are necessary for running motivation.* A mouse operant procedure was developed wherein the cost, i.e., nose poke (NP) performance (Figure 1A), to temporarily (1 minute) unlock a running wheel was held constant under 60-minute fixed ratio (FR) reinforcement schedules before being incremented after each running sequence during a 60-minute progressive ratio (PR) session. By providing the maximal effort cost accepted — as quantified through the number of NP and hence the breakpoint level (i.e., the last reinforced ratio) — the PR session allows estimation of reward motivation (23). We first ensured that our protocol allowed us to uncover in mice the rewarding properties of wheel running that have been most often reported in rats (19, 21, 22). One criterion defining such a property is the reinstatement of reward seeking after an extinction period during which nose poking is ineffective (24). In confirmation of this, mice trained under FR conditions (Figure 1B) and exposed to extinction sessions (Figure 1C) displayed a significant cue-induced reinstatement of exercise seeking (Figure 1D). A second criterion is the ability of dopamine (DA) receptor antagonists to reduce the breakpoint level (10, 11). Systemic pretreatment with the DA D2 receptor antagonist haloperidol in trained mice (Figure 1E) decreased both the number of active NP and the breakpoint level (Supplemental Figure 1; supplemental material available online with this article; <https://doi.org/10.1172/jci.insight.126190DS1>) during the PR session (Figure 1F). This occurred without any change in the running duration at each rewarded sequence, excluding any cataleptic effect (Figure 1F). In keeping with the inhibitory effect of haloperidol on wheel-running motivation (as evidenced in the PR session) on the one hand, and the key role of the mesolimbic dopaminergic system in reward motivation on the other hand, we next wondered whether a link between running motivation and the firing activity of mesolimbic DA neurons could be established. To isolate the effect of running motivation (reward “wanting”) from wheel running per se (reward “consumption”) during the PR test, we trained mice under FR schedules in pairs/triplets. Each pair/triplet consisted of 1 “operant” mouse, which went through FR sessions as described above, with the exception that completion of the required NP freed both its own wheel and that of 1 “yoked” mouse or 2 yoked mice, which was/were thus able to run without prior effort (Figure 1G). These mice were compared with “control” mice, which were placed in operant chambers with locked wheels during all FR and PR sessions. One hour after PR sessions — which confirmed that operant and yoked mice had similar wheel-running performance (Figure 1H) — we performed electrophysiological recordings in ventral tegmental area (VTA, the origin of the mesocortical dopaminergic pathway) DA cells ( $n = 7-13$ /mouse) of anesthetized control, operant, and yoked mice (Figure 1I). Although the firing rate of DA cells in operant mice ( $4.59 \pm 0.24$  Hz,  $n = 102$  neurons) did not significantly differ from that of the controls ( $4.19 \pm 0.26$  Hz,  $n = 57$  neurons) or the yoked mice ( $4.17 \pm 0.23$  Hz,  $n = 115$  neurons), it was observed that the mean firing rate of DA cells was positively linked to the individual number of active NP of operant mice (Figure 1J) but not to the individual running



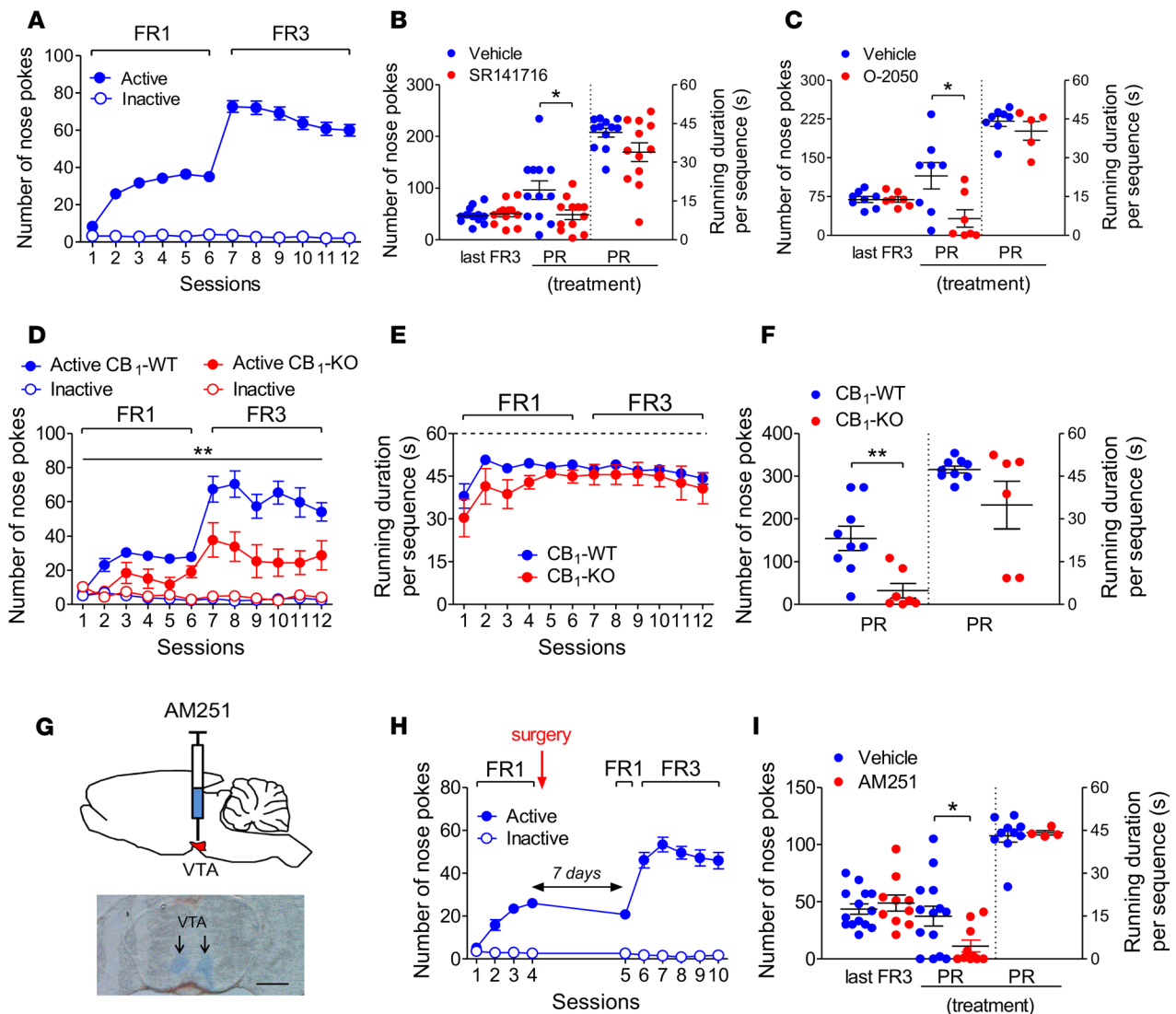
**Figure 1. The rewarding effect of conditioned wheel running is linked to dopaminergic activity.** (A) Operant chamber set up with active/inactive nose poke (aNP/iNP) ports. (B–D) NP performed by CB<sub>1</sub>-WT mice during fixed ratio (FR) and extinction sessions and during a cue-induced reinstatement session (*n* = 10). (E) NP performed by C57BL/6N mice during the acquisition phase of conditioned wheel running (*n* = 34). (F) Intraperitoneal administration of haloperidol (*n* = 9 at 0.15 mg/kg haloperidol and *n* = 10 at 0.3 mg/kg haloperidol vs. *n* = 15 for vehicle) prior to a progressive ratio (PR) session (session 13) decreased the maximal performance of aNP but not the running duration per sequence. (G) Chamber set-up protocol in C57BL/6N mice that distinguishes the respective effects of (a) the exposure to operant chambers with inactive wheels (controls; *n* = 6), (b) wheel running elicited by prior aNP performance (operant; *n* = 10), and (c) wheel running elicited by prior aNP performance of an operant congener (yoked mouse; *n* = 12). (H) aNP/iNP performed by the operant mice (*n* = 10) and duration of wheel running in operant and yoked mice (*n* = 12) during FR/PR sessions. (I) Schematic illustration of the electrophysiological recording of VTA dopaminergic neurons with representative electrophysiological traces of these neurons in control mice, in weakly (low PR) and highly (high PR) motivated operant mice, and in yoked mice. (J) Relationship between the number of aNP performed during the PR session and the firing rate of VTA dopaminergic neurons in operant mice. (K) Lack of relationship between running duration during the PR session and the firing rate of VTA dopaminergic neurons in yoked mice. Data represent mean ± SEM. \*\**P* < 0.01 for 2-group comparisons by Student's *t* tests (D) and for multiple-group comparisons performed by Tukey's test when 1-way ANOVA provided significant variable interaction (F) In J and K, *P* values were obtained by 1-way ANOVA for regression lines; the numbers above/below means refer to the numbers of recorded neurons per mouse (J and K). Scale bar: 1 second (I).

duration of the yoked mice (Figure 1K).

Having ensured that our operant protocol allowed us (a) to measure wheel-running motivation and (b) to discern, including through electrophysiological means, running motivation from mere wheel consumption, we next investigated the role of the ECS in each of these two behavioral dimensions. First, mice conditioned as above (Figure 2A) and bearing similar FR3 performances to their respective vehicle-injected counterparts (Figure 2, B and C) were administered either of 2 CB<sub>1</sub> receptor antagonists, namely SR141716 or O-2050 (14, 25), before the PR session. These pretreatments reduced by 47% ± 15% and 72% ± 15%, respectively, the numbers of active NP performed during the PR session (Figure 2, B and C, and Supplemental Figure 1), without affecting the running duration per sequence (Figure 2, B and C). Consistently, mutant mice bearing a general deletion of CB<sub>1</sub> receptors (CB<sub>1</sub>-KO mice; refs. 15, 16, 26) performed fewer active NP during both FR sessions (Figure 2D) and the PR session (Figure 2F and Supplemental Figure 1 for breakpoints) but displayed similar running duration (and distance covered: Supplemental Figure 2) per rewarded sequence, compared with their WT littermates (Figure 2, E and F). Equivalent NP hole discrimination rates in both genotypes (Supplemental Figure 1) ruled out learning deficits in CB<sub>1</sub>-KO mice. With respect to the PR session, it is noteworthy that the constitutive mutation of CB<sub>1</sub> receptors yielded a 79% ± 11% reduction in the number of active NP performed during the PR test, indicating a major role for CB<sub>1</sub> receptors in the control of wheel-running motivation. In keeping with the observation that the latter is tightly linked to the firing activity of VTA DA neurons (Figure 1J), we next wondered whether this CB<sub>1</sub> receptor-mediated control of wheel-running motivation involved local (i.e., VTA) CB<sub>1</sub> receptors to a significant extent. Infusion with the selective CB<sub>1</sub> receptor antagonist AM251 (Figure 2G) in the VTA of mice trained beforehand to the conditioning procedure (Figure 2H) decreased by 70% ± 14% the number of active NP performed during the PR session (Figure 2I and Supplemental Figure 1), compared with vehicle infusion, without altering the running duration per sequence (Figure 2I). Taken together, these pharmacologic and genetic findings indicated that CB<sub>1</sub> receptors exert major control on wheel-running motivation, these receptors being located to a significant extent in the VTA.

*CB<sub>1</sub> receptors on GABAergic neurons are necessary and sufficient for running motivation.* As shown in Figure 3, A–C, the above-mentioned deficit in the numbers of active NP — but not in the time spent running per rewarded episode — performed by CB<sub>1</sub>-KO mice exposed to FR/PR sessions extended to mice lacking CB<sub>1</sub> receptors in forebrain GABAergic neurons (GABA-CB<sub>1</sub>-KO mice; refs. 16, 27, 28). Of note was the finding that the reduction in the number of active NP performed by GABA-CB<sub>1</sub>-KO mice during the PR session, compared with that of GABA-CB<sub>1</sub>-WT mice, reached 57% ± 9% (Figure 3C), a percentage reduction that did not significantly differ from that displayed by CB<sub>1</sub>-KO mice (see above). This indicated that CB<sub>1</sub> receptors located on GABAergic neurons play a major, if not unique, role in the CB<sub>1</sub> receptor-dependent control of wheel-running motivation. Although GABA-CB<sub>1</sub>-KO mice did not differ from their WT littermates with respect to reward consumption (i.e., running duration per sequence), they displayed a reduction in their mean running distance per sequence (Supplemental Figure 2), hence suggesting decreased running speed. Taking into account the finding that CB<sub>1</sub> receptor subpopulations in GABAergic neurons and in glutamatergic neurons have been reported to play opposite roles in several functions (e.g., ref. 28), we extended our investigation to mice with a deletion of CB<sub>1</sub> receptors in (cortical) glutamatergic neurons (Glu-CB<sub>1</sub>-KO mice; refs. 16, 27, 28). Compared with their WT littermates, these mice displayed similar NP responding (and breakpoint levels; Supplemental Figure 1) during FR/PR sessions (Figure 3, D and F). However, these mutant mice differed from WT mice in that they showed an increased duration of running per rewarded sequence (Figure 3, E and F), a trend that was also observed in the last FR3 sessions when the mean distance ran per sequence was considered (Supplemental Figure 2). The finding that CB<sub>1</sub> receptors on GABAergic neurons, but not on glutamatergic neurons, were necessary for running motivation led us to investigate whether this receptor subpopulation played also a sufficient role. Mice bearing a loxP-flanked Stop cassette placed before the open reading frame of the CB<sub>1</sub> receptor gene (29) were crossed with mice expressing the *Dlx5/6*-Cre recombinase so as to reexpress CB<sub>1</sub> receptors selectively in GABAergic neurons (GABA-CB<sub>1</sub>-Rescue; ref. 30). Stop-CB<sub>1</sub> mice behaved similarly to CB<sub>1</sub>-KO mice under FR/PR schedules of reinforcement, except for the running duration per sequence, which stabilized later (Figure 3, G and H). Compared with Stop-CB<sub>1</sub> mice, GABA-CB<sub>1</sub>-Rescue mice displayed increased active NP responses during FR and PR sessions (Figure 3, G and I, and Supplemental Figure 1). Taken together, these results indicated that CB<sub>1</sub> receptors on GABAergic neurons are

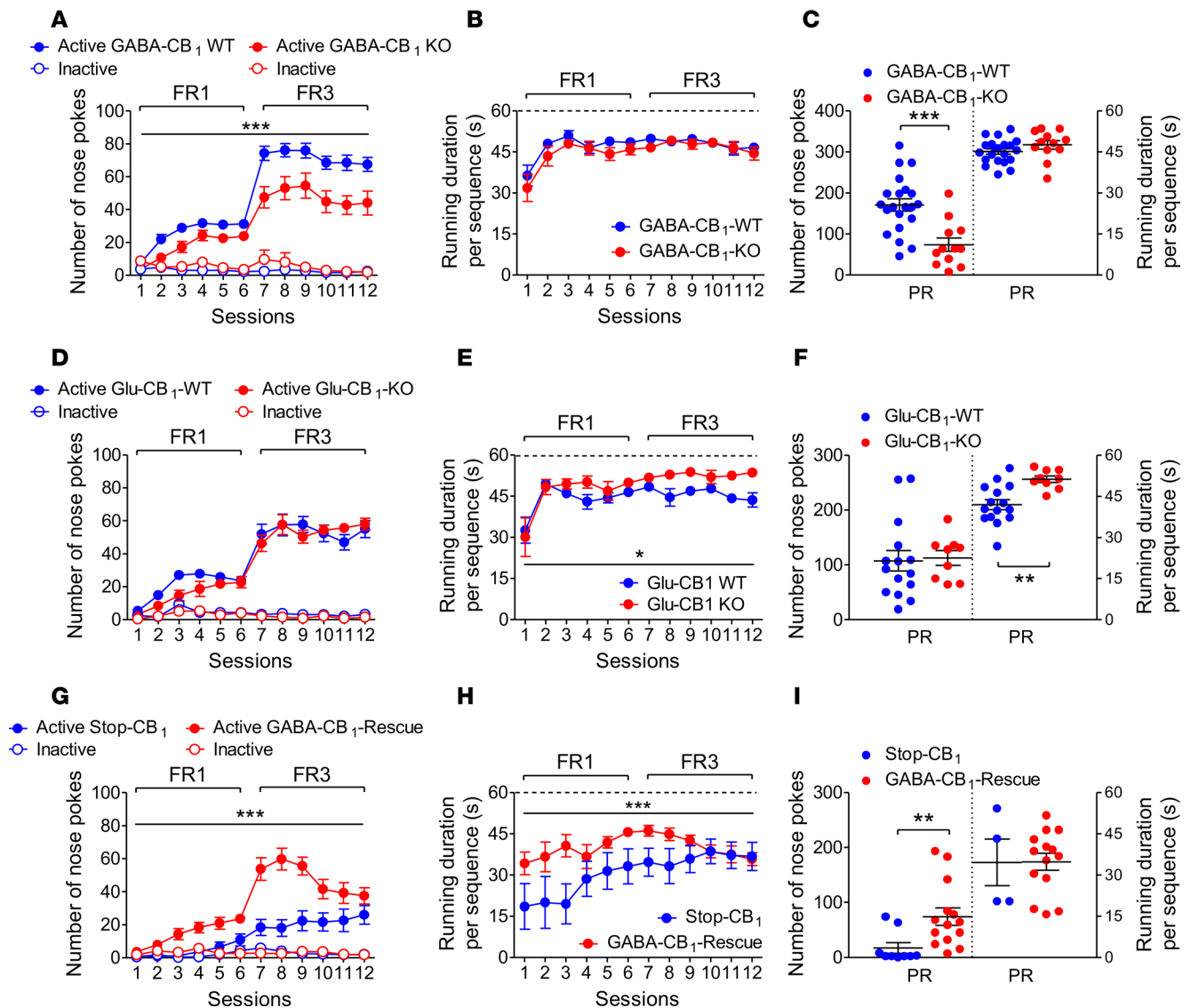




**Figure 2. CB<sub>1</sub> receptors control running motivation.** (A) Active/inactive nose poke (aNP/iNP) performed by C57BL/6N mice during the acquisition phase of conditioned wheel running ( $n = 39$ ). (B and C) Intraperitoneal administration of SR141716 ( $n = 12$  vs.  $n = 12$  for vehicle; B) or O-2050 ( $n = 8$  vs.  $n = 7$  for vehicle; C) prior to a progressive ratio (PR) session (session 13) decreased the maximal performance of aNP but not the running duration per sequence ( $n = 5$  for that variable in O-2050-treated mice). (D and E) CB<sub>1</sub>-KO mice ( $n = 7$ ) displayed fewer aNP, but not a defective running performance per sequence, compared with their WT littermates ( $n = 9$ ). (F) aNP responses, but not the running duration per sequence, were reduced in CB<sub>1</sub>-KO mice ( $n = 6$ ) tested under a PR schedule of reinforcement (session 13), compared with WT littermates ( $n = 13$ ). (G) Schematic illustration of the bilateral infusion of the CB<sub>1</sub> receptor antagonist AM251 in the ventral tegmental area (VTA) of C57BL/6N mice, with an image of a coronal section showing the injection sites. (H) NP responses before and after VTA cannula implantation in C57BL/6N mice ( $n = 24$ ). (I) Intra-VTA infusion of AM251 decreases the maximal number of aNP performed during the PR session ( $n = 10$ ), but not the running duration per rewarded sequence ( $n = 4$ ), compared with vehicle-perfused mice ( $n = 14$  and  $n = 10$  for each variable, respectively). Data represent mean  $\pm$  SEM. \* $P < 0.05$ , \*\* $P < 0.01$  for 2-group comparisons by Student's *t* tests (B, C, F, and I) and for overall genotype differences in 2-way ANOVA (D). Scale bar: 2 mm (G).

both necessary and sufficient for running motivation.

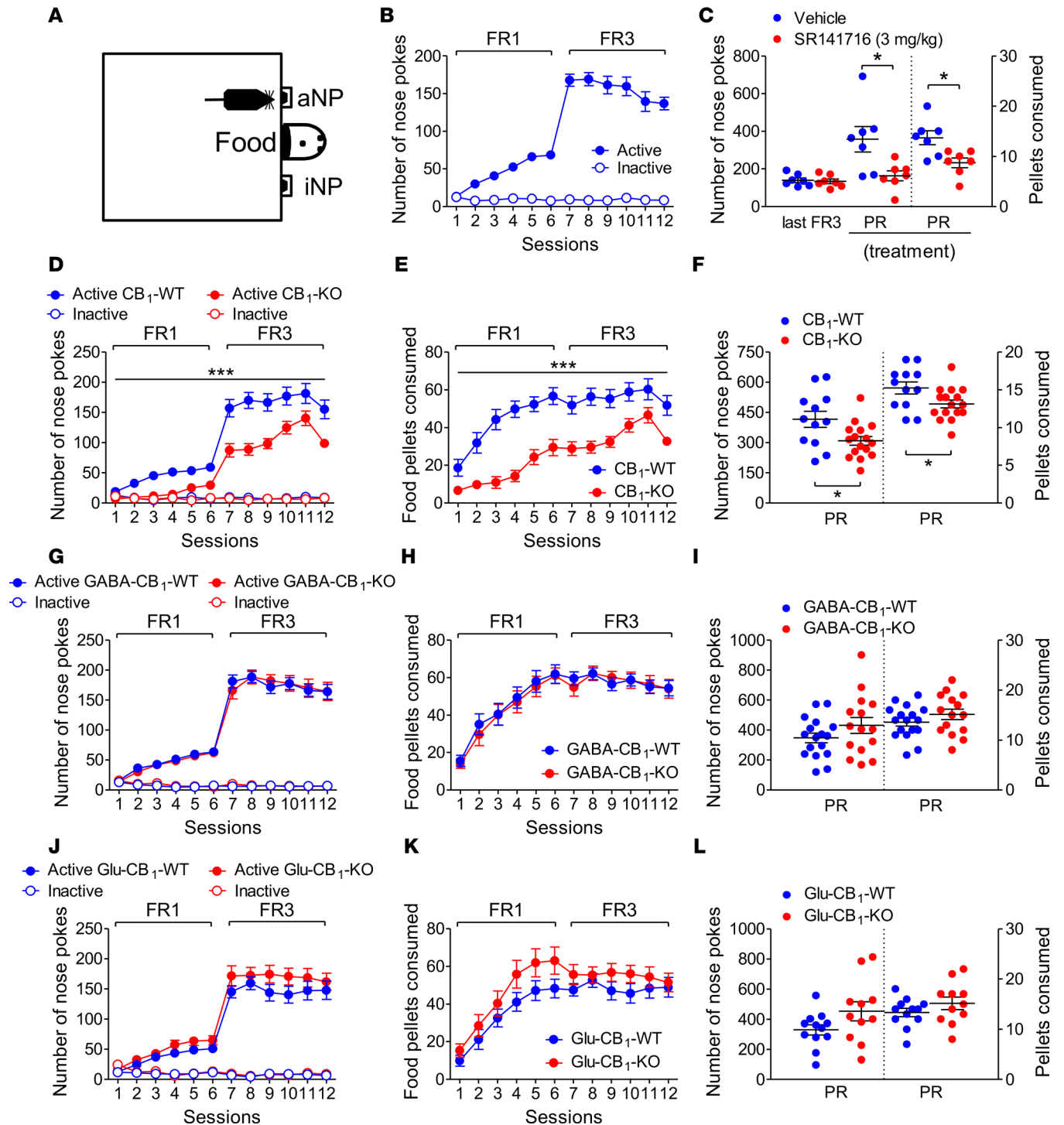
*CB<sub>1</sub> receptors on GABAergic neurons are dispensable for feeding motivation in food-restricted mice.* As the ECS sets the motivation for numerous rewards, whether natural or not (31, 32), we considered the possibility that the control of running motivation by CB<sub>1</sub> receptors on GABAergic neurons might be reward unspecific. Therefore, we analyzed in food-restricted mice the motivation for palatable feeding (Figure 4A), another ECS-mediated process (33–35), under pharmacologic or genetic manipulations of its activity. The acute administration of SR141716 decreased feeding motivation (by  $54\% \pm 7\%$ ) and hence food pellet consumption during the PR session (Figure 4, B and C). Accordingly, the deletion of CB<sub>1</sub> receptors decreased feeding motivation/consumption throughout all FR sessions (Figure 4, D and E) and the PR test (Figure 4F). The difference in feeding motivation between CB<sub>1</sub>-WT mice and CB<sub>1</sub>-KO mice tested during the PR session, albeit significant, was found



**Figure 3. CB<sub>1</sub> receptors on GABAergic neurons play a necessary and sufficient role on running motivation.** (A–C) Decreased active nose pokes (aNP), but not running performance, in GABA-CB<sub>1</sub>-KO mice during fixed ratio (FR) and progressive ratio (PR) sessions ( $n = 12$ ), compared with their WT littermates ( $n = 21$ ). (D) Similar NP responses in Glu-CB<sub>1</sub>-WT ( $n = 15$ ) and Glu-CB<sub>1</sub>-KO ( $n = 9$ ) mice during FR sessions. (E and F) The running duration per rewarded sequence was increased during FR and PR sessions in Glu-CB<sub>1</sub>-KO mice, compared with Glu-CB<sub>1</sub>-WT mice. (G) Reexpression of CB<sub>1</sub> receptors in GABAergic neurons ( $n = 14$ ) increased active NP during FR sessions, compared with Stop-CB<sub>1</sub> mice ( $n = 9$ ). (H) This behavior was associated with increased running duration per running sequence during FR sessions. (I) Increased active NP, but not running performance, in GABA-CB<sub>1</sub>-Rescue mice during the PR session ( $n = 14$ ), compared with Stop-CB<sub>1</sub> mice ( $n = 9$  and 4 for NP and running performance, respectively). Data represent mean  $\pm$  SEM. \* $P < 0.05$ , \*\* $P < 0.01$ , \*\*\* $P < 0.001$  for 2-group comparisons by Student's  $t$  tests (C, F, and I) and for main genotype significance in the 2-way ANOVA (A, G, and H). All PR tests were performed during sessions 13.

to be of lower amplitude ( $36\% \pm 5\%$ ) than that reported above for wheel running ( $79\% \pm 11\%$ ;  $P = 0.002$  by Mann-Whitney test). As opposed to the whole-body deletion of CB<sub>1</sub> receptors, their selective deletion from GABAergic neurons did not alter the motivation for, and the consumption of, food during FR and PR sessions (Figure 4, G–I), an observation that extended to Glu-CB<sub>1</sub>-KO mice (Figure 4, J–L).

*CB<sub>1</sub> receptors on GABAergic neurons are involved in the preference for wheel running over palatable food intake in ad libitum-fed and food-restricted mice.* Recent works have indicated that the study of motivation processes for a particular reward might provide misleading conclusions due to the lack of an alternative for that reward (36, 37). Taking into account this major observation, we next examined the role of CB<sub>1</sub> receptors on wheel-running motivation in animals confronted with a reward choice translatable to human day life, i.e., exercise versus palatable feeding. We thus set a protocol wherein mice were first tested for each reward pro-



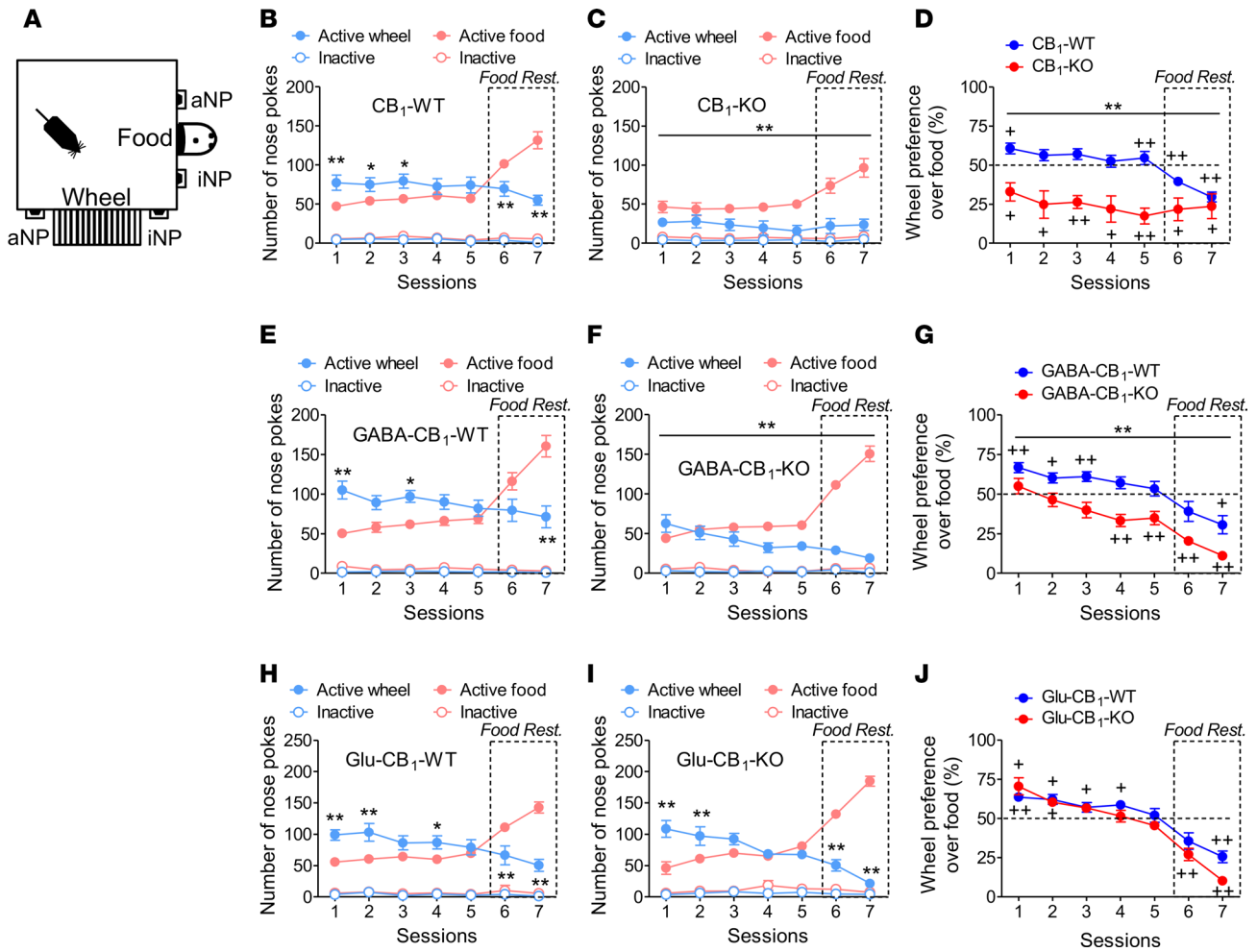
**Figure 4. CB<sub>1</sub> receptors on GABAergic neurons are dispensable for palatable food motivation in food-restricted mice.** (A) Operant chamber set up with active/inactive nose poke (aNP/iNP) ports. (B) NP performed by C57BL/6N mice during fixed ratio (FR) sessions ( $n = 14$ ). (C) Intraperitoneal administration of SR141716 decreased the maximal numbers of NP and pellets consumed during a progressive ratio (PR) session (session 13), compared with vehicle ( $n = 7$  for each). (D and E) Decreased aNP and food pellets consumed ( $P < 0.0001$ ) by CB<sub>1</sub>-KO mice ( $n = 16$ ) during FR sessions, compared with WT mice ( $n = 12$ ). (F) aNP and food pellets consumed were lower in CB<sub>1</sub>-KO mice than in WT mice during the PR ( $n = 16$  and  $12$ , respectively). (G–I) NP and food pellets consumed during FR/PR sessions did not differ between GABA-CB<sub>1</sub>-WT mice ( $n = 17$ ) and GABA-CB<sub>1</sub>-KO mice ( $n = 15$ ). (J–L) aNP and food pellets consumed during FR/PR sessions did not differ, respectively, between Glu-CB<sub>1</sub>-WT mice ( $n = 12$ ) and Glu-CB<sub>1</sub>-KO mice ( $n = 11$ ). Data represent mean  $\pm$  SEM. \* $P < 0.05$ , \*\*\* $P < 0.001$  for 2-group comparisons by Student's  $t$  tests (C and F) and for main genotype significance in the 2-way ANOVA (D and E). All PR tests were performed during sessions 13.

vided alone before both rewards were made concurrent (Figure 5A). Moreover, to ensure that our protocol captured preference changes when the incentive salience of one reward was altered, mice were tested under ad libitum food conditions before being food restricted for the last 2 days of the experiments. When each reward was provided alone, response numbers for wheel running were higher than those for palatable food in all genotypes, except for CB<sub>1</sub>-KO mice and GABA-CB<sub>1</sub>-KO mice (Supplemental Figure 3). These trends were amplified when rewards were made concurrent. Thus, ad libitum-fed CB<sub>1</sub>-WT mice (Figure 5, B and D), GABA-CB<sub>1</sub>-WT mice (Figure 5, E and G), and Glu-CB<sub>1</sub>-WT mice and Glu-CB<sub>1</sub>-KO mice (Figure 5, H–J) displayed increased preference for running over feeding, while the opposite was true for CB<sub>1</sub>-KO mice (Figure 5, C and D) and GABA-CB<sub>1</sub>-KO mice (Figure 5, F and G). Under food restriction, a progressive increase in food seeking was observed, and this increase was strong enough to evoke or amplify (GABA-CB<sub>1</sub>-KO mice) food preference over running (Figure 5, B–J). Because the data gathered under ad libitum feeding conditions relied on whole-session analyses, we could not exclude the possibility that CB<sub>1</sub>-KO mice and/or GABA-CB<sub>1</sub>-KO mice actually displayed temporary within-session preferences for the wheel over feeding that were masked when analyzed at the whole-session level. Kinetic analyses (using 10-minute periods as within-session units) of rewarded events allowed us to reject this possibility. Thus, as opposed to their respective WT littermates (Figure 6, A and C), CB<sub>1</sub>-KO mice and GABA-CB<sub>1</sub>-KO mice performed stable numbers of wheel-rewarded NP throughout the entire sessions, and these numbers were reduced when compared with the numbers of food-rewarded NP (Figure 6, B and D, and Supplemental Figure 4).

## Discussion

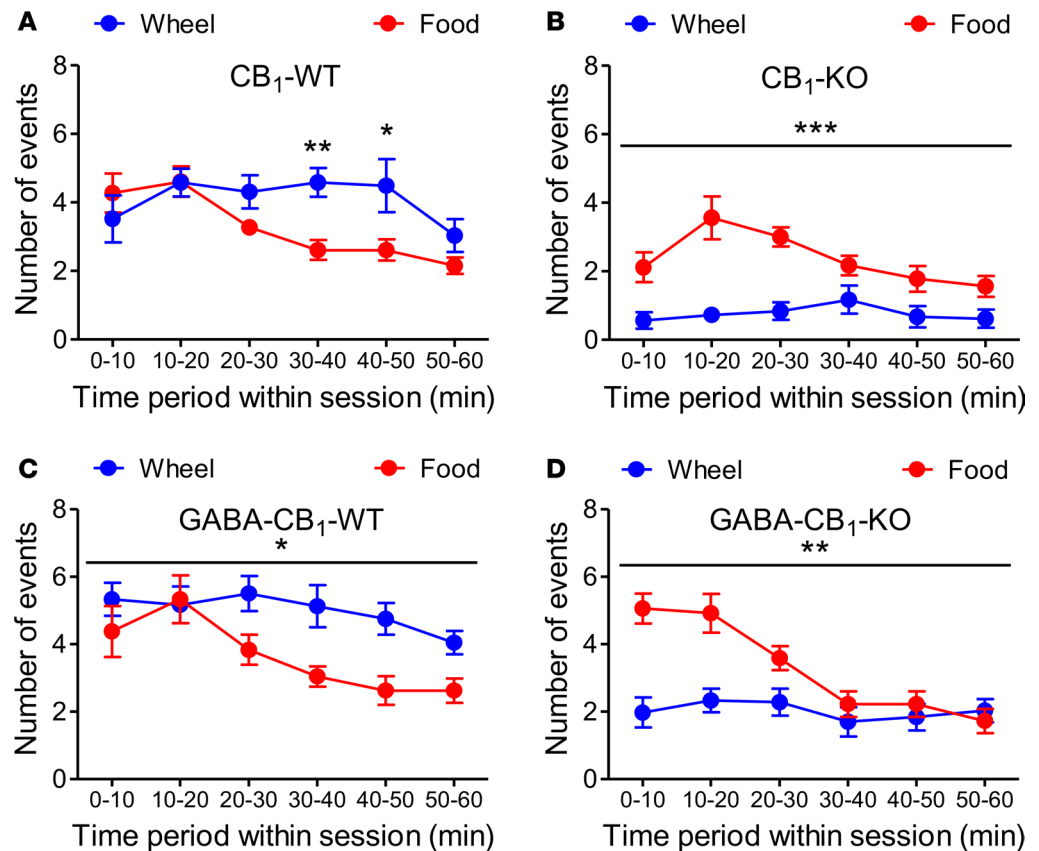
The crucial need to use effort-based paradigms to define the neurobiological bases of exercise motivation led us to develop an operant conditioning protocol in which NP responding under FR/PR schedules of reinforcement was a prerequisite for mice to be able to perform wheel running. We provided evidence in preliminary experiments that our FR protocol showed the high reinforcing property of wheel running, as illustrated by a cue-induced reinstatement of wheel running seeking after an extinction period. This conclusion was strengthened by the observation that our mice did not need to be partly food deprived prior to the operant running sessions, a procedure often used to facilitate the reinforcing efficacy of natural and drug rewards. Taking advantage of our procedure, we next examined whether we could refine our knowledge of the relationships between wheel running and the activity of VTA DA neurons. Past studies have indicated that (a) burst firing of VTA DA cells might be observed at onsets and offsets of wheel-running episodes (38); (b) acute treadmill running increases extracellular DA levels in the nucleus accumbens, the main projection of mesolimbic DA neurons (39); and (c) transcripts of tyrosine hydroxylase, the rate-limiting enzyme in DA synthesis, are increased in the VTA of chronic wheel-runners (40). However, it is noteworthy that these studies involved free (i.e., costless) wheel-running access (38, 40) or forced treadmill running (39), leaving unsolved the question as to the strength of the link, if any, between running motivation and the mesolimbic DA system. In a first series of experiments, we analyzed whether the D2 receptor antagonist haloperidol, which was shown to be effective against the motivational drives for other rewards (11, 18), affected running motivation. Indeed, noncataleptic doses (as revealed by the mean running durations per running sequences) of haloperidol decreased running motivation in a dose-dependent manner. This observation gave rise to the key issue of the respective links between the motivation drive (as assessed from PR scores) on the one hand, and the consummatory drive (as assessed by wheel-running performance) on the other hand, and VTA dopaminergic activity. To deal with this crucial need to separate running motivation from running exertion, we set a protocol that to our knowledge is unique in the present field. Hence, operant mice (which displayed running motivation and consumption), yoked mice (which were only allowed running consumption, the level of which was experimentally set at that performed by operant mice), and control mice (to include the intrinsic effect of the transfers/exposures to the chambers in the first 2 mouse groups) were respectively compared for their VTA dopaminergic activities. The results, which indicated a positive link between the desire to run (but not running duration) and the firing activity of DA cells, provide for the first time to our knowledge direct evidence for a stimulatory effect of running motivation on the activity of the mesolimbic system. Taken together, the results gathered during this validation step of our operant conditioning protocol allowed us to shift to an analysis of the role of the ECS in running motivation.

To our knowledge, the sole study on the role of the ECS on operant wheel running refers to rats (41), a species in which a genetic identification of the cell type(s) involved in such a role is, however, rendered complex. In the latter study, the acute administration of SR141716 triggered a significant decrease in breakpoint



**Figure 5. CB<sub>1</sub> receptors on GABAergic neurons gate the motivation for running over palatable food in ad libitum-fed mice and food-restricted mice. (A)** Operant chamber set up with active/inactive nose poke (aNP/iNP) ports. **(B)** Fed, but not food-restricted, CB<sub>1</sub>-WT mice (*n* = 10) displayed more aNP for wheel running than for food during fixed ratio 3 (FR3) choice sessions. **(C)** Fed and food-restricted CB<sub>1</sub>-KO mice (*n* = 6) performed fewer aNP for wheel running than for food during choice sessions. **(D)** Preference scores for wheel running were lower in CB<sub>1</sub>-KO mice than in CB<sub>1</sub>-WT mice. **(E)** Fed, but not food-restricted, GABA-CB<sub>1</sub>-WT mice (*n* = 8) displayed more aNP for wheel running than for food during choice sessions. **(F)** Fed and food-restricted GABA-CB<sub>1</sub>-KO mice (*n* = 12) performed fewer aNP for wheel running than for food under FR3 schedules of reinforcement. **(G)** Preference scores for wheel running were lower in GABA-CB<sub>1</sub>-KO mice than in GABA-CB<sub>1</sub>-WT mice under fed and food-restricted conditions. **(H and I)** Fed, but not food-restricted, Glu-CB<sub>1</sub>-WT mice (*n* = 5) and Glu-CB<sub>1</sub>-KO mice (*n* = 5) displayed more aNP for wheel running than for food during choice sessions. **(J)** Preference scores for wheel running were similar in Glu-CB<sub>1</sub>-WT and Glu-CB<sub>1</sub>-KO mice. Data represent mean ± SEM. \**P* < 0.05, \*\**P* < 0.01 for comparisons between wheel and food (performed by Tukey's test if the 2-way ANOVA provided significant variable interaction; **B, E, H, and I**) and for main significance in the 2-way ANOVA between the rewards (**C, D, F, and G**). +*P* < 0.05, ++*P* < 0.01 for comparisons between wheel preference scores and nonpreference (50%) by 1-tailed Student's *t* tests (**D, G, and J**).

levels without altering the mean number of revolutions performed per reinforcer (41). However, (a) these rats were maintained at 90% of their body weight, thus raising the question of whether this result was extendable to ad libitum-fed animals, and (b) a high dose (i.e., 10 mg/kg), but not low-to-moderate doses (1–3 mg/kg), of SR141716 proved efficient, raising the issue of the extent to which the ECS was selectively involved. By means of 2 different CB<sub>1</sub> receptor antagonists, one of which, namely O-2050, is thought to be a neutral antagonist (25), we extend to (ad libitum-fed) mice the above-mentioned report that the ECS controls in a tonic manner rat running motivation. Of interest was our finding that CB<sub>1</sub> receptor antagonists decreased running motivation without an effect on the time spent running per rewarded sequence. In line with our electrophysiological experiments and the general belief that reward access and reward consumption are separate entities (10, 11), this last observation strongly suggested that the ECS specifically controls wheel-running motivation but not wheel running per se. The behaviors of CB<sub>1</sub>-KO mice when placed under PR schedules of reinforcement, i.e., decreased numbers of active NP but no alteration in the time spent running per sequence (compared with their WT littermates), provided an experimental support for our pharmacological results.



**Figure 6. Time-independent decreases in wheel-running preference over palatable feeding in ad libitum-fed CB<sub>1</sub>-KO mice and GABA-CB<sub>1</sub>-KO mice.** (A and B) Fed CB<sub>1</sub>-KO mice ( $n = 6$ ), but not fed CB<sub>1</sub>-WT mice ( $n = 10$ ), displayed a time-independent decrease in mean wheel-running sequences, compared with feeding sequences, during the first 5 choice sessions. (C and D) Fed GABA-CB<sub>1</sub>-KO mice ( $n = 12$ ), but not fed GABA-CB<sub>1</sub>-WT mice ( $n = 8$ ), displayed a time-independent decrease in mean wheel-running sequences, compared with feeding sequences, during the first 5 choice sessions. Data represent mean  $\pm$  SEM. \* $P < 0.05$ , \*\* $P < 0.01$ , \*\*\* $P < 0.001$  for the overall differences between rewards in the 2-way ANOVA (B-D). \* $P < 0.05$ , \*\* $P < 0.01$  for the time-dependent differences (Tukey's test) following significant time  $\times$  reward interactions in the 2-way ANOVA (A).

The additional finding that the intra-VTA infusion with the CB<sub>1</sub> receptor antagonist AM251 (which exerts stronger central actions than SR141716; ref. 16) decreased to a major extent running motivation indicates that most, if not all, of the tonic control exerted by CB<sub>1</sub> receptors on running motivation — but not on running performance — finds its roots in the VTA. This conclusion is in keeping with the key role exerted by VTA CB<sub>1</sub> receptors on the mesolimbic system and hence motivation for natural and nonnatural rewards (31, 32).

The differential consequences of the deletion of CB<sub>1</sub> receptors on running motivation and the time spent running during each rewarded sequence were fully recapitulated in mice lacking CB<sub>1</sub> receptors on GABAergic neurons. Besides questioning whether the latter receptor subpopulation is partly/fully located in the VTA, these results raise several issues. The first relates to the dichotomy between (a) the consequences of the whole body deletion of CB<sub>1</sub> receptors or the specific deletion of CB<sub>1</sub> receptors from GABAergic neurons on the numbers of effort-based approaches to the wheel during FR/PR sessions and (b) the lack of effect of these deletions on the time spent running per rewarded sequence during these sessions. Thus, as opposed to the time spent running per rewarded sequence, the deletion of CB<sub>1</sub> receptors from GABAergic neurons — but not their deletion from the whole body — decreased the distance ran per rewarded sequence. This trend, which was especially pronounced during the first FR sessions, suggests that running speed is tonically controlled by CB<sub>1</sub> receptors located on GABAergic neurons. It should be noted that the latter conclusion might, however, only apply to the present operant protocol, because GABA-CB<sub>1</sub>-KO mice provided access to running wheels under no-cost conditions display equivalent reductions in running durations and distances (16). The second issue relates to the finding that the mean percentage of reduction in the number of NP responses displayed by CB<sub>1</sub>-KO mice exposed to the PR session, compared with their

WT littermates, did not significantly differ from that measured in GABA-CB<sub>1</sub>-KO mice exposed to that session, compared with their respective WT littermates. Although this lack of difference might be taken as an argument for the main involvement of CB<sub>1</sub> receptors in GABAergic neurons in the ECS-mediated control of running motivation, we cannot exclude the involvement of other CB<sub>1</sub> receptor subpopulations (including in noncortical glutamatergic neurons). If so, these subpopulations, however, might only play a minor role on running motivation. Such an hypothesis is somewhat supported by our additional finding that the selective reexpression of CB<sub>1</sub> receptors in GABAergic neurons in mice lacking CB<sub>1</sub> receptors markedly amplified NP performance during FR and PR sessions. The extent to which CB<sub>1</sub> receptors on GABAergic neurons exert such a sufficient role on running motivation is unknown. Thus, although this study involved two mouse models lacking CB<sub>1</sub> receptor expression (i.e., gene deletion for CB<sub>1</sub>-KO mice, gene silencing for Stop-CB<sub>1</sub> mice: refs. 26, 29), the difference in their genetic grounds renders any comparison between these mouse lines, including a comparison between CB<sub>1</sub>-WT mice and GABA-CB<sub>1</sub>-Rescue mice, uneasy. As an illustration, the performance of Stop-CB<sub>1</sub> mice was found to be worst than that of CB<sub>1</sub>-KO mice when exposed to FR/PR sessions. This difference might be accounted for by the fact that Stop-CB<sub>1</sub> mutant mice have a Stop-CB<sub>1</sub> mother, i.e., a mother that might be prone to maternal neglect behaviors due to the lack of CB<sub>1</sub> receptor expression (42), a limit that does not apply to CB<sub>1</sub>-KO mice, which are bred with heterozygote CB<sub>1</sub>-KO/CB<sub>1</sub>-WT mothers. Finally, mice lacking CB<sub>1</sub> receptors in cortical glutamatergic neurons displayed increased running duration per sequence during FR and PR sessions, without any alteration in the appetitive motivation to run. This observation suggests that this receptor subpopulation might exert a tonic, albeit negative, control over the consumption of that reward. Although not significant, a similar tendency could be observed when the running distance per running sequence was examined (Supplemental Figure 3), indicating that this receptor subpopulation does not control running speed under an effort-based task.

As indicated above, the ECS mainly regulates reward processes — whether these rewards are natural or nonnatural — through CB<sub>1</sub> receptors located on GABAergic neurons and on glutamatergic neurons projecting to the mesolimbic (and the mesocortical) dopaminergic system (31, 32). In turn, this close link between the ECS and reward processes might be taken as an argument for a reward-unspecific role of CB<sub>1</sub> receptors (on GABAergic neurons) in running motivation. This argument is, however, rendered invalid by the recent report that CB<sub>1</sub> receptors on GABAergic neurons negatively regulate the motivation to self-administer cocaine, i.e., GABA-CB<sub>1</sub>-KO mice actually display increased motivation for the intake of cocaine, compared with GABA-CB<sub>1</sub>-WT mice (43). Although this result spoke in favor of a reward-specific control by CB<sub>1</sub> receptors on GABAergic neurons, we aimed at confirming this suggestion by extending our study to the role of the ECS on another natural (nondrug) reward. In keeping with the pathophysiological consequences of the imbalance between exercise and palatable food intake in both humans and animals (see Introduction), palatable feeding in food-restricted mice was chosen as the second reward of investigation. We first verified through pharmacology (SR141716) and genetics (CB<sub>1</sub>-KO mice) that CB<sub>1</sub> receptors were involved in the motivation for palatable food, thus confirming previous reports (33–35). Interestingly, although we used mice in which the drive for feeding was experimentally increased through food restriction, the negative effect of CB<sub>1</sub> receptor deletion on feeding motivation was found to be much lower than that exerted by this deletion on running motivation. This observation confirmed the above-mentioned finding that CB<sub>1</sub> receptors play a major, if not a unique, role on running motivation. As opposed to its negative consequence on running motivation, the deletion of CB<sub>1</sub> receptors from GABAergic neurons did not affect the drive for palatable feeding. Besides questioning the identity of the receptor subpopulation(s) involved in the control of palatable feeding by the ECS, our results allowed us to reject the hypothesis that CB<sub>1</sub> receptors in GABAergic neurons control running motivation in a reward-unspecific manner. The differential effect of this CB<sub>1</sub> receptor population on the respective drives for running and palatable food intake should be replaced within the recent theory that the control of reward motivation by the mesolimbic dopaminergic system belongs to a broader homeostatic network, the first goal of which is to regulate energy conservation/expenditure (44). Hence, this system would favor both energy expenditure (at the expense of conservation) and exploration (at the expense of resource exploitation), i.e., processes that might depend on running motivation. If so, CB<sub>1</sub> receptors on GABAergic neurons would be one among specific upstream mechanisms allowing the mesolimbic dopaminergic system to respond in a resource-dependent manner. One obvious limitation of this proposal was that we examined the role of this receptor population in animals offered the possibility to work to get only one single reward (running, palatable feeding). This paradigm is obviously different from human

daily life where reward choices (including exercise vs. feeding) are permanent. Indeed, recent works indicate that the study of motivation processes for one single reward might provide misleading conclusions due to the lack of a reward alternative (36, 37). For instance, Cantin et al. have shown that rats work more for cocaine than for saccharin when proposed alone but the opposite preference is observed when rats are offered these rewards in a choice paradigm (45). Taken together, all these observations led us to set an operant conditioning task where mice trained to work for each reinforcer provided alone were then given the choice between the two reinforcers under ad libitum-fed and food-restricted conditions. By this means, we first revealed that, although mice lacking CB<sub>1</sub> receptors displayed lower motivation for either wheel running or palatable feeding when proposed alone (see above), the balance between the respective drives for energy intake and energy expenditure was markedly dysregulated in favor of energy intake under a choice paradigm. The second finding relates to the observation that the key role exerted by CB<sub>1</sub> receptors on GABAergic neurons on the drive for running when the latter was the sole reward available extended to a choice situation. Kinetic analyses further indicated that these preferences for feeding over running were almost kept constant within choice sessions in CB<sub>1</sub>-KO and in GABA-CB<sub>1</sub>-KO mice. Of interest was the additional observation that the respective WT counterparts of these mutants displayed decreased NP responses for palatable food with time. This is unlikely to be accounted for by the hypophagic consequences of wheel running, because the latter increases, rather than decreases, food intake as to provide energy for wheel running, hence maintaining constant body weights (15). More likely, this negative time-dependent trend illustrates precocious satiety, especially in ad libitum-fed animals.

Taken together, these results pinpoint CB<sub>1</sub> receptors, especially those located on GABAergic neurons, as major regulators of the balance between the respective drives for palatable food and exercise. It should be noted, however, that limits inherent to animal models of reward seeking surely apply to the present study. One of these relates to the daily acute exposure of animals to the operant chambers. Although such an exposure always occurred during the active phase of the nycthemeral cycle, it by no means fully recapitulates the human condition where reward choices are permanent. One means to circumvent this limit might consist of housing the animals in operant chambers (46) with permanent choices between wheel running and feeding. Our future experiments, aimed at focusing on this paradigm, will surely help to refine the present results.

In conclusion, this study reveals by means of operant conditioning procedures that the ECS, through CB<sub>1</sub> receptors located in GABAergic neurons, exerts a major tonically active control of the intrinsic motivation (“wanting”) to run, including when another reward, such as palatable feeding, is proposed as an alternative. The reward choice paradigm developed herein should facilitate the future discovery of the mechanisms responsible for pathological imbalances between exercise motivation and feeding motivation and whether these imbalances favor feeding over running (e.g., obesity) or running over feeding (e.g., restrictive anorexia nervosa).

## Methods

**Animals.** This study involved 6- to 8-week-old male C57BL/6N mice and 8- to 14-week-old male constitutive and conditional CB<sub>1</sub> receptor mutant (KO) and WT animals (established since 2006 in our breeding facilities). These animals included CB<sub>1</sub>-KO mice and their CB<sub>1</sub>-WT littermates (15, 26–28), conditional mutants lacking floxed CB<sub>1</sub> receptors in forebrain GABAergic neurons due to the expression of the *Dlx5/6*-Cre recombinase (GABA-CB<sub>1</sub>-KO mice) and their WT littermates (16, 27, 28), and conditional mutants lacking floxed CB<sub>1</sub> receptors in cortical glutamatergic neurons due to the expression of the *Nex*-Cre recombinase (Glu-CB<sub>1</sub>-KO mice) and their WT littermates (16, 27, 28). To check for the sufficient role of CB<sub>1</sub> receptors on GABAergic neurons on wheel-running motivation, we additionally used Stop-CB<sub>1</sub> mice and mice bearing a selective rescue of CB<sub>1</sub> receptor expression in GABAergic neurons (thereafter termed GABA-CB<sub>1</sub>-Rescue mice) (bred since 2010 in our animal facilities). To generate the Stop-CB<sub>1</sub> mouse line, the endogenous CB<sub>1</sub> gene (also known as *Cnr1*) was silenced by insertion of a loxP-flanked stop cassette in the 5' UTR of the CB<sub>1</sub> receptor start codon (29, 30). To generate mice with (GABA-CB<sub>1</sub>-Rescue) or without (Stop-CB<sub>1</sub>) a selective rescue of CB<sub>1</sub> receptors on GABAergic neurons, Stop-CB<sub>1</sub> mice were crossed with our mouse line expressing a Cre recombinase under the regulatory elements of the *Dlx5/6* gene (see above). Mutant and WT mice, bred in a mixed genetic background with a predominant C57BL/6N contribution, were genotyped (at 2–3 weeks old) and regenotyped (at the end of experiments), as described previously (15, 16, 28).

**Operant procedures.** The behavioral set-up comprised 6–12 individual operant chambers (28 cm long × 26 cm wide × 38 cm high) located in a room adjacent to the animal housing room. These chambers were placed inside wooden casings (60 cm long × 62 cm wide × 49 cm high) that were ventilated to guarantee air circulation and



to provide background noise (Imetronic). For operant running experiments, lateral walls were made of gray Perspex, while the rear wall had a central hollow for mounting the 20-cm diameter wheel, the release trigger of which was connected to a circuit enabling the wheel to be locked or unlocked (by means of a brake pad) in accordance with predefined experimental conditions. A cue light placed above the wheel indicated the wheel unlocking. The wheel was flanked by two small ports (2.5 cm above the chamber gridded floor with cue lights located above) set into the rear wall to allow the animal to “poke” its nose through. For operant feeding, the rear side (running wheel, NP ports, cue lights) was covered by gray Perspex whereas the left panel of the chamber housed in its center a recessed pellet tray surrounded by 2 NP ports. Cue lights were placed above the NP ports and the feeder to indicate respectively effectiveness of the NP and pellet distribution.

*Operant running protocol.* NP performance could be either “active” (leading to cue light illumination and wheel unlocking) or “inactive” (having no consequence). Left/right allocation of active/inactive NP ports was counterbalanced between animals during experiments. All devices in the operant chambers were linked to a computer that recorded the number of active/inactive NP, the number of running sequences, and the running duration/distance covered during each sequence. The experiments were performed during the active (dark) phase of the light/dark cycle of the mice, each mouse group (comprising WT and mutant animals) being tested at the same time daily. All animals were first habituated to a running wheel by being placed for 60 min/d in individual cages housing 25-cm diameter running wheels (Intellibio; refs. 15, 16). This procedure was performed on 2 consecutive days before experiments commence in the operant cages with 5–7 sessions/week. On the third session, mice were placed in the chambers where the cue light above the unlocked running wheel remained illuminated while the 2 NP ports were covered up by metal pieces. This first conditioning session was aimed at habituating the mice to both the operant chamber, the wheel, and the cue indicating wheel unlocking. When learning sessions began, the wheel-locking/unlocking mechanism and the NP ports were fully operational. The wheel was unlocked for 60 seconds (wheel brake released) following NP the mouse executed in its allocated active NP port. The other port, although accessible to NP, remained inactive. In the FR1 condition, a single active NP was sufficient to simultaneously illuminate the cue light above the port for 10 seconds and unlock the running wheel for 60 seconds under light. NP in the inactive port were counted but had no consequence. When the 60 seconds had elapsed, the wheel light extinguished and the brake applied, so that the mouse had to step down from the wheel and execute a further NP in order to unlock it again. NP made in the active port while the wheel was already unlocked were without consequence. Habituation and FR1 sessions were ran once daily and lasted for 60 minutes. There were always 6 FR1 sessions, except for the mice that underwent intra-VTA perfusions, which were conditioned for only 5 sessions due to loud renovation-associated noise planned in the animal facility several days thereafter. After completing the FR1 schedule of reinforcement, mice moved on to the FR3 condition, i.e., a 60-second wheel-running period was contingent on 3 consecutive NP in the active port. As above, this experimental condition was repeated over 6 sessions except for in the mice tested with intra-VTA perfusions, which were only allowed 5 FR3 sessions (for the reasons mentioned above). The day after the last FR3 session mice were tested under a linear PR schedule of reinforcement where (a) the number of active NP required to free the running wheel was incremented by 3 between each rewarded step (3, 6, 9, etc.; PR3), with (b) a time limit of 15 minutes between 2 successive steps. For experiments involving treatments prior to the PR session, mouse groups with similar mean NP scores during the last FR3 session were formed to avoid a priori biases. In one series of experiments (Figure 1, B–D), mice underwent 9 (60-minute) extinction sessions immediately after the sixth FR3 session; these extinction sessions were followed by 1 cue-induced reinstatement session. During extinction, neither active/inactive NP nor cue lights were functional, hence the running wheel remained locked through the sessions. Following stable extinction scores, reinstatement was initiated by lighting for 10 seconds the cue above the active NP of each mouse 30 seconds after its placement in the chamber. Following this initial, automatic cue light illumination, if the animal executed one active NP (as per FR1) the cue light came on again for 10 seconds. After this first FR1 operant illumination of the cue, 3 NP were required for each subsequent illumination of 10 seconds (as per FR3). The wheel light, however, remained off, and the wheel itself remained locked for the full duration of the reinstatement session. Throughout all experiments described above, the mice were required a minimal discrimination index (number of NP in the active port over the total number of NP) of 75% and a maximal 20% variation in the mean number of active NP over the last 3 FR3 sessions to be tested under the PR3 schedule of reinforcement. To evaluate wheel-running consumption during FR/PR sessions, we divided the total running duration within each session over the number of rewarded events during that session (when necessary, a similar procedure was applied for the calculation of the distance covered per rewarded session).

Because some animals placed under PR schedules did not reach the first rewarded level of NP responding (i.e., 3 active NP), hence preventing any calculation of that ratio, within-group animal numbers might differ from those indicated for the achievement of active NP levels.

*Operant feeding protocol.* As for the operant running experiments, left/right allocation of active/inactive NP ports was counterbalanced between animals during experiments. All devices in the operant chambers were linked to a computer that recorded both the number of active/inactive NP, the number of pellets distributed, and the number of entries into the feeder. All experiments were performed during the active phase of the light/dark cycle of the mice, each mouse group (comprising WT and mutant animals) was tested at the same time daily. The daily food consumption and the body weight of each mouse were recorded daily for a week before mice were given a limited quantity of food, as to maintain their body weight at 90% levels of their free-feeding weight. Food was always provided 60–90 minutes after the daily completion of the operant conditioning session, as to minimize the possibility of interactions between free-feeding and operant behavior. Prior to the onset of the operant conditioning procedure, animals were first habituated to the 20-mg chocolate pellets used in the operant chambers (Dustless precision pellets, F05301; Plexx, for BioServ) by providing them with 5 pellets/d for 3 days in their home cages. Thereafter, mice were placed in the chambers, with the cue light above the pellet tray remaining illuminated while the 2 NP ports were covered up by metal pieces. Immediately after placement of the mouse in the operant chamber, 17 food pellets were successively distributed to the tray. This first conditioning session was aimed at habituating the mice to the operant chamber, the feeder, and the cues indicating pellet distribution. When learning sessions began, the feeder was empty while the NP ports were fully operational. During FR1 sessions, a single active NP was sufficient to simultaneously illuminate the cue light above the feeder and dispense one pellet. NP in the inactive port were counted but had no consequence. The pellet distribution was followed by a 15-second time-out period during which NP activity was inefficient. Habituation and FR1 sessions were ran once daily and lasted for 30 minutes to avoid satiety. To compare with operant running experiments, the number of FR1 sessions was fixed to 6, a number sufficient to reach performance stability. After completing the FR1 schedule of reinforcement, mice moved on to the FR3 condition, i.e., mice had to NP 3 consecutive times in the active port to get 1 food pellet. As above, this experimental condition was repeated over 6 sessions. The day after the last FR3 session mice were tested under a linear PR3 schedule of reinforcement similar to the one described above, except that there was no time limit between steps in keeping with the short (i.e., 30-minute) duration of the PR session. For experiments involving treatments prior to the PR session, mouse groups with similar mean NP scores during the last FR3 session were formed to avoid a priori biases. Inclusion criteria for PR proceeding were similar to those indicated above.

*Operant choice protocol.* The protocol followed a 2-step process: the first step involved the conditioning for wheel running and food intake provided separately. Hence, each day, mice were placed in the chambers for 2 consecutive 30-minute sessions, with the nature of the reward (wheel running or palatable food) being inverted each day and counterbalanced between mice belonging to the same genotype. Five FR1 sessions and five FR3 sessions were performed as indicated above, except for the fact that active NP illuminated simultaneously the cue lights above the ports for 5 seconds and the cue lights above the wheel or the feeder for 20 seconds and 15 seconds, respectively. These numbers were chosen as to provide to the closest extent similar reward consumption durations, while avoiding within-session food satiety on the one hand, but maintaining enough running duration to keep wheel-running attractive on the other hand. To facilitate the learning of the contingency for food (and hence running), mice were first food restricted (as to display a stable 10% body weight reduction) for the first 2–3 FR1 sessions. The second step involved the daily placement of the mice in the chambers with the possibility to work for either reward (choice protocol). Thus, animals were placed in a choice condition with either wheel unlocking or food distribution being accessible under an FR3 schedule. However, choosing one reward excluded the possibility to obtain simultaneously the second reward. The respective durations of activation of the wheel (20 seconds) and the feeder (15 seconds) cue lights remained as in the preceding sessions. However, to further indicate to the mice that ran during the entire 20-second sequence that the reward choice was mutually exclusive, we added a 5-second period during which a green ceiling light was switched on while none of the NP ports was active. Five daily consecutive choice sessions were performed to establish food and wheel preferences, each session being 60-minute long (as to coincide with the FR sessions during which one 30-minute session/reward was proposed daily; see above). After these 5 choice sessions, mice were food restricted as above for 2 consecutive days, during which choices were again assessed. This experiment was aimed

at (a) ensuring that our choice protocol captured the changes in the wheel/food preference scores that result from the modification of one motivational drive and (b) analyzing whether food restriction might alter the control of the wheel/food preference ratio by CB<sub>1</sub> receptors. Wheel preference (percentage) was quantified by dividing the number of active NP that led access to the wheel by the total number of active NP performed for both rewards (food + wheel). Hence, scores above 50% indicated a preference for wheel running while scores below 50% indicated a preference for food.

*In vivo electrophysiology.* At the end of the PR sessions, mice were returned to their home cages before being transferred to an anesthesia chamber where they inhaled halothane. Stereotaxic surgery was performed as previously described (16, 47, 48). Thus, recording pipettes were inserted into the VTA with the skull flat, at the following coordinates: -3.16 mm from bregma; 0.5 mm from midline. A glass micropipette (tip diameter = 2–3 μm, 4–6 MΩ) filled with a 2% pontamine sky blue solution in 0.5 M NaCH<sub>3</sub>CO<sub>2</sub> was lowered into the VTA. DA neurons were identified according to well-established electrophysiological features (49). The extracellular potential was recorded with an Axoclamp2B amplifier in the bridge mode. The extracellular potential amplified 10 times by the Axoclamp2B amplifier was further amplified 100 times and filtered (low-pass filter at 300 Hz and high-pass filter at 0.5 kHz) via a differential AC amplifier (model 1700; A-M Systems). Single neuron spikes were discriminated and digital pulses were collected online using a laboratory interface and software (CED 1401, SPIKE 2; Cambridge Electronic Design). At the end of each recording experiment, the electrode placement was marked with an iontophoretic deposit of pontamine Sky Blue dye (-20 μA, continuous current for 12–15 minutes), and the animals were deeply anesthetized with halothane (5%) and decapitated. Brains were removed and snap-frozen in a solution of isopentane at -70°C. Basal firing rate and burst event frequency of VTA DA neuron impulse activity were computed over 200-second epochs after a 5-minute stable baseline period. Bursts were identified as discrete events consisting in a sequence of spikes, such that their onset was defined by 2 consecutive spikes within an interval lower than 80 milliseconds whenever they terminated with an interval greater than 160 milliseconds (49).

*Drug infusion in the VTA.* As previously described (16), mice were anesthetized by the intraperitoneal injection of a mixture of ketamine/xylazine and placed into a stereotaxic apparatus (David Kopf Instruments). Mice were bilaterally implanted with 2.7-mm stainless cannulae targeting the VTA with the following coordinates: AP -3,0; L ± 0,5; DV -4.7 (6). The cannulae were secured with dental cement, and the mice were allowed to recover for a week when mice displayed at least their presurgery body weights. For intra-VTA infusion of AM251 (1 μg/side) or its vehicle, 4.7-mm-long injectors were connected to polyethylene tubing to Hamilton syringes (10-μl volumes) and 250 nl/min AM251/vehicle was infused in each side for 2 minutes. This was followed by a 1-minute period during which the injectors were left in place to allow further diffusion. Thereafter, all mice were returned to their home cages for 15–20 minutes before being placed in the operant chambers. At the end of the experiments, mice were bilaterally injected with Sky Blue before being sacrificed. Brains were rapidly removed and placed in dry ice before storage at -80°C. Coronal sections (40-μm wide) were then cut using a Microm HM 500M cryostat (Microm Microtech), stained with Neutral Red, and observed under an Olympus SZX10 stereomicroscope (Olympus).

*Drugs.* Haloperidol was from MilliporeSigma, SR141716 was from Interchim (for Caiman Chemical), and O-2050 and AM251 were from R&D System (for Tocris). Haloperidol was made fresh before injection, while SR141716 and O-2050 were stocked in DMSO at -20°C before final preparation. Haloperidol (0.15–0.3 mg/kg i.p. 45 minutes beforehand) was prepared in 0.9% NaCl (10 ml/kg) before injection. SR141716 (3 mg/kg i.p. 30 minutes beforehand) and O-2050 (0.5 mg/kg i.p. 30 minutes beforehand) or their vehicle (DMSO, final concentration: 1.25%) were diluted in 1 droplet of Tween 80 and then in 0.9% NaCl (10 ml/kg). For local infusions, AM251 (1 μg/side) or its vehicle (DMSO, final concentration: 10%) were diluted in cremophor (final concentration: 10%) and then in 0.9% NaCl 20–30 minutes beforehand.

*Statistics.* All analyses were performed with GB-Stat software (version 10; Dynamic Microsystems Inc.), with *P* values of less than 0.05 being considered significant. Two-group (treatment or genotype) comparisons of the data gathered during the PR sessions were achieved by means of 2-tailed Student's *t* tests. Genotype differences in NP activity, running duration per rewarded sequence, and number of food pellets consumed during the FR1 and FR3 sessions were assessed by 2-way ANOVA. Homogeneity of the variances was achieved by prior logarithmic transformation of the data, if necessary. A repeated design was always included in the 2-way ANOVA, except for the analysis of the running duration per running sequence in Stop-CB<sub>1</sub> and GABA-CB<sub>1</sub>-Rescue, where a mouse-dependent and session-dependent lack of running activity in Stop-CB<sub>1</sub> impeded such an inclusion. Post hoc group comparisons (Tukey's test) were

performed only if genotype  $\times$  session interactions were found significant. In choice experiments, preference scores were compared with nonpreference (50% preference for 1 reward) by 1-tailed Student's *t* tests. Except for wheel-running extinction and cue-induced reinstatement data (Figure 1, B–D) and behaviors of mice from the Glu-CB<sub>1</sub> line in the wheel-running/food choice paradigm (Figure 5, I and J), all data were gathered from experiments that were at least performed twice with different animal batches.

*Study approval.* All experiments obeyed the French (Décret 2013-118) and European (2010/63/EU) rules on animal experimentation. Approval of animal care and use for these experiments was provided by the Ethics Committee of Bordeaux University (Bordeaux, France) on behalf of the Préfecture de la Gironde (Bordeaux, France) and the French Ministry of Agriculture (Paris, France), with authorization 33-063-69 (to FC) and 13649 (to FC) and A33-063-098 (animal facilities).

### Author contributions

CM, BR, SC, FG, GM, and FC designed the research. CM, BR, GRF, IH, AS, CN, CS, ESG, MV, JD, AC, ABG, TP, FG, and FC performed the research. CM, BR, GRF, CS, CN, ESG, FG, and FC analyzed data. FC wrote the first version of the manuscript before it was edited and approved by all authors.

### Acknowledgments

The authors wish to thank the reviewers for their positive and constructive advice. We thank all the personnel from the Animal Facility and the Genotyping platform of the NeuroCentre INSERM U1215, Virginie Morales and the other members of Marsicano's laboratory for their daily support and for useful discussions, and Serge Ahmed (IMN, CNRS UMR 5293, Bordeaux) for his help in setting the choice paradigm. This work was supported by Institut National de la Santé et de la Recherche Médicale (to GM), la Région Aquitaine (to GM), the University of Bordeaux (to GM), the European Research Council (CannaPreg, ERC-2014-PoC-640923 and MiCaBra, ERC-2017-AdG-786467 to GM), l'Agence Nationale de la Recherche (Neuro-NutriSens ANR-13-BSV4-0006-02 and Orups ANR-16-CE37-0010 to GM and ANR-12-BSV4-0022 to FG), l'Agence Française de Lutte contre le Dopage (to FC), the LabEx-Bordeaux Région Aquitaine Initiative for Neuroscience (to FC, and FG), the Ministère de l'Enseignement Supérieur, de la Recherche et de l'Innovation (to BR), and the government of the Basque Country (to CM and FC).

Address correspondence to: F. Chaouloff, Endocannabinoids & NeuroAdaptation, NeuroCentre INSERM U1215, 146 rue Léo Saignat, 33077 Bordeaux, France. Phone: 0033.557.57.37.55; Email: francis.chaouloff@inserm.fr.

- Lee IM, et al. Effect of physical inactivity on major non-communicable diseases worldwide: an analysis of burden of disease and life expectancy. *Lancet*. 2012;380(9838):219–229.
- Ding D, et al. The economic burden of physical inactivity: a global analysis of major non-communicable diseases. *Lancet*. 2016;388(10051):1311–1324.
- Ladabaum U, Mannalithara A, Myer PA, Singh G. Obesity, abdominal obesity, physical activity, and caloric intake in US adults: 1988 to 2010. *Am J Med*. 2014;127(8):717–727.e12.
- Pelletier LG, Fortier MS, Vallerand RJ, Tuson KM, Brière NM, Blais MR. Toward a new measure of intrinsic motivation, extrinsic motivation, and amotivation in sports: the sport motivation scale (SMS). *J Sport Exerc Psychol*. 1995;17(1):35–53.
- Ekkekakis P, Hall EE, Petruzzello SJ. The relationship between exercise intensity and affective responses demystified: to crack the 40-year-old nut, replace the 40-year-old nutcracker! *Ann Behav Med*. 2008;35(2):136–149.
- Sherwin CM. Voluntary wheel running: a review and novel interpretation. *Anim Behav*. 1998;56(1):11–27.
- Lett BT, Grant VL, Koh MT. Naloxone attenuates the conditioned place preference induced by wheel running in rats. *Physiol Behav*. 2001;72(3):355–358.
- Fernandes MF, et al. Leptin suppresses the rewarding effects of running via STAT3 signaling in dopamine neurons. *Cell Metab*. 2015;22(4):741–749.
- Belke TW, Wagner JP. The reinforcing property and the rewarding aftereffect of wheel running in rats: a combination of two paradigms. *Behav Processes*. 2005;68(2):165–172.
- Berridge KC. The debate over dopamine's role in reward: the case for incentive salience. *Psychopharmacology (Berl)*. 2007;191(3):391–431.
- Salamone JD, Correa M. The mysterious motivational functions of mesolimbic dopamine. *Neuron*. 2012;76(3):470–485.
- Nestler EJ. Is there a common molecular pathway for addiction? *Nat Neurosci*. 2005;8(11):1445–1449.
- Koob GF, Volkow ND. Neurobiology of addiction: a neurocircuitry analysis. *Lancet Psychiatry*. 2016;3(8):760–773.
- Piomelli D. The molecular logic of endocannabinoid signalling. *Nat Rev Neurosci*. 2003;4(11):873–884.
- Dubreucq S, Koehl M, Abrous DN, Marsicano G, Chaouloff F. CB1 receptor deficiency decreases wheel-running activity: consequences on emotional behaviours and hippocampal neurogenesis. *Exp Neurol*. 2010;224(1):106–113.

16. Dubreucq S, et al. Ventral tegmental area cannabinoid type-1 receptors control voluntary exercise performance. *Biol Psychiatry*. 2013;73(9):895–903.
17. Fuss J, et al. A runner's high depends on cannabinoid receptors in mice. *Proc Natl Acad Sci USA*. 2015;112(42):13105–13108.
18. Salamone JD, Correa M, Farrar AM, Nunes EJ, Pardo M. Dopamine, behavioral economics, and effort. *Front Behav Neurosci*. 2009;3:13.
19. Iversen IH. Techniques for establishing schedules with wheel running as reinforcement in rats. *J Exp Anal Behav*. 1993;60(1):219–238.
20. Belke TW, Garland T. A brief opportunity to run does not function as a reinforcer for mice selected for high daily wheel-running rates. *J Exp Anal Behav*. 2007;88(2):199–213.
21. Collier G, Hirsch E. Reinforcing properties of spontaneous activity in the rat. *J Comp Physiol Psychol*. 1971;77(1):155–160.
22. Belke TW. Running and responding reinforced by the opportunity to run: effect of reinforcer duration. *J Exp Anal Behav*. 1997;67(3):337–351.
23. Hodos W. Progressive ratio as a measure of reward strength. *Science*. 1961;134(3483):943–944.
24. Shaham Y, Shalev U, Lu L, de Wit H, Stewart J. The reinstatement model of drug relapse: history, methodology and major findings. *Psychopharmacology (Berl)*. 2003;168(1-2):3–20.
25. Wiley JL, et al. Structural and pharmacological analysis of O-2050, a putative neutral cannabinoid CB(1) receptor antagonist. *Eur J Pharmacol*. 2011;651(1-3):96–105.
26. Marsicano G, et al. The endogenous cannabinoid system controls extinction of aversive memories. *Nature*. 2002;418(6897):530–534.
27. Monory K, et al. The endocannabinoid system controls key epileptogenic circuits in the hippocampus. *Neuron*. 2006;51(4):455–466.
28. Bellocchio L, et al. Bimodal control of stimulated food intake by the endocannabinoid system. *Nat Neurosci*. 2010;13(3):281–283.
29. Ruehle S, et al. Cannabinoid CB1 receptor in dorsal telencephalic glutamatergic neurons: distinctive sufficiency for hippocampus-dependent and amygdala-dependent synaptic and behavioral functions. *J Neurosci*. 2013;33(25):10264–10277.
30. Remmers F, Lange MD, Hamann M, Ruehle S, Pape HC, Lutz B. Addressing sufficiency of the CB1 receptor for endocannabinoid-mediated functions through conditional genetic rescue in forebrain GABAergic neurons. *Brain Struct Funct*. 2017;222(8):3431–3452.
31. Melis M, Muntoni AL, Pistis M. Endocannabinoids and the processing of value-related signals. *Front Pharmacol*. 2012;3:7.
32. Parsons LH, Hurd YL. Endocannabinoid signalling in reward and addiction. *Nat Rev Neurosci*. 2015;16(10):579–594.
33. Sanchis-Segura C, Cline BH, Marsicano G, Lutz B, Spanagel R. Reduced sensitivity to reward in CB1 knockout mice. *Psychopharmacology (Berl)*. 2004;176(2):223–232.
34. Solinas M, Goldberg SR. Motivational effects of cannabinoids and opioids on food reinforcement depend on simultaneous activation of cannabinoid and opioid systems. *Neuropsychopharmacology*. 2005;30(11):2035–2045.
35. Hernandez G, Cheer JF. Effect of CB1 receptor blockade on food-reinforced responding and associated nucleus accumbens neuronal activity in rats. *J Neurosci*. 2012;32(33):11467–11477.
36. Ahmed SH, Lenoir M, Guillem K. Neurobiology of addiction versus drug use driven by lack of choice. *Curr Opin Neurobiol*. 2013;23(4):581–587.
37. Ahmed SH. Trying to make sense of rodents' drug choice behavior. *Prog Neuropsychopharmacol Biol Psychiatry*. 2018;87(Pt A):3–10.
38. Wang DV, Tsien JZ. Conjunctive processing of locomotor signals by the ventral tegmental area neuronal population. *PLoS ONE*. 2011;6(1):e16528.
39. Wilson WM, Marsden CA. Extracellular dopamine in the nucleus accumbens of the rat during treadmill running. *Acta Physiol Scand*. 1995;155(4):465–466.
40. Greenwood BN, et al. Long-term voluntary wheel running is rewarding and produces plasticity in the mesolimbic reward pathway. *Behav Brain Res*. 2011;217(2):354–362.
41. Rasmussen EB, Hillman C. Naloxone and rimonabant reduce the reinforcing properties of exercise in rats. *Exp Clin Psychopharmacol*. 2011;19(6):389–400.
42. Schechter M, Pinhasov A, Weller A, Fride E. Blocking the postpartum mouse dam's CB1 receptors impairs maternal behavior as well as offspring development and their adult social-emotional behavior. *Behav Brain Res*. 2012;226(2):481–492.
43. Martín-García E, et al. Differential control of cocaine self-administration by GABAergic and glutamatergic CB1 cannabinoid receptors. *Neuropsychopharmacology*. 2016;41(9):2192–2205.
44. Beeler JA, Frazier CR, Zhuang X. Putting desire on a budget: dopamine and energy expenditure, reconciling reward and resources. *Front Integr Neurosci*. 2012;6:49.
45. Cantin L, et al. Cocaine is low on the value ladder of rats: possible evidence for resilience to addiction. *PLoS ONE*. 2010;5(7):e11592.
46. Atalayer D, Rowland NE. Effects of meal frequency and snacking on food demand in mice. *Appetite*. 2012;58(1):117–123.
47. Jalabert M, et al. Neuronal circuits underlying acute morphine action on dopamine neurons. *Proc Natl Acad Sci USA*. 2011;108(39):16446–16450.
48. Glangetas C, et al. Ventral subiculum stimulation promotes persistent hyperactivity of dopamine neurons and facilitates behavioral effects of cocaine. *Cell Rep*. 2015;13(10):2287–2296.
49. Grace AA. In vivo and in vitro intracellular recordings from rat midbrain dopamine neurons. *Ann N Y Acad Sci*. 1988;537:51–76.

# ANNEX 2

## An Operant Conditioning Task to Assess the Choice between Wheel Running and Palatable Food in Mice

Bio-protocol 9(19): e3381.

**Bastien Redon**, Imane Hurel, Giovanni Marsicano and Francis  
Chaouloff



## An Operant Conditioning Task to Assess the Choice between Wheel Running and Palatable Food in Mice

Bastien Redon<sup>1, 2, \*</sup>, Imane Hurel<sup>1, 2</sup>, Giovanni Marsicano<sup>1, 2</sup> and Francis Chaouloff<sup>1, 2</sup>

<sup>1</sup>Inserm U1215, Neurocentre Magendie, Team Endocannabinoids & NeuroAdaptation, Bordeaux F33077, France; <sup>2</sup>Université de Bordeaux, Bordeaux-F33077, France

\*For correspondence: [bastien.redon@inserm.fr](mailto:bastien.redon@inserm.fr)

**[Abstract]** Wheel running, especially in the homecage, has been widely used to study the neurobiology of exercise because animal tends to use it voluntarily. However, as for each reward, its consumption (in the present case, running performance) does not specifically provide information on its incentive value, *i.e.*, the extent to which animals are motivated to run independently from their consumption of that reward. This is a major drawback, especially when focusing on the neurobiology governing the pathological imbalances between exercise and *e.g.*, feeding (obesity, anorexia nervosa). Yet, few studies have shown that operant conditioning wherein wheel-running is used as a reinforcer that can be "consumed" after nose-poking or lever-pressing allows to distinguish motivation from consumption. Thus, nose-poking or lever-pressing under a progressive ratio schedule of reinforcement in animals trained under fixed ratio reinforcement schedules provides, through the so-called breakpoint, an index of running motivation. As compared to wheel-running, numerous studies have used food as a reinforcer, which helped to uncover the neurobiology of feeding. However, to our knowledge, there is no paradigm allowing the assessment of the choice between running and feeding when presented in concurrence, with the possibility to measure *a priori* the motivation for each reward. Herein, we describe a protocol that first permits to measure the drive for each of these two rewards before it allows to measure the preference for one over the other in a reward choice setting. This paradigm could help to better characterize the neurobiology underlying pathological imbalances between physical activity and feeding, which is the core feature of eating disorders.

**Keywords:** Operant conditioning, Choice, Reward, Motivation, Wheel-running, Palatable food, Exercise, Physical Activity

**[Background]** Physical inactivity is a growing burden for society nowadays, and it finds its root in a lack of motivation to engage in or to adhere to a long-term exercise program (Ekkekakis *et al.*, 2008). More broadly, eating disorders result from an alteration of the energy balance, between caloric intake (*e.g.*, food intake) and expenses (*e.g.*, physical activity). Interestingly, such an alteration finds its origin at the motivation level. It is thus of prime importance to study in a combined manner the motivation for physical activity with the motivation for food intake. To unravel the neurobiology behind exercise motivation, most studies have used the running wheel paradigm as wheel-running is a volitional and well-conserved behavior with highly rewarding properties (Sherwin, 1998). Indeed wheel running is able to reinforce operant conditioning (Belke, 1997), even when the duration of running is minimal (Iversen, 1993). The



basic principle of operant conditioning is to render the reward access contingent to the realization of an effort (e.g., lever pressing, nose-poking). By progressively increasing the effort, it allows estimating the animal's motivation for this reward. However, studying motivation for physical activity in the context of eating disorders requires to compare it with the motivation for food intake in order to integrate both aspects of energy balance. Noteworthy is the observation that the comparison between the maximal efforts the animal displays for each reward taken individually can be misleading because it doesn't represent the preference for one reward over another in the natural context of a choice between these rewards (Cantin *et al.*, 2010, in this paper the authors designed an operant conditioning protocol to assess the choice between cocaine and sucrose). A previous study investigated the choice between wheel-running and sucrose in a T-maze (Correa *et al.*, 2016). Although providing a cue with regard to the preference between the rewards under effort-less conditions, this approach does not allow to dissect the motivation for each reward from its mere consumption. To our knowledge, the protocol we are describing here is the first to allow the *a priori* assessment of motivation for both wheel running and palatable food, and the preference for one over the other in a concurrent choice context using operant conditioning (Muguruza *et al.*, 2019). Such a protocol allows access to both sides of the energy balance as to study the mechanisms involved in such a regulation. Furthermore, by modulating the effort that is required for each reward, one can externally affect the preference for one reward over the other one, hence helping to assess the neurobiological grounds governing each preference level. As it is the case for most studies investigating reward neurobiology, our protocol bears some limitations. Even though animals are always exposed to the operant chambers during their active phase (dark phase), this daily single and restricted exposure cannot fully recapitulate the human situation. Indeed, the animals are exposed to this concurrent choice once a day in a different environment than their homecage when humans have permanently to choose between concurrent rewarding activities. One possibility to circumvent this limitation would be to host the animal in an operant chamber where it would access running and feeding activities, these being fully contingent to an effort (namely nose poking).

## **Materials and Reagents**

1. C57Bl/6N mouse line (Janvier Labs): used to validate the protocol (7-8 weeks old)

### *Notes:*

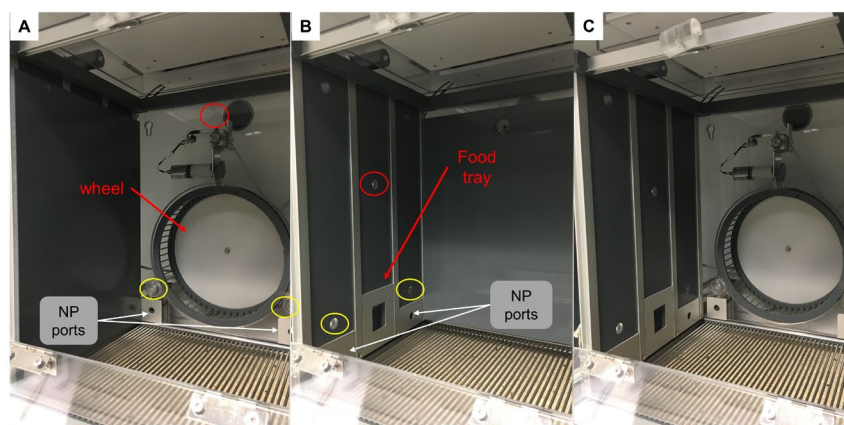
- a. *The use of other mouse lines is possible in the following protocol given that no learning or motor deficits are observed in this line. Hereafter we show example of graphs based on the use of a transgenic line, the SimCB1 mouse line (C57Bl/6N background).*
  - b. *The size and the strength of the mouse are important to take into account so as to screw the wheel properly, avoiding a spontaneous rotation (too loose) or the impossibility for the animal to make it turn (too tight).*
2. Safe A03 (Safe Diet, U8200G10R, stored at room temperature after opening) contains 3.4 Kcal/g (61.3 percent from carbohydrates, 25.2 percent from proteins and 13.5 percent from fat): Standard homecage food

3. Dustless Precision Pellets<sup>®</sup>, 20 mg, Rodent Purified Diet, Chocolate Flavor (BioServ, Product #F05301, stored at room temperature with silica gel after opening) contains 3.60 Kcal/g (65.6 percent from carbohydrates, 20.6 percent from proteins and 13.9 percent from fat) with an addition of a chocolate flavoring : Palatable food reward
4. Phagospray<sup>®</sup> (Laboratoire Phagogène, Christeys France). Antimicrobial disinfectant spray designed for non-invasive medical devices and surfaces: used to clean the operant chambers between animals

## Equipment

1. Apparatus: Operant conditioning chamber (Imetronic, 156 avenue Jean Jaurès 33600 Pessac, France, customized apparatus) (Figure 1)

Individual operant conditioning chamber (28 cm long x 26 cm wide x 38 cm high) placed in a wooden case (60 cm long x 62 cm wide x 49 cm high) ventilated to ensure air circulation and background noise. The rear side has a 20 cm diameter wheel mounted at the center, surrounded by two nose poke ports, with a brake pad on top of it to be able to lock or unlock it. The left panel has a food tray placed at the center surrounded by two nose poke ports. Both panels (rear or left) can be hidden using grey Perspex depending on the task. The floor consists of a grid above a drawer filled with litter (same litter as animals' homecages). All operant chambers are connected to a computer through an interface allowing (i) the allocation of files and exercise (see following sections) for each animal/cage and (ii) real-time visualization of animal behavior and recordings. For a given batch of animal, the active nose poke port is allocated to be the right one for half of the animals, and the left for the other half in order to counterbalance the position.



**Figure 1. Operant chambers for wheel running and palatable food.** A. The configuration for wheel running involves a wheel mounted on the rear side surrounded by two nose poke ports associated with light cues (yellow circles) that can be paired with another light cue (red circle) on the top of the wheel (the left panel being covered by gray Perspex). The floor is constituted of a metal grid on the top of a litter drawer. B. The configuration for palatable food involves a

food tray on the left panel surrounded by two nose poke ports associated with light cues (yellow circle) that can be paired with another light cue (red circle) on the top of the food tray (the rear side covered by gray Perspex). The floor is made of a metal grid on the top of a litter drawer. C. The choice configuration involves the removal of the two gray Perspex sides to free the access to both rewards. The floor is made of a metal grid on the top of a litter drawer. Illustration taken from Hurel *et al.* (2019).

## **Software**

1. Polywheel 5.2.2 (16/04/2015) Imetronic, 156 avenue Jean Jaurès 33600 Pessac, France: Software used on-line allowing the allocation of exercise (see section “procedure” and sub-sections “exercise design”), and the real-time acquisition of data from the operant chambers
2. Poly files V4.5.2 (09/04/2018) Imetronic, 156 avenue Jean Jaurès 33600 Pessac, France: Software used off-line to extract data using pre-defined variables into Excel files
3. GraphPad Prism version 8 (GraphPad Software 2365 Northside Dr., suite 560, San Diego, CA 92108): Data analysis

## **Procedure**

*Note: All experiments are performed during the dark phase of the light/dark cycle to be in the active phase. We are thus working in a partly inverted 12 h/12 h cycle with lights off at 10 AM and on at 10 PM.*

### A. Acclimation

1. Habituate the animal to the inverted cycle one week before starting the protocol.
2. Individualize the animals.
3. Three days before starting the protocol, give 3-4 chocolate food pellets in the homecage to avoid neophobia.

### B. General description of operant conditioning sessions

1. Select the specific file for each mouse (one per reinforcement schedule and per mouse *e.g.*, FR1\_mouse1).
2. Select the corresponding exercise (cf. Procedure: Exercises design).
3. Place the mouse inside the operant chamber.
4. Start the recording.
5. At the end of the session, remove the mouse from the operant chamber.

If the session is for palatable food:

6. Count the remaining pellets in 1) the food tray and 2) the litter below the grid.

For both wheel running and palatable food:

7. Clean the operant chamber using Phagospray® and, if within a palatable food session, clean the food tray with dry air spray.

For habituation, FR1 and FR3 sessions:

8. Go back to Step B1 for the second session of the day (second reward).

*Note: To avoid the effect of one reward over the other on the same day, half of the animal must start with a session of wheel running, the other half with a session of palatable food, the order being inverted each day.*

#### C. Habituation (2 days)

##### 1. Exercise design

###### **Wheel-running**

- a. The sessions last 30 min each.
- b. The cue light paired with the wheel (on top of it) turns on at the beginning of the session and remains on for 30 min.

*Note: The wheel-paired cue light indicates the availability of the wheel. Thus, it remains on all over the habituation session.*

- c. The wheel remains unlocked all session-long.

###### **Palatable food**

- a. The sessions last 30 min each.
- b. The cue light paired with the food tray (on top of it) turns on at the beginning of the session and remains on for 30 min.

*Note: The food tray-paired cue light indicates the delivery of food pellets in the food tray. Thus, it remains on all over the habituation session.*

- c. Seventeen pellets are distributed consecutively at the beginning of the session.

##### 2. Practical steps

- a. Cover all nose poke ports with the appropriate metal piece.
- b. Place the appropriate Perspex wall to cover either the food tray or the wheel and their corresponding nose poke ports.
- c. Perform two sessions (1/day) for both rewards applying the instructions of Procedure B.
- d. No criteria are needed to be met to move on to the next step.

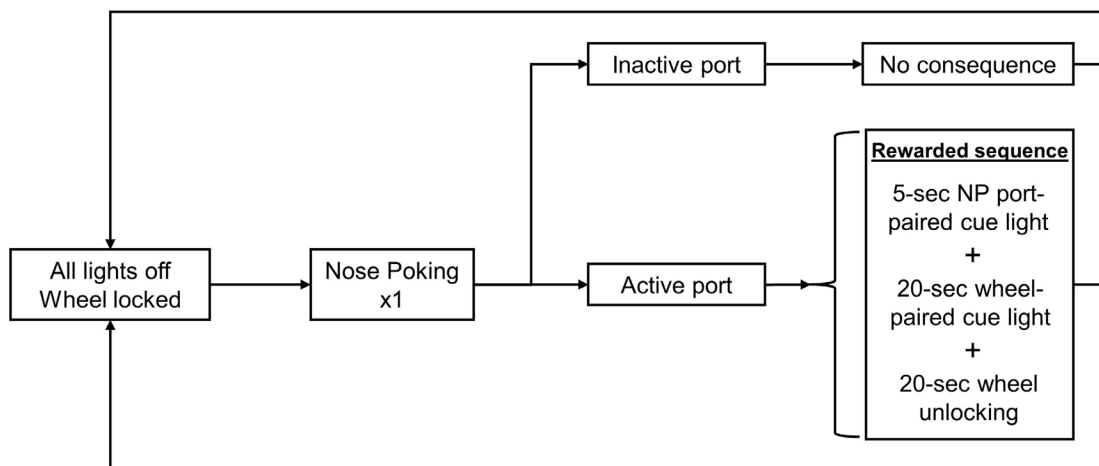
#### D. Fixed ratio 1 schedule of reinforcement (5 days)

##### 1. Exercise design

###### **Wheel-running (Figure 2)**

- a. The sessions last 30 min.
- b. The sessions start without any light cue, the wheel being blocked by the brake pad.

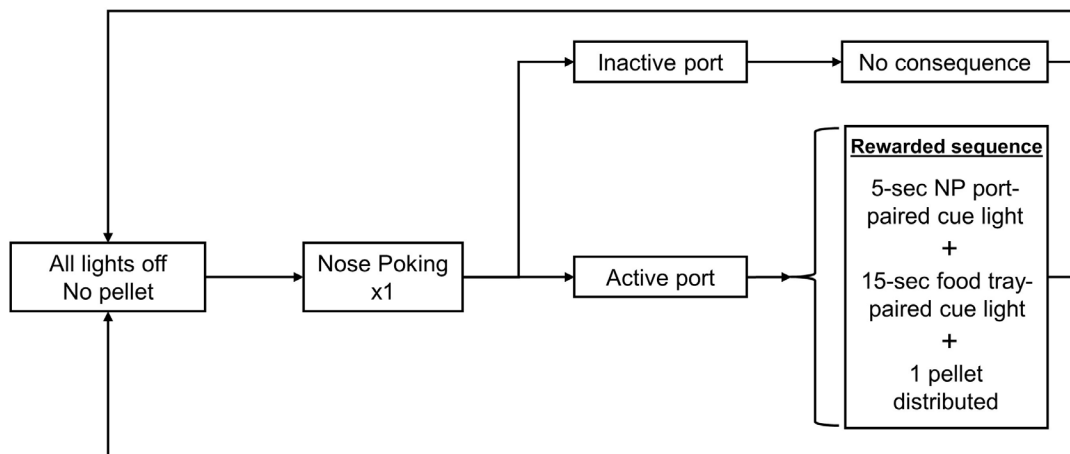
- c. One nose poke (NP) in the active port triggers a rewarded sequence with simultaneous:
  - i. Five-second NP-paired cue light turns on.  
*Note: This NP-paired cue light is a conditioned stimulus indicating that the effort required to get access to the wheel is completed.*
  - ii. Twenty-second wheel-paired cue light turns on.  
*Note: The wheel-paired cue light is a conditioned stimulus indicating the availability of the wheel.*
  - iii. Twenty-second unlocking of the wheel (removing the brake pad).
- d. Nose-poking during the rewarded sequence is recorded but has no functional consequence.
- e. After the rewarded sequence, the program goes back to the first step until the next NP.



**Figure 2. Logigram of Fixed ratio 1 schedule of reinforcement for wheel running.** During the 30-min session, one nose poke in the active port gives access to a rewarded sequence of 20 s before going back to the initial condition. NP: Nose Poke.

**Palatable food (Figure 3)**

- a. The sessions last 30 min.
- b. The sessions start without any light cue, the food tray being available but empty.
- c. One NP in the active port triggers a rewarded sequence with simultaneous:
  - i. Five-second NP-paired cue light turns on.  
*Note: This NP-paired cue light is a conditioned stimulus indicating that the effort required to get one food pellet is completed.*
  - ii. Fifteen-second food tray-paired cue light turns on.  
*Note: The food tray-paired cue light is a conditioned stimulus indicating the delivery of one food pellet.*
  - iii. One chocolate food pellet is distributed.
- d. Nose-poking during the rewarded sequence is recorded but has no functional consequence.
- e. After the rewarded sequence, the program goes back to the first step until the next NP.



**Figure 3. Logigram of Fixed ratio 1 schedule of reinforcement for palatable food.** During the 30-min session, one nose poke in the active port gives access to a rewarded sequence of 15 s before going back to the initial condition. NP: Nose Poke.

## 2. Practical steps

*Note: In order to facilitate the learning, the animals are mildly food-restricted for the 2-3 first sessions so as to reach a stable 10% decrease in body weight.*

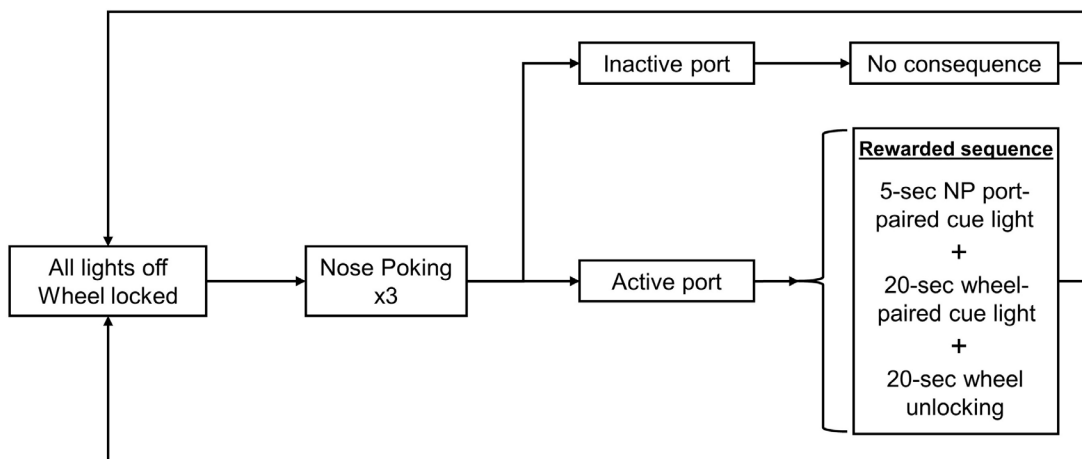
- a. Remove all the metal pieces from nose poke ports so as to render them accessible.
- b. Place the appropriate Perspex wall to cover either the food tray or the wheel and their corresponding nose poke ports.
- c. Perform five sessions (1/day) for both rewards following the instructions of Procedure B.
- d. No criteria are needed to be met to move on to the next step.

## E. Fixed ratio 3 schedule of reinforcement (5 days)

### 1. Exercise design

#### **Wheel-running (Figure 4)**

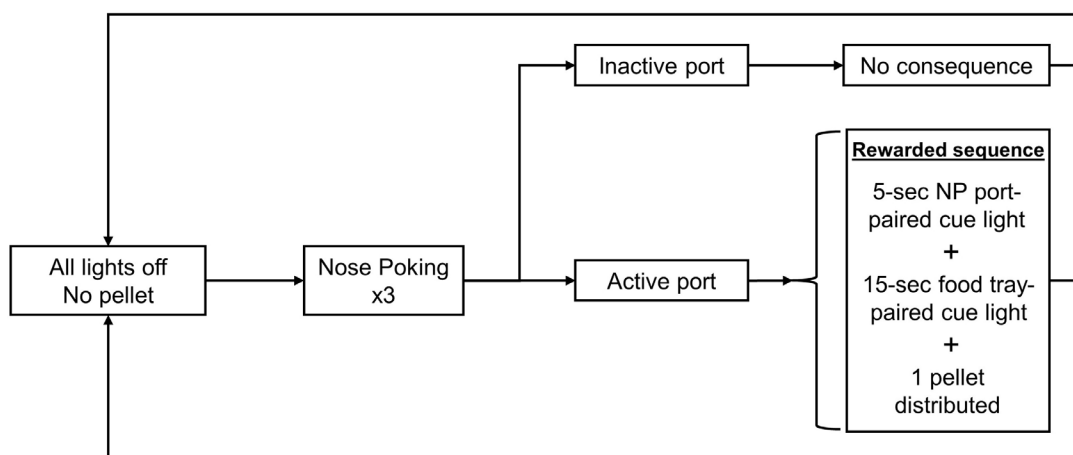
- a. The sessions last 30 min.
- b. The sessions start without any light cue, the wheel being blocked by the brake pad.
- c. Three consecutive NPs in the active port trigger a rewarded sequence with simultaneous:
  - i. Five-second NP-paired cue light turns on.
  - ii. Twenty-second wheel-paired cue light turns on.
  - iii. Twenty-second unlocking of the wheel (removing the brake pad).
- d. Nose-poking during the rewarded sequence is recorded but has no functional consequence.
- e. After the rewarded sequence, the program goes back to the first step until the next NP.



**Figure 4. Logigram of Fixed ratio 3 schedule of reinforcement for wheel running.** During the 30-min session, three consecutive nose pokes in the active port give access to a rewarded sequence of 20 s before going back to the initial condition. NP: Nose Poke.

**Palatable food (Figure 5)**

- a. The sessions last 30 min.
- b. The sessions start without any light cue, the food tray being available but empty.
- c. Three consecutive NPs in the active port trigger a rewarded sequence with simultaneous:
  - i. Five-second NP-paired cue light turns on.
  - ii. Fifteen-second food tray-paired cue light turns on.
  - iii. One chocolate food pellet is distributed.
- d. Nose-poking during the rewarded sequence is recorded but has no functional consequence.
- e. After the rewarded sequence, the program goes back to the first step until the next NP.



**Figure 5. Logigram of Fixed ratio 3 schedule of reinforcement for palatable food.** During the 30-min session, three consecutive nose pokes in the active port give access to a rewarded sequence of 15 s before going back to the initial condition. NP: Nose Poke.

## 2. Practical steps

- a. Remove all the metal pieces from nose poke ports so as to render them accessible.
- b. Place the appropriate Perspex wall to cover either the food tray or the wheel and their corresponding nose poke ports.
- c. Perform five sessions (1/day) for both rewards following the instructions of Procedure B.
- d. All animals need to meet the following criteria:
  - i. Stability of performance over 3 consecutive days (< 20% variation in the total number of active nose pokes).
  - ii. Discrimination index over 75% (see “Data analysis” part).

## F. Progressive ratio schedule of reinforcement (2 days)

### *Note:*

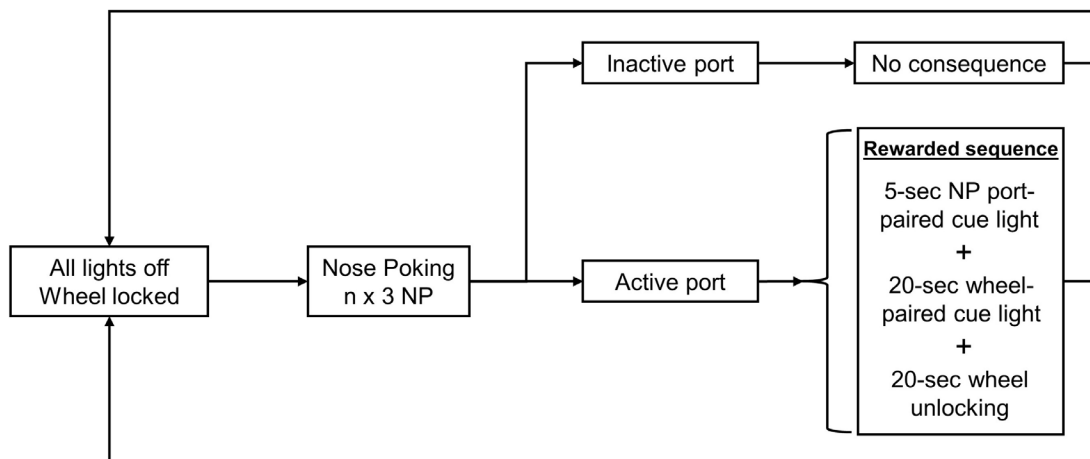
1. *A 30 min session for the assessment of wheel running and palatable food breakpoints was chosen in order to have a comparable duration for both rewards without reaching satiety in the palatable food session.*
2. *This duration can be adapted by investigators depending on the information needed from the progressive ratio assessment.*

## 1. Exercise design

### **Wheel-running (Figure 6)**

- a. The session lasts 30 min.
- b. The session starts without any light cue, the wheel being blocked by the brake pad.
- c. Performing  $n \times 3$  NP (with “n” being the rank number of the reward accessed e.g., the first access to the wheel required  $1 \times 3 = 3$  NP, the second one  $2 \times 3 = 6$  NP etc. The sequence is thus as follows: 3, 6, 9, 12, 15, 18, 21, 24, 27...) in the active port trigger a rewarded sequence with simultaneous:
  - i. Five-second NP-paired cue light turns on.
  - ii. Twenty-second wheel-paired cue light turns on.
  - iii. Twenty-second unlocking of the wheel (removing the brake pad).
- d. Nose-poking during the rewarded sequence is recorded but has no functional consequence.
- e. After the rewarded sequence, the program goes back to the first step until the next NP.
- f. The last ratio completed ( $n_{\text{final}} \times 3$  NP) is called the breakpoint: it is the maximum number of nose pokes the animal accepts to perform to obtain the reward in a given session.



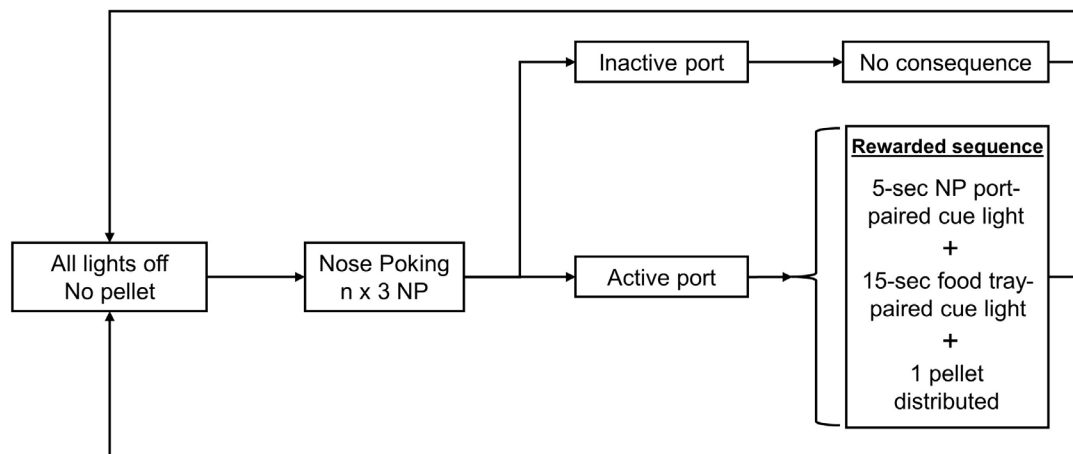


**Figure 6. Logigram of Progressive ratio schedule of reinforcement for wheel running.**

During the 30-min session, the effort required to unlock the wheel is progressively increased between each rewarded sequence. The last ratio completed by the animal is the breakpoint. NP: nose poke; n: rank number of reward accessed.

**Palatable food (Figure 7)**

- a. The session lasts 30 min.
- b. The session starts without any light cue, the food tray being available but empty.
- c. Performing  $n \times 3$  NP (with “n” being the rank number of the reward accessed e.g., the first access to the wheel required  $1 \times 3 = 3$  NP, the second one  $2 \times 3 = 6$  NP etc. The sequence is thus as follows: 3, 6, 9, 12, 15, 18, 21, 24, 27...) in the active port trigger a rewarded sequence with simultaneous:
  - i. Five-second NP-paired cue light turns on.
  - ii. Fifteen-second food tray-paired cue light turns on.
  - iii. One chocolate food pellet is distributed.
- d. Nose-poking during the rewarded sequence is recorded but has no functional consequence.
- e. After the rewarded sequence, the program goes back to the first step until the next NP.



**Figure 7. Logigram of progressive ratio schedule of reinforcement for palatable food.**

During the 30-min session, the effort required to obtain a pellet is progressively increased between each rewarded sequence. The last ratio completed by the animal is the breakpoint. NP: nose poke; n: rank number of reward accessed.

## 2. Practical steps

*Note: This test is intended to assess the maximum effort an animal is willing to expend to get access to the reward. Accordingly, one unique 30-min session per day is performed for each animal given the highly demanding nature of the task.*

- a. Remove all the metal pieces from nose poke ports so as to render them accessible.
- b. Place the appropriate Perspex wall to cover either the food tray or the wheel and their corresponding nose poke ports.
- c. The first day, half of the animal will undergo one unique session of PR for wheel running, the other half one unique session of PR for palatable food. For this apply the instructions of Procedure B from Step B1 to Step B7.
- d. The second day, the animal undergoes one unique session of PR for the reward not given on the first day. For this apply the instructions of Procedure B from Step B1 to Step B7.
- e. No criteria are needed to be met to move on to the next step.

## G. Fixed Ratio 3 Schedule of reinforcement post-progressive ratio (1 day)

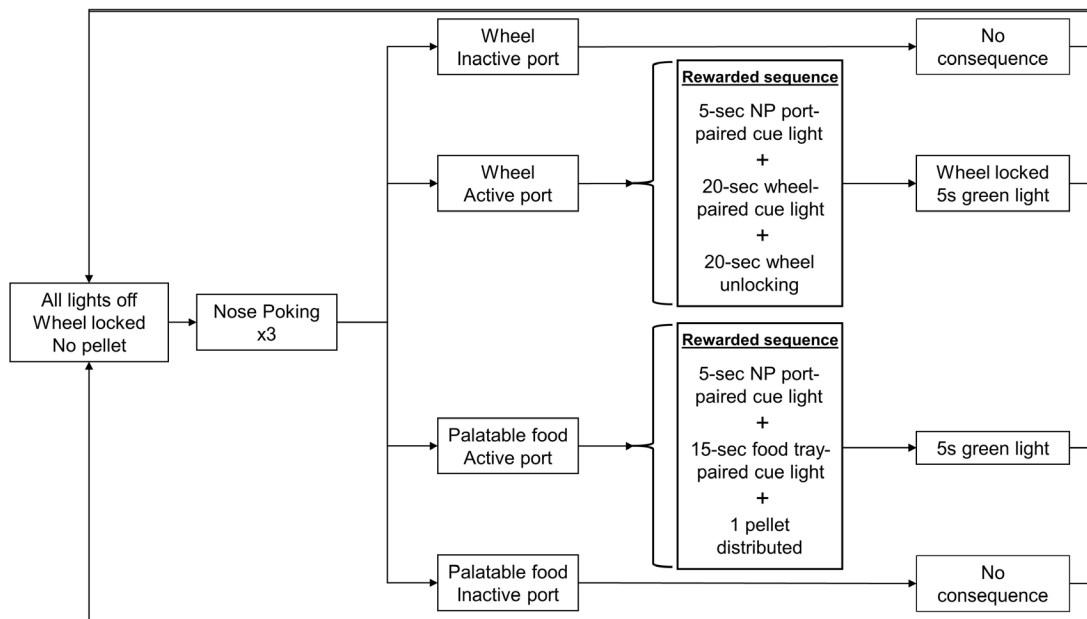
*Note: This step is intended to ensure that the performances of the animals go back to pre-PR levels.*

1. Exercise design  
Follow instructions of Procedure E1
2. Practical steps  
Follow instructions of Procedure E2 for 1 day

## H. Choice (Figure 8) (Video 1)

### 1. Exercise design

- a. The sessions last 60 min.
- b. The sessions start without any light cue, the wheel being blocked by the brake pad, and the food tray being available but empty.
- c. If the animal performs 3 consecutive NP in the active port for the wheel running, it gets access to a wheel-rewarded sequence:
  - i. Simultaneous:
    - Five-second NP-paired cue turns on
    - Twenty-second wheel-paired cue turns on
    - Twenty-second wheel unlocking
  - ii. Nose-poking during the rewarded sequence is recorded but has no functional consequence.
  - iii. At the end of the rewarded sequence, a green ceiling light turns on for 5 additional seconds during which no reward is accessible. Nose poking is recorded but has no functional consequence.
  - iv. Then, the program goes back to the start of Step H1b until the next NP.
- d. If the animal performs 3 consecutive NP in the active port for the palatable food, it gets access to a palatable food-rewarded sequence:
  - i. Simultaneous:
    - Five-second NP-paired cue turns on
    - Fifteen-second food tray-paired cue turns on
    - One chocolate food pellet is distributed
  - ii. Nose-poking during the rewarded sequence is recorded but has no functional consequence.
  - iii. At the end of the rewarded sequence, a green ceiling light turns on for 5 additional seconds during which no reward is accessible. Nose poking is recorded but has no functional consequence.
  - iv. Then, the program goes back to the start of step H1b until the next NP.



**Figure 8. Logigram of the choice between wheel running and palatable food.** Nose poking gives access to one reward but the choice is mutually exclusive, meaning that choosing one reward excludes the possibility to obtain the other reward for a given time.



**Video 1. Choice session showing (i) a food-rewarded sequence followed by (ii) a wheel-rewarded sequence.** (All experiments obeyed the French (Décret 2013-118) and European (2010/63/EU) rules on animal experimentation with authorization numbers 33-063-69 (F.C.) and A33-063-098 (Animal facilities).)

## 2. Practical steps

### a. Choice in fed animals (5 days)

- i. Remove all the metal pieces from nose poke ports so as to render them accessible.
- ii. Remove all the Perspex walls so as to render both rewards accessible.
- iii. Perform five sessions applying the instructions of Procedure B from Step B1 to Step B7.

### b. Choice under mild food restriction

- i. In the hour preceding the dark phase before the first session, remove the food from the home cage.
- ii. In the hour preceding the dark phase, weigh the animals.
- iii. Remove all the metal pieces from nose poke ports so as to render them accessible.
- iv. Remove all the Perspex walls so as to render both rewards accessible.
- v. Perform one session applying the instructions of Procedure B from Step B1 to Step B7.
- vi. Calculate the amount of food to give:
  - 1) Seventy percent of mean daily consumption.
  - 2) Subtract the amount eaten during the session.
- vii. Give the food in the home cage at least 1 h after the end of the operant conditioning session
- viii. Perform the other sessions on the following days applying Steps H2b ii to H2b vii.

*Note: The body weight must be comprised between 85 and 90% of the normal body weight. If it is above or below this range, reduce or increase the amount of food accordingly.*

## **Data analysis**

### A. Inclusion criteria

1. Learning of the contingency between nose-poking and reward access is assessed by the discrimination index =  $\frac{\text{Number of active nose pokes}}{\text{Total number of nose pokes}}$
2. Animals should display a stable performance over 3 consecutive sessions at the end of the FR3 step: < 20% variation of the number of active nose pokes.
3. Animals that do not meet the preceding criteria are discarded from the experiment.

### B. All protocol

1. Number of active nose pokes: (Figure 9)  
Analyzed by two-way ANOVA (repeated measures) for each step of the protocol separately (FR1, FR3 and Choice).
2. Number of inactive nose pokes (Figure 9).
3. Running duration per rewarded sequence
  - a. This index gives an insight into how much the animal runs every time it gains access to the wheel (for details see Muguruza *et al.* 2019).
  - b. Running duration per rewarded sequence =  $\frac{\text{total running duration (seconds)}}{\text{number of rewarded sequences}}$
  - c. Analyzed with two-way ANOVA (repeated measures) for each step of the protocol separately (FR1, FR3 and Choice).
4. Pellets consumed
  - a. This index measures the consumption of the rewards obtained (to ensure that the pellets earned are consumed).

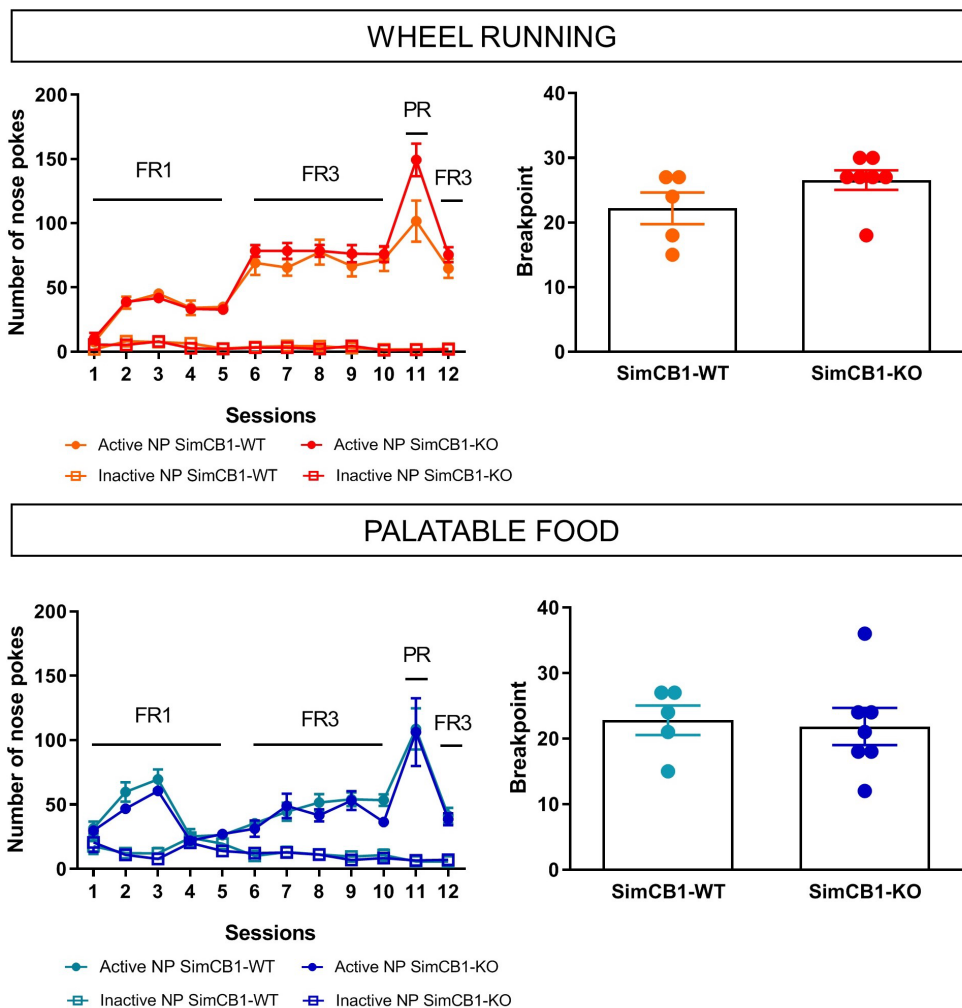
b. Analyzed with two-way ANOVA (repeated measures) for each step of the protocol separately (FR1, FR3 and Choice).

C. Progressive Ratio (Figure 9)

1. Number of active nose pokes: (Figure 9) Analyzed by two-tailed Student's *t*-test.
2. Breakpoint: (Figure 9) Analyzed by two-tailed Student's *t*-test.

The breakpoint is defined as the last rewarded step reached during the PR session, in other words, it corresponds to the maximum number of nose pokes the animal accepts to perform to get access to one reward in a given session.

3. Pellets consumed: Analyzed by two-tailed Student's *t*-test.
4. If the results do not follow normality, C.1, C.2 and C.3 should be analyzed using a Mann-Whitney test.

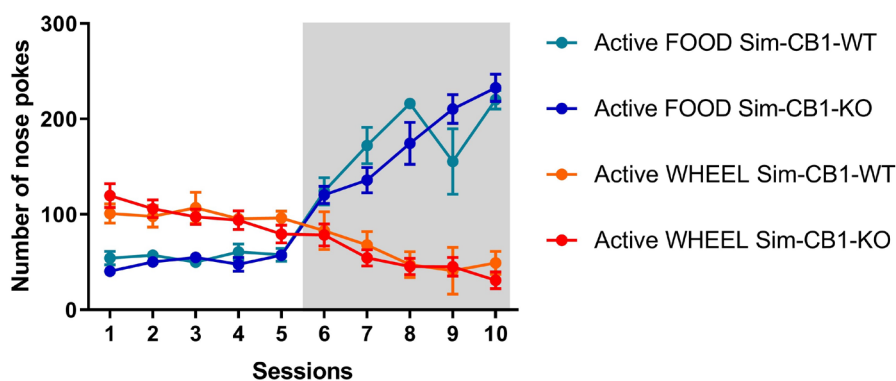


**Figure 9. Representation of the number of nose pokes and breakpoints when each reward is presented separately (FR1, FR3 and PR).** The graphs presented here are data obtained from the Sim-CB1 mouse line, comparing knock-out mice (Sim-CB1-KO) to their wild-type littermates (Sim-CB1-WT). This transgenic mouse line bears a deletion of the cannabinoid type-

1 receptor (CB1R) in Sim1-positive cells, mainly found in the paraventricular nucleus of the hypothalamus (PVN). For both wheel running (upper panel) and palatable food (bottom panel), the number of nose pokes performed all over fixed- and progressive-ratio schedule of reinforcement (left) and the breakpoint reached during the progressive ratio session (right) are represented. NP: Nose Poke.

D. Choice sessions

1. Number of active nose pokes (Figure 10): Analyzed by two-way ANOVA (repeated measures) for each step separately (*ad libitum* fed and food restricted).

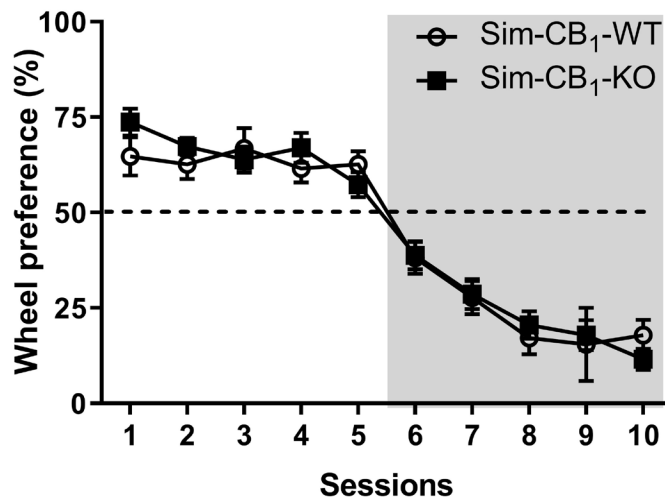


**Figure 10. Representation of the number of active nose poke during the choice sessions for the Sim-CB1 mouse line (WT vs. KO).** The graphs presented here are the data obtained from the Sim-CB1 mouse line, comparing knock-out mice (Sim-CB1-KO) to their wild-type littermates (SimCB1-WT). This transgenic mouse line bears a deletion of the cannabinoid type-1 receptor (CB1R) in Sim1-positive cells, mainly found in the paraventricular nucleus of the hypothalamus (PVN). The blank and grey areas refer to the choice sessions under *ad libitum* fed and food restricted conditions, respectively.

2. Preference ratio (Figure 11): Allows evaluating the performance for one reward (for example, preference for wheel running over palatable food) with an index allowing inter-individual comparisons.

$$\text{Preference ratio} = \frac{\text{Number of active nose pokes for wheel running}}{\text{Total number of nose pokes}} \times 100.$$

Analyzed by two-way ANOVA (repeated measures) for each step separately (*ad libitum* fed and food restricted).



**Figure 11. Preference ratio representation for the Sim-CB1 mouse line (WT vs. KO).** The graphs presented here are the data obtained from the Sim-CB1 mouse line, comparing knock-out mice (Sim-CB1-KO) to their wild-type littermates (Sim-CB1-WT). This transgenic mouse line bears a deletion of the cannabinoid type-1 receptor (CB1R) in Sim1-positive cells, mainly found in the paraventricular nucleus of the hypothalamus (PVN). Scores over 50% indicate a preference for wheel running and scores below 50% indicate a preference for the palatable food. White part: *ad libitum* fed condition choice sessions; Grey part: food restricted condition.

### Acknowledgments

Our acknowledgments go to all the members of Marsicano team for their critics and useful discussions. We would like to thank particularly Dr. Serge Ahmed (IMN, CNRS UMR 5293, Bordeaux) for sharing his experience in the domain and his help in setting up the protocol. We thank Imetric (Pessac, France) for their availability and their help to design the programs. Finally, we acknowledge the help of the members of the animal facilities and genotyping platforms in the NeuroCentre Magendie (Inserm U1215, Bordeaux, France) for their assistance.

This work was supported by Institut National de la Santé et de la Recherche Médicale (to GM), la Région Aquitaine (to GM), the University of Bordeaux (to GM), l'Agence Française de Lutte contre le Dopage (to FC), the LabEx-Bordeaux Région Aquitaine Initiative for Neuroscience (to FC), the Ministère de l'Enseignement Supérieur, de la Recherche et de l'Innovation (to BR).

### Competing interests

The authors have no conflicts of interest.



## **Ethics**

All experiments obeyed the French (Décret 2013-118) and European (2010/63/EU) rules on animal experimentation with authorization numbers 33-063-69 (F.C.) and A33-063-098 (Animal facilities).

## **References**

1. Belke, T. W. (1997). [Running and responding reinforced by the opportunity to run: effect of reinforcer duration.](#) *J Exp Anal Behav* 67(3): 337-351.
2. Cantin, L., Lenoir, M., Augier, E., Vanhille, N., Dubreucq, S., Serre, F., Vouillac, C. and Ahmed, S. H. (2010). [Cocaine is low on the value ladder of rats: possible evidence for resilience to addiction.](#) *PLoS One* 5(7): e11592.
3. Correa, M., Pardo, M., Bayarri, P., Lopez-Cruz, L., San Miguel, N., Valverde, O., Ledent, C. and Salamone, J. D. (2016). [Choosing voluntary exercise over sucrose consumption depends upon dopamine transmission: effects of haloperidol in wild type and adenosine A\(2\)AKO mice.](#) *Psychopharmacology (Berl)* 233(3): 393-404.
4. Ekkekakis, P., Hall, E. E. and Petruzzello, S. J. (2008). [The relationship between exercise intensity and affective responses demystified: to crack the 40-year-old nut, replace the 40-year-old nutcracker!](#) *Ann Behav Med* 35(2): 136-149.
5. Hurel, I., Redon, B., Scocard, A., Malezieux, M., Marsicano, G. and Chaouloff, F. (2019). [Beyond the activity-based anorexia model: reinforcing values of exercise and feeding examined in stressed adolescent male and female mice.](#) *Front Pharmacol* 10: 587.
6. Iversen, I. H. (1993). [Techniques for establishing schedules with wheel running as reinforcement in rats.](#) *J Exp Anal Behav* 60(1): 219-238.
7. Muguruza, C., Redon, B., Fois, G. R., Hurel, I., Scocard, A., Nguyen, C., Stevens, C., Soria-Gomez, E., Varilh, M., Cannich, A., Daniault, J., Busquets-Garcia, A., Pelliccia, T., Caille, S., Georges, F., Marsicano, G. and Chaouloff, F. (2019). [The motivation for exercise over palatable food is dictated by cannabinoid type-1 receptors.](#) *JCI Insight* 4(5). pii: 126190.
8. Sherwin, C. M. (1998). [Voluntary wheel running: a review and novel interpretation.](#) *Anim Behav* 56(1): 11-27.

# ANNEX 3

## Cannabis and exercise: Effects of $\Delta$ 9-tetrahydrocannabinol on preference and motivation for wheel-running in mice

Progress in Neuropsychopharmacology & Biological Psychiatry. 2021;105:110117.

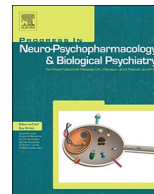
Imane Hurel\*, Carolina Muguruza\*, **Bastien Redon**, Giovanni Marsicano, Francis Chaouloff

\*Share first authorship



Contents lists available at [ScienceDirect](https://www.sciencedirect.com)

# Progress in Neuropsychopharmacology & Biological Psychiatry

journal homepage: [www.elsevier.com/locate/pnp](http://www.elsevier.com/locate/pnp)

## Cannabis and exercise: Effects of $\Delta^9$ -tetrahydrocannabinol on preference and motivation for wheel-running in mice

Imane Hurel<sup>a,b,1</sup>, Carolina Muguruza<sup>a,b,c,d,1</sup>, Bastien Redon<sup>a,b</sup>, Giovanni Marsicano<sup>a,b</sup>, Francis Chaouloff<sup>a,b,\*</sup>

<sup>a</sup> Endocannabinoids and NeuroAdaptation, NeuroCentre INSERM U1215, 33077 Bordeaux, France

<sup>b</sup> Université de Bordeaux, 33077 Bordeaux, France

<sup>c</sup> Department of Pharmacology, University of the Basque Country UPV/EHU, Leioa, Bizkaia, Spain

<sup>d</sup> Centro de Investigación Biomédica en Red de Salud Mental, CIBERSAM, Spain

### ARTICLE INFO

#### Keywords:

CB<sub>1</sub> receptor

T-maze

Operant conditioning

Cue-induced reinstatement

JZL184

### ABSTRACT

Recent surveys have revealed close links between cannabis and exercise. Specifically, cannabis usage before and/or after exercise is an increasingly common habit primarily aimed at boosting exercise pleasure, motivation, and performance whilst facilitating post-exercise recovery. However, whether these beliefs reflect the true impact of cannabis on these aspects of exercise is unknown. This study has thus examined the effects of cannabis' main psychoactive ingredient, namely  $\Delta^9$ -tetrahydrocannabinol (THC), on (i) mouse wheel-running preference and performance and (ii) running motivation and seeking behaviour. Wheel-running preference and performance were investigated using a T-maze with free and locked wheels located at the extremity of either arm. Running motivation and seeking were assessed by a cued-running operant task wherein wheel-running was conditioned by nose poking. Moreover, because THC targets cannabinoid type 1 (CB<sub>1</sub>) receptors, i.e. receptors previously documented to control running motivation, this study also assessed the role of these receptors in running preference, performance, and craving-like behaviour. Whilst acute blockade or genetic deletion of CB<sub>1</sub> receptors decreased running preference and performance in the T-maze, THC proved ineffective on either variable. The failure of THC to affect running variables in the T-maze extended to running motivation, as assessed by cued-running under a progressive ratio (PR) reinforcement schedule. This ineffectiveness of THC was not related to the treatment protocol because it successfully increased motivation for palatable food. Although craving-like behaviour, as indexed by a cue-induced reinstatement of running seeking, was found to depend on CB<sub>1</sub> receptors, THC again proved ineffective. Neither running motivation nor running seeking were affected when CB<sub>1</sub> receptors were further stimulated by increasing the levels of the endocannabinoid 2-arachidonoylglycerol. These results, which suggest that the drive for running is insensitive to the acute stimulation of CB<sub>1</sub> receptors, raise the hypothesis that cannabis is devoid of effect on exercise motivation. Future investigation using chronic administration of THC, with and without other cannabis ingredients (e.g. cannabidiol), is however required before conclusions can be drawn.

### 1. Introduction

Does cannabis consumption facilitate exercise? If so, does cannabis act on exercise motivation, exercise pleasure, and/or exercise performance? Recent years have seen an expanding number of online press reports from top newspapers (see e.g. [Ducharme, 2019](#); [Hesse, 2016](#); [Miller, 2018](#)) and an Outlook in Nature ([Nguyen, 2019](#)) that focused on these questions. This media interest is accounted for by a growing number of sportspeople interviews, initially thought to be only

anecdotal, highlighting the expanding use of cannabis prior to or after exercise (most often long-distance running). The main reasons for cannabis use are the beliefs that it increases exercise pleasure and performance whilst alleviating after-exercise fatigue symptoms ([Nguyen, 2019](#)). Nowadays, the anecdotal reports on the relationship between cannabis and exercise have given way to true scientific interest. Studies based on self-reports in large individual samples confirm that cannabis use is primarily aimed at increasing exercise pleasure (and hence possibly precipitate the so-called “runner's high”),

\* Corresponding author at: Endocannabinoids and NeuroAdaptation, NeuroCentre INSERM U1215, 33077 Bordeaux, France.

E-mail address: [francis.chaouloff@inserm.fr](mailto:francis.chaouloff@inserm.fr) (F. Chaouloff).

<sup>1</sup> Equal contribution.

<https://doi.org/10.1016/j.pnpbp.2020.110117>

Received 4 August 2020; Received in revised form 11 September 2020; Accepted 20 September 2020

Available online 22 September 2020

0278-5846/ © 2020 Elsevier Inc. All rights reserved.

performance, motivation, and after-exercise recovery (Gillman et al., 2015; Huestis et al., 2011; Kennedy, 2017; Ware et al., 2018). However, how these beliefs range compared to each other was unknown until a recent study addressed this issue. The recent legalisation of cannabis use in several states of the United States of America has facilitated the largest survey (i.e. hundreds of aerobic and anaerobic exercise practitioners) on the beliefs underlying cannabis use before/after exercise (YorkWilliams et al., 2019). The results indicate that beliefs linked to exercise pleasure and after-exercise recovery actually surpass the belief that cannabis increases exercise motivation or exercise performance (YorkWilliams et al., 2019). The finding that exercise performance was not the main reason why cannabis was used prior to exercise is in keeping with the observation that cannabis negatively impacts such a performance in certain individuals (Gillman et al., 2015; Huestis et al., 2011; Kennedy, 2017; Ware et al., 2018). Moreover, because cannabis does not have an ergogenic effect on its own (Ware et al., 2018), it is widely accepted that the positive effects of cannabis on performance, if any, are indirect and are chiefly accounted for by relaxation, well-being, and analgesia (effects that underlie the forbidden use of cannabis in sport competition by the World Anti-Doping Agency since 2004).

These findings question the extent to which the belief in the positive effects of cannabis before/after exercise reflect scientifically-proven properties of cannabis. One means of answering this question is through the use of animal models of exercise. However, because cannabis cannot be provided as such to laboratory animals, one prerequisite for the study of cannabis' impact on exercise is to identify the compounds through which cannabis bears its effects. Cannabis is made of hundreds of compounds (Andre et al., 2016) and it is assumed that its effects during/after exercise, including the adverse ones (Kennedy, 2017), are accounted for by the psychoactive properties of  $\Delta^9$ -tetrahydrocannabinol (THC; Wachtel et al., 2002). Rodent models of exercise chiefly include treadmill-running and wheel-running (swimming is a stress response in laboratory rodents: Porsolt et al., 1978). However, the former relies on a negative reinforcement process because rodents are forced to run to escape electric shocks or air puffs. Hence, wheel-running, by virtue of its volitional use, is the preferred model of exercise (Sherwin, 1998). Accordingly, most investigators place a running wheel in the rodent housing cage, thereby allowing free access to the wheel and on-line measures of running performance. As an illustration, mice housed with running wheels run several kilometres a day (see e.g. Dubreucq et al., 2010), further suggesting that wheel-running is a strong reward in laboratory rodents (see below).

Using home cage wheel-running, we and others have shown that the endocannabinoid system exerts a tonic control on wheel-running performance, as assessed by running distances or durations (Dubreucq et al., 2010; Keeney et al., 2008; Zhou and Shearman, 2004). This tonic control is mediated by CB<sub>1</sub> receptors - the principal cannabinoid receptor in the brain - located in the ventral tegmental area (VTA; Dubreucq et al., 2013), the structure from which project reward-regulating mesocorticolimbic dopaminergic neurones. Because THC's psychoactive effects are accounted for by the stimulation of CB<sub>1</sub> receptors (Huestis et al., 2001), it is expected that THC augments running performance. Actually, when acutely tested at doses devoid of intrinsic locomotor effects, THC lacked effects on running performance (Dubreucq et al., 2013). However, in keeping with the running paradigm used in this study, i.e. permanent housing with a wheel, thus allowing running with neither any constraint nor any other alternative than resting, this result does not document whether THC impacts (i) preference for running and/or (ii) running motivation. The T-maze test allows preference for a reward to be measured since the reward is located at the extremity of one of the arms of the maze. Therefore, animals have to first make the choice for a distant reward before exerting exploratory efforts to reach that reward. Several T-maze studies have used a running wheel, either provided alone (Hill, 1961) or in concurrence with a second reward placed at the other end of the maze (Correa et al., 2016), but none have explored (i) whether the

endocannabinoid system controls running motivation, and if so, (ii) whether the latter is modified by THC administration. Although it has been claimed that the T-maze additionally provides information on reward motivation (Robinson et al., 2005), it is thought that the (exploratory) cost to access the reward in the T-maze is too low to efficiently provide such an information (unless a surmountable barrier is added: Salamone et al., 1994). As opposed to the T-maze, cued-reward instrumental tasks - where e.g. lever pressing is needed for reward access - provide indices of the primary reinforcing value of the reward under investigation; indeed, such procedures have confirmed that wheel-running is highly reinforcing (Belke and Garland Jr, 2007; Collier and Hirsch, 1971; Iversen, 1993). Measuring the maximal efforts exerted to reach the reward under progressive ratio (PR) reinforcement schedules provides selective indices of motivation for that reward (Hodos, 1961). Having developed a paradigm wherein wheel-running is conditioned by prior nose poking, we have shown that VTA CB<sub>1</sub> receptors exert a tonic control over running motivation (Muguruza et al., 2019). However, whether acute THC administration affects running motivation in this paradigm remains an open question. Besides measuring motivation for a reward, operant conditioning procedures further permit craving-like behaviour for a reward to be measured by means of a cue-induced reinstatement of reward seeking in animals that have extinguished the cue-reward association (Shaham et al., 2003; Venniro et al., 2016). Indeed, we have further shown that wheel-running is a reward strong enough to promote seeking after such an extinction period (Muguruza et al., 2019). Again, whether THC affects the intensity of exercise seeking is an issue for which information is still lacking.

The present study has thus examined the acute impact of THC administration on (i) preference for wheel-running and running performance in a T-maze wherein animals had the choice between two arms containing at their extremities either a free wheel or a locked wheel, and (ii) wheel-running motivation and craving-like behaviour, as assessed through a PR session and a cue-induced reinstatement of running seeking session respectively, using operant conditioning procedures. In the final series of experiments, we wondered whether the effects of THC on running motivation and seeking mimicked those elicited by an endogenous overstimulation of CB<sub>1</sub> receptors. To this end, mice were pretreated with the monoacylglycerol lipase (MAGL) inhibitor JZL184 (Long et al., 2009a) (which increases the levels of the endocannabinoid 2-arachidonoylglycerol (2-AG), before being tested either under a PR reinforcement schedule or in a cue-induced reinstatement of running seeking session.

## 2. Materials and methods

### 2.1. Animals

T-Maze experiments involved male C57BL/6N mice (Elevage Janvier, Le Genest-Saint-Isle, France) aged 8–12 weeks, and 8–14 week-old male constitutive CB<sub>1</sub> receptor mutant (CB<sub>1</sub> KO) mice and their wild-type (CB<sub>1</sub> WT) littermates (Bellocchio et al., 2010; Dubreucq et al., 2013; Muguruza et al., 2019). Operant conditioning procedures used 8–12 week-old males from a C57BL/6N-derived mouse line bred in our animal facilities, namely the *Cnr1*<sup>fl<sub>ox</sub>/fl<sub>ox</sub></sup> (CB<sub>1</sub>-floxed) line, and conditional mutants lacking floxed CB<sub>1</sub> receptors in cortical glutamatergic neurons - due to the expression of the *Nex-Cre* recombinase (Glu-CB<sub>1</sub> KO) - and their wild-type littermates (Glu-CB<sub>1</sub> WT; Bellocchio et al., 2010; Dubreucq et al., 2013; Muguruza et al., 2019). Mutant and wild-type mice, all bred in our animal facilities, were in a mixed genetic background with a predominant C57BL/6N contribution. Note that CB<sub>1</sub>-floxed mice behave similarly to C57BL/6N with regard to the reinforcing value of wheel-running and its control by CB<sub>1</sub> receptors (Muguruza et al., 2019). All mice were genotyped (at 2–3 weeks-old) and re-genotyped (at the end of experiments), as described previously (Bellocchio et al., 2010; Dubreucq et al., 2013; Muguruza et al., 2019).

## 2.2. Housing

At least one week before the beginning of the experiments, all mice were individually housed (to avoid inter-individual aggression) with (T-maze experiments) or without (operant conditioning experiments) a running wheel similar to that used in the T-maze (see below). Mice were located in a thermoregulated room (21–22 °C) placed under a partly inverted 12-h light/12-h dark cycle, with the lights turning off at 2.00 PM (T-maze experiments) or at 9.00 AM (operant conditioning experiments). Except for one series of experiments which required a restriction feeding regimen (see below), mice were all provided with food and water *ad libitum*.

## 2.3. T-maze experiments

The maze was made of three grey Perspex arms (8-cm large x 14-cm high). One arm, harbouring the start box (11-cm), was 35-cm long. The two other arms, opposing each other, were 45-cm long, including a compartment (16-cm long x 20-cm wide) placed at their respective ends. Each compartment housed a free or a locked 12-cm diameter running wheel (Intellibio, France). The right/left arm locations of the free/locked wheel were inverted between two successive mice. Except for one series of experiments conducted under light exposure (see below), all experiments were run with a red lamp placed above the T-maze to deliver a 0.2-lx illumination to the start box.

The first day of test, mice were placed in the start box and then freed through a sliding door to allow them to explore the T-maze for 5 min without either running wheel in the wheel compartments. One to two hours later, each mouse was placed back in the starting chamber before being freed to explore the T-maze for 5 min with the free and locked wheels. The next day, mice were put back in the starting chamber before being allowed to explore the starting arm and one of the two wheel-containing arms for 150 s, the second arm being blocked by a sliding door. At the end of this period, mice were put back in the starting chamber before repeating the previous test, except that the blocked arm was now free whilst the free arm was now blocked. The two tests achieved the second day were repeated in the opposite order the third day. On test days 4, 5, and 6, only one daily session was conducted wherein mice were left free to explore the T-maze for 5 min. The initial latency to enter the free wheel, the respective numbers of entries into the free wheel and the locked wheel, the duration of running in the free wheel, the time spent in the locked wheel, and the total number of entries in the arms were all video-recorded by means of a sensitive camera placed above the apparatus connected to a computer in an adjacent room. All behavioural variables were scored by means of a customised EVENTLOG program. Preference ratios were calculated as the time spent running in the free wheel over the total time spent in both free and locked wheels. Data from CB<sub>1</sub> KO mutants and their CB<sub>1</sub> WT littermates are reported as the mean  $\pm$  SEM of the performances recorded during days 4–6. For tests with pharmacological intervention (C57Bl/6N mice), the performances were recorded 30 min after acute drug (SR141716, THC) or vehicle administration on day 6. As indicated above, mice were tested during the dark phase of the light/dark cycle in keeping with their nocturnal activity. However, in one series of experiments aimed at examining the impact of THC when mice are naturally inactive, mice were trained (days 1–3) as described above (i.e. under the dark phase) but exposed to T-maze tests (and THC treatments) during the light phase (days 4–6) under a 56-lx illumination.

## 2.4. Conditioned running procedures

### 2.4.1. Experimental set-up

The set-up included operant chambers (28 cm  $\times$  26 cm  $\times$  38 cm; Imetronic, France) located in a room adjacent to the housing room. These chambers, placed inside wooden casings (60 cm  $\times$  62 cm  $\times$  49 cm), were ventilated to guarantee air circulation

and to provide background noise. The rear wall had a hollow for mounting a 20-cm-wheel that was locked or unlocked (by means of a brake-pad) according to predefined experimental conditions. The central wheel was flanked by 2 small holes set into the rear wall, allowing the animal to ‘poke’ its nose through, with cue-lights located above nose poke ports. An additional light was placed above the wheel, which illuminated the wheel while it was unlocked. Nose pokes could be either “active” (simultaneously leading to cue-light illumination above the active port, wheel unlocking, and illumination of the wheel) or “inactive” (having no consequence). The left/right allocation of active/inactive ports was switched between animals. A gridded floor was placed above a drawer to allow for easy removal of solid/liquid waste material. All devices in the operant chambers were linked to a computer (Polywheel software, version 5.2.2; Imetronic, France). The number of active/inactive nose pokes, the number of running sequences, and the running duration of each rewarded sequence were detected and transmitted online (Hurel et al., 2019; Muguruza et al., 2019).

### 2.4.2. Wheel-running under fixed ratio (FR) and PR reinforcement schedules

The operant protocol consisted of daily 1-h sessions, as previously described (Hurel et al., 2019; Muguruza et al., 2019). The first day, mice were placed in the chambers, with the light above the unlocked running wheel remaining illuminated during the whole session. The nose poke ports were covered up by metal pieces and the cue-light above the active port remained off. This phase – which was performed on 2 consecutive days – was aimed at habituating the mice to the operant chambers, the wheel, and the wheel-light indicating availability of the reward. When learning sessions began on the third day (session 1), the wheel locking/unlocking mechanism and the nose poke ports became fully operational. The wheel was unlocked for 1 min (wheel brake released) following nose pokes the mouse performed in its allocated active port. The other port, although accessible, remained inactive. Learning sessions began with FR1 sessions during which a single active nose poke was sufficient to simultaneously illuminate the cue-light above the port for 10 s and unlock the running wheel for 1 min under light. When this time period elapsed, the wheel-light extinguished and the brake was applied, so that the mouse had to step down from the wheel and execute a further nose poke in order to unlock it again. Nose pokes made in the active port while the wheel was already unlocked were without effect. After completing the FR1 schedule of reinforcement (6 daily sessions), mice were moved on to the FR3 condition where a 1-min wheel-running period was contingent on 3 consecutive active nose pokes. This experimental condition was repeated over 6 sessions. The day after the last FR3 session, four mouse groups were formed on the basis of similar mean nose pokes scores during this last FR3 session (to avoid a priori biases). Mice were then injected with THC or JZL184 (or their corresponding vehicle) 30 min or 120 min, respectively, before being tested under a linear PR schedule of reinforcement. Under this schedule, the number of active nose pokes required to free the running wheel was incremented by 3 between each rewarded step with a time limit of 15 min between two successive steps.

### 2.4.3. Cue-induced reinstatement of running seeking

In another series of experiments, mice were placed under 12 FR (6 FR1 followed by 6 FR3) sessions of conditioned wheel-running as described above. Twenty four hours after the last FR3 session (session 12), mice underwent daily 1-h extinction sessions for 7 consecutive days. Throughout the extinction procedure, neither active nose poke ports nor cue lights were active and the running wheel remaining locked, as previously described (Muguruza et al., 2019). The day after the last extinction session (session 19), mouse groups - with identical scores during that session - were pretreated with either (i) THC or its vehicle, or (ii) JZL184 or its vehicle. Thirty minutes (THC experiments) or two hours (JZL184 experiments) later, a cue-induced reinstatement session was performed (session 20). Two minutes after this session began, a

single 10-s lighting of the cue above the active nose poke port appeared. Then, when the animal performed one active nose poke (as for the FR1 schedule) the cue-light was lit again for 5 s (the wheel remaining locked, including for the rest of the session). Next, three active nose pokes were required (as for the FR3 schedule) to switch on the light; this procedure was then kept constant throughout the session. Whatever the number of active nose pokes required to light the active port, the running wheel remained locked whilst the cue light above the wheel remained inactive (Muguruza et al., 2019).

#### 2.4.4. Conditioned feeding procedures

Owing to the stimulatory effect of THC on palatable feeding, we verified that the highest dose of THC used in this study (1 mg/kg) was pharmacologically efficient by measuring its acute impact on motivation for palatable feeding in food-restricted mice. The operant chambers described above were configured so as to host on their left panel a recessed pellet tray surrounded by two nose poke ports (Hurel et al., 2019; Muguruza et al., 2019). Cue-lights were placed above both the nose poke ports and the feeder to indicate effectiveness of the nose pokes and pellet distribution, respectively. The rear side (where the running wheel and its corresponding nose poke ports and cue-lights are located; see above) was covered by grey Perspex. Note that the operant protocol consisted of 30-min daily sessions to avoid premature satiety.

The daily food consumption and the body weight of each mouse were recorded every day for a week before mice were given a limited quantity of food so as to maintain their body weight to 90% levels of their free-feeding weight. Prior to the onset of the operant conditioning procedure, animals were first habituated to the 20-mg chocolate pellets used in the operant chambers (Dustless precision pellets F05301; Plexx, The Netherlands for BioServ) by being provided with 5 pellets/day for 3 days in their home cages. Thereafter, mice were placed in the chambers with the cue light above the pellet tray remaining illuminated while the two NP ports were covered-up by metal objects. Immediately after placement of the mouse in the operant chamber, 17 food pellets were successively distributed to the tray. This first conditioning session was aimed at habituating the mice to both the operant chamber, the feeder, and the cues indicating pellet distribution. When learning sessions began, the feeder was empty whilst the NP ports were fully operational. During FR1 sessions, a single active NP was sufficient to simultaneously illuminate the cue-lights above the active nose poke port and the feeder and to dispense one pellet. NP in the inactive port were counted but had no effect. The pellet distribution was followed by a 15-s time-out period during which NP activity was ineffectual. To compare with operant running experiments, the number of FR1 sessions was fixed to 6, a number sufficient to reach performance stability. After completing the FR1 schedule of reinforcement, mice moved on to the FR3 condition, i.e. mice had to NP 3 consecutive times in the active port to get one food pellet. As above, this experimental condition was repeated over 6 sessions. The day after the last FR3 session, two mouse groups were formed on the basis of similar mean nose poke scores during this last FR3 session. Mouse groups were then injected with 1 mg/kg THC or its vehicle 30 min before being tested under a linear PR schedule of reinforcement similar to the one described above, except that there were no time limits between steps in keeping with the short (i.e. 30-min) duration of the PR session (Hurel et al., 2019; Muguruza et al., 2019).

#### 2.5. Drugs

SR141716 and JZL184 were from Interchim (Montluçon, France, for Caiman Chemical) whilst THC was from THC-Pharm GmbH (Frankfurt, Germany). SR141716 (3 mg/kg) or its vehicle (DMSO, final concentration: 1.25%) were diluted in one droplet of Tween 80 and then in 0.9% NaCl. THC (0.1–1 mg/kg) or its vehicle (a mixture of ethanol and Cremophor-EL at final concentrations of 5%) were dissolved in 0.9% NaCl (final concentration of ethanol: 0.395 g/kg). JZL184 (8 mg/kg) or

its vehicle (DMSO, final concentration: 10%) were diluted in one droplet of Tween 80 and then in 0.9% NaCl. All volumes of (i.p.) injection were 10 ml/kg.

#### 2.6. Statistics

Data are shown as mean  $\pm$  SEM with individual values. Because several data sets did not obey normality rules and/or displayed variance heterogeneities, all data were analysed with non-parametric tests. Except for two series of experiments involving multiple THC doses, all data were compared with a Mann–Whitney test (2-group comparisons). Multiple THC doses were compared by means of Kruskal–Wallis analyses of variance. However, these analyses of variance did not prove significant, hence impeding post hoc comparisons. All analyses were achieved using GB-Stat software (version 10.0; Dynamic Microsystems Inc., CA, USA).

### 3. Results

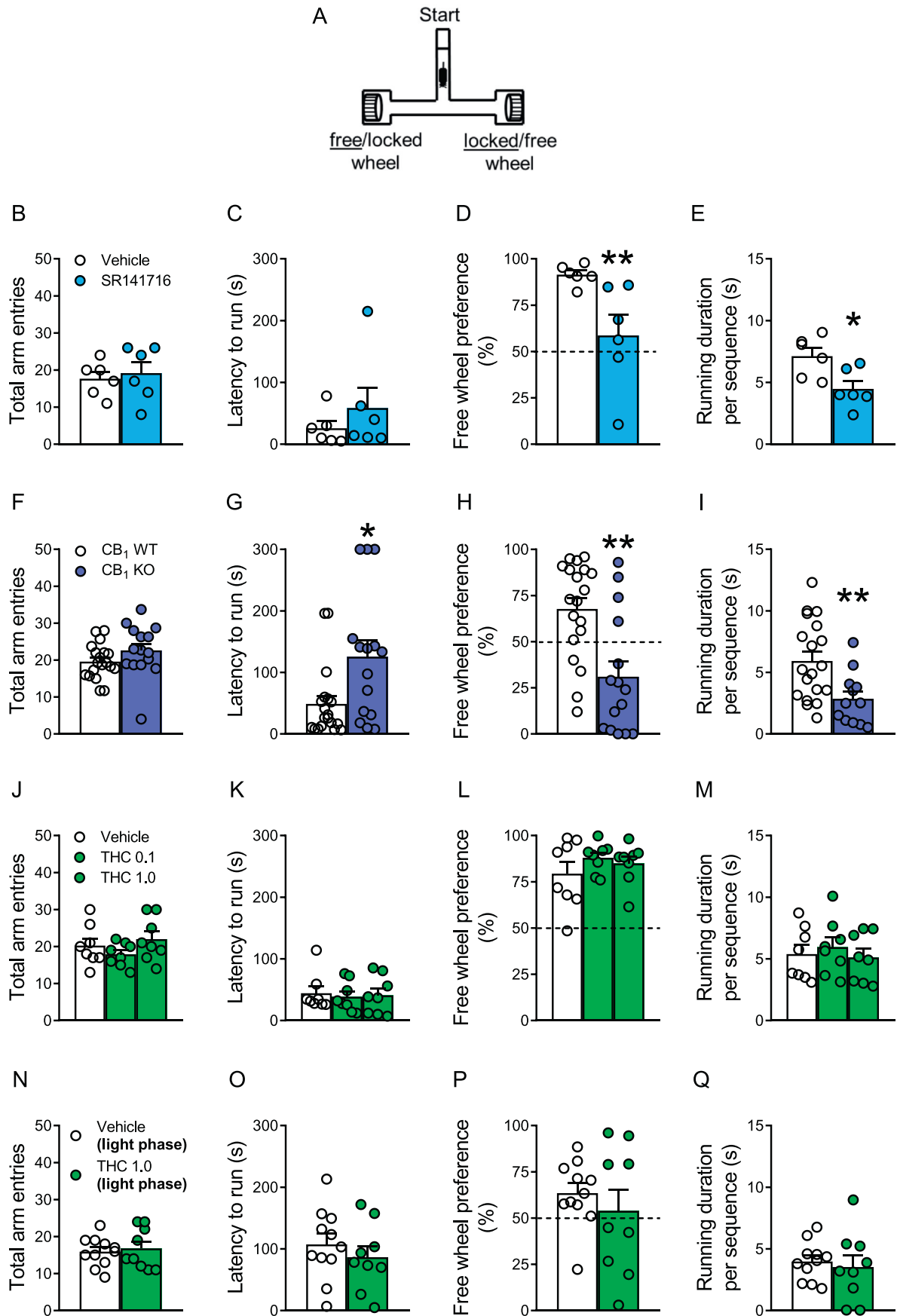
#### 3.1. Effects of THC on wheel-running preference and performance in T-maze tests

We developed a choice procedure wherein two arms contained at their extremities either a free wheel or a locked wheel (Fig. 1A). This design allowed us to measure (i) the initial latency to reach the wheel and run, (ii) running preference (over a locked wheel), and (iii) running performance during 5-min tests. In contrast to operant conditioning procedures in which the role of CB<sub>1</sub> receptors in the control of running motivation has been established (see above), their role in T-maze behaviours remained to be established. In the first series of experiments, we thus assessed which of the above-mentioned running variables were decreased by CB<sub>1</sub> receptor blockade or by genetic deletion of CB<sub>1</sub> receptors. The CB<sub>1</sub> receptor antagonist SR141716, which was administered at a dose (3 mg/kg) devoid of any intrinsic effect on locomotion (as indicated by total exploration scores; Fig. 1B), did not affect the initial latency to run (Fig. 1C) but decreased free wheel preference (Mann–Whitney test:  $z = 2.57$ ,  $p = 0.009$ ; Fig. 1D) and the running duration per sequence (Mann–Whitney test:  $z = 2.24$ ,  $p = 0.025$ ; Fig. 1E). Compared to CB<sub>1</sub> WT mice, mice lacking CB<sub>1</sub> receptors (CB<sub>1</sub> KO mice) showed similar locomotion (Fig. 1F) but were impaired in the initial latency for the first running sequence (Mann–Whitney test:  $z = 2.29$ ,  $p = 0.022$ ; Fig. 1G), in free wheel preference (Mann–Whitney test:  $z = 3.05$ ,  $p = 0.002$ ; Fig. 1H), and in the mean running duration per running sequence (Mann–Whitney test:  $z = 2.63$ ,  $p = 0.008$ ; Fig. 1I).

As opposed to the effects of CB<sub>1</sub> receptor blockade or deletion, nonselective stimulation of these receptors by THC, at doses lacking intrinsic effects on locomotion (Fig. 1J), was ineffective on T-maze variables (Fig. 1 K–M). These results led us to consider the possibility that THC does not affect running preference when intrinsically high, as expected during the dark phase of the light/dark cycle. Thus, we next tested the effects of THC during the light phase, i.e. when running activity and hence preference is the weakest (see Discussion). Testing during the light phase increased the initial latency to run in vehicle-injected mice, compared to that measured in vehicle-injected mice tested in the dark phase (Mann–Whitney test:  $z = 2.48$ ,  $p = 0.013$ ; Fig. 1O). In addition, it decreased the total running duration during the 5-min test ( $89.2 \pm 19.4$  s and  $38.4 \pm 6.5$  s in mice tested under the dark and the light phases, respectively; Mann–Whitney test:  $z = 2.06$ ,  $p = 0.039$ ). However, contrarily to our expectations, a 1 mg/kg dose of THC still proved ineffective in the T-maze when tested under the light phase (Fig. 1 N–Q).

#### 3.2. Effects of THC on wheel-running motivation

Using a mouse operant procedure wherein nose poke performance



(caption on next page)



**Fig. 1.** Wheel-running preference and performance are insensitive to THC. (A) T-maze set-up with free and locked running wheels at arm extremities. Except for one series of experiments (N-Q), all tests were ran during the dark phase of the light/dark cycle. Acute CB<sub>1</sub> receptor blockade by SR141716 (3 mg/kg, *n* = 6) 30 min beforehand affects neither total locomotion (B) nor the initial latency to run (C) but reduces free wheel preference (D) and running duration per running sequence (E), compared to its vehicle (*n* = 6). Total locomotion is similar in mice with a genetic deletion of CB<sub>1</sub> receptors (CB<sub>1</sub> KO; *n* = 15), compared to their wild-type (CB<sub>1</sub> WT; *n* = 19) littermates (F). CB<sub>1</sub> KO animals display an increased initial latency to run (G), decreased wheel preference (H), and decreased running performance per running sequence (I), compared to CB<sub>1</sub> WT mice. Administration of 0.1 or 1 mg/kg THC (*n* = 8 per dose) 30 min beforehand does not affect T-maze behaviours, compared to vehicle treatment (*n* = 8; J-M). Administration of 1 mg/kg THC (*n* = 9) during the light phase of the light/dark cycle does not alter T-maze behaviours, compared to vehicle administration (*n* = 11; N-Q). All data are shown as mean ± SEM. \* *p* < 0.05 and \*\* *p* < 0.01 (Mann-Whitney tests).

temporarily unlocks a running wheel (Fig. 2A), we trained mice under FR1 and FR3 reinforcement schedules (Fig. 2B), and then administered 0.1–1 mg/kg doses of THC 30 min before a PR session. Indeed, none of these doses affected the maximal number of nose pokes performed during that session (as indicated by Kruskal-Wallis analyses of variance; Fig. 2C) and, hence, breakpoint levels (which ranged from  $7.6 \pm 1.1$  to  $10.5 \pm 1.3$  in THC-injected mice, compared to  $9.8 \pm 1.2$  in vehicle-injected mice). This observation extended to running performances, as assessed by the running duration per rewarded sequence (Fig. 2D).

These negative results might be rooted in the inability of our THC treatment protocols to effectively stimulate CB<sub>1</sub> receptors, and hence affect running motivation. We thus tested the impact of a 1 mg/kg dose of THC on motivation for another reward, namely palatable feeding. Accordingly, mice were tested in a cued-feeding instrumental task wherein food-restricted animals had to nose poke under a PR reinforcement schedule to get access to chocolate-flavoured pellets (Fig. 2E). Following efficient training under FR1 and FR3 schedules of reinforcement (Fig. 2F), mice were treated with 1 mg/kg THC before the PR session. This treatment increased the maximal number of nose pokes performed to get access to food pellets (Mann-Whitney test:  $z = 2.12$ ,  $p = 0.034$ ; Fig. 2G), leading to an increased breakpoint level ( $44 \pm 2$  and  $53.7 \pm 3.9$  in vehicle- and THC-treated mice, respectively; Mann-Whitney test:  $z = 1.97$ ,  $p = 0.049$ ). THC-elicited potentiation of feeding motivation increased food pellet consumption, albeit to a nonsignificant extent (Mann-Whitney test:  $z = 1.88$ ,  $p = 0.06$ ; Fig. 2H). These series of experiments thus suggested that the net impact of THC on motivation for a reward was dependent on the type of reward.

### 3.3. Effects of THC on wheel-running seeking

Cue-induced reinstatement of reward seeking in animals that have extinguished a reward-reinforced task performance (lever pressing, nose poking) allows us to study craving-like behaviour for that reward (Shaham et al., 2003; Venniro et al., 2016). In the present series of experiments, we thus aimed at investigating whether THC affects exercise craving-like behaviour (Fig. 3A). As for T-maze experiments, we first investigated whether wheel-running seeking after extinction of running-reinforced nose poking is controlled by CB<sub>1</sub> receptors. To selectively assess the role of these receptors during the reinstatement step (thus excluding the use of CB<sub>1</sub> KO mice which display decreased operant responses under FR schedules of reinforcement), naive mice were first exposed to FR reinforcement schedules (Fig. 3B) before being exposed to an extinction period of running-reinforced nose poking (Fig. 3C). Thereafter, mice were pretreated with the CB<sub>1</sub> receptor antagonist SR141716 (or its vehicle) before a cue-induced reinstatement session. Pretreatment with this antagonist decreased the number of nose pokes performed during reinstatement of running seeking (Mann-Whitney test:  $z = 2.78$ ,  $p = 0.005$ ; Fig. 3D), indicating that it is controlled by CB<sub>1</sub> receptors. Taking advantage of this result, we aimed at further dissecting the relationships between the endocannabinoid system and cue-induced reinstatement of running seeking. Because frontocortical glutamatergic neurones play a key role in cue-induced reinstatement of reward seeking (Gourley and Taylor, 2016; Shaham et al., 2003), we wondered whether these neurones host the CB<sub>1</sub> receptor population controlling running seeking. As shown previously

(Muguruza et al., 2019), the primary reinforcing value of wheel-running was not different between mice lacking CB<sub>1</sub> receptors on cortical glutamatergic neurones (Glu-CB<sub>1</sub> KO mice) and their wild-type (Glu-CB<sub>1</sub> WT) littermates (Fig. 3E). Similar genotype-independent patterns emerged during either the extinction period (Fig. 3F) or a cue-induced reinstatement session (Fig. 3G).

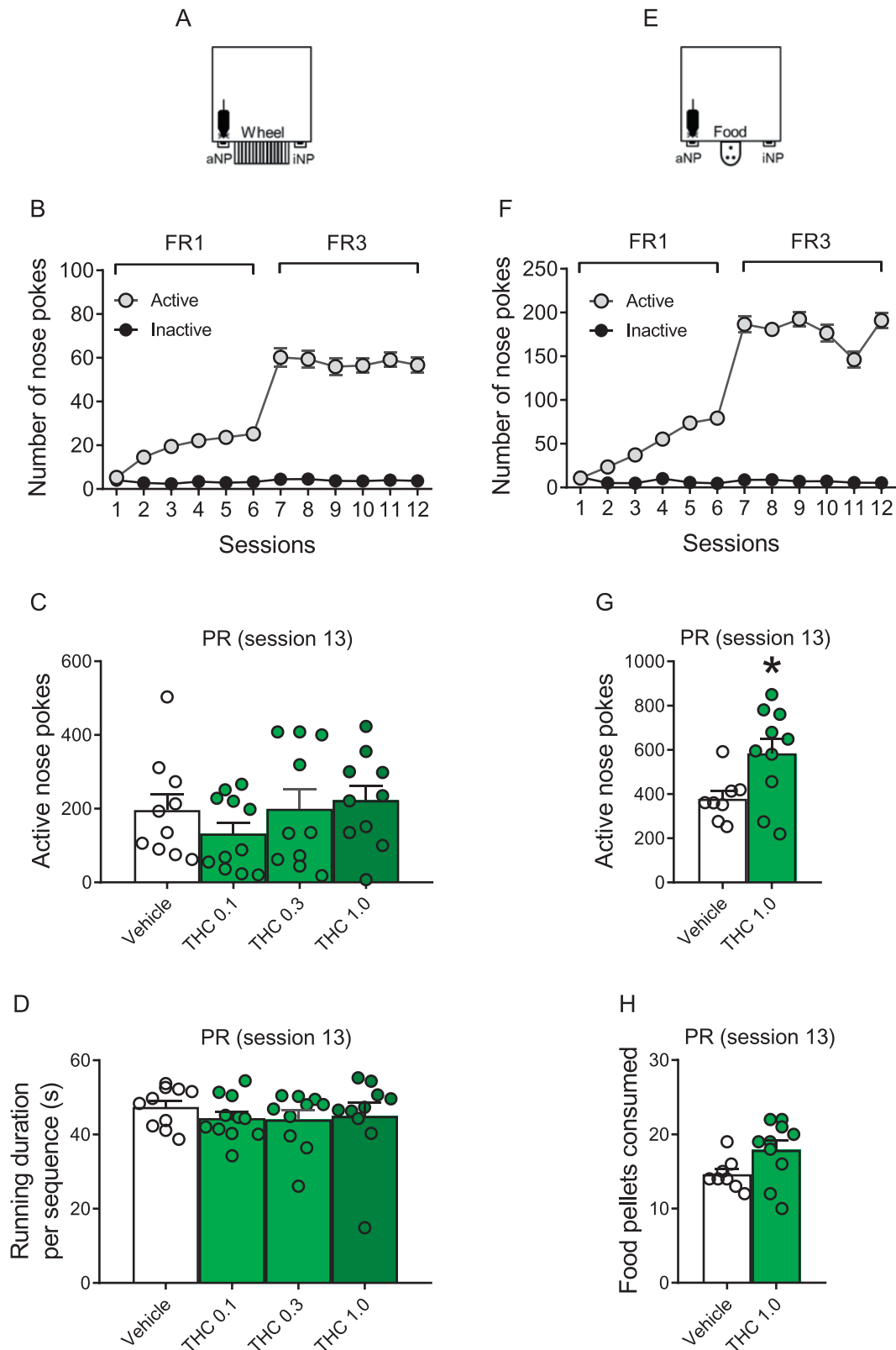
Having established that CB<sub>1</sub> receptors control running seeking (independently of cortical glutamatergic processes), we then tested the effect of a 1 mg/kg dose of THC. Administration of this dose in mice that underwent prior FR training (Fig. 3H) and extinction (Fig. 3I) phases did not change the amplitude of running seeking (Fig. 3J). Taken together, these data indicated that although CB<sub>1</sub> receptors control running seeking, their stimulation by THC does not affect this behaviour.

### 3.4. Effects of JZL184 on wheel-running motivation and seeking

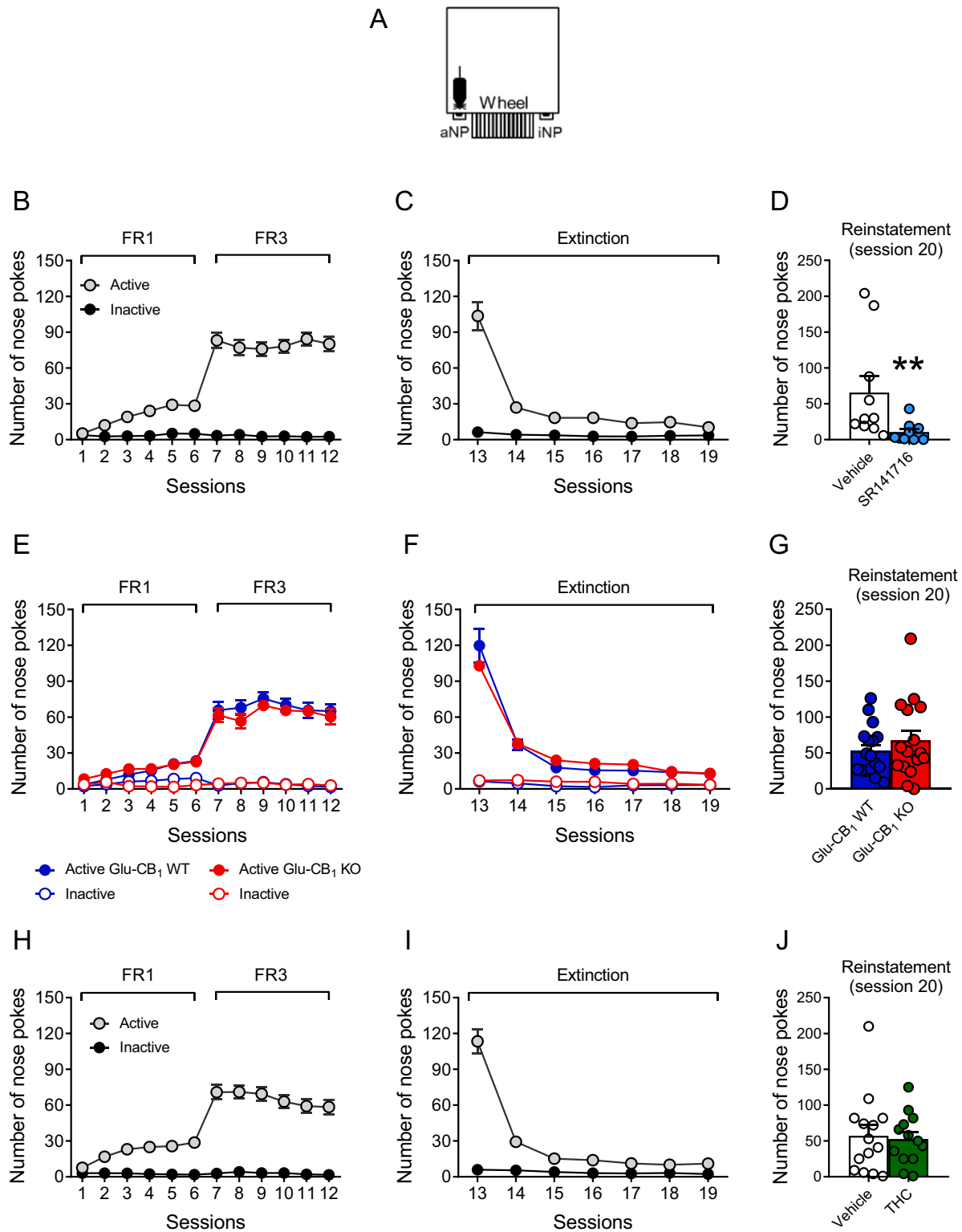
The above operant conditioning experiments indicated that THC does not stimulate running motivation or running seeking, which both require tonic CB<sub>1</sub> receptor stimulation (see Discussion). In turn, this suggested that the exogenous overstimulation of CB<sub>1</sub> receptors was ineffective on either running variable, hence questioning the generalisation of this ineffectiveness to the endogenous overstimulation of CB<sub>1</sub> receptors. Prior evidence for 2-AG being the endocannabinoid through which CB<sub>1</sub> receptors control reward processes (Covey et al., 2017) led us to examine whether JZL184 boosts running motivation. JZL184 is a selective inhibitor of MAGL (Long et al., 2009a), the enzyme that degrades 2-AG molecules at the presynaptic level. Administration of JZL184 thus potentiates 2-AG-elicited stimulation of CB<sub>1</sub> receptors. Mice conditioned to run (Fig. 4A) under FR1 and FR3 reinforcement schedules (Fig. 4B) were thus tested in a PR session 2 h after being administered 8 mg/kg JZL184 (or its vehicle). Indeed, JZL184-treated animals displayed running motivation scores (Fig. 4C) and running performances during each rewarded sequence (Fig. 4D) that were both similar to those measured in vehicle-injected animals. To examine whether MAGL inhibition affected exercise craving-like behaviour, mice that had undergone FR1/3 (Fig. 4E) and extinction (Fig. 4F) sessions were administered JZL184 before a cue-induced reinstatement. As for running motivation, MAGL inhibition did not change the intensity of running seeking (Fig. 4G). These data thus suggested that both running motivation and running seeking were unaffected by the endogenous overstimulation of CB<sub>1</sub> receptors.

## 4. Discussion

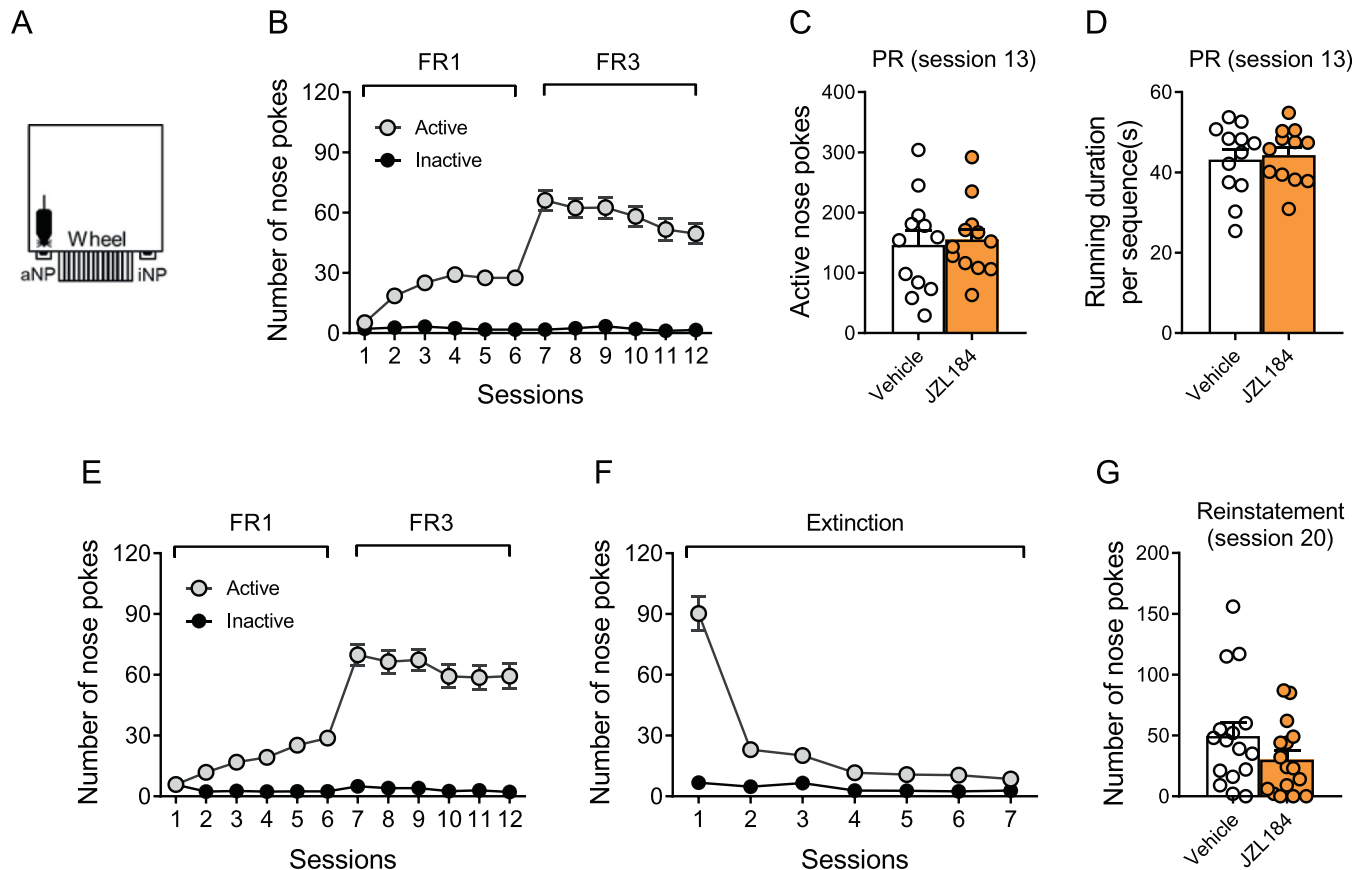
Self-reports suggest that cannabis usage prior to exercise is mainly aimed at increasing exercise pleasure whilst facilitating post-exercise recovery (Gillman et al., 2015; Huestis et al., 2011; Kennedy, 2017; Ware et al., 2018). In some cases, cannabis usage might also increase exercise motivation, and to a lesser extent, performance (YorkWilliams et al., 2019), although these effects might occur in a sport discipline-dependent manner (Lorente et al., 2005). This information, however, relies on survey-based beliefs for which scientific grounds are still lacking. This study has therefore examined in mice the respective impacts of cannabis' main psychoactive ingredient, namely THC, on running performance, preference, and motivation, and extended this



**Fig. 2.** THC boosts motivation for palatable feeding, but not for wheel-running. (A) Operant chamber set-up for the study of wheel-running motivation. (B) Performances of active and inactive nose pokes during the conditioning phase of wheel-running (12 sessions) under FR1 and FR3 schedules of reinforcement ( $n = 41$ ). (C and D) Administration of 0.1–1 mg/kg doses of THC ( $n = 10$ –11 per dose) 30 min beforehand does not affect either the maximal number of nose pokes performed (C) or the running duration per rewarded sequence (D) under a PR reinforcement schedule. (E) Operant chamber set-up for the study of palatable food motivation. (F) Performances of active and inactive nose pokes during the conditioning phase of feeding (12 sessions) under FR1 and FR3 schedules of reinforcement ( $n = 18$ ). (G and H) Administration of 1 mg/kg THC ( $n = 10$ ) 30 min beforehand increases the maximal number of nose pokes performed (G) but not the number of food pellets consumed (D) under a PR reinforcement schedule, compared to vehicle ( $n = 8$ ). All data are shown as mean  $\pm$  SEM. \*  $p < 0.05$  (Mann-Whitney tests).



**Fig. 3.** Cue-induced reinstatement of wheel-running seeking is insensitive to THC. (A) Operant chamber set-up for the study of wheel-running seeking. (B and C) Active and inactive nose pokes for wheel-running under FR1 and FR3 schedules of reinforcement (B) and during extinction sessions ( $n = 19$ ; C). (D) Pretreatment with the CB<sub>1</sub> receptor antagonist SR141716 (3 mg/kg,  $n = 9$ ) 30 min beforehand decreases active nose poke performance during a cue-induced reinstatement session, compared with its vehicle ( $n = 10$ ). (E and F) Active and inactive nose pokes for wheel-running under FR1 and FR3 schedules of reinforcement (E) and during extinction sessions (F) in mice lacking CB<sub>1</sub> receptors on cortical glutamatergic neurones (Glu-CB<sub>1</sub> KO;  $n = 16$ ) and in their wild-type (Glu-CB<sub>1</sub> WT;  $n = 17$ ) littermates. (G) Cue-induced reinstatement of wheel-running seeking is not different between Glu-CB<sub>1</sub> KO and Glu-CB<sub>1</sub> WT mice. (H and I) Active and inactive nose pokes for wheel-running under FR1 and FR3 schedules of reinforcement (H) and during extinction sessions ( $n = 27$ ; I). (J) Active nose poke performance during a cue-induced reinstatement session is insensitive to a pretreatment 30 min beforehand with a 1 mg/kg dose of THC ( $n = 13$ ), compared to vehicle pretreatment ( $n = 14$ ). All data are shown as mean  $\pm$  SEM. \*\*  $p < 0.01$  (Mann-Whitney tests).



**Fig. 4.** Wheel-running motivation and seeking are insensitive to MAGL inhibition. (A) Operant chamber set-up for the study of running motivation and craving-like behaviour. (B) Performances of active and inactive nose pokes during the conditioning phase of wheel-running (12 sessions) under FR1 and FR3 schedules of reinforcement ( $n = 24$ ). (C and D) Administration of 8 mg/kg JZL184 ( $n = 12$ ) 2 h beforehand does not change the maximal number of nose pokes performed (C) or the running duration per rewarded sequence (D) under a PR reinforcement schedule, compared to vehicle administration ( $n = 12$ ). (E and F) Active and inactive nose pokes for wheel-running under FR1 and FR3 schedules of reinforcement (E) and during extinction sessions ( $n = 32$ ; F). (G) Active nose pokes performance during a cue-induced reinstatement session is insensitive to a pretreatment 2 h beforehand with an 8 mg/kg dose of JZL184 ( $n = 16$ ), compared to vehicle pretreatment ( $n = 16$ ). All data are shown as mean  $\pm$  SEM.

investigation to running seeking. Although  $CB_1$  receptors exert a tonic control on running motivation, their stimulation by THC boosted neither running motivation nor running performance. Conversely, THC increased palatable feeding motivation, suggesting that THC might stimulate reward motivation in a reinforcer-dependent manner. The inability of THC to stimulate running motivation extended to exercise craving-like behaviour, as assessed by a cue-induced reinstatement of running seeking. The finding that similar results were observed when 2-AG degradation was impeded suggests that running motivation and performance are insensitive to the acute endogenous/exogenous overstimulation of  $CB_1$  receptors.

In the first series of experiments, we aimed at investigating whether THC affects running preference and performance. To do so, we could have used classical conditioned place preference tests whereby neurobiological bases for wheel-running preference have been established (Fernandes et al., 2015; Lett et al., 2001). However, these tests actually measure after-running, rather than running, preference, and it has been reported that running and after-running might depend on different processes (Belke and Wagner, 2005). This led us to use a different paradigm. We thus developed a T-maze procedure wherein mice could choose between a free running wheel and a locked wheel (in order to control for unspecific reward preferences linked to wheel shape or texture). We first observed that  $CB_1$  receptors exert a tonic control on running preference and performance. Whether these receptors are those shown to control running motivation under operant conditioning

procedures (Muguruza et al., 2019) is presently unknown. In this context, it is relevant to mention that the T-maze has been proposed to provide a motivation index by means of the initial latency to reach the reward (Robinson et al., 2005). This suggestion is supported by the observation that dopamine transients in the nucleus accumbens (to which project VTA dopaminergic neurones) progressively increase with the approach to the reward at the arm extremity (Howe et al., 2013). Our finding that the genetic deletion of  $CB_1$  receptors increased the initial latency to reach the reward therefore might suggest that running motivation, whether measured in the T-maze or under PR reinforcement schedules, is controlled by one unique  $CB_1$  receptor population (located on GABAergic terminals; Muguruza et al., 2019). The additional observation that neither SR141716 pretreatment nor genetic deletion of the  $CB_1$  receptor gene affected total locomotion confirmed our previous suggestion that  $CB_1$  receptor-dependent controls of locomotor and running activities rely on distinct processes (Chaouloff et al., 2011). As opposed to the acute blockade of  $CB_1$  receptors, their acute stimulation by THC failed to affect running preference or running performance. The latter result is in keeping with our previous observation that at doses up to 1 mg/kg THC does not modify free wheel-running performance (Dubreucq et al., 2013). Several explanations might be provided for the inability of THC to affect T-maze behaviours. Besides that based on a balance between rewarding and aversive effects of THC (Han et al., 2017; see below), one possible explanation is that due to the partial agonistic property of THC (Pertwee, 2008), THC can

behave as a CB<sub>1</sub> receptor antagonist when this receptor is weakly expressed. However, the observation that SR141716 was effective in the T-maze renders this possibility unlikely. Alternatively, the failure of THC to affect T-maze behaviours could be explained by the inability of the cannabinoid, at the doses used herein, to effectively stimulate CB<sub>1</sub> receptors. Besides previous evidence for 1 mg/kg THC being effective on other CB<sub>1</sub> receptor-dependent functions in mice, including fasting-induced refeeding (Bellocchio et al., 2010) and mediated aversion in reality testing paradigms (Busquets-García et al., 2017), our present observation that this THC dose increased motivation for palatable feeding (see below) permits us to reject this possibility. Another explanation lies in our experimental conditions. Mice were tested during the dark phase of the light/dark cycle, i.e. when animals are the most active and hence the most motivated for running. Confirmingly, laboratory rodents voluntarily perform most, if not all, of their daily wheel-running activity during the dark phase of the diurnal cycle (see Dubreucq et al., 2013 for an illustration). Indeed, there is evidence for a circadian regulation of mesocorticolimbic VTA dopaminergic neuronal activities (Mendoza and Challet, 2014; Sidor et al., 2015). Accordingly, we could not discard the possibility that running preference, and hence performance, reached their maximal levels when tests were performed, thus impeding stimulatory impacts of THC on these variables. To examine this possibility, we then tested THC effects under the light phase of the light/dark cycle, i.e. when the reinforcing value of wheel-running is at its lowest level. As expected, the initial latencies to reach the free wheel were increased whilst running performances were decreased, compared to the values measured during the dark phase. These differences were not accounted for by putative differences in training efficiencies because mice from both series of experiments were trained under the dark phase, and hence showed similar scores during the training process. THC still proved ineffective on running preference and performance when tested during the light phase, indicating that the inability of THC to boost these variables is independent of baseline reinforcing values of wheel-running. However, we cannot exclude that mice felt the light as stressful, which might have introduced a bias in our analysis of THC effects under low running motivation.

Operant responding for a reward under PR reinforcement schedules allows for a selective estimation of the drive for that reward (Hodos, 1961). By means of this procedure, we have shown that CB<sub>1</sub> receptors present in the VTA are both necessary and sufficient for running motivation (Muguruza et al., 2019). This receptor population, located on GABAergic terminals, is likely the one shown to control running performance under no-cost conditions, i.e. when mice have free access to the wheel (Dubreucq et al., 2013). The finding that running motivation levels, as measured under PR reinforcement schedules, correlate with the firing rates of VTA dopaminergic neurones (Muguruza et al., 2019) strengthens the hypothesis that CB<sub>1</sub> receptors controlling running motivation are located on GABAergic terminals exerting a tonic inhibitory control of VTA dopaminergic neurones (Covey et al., 2017; Lupica and Riegel, 2005; Melis et al., 2012). Indeed, disinhibition of dopaminergic neurones, as expected from the stimulation of this CB<sub>1</sub> receptor population, generates high-frequency bursts in these neurones (Lobb et al., 2010), hence allowing reward processing (Corre et al., 2018; van Zessen et al., 2012). Acute THC increases VTA dopaminergic activity and dopamine release at projection sites (Chen et al., 1993; French et al., 1997; Tanda et al., 1997), including in humans (Bossong et al., 2015), and does so likely through VTA CB<sub>1</sub> receptor-expressing GABAergic neurones (Covey et al., 2017; Lupica and Riegel, 2005; but see Good and Lupica, 2010). These data thus strongly suggested that THC might actually amplify running motivation; however, doses up to 1 mg/kg were found to be ineffective. This result could not be explained by the (5%) ethanol solution in which THC was dissolved as breakpoint levels and running performances were respectively similar in vehicle-injected mice and in mice injected with JZL184 vehicle (which was ethanol-free). Taken with the above mentioned observation that a 1 mg/kg dose of THC increased palatable feeding motivation (in agreement with

Barbano et al., 2009), this last result indicates that THC stimulates motivation for one reinforcer but not for another. This differential effect of THC might be accounted for by the findings that running motivation and motivation for palatable feeding are controlled by different CB<sub>1</sub> receptor populations. Thus, whilst CB<sub>1</sub> receptors on GABAergic neurones exert a tight control on running motivation, these receptors are not involved in the CB<sub>1</sub> receptor-mediated control of the motivation for palatable feeding (Muguruza et al., 2019). On the other hand, CB<sub>1</sub> receptors located on cortical glutamatergic neurones lack influence on running motivation (Muguruza et al., 2019) but control in a tonic manner motivation for palatable feeding (Domingo-Rodriguez et al., 2020). These findings, which illustrate how the endocannabinoid system controls motivation in a reward-specific manner, suggest that THC might then preferentially stimulate CB<sub>1</sub> receptors located on cortical glutamatergic neurones when offered palatable food whilst it might preferentially stimulate CB<sub>1</sub> receptors located on GABAergic neurones when offered wheel-running. In addition to this qualitative (CB<sub>1</sub> receptor population-dependent) control of reward motivation, THC might also exert a quantitative (CB<sub>1</sub> receptor population-dependent) control of reward consumption (and possibly motivation). Thus, mouse fasting-refeeding experiments have indicated that the respective hyperphagic and hypophagic effects of 1 mg/kg and 2.5 mg/kg doses of THC are mediated by distinct CB<sub>1</sub> receptor populations. Thus, THC-induced hyperphagia depends on CB<sub>1</sub> receptors located on glutamatergic neurones whilst the hypophagic effect of THC requires CB<sub>1</sub> receptors located on GABAergic neurones (Bellocchio et al., 2010). Whether this differential control finds its origins at the motivation level remains however to be determined. Another possibility relates to the finding that GABA-mediated reinforcing effects of THC, when present, might be opposed by the aversive consequences of THC stimulation of CB<sub>1</sub> receptors on VTA (Vglut2-expressing) glutamatergic neurones (Han et al., 2017) and/or CB<sub>2</sub> receptors on dopaminergic neurones (Zhang et al., 2014). Although we cannot reject the hypothesis that such opposing actions of THC occur when animals want to run, but not to feed, two observations suggest that this might not be the case. First, THC doses lower than 3 mg/kg did not target CB<sub>1</sub> receptors on VTA glutamatergic neurones in mice (Han et al., 2017). Second, neither a selective CB<sub>2</sub> receptor agonist nor a CB<sub>2</sub> receptor antagonist modified wheel-running performance under no-cost conditions (Dubreucq et al., 2013), suggesting that running motivation and/or intrinsic running performance are insensitive to CB<sub>2</sub> receptor stimulation. One last mechanism that possibly underlies the differential effects of THC on palatable feeding motivation and running motivation involves the use of food restriction, as opposed to ad libitum feeding, in palatable feeding tests. Indeed, VTA dopaminergic neurones – through which THC affects reward processes (see above) – are highly sensitive to chronic food restriction. As an example, amphetamine- and cocaine-elicited increases in accumbal extracellular dopamine levels are amplified by chronic food restriction (Cadoni et al., 2003; Rougé-Pont et al., 1995; Stuber et al., 2002). Moreover, the burst firing activity of dopaminergic neurones is increased by prior food restriction (Branch et al., 2013). Apart from intrinsic impacts on VTA dopaminergic neurones, food restriction also elicits CB<sub>1</sub> receptor-dependent changes in synaptic plasticity (Thoeni et al., 2020), which might have contributed to the aforementioned differential effects of THC on motivation for feeding and running.

There is overwhelming evidence for CB<sub>1</sub> receptors exerting a control on reinstatement of drug-seeking following drug-free periods. For example, SR141716 has been shown to block reinstatement for heroin triggered by a priming injection of the opioid (Fattore et al., 2003). Similarly, CB<sub>1</sub> receptor blockade prevents cocaine-elicited reinstatement of cocaine seeking (De Vries et al., 2001). When reinstatement is promoted by the exposure to the cues paired with reward self-administration, SR141716 decreases reinstatement for drugs such as cocaine (De Vries et al., 2001), methamphetamine (Anggadiredja et al., 2004), heroin, nicotine, and alcohol (De Vries and Schoffelmeier, 2005) and for

a natural reward such as palatable food (De Vries and Schoffelmeer, 2005; Ward et al., 2007). In line with these results, SR141716 decreased cue-induced reinstatement of running seeking, suggesting that CB<sub>1</sub> receptors control this behaviour. However, because we could not test CB<sub>1</sub> receptor knock-out mice due to the lower reinforcing value of wheel-running in these mice, as evidenced under FR reinforcement schedules (Muguruza et al., 2019), it is unknown whether this negative impact of SR141716 was accounted for by its CB<sub>1</sub> receptor blocking properties or by its inverse agonist actions at these receptors (Bouaboula et al., 1997). On the other hand, it is unlikely that SR141716 decreased running seeking through its blockade of mu-opioid receptors (Seely et al., 2012) because *in vivo* evidence for such a blockade in mice was based on a high (10 mg/kg) dose of SR141716. In this context, it is relevant to note that naloxone, at a dose (3 mg/kg) decreasing fasting-induced refeeding by more than 60%, failed to alter wheel-running motivation (as assessed under PR reinforcement schedules; unpublished observations), an observation in line with a previous report in rats (Rasmussen and Hillman, 2011). The observation that the CB<sub>1</sub> receptor population controlling cue-induced reinstatement of running seeking is not located on cortical glutamatergic neurones contrasts with the finding that cue-induced reinstatement of cocaine seeking is increased in Glu-CB<sub>1</sub> KO mice compared to Glu-CB<sub>1</sub> WT mice (Martín-García et al., 2016). Because the deletion of CB<sub>1</sub> receptors from GABAergic neurones diminishes motivation for running (Muguruza et al., 2019), but increases that for cocaine (Martín-García et al., 2016), our results reinforce the above-mentioned suggestion that the mechanisms through which the endocannabinoid system controls reward processes are reward-dependent. Studies aimed at examining the effects of THC in reinstatement protocols have provided mixed results. Thus, THC failed to affect drug priming-elicited reinstatement for heroin (Fattore et al., 2003) or for cocaine (Schenk and Partridge, 1999), reduced reinstatement for methamphetamine (but increased that elicited by exposure to the conditioning cues: Anggadiredja et al., 2004), and increased alcohol seeking (McGregor et al., 2005). The present study indicates that THC does not modify wheel-running seeking, as modelled by a cue-induced reinstatement protocol. However, whether a similar result would have been observed if the animals had been primed by a preliminary free access to the wheel remains to be explored.

Taken together, the present observations indicate that acute THC administration does not affect running preference, performance, or motivation, suggesting in a more general manner that CB<sub>1</sub> receptor stimulation does not bear an effect on running. Although there is biochemical (Diez-Alarcia et al., 2016) and behavioural (Panagis et al., 2014) evidence for functional differences between THC and prototypical CB<sub>1</sub> receptor agonists, our results suggest that stimulation of CB<sub>1</sub> receptors cannot boost running when these receptors are already endogenously stimulated by endocannabinoids. If true, it is then expected that overstimulating these receptors, e.g. by blocking endocannabinoid degradation, would be without impact on running variables. In keeping with the key role of 2-AG in the control of VTA dopaminergic activity (and hence reward processes) by the endocannabinoid system (Covey et al., 2018; Oleson et al., 2014; Oleson et al., 2012; but see Wiebelhaus et al., 2015), we thus tested the impact of the MAGL inhibitor JZL184. As observed with THC, a mouse treatment regimen (8 mg/kg, 2 h beforehand) shown to increase tissue 2-AG levels (Busquets-García et al., 2011; Long et al., 2009a) and to increase motivation for alcohol (Gianessi et al., 2020), affected neither running motivation nor running seeking. Our results suggest that potentiating the endocannabinoid tone (and hence CB<sub>1</sub> receptor stimulation) through inhibition of 2-AG degradation does not further increase the drive for running. On the other hand, this raises the possibility that increasing the endocannabinoid tone through degradation of the other major endocannabinoid, namely anandamide (AEA), might have led to a different result. This suggestion is at first sight supported by the observation that acute exercise increases circulating levels of AEA, but not 2-AG, in humans (Hillard, 2018). However, except for one study

which also observed an increase in AEA levels (Fuss et al., 2015), the other analyses of blood endocannabinoid levels in trained rodents exposed to acute wheel-running sessions did not detect changes in endocannabinoid levels (Chaouloff et al., 2012; Thompson et al., 2017). Moreover, studies aimed at examining the impact of acute wheel-running on brain endocannabinoids failed to detect significant increases (Chaouloff et al., 2012; Fuss et al., 2015; Thompson et al., 2017), a result which might be accounted for by the time lag between brain sampling and exercise onset and/or the likeliness that changes in endocannabinoid release with exercise are too discrete with regard to their location to be observed in gross tissue samples. Although we cannot discard the possibility that increasing AEA levels or both AEA and 2-AG levels might boost running motivation and/or seeking, the following observations are noteworthy. First, systemic administration of a dual inhibitor of MAGL and of the AEA-degrading enzyme, fatty acid amide hydrolase (FAAH), namely JZL195 (Long et al., 2009b), decreased wheel-running performance (Dubreucq et al., 2013). When locally perfused in the VTA, JZL195 lacked impact on wheel-running performance (Dubreucq et al., 2013). Lastly, administration of URB597, a selective FAAH inhibitor (Kathuria et al., 2003), using an effective protocol in mice (1–3 mg/kg, 1 h beforehand; Busquets-García et al., 2011) also failed to alter wheel-running performance (unpublished observations). Although these observations might suggest that inhibition of AEA degradation does not boost running motivation, a direct examination of this suggestion will require JZL195- and/or URB597-treated mice exposed to PR reinforcement schedules.

Although this study is the first to dissect the relationship between THC and running drive, its relevance to human exercise is hampered by several limitations. Firstly, we exclusively used THC even though cannabis is composed of hundreds of ingredients, including cannabidiol (CBD), which shares anxiolytic and analgesic properties with THC and modulates the negative impacts of THC (Curran et al., 2016; Elsaid et al., 2019). Indeed, while acute THC administration to humans decreases motivation – as assessed by an effort task – to earn money, this amotivation effect is buffered when CBD is added to THC (Lawn et al., 2016). Moreover, it is the combination of THC and CBD, as compared to either compound alone, that is the most frequently linked to well-being effects in sport (Zeiger et al., 2019). Although these studies illustrate the need to include CBD with THC in animal studies aimed at deciphering the effects of human cannabis, it is noteworthy that the THC content of street cannabis has recently increased at the expense of CBD content. Because THC mediates the rewarding value of cannabis (Curran et al., 2016) and hence its addictive properties, it is thus likely that THC is the main cannabinoid that mediates cannabis usage by sportspeople. The second limit lies in the acute use of THC in animals never exposed to the cannabinoid beforehand. This contrasts with the human situation wherein sportspeople using cannabis before and/or after exercise are chronic cannabis consumers. One consequence of such a chronic usage is the observation that exercise increases THC circulating levels (Wong et al., 2013) following THC long-term storage in, and release from, fat tissues (Kreuz and Axelrod, 1973). Accordingly, the kinetics of THC entry into the brain should differ from those triggered by its acute administration in naive individuals, with possible impacts on running. Another limit of the acute use of THC relates to the intrinsic impact of prior chronic cannabis/THC ingestion on motivation processes. As indicated above, chronic cannabis usage leads to amotivation, in line with the negative effects of chronic use on mesocorticolimbic dopaminergic activity (Bloomfield et al., 2016). However, this might not include motivation for exercise owing to the significant number of cannabis users who are regular exercisers. The paucity of animal data on that issue does not help to solve this question as, to our knowledge, only three studies examined the consequences of repeated THC administration on wheel-running. In fact, different doses of THC proved ineffective on wheel-running performance in fed rats (Scherma et al., 2017). Moreover, repeated THC treatment to food-restricted animals increased food intake whilst decreasing (Verty et al., 2011) or

not effecting (Lewis and Brett, 2010) wheel-running performance. Taken together, these data suggest that repeated THC administration does not boost running performance.

One last limit of the present study is linked to our noncontingent THC administration protocol. Indeed, self-administration of drugs associated with specific cues and contexts is more relevant to human drug usage. For example, cued-cocaine self-administration has longer-lasting synaptic impacts on VTA dopaminergic neurones, compared with noncontingent cocaine administration (Chen et al., 2008). This is also true for wheel-running as the amplitude of the acute running-elicited potentiation of excitatory inputs to VTA dopaminergic neurones is higher when running is cued, compared to free running (Medrano et al., 2020). However, although THC self-administration is observed in monkeys (Justinova et al., 2005), this procedure has proven to be difficult to introduce in laboratory rodents (but see: Melis et al., 2017; Smoker et al., 2019; Spencer et al., 2018; Zangen et al., 2006). This difficulty is mainly due to the poor reinforcing properties of THC in these species (Panagis et al., 2014) and the main use of the intravenous, as opposed to the inhalation, route of administration (Melis et al., 2017). Recently, a study reported the successful development of a cued-THC (or CBD) self-administration procedure wherein rats are willing to exert effort to inhale either of these cannabis ingredients under FR and PR reinforcement schedules (Freels et al., 2020). The use of this paradigm should thus prove useful to dissect the relationships between the respective drives for cannabis and exercise.

## 5. Conclusion

This study is the first to examine the consequences of acute THC administration on running preference and performance in a T-maze task, and on running motivation in a cued-running instrumental task. Although running preference and motivation are tonically controlled by CB<sub>1</sub> receptors, THC proved ineffective on these two variables. This ineffectiveness contrasted with the stimulating impact of THC on palatable feeding motivation. Lastly, THC also proved unable to affect cued-induced reinstatement of running seeking. Future works using chronic THC treatment regimens with or without other cannabis ingredients such as CBD should help define cannabis' effects in human sportspeople.

## Ethical statement

Animal procedures, which complied with the French (Décret 2013-118) and European (2010/63/EU) rules on animal experimentation, were approved by the local Ethic Committee (Comité d'Ethique 50) with agreement numbers 33-063-69 and 22435 (F.C.) and A33-063-098 (animal facilities) provided under authority of the Préfecture de Gironde and the French Ministry of Agriculture.

## Authors contribution

I.H., C.M., B.R., G.M., and F.C. contributed to the conception and design of the study, I.H., C.M., B.R., and F.C. participated in acquisition and analyses of the data, F.C. drafted the article, I.H., C.M., B.R., G.M., and F.C. revised the article and approved its final version.

## Declaration of Competing Interest

The authors declare no conflicts of interest.

## Acknowledgements

We thank Lucie Cabiro for technical help, Dr. Alex Fletcher-Jones for English correction and editing, and all the personnel from the Animal Facility and the Genotyping platform of the NeuroCentre Magendie. We also thank Virginie Morales and the other members of

Marsicano's laboratory for their daily support and for useful discussions. This work was supported by the Agence Française de Lutte contre le Dopage (AFLD, to F.C.), l'Institut National de la Santé et de la Recherche Médicale (to G.M.), la Région Aquitaine (to G.M.), the European Research Council (ERC-2017-AdG-786467 to G.M.), the University of Bordeaux (to G.M.), the Ministère de l'Enseignement Supérieur, de la Recherche et de l'Innovation (to B.R.), and the Basque Government (POS-2013-1-177 to C.M.).

## References

- Andre, C.M., Hausman, J.F., Guerriero, G., 2016. Cannabis sativa: the plant of the thousand and one molecules. *Front. Plant Sci.* 7 (19).
- Anggadiredja, K., Nakamichi, M., Hiranita, T., Tanaka, H., Shoyama, Y., Watanabe, S., Yamamoto, T., 2004. Endocannabinoid system modulates relapse to methamphetamine seeking: possible mediation by the arachidonic acid cascade. *Neuropsychopharmacology* 29 (8), 1470–1478.
- Barbano, M.F., Castañé, A., Martín-García, E., Maldonado, R., 2009. Delta-9-tetrahydrocannabinol enhances food reinforcement in a mouse operant conflict test. *Psychopharmacology* 205 (3), 475–487.
- Belke, T.W., Garland Jr., T., 2007. A brief opportunity to run does not function as a reinforcer for mice selected for high daily wheel-running rates. *J. Exp. Anal. Behav.* 88 (2), 199–213.
- Belke, T.W., Wagner, J.P., 2005. The reinforcing property and the rewarding aftereffect of wheel running in rats: a combination of two paradigms. *Behav. Proc.* 68 (2), 165–172.
- Bellocchio, L., Lafenêtre, P., Cannich, A., Cota, D., Puente, N., Grandes, P., Chaouloff, F., Piazza, P.V., Marsicano, G., 2010. Bimodal control of stimulated food intake by the endocannabinoid system. *Nat. Neurosci.* 13 (3), 281–283.
- Bloomfield, M.A., Ashok, A.H., Volkow, N.D., Howes, O.D., 2016. The effects of  $\Delta^9$ -tetrahydrocannabinol on the dopamine system. *Nature* 539 (7629), 369–377.
- Bossong, M.G., Mehta, M.A., van Berckel, B.N., Howes, O.D., Kahn, R.S., Stokes, P.R., 2015. Further human evidence for striatal dopamine release induced by administration of  $\Delta^9$ -tetrahydrocannabinol (THC): selectivity to limbic striatum. *Psychopharmacology* 232 (15), 2723–2729.
- Bouaboula, M., Perrachon, S., Milligan, L., Canat, X., Rinaldi-Carmona, M., Portier, M., Barth, F., Calandra, B., Pecceu, F., Lupker, J., Maffrand, J.-P., Le Fur, G., Casellas, P., 1997. A selective inverse agonist for central cannabinoid receptor inhibits mitogen-activated protein kinase activation stimulated by insulin or insulin-like growth factor 1. *J. Biol. Chem.* 272 (35), 22330–22339.
- Branch, S.Y., Goertz, R.B., Sharpe, A.L., Pierce, J., Roy, S., Ko, D., Paladini, C.A., Beckstead, M.J., 2013. Food restriction increases glutamate receptor-mediated burst firing of dopamine neurons. *J. Neurosci.* 33 (34), 13861–13872.
- Busquets-García, A., Puighearnal, E., Pastor, A., de la Torre, R., Maldonado, R., Ozaita, A., 2011. Differential role of anandamide and 2-arachidonoylglycerol in memory and anxiety-like responses. *Biol. Psychiatry* 70 (5), 479–486.
- Busquets-García, A., Soria-Gómez, E., Redon, B., Mackenbach, Y., Vallée, M., Chaouloff, F., Varilh, M., Ferreira, G., Piazza, P.V., Marsicano, G., 2017. Pregnenolone blocks cannabinoid-induced acute psychotic-like states in mice. *Mol. Psychiatry* 22 (11), 1594–1603.
- Cadoni, C., Solinas, M., Valentini, V., Di Chiara, G., 2003. Selective psychostimulant sensitization by food restriction: differential changes in accumbens shell and core dopamine. *Eur. J. Neurosci.* 18 (8), 2326–2334.
- Chaouloff, F., Dubreucq, S., Bellocchio, L., Marsicano, G., 2011. Endocannabinoids and motor behavior: CB1 receptors also control running activity. *Physiology* 26 (2), 76–77.
- Chaouloff, F., Dubreucq, S., Matias, I., Marsicano, G., 2012. Physical Activity Feel-good Effect: The Role of Endocannabinoids. *Routledge Handbook of Physical Activity and Mental Health*, Routledge, London, pp. 71–87.
- Chen, J., Marmur, R., Pulles, A., Paredes, W., Gardner, E.L., 1993. Ventral tegmental microinjection of delta 9-tetrahydrocannabinol enhances ventral tegmental somatodendritic dopamine levels but not forebrain dopamine levels: evidence for local neural action by marijuana's psychoactive ingredient. *Brain Res.* 621 (1), 65–70.
- Chen, B.T., Bowers, M.S., Martin, M., Hopf, F.W., Guillery, A.M., Carelli, R.M., Chou, J.K., Bonci, A., 2008. Cocaine but not natural reward self-administration nor passive cocaine infusion produces persistent LTP in the VTA. *Neuron* 59 (2), 288–297.
- Collier, G.H., Hirsch, E., 1971. Reinforcing properties of spontaneous activity in the rat. *J. Comp. Physiol. Psychol.* 77 (1), 155–160.
- Corre, J., van Zessen, R., Loureiro, M., Patriarchi, T., Tian, L., Pascoli, V., Lüscher, C., 2018. Dopamine neurons projecting to medial shell of the nucleus accumbens drive heroin reinforcement. *Elife* 7, e39945.
- Correa, M., Pardo, M., Bayarri, P., López-Cruz, L., San Miguel, N., Valverde, O., Ledent, C., Salamone, J.D., 2016. Choosing voluntary exercise over sucrose consumption depends upon dopamine transmission: effects of haloperidol in wild type and adenosine A<sub>2A</sub>KO mice. *Psychopharmacology* 233 (3), 393–404.
- Covey, D.P., Mateo, Y., Sulzer, D., Cheer, J.F., Lovinger, D.M., 2017. Endocannabinoid modulation of dopamine neurotransmission. *Neuropharmacology* 124, 52–61.
- Covey, D.P., Dantrassy, H.M., Yohn, S.E., Castro, A., Conn, P.J., Mateo, Y., Cheer, J.F., 2018. Inhibition of endocannabinoid degradation rectifies motivational and dopaminergic deficits in the Q175 mouse model of Huntington's disease. *Neuropsychopharmacology* 43 (10), 2056–2063.
- Curran, H.V., Freeman, T.P., Mokrysz, C., Lewis, D.A., Morgan, C.J., Parsons, L.H., 2016.

- Keep off the grass? Cannabis, cognition and addiction. *Nat. Rev. Neurosci.* 17 (5), 293–306.
- De Vries, T.J., Schoffelmeer, A.N., 2005. Cannabinoid CB1 receptors control conditioned drug seeking. *Trends Pharmacol. Sci.* 26 (8), 420–426.
- De Vries, T.J., Shaham, Y., Homberg, J.R., Crombag, H., Schuurman, K., Dieben, J., Vanderschuren, L.J., Schoffelmeer, A.N., 2001. A cannabinoid mechanism in relapse to cocaine seeking. *Nat. Med.* 7 (10), 1151–1154.
- Diez-Alarcia, R., Ibarra-Lecue, I., Lopez-Cardona, Á.P., Meana, J., Gutierrez-Adán, A., Callado, L.F., Agirregoitia, E., Urigüen, L., 2016. Biased agonism of three different cannabinoid receptor agonists in mouse brain cortex. *Front. Pharmacol.* 7, 415.
- Domingo-Rodríguez, L., Ruiz de Azua, I., Dominguez, E., Senabre, E., Serra, I., Kummer, S., Navandar, M., Baddenhausen, S., Hofmann, C., Andero, R., Gerber, S., Navarrete, M., Dierssen, M., Lutz, B., Martín-García, E., Maldonado, R., 2020. A specific pre-limbic-nucleus accumbens pathway controls resilience versus vulnerability to food addiction. *Nat. Commun.* 11 (1), 782.
- Dubreucq, S., Koehl, M., Abrous, D.N., Marsicano, G., Chaouloff, F., 2010. CB1 receptor deficiency decreases wheel-running activity: consequences on emotional behaviours and hippocampal neurogenesis. *Exp. Neurol.* 224 (1), 106–113.
- Dubreucq, S., Durand, A., Matias, I., Bénard, G., Richard, E., Soria-Gomez, E., Glangetas, C., Groc, L., Wadleigh, A., Massa, F., Bartsch, D., Marsicano, G., Georges, F., Chaouloff, F., 2013. Ventral tegmental area cannabinoid type-1 receptors control voluntary exercise performance. *Biol. Psychiatry* 73 (9), 895–903.
- Ducharme, J., 2019. Many Marijuana Users Turn to the Drug for a Surprising Reason: Workout Fuel. *Time* May 7 2019. <https://time.com/5582780/marijuana-exercise/>.
- Elsaid, S., Kloiber, S., Le Foll, B., 2019. Effects of cannabidiol (CBD) in neuropsychiatric disorders: a review of pre-clinical and clinical findings. *Prog. Mol. Biol. Transl. Sci.* 167, 25–75.
- Fattore, L., Spano, M.S., Cossu, G., Deiana, S., Fratta, W., 2003. Cannabinoid mechanism in reinstatement of heroin-seeking after a long period of abstinence in rats. *Eur. J. Neurosci.* 17 (8), 1723–1726.
- Fernandes, M.F., Matthys, D., Hryhorczuk, C., Sharma, S., Mogra, S., Alquier, T., Fulton, S., 2015. Leptin suppresses the rewarding effects of running via STAT3 signaling in dopamine neurons. *Cell Metab.* 22 (4), 741–749.
- Freels, T.G., Baxter-Potter, L.N., Lugo, J.M., Glodskoy, N.C., Wright, H.R., Baglot, S.L., Petrie, G.N., Yu, Z., Clowers, B.H., Cuttler, C., Fuchs, R.A., Hill, M.N., McLaughlin, R.J., 2020. Vaporized cannabis extracts have reinforcing properties and support conditioned drug-seeking behavior in rats. *J. Neurosci.* 40 (9), 1897–1908.
- French, E.D., Dillon, K., Wu, X., 1997. Cannabinoids excite dopamine neurons in the ventral tegmentum and substantia nigra. *Neuroreport* 8 (3), 649–652.
- Fuss, J., Steinle, J., Bindila, L., Auer, M.K., Kirchherr, H., Lutz, B., Gass, P., 2015. A runner's high depends on cannabinoid receptors in mice. *Proc. Natl. Acad. Sci. U. S. A.* 112 (42), 13105–13108.
- Gianessi, C.A., Groman, S.M., Thompson, S.L., Jiang, M., van der Stelt, M., Taylor, J.R., 2020. Endocannabinoid contributions to alcohol habits and motivation: relevance to treatment. *Addict. Biol.* 25 (3), e12768.
- Gillman, A.S., Hutchison, K.E., Bryan, A.D., 2015. Cannabis and exercise science: a commentary on existing studies and suggestions for future directions. *Sports Med.* 45 (10), 1357–1363.
- Good, C.H., Lupica, C.R., 2010. Afferent-specific AMPA receptor subunit composition and regulation of synaptic plasticity in midbrain dopamine neurons by abused drugs. *J. Neurosci.* 30 (23), 7900–7909.
- Gourley, S.L., Taylor, J.R., 2016. Going and stopping: dichotomies in behavioral control by the prefrontal cortex. *Nat. Neurosci.* 19 (6), 656–664.
- Han, X., He, Y., Bi, G.H., Zhang, H.Y., Song, R., Liu, Q.R., Egan, J.M., Gardner, E.L., Li, J., Xi, Z.X., 2017. CB1 receptor activation on Vglut2-expressing glutamatergic neurons underlies  $\Delta^9$ -tetrahydrocannabinol ( $\Delta^9$ -THC)-induced aversive effects in mice. *Sci. Rep.* 7 (1), 12315.
- Hesse, J., 2016. Runner's high: the athletes who use marijuana to improve their training. *The Guardian* May 2 2016. <https://www.theguardian.com/society/2016/may/02/marijuana-athlete-running-performance-enhancing-drug>.
- Hill, W.F., 1961. Effects of activity deprivation on choice of an activity incentive. *J. Comp. Physiol. Psychol.* 54, 78–82.
- Hillard, C.J., 2018. Circulating endocannabinoids: from whence do they come and where are they going? *Neuropsychopharmacology* 43 (1), 155–172.
- Hodos, W., 1961. Progressive ratio as a measure of reward strength. *Science* 134 (3483), 943–944.
- Howe, M.W., Tierney, P.L., Sandberg, S.G., Phillips, P.E., Graybiel, A.M., 2013. Prolonged dopamine signalling in striatum signals proximity and value of distant rewards. *Nature* 500 (7464), 575–579.
- Huestis, M.A., Gorelick, D.A., Heishman, S.J., Preston, K.L., Nelson, R.A., Moolchan, E.T., Frank, R.A., 2001. Blockade of effects of smoked marijuana by the CB1-selective cannabinoid receptor antagonist SR141716. *Arch. Gen. Psychiatry* 58 (4), 322–328.
- Huestis, M.A., Mazzoni, I., Rabin, O., 2011. Cannabis in sport: anti-doping perspective. *Sports Med.* 41 (11), 949–966.
- Hurel, I., Redon, B., Scocard, A., Malezieux, M., Marsicano, G., Chaouloff, F., 2019. Beyond the activity-based anorexia model: reinforcing values of exercise and feeding examined in stressed adolescent male and female mice. *Front. Pharmacol.* 10, 587.
- Iversen, I.H., 1993. Techniques for establishing schedules with wheel-running as reinforcement in rats. *J. Exp. Anal. Behav.* 60 (1), 219–238.
- Justina, Z., Goldberg, S.R., Heishman, S.J., Tanda, G., 2005. Self-administration of cannabinoids by experimental animals and human marijuana smokers. *Pharmacol. Biochem. Behav.* 81 (2), 285–299.
- Kathuria, S., Gaetani, S., Fegley, D., Valiño, F., Duranti, A., Tontini, A., Mor, M., Tarzia, G., La Rana, G., Calignano, A., Giustino, A., Tattoli, M., Palmery, M., Cuomo, V., Piomelli, D., 2003. Modulation of anxiety through blockade of anandamide hydrolysis. *Nat. Med.* 9 (1), 76–81.
- Keeney, B.K., Raichlen, D.A., Meek, T.H., Wijeratne, R.S., Middleton, K.M., Gerdeman, G.L., Garland Jr., T., 2008. Differential response to a selective cannabinoid receptor antagonist (SR141716: rimonabant) in female mice from lines selectively bred for high voluntary wheel-running behaviour. *Behav. Pharmacol.* 19 (8), 812–820.
- Kennedy, M.C., 2017. Cannabis: exercise performance and sport. A systematic review. *J. Sci. Med. Sport* 20 (9), 825–829.
- Kreuz, D.S., Axelrod, J., 1973. Delta-9-tetrahydrocannabinol: localization in body fat. *Science* 179 (4071), 391–393.
- Lawn, W., Freeman, T.P., Pope, R.A., Joye, A., Harvey, L., Hindocha, C., Mokrysz, C., Moss, A., Wall, M.B., Bloomfield, M.A., Das, R.K., Morgan, C.J., Nutt, D.J., Curran, H.V., 2016. Acute and chronic effects of cannabinoids on effort-related decision-making and reward learning: an evaluation of the cannabis 'amotivational' hypotheses. *Psychopharmacology* 233 (19–20), 537–552.
- Lett, B.T., Grant, V.L., Koh, M.T., 2001. Naloxone attenuates the conditioned place preference induced by wheel running in rats. *Physiol. Behav.* 72 (3), 355–358.
- Lewis, D.Y., Brett, R.R., 2010. Activity-based anorexia in C57/BL6 mice: effects of the phytocannabinoid, delta9-tetrahydrocannabinol (THC) and the anandamide analogue, OMDM-2. *Eur. Neuropsychopharmacol.* 20 (9), 622–631.
- Lobb, C.J., Wilson, C.J., Paladini, C.A., 2010. A dynamic role for GABA receptors on the firing pattern of midbrain dopaminergic neurons. *J. Neurophysiol.* 104 (1), 403–413.
- Long, J.Z., Li, W., Booker, L., Burston, J.J., Kinsey, S.G., Schlosburg, J.E., Pavón, F.J., Serrano, A.M., Selley, D.E., Parsons, L.H., Lichtman, A.H., Cravatt, B.F., 2009a. Selective blockade of 2-arachidonoylglycerol hydrolysis produces cannabinoid behavioral effects. *Nat. Chem. Biol.* 5 (1), 37–44.
- Long, J.Z., Nomura, D.K., Vann, R.E., Walentiny, D.M., Booker, L., Jin, X., Burston, J.J., Sim-Selley, L.J., Lichtman, A.H., Wiley, J.L., Cravatt, B.F., 2009b. Dual blockade of FAAH and MAGL identifies behavioral processes regulated by endocannabinoid crosstalk in vivo. *Proc. Natl. Acad. Sci. U. S. A.* 106 (48), 20270–20275.
- Lorente, F.O., Peretti-Watel, P., Grelot, L., 2005. Cannabis use to enhance sportive and non-sportive performances among French sport students. *Addict. Behav.* 30 (7), 1382–1391.
- Lupica, C.R., Riegel, A.C., 2005. Endocannabinoid release from midbrain dopamine neurons: a potential substrate for cannabinoid receptor antagonist treatment of addiction. *Neuropharmacology* 48 (8), 1105–1116.
- Martín-García, E., Bourgoin, L., Cathala, A., Kasanetz, F., Mondesir, M., Gutiérrez-Rodríguez, A., Reguero, L., Fiancette, J.F., Grandes, P., Spampinato, U., Maldonado, R., Piazza, P.V., Marsicano, G., Deroche-Gamonet, V., 2016. Differential control of cocaine self-administration by GABAergic and Glutamatergic CB1 cannabinoid receptors. *Neuropsychopharmacology* 41 (9), 2192–2205.
- McGregor, I.S., Dam, K.D., Mallet, P.E., Gallate, J.E., 2005. Delta9-THC reinstates beer- and sucrose-seeking behaviour in abstinent rats: comparison with midazolam, food deprivation and predator odour. *Alcohol Alcohol.* 40 (1), 35–45.
- Medrano, M.-C., Hurel, I., Mesguich, E., Redon, B., Stevens, C., Georges, F., Melis, M., Marsicano, M., Chaouloff, F., 2020. Exercise craving potentiates excitatory inputs to ventral tegmental area dopaminergic neurons. *Addict. Biol.* (In press).
- Melis, M., Muntoni, A.L., Pistis, M., 2012. Endocannabinoids and the processing of value-related signals. *Front. Pharmacol.* 3, 7.
- Melis, M., Frau, R., Kalivas, P.W., Spencer, S., Chioma, V., Zamberletti, E., Rubino, T., Parolaro, D., 2017. New vistas on cannabis use disorder. *Neuropharmacology* 124, 62–72.
- Mendoza, J., Challet, E., 2014. Circadian insights into dopamine mechanisms. *Neuroscience* 282, 230–242.
- Miller, J.A., 2018. Turning to Marijuana for a Runner's High and More. *The New York Times* April 20 2018. <https://www.nytimes.com/2018/04/20/well/move/runners-high-marijuana-pot-sports-exercise-weed.html>.
- Muguruza, C., Redon, B., Fois, G.R., Hurel, I., Scocard, A., Nguyen, C., Stevens, C., Soria-Gomez, E., Varilh, M., Cannich, A., Daniault, J., Busquets-García, A., Pellier, T., Caillé, S., Georges, F., Marsicano, G., Chaouloff, F., 2019. The motivation for exercise over palatable food is dictated by cannabinoid type-1 receptors. *JCI Insight* 4 (5), e126190.
- Nguyen, T., 2019. Working out with weed. *Nature* 572 (7771), S14–S15.
- Oleson, E.B., Beckert, M.V., Morra, J.T., Lansink, C.S., Cachope, R., Abdullah, R.A., Loriaux, A.L., Schettler, D., Pattij, T., Roitman, M.F., Lichtman, A.H., Cheer, J.F., 2012. 2012. Endocannabinoids shape accumbal encoding of cue-motivated behavior via CB1 receptor activation in the ventral tegmentum. *Neuron* 73 (2), 360–373.
- Oleson, E.B., Cachope, R., Fitoussi, A., Tsutsui, K., Wu, S., Gallegos, J.A., Cheer, J.F., 2014. Cannabinoid receptor activation shifts temporally engendered patterns of dopamine release. *Neuropsychopharmacology* 39 (6), 1441–1452.
- Panagis, G., Mackey, B., Vlachou, S., 2014. Cannabinoid regulation of brain reward processing with an emphasis on the role of CB1 receptors: a step back into the future. *Front. Psychiatry* 5, 92.
- Pertwee, R.G., 2008. The diverse CB1 and CB2 receptor pharmacology of three plant cannabinoids: delta9-tetrahydrocannabinol, cannabidiol and delta9-tetrahydrocannabivarin. *Br. J. Pharmacol.* 153 (2), 199–215.
- Porsolt, R.D., Anton, G., Blavet, N., Jalife, M., 1978. Behavioural despair in rats: a new model sensitive to antidepressant treatments. *Eur. J. Pharmacol.* 47 (4), 379–391.
- Rasmussen, E.B., Hillman, C., 2011. Naloxone and rimonabant reduce the reinforcing properties of exercise in rats. *Exp. Clin. Psychopharmacol.* 19 (6), 389–400.
- Robinson, S., Sandstrom, S.M., Denenberg, V.H., Palmiter, R.D., 2005. Distinguishing whether dopamine regulates liking, wanting, and/or learning about rewards. *Behav. Neurosci.* 119 (1), 5–15.
- Rougé-Pont, F., Marinelli, M., Le Moal, M., Simon, H., Piazza, P.-V., 1995. Stress-induced sensitization and glucocorticoids. II. Sensitization of the increase in extracellular dopamine induced by cocaine depends on stress-induced corticosterone secretion. *J. Neurosci.* 15 (11), 7189–7195.
- Salamone, J.D., Cousins, M.S., Bucher, S., 1994. Anhedonia or anergia? Effects of



- haloperidol and nucleus accumbens dopamine depletion on instrumental response selection in a T-maze cost/benefit procedure. *Behav. Brain Res.* 65 (2), 221–229.
- Schenk, S., Partridge, B., 1999. Cocaine-seeking produced by experimenter-administered drug injections: dose-effect relationships in rats. *Psychopharmacology* 147 (3), 285–290.
- Scherma, M., Satta, V., Collu, R., Boi, M.F., Usai, P., Fratta, W., Fadda, P., 2017. Cannabinoid CB<sub>1</sub>/CB<sub>2</sub> receptor agonists attenuate hyperactivity and body weight loss in a rat model of activity-based anorexia. *Br. J. Pharmacol.* 174 (16), 2682–2695.
- Seely, K.A., Brents, L.K., Franks, L.N., Rajasekaran, M., Zimmerman, S.M., Fantegrossi, W.E., Prather, P.L., 2012. AM-251 and rimonabant act as direct antagonists at mu-opioid receptors: implications for opioid/cannabinoid interaction studies. *Neuropharmacology* 63 (5), 905–915.
- Shaham, Y., Shalev, U., Lu, L., de Wit, H., Stewart, J., 2003. The reinstatement model of drug relapse: history, methodology and major findings. *Psychopharmacology* 168 (1–2), 3–20.
- Sherwin, C.M., 1998. Voluntary wheel running: a review and novel interpretation. *Anim. Behav.* 56 (1), 11–27.
- Sidor, M.M., Spencer, S.M., Dzirasa, K., Parekh, P.K., Tye, K.M., Warden, M.R., Arey, R.N., Enwright, J.F., Jacobsen, J.P., Kumar, S., Remillard, E.M., Caron, M.G., Deisseroth, K., McClung, C.A., 2015. Daytime spikes in dopaminergic activity drive rapid mood-cycling in mice. *Mol. Psychiatry* 20 (11), 1406–1419.
- Smoker, M.P., Mackie, K., Lapish, C.C., Boehm, S.L., 2019. Self-administration of edible  $\Delta^9$ -tetrahydrocannabinol and associated behavioral effects in mice. *Drug Alcohol Depend.* 199, 106–115.
- Spencer, S., Neuhofer, D., Chioma, V.C., Garcia-Keller, C., Schwartz, D.J., Allen, N., Scofield, M.D., Ortiz-Ithier, T., Kalivas, P.W., 2018. A model of  $\Delta^9$ -tetrahydrocannabinol self-administration and reinstatement that alters synaptic plasticity in nucleus accumbens. *Biol. Psychiatry* 84 (8), 601–610.
- Stuber, G.D., Evans, S.B., Higgins, M.S., Pu, Y., Figlewicz, D.P., 2002. Food restriction modulates amphetamine-conditioned place preference and nucleus accumbens dopamine release in the rat. *Synapse* 46 (2), 83–90.
- Tanda, G., Pontieri, F.E., Di Chiara, G., 1997. Cannabinoid and heroin activation of mesolimbic dopamine transmission by a common mu1 opioid receptor mechanism. *Science* 276 (5321), 2048–2050.
- Thoeni, S., Loureiro, M., O'Connor, E.C., Lüscher, C., 2020. Depression of accumbal to lateral hypothalamic synapses gate overeating. *Neuron* 107 (1), 158–172.
- Thompson, Z., Argueta, D., Garland Jr., T., Di Patrizio, N., 2017. Circulating levels of endocannabinoids respond acutely to voluntary exercise, are altered in mice selectively bred for high voluntary wheel running, and differ between the sexes. *Physiol. Behav.* 170, 141–150.
- van Zessen, R., Phillips, J.L., Budygin, E.A., Stuber, G.D., 2012. Activation of VTA GABA neurons disrupts reward consumption. *Neuron* 73 (6), 1184–1194.
- Venniro, M., Caprioli, D., Shaham, Y., 2016. Animal models of drug relapse and craving: from drug priming-induced reinstatement to incubation of craving after voluntary abstinence. *Prog. Brain Res.* 224, 25–52.
- Verty, A.N., Evetts, M.J., Crouch, G.J., McGregor, I.S., Stefanidis, A., Oldfield, B.J., 2011. The cannabinoid receptor agonist THC attenuates weight loss in a rodent model of activity-based anorexia. *Neuropsychopharmacology* 36 (7), 1349–1358.
- Wachtel, S.R., ElSohly, M.A., Ross, S.A., Ambre, J., de Wit, H., 2002. Comparison of the subjective effects of Delta(9)-tetrahydrocannabinol and marijuana in humans. *Psychopharmacology* 161 (4), 331–339.
- Ward, S.J., Walker, E.A., Dykstra, L.A., 2007. Effect of cannabinoid CB1 receptor antagonist SR141716A and CB1 receptor knockout on cue-induced reinstatement of ensure and corn-oil seeking in mice. *Neuropsychopharmacology* 32 (12), 2592–2600.
- Ware, M.A., Jensen, D., Barrette, A., Vernec, A., Derman, W., 2018. Cannabis and the health and performance of the elite athlete. *Clin. J. Sport Med.* 28 (5), 480–484.
- Wiebelhaus, J.M., Grim, T.W., Owens, R.A., Lazenka, M.F., Sim-Selley, L.J., Abdullah, R.A., Niphakis, M.J., Vann, R.E., Cravatt, B.F., Wiley, J.L., Negus, S.S., Lichtman, A.H., 2015.  $\Delta^9$ -Tetrahydrocannabinol and endocannabinoid degradative enzyme inhibitors attenuate intracranial self-stimulation in mice. *J. Pharmacol. Exp. Ther.* 352 (2), 195–207.
- Wong, A., Montebello, M.E., Norberg, M.M., Rooney, K., Lintzeris, N., Bruno, R., Booth, J., Arnold, J.C., McGregor, I.S., 2013. Exercise increases plasma THC concentrations in regular cannabis users. *Drug Alcohol Depend.* 133 (2), 763–767.
- YorkWilliams, S.L., Gust, C.J., Mueller, R., Bidwell, L.C., Hutchison, K.E., Gillman, A.S., Bryan, A.D., 2019. The new runner's high? Examining relationships between cannabis use and exercise behavior in states with legalized cannabis. *Front. Public Health* 7, 99.
- Zangen, A., Solinas, M., Ikemoto, S., Goldberg, S.R., Wise, R.A., 2006. Two brain sites for cannabinoid reward. *J. Neurosci.* 26 (18), 4901–4907.
- Zeiger, J.S., Silvers, W.S., Flegler, E.M., Zeiger, R.S., 2019. Cannabis use in active athletes: Behaviors related to subjective effects. *PLoS One* 14 (6), e0218998.
- Zhang, H.Y., Gao, M., Liu, Q.R., Bi, G.H., Li, X., Yang, H.J., Gardner, E.L., Wu, J., Xi, Z.X., 2014. Cannabinoid CB2 receptors modulate midbrain dopamine neuronal activity and dopamine-related behavior in mice. *Proc. Natl. Acad. Sci. U. S. A.* 111 (46), E5007–E5015.
- Zhou, D., Shearman, L.P., 2004. Voluntary exercise augments acute effects of CB1-receptor inverse agonist on body weight loss in obese and lean mice. *Pharmacol. Biochem. Behav.* 77 (1), 117–125.

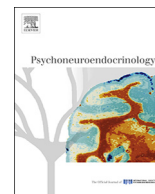
# ANNEX 4

The ergogenic impact of the glucocorticoid prednisolone does not translate into increased running motivation in mice

Psychoneuroendocrinology 2019;111:104489

**Bastien Redon**, Claire Violleau, François Georges, Giovanni Marsicano, Francis Chaouloff





# The ergogenic impact of the glucocorticoid prednisolone does not translate into increased running motivation in mice

Bastien Redon<sup>a,b</sup>, Claire Violleau<sup>a,b</sup>, François Georges<sup>b,c</sup>, Giovanni Marsicano<sup>a,b</sup>, Francis Chaouloff<sup>a,b,\*</sup>

<sup>a</sup> Endocannabinoids & NeuroAdaptation, NeuroCentre INSERM U1215, 33077 Bordeaux, France

<sup>b</sup> Université de Bordeaux, 33077 Bordeaux, France

<sup>c</sup> Neurodegenerative Diseases Institute, CNRS UMR 5293, 33077 Bordeaux, France

## ARTICLE INFO

### Keywords:

Wheel-running  
Operant conditioning  
Progressive ratio  
Grid-hanging test  
Glucocorticoid  
Motivation

## ABSTRACT

Glucocorticoids, such as prednisolone, are considered sport doping agents owing to their ergogenic properties. These are accounted for by peripheral mechanisms associated with energetic and anti-inflammatory processes. However, because glucocorticoids target brain tissues, it is likely that these ergogenic impacts are associated with central effects. One of these might be reward motivation, which relies on glucocorticoid receptor-expressing mesocorticolimbic dopaminergic neurons. In keeping with this possibility, this study has explored in mice whether repeated prednisolone administration (5 or 15 µg/ml of drinking water for 10 days) affected intrinsic motivation for running, a strong reinforcer in rodents. Running motivation was assessed by means of a cued-reward motivated instrumental task wherein wheel-running was conditioned by prior nose poke responses under fixed (FR), and then progressive (PR), ratio reinforcement schedules. Sub-chronic ingestion of prednisolone decreased the running distance covered during each rewarded sequence under FR schedules. This finding did not extend to wheel-running performances in mice provided free (i.e. unconditioned) wheel-running opportunities. Running motivation, as estimated under a PR reinforcement schedule, was found to be decreased (lowest concentration) or to remain unaffected (highest concentration) by prednisolone concentration. Lastly, an inter-individual analysis of the respective effects of prednisolone on muscular endurance (as assessed in the wire grid-hanging test) and on running motivation indicated that the former was not predictive of the latter. This observation suggests that prednisolone ergogenic impacts might occur without any concomitant increase in intrinsic exercise motivation.

## 1. Introduction

The World Anti-Doping Agency (WADA) has established lists of substances that are considered to be sport doping agents on the basis of three criteria: performance enhancers, health risk factors and/or spirit of sport threateners (World Antidoping Agency (WADA), 2019). Owing to their ergogenic properties, glucocorticoids, such as prednisolone, are forbidden when used in-, but not out-, competition (World Antidoping Agency (WADA), 2019). These physical performance-enhancing properties are thought to be accounted for by their peripheral actions as both endogenous (cortisone and cortisol produced from the human adrenal cortex) and exogenous glucocorticoids primarily stimulate hepatic and adipose metabolic pathways as to provide muscular energy (Magomedova and Cummins, 2016). In addition, glucocorticoids are endowed with anti-inflammatory properties which ease respiration and

prevent muscle and joint pains (Adcock and Mumby, 2016), all these effects facilitating physical performance and after-exercise recovery (Duclos, 2010).

Besides their peripheral origins, the doping impacts of glucocorticoids have been suggested to involve several of their central effects. Whereas evidence for centrally-mediated changes in the secretion of several hormones brings direct support to this hypothesis (Collomp et al., 2016; Duclos, 2010), it remains to establish that other central effects of glucocorticoid on e.g. mood, anxiety, hedonia (De Kloet et al., 2005; Piazza and Le Moal, 1997) are relevant to doping protocols. Corticosteroid receptors, whether of the mineralocorticoid receptor (MR) or of the glucocorticoid receptor (GR) subtype, are present in numerous brain regions, albeit in an uneven manner (De Kloet et al., 2005; McEwen et al., 1986). When bound by natural or exogenous corticoids, these receptors, located both in neurons and astrocytes, then

\* Corresponding author at: Endocannabinoids & NeuroAdaptation, NeuroCentre INSERM U1215, 146 rue Léo Saignat, 33077 Bordeaux, France.

E-mail address: [francis.chaouloff@inserm.fr](mailto:francis.chaouloff@inserm.fr) (F. Chaouloff).

act either at cell membranes, doing so with rapid consequences, or in cell nuclei, doing so as transcription factors, and hence with longer delays (Chaouloff and Groc, 2011; Joëls, 2018). GRs, which bear low affinity for cortisol (human) or corticosterone (rodent), as compared to MRs, are present within the mesocorticolimbic system (Ambroggi et al., 2009; Härfstrand et al., 1986), a tractus exerting a key role in motivation processes (Koob and Volkow, 2016; Nestler, 2005). Hence, glucocorticoids have been reported to impact, albeit in different directions, the motivation for natural rewards (e.g. food: Gourley et al., 2008) and drugs of abuse (e.g. cocaine and amphetamine: Goeders, 2002; Piazza and le Moal, 1997; but see Graf et al., 2013; Mantsch et al., 1998). Motivation for exercise, whether intrinsic (i.e. for the pleasure of exercise) or extrinsic (i.e. for healthy reasons or for an award, whether a medal or a record), is a prerequisite for exercise training. As such, the above mentioned results raise the hypothesis that besides its ergogenic consequences glucocorticoid administration, by targeting the mesocorticolimbic system, actually stimulates exercise motivation. To our knowledge, this hypothesis has never been tested so far. The use of wheel-running in rodents, a model of volitional exercise, has indicated that high concentrations of corticosterone (as to stimulate GRs) or administration of glucocorticoids either decrease (Menezes et al., 1985) or prove ineffective (Cobos et al., 2012; Duclos et al., 2009; Yau et al., 2011) on running performance. However, the use of running performance as an index of running motivation is misleading. Thus, overall consumption of a reward when the latter is provided freely (i.e. without any effort prerequisite for its access), as is the case for the "free" wheel-running paradigm, is accounted for by both motivation for that reward and its consumption, i.e. two reward-related dimensions with different neurobiological grounds (Salamone and Correa, 2012). An appropriate estimation of running motivation requires the measurement of the maximal quantity of efforts the animals are able to achieve ("wanting" dimension) to then exert their running activity ("consumption" of the wheel linked to the "liking" dimension) (Berridge, 2007; Salamone and Correa, 2012). The sole paradigm allowing such a measurement relies on operant conditioning procedures whereby animals first need to lever-press or to nose-poke under fixed ratio (FR) schedules of reinforcement before their motivation is tested under a progressive ratio (PR) reinforcement schedule (Hodos, 1961). Although several studies have used such a cued-reward motivated instrumental task to assess running motivation in rats (Collier and Hirsch, 1971; Iversen, 1993) or mice (Belke and Garland, 2007; Hurel et al., 2019; Muguruza et al., 2019), none of them has examined the respective impacts of glucocorticoids on the motivation and consumption dimensions of wheel-running rewarding properties.

In keeping with the data reported above, the present mouse study first investigated whether subchronic ingestion of two concentrations of the glucocorticoid prednisolone increased conditioned exercise motivation and consumption (i.e. performance) whilst proving ergogenic. For running motivation analyses, we used our recently developed model wherein mice have to nose-poke under FR, and then PR, schedules of reinforcement to unbrake a running wheel (Hurel et al., 2019; Muguruza et al., 2019). The ergogenic impact of prednisolone was assessed by the wire grid-hanging test, a paradigm that provides an index of muscular resistance (Morrison-Nozik et al., 2015). The aforementioned inability of free running paradigms to discriminate between running motivation and consumption led us to perform a second series of experiments wherein mice provided a permanent free (i.e. unconditioned) access to running wheels were analyzed for the impact of ergogenic concentrations of prednisolone on running performance.

## 2. Materials and methods

### 2.1. Animals

All protocols, which complied with the French (Décret 2013-118) and European (2010/63/EU) rules on animal experimentation, were

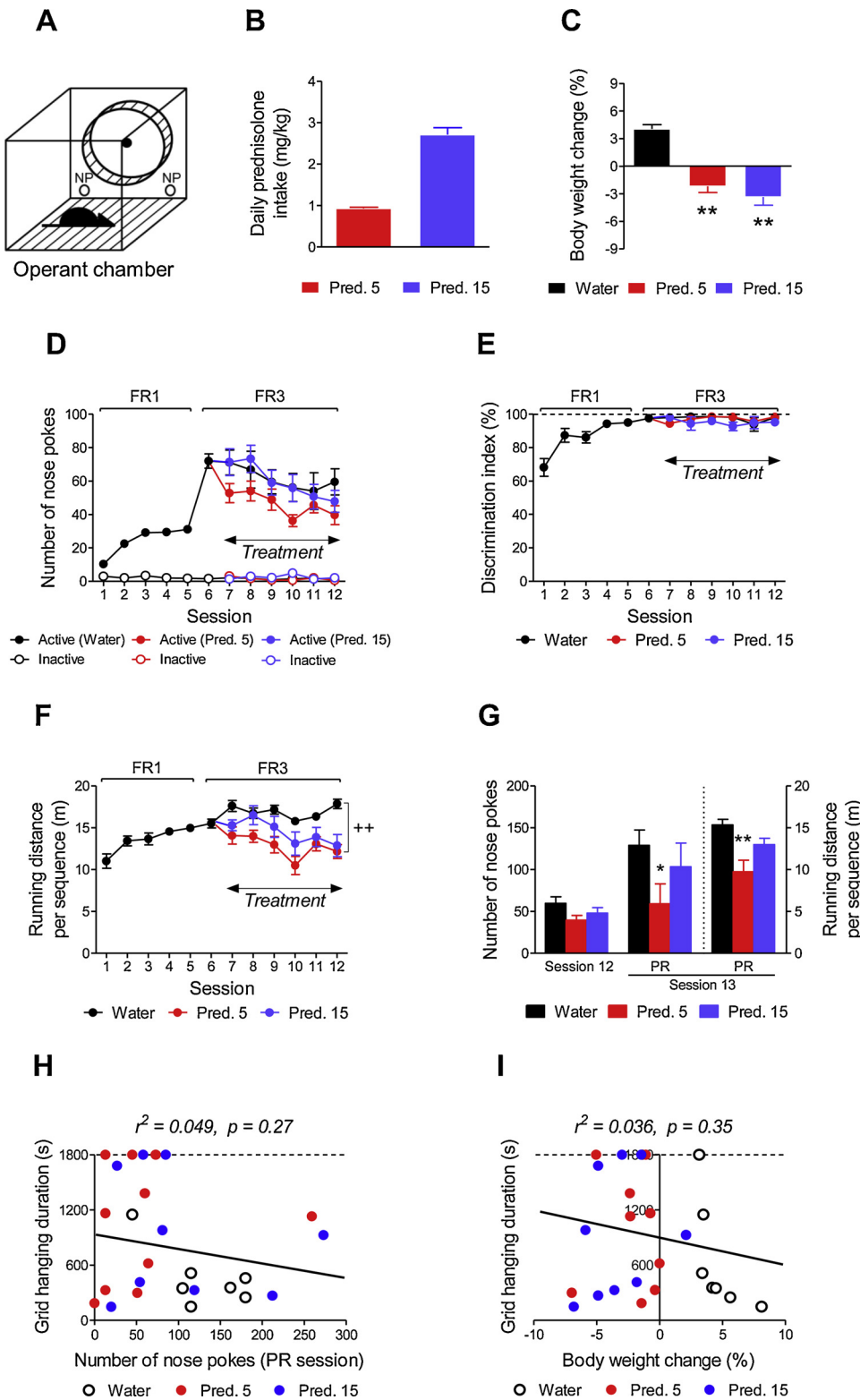
approved by the local Ethic Committee (Comité d'Ethique 50) with agreement numbers DIR13111, 13649, 33-063-69 (F.C.) and A33-063-098 (animal facilities) provided under authority of the Préfecture de Gironde and the Ministry of Agriculture.

This study used male C57BL/6N mice (Elevage Janvier, Le Genest Saint Isle, France), aged 8-week-old upon arrival in our animal facilities. For operant conditioning studies, mice were individually housed in standard mouse cages (with nesting material) whilst for free running performance studies a second batch of animals was housed in cages with a running wheel (25-cm diameter, Intellibio, Seichamps, France). All mice were placed in a thermoregulated room (21–22 °C) under a partly inverted 12-h light/12-h dark cycle (lights off at 10.00 AM). Mice, which were tested between 11.00 AM and 5.00 PM during the active phase of the diurnal cycle, were provided with *ad libitum* food and water, including when prednisolone was added to water (see below).

### 2.2. Operant conditioning protocols

As previously reported (Muguruza et al., 2019), motivation for wheel-running was studied in 12 individual operant chambers (28-cm long x 26-cm wide x 38-cm high; Imetronic, Pessac, France) located in a room adjacent to the animal housing room. Their rear wall had a central hollow for mounting the 20-cm diameter wheel, the release trigger of which was connected to a circuit enabling the wheel to be locked or unlocked (by means of a brake-pad) in accordance with predefined experimental conditions. A cue-light placed above the wheel indicated wheel unlocking. The wheel was flanked by two small ports (2.5 cm above the chamber gridded floor with cue lights located above) set into the rear wall to allow the animal to 'poke' its nose through. Nose poke performance could be either "active" (leading to cue-light illumination and wheel unlocking) or "inactive" (having no consequence).

Mice first underwent one daily habituation session in the operant chambers for two consecutive days. To this aim, mice were placed in the operant chambers with the cue light above the unlocked running wheel remaining illuminated while the two nose poke ports were covered-up by metal pieces. These two 60-min sessions were aimed at habituating the mice to both the operant chamber, the wheel and the cue indicating wheel-unlocking. When learning sessions began, the wheel locking/unlocking mechanism and the nose poke ports were fully operational. The wheel was unlocked for 60 s (wheel brake release) following nose pokes the mouse executed in its allocated active nose poke port. In the FR1 condition, a single active nose poke was sufficient to simultaneously illuminate the cue-light above the port for 10 s, unlock the running wheel for 60 s and illuminate a light above the wheel. Nose pokes in the other port were counted but were without functional consequence. When the 60-s period had elapsed, the wheel-light extinguished and the brake applied, so that the mouse had to step down from the wheel and execute a further nose poke in order to unlock it again. Nose pokes made in the active port while the wheel was already unlocked counted as uncorrect responses but were without consequence. Habituation and FR1 sessions were ran once daily and lasted for 60 min. After completing 5 FR1 sessions, mice moved on to the FR3 condition in which a 60-s wheel-running period was contingent on 3 consecutive nose pokes in the active port. Daily treatments with hemisuccinate-coupled prednisolone (through its dilution in drinking water) began after this first FR3 session. Thereafter, mice completed 6 additional FR3 sessions before being tested under a linear PR schedule of reinforcement where (i) the number of active nose pokes required to free the running wheel was incremented by 3 between each rewarded step (3, 6, 9...etc), with (ii) a time limit of 15 min between two successive steps. Reaching the next step before that limit reset the novel time limit to 15 min. The maximal number of nose poke responses achieved during that session and the last rewarding step that was reached (breakpoint level) were used as motivation indices (Hodos,



**Fig. 1.** Prednisolone ergogenic impacts do not translate into increased running motivation. (A) Operant chamber set up with nose poke (NP) ports for the study of wheel-running motivation in mice. (B) Mean daily prednisolone intakes in mice treated with prednisolone (5 and 15 µg/ml of drinking water). (C) Respective effects of vehicle (water) and prednisolone treatments on body weights. (D) Prednisolone does not alter the daily numbers of nose poke responses for wheel-running under FR3 schedules of reinforcement. (E) Prednisolone does not affect mouse ability to discriminate between the active and inactive nose poke ports. (F) Running distances per rewarded sequences are decreased under FR3 schedules of reinforcement. (G) The lowest, but not the highest, prednisolone concentration decreases both the maximal numbers of nose poke responses for wheel-running and the running distance per rewarded sequence under a PR schedule of reinforcement. (H) Lack of relationship between running motivation (X-axis) and muscular strength, as assessed by the hanging duration in the wire-grid hanging test (Y-axis), in mice ingesting water alone or water and prednisolone. (I) Lack of relationship between body weight changes (X-axis) and grid hanging duration (Y-axis) in mice ingesting water alone or water and prednisolone. The values are the means ± SEM of n = 7 mice, n = 10 mice (Pred. 5), and n = 9 mice (Pred. 15). ++ p < 0.01 for the main impact of the treatment (two-way analyses of variance); \* p < 0.05 and \*\* p < 0.01 for the difference with water alone.

1961). The ability of mice to distinguish the active nose poke port from the inactive nose poke port was quantified by means of a discrimination index calculated as the ratio of the number of active nose pokes over the total (active + inactive) number of nose pokes. To evaluate wheel-running consumption during FR and PR sessions, the total running distance within each session was divided by the number of rewarded events during that session. All mice still received their respective treatments during one week-end (i.e. between the 4<sup>th</sup> and 5<sup>th</sup> sessions

under the FR3 schedule of reinforcement) although they were not tested during that 2-day period. Accordingly, the daily session numbers provided in the graphs do not necessarily correspond to successive days.

### 2.3. Free wheel-running protocols

Mice permanently housed with running wheels were given a 9-day period of habituation before hemisuccinate-coupled prednisolone was

added or not (water group) to their drinking water for 9 additional days. Daily running distances were recorded throughout the 18 days of experiment by means of the ActiWheel software (Intellibio, Seichamps, France), as previously reported (Dubreucq et al., 2013).

#### 2.4. Wire grid-hanging tests

To analyze whether prednisolone treatments were ergogenic, mice were exposed to a 30-min four limb-hanging test (Morrison-Nozik et al., 2015). Briefly, the morning of their 10<sup>th</sup> treatment day - 24 h after PR sessions (operant experiments) and 24 h after 18 days of housing with running wheels (free wheel-running experiments) - mice were placed on cage grids 90-cm above big cages filled with polystyrene chips as to prevent any damage when falling. The test began with the grids being slowly inverted, the latency to fall being individually recorded. A mouse that did not fall throughout the entire session was given a latency of 1800s.

#### 2.5. Treatment

To avoid an invasive treatment procedure (i.e. injections) whilst favoring the ingestion of the glucocorticoid during the active period of the light/dark cycle, i.e. the period during which drinking and running drives are the most prominent, mice were provided prednisolone through their drinking water. In both series of experiments (conditioned wheel-running, free wheel-running), prednisolone was provided for 10 days, the last day corresponding to the wire grid-hanging tests. Note that water and prednisolone (dissolved in water) were available throughout, except during the 1-h operant sessions. The hemisuccinate-bound prednisolone complex (to ease dilution without additives such as ethanol) was added to drinking water at concentrations of 5 µg/ml and 15 µg/ml (effective concentrations of the prednisolone molecule). Prednisolone solutions were prepared fresh every 3–4 days, all drinking solutions being provided through small bottles equipped with beads, as to avoid leaks, and covered with alumina paper to provide light protection. Bottles were weighed before and after each change to calculate the individual amount of prednisolone ingested. As mentioned above, mice that underwent operant conditioning protocols were provided the treatments after the first FR3 session, and not during FR1 sessions. This was meant at avoiding potential influences of these treatments on the FR1-to-FR3 change in the cued-running motivated instrumental task mice had to learn. In each series of experiments, prednisolone and vehicle groups were defined on the basis of identical scores reached during the first FR3 session as to avoid pretreatment differences. Because these groups did not differ prior to their respective treatments, figure graphs report merged pretreatment values (i.e. up to the first FR3 session) within one unique group for the sake of clarity.

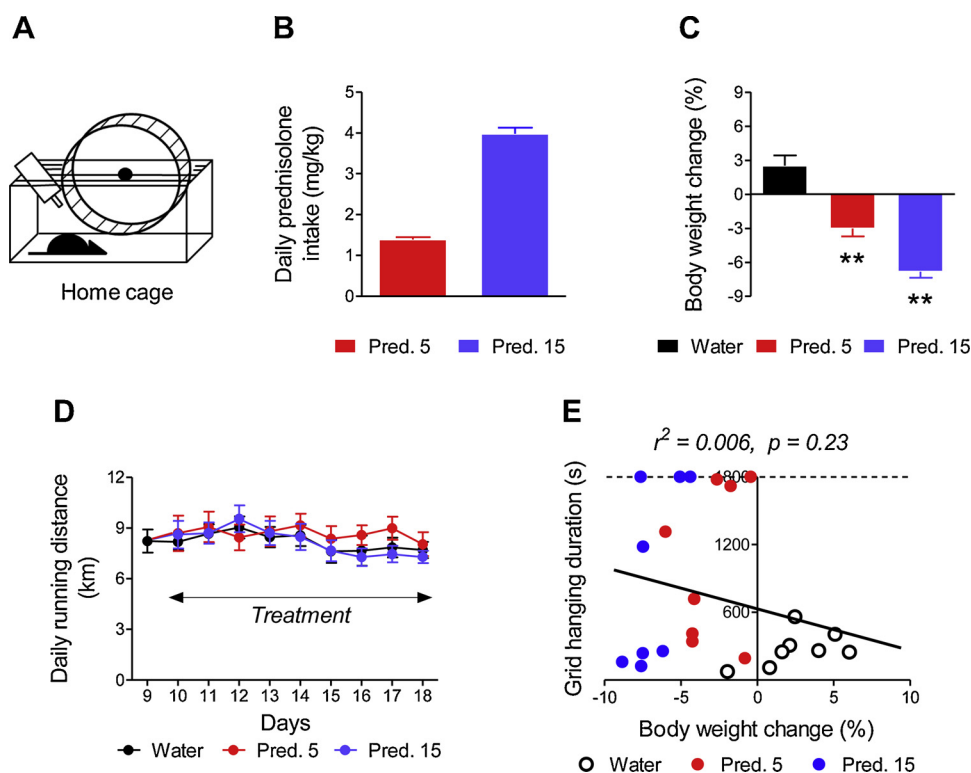
#### 2.6. Statistics

All data are shown as means  $\pm$  standard errors of the mean (SEM). Two-group treatment comparisons were achieved by means of two-tailed Student t-tests. Multiple data comparisons were performed either with multiple analyses of variance (with/without repeated factor) or with Kruskal-Wallis analyses (followed, if significant, by Mann-Whitney U-tests) for nonparametric data. Post hoc comparisons (using Tukey test) following multiple analyses of variance were only performed if interactions between main variables were significant. All these analyses were achieved using the GB-Stat 10.0 software (Dynamic Microsystems, USA).

### 3. Results

#### 3.1. The ergogenic effects of prednisolone occur without increased running motivation

In a first series of experiments, operant conditioning procedures (Fig. 1A) were used to study the impact of the repeated ingestion of 5 µg/ml (n = 10) and 15 µg/ml (n = 9) prednisolone, as compared to water ingestion (n = 7), on running motivation. Post hoc analysis of daily prednisolone intakes through drinking water (Fig. 1B) and their inhibitory consequences on body weights ([F(223) = 27.95; p < 0.001]; Fig. 1C) indicated effectiveness of the administration protocol. These body weight decreases were yet observed 3 days after treatment initiation, the amplitude of these declines progressively increasing throughout the experiment (data not shown). The analysis of active nose poke responses under FR3 schedules of reinforcement in prednisolone-treated mice did not reveal a significant impact of the glucocorticoid although a trend for a reduction could be noted in mice treated with the lowest concentration (i.e. 5 µg/ml; Fig. 1D). To ensure that prednisolone did not affect the ability of mice to distinguish the active nose poke port from the inactive one, a discrimination index was calculated which revealed that all mice, including prednisolone-treated ones, fully discriminated the active nose poke port from the inactive one (Fig. 1E). As opposed to its inability to affect the reinforcing value of wheel-running during FR3 sessions, prednisolone decreased in a concentration-independent manner the mean running distance (i.e. wheel consumption) during each rewarded sequence [F(223) = 7.04; p = 0.0041] (Fig. 1F). When next tested for their running motivation, as assessed under a PR schedule of reinforcement, mouse groups differed in their maximal numbers of active nose poke responses [H = 6.30; p = 0.0429] (Fig. 1G). This was also true when the last steps reached (i.e. breakpoints; data not shown) were considered (24.42  $\pm$  2.01 for vehicle-treated mice, and 13.5  $\pm$  3.17 and 20.33  $\pm$  3.42 for mice treated with the lowest and the highest prednisolone concentration, respectively; [H = 6.43; p = 0.0401]). Post hoc comparisons indicated that mice tested with the lowest, but not the highest, prednisolone concentration displayed a decrease in the number of nose poke responses (Fig. 1G) and, hence, in their breakpoint level (p < 0.05). During the PR session, mouse groups were also found to differ with respect to their running performance during each rewarded sequence [H = 9.11; p = 0.0105], mice ingesting 5 µg/ml prednisolone displaying a significant decrease in wheel consumption (Fig. 1G). When exposed to the wire grid-hanging test, falling latencies of prednisolone-treated mice (1050  $\pm$  206 s and 927  $\pm$  229 s in mice provided the lowest and the highest doses, respectively) did not significantly differ from those measured in control mice (419  $\pm$  130 s) due to heterogeneity of the data. In keeping with this heterogeneity, we next analyzed at the individual level whether there was a relationship between the respective impacts of the treatments on motivation on the one hand, and muscular performance on the other hand (Fig. 1H). This analysis clearly demonstrated the absence of a link between the two variables; indeed, in prednisolone-treated mice, mice that never fell from the wire grid during the 30-min test (which thus displayed the maximal ergogenic scores) were among those with the lowest scores in the PR session (Fig. 1H). Because prednisolone-treated mice were lighter than their control counterparts (see above), we could not exclude that in these mice the latency to fall was significantly accounted for by such a body weight reduction. Accordingly, we analyzed at the individual level whether there was a relationship between body weight changes (expressed as percentages of pretreatment levels to avoid biases due to pretreatment weight differences) and muscular performance (Fig. 1I). As shown in Fig. 1I, this analysis proved negative, hence indicating that prednisolone impacts on body weights do not bear consequences in the wire grid-hanging test.



**Fig. 2.** Prednisolone ergogenic properties do not translate into increased wheel-running performance under no-cost conditions. (A) Wheel-running configuration in home cages. (B) Mean daily prednisolone intakes in mice treated with prednisolone (5 and 15  $\mu\text{g}/\text{ml}$  of drinking water). (C) Respective effects of vehicle (water) and prednisolone treatments on body weights. (D) Prednisolone does not affect the daily running distance covered by mice permanently housed with free running wheels. (E) Lack of relationship between body weight changes (X-axis) and muscular strength, as assessed by the hanging duration in the wire-grid hanging test (Y-axis), in mice ingesting water alone or water and prednisolone. The values are the means  $\pm$  SEM of  $n = 8$  mice per treatment. At least \*\*  $p < 0.01$  for the difference with water alone.

### 3.2. Prednisolone ingestion does not affect free wheel-running performance

The aforementioned series of experiments revealed that the running distance per rewarded sequence during FR and PR schedules of reinforcement (i.e. an index of reward consumption) was sensitive to the lowest and/or the highest prednisolone concentrations. However, this observation might have been accounted for by the operant protocol wherein performance of an instrumental task was a prerequisite for 1-min running sequences. To solve this issue, we examined if prednisolone treatment affected free wheel-running activity, as opposed to the former cost-effective running model. To this end, mice housed with running wheels (Fig. 2A) were provided prednisolone ( $n = 8/\text{dose}$ ), or not (vehicle-group;  $n = 8$ ), in their drinking water, the onset of prednisolone administration occurring after an 8-day habituation period (a time at which wheel-running performance levels had stabilized; data not shown). Prednisolone-treated mice ingested the glucocorticoid in a concentration-dependent manner (Fig. 2B). However, they did so with a much higher amplitude (+ 47–50 % increases) than in mice that underwent operant conditioning experiments (Fig. 1B), a difference that was accounted for by daily 8–9 km running distances, and hence increased water intake. These high prednisolone intakes thus triggered a massive concentration-dependent decrease in body weights [F(221) = 42.77;  $p < 0.001$ ] (Fig. 2C), which, however, did not impact their “free” wheel-running performances (Fig. 2D). As opposed to the analysis conducted in mice that had undergone operant conditioning, control mice ( $276 \pm 55$  s) and prednisolone-treated mice ( $1035 \pm 245$  s and  $920 \pm 284$  s in mice provided the lowest and the highest doses, respectively) were found to differ in their latencies to fall in the wire grid-hanging test [F(221) = 3.49;  $p = 0.049$ ]. However, post hoc differences did not reach significance due to data heterogeneity. As observed above (Fig. 1I), there was no direct relationship between body weights and latencies to fall, including in mice that never fell from the grid (and which all belonged to the prednisolone-treated groups; Fig. 2E).

### 4. Discussion

Whether (Duclos, 2010) or not (Orchard, 2008) glucocorticoids should be considered doping agents has been a matter of discussion. Thus, besides their obvious potential negative impacts on health, evidence for the ergogenic impact of glucocorticoids has been reported in several, but not all, studies (Collomp et al., 2016). Although one main argument for the ergogenic effect of glucocorticoids stems from their metabolic and anti-inflammatory properties at peripheral tissues, their potential central effects – on e.g. stress perception, mood, and reward motivation – are often considered as additional arguments for their ban (Duclos, 2010). However, this argumentation often lacks the distinction between the permissive (i.e. tonic) impacts of glucocorticoids and their phasic effects, the latter effects being relevant to doping. Means to demonstrate the tonic effects include (i) the ability of glucocorticoid administration to restore a function partly/totally lost after glucocorticoid removal (by prior adrenalectomy) or following glucocorticoid synthesis inhibition, or (ii) the measure of the consequences of either GR pharmacological blockade or constitutive/conditional deletions of the GR-encoding gene. With regard to reward motivation processes, the aforementioned protocols have indicated that glucocorticoids exert a tonic control on the motivation to self-administer drugs of abuse such as cocaine or amphetamine (Goeders, 2002; Piazza and le Moal, 1997). The recent use of animals genetically deleted for the GR further indicates that this tonic control takes place at mesolimbic or mesocortical synapses (Ambroggi et al., 2009; Parnaudeau et al., 2014). Conversely, motivation for a natural reward, namely food, is independent from mesocorticolimbic GR (Parnaudeau et al., 2014), thus opening the question of the role of GR in the motivation for another natural reward such as running. The sole information available so far is that glucocorticoids might control in a tonic manner wheel-running performance (Duclos et al., 2009; Ebada et al., 2016) but by no means is this indicative of a similar control on running motivation (Belke and Garland, 2007; Hurel et al., 2019). As for any reward provided in an unconditioned manner, the measure of running performance under “free” wheel access does not allow to separate the incentive properties of the wheel from its mere consumption.



As opposed to its tonic impacts, the phasic impacts of glucocorticoid administration on reward processes have been reported to be either inhibitory or stimulatory (Goeders, 2002; Gourley et al., 2008; Piazza and le Moal, 1997), this divergence being likely accounted for by the reward under scrutiny (natural reward vs drug of abuse) and/or treatment protocols (injection vs ingestion). In keeping with the finding that rodents may self-administer corticosterone (Deroche et al., 1993), hence supporting an impact of corticosterone on motivation for rewards, it is noticeable that most studies used corticosterone (the rodent equivalent of human cortisol) instead of a selective glucocorticoid. In order to (i) mimic the volitional ingestion of glucocorticoids for doping purposes, (ii) favor that ingestion during the active part of the light/dark cycle, as in humans, and (iii) avoid the stress associated with systemic injections, the present study provided mice with prednisolone dissolved in their drinking water. Indeed, such a mode of corticoid administration has proved to be effective in past studies (Gourley et al., 2008; Karatsoreos et al., 2010). Prednisolone was chosen because it is the glucocorticoid for which ergogenic properties have been the most studied in humans (Collomp et al., 2016). The prednisolone concentrations that were used for 10 consecutive days in the present study led to a daily 0.93–2.71 mg/kg intake in the first series of experiments and a daily 1.39–3.98 mg/kg intake in the second series of experiments. Because the concentrations thought to be effective on human endurance are in the 20–60 mg range (Collomp et al., 2016), the relevance of the present mouse treatment regimen might be questioned. A calculation based on the body surface normalization method to provide human equivalent doses of animal treatments (Reagan-Shaw et al., 2007) indicates that our treatment protocol gives rise to circulating prednisolone molecules that are either below or within the range of their human equivalents (e.g. 6–17 mg for operant studies and 9–25 mg for “free” wheel running studies, assuming an 80-kg body weight). With regard to treatment duration, ours, i.e. 10 days, was slightly longer than that usually observed in humans (5–7 days; Collomp et al., 2016), a difference due to operant conditioning protocol requirements.

Prednisolone treatments were effective, as indicated by their inhibitory impacts on body weights which are in keeping with the early catabolic impacts of glucocorticoids that either disappear thereafter (low concentrations) or precede progressive increases in body weights (high concentrations) (Karatsoreos et al., 2010). Of note is the observation that the prednisolone doses used herein were in the same range as those previously reported to be ergogenic using either the wire-hanging test (3 mg/kg by gavage every other day during 7 days; Morrison-Nozik et al., 2015). Moreover, we used doses which are well below those reported to promote anxiety in mice (50–100 mg/kg; Kajiyama et al., 2010), a behavioral change which could have biased the wire-grid hanging scores. In our hands, the ergogenic effect of prednisolone, as assessed using this test, did not reach statistical significance due to high inter-individual variability; however, as discussed below, such a variability allowed us to examine at the individual level whether prednisolone ergogenic effects, when present, were linked to changes in running motivation. In keeping with the catabolic effects of prednisolone, which suggest muscle atrophy, the use of the wire grid-hanging test to measure the ergogenic impacts of prednisolone might be prone to criticism. Indeed, it has been shown that the pathways that mediate prednisolone-induced muscle atrophy and prednisolone ergogenic effects are independent (Morrison-Nozik et al., 2015). Indeed, the latter, but not the former, depends on the metabolic transcription factor KLF15 (Morrison-Nozik et al., 2015). Confirmingly, the positive effects of prednisolone in the wire grid-hanging test are also observed when using the grip-strength test in which forelimb muscular strength is dynamically measured (Morrison-Nozik et al., 2015).

Repeated ingestion of the lowest, but not the highest, prednisolone concentration decreased running motivation. The mechanism(s) responsible for such a differential influence of prednisolone on running motivation are unknown. One such mechanism could be linked to the stimulation of GR populations that differ with the respective

prednisolone concentrations. A second explanation lies on the findings that prednisolone might efficiently bind and/or stimulate MRs (Grossmann et al., 2004; Lan et al., 1982; Trune et al., 2006). If so, we cannot discard the possibility that the highest prednisolone concentration recruited MRs receptors in addition to GRs, these actions bearing self-opposed influences on running motivation. In contrast with the concentration-dependent inhibitory effect of prednisolone on running motivation, prednisolone impacts on mean falling latencies in the wire-hanging test proved concentration-independent. This observation provided a first argument against a link between the ergogenic impact of prednisolone and running motivation. Further evidence for the absence of such a link was gathered by our analysis of running motivation and muscular strength at the individual level. Thus, such an analysis clearly indicated that both variables were independent. Because prednisolone triggered a significant loss in body weight, the possibility that the latter had an influence in the wire grid-hanging test had to be considered although, as indicated above, these are independent processes (Morrison-Nozik et al., 2015). Confirmingly, the analyses of inter-individual relationships between grid fall latencies and body weight losses (expressed as percentages from pretreatment weights) in mice conditioned to run proved negative. This lack of relationship extended to mice allowed to run freely in their home cages, further confirming the independence between both variables. Although muscle wasting did not bear any influence, it should be acknowledged that such a consequence of prednisolone administration is a major limit of our study, especially when translating its observations to humans. Future studies with concentrations of prednisolone without body weight-reducing impacts, i.e. as observed in humans, could then help to further test our initial hypothesis.

Prednisolone treatment progressively decreased in a concentration-independent manner the running distance per rewarded sequence under the FR3 reinforcement schedule, a change that was also evidenced with the lowest prednisolone concentration when tested in the PR session. These results suggest that depending on the concentration and reinforcement schedule tested prednisolone affected negatively reward consumption. Whether this was reminiscent of a general effect of prednisolone on running performance was however unknown because, as stated above, wheel-running performances under cost conditions do not reflect free wheel-running performances (Belke and Garland, 2007; Hurel et al., 2019). We thus examined this issue in mice housed with free running wheels, i.e. the animal model of exercise that is the most widely used. A direct comparison with running performance in the operant chambers would have required to daily restrict to 60 min the availability of the wheels. However, we chose to provide unlimited free access to the wheels for the following reasons: (i) limiting the availability to the wheel although the latter (i.e. the reward) is present during the whole light/dark cycle in the home cage environment (as opposed to mice tested in the operant chambers) might have biased the results, (ii) the great majority of studies modelling physical activity by means of rodent running wheels rely on unlimited wheel access; accordingly, we used a similar protocol for the sake of appropriate comparison, and (iii) providing mice with unlimited wheel access allowed us to measure putative long-term prednisolone impacts on performance that could occur over 60 min. Using such an unconditioned wheel-running paradigm, we observed that prednisolone did not affect running performance although the net prednisolone amounts ingested by the mice were increased (compared to the operant series of experiments) due to increased water intake. This negative finding is in keeping with the lack of effect of either acute prednisolone (5 mg/kg) on wheel-running in mice (Cobos et al., 2012) or repeated treatment with high concentrations of corticosterone on rat wheel-running performance (Duclos et al., 2009; Yau et al., 2011). The striking contrast between the inhibitory influence of prednisolone on performance under costly conditions (operant protocols) and its inability to affect such a performance under free conditions confirms the aforementioned indication that conditioned wheel-running performance does not reflect

free wheel-running performance (Belke and Garland, 2007; Hurel et al., 2019). Besides obvious protocol differences, one additional reason underlying such a contrast is accounted for by the inability to disentangle the incentive value of the wheel from its mere consumption when running is unconditioned. Hence, the use of the free wheel does not permit any distinction between the "wanting/seeking" dimension of running - accounted for by a cannabinoid-mesocorticolimbic dopamine relay - from its "consuming/liking" dimension which is independent from such a relay (Muguruza et al., 2019). With respect to the ergogenic effects of prednisolone in freely running mice, inter-individual analyses revealed that prednisolone-treated mice bearing the highest fall latencies in the wire-hanging test did not differ from controls with respect to free wheel-running performance. The most obvious explanation for such a dichotomy is that the free running wheel model is not the best suited for deciphering the ergogenic properties of doping substances. Alternatively, the need to include endurance and exhaustion tests argues for the use of another exercise model, namely the treadmill model, for such purposes. Supporting this need for endurance protocols is the observation that prednisolone is effective in humans in endurance-based exercise tasks only (Collomp et al., 2016; Duclos, 2010). Confirmingly, repeated administration of prednisolone has been reported to increase time to exhaustion in mice exposed to treadmill endurance tests (Morrison-Nozick et al., 2015). However, the need to force the animals to run in the first training days (and during exhaustion tests), doing so by the use of footshocks, a major stress, is an important drawback that cannot be ignored (especially when testing corticosteroids). This drawback is further reinforced by the experimenter inability to differentiate the positive reinforcement properties of running from its negative reinforcement properties to escape footshocks. Taking into account that running is an important reward for rodents (as illustrated in this study), one possible means to circumvent this bias could consist in the use of running wheels to which braking forces would be progressively added as to quantify the ergogenic impacts of doping agents. However, such a paradigm should include a cued-reward task as a prerequisite for running in order to specifically measure the links between running motivation and muscular strength under these particular conditions.

## CRedit roles

F.G., G.M., and F.C. contributed to the conception and design of the study, B.R., C.V., and F.C. participated in acquisition and analyses of the data, F.C. drafted the article, B.R., C.V., F.G., G.M., and F.C. revised the article and approved its final version.

## Declaration of Competing Interest

The authors declare no conflicts of interest.

## Acknowledgements

We thank all the personnel from the Animal Facility and the Genotyping platform of the NeuroCentre Magendie, Virginie Morales and the other members of Marsicano's laboratory for their daily support and for useful discussions. This work was supported by the Agence Française de Lutte contre le Dopage (AFLD, to F.C. and F.G.), Institut National de la Santé et de la Recherche Médicale (to G.M.), la Région Aquitaine (to G.M.), the University of Bordeaux (to G.M.), and l'Agence Nationale de la Recherche (to G.M.).

## References

Adcock, I.M., Mumby, S., 2016. Glucocorticoids. *Handb. Exp. Pharmacol.* 237, 171–196.  
 Ambroggi, F., Turiault, M., Milet, A., Deroche-Gamonet, V., Parnaudéau, S., Balado, E., Barik, J., van der Veen, R., Maroteaux, G., Lemberger, T., Schütz, G., Lazar, M., Marinelli, M., Piazza, P.V., Tronche, F., 2009. Stress and addiction: glucocorticoid

receptor in dopaminergic neurons facilitates cocaine seeking. *Nat. Neurosci.* 12, 247–249.  
 Belke, T.W., Garland Jr., T., 2007. A brief opportunity to run does not function as a reinforcer for mice selected for high daily wheel-running rates. *J. Exp. Anal. Behav.* 2007 (88), 199–213.  
 Berridge, K.C., 2007. The debate over dopamine's role in reward: the case for incentive salience. *Psychopharmacology* 191, 391–431.  
 Chaouloff, F., Groc, L., 2011. Temporal modulation of hippocampal excitatory transmission by corticosteroids and stress. *Front. Neuroendocrinol.* 32, 25–42.  
 Cobos, E.J., Ghasemlou, N., Araldi, D., Segal, D., Duong, K., Woolf, C.J., 2012. Inflammation-induced decrease in voluntary wheel running in mice: a nonreflexive test for evaluating inflammatory pain and analgesia. *Pain* 153, 876–884.  
 Collier, G.H., Hirsch, E., 1971. Reinforcing properties of spontaneous activity in the rat. *J. Comp. Physiol. Psychol.* 77, 155–160.  
 Collomp, K., Arlettaz, A., Buisson, C., Lecoq, A.M., Mongongu, C., 2016. Glucocorticoid administration in athletes: performance, metabolism and detection. *Steroids* 115, 193–202.  
 De Kloet, E.R., Joëls, M., Holsboer, F., 2005. Stress and the brain: from adaptation to disease. *Nat. Rev. Neurosci.* 6, 463–475.  
 Deroche, V., Piazza, P.V., Deminière, J.M., Le Moal, M., Simon, H., 1993. Rats orally self-administer corticosterone. *Brain Res.* 622, 315–320.  
 Dubreucq, S., Durand, A., Matias, I., Bénard, G., Richard, E., Soria-Gomez, E., Glangetas, C., Groc, L., Wadleigh, A., Massa, F., Bartsch, D., Marsicano, G., Georges, F., Chaouloff, F., 2013. Ventral tegmental area cannabinoid type-1 receptors control voluntary exercise performance. *Biol. Psychiatry* 73, 895–903.  
 Duclos, M., 2010. Evidence on ergogenic action of glucocorticoids as a doping agent risk. *Phys. Sportsmed.* 38, 121–127.  
 Duclos, M., Gatti, C., Bessière, B., Mormède, P., 2009. Tonic and phasic effects of corticosterone on food restriction-induced hyperactivity in rats. *Psychoneuroendocrinology* 34, 436–445.  
 Ebada, M.E., Kendall, D.A., Pardon, M.C., 2016. Corticosterone and dopamine D2/D3 receptors mediate the motivation for voluntary wheel running in C57BL/6J mice. *Behav. Brain Res.* 311, 228–238.  
 Goeders, N.E., 2002. The HPA axis and cocaine reinforcement. *Psychoneuroendocrinology* 27, 13–33.  
 Gourley, S.L., Kiraly, D.D., Howell, J.L., Olausson, P., Taylor, J.R., 2008. Acute hippocampal brain-derived neurotrophic factor restores motivational and forced swim performance after corticosterone. *Biol. Psychiatry* 64, 884–890.  
 Graf, E.N., Wheeler, R.A., Baker, D.A., Ebben, A.L., Hill, J.E., McReynolds, J.R., Robble, M.A., Vranjkovic, O., Wheeler, D.S., Mantsch, J.R., Gasser, P.J., 2013. Corticosterone acts in the nucleus accumbens to enhance dopamine signaling and potentiate reinstatement of cocaine seeking. *J. Neurosci.* 33, 11800–11810.  
 Grossmann, C., Scholz, T., Rochel, M., Bumke-Vogt, C., Oelkers, W., Pfeiffer, A.F.H., Diederich, S., Bähr, V., 2004. Transactivation via the human glucocorticoid and mineralocorticoid receptor by therapeutically used steroids in CV1-cells: a comparison of their glucocorticoid and mineralocorticoid properties. *Eur. J. Endocrinol.* 151, 397–406.  
 Härfstrand, A., Fuxe, K., Cintra, A., Agnati, L.F., Zini, I., Wikström, A.C., Okret, S., Yu, Z.Y., Goldstein, M., Steinbusch, H., Verhofstad, A., Gustafsson, J.A., 1986. Demonstration of glucocorticoid receptor immunoreactivity in monoamine neurons of the rat brain. *Proc. Natl. Acad. Sci. U.S.A.* 83, 9779–9783.  
 Hodos, W., 1961. Progressive ratio as a measure of reward strength. *Science* 134, 943–944.  
 Hurel, I., Redon, B., Soccard, A., Malezieux, M., Marsicano, G., Chaouloff, F., 2019. Beyond the activity-based anorexia model: reinforcing values of exercise and feeding examined in stressed adolescent male and female mice. *Front. Pharmacol.* 10, 587.  
 Iversen, I.H., 1993. Techniques for establishing schedules with wheel-running as reinforcement in rats. *J. Exp. Anal. Behav.* 60, 219–238.  
 Joëls, M., 2018. Corticosteroids and the brain. *J. Endocrinol.* 238, R121–R130.  
 Kajiyama, Y., Iijima, Y., Chiba, S., Furuta, M., Ninomiya, M., Izumi, A., Shibata, S., Kunugi, H., 2010. Prednisolone causes anxiety- and depression-like behaviors and altered expression of apoptotic genes in mice hippocampus. *Prog. Neuropsychopharm. Biol. Psychiatry* 34, 159–165.  
 Karatsoreos, I.N., Bhagat, S.M., Bowles, N.P., Weil, Z.M., Pfaff, D.W., McEwen, B.S., 2010. Endocrine and physiological changes in response to chronic corticosterone: a potential model of the metabolic syndrome in mouse. *Endocrinology* 151, 2117–2127.  
 Koob, G.F., Volkow, N.D., 2016. Neurobiology of addiction: a neurocircuitry analysis. *Lancet Psychiatry* 3, 760–763.  
 Lan, N.C., Graham, B., Bartter, F.C., Baxter, J.D., 1982. Binding of steroids to mineralocorticoid receptors: implications for *in vivo* occupancy by glucocorticoids. *J. Clin. Endocrinol. Metab.* 54, 332–342.  
 Magomedova, L., Cummins, C.L., 2016. Glucocorticoids and metabolic control. *Handb. Exp. Pharmacol.* 233, 73–93.  
 Mantsch, J.R., Saphier, D., Goeders, N.E., 1998. Corticosterone facilitates the acquisition of cocaine self-administration in rats: opposite effects of the type II glucocorticoid receptor agonist dexamethasone. *J. Pharmacol. Exp. Ther.* 287, 72–80.  
 McEwen, B.S., De Kloet, E.R., Rostene, W., 1986. Adrenal steroid receptors and actions in the nervous system. *Physiol. Rev.* 66, 1121–1188.  
 Menezes, L.G., Sobreira, C., Neder, L., Rodrigues-Júnior, A.L., Martinez, J.A., 1985. Creatine supplementation attenuates corticosteroid-induced muscle wasting and impairment of exercise performance in rats. *J. Appl. Physiol.* 102, 698–703.  
 Morrison-Nozick, A., Anand, P., Zhu, H., Duan, Q., Sabeh, M., Prosdocimo, D.A., Lemieux, M.E., Nordborg, N., Russell, A.P., MacRae, C.A., Gerber, A.N., Jain, M.K., Haldar, S.M., 2015. Glucocorticoids enhance muscle endurance and ameliorate Duchenne muscular dystrophy through a defined metabolic program. *Proc. Natl. Acad. Sci. U.S.A.* 112, E6780–6789.

- Muguruza, C., Redon, B., Fois, G.R., Hurel, I., Scocard, A., Nguyen, C., Stevens, C., Soria-Gomez, E., Varilh, M., Cannich, A., Daniault, J., Busquets-Garcia, A., Pelliccia, T., Caillé, S., Georges, F., Marsicano, G., Chaouloff, F., 2019. The motivation for exercise over palatable food is dictated by cannabinoid type-1 receptors. *JCI* 4, 126190. [Insight. pii.](#)
- Nestler, E.J., 2005. Is there a common molecular pathway for addiction? *Nat. Neurosci.* 8, 1445–1449.
- Orchard, J.W., 2008. Why glucocorticoids should be removed from the World Antidoping Agency's list of banned products. *Br. J. Sports Med.* 42, 944–945.
- Parnaudeau, S., Dongelmans, M.L., Turiault, M., Ambroggi, F., Delbes, A.S., Cansell, C., Luquet, S., Piazza, P.V., Tronche, F., Barik, J., 2014. Glucocorticoid receptor gene inactivation in dopamine-innervated areas selectively decreases behavioral responses to amphetamine. *Front. Behav. Neurosci.* 8, 35.
- Piazza, P.V., Le Moal, M., 1997. Glucocorticoids as a biological substrate of reward: physiological and pathophysiological implications. *Brain Res. Rev.* 25, 359–372.
- Reagan-Shaw, S., Nihal, M., Ahmad, N., 2007. Dose translation from animal to human studies revisited. *FASEB J.* 22, 659–661.
- Salamone, J.D., Correa, M., 2012. The mysterious motivational functions of mesolimbic dopamine. *Neuron* 76, 470–485.
- Trune, D.R., Kempton, J.B., Gross, N.D., 2006. Mineralocorticoid receptor mediates glucocorticoid treatment effects in the autoimmune mouse ear. *Hear. Res.* 2012, 22–32.
- World Antidoping Agency (WADA). List of prohibited substances. [www.wada-ama.org/en/content/what-is-prohibited](http://www.wada-ama.org/en/content/what-is-prohibited).
- Yau, S.Y., Lau, B.W., Tong, J.B., Wong, R., Ching, Y.P., Qiu, G., Tang, S.W., Lee, T.M., So, K.F., 2011. Hippocampal neurogenesis and dendritic plasticity support running-improved spatial learning and depression-like behaviour in stressed rats. *PLoS One* 6, e24263.

# ANNEX 5

## Beyond the Activity-Based Anorexia Model: Reinforcing Values of Exercise and Feeding Examined in Stressed Adolescent Male and Female Mice

Frontiers in Pharmacology 2019;10:587.

Imane Hurel\*, **Bastien Redon**\*, Amandine Scocard, Meryl Malezieux, Giovanni Marsicano and Francis Chaouloff

\*Share first authorship





# Beyond the Activity-Based Anorexia Model: Reinforcing Values of Exercise and Feeding Examined in Stressed Adolescent Male and Female Mice

## OPEN ACCESS

### Edited by:

Salvatore Salomone,  
Università degli Studi di Catania,  
Italy

### Reviewed by:

Matthew Hurley,  
Johns Hopkins University,  
United States

Javier Gilabert-Juan,  
Collège de France,  
France

### \*Correspondence:

Francis Chaouloff  
francis.chaouloff@inserm.fr

†These authors have contributed  
equally to this work.

### †Present Address:

Meryl Malezieux,  
Synaptic Circuits of Memory,  
IINS CNRS UMR5297,  
Bordeaux, France

### Specialty section:

This article was submitted to  
Experimental Pharmacology  
and Drug Discovery,  
a section of the journal  
Frontiers in Pharmacology

**Received:** 22 March 2019

**Accepted:** 07 May 2019

**Published:** 17 May 2019

### Citation:

Hurel I, Redon B, Scocard A,  
Malezieux M, Marsicano G and  
Chaouloff F (2019) Beyond the  
Activity-Based Anorexia Model:  
Reinforcing Values of Exercise and  
Feeding Examined in Stressed  
Adolescent Male and Female Mice.  
*Front. Pharmacol.* 10:587.  
doi: 10.3389/fphar.2019.00587

**Imane Hurel<sup>1,2†</sup>, Bastien Redon<sup>1,2†</sup>, Amandine Scocard<sup>1,2</sup>, Meryl Malezieux<sup>1,2†</sup>,  
Giovanni Marsicano<sup>1,2</sup> and Francis Chaouloff<sup>1,2\*</sup>**

<sup>1</sup> Endocannabinoids and NeuroAdaptation, NeuroCentre INSERM U1215, Bordeaux, France, <sup>2</sup> University of Bordeaux, Bordeaux, France

Anorexia nervosa (AN), mostly observed in female adolescents, is the most fatal mental illness. Its core is a motivational imbalance between exercise and feeding in favor of the former. The most privileged animal model of AN is the “activity-based anorexia” (ABA) model wherein partly starved rodents housed with running wheels exercise at the expense of feeding. However, the ABA model bears face and construct validity limits, including its inability to specifically assess running motivation and feeding motivation. As infant/adolescent trauma is a precipitating factor in AN, this study first analyzed post-weaning isolation rearing (PWIR) impacts on body weights and wheel-running performances in female mice exposed to an ABA protocol. Next, we studied through operant conditioning protocols i) whether food restriction affects in a sex-dependent manner running motivation before ii) investigating how PWIR and sex affect running and feeding drives under *ad libitum* fed conditions and food restriction. Besides amplifying ABA-elicited body weight reductions, PWIR stimulated wheel-running activities in anticipation of feeding in female mice, suggesting increased running motivation. To confirm this hypothesis, we used a cued-reward motivated instrumental task wherein wheel-running was conditioned by prior nose poke responses. It was first observed that food restriction increased running motivation in male, but not female, mice. When fed grouped and PWIR mice were tested for their running and palatable feeding drives, all mice, excepted PWIR males, displayed increased nose poke responses for running over feeding. This was true when rewards were proposed alone or within a concurrent test. The increased preference for running over feeding in fed females did not extend to running performances (time, distance) during each rewarded sequence, confirming that motivation for, and performance during, running are independent entities. With food restriction, mice displayed a sex-independent increase in their preference for feeding over running in both group-housed and PWIR conditions. This study shows that the ABA model does not specifically capture running and feeding drives, i.e. components known to be affected in AN.

**Keywords:** restrictive anorexia nervosa, post-weaning isolation rearing, wheel-running, palatable food, food anticipatory activity, operant conditioning, motivation, reward choice

## INTRODUCTION

Anorexia nervosa (AN), which mainly affects older adolescent and young adult females (with a sex ratio of 8 for 1 male), is a psychiatric disorder where self-starvation and hence dramatic underweight is a core symptom (Kaye et al., 2009; Zipfel et al., 2015). As opposed to a general belief, it is unlikely that socio/cultural influences play a major, if not unique, role as AN was already reported centuries ago (Casper, 2006). Its lifetime prevalence in high-income countries is ~1–4% (Smink et al., 2012; Zipfel et al., 2015; Keski-Rahkonen and Mustelin, 2016), with a constant increase in that percentage over recent years (Smink et al., 2012). However, AN, whether restrictive or associated with purgative behavior, is not solely accounted for by a decreased drive for feeding. In many cases, especially in restrictive anorexia, this decrease is associated, and often preceded by, motor restlessness and/or an increased drive for another reward, i.e. exercise, mostly running (Brewerton et al., 1995; Davis, 1997; Klein et al., 2004; Meyer et al., 2011; Casper, 2018). Reinforcing the hypothesis that increased exercise is at the core of AN are the reports that i) exercise dependence might be one cause of altered eating behavior (Cook and Hausenblas, 2008), ii) remitted AN patients still display craving for exercise (Shroff et al., 2006), and that iii) the latter amplifies the anhedonic profile of these patients (Davis and Woodside, 2002). It is this imbalance between energetic supply and energy consumption rates that provides AN with severe and often lethal consequences. Although AN etiology is ill-defined (Clarke et al., 2012), family and twin studies have indicated that AN patients are at risk to transmit the disease to their progeny (Bulik et al., 2007; Zipfel et al., 2015). However, the identification of AN genetic defects is rendered complex as this disease is not accounted for by one single gene (Bulik et al., 2007). Besides familial causes, environmental risk factors have also been delineated. Among these, perinatal (e.g., prematurity, imbalanced maternal control) and/or childhood trauma have been underlined (Leung et al., 2000; Romans et al., 2001; Canetti et al., 2008; Pike et al., 2008; Zipfel et al., 2015). This might explain why patients suffering AN display comorbidity with mood disorders, including major depression, anxiety, and obsessive-compulsive disorders (Kaye et al., 2009; Zipfel et al., 2015). With respect to childhood trauma, physical abuse, sexual abuse and parental neglect are the more documented forms of social stress that might, in combination with genetic or other environmental factors, precipitate AN (Yackobovitch-Gavan et al., 2009; Jaite et al., 2012; Racine and Wildes, 2015). The negative impact of childhood trauma is further illustrated by the report that post-traumatic stress disorder and AN might actually co-occur (Reyes-Rodríguez et al., 2011). The observation that early traumatic events provide a long-term psychoneuroendocrine vulnerability to future stressors in laboratory rodents (Lupien et al., 2009; McCormick et al., 2016) provides support for an etiological role of early trauma in AN.

To date, the model considered to be the most pertinent for AN—although it is unlikely that a single model recapitulates such a complex pathology—is the so-called “activity-based anorexia (ABA)” paradigm (Boakes, 2007; Scheurink et al., 2010;

Kim, 2012; Mequinion et al., 2015). Thus, rodents housed with a running wheel and placed under a severe restricted feeding regimen (i.e., a single time- or quantity-limited access to food per day) display a progressive increase in running activity at the expense of feeding. Such an increase is mainly accounted for by high wheel-running activity prior to food delivery (namely food anticipatory activity, FAA). After several days, body weight loss is so pronounced (up to 30%) that death might occur, especially in rats (Routtenberg and Kuznesof, 1967). Beyond methodological limits that might question the causal relationship between food scarcity and physical hyperactivity (Dwyer and Boakes, 1997; Rowland et al., 2018), the validity of the ABA paradigm as an animal model of AN might be discussed with regard to the construct, face, and predictive validity criteria thought to define any model of human (psycho)pathology (see Willner, 1984). This is especially true for the construct criterion in which factors thought to be of etiological significance in AN pathology should thus logically bear consequences in the ABA model. In keeping with the data reported above, genetics, sex (female vs. males), age (adolescence vs. adulthood), and early traumatic stimuli are expected to have significant impacts in the ABA model. As opposed to genetic studies, which provide thorough evidence that the consequences of the exposure to the ABA model depend on the rat/mouse line tested therein (Pjetri et al., 2012; Klenotich et al., 2012), studies aimed at investigating the respective impacts of sex and age in this model have provided contradictory results (Mequinion et al., 2015; Rowland et al., 2018). As opposed to genetics, sex, and age, available data on the impact of early traumatic stimuli in the ABA paradigm are somewhat scarce. Prenatal stress (Boersma et al., 2016; Schroeder et al., 2018), early weaning (Glavin and Pare, 1985) or postnatal separation (Carrera et al., 2009; Hancock and Grant, 2009) have shown diverse effects, including when considering the animal sex. Although these studies addressed the consequences of prenatal and perinatal stress manipulations that might bear translational value with respect to AN, the question of the impact of stress during childhood and early adolescence should be considered. As mentioned above, physical and/or sexual insults during these periods have long-lasting psychological consequences, especially in females where such stressors increase the propensity to develop affective disorders (Bale and Epperson, 2015). Of major relevance to the present focus, childhood and early adolescence trauma can be modeled in rodents through the so-called post-weaning isolation rearing (PWIR) stress paradigm. Actually, rodents housed individually immediately after weaning (21 days in rodents), and thus deprived of social contacts, display long-lasting emotional disturbances (e.g., anxiety, cognitive rigidity, aggression, proneness to drug self-administration; Fone and Porkess, 2008; Walker et al., 2019) that might be translationally relevant to AN in humans.

Herein, we first studied the consequences of PWIR on wheel-running performances in an ABA paradigm wherein food-restricted female mice were provided a limited amount of food at the onset of the dark cycle. Because the core of AN is an imbalance between the respective motivation drives for exercise and feeding (Klein et al., 2004; Casper, 2006; Keating, 2010; Keating et al., 2012), we next asked whether the impact of PWIR

in the ABA found its origin at the motivation level. To do so, we shifted to an operant conditioning procedure wherein mice needed to nose-poke to unbrake a running wheel (Muguruza et al., 2019). This procedure allowed us to examine how i) food restriction and ii) PWIR respectively affected running motivation. As AN involves decreased motivation for feeding, we finally asked the question of i) the impact of PWIR on motivation for palatable food before ii) examining the respective drives for wheel-running and palatable feeding under *ad libitum* and food restricted conditions when these rewards were made concurrent (Muguruza et al., 2019).

## MATERIALS AND METHODS

### Animals

All protocols, which complied with the French (Décret 2013-118) and European (2010/63/EU) rules on animal experimentation, were approved by the local Ethic Committee (Comité d’Ethique 50) with agreement numbers DIR13111, 13649, 33-063-69 (F.C.) and A33-063-098 (animal facilities) provided under authority of the Préfecture de Gironde and the Ministry of Agriculture. Accordingly, the 3R-rules were followed, including through the use of the minimal number of animals per series of experiments that was required to reach conclusions. In addition, in keeping with the procedures used in this study (see the methodological outline), and which could have long-lasting consequences, all animals were only used once and sacrificed thereafter.

This study mainly used 3-week-old male and female C57BL/6N mice (Elevage Janvier, Le Genest Saint Isle, France). Upon arrival in our animal facilities, these mice were housed either singly (PWIR) or in three to four (group-housed). This study also involved 8-week-old male and female C57BL/6N mice, all individually housed (to avoid inter-individual aggression). All animals were housed in a thermoregulated room (21–22°C) placed under a partly inverted 12-h light/12-h dark cycle with lights off at 2:00 PM (free wheel-running experiments) or at 10:00 AM (operant conditioning experiments). Excepted for experiments involving restriction feeding regimen (see below), mice were provided with food and water *ad libitum*.

### Methodological Outline

A first series of experiments involved group-housed and PWIR female mice provided with wheels in their home cages under *ad libitum* fed conditions before being food-restricted (ABA protocol; **Figure 1A**). A second series of experiments involved individually-housed fed and food-restricted male and female mice, these mice being conditioned to nose poke for access to running wheels located in operant chambers (wheel-running motivation; **Figure 1B**). A third series of experiments used group-housed and PWIR male and female mice which were conditioned to nose poke for access to wheel-running or palatable food, these rewards being first proposed alone before being proposed in competition under fed and, then, food-restricted conditions (**Figure 1C**).

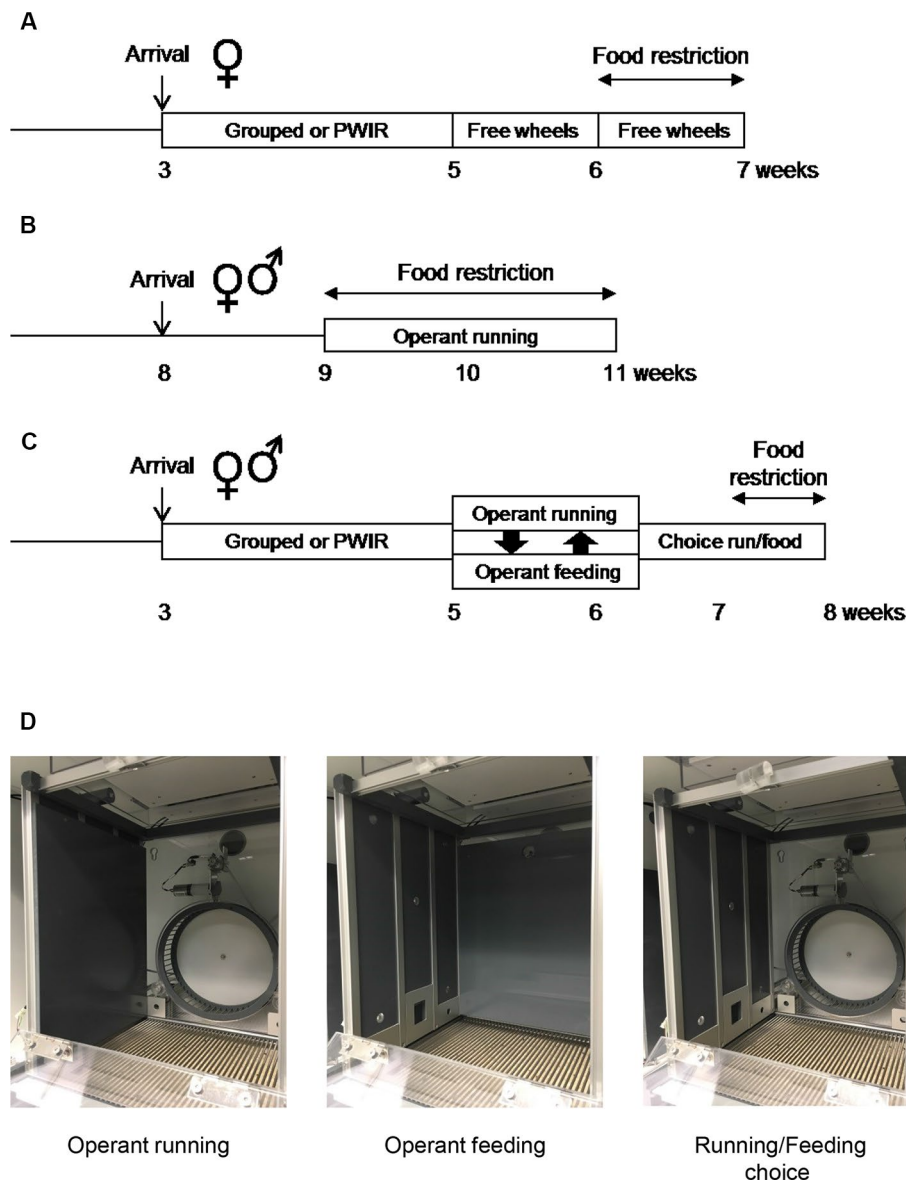
### Activity-Based Anorexia Protocol

At the age of 5 weeks, group-housed mice and mice singly-housed after weaning were singly placed in cages housing a running wheel (25-cm diameter, Intellibio, Seichamps, France). Following a 7-day period of habituation to their new environment during which food intakes, body weights and daily running activity were monitored, mice were then placed under a food-restriction procedure for another 7-day period (**Figure 1A**). This restriction procedure consisted in the daily placement of a limited amount of food (50% of the mean daily intake measured during the preceding week) in each cage, this amount being provided (after having checked for the absence of food crumbs) at the onset of the dark part of the light/dark cycle. Body weights were monitored daily while wheel-running performances were recorded on an hourly basis.

### Operant Conditioning Set-Up

Motivation for wheel-running and/or food intake was studied in 12 individual operant chambers (28 cm long × 26 cm wide × 38 cm high) located in a room adjacent to the animal housing room, as previously described (Muguruza et al., 2019). These chambers were placed inside wooden casings (60 cm long × 62 cm wide × 49 cm high) that were ventilated to guarantee air circulation and to provide background noise (Imetronic, Pessac, France). For operant running experiments, lateral walls were made of gray Perspex while the rear wall had a central hollow for mounting the 20-cm-diameter wheel, the release trigger of which was connected to a circuit enabling the wheel to be locked or unlocked (by means of a brake-pad) in accordance with predefined experimental conditions (**Figure 1D**, operant running configuration). A cue-light placed above the wheel indicated the wheel unlocking. The wheel was flanked by two small ports (2.5 cm above the chamber gridded floor with cue lights located above) set into the rear wall to allow the animal to “poke” its nose through. For operant feeding, the rear side (running wheel, nose poke ports, cue-lights) was covered by gray Perspex whereas the left panel of the chamber housed in its center a recessed pellet tray surrounded by two nose poke (nose poke) ports (**Figure 1D**, operant feeding configuration). Cue-lights were placed above the nose poke ports and the feeder to indicate respectively effectiveness of the nose poke and pellet distribution. For reward choice sessions, the above-mentioned Perspex walls were removed to allow conditioned wheel-running or conditioned feeding (**Figure 1D**, running/feeding choice configuration). Nose poke performance could be either “active” (leading to cue-light illumination and wheel unlocking or cue-light illumination and pellet distribution) or “inactive” (having no consequence). Left/right allocation of active/inactive nose poke ports was counterbalanced between animals during experiments. All devices in the operant chambers were linked to a computer which recorded both the number of active/inactive nose poke, the number of running sequences, and the running duration/distance covered during each rewarded sequence (wheel-running configuration), and the number of active/inactive nose pokes, the number of pellets distributed, and the number of entries into the feeder (feeding configuration). Food





**FIGURE 1** | Experimental protocols and operant chamber set-ups. **(A–C)** Protocol schemes for the three series of experiments aimed respectively at investigating the effects of post-weaning isolation rearing (PWIR) on free wheel-running in food-restricted mice **(A)**, of the mouse sex on running motivation under fed and food restriction conditions **(B)**, and of the mouse sex and of PWIR on the choice between running and feeding under fed and food restriction conditions **(C)**. **(D)** Operant chamber set-up for the study of running motivation alone (left), palatable feeding motivation alone (center), and the preference between running and feeding in a concurrent choice design (right).

pellets were 20-mg chocolate-flavored pellets composed of 59.1% glucids, 18.4% proteins, 5.5% lipids, 6.5% minerals and 4.6% fibers (72 cal per 20-mg F05301 BioServ pellet; Plexx, Elst, The Netherlands).

## Operant Conditioning Protocols

All protocols were similar to those already reported (Muguruza et al., 2019). In one series of experiments aimed at assessing the respective influences of the animal sex and of food restriction on wheel-running motivation (see above), operant conditioning

procedures involved training under fixed-ratio 1 (FR1) and FR3 schedules of wheel-running reinforcement followed by a progressive ratio (PR) schedule of reinforcement. In a second series of experiments aimed at assessing the respective influences of the animal sex, of PWIR and of food restriction on wheel-running motivation and on feeding motivation in a choice paradigm, operant conditioning procedures first involved training under FR1 and FR3 schedules of wheel-running or palatable food intake reinforcements, each reward being available alone. These training procedures were then followed by a PR schedule of reinforcement for each reward. Mice were then returned

to one session of FR3 schedule reinforcement with wheel-running and palatable food intake being reinforced separately. Thereafter, mice were placed under additional FR3 schedules of reinforcement with both rewards being provided in a choice paradigm. The selection of one reward temporarily excluded any possibility to obtain the second reward. In all experiments, food-restricted mice, whether tested for running motivation or for palatable food motivation, were provided their daily chow at least 1 h after their operant session. Daily food provision, which was calculated as to promote a 10% reduction in initial body weights, took into account the amount of food eaten during the preceding test session. The time schedule that we chose, i.e., motivation tests 1–2 h before feeding, thus allowed to examine running and feeding drives at time periods corresponding to those during which FAA was observed in the ABA protocol.

For the first series of experiments (**Figure 1B**), male and female mice singly housed for a week, and aged 9 weeks old, underwent one daily habituation session in the operant chambers for two consecutive days. Mice were placed in the operant chambers with the cue light above the unlocked running wheel remaining illuminated while the two nose poke ports were covered-up by metal pieces. These two 60-min sessions were aimed at habituating the mice to both the operant chamber, the wheel and the cue indicating wheel-unlocking. When learning sessions began (**Figure 1D**, operant running configuration), the wheel locking/unlocking mechanism and the nose poke ports were fully operational. The wheel was unlocked for 60 s (wheel brake release) following nose pokes the mouse executed in its allocated active nose poke port. In the FR1 condition, a single active nose poke was sufficient to simultaneously illuminate the cue-light above the port for 10 s, unlock the running wheel for 60 s and illuminate a light above the wheel. Nose pokes in the other port were counted but were without functional consequence. When the 60-s period had elapsed, the wheel-light extinguished and the brake applied, so that the mouse had to step down from the wheel and execute a further nose poke in order to unlock it again. Nose pokes made in the active port while the wheel was already unlocked, counted as incorrect responses, were without consequence. Habituation and FR1 sessions were ran once daily and lasted for 60 min. After completing six FR1 sessions, mice moved on to the FR3 condition, i.e., a 60-s wheel-running period was contingent on three consecutive nose pokes in the active port. The day after the last FR3 session mice were tested under a linear PR schedule of reinforcement where i) the number of active nose pokes required to free the running wheel was incremented by three between each rewarded step (three, six, nine ... etc: PR3), with ii) a time limit of 15 min between two successive steps.

For the second series of experiments (**Figure 1C**), group-housed mice and PWIR mice were first habituated to the 20-mg food pellets by providing them 3 to 5 pellets/day in their home cages for the 3 days that preceded their first day of exposure to the operant chambers. On this first day of habituation to the chambers, mice were exposed to two consecutive 30-min sessions with the running wheel being unlocked during the first session (**Figure 1D**, operant running configuration) while during the second session, the feeder distributed 17 chocolate pellets (**Figure 1D**, operant feeding configuration). In between,

mice were returned for 5 min in their home cages (with drinking water) as to allow operant chamber configuration changes (wheel to food or *vice versa*). During these two sessions, whose reward order was counterbalanced, cue lights above the unlocked running wheel or the pellet tray remained illuminated while nose poke ports were covered-up by metal pieces for each configuration. These habituation periods were followed by a conditioning phasis wherein animals learned the contingency between the introduction of the muzzle into the “active” nose poke port and the access to the related reward. For this purpose, nose poke holes were not masked anymore as to allow the mouse to “poke” its nose through. As for habituation, two consecutive sessions per day (30 min/session) were performed: one for food (50% of the individuals in each mouse group) and the second for wheel-running (the remaining 50% of the individuals in each mouse group), the order between the sessions being daily alterned. To facilitate the learning of the contingency for food (and hence running), mice were first food-restricted (as to display a stable 10% body weight reduction) for the first two to three FR1 sessions, i.e., sessions during which a single nose poke was sufficient to illuminate the cue light above the wheel or the food port for 5 s. Simultaneously the cue light above the wheel was activated for 20 s (indicating the possibility to run) while that above the food magazine was activated for 15 s (indicating the distribution of one food pellet). Although mice consumed their food pellet rapidly, we decided not to shorten the rewarding periods as i) to allow sufficient time for running and ii) to avoid rapid food satiety. Wheel unlocking or pellet distribution was respectively followed by 20- and 15-s time-out periods during which nose poke activity was inefficient. Five sessions of FR1 for each reward were sufficient to ensure that all animals learned and expressed stable performance over days. Then, animals were placed for another 5-day period under a FR3 schedule wherein three consecutive nose pokes in the active port were required to get one reward (i.e., 20-s wheel running or one chocolate pellet). All mice had a minimal discrimination index of 80% between active and inactive nose pokes. On the two consecutive days that followed the last FR3 session, mice were tested under PR 3 schedule of reinforcements where the number of consecutive active nose pokes required to free the running wheel or to trigger the distribution of one pellet was incremented by three between each rewarded step (three, six, nine...). Half of the mice within each mouse group were tested for wheel-running reinforcement on the first day, the second half being tested for food reinforcement, and vice versa on the second day PR session. PR schedules of reinforcement, by allowing an estimation of the maximal number of consecutive nose pokes performed (and hence the last rewarded step that was reached, i.e., the so-called “breakpoint” level), provide an index of the appetitive motivation for each reward.

## Preference for Wheel-Running Over Palatable Food Consumption

The day after the last PR session, mice from the second series of experiments were returned to FR3 schedules of wheel and food reinforcement as to indicate to the mice that the rewards were

again available following a fixed number of active nose pokes. Then, animals were placed in a choice condition (**Figure 1D**, running/feeding choice configuration) with either wheel unlocking or food distribution being accessible under an FR3 schedule (Muguruza et al., 2019). However, choosing one reward excluded the possibility to obtain simultaneously the second reward. The respective durations of activation of the wheel (20 s) and the feeder (15 s) cue-lights remained as in the preceding sessions. However, to further indicate to the mice that might run during the entire 20-s sequence that the reward choice was mutually exclusive, we added a 5-s period during which a green ceiling light was switched on while none of the nose poke ports was active. Five daily consecutive choice sessions were performed to establish food and wheel preferences, each session being 60-min long. To explore how PWIR affected the impact of food restriction on the preference between wheel-running and feeding (as under ABA conditions; see above), these choice sessions were followed by five choice sessions during which the mice were food-restricted (to extents similar to those measured during the first two to three FR1 sessions; see above).

## Data Analyses and Statistics

Measures of wheel-running performances (ABA experiments) were gathered using the ActiviWheel software (Intellibio, France) while operant running and/or feeding data were obtained using the PolyWheel software (Imetronic, France). To evaluate wheel-running consumption during FR/PR sessions in the operant protocols, we divided the total running duration (or the total distance covered) within each session over the number of rewarded events during that session. Additionally, wheel preference (%) in the choice sessions was quantified by dividing the number of active nose pokes that led access to the wheel by the total number of active nose pokes performed for both rewards (food + wheel). Scores above 50% thus indicates a preference for wheel-running while scores below 50% indicates a preference for food.

All data are shown as means  $\pm$  standard errors of the mean. Two-group (treatment or genotype) comparisons of the data gathered during the PR sessions were achieved by means of two-tailed Student *t*-tests. Multiple data comparisons were performed through multiple (two- or three-way) analyses of variance (with/without repeated factor), data being log-transformed to achieve variance homogeneity if needed. *Post hoc* comparisons (Tukey test) were only performed if interactions between main variables were significant. In choice experiments, preference scores were compared to non-preference (50% preference for one reward) by one-tailed Student's *t*-tests. All analyses were achieved using the GB-Stat 10.0 software (Dynamic Microsystems, USA).

## RESULTS

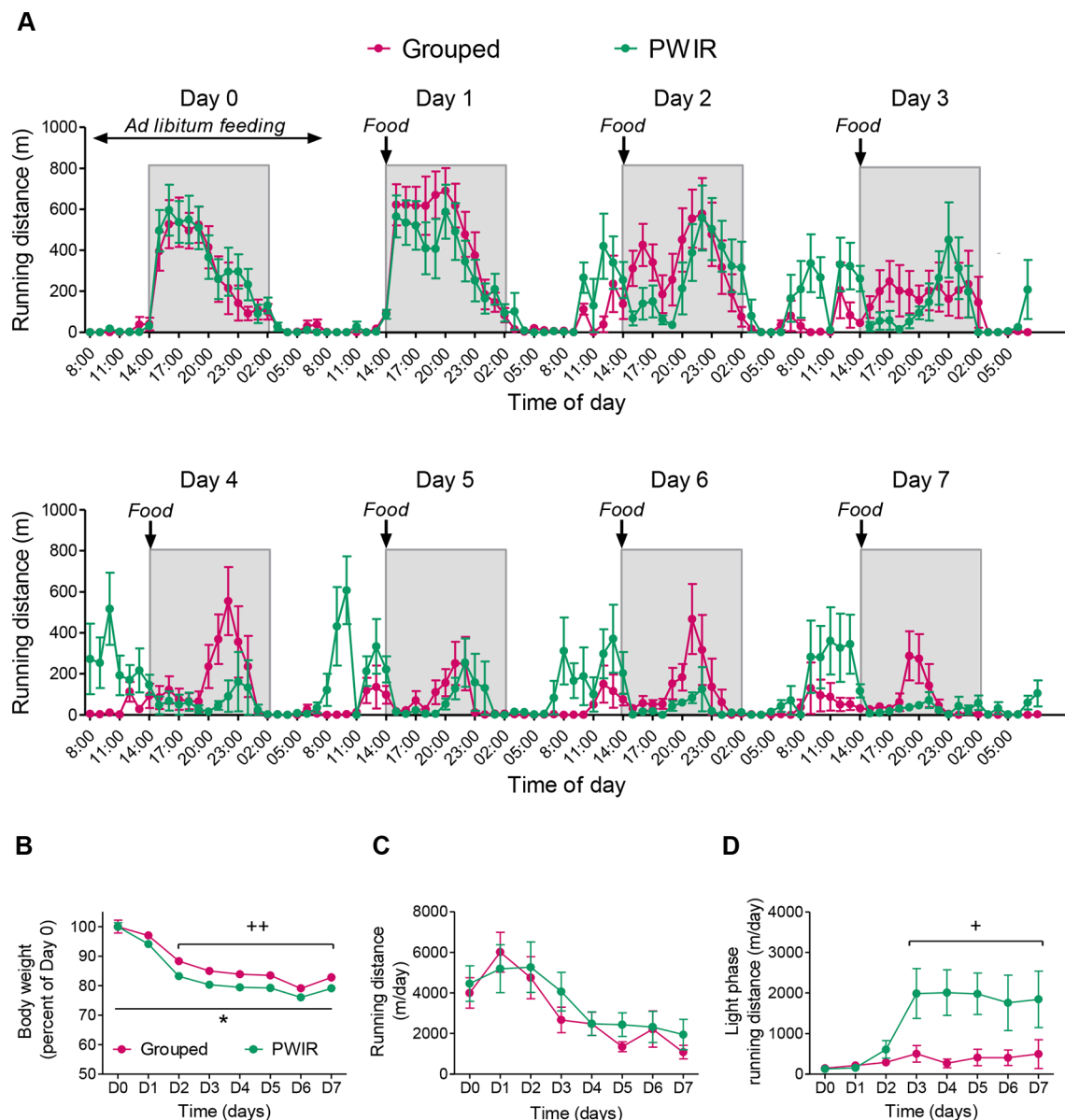
### PWIR Female Mice Display Increased Food Anticipatory Wheel-Running Activity

Food-restricted grouped and PWIR mice displayed a progressive session-dependent shift of wheel-running activity from the dark part of the nycthemeral cycle to its light part (**Figure 2A**). This shift, which was mainly observed during the hours that preceded food availability (i.e., FAA), concerned to a higher extent the

PWIR mice, compared to their grouped counterparts (**Figure 2A**). The overall analysis of wheel-running performances confirmed the latter observation. Thus, food restriction, which decreased body weights in all mice ( $F_{7,91} = 119.92, p < 0.0001$ ), this decrease being larger in PWIR mice ( $F_{1,13} = 24.84, p = 0.0002$ ; **Figure 2B**), inhibited wheel-running activity in both mouse groups ( $F_{7,91} = 18.26, p < 0.0001$ ; **Figure 2C**). However, this overall inhibition was associated with an increased wheel-running activity during the light part of the cycle, hence reflecting increased FAA ( $F_{7,91} = 7.07, p < 0.0001$ ), the amplitude of which was more pronounced in PWIR females, compared to their controls ( $F_{7,91} = 4.33, p = 0.0004$  for the time  $\times$  mouse group interaction; **Figure 2D**).

### Sex-Dependent Effects of Food Restriction on Wheel-Running Motivation

Taken together, the above-mentioned results indicated that PWIR amplified the stimulatory impact of food restriction on FAA in female mice. To examine whether this impact of PWIR in food-restricted mice was accounted for by specific changes in wheel-running motivation, and if so, whether these changes were sex-specific, we shifted from "free" wheel-running experiments to "effort-based" wheel-running experiments. Using operant conditioning, we first examined how food restriction affected running motivation in male and female mice before we analyzed the extent to which PWIR in male and female mice affected their motivation for i) wheel-running and ii) food intake under fed and food-restricted conditions. Food restriction did not affect male (**Figure 3A**) and female (**Figure 3B**) nose poke responses for wheel-running under FR1/FR3 schedules of reinforcement. Beside, the overall analysis of nose pokes in (fed and food-restricted) male and female mice revealed higher scores in females, as compared to males ( $F_{1,44} = 20.74, p < 0.0001$ ; **Figure 3A and B**). As opposed to its lack of effect on nose poke responses, food-deprivation increased both the running duration per rewarded sequence ( $F_{1,23} = 11.82, p = 0.0022$ ; **Figure 3C**) and the distance ran per rewarded sequence ( $F_{1,23} = 12.83, p = 0.0016$ ; **Figure 3E**) in male mice, but not in female mice (**Figure 3D and F**). When tested under a PR schedule of reinforcement, fed and food-restricted females were found to perform better than their fed and food-restricted male counterparts ( $F_{1,44} = 10.42, p = 0.0024$ ; **Figure 3G and H**), indicating higher motivation in the former mouse groups. However, when focusing on the effects of the feeding regimen on running motivation, males (**Figure 3G**), but not females (**Figure 3H**), proved sensitive to the stimulatory impact of food restriction although the latter bore sex-independent body weight-reducing effects (**Figure 3G and H**). Sex- and food restriction-dependent influences on wheel-running performances during the FR sessions extended to PR sessions as running durations per rewarded sequences ( $39.74 \pm 2.83$  s) and running distances per rewarded sequences ( $10.04 \pm 1.22$  m) were respectively increased by food restriction ( $47.91 \pm 1.96$  s and  $14.81 \pm 1.11$  m;  $p = 0.031$  and  $p = 0.011$ , respectively) in males, but not in females (data not shown). Taken together, these results revealed that although females displayed higher running motivation than males, their drive proved insensitive to food restriction, as opposed to that of males.

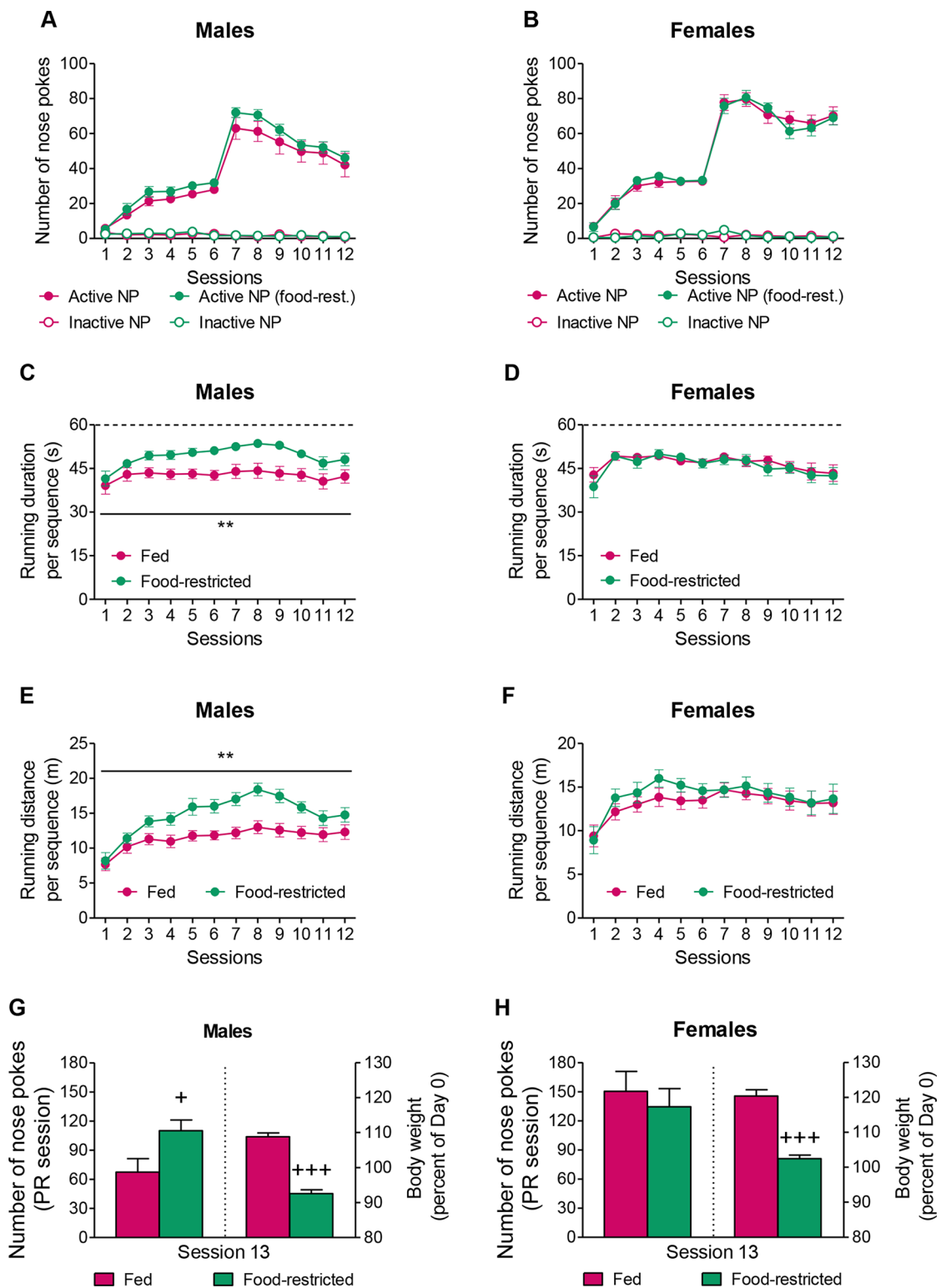


**FIGURE 2** | Wheel-running performances of grouped and post-weaning isolation reared (PWIR) female mice submitted to a restricted feeding protocol. **(A)** Hourly wheel-running activities before and during repeated food restriction (days 1–7). A limited amount of food (50% of the food quantity consumed during *ad libitum* feeding conditions) was provided at the daily onset of the dark period of the light/dark cycle. **(B)** Food restriction-elicited body weight reductions in grouped and PWIR mice. **(C,D)** Food restriction effects on daily running distances **(C)** and on daily distances ran during the light part of the light/dark cycle **(D)**. The values are the mean  $\pm$  standard error of the mean of  $n = 7-8$  mice. \*  $p < 0.05$  for the impact of PWIR (multiple-way analysis of variance). +  $p < 0.05$  and ++  $p < 0.01$  for the difference with D0 (*post hoc* Tukey test following a significant day  $\times$  mouse group interaction in the multiple-way analyses of variance). D0–D7 refer to day 0–day 7.

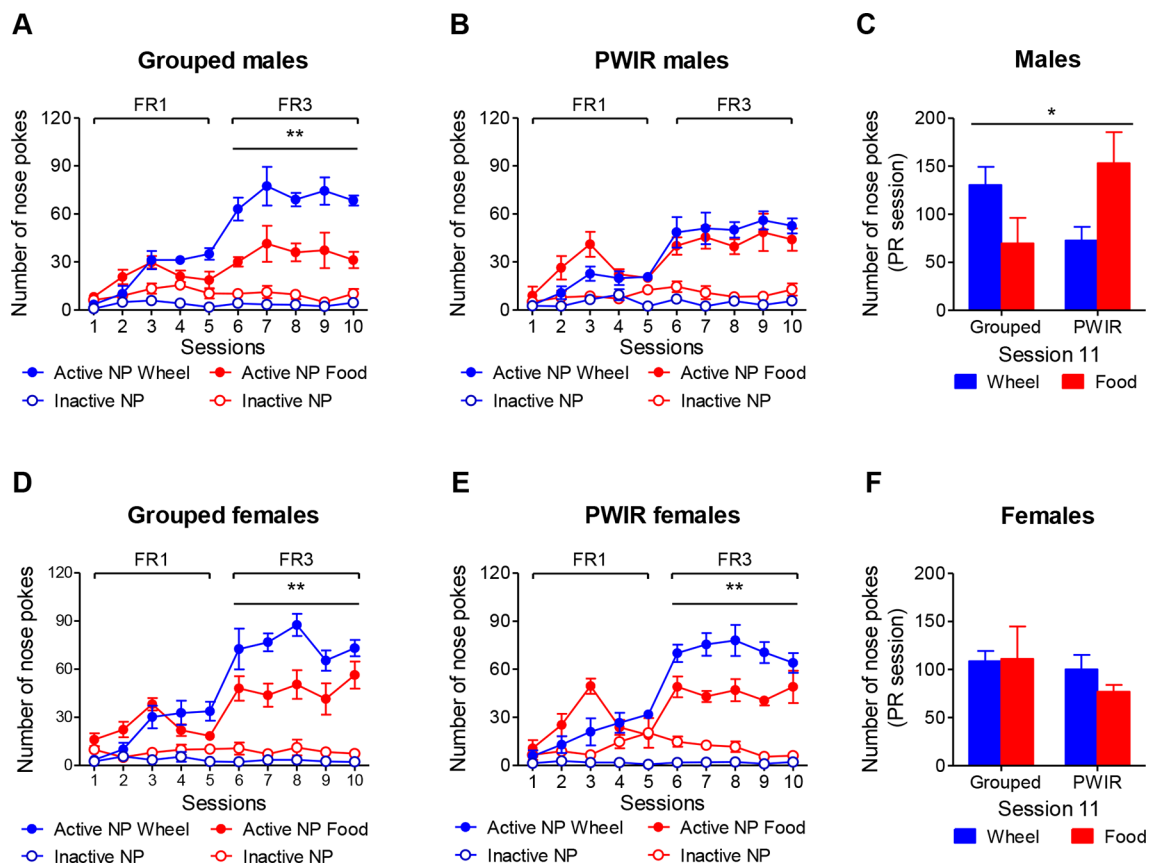
## Sex-Dependent Effects of PWIR on Nose-Poke Responding Reinforced by Wheel-Running or Palatable Food

The results gathered in the two preceding series of experiments rose the hypothesis that PWIR might increase nose poke responses for wheel-running in food-restricted females while possibly amplifying those evoked by food restriction in males. To test this hypothesis, we however had first to document i) the specificity of the effects of PWIR with regard to the nutritional

status of the animals (*ad libitum* fed vs. food restricted), and ii) measure whether these wheel-running responses were associated with PWIR- and/or sex-dependent changes in nose poke responses for food with/without food restriction. Accordingly, we measured the respective influences of PWIR, food restriction, and sex on nose poke responses for wheel-running and palatable feeding, each reward being provided alone. Grouped (**Figure 4A**), but not PWIR (**Figure 4B**), males displayed higher nose poke responses for wheel-running than



**FIGURE 3 |** Sex-dependent effects of food restriction on running motivation and running performances. **(A,B)** Neither male mice **(A)** nor female mice **(B)** displayed changes in their nose poke responses for wheel-running with food restriction when placed under FR1/FR3 schedules of reinforcement. **(C,D)** Food restriction increased the running duration per rewarded sequence in male mice **(C)**, but not in female mice **(D)**. **(E,F)** Food restriction increased the distance ran per rewarded sequence in male mice **(E)**, but not in female mice **(F)**. **(G,H)** A food restriction regimen leading to a 15–16% reduction in body weight amplified male **(G)**, but not female **(H)** nose poke responses for wheel-running during a PR session. The values are the mean  $\pm$  standard error of the mean of  $n = 11$ –14 mice. \*\*  $p < 0.01$  for the impact of food restriction (multiple-way analysis of variance). +  $p < 0.05$  and +++  $p < 0.001$  for the effect of food restriction during the PR session (Student t-test).



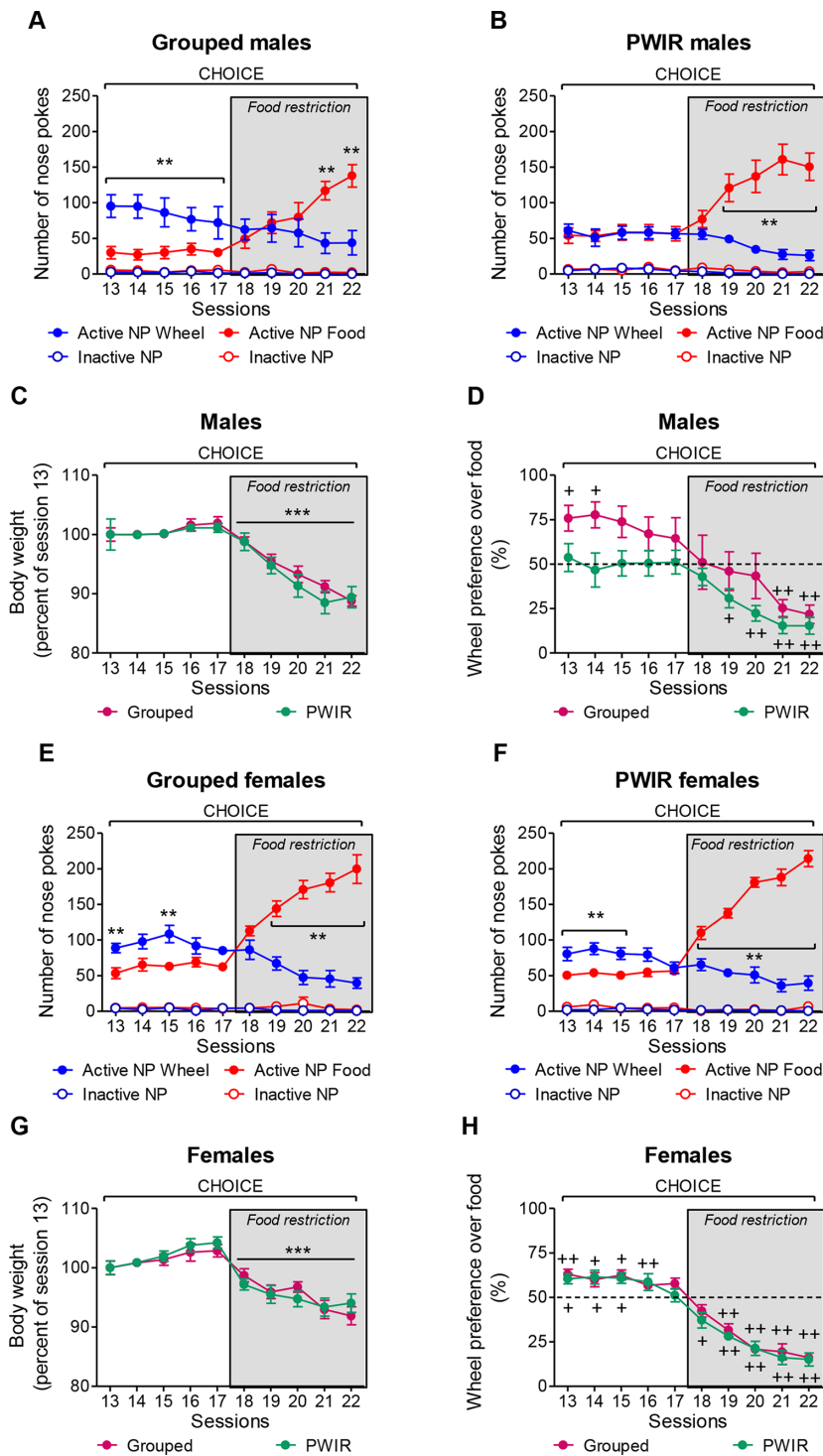
**FIGURE 4 |** Sex-dependent effects of post-weaning isolation rearing (PWIR) on running motivation and palatable feeding motivation (each reward provided separately). **(A,B)** Grouped **(A)**, but not PWIR **(B)**, males displayed higher nose poke responses for wheel-running than for palatable food under FR3 schedules of reinforcement. **(C)** Grouped and PWIR male mice showed opposed profiles of nose poke responses for running and feeding during a PR session. **(D,E)** Both grouped **(D)** and PWIR **(E)** females displayed a higher number of nose poke responses for running, compared to feeding, under FR3 schedules of reinforcement. **(F)** Neither PWIR nor the reward nature exerted influences on the number of nose responses displayed by female mice for reward access during a PR session. The values are the mean  $\pm$  standard error of the mean of  $n = 5-6$  mice. \*  $p < 0.05$  for the PWIR  $\times$  reward interaction during the PR session, and \*\*  $p < 0.01$  for the overall difference between rewards under FR3 schedules of reinforcement (multiple-way analyses of variance).

for palatable food under an FR3 schedule of reinforcement ( $F_{1,8} = 17.19, p = 0.0031$ ). Examination of these responses under a PR schedule of reinforcement revealed a reward  $\times$  housing interaction ( $F_{1,9} = 5.86, p = 0.0385$ ) that was mainly accounted for by increased motivation for palatable food over wheel-running in isolated animals (**Figure 4C**). As opposed to males, both group-housed ( $F_{1,8} = 12.21, p = 0.008$ ; **Figure 4D**) and PWIR ( $F_{1,10} = 13.49, p = 0.0043$ ; **Figure 4E**) female mice responded more for wheel-running than for food under FR3 schedules of reinforcement. However, these trends did not translate into higher responses for wheel-running in the PR sessions whether nose poke numbers (**Figure 4F**) or breakpoint levels (data not shown) were considered.

## Sex-Dependent Effects of PWIR on the Choice Between Wheel-Running and Palatable Food

The aforementioned experiments alternatively used wheel-running or palatable feeding as reinforcers. To examine

whether the conclusions raised by these experiments extended to a reward choice situation (as daily encountered by humans, including AN patients), we performed one series of experiments wherein mice placed under an FR3 schedule of reinforcement could select one of the two rewards, this choice being temporarily exclusive. Moreover, as PWIR affected the amplitudes of the respective impacts of food restriction on body weight losses and FAA in female mice (**Figure 2B** and **D**), these experiments involved mice initially provided food *ad libitum* before being placed under a food restriction regimen. The analysis of the respective nose poke responses for wheel-running and palatable feeding revealed significant reward  $\times$  food regimen  $\times$  session interactions on nose poke responses in grouped males ( $F_{4,32} = 8.23, p = 0.0001$ ; **Figure 5A**) and in PWIR males ( $F_{4,40} = 22.31, p < 0.0001$ ; **Figure 5B**). However, while nose poke responses for wheel-running exceeded those for feeding during *ad libitum* feeding conditions—a difference which vanished during food restriction—in grouped males (**Figure 5A**), nose poke responses for each reward were similar in their PWIR counterparts (**Figure 5B**). Comparisons of the



**FIGURE 5 |** Sex-dependent effects of post-weaning isolation rearing (PWIR) on the preference between running and palatable feeding (choice sessions). **(A)** The difference in nose poke responses for running over feeding in grouped males was progressively inverted with food restriction. **(B)** Fed PWIR males displayed equal numbers of nose responses for running and feeding. **(C)** Grouped and PWIR male mice showed similar body weight losses during food restriction. **(D)** Grouped, but not PWIR, mice displayed time-dependent preferences for wheel-running over feeding. **(E,F)** The difference in nose poke responses for running over feeding in grouped and PWIR females was progressively inverted with food restriction. **(G)** Identical body weight losses in food-restricted grouped and PWIR female mice during the choice sessions. **(H)** Similar profiles of wheel-running preference over feeding in grouped and PWIR females during the choice sessions. The values are the mean  $\pm$  standard error of the mean of  $n = 5-6$  mice. \*\*  $p < 0.01$  for the time-dependent differences between nose poke responses for wheel-running and feeding (*post hoc* Tukey tests following significant session  $\times$  reward interaction in the multiple-way analyses of variance), and \*\*\*  $p < 0.001$  for the overall impacts of food restriction on body weights (multiple-way analyses of variance). +  $p < 0.05$  and ++  $p < 0.01$  for the differences with the non-preference (50%) level (one-tailed Student *t*-tests).

respective reward preference ratios in grouped males and in PWIR males ( $F_{4,36} = 4.90$ ,  $p = 0.0029$ ) confirmed these trends based on absolute nose poke responses for each reward (**Figure 5D**). Actually, the slopes of the session-dependent decreases in body weights ( $F_{1,9} = 67.07$ ,  $p < 0.0001$ ; **Figure 5C**) and wheel preference (**Figure 5D**) were similar in food-restricted grouped and PWIR males. As in males, PWIR in female mice did not affect the amplitude of body weight losses following food restriction ( $F_{1,9} = 54.88$ ,  $p < 0.0001$ ; **Figure 5G**). However, as opposed to *ad libitum* fed males, PWIR proved ineffective on the amplitude of the preference for wheel-running over feeding during *ad libitum* feeding. This was true whether absolute nose poke responses for wheel-running and palatable feeding ( $F_{4,32} = 20.81$ ,  $p < 0.0001$  and  $F_{4,40} = 19.28$ ,  $p < 0.0001$  in group-housed mice and in PWIR mice, respectively; **Figure 5E and F**) or reward preference ratios ( $F_{4,36} = 14.25$ ,  $p = 0.0001$ ; **Figure 5H**) were considered. Lastly, it is worthy of mention that the mean running preference ratio, although over 50% in grouped males (**Figure 5D**) and grouped females (**Figure 5H**), showed a sex-dependent heterogeneity of responses. Hence, in males, this heterogeneity was partly, but not fully, accounted for by one male (over five) which displayed 88–100% preference for wheel-running over feeding under *ad libitum* fed conditions before showing delayed preference for feeding, compared to the other males, under restricted conditions.

## PWIR Decreases Wheel-Running Performances in Male Mice

The aforementioned observation that PWIR reduced the wheel preference over food in male mice might have been biased by an increased wheel-running performance during each rewarded sequence. If so, “consumption” of the reward would have compensated for decreased reward motivation in this mouse group. Analyses of wheel-running performances during each rewarded sequence argued against such a possibility. Thus, either the running duration ( $F_{1,9} = 10.57$ ,  $p = 0.01$ ; **Figure 6A**) or the running distance ( $F_{1,9} = 5.85$ ,  $p = 0.039$ ; **Figure 6C**) per rewarded sequence proved sensitive to PWIR, PWIR mice displaying decreased performances compared to group-housed mice. Indeed, these two performance indices were affected to a similar extent by PWIR, an observation which accounted for the lack of influence of that stressor on the mouse mean speed (data not shown). The impact of PWIR on wheel-running performances was sex-specific as it proved ineffective in female mice (**Figure 6B and D**).

## DISCUSSION

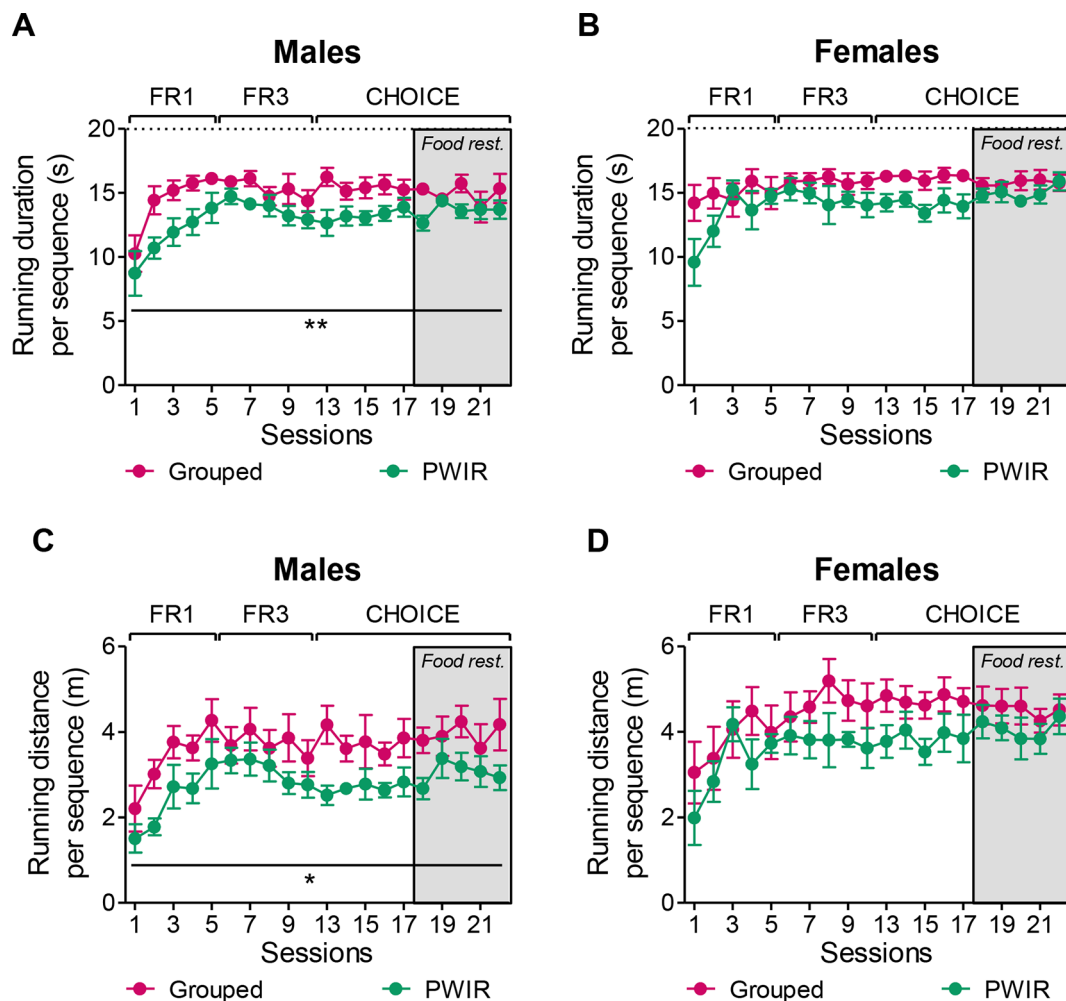
AN bears the highest mortality rate among psychiatric diseases (Kaye et al., 2009), which is accounted for by our poor knowledge of its neurobiological underpinnings and hence a lack of efficient therapy for the most dramatic cases. Our ignorance of AN neurobiology lies on both its complex etiology and the translational limits of AN animal models. Although different animal models of AN exist (Mequinion et al., 2015), the one that has gained much

audience is the ABA model. However, the great majority of ABA studies uses “free” wheel-running (i.e. costless access to running wheels) in their quest to elucidate the bases of AN. This can be questioned on the basis of former evidence for a motivation conflict between exercise and feeding in AN (Klein et al., 2004; Casper, 2006; Keating, 2010; Keating et al., 2012). Actually, recent observations strengthen the hypothesis of a general alteration in reward pathways in AN, whether brain responses to losses in monetary gambling tasks or therapeutic responses to the deep brain stimulation of the nucleus accumbens—a key node in brain reward pathways—are concerned (Bischoff-Grethe et al., 2013; Lipsman et al., 2017; Bernardoni et al., 2018). To date, only one study addressed the role of these pathways in the ABA model. Thus, selective chemogenetic stimulation of the dopaminergic mesoaccumbal pathway increased the percent survival to the ABA protocol, doing so by increasing food intakes and FAA-induced body weight loss in female rats (Foldi et al., 2017). An additional concern with the use of the ABA model relates to the observation that it provides neither an index of feeding motivation nor an analysis of the balance between running motivation and feeding motivation when both are available (as in the daily life of anorexics). By comparing the respective results provided by the ABA on the one hand, and reward-motivated instrumental responses on the other hand, this study provides evidence that conclusions based on the former are not valid when motivation-driven responses are considered.

As indicated above, the wide use of the ABA model is accounted for by the seminal observation that rats undergoing a food restriction regimen, i.e., a unique (time- or quantity-restricted) daily access to food, progressively increase their running performances when housed with running wheels. Actually, such an increase in performance mainly relates to FAA, a behavior classically observed in food-restricted animals prior to food presentation. The negative balance between energy intake and energy expenditure in favor of the latter thus accounts for the widespread use of ABA as an animal model of AN (although species-dependent sensitivities must be considered; Rowland et al., 2018). If so, it is expected that AN precipitating factors, such as perinatal and postnatal trauma (see Introduction), amplify such an imbalance. Actually, the use of prenatal stress, early weaning or repeated maternal separation has indicated that ABA symptomatology might be exacerbated by these procedures, albeit not necessarily in a sex-dependent manner (Glavin and Pare, 1985; Hancock and Grant, 2009; Schroeder et al., 2018). In the present study, we selected PWIR as the infant trauma. Thus, social isolation at the onset of the post-weaning period and throughout adolescence is endowed with long-lasting behavioral disturbances (e.g. anxiety, alterations in impulse control, deficit in social interactions, increased drug preference, efficient acquisition of drug self-administration; Burke et al., 2017; Walker et al., 2019) that are relevant to the scope of this study. The origins of these disturbances are likely due to the inability to express social play behavior, a highly rewarding activity that contributes to a major extent to the normal development of emotional processes (Vanderschuren et al., 2016).

As indicated above, ABA relies on a unique time- or quantity-restricted daily access to food. In most cases, a short time-window is privileged for daily food access. In our hands, preliminary observations using a daily 3-h access to food indicated that this protocol was too severe for the animals, as illustrated by precipitated





**FIGURE 6** | Impaired nose poke responses for wheel-running were associated with decreased running performances in PWIR males. **(A,B)** PWIR decreased the running duration per rewarded sequence in males **(A)**, but not in females **(B)**. **(C,D)** PWIR males **(C)**, but not females **(D)**, ran less distance per rewarded sequence, compared to their respective grouped controls. The values are the mean  $\pm$  standard error of the mean of  $n = 5$ – $6$  mice. \*  $p < 0.05$  and \*\*  $p < 0.01$  for the overall impacts of PWIR throughout test sessions (multiple-way analyses of variance).

and important body weight decreases that led to the discontinuation of wheel-running activity after 4 days in several animals (and hence interruption of the study for welfare reasons). Accordingly, we chose a quantity-restricted paradigm that allowed to observe significant wheel-running activity in all animals. In keeping with the aforementioned prevalence of woman suffering AN, as compared to males, we first tested whether PWIR was endowed with a significant impact in female mice exposed to an ABA paradigm. The observation that PWIR amplified the food restriction-elicited decrease in body weight—extending data in male rats (Ness et al., 1995)—while amplifying FAA, but not postprandial activity, argues against the proposal that the latter is directly related to weight loss (Wu et al., 2014). Besides putative species differences (mice vs. rats), one likely explanation for this discrepancy lies on the fact that in the latter study food-restricted animals were provided food during the light phase of the light/dark cycle (as in many other ABA studies), and not at the onset of the dark phase (present study), i.e., when rodents normally begin eating. Actually, such a time-dependent

importance of food delivery, with respect to the light/dark cycle, has been documented elsewhere (Dwyer and Boakes, 1997). Thus, body weight losses, besides being of lower amplitude if food is provided at the onset of the dark period, were found to stabilize more rapidly when feeding occurred within the dark period than within the light period (Dwyer and Boakes, 1997). Noteworthy is the additional finding that the comparison between animals only allowed FAA (i.e., by unblocking the wheels during the hours preceding food provision) and animals allowed to run throughout the light/dark cycle indicated that ABA was fully accounted for by FAA (Dwyer and Boakes, 1997).

Our finding that FAA was increased in PWIR females, as compared to group-housed females, suggested that wheel-running motivation might be exacerbated in the former animals. Besides indicating the crucial need to shift to a paradigm allowing to specifically measure running motivation (Collier and Hirsch, 1971; Iversen, 1993; Belke, 1997; Muguruza et al., 2019)—doing so through the quantitation of the efforts the mice accept to provide

to unlock a running wheel—this result raised two issues. The first was related to the impact of sex, if any, on running motivation in PWIR mice. The second issue involved the need to measure feeding motivation as to appreciate how PWIR might affect the balance between running and feeding drives. To explore these issues, we exposed fed/food-restricted group-housed/PWIR mice to operant protocols that specifically allow to estimate wheel-running and feeding drives as well as running performances (Muguruza et al., 2019). However, before focusing on these issues, we asked two preliminary, albeit important, questions within the present context, i.e. does food-restriction increase wheel-running motivation, and if so, is the amplitude of that increase sex-dependent? Thus, although the stimulatory impacts of either food restriction or complete fasting on wheel-running performance are known since almost 70 years (Finger, 1951), only one study, which used rats, compared males and females with respect to wheel-running motivation under fed and food-restricted conditions (Pierce et al., 1986). It was observed that the relationship between the amplitude of food restriction and running motivation, as estimated during a PR session, followed an inverted U-shaped curve with females responding to food restriction with seemingly higher running motivation than males (albeit the low number of animals impedes any conclusion; Pierce et al., 1986). The observation that food-restriction might increase running motivation fits with the finding that motivation for wheel-running under food-limited conditions is food-related, hence increasing performance, at least under “free” wheel-running conditions (Belke and Pierce, 2016). To our surprise, our female mice, albeit responding more than males for wheel-running under both constant (FR) and progressive (PR) reinforcement schedules, proved insensitive to food restriction. Conversely, food restriction stimulated male nose poke responses during the PR, but not the FR, sessions, indicating increased motivation. Interestingly, the lack of impact of food restriction on male nose poke responses during FR sessions did not extend to wheel-running performances at each rewarded sequence, as illustrated by the increased running duration/distance throughout these sessions. In keeping with our previous observation that mice bearing a deletion of the cannabinoid type-1 (CB1) receptor display decreased nose poke responses for wheel-running during FR/PR sessions without any alteration in running duration/distance at each rewarded sequence (Muguruza et al., 2019), the present study reinforces the belief that running motivation and running “consumption” (as assessed from running performances) are different entities (Belke and Garland, 2007; Muguruza et al., 2019).

That food restriction did not stimulate running motivation in our female mice although ABA-induced FAA, albeit of weak amplitude, could be observed in these animals suggested that FAA is not an index of running motivation. If so, this in turn would indicate that the aforementioned stimulatory impact of PWIR on FAA occurs without any change in running motivation. At first sight, this possibility might appear counterintuitive in keeping with the aforementioned report that chemogenetic stimulation of the mesolimbic pathway, which plays a key role in motivation for rewards, slightly, but significantly, amplifies FAA (Foldi et al., 2017). Accordingly, we analyzed wheel-running motivation in PWIR and grouped females, extending this investigation to males as running motivation was stimulated in a sex-dependent manner by food

restriction. Moreover, as AN associates high exercise motivation with low feeding motivation under circumstances during which both rewards are in competition, we took advantage of our recently developed operant paradigm wherein the reinforcing values of these two rewards can be assessed separately in fed animals before being compared within a choice paradigm under fed and food-restricted conditions (Muguruza et al., 2019). Under fed conditions, whether the rewards were provided separately or within a choice paradigm, PWIR males responded to similar extents for wheel-running and for palatable food when all other mouse groups displayed increased responding for wheel-running. The negative impact of PWIR on male nose poke responding for wheel-running, compared to that measured in the other mouse groups, extended to running performance. Thus, when analyzed when wheel-running was proposed either solely or in concurrence with palatable food, the running duration/distance per rewarded sequence was decreased in PWIR males, compared to grouped males. This suggests that PWIR bears negative consequences on both wheel-running motivation and wheel-running “consumption”. Considering the finding mentioned above that wheel-running motivation is under tight control by CB1 receptors (Rasmussen and Hillman, 2011; Muguruza et al., 2019), the observation that PWIR decreases CB1 receptor activity in rats (Zamberletti et al., 2012) and mice (Muguruza et al., in preparation) might provide a route of investigation to unravel the neurobiological underpinnings of decreased running motivation in PWIR males. As concerns the reduced wheel-running performance in these animals, the finding that opioid receptors, the density of which is reduced by PWIR (Schenk et al., 1982), might control wheel-running performance without impacting on running motivation (Rasmussen and Hillman, 2011), provides another promising route of investigation. Confirmingly, opiate receptor blockade has been reported to alleviate, through decreased wheel-running, ABA severity (Boer et al., 1990). Using a food restriction protocol similar to that used in animals which were only tested for their running motivation (see above), motivation for food overpassed progressively that for running in all groups (with females reaching higher levels than males). In sharp contrast with the above-mentioned higher FAA in PWIR females, compared to grouped females, motivation for wheel-running proved insensitive to PWIR. Besides running protocol differences, the fact that another reward, namely palatable food, was accessible might explain this differential effect of PWIR. Indeed, studies from Ahmed’s group have shown that the rank of motivation for one of two rewards provided separately might be reversed when both rewards are proposed in concurrence (Cantin et al., 2010).

Taken together, the results from this study show that changes in “free” wheel-running performances, including FAA, in an ABA protocol by no means reflect alterations in the drive for running (as assessed through an effort-based protocol). Because AN imbalances in the respective drives for exercise and feeding are at the core of the pathology, our results question the translational usefulness of ABA. There are of course limits to the present study. One limit relates to the low numbers of animals which might have underpowered our analyses. Although this possibility must be taken into account, the data gathered in the present study clearly show that the measurement of FAA in the ABA protocol does not provide information on running motivation. The second limit is linked to our use of palatable food,

instead of normal chow food, to assess the impact of PWIR on feeding motivation. Thus, adding food palatability to normal (i.e., chow) feeding behavior likely recruits additional central circuit components, including those projecting to the mesocorticolimbic dopaminergic system (Fulton, 2010). However, because i) only food-restricted mice do work to a significant extent to get access to normal chow food, and ii) this study wished to assess the respective impacts of PWIR on feeding drives under both *ad libitum* fed and food restriction conditions, the sole option was to use palatable food although we acknowledge the fact that such a use amplified PR nose poke responses, at least in fed animals, compared to normal chow. A third limit relates to the fact that this study involved animals tested daily for 30–60 min, hence increasing the objective value of each reward. Thus, AN patients are confronted throughout their daily life to the choice between these two rewards. A fourth limit is in keeping with former evidence for the oestrous cycle stage impacting on reward motivation (oestrus > dioestrus), at least for cocaine (Calipari et al., 2017). Although we cannot exclude that cycle variations contributed to the differential impacts of PWIR in the present study, it should be noted that its respective effects on FAA and nose poke responses under an FR3 schedule of reinforcement were studied through a successive number of days that encompassed the duration of the oestrus cycle. The fact that we did not include genetics in our study—although these are involved in AN etiology (see above)—might be considered another key limit. Hence, it might be that testing mouse lines different from the one used herein would have provided a female-specific increase in running motivation at the expense of that for feeding after PWIR. Another important limit stems from our procedure which only compared the respective drives for running and feeding under one schedule of reinforcement (i.e., FR3). Although the purpose of this study was not to compare the intrinsic rewarding values of running and feeding, a procedure which would have required different schedules of reinforcement (Hursh et al., 1988; Hursh and Silberberg, 2008), we cannot exclude that increasing the costs for each reward would have led to results differing from the present ones. As rightly proposed by Rowland et al., 2018 in their use of a cost-based anorexia model, increasing the cost to access food would mimic the high cost AN patients feel with regard to food. Accordingly, using a cost-based anorexia model wherein mice would be proposed food at progressively higher costs in their living environment (Atalayer and Rowland, 2011), and adding to that model increasing costs for running, could help to disentangle the neurobiological grounds of AN. Such a model would prove useful for the development of pharmacological agents aimed at specifically altering the exercise/food drive balance (in either direction) for therapeutic goals.

## REFERENCES

- Atalayer, D., and Rowland, N. E. (2011). Structure of motivation using food demand in mice. *Physiol. Behav.* 104, 15–19. doi: 10.1016/j.physbeh.2011.04.042
- Bale, T. L., and Epperson, C. N. (2015). Sex differences and stress across the lifespan. *Nat. Neurosci.* 18, 1413–1420. doi: 10.1038/nn.4112
- Belke, T. W. (1997). Running and responding reinforced by the opportunity to run: effect of reinforcement duration. *J. Exp. Anal. Behav.* 67, 337–351. doi: 10.1901/jeab.1997.67-337

## ETHICS STATEMENT

All protocols, which complied with the French (Décret 2013-118) and European (2010/63/EU) rules on animal experimentation, were approved by the local Ethic Committee (Comité d’Ethique 50) with agreement numbers DIR13111, 13649, 33-063-69 (F.C.) and A33-063-098 (animal facilities) provided under authority of the Préfecture de Gironde and the Ministry of Agriculture. Accordingly, the 3R-rules were followed, including through the use of the minimal number of animals per series of experiments that was required to reach conclusions. In addition, in keeping with the procedures used in this study (see the methodological outline), and which could have long-lasting consequences, all animals were only used once and sacrificed thereafter.

## AUTHOR CONTRIBUTIONS

BR, IH, GM, and FC designed the research. BR, IH, AS, MM, and FC performed research. BR, IH, AS, MM, and FC analyzed the data. FC wrote the first version of the manuscript before it was edited and approved by all authors.

## FUNDING

This work was supported by Institut National de la Santé et de la Recherche Médicale (to GM), la Région Aquitaine (to GM), the University of Bordeaux (to GM), the European Research Council (ERC-2017-AdG-786467 to GM), l’Agence Nationale de la Recherche (to GM and FG), l’Agence Française de Lutte contre le Dopage (to FC), and the LabEx-Bordeaux Région Aquitaine Initiative for Neuroscience (to GM and FC).

## ACKNOWLEDGMENTS

The reviewers of this publication are thanked for their constructive criticisms. We also thank all the personnel from the Animal Facility and the Genotyping platform of the NeuroCentre Magendie, Virginie Morales and the other members of Marsicano’s laboratory for their daily support and for useful discussions, and Dr Serge Ahmed (IMN, CNRS UMR 5293, Bordeaux) for his help in setting the choice paradigm.

- Belke, T. W., and Garland, T., Jr. (2007). A brief opportunity to run does not function as a reinforcer for mice selected for high daily wheel-running rates. *J. Exp. Anal. Behav.* 88, 199–213. doi: 10.1901/jeab.2007.62-06
- Belke, T. W., and Pierce, W. D. (2016). Wheel-running reinforcement in free-feeding and food-deprived rats. *Behav. Processes.* 124, 1–9. doi: 10.1016/j.beproc.2015.11.018
- Bernardoni, F., Geisler, D., King, J. A., Javadi, A. H., Ritschel, F., Murr, J., et al. (2018). Altered medial frontal feedback learning signals in anorexia nervosa. *Biol. Psychiatry* 83, 235–243. doi: 10.1016/j.biopsych.2017.07.024

- Bischoff-Grethe, A., McCurdy, D., Grenesko-Stevens, E., Irvine, L. E., Wagner, A., Yau, W. Y., et al. (2013). Altered brain response to reward and punishment in adolescents with anorexia nervosa. *Psychiatry Res.* 214, 331–340. doi: 10.1016/j.psychres.2013.07.004
- Boakes, R. A. (2007). Self-starvation in the rat: running versus eating. *Span. J. Psychol.* 10, 251–257. doi: 10.1017/S113874160000651X
- Boer, D. P., Epling, W. F., Pierce, W. D., and Russell, J. C. (1990). Suppression of food deprivation-induced high-rate wheel running in rats. *Physiol. Behav.* 48, 339–342. doi: 10.1016/0031-9384(90)90324-W
- Boersma, G. J., Liang, N. C., Lee, R. S., Albertz, J. D., Kastelein, A., Moody, L. A., et al. (2016). Failure to upregulate Agrp and Orexin in response to activity based anorexia in weight loss vulnerable rats characterized by passive stress coping and prenatal stress experience. *Psychoneuroendocrinology* 67, 171–181. doi: 10.1016/j.psyneuen.2016.02.002
- Brewerton, T. D., Stelfox, E. J., Hibbs, N., Hodges, E. L., and Cochrane, C. E. (1995). Comparison of eating disorder patients with and without compulsive exercising. *Int. J. Eat. Disord.* 17, 413–416. doi: 10.1002/1098-108X(199505)17:4<413::AID-EAT2260170414>3.0.CO;2-0
- Bulik, C. M., Slof-Op't Landt, M. C., van Furth, E. F., and Sullivan, P. F. (2007). The genetics of anorexia nervosa. *Annu. Rev. Nutr.* 27, 263–275. doi: 10.1146/annurev.nutr.27.061406.093713
- Burke, A. R., McCormick, C. M., Pellis, S. M., and Lukkes, J. L. (2017). Impact of adolescent social experiences on behavior and neural circuits implicated in mental illnesses. *Neurosci. Biobehav. Rev.* 76, 280–300. doi: 10.1016/j.neubiorev.2017.01.018
- Calipari, E. S., Juarez, B., Morel, C., Walker, D. M., Cahill, M. E., Ribeiro, E., et al. (2017). Dopaminergic dynamics underlying sex-specific cocaine reward. *Nat. Commun.* 10, 13877. doi: 10.1038/ncomms13877
- Canetti, L., Kanyas, K., Lerer, B., Latzer, Y., and Bachar, E. (2008). Anorexia nervosa and parental bonding: the contribution of parent-grandparent relationships to eating disorder psychopathology. *J. Clin. Psychol.* 64, 703–716. doi: 10.1002/jclp.20482
- Cantin, L., Lenoir, M., Augier, E., Vanhille, N., Dubreucq, S., Serre, F., et al. (2010). Cocaine is low on the value ladder of rats: possible evidence for resilience to addiction. *PLoS ONE* 5, e11592. doi: 10.1371/journal.pone.0011592
- Carrera, O., Cerrato, M., Sanchez, A., and Gutierrez, E. (2009). Long maternal separation has protective effects in rats exposed to activity-based anorexia. *Dev. Psychobiol.* 51, 616–624. doi: 10.1002/dev.20396
- Casper, R. C. (2006). The 'drive for activity' and "restlessness" in anorexia nervosa: potential pathways. *J. Affect. Disord.* 92, 99–107. doi: 10.1016/j.jad.2005.12.039
- Casper, R. C. (2018). Not the function of eating, but spontaneous activity and energy expenditure, reflected in "restlessness" and a "drive for activity" appear to be dysregulated in anorexia nervosa: treatment implications. *Front. Psychol.* 9, 2303. doi: 10.3389/fpsyg.2018.02303
- Clarke, T. K., Weiss, A. R., and Berrettini, W. H. (2012). The genetics of anorexia nervosa. *Clin. Pharmacol. Ther.* 91, 181–188. doi: 10.1038/clpt.2011.253
- Collier, G. H., and Hirsch, E. (1971). Reinforcing properties of spontaneous activity in the rat. *J. Comp. Physiol. Psychol.* 77, 155–160. doi: 10.1037/h0031588
- Cook, B. J., and Hausenblas, H. A. (2008). The role of exercise dependence for the relationship between exercise behavior and eating pathology: mediator or moderator? *J. Health. Psychol.* 13, 495–502. doi: 10.1177/1359105308088520
- Davis, C. (1997). Eating disorders and hyperactivity: a psychobiological perspective. *Can. J. Psychiatry* 42, 168–175. doi: 10.1177/070674379704200207
- Davis, C., and Woodside, D. B. (2002). Sensitivity to the rewarding effects of food and exercise in the eating disorders. *Compr. Psychiatry* 43, 189–194. doi: 10.1053/comp.2002.32356
- Dwyer, D. M., and Boakes, R. A. (1997). Activity-based anorexia in rats as failure to adapt to a feeding schedule. *Behav. Neurosci.* 111, 195–205. doi: 10.1037/0735-7044.111.1.195
- Finger, F. W. (1951). The effect of food deprivation and subsequent satiation upon general activity in the rat. *J. Comp. Physiol. Psychol.* 44, 5575–5564. doi: 10.1037/h0055692
- Foldi, C. J., Milton, L. K., and Oldfield, B. J. (2017). The role of mesolimbic reward neurocircuitry in prevention and rescue of the activity-based anorexia (ABA) phenotype in rats. *Neuropsychopharmacology* 42, 2292–2300. doi: 10.1038/npp.2017.63
- Fone, K. C., and Porkess, M. V. (2008). Behavioural and neurochemical effects of post-weaning social isolation in rodents-relevance to developmental neuropsychiatric disorders. *Neurosci. Biobehav. Rev.* 32, 1087–1102. doi: 10.1016/j.neubiorev.2008.03.003
- Fulton, S. (2010). Appetite and reward. *Front. Neuroendocrinol.* 31, 85–103. doi: 10.1016/j.yfrne.2009.10.003
- Glavin, G. B., and Pare, W. P. (1985). Early weaning predisposes rats to exacerbated activity-stress ulcer formation. *Physiol. Behav.* 34, 907–909. doi: 10.1016/0031-9384(85)90012-5
- Hancock, S., and Grant, V. (2009). Early maternal separation increases symptoms of activity-based anorexia in male and female rats. *J. Exp. Psychol. Anim. Behav. Process.* 35, 394–406. doi: 10.1037/a0014736
- Hursh, S. R., Raslear, T. G., Shurtleff, D., Bauman, R., and Simmons, L. (1988). A cost-benefit analysis of demand for food. *J. Exp. Anal. Behav.* 50, 419–440. doi: 10.1901/jeab.1988.50-419
- Hursh, S. R., and Silberberg, A. (2008). Economic demand and essential value. *Psychol. Rev.* 115, 186–198. doi: 10.1037/0033-295X.115.1.186
- Iversen, I. H. (1993). Techniques for establishing schedules with wheel-running as reinforcement in rats. *J. Exp. Anal. Behav.* 60, 219–238. doi: 10.1901/jeab.1993.60-219
- Jaita, C., Schneider, N., Hilbert, A., Pfeiffer, E., Lehmkuhl, U., and Salbach-Andrae, H. (2012). Etiological role of childhood emotional trauma and neglect in adolescent anorexia nervosa: a cross-sectional questionnaire analysis. *Psychopathology* 45, 61–66. doi: 10.1159/000328580
- Kaye, W. H., Fudge, J. L., and Paulus, M. (2009). New insights into symptoms and neurocircuit function of anorexia nervosa. *Nat. Rev. Neurosci.* 10, 573–584. doi: 10.1038/nrn2682
- Keating, C. (2010). Theoretical perspective on anorexia nervosa: the conflict of reward. *Neurosci. Biobehav. Rev.* 34, 73–79. doi: 10.1016/j.neubiorev.2009.07.004
- Keating, C., Tilbrook, A. J., Rossell, S. L., Enticott, P. G., and Fitzgerald, P. B. (2012). Reward processing in anorexia nervosa. *Neuropsychologia* 50, 567–575. doi: 10.1016/j.neuropsychologia.2012.01.036
- Keski-Rahkonen, A., and Mustelin, L. (2016). Epidemiology of eating disorders in Europe: prevalence, incidence, comorbidity, course, consequences, and risk factors. *Curr. Opin. Psychiatry* 29, 340–345. doi: 10.1097/YCO.0000000000000278
- Kim, S. F. (2012). Animal models of eating disorders. *Neuroscience* 211, 2–12. doi: 10.1016/j.neuroscience.2012.03.024
- Klein, D. A., Bennett, A. S., Schebendach, J., Foltin, R. W., Devlin, M. J., and Walsh, B. T. (2004). Exercise "addiction" in anorexia nervosa: model development and pilot data. *CNS Spectr.* 9, 531–537. doi: 10.1017/S1092852900009627
- Klenotich, S. J., Seiglie, M. P., McMurray, M. S., Roitman, J. D., Le Grange, D., Dugad, P., et al. (2012). Olanzapine, but not fluoxetine, treatment increases survival in activity-based anorexia in mice. *Neuropsychopharmacology* 37, 1620–1631. doi: 10.1038/npp.2012.7
- Leung, N., Thomas, G., and Waller, G. (2000). The relationship between parental bonding and core beliefs in anorexic and bulimic women. *Br. J. Clin. Psychol.* 39, 205–213. doi: 10.1348/014466500163220
- Lipsman, N., Lam, E., Volpini, M., Sutandar, K., Twose, R., Giacobbe, P., et al. (2017). Deep brain stimulation of the subcallosal cingulate for treatment-refractory anorexia nervosa: 1 year follow-up of an open-label trial. *Lancet Psychiatry* 4, 285–294. doi: 10.1016/S2215-0366(17)30076-7
- Lupien, S. J., McEwen, B. S., Gunnar, M. R., and Heim, C. (2009). Effects of stress throughout the lifespan on the brain, behaviour and cognition. *Nat. Rev. Neurosci.* 10, 434–445. doi: 10.1038/nrn2639
- McCormick, C. M., Green, M. R., and Simone, J. J. (2016). Translational relevance of rodent models of hypothalamic-pituitary-adrenal function and stressors in adolescence. *Neurobiol. Stress* 6, 31–43. doi: 10.1016/j.ynst.2016.08.003
- Mequinion, M., Chauveau, C., and Viltart, O. (2015). The use of animal models to decipher physiological and neurobiological alterations of anorexia nervosa patients. *Front. Endocrinol. (Lausanne)* 6, 68. doi: 10.3389/fendo.2015.00068
- Meyer, C., Taranis, L., Goodwin, H., and Haycraft, E. (2011). Compulsive exercise and eating disorders. *Eur. Eat. Disord. Rev.* 19, 174–189. doi: 10.1002/erv.1122
- Muguruza, C., Redon, B., Fois, G. R., Hurel, I., Soccard, A., Nguyen, C., et al. (2019). The motivation for exercise over palatable food is dictated by cannabinoid type-1 receptors. *JCI Insight* 4, 1–4. doi: 10.1172/jci.insight.126190. eCollection 2019 Mar 7.
- Ness, J. W., Marshall, T. R., and Aravich, P. F. (1995). Effects of rearing condition on activity-induced weight loss. *Dev. Psychobiol.* 28, 165–173. doi: 10.1002/dev.420280304
- Pierce, W. D., Epling, W. F., and Boer, D. P. (1986). Deprivation and satiation: the interrelations between food and wheel running. *J. Exp. Anal. Behav.* 46, 199–210. doi: 10.1901/jeab.1986.46-199

- Pike, K. M., Hilbert, A., Wilfley, D. E., Fairburn, C. G., Dohm, F. A., Walsh, B. T., et al. (2008). Toward an understanding of risk factors for anorexia nervosa: a case-control study. *Psychol. Med.* 38, 1443–1453. doi: 10.1017/S0033291707002310
- Pjetri, E., de Haas, R., de Jong, S., Gelegen, C., Oppelaar, H., Verhagen, L. A., et al. (2012). Identifying predictors of activity based anorexia susceptibility in diverse genetic rodent populations. *PLoS One* 7, e50453. doi: 10.1371/journal.pone.0050453
- Racine, S. E., and Wildes, J. E. (2015). Emotion dysregulation and anorexia nervosa: an exploration of the role of childhood abuse. *Int. J. Eat. Disord.* 48, 55–58. doi: 10.1002/eat.22364
- Rasmussen, E. B., and Hillman, C. (2011). Naloxone and rimonabant reduce the reinforcing properties of exercise in rats. *Exp. Clin. Psychopharmacol.* 19, 191–197. doi: 10.1037/a0024142
- Reyes-Rodríguez, M. L., Von Holle, A., Ulman, T. F., Thornton, L. M., Klump, K. L., Brandt, H., et al. (2011). Posttraumatic stress disorder in anorexia nervosa. *Psychosom. Med.* 73, 491–497. doi: 10.1097/PSY.0b013e31822232bb
- Romans, S. E., Gendall, K. A., Martin, J. L., and Mullen, P. E. (2001). Child sexual abuse and later disordered eating: a New Zealand epidemiological study. *Int. J. Eat. Disord.* 29, 380–392. doi: 10.1002/eat.1034
- Routtenberg, A., and Kuznesof, A. W. (1967). Self-starvation of rats living in activity wheels on a restricted feeding schedule. *J. Comp. Physiol. Psychol.* 64, 414–421. doi: 10.1037/h0025205
- Rowland, N. E., Atalayer, D., Cervantez, M. R., Minaya, D. M., and Splane, E. C. (2018). Cost-based anorexia: a novel framework to model anorexia nervosa. *Appetite* 130, 50–58. doi: 10.1016/j.appet.2018.07.034
- Schenk, S., Britt, M. D., Atalay, J., and Charleson, S. (1982). Isolation rearing decreases opiate receptor binding in rat brain. *Pharmacol. Biochem. Behav.* 16, 841–842. doi: 10.1016/0091-3057(82)90245-3
- Scheurink, A. J., Boersma, G. J., Nergårdh, R., and Södersten, P. (2010). Neurobiology of hyperactivity and reward: agreeable restlessness in anorexia nervosa. *Physiol. Behav.* 100, 490–495. doi: 10.1016/j.physbeh.2010.03.016
- Schroeder, M., Jakovcevski, M., Polacheck, T., Drori, Y., Ben-Dor, S., Röh, S., et al. (2018). Sex dependent impact of gestational stress on predisposition to eating disorders and metabolic disease. *Mol. Metab.* 17, 1–16. doi: 10.1016/j.molmet.2018.08.005
- Shroff, H., Reba, L., Thornton, L. M., Tozzi, F., Klump, K. L., Berrettini, W. H., et al. (2006). Features associated with excessive exercise in women with eating disorders. *Int. J. Eat. Disord.* 39, 454–461. doi: 10.1002/eat.20247
- Smink, F. R., van Hoeken, D., and Hoek, H. W. (2012). Epidemiology of eating disorders: incidence, prevalence and mortality rates. *Curr. Psychiatry Rep.* 14, 406–414. doi: 10.1007/s11920-012-0282-y
- Vanderschuren, L. J., Achterberg, E. J., and Trezza, V. (2016). The neurobiology of social play and its rewarding value in rats. *Neurosci. Biobehav. Rev.* 70, 86–105. doi: 10.1016/j.neubiorev.2016.07.025
- Walker, D. M., Cunningham, A. M., Gregory, J. K., and Nestler, E. J. (2019). Long-term behavioral effects of post-weaning social isolation in males and females. *Front. Behav. Neurosci.* 13, 66. doi: 10.3389/fnbeh.2019.00066
- Willner, P. (1984). The validity of animal models of depression. *Psychopharmacology (Berl)* 83, 1–16. doi: 10.1007/BF00427414
- Wu, H., van Kuyck, K., Tambuyzer, T., Luyten, L., Aerts, J. M., and Nuttin, B. (2014). Rethinking food anticipatory activity in the activity-based anorexia rat model. *Sci. Rep.* 4, 3929. doi: 10.1038/srep03929
- Yackobovitch-Gavan, M., Golan, M., Valevski, A., Kreitler, S., Bachar, E., Lieblich, A., et al. (2009). An integrative quantitative model of factors influencing the course of anorexia nervosa over time. *Int. J. Eat. Disord.* 42, 306–317. doi: 10.1002/eat.20624
- Zamberletti, E., Viganò, D., Guidali, C., Rubino, T., and Parolaro, D. (2012). Long-lasting recovery of psychotic-like symptoms in isolation-reared rats after chronic but not acute treatment with the cannabinoid antagonist AM251. *Int. J. Neuropsychopharmacol.* 15, 267–280. doi: 10.1017/S1461145710001185
- Zipfel, S., Giel, K. E., Bulik, C. M., Hay, P., and Schmidt, U. (2015). Anorexia nervosa: aetiology, assessment, and treatment. *Lancet Psychiatry* 2, 1099–1111. doi: 10.1016/S2215-0366(15)00356-9

**Conflict of Interest Statement:** The authors declare that the research was conducted in the absence of any commercial or financial relationships that could be construed as a potential conflict of interest.

Copyright © 2019 Hurel, Redon, Scocard, Malezieux, Marsicano and Chaouloff. This is an open-access article distributed under the terms of the Creative Commons Attribution License (CC BY). The use, distribution or reproduction in other forums is permitted, provided the original author(s) and the copyright owner(s) are credited and that the original publication in this journal is cited, in accordance with accepted academic practice. No use, distribution or reproduction is permitted which does not comply with these terms.