



**HAL**  
open science

**Systèmes hybrides photovoltaïque / thermique /  
thermoélectrique à concentrateur parabolique :  
modélisation thermique, analyse paramétrique et études  
de cas**

Amal Herez

► **To cite this version:**

Amal Herez. Systèmes hybrides photovoltaïque / thermique / thermoélectrique à concentrateur parabolique : modélisation thermique, analyse paramétrique et études de cas. Thermique [physics.class-ph]. Université d'Angers, 2021. Français. NNT : 2021ANGE0009 . tel-03412756v1

**HAL Id: tel-03412756**

**<https://theses.hal.science/tel-03412756v1>**

Submitted on 3 Nov 2021 (v1), last revised 4 Nov 2021 (v2)

**HAL** is a multi-disciplinary open access archive for the deposit and dissemination of scientific research documents, whether they are published or not. The documents may come from teaching and research institutions in France or abroad, or from public or private research centers.

L'archive ouverte pluridisciplinaire **HAL**, est destinée au dépôt et à la diffusion de documents scientifiques de niveau recherche, publiés ou non, émanant des établissements d'enseignement et de recherche français ou étrangers, des laboratoires publics ou privés.

# THESE DE DOCTORAT DE

L'UNIVERSITE D'ANGERS

ECOLE DOCTORALE N° 602  
*Sciences pour l'Ingénieur*  
Spécialité : Energétique-Thermique

Par

**Mme Amal HEREZ**

**Systèmes hybrides photovoltaïque / thermique / thermoélectrique à concentrateur parabolique : modélisation thermique, analyse paramétrique et études de cas**

Hybrid Photovoltaic/Parabolic trough thermal/Thermoelectric systems: Thermal modeling, parametric analysis, and case studies

Thèse présentée et soutenue à Polytech Angers, le 07/07/2021

Unité de recherche : LARIS EA 7315

Thèse N° :

## Rapporteurs avant soutenance :

Mme Nolwenn LE PIERRES	Pr.	Polytech Annecy-Chambéry
Mme Monica SIROUX	Pr.	INSA Strasbourg

## Composition du Jury :

Président :	<i>(à préciser après la soutenance)</i>		
Examineurs :	M. David BIGAUD	Pr.	Polytech Angers
	M. Charbel HABCHI	MCF HDR	NDU Louaize (Liban)
	M. Mahmoud KHALED	MCF	LIU Beirut (Liban)
Dir. de thèse :	M. Thierry LEMENAND	MCF HDR	Polytech Angers
Co-encadrant :	M. Hisham ELHAGE	Pr.	LIU Beirut (Liban)
Co-encadrant :	M. Mohamad RAMADAN	MCF	LIU Beirut (Liban)

# Table des Matières

<b>Introduction.....</b>	<b>1</b>
<b>Chapitre 1. Revue bibliographique et état de l'art .....</b>	<b>7</b>
<b>1.1 Revue des systèmes de cuiseurs solaires : étude économique et environnementale pour différents scénarios libanais .....</b>	<b>11</b>
Introduction.....	12
Principle and classification of solar cookers .....	13
Parameters effecting solar cookers performance .....	16
Energy and exergy analysis.....	18
Economic and environmental concerns .....	18
Conclusions.....	21
References.....	22
<b>1.2 Séchage solaire : un bilan avec évaluation économique et environnementale.....</b>	<b>25</b>
Introduction.....	26
Principle of solar dryers .....	27
Components of solar dryers .....	27
Classifications of solar dryers .....	27
Affecting parameters on solar dryers performance.....	30
Discussion.....	30
Economic and environmental concerns: Lebanese case .....	33
Conclusions.....	36
Future works and recommendations .....	36
References.....	37
<b>1.3 Chauffage solaire de l'eau .....</b>	<b>41</b>
Introduction.....	42
Principle of solar water heating .....	45
Classification of solar water heating .....	47
Analysis of previous works on solar water heating systems.....	53
Electricity concern in Lebanon .....	64
Conclusions.....	79
References.....	79

<b>1.4 Solaire photovoltaïque : bilan avec étude économique et environnementale au Liban .....</b>	<b>87</b>
Introduction.....	89
Photovoltaic systems.....	90
Previous researches on solar photovoltaic .....	96
Economic and environmental analyses .....	112
Conclusion .....	117
References.....	117
<b>1.5 Capteurs solaires hybrides photovoltaïques / thermiques : classifications, applications et nouveaux systèmes .....</b>	<b>127</b>
Introduction.....	128
Background on PVT hybrid systems .....	129
Classifications of PVT .....	130
Applications .....	142
PVT system using thermoelectric generators.....	146
Closure and discussion.....	149
References.....	149
<b>Chapitre 2. Système hybride photovoltaïque/thermique à concentrateur parabolique : modélisation thermique et analyse paramétrique.....</b>	<b>155</b>
Introduction.....	160
Concept of the system.....	162
Thermal modeling and iterative procedure .....	162
Parametric analysis .....	166
Conclusions and recommendations.....	171
References.....	171
<b>Chapitre 3. Système hybride photovoltaïque/thermique à concentrateur parabolique : modélisation thermique, études de cas et études économiques et environnementales .....</b>	<b>173</b>
Introduction.....	176
Structure and mode of operation.....	181
Thermal modeling and iterative process .....	182
Case studies and discussions.....	190
Economic and environmental analyses .....	197
Conclusions.....	201
References.....	202



<b>Chapitre 4. Système hybride triple photovoltaïque/thermique/thermoélectrique à concentrateur parabolique : modélisation thermique, études de cas, et analyses économiques et environnementales .....</b>	<b>205</b>
Introduction.....	213
Concept of parabolic trough PVT-TE hybrid system .....	215
Thermal modeling.....	216
Thermal model validation .....	221
Case studies and discussions.....	222
Economic and environmental analyses .....	232
Conclusions.....	234
References.....	236
<b>Chapitre 5. Conclusions et perspectives.....</b>	<b>239</b>
<b>Références .....</b>	<b>245</b>

# Introduction

Depuis de longues décennies, les sources d'énergie conventionnelles sont les clés du développement économique et une source d'énergie fiable. Cependant, leur utilisation conduit à un épuisement accompagné de graves problèmes environnementaux causés par les émissions de gaz à effet de serre. Depuis quelques années, l'humanité commence à prendre réellement conscience du défi pour répondre à la demande énergétique mondiale en recherchant des sources d'énergie alternatives et durables qui sont également respectueuses de l'environnement. Les sources d'énergie renouvelables sont l'une des solutions les plus prometteuses pour surmonter la crise énergétique et les problèmes environnementaux. Elles sont durables et respectueuses de l'environnement. Par conséquent, l'utilisation des énergies renouvelables a commencé à croître continuellement : ainsi en 2019 elle a contribué à produire 41% de l'énergie primaire mondiale [1]. De plus, il est prévu que les énergies renouvelables pourront fournir 100% de l'énergie électrique globale requise entre 2050 et 2055 [2]. En outre, les émissions de dioxyde de carbone dues à la consommation d'énergie ont augmenté de 0,5% en 2019, ce qui représente moins de la moitié de la croissance moyenne sur 10 ans (1,1% par an) [1].

L'énergie solaire est l'une des sources d'énergie renouvelables les plus durables, les plus abondantes et les plus potentielles. La Terre reçoit environ  $1,8 \times 10^{11}$  MW de la puissance du Soleil, ce qui est bien plus que la consommation énergétique mondiale actuelle [3]. Les systèmes d'énergie solaire sont principalement classés en deux groupes : les systèmes solaires photovoltaïques (PV) et solaires thermiques. Le solaire PV convertit le rayonnement solaire absorbé en énergie électrique

tandis que les systèmes solaires thermiques le transforment en énergie thermique qui peut être utilisée dans plusieurs applications telles que la cuisson, le séchage, le chauffage / refroidissement, le chauffage de l'eau, la production d'électricité, etc. Selon l'IRENA (International Renewable Energy Agency), la production mondiale d'électricité à partir de l'énergie solaire est passée de 33813 MW à 562033 MW de 2010 à 2019, ce qui signifie une augmentation de 1562%.

Le principal défi des technologies de l'énergie solaire consiste à optimiser les performances du système et à maximiser son efficacité au moindre coût. De plus, le rendement de conversion de la cellule PV est compris entre 15 et 18%, alors 82 à 85% de l'énergie solaire absorbée est soit réfléchi, soit absorbée par la cellule PV ce qui augmente sa température [4]. Cependant, l'augmentation de la température de la cellule PV d'un degré entraîne une atténuation de l'efficacité PV entre 0,4 et 0,65% [5]. Par conséquent, les systèmes d'énergie solaire, en particulier les systèmes photovoltaïques, ont fait l'objet d'efforts des chercheurs pour augmenter son efficacité.

Pour atteindre cet objectif, il y a une tendance de nos jours à combiner des systèmes d'énergie solaire tels que l'énergie solaire photovoltaïque avec un capteur solaire thermique pour obtenir un système solaire hybride PVT (Photovoltaïque / Thermique). Ce système permet d'améliorer l'efficacité de la cellule PV et d'augmenter le bénéfice des radiations solaires. Le système solaire hybride PVT est capable de produire de l'énergie thermique et de générer de l'énergie électrique simultanément avec la moitié de la surface requise et un coût d'installation réduit. De plus, ce système peut être optimisé en y intégrant des générateurs thermoélectriques.

Sur la base de ce contexte, le but de la présente étude est d'examiner de manière étendue la littérature liée aux études d'énergie solaire, particulièrement les systèmes hybrides, mais aussi de suggérer de nouveaux systèmes hybrides et d'analyser d'autres systèmes existants en utilisant des modélisations thermiques appropriées ainsi que des analyses paramétriques et études de cas.

Ainsi les objectifs suivants ont été définis :

- Une nouvelle méthodologie de développement de modèle thermique pour les systèmes solaires hybrides PTPVT (Parabolic Trough Photovoltaic / Thermal) et PTPVT-TE (Parabolic Trough Photovoltaic / Thermal / Thermoelectric) est proposée.
- Une analyse paramétrique est effectuée pour étudier l'effet d'une large plage de paramètres sur les performances du système PTPVT.
- Des études de cas sont menées sur le système PTPVT pour fournir des analyses économiques et environnementales utiles des performances du système PTPVT pour trois conditions météorologiques différentes : les pays à climat méditerranéen, modéré et chaud qui sont respectivement le Liban, la France et les Émirats Arabes Unis (EAU).
- Des études de cas sont réalisées sur le système PTPVT-TE pour prédire et optimiser les performances des systèmes PTPVT en étudiant l'effet des conditions météorologiques en plus de paramètres distincts ainsi que l'effet de l'utilisation des TEG (thermoelectric generator) sur les performances du système.

Pour atteindre ces objectifs, une revue bibliographique approfondie et détaillée de la littérature sur l'énergie solaire a été réalisée et présentée au **chapitre 1**. Elle comprend une revue de plusieurs applications et systèmes d'énergie solaire tels que les cuiseurs solaires, les séchoirs solaires, les chauffe-eau solaires et le solaire PV. De plus, comme l'objectif principal de ce travail repose sur les systèmes solaires hybrides PVT, un examen détaillé est effectué sur ces systèmes. Les revues décrivent principalement le principe, les composants et les classifications ainsi que les avantages

et les limites des systèmes. De plus, un résumé des précédentes recherches menées sur les systèmes solaires est présenté dans ce chapitre.

Le **chapitre 2** traite des systèmes hybrides PTPVT. La structure et le concept du système sont décrits. Une nouvelle méthodologie pour conduire le modèle thermique du système est suggérée basée sur l'analogie électrique de la résistance thermique. En outre, une comparaison et une validation de la modélisation thermique par rapport aux travaux antérieurs sont effectuées. Une analyse paramétrique est effectuée afin d'étudier l'influence du nombre de Reynolds, de la longueur du côté du récepteur, de la longueur du tube récepteur et de l'épaisseur de l'absorbeur sur les performances thermiques et électriques du système.

Dans le **chapitre 3**, le même système est considéré sur lequel des études de cas sont réalisées pour trois pays de climats différents que sont le Liban (climat méditerranéen), la France (climat modéré) et les Émirats Arabes Unis (climat chaud) afin d'étudier l'effet de la météorologie sur les performances thermiques et électriques du système. Par ailleurs, des analyses environnementales et économiques sont menées pour chaque pays afin de tirer des conclusions pratiques sur l'importance du système étudié. La période de retour sur investissement du système et la réduction des émissions de CO<sub>2</sub> lors de l'utilisation du système hybride sont calculées et comparées entre les trois pays.

Le **chapitre 4** est ensuite consacré à l'étude de la performance du système PTPVT-TE qui est obtenu en intégrant des générateurs thermoélectriques au système PTPVT précédemment étudié. La disposition et le mode de fonctionnement du système sont présentés. L'analogie électrique de la résistance thermique est proposée comme nouvelle méthodologie pour développer un modèle thermique du système. De plus, le modèle thermique est comparé et validé. Par ailleurs, des études de cas sont mises en œuvre en considérant trois pays de climats distincts que sont le Liban

(méditerranéen), la France (modéré) et les Émirates Arabes Unies (chaud) afin d'étudier l'effet des conditions climatiques sur les performances du système étudié. De plus, des analyses économiques et environnementales sont effectuées pour évaluer l'influence économique et environnementale de l'utilisation du système hybride PTPVT-TE.

Enfin, le **chapitre 5** reprend les principales conclusions de la thèse et propose des travaux futurs.



# Chapitre 1

## Revue bibliographique et état de l'art

L'augmentation continue de la demande d'énergie et les problèmes environnementaux sont parmi les principaux problèmes et défis critiques dans le monde. Ainsi, les sources d'énergie non combustibles telles que les sources d'énergie renouvelables sont actuellement distinguées et deviennent prépondérantes dans le monde entier. Les sources d'énergie renouvelables sont abondantes, durables et respectueuses de l'environnement. L'énergie solaire est l'un des types les plus éminents de sources d'énergie renouvelables qui a retenu l'attention et les efforts des chercheurs pour promouvoir son utilisation. L'énergie solaire peut être convertie directement en énergie thermique à l'aide de capteurs solaires thermiques, ou en énergie électrique à l'aide du photovoltaïque. Néanmoins, il existe une grande tendance à fusionner les systèmes solaires pour obtenir des systèmes solaires hybrides qui améliorent les avantages de l'énergie solaire.

Dans ce chapitre, l'objectif est de réaliser une revue détaillée de la littérature sur l'énergie solaire. L'examen a concerné les types de technologies d'énergie solaire. Étant donné que l'objectif principal de cette thèse repose sur les systèmes solaires hybrides, un examen des types et des classifications des systèmes d'énergie solaire hybrides est présenté.



Cinq études ont été réalisées pour atteindre les objectifs proposés au début de la thèse et sont les suivantes :

- **Systèmes de cuiseurs solaires.** Etude économique et environnementale pour différents scénarii libanais. L'examen comprend le principe et la classification du cuiseur solaire, les paramètres influençant les performances d'un cuiseur solaire, et l'analyse d'énergie et d'exergie liée aux systèmes de cuiseur solaire. En outre, des analyses économiques et environnementales ont été menées pour différents scénarii dans le pays (Liban) pour plusieurs catégories de cuiseurs solaires. Cette revue a été publiée sous le titre « Review on solar cooker systems: Economic and environmental study for different Lebanese scenarios » dans le journal *Renewable and Sustainable Energy Reviews* (2018), [doi.org/10.1016/j.rser.2017.08.021](https://doi.org/10.1016/j.rser.2017.08.021).
- **Séchage solaire.** Une revue avec évaluation économique et environnementale. L'examen comprend les principaux composants, les classifications et les paramètres affectant les avantages, les inconvénients et les limites du sécheur solaire. En outre, des études économiques et environnementales ont été menées pour mettre en évidence les avantages de cette technologie sur les questions économiques et environnementales. Cette revue a été publiée sous le titre « An investigation on solar drying: A review with economic and environmental assessment » dans le journal *Energy* (2018), [doi.org/10.1016/j.energy.2018.05.197](https://doi.org/10.1016/j.energy.2018.05.197).
- **Chauffage solaire de l'eau.** La revue comprend le principe, les composants et la classification des SWHS (Solar Water Heating Systems), le résumé des études menées sur les SWHS ainsi que leurs avantages et inconvénients. En outre, un aperçu des problèmes

d'électricité au Liban est présenté, y compris des études économiques et environnementales pour plusieurs cas libanais. Cette étude doit être soumise pour Renewable Energy Focus.

- **Solaire photovoltaïque.** Une revue avec étude économique et environnementale appliquée au cas du Liban. Un examen détaillé de la technologie solaire photovoltaïque avec des études économiques et environnementales a été rédigé et destiné à être soumis au journal *Solar Energy*. L'examen comprend principalement le principe des systèmes PV, les types de systèmes PV, la classification des technologies PV, la liste des travaux antérieurs sur ces systèmes, ainsi que l'évaluation économique et environnementale.
- **Capteurs solaires hybrides photovoltaïques/thermiques.** Revue détaillée des capteurs solaires hybrides PVT qui comprend l'histoire des systèmes solaires hybrides PVT, le concept principal, les avantages et les classifications selon diverses manières, en plus de l'intégration de générateurs thermoélectriques avec des systèmes PVT. Cette revue a été publiée sous le titre « Review on photovoltaic/thermal hybrid solar collectors: Classifications, applications and new systems » dans le journal *Solar Energy* (2020), [doi.org/10.1016/j.solener.2020.07.062](https://doi.org/10.1016/j.solener.2020.07.062).

Les principales conclusions de la littérature bibliographique réalisée sont les suivantes :

- 1- Plusieurs systèmes solaires, même les non hybrides particulièrement le chauffage solaire de l'eau et les systèmes photovoltaïques, méritent encore d'être examinés plus profondément ;
- 2- Il y a une tendance évidente vers les systèmes hybrides solaires même si ces systèmes nécessitent des études plus exploratoires et plus profondes ;

**3-** la proposition de nouveaux systèmes solaires hybrides est l'un des principaux défis de nos jours dans le monde solaire.

En se basant sur les principales conclusions ci-dessus, il a été décidé de concentrer le reste du projet de thèse sur la proposition de nouveaux systèmes hybrides et l'analyse approfondie d'autres systèmes existants en utilisant des modélisations thermiques appropriées ainsi que des analyses paramétriques et études de cas. Sur cette base, trois grandes études ont été menées et font l'objet des trois chapitres suivants : chapitre 2, 3 et 4.

## 1.1 Revue des systèmes de cuiseurs solaires : étude économique et environnementale pour différents scénarios libanais

Cet article est publié dans « **Renewable and Sustainable Energy Reviews** »

[doi.org/10.1016/j.rser.2017.08.021](https://doi.org/10.1016/j.rser.2017.08.021)

**Résumé** – Une revue sur les cuiseurs solaires est présentée. Cette étude comprend le principe et la classification, les paramètres influençant les performances d'un cuiseur solaire et l'analyse d'énergie et d'exergie liées aux systèmes de cuiseur solaire. Par ailleurs, une étude économique est réalisée pour différents scénarii au Liban (maison, hôtel, restaurant et snack) et pour plusieurs catégories de cuiseurs solaires (cuiseur à caisson solaire, cuiseur à panneaux solaires, cuiseur solaire parabolique et cuiseur solaire à tube sous vide avec stockage thermique). L'idée principale de l'étude économique est d'estimer la durée d'amortissement en fonction du pourcentage de temps ( $P_r$ ) pendant lequel le cuiseur solaire est utilisé, pour chaque cuiseur solaire et dans chaque scénario. Il a été obtenu que la plus grande dépendance vis-à-vis du cuiseur solaire diminue la durée d'amortissement. En outre, une analyse environnementale est mise en œuvre pour calculer la réduction des émissions de dioxyde de carbone dans les différents scénarii en pourcentage du temps pendant lequel le cuiseur solaire est utilisé. Il a été montré que la réduction de la quantité de  $CO_2$  passait de 6.05 à 60.55 kg/mois, de 605 à 6055 kg/mois, de 399.64 à 3996 kg/mois et de 90.82 à 908 kg/mois à la maison, au restaurant, à l'hôtel et au snack lorsque  $P_r$  passe de 0.1 à 1. Par conséquent, l'utilisation d'un cuiseur solaire diminue les émissions de dioxyde de carbone dans tous les scénarii où  $P_r$  a une relation directe avec la minimisation des émissions de dioxyde de carbone.

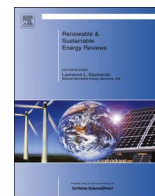

## Review on solar cooker systems: Economic and environmental study for different Lebanese scenarios



Amal Herez<sup>a</sup>, Mohamad Ramadan<sup>a,b,\*</sup>, Mahmoud Khaled<sup>a,c</sup>

<sup>a</sup> Energy and Thermo-Fluid group, School of Engineering, Lebanese International University LIU, PO Box 146404, Beirut, Lebanon

<sup>b</sup> FCLAB, CNRS, Univ. Bourgogne Franche-Comte, Belfort Cedex, France

<sup>c</sup> Univ Paris Diderot, Sorbonne Paris Cité, Interdisciplinary Energy Research Institute (PIERI), Paris, France

### ARTICLE INFO

#### Keywords:

Solar cookers  
Renewable energy  
Review  
Classification  
Performance  
Environment  
Economy

### ABSTRACT

In this work, a review on solar cookers is presented. This review includes principle and classification, parameters influencing the performance of a solar cooker, and energy and exergy analysis related to solar cooker systems. Moreover, an economic study is performed for different scenarios in Lebanon (home, hotel, restaurant and snack) and for several categories of solar cookers (solar box cooker, solar panel cooker, parabolic solar cooker and evacuated tube solar cooker with thermal storage). The main idea of the economic study is to estimate the payback period in function of percentage of time  $P_r$  where solar cooker is utilized, for each solar cooker and in each scenario. It was obtained that the higher dependence on solar cooker decreases payback period. Besides, environmental analysis is implemented to compute the amount of reduction in carbon dioxide emissions in the different scenarios as percentage of time where solar cooker is used varies. It was shown that the reduction in amount of carbon dioxide raised from 6.05 to 60.55 kg/month, 605.52 to 6055.2 kg/month, 399.64 to 3996.43 kg/month and from 90.82 to 908.28 kg/month in home, restaurant, hotel and snack respectively when  $P_r$  increased from 0.1 to 1. Hence, utilizing a solar cooker diminishes carbon dioxide emissions in all scenarios where  $P_r$  has direct relationship with minimization of carbon dioxide emissions.

### 1. Introduction

During the last centuries, world energy demand relied to a great extent on fossil fuels. Annually, energy consumption progresses by an average of 1% in developed countries and 5% in developing countries [1,2]. Due to the continuous rise in energy demand, several expectations reveal that fossil fuel will not meet this growing demand and its cost will definitely increase sharply. Thus, the mounting cost of fossil fuel in addition to some environmental issues such as pollution, greenhouse effect, global warming, etc., gave renewable energy [3–8] a remarkable interest at the international level during the last years. Renewable sources of energy are environmentally friendly and they are supplying about 14% of the world energy demand which will ascend in the future [9]. Indeed, solar energy occupies the throne of renewable energies. It is estimated that solar energy falls on the surface of the earth at an average of 120 pet watt. This reveals that solar energy received to the earth in one day is equivalent to energy demand required in 20 years. International Energy Agency showed that in year 2050 solar energy can supply approximately 45% of the world energy request [10].

Solar energy is used in a large diverse of applications that can be divided into two types of systems [11]: systems that rely on converting solar energy into thermal energy to be used for different purposes [12], and systems that transform solar energy directly into electricity by photovoltaic technology [13]. Solar energy can be categorized also according to the type of solar collector [14,15]. The main role of solar collector is to gather solar radiation, transform it into heat and transport it to a working fluid. Fig. 1 illustrates the major categories of solar energy and their types.

Solar cooker [1,16–19] is harnessed for cooking food, pasteurizing and sterilizing. Solar dryers [20–25] are used in agricultural and industrial products for mitigating bacterial growth and preserving them by removing moisture. Solar water heating systems [26–31] heat water for domestic and industrial purposes. The heated water in the storage tank flow through a coil to heat air directed to the coil by a fan and enters to the space and heat it [32–36]. Solar space cooling and refrigeration [37–42] are utilized for refrigerating medicines or food, or cooling space. Concentrated solar power [43–48] uses mirrors and lenses to concentrate solar energy and thus generating heat and power indirectly. Photovoltaic systems [49–54] convert sunlight directly into electricity by the absorption of photons.

\* Corresponding author at: School of Engineering, International University of Beirut, PO Box 146404, Beirut, Lebanon.  
E-mail address: [mohamad.ramadan@liu.edu.lb](mailto:mohamad.ramadan@liu.edu.lb) (M. Ramadan).

<http://dx.doi.org/10.1016/j.rser.2017.08.021>

Received 17 February 2017; Received in revised form 21 May 2017; Accepted 8 August 2017  
1364-0321/ © 2017 Elsevier Ltd. All rights reserved.

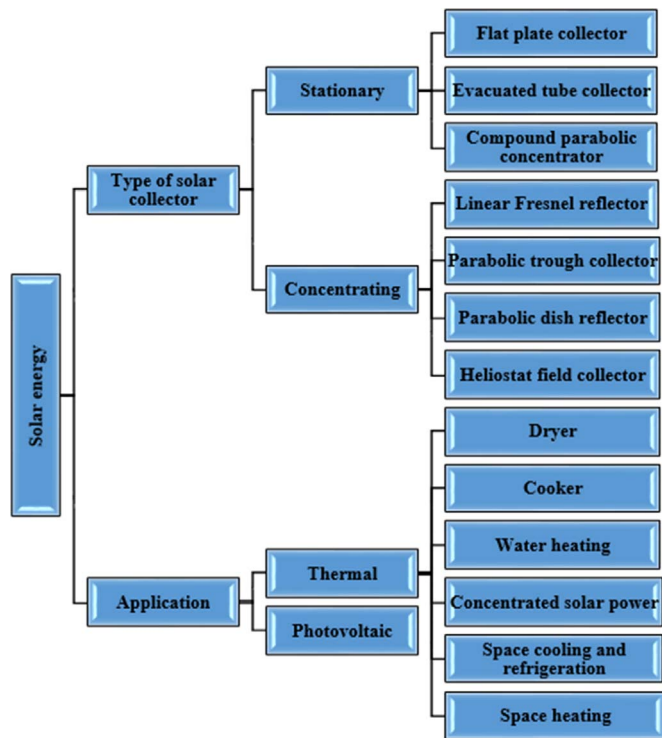

Fig. 1. Classification of solar energy.

Solar cooker is one of the most significant solar energy applications. Energy required for cooking represents about 36% of the global primary energy consumed [55]. Hence, solar cooker has a great potential in the domestic sector.

Fig. 2 shows the number of studies conducted on solar cookers from 1990 to 2016. It is shown that the number of researches on solar cookers is striking of all over the years and especially for the last four years. This explicates the magnitude of solar cookers as a solar energy device and its capability of being vital application in the coming years. In this context, the present work concerns a review on solar cooker technology. It presents particularly the principle, classification, and parameters affecting the performance of a solar cooker. Also, Energy and exergy analyses are exhibited. Moreover, environmental and economic concerns are presented to highlight the requisite role of solar cooker on both fields and for several scenarios in Lebanon country.

Section 2 of the paper presents the principle and classification of solar cooker. Section 3 delineates the effective parameters that impact the solar cooker performance. Section 4 is devoted to energy and exergy analysis. In Section 5, economic and environmental concerns are exposed. Section 6 draws the main conclusions of the work.

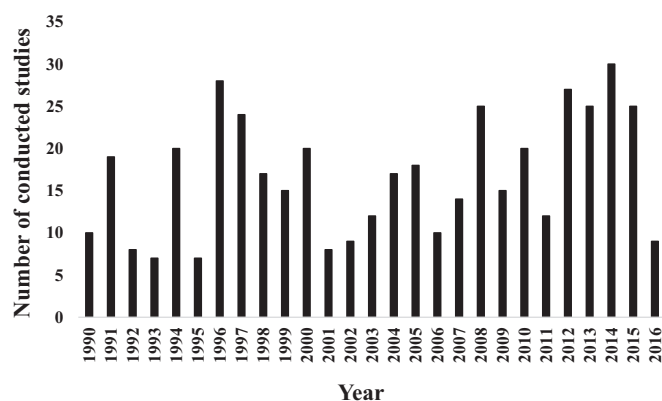

Fig. 2. Number of solar cooker studies over the years.

### 1.1. Historical note

Cooking food was unknown before the age of civilization, people used to eat food in its condition as they found it [56]. In 1767, Horace de Saussure, a French-Swiss physicist built box to cook fruit using solar energy where it reached temperature to 88 °C. In 1830, an English astronomer named Sir John Herschel tried to cook food in an insulated box cooker during campaign to South Africa. W. Adams progressed oven of octagonal shape made up of 8 mirrors in 1876. He stated that the oven cooked in two hours lots for seven soldiers. In 1945, Sri M. K. Ghosh, an Indian pioneer fabricated the first trade box type solar cooker. Dr. Metcalf and his student Marshall Longvin carried out water pasteurization using solar box cooker in 1979 [16]. In these days, solar cooker became a favorable application in which it provokes utilization of environmentally friendly renewable sources of energy and reduces dependence on conventional power sources. Due to its importance, various numerical, analytical and experimental studies [57–65] have been performed to enhance power capacity of solar cookers, evaluate its performance and identify parameters which help in optimizing it.

## 2. Principle and classification of solar cookers

Solar cooker is a viable and with great facility application of solar energy. Otte [66] briefly defined solar cooker as it is a way to exploit energy of sun in order to cook. Several studies [19,67–69] described the principle of solar cooker. Hence, solar cooker is an appliance that absorbs solar radiation, transfers it into heat, retains the heat and transmits it to food through cooking pot walls. It can be used for heating or cooking food or drink. Also, it can be utilized to achieve vital processes mainly pasteurization and sterilization.

Many sorts of solar cookers may be found in the literature. Moreover, new solar cookers designed with new improvements are continuously proposed, which requires continuous update of solar cooker classifications. However, it can be confirmed that solar cookers can be categorized into direct and indirect type according to the heat transfer mechanism to the cooking pot [18]. Sedighi and Zakariapour [17] presented a review on direct and indirect solar cookers with experimental, numerical and theoretical analysis to evaluate performance and compare efficiency of solar cookers. Box, panel and concentrated solar cookers are under the direct type. Indirect type is categorized according to the solar collector used, or energy storage. Cooking process in the direct type occurs by using sunlight directly, whereas in the indirect type, heat is transferred to the cooking unit using a heat transfer fluid. Fig. 3 represents a diagram showing the main types of solar cooker. Regattieri et al. [70] implemented an easy-use portable solar cooker by reutilizing cardboard packaging waste. Such device is demonstrated to complete kitchen-set for humanitarian people to solve problem of fuel and wood leakage. The cooker can be utilized for heating, cooking meals, boiling water and purifying raw water from rivers and lakes. Several cooker prototypes were designed, developed and tested by the authors to determine the optimum shape and predict the efficiency of the solar cooker. The results showed that parabolic configuration yields that best results where its efficiency ranges between 14% and 18%.

### 2.1. Direct solar cooker

#### 2.1.1. Solar box cooker

Box type solar cooker [71–75] consists of an insulated box with single or double transparent window made up of glass or plastic. Solar radiation passes through the transparent window and is absorbed by the cooking utensils, the walls and the bottom of the cooker [76]. The inner part of the box and the cooking pots must be painted in black color to maximize the heating effect [77]. The window provides a greenhouse effect in which it permits the passage of solar radiation but prevents it to get out from the cooking vessel [78]. Thus, heat

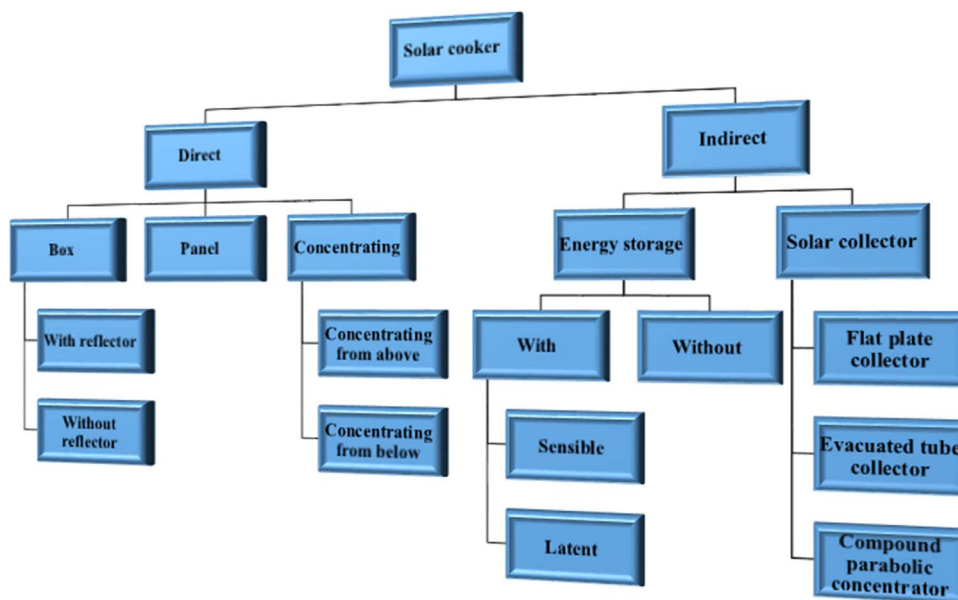

Fig. 3. Classification of solar cookers.

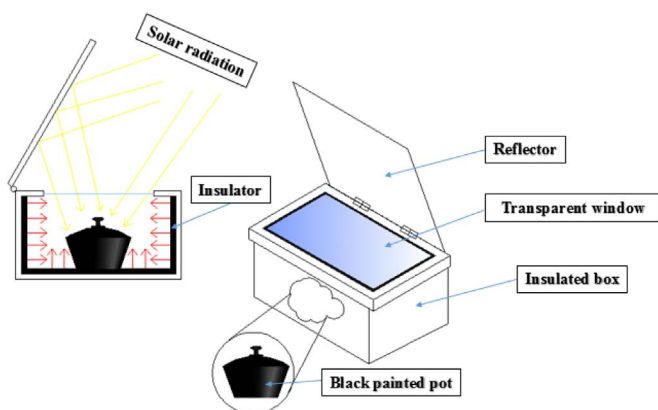

Fig. 4. Solar box cooker with reflector.

radiations coming from the cooker's walls and the cooking pots will be trapped inside the box heating the air. The double window reduces conduction which symbolized that it is better than the single one. In addition to that, on the side top of the box a reflector can be placed to reflect sun light into the box where maximum four cooking pots can be placed inside it. Fig. 4 shows a schematic diagram of box type solar cooker and its components. Farooqui [79] investigated improved power solar box cooker with free tracking system. It was found from the experimental results that the system tracks the sun for up to six hours. Lahkar and Samdarshi [80] reviewed thermal performance parameters of solar box cooker and the test procedure for these parameters. In addition to that, these parameters were used to derive objective parameters from simple relations. It was concluded that the objective parameters are able to supply all needed information to determine most convenient solar cooker regarding climate and geographical location, with the help of performance parameters that are independent on external factors. Harmim et al. [81] designed a novel solar box cooker integrated with compound parabolic concentrator. Also, heat transfer process of this cooker was modeled mathematically. The cooker contains utensil laden with water and deposited on the floor of the box. The purpose of the model was to study the effect of diverse parameters such as solar radiation, load of water and clouds on the dynamic behavior of the cooker. Joshi and Jani [82] designed Small Scale Box type Hybrid solar cooker coupling both thermal energy and photovoltaic. This cooker weight 6.5 kg and it is a modified design of

Small Scale Box type solar cooker of weight 4.8 kg. the cooker was integrated with 5 panels of 15 W each. The experimental results reveal that reduction in cooking time due to the increase of input power (thermal power added to it photovoltaic power). It was also found that the Improved Small Scale Box type Hybrid solar cooker has an average efficiency 38% greater than the efficiency of Small Scale Box type solar cooker (30%). In addition to that, the estimated cost of the Improved Small Scale Box type Hybrid solar cooker is \$120 and it is predicted to decrease to make it more favorable and likeable. Such research offers an idea to optimize the performance of a solar cooker by adding solar panels to it and exploiting photovoltaic power. However, improving the solar cooker performance can be achieved by other methods and cheaper than photovoltaic panels like enhancing configurations of the solar cooker, type of insulations, absorber tray and the cooking pot, using additional reflector, etc.

Box-type solar cookers have manifold profits [83] which make it favorable for usage. First, it uses direct and diffused radiations. Second, they are easy to handle and operate, in which they don't need tracking. Also, they require little intervention from the user since the moderate temperatures make stirring unnecessary. In addition to that, several vessels can be placed in it, and they can be kept warm due to the retained heat [84]. Box types are relatively inexpensive and they can be produced or repaired easily. Nevertheless, there are some hindrances of box solar cooker which can be illustrated by slow cooking process due to low temperature, cooking must be limited to daylight and it can't be used for frying or grilling.

### 2.1.2. Solar panel cooker

Solar panel cookers [85] are similar to solar box cookers in their principle of operation. But the panel cooker utilizes large reflective panel instead of insulated box to focus sunlight on the black cooking vessel that converts sunlight into heat energy. Besides, it has easy construction and low cost material in which it can be built from a single cardboard box and some aluminum foil. The pot is surrounded by a transparent cover which prevents heat from escaping and trap it, providing greenhouse effect. Solar panel cooker and its components are illustrated in Fig. 5.

Panel cooker's performance are extremely affected by the reflected radiation, thus it doesn't seem to be effective under dark, windy or cloudy weathers. Also, it should be placed in direct sunlight for several hours before it became ready to be used. Panel cooker can bake breads and cakes but it can't fry food. "CooKit" is the most widely used cooker,



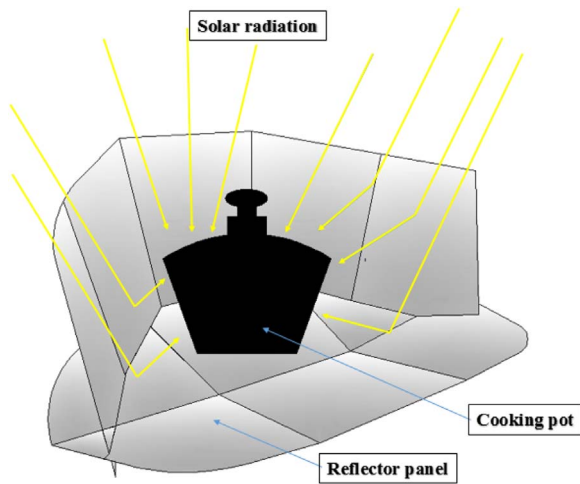

Fig. 5. Solar panel cooker.

it was developed and produced by a volunteer group of engineers and solar cooks associated with the Solar Cookers International, in 1994.

### 2.1.3. Solar concentrating cooker

Concentrating solar cooker [1,56] cooks food directly by absorbing the heat from the sun light without any interference of any material between the sun light and the cooking pot. It relies on the principle of solar optics in which it concentrates direct solar radiation on the bottom of the cooking pot to heat it and achieve extremely high temperatures. Concentrating cooker is formed of a parabolic reflector, cooking pot which is placed on the focus point of the cooker [76] and a stand as a support with turning mechanism to keep the reflector facing the sun. Fig. 6 shows a schematic drawing of the parabolic solar cooker. The two major kinds of concentrating cookers are: cookers concentrating light from above and cookers concentrating light from below.

Parabolic solar cooker is characterized by short cooking time due to the high temperature that it can be achieved. Also, some of the parabolic cookers can be utilized for baking [86]; however, this type of cookers requires the user's attention due to the risk of fires and burns that it may cause.

### 2.2. Indirect solar cooker

Indirect solar cooker consists of a collector to gather heat and cooking part to exploit the yield. The cooking vessel is displaced from

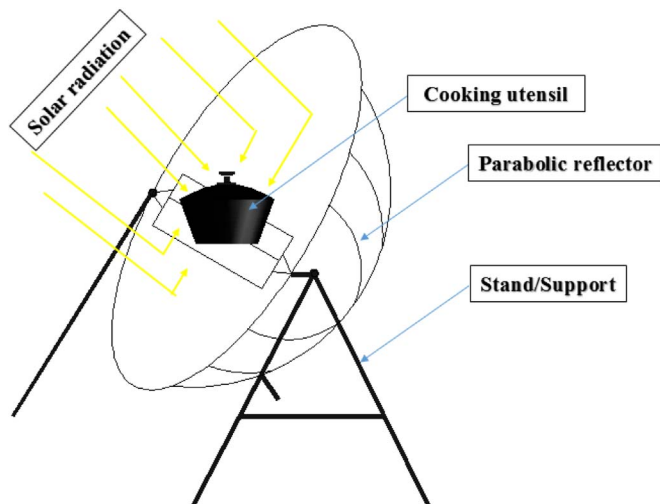

Fig. 6. Solar concentrating cooker.

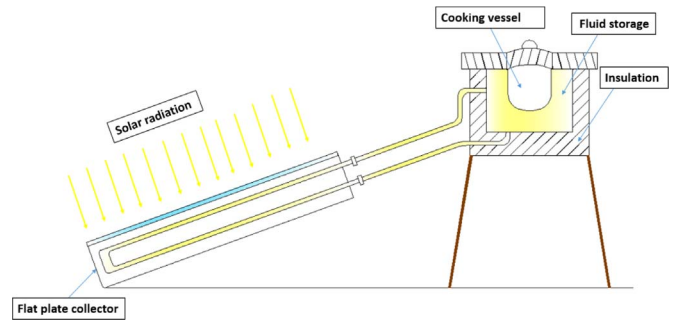

Fig. 7. Indirect solar cooker with flat plate collector.

the collector in which it is separated and protected from radiation. Heat is transferred from the collector to the cooking pot by a heat-transferring fluid, where a small circulating pump may be utilized to circulate the working fluid especially when the collector is kept at height above the cooking unit. On the other hand, a manual control valve orients the heat transfer fluid flow rate to the pot or to the storage tank.

Indirect solar cookers are commonly categorized according to the type of collector [87] used whether it is flat plate collector, evacuated tube collector [88,89] or compound parabolic concentrator. Fig. 7 shows a schematic diagram of an indirect solar cooker with flat plate collector.

In an indirect solar cooker, it is possible to cook in a separate place or to store energy during sunshine as a sensible or latent energy, and exploit it later (during evening, night or cloudy weather) [90–92]. In other words, indirect solar cookers may have sensible or latent heat storage; or it may not [93]. The thermal storage increases the performance and competitiveness of the solar cooker significantly, and optimizes the utilization of the energy collected since solar irradiation is irregular.

Sensible heat storage is the simplest form to store the thermal energy, in which it occurs by raising the temperature of a solid or liquid [94,95]. Fig. 8 illustrates an indirect solar cooker with sensible heat storage. The heat transfer fluid moves to the cooking unit after it has been heated in the collector, where part of its sensible energy is transferred to the double-walled cooking pot. Water, rocks, iron and oil are the main sensible heat storage media that have increasing heat capacity with temperature, which makes them motivating options for storing energy. Storing thermal energy allows cooking at night and reaching high temperature in short time, as well as keeping food warm for longer time. But the limitation of sensible systems is that most materials have small capability to store sensible heat.

Mawire et al. [96] compared experimentally the performance of thermal storage oils for solar cookers during charging. Experiments were carried on using an insulated 20 L storage tank, and three thermal oils: Sunflower Oil, Shell Thermia C and Shell Thermia B are used to be tested and evaluated. It was concluded from the experimental results that under high power charging, Sunflower Oil

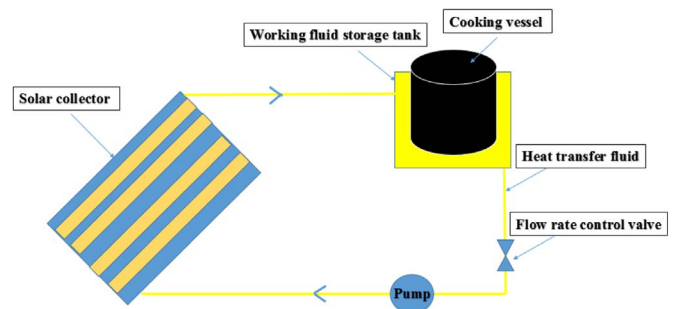

Fig. 8. Indirect solar cooker with sensible heat storage.



has the best performance between the other tested thermal oils.

Latent heat storage exploits the stored energy by using Phase Change Material (PCM) which allows to store significant amount of energy over narrow temperature range [97,98]. PCMs are characterized by their high thermal energy storage capacity, they have the ability to absorb energy during heating process and release it to the environment during cooling process. For example, during solid-liquid phase change, fusion absorbs energy and solidification releases it. Some of the latent heat storage materials that can be selected for solar cooking are: magnesium nitrate hexahydrate, magnesium chloride hexahydrate and stearic acid, acetamide, acetanilide and erythritol [99–103]. Energy storage has an essential role in retaining energy, upgrading reliability and performance of energy systems, as well as minimizing mismatch between supply and demand.

Nkhonjera et al. [104] presented a review of thermal energy storage designs, heat storage materials and cooking performance of solar cookers with heat storage. The authors stated in their paper that the most potential and vital issues of research in heat storage for cooking are the implementation of high temperature thermal storage units, progress in their geometry in addition to their heat transfer characteristics. Lecuona et al. [105] investigated experimentally portable parabolic type solar cooker combined with heat storage based on phase change material. A numerical modeling is performed to identify the climatic conditions of Madrid and to prove the experimental results. Technical grade paraffin and erythritol are the two checked phase change materials. It was obtained by the results that cooker with heat storage along the day can cook lunch for a family. Also, cooking the dinner and breakfast for the next day is possible if the pot is placed inside insulated box. Singh et al. [106] experimentally compared thermal performance of solar cookers with different heat transfer fluid (water and oil). Also, phase change material discharged was studied depending on the effect of gate valve. Commercial grade acetanilide was utilized as phase change material. The results revealed that the temperature of phase change material at 18:00 h was 10.7 °C when valves are closed, more than when valves are opened which is 13.1 °C (where water was the heat transfer fluid). Also, it was obtained that the average stored energy by phase change material increased by 18.88% when using oil as heat transfer fluid compared to water. Sharma et al. [107] presented a review on the available thermal energy storage that can be incorporated with solar cooker.

### 3. Parameters effecting solar cookers performance

The thermal performance of a solar cooker is highly influenced by its main components. Thus, it's obvious that geometry of the cooker determines its performance. The geometry parameters are: booster mirrors, glazing, and absorber plate, cooking pots, heat storage materials and insulation [108].

#### 3.1. Booster mirror

A booster mirror is important in solar cooker since it makes cooking in low ambient temperature possible. It provokes higher working temperatures by permitting higher lightening intensity on the aperture area, thus enhancing the efficiency. Utilizing booster mirrors reduces cooking time since it reflects the extra radiation on the surface of the cooker. Fig. 9 presents a schematic diagram of solar box cooker with three reflectors.

El-Tous et al. [109] performed experiment on tracking system which is progressed to promote solar heating in solar cooker. Solar heater was rotated to track the sun by electronic sun tracking device. The results obtained from comparing fixed and sun tracking cooker revealed that the heating temperature increase by 36% when utilizing sun tracking. It was also found that utilizing sun tracker increases the pot water temperature and decreases the thermal capacity of the water by rising the evaporation rate. The authors concluded that the amount

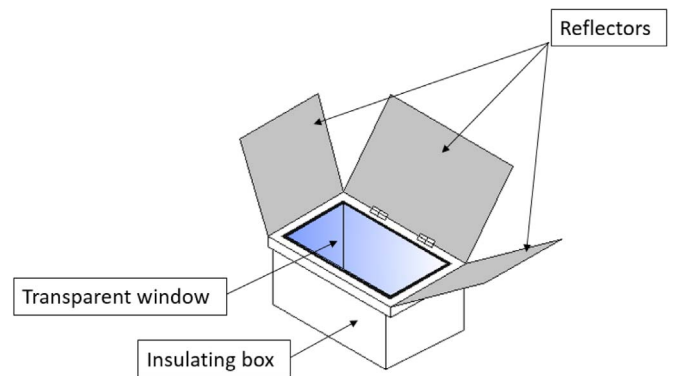

Fig. 9. Solar box cooker with three reflectors. /.

of solar intensity was increased by 20% when tracking sun on the cooker. M. B. Kahsaya et al. [72] compared between solar box cookers with and without internal reflector. The two types of cookers were modeled theoretically by taking into consideration the radiation, convection and conduction heat transfer. Steady state heat transfer analysis of the cooker was employed in the theoretical analysis. Also, experiments have been done to compare the two cookers made up of same materials (except internal absorber) and have same aperture area. The theoretical analysis foresees that utilizing internal reflector will enhance performance of a solar cooker. It was revealed by steady state analysis that the bottom absorber plate temperature in cooker with reflector is higher than that of cooker without reflector. Also, dry test and water boiling tests showed better performance for cooker with reflector. It was found that cooker with reflector has standard stagnation temperature and cooking power higher than that for cooker without reflection. Also, it was concluded that enhancing the performance of box solar cooker can be achieved by making suitable angle side walls of the absorber and utilizing internal reflector. Farooqui [110] performed experiment and numerical simulations to determine the performance parameters of dual booster mirror solar box cookers of three different lengths to width ratios. Also, the optimal tilt angle for both booster mirrors of each day of the year was determined for free tracking operation. Numerical investigation has been performed for 25° latitude location for all days of the year in order to specify the best power collection capability of such cooker during 6 h of the favorable period of cooking which range between 3 h before and after the solar noon. The selected solar cookers for this investigation have 1.33, 2.66 and 3.99 length to width ratios. The experiments have been conducted for 3 days to compare performance of three cookers simultaneously with regular water load. The experimental results has been analyzed to specify the first and second figures of merit, cooking power, quality factor and exergy efficiency for each cooker. It was concluded that the optimum performance of fully loaded solar box cookers with two booster mirrors tilted at suitable angle is attained with aspect ratio of 2.66. Zamani et al. [111] designed two similar solar cookers and experimentally studied the impact of flat and parabolic surfaces on the performance of double exposure solar cookers. The obtained results reveal that the performance of the solar cooker was affected by about 18.5% by flat mirrors on the box part, while about 25% by the mirrors located on the parabolic curve. The authors deduced that the parabolic part has more considerable influence on the performance of solar cooker compared to the box part.

#### 3.2. Glazing

In a solar cooker solar radiation passes through glazing which is utilized to reduce convection losses from the absorber plate by suppressing the static air layer between the absorber plate and the glass. Also, glazing serves in minimizing radiation losses by which it is transparent to short wave radiation (coming from the sun) but opaque

to long wave thermal radiation (emitted from absorber plate). Glazing comprises glass, fiberglass, acrylic and other materials. Badar et al. [112] investigated the thermal performance of double glazed solar oven. Experiments were done and the temperatures inside the box cavity are recorded on different days and times with diverse intensities of solar radiation available. Also, steady state heat transfer numerical model is carried out on solar oven without reflector. Based on the experiments and numerical calculations, a parametric study is performed to evaluate the impact of several parameters on the thermal performance of the oven such as distance between glazing, number of glazing, etc. Regarding number of glazing, it was found that higher box temperature is achieved when using double glazing than single glazing. Ghosh et al. [113] studied the thermal performance of a solar cooker with special cover glass of low-e antimony doped indium oxide (IAO) coating. The study was conducted by comparing this solar cooker with a solar cooker uncoated glaze soda lime silicate glass cover, then comparing it with the same solar cooker with evacuated glazed cover attaining vacuum of  $10^{-3}$  atm in the glazing system. At ambient condition, the thermal performance of solar cookers was distinct due to the fluctuation of heat flow through different glazing systems. The thermal performance of a solar cooker box with single glazed low-e IAO coated glass cover was favorable. Thus, solar cooker with low-e IAO coated single glass cover is better preferable.

### 3.3. Absorber tray

Absorber plate is a key point of solar cooker where cooking process depends on its ability to absorb the useful energy from sun. Solar radiation crosses the glazing of a solar cooker and clashes the high absorptivity absorber surface. Then the tray absorbs high quantity of this energy and transmits it to the food placed in the cooking pot to be cooked. The absorber tray must be painted in black to maximize amount of solar radiation that can be absorbed [114]. Also, it is well known that the geometric structure of the absorber tray is crucial regarding increasing the intensity of light falling and promoting heat transfer to the food in the cooking pot. Zamani et al. [115] interestingly stated that, optimization of absorber plate is one of the most adopted and investigated strategies in the field of optimizing thermal and radiation performance. Besides, Harmim et al. [116] developed experimental work to compare the performance of two solar box cookers; the first one is provided with finned absorber tray while the absorber plate of the second one is without fins. The results revealed that if thermal fins were added to absorber plate of solar box cooker, the temperature will increase by 7% and the boiling time will be minimized by 12% in comparison with solar box cooker of absorber plate without fins.

### 3.4. Cooking equipment

Cooking vessels are components of solar cooker that are in direct contact with the absorber plate. Both serves in receiving the absorbed useful energy and transmitting it to the food. Various shapes of cooking pots can be utilized, however, the rectangular and cylindrical shaped cooking utensils that are made up of aluminum or copper are recommended. The cooking pot is painted black from outside and placed in the center of the absorber tray to rise the rate of heat transfer by conduction between them. The quantity and nature of food cooked determines the number of cooking vessels.

Sethi et al. [117] evaluated the performance of an inclined box solar cooker with single supporter mirror designed with a novel parallelepiped cooking pot for better cooking efficiency during winter conditions. The new parallelepiped shaped design is specialized by longer inclined south wall and trapezoidal shaped cavity on the pot cover which maximize heat transfer to the food. The performance parameters of this cooker (inclined cooker with parallelepiped cooking vessel) are compared with similar cooker of cylindrical pot design and horizontally placed, in January 2010 (winter month) at Ludhiana climate ( $30^{\circ}$ N

$77^{\circ}$ E), India. The results revealed that the first and second figures of merit (F1 and F2) for inclined cooker were 0.16 and 0.54 greater than that for horizontally located cooker (0.14 and 0.43). Time taken to boil water and the cooking power was 37% less and 40% more respectively in parallelepiped shaped cooking pot of inclined cooker compared to cylindrical vessel of horizontally located cooker. Hermelinda and Mauricio [118] proceeded in developing jorhejpatarnskua, which is a solar cooker integrated with compound parabolic concentrator. Several tests were performed using several pots simultaneously to study and analyze thermal standards of the cooker. The results unveiled that as cooking pots increase, cooking power, thermal efficiency and second merit decrease to the half in case of two pots and one third in case of three containers. Misraa and Aseri [119] presented a comparative experimental study to enhance performance of solar box cooker. Experiments were conducted on two solar cookers of different cooking environments: natural convection and forced convection heat transfer solar cookers. The experimental results of thermal performance tests showed that the stagnation absorber plate temperatures were  $133.9^{\circ}$ C and  $119.3^{\circ}$ C and the boiling times for heating 1 kg of water were 52 min and 75 min, for forced and natural convection solar cooker, respectively. Also, it was obtained that forced convection solar cooker cooked rice with higher quality compared to the cooked rice by natural convection solar cooker. It was concluded that forced convection solar cooker has the ability to cook food with good quality and much less time compared to natural convection solar cooker. Hence, performance of solar cooker can be improved by utilizing a small fan to the cooker and achieve forced convection.

### 3.5. Heat storage material

It is well recognized that solar cookers are elegant application of solar energy that will have a significant potential in the future. But such technology still has some impediments which requires a lot of studies and researches. One of the most critical obstructions challenging solar cookers is their disability to achieve successful cooking process when the sun fades. In most cases, such problem was solved by using phase change materials in order to store energy and use it when there is not enough solar energy. Fig. 10 presents a schematic diagram of an indirect solar cooker with heat storage material (PCM).

Saxena et al. [120] presented various types of phase change materials used in solar cookers. An experiment is done by comparing simple solar box cooker using stearic acid with another solar cooker of similar design but with no phase change material. It was found that among the phase change materials stearic acid is a pleasant choice for storing latent heat. Mussard [121] experimentally compared between the cooking performance of a widespread SK14 cooker and a prototype of parabolic trough solar concentrator cooker with heat storage. The first cooker is direct type solar cooker where the cooking utensil is located on the central point of the dish. In the second cooker working fluid (thermal oil) circulates and transmits heat from the absorber to the storage unit where cooking is achieved at the top of the storage. Boiling and frying tests are conducted to evaluate the efficiency of heat storage system. In addition to that, simulations are performed for progressing and optimizing the system. It was found that cookers with

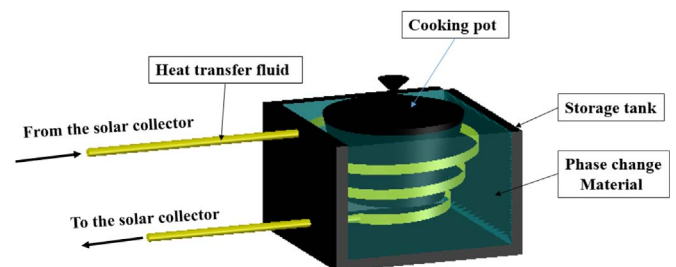

Fig. 10. Indirect solar cooker with heat storage material (PCM).

heat storage system of optimized surface contact have the best performance compared to standard cooker or any other cooking appliances. Chaudhary et al. [122] experimentally investigated solar cooker integrated with parabolic dish collector and phase change thermal storage unit (acetanilide is the phase change material). Experimental setup was performed on three solar cookers: ordinary solar cooker, solar cooker with outer surface painted black, and solar cooker with outer surface painted black along with glazing. The experimental results manifested that the maximum temperature of phase change material attained in ordinary solar cooker, solar cooker with outer surface painted black, and solar cooker with outer surface painted black along with glazing was 119 °C, 175.4 °C and 186.3 °C respectively. Also, it was found that in solar cooker with outer surface painted black and solar cooker with outer surface painted black along with glazing, phase change material stored 26.8% and 32.3%, respectively, more heat compared to that in ordinary solar cooker. The authors concluded that solar cooker with outer surface painted black along with glazing has the best performance compared to ordinary solar cooker and solar cooker with outer surface painted black.

### 3.6. Insulation

One of the most essential components of solar cookers is insulation which reduces interaction between solar cooker and the environment. It allows maximizing the amount of heat energy stored and thus working more efficiently. To minimize the transmission of heat energy from the cooker to the surrounding, it is mandatory to utilize insulating materials. Insulation can be achieved by using any material of low thermal conductivity, but the selection relies on the lower cost.

Aremu and Akinoso [123] studied the impact of insulating materials on the performance of solar heater. A box solar heater using domestic agricultural insulations is presented. The usage of coconut coir leads to achieve temperature up to 159 °C. Also, it was obtained that during dry season the shortest duration to heat 1 L and 1.5 L of water was 50 and 65 min respectively, and 120–170 min to boil 1 L of water during wet season. It was concluded that performance of agricultural insulations are more efficient than manufactured insulating materials and serves in decreasing the cost of solar box heater. Also, Aremu and Igbeka [124] evaluated energy and exergy efficiencies of solar box cooker with diverse insulating materials. Experiments have been carried out on five solar box cookers with maize cob, air (control), maize husk, coconut coir and polyurethane foam, at Department of Agricultural and Environmental Engineering, for 3 years. Water heating test was used to evaluate energy and exergy of the cookers and the results were analyzed by using ANOVA. It was reported that a solar cooker with air as insulation has the lowest energy and exergy efficiencies (11% and 1.07% respectively) compared to others. This proves the fundamental of using good insulating material for solar box cooker. Mussard and Nydal [125] conducted two tests on solar cooker of heat storage coupled with a self-circulating solar parabolic trough filled with thermal oil. In the first experiment the receiver tube is not insulated while in the second it is insulated with glass tube of 7 mm thickness. Results noted that insulating the absorber tube is not necessary at low temperature and the efficiency is higher in the non-insulated tube. However, glass tube is needed as the storage temperature becomes high and reaches 200 °C, where above it is difficult to gather heat without insulating the absorber.

## 4. Energy and exergy analysis

Solar cooking is an adequate process of utilizing solar energy to meet cooking request. Many researchers tried to compare and evaluate solar cookers in order to acquire the best performance. Energy and exergy analysis [126,127] is one of the most significant means of studying and evaluating the performance of solar cookers [128].

Panwar et al. [129] stated that energy analysis is based on the first law of thermodynamics, in which the net heat provided is transformed

into work. In a solar cooker, energy input depends on collector size and solar intensity, while energy output relies on quantity of cooking fluid and number of cooking pots placed on the absorber tray [130]. The energy efficiency  $\eta$  is defined as the ratio of output energy ( $E_o$ ) to the input energy ( $E_i$ ) of solar cooker and it is shown in the following equation [129]:

$$\eta = \frac{\text{output energy}}{\text{input energy}} = \frac{E_o}{E_i} = \frac{m_w C_{p,w} (T_{wf} - T_{wi})}{I_t A_{sc} \Delta t} \quad (1)$$

where  $C_{p,w}$  is water specific heat,  $T_{wf}$  is final temperature of water,  $T_{wi}$  is initial temperature of water,  $t$  represents the time,  $I_t$  is the total instantaneous solar radiation and  $A_{sc}$  is intercept area of solar cooker.

Panwar [131] reported that the concept of exergy is based on first and second law of thermodynamics. Exergy input and output analysis allow finding the locations of the maximum degraded energy of solar cooker. Exergy is defined as the maximum amount of work that can be achieved from a system. The exergy efficiency  $\psi$  of a solar cooker is the ratio of output exergy ( $E_{xo}$ ) to the input exergy ( $E_{xi}$ ) [128]. It can be calculated using the following equation [130]:

$$\psi = \frac{\text{output exergy}}{\text{input exergy}} = \frac{E_{xo}}{E_{xi}} = \frac{m_w C_{p,w} \left[ (T_{wf} - T_{wi}) - \left( T_o \ln \left( \frac{T_{wf}}{T_{wi}} \right) \right) \right]}{I_t A_{sc} \left( 1 - \frac{4T_o}{3T_s} \right)} \quad (2)$$

where  $T_o$  is the outside temperature,  $T_a$  is the ambient temperature and  $T_s$  is the sun temperature. Exergy analysis is qualitative estimation of energy while energy analysis is quantitative estimation of energy. It can be said that for predicting the efficiency of a solar cooker, exergy analysis is more convenient than energy analysis. Farooqui [132] presented a review in indirect type vacuum tube based solar cooker. Also, energy and exergy analysis of single vacuum tube based prototype has been performed experimentally. Three experiments has been done within 10 days during March and April 2013. It was obtained from the performance parameter that the cooker has high peak exergy power (55.6 W), 0.042 quality factor, 20–30% energy efficiency and 4–6% exergy efficiency. Also, Farooqui [133] experimentally investigated the effect of varying load on energy and exergy efficiencies and other diverse performance measuring parameters. Five experiments have been performed with variable water loads (range of 3–7 kg), on 14, 15, and 31 of March, 26 and 27 of November 2014. It was obtained that the maximum energy efficiency range is 20–25%, maximum exergy efficiency range remained 2.3–3.8%, maximum exergy output power was 46.4 W and peak exergy output power versus temperature difference was 51.07 W which are the highest compared to other solar cookers. Thus, it was concluded by Farooqui [132,133] that despite its compact size, vacuum tube type solar cooker is comparable to other single family cooker types. Park et al. [134] presented a comprehensive review on energy and exergy analyses of typical renewable energy systems such as solar thermal, solar photovoltaic and biomass cook stove system. The authors concluded that energy analysis is the basic analysis for renewable energy systems. Moreover, the authors found that the performance relied on exergy analysis is lesser than that of energy analysis for all renewable energy systems.

## 5. Economic and environmental concerns

Solar cooker is a promising option of solar energy appliances. It plays a key role in progressing life and making it healthier. Precisely, solar cooker has a significant influence and benefits that has to do with environment, economic and health.

Solar cookers reduce the dependence on conventional sources of energy and thus lower emissions of greenhouse gases which reduce pollution. As a result, humans become healthier and distant from diseases that are in high rate these days due to pollution. From an economic view, usage of renewable source of energy application (solar cooker) will



decrease the increased cost of fossil fuel and will serve in saving a great amount of money. Also, when disease diminish, money spent on medical treatments will also be economized which is a privilege for people. In addition to that, solar cookers minimize utilization of fire wood which reduce deforestation and desertification. Besides, solar cookers decrease the release of smokes from firewood that are harmful to eyes and respiratory system as well, especially for children. In places like Africa, there is a high dependence on wood stoves which are used indoor and outdoor. Indoor pollution resulted from the incomplete combustion of wood generates carbon monoxide gas which is harmful to lungs. Thus, utilization of wood stoves is the main reason of many diseases especially lung cancer, and other respiratory diseases like asthma, etc.

Sosa et al. [135] presented a project implementing prototypes of solar cookers with compound parabolic concentrators in Mexico. It was aimed from this project to reduce timber resource extraction through harnessing renewable energy sources. This reduction was predicted to be 30%. Interviews has been done and showed that 85% of beneficiaries have utilized solar cookers. It was found from the monitoring results that despite the fact that each family expended about 145 kg fuel wood per 1 week, 43% of households have been economizing 50% fuel wood by using solar cooker. This study successfully highlighted the necessity to utilize solar cooker instead of fire wood for human and environmental care in addition to economic benefit.

Succinctly, solar cooker is a gracious application of solar energy. It is friend environment, produces food of high value of nutrition, and it is cheap and convenient for all economic levels of people in society.

5.1. Economic analysis

Referring to the aforementioned comments, solar cooker has an appreciable economic impact. A study is performed to evaluate the amount of saved money if a solar cooker is utilized instead of traditional LPG (Liquefied Petroleum Gas) cooker. Then, the payback period is computed according to the cost of the solar cooker and the amount of saved money. In this study, several types of solar cookers are taken under study and different scenarios in Lebanon country are considered including residential apartment, restaurant, snack and hotel. A survey was done to measure the amount of LPG consumed in each scenario. The survey was perfumed with several number of people having residential apartment, restaurant, snack or hotel. After estimating the amount of LPG, the cost of LPG is calculated for each scenario. The calculation is based on the price in the Lebanese market where the cost of 1 kg of liquefied petroleum gas is approximately \$0.91. Table 1 illustrates the consumed amount of LPG (kg/month) and its cost (\$/month) for each scenario.

To calculate the payback period for the different solar cooker types, the saved money SM is calculated as follows:

$$smpm = P_r \cdot M_{lpg} \cdot P_{lpg} \tag{3}$$

where *smpm* is the amount of saved money per month,  $P_r$  is the percentage of time where the SC is used,  $M_{lpg}$  is the mass of LPG consumed per month and  $P_{lpg}$  the price 1 kg of LPG. Hence, the payback period *pbp* is calculated as follow:

$$pbp = \frac{scc}{smpm} \tag{4}$$

where *scc* is the total cost of solar cooker.

Table 2 illustrates different types of solar cookers with their cost in

**Table 1**  
Amount of liquefied petroleum gas used and its cost for each scenario.

	Amount of LPG (kg/month)	Cost of LPG (\$/month)
Home	20	18.2
Restaurant	2000	1820
Hotel	1320	1201.2
Snack	300	273

**Table 2**  
Different types of solar with their cost.

Solar cooker	cost (\$)
Box	350
Panel	86
Parabolic	349
Indirect evacuated tube with thermal storage	640

**Table 3**  
Saved money for each scenario.

Scenario	Saved money (\$/month)
Home	9.1
Restaurant	910
Hotel	600.6
Snack	136.5

\$. Table 3 shows the amount of money saved for each scenario by considering  $P_r = 0.5$ . Table 4 reports the number of solar cookers needed, total cost and the payback period for each solar cooker and for different scenarios.

The number of required solar cookers varies according to the type of solar cookers where each solar cooker accommodates specific number of cooking pots. For example, four cooking units can be placed in solar box cooker while only one pot can be located in a parabolic solar cooker. Also, the cooking site determines the number of needed solar cookers. For instance, hotel and restaurant need more solar cookers than home or snack. Therefore, the number of solar cookers determines the total cost of solar cookers in each scenario. As shown in Table 4, regardless to the type of the solar cooker, the payback period for home is the highest compared to other scenarios, while restaurant has the lowest payback period. On the other hand, regardless to the cooking site, parabolic solar cooker and indirect evacuated solar cooker have the highest payback period due to the fact that they have high cost, and solar parabolic cooker accommodates one cooking pot which requires more than one cooker in some scenarios and thus increases its cost. While solar box and panel cookers has the lowest payback period knowing that solar panel cooker has low cost, and solar box cooker accommodates four pots which decreases number of needed cooker and thus the cost. But in general, payback periods are low, where the highest is for parabolic solar cooker in home (about 6 year and 5 months).

**Table 4**  
Payback period for each solar cooker and for different scenarios.

solar cooker	Scenario	Number of solar cookers required	Total cost of solar cookers	Payback period (month)
Box	Home	1	350	39
	Restaurant	2	700	1
	Hotel	2	700	2
	Snack	1	350	3
Panel	Home	2	172	19
	Restaurant	6	516	1
	Hotel	6	516	1
	Snack	4	344	3
Parabolic	Home	2	698	77
	Restaurant	6	2094	3
	Hotel	6	2094	4
	Snack	4	1396	11
Indirect evacuated tube with thermal storage	Home	1	640	71
	Restaurant	2	1280	2
	Hotel	2	1280	3
	Snack	1	640	5

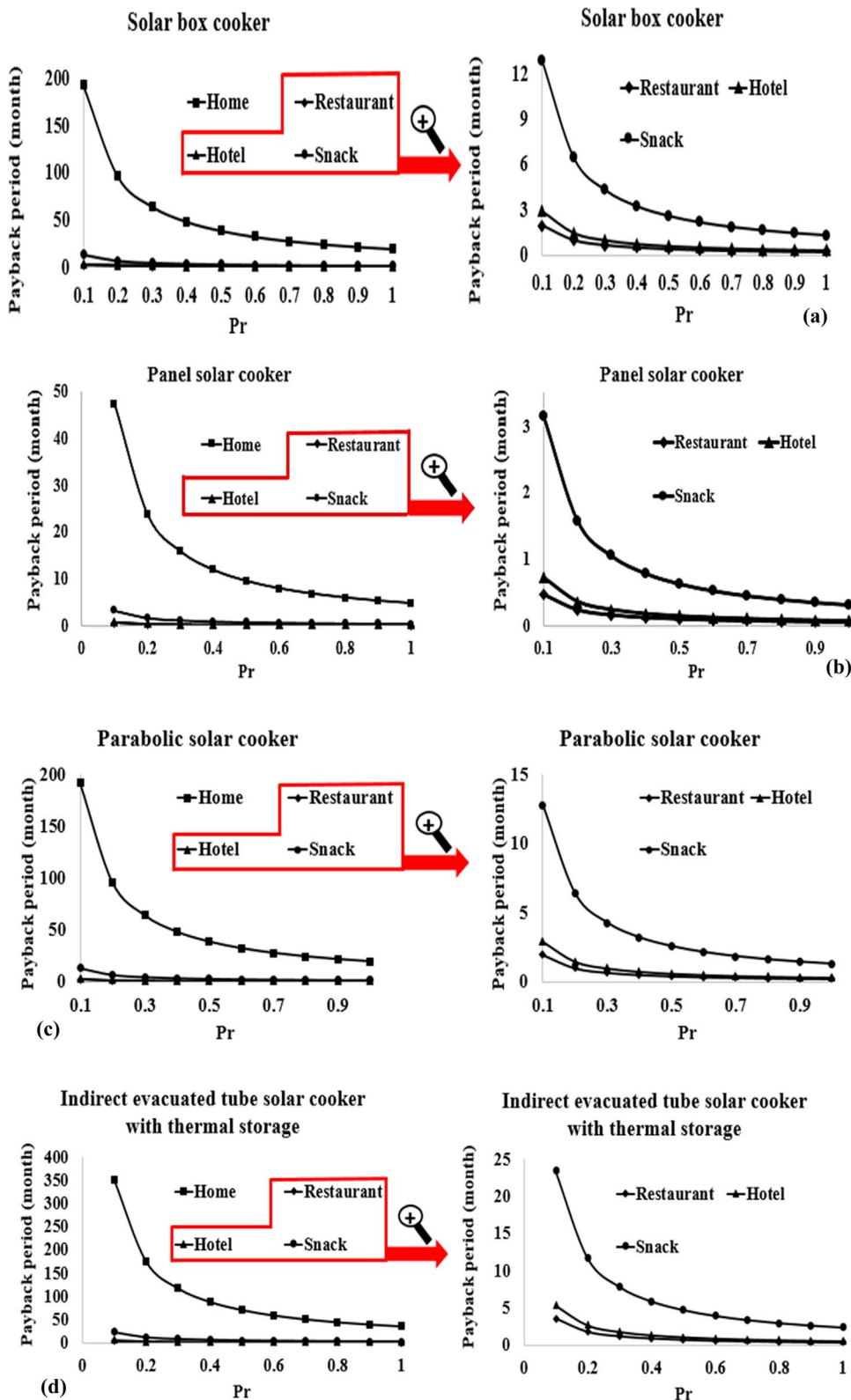

Fig. 11. Variation of payback period as function of Pr and scenarios for (a) solar box cooker (b) solar panel cooker (c) solar parabolic cooker (d) indirect evacuated tube solar cooker with thermal storage.

For Pr = 0.5, the amount of payback period in home is 39 months if solar box cooker will be used, 19 months for solar panel cooker, 77 months for solar panel cooker and 71 months for parabolic solar cooker. Thus, solar panel cooker is the best choice to be used at homes and hotels. Similarly, solar box cooker and solar panel cooker are better to be used at restaurants and snacks. The choice of a solar cooker

depends here on the economic side, regardless to the cooker efficiency and performance.

Fig. 11 shows variation of payback period as function of Pr and scenarios for (a) solar box cooker (b) solar panel cooker (c) solar parabolic cooker (d) indirect evacuated tube solar cooker with thermal storage. It can be easily noticed that the payback period is inversely

proportional to  $P_r$ . For example, for solar box cooker, when  $P_r$  was 0.2 the payback period was about 96 months, 1 month, 2 months, and 7 months respectively for home, restaurant, hotel and snack. However, when  $P_r$  was 0.8 the payback period was approximately 24 months, 0.5 month, 1 months, and 2 months respectively for home, restaurant, hotel and snack.

### 5.2. Environmental analysis

From an environmental point of view, a solar cooker can highly decrease the amount of produced carbon dioxide gas ( $CO_2$ ) per year [136].

Panwar et al. [137] interestingly shed light on fuel replacement and carbon dioxide reduction by investigating techno-economic study on animal feed solar cooker in rural areas of India. The results showed that, in 1 year, carbon dioxide emission was decreased by 424.8 kg when using animal feed solar cooker, where the fuel (wood) cost is almost negligible with respect to LPG. Xu et al. [67] discussed methods to minimize carbon footprint of cooking operations according to life cycle assessment methodology. Types of food, fuels, and cookware, correct use and management of cookware, and cooking waste were carried on to study their effect on decreasing carbon footprint. He et al. [3] stated that in China, the government supported energy conservation targets and renewable energy utilization to decrease release of carbon intensity by 17% during years 2011–2015, and reach this decrease to 40–50% by year 2020 where the peak will be attained by year 2030.

To quantify the environmental impact of solar cookers, a study on the amount of carbon dioxide gas ( $CO_2$ ) produced from the combustion of liquefied petroleum gas in home, restaurant, hotel and fast food restaurant in Lebanon country is carried out. Indeed LPG is mainly formed of butane and propane in addition to other natural gases. In this study, LPG is considered to undergo complete combustion and formed of about 80% of butane and 20% of propane. Eqs. (3) and (4) represent the complete combustion equation of butane and propane respectively.

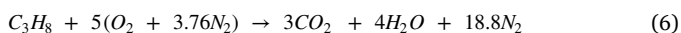
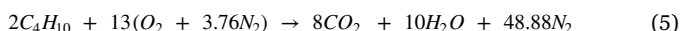

According to stoichiometric proportion of these two equations, for every 1 kg of butane and propane 3.0345 kg and 3 kg of Carbone dioxide is produced respectively. Table 5 illustrates the amount of LPG used (kg/month), amount of butane and propane existing in this LPG and the amount of produced carbon dioxide.

The amount of carbon dioxide reduced  $M_{reduced\ CO_2}$  (due to the utilization of a solar cooker instead of conventional LPG cooker) can be calculated as follow:

$$M_{reduced\ CO_2} = P_r \cdot M_{CO_2\ total} \quad (7)$$

Where  $M_{CO_2, total}$  is the total amount of carbon dioxide produced (kg/month).

Fig. 12 sheds light on the amount of carbon dioxide that will be reduced when traditional LPG cooker is replaced by a solar cooker. If a solar cooker is utilized during 50% of cooking time, 30.27, 3027.6, 1998.21 and 454.14 kg/month of carbon dioxide will be reduced in

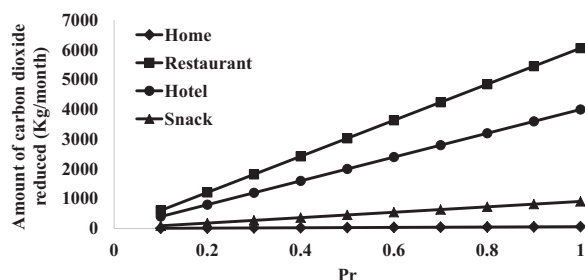

Fig. 12. Amount of carbon dioxide reduced for different values of  $P_r$ .

home, restaurant, hotel and snack respectively. While 60.55, 6055.2, 3996.43 and 908.28 kg/month of carbon dioxide will be reduced in home, restaurant, hotel and snack respectively if cooking depends only on solar cooker ( $P_r = 1$ ). Thus, less carbon dioxide will be formed when the percentage of time where a solar cooker is used increase. This study ensures that solar cooker is environmentally friendly, where it serves in reducing emission of carbon dioxide which is polluting gas.

### 6. Conclusions

The present work call into question the use of solar cookers. It presents a review on the fundamentals of solar cookers with a detailed description of the influence of several key-parameters on their performance. Energy and exergy analysis is presented and environmental and economic studies are developed.

The economic study is carried out to compute the payback period for different solar cookers (solar box cooker, solar panel cooker, parabolic solar cooker and evacuated tube solar cooker with thermal storage) and for several scenarios in Lebanon (home, hotel, restaurant and snack), where  $P_r$  is varied from 0.1 to 1. The results confirmed that there is inversely relationship between  $P_r$  and payback period (for all solar cookers and scenarios). To exemplify for solar box cooker, the payback period decreased from 96 to 24 months, 1 to 0.5 months, 2 to 1 month, and from 7 to 2 months in home, restaurant, hotel and snack when  $P_r$  increased from 0.2 to 0.8.

The environmental study was developed on the previously stated scenarios to shed light on the impact of utilizing solar cookers on carbon dioxide production. It was shown that solar cookers serve in reducing carbon dioxide emissions and there is direct relation between  $P_r$  and reduction in carbon dioxide production. To illustrate, the amount of carbon dioxide minimized increased from 30.27 to 60.55 kg/month, 3027.6 to 6055.2 kg/month, 1998.21 to 3996.43 kg/month and from 454.14 to 908.28 kg/month in home, restaurant, hotel and snack respectively when  $P_r$  increased from 0.5 to 1.

It is obvious that solar cooker has a great beneficial impact on economic, health and environment. That is why it is expected that the use of solar cookers will spread all over the world especially in countries such as Lebanon.

Governments and social associations should play an essential role in recommending the more adapted type of solar cooker depending on the weather conditions and local cost of components.

Safety of solar cooker is a crucial issue that should be taken into consideration especially when oil working fluid is used.

Table 5

Total amount of carbon dioxide produced from combustion of LPG.

	Amount of LPG (kg/month)	Amount of butane (kg/month)	Amount of propane (kg/month)	Amount of CO2 formed from butane (kg/month)	Amount of CO2 formed from propane (kg/month)	Total amount of carbon produced (kg/month)
Home	20	16	4	48.55	12	60.55
Restaurant	2000	1600	400	4855.2	1200	6055.2
Hotel	1320	1056	264	3204.43	792	3996.43
Snack	300	240	60	728.28	180	908.28

## References

- [1] Yettou F, Azoui B, Malek A, Gama A, Panwar NL. Solar cooker realizations in actual use: an overview. *Renew Sustain Energy Rev* 2014;37, [288–19].
- [2] Stambouli AB, Koinuma H. A primary study on a long-term vision and strategy for the realisation and the development of the Sahara Solar Breeder project in Algeria. *Renew Sustain Energy Rev* 2012;16:591–8.
- [3] He Y, Xu Y, Pang Y, Tian H, Wu R. A regulatory policy to promote renewable energy consumption in China: review and future evolutionary path. *Renew Energy* 2016;89, [695–11].
- [4] Li D, He J, Li L. A review of renewable energy applications in buildings in the hot-summer and warm-winter region of China. *Renew Sustain Energy Rev* 2016;57, [327–10].
- [5] Pacesila M, Burcea SG, Colesca SE. Analysis of renewable energies in European Union. *Renew Sustain Energy Rev* 2016;56, [156–15].
- [6] Kuang Y, Zhang Y, Zhou B, Li C, Cao Y, Li L, et al. A review of renewable energy utilization in islands. *Renew Sustain Energy Rev* 2016;59:504–10.
- [7] Zamfir A, Colesca SE, Corbos RA. Public policies to support the development of renewable energy in Romania: a review. *Renew Sustain Energy Rev* 2016;58, [87–20].
- [8] Solorzano YC, Sanchez JP, Trashorras AJ, Bernat JX. The development of renewable energy resources in the State of Veracruz, Mexico. *Uti Policy* 2016;39:1–4.
- [9] Panwar NL, Kaushik SC, Kothari S. Role of renewable energy sources in environmental protection: a review. *Renew Sustain Energy Rev* 2011;15, [1513–12].
- [10] Mekhilef S, Saidur R, Safari A. A review on solar energy use in industries. *Renew Sustain Energy Rev* 2011;15, [1777–14].
- [11] Gulhane NP, Chavan KV. A critical technological literature review of – photovoltaic/thermal solar collectors system. *Int J Curr Eng Technol* 2014;3, [258–7].
- [12] Kumara V, Shrivastava RL, Untawale SP. Solar energy: review of potential green & clean energy for coastal and offshore applications. *Aquat Procedia* 2015:473–8.
- [13] El-Khozondar HJ, El-Khozondar RJ, Matter K. Parameters influence on MPP value of the photo voltaic cell. *Energy Procedia* 2015;74:1142–8.
- [14] Patel K, Patel P, Patel J. Review of solar water heating systems. *Int J Adv Eng Technol* 2012;3, [146–4].
- [15] Tiwari R, Jaurkar AR. Theoretical analysis of solar water heater – a review. *Glob J Multidiscip Stud* 2014;3:1–7.
- [16] Cuce E, Cuce PM. A comprehensive review on solar cookers. *Appl Energy* 2013;102, [1399–23].
- [17] Sedighi M, Zakariapour M. A review of direct and indirect solar cookers. *Sustain Energy* 2014;2:44–8.
- [18] Harmim A, Merzouk M, Boukar M, Amar M. Solar cooking development in Algerian Sahara: towards a socially suitable solar cooker. *Renew Sustain Energy Rev* 2014;37:207–8.
- [19] Regattieri A, Piana F, Bortolini M, Gamberi M, Ferrari E. Innovative portable solar cooker using the packaging waste of humanitarian supplies. *Renew Sustain Energy Rev* 2016;57, [319–8].
- [20] Sangamithra A, Swamy GJ, Prema RS, Priyavarshini R, Chandrasekar V, Sasikala S. An overview of a polyhouse dryer. *Renew Sustain Energy Rev* 2014;40:902–9.
- [21] Prakash O, Laguri V, Pandey A, Kumar A, Kumar A. Review on various modelling techniques for the solar dryers. *Renew Sustain Energy Rev* 2016;62, [396–22].
- [22] Shalaby SM, Bek MA, El-Sebaei AA. Solar dryers with PCM as energy storage medium: a review. *Renew Sustain Energy Rev* 2014;33:110–7.
- [23] Patil R, Gawande R. A review on solar tunnel greenhouse drying system. *Renew Sustain Energy Rev* 2016;56, [196–19].
- [24] Chauhan PS, Kumar A, Tekasakul P. Applications of software in solar drying systems: a review. *Renew Sustain Energy Rev* 2015;51, [1326–12].
- [25] Prakash O, Kumar A. Solar greenhouse drying: a review. *Renew Sustain Energy Rev* 2014;29:905–6.
- [26] Sadrishikumar S, Balusamy T. Performance improvement in solar water heating systems—a review. *Renew Sustain Energy Rev* 2014;37:191–8.
- [27] Buker MS, Riffat SB. Solar assisted heat pump systems for low temperature water heating applications: a systematic review. *Renew Sustain Energy Rev* 2016;55, [399–15].
- [28] Wang Z, Yang W, Qiu F, Zhang X, Zhao X. *Renew Sustain Energy Rev* 2015;41, [68–17].
- [29] Seddegh S, Wang X, Henderson AD, Xing Z. Solar domestic hot water systems using latent heat energy storage medium: a review. *Renew Sustain Energy Rev* 2015;49, [517–17].
- [30] Singh R, Lazarus IJ, Souliotis M. Recent developments in integrated collector storage (ICS) solar water heaters: a review. *Renew Sustain Energy Rev* 2016;54, [270–29].
- [31] Nogueira CEC, Vidotto ML, Toniazzo F, Debastiani G. Software for designing solar water heating systems. *Renew Sustain Energy Rev* 2016;58, [361–15].
- [32] Glembin J, Haselhorst T, Steinweg J, Foste S, Rockendorf G. Direct integration of solar heat into the space heating circuit. *Sol Energy* 2016;131:1–20.
- [33] Fação J, Lobato A, Baldo C. The COOLSUN triple-technology approach to reach high solar fractions for space heating, space cooling and domestic hot water. *Energy Procedia* 2014;48:554–7.
- [34] Eicher S, Hildbrand C, Kleijer A, Bony J, Bunea M, Citherlet S. Life cycle impact assessment of a solar assisted heat pump for domestic hot water production and space heating. *Energy Procedia* 2014;48:813–6.
- [35] Chen JF, Dai YJ, Wang RZ. Experimental and theoretical study on a solar assisted CO<sub>2</sub> heat pump for space heating. *Renew Energy* 2016;89, [295–10].
- [36] Bellos E, Tzivanidis C, Moschos K, Antonopoulos KA. Energetic and financial evaluation of solar assisted heat pump space heating systems. *Energy Convers Manag* 2016;120:306–14.
- [37] Nkwetta DN, Sanderecock J. A state-of-the-art review of solar air-conditioning systems. *Renew Sustain Energy Rev* 2016;60, [1351–16].
- [38] Soni SK, Pandey M, Barataria VN. Hybrid ground coupled heat exchanger systems for space heating/cooling applications: a review. *Renew Sustain Energy Rev* 2016;60, [724–15].
- [39] Ghafoor A, Munir A. Worldwide overview of solar thermal cooling technologies. *Renew Sustain Energy Rev* 2015;43, [763–12].
- [40] Ge TS, Dai YJ, Wang RZ. Review on solar powered rotary desiccant wheel cooling system. *Renew Sustain Energy Rev* 2014;39, [476–22].
- [41] Allouhi A, Kousksou T, Jamil A, Bruel P, Mourad Y, Zeraoui Y. Solar driven cooling systems: an updated review. *Renew Sustain Energy Rev* 2015;44, [159–23].
- [42] Rodríguez-Muñoz JL, Belman-Flores JM. Review of diffusion-absorption refrigeration technologies. *Renew Sustain Energy Rev* 2014;30:145–9.
- [43] Prieto C, Cooper P, Fernández AI, Cabeza LF. Review of technology: thermochemical energy storage for concentrated solar power plants. *Renew Sustain Energy Rev* 2016;60:909–21.
- [44] Liu M, Tay NHS, Bell S, Belusko M, Jacob R, et al. Review on concentrating solar power plants and new developments in high temperature thermal energy storage technologies. *Renew Sustain Energy Rev* 2016;53:1411–22.
- [45] Xu X, Vignarooban K, Xu B, Hsu K, Kannan AM. Prospects and problems of concentrating solar power technologies for power generation in the desert regions. *Renew Sustain Energy Rev* 2016;53:1106–26.
- [46] Balghouthi M, Trabelsi SE, Ben Amara M, Bel Hadji Ali A, Guizani A. Potential of concentrating solar power (CSP) technology in Tunisia and the possibility of interconnection with Europe. *Renew Sustain Energy Rev* 2016;56, [1227–22].
- [47] Baharoon DA, AbdulRahman H, WanOmar WZ, Fadhl SO. Historical development of concentrating solar power technologies to generate clean electricity efficiently – a review. *Renew Sustain Energy Rev* 2016;41, [996–32].
- [48] Arousseau A, Vuillerme V, Bejian JJ. Control systems for direct steam generation in linear concentrating solar power plants – a review. *Renew Sustain Energy Rev* 2016;56:611–20.
- [49] Sahoo SK. Renewable and sustainable energy reviews solar photovoltaic energy progress in India: a review. *Renew Sustain Energy Rev* 2016;59, [927–13].
- [50] Guerrero-Lemus R, Vega R, Kim T, Kimm A, Shephard LE. Bifacial solar photovoltaics – a technology review. *Renew Sustain Energy Rev* 2016;60, [1533–17].
- [51] Khan J, Arsalan MH. Solar power technologies for sustainable electricity generation – a review. *Renew Sustain Energy Rev* 2016;55, [414–12].
- [52] Sugathan V, John E, Sudhakar K. Recent improvements in dye sensitized solar cells: a review. *Renew Sustain Energy Rev* 2015;52, [54–11].
- [53] Kow KW, Wong YW, Rajkumar RK, Rajkumar RK. A review on performance of artificial intelligence and conventional method in mitigating PV grid-tied related power quality events. *Renew Sustain Energy Rev* 2016;56, [334–13].
- [54] Hernández JM, Alonso BC, Álvarez JH, Carrillo BC. An overview of solar photovoltaic energy in Mexico and Germany. *Renew Sustain Energy Rev* 2014;31, [639–11].
- [55] Bansal M, Saini RP, Khatod DK. Optimal sizing of a solar–biogas-based cooking system for a cluster of villages. *Int J Sustain Energy* 2014;33, [1017–17].
- [56] Panwara NL, Kaushik SC, Kothari S. State of the art of solar cooking: an overview. *Int J Sustain Energy* 2012;16, [3776–10].
- [57] Topriska E, Kolokotroni M, Dehouche Z, Wilson E. Solar hydrogen system for cooking applications: experimental and numerical study. *Renew Energy* 2015;83, [717–12].
- [58] Otte PP. Warming up to solar cooking – a comparative study on motivations and the adoption of Institutional solar cookers in developing countries. *Energy Procedia* 2014;57, [1632–10].
- [59] Avilés G, Juan J, Avilés G, Mauricio . Thermal model of a solar cooker JORHEJPATARANSKUA. *Energy Procedia* 2014;57:1623–9.
- [60] Vanschoenwinkel J, Lizin S, Swinnen G, Azadi H, Passel SV. Solar cooking in Senegalese villages: an application of best–worst scaling. *Energy Policy* 2014;67, [447–12].
- [61] Topriska E, Kolokotroni M, Dehouche Z, Novieto DT, Wilson EA. The potential to generate solar hydrogen for cooking applications: case studies of Ghana, Jamaica and Indonesia. *Renew Energy* 2016;95, [495–15].
- [62] Mahavar S, Sengar N, Rajawata P, Verma M, Dashora P. Design development and performance studies of a novel single family solar cooker. *Renew Energy* 2012;47, [67–10].
- [63] Purohit I, Purohit P. Instrumentation error analysis of a box-type solar cooker. *Energy Convers Manag* 2009;50, [365–11].
- [64] Mirdha US, Dhariwal SR. Design optimization of solar cooker. *Renew Energy* 2008;33, [530–15].
- [65] Nkhonejera L, Kuboth M, König-Haagen A, John G, King'ondo C, Brüggemann D, et al. Experimental investigation of a finned pentaerythritol-based heat storage unit for solar cooking at 150–200 °C. *Energy Procedia* 2016;93:160–8.
- [66] Otte PP. A (new) cultural turn toward solar cooking—evidence from six case studies across India and Burkina Faso. *Energy Res Social Sci* 2014;2, [49–10].
- [67] Xu Z, Suna DW, Zhanga Z, Zhu Z. Research developments in methods to reduce carbon footprint of cooking operations: a review. *Trends Food Sci Technol* 2015;44, [49–9].
- [68] Otte PP. Solar cookers in developing countries—what is their key to success?. *Energy Policy* 2013;63:375–7.
- [69] Arunachala UC, Jhalaria A, Mashhood S. Design, fabrication and performance



- analysis of solar cooker for night cooking. *Renew Energy Environ Eng* 2014;2, [228–6].
- [70] Regattieri A, Piana F, Bortolini M, Gamberi M, Ferrari E. Innovative portable solar cooker using the packaging waste of humanitarian supplies. *Renew Sustain Energy Rev* 2016;57, [319–8].
- [71] Farooqui SZ. A gravity based tracking system for box type solar cookers. *Sol Energy* 2013;92:62–7.
- [72] Kahsaya MB, Paintin J, Mustefa A, Haileselassie A, Tesfay M, Gebraya B. Theoretical and experimental comparison of box solar cookers with and without internal reflector. *Energy Procedia* 2014;57, [1613–10].
- [73] Mahavar S, Rajawat P, Punia RC, Sengar N, Dashora P. Evaluating the optimum load range for box-type solar cookers. *Renew Energy* 2015;74:187–8.
- [74] Terres H, Lizardi A, López R, Vaca M, Chávez S. Mathematical model to study solar cookers box-type with internal reflectors. *Energy Procedia* 2014;57, [1583–10].
- [75] Harmim A, Merzouk M, Boukar M, Amar M. Design and experimental testing of an innovative building-integrated box type solar cooker. *Sol Energy* 2013;98, [422–12].
- [76] Kumaresan G, Raju G, Iniyan S, Velraj R. CFD analysis of flow and geometric parameter for a double walled solar cooking unit. *Appl Math Model* 2015;39, [137–10].
- [77] Mahavar S, Rajawat P, Marwal VK, Punia RC, Dashora P. Modeling and on-field testing of a solar rice cooker. *Energy* 2013;49:404–9.
- [78] Arabacigil B, Yuksel N, Avci A. The use of paraffin wax in a new solar cooker with inner and outer reflectors. *Therm Sci* 2015;19, [1663–10].
- [79] Farooqui SZ. An improved power free tracking system for box type solar cookers. *Sol Energy* 2015;120:100–4.
- [80] Lahkar PJ, Samdarshi SK. A review of the thermal performance parameters of box type solar cookers and identification of their correlations. *Renew Sustain Energy Rev* 2010;14:1615–7.
- [81] Harmim A, Merzouk M, Boukar M, Amar M. Mathematical modeling of a box-type solar cooker employing an asymmetric compound parabolic concentrator. *Sol Energy* 2012;86, [1673–10].
- [82] Joshi SB, Jani AR. Design, development and testing of a small scale hybrid solar cooker. *Sol Energy* 2015;122, [148–8].
- [83] Verdugo AS. Experimental analysis and simulation of the performance of a box-type solar cooker. *Energy Sustain Dev* 2015;29:65–7.
- [84] Otte PP. Solar cooking in Mozambique—an investigation of end-user's needs for the design of solar cookers. *Energy Policy* 2014;74, [366–10].
- [85] Geddani S, Dinesh GK, Sivasankar T. Determination of thermal performance of a box type solar cooker. *Sol Energy* 2015;113:324–8.
- [86] Stamboulia AB, Koinuma H. A primary study on a long-term vision and strategy for the realisation and the development of the Sahara Solar Breeder project in Algeria. *Renew Sustain Energy Rev* 2012;16:591–8.
- [87] Kassem TK, Youssef MS. Solar cookers and its application for food cooking in remote areas: review. *J Eng Sci* 2011;39, [1033–10].
- [88] Sabiha MA, Saidur R, Mekhilef S, Mahian O. Progress and latest developments of evacuated tube solar collectors. *Renew Sustain Energy Rev* 2015;51, [1038–17].
- [89] Gupta M, Kumar S, Katyal P. Experimental investigation of indirect solar cooker using evacuated tube collector with dual thermal storage unit. *Int J Therm Technol* 2015;5:200–10.
- [90] Kumaresan G, Vigneswaran VS, Esakkimuthu S, Velraj R. Performance assessment of a solar domestic cooking unit integrated with thermal energy storage system. *J Energy Storage* 2016;6, [70–10].
- [91] Nyeinga K, Nydal OJ, Okello D, Banda E. Dynamic model of a small scale concentrating solar cooker with rock bed heat storage. *J Energy South Afr* 2016;27:20–8.
- [92] Saini P, Sharma V, Singh C, Singh S. Solar cookers for off-sunshine cooking. *J Acad Ind Res (JAIR)* 2015;3, [438–7].
- [93] Mussard M, Nydal OJ. Comparison of oil and aluminum-based heat storage charged with a small-scale solar parabolic trough. *Appl Therm Eng* 2013;58:146–9.
- [94] Li G. Sensible heat thermal storage energy and exergy performance evaluations. *Renew Sustain Energy Rev* 2016;53, [897–27].
- [95] Muthusivagami RM, Velraj R, Sethumadhavan R. Solar cookers with and without thermal storage—a review. *Renew Sustain Energy Rev* 2010;14, [691–11].
- [96] Mawire A, Phori A, Taole S. Performance comparison of thermal energy storage oils for solar cookers during charging. *Appl Therm Eng* 2014;73:1323–9.
- [97] John G, Haagen AK, Kingondu CK, Bruggemann D, Nkhonjera L. Galactitol as phase change material for latent heat storage of solar cookers: investigating thermal behavior in bulk cycling. *Sol Energy* 2015;119:415–7.
- [98] Ibrahim BH, Jose V. Hybrid indirect solar cooker with latent heat storage. *Int J Eng Sci Res Technol* 2016;5, [169–7].
- [99] Chen CR, Sharma A, Tyagi SK, Buddhi D. Numerical heat transfer studies of PCMs used in a box-type solar cooker. *Renew Energy* 2008;33:1121–9.
- [100] Hussein HMS, El-Ghetany HH, Nada SA. Experimental investigation of novel indirect solar cooker with indoor PCM thermal storage and cooking unit. *Energy Convers Manag* 2008;49, [2237–10].
- [101] El-Sebaei AA, Al-Heniti S, Al-Agel F, Al-Ghamdi AA, Al-Marzouki F. One thousand thermal cycles of magnesium chloride hexahydrate as a promising PCM for indoor solar cooking. *Energy Convers Manag* 2011;52:1771–7.
- [102] Tarwidi D, Murtiansyah DT, Ginanjar N. Performance evaluation of various phase change materials for thermal energy storage of a solar cooker via numerical simulation. *Int J Renew Energy Dev* 2016;5, [199–12].
- [103] Nayak N, Abu Jarir H, Al Ghassani H. Solar cooker study under Oman conditions for late evening cooking using stearic acid and acetanilide as PCM materials. *J Sol Energy* 2016;1–6.
- [104] Nkhonjera L, Bello-Ochende T, John G, King'ondeu C. A review of thermal energy storage designs, heat storage materials and cooking performance of solar cookers with heat storage. *Renew Sustain Energy Rev* 2017;75, [157–11].
- [105] Lecuona A, Nogueira JI, Ventas R, Hidalgo MR, Legrand M. Solar cooker of the portable parabolic type incorporating heat storage based on PCM. *Appl Energy* 2013;111, [1136–11].
- [106] Singh H, Gagandeep , Saini K, Yadav A. Experimental comparison of different heat transfer fluid for thermal performance of a solar cooker based on evacuated tube collector. *Environ Dev Sustain* 2015;17, [497–15].
- [107] Sharma A, Chen CR, Murty VVS, Shukla A. Solar cooker with latent heat storage systems: a review. *Renew Sustain Energy Rev* 2009;13, [1599–7].
- [108] Saxena A, Varunb , Pandey SP, Srivastava G. A thermodynamic review on solar box type cookers. *Renew Sustain Energy Rev* 2011;15:3301–18.
- [109] El-Tous Y, Badran OO, Al-Mofleh A. Thermal evaluation of a sun tracking solar cooker. *Int J Energy Environ (IJEE)* 2012;3:83–9.
- [110] Farooqui SZ. Angular optimization of dual booster mirror solar cookers – tracking free experiments with three different aspect ratios. *Sol Energy* 2015;114, [337–12].
- [111] Zamani H, Kianifar A, Moghiman M, Mamourian M. Experimental study of a double-exposure solar cooker based on the parabolic and flat reflected surfaces. *Int J Adv Renew Energy Res* 2015;2:240–6.
- [112] Badar A, Zaryab SA, Abedin ZU, Khan MY. Performance modeling and parametric analysis of a double glazed solar oven. *J Clean Energy Technol* 2016;4, [187–5].
- [113] Ghosh SS, Biswas PK, Neogi S. Thermal performance of solar cooker with special cover glass of low-e antimony doped indium oxide (IAO) coating. *Appl Therm Eng* 2017;113:103–9.
- [114] Cuce E, Cuce PM. Theoretical investigation of hot box solar cookers having conventional and finned absorber plates. *Int J Low-Carbon Technol* 2015;10:238–9.
- [115] Zamani H, Moghiman M, Kianifar A. Optimization of the parabolic mirror position in a solar cooker using the response surface method (RSM). *Renew Energy* 2015;81:753–7.
- [116] Harmim A, Bellhamel M, Boukar M, Amar M. Experimental investigation of a box-type solar cooker with a finned absorber plate. *Energy* 2010;35, [3799–4].
- [117] Sethi VP, Pal DS, Sumathy K. Performance evaluation and solar radiation capture of optimally inclined box type solar cooker with parallelepiped cooking vessel design. *Energy Convers Manag* 2014;81, [231–11].
- [118] Hermelinda SC, Mauricio GA. Development of the solar cooker JORHEJPATARNSKUA: thermal standard analysis of solar cooker with several absorber pots. *Energy Procedia* 2014;57, [1573–10].
- [119] Misraa R, Aseri TK. Thermal performance enhancement of box-type solar cooker: a new approach. *Int J Sustain Energy* 2012;31:107–13.
- [120] Saxena A, Lath S, Tirth V. Solar cooking by using PCM as a thermal heat storage. *Int J Mech Eng* 2013;3:91–5.
- [121] Mussard M, Gueno A, Nydal OJ. Experimental study of solar cooking using heat storage in comparison with direct heating. *Sol Energy* 2013;98:375–9.
- [122] Chaudhary A, Kumar A, Yadav A. Experimental investigation of a solar cooker based on parabolic dish collector with phase change thermal storage unit in Indian climatic conditions. *J Renew Sustain Energy* 2013;5:1–14.
- [123] Aremu AK, Akinoso R. Effect of insulating materials on performance of solar heater. *J Eng Appl Sci* 2013;8:64–5.
- [124] Aremu AK, Igbeka JC. Energetic and exergetic evaluation of box-type solar cookers using different insulation materials. *Int Sch Sci Res Innov* 2015;9:440–7.
- [125] Mussard M, Nydal OJ. Charging of a heat storage coupled with a low-cost small-scale solar parabolic trough for cooking purposes. *Sol Energy* 2013;95, [144–11].
- [126] Kumar N, Vishwanath G, Gupta A. An energy based unified test protocol for solar cookers of different geometries. *Renew Energy* 2012;44, [457–6].
- [127] Ozturk HH. Comparison of energy and exergy efficiency for solar box and parabolic cookers. *J Energy Eng* 2007;1:11.
- [128] Pandey AK, Tyagi VV, Park SR, Tyagi SK. Comparative experimental study of solar cookers using exergy analysis. *J Therm Anal Calorim* 2012;109:425–8.
- [129] Panwar NL, Kothari S, Kaushik SC. Energetic and exergetic analysis of three different solar cookers. *J Renew Sustain Energy* 2013;5:1–13.
- [130] Saravanan K, Janarthanan B. Energy and exergy analysis of double exposure box-type solar cooker. *Int J Innov Res Sci Eng Technol* 2014;3:13104–10.
- [131] Panwar NL. Thermal modeling, energy and exergy analysis of animal feed solar cooker. *J Renew Sustain Energy* 2013;5:1–18.
- [132] Farooqui SZ. A review of vacuum tube based solar cookers with the experimental determination of energy and exergy efficiencies of a single vacuum tube based prototype. *Renew Sustain Energy Rev* 2014;31, [439–7].
- [133] Farooqui SZ. Impact of load variation on the energy and exergy efficiencies of a single vacuum tube based solar cooker. *Renew Energy* 2015;77:152–7.
- [134] Park SR, Pandey AK, Tyagi VV, Tyagi SK. Energy and exergy analysis of typical renewable energy systems. *Renew Sustain Energy Rev* 2014;30:105–19.
- [135] Sosaa LBL, Avilésa MG, Péreza DG, Gutiérreza YS. Rural Solar Cookers, an alternative to reduce the timber resource extraction through the use of renewable energy sources: technology transfer and monitoring project. *Energy Procedia* 2014;57, [1593–10].
- [136] Jerneck A, Olsson L. A smoke-free kitchen: initiating community based co-production for cleaner cooking and cuts in carbon emissions. *J Clean Prod* 2013;60, [208–8].
- [137] Panwar NL, Kothari S, Kaushik SC. Techno-economic evaluation of masonry type animal feed solar cooker in rural areas of an Indian state Rajasthan. *Energy Policy* 2013;52:583–4.





## 1.2 Séchage solaire : un bilan avec évaluation économique et environnementale

Cet article est publié dans « **Energy** »

[doi.org/10.1016/j.energy.2018.05.197](https://doi.org/10.1016/j.energy.2018.05.197)

**Résumé** - Une revue sur le séchage solaire est présentée. La revue comprend les principaux composants, les classifications et les paramètres influençants. Les avantages, les inconvénients et les limites de cette technologie sont également étudiés. Cela dit, les séchoirs solaires sont évalués en fonction de trois éléments clés : le mode de circulation de l'air (passif et actif), le mode de transfert de chaleur (direct et indirect, hybride et mixte) et le type de chambre de séchage (armoire, serre et tente). De plus, des études économiques et environnementales sont réalisées pour le cas libanais afin d'évaluer la durée d'amortissement (PP) et la réduction de CO<sub>2</sub>. Les paramètres examinés sont le pourcentage de temps pendant lequel le séchoir solaire est utilisé (Pr), la masse d'aliments séchés et le type d'aliment. Les résultats montrent que pour Pr égal à 0.6, lors du séchage de 120 kg de carottes à l'aide d'un séchoir solaire, la quantité d'argent économisé (SM) est de 780 \$/mois, PP est de 10 mois et la quantité d'émissions de CO<sub>2</sub> diminue de 6400 kg/mois.

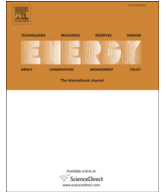

# An investigation on solar drying: A review with economic and environmental assessment

Hicham El Hage<sup>a</sup>, Amal Herez<sup>a</sup>, Mohamad Ramadan<sup>a, b, \*</sup>, Hassan Bazzi<sup>a</sup>, Mahmoud Khaled<sup>a, c</sup>

<sup>a</sup> International University of Beirut, PO Box 146404, Beirut, Lebanon

<sup>b</sup> Associate Member at FCLAB, CNRS, Univ. Bourgogne Franche-Comte, Belfort Cedex, France

<sup>c</sup> Univ Paris Diderot, Sorbonne Paris Cité, Interdisciplinary Energy Research Institute (PIERI), Paris, France

## ARTICLE INFO

### Article history:

Received 25 October 2017

Accepted 30 May 2018

Available online 31 May 2018

### Keywords:

Energy

Renewable energy

Review

Solar dryers

Solar energy

## ABSTRACT

In this paper, a review on solar drying is presented. The review comprises the main components, classifications and affecting parameters. Advantages, disadvantages and limitations of such technology are also investigated. That said, solar dryers are assessed according to three key-elements: way of air movement (passive and active), mode of transferring heat (direct and indirect, hybrid and mixed) and type of drying chamber (cabinet, greenhouse and tent). Moreover, economic and environmental studies are performed for the Lebanese case in order to assess the Payback Period (PP) and the amount of CO<sub>2</sub> reduction. The examined parameters are the percentage of time where solar dryer is utilized (Pr), the mass of dried food and food type. Results show that for Pr equals to 0.6, when drying 120 kg of carrots using solar dryer the amount of Saved Money (SM) is 780 \$/month, PP is 10 months and the amount of CO<sub>2</sub> emissions decreases by 6400 kg/month.

© 2018 Elsevier Ltd. All rights reserved.

## 1. Introduction

Drying is an outstanding way to overcome spoiling problems of food such as fruits, vegetables and grains. It is a powerful process of relatively high energy consumption where it presents about 10–15% of the overall world industrial energy consumption [1,2]. On the other hand, energy domain is witnessing an accelerated effort to find solutions for the current energy crisis. The panel of solutions ranges from heat recovery to renewable energy sources and energy storage. Heat recovery systems [3–13] are based on reusing the dissipated heat from several application in order to increase the energy usage efficiency, where heat exchanger [14] is the main component of such system. Renewable energy systems rely on sustainable sources such as wind [15–20], biomass [21–35], solar [36–43], geothermal [44–50], hydropower [51–56] and tidal [57–62]. Fig. 1 illustrates the different strategies to avoid energy crisis.

Actually, earth receives a plenty annual amount of solar radiation energy which is greater than the world energy request by more

than 10000 times [63,64]. Hence, renewable sources of energy, especially solar energy are the optimum method that can be used to reduce the cost of energy and decrease CO<sub>2</sub> (carbon dioxide) emissions.

One of the most potential applications of solar energy is solar dryer [65–70]. Solar dryer is a device which exploits solar energy to add significant amount of heat to a product and extract humidity from it without affecting its quality. It is utilized in several domains mainly agriculture and industries where it reduces bacteria and preserves agricultural products.

Since many years, open sun drying was the common way to dry and preserve food and agricultural products. However, open sun drying has several limitations including degradation of materials quality due to dust, rain, wind, insects and animals, in addition to inability to control external drying parameters such as moisture content, temperature and drying air flow rate. In 1976, Everitt and Stanley developed solar dryer to avert open sun drying conflicts and supply a progressed way to dry products [71–73]. The solar dryer consisted of a box shape housing unit with a transparent sunlight cover. After decades, numerous distinguished researchers [74–78] conducted developments on solar dryer to maintain the optimum eligible drying features.

That said, due to the fact that Lebanon is one of the countries

\* Corresponding author. International University of Beirut, PO Box 146404, Beirut, Lebanon

E-mail address: [mohamad.ramadan@liu.edu.lb](mailto:mohamad.ramadan@liu.edu.lb) (M. Ramadan).

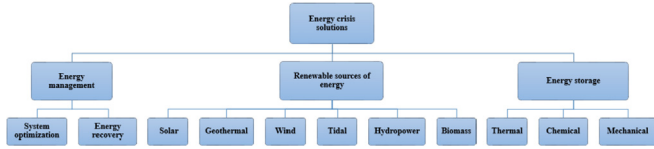

Fig. 1. Different strategies to avoid energy crisis.

that suffers from fuel scarcity and economical deficiency, solar dryers could represent an efficient solution to decrease energy consumption in drying processes. In the frame of this view the aim of the presented study is to present a review on solar dryer concerning its principle and components, classification and effecting parameters, advantages and disadvantages. Besides, economic and environmental analyses are developed to shed light on the significant role of solar dryers in Lebanon regarding saving money and decreasing CO<sub>2</sub> emissions. Hence, the objectives of this paper are to study solar dryer technology, to make it more familiar to be utilized, and to expose the importance of utilizing it especially in Lebanon country.

The rest of this paper is organized as follows: section 2 and 3 respectively present the principle and components of solar dryer, section 4 is devoted to review the different classifications of solar dryers and section 5 delineates the effective parameters on drying rate of solar dryers, section 6 elucidates the benefits and drawbacks and barriers of solar dryers, section 7 exposes economic and environmental concerns in Lebanon, section 8 draws the main conclusions of the work and section 9 lists some future works and recommendations to fulfill them.

## 2. Principle of solar dryers

Solar dryer is an appliance which transmits heat from heat source to a product, and transfers mass (moisture) from the surface of the product to the surrounding air [79]. The basic function of a solar dryer is to rise the vapor pressure of moisture found inside the product and increase moisture carrying capacity of the drying air by decreasing its relative humidity [80]. During solar drying, warm air captures moisture from the dried product [81]. The amount of moisture removed depends on the temperature of the dried air where warm air has the ability to catch moisture more than cold air. Fig. 2 shows a schematic that explains in general the principle of solar dryer.

## 3. Components of solar dryers

In general, solar dryer is composed of three prime components

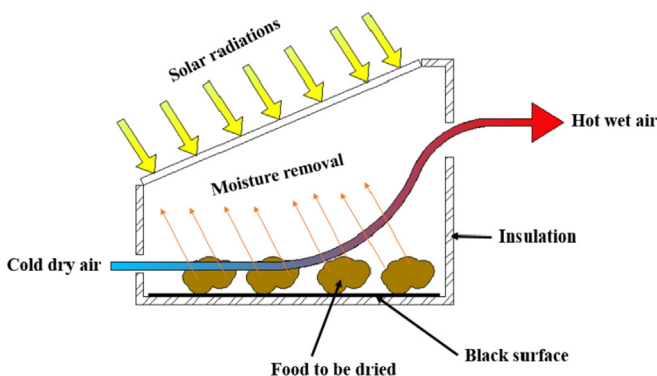

Fig. 2. Principle of solar dryer.

which are the drying chamber, air heater and air flow system. The drying chamber is the location where dried food are placed. It protects food from dust and dirt. In most cases it is insulated to increase the drying efficiency. The solar heater (solar collector) is a box of dark color with a transparent cover. It heats the drying air by raising the ambient temperature 10–30 K. While air flow system exhausts the moist air to the surrounding.

## 4. Classifications of solar dryers

Numerous types or designs of solar dryers may be presented in the literature. With this in mind, persistent update of solar dryers' classifications should be developed due to the continuous progress in designing solar dryers. Moreover, different manners can be taken into account to categorize solar dryers. Indeed, various classifications of solar dryers have been presented in the literature [82–90]. In this work solar dryers are classified according to method of air flow, mode of transferring heat from sun to the product and type of drying chamber. Fig. 3 illustrates the different categories of solar dryers.

Several studies [71,91–94] were performed to present a review on the exciting types of solar dryers. Kumar et al. [91] presented a state of art review of several designs, details of constructional features and operational principles of wide variety of practically realized solar drying systems. Fudholi et al. [92] presented a review on four types of solar dryers: direct, indirect, mixed, and hybrid. The study was conducted regarding the material to be dried, economic and technical aspects. The progress of solar drying systems of agricultural products relies on technical directions such as compact design of the collector, integrated storage, good efficiency and long lasting drying system. Sontakke and Salve [93] presented a review on the several techniques and modes of solar dryers. Similarly, Kumar et al. [71] pursue a review on mainly three types of solar dryers which are direct, indirect and hybrid solar dryer and their drying applications. Mustayen et al. [94] presented in a paper the different types of solar dryer that are widely used. Dryers are categorized into indirect, direct, and mixed dryers in addition to active and passive types. Also, the paper sheds light on the environmental impact of solar energy, specifically solar dryers. In addition to that, technologies that may serve in progressing solar dryers are implemented.

### 4.1. Mode of air movement

#### 4.1.1. Passive solar dryers

Passive solar dryers depend on the natural movement of air due

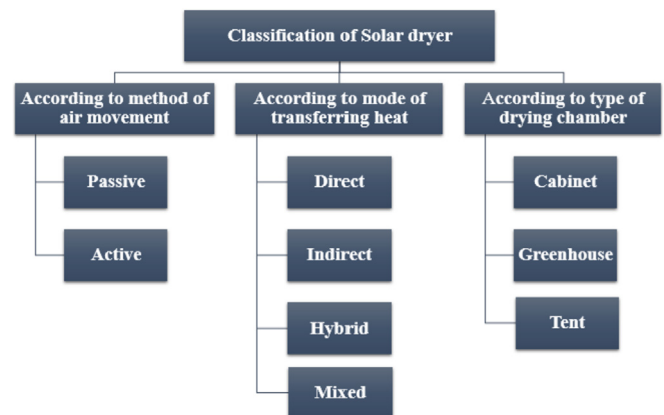

Fig. 3. Classifications of solar dryers.

to buoyancy force, wind pressure difference, or combination of them. Hence, this type of dryers is known as natural convection solar dryers. Such solar dryers have slow drying rate due to the slow movement of air [95].

#### 4.1.2. Active solar dryers

Active solar dryers require fans to duct air through the dryer components which can be mounted either at the inlet or at the exit. It has a higher drying rate compared to the passive mode, but it needs electrical energy to drive the fan [96].

### 4.2. Mode of transferring heat

#### 4.2.1. Direct solar dryer

Direct solar dryer is composed of a drying chamber which is covered by transparent glazing made up of plastic or glass [97]. In direct solar dryer, the product is placed in an enclosure of transparent cover. Solar radiation is absorbed by the material and the internal surfaces of the drying chamber, generating heat. Then heat evaporates moisture from the product and thus it is dried. Fig. 4 illustrates a schematics of direct passive and direct active solar dryers respectively.

Direct dryers can be constructed simply, they are inexpensive and require low maintenance cost. However, such dryer has low drying rate because it is dependable on climate conditions. Also, it requires large space area and it lowers the product quality due to direct sun exposure [93].

#### 4.2.2. Indirect solar dryer

Indirect solar dryer [95] is made up of drying chamber which has opaque cover, fan and solar air heater/solar collector which may be fixed plate collector or concentrated type collector [98]. Solar collector heats the atmospheric air, in which the product is not exposed directly to solar radiation. Then, warm air is ducted to the drying chamber by the fan (in active type) where it transfers heat to the material and evaporates moisture from it. Fig. 5 shows a schematics of indirect passive and indirect active solar dryers respectively.

Indirect solar dryer is more efficient than direct type, it has a high drying rate compared to direct dryer. Having said that, in an indirect solar dryer air velocity, dryer temperature and solid loading can be simply controlled compared to direct solar dryers [99]. Moreover, it preserves product quality by preventing direct exposure to sun, and it is recommended for photosensitive products. But this dryer has high capital cost and requires high

maintenance compared to direct dryer [100].

Phadke et al. [100] did a review on indirect solar dryers, where the various technologies of indirect dryers against direct type solar dryers and against each other were presented. Also different techniques that can be installed to solar dryers for improvising their efficiency were implemented. Pastrana [101] designed and studied the drying process of an indirect solar dryer.

#### 4.2.3. Mixed solar dryer

Mixed solar dryer [95,102] is a combination of the direct and indirect types [98,103]. The cover of drying chamber in mixed dryer is transparent. In such dryer a separate collector preheats air before entering drying chamber and then sunlight adds heat to the products which will be dried.

Mixed solar dryer has the highest drying rate compared to direct and indirect dryers. Besides, it can achieve in a short time temperature much higher than ambient which serves in attaining suitable level of moisture in the product [99]. But it is complex and of high initial cost [100].

#### 4.2.4. Hybrid solar dryer

Hybrid solar dryers [104–106] are dryers that depend on solar energy and another source such as biomass or fossil fuel. Such dryers have the ability to operate without solar energy which reduce the risk of losing food. Ayala and Topete [107] reported in a study on drying pineapple in hybrid solar dryer that the time needed to dry pineapple in solar dryer is 31.2% longer than that required when utilizing hybrid solar dryer. Thus, hybrid solar dryer reduced the drying time compared to solar dryer. On the other hand, hybrid solar dryers are expensive and they may lead to fuel dependent, where the main purpose of solar dryers is to decrease fuel dependence.

The substantial difference between mixed solar dryers and hybrid solar dryers is that in mixed solar dryers the only source of energy is solar energy however the operational mode includes a combination between direct and indirect solar dryers. Having said that, hybrid solar dryers do not depend only on solar energy it couples several energy sources such as solar energy and biomass.

### 4.3. Type of drying chamber

#### 4.3.1. Cabinet solar dryer

Cabinet solar dryer is a large box made up of metal or wood. The products that will be dried are placed in shelves inside the chamber. Heat storage systems can be installed in the dryer [108,109].

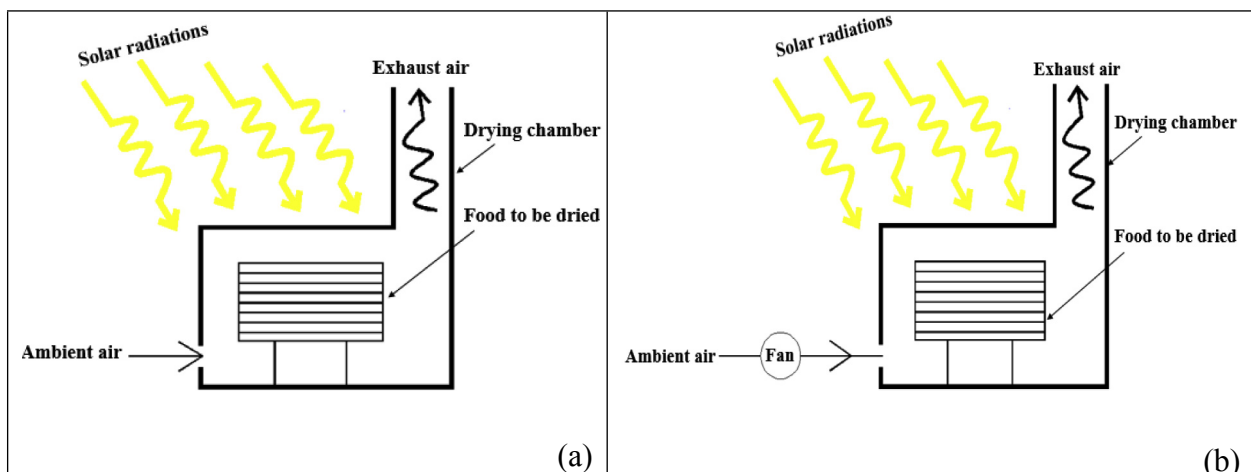

Fig. 4. (a) Direct passive solar dryer; (b) Direct active solar dryer.

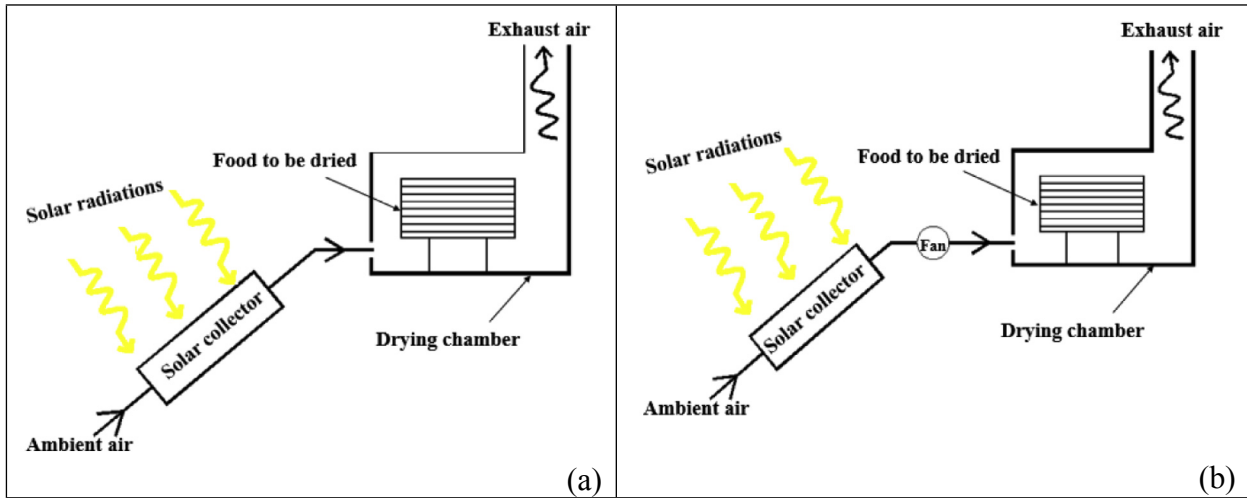

Fig. 5. (a) Indirect passive solar dryer; (b) Indirect active solar dryer.

Cabinet dryers may be of direct or indirect type depending on the type of drying chamber. In direct type the chamber is transparent while in the indirect one the chamber is opaque. Figs. 6 and 7 are schematic diagrams for direct and indirect cabinet solar dryer respectively.

Cabinet solar dryer can be simply constructed and it has low initial cost [63]. Ghaffari and Mehdipour [110] modeled and improved a typical cabinet solar dryer by using computational fluid dynamics. However, cabinet solar dryer has a low removal of moisture and it has tendency to over dry the lower trays.

4.3.2. Greenhouse solar dryer

Greenhouse dryer is a solar dryer which combines the operation of solar collector with greenhouse system. The dryer's walls and

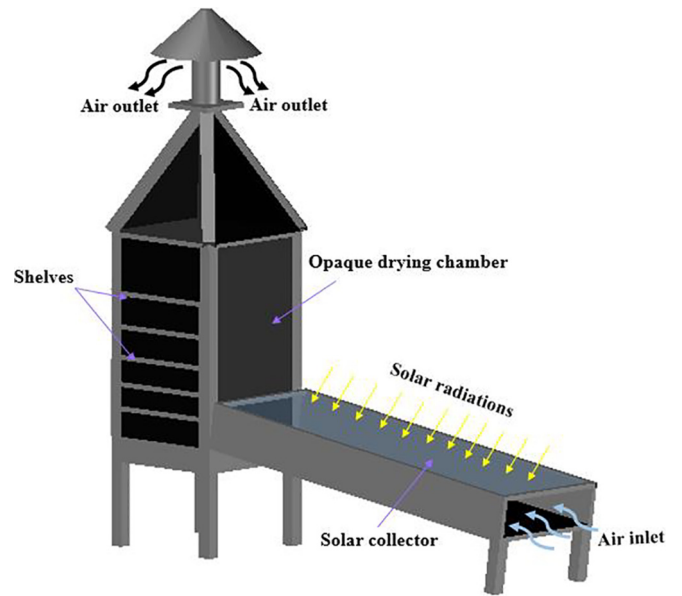

Fig. 7. Indirect cabinet solar dryer.

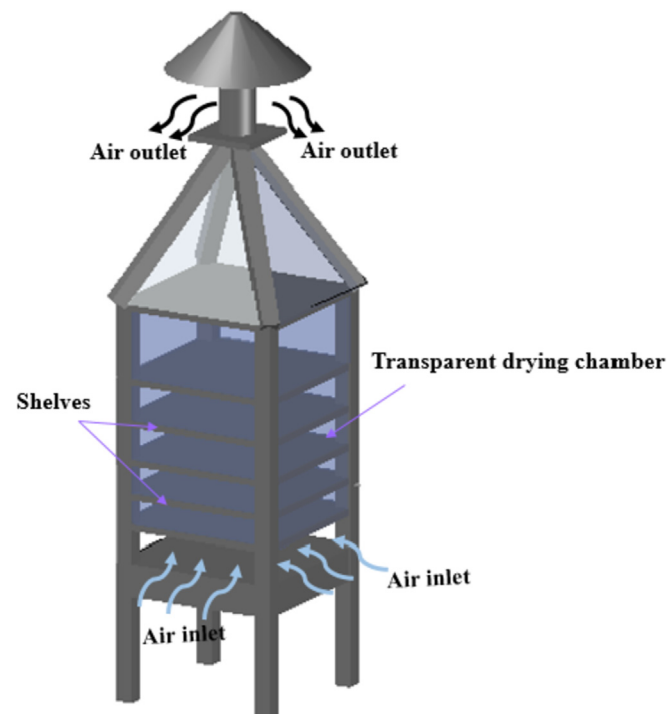

Fig. 6. Direct cabinet solar dryer.

roofs are manufactured from a transparent material such as glass, fiber glass, UV stabilized plastic or polycarbonate sheets [108]. To enhance the absorption of solar radiation, black surface is required. Such type of dryer has a considerable drying control compared to other types. It can be applied for large quantities of products. Fig. 8

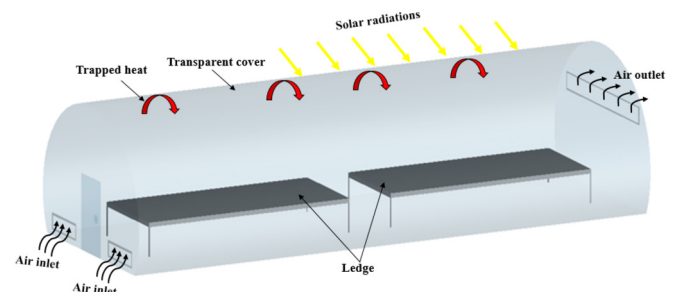

Fig. 8. Passive greenhouse solar dryer.



represents a schematic diagram for passive greenhouse solar dryer.

Kaewkiew et al. [111] investigated the performance of large scale greenhouse solar dryer for chili drying. The dryer has parabolic shape covered with polycarbonate sheets, and its base is made up of concrete with  $8 \times 20 \text{ m}^2$  area. The dryer is ventilated by nine DC (direct current) fans which are powered by three solar cell modules of 50 W each. It was implemented in Ubon Ratchathani, Thailand, where three chili batches were dried in it. The experiment revealed that 500 kg of chili with 74% initial moisture content needs 3 days to be dried in solar dryer while 5 days to be dried by natural sun.

#### 4.3.3. Tent solar dryer

Tent solar dryer consists of wooden pillars covered with plastic sheet, where the background plastic sheet has black color to absorb more solar radiation. At the upper side of the tent a vent is applied to allow flow of air stream inside it. The products to be dried are located on a ledge above the ground [108]. Solar drying using tent solar dryer requires same duration of time as drying in open air drying [63]. Tent dryer is cheap and it can be simply constructed. However, strong wind can easily destroy it. Fig. 9 illustrates a schematic diagram of tent solar dryer.

### 5. Affecting parameters on solar dryers performance

Drying rate of solar dryers can be affected by several parameters. The most essential parameters that affect solar dryer performance are the type of material, its loading and pretreatment, temperature attained inside the dryer, drying air velocity and relative humidity. Kapadiya and Desai [99] described the influence of the aforementioned parameters on performance of solar dryer. Kucuk et al. [112] reviewed 67 models of thin-layer drying curve and compared their drying behavior by taking into consideration several effecting parameters including product type, pretreatment type, temperature, air velocity and others.

Drying rate is influenced by the type of the product to be dried in which some materials are sensitive to heat so they don't endure high drying temperature or long drying duration. Fudholi et al. [92] reviewed numerous designs of solar dryers that has been developed for drying several types of agricultural and marine products.

A vital parameter affecting performance of solar dryer is the amount of dried products. Higher load of solids requires greater amount of drying air. This increases the risk of obtaining poor quality of the dried products due to inability to attain the desired moisture content inside the materials. In contrast, small amount of

dried products rises the drying rate of the solar dryer but in some cases this may cause loss of energy.

Pretreatment of samples before undergoing drying process is essential in which it enhances the drying rate and reduces the drying time [113]. Thus, high quality of the product will be achieved with less consumption of energy. Pretreatment may include slicing the fruits where in Ref. [114] mango fruits were utilized for drying test and cut into horizontal 4 mm thick slices.

Temperature is a parameter that has an influence on both drying rate and the final properties of a sample. Higher temperature achieved inside the dryer rises the drying rate and shortens drying duration, when the initial moisture content is high. However, at low moisture content, temperature doesn't have a considerable effect since small amount of heat is required to evaporate moisture. Besides, temperature control is significant when drying material that are sensitive to heat. Bennamoun and Belhamri [94] stated in their study on simple efficient and inexpensive solar batch dryer for agriculture products that drying is essentially affected by air temperature. For  $60^\circ\text{C}$ , the time needed to achieve the desired moisture was 500 min, however; it took 900 min for temperature equal to  $40^\circ\text{C}$ .

Another key parameter is air flow rate. The increase in flow rate of air leads to decrease in conduction and radiation losses due to the negligible increase in temperature. However, at high flow rate air may not have sufficient contact time with product to remove moisture from it leading to a deterioration in the efficiency of the solar dryer. Insufficient flow rate increases the dryer temperature and slows down moisture extraction.

Relative humidity of air is a primary factor that has great impact on solar dryer performance. Higher amount of energy is needed in case of high humidity due to the fact that air can't capture moisture when it is saturated. Thus slow drying rate is obtained when the humidity is high. However, when air has low humidity it has the tendency to catch moisture from the dried material and drying duration becomes shorter.

Leon et al. [115] presented a detailed review of parameters that are generally used in testing and evaluating different types of solar food dryers. In this work the authors highlighted on the effect of air temperature, flow rate and relative humidity in addition to other parameters. Table 1 illustrates recent researches that are performed on various types of solar dryers.

### 6. Discussion

#### 6.1. Benefits of solar dryers

Solar dryers are in general of relatively low cost because they are made of locally available materials and their mode of construction is relatively simple [63,166]. They offer several advantages such as drying food without affecting its flavor, texture or color in which the dried food is tasty and nutritious. Moreover, solar dryers reduce losses of products, promote longer storage duration and prevent spoilage of stored materials [167,168]. Furthermore, the energy required to dry food is less than that needed to freeze or can, and the storage space is negligible in comparison with that required for freezing containers or canning jars. That said, solar dryers mitigates consumption of conventional sources of energy such as fossil fuels, thus they allow to reduce  $\text{CO}_2$  emissions [100,108].

#### 6.2. Drawbacks of solar dryers

Despite its several advantages, solar dryers have some limitations that deteriorate its performance and negatively affect its drying rate. Indeed, the use of solar dryers is exclusively limited to daytime where there is sufficient amount of solar radiation.

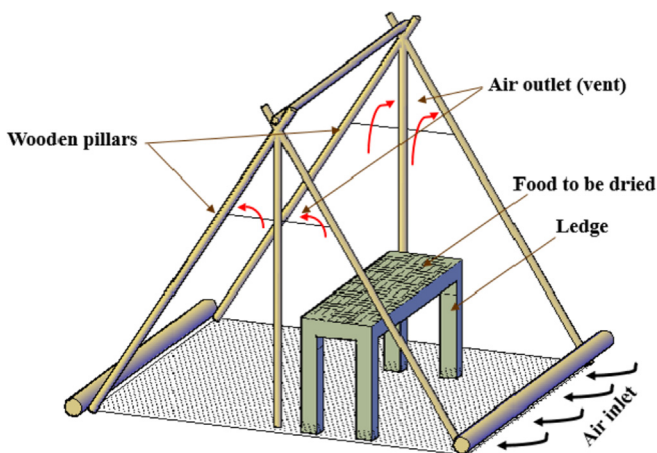

Fig. 9. Tent solar dryer.

**Table 1**  
Recent researches on various types of solar dryers.

St. No.	Reference	Title of journal	Year	Topic	Type of solar dryer	Type of study
1	Yaldiz et al. [116]	Energy	2001	Mathematical modeling of thin layer solar drying of sultana grapes	• Solar cabinet dryer	• Mathematical modeling • Experimental study
2	Pangavhane et al. [117]	Energy	2002	Design, development and performance testing of a new natural convection solar dryer	• Natural convection cabinet solar dryer	• Experimental study
3	Prakash et al. [118]	Journal of Food Engineering	2004	Performance evaluation of blanched carrots dried by three different driers	• Cabinet solar dryer	• Mathematical modeling • Experimental study
4	Sreekumar et al. [119]	Energy Conversion and Management	2008	Performance of indirect solar cabinet dryer	• Indirect solar cabinet dryer	• Experimental analysis • Economic analysis
5	Olokor et al. [120]	Nature and Science	2009	Adaptation And Improvement Of A Simple Solar Tent Dryer To Enhance Fish Drying	• Tent solar dryer	• Experimental analysis
6	Ojutiku et al. [121]	Pakistan Journal of Nutrition	2009	Comparative Study of Sun Drying and Solar Tent. Drying of <i>Hyperopisus bebe occidentalis</i>	• Tent solar dryer	• Experimental study
7	Banout et al. [122]	Journal of Food Process Engineering	2010	Effect of solar drying on the composition of essential oil of sacha culantro ( <i>eryngium foetidum</i> L.) grown in the peruvian amazon	• Direct and indirect cabinet solar dryer	• Experimental analysis
8	Fudholi et al. [92]	Renewable and Sustainable Energy Reviews	2010	Review of solar dryers for agricultural and marine products	• Natural convection solar dryer • Forced convection solar dryer • Hybrid solar dryer	• Review
9	Akbulut and Durmus [123]	Energy	2010	Energy and exergy analyses of thin layer drying of mulberry in a forced solar dryer	• Forced convection cabinet solar dryer	• Experimental analysis • Modeling
10	Sami et al. [124]	Energy	2011	Energy and exergy analysis of an indirect solar cabinet dryer based on mathematical modeling results	• Indirect solar cabinet dryer	• Mathematical modeling • Experimental analysis
11	Bennamoun [1]	Renewable and Sustainable Energy Reviews	2011	Reviewing the experience of solar drying in Algeria with presentation of the different design aspects of solar dryers	• Passive mode solar dryer • Active mode solar dryer	• Review
12	Bennamoun [125]	International Journal of Energy Engineering	2012	An Overview on Application of Exergy and Energy for Determination of Solar Drying Efficiency	• Cabinet solar dryer	• Mathematical modeling
13	Almuhanna [88]	Journal of Agricultural Science	2012	Utilization of a Solar Greenhouse as a Solar Dryer for Drying Dates under the Climatic Conditions of the Eastern Province of Saudi Arabia Part I: Thermal Performance Analysis of a Solar Dryer	• Solar greenhouse dryer	• Mathematical modeling • Experimental analysis
14	Janjai [126]	International journal of energy and environment	2012	A greenhouse type solar dryer for small-scale dried food industries: Development and dissemination	• Solar greenhouse dryer	• Experimental analysis • Modeling • Economic evaluation
15	Sebaili and S. M. Shalaby [127]	Renewable and Sustainable Energy Reviews	2012	Solar drying of agricultural products: A review	• Direct solar dryer • Indirect solar dryer • Mixed solar dryer	• Review
16	Kaewkiew et al. [111]	Procedia Engineering	2012	Experimental investigation of the performance of a large-scale greenhouse type solar dryer for drying chilli in Thailand	• Greenhouse solar dryer	• Experimental study
17	Singh and Kumar [83]	International Journal of Sustainable Energy Development	2012	Comparative Thermal Performance Study of Indirect and Mixed-mode Solar Dryers	• Indirect solar dryer • Mixed solar dryer	• Experimental analysis • Parametric study
18	Singh and Kumar [128]	Energy	2013	Solar drying for different test conditions: Proposed framework for estimation of specific energy consumption and CO2 emissions mitigation	• forced convection mixed mode cabinet solar dryer	• Experimental study
19	Aritestya and Wulandani [129]	Energy Procedia	2014	Performance of the Rack Type-Greenhouse Effect Solar Dryer for Wild Ginger ( <i>Curcuma xanthorrhiza</i> Roxb.) Drying	• Solar greenhouse dryer	• Experimental study
20	Mustayen et al. [89]	Renewable and Sustainable Energy Reviews	2014	Performance study of different solar dryers: A review	• Direct, indirect and mixed solar dryer • Natural and forced convection solar dryer	• Review
21	Prakash and Kumar [130]	Renewable and Sustainable Energy Reviews	2014	Solar greenhouse drying: A review	• Solar greenhouse dryer	• Review
22	Ayala and Topete [107]	Energy Procedia	2014	Pineapple drying using a new solar hybrid dryer	• Hybrid solar dryer	• Experimental analysis
23	Finck-Pastrana [101]	Energy Procedia	2014	NOPAL ( <i>Opuntia Lasiacantha</i> ) drying using an indirect solar dryer	• Indirect solar cabinet dryer	• Experimental study



Table 1 (continued)

St. No.	Reference	Title of journal	Year	Topic	Type of solar dryer	Type of study
24	Ferreira et al. [131]	Applied Thermal Engineering	2014	Solar drying of a solid waste from steel wire industry	• Active indirect solar dryer	• Experimental analysis
25	Elkhadraoui et al. [132]	Renewable Energy	2015	Experimental investigation and economic evaluation of a new mixed mode solar greenhouse dryer for drying of red pepper and grape	• Mixed mode solar greenhouse solar dryer	• Experimental study • Economic analysis
26	Phadke et al. [100]	ARPN Journal of Engineering and Applied Sciences	2015	A review on indirect solar dryers	• Natural and forced convection indirect solar dryer	• Review
27	Ghaffari and Mehdipour [110]	International Journal of Food Engineering	2015	Modeling and Improving the Performance of Cabinet Solar Dryer Using Computational Fluid Dynamics	• Cabinet solar dryer	• Numerical modeling
28	Sansaniwal and Kumar [65]	Journal of Mechanical Engineering and Sciences	2015	Analysis of ginger drying inside a natural convection indirect solar dryer: An experimental study	• Natural convection indirect solar cabinet dryer	• Experimental study
29	Chauhan et al. [79]	Renewable and Sustainable Energy Reviews	2015	Applications of software in solar drying systems: A review	• Direct solar dryer • Indirect solar dryer • Mixed solar dryer • Hybrid solar dryer	• Review • Case study
30	Patil and Gawande [133]	Renewable and Sustainable Energy Reviews	2016	A review on solar tunnel greenhouse drying system	• Natural and forced convection Solar greenhouse dryer	• Review
31	Afriyie et al. [134]	International Journal of Science and Engineering Applications	2016	Field Drying of Cassava in a Solar Tent Dryer equipped with a Solar Chimney	• Tent solar dryer	• Modeling • Experimental study
32	Kumar et al. [71]	Renewable and Sustainable Energy Reviews	2016	Progress in solar dryers for drying various commodities	• Direct solar dryer • Indirect solar dryer • Hybrid solar dryer	• Review
33	Sekyere et al. [102]	Renewable Energy	2016	Experimental investigation of the drying characteristics of a mixed mode natural convection solar crop dryer with back up heater	• Mixed mode natural convection solar dryer	• Experimental study
34	Tiwari et al. [90]	Renewable and Sustainable Energy Reviews	2016	Development and recent trends in greenhouse dryer: A review	• Solar greenhouse dryer	• Review
35	Hasan and Langrish [135]	Energy	2016	Time-valued net energy analysis of solar kilns for wood drying: A solar thermal application	• Solar greenhouse dryer	• Modeling
36	Kiggundu et al. [136]	Agricultural Engineering International	2016	Solar fruit drying technologies for smallholder farmers in Uganda, A review of design constraints and solutions	• Cabinet solar dryer • Solar greenhouse dryer	• Review
37	Hasan and Langrish [137]	Solar Energy	2016	Development of a sustainable methodology for life-cycle performance evaluation of solar dryers	• Solar greenhouse dryer	• Modeling
38	Yahya et al. [138]	Solar Energy	2016	Comparison of solar dryer and solar-assisted heat pump dryer for cassava	• Cabinet solar dryer	• Modeling • Experimental study
39	Shrivastava and Kumar [139]	Heat Mass Transfer	2016	Experimental investigation on the comparison of fenugreek drying in an indirect solar dryer and under open sun	• Indirect cabinet solar dryer	• Experimental study • Numerical computation
40	Kabeel and Abdelgaied [140]	Process Safety and Environmental Protection	2016	Performance of novel solar dryer	• Indirect solar dryer	• Numerical investigation • Theoretical modeling • Experimental validation
41	Nabnean et al. [141]	Renewable Energy	2016	Experimental performance of a new design of solar dryer for drying osmotically dehydrated cherry tomatoes	• Indirect cabinet solar dryer	• Experimental investigation
42	Blanco-Cano [142]	Applied Thermal Engineering		Modeling the thin-layer drying process of Granny Smith apples: Application in an indirect solar dryer	• Indirect solar dryer	• Mathematical modeling • Experimental validation
43	Daghigh and Shafieian [143]	Renewable Energy	2016	An experimental study of a heat pipe evacuated tube solar dryer with heat recovery system	• Indirect solar dryer	• Experimental study • Numerical
44	Dejchanchaiwong et al. [144]	Energy for Sustainable Development	2016	Mathematical modeling and performance investigation of mixed-mode and indirect solar dryers for natural rubber sheet drying	• Mixed mode solar dryer • Indirect solar dryer	• Mathematical modeling • Experimental investigation
45	Vijayan et al. [145]	Innovative Food Science and Emerging Technologies	2016	Mathematical modeling and performance analysis of thin layer drying of bitter gourd in sensible storage based indirect solar dryer	• Indirect solar dryer	• Mathematical modeling • Experimental analysis
46	Rabha et al. [146]	Renewable Energy	2017	Experimental investigation of thin layer drying kinetics of ghost chilli pepper ( <i>Capsicum Chinense</i> Jacq.) dried in a forced convection solar tunnel dryer	• Forced convection solar dryer	• Experimental study

(continued on next page)

Table 1 (continued)

St. No.	Reference	Title of journal	Year	Topic	Type of solar dryer	Type of study
47	Téllez et al. [147]	Applied Thermal Engineering	2017	Dehydration of the red chilli ( <i>Capsicum annum L.</i> , costeño) using an indirect-type forced convection solar dryer	• Forced convection indirect solar dryer	• Modeling • Experimental study
48	Baniasadi et al. [148]	Renewable Energy	2017	Experimental investigation of the performance of a mixed-mode solar dryer with thermal energy storage	• Mixed mode solar dryer	• Experimental investigation
49	Morad et al. [149]	Renewable Energy	2017	Thermal analysis and performance evaluation of a solar tunnel greenhouse dryer for drying peppermint plants	• Forced convection greenhouse solar dryer	• Experimental study
50	Rabha and Muthukumar [150]	Solar Energy	2017	Performance studies on a forced convection solar dryer integrated with a paraffin wax–based latent heat storage system	• Forced convection solar dryer	• Thermal modeling
51	Tiwari and Tiwari [151]	Energy	2017	Energy and exergy analysis of a mixed-mode greenhouse-type solar dryer, integrated with partially covered N-PVT air collector	• Mixed mode greenhouse solar dryer	• Thermal modeling • Experimental validation
52	Erbay and Hepbasli [152]	Energy	2017	Assessment of cost sources and improvement potentials of a ground source heat pump food drying system through advanced exergoeconomic analysis method	• Cabinet solar dryer	• Experimental analysis
53	Atalay et al. [153]	Energy	2017	Modeling of the drying process of apple slices: Application with a solar dryer and the thermal energy storage system	• Indirect solar dryer	• Mathematical modeling • Experimental analysis
54	Jafarian et al. [154]	Journal of Agricultural Science and Technology	2017	Experimental Investigation on Dill Drying in a Solar-Assisted Heat Pump Dryer	• Cabinet solar dryer	• Experimental analysis
55	Simo-Tagne et al. [155]	Maderas. Ciencia y tecnología	2017	Modeling and simulation of an industrial indirect solar dryer for iroko wood ( <i>chlorophora excelsa</i> ) in a tropical environment	• Indirect solar dryer	• Modeling • Experimental analysis • Numerical
56	El Khadraoui et al. [156]	Journal of Cleaner Production	2017	Thermal behavior of indirect solar dryer: Nocturnal usage of solar air collector with PCM	• Indirect solar dryer	• Experimental investigation
57	Azaizia et al. [157]	International Journal of Hydrogen Energy	2017	Investigation of a new solar greenhouse drying system for peppers	• Solar greenhouse dryer	• Mathematical modeling • Experimental analysis
58	Kabeel and M.Abdelgaied [158]	Desalination	2018	Experimental evaluation of a two-stage indirect solar dryer with reheating coupled with HDH desalination system for remote areas	• Indirect cabinet solar dryer	• Experimental analysis
59	Lakshmi et al. [159]	Renewable Energy	2018	Drying kinetics and quality analysis of black turmeric ( <i>Curcuma caesia</i> ) drying in a mixed mode forced convection solar dryer integrated with thermal energy storage	• Mixed mode forced convection solar dryer	• Experimental analysis
60	Simo-Tagne et al. [160]	Applied Thermal Engineering	2018	Mathematical modeling and numerical simulation of a simple solar dryer for tropical wood using a collector	• Indirect solar dryer	• Mathematical modeling • Numerical simulation
61	Deeto et al. [161]	Renewable Energy	2018	The experimental new hybrid solar dryer and hot water storage system of thin layer coffee bean dehumidification	• Hybrid solar dryer	• Experimental study
62	Singh et al. [162]	Renewable Energy	2018	Heat transfer analysis of PV integrated modified greenhouse dryer	• Greenhouse solar dryer	• Experimental analysis • Mathematical modeling
63	Wang et al. [163]	Applied Thermal Engineering	2018	Thermal performance of indirect forced convection solar dryer and kinetics analysis of mango	• Indirect forced convection solar dryer	• Experimental analysis
64	Chauhan and Kumar [164]	Applied Thermal Engineering	2018	Thermal modeling and drying kinetics of gooseberry drying inside north wall insulated greenhouse dryer	• Greenhouse solar dryer	• Thermal modeling
65	Singh et al. [165]	Renewable and Sustainable Energy Reviews	2018	Recent developments in greenhouse solar drying: A review	• Greenhouse solar dryer	• Review

Consequently, they can't be utilized during night. As a matter of fact, their use varies with month since the daytime varies from month to month. That is why an electric backup heater should be harnessed which increases the cost of the solar dryers [100,108].

### 6.3. Barriers of solar dryers

Having said that utilization of solar dryer is very beneficial, some barriers inhibit adaptation of such vital technology. The first barrier is the lack of funding and governmental support to perform advanced research program on solar drying. Besides, the high initial investment and initial cost of some types of solar dryers are major

affecting barriers. Another key barrier is the lack of technical expertise which is a vital factor for manufacturing and installing a solar drying system with high efficiency. In addition to that, the lack of awareness of the importance and benefits of solar drying prevents utilizing solar dryer.

### 7. Economic and environmental concerns: lebanese case

Solar dryer serves in mitigating usage of conventional sources of energy, mainly fossil fuels [169]. As a matter of fact it reduces production of CO<sub>2</sub> gas which is the main factor causing global warming. As a result, solar dryer could be a contributor in

protecting the environment. It was reported in Ref. [170] that the electricity demand of Lebanon in year 2009 was 2300 MW, where the “Électricité Du Liban” (EDL) is permanently struggling to cover the needed load however the production is lower than the local demand. Moreover, energy demand is rising, nevertheless there is a continuous shortage in local resources of energy and limitations in power generation capabilities. In addition to that, Lebanon is suffering from economic shortage which limits its ability to cover the need in terms of fuel. In other words it is unescapable to find new renewable techniques that permits to decrease the use of conventional sources of energy.

Another key element that should be mentioned is the nutritive value of dried food. Indeed, it contains large quantity of vitamins, fiber, minerals and carbohydrates, and low in fat which make them healthy. Also, this improves the economic flexibility of farmers, since they sometimes sell at low prices during harvest periods because they can't preserve excess products [127]. Moreover, solar dryer can open new markets and income in which it offers employment opportunities.

7.1. Economic analysis

To assess the economic impact of using solar dryer, a study is performed using a typical dryer of 15 kW input power, 120 kg/batch capacity and 50–140 °C working temperature. The study is conducted to compute the amount of electrical energy consumed when drying several types of fruits and vegetables. Then, the cost of electric energy is calculated to estimate the money saved when replacing this conventional dryer by solar dryer. Besides, the PP of solar dryer is calculated depending on the amount of SM and the cost of a solar dryer which has similar specifications as the conventional dryer.

7.1.1. Amount of saved money

The energy consumed by the electric dryer can be calculated using the formulas of equations (1) and (2).

$$E_{day} = P_{input} \cdot t \tag{1}$$

where “ $E_{day}$ ” is the energy consumed per day (kWh/day), “ $P_{input}$ ” is the input power (kW) and “ $t$ ” is the time where the dryer is used per day (h/day), it can be calculating according to equation (2).

$$t = \frac{M}{C} \cdot d \tag{2}$$

where “ $M$ ” is the mass of food to be dried per day (kg/day). In this study, several cases were taken into account where in each case the amount of load (mass) is varies and four different values are considered: 120 kg, 360 kg, 600 kg and 960 kg “ $C$ ” is the capacity of the dryer (kg/batch) and “ $d$ ” is the drying time (hr/batch). It defers according to the type of food. Table 2 illustrates the drying time for the studied type of fruits and vegetables.

After computing energy consumed per day, energy consumed per month should be calculated to estimate from it the amount of money that could be saved when utilizing solar dryers. Equations (3) and (4) represent calculations of energy consumed per month and amount of saved money, respectively.

$$E_{month} = E_{day} \cdot n_{wd} \tag{3}$$

where “ $E_{month}$ ” is the energy consumed per month (kWh/month) and “ $n_{wd}$ ” is the number of working days per month, it is equal to 20 days/month.

$$SM = Pr \cdot E_{month} \cdot P_{1kwhr} \tag{4}$$

where “ $SM$ ” is the saved money per month, “ $Pr$ ” is the percentage of time where the solar dryer is utilized.  $Pr$  varies from 0.1 to 1. “ $P_{1kwhr}$ ” is the price of 1 kWh. In Lebanon it is equal to 0.0867 \$/kWh for industrial sectors.

Fig. 10 illustrates the variation of  $SM$  as function of  $Pr$  for each type of food and for different masses of the dried food. Results show that the amount of  $SM$  depends on  $Pr$ , mass and type of dried food. In order of magnitudes, as  $Pr$  increased from 0.1 to 1, the amount of  $SM$  raised from 130 \$/month, 185 \$/month, 235 \$/month, 260 \$/month, 290 \$/month, 200 \$/month, 545 \$/month and 415 \$/month to 1300 \$/month, 1820 \$/month, 2340 \$/month, 2600 \$/month, 2860 \$/month, 2080 \$/month, 5460 \$/month and 4160 \$/month for drying 120 kg of carrots, corn, mushrooms, potatoes, apples, bananas, cherries and peaches respectively.

For  $Pr$  equal to 0.6, the amount of  $SM$  is 1400 \$/month, 1560 \$/month, for drying 120 kg of mushrooms and potatoes respectively. By fixing  $Pr$  at 0.6 and increasing the mass from 120 kg to 360 kg the amount of  $SM$  becomes 4200 \$/month, 4700 \$/month for drying mushrooms and potatoes respectively. On the other hand, when raising the mass to 900 kg and for 0.6  $Pr$ , higher amount of  $SM$  is attained where it becomes 11240 \$/month, 12500 \$/month for drying mushrooms and potatoes respectively. This indicates that for higher amount of dried food, more money will be saved when using solar dryer.

7.1.2. Payback period (PP)

The studied solar dryer is an indirect cabinet solar dryer type which has similar specifications as the electric dryer. Its cost is 8000\$. To calculate the payback period of such dryer formula of equation (5) can be used.

$$PP = \frac{C_{sd}}{SM} \tag{5}$$

where “ $PP$ ” is the payback period and “ $C_{sd}$ ” is the cost of solar dryer (8000\$).

Fig. 11 presents the  $PP$  as function of  $Pr$  for each type of food and for different masses of the dried food. The results reveals that the  $PP$  is affected by  $Pr$ , mass and type of dried food. For illustration, as  $Pr$  increased from 0.1 to 1, the  $PP$  decreased from approximately 62 months, 44 months, 34 months, 31 months, 28 months, 39 months, 15 months and 19 months–6 months, 5 months, 4 months, 3 months, 2.8 months, 4 months, 1.5 months and 2 months for drying 120 kg of carrots, corn, mushrooms, potatoes, apples, bananas, cherries and peaches respectively.

Moreover, for  $Pr$  equal to 0.6, the  $PP$  was about 5 and 7 months for drying 120 kg of apples and bananas respectively. For the same value of  $Pr$  and higher amount of food (600 kg), the amount of  $SM$  becomes approximately 0.9 and 1.3 months, for drying apples and bananas respectively. Therefore, higher amount of dried food leads

**Table 2**  
Drying time for studied type of fruits and vegetables.

Food	Carrot	Corn	Mushrooms	Potatoes	Apples	Bananas	Cherries	Peaches
Drying time (hr)	5	7	9	10	11	8	21	16

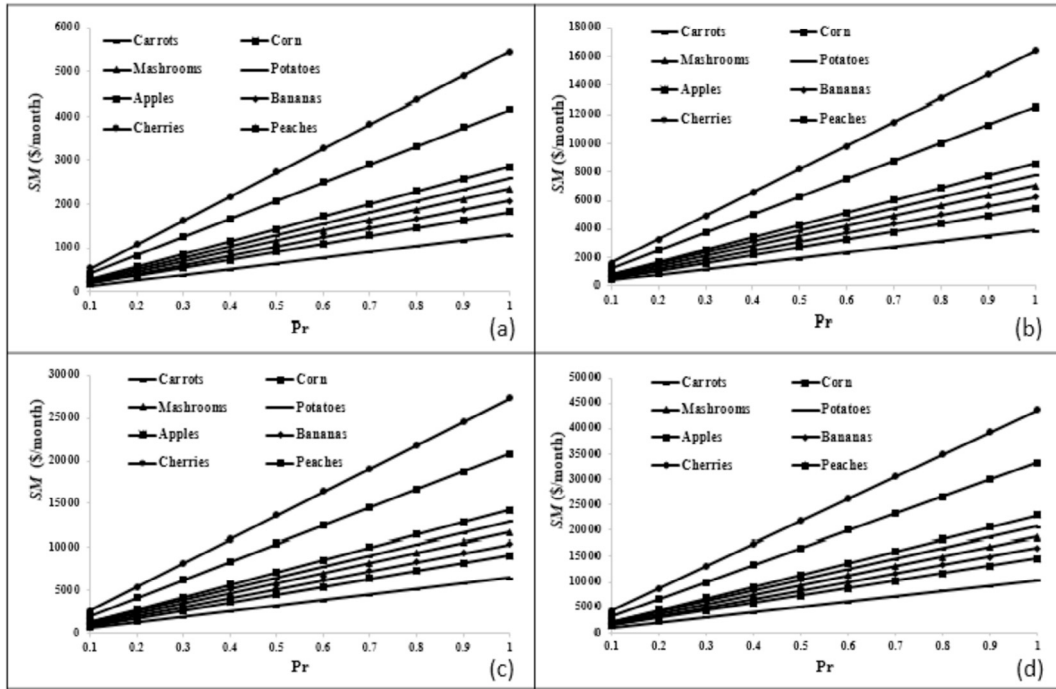

Fig. 10. Variation of amount of SM as function of Pr for mass equal to (a) 120 kg (b) 360 kg (c) 600 kg (d) 960 kg.

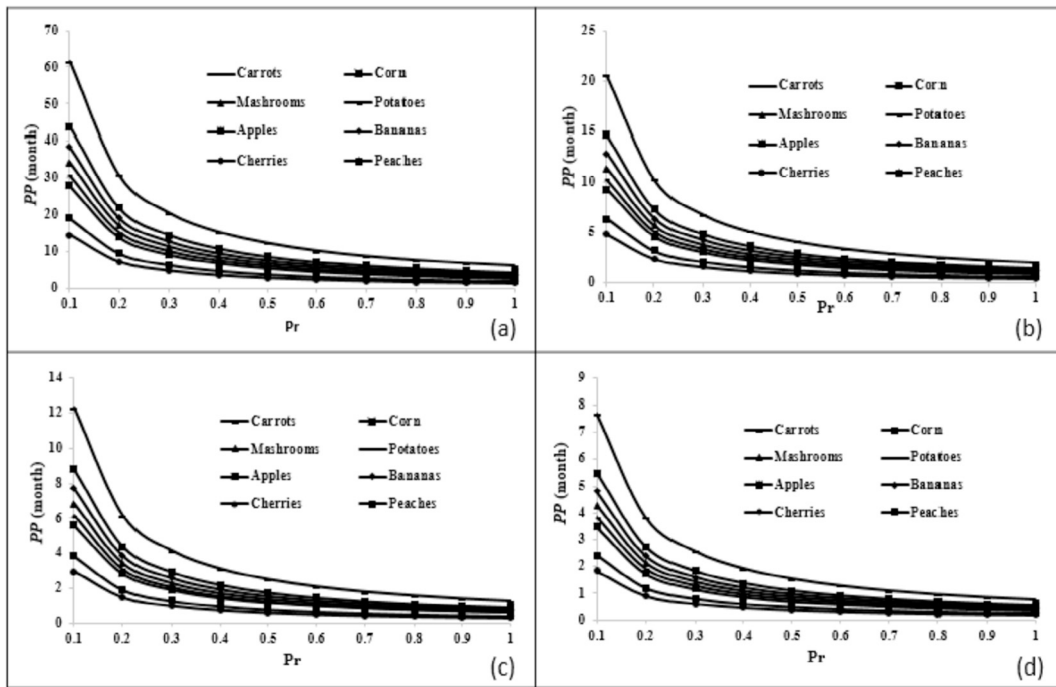

Fig. 11. Variation of PP as function of Pr for mass equal to (a) 120 kg (b) 360 kg (c) 600 kg (d) 960 kg.

to lower payback duration for solar dryer.

### 7.2. Environmental analysis

From an environmental point of view, solar dryer serves to a great extent in reducing the amount of CO<sub>2</sub> emissions. Fudholi et al. [171] reviewed various economic and environmental analyses that has been developed on solar dryers. Kumar and Kandpal [125]

estimated the mitigated CO<sub>2</sub> emissions relying on the amount of fuels that would be saved when solar dryer is harnessed.

To size the environmental influence of solar dryer, a study is conducted on the aforementioned electrical dryer to compute the amount of CO<sub>2</sub> produced per month. Thus, by replacing this dryer by a solar dryer CO<sub>2</sub> emission will be mitigated.

The amount of CO<sub>2</sub> produced ( $M_{produced\ CO_2}$ ) and amount of reduction in CO<sub>2</sub> emission ( $M_{reduced\ CO_2}$ ) can be calculated from

equations (6) and (7) respectively.

$$M_{produced\ CO_2} = E_{month} \cdot M_{CO_2/1\ Kwhr} \tag{6}$$

where “ $M_{CO_2/1\ Kwhr}$ ” is the amount of  $CO_2$  produced from 1 kWh electricity. In Lebanon it is estimated to be about 0.71 kg  $CO_2/1\ kWh$ .

$$M_{reduced\ CO_2} = Pr \cdot M_{produced\ CO_2} \tag{7}$$

Fig. 12 represents the variation of  $M_{reduced\ CO_2}$  as function of Pr for different masses varying between 120 and 960 kg. For drying 120 kg of food, utilizing solar dryer for 60% of the drying time will lead to decrease in  $CO_2$  emissions approximately 26850 kg/month and 20500 kg/month for drying cherries and peaches respectively. However, for higher value of Pr (0.9), 40300 kg/month and 30700 kg/month of  $CO_2$  emissions will be minimized from drying the aforementioned foods.

Thus, it can be concluded from the above analysis that the  $M_{reduced\ CO_2}$  increases as solar dryer is more utilized. Having said that, it can be confirmed that  $M_{reduced\ CO_2}$  varies according to the type of load (food).

Moreover, Fig. 12 highlights the relation between  $M_{reduced\ CO_2}$  and the amount of load to be dried. For example, using solar dryer for 70% of the drying time to dry peaches lead to increase in  $M_{reduced\ CO_2}$  from 71600 kg/month to 190900 kg/month as mass increased from 360 kg to 960 kg. It is obvious that the more dependence on solar dryer the least amount of  $CO_2$  will be produced.

### 8. Conclusions

A review on solar dryers was presented in this work. Principle, components and various classifications of solar dryer has been reported. In addition to that, impact of several parameters on performance of solar dryer and its benefits and limitations have been described. Nevertheless, an economic and environmental analyses

have been conducted to quantify the effects of utilizing solar dryer.

A case study on Lebanon was considered. A typical electrical dryer was taken under considerations to compute the amount of electric energy consumed when drying different masses of food ranging from 120 to 960 kg. Furthermore, the amount of SM was calculated when replacing this traditional dryer by solar dryer. The amount of SM was dependent on Pr, mass and type of dried food. It was shown that the amount of SM increased from 130 to 182 to 1300 and 1820 for drying 120 kg of carrots and corn respectively, as Pr increased from 0.1 to 1.

Furthermore, an indirect cabinet solar dryer of similar specifications of electrical dryer had been examined to evaluate the PP. It was shown that the PP decreased from approximately 62 months and 44 months–6 months and 5 months for drying 120 kg of carrots and corn respectively, when Pr increased from 0.1 to 1. That said, an environmental study is performed on the aforementioned dryers to estimate the decrease in the amount of  $CO_2$  gas produced when using solar dryer instead of electrical one. It was shown that for drying 120 kg of carrots and corn 6400 kg/month and 8950 kg/month of  $CO_2$  emissions will be minimized respectively, for Pr equal to 60%.

### 9. Future works and recommendations

From the above-presented studies it can be concluded that solar dryers could offer a broad panel of advantages for countries like Lebanon where sun is available about 300 days per year. Such benefits have to do with economic and technological progress, health and environment. As future works, huge effort should be carried out to enhance and promote solar drying. First, the performance of the system could be enhanced by using more efficient solar receivers [172]. Moreover, multi-function solar systems incorporating solar dryer and other solar systems such as solar cooker [173], could be suggested as a solution to offer more flexibility in using solar energy. That said, implementing hybrid systems coupling solar dryer to other energy concepts such as biomass

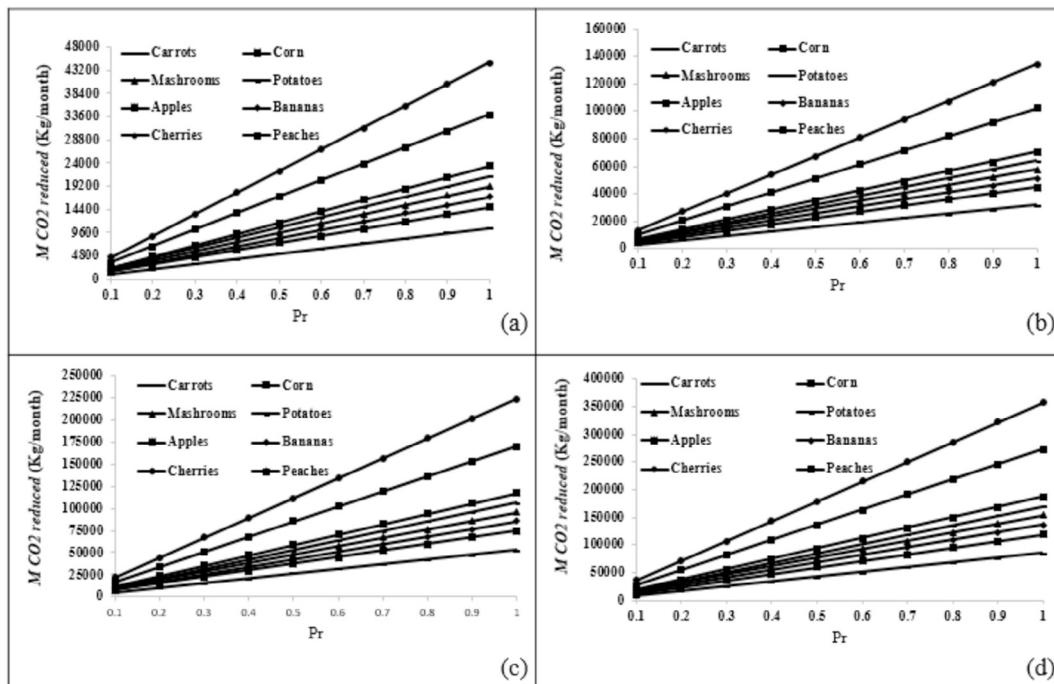

Fig. 12. Variation of  $M_{reduced\ CO_2}$  as function of Pr for mass equal to (a) 120 kg (b) 360 kg (c) 600 kg (d) 960 kg.



based systems [174–176], energy storage [177,178] and energy recovery [179] could be an efficient solution especially for isolated regions such as islands. Furthermore, numerical and experimental comparison should be conducted for different types of solar dryers to evaluate their thermal and energy performance in terms of location and weather conditions.

As a matter of fact, it is tremendously beneficial to encourage the usage of solar dryers especially in region with high solar energy potential. Achieving such aim requires financial and technical efforts to promote studies and investigations on solar dryers. Besides, scientific marketing such as awareness, expedition, lectures and advertisements is required to attract attentions toward this domain.

## References

- [1] Bennamoun L. Reviewing the experience of solar drying in Algeria with presentation of the different design aspects of solar dryers. *Renew Sustain Energy Rev* 2011;15:3371–9.
- [2] Kerkhof P, Coumans WJ. Drying: a fascinating unit operation. *Chem Eng J* 2002;86:1–2.
- [3] Jaber H, Khaled M, Lemenand T, Faraj J, Bazzi H, Ramadan M. Effect of exhaust gases temperature on the performance of a hybrid heat recovery system. *Energy Procedia* 2017;119:775–82.
- [4] Mays El, Ammar R, Hawa M, Abou Akroush M, Hachem F, Khaled M, Ramadan M. Using phase change material in under floor heating. *Energy Procedia* 2017;119:806–11.
- [5] Khaled M, Ramadan M, El Hage H. Parametric analysis of heat recovery from exhaust gases of generators. *Energy Procedia* August 2015;75:3295–300.
- [6] Ramadan M, Lemenand T, Khaled M. Recovering heat from hot drain water—experimental evaluation, parametric analysis and new calculation procedure. *Energy Build* 15 September 2016;128:575–58.
- [7] Khaled M, Ramadan M. Study of the thermal behavior of multi concentric tube tank in heat recovery from chimney – analysis and optimization. *Heat Transfer Eng J* 2017;8:1–11.
- [8] Ramadan M, Gad El Rab M, Khaled M. Parametric analysis of air–water heat recovery concept applied to HVAC systems: effect of mass flow rates. *Case Stud Thermal Eng* 2015;6:61–8.
- [9] Khaled M, Ramadan M, El Hage H. Parametric analysis of heat recovery from exhaust gases of generators. *Energy Procedia* 2015;75:3295–300.
- [10] Khaled M, Ramadan M, Chahine K, Assi A. Prototype implementation and experimental analysis of water heating using recovered waste heat of chimneys. *Case Stud Thermal Eng* 2015;5:127–33.
- [11] Khaled M, Ramadan M. Heating fresh air by hot exhaust air of HVAC systems. *Case Stud Thermal Eng* September 2016;8:398–402.
- [12] Jaber H, Khaled M, Lemenand T, Ramadan M. Short review on heat recovery from exhaust gas. In: AIP conference proceedings; 2016. p. 1758. <https://doi.org/10.1063/1.4959441>.
- [13] Ramadan Mohamad, Murr Rabih, Khaled Mahmoud, Ghani Olabi Abdul. Mixed numerical - experimental approach to enhance the heat pump performance by drain water heat recovery. *Energy* 15 April 2018;149:1010–21.
- [14] El Hage H, Castelain C, Faraj J, Hachem F, Ramadan M, Khaled M. Enhancing the performance of vehicle cooling modules using diffusers. *Case Stud Thermal Eng* 2018;11:120–4.
- [15] Tiwari S, Tiwari G. Energy and exergy analysis of a mixed-mode greenhouse-type solar dryer, integrated with partially covered N-PVT air collector. *Energy* 1 June 2017;128:183–95.
- [16] Ibanez-Lopez A, Moratilla-Soria B. An assessment of Spain's new alternative energy support framework and its long-term impact on wind power development and system costs through behavioral dynamic simulation. *Energy* 1 November 2017;138:629–46.
- [17] Zhou B, Xu D, Chan K, Li C, Cao Y, Bu S. A two-stage framework for multi-objective energy management in distribution networks with a high penetration of wind energy. *Energy* 15 September 2017;135:754–66.
- [18] Al-Swaiti M, Al-Awami A, Khalid M. Co-optimized trading of wind-thermal-pumped storage system in energy and regulation markets. *Energy* 1 November 2017;138:991–1005.
- [19] Bosch J, Staffell I, Hawkes A. Temporally-explicit and spatially-resolved global onshore wind energy potentials. *Energy* 15 July 2017;131:207–17.
- [20] Andresen G, Søndergaard A, Greiner M. Validation of Danish wind time series from a new global renewable energy atlas for energy system analysis. *Energy* 15 December 2015;93(Part 1):1074–88.
- [21] Dogan E, Inglesi-Lotz R. Analyzing the effects of real income and biomass energy consumption on carbon dioxide (CO<sub>2</sub>) emissions: empirical evidence from the panel of biomass-consuming countries. *Energy* 1 November 2017;138:721–7.
- [22] Tan Q, Wang T, Zhang Y, Miao X, Zhu J. Nonlinear multi-objective optimization model for a biomass direct-fired power generation supply chain using a case study in China. *Energy* 15 November 2017;139:1066–79.
- [23] Wang J, Mao T, Wu J. Modified exergoeconomic modeling and analysis of combined cooling heating and power system integrated with biomass-steam gasification. *Energy* 15 November 2017;139:871–82.
- [24] Zhai Y, Peng C, Xu B, Wang T, Li C, Zeng G, Zhu Y. Hydrothermal carbonisation of sewage sludge for char production with different waste biomass: effects of reaction temperature and energy recycling. *Energy* 15 May 2017;127:167–74.
- [25] Alaswad A, Dassisti M, Prescott T, Olabi AG. Technologies and developments of third generation biofuel production. *Renew Sustain Energy Rev* 2015;51:1446–60.
- [26] Tedesco S, Barroso TM, Olabi AG. Optimization of mechanical pre-treatment of Laminariaceae spp. biomass-derived biogas. *Renew Energy* 2014;62:527–34.
- [27] Rodriguez C, Alaswad A, Mooney J, Prescott T, Olabi AG. Pre-treatment techniques used for anaerobic digestion of algae. *Fuel Process Technol* 2015;138:765–79.
- [28] Montingelli ME, Benyounis KY, Stokes J, Olabi AG. Pretreatment of macroalgal biomass for biogas production. *Energy Convers Manag* 2016;108:202–9.
- [29] Rodriguez C, Alaswad A, Benyounis KY, Olabi AG. Pretreatment techniques used in biogas production from grass. *Renew Sustain Energy Rev* 2017;68:1193–204.
- [30] Rodriguez C, Alaswad A, El-Hassan Z, Olabi AG. Mechanical pretreatment of waste paper for biogas production. *Waste Manag* 2017;68:157–64.
- [31] Montingelli ME, Benyounis KY, Quilty B, Stokes J, Olabi AG. Influence of mechanical pretreatment and organic concentration of Irish brown seaweed for methane production. *Energy* 2017;118:1079–89.
- [32] Tedesco S, Barroso TM, Olabi AG. Optimization of mechanical pre-treatment of Laminariaceae spp. biomass-derived biogas. *Renew Energy* 2014;62:527–34.
- [33] Ekpeni LEN, Nkem-Ekpeni FF, Benyounis KY, AKM Aboderheeba. Yeast: a potential biomass substrate for the production of cleaner energy (Biogas). *Energy Procedia* 2014;61:1718–31.
- [34] Hosseinpour S, Aghbashlo M, Tabatabaei M, Mehrpooya M. Estimation of biomass higher heating value (HHV) based on the proximate analysis by using iterative neural network-adapted partial least squares (INNPLS). *Energy* 1 November 2017;138:473–9.
- [35] Wei R, Feng S, Long H, Li J, Yuan Z, Cang D, Xu C. Coupled biomass (lignin) gasification and iron ore reduction: a novel approach for biomass conversion and application. *Energy* 1 December 2017;140(Part 1):406–14.
- [36] Herez A, Ramadan M, Abdulhuy B, Khaled M. Short review on solar energy systems. In: AIP conference proceedings; 2016. p. 1758. <https://doi.org/10.1063/1.4959437>.
- [37] Mays El, Ammar R, Hawa M, Abou Akroush M, Hachem F, Khaled M, Ramadan M. Improving photovoltaic panel using finned plate of aluminum. *Energy Procedia* 2017;119:812–7.
- [38] Hachem F, Abdulhuy B, Ramadan M, El Hage H, Gad El Rab M, Khaled M. Improving the performance of photovoltaic cells using pure and combined phase change materials – experiments and transient energy balance. *Renew Energy* July 2017;107:567–75.
- [39] Ramadan M, Khaled M, Ramadan HS, Becherif M. Modeling and sizing of combined fuel cell-thermal solar system for energy generation. *Int J Hydrogen Energy* 26 November 2016;41(44):19929–35.
- [40] Sakr I, Abdelsalam A, El-Askary W. Effect of electrodes separator-type on hydrogen production using solar energy. *Energy* 1 December 2017;140(Part 1):625–32.
- [41] Reda F, Arcuri N, Loiacono P, Mazzeo D. Energy assessment of solar technologies coupled with a ground source heat pump system for residential energy supply in Southern European climates. *Energy* November 2015;91:294–305.
- [42] Kosmopoulos P, Kazadzis S, Lagouvardos K, Kotroni V, Bais A. Solar energy prediction and verification using operational model forecasts and ground-based solar measurements. *Energy* 15 December 2015;93(Part 2):1918–30.
- [43] Islam S, Dincer I, Yilbas B. Energetic and exergetic performance analyses of a solar energy-based integrated system for multigeneration including thermoelectric generators. *Energy* 15 December 2015;93(Part 1):1246–58.
- [44] Herez A, Khaled M, Murr R, Haddad A, Elhage H, Ramadan M. Using geothermal energy for cooling - parametric study. *Energy Procedia* 2017;119:783–91.
- [45] Wang F, Deng S, Zhao J, Wang J, Sun T, Yan J. Performance and economic assessments of integrating geothermal energy into coal-fired power plant with CO<sub>2</sub> capture. *Energy* 15 January 2017;119:278–87.
- [46] Zhu J, Hu K, Lu X, Huang X, Liu K, Wu X. A review of geothermal energy resources, development, and applications in China: current status and prospects. *Energy* 15 December 2015;93(Part 1):466–83.
- [47] Yang Y, Huo Y, Xia W, Wang X, Zhao P, Dai Y. Construction and preliminary test of a geothermal ORC system using geothermal resource from abandoned oil wells in the Huabei oilfield of China. *Energy* 1 December 2017;140(Part 1):633–45.
- [48] Li J, Zhang Y. GIS-supported certainty factor (CF) models for assessment of geothermal potential: a case study of Tengchong County, southwest China. *Energy* 1 December 2017;140(Part 1):552–65.
- [49] Willems C, Nick H, Weltje G, Bruhn D. An evaluation of interferences in heat production from low enthalpy geothermal doublets systems. *Energy* 15 September 2017;135:500–12.
- [50] Wu B, Zhang G, Zhang X, Jeffrey R, Kear J, Zhao T. Semi-analytical model for a

- geothermal system considering the effect of areal flow between dipole wells on heat extraction. *Energy* 1 November 2017;138:290–305.
- [51] André C, Mendes B, Beluco A, Canales F. Some important uncertainties related to climate change in projections for the Brazilian hydropower expansion in the Amazon. *Energy* 15 December 2017;141:123–38.
- [52] Olateju B, Kumar A. A techno-economic assessment of hydrogen production from hydropower in Western Canada for the upgrading of bitumen from oil sands. *Energy* 15 November 2016;115(Part 1):604–14.
- [53] Tarroja B, AghaKouchak A, Samuelsen S. Quantifying climate change impacts on hydropower generation and implications on electric grid greenhouse gas emissions and operation. *Energy* 15 September 2016;111:295–305.
- [54] Zheng T, Qiang M, Chen W, Xia B, Wang J. An externality evaluation model for hydropower projects: a case study of the Three Gorges Project. *Energy* 1 August 2016;108:74–85.
- [55] Shen J, Cheng C, Cheng X, Lund J. Coordinated operations of large-scale UHVDC hydropower and conventional hydro energies about regional power grid. *Energy* 15 January 2016;95:433–46.
- [56] Chang J, Li Y, Yuan M, Wang Y. Efficiency evaluation of hydropower station operation: a case study of Longyangxia station in the Yellow River, China. *Energy* 15 September 2017;135:23–31.
- [57] Lewis M, Angeloudis A, Robins P, Evans P, Neill S. Influence of storm surge on tidal range energy. *Energy* 1 March 2017;122:25–36.
- [58] Coles D, Blunde L, Bahaj A. Assessment of the energy extraction potential at tidal sites around the Channel Islands. *Energy* 1 April 2017;124:171–86.
- [59] Mestres M, Griño M, Sierra J, Mósso C. Analysis of the optimal deployment location for tidal energy converters in the mesotidal Ria de Vigo (NW Spain). *Energy* 15 November 2016;115(Part 1):1179–87.
- [60] Vazquez A, Iglesias G. Capital costs in tidal stream energy projects – a spatial approach. *Energy* 15 July 2016;107:215–26.
- [61] Henriques T, Hedges T, Owen I, Poole R. The influence of blade pitch angle on the performance of a model horizontal axis tidal stream turbine operating under wave–current interaction. *Energy* 1 May 2016;102:166–75.
- [62] O'Rourke F, Boyle F, Reynolds A, Kennedy D. Hydrodynamic performance prediction of a tidal current turbine operating in non-uniform inflow conditions. *Energy* 15 December 2015;93(Part 2):2483–96.
- [63] Tiwari A. A review on solar drying of agricultural produce. *J Food Process Technol* 2016;7:1–12.
- [64] Nguyen M, Price WE. Air-drying of banana: influence of experimental parameters, slab thickness, banana maturity and harvesting season. *J Food Eng* 2007;79:200–7.
- [65] Sansaniwal SK, Kumar M. Analysis of ginger drying inside a natural convection indirect solar dryer: an experimental study. *J Mech Eng Sci* 2015;9:1671–85.
- [66] Montero I, et al. Solar dryer application for olive oil mill wastes. *Energies* 2015;8:14049–63.
- [67] Fudholi A, et al. Techno-economic of solar drying systems with water based solar collectors in Malaysia: a review. *Renew Sustain Energy Rev* 2015;51:809–20.
- [68] Yuan G. Experimental investigation of a solar dryer system for drying carpet. *Energy Procedia* 2015;70:626–33.
- [69] Agarwala A, Sarviyaa RM. Characterization of commercial grade paraffin wax as latent heat storage material for solar dryers. *Mater Today: Proc* 2017;4:779–89.
- [70] Bououd M, Mechaqrane A. Concentration solar dryer water-to-air heat exchanger: modeling and parametric studies. *Int J Hydrogen Energy* 2017;42:8631–43.
- [71] Kumar M, Sansaniwal SK, Khatak P. Progress in solar dryers for drying various commodities. *Renew Sustain Energy Rev* 2016;55:346–60.
- [72] Herez A, Khaled M, Ramadan M, Bazzi H. A review on solar dryer - economic and environmental investigation for the lebanese case. In: 10TH international conference on sustainable energy and environmental protection; 2017. <https://doi.org/10.18690/978-961-286-061-5.49>.
- [73] Saravanapriya G, Mahendiran R. Design and development of solar tunnel dryer with control system for large scale drying of agro products. *Int J Agric Sci* 2017;9:4626–31.
- [74] Aravindh MA, Sreekumar A. Solar drying—a sustainable way of food processing. *Energy Sustain Through Green Energy* 2015:27–46.
- [75] Alongé AF, Adeboye OA. Drying rates of some fruits and vegetables with passive solar dryers. *Int J Agric & Biol Eng* 2012;5:83–90.
- [76] VijayaVenkataRamana S, Iniyamb S, Goicc R. A review of solar drying technologies. *Renew Sustain Energy Rev* 2012;16:2652–70.
- [77] Nabnean S, et al. Experimental performance of a new design of solar dryer for drying osmotically dehydrated cherry tomatoes. *Renew Energy* 2016;94:147–56.
- [78] Ndukwu MC, Bennamoun L, Abam FI, Eke AB, Ukoha D. Energy and exergy analysis of a solar dryer integrated with sodium sulfate decahydrate and sodium chloride as thermal storage medium. *Renew Energy* 2017;113:1182–92.
- [79] Chauhan PS, et al. Applications of software in solar drying systems: a review. *Renew Sustain Energy Rev* 2015;51:1326–37.
- [80] Sangamithra A, et al. An overview of a polyhouse dryer. *Renew Sustain Energy Rev* 2014;40:902–10.
- [81] Shringi V, Kothari S, Panwar NL. Experimental investigation of drying of garlic clove in solar dryer using phase change material as energy storage. *J Therm Anal Calorim* 2014;118:533–9.
- [82] Chaudhari AD, Salve SP. A review of solar dryer technologies. *Inter J Rese Adv Technol* 2014;2:218–32.
- [83] Singh S, Kumar S. Comparative thermal performance study of indirect and mixed mode solar dryers. *Inter J Sustain Energy Dev (IJSED)* 2012;1:6–13.
- [84] Shalaby SM, Bek MA, El-Sebaai AA. Solar dryers with PCM as energy storage medium: a review. *Renew Sustain Energy Rev* 2014;33:110–6.
- [85] Jain D, Tewari P. Performance of indirect through pass natural convective solar crop dryer with phase change thermal energy storage. *Renew Energy* 2015;80:244–50.
- [86] Singh S, Kumar S. Development of convective heat transfer correlations for common designs of solar dryer. *Energy Convers Manag* 2012;64:403–14.
- [87] Singh S, Kumar S. Testing method for thermal performance based rating of various solar dryer designs. *Sol Energy* 2012;86:87–98.
- [88] Almuhanna EA. Utilization of a solar greenhouse as a solar dryer for drying dates under the climatic conditions of the eastern province of Saudi Arabia. Part I: thermal performance analysis of a solar dryer. *J Agric Sci* 2012;4:237–46.
- [89] Mustayen A, Mekhilef S, Saidur R. Performance study of different solar dryers: a review. *Renew Sustain Energy Rev* 2014;34:463–70.
- [90] Tiwari S, Tiwari GN, Al-Helal IM. Development and recent trends in greenhouse dryer: a review. *Renew Sustain Energy Rev* 2016;65:1048–64.
- [91] Kumar A, Singh R, Prakash O, Ashutosh. Review on global solar drying status. *Agric Eng Int: CIGR Journal* 2014;16:161–77.
- [92] Fudholi A, Sopian K, Ruslan MH, Alghoul MA, Sulaiman MY. Review of solar dryers for agricultural and marine products. *Renew Sustain Energy Rev* 2010;14:1–30.
- [93] Sontakke MS, Salve SP. Solar drying technologies: a review. *Inter Ref J Eng Sci* April 2015;4:29–35.
- [94] Bennamoun L, Belhamri A. Design and simulation of a solar dryer for agriculture products. *J Food Eng* 2003;59:259–66.
- [95] Bala BK, Debnath Nipa. Solar drying technology: potentials and developments. *J Fund Renew Energy Appl* 2012;2:1–5.
- [96] Gulcimen F, Karakaya H, Durmus A. Drying of sweet basil with solar air collectors. *Renew Energy* 2016;93:77–86.
- [97] Zarezade M, Mostafaiepour A. Identifying the effective factors on implementing the solar dryers for Yazd province, Iran. *Renew Sustain Energy Rev* 2016;57:765–75.
- [98] Prakash O, Laguri V, Pandey A, Kumar A, Kumar A. Review on various modelling techniques for the solar dryers. *Renew Sustain Energy Rev* 2016;62:396–417.
- [99] Kapadiya S, Desai MA. Solar drying of natural and food products: a review. *Int J Agric Food Sci Technol* 2014;5:565–76.
- [100] Phadke PC, Walke PV, Kriplani VM. A review on indirect solar dryers. *ARPN J Eng Appl Sci* 2015;10:3360–71.
- [101] Finck-Pastrana AG. NOPAL (*Opuntia lasiacantha*) drying using an indirect solar dryer. *Energy Procedia* 2014;57:2984–93.
- [102] Sekyere CKK, Forson FK, Adam FW. Experimental investigation of the drying characteristics of a mixed mode natural convection solar crop dryer with back up heater. *Renew Energy* 2016;92:532–42.
- [103] Stiling J, Li S, Stroev P, Thompson J, Mjawa B, Kornbluth K, Barrett DM. Performance evaluation of an enhanced fruit solar dryer using concentrating panels. *Energy Sustain Dev* 2012;16:224–30.
- [104] Kouchakzadeh A. The hybrid drying of pistachios by solar energy and high electric field. *Agr. Eng. Inter. CIGR J* 2016;18:129–37.
- [105] Reyes A, Mahn A, Vásquez F. Mushrooms dehydration in a hybrid-solar dryer, using a phase change material. *Energy Convers Manag* 2014;83:241–8.
- [106] Lopez-Vidana EC, Mendez-Lagunas LL, Rodríguez-Ramírez J. Efficiency of a hybrid solar–gas dryer. *Sol Energy* 2013;93:23–31.
- [107] Gudiño-Ayala D, Calderón-Topete Á. Pineapple drying using a new solar hybrid dryer. *Energy Procedia* 2014;57:1642–50.
- [108] Toshniwal U, Karale SR. A review paper on Solar Dryer. *Int J Eng Res Afr* 2013;3:896–902.
- [109] Kant K, Shukla A, Sharma A, Kumar A, Jain A. Thermal energy storage based solar drying systems: a review. *Innovat Food Sci Emerg Technol* 2016;34:86–99.
- [110] Ghaffari A, Mehdipour R. Modeling and improving the performance of cabinet solar dryer using computational fluid dynamics. *Int J Food Eng* 2015;11:157–72.
- [111] Kaewkiew J, Nabnean S, Janjai S. Experimental investigation of the performance of a large-scale greenhouse type solar dryer for drying chilli in Thailand. *Procedia Eng* 2012;32:433–9.
- [112] Kucuk H, Midilli A, Kilic A, Dincer I. A review on thin-layer drying-curve equations. *Dry Technol* 2014;32:757–73.
- [113] Hedayatzadeh M, Chaji H. A review on plum drying. *Renew Sustain Energy Rev* 2016;56:362–7.
- [114] Sreekumar A. Evaluation of a roof-integrated solar air heating system for drying foodstuffs. *Inter J Emerg Technol Adv Eng* 2013;3:209–13.
- [115] Leon MA, Kumar S, Bhattacharya SC. A comprehensive procedure for performance evaluation of solar food dryers. *Renew Sustain Energy Rev* 2002;6:367–93.
- [116] Yaldiz O, Ertekin C, Uzun HI. Mathematical modeling of thin layer solar drying of sultana grapes. *Energy* 2001;26:457–65.
- [117] Pangavhane DR, Sawhney RL, Sarsavadia PN. Design, development and

- performance testing of a new natural convection solar dryer. *Energy* 2002;27:579–90.
- [118] Prakash S, Jha SK, Datta N. Performance evaluation of blanched carrots dried by three different dryers. *J Food Eng* 2004;62:305–13.
- [119] Sreekumar A, Manikantan PE, Vijayakumar KP. Performance of indirect solar cabinet dryer. *Energy Convers Manag* 2008;49:1388–95.
- [120] Olokor J, Oghenekaro, Omojowo F. Samuel. Adaptation and improvement of a simple solar tent dryer to enhance fish drying. *Nat Sci* 2009;7:19–24.
- [121] Ojutiku RO, Kolo RJ, Mohammed ML. Comparative study of sun drying and solar tent drying of hyperopisus bebe occidentalis. *Pakistan J Nutr* 2009;8:955–7.
- [122] banout J, havlik J, kulik M, kloucek P, lojka B, valterova I. Effect of solar drying on the composition of essential oil of sacha culantro (*Eryngium foetidum* L.) grown in the peruvian amazon. *J Food Process Eng* 2010;33:83–103.
- [123] Akbulut A, Durmus A. Energy and exergy analyses of thin layer drying of mulberry in a forced solar dryer. *Energy* 2010;35:1754–63.
- [124] Sami S, Etesami N, Rahimi A. Energy and exergy analysis of an indirect solar cabinet dryer based on mathematical modeling results. *Energy* 2011;36:2847–55.
- [125] Bennamoun L. An overview on application of exergy and energy for determination of solar drying efficiency. *Int J Energy Eng* 2012;2:184–94.
- [126] Janjai S. A greenhouse type solar dryer for small-scale dried food industries: development and dissemination. *Int J Energy Environ* 2012;3:383–98.
- [127] El-Sebaï AA, Shalaby SM. Solar drying of agricultural products: a review. *Renew Sustain Energy Rev* 2012;16:37–43.
- [128] Singh S, Kumar S. Solar drying for different test conditions: proposed framework for estimation of specific energy consumption and CO<sub>2</sub> emissions mitigation. *Energy* 2013;51:27–36.
- [129] Aritesty E, Wulandani D. Performance of the rack type-greenhouse effect solar dryer for wild ginger (*Curcuma xanthorrhiza* roxb.) drying. *Energy Procedia* 2014;47:94–100.
- [130] Prakash O, Kumar A. Solar greenhouse drying: a review. *Renew Sustain Energy Rev* 2014;29:905–10.
- [131] Ferreira AG, Gonçalves LM, Maia CB. Solar drying of a solid waste from steel wire industry. *Appl Therm Eng* 2014;73:104–10.
- [132] Elkhadraoui A, Kooli S, Hamdi I, Farhat A. Experimental investigation and economic evaluation of a new mixed mode solar greenhouse dryer for drying of red pepper and grape. *Renew Energy* 2015;77:1–8.
- [133] Patil R, Gawande R. A review on solar tunnel greenhouse drying system. *Renew Sustain Energy Rev* 2016;56:196–214.
- [134] Afriyie JK, Achaw O-W, Aikins KA, Sekyere CKK, Bart-Plange A. Field drying of cassava in a solar tent dryer equipped with a solar chimney. *Int J Sci Eng Appl* 2016;5:161–74.
- [135] Hasan M, Langrish TAG. Time-valued net energy analysis of solar kilns for wood drying: a solar thermal application. *Energy* 2016;96:415–26.
- [136] Kiggundu N, Wanyama J, Galyaki C, Banadda N, Muyonga JH, Zziwa A, Kabenge I. Solar fruit drying technologies for smallholder farmers in Uganda. A review of design constraints and solutions. *Agr Eng Inter* 2016;18:200–10.
- [137] Hasan M, Langrish TAG. Development of a sustainable methodology for life-cycle performance evaluation of solar dryers. *Sol Energy* 2016;135:1–13.
- [138] Yahya M, Fudholi A, Hafiz H, Sopian K. Comparison of solar dryer and solar-assisted heat pump dryer for cassava. *Sol Energy* 2016;136:606–13.
- [139] Shrivastava V, Kumar A. Experimental investigation on the comparison of fenugreek drying in an indirect solar dryer and under open sun. *Heat Mass Tran* 2016;52:1963–72.
- [140] Kabeel AE, Abdelgaied M. Performance of novel solar dryer. *Process Saf Environ Protect* 2016;102:183–9.
- [141] Nabnean S, Janjai S, Thepa S, Sudaprasert K, Songprakorp R, Bala BK. Experimental performance of a new design of solar dryer for drying osmotically dehydrated cherry tomatoes. *Renew Energy* 2016;94:147–56.
- [142] Blanco-Cano L, Soria-Verdugo A, Garcia-Gutierrez LM, Ruiz-Rivas U. Modeling the thin-layer drying process of Granny Smith apples: application in an indirect solar dryer. *Appl Therm Eng* 2016;108:1086–94.
- [143] Daghig R, Shafeian A. An experimental study of a heat pipe evacuated tube solar dryer with heat recovery system. *Renew Energy* 2016;96:872–80.
- [144] Dejchanchaiwong R, Arkasuwana A, Kumar A, Tekasakul P. Mathematical modeling and performance investigation of mixed-mode and indirect solar dryers for natural rubber sheet drying. *Energy Sustain Dev* 2016;34:44–53.
- [145] Vijayan S, Arjunana TV, Kumar Anil. Mathematical modeling and performance analysis of thin layer drying of bitter melon in sensible storage based indirect solar dryer. *Innovat Food Sci Emerg Technol* 2016;36:59–67.
- [146] Rabha DK, Muthukumar P, Somayaji C. Experimental investigation of thin layer drying kinetics of ghost chilli pepper (*Capsicum Chinense* Jacq.) dried in a forced convection solar tunnel dryer. *Renew Energy* 2017;105:583–9.
- [147] Castillo-Téllez M, Pilatowsky-Figueroa I, López-Vidaña EC, Sarracino-Martínez O, Hernández-Galvez G. Dehydration of the red chilli (*Capsicum annum* L, costeño) using an indirect-type forced convection solar dryer. *Appl Therm Eng* 2017;114:1137–44.
- [148] Baniyadi E, Ranjbar S, Boostanipour O. Experimental investigation of the performance of a mixed-mode solar dryer with thermal energy storage. *Renew Energy* 2017;112:143–50.
- [149] Morad MM, El-Shazly MA, Wasfy KI, El-Maghawry Hend AM. Thermal analysis and performance evaluation of a solar tunnel greenhouse dryer for drying peppermint plants. *Renew Energy* 2017;101:992–1004.
- [150] Rabha DK, Muthukumar P. Performance studies on a forced convection solar dryer integrated with a paraffin wax-based latent heat storage system. *Sol Energy* 2017;149:214–26.
- [151] Tiwari Sumit, Tiwari GN. Energy and exergy analysis of a mixed-mode greenhouse-type solar dryer, integrated with partially covered N-PVT air collector. *Energy* 2017;128:183–95.
- [152] Erbay Z, Hepbasli A. Assessment of cost sources and improvement potentials of a groundsource heat pump food drying system through advanced exergo-economic analysis method. *Energy* 2017;127:502–15.
- [153] Atalay H, Çoban MT, Kincay O. Modeling of the drying process of apple slices: application with a solar dryer and the thermal energy storage system. *Energy* 2017;134:382–91.
- [154] Jafarian H, Tabatabaekolour R, Seyedi SR. Experimental investigation on dill drying in a solar-assisted heat pump dryer. *J Agric Sci Technol* 2017;19:835–45.
- [155] Simo-Tagne1 M, Zoulalian A, Remond R, Rogaume Y, Bonoma B. Modeling and simulation of an industrial indirect solar dryer for iroko wood (*Chlorophora excelsa*) in a tropical environment. *Maderas Ciencia y tecnología* 2017;19:95–112.
- [156] El Khadraoui A, Bouadila S, Kooli S, Farhat A, Guizani A. Thermal behavior of indirect solar dryer: nocturnal usage of solar air collector with PCM. *J Clean Prod* 2017;148:37–48.
- [157] Azaizia Z, Kooli S, Elkhadraoui A, Hamdi I, Guizani A. Investigation of a new solar greenhouse drying system for peppers. *Int J Hydrogen Energy* 2017;42:8818–26.
- [158] Kabeel AE, Abdelgaied M. Experimental evaluation of a two-stage indirect solar dryer with reheating coupled with HDH desalination system for remote areas. *Desalination* 2018;425:22–9.
- [159] Lakshmi DVN, Muthukumar P, Layek Apurba, Nayak Prakash Kumar. Drying kinetics and quality analysis of black turmeric (*Curcuma caesia*) drying in a mixed mode forced convection solar dryer integrated with thermal energy storage. *Renew Energy* 2018;120:23–34.
- [160] Simo-Tagne Merlin, Zoulalian André, Rémond Romain, Rogaume Yann. Mathematical modelling and numerical simulation of a simple solar dryer for tropical wood using a collector. *Appl Therm Eng* 2018;131:356–69.
- [161] Deeto S, Thepa S, Monyakul V, Songprakorp R. The experimental new hybrid solar dryer and hot water storage system of thin layer coffee bean dehumidification. *Renew Energy* 2018;115:954–68.
- [162] Singh Chauhan Prashant, Kumar Anil, Nuntadusit Chayut. Heat transfer analysis of PV integrated modified greenhouse dryer. *Renew Energy* 2018;121:53–65.
- [163] Wang Wei, Li Ming, Hassanien Reda, Hassanien Emam, Wang Yunfeng, Yang Luwei. Thermal performance of indirect forced convection solar dryer and kinetics analysis of mango. *Appl Therm Eng* 2018;134:310–21.
- [164] Singh Chauhan Prashant, Kumar Anil. Thermal modeling and drying kinetics of gooseberry drying inside north wall insulated greenhouse dryer. *Appl Therm Eng* 2018;130:587–97.
- [165] Singh Pushpendra, Shrivastava Vipin, Kumar Anil. Recent developments in greenhouse solar drying: a review. *Renew Sustain Energy Rev* 2018;82(Part 3):3250–62.
- [166] Yataganbaba A, Kurtbaş İ. A scientific approach with bibliometric analysis related to brick and tile drying: a review. *Renew Sustain Energy Rev* 2016;59:206–24.
- [167] Patel AH, Shah SA, Bhargav H. Review on solar dryer for grains, vegetables and fruits. *Int J Eng Res Technol* 2013;2:1–7.
- [168] Tomar V, Tiwari GbN, Norton B. Solar dryers for tropical food preservation: thermophysics of crops, systems and components. *Sol Energy* 2017;154:2–13.
- [169] Pirasteh G, Saidur R, Rahman S, Rahim N. A review on development of solar drying applications. *Renew Sustain Energy Rev* 2014;31:133–48.
- [170] El-Fadel RH, Hammond GP, Harajli HA, Jones CI, Kabakian VK, Winnett AB. The Lebanese electricity system in the context of sustainable development. *Energy Pol* 2010;38:751–61.
- [171] Fudholi A, Sopian K, Bakhtyar B, Gabbasa M, Othman MY, Ruslan MH. Review of solar drying systems with air based solar collectors in Malaysia. *Renew Sustain Energy Rev* 2015;51:1191–204.
- [172] Wang K, Wu H, Wang D, Wang Y, Tong Z, Lin F, Olabi AG. Experimental study on a coiled tube solar receiver under variable solar radiation condition. *Sol Energy* 2015;122:1080–90.
- [173] Herez A, Ramadan M, Khaled M. Review on solar cooker systems: economic and environmental study for different Lebanese scenarios. *Renew Sustain Energy Rev* 2018;81(Part 1):421–32.
- [174] Ekpeni Leonard EN, Benyounis Khaled Y, Nkem-Ekpeni Fehintola, Stokes Joseph, Olabi AG. Energy diversity through renewable energy source (RES) – a case study of biomass. *In Energy Procedia* 2014;61:1740–7.
- [175] Ekpeni Leonard EN, Nkem-Ekpeni Fehintola F, Benyounis Khaled Y, Aboderheeba Ayad KM, Stokes Joseph, Olabi AG. Yeast: a potential biomass substrate for the production of cleaner energy (biogas). *In Energy Procedia* 2014;61:1718–31.
- [176] Ekpeni Leonard EN, Benyounis KY, Fehintola F, Nkem-Ekpeni J, Olabi Stokes AG. Underlying factors to consider in improving energy yield from biomass source through yeast use on high-pressure homogenizer (hph). *Energy* 2015;81:74–83.
- [177] Lawlor V, Olabi AG. Review of scientific research regarding PPO, tallow and RVO as diesel engine fuel. *Fuel* 2015;145:25–38.
- [178] Olabi AG, Akansu Selahaddin Orhan, Kahraman Nafiz. Fuel cell and energy



storage systems: a special issue section on “the 9th international conference on sustainable energy and environmental protection (SEEP 2016), 22–25 September 2016, Kayseri, Turkey”. *Int J Hydrogen Energy* 2017;42(40): 25544–9.

[179] Ramadan Mohamad, Khaled Mahmoud, El Hage Hicham. Using speed bump for power generation –experimental study. In *Energy Procedia* 2015;75: 867–72. ISSN 1876-6102, <https://doi.org/10.1016/j.egypro.2015.07.192>.

### 1.3 Chauffage solaire de l'eau

Cette étude devrait être soumise à « **Renewable Energy focus** »

**Résumé** - Le but de ce travail est de présenter une revue des systèmes solaires de chauffe-eau (SWHS<sup>1</sup>). Dans ce contexte, le principe, les composants et la classification des SWHS sont présentés dans cet article. En outre, plusieurs études menées sur les SWHS ainsi que leurs avantages et inconvénients sont établis dans cette revue. En outre, un aperçu des problèmes d'électricité au Liban est présenté, y compris des études économiques et environnementales. Les études précitées sont développées pour plusieurs cas libanais (famille, école, restaurant, hôtel et salle de sport). L'objectif principal de ces analyses est d'estimer le montant d'argent qui sera économisé en utilisant un SWHS au lieu du chauffage électrique et sa durée d'amortissement ainsi que la réduction d'émissions de dioxyde de carbone. Il est obtenu à partir des résultats des analyses que pour une dépendance plus élevée à SWHS, la durée d'amortissement du système est plus faible et les réductions d'émissions de CO<sub>2</sub> sont plus élevées. De plus, pour une utilisation élevée de SWHS (Pr = 0,9), la durée d'amortissement moyenne du système pour une famille, une école, un restaurant, un hôtel et une salle de sport est respectivement de 14,2 ans, 4,6 ans, 9,2 ans, 4,4 ans et 5,3 ans. En outre, les résultats révèlent que la quantité annuelle de réduction d'émissions de CO<sub>2</sub> est de 0,16 tonne/personne, 0,016 tonne/élève, 0,04 tonne/service, 0,37 tonne/lit et 0,11 tonne/personne si SWHS est utilisé dans la famille, l'école, le restaurant, l'hôtel et salle de sport respectivement.

<sup>1</sup> Solar Water Heating System

# A review on solar water heating - Toward an optimal use in Lebanon

Amal Herez<sup>1,2</sup>, Hicham El Hage<sup>1</sup>, Thierry Lemenand<sup>2</sup>, Mohamad Ramadan<sup>3,4</sup>, and Mahmoud Khaled<sup>3,5,\*</sup>

<sup>1</sup>Energy and Thermofluid Group, Lebanese International University LIU, Bekaa, Lebanon

<sup>2</sup>LARIS EA 7315, Polytech Angers, Univ. Angers, Angers, France

<sup>3</sup>Energy and Thermofluid Group, International University of Beirut BIU, Beirut, Lebanon

<sup>4</sup>Associate member at FCLAB, CNRS, Univ. Bourgogne Franche-Comté, Belfort cedex, France

<sup>5</sup>University Paris Diderot, Sorbonne Paris Cité, Interdisciplinary Energy Research Institute (PIERI), Paris, France

\*Corresponding author email: mahmoud.khaled@liu.edu.lb

**Abstract.** The purpose of this work is to present a review on solar water heating systems (SWHS). In this context, principle, components and classification of SWHS are being presented in this paper. In addition, several studies conducted on SWHS as well as their advantages and disadvantages are established in this review. Moreover, an overview on electricity concern in Lebanon is presented including economic and environmental studies. The aforesaid studies are developed for several Lebanese cases (family and school, restaurant, hotel and gym). The main aim of these analyses is to estimate the amount of money that will be saved by using SWHS instead of electric heater and its payback period as well as the amount of carbon dioxide emissions mitigated. It is obtained that for a higher dependence on SWHS, the payback period of the system is lower and the mitigated CO<sub>2</sub> emissions is higher. Furthermore, for a high usage of SWHS (percentage of time when the system is used Pr=0.9), the average payback period of the system for a family, school, restaurant, hotel and gym is 14.2 years, 4.6 years, 9.2 years, 4.4 years and 5.3 years respectively. Besides, the results reveal that the annual amount of CO<sub>2</sub> reduced is 0.16 ton/person, 0.016 ton/pupil, 0.04 ton/service, 0.37 ton/bed and 0.11 ton/person if SWHS is used in family, school, restaurant, hotel and gym respectively.

**Keywords:** SWHS, Renewable Energy, Review, Classification, Environment, Economy.

## 1- INTRODUCTION

During the last decades, energy became an essential solicitude all over the world. Its quality and quantity are directly related to human lifestyle. Presently, energy demand requires the usage of 80% of the conventional sources of energy, and its consumption is predicted to increase 1.5% per year till 2030 [1–3]. The main concerns of conventional energy sources depletion in addition to economic and environmental problems demands intensive efforts to encourage exploiting renewable energy sources [4–8] or to rely on energy management; mainly energy recovery [9–15]. Renewable energy sources mainly include wind [16–18], solar [19–24], biomass and geothermal [25–28], while energy recovery is the reuse of energy that is dissipated to environment.

Indeed, solar energy is one of the solutions that has a great potential to meet the global energy demand. Solar energy may be mainly utilized either for thermal uses or electricity production. Various technologies have been progressed to exploit solar energy, but they had limitations over systems that depend on fossil fuel. Harnessing solar thermal energy is effective in comparison to other solar energy conversions. Figure 1 illustrates the major applications operated by solar thermal energy.

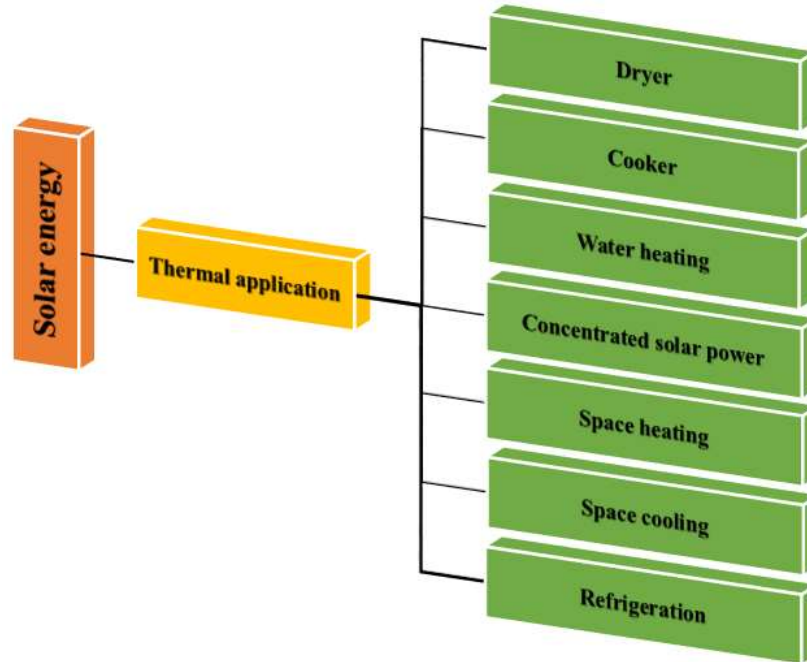

*Figure 1. Solar thermal energy applications.*

Heating water by solar energy [29–31] is an elegant application of solar thermal energy. The main concept of SWHS is to absorb solar radiations and convert thermal energy into heat energy that heats water. SWHS has been constructed and utilized for many years due to its simplicity in exploiting solar radiations in addition to its role in saving money and energy. In the 18<sup>th</sup> century, Horace-Bénédict de Saussure constructed an insulated box painted by black color at its bottom to maximize absorption of solar energy [32]. In 1891, the first commercially produced SWHS was by Clarence Kemp. The system was a simple batch SWHS which consists of metal tank placed inside a wooden box that is covered by glazing. The system was named by “The Climax” and it produced hot water during sunny days of temperature 38.8°C. In 1909, William Bailey patented the first thermosiphon type SWHS where the tank is located above the level of the solar collector [33]. The system works by relying on heating water which becomes lighter so that it rises to the top of the tank and cold water enters from its bottom. In these days, SWHSs are utilized in wide manners all over the world. Solar water heating accounts for 80% of the worldwide solar thermal market [34]. Residential and service sectors consume 35.3% of the global energy consumption, where 75% of this percentage is utilized for water and space heating [52, 53].

Pandey et al [37] presented a review which comprises the recent researches that are conducted on the energy, exergy, exergo-economic and enviro-economic approach of SWHSs with and without phase change materials (PCMs). The review also proffers the technical conflicts that

challenges SWHSs. It was concluded that the integration of PCMs increases the exergy and energy efficiency of SWHS. Gautam et al [38] proffered a review on SWHSs regarding their classification based on the flow of the working fluid, their components as well as their progresses. The review also includes their global scenario and economic advantages. It was concluded that there is noticeable progress in the SWHS technical part, however, it has high initial cost in comparison to the traditional water heating systems. Jamar et al [39] reviewed the recent progress of SWHS and developments of several types of solar collectors that are utilized in SWHSs such as the non-concentrating collectors (evacuated tube collector and flat plate collector) and the concentrating type (parabolic trough and parabolic dish collectors). It was obtained that the parabolic dish reflector attains the best global performance. Kalair et al [40] implemented a simulation study on evacuated glass tube SWHS using TRNSYS software. Also, the authors carried out parametric analysis to estimate the optimal configurations and sizes of heat exchangers, solar collectors, tank heights and volumes for yearly evaluation of the performance of solar water heaters. It was concluded that the optimum system must have collector area of 6 m<sup>2</sup>, tank volume and height of 0.42 m<sup>3</sup> and 1.2 m respectively in order to meet a single family dwelling heating demands. Sathishkumar and Balusamy presented a review which summarizes the latest conducted researches on SWHSs with distinct heat transfer development methods including the collector design and tilt angle, pipes coating, fluid flow rate, thermal energy storage, thermal insulation, usage of phase change material, integrated collector storage and integration of twisted tapes. The authors investigated the methods for optimizing and simulating SWHSs by estimating the thermal behavior of the solar collectors which serves in enhancing its thermal performance.

It is clear from the literature that there are numerous researches that are implemented on SWHSs, however, rare are the studies which present a detailed review on such system and highlight the economic and environmental benefits of utilizing it. On the other hand, it is well known that Lebanon is a country that is permanently striving to compensate the shortage in electricity demand. Besides, it has been stated in [41] that 81% of Lebanese residences utilize electric heaters for domestic hot water. Hence, SWHS reliance may be the optimum choice which will reduce electricity consumption and thus recompense the deficiency. Moreover, it has been reported in [42] that 60 to 80% of residential electricity utilized may be saved if SWHSs are used which is a noticeable value.

In this context, the target of this paper is to present a review on solar water heating applications regarding their principle, main components and classifications including mode of operation of each type. In addition, the review comprises the recent researches performed on SWHS as well as their benefits and drawbacks. Moreover, electricity concern in Lebanon is summarized to shed light on the electricity deficiency and the role of using SWHSs in reducing such problem. Furthermore, economic and environmental analyses are conducted to manifest the significance of utilizing solar energy for heating water instead of electric heater in Lebanon, on both economic and environmental issues.

Section 2 of the paper describes the principle of solar water heating, lists the main components of SWHS and illustrates the pros and cons of SWHS. Section 3 is devoted for classification of SWHS. Section 4 investigates the previous work that are conducted on SWHS. Section 5 illustrates the electricity concern in Lebanon in addition to economic and environmental analyses. Finally, Section 6 draws out the main conclusions of the paper.

## 2- PRINCIPLE OF SOLAR WATER HEATING

Solar water heating is an application of solar energy which exploits thermal energy from solar radiation to heat water for domestic and industrial aims [43]. Hot water is essential for domestic purposes, at hotels, hostels, hospitals, as well as in industries. Numerous studies [44–52] have been conducted to evaluate the thermal performance of SWHS, identify the parameters that affect it and maximize it to reach the optimum performance. In 2010, the global capacity of installed SWHS was 160 GW and it raised to 185 GW in year 2011 [53], while in 2018 it increased to 483 GW [54].

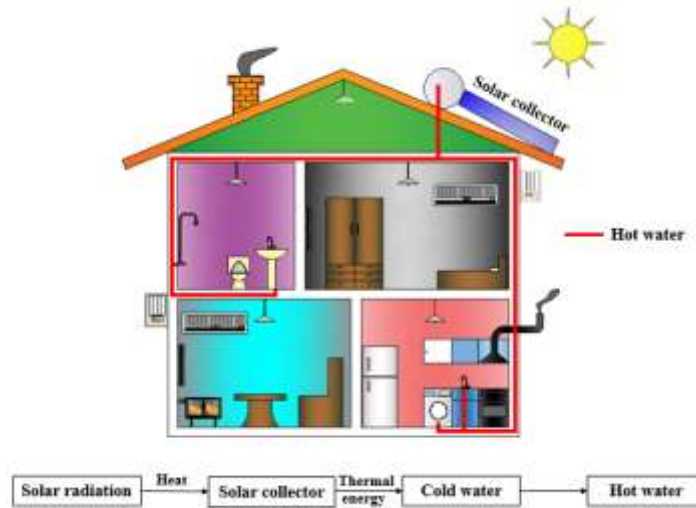

Figure 2. Schematic of principle of SWHS.

Figure 2 shows a schematic that summarizes the principle of water heating system. In such system, fluid is heated by transporting it in contact with dark surface which is imposed to solar radiation. This dark surface is the solar collector whose role is to absorb solar radiation and reduce heat loss [55,56]. Flat plate collector [57] and evacuated tube collector [58] are the most utilized solar collectors in SWHS. Flat plate collector consists of a plate absorber which is attached to fins or tubes and welded by transparent glazing. Evacuated tube collector is composed of heat pipe inside a vacuum sealed tube. In SWHS, the fluid may be either water which will be heated and utilized directly, or heat transfer fluid such as glycol/water that will pass through form of heat exchanger and heat water to be used.

SWHS may be utilized in many areas such as residential houses, hospitals and nursing home, hotels and restaurants, swimming pools and gyms. SWHS are simply constructed and installed and they require very low maintenance and operating cost compared to other solar systems.

### 2.1 Components of solar water heating system

Typically, a SWHS consists of three major components which are the solar collector, the storage tank and the heat transfer fluid. Nevertheless, various supplementary constituents are harnessed in some systems such as auxiliary heating unit (when no solar radiation is available), piping units,

heat exchangers and pumps (to recirculate water inside the system and prevent the pipes from freezing).

The solar collector is a distinguished type of heat exchangers which represents the heart of any solar system. The main role of solar collector is to absorb solar energy as much as possible, convert it into heat energy to be transferred to the working fluid (water, oil or air) that is circulating through the system. The most commonly used solar collectors in SWHS are flat plate collector, evacuated tube collector and parabolic trough collector.

The working fluid is utilized to complete the role of the solar collector in which it is the link between the solar collector and the water inside the storage tank that should be heated. It receives the heat energy from the solar collector and conveys it to the storage tank containing water either in a direct way or in an indirect way by the mean of heat exchanger. The heat transfer fluid is selected according to some properties such as high specific heat capacity and thermal conductivity, low viscosity, thermal expansion coefficient and cost and anti-corrosive property. Generally, the heat transfer fluid utilized are water, silicon oils, hydrocarbon oils and glycol group. Among these fluids, water is the best choice due to its low cost, availability and thermal efficiency. Nevertheless, it has negative points in which it freezes easily and it causes corrosion.

The third main constituent of SWHS is the storage tank which is incorporated into the solar collector or placed above it. The storage tank can be either integrated unit in which it is combined with the solar collector (solar collector is also a storage tank), or it can be a single unit where it is separated from it. In some SWHS, an insulated storage tank is required to prohibit heat losses.

## **2.2 Pros of solar water heating systems**

SWHS is a promising technology which has several advantages that attracts people all over the world to utilize it. Free and endless amount of energy necessitated to heat water will be available when utilizing such system. First of all, concerning the economic issue, SWHS is cost saving since it decreases the cost of energy bills required to heat water. To explain, such system mitigates the consumption of conventional energy which is expensive and whose cost is continuously increasing day after day. Hence, these saved utility bills can be used to pay back the cost of SWHS. Also, the aforementioned system requires low maintenance after installation and it has long lifetime span compared to conventional systems. Besides, SWHS is characterized by its high efficiency in which about 80% of the sun's radiation is exploited to heat water. Moreover, SWHS requires less installation space compared to other solar systems such as photovoltaic. Furthermore, such system has a significant benefits on environment. It is environmentally friendly where it keeps environment clean, reduces emissions of greenhouse gases and hence saves it from pollution and several environmental problems.

## **2.3 Cons of solar water heating systems**

Despite its several avails, SWHS has few negative points that affects its performance. To begin with, regardless to the fact that SWHS can pay back its cost on the long run, its initial investment and installation cost is expensive. Besides, SWHS performance is highly dependent on the weather. To illustrate, its efficiency greatly decreases, or even it may not operate during cloudy, rainy or foggy days. Hence, backup heaters are essential to compensate the absence of solar energy. Therefore, the cost of the system increases in addition to the energy bills that should be paid to run



the backup heaters. Moreover, insulated storage tank that maintain water temperature is another additional component that should be integrated to the system. To explain, SWHS doesn't function during nighttime so, the excess heated water provided during daytime can be stored in such insulated tanks to be used later (during night or even during bad weathers). Furthermore, SWHS is located on the roofs to collect the best amount of solar energy, due to that it requires overheating or freezing protection to emphasize the optimal performance of all components of the system.

### 3- CLASSIFICATION OF SOLAR WATER HEATING

SWHS can be categorized according to different manners [59]. In this review SWHS is classified according to the method of circulation of the flow inside the system (between storage tank and solar collector) into passive and active systems, and according to the type of solar collector used whether it is flat plate collector, evacuated tube collector or parabolic trough collector. Figure 3 illustrates the different classifications of SWHS [60,61].

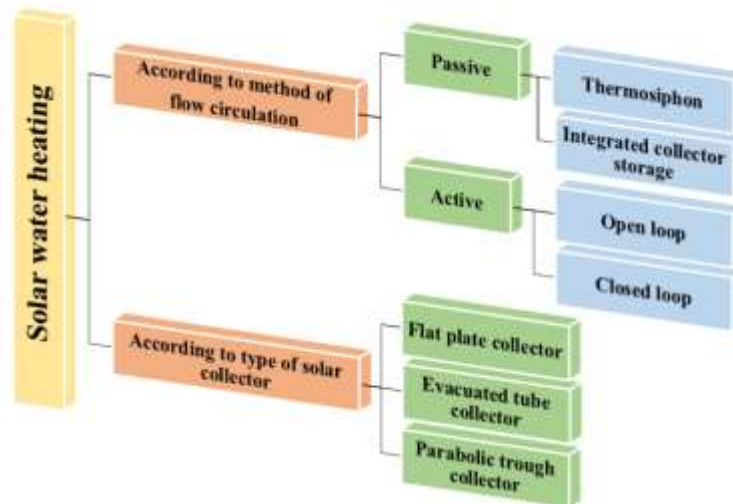

Figure 3. Classifications of SWHS [60,61].

Jamar et al. [62] presented a review which discusses the latest progress of SWHS based on three major components that may influence the thermal performance of the system. The review also includes the different types of solar water heating collector such as non-concentrating collectors which include flat plate collector and evacuated tube collector, and concentrating collectors such as parabolic dish reflector, parabolic trough collector. Patel et al. [63], Chaudhari et al. [64], Tiwari et al. [65] and Shelke et al. [66] presented reviews including the existing SWHS as well as their applications.

#### 3.1- Method of flow circulation

Passive systems are the systems in which they don't depend on pumps to circulate the flow between the storage tank and collector. They are less expensive compared to active systems and have low maintenance cost due to the absence of moving parts in the system (pumps). On the other hand, active solar water heating requires some mechanical forces in order to circulate fluid through the

system [67]. It utilizes one or more pumps, valves and controllers to circulate the heat transfer fluid through the collector. Due to that, active systems are also named as forced circulation systems.

### 3.1.1 Thermosiphon system

Thermosiphon system [68–72] depends on the natural convection in which water in collector is heated and expands, becoming less dense. Water in the tank which is above the collector is cooler, having higher density, so it flows down to the collector forcing hot water to go up to the storage insulated tank. The water will remain circulating as long as the sun is shining. It requires a large size diameter pipe to reduce the friction since the flow is driven by a small density difference force. Storage tank bottom should be about 30 cm above collector top in order to prevent the reversed motion of flow at night which is caused by the presence of cool water in collector and hot water in storage tank. Pressure reducing valve is required when there is no cold water storage tank (city water is directly connected to the inlet port of the collector). Figure 4 shows a schematic and a real image of thermosiphon system.

Thermosiphon system is characterized by its low maintenance and installation cost in addition to its relatively high efficiency. However, pipes in collector in such systems may clog or corrode due to impurity of water. Also it has tall unit which make them unattractive. Liu et al. [73] installed eight thermosiphon SWHSs in series to evaluate the thermal performance and temperature profiles under designated charge conditions. The authors tested the system under no load, interrupted and continues load conditions. The results showed that the thermal efficiency for interrupted load conditions is approximately 5.8% to 7% higher than that for no load conditions.

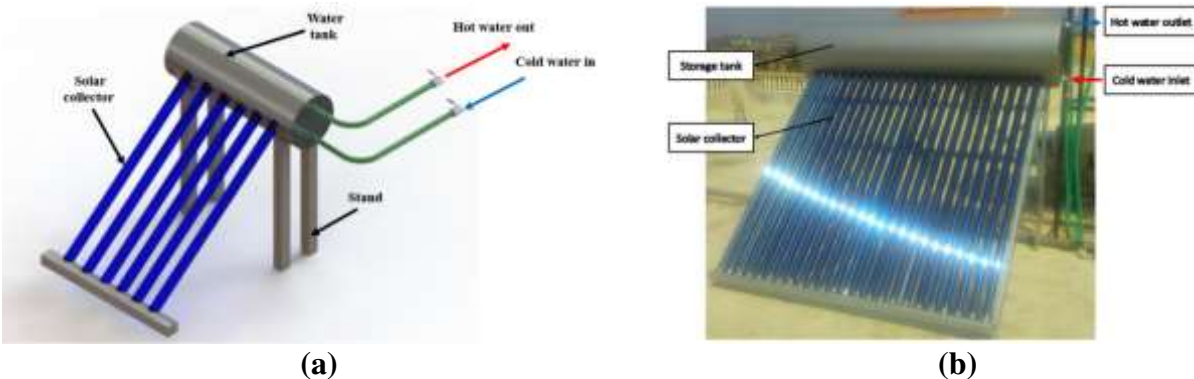

Figure 4. (a) Schematic and (b) Real image of thermosiphon system.

### 3.1.2 Integrated collector storage

Integrated collector storage system [74–76] is also known as batch system. This system works as thermosiphon system works but the main difference is that the storage tank is used also as a collector. The storage tank is placed in an insulated box having a glazed side which allows solar radiation to heat the tank. Singh et al. [77] presented a review including the recent developments in integrated collector storage SWHS. The main disadvantage of such system is thermal losses at

night, in winter, or in a cloudy low ambient temperature day. Figure 5 shows a schematic and a real prototype of integrated collector storage.

Advanced integrated collector storage systems use two tanks in which one is glazed and the other is totally insulated to reduce thermal losses, or they use compound parabolic collector [78] installed on the glazed tank to increase thermal efficiency during sunshine. Kessentini and Bouden [79] conducted a numerical study to test the thermal performance of a double tank integrated collector storage system with compound parabolic concentrator. A prototype of the system is implemented and experiments are developed to validate the results of the model. The experimental results showed that during day time a significant increase in water temperature takes place while during night a moderate temperature is preserved.

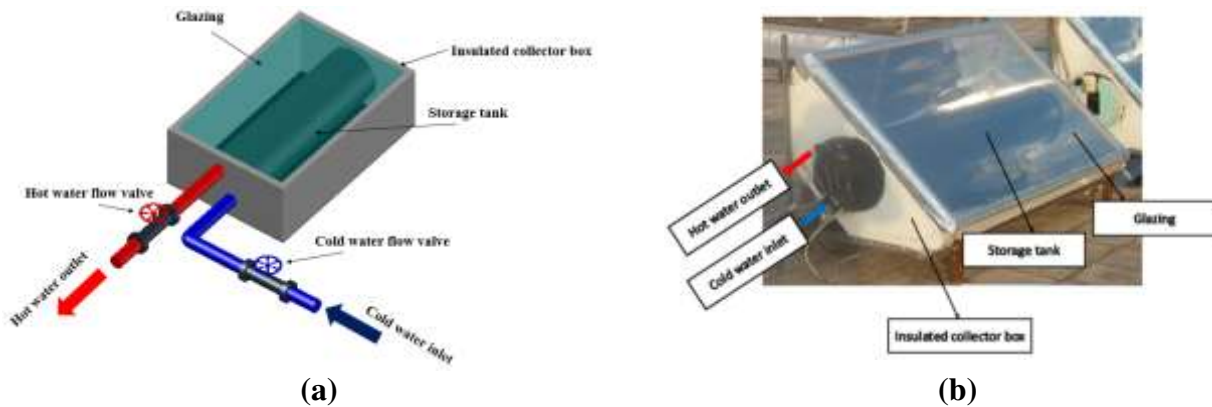

Figure 5. (a) Schematic and (b) Real prototype of integrated collector storage [75].

### 3.1.3 Open loop system

In the direct active system, water is directly circulated by a pump from the storage tank to the collector to be heated by solar energy, and then returned to the storage tank to be used when needed [80], as shown on a schematic of open loop system on Figure 6. The storage tank can be mounted above or below the collector. Direct circulation systems typically utilize single storage tank with an auxiliary water heater, but it can also use two-tank storage systems. Also, this system can be used with water supplied from a cold water storage tank or connected directly to service water. When the pressure of the city water is greater than the working pressure, pressure-reducing valves and pressure relief valves will be required. This system is effective and has low operating cost, and it can be used in areas where freezing is not permanent, but it is not appropriate for hard or acidic water where corrosion instantly damages the system.

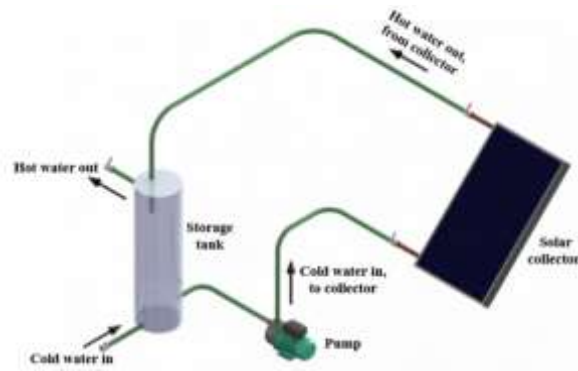

Figure 6. *Open loop system.*

### 3.1.4 Closed loop system

In the closed loop active system, potable water is heated in an indirect way by circulating a heat transfer fluid through the collector where it rejects its heat via a heat exchanger to the water in the storage tank [80], as illustrated on a schematic of closed loop system on Figure 7. Water/ethylene glycol solution is the most utilized heat transfer fluid, although silicone oils and refrigerants can be also used. Double-wall heat exchanger must be involved when the fluid used are toxic or non-potable. The heat exchanger can be placed inside the storage tank, around it, or it can be external. An expansion tank and pressure relief valve should be required since the collector loop is closed. This design offers good freeze protection which made it popular in areas that are subjected to extended freezing temperature.

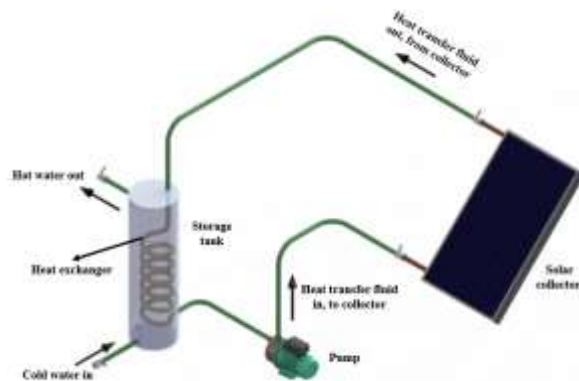

Figure 7. *Closed loop system.*

## 3.2 Type of solar collector

### 3.2.1 Flat plate collector

Flat plate collector is a stationary solar collector that is described by its ability to exploit both direct and diffused rays of solar radiations. It is one of the most harnessed collectors in SWHS since it can attain temperature between 40 and 70°C. Basically, flat plate solar collector is composed of

glazing, tubes and dark colored absorber plate, header, insulation and casing, as Figure 8 shows a schematic of flat plate solar collector. The glazing can transmit up to 90% of the entering shortwaves solar irradiation while it is opaque to the long wave radiation that is coming back from the absorber plate. Also, it minimizes the convection losses by inhibiting air to hit the absorber. Tubes are connected at both ends by large header tubes so that they direct the heat transfer fluid from inlet to outlet. The major role of the absorber plate, is to carry the retained heat by the glazing to the transport fluid, while the insulation is utilized to minimize heat losses. The casing is a frame for the aforementioned components which protects them from dust, moisture, etc.

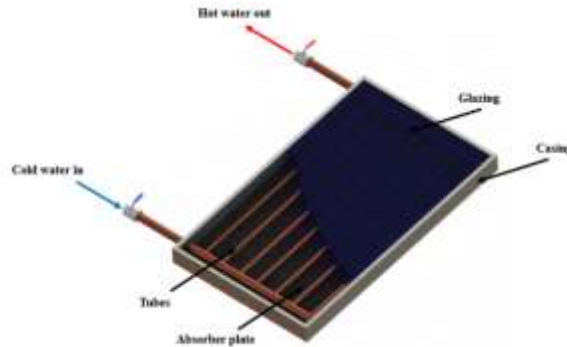

Figure 8. Flat plate solar collector.

Kalogirou et al. [81] established a new TRNSYS type for evaluating energy of thermosiphon solar water heating system using solar flat plate collector. The agreement attained between simulation and experimental results shows that the developed TRNSYS type is legitimized successfully. Hashim et al. [82] experimentally studied the performance of solar water heating with flat plate collector. The results showed that the maximum achieved temperature is 51.4°C and 49°C at 5.3 L/min and 6.5 L/min flow rate, respectively. The authors concluded that higher water temperature can be attained at lower flow rate (5.3 L/min). Dondapati et al. [83] described the effect of design parameters and ambient conditions such as solar irradiance, overall heat loss coefficient and heat removal factor on the solar flat plate collector efficiency. The authors aimed from their work to enhance and optimize the efficiency of solar flat plate collector. Sint et al. [84] analyzed theoretically the efficiency of nano-fluid based solar flat plate collector. The authors developed a mathematical model and MATLAB code to compute the efficiency of solar flat plate collector for domestic hot water heating system taking into account weather conditions of a city in Myanmar. The efficiency of the collector raises with the increase in the volume concentration by 2%, while it is marginally affected by the nanoparticle size. Under the same ambient, operating and radiant conditions, the efficiency of solar flat plate collector efficiency could be improved up to 5% when the working fluid used is CuO-water nano-fluid, in comparison with water.

### 3.2.2 Evacuated tube collector

Evacuated tube collector is another type of stationary solar collectors that is utilized in SWHS. It is more expensive but more efficient compared to flat plate collector since it can achieve an outlet temperature between 50 and 200°C. Such collector mainly consists of parallel rows of glass tubes that are connected to a manifold, Figure 9 presents a schematic of evacuated tube solar collector. Each tube is composed of a heat pipe inside an evacuated tube. The pipe comprises a small amount

of liquid-vapor phase fluid (mainly methanol) which performs a continuous evaporation-condensation cycle. Black copper fins are attached to the heat pipe to absorb solar radiations and convey heat to the fluid which evaporates and moves to the top of the pipe. When it reaches the top of the pipe it condensates after releasing latent heat to the moving fluid in the manifold.

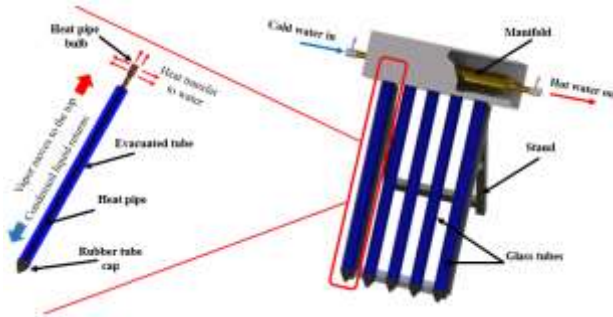

*Figure 9. Evacuated tube solar collector.*

Wannagosit et al. [85] performed an experimental and theoretical investigation on evacuated tube thermosiphon solar water heating system. The authors developed a mathematical model in which thermal resistance method and explicit finite difference method (EFDM) are validated experimentally. The results revealed that solar water heating system thermal efficiency was 58.3% based on the experimental results, 56.0% based on thermal resistance method and 57.6% based on EFDM. It was concluded that the results provided by EFDM are more accurate than that provided by thermal resistance method. Feliński and Sekret [86] established the influence of Phase Change Material (PCM) utilization in evacuated tube collector on the properties of the functioning parameters of solar water heating system. The authors suggested a methodology to identify the thermal performance of the evacuated tube collector/storage unit. It was obtained that the evacuated tube collector with PCM storage enhances the annual solar fraction of domestic hot water system by 20.5% in comparison with evacuated tube collector with no storage. Daghigh and Shafieian [87] performed a theoretical and experimental investigation to assess the performance of a solar water heating system utilizing evacuated tube collector. The authors developed a mathematical model based on thermal and exergy analysis to demonstrate the performance of the collector. Then, the system prototype was built and tested experimentally. The results reveal that the optimum number of collector pipes should be 15 and the maximum water temperature attained by the collector is 64°C. The developed mathematical model was validated by the experimental results, which means that the model is capable of predicting the performance of heat pipe solar water heater with maximum relative and standard errors of 8.4% and 1.91% respectively. Shafieian et al. [88] conducted a theoretical and experimental analysis to assess the performance of evacuated tube heat pipe solar water heating system during cold season. The authors developed a mathematical model to compute the optimal number of glass tubes of the collector. Also, a 25 glass tubes collector was designed, constructed and tested. The results showed that the performance of solar water heating system is considerably affected by the hot water extraction. It was obtained that the highest exergy efficiency is 15.58% and the highest thermal efficiency is 92.7%.



### 3.2.3 Parabolic trough collector

Heating water using solar energy by the mean of parabolic trough collector [89–91] is one of the most progressed solar technology in which parabolic trough collector can generate heat temperature up to 400°C. Parabolic trough collector is composed of reflective material sheet that is bent into parabolic shape and directed towards the sun [92]. Besides, it is made of a receiver where a metal black glazed tube is located at its focal line. The space between the receiver and the glass cover is evacuated to decrease convective losses. Solar radiation hits the parabola which in its turn reflects it into the receiver where a working fluid is passing inside it. The heated working fluid transmits heat into the water to be used for several aims. Figure 10 illustrates a schematic and a real image of parabolic trough collector.

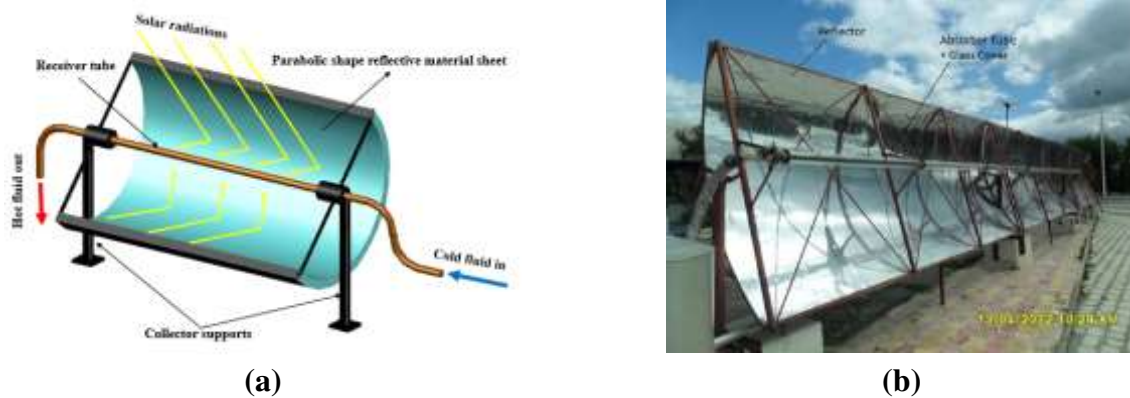

Figure 10. (a) Schematic and (b) Real image of parabolic trough collector [91].

Ramadan et al. [93] developed a prototype of a new design of heating water using parabolic trough with solar tracking system. The authors implemented an experimental study to evaluate the performance of the system as function of the weather conditions. It was found that water can be heated from 23 to 57°C using a parabolic trough of 0.6 m<sup>2</sup>, where the temperature can reach 69°C when activating the tracking system. Besides, Khaled et al. [94] conducted theoretical and case studies related to a new design of residential water heating using parabolic trough. A comparison between parabolic trough and flat plate collector has been presented. It was observed that for a constant volume, the time needed to heat water up to 70°C is minimized by 33% and 22.4% when using parabolic trough with and without tracking respectively. Moreover, Zou et al. [95] suggested a small-sized parabolic trough collector, and assessed its characteristics via conducting experimental analysis and testing. The results showed that even under solar radiation less than 310 W/m<sup>2</sup>, the thermal efficiency of the collector is 67% which means that it can operate efficiently. The results also reveal that the maximum attained efficiencies were 26% and 56% during frosting and at 5 m/s wind velocity, respectively.

## 4- ANALYSIS OF PREVIOUS WORKS ON SOLAR WATER HEATING SYSTEMS

Since its invention, numerous studies have been conducted to study SWHS in order to progress its performance to maintain the optimum one. Hence, the aim of this section is to review and analyze

several researches that are performed on SWHS throughout the years. Table 1 summarizes various studies that have been developed on SWHS.

Table 1. Developed studies on SWHS.

Authors	Journal	Year	Title	Type of study	Objectives
Kalogirou and Papamarcou [96]	Renewable Energy	2000	Modelling of a thermosiphon solar water heating system and simple model validation	Modeling and experimental	<ul style="list-style-type: none"> <li>➤ Modeling, using TRNSYS, a thermosiphon solar water heater which consists of two flat plate collectors of 2.7 m<sup>2</sup> aperture area and 150 L storage tank.</li> <li>➤ Experimental validations of the model.</li> </ul>
Kalogirou and Panteliou [97]	Solar Energy	2000	Thermosiphon solar domestic water heating systems: long term performance prediction using artificial neural networks	Modeling and experimental	<ul style="list-style-type: none"> <li>➤ Predicting the long term performance for a thermosiphon solar domestic water heating system by utilizing artificial neural networks.</li> </ul>
Faiman et al. [98]	Solar Energy	2001	Reducing the heat loss at night from solar water heaters of the integrated collector–storage variety	Experimental	<ul style="list-style-type: none"> <li>➤ Perform experimental study to present a method for reducing the heat loss during night in an integrated collector storage solar water heater.</li> </ul>
Diakoulaki et al. [99]	Energy Conversion and Management	2001	Cost benefit analysis for solar water heating systems	Analytical	<ul style="list-style-type: none"> <li>➤ Conduct a cost benefit analysis to evaluate SWHS in comparison with competitive conventional technologies in Greece.</li> </ul>
Bojic et al. [100]	Renewable Energy	2002	Simulation of a solar domestic water heating system using a time marching model	Modelling and numerical	<ul style="list-style-type: none"> <li>➤ Modelling and simulation of a SWHS using a time marching model.</li> </ul>
Chuawittaya wuth and Kumar [101]	Renewable Energy	2002	Experimental investigation of temperature and flow distribution in a thermosiphon solar water heating system	Experimental	<ul style="list-style-type: none"> <li>➤ Experimental observation of the temperature and flow distribution in a natural circulation SWHS.</li> <li>➤ Comparison between experimental and theoretical models.</li> </ul>
Mohsen and Akash [102]	International Communications in Heat and Mass Transfer	2002	On integrated solar water heating system	Experimental	<ul style="list-style-type: none"> <li>➤ Perform experiment at local conditions to investigate the performance of integrated solar water heater.</li> </ul>
Kuang et al. [103]	Energy Conversion and Management	2003	Experimental study on solar assisted heat pump system for heat supply	Experimental	<ul style="list-style-type: none"> <li>➤ Development of a simple and cost effective solar assisted heat pump system which consists of flat plate collector, hot water storage tank and water source heat pump.</li> </ul>
Chyng et al. [104]	Solar Energy	2003	Performance analysis of a solar-assisted heat pump water heater	Modelling and numerical	<ul style="list-style-type: none"> <li>➤ Perform modeling and simulation of an integral type solar assisted heat pump water heater.</li> </ul>
Smyth et al. [105]	Solar Energy	2003	Heat retaining integrated collector / storage solar water heaters	Experimental	<ul style="list-style-type: none"> <li>➤ Develop experimental study on an integrated collector / storage solar water heater (ICSSWH) that can noticeably decrease heat loss to ambient during non-collection periods.</li> </ul>
Langniss and Ince [106]	Refocus	2004	Solar water heating: A viable industry in developing countries	Review	<ul style="list-style-type: none"> <li>➤ Overview of the underused potential of solar thermal energy in certain developing countries, with a special focus on the experience of the island of Barbados in the Caribbean.</li> </ul>

Tripanagnostopoulos and Souliotis [107]	Renewable Energy	2004	ICS solar systems with horizontal cylindrical storage tank and reflector of CPC or involute geometry	Modeling and experimental	<ul style="list-style-type: none"> <li>➤ Perform experimental models of six integrated collector storage solar system to determine their stored water temperature variation, mean daily efficiency and thermal losses during night.</li> </ul>
Souliotis and Tripanagnostopoulos [108]	Solar Energy	2004	Experimental study of CPC type ICS solar systems	Experimental	<ul style="list-style-type: none"> <li>➤ Perform experiments on integrated collector storage solar systems that have different storage tank diameter to estimate their thermal performance and the ratio of the stored water volume per aperture area and per total external surface area.</li> </ul>
Kaldellis et al. [109]	Renewable and Sustainable Energy Reviews	2005	Investigating the real situation of Greek solar water heating market	Review	<ul style="list-style-type: none"> <li>➤ Valuation of the local domestic SWHS market by analyzing its time variation, taking into consideration the corresponding annual replacement rate.</li> </ul>
Esen and Esen [110]	Solar Energy	2005	Experimental investigation of a two-phase closed thermosiphon solar water heater	Experimental	<ul style="list-style-type: none"> <li>➤ Conduct experimental studies to show how the thermal performance of a two-phase thermosiphon solar collector was influenced by utilizing distinct refrigerants.</li> </ul>
Houri [111]	Renewable Energy	2006	Solar water heating in Lebanon: current status and future prospects	Case study	<ul style="list-style-type: none"> <li>➤ Highlight the significance of utilizing SWHS in Lebanon by performing a case study on thermosiphon SWHS.</li> </ul>
Chow et al. [112]	Applied Energy	2006	Potential application of a centralized solar water-heating system for a high-rise residential building in Hong Kong	Numerical	<ul style="list-style-type: none"> <li>➤ Estimation of the potential application of a centralized SWHS in high-rise residence.</li> </ul>
Pillai and Banerjee [113]	Solar Energy	2007	Methodology for estimation of potential for solar water heating in a target area	Numerical	<ul style="list-style-type: none"> <li>➤ Suggestion of a methodology for potential evaluation of solar water heating in a target area taking into account the parameters that influence adoption at the end use level (micro-level factor) and parameters that impact the aggregate market (macro-level factor).</li> </ul>
Gunerhan and Hepbasli [114]	Energy and Buildings	2007	Exergetic modeling and performance evaluation of solar water heating systems for building applications	Modeling	<ul style="list-style-type: none"> <li>➤ Use exergy analysis to model and evaluate SWHS.</li> <li>➤ Study the influence of variation of water inlet temperature to the collector on the exergy efficiencies of SWHS.</li> <li>➤ Discuss several thermodynamic parameters and exergetic improvement potential.</li> <li>➤ Perform exergy efficiency curve similar to the thermal efficiency curve for solar collectors.</li> </ul>
Currie et al. [115]	Building Services Engineering Research and Technology	2008	Modelling bulk water temperature in integrated collector storage systems	Modeling, experimental and numerical	<ul style="list-style-type: none"> <li>➤ Experimental and numerical study on integrated collector storage solar water heating.</li> <li>➤ Comparison between experimental and numerical results with a new constructed macro model.</li> </ul>
Sutthivirode et al. [116]	Applied Energy	2009	A new version of a solar water heating system coupled with a solar water pump	Experimental	<ul style="list-style-type: none"> <li>➤ Improvement of the thermal efficiency of a SWHS connected to built-in solar water pump.</li> </ul>

Smyth and Skates [117]	Solar Energy	2009	A passive solar water heating system for vineyard frost protection	Experimental	➤ Design and testing the performance of a passive SWHS under real vineyard operating conditions.
Kishor et al. [118]	Solar Energy	2010	Fuzzy model representation of thermosiphon solar water heating system	Modeling	➤ Present a fuzzy model to represent the solar collector in thermosiphon SWHS and improve the prediction accuracy of such model.
Jaisankara et al. [71]	Renewable and Sustainable Energy Reviews	2011	A comprehensive review on solar water heaters	Review	➤ Review on different techniques to improve the thermal efficiency of solar water heaters. ➤ Detailed discussion on the restrictions of present research, research gap and possible modifications are suggested.
Patel et al. [63]	International Journal of Advanced Engineering Technology	2012	Review of solar water heating systems	Review	➤ Review of the existing SWHS and their applications.
Sivakumar et al. [119]	ARPJ Journal of Engineering and Applied Sciences	2012	Performance improvement study of solar water heating system	Experimental	➤ Experimental implementation to progress the performance of a flat plate solar collector and reduce the cost.
Souliotis et al. [75]	Renewable Energy	2013	Experimental study of integrated collector storage solar water heaters	Experimental	➤ Design and construction of solar water heaters of low cost with progressed thermal performance and lower depth.
Liu et al. [69]	Energy Conversion and Management	2013	Thermal performance of an open thermosiphon using nanofluid for evacuated tubular high temperature air solar collector	Experimental	➤ Design of evacuated tube solar air collector integrated with compound parabolic concentrator and open thermosiphon using water based CuO nanofluid as the working fluid.
Kessentini and Bouden et al. [79]	Renewable Energy	2013	Numerical and experimental study of an integrated solar collector with CPC reflectors	Numerical and experimental	➤ Implementation of numerical code which predicts the thermal performance of a double integrated collector storage system with compound parabolic concentrator. ➤ Construction of prototype and experimental testing to validate the numerical results.
Chaudhari et al. [64]	International Journal of Advanced Engineering Technology	2013	A critical review on solar water heater	Review	➤ Review of researches conducted on SWHS by several researchers in the world.
Shukla et al. [53]	Renewable and Sustainable Energy Reviews	2013	Recent advances in the solar water heating systems: A review	Review	➤ Review on the design aspects of SWHS including summary of the progress of several system components and technological advancements in developing the performance and cost effectiveness of SWHS.
Omojaro and Brei tkopf [120]	Renewable and Sustainable Energy Reviews	2013	Direct expansion solar assisted heat pumps: A review of applications and recent research	Review	➤ Summary of different investigations and analysis of direct expansion solar assisted heat pump systems.
Amin and Hawlader [121]	Renewable and Sustainable Energy Reviews	2013	A review on solar assisted heat pump systems in Singapore	Review	➤ Summary of the results obtained from testing of solar assisted heat pump systems that were performed under meteorological conditions of Singapore for different applications.

Sadhishkumar and Balusamy [59]	Renewable and Sustainable Energy Reviews	2014	Performance improvement in solar water heating systems - a review	Review	➤ Summary of the previous works on SWHS with various heat transfer enhancement techniques such as collector design, collector tilt angle, coating of pipes, fluid flow rate, thermal insulation, integrated collector storage, thermal energy storage, use of phase change materials, and insertion of twisted tapes.
Tiwari and Jaurkar [65]	Global Journal of Multidisciplinary Studies	2014	Theoretical analysis of solar water heater - a review	Review	➤ Review of the existing SWHS and their applications.
Shelke et al. [66]	International Journal of Scientific Engineering and Research	2015	Solar water heating systems: a review	Review	➤ Review which studies the existing SWHS and their applications.
Halawa et al. [122]	Renewable and Sustainable Energy Reviews	2015	Thermal performance evaluation of solar water heating systems in Australia, Taiwan and Japan - A comparative review	Review	➤ Discussion of benefits and weaknesses of each approach and investigation of possible common approach that will develop the present methodologies.
Wang et al. [60]	Renewable and Sustainable Energy Reviews	2015	Solar water heating: From theory, application, marketing and research	Review	➤ Comprehensive critical review including the theoretical issues related to solar water heating technology, solar water heating production, engineering applications and its future marketing in addition to research questions related to solar water heating.
Ko [52]	Energies	2015	A novel design method for optimizing an indirect forced circulation solar water heating system based on life cycle cost using a genetic algorithm	Mathematical modeling and case study	➤ Novel design method for optimizing different design variable of an indirect forced circulation SWHS which is dependent on the life cycle cost and uses a genetic algorithm.
Garg et al. [43]	International Journal of Engineering Research & Management Technology	2015	Solar water heating system (SWHS)	Review	➤ Review including researches performed by various researchers on solar water heater.
Lima et al. [48]	Solar Energy	2015	Solar water heating for a hospital laundry: A case study	Modeling, Numerical and case study	➤ Numerical simulation to investigate the technical and financial viability of a SWHS for a hospital laundry in the city of Recife, Brazil.
Singh et al. [77]	Renewable and Sustainable Energy Reviews	2016	Recent developments in integrated collector storage (ICS) solar water heaters: A review	Review	➤ Review on various concentrating and non-concentrating integrated collector storage SWHS.
Ntsaluba et al. [67]	Renewable Energy	2016	Optimal flow control of a forced circulation solar water heating system with energy storage units and connecting pipes	Mathematical modeling and case study	➤ Determination of the optimal pump flow rate for forced circulation SWHS with pipes in the primary and secondary loops to maximize the energy transfer to circulating fluid storage tank.
Jamar et al. [62]	International Communications in Heat and Mass Transfer	2016	A review of water heating system for solar energy applications	Review	➤ Discussion of the latest improvements of a solar water heater based on three major components that may influence the thermal performance of the system.

Khan et al. [123]	International Journal of Photoenergy	2016	Design, fabrication, and efficiency study of a novel solar thermal water heating system: towards sustainable development	Experimental	<ul style="list-style-type: none"> <li>➤ Development and testing of new loop heat pipe based solar thermal heat pump system for small scale hot water production for household purposes.</li> </ul>
Liu et al. [124]	Energy Procedia	2017	Experiments of a heat pump water heating system using stored solar energy to defrost	Experimental	<ul style="list-style-type: none"> <li>➤ Suggestion of a novel solar assisted heat pump system which uses stored solar energy for defrosting.</li> <li>➤ Implementation of experiments to study the performance of the new design.</li> </ul>
Semmaria et al. [125]	Case Studies in Thermal Engineering	2017	Case study for experimental validation of a new presizing tool for solar heating, cooling and domestic hot water closed systems	Case study	<ul style="list-style-type: none"> <li>➤ Presentation of a case study experimental validation of a new presizing tool named PISTACHE which allow to foretell the design and performance of solar heating, cooling and domestic hot water systems.</li> </ul>
Ciocănea and Buretea [126]	Energy Procedia	2017	The influence of flow tube vibrations over the efficiency of solar water heating collectors	Modeling and experimental	<ul style="list-style-type: none"> <li>➤ Modeling and experimental validation to study the influence of vibration over a flow tube from a solar water heating collector and improve the heat exchange.</li> </ul>
Shrivastava et al. [127]	Renewable and Sustainable Energy Reviews	2017	Modeling and simulation of solar water heater: A TRNSYS perspective	Review	<ul style="list-style-type: none"> <li>➤ Critical review of simulation of SWHS including early works, comparative analysis of popular simulation tools and their architecture in perspective of TRNSYS</li> <li>➤ Discussion of assumptions, modeling of different components, advantages and drawbacks of simulation.</li> </ul>
Varghese et al. [128]	Applied Thermal Engineering	2017	A parametric study of a concentrating integral storage solar water heater for domestic uses	Parametric and experimental	<ul style="list-style-type: none"> <li>➤ Perform parametric study on concentrating integral storage solar water heater.</li> <li>➤ Conduct experimental studies to calculate the mean collector efficiency for the model with an air gap introduced in the side walls.</li> <li>➤ Compare the results of the parametric study with the collected results from the experiments.</li> </ul>
Abas et al. [129]	Cold Regions Science and Technology	2017	A thermosiphon solar water heating system for subzero temperature areas	Modeling and experimental	<ul style="list-style-type: none"> <li>➤ Perform modeling and experimental testing of thermosiphon SWHS for subzero temperature areas to show how solar energy could be used for water heating in low solar insolation areas.</li> </ul>
Liu et al. [130]	Solar Energy	2017	Design of high-performance water-in-glass evacuated tube solar water heaters by a high-throughput screening based on machine learning: A combined modeling and experimental study	Experimental and modeling	<ul style="list-style-type: none"> <li>➤ Conduct experimental and modeling to show that HTS method can be used to modify the design of water-in-glass evacuated tube solar water heater with a few knowledge about the highly complicated correlations between the extrinsic properties and heat collection rate of solar water heaters.</li> </ul>



Gautam et al.[131]	Renewable and Sustainable Energy Reviews	2017	A review on technical improvements, economic feasibility and world scenario of solar water heating system	Review	<ul style="list-style-type: none"> <li>➤ Present the studies that demonstrate the economic feasibility of SWHS in the long run.</li> </ul>
Poppi et al. [132]	Renewable and Sustainable Energy Reviews	2018	Techno economic review of solar heat pump systems for residential heating applications	Review, modeling and numerical	<ul style="list-style-type: none"> <li>➤ Review the different system boundaries and the main performance indicators used for assessing energetic and economic performances.</li> <li>➤ Review techno-economic studies in the literature and identify which studies give enough information and are compatible enough for making an economic inter-comparison.</li> <li>➤ Present an economic inter-comparison based on the identified systems.</li> </ul>
Razavi et al. [133]	Applied Thermal Engineering	2018	Modeling, simulation and dynamic control of solar assisted ground source heat pump to provide heating load and DHW	Modeling and numerical	<ul style="list-style-type: none"> <li>➤ Suggest a sustainable renewable energy system to heat residential buildings and supply domestic hot water.</li> <li>➤ Using TRNSYS software, perform modeling, simulation, and operation controlling.</li> <li>➤ Estimate and compare the coefficient of performance (COP), electrical power consumption of the GSHP, soil temperature, as well as building and domestic hot water temperatures for 10 years of operation.</li> </ul>
Abdelghani-Idrissi et al. [134]	Renewable Energy	2018	Solar tracker for enhancement of the thermal efficiency of solar water heating system	Experimental and modeling	<ul style="list-style-type: none"> <li>➤ Improvement of the thermal efficiency of SWHS integrated with a solar tracker.</li> <li>➤ Establish the thermal behavior of SWHS by conducting energy balance on solar panels, heat exchanger and storage system.</li> <li>➤ The experimental results reveal that the solar tracker leads to 40% gain in the global thermal energy stored in comparison to the fixed inclinations of the solar panels.</li> </ul>
Sadiq [135]	Journal of Cleaner Production	2018	Solar water heating system for residential consumers of Islamabad, Pakistan: A cost benefit analysis	Analytical	<ul style="list-style-type: none"> <li>➤ Perform a cost benefit analysis of SWHS in residential sector of Islamabad, Pakistan.</li> </ul>
Shafieian et al. [88]	Applied Thermal Engineering	2018	Thermal performance of an evacuated tube heat pipe solar water heating system in cold season	Modeling and experimental	<ul style="list-style-type: none"> <li>➤ Estimate the performance of a heat pipe SWHS to meet a real residential hot water consumption pattern under non-ideal climatic conditions during a cold day in Perth, Australia.</li> </ul>
Zhang et al. [136]	Sustainable Energy Technologies and Assessments	2018	Techno-economic feasibility of solar water heating system: Overview and meta-analysis	Overview and analytical	<ul style="list-style-type: none"> <li>➤ Present an overview of the existing techno-economic analyses of SWHS.</li> </ul>

Yilmaz [137]	Journal of Cleaner Production	2018	Residential use of solar water heating in Turkey: A novel thermos-economic optimization for energy savings, cost benefit and ecology	Modeling and analytical	<ul style="list-style-type: none"> <li>➤ Present the recent trends in residential solar water heating and its efficient usage in Turkey.</li> <li>➤ Suggest a novel methodology for determining the optimum orientation and sizing of water-in-glass evacuated tube SWHS.</li> <li>➤ Perform a transient modeling for the prediction of a full year's system performance via the System Advisor Model.</li> </ul>
Baneshi and Bahreini [138]	Sustainable Energy Technologies and Assessments	2018	Impacts of hot water consumption pattern on optimum sizing and techno-economic aspects of residential hybrid solar water heating systems	Modeling and case study	<ul style="list-style-type: none"> <li>➤ Conduct a techno-economic modeling of hybrid water heating systems considering different domestic hot water (DHW) consumption patterns.</li> </ul>
Wu et al. [139]	Solar Energy	2018	Experimental study on the performance of a novel solar water heating system with and without PCM	Experimental	<ul style="list-style-type: none"> <li>➤ Implement a novel SWHS which is capable of reducing the impact of solar radiation intensity fluctuations, by using phase change materials for thermal energy storage and inserted oscillating heat pipe for performance improvement.</li> </ul>
Hashim et al. [140]	Case Studies in Thermal Engineering	2018	Case study on solar water heating for flat plate collector	Experimental and case study	<ul style="list-style-type: none"> <li>➤ Conduct experiments to study the performance of solar water heating for flat plate collector.</li> </ul>
Endale [141]	Renewable Energy	2019	Analysis of status, potential and economic significance of solar water heating system in Ethiopia	Numerical simulation	<ul style="list-style-type: none"> <li>➤ Estimate the energy output of a closed loop SWHS using System Advisor Model software.</li> <li>➤ Predict the future energy demand for hot water production using Long-range Energy Alternatives Planning System software.</li> <li>➤ Estimate the amount of electric energy, imported oils and firewood that can be saved through SWHS.</li> </ul>
Garcia et al. [142]	Renewable Energy	2019	Profitability of a solar water heating system with evacuated tube collector in the meat industry	Experimental	<ul style="list-style-type: none"> <li>➤ Analyze the feasibility and profitability of using thermal solar systems with evacuated tube collectors to supply part of the hot water demand of meat industries.</li> </ul>
Gomariz et al. [143]	Solar Energy	2019	An analysis of low flow for solar thermal system for water heating	Experimental and numerical	<ul style="list-style-type: none"> <li>➤ Estimate the thermal performance of a typical serpentine collector for several mass flow rates.</li> <li>➤ Conduct modeling of the system and compute the initial investment and operating cost for high and low flow designs.</li> </ul>
Hohne et al. [144]	Sustainable Energy Technologies and Assessments	2019	Optimal energy management and economic analysis of a grid-connected hybrid solar water heating system: A case of Bloemfontein, South Africa	Modeling and case study	<ul style="list-style-type: none"> <li>➤ Present the optimum energy management of a hybrid solar electric water heater.</li> <li>➤ Assess the energy and cost saving potential of the system.</li> </ul>

Prakash et al. [145]	Applied Energy	2019	Off-grid solar thermal water heating system using phase-change materials: design, integration and real environment investigation	Experimental	<ul style="list-style-type: none"> <li>➤ Design, construct and assess an off-grid solar thermal water heating system which utilizes paraffin wax, PureTemp 68 and Stearic Acid/Palmitic Acid eutectic mixture based phase change materials.</li> </ul>
Giglio et al. [146]	Renewable Energy	2019	Analyzing the impact of small solar water heating systems on peak demand and on emissions in the Brazilian context	Experimental	<ul style="list-style-type: none"> <li>➤ Demonstrate a methodology to evaluate the influence of solar heating systems on mitigating the peak demand and reduce emissions when it is utilized in low-income housing project.</li> </ul>
Nwaji et al. [147]	Energy & Buildings	2019	Hybrid solar water heating/nocturnal radiation cooling system I: A review of the progress, prospects and challenges	Review	<ul style="list-style-type: none"> <li>➤ Present a review on hybrid SWH/nocturnal radiation cooling system utilizing a single collector/radiator for double functions.</li> </ul>
Abas et al. [148]	Applied Thermal Engineering	2019	Dynamic simulation of solar water heating system using supercritical CO <sub>2</sub> as mediating fluid under sub-zero temperature conditions	Numerical simulation and experimental	<ul style="list-style-type: none"> <li>➤ Implement simulation using TRNSYS software to study the performance of SWHS using CO<sub>2</sub> as mediating fluid under conditions of sub-zero temperature.</li> <li>➤ Design, fabricate and test an evacuated tube solar collector.</li> </ul>
Shafieian et al. [149]	Applied Thermal Engineering	2019	Thermal performance of an evacuated tube heat pipe solar water heating system in cold season	Modeling and experimental	<ul style="list-style-type: none"> <li>➤ Conduct a theoretical and experimental assessment of a heat pipe SWHS to provide the required hot water consumption for real residence under non ideal climatic conditions and during a cold day in Perth, Australia.</li> <li>➤ Develop a mathematical model to compute the optimum number of glass tubes of the studied solar collector.</li> <li>➤ A heat pipe solar collector of 25 glass tubes is designed based on the obtained data of the model, built and tested.</li> </ul>
Mehmood et al. [150]	Energy Reports	2019	Performance evaluation of solar water heating system with heat pipe evacuated tubes provided with natural gas backup	Numerical simulation and experimental	<ul style="list-style-type: none"> <li>➤ Conduct a simulation model, using TRNSYS, on heat pipe evacuated tubes SWHS which is hybridized with traditional fuel backup for preventing the interrupted supply of thermal energy.</li> <li>➤ Develop experimental setup to validate the simulated model.</li> </ul>
Morrison et al. [151]	Solar Energy	2019	Design and simulated performance of a solar-thermal system employing seasonal storage for providing the majority of space heating and domestic hot water heating needs to a single-family house in a cold climate	Numerical simulation and experimental	<ul style="list-style-type: none"> <li>➤ Perform simulation study and design a building-scale solar thermal system with seasonal storage for a research house with a heated floor area of approximately 150 m<sup>2</sup>.</li> </ul>

Allouhi et al. [152]	Energy	2019	Forced-circulation solar water heating system using heat pipe-flat plate collectors: Energy and exergy analysis	Modeling and simulation	<ul style="list-style-type: none"> <li>➤ Introduce a new design of solar thermal collector and integrate it to SWHS.</li> <li>➤ Provide a detailed one-dimensional transient mathematical model for the suggested system and evaluate its exergetic and energetic performance under severe meteorological conditions.</li> </ul>
Modi et al. [153]	Cleaner Engineering and Technology	2020	Efficacy of organic and inorganic nanofluid on thermal performance of solar water heating system	Experimental	<ul style="list-style-type: none"> <li>➤ Carry out experiment investigation to evaluate the performance of SWHS using organic and inorganic nanofluid.</li> </ul>
Kulkarni et al. [154]	Materials Today: Proceedings	2020	An innovative design approach of hot water storage tank for solar water heating system using artificial neural network	Modeling	<ul style="list-style-type: none"> <li>➤ Conduct Artificial Neural Network (ANN) modeling to evaluate the accuracy of calculated total conductance in terms of equivalent thermal resistance.</li> </ul>
Shafieian and Khiadani [155]	Case Studies in Thermal Engineering	2020	Integration of heat pipe solar water heating systems with different residential households: An energy, environmental, and economic evaluation	Modeling and experimental	<ul style="list-style-type: none"> <li>➤ Present detailed methodology to assess the energy, economic and environmental contributions of heat pipe SWHS in several households.</li> <li>➤ Design, manufacture and test the considered system.</li> </ul>
Mohamed and Michel [156]	Energy Reports	2020	Design optimisation of a combined pellets and solar heating systems for water heating in a public bathhouse	Analytical	<ul style="list-style-type: none"> <li>➤ Evaluate the economic and energy potential of flat plate collectors utilized in combination with modern, automatic pellet boilers for large hot water preparation in a commercial building under the weather conditions of Marrakesh, Morocco.</li> <li>➤ Conduct annual simulations using TRNSYS software and carry out financial analysis using life cycle savings methods.</li> </ul>
Li et al. [157]	Energy and Buildings	2020	Energy Efficiency Improvement of Solar Water Heating Systems - An IoT Based Commissioning Methodology	Analytical and experimental	<ul style="list-style-type: none"> <li>➤ Investigate and enhance the energy efficiency of SWHS in a hospital building in Singapore.</li> <li>➤ Implement a comprehensive energy audit to evaluate the sub-system efficiency and the overall system performance.</li> <li>➤ Conduct experimental test on the site of the studied SWHS to confirm the effectiveness of the suggested control strategies.</li> </ul>

Xiao et al. [158]	Solar Energy	2020	The application of solar-to-thermal conversion phase change material in novel solar water heating system	Experimental	<ul style="list-style-type: none"> <li>➤ Prepare composite PCMs with and without graphene oxide and examine their thermal stabilities, phase change characteristics and thermal conductivities by utilizing a differential scanning calorimeter (DSC), a thermal constant analyzer and thermal gravimetric analyzer (TG).</li> <li>➤ Construct a novel SWHS using SAT/GO/EG at proper density as solar-absorbing substance and heat storage media and investigate the solar to thermal conversion efficiency of the system.</li> </ul>
Heidari and Khovalyg [159]	Solar Energy	2020	Short-term energy use prediction of solar-assisted water heating system: Application case of combined attention-based LSTM and time-series decomposition	Analytical	<ul style="list-style-type: none"> <li>➤ Introduce a hybrid model which amalgamates the attention mechanism and time series decomposition with Long Short Term Memory neural networks in order to increase the accuracy of predicting long term time series data.</li> </ul>
Ding et al. [160]	Solar Energy	2020	Dynamic simulation and parametric study of solar water heating system with phase change materials in different climate zones	Modeling and simulation	<ul style="list-style-type: none"> <li>➤ Assess the performance of integrating PCM to SWHS and estimate the optimal design parameters of PCM.</li> <li>➤ Establish mathematical models for SWHS with and without PCM.</li> <li>➤ Carry out annual simulation under several PCM parameters in six distinct cities.</li> </ul>
Huang et al. [161]	Solar Energy	2020	A policy study on the mandatory installation of solar water heating systems – Lessons from the experience in China	Review	<ul style="list-style-type: none"> <li>➤ Review the development history and status of China's mandatory installation policy for SWHS.</li> <li>➤ Summarize the lessons learned and experience derived from mandatory installation in buildings lower than 100 m in Ji'nan City and Shenzhen City, China.</li> </ul>
Wu et al. [162]	Renewable Energy	2020	A novel composite PCM for seasonal thermal energy storage of solar water heating system	Numerical and experimental	<ul style="list-style-type: none"> <li>➤ Suggest a novel composite PCM which is able to meet the demand for seasonal thermal energy storage.</li> <li>➤ Develop 3-D numerical model for evacuated tube collector and validate it by implementing an outdoor test rig.</li> </ul>
Khargotra et al. [163]	Case Studies in Thermal Engineering	2021	Impact of perforated shapes in delta type hindrance promoter on thermo-hydraulic performance of solar water heating system (An experimental study)	Experimental	<ul style="list-style-type: none"> <li>➤ Study the effect of non-circular holes in perforated delta-winglets on the thermo-hydraulic performance of SWHS.</li> </ul>
Nasirov et al. [164]	Renewable and Sustainable Energy Reviews	2021	Public perception and adoption of solar water heating systems in Chile: The role of supply side income tax credits	Analytical	<ul style="list-style-type: none"> <li>➤ Assess the public knowledge regarding utilizing SHWS and the specific function of tax credit program in the diffusion of SWHS during the initial period.</li> </ul>
Singh et al. [165]	Sustainable Energy Technologies and Assessments	2021	Environmental, technical and financial feasibility study of domestic solar water heating system in India	Analytical	<ul style="list-style-type: none"> <li>➤ Study the technical, environmental and financial viability of evacuated tube SWHS at distinct geographical locations in seven Indian cities.</li> </ul>

Long et al. [166]	Energy Conversion and Management	2021	Study on energy-saving operation of a combined heating system of solar hot water and air source heat pump	Modeling, simulation and experimental	<ul style="list-style-type: none"> <li>➤ Propose a hybrid solar hot water and air source heat pump combined heating system.</li> <li>➤ Simulate and analyze the energy efficiency of the combined heating system during cold season.</li> </ul>
-------------------	----------------------------------	------	---	---------------------------------------	---

## 5- ELECTRICITY CONCERN IN LEBANON

Lebanon is one of the countries that are struggling for several years to meet the energy demand of its population [167]. To clarify, in year 2009 the electricity demand of Lebanon was 2300 MW while the main electricity company in Lebanon, EDL is constantly striving to supply a maximum power delivery of 1500 MW [168]. Consequently, the constant production of electricity in Lebanon and the permanent increase in the population made meeting the electricity demand impossible to be achieved. It has been reported in Yathreb [169] that the energy demand of Lebanese in year 2030 is predicted to be 250% of the energy required in 2010.

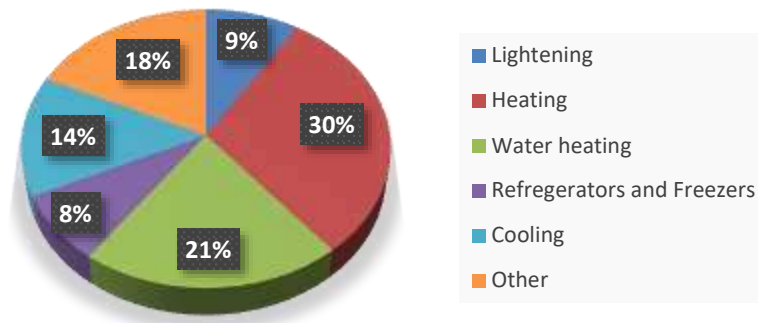

Figure 11. Electricity consumption in Lebanon [170].

Figure 11 shows a pie diagram for electricity consumption [170]. It is clear that the amount of electricity consumed for heating and heating water (30% and 21% respectively) is high compared to the other uses. Thus, heating water requires high amount of electricity in Lebanon which suffers from electricity deficiency. From this point, investment of solar energy may recompense electricity shortage in Lebanon, especially for water heating. This explains that adopting SWHS may be the best solution for electricity crisis in Lebanon. In addition, utilization of solar energy for heating water serve in saving energy consumption which in its turn lead to evolve in the national economy as well as progress in environmental conditions.

In order to emphasize the significance of solar energy to heat water in Lebanon and utilize solar heating systems, economic and environmental analyses will be developed in the coming sections.

### 5.1 Economic study

Martinopoulos and Tsalikis [171] conducted a technical economic and environmental evaluation of a typical solar space and water heating systems for four climatic zones according to Greek regulation.



In order to highlight the economic impact of utilizing solar energy in heating water, a study is developed to evaluate the amount of money saved when using SWHS instead of electric heaters. Then, a common type of SWHS will be taken to calculate its payback period depending on the saved money and the cost of this system. The study is conducted in Lebanon and for several scenarios where each scenario is found in three sizes as shown in table 2. The first case deals with family of 4, 6 and 8 persons, the second case includes school containing 400, 850 and 1200 pupils, the third one is restaurant which serves 25, 60 and 150 services, the fourth case is a four stars hotel with 50, 100 and 200 beds and the last case is gym which includes 30, 50 and 100 persons.

Table 2. The considered scenarios and their sizes.

Case	Size
Family	4 persons
	6 persons
	8 persons
School	400 pupils
	850 pupils
	1200 pupils
Restaurant	25 services
	60 services
	150 services
Hotel	50 beds
	100 beds
	200 beds
Gym	30 persons
	50 persons
	100 persons

### 5.1.1 Saved money

To calculate the amount of monthly consumed energy to heat water to 60°C, the formulas of equations (1) and (2) can be used.

$$Q_{month}^S = N_{days} \cdot \frac{m \cdot C_p \cdot (T_{out} - T_{in}^S)}{\eta} \quad (1)$$

$$Q_{month}^W = N_{days} \cdot \frac{m \cdot C_p \cdot (T_{out} - T_{in}^W)}{\eta} \quad (2)$$

where  $Q_{month}^S$  and  $Q_{month}^W$  are the monthly energy required to heat water (kJ/month) during summer and winter respectively.  $N_{days}$  is the number of days per month, considered equal to 30.  $m$  is the mass of water calculated using equation (3) and  $C_p$  is the specific heat of water equals 4.1855 kJ/kg.K.  $T_{out}$  is the outlet water temperature which is equal to 60°C [172],  $T_{in}^S$  and  $T_{in}^W$  are the inlet water temperatures during summer and winter which are 28°C and 13°C respectively [173].  $\eta$  is the efficiency of the electric heater, equal to 80% [174].

$$m = \rho \cdot V \quad (3)$$

where  $\rho$  is the density of water which is 1000 kg/m<sup>3</sup> and  $V$  is the volume of water. Table 3 shows the daily volume of hot water (HW) required for each type of the studied scenarios (L/day) [175].

Table 3. Amount of HW demand for each scenario [175].

Type of HW costumer	HW demand (L/day)
Family	30 L/person
School	3 L/person
Restaurant	8 L/service
Hotel	70 L/bed
Gym	20 L/person

After estimating the amount of energy required to heat water during summer and winter, the cost of this energy is calculated using formulas of equations (4) and (5).

$$PE_{month}^S = Q_{month}^S \cdot P_{1kWh} \quad (4)$$

$$PE_{month}^W = Q_{month}^W \cdot P_{1kWh} \quad (5)$$

where  $PE_{month}^S$  and  $PE_{month}^W$  are the monthly price of energy consumed (\$/month) during summer and winter and  $P_{1kWh}$  is the price of one kilowatt hour. Table 4 illustrates the price of kWh in Lebanon.

Table 4. Price of kWh in Lebanon [176].

Range	Price (\$)
Below 100 kWh	0.023
100 – 300 kWh	0.040
300 – 400 kWh	0.053
400 – 500 kWh	0.080
Above 500 kWh	0.133

To evaluate the amount of money saved when utilizing SWHS, equation (6) can be utilized.

$$SM_{year} = Pr \cdot [(N_{month}^S \cdot PE_{month}^S) + (N_{month}^W \cdot PE_{month}^W)] \quad (6)$$

where  $SM_{year}$  is the amount of annual saved money (\$/year) and Pr is the percentage of time during when SWHS is utilized.  $N_{month}^S$  and  $N_{month}^W$  are the number of summer and winter months per year. It is assumed that there are six summer and six winter months per year.

Figure 12 shows the variation of saved money for family of 4, 6 and 8 persons. It is clear that as Pr and number of persons in the family increase the amount of saved money increases linearly. For a moderately efficient case where Pr equals to 0.6, the annual amount of saved money is about \$48, \$81 and \$127 for family of 4, 6 and 8 persons respectively. While for a very efficient case (Pr=0.9), the annual amount of saved money is duplicated to \$71, \$121 and \$190 for family of 4, 6 and 8 persons respectively. Moreover, the average ratio of annual saved money per person is \$10.8, \$12.3 and \$14.5 for family of 4, 6 and 8 persons respectively. Hence, the average annual saved money in a family is about 12.5 \$/person.

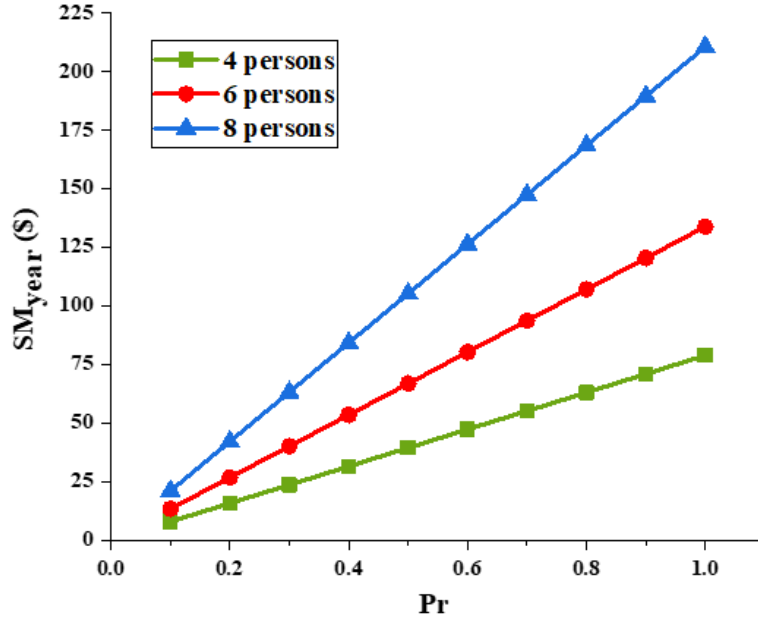

Figure 12. Variation of saved money for family of 4, 6 and 8 persons.

Figure 13 presents the variation of saved money for school of 400, 850 and 1200 pupils. It is obvious that the saved money increases as the utilization of SWHS increases. As Pr increase from 0.6 (moderately efficient case) to 0.9 (highly efficient case), the annual amount of saved increases from \$1073, \$2412, \$3453 to \$1609, \$3618 and \$5180 for school of 400, 850 and 1200 pupils, respectively. Besides, the average ratio of annual saved money per pupil is \$2.5, \$2.6 and \$2.7 for school of 400, 850 and 1200 pupils respectively. Therefore, the average annual saved money in a school is about 2.6 \$/pupil.

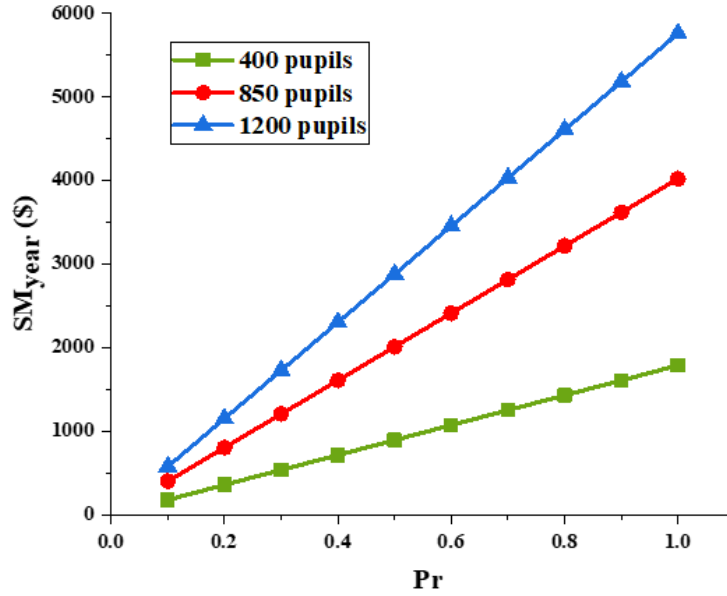

Figure 13. Variation of saved money for school of 400, 850 and 1200 pupils.

Figure 14 illustrates the variation of saved money for restaurant of 25, 60 and 150 services. It is obvious that there is direct relationship between the amount of saved money and the percentage of time where SWHS are used and between the amount of saved money and the number of services of the restaurant. To illustrate, for 60% dependence on SWHS which is a moderately efficient case, the annual amount of saved money is \$81, \$359 and \$1073 for restaurant of 25, 60 and 150 services, respectively. While the increase in the percentage of time when SWHS is used to 90%, the annual amount of saved money is \$121, \$538 and \$1609 for restaurant of 25, 60 and 150 services, respectively. Furthermore, the average ratio of annual saved money per person is \$2.9, \$5.5 and \$6.6 for restaurant of 25, 60 and 150 services respectively. Hence, the average annual saved money in a restaurant is about 5 \$/service.

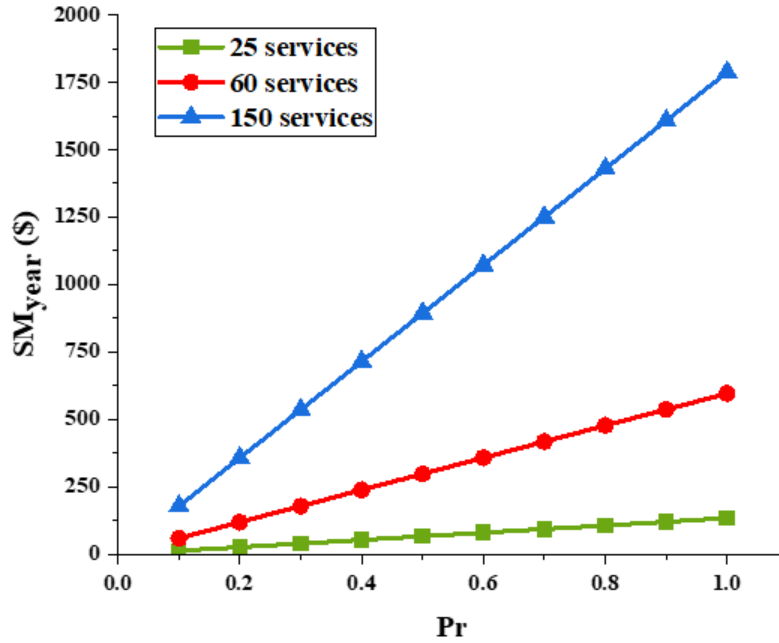

Figure 14. Variation of saved money for restaurant of 25, 60 and 150 services.

Figure 15 shows the variation of saved money for hotel of 50, 100 and 200 beds. For rise in Pr from 0.6 to 0.9, the annual amount of saved money increases from \$3354 to 5031\$, \$6826 to 10239\$ and \$13770 to \$20655 for four stars hotels of 50, 100 and 200 beds. Hence, as Pr and number of beds increase, the amount of saved money increases. Moreover, the average ratio of annual saved money per bed is \$61.5, \$62.6 and \$63.1 for hotel of 50, 100 and 200 beds respectively. Hence, the average annual saved money in a hotel is about 62.4 \$/bed.

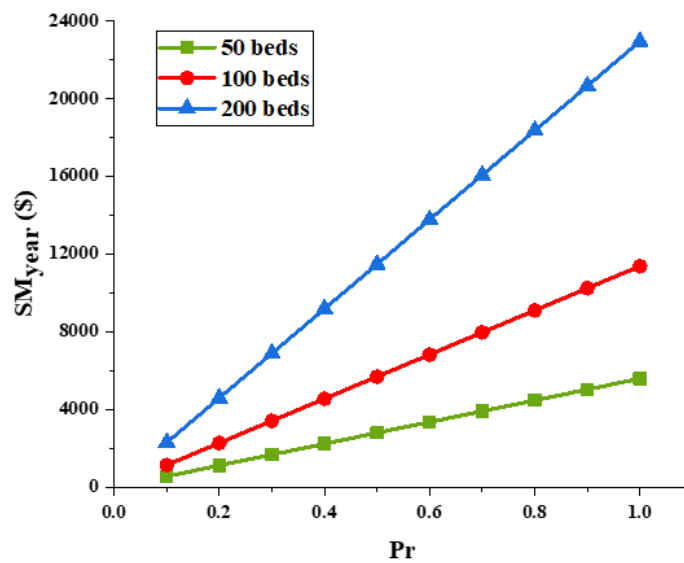

Figure 15. Variation of saved money for hotel of 50, 100 and 200 beds.

Figure 16 represents the variation of saved money for gym of 30, 50 and 100 persons. The annual amount of saved money increases from \$478 to 796\$, \$874 to \$1457 and \$1866 to \$3110 for gym of 30, 50 and 100 persons respectively in the time that Pr rises from 0.6 (moderately efficient case) to 0.9 (highly efficient case). Thus, Pr and number of persons have direct effect on the increase in the amount of saved money when SWHS is utilized. Besides, the average ratio of annual saved money per person is \$14.6, \$16.0 and \$17.1 for gym of 30, 50 and 100 persons respectively. Hence, the average annual saved money in a gym is about 15.9 \$/person.

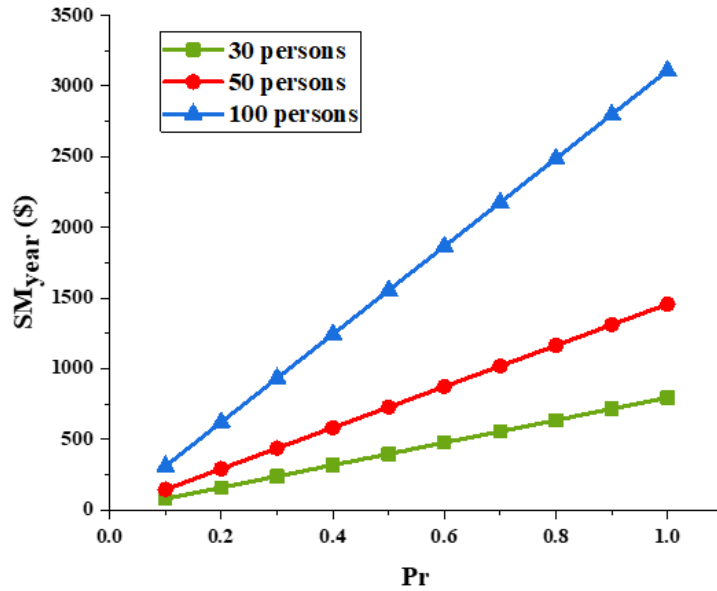

Figure 16. Variation of saved money for gym of 30, 50 and 100 persons.

### 5.1.2 Payback period

Due to the fact that thermosiphon system is the most commonly utilized type of SWHS in Lebanon, it will be taken under consideration in this analysis. Hence, to estimate the payback period of this system formula of equation (7) is used.

$$Pbp = \frac{C_{SWHS_T}}{SM_{year}} \quad (7)$$

where  $Pbp$  is the payback period (month) and  $C_{SWHS_T}$  is the total cost of SWHS (\$).  $C_{SWHS_T}$  is calculated using equation (8).

$$C_{SWHS_T} = C_{SWHS} \cdot N_{SWHS} \quad (8)$$

where  $C_{SWHS}$  is the cost of specific type of SWHS and  $N_{SWHS}$  is the number of SWHS required, computed from equation (9).

$$N_{SWHS} = \frac{V}{Size} \quad (9)$$

where *Size* is the size of SWHS.

Table 5 illustrates the sizes and costs of SWHS in Lebanon and Table 6 shows the number, type and total cost of SWH systems required for each case.

Table 5. Size and cost of SWH systems [177].

Size (L)	Cost (\$)
200	867
250	1134
300	1267

Table 6. Number, type and total cost of SWH systems required for each case.

Type of HW costumer	Number of SWH system	Type of SWH system	Total cost of SWH system (\$)	
Family	4 persons	1	200 L	867
	6 persons	1	250 L	1134
	8 persons	1	300 L	1267
School	400 pupils	4	300 L	5068
	850 pupils	9	300 L	11403
	1200 pupils	12	300 L	15204
Restaurant	25 services	1	300 L	1267
	60 services	2	300 L	2534
	150 services	4	300 L	5068
Hotel	50 beds	12	300 L	15204
	100 beds	24	300 L	30408
	200 beds	47	300 L	59549
Gym	30 persons	2	300 L	2534
	50 persons	4	300 L	5068
	100 persons	7	300 L	8869

Figure 17 shows the variation of payback period for family of 4, 6 and 8 persons. According to equation (7) the payback period and the saved money are inversely proportional to each other. Furthermore, the amount of saved money is directly proportional to the number of persons and  $Pr$ . Hence, the payback period mitigates as the percentage of time for using SWHS and the number of persons increase. To illustrate, for a moderately efficient case ( $Pr$  is 60%), the payback period is about 18.3 years, 14.1 years and 10.0 years for family of 4, 6 and 8 persons respectively. While when  $Pr$  is 90%, the payback period decreases to approximately 12.2 years, 9.4 years and 6.7 years for family of 4, 6 and 8 persons respectively. Hence, the average payback period of SWHS for a family is 14.2 years and 9.5 years in case of moderate and high usage of the system respectively.



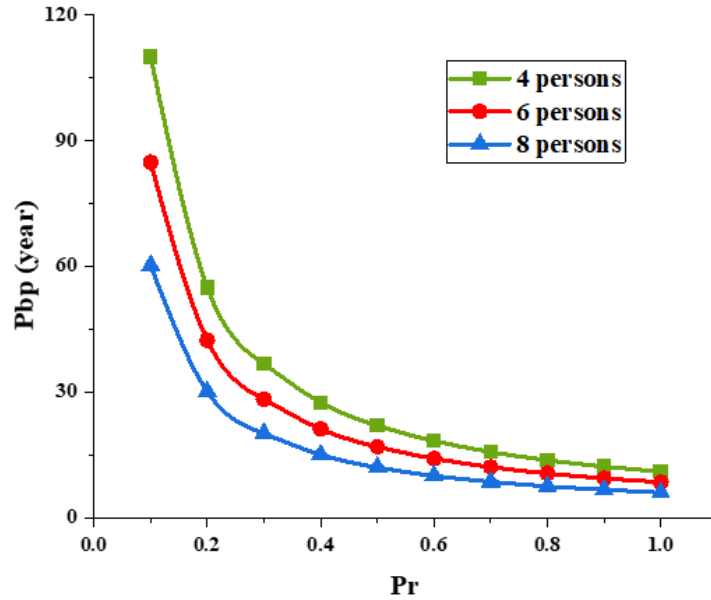

Figure 17. Variation of payback period for family of 4, 6 and 8 persons.

Figure 18 illustrates the variation of payback period season for school of 400, 850 and 1200 pupils. It is obvious that there is inverse relationship between the payback period and the percentage of time where SWHSs are used. Also, the payback period is approximately the same in the three cases. To illustrate, when Pr was 0.6, the payback period in school is about 4.7 years for 400 and 850 pupils and 4.4 years for 1200 pupils. While for a high dependence on SWHS ( $Pr=0.9$ ), the payback period decreased to approximately 3.2 years for 400 and 850 pupils and 2.9 years for 1200 pupils. Hence, regardless to the number of pupils, more utilization of SWHS minimizes its payback period. Furthermore, the average payback period of SWHS for a school is 4.6 years and 3.1 years in case of moderate and high utilization of the system respectively.

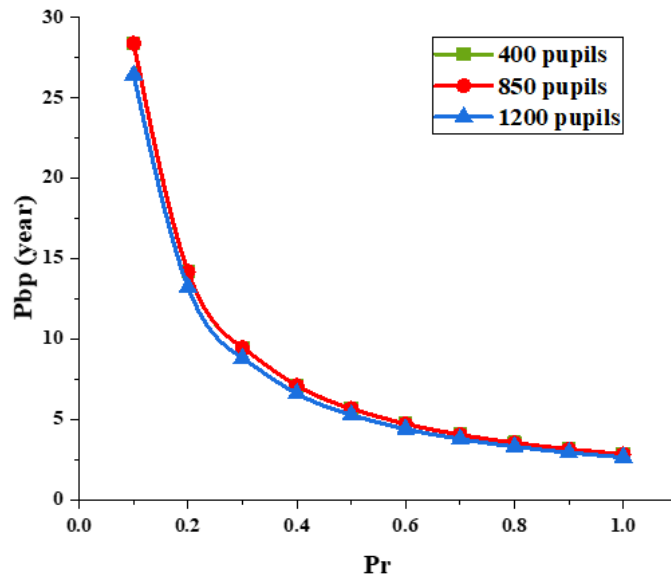

Figure 18. Variation of payback period for school of 400, 850 and 1200 pupils.

Figure 19 represents the variation of payback period for restaurant of 25, 60 and 150 services. The payback period reduces from 15.8 to 10.5, 7.1 to 4.7 and from 4.7 to 3.2 years for restaurant of 25, 60 and 150 services respectively in the time that Pr rises from 0.6 to 0.9. Thus, Pr has direct effect on minimizing the payback period when SWHS is utilized. Hence, as much as the SWHS is used efficiently, the payback period decreases. Besides, the average payback period of SWHS for a restaurant is 9.2 years and 6.1 years for moderately efficient and highly efficient case respectively.

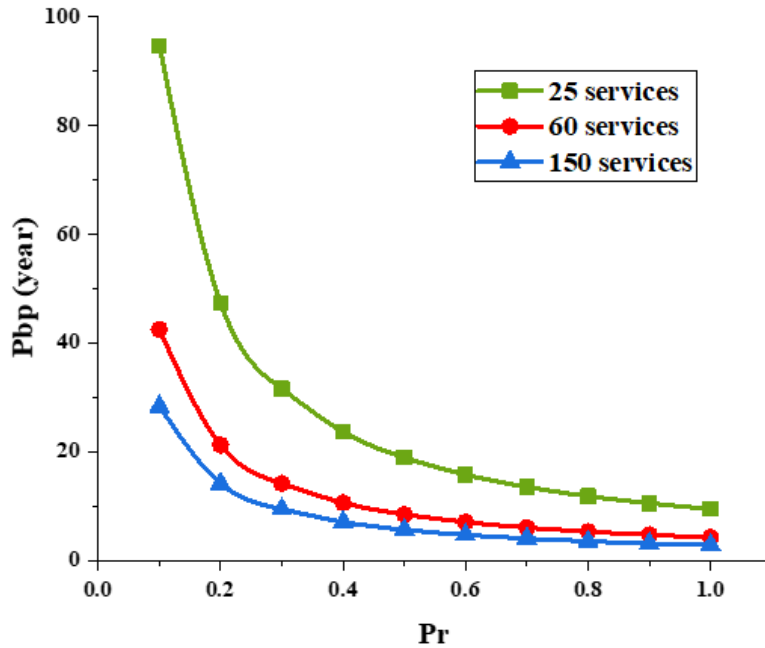

Figure 19. Variation of payback period for restaurant of 25, 60 and 150 services.

Figure 20 presents the variation of payback period for hotel of 50, 100 and 200 beds. It is shown that the payback period decreases with increase in Pr as well but it is not affected as the number of beds in hotel differs. To clarify, the payback period is 4.5 years, 4.4 years and 4.3 years for Pr equals to 0.6 for hotel of 50, 100 and 200 beds respectively. For 90% Pr, the payback period is 3.0, 2.9 and 2.8 years for Pr equals to 0.6 for hotel of 50, 100 and 200 beds respectively. Therefore, the payback period in a hotel is dependent on Pr more than the number of beds. Moreover, the average payback period of SWHS for a hotel is 4.4 years and 2.9 years for moderate and high usage of the system, respectively.

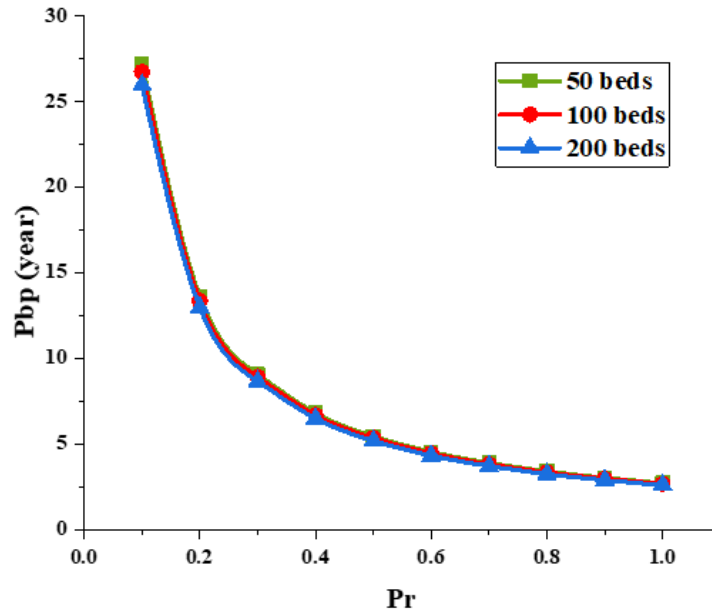

Figure 20. Variation of payback period for hotel of 50, 100 and 200 beds.

Figure 21 shows the variation of payback period for gym of 30, 50 and 100 persons. It is clear that as Pr rises the payback period mitigates. In orders of magnitudes, when Pr increases from 0.6 to 0.9 the payback period decreases from 5.3 to 3.5, 5.8 to 3.9 and from 4.8 to 3.2 years for gym of 30, 50 and 100 persons respectively. Moreover, the average payback period of SWHS for a gym is 5.3 years and 3.5 years for moderate and high exploitation of the system, respectively.

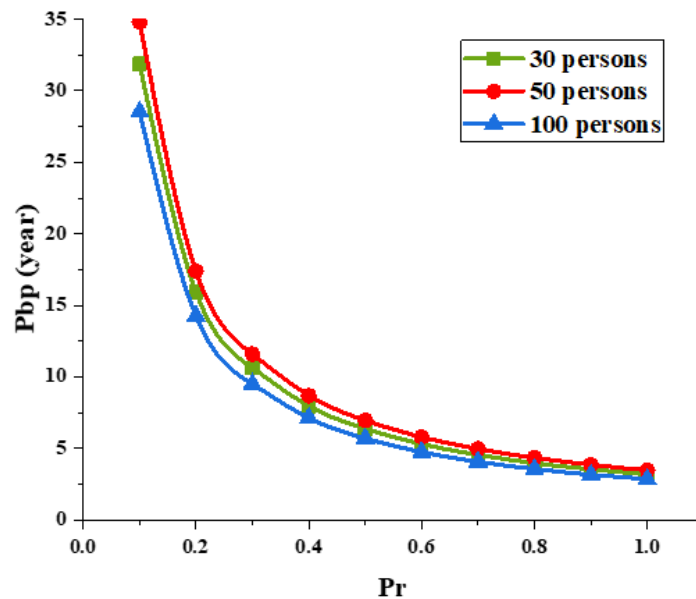

Figure 21. Variation of payback period for gym of 30, 50 and 100 persons.

## 5.2 Environmental study

Koroneos and Namaki [178] investigated the technical and environmental impact of solar water heater using the method of life cycle assessment. Greenhouse effect, ozone depletion, acidification, eutrophication, heavy metals, carcinogens, winter smog and summer smog are the environmental effects that are taken into account in this study. Acidification is the major environmental effect whose percentage reached 54%, while the second one is winter smog potential which reached value of 25%. In third position is the global warming potential due to CO<sub>2</sub>, which is 12%, and the other environmental impacts have lower contribution of 9%. Furundzic et al. [179] presented the privileges that could be maintained when utilizing SWHS instead of water heating systems that rely on conventional fuel oil, electricity or gas based. Bessa and Prado [180] estimated the expected mitigation in carbon dioxide when using SWHS in comparison with electric showers in social houses in various Brazilian climatic zones.

To evaluate the environmental impact of SWHS in Lebanon, a study is developed to compute the amount of carbon dioxide released per month when an electric heater is used. Then, estimate the amount of carbon dioxide emission that will be mitigated by replacing the electric heater by SWHS to demonstrate the privilege of utilizing solar energy in heating water.

The annual amount of CO<sub>2</sub> produced can be calculated from equation (10).

$$M_{produced}^{CO_2} = Q_{year} \cdot M_{1kWh}^{CO_2} \quad (10)$$

where  $M_{produced}^{CO_2}$  is the annual amount of CO<sub>2</sub> produced (ton/year) and  $M_{1kWh}^{CO_2}$  is the amount of CO<sub>2</sub> produced from 1 kWh electricity. In Lebanon it is estimated to be about 0.47 kg CO<sub>2</sub>/1 kWh [174].  $Q_{year}$  is the annual amount of consumed energy (kJ/year) which is calculated using equation (11).

$$Q_{year} = (N_{month}^S \cdot Q_{month}^S) + (N_{month}^W \cdot Q_{month}^W) \quad (11)$$

The annual amount of reduced CO<sub>2</sub> emissions can be computed using the following equation:

$$M_{reduced}^{CO_2} = Pr \cdot M_{produced}^{CO_2} \quad (12)$$

where  $M_{reduced}^{CO_2}$  is the annual amount of CO<sub>2</sub> reduced (ton/year).

Figure 22 illustrates the variation of annual amount of CO<sub>2</sub> mitigated for family of 4, 6 and 8 persons. It is obvious that there is direct relationship between the amount of CO<sub>2</sub> reduced and the percentage of time where SWHS are used and between the amount of CO<sub>2</sub> decreased and the number of persons. To illustrate, when Pr increases from 0.6 to 0.9, the amount of CO<sub>2</sub> mitigated for family of 4, 6 and 8 persons respectively increases from 0.7 to 1.0, 1.0 to 1.6 and 1.4 to 2.1 ton/year. Moreover, the ratio of annual decreased CO<sub>2</sub> emissions to the number of persons in a family is 0.17 ton/person and 0.26 ton/persons for moderately efficient and high efficient case respectively. Furthermore, the average annual amount of CO<sub>2</sub> reduced when SWHS is utilized in a family is 0.16 ton/person.

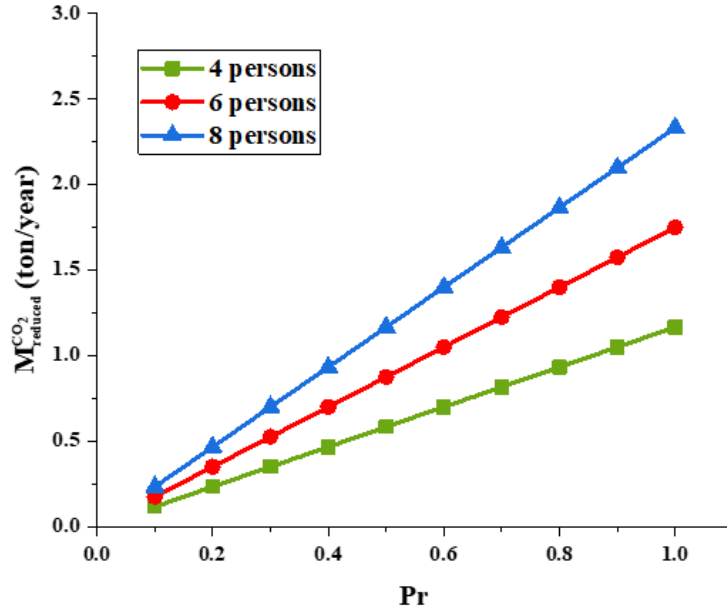

Figure 22. Variation of amount of CO<sub>2</sub> reduced for family of 4, 6 and 8 persons.

Figure 23 shows the variation of amount of CO<sub>2</sub> reduced for school of 400, 850 and 1200 pupils. For rise in Pr from 0.6 to 0.9, the amount of decreased CO<sub>2</sub> increases from 7.0 to 10.5, 14.9 to 22.3 and 21.0 to 31.5 ton/year for school of 400, 850 and 1200 pupils. Hence, as Pr and number of pupils increase, the amount of amount of CO<sub>2</sub> reduced increases. Therefore, for moderately efficient and high efficient case, the ratio of annual mitigated CO<sub>2</sub> emissions to the number of pupils in a school is 0.017 ton/pupil and 0.026 ton/ pupil respectively. Besides, the average annual amount of CO<sub>2</sub> mitigated when SWHS is utilized in a school is 0.016 ton/pupil.

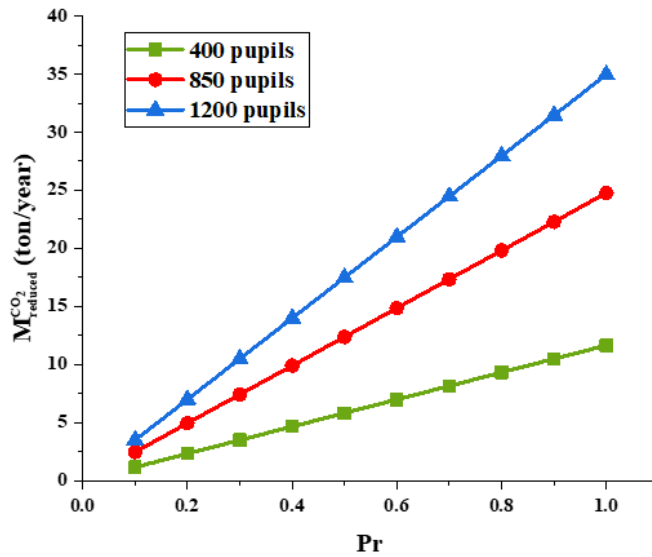

Figure 23. Variation of amount of CO<sub>2</sub> reduced for school of 400, 850 and 1200 pupils.

Figure 24 represents the variation of annual amount of CO<sub>2</sub> decreased for restaurant of 25, 60 and 150 services. The amount of mitigated CO<sub>2</sub> increases from 1.2 to 1.7, 2.8 to 4.2 and 7.01 to 10.5 ton/year for restaurant of 25, 60 and 150 services respectively in the time that Pr rises from 0.6 to 0.9. Thus, Pr and number of services have direct effect on the increase in the amount of CO<sub>2</sub> mitigated when SWHS is utilized instead of electric heater. Furthermore, the ratio of the annual reduced CO<sub>2</sub> emissions to the number of services in a restaurant is 0.05 ton/service and 0.07 ton/service for moderately efficient and high efficient case respectively. Besides, the average annual amount of CO<sub>2</sub> decreases when SWHS is utilized in a restaurant is 0.04 ton/service.

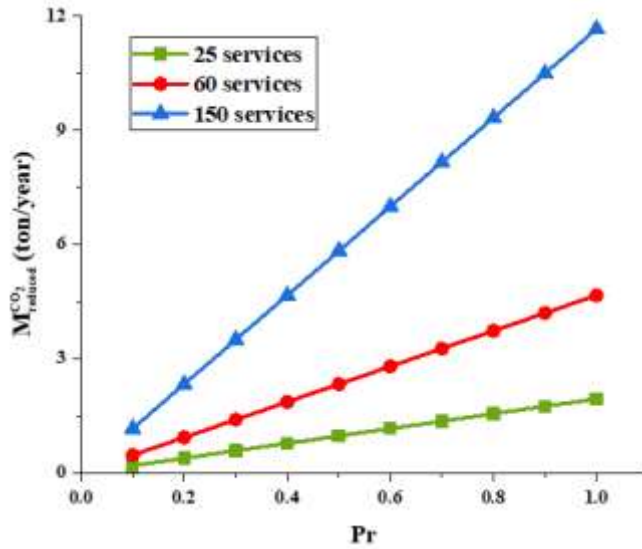

Figure 24. Variation of amount of CO<sub>2</sub> reduced for restaurant of 25, 60 and 150 services.

Figure 25 shows the variation of annual amount of mitigated CO<sub>2</sub> for hotel of 50, 100 and 200 beds. It is clear that as Pr and number of beds in the hotel increase the amount of decreased CO<sub>2</sub> increases. In orders of magnitudes, when Pr rises from 0.6 to 0.9 the amount of mitigated CO<sub>2</sub> rises from 20.4 to 30.6, 40.8 to 61.2 and from 81.6 to 122.4 ton/year for hotel of 50, 100 and 200 beds respectively. Besides, the ratio of the annual alleviated CO<sub>2</sub> emissions to the number of beds in a hotel is 0.41 ton/bed and 0.61 ton/bed for moderately efficient and high efficient case respectively. Moreover, the average annual amount of CO<sub>2</sub> decreases when SWHS is utilized in a hotel is 0.37 ton/bed.

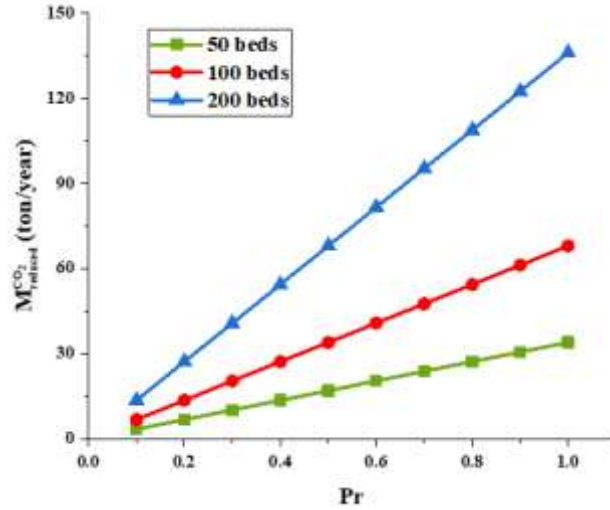

Figure 25. Variation of amount of CO<sub>2</sub> reduced for hotel of 50, 100 and 200 beds.

Figure 26 presents the variation of annual amount of reduced CO<sub>2</sub> for gym of 30, 50 and 100 persons. It is shown that the amount of decreased CO<sub>2</sub> increases with increase in Pr as well as the number of persons. To clarify, the amount of mitigated CO<sub>2</sub> rises from 3.5 to 5.2, 5.8 to 8.7 and from 11.7 to 17.5 ton/year for gym of 30, 50 and 100 persons respectively when Pr increases from 60 to 90%. Moreover, the ratio of the annual reduced CO<sub>2</sub> emissions to the number of persons in a gym for moderately efficient and high efficient case is 0.12 ton/person and 0.17 ton/person respectively. Moreover, the average annual amount of CO<sub>2</sub> decreases when SWHS is utilized in a gym is 0.11 ton/person.

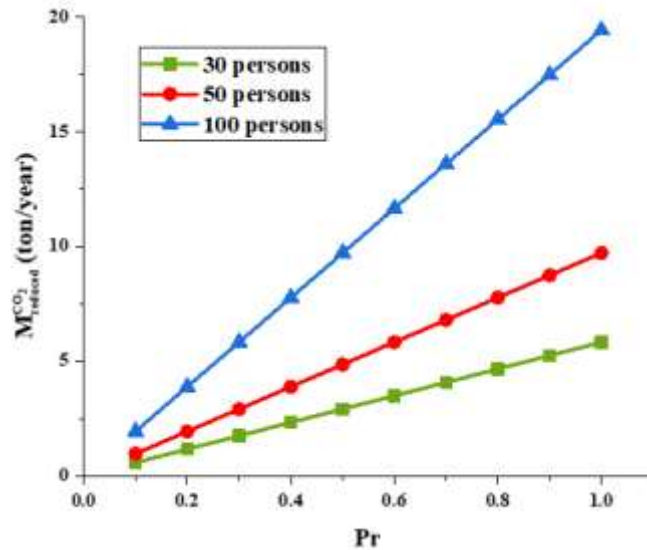

Figure 26. Variation of amount of CO<sub>2</sub> reduced for gym of 30, 50 and 100 persons.



## 6- CONCLUSIONS

Solar energy is a renewable energy that has tremendous effect on human life and environment. Solar water heating is an efficient application of solar energy due to the fact that hot water is essential for public, schools, hotels, restaurants, etc. Thus, such application exploits the thermal solar energy and serve in solving the current problems regarding depletion of fossil fuel in addition to the environmental and economic disasters.

In this work, a short review on SWHS is presented. The principle, components and classifications are carried out with a brief description of mode of operation of each kind. Also, the previous researches implemented on SWHS and the pros and cons of such system are summarized in this work. Besides, electricity concern in Lebanon is exposed. In addition to that, economic and environmental analyses have been conducted to quantify the effects of utilizing SWHS instead of electric heater.

The economic study was implemented to compute the payback period for several scenarios in Lebanon where  $Pr$  is varied from 0.1 to 1. The scenarios include family of 4, 6 and 8 persons, school of 400, 850 and 1200 pupils, restaurant of 25, 60 and 150 services, hotel of 50, 100 and 200 beds and gym of 30, 50 and 100 persons. The results confirmed that there is inversely relationship between  $Pr$  and payback period. The results show that for a moderate and high utilization of SWHS the average payback period of the system is 14.2 years and 9.5 years for a family, 4.6 years and 3.1 years for a school, 9.2 years and 6.1 years for a restaurant, 4.4 years and 2.9 years for a hotel, and 5.3 years and 3.5 years for a gym.

The environmental study was conducted on the aforementioned scenarios to shed light on the effect of utilizing solar energy for heating water on carbon dioxide production. It was obtained that SWHS serves in mitigating carbon dioxide emissions in which  $Pr$  and reduction in carbon dioxide production has a proportional relationship. It was also shown that for moderate and high utilization of SWHS, the annual amount of  $CO_2$  reduced is respectively about 0.17 ton/person and 0.26 ton/person in a family, 0.017 ton/pupil and 0.026 ton/pupil in a school, 0.05 ton/service and 0.07 ton/service in a restaurant, 0.41 ton/bed and 0.61 ton/bed in a hotel, and 0.12 ton/person and 0.17 ton/person in a gym. Hence, if SWHS is utilized in family, school, restaurant, hotel and gym the average annual amount of  $CO_2$  mitigated is 0.16 ton/person, 0.016 ton/pupil, 0.04 ton/service, 0.37 ton/bed and 0.11 ton/person, respectively.

This paper clearly investigates the significant influence of SWHS on economic and environmental sides and inevitably on health of human beings. Due to this, it is anticipated that utilization of SWHS will be one of the priority and will be spread all over the world, likewise in Lebanon country.

## 7- REFERENCES

- [1] Handayani NA, Ariyanti D. Potency of Solar Energy Applications in Indonesia. *Int J Renew Energy Dev* 2012;1:33–8.
- [2] Hasan MH, Mahlia TMI, Nur H. A review on energy scenario and sustainable energy in Indonesia. *Renew Sustain Energy Rev* 2012;16:2316–28. doi:10.1016/j.rser.2011.12.007.
- [3] Mekhilef S, Saidur R, Safari A. A review on solar energy use in industries. *Renew Sustain Energy Rev* 2011;15:1777–90. doi:10.1016/j.rser.2010.12.018.
- [4] Ikpesu JE, Iyuke SE, Daramola M, Okewale AO. Synthesis of improved dye-sensitized solar cell for renewable energy power generation. *Sol Energy* 2020;206:918–34. doi:10.1016/j.solener.2020.05.002.
- [5] Elghamry R, Hassan H. Experimental investigation of building heating and ventilation by using Trombe wall coupled with renewable energy system under semi-arid climate conditions. *Sol Energy* 2020;201:63–74. doi:10.1016/j.solener.2020.02.087.
- [6] Jurasz J, Canales FA, Kies A, Guezgouz M, Beluco A. A review on the complementarity of renewable energy sources: Concept, metrics, application and future research directions. *Sol Energy* 2020;195:703–24.

- doi:10.1016/j.solener.2019.11.087.
- [7] Dong Z, Bingyang L, Qintong Z, Jinping L. Thermal performance and energy characteristic analysis of multiple renewable energy complementary heat pump system. *Sol Energy* 2020;196:287–94. doi:10.1016/j.solener.2019.12.030.
- [8] Hamidi MN, Ishak D, Mohd Zainuri MAA, Ooi CA. An asymmetrical multilevel inverter with optimum number of components based on new basic structure for photovoltaic renewable energy system. *Sol Energy* 2020;204:13–25. doi:10.1016/j.solener.2020.04.056.
- [9] Jaber H, Khaled M, Lemenand T, Ramadan M. Short review on heat recovery from exhaust gas. *AIP Conf. Proc.*, vol. 1758, AIP Publishing LLC; 2016, p. 030045. doi:10.1063/1.4959441.
- [10] Khaled M, Ramadan M. Heating fresh air by hot exhaust air of HVAC systems. *Case Stud Therm Eng* 2016;8:398–402. doi:10.1016/J.CSITE.2016.10.004.
- [11] Khaled M, Ramadan M. Study of the Thermal Behavior of Multi Tube Tank in Heat Recovery from Chimney—Analysis and Optimization. *Heat Transf Eng* 2018;39:399–409. doi:10.1080/01457632.2017.1312864.
- [12] Jaber H, Khaled M, lemenand T, Faraj J, Bazzi H, Ramadan M, et al. Short review on heat recovery from exhaust gas. *Case Stud Therm Eng* 2015;119:95–110. doi:10.1016/J.RSER.2017.08.016.
- [13] Jaber H, Khaled M, Lemenand T, Murr R, Faraj J, Ramadan M. Domestic thermoelectric cogeneration drying system: Thermal modeling and case study. *Energy* 2019;170:1036–50. doi:10.1016/j.energy.2018.12.071.
- [14] Jaber H, Khaled M, Lemenand T, Faraj J, Bazzi H, Ramadan M. Effect of Exhaust Gases Temperature on the Performance of a Hybrid Heat Recovery System. *Energy Procedia*, vol. 119, Elsevier Ltd; 2017, p. 775–82. doi:10.1016/j.egypro.2017.07.110.
- [15] Jaber H, Khaled M, Lemenand T, Ramadan M. Effect of generator load on hybrid heat recovery system. *Case Stud Therm Eng* 2019;13:100359. doi:10.1016/j.csite.2018.11.010.
- [16] Shivaie M, Mokhayeri M, Kiani-Moghaddam M, Ashouri-Zadeh A. A reliability-constrained cost-effective model for optimal sizing of an autonomous hybrid solar/wind/diesel/battery energy system by a modified discrete bat search algorithm. *Sol Energy* 2019;189:344–56. doi:10.1016/j.solener.2019.07.075.
- [17] Zhang G, Wu B, Maleki A, Zhang W. Simulated annealing-chaotic search algorithm based optimization of reverse osmosis hybrid desalination system driven by wind and solar energies. *Sol Energy* 2018;173:964–75. doi:10.1016/j.solener.2018.07.094.
- [18] Guo S, He Y, Pei H, Wu S. The multi-objective capacity optimization of wind-photovoltaic-thermal energy storage hybrid power system with electric heater. *Sol Energy* 2020;195:138–49. doi:10.1016/j.solener.2019.11.063.
- [19] Herez A, Ramadan M, Abdulhay B, Khaled M. Short review on solar energy systems. *AIP Conf. Proc.*, vol. 1758, AIP Publishing LLC; 2016, p. 030041. doi:10.1063/1.4959437.
- [20] Herez A, Ramadan M, Khaled M. Review on solar cooker systems: Economic and environmental study for different Lebanese scenarios. *Renew Sustain Energy Rev* 2018;81:421–32. doi:10.1016/J.RSER.2017.08.021.
- [21] El Hage H, Herez A, Ramadan M, Bazzi H, Khaled M. An investigation on solar drying: A review with economic and environmental assessment. *Energy* 2018;157:815–29. doi:10.1016/j.energy.2018.05.197.
- [22] Herez A, Ramadan M, Khaled M, Bazzi H. A Review on Solar Dryer - Economic and Environmental Investigation for the Lebanese Case. *10TH Int. Conf. Sustain. Energy Environ. Prot.*, Slovenia; 2017.
- [23] Herez A, El Hage H, Lemenand T, Ramadan M, Khaled M. Review on photovoltaic/thermal hybrid solar collectors: Classifications, applications and new systems. *Sol Energy* 2020;207:1321–47. doi:10.1016/j.solener.2020.07.062.
- [24] Herez A, El Hage H, Lemenand T, Ramadan M, Khaled M. Parabolic trough photovoltaic/thermal hybrid system: Thermal modeling and parametric analysis. *Renew Energy* 2021;165:224–36. doi:10.1016/j.renene.2020.11.009.
- [25] Herez A, Khaled M, Murr R, Haddad A, Elhage H, Ramadan M. Using Geothermal Energy for cooling - Parametric study. *Energy Procedia* 2017;119:783–91. doi:10.1016/J.EGYPRO.2017.07.111.
- [26] Boughanmi H, Lazaar M, Guizani A. A performance of a heat pump system connected a new conic helicoidal geothermal heat exchanger for a greenhouse heating in the north of Tunisia. *Sol Energy* 2018;171:343–53. doi:10.1016/j.solener.2018.06.054.
- [27] Ananno AA, Masud MH, Dabnichki P, Ahmed A. Design and numerical analysis of a hybrid geothermal PCM flat plate solar collector dryer for developing countries. *Sol Energy* 2020;196:270–86. doi:10.1016/j.solener.2019.11.069.
- [28] Elghamry R, Hassan H. An experimental work on the impact of new combinations of solar chimney, photovoltaic and geothermal air tube on building cooling and ventilation. *Sol Energy* 2020;205:142–53. doi:10.1016/j.solener.2020.05.049.
- [29] Bazgaou A, Fatnassi H, Bouharrou R, Elame F, Ezzaeri K, Gourdo L, et al. Performance assessment of combining rock-bed thermal energy storage and water filled passive solar sleeves for heating Canarian greenhouse. *Sol Energy* 2020;198:8–24. doi:10.1016/j.solener.2020.01.041.
- [30] Ran S, Li X, Xu W, Wang B. A solar-air hybrid source heat pump for space heating and domestic hot water. *Sol Energy* 2020;199:347–59. doi:10.1016/j.solener.2020.02.038.
- [31] Zhang T, Yan ZW, Wang LY, Zheng WJ, Su YH. Comparative study on the annual performance between loop thermosyphon solar water heating system and conventional solar water heating system. *Sol Energy* 2020;197:433–42. doi:10.1016/j.solener.2020.01.019.
- [32] Seddegh S, Wang X, Henderson AD, Xing Z. Solar domestic hot water systems using latent heat energy storage medium: A review. *Renew Sustain Energy Rev* 2015;49:517–33. doi:10.1016/j.rser.2015.04.147.
- [33] Laddha V, Zamre GS. Review on Formation of Solar Water Heating System . *Int J Emerg Technol Adv Eng*

- 2015;5:325–8.
- [34] Wang Z, Yang W. A review on loop heat pipe for use in solar water heating. *Energy Build* 2014;79:143–54. doi:10.1016/j.enbuild.2014.04.051.
- [35] Wang W, He S, Guo S, Yan J, Ding J. A combined experimental and simulation study on charging process of Erythritol-HTO direct-blending based energy storage system. *Energy Convers Manag* 2014;83:306–13. doi:10.1016/j.enconman.2014.03.054.
- [36] Sharif MKA, Al-Abidi AA, Mat S, Sopian K, Ruslan MH, Sulaiman MY, et al. Review of the application of phase change material for heating and domestic hot water systems. *Renew Sustain Energy Rev* 2015;42:557–68. doi:10.1016/j.rser.2014.09.034.
- [37] Pandey AK, Ali Laghari I, Reji Kumar R, Chopra K, Samykano M, Abusorrah AM, et al. Energy, exergy, exergoeconomic and enviroeconomic (4-E) assessment of solar water heater with/without phase change material for building and other applications: A comprehensive review. *Sustain Energy Technol Assessments* 2021;45:101139. doi:10.1016/j.seta.2021.101139.
- [38] Gautam A, Chamoli S, Kumar A, Singh S. A review on technical improvements, economic feasibility and world scenario of solar water heating system. *Renew Sustain Energy Rev* 2017;68:541–62. doi:10.1016/j.rser.2016.09.104.
- [39] Jamar A, Majid ZAA, Azmi WH, Norhafana M, Razak AA. A review of water heating system for solar energy applications. *Int Commun Heat Mass Transf* 2016;76:178–87. doi:10.1016/j.icheatmasstransfer.2016.05.028.
- [40] Raza Kalair A, Abbas N, Seyedmahmoudian M, Stojcevski A, Dilshad S. Performance assessment of solar water heating system using CO<sub>2</sub> under various climate conditions. *Energy Convers Manag* 2021;236:114061. doi:10.1016/j.enconman.2021.114061.
- [41] Hajj Shehadeh N. Lebanon 's First National Survey Study of The 2014.
- [42] Hourri A. Renewable Energy Resources in Lebanon : Practical Applications. *Sci Technol Vis* 2005;1:65–8. doi:10.1094/PD-80-0711C.
- [43] Garg M, Kumar A, D.P.Singh. SOLAR WATER HEATING SYSTEM (SWHS). *Int J Eng Res Manag Technol* 2015;2:268–71.
- [44] Ruicheng Z. Evaluation Standard for Solar Water Heating System of Civil Buildings in China. *Energy Procedia* 2014;57:2461–6. doi:10.1016/j.egypro.2014.10.255.
- [45] Andersen E, Chen Z, Fan J, Furbo S, Perers B. Investigations of intelligent solar heating systems for single family house. *Energy Procedia* 2014;48:1–8. doi:10.1016/j.egypro.2014.02.002.
- [46] Whaley DM, Saman WY, Alemu AT. Integrated solar thermal system for water and space heating, dehumidification and cooling. *Energy Procedia* 2014;57:2590–9. doi:10.1016/j.egypro.2014.10.270.
- [47] Daghigh R, Ruslan MH, Sopian K. Parametric studies of an active solar water heating system with various types of PVT collectors. *Sadhana - Acad Proc Eng Sci* 2015;40:2177–96. doi:10.1007/s12046-015-0417-z.
- [48] Lima TP, Dutra JCC, Primo ARM, Rohatgi J, Ochoa AA V. Solar water heating for a hospital laundry: A case study. *Sol Energy* 2015;122:737–48. doi:10.1016/j.solener.2015.10.006.
- [49] Eicher S, Hildbrand C, Kleijer A, Bony J, Bunea M, Citherlet S. Life cycle impact assessment of a solar assisted heat pump for domestic hot water production and space heating. *Energy Procedia* 2014;48:813–8. doi:10.1016/j.egypro.2014.02.094.
- [50] Fação J, Lobato A, Baldo C. The COOLSUN triple-technology approach to reach high solar fractions for space heating, space cooling and domestic hot water. *Energy Procedia* 2014;48:554–60. doi:10.1016/j.egypro.2014.02.065.
- [51] Glembin J, Haselhorst T, Steinweg J, Föste S, Rockendorf G. Direct integration of solar heat into the space heating circuit. *Sol Energy* 2016;131:1–20. doi:10.1016/j.solener.2016.02.032.
- [52] Ko MJ. A novel design method for optimizing an indirect forced circulation solar water heating system based on life cycle cost using a genetic algorithm. *Energies* 2015;8:11592–617. doi:10.3390/en81011592.
- [53] Shukla R, Sumathy K, Erickson P, Gong J. Recent advances in the solar water heating systems: A review. *Renew Sustain Energy Rev* 2013;19:173–90. doi:10.1016/j.rser.2012.10.048.
- [54] Statista. Global solar water heating capacity by country 2018. <https://www.statista.com/statistics/260697/global-solar-water-heating-capacity/>.
- [55] Tian Y, Zhao CY. A review of solar collectors and thermal energy storage in solar thermal applications. *Appl Energy* 2013;104:538–53. doi:10.1016/j.apenergy.2012.11.051.
- [56] Ramasamy S, Balashanmugam P. Thermal Performance Analysis of the Solar Water Heater with Circular and Rectangular Absorber Fins. *Int J Innov Sci Eng Technol* 2015;2:596–603.
- [57] Roberts DE, Forbes A. An analytical expression for the instantaneous efficiency of a flat plate solar water heater and the influence of absorber plate absorptance and emittance. *Sol Energy* 2012;86:1416–27. doi:10.1016/j.solener.2012.01.032.
- [58] Feliński P, Sekret R. Effect of PCM application inside an evacuated tube collector on the thermal performance of a domestic hot water system. *Energy Build* 2017;152:558–67. doi:10.1016/J.ENBUILD.2017.07.065.
- [59] Sadhishkumar S, Balusamy T. Performance improvement in solar water heating systems - A review. *Renew Sustain Energy Rev* 2014;37:191–8. doi:10.1016/j.rser.2014.04.072.
- [60] Wang Z, Yang W, Qiu F, Zhang X, Zhao X. Solar water heating: From theory, application, marketing and research. *Renew Sustain Energy Rev* 2015;41:68–84. doi:10.1016/j.rser.2014.08.026.
- [61] Stallon SD, Kasim MM, Nagarajan K, Kumar P. A Descriptive Study on Various Types of Solar Water Heating Systems in Buildings with its Parameters. *Int J Innov Res Sci Technol* 2015;1:122–8.

- [62] Jamar A, Majid ZAA, Azmi WH, Norhafana M, Razak AA. A review of water heating system for solar energy applications. *Int Commun Heat Mass Transf* 2016;76:178–87. doi:10.1016/j.icheatmasstransfer.2016.05.028.
- [63] Patel K, Patel P, Patel J. Review of Solar Water Heating Systems. *Int J Adv Eng Technol* 2012;3:146–9.
- [64] Article R, Chaudhari S, Parmar N, Panchal HN, Engineering GP. A critical review on solar water heater. *Int J Adv Eng Technol* 2013;IV:1–3.
- [65] Ramesh Tiwari, Jaurkar AR. Theoretical Analysis of Solar Water Heater-A Review. *Glob J Multidiscip Stud* 2014;3:1–6.
- [66] Shelke VG, Patil C V, Sontakke KR. Solar Water Heating Systems : A Review. *Int Conf Emerg Vista Technol 21st Century* 2015;3:13–7. doi:10.13140/2.1.1910.5281.
- [67] Ntsaluba S, Zhu B, Xia X. Optimal flow control of a forced circulation solar water heating system with energy storage units and connecting pipes. *Renew Energy* 2016;89:108–24. doi:10.1016/j.renene.2015.11.047.
- [68] Carbonell D, Cadafalch J, Consul R. Dynamic modelling of flat plate solar collectors: Analysis and validation under thermosyphon conditions. *Sol Energy* 2013;89:100–12. doi:10.1016/j.solener.2012.12.014.
- [69] Liu ZH, Hu RL, Lu L, Zhao F, Xiao HS. Thermal performance of an open thermosyphon using nanofluid for evacuated tubular high temperature air solar collector. *Energy Convers Manag* 2013;73:135–43. doi:10.1016/j.enconman.2013.04.010.
- [70] Chargui R, Sammouda H. Effects of different collector's area on the coupling of a thermosyphon collector and a single zone. *Energy Convers Manag* 2014;77:356–68. doi:10.1016/j.enconman.2013.09.059.
- [71] Jaisankar S, Ananth J, Thulasi S, Jayasuthakar ST, Sheeba KN. A comprehensive review on solar water heaters. *Renew Sustain Energy Rev* 2011;15:3045–50. doi:10.1016/j.rser.2011.03.009.
- [72] Ceylan I. Energy and exergy analyses of a temperature controlled solar water heater. *Energy Build* 2012;47:630–5. doi:10.1016/j.enbuild.2011.12.040.
- [73] Liu YM, Chung KM, Chang KC, Lee TS. Performance of thermosyphon solar water heaters in series. *Energies* 2012;5:3266–78. doi:10.3390/en5093266.
- [74] Devanarayanan K, Kalidasa Murugavel K. Integrated collector storage solar water heater with compound parabolic concentrator - Development and progress. *Renew Sustain Energy Rev* 2014;39:51–64. doi:10.1016/j.rser.2014.07.076.
- [75] Souliotis M, Chemisana D, Caouris YG, Tripanagnostopoulos Y. Experimental study of integrated collector storage solar water heaters. *Renew Energy* 2013;50:1083–94. doi:10.1016/j.renene.2012.08.061.
- [76] Souliotis M, Panaras G, Fokaides PA, Papaefthimiou S, Kalogirou SA. Solar water heating for social housing: Energy analysis and Life Cycle Assessment. *Energy Build* 2018;169:157–71. doi:10.1016/J.ENBUILD.2018.03.048.
- [77] Singh R, Lazarus IJ, Souliotis M. Recent developments in integrated collector storage (ICS) solar water heaters: A review. *Renew Sustain Energy Rev* 2016;54:270–98. doi:10.1016/j.rser.2015.10.006.
- [78] Jadhav AS, Gudekar AS, Patil RG, Kale DM, Panse S V., Joshi JB. Performance analysis of a novel and cost effective CPC system. *Energy Convers Manag* 2013;66:56–65. doi:10.1016/j.enconman.2012.09.030.
- [79] Kessentini H, Bouden C. Numerical and experimental study of an integrated solar collector with CPC reflectors. *Renew Energy* 2013;57:577–86. doi:10.1016/j.renene.2013.02.015.
- [80] Camargo Nogueira CE, Vidotto ML, Toniazzo F, Debastiani G. Software for designing solar water heating systems. *Renew Sustain Energy Rev* 2016;58:361–75. doi:10.1016/j.rser.2015.12.346.
- [81] Kalogirou SA, Agathokleous R, Barone G, Buonomano A, Forzano C, Palombo A. Development and validation of a new TRNSYS Type for thermosyphon flat-plate solar thermal collectors: energy and economic optimization for hot water production in different climates. *Renew Energy* 2019;136:632–44. doi:10.1016/J.RENENE.2018.12.086.
- [82] Hashim WM, Shomran AT, Jurmut HA, Gaaz TS, Kadhum AAH, Al-Amiery AA. Case study on solar water heating for flat plate collector. *Case Stud Therm Eng* 2018;12:666–71. doi:10.1016/J.CSITE.2018.09.002.
- [83] Sekhar Dondapati R, Agarwal R, Saini V, Vyas G, Thakur J. Effect of Glazing Materials on the Performance of Solar Flat Plate Collectors for Water Heating Applications. *Mater Today Proc* 2018;5:27680–9. doi:10.1016/J.MATPR.2018.10.002.
- [84] Sint NKC, Choudhury IA, Masjuki HH, Aoyama H. Theoretical analysis to determine the efficiency of a CuO-water nanofluid based-flat plate solar collector for domestic solar water heating system in Myanmar. *Sol Energy* 2017;155:608–19. doi:10.1016/J.SOLENER.2017.06.055.
- [85] Wannagosit C, Sakulchangsattajai P, Kammuang-lue N, Terdtoon P. Validated mathematical models of a solar water heater system with thermosyphon evacuated tube collectors. *Case Stud Therm Eng* 2018;12:528–36. doi:10.1016/J.CSITE.2018.07.005.
- [86] Feliński P, Sekret R. Effect of PCM application inside an evacuated tube collector on the thermal performance of a domestic hot water system. *Energy Build* 2017;152:558–67. doi:10.1016/J.ENBUILD.2017.07.065.
- [87] Daghigh R, Shafieian A. Theoretical and experimental analysis of thermal performance of a solar water heating system with evacuated tube heat pipe collector. *Appl Therm Eng* 2016;103:1219–27. doi:10.1016/J.APPLTHERMALENG.2016.05.034.
- [88] Shafieian A, Khiadani M, Nosrati A. Thermal performance of an evacuated tube heat pipe solar water heating system in cold season. *Appl Therm Eng* 2019;149:644–57. doi:10.1016/J.APPLTHERMALENG.2018.12.078.
- [89] Salgado Conrado L, Rodriguez-Pulido A, Calderón G. Thermal performance of parabolic trough solar collectors. *Renew Sustain Energy Rev* 2017;67:1345–59. doi:10.1016/J.RSER.2016.09.071.
- [90] Zou B, Dong J, Yao Y, Jiang Y. An experimental investigation on a small-sized parabolic trough solar collector for

- water heating in cold areas. *Appl Energy* 2016;163:396–407. doi:10.1016/J.APENERGY.2015.10.186.
- [91] Hafez AZ, Attia AM, Eltwab HS, Elkousy AO, Afifi AA, Abdelhamid AG, et al. Design analysis of solar parabolic trough thermal collectors. *Renew Sustain Energy Rev* 2018;82:1215–60. doi:10.1016/J.RSER.2017.09.010.
- [92] Patel MP V, Patel HD, Prof A, Patel PJ. Design and Fabrication of Parabolic Trough Solar Water Heater for Hot Water Generation. *Int J Eng Res Technol* 2012;1:1–9.
- [93] Ramadan M, Khaled M, Abdulhay B, Hammoud M, Shaito A. ESDA2014-20593 USING PARABOLIC TROUGH CONCENTRATORS WITH TRACKING SYSTEM FOR The Solar Tracking Parabolic troughs Water Heating. Proc 12th Bienn Conf Eng Syst Des Anal 2014:1–5.
- [94] Khaled M, Beltagy H, Shaito A, El Hage H, Ramadan M. Heating residential water using parabolic trough concentrators: Theoretical calculations and analysis. *Prog Ind Ecol* 2016;10:321–33. doi:10.1504/PIE.2016.083910.
- [95] Zou B, Dong J, Yao Y, Jiang Y. An experimental investigation on a small-sized parabolic trough solar collector for water heating in cold areas. *Appl Energy* 2016;163:396–407. doi:10.1016/J.APENERGY.2015.10.186.
- [96] Kalogirou SA, Papamarcou C. Modelling of a thermosiphon solar water heating system and simple model validation. *Renew Energy* 2000;21:471–93. doi:10.1016/S0960-1481(00)00086-0.
- [97] Kalogirou SA, Panteliou S. Thermosiphon solar domestic water heating systems: long-term performance prediction using artificial neural networks. *Sol Energy* 2000;69:163–74. doi:10.1016/S0038-092X(00)00058-X.
- [98] Faiman D, Hazan H, Laufer IDO. Reducing the Heat Loss At Night From Solar Water Heaters of the Integrated Collector – Storage Variety. *Sol Energy* 2001;71:87–93.
- [99] Diakoulaki D, Zervos A, Sarafidis J, Mirasgedis S. Cost benefit analysis for solar water heating systems. *Energy Convers Manag* 2001;42:1727–39. doi:10.1016/S0196-8904(00)00153-9.
- [100] Bojić M, Kalogirou S, Petronijević K. Simulation of a solar domestic water heating system using a time marching model. *Renew Energy* 2002;27:441–52. doi:10.1016/S0960-1481(01)00098-2.
- [101] Chuawittayawuth K, Kumar S. Experimental investigation of temperature and flow distribution in a thermosiphon solar water heating system. *Renew Energy* 2002;26:431–48. doi:10.1016/S0960-1481(01)00085-4.
- [102] Mohsen MS, Akash BA. On integrated solar water heating system. *Int Commun Heat Mass Transf* 2002;29:135–40. doi:10.1016/S0735-1933(01)00332-3.
- [103] Kuang YH, Wang RZ, Yu LQ. Experimental study on solar assisted heat pump system for heat supply. *Energy Convers Manag* 2003;44:1089–98. doi:10.1016/S0196-8904(02)00110-3.
- [104] Chyng JP, Lee CP, Huang BJ. Performance analysis of a solar-assisted heat pump water heater. *Sol Energy* 2003;74:33–44. doi:10.1016/S0038-092X(03)00110-5.
- [105] Smyth M, Eames PC, Norton B. Heat retaining integrated collector/storage solar water heaters. *Sol Energy* 2003;75:27–34. doi:10.1016/S0038-092X(03)00229-9.
- [106] Langniss O, Ince D. Solar water heating: A viable industry in developing countries. *Refocus* 2004;5:18–21. doi:10.1016/S1471-0846(04)00137-4.
- [107] Tripanagnostopoulos Y, Souliotis M. ICS solar systems with horizontal cylindrical storage tank and reflector of CPC or involute geometry. *Renew Energy* 2004;29:13–38. doi:10.1016/S0960-1481(03)00139-3.
- [108] Souliotis M, Tripanagnostopoulos Y. Experimental study of CPC type ICS solar systems. *Sol Energy* 2004;76:389–408. doi:10.1016/j.solener.2003.10.003.
- [109] Kaldellis JK, Kavadias KA, Spyropoulos G. Investigating the real situation of Greek solar water heating market. *Renew Sustain Energy Rev* 2005;9:499–520. doi:10.1016/j.rser.2004.04.006.
- [110] Esen M, Esen H. Experimental investigation of a two-phase closed thermosiphon solar water heater. *Sol Energy* 2005;79:459–68. doi:10.1016/j.solener.2005.01.001.
- [111] Hourri A. Solar water heating in Lebanon: Current status and future prospects. *Renew Energy* 2006;31:663–75. doi:10.1016/j.renene.2005.08.003.
- [112] Chow TT, Fong KF, Chan ALS, Lin Z. Potential application of a centralized solar water-heating system for a high-rise residential building in Hong Kong. *Appl Energy* 2006;83:42–54. doi:10.1016/j.apenergy.2005.01.006.
- [113] Pillai IR, Banerjee R. Methodology for estimation of potential for solar water heating in a target area. *Sol Energy* 2007;81:162–72. doi:10.1016/j.solener.2006.04.009.
- [114] Gunerhan H, Hepbasli A. Exergetic modeling and performance evaluation of solar water heating systems for building applications. *Energy Build* 2007;39:509–16. doi:10.1016/j.enbuild.2006.09.003.
- [115] Currie JI, Garnier C, Muneer T, Grassie T, Henderson D. Modelling bulk water temperature in integrated collector storage systems. *Build Serv Eng Res Technol* 2008;29:203–18. doi:10.1177/0143624408094277.
- [116] Sutthivirode K, Namprakai P, Roonprasang N. A new version of a solar water heating system coupled with a solar water pump. *Appl Energy* 2009;86:1423–30. doi:10.1016/j.apenergy.2008.12.002.
- [117] Smyth M, Skates H. A passive solar water heating system for vineyard frost protection. *Sol Energy* 2009;83:400–8. doi:10.1016/j.solener.2008.08.014.
- [118] Kishor N, Das MK, Narain A, Prakash Ranjan V. Fuzzy model representation of thermosiphon solar water heating system. *Sol Energy* 2010;84:948–55. doi:10.1016/j.solener.2010.03.002.
- [119] Sivakumar P, Christraj W, Sridharan M, Jayamalathi N. Performance Improvement Study of Solar Water Heating System. *J Eng Appl Sci* 2012;7:45–9.
- [120] Omojaro P, Breitkopf C. Direct expansion solar assisted heat pumps: A review of applications and recent research. *Renew Sustain Energy Rev* 2013;22:33–45. doi:10.1016/j.rser.2013.01.029.

- [121] Amin ZM, Hawlader MNA. A review on solar assisted heat pump systems in Singapore. *Renew Sustain Energy Rev* 2013;26:286–93. doi:10.1016/j.rser.2013.05.032.
- [122] Halawa E, Chang KC, Yoshinaga M. Thermal performance evaluation of solar water heating systems in Australia, Taiwan and Japan - A comparative review. *Renew Energy* 2015;83:1279–86. doi:10.1016/j.renene.2015.04.023.
- [123] Khan MZH, Al-Mamun MR, Sikdar S, Halder PK, Hasan MR. Design, Fabrication, and Efficiency Study of a Novel Solar Thermal Water Heating System: Towards Sustainable Development. *Int J Photoenergy* 2016;2016:1–8. doi:10.1155/2016/9698328.
- [124] Liu T, Li Z, He G. Experiments of a Heat Pump Water Heating System Using Stored Solar Energy to Defrost. *Energy Procedia* 2017;105:1130–5. doi:10.1016/j.egypro.2017.03.480.
- [125] Semmari H, Ledenn A, Boudéhenn F, Praene JP, Lucas F, Marc O. Case study for experimental validation of a new presizing tool for solar heating, cooling and domestic hot water closed systems. *Case Stud Therm Eng* 2017;10:272–82. doi:10.1016/j.csite.2017.07.007.
- [126] Ciocănea A, Bureea DL. The Influence of Flow Tube Vibrations over the Efficiency of Solar Water Heating Collectors. *Energy Procedia* 2017;112:330–5. doi:10.1016/j.egypro.2017.03.1059.
- [127] Shrivastava RL, Kumar V, Untawale SP. Modeling and simulation of solar water heater: A TRNSYS perspective. *Renew Sustain Energy Rev* 2017;67:126–43. doi:10.1016/j.rser.2016.09.005.
- [128] Varghese J, Samsher, Manjunath K. A parametric study of a concentrating integral storage solar water heater for domestic uses. *Appl Therm Eng* 2017;111:734–44. doi:10.1016/j.applthermaleng.2016.09.127.
- [129] Abas N, Khan N, Haider A, Saleem MS. A thermosyphon solar water heating system for sub zero temperature areas. *Cold Reg Sci Technol* 2017;143:81–92. doi:10.1016/j.coldregions.2017.08.012.
- [130] Liu Z, Li H, Liu K, Yu H, Cheng K. Design of high-performance water-in-glass evacuated tube solar water heaters by a high-throughput screening based on machine learning: A combined modeling and experimental study. *Sol Energy* 2017;142:61–7. doi:10.1016/j.solener.2016.12.015.
- [131] Gautam A, Chamoli S, Kumar A, Singh S. A review on technical improvements, economic feasibility and world scenario of solar water heating system. *Renew Sustain Energy Rev* 2017;68:541–62. doi:10.1016/j.rser.2016.09.104.
- [132] Poppi S, Sommerfeldt N, Bales C, Madani H, Lundqvist P. Techno-economic review of solar heat pump systems for residential heating applications. *Renew Sustain Energy Rev* 2018;81:22–32. doi:10.1016/j.rser.2017.07.041.
- [133] Razavi SH, Ahmadi R, Zahedi A. Modeling, simulation and dynamic control of solar assisted ground source heat pump to provide heating load and DHW. *Appl Therm Eng* 2018;129:127–44. doi:10.1016/j.applthermaleng.2017.10.003.
- [134] Abdelghani-Idrissi MA, Khalfallaoui S, Seguin D, Vernières-Hassimi L, Leveneur S. Solar tracker for enhancement of the thermal efficiency of solar water heating system. *Renew Energy* 2018;119:79–94. doi:10.1016/j.renene.2017.11.072.
- [135] Sadiq M. Solar water heating system for residential consumers of Islamabad, Pakistan: A cost benefit analysis. *J Clean Prod* 2018;172:2443–53. doi:10.1016/j.jclepro.2017.11.166.
- [136] Zhang R, Shen GQP, Ni M, Wong JKW. Techno-economic feasibility of solar water heating system: Overview and meta-analysis. *Sustain Energy Technol Assessments* 2018;30:164–73. doi:10.1016/J.SETA.2018.10.004.
- [137] Yılmaz İH. Residential use of solar water heating in Turkey: A novel thermo-economic optimization for energy savings, cost benefit and ecology. *J Clean Prod* 2018;204:511–24. doi:10.1016/J.JCLEPRO.2018.09.060.
- [138] Baneshi M, Bahreini SA. Impacts of hot water consumption pattern on optimum sizing and techno-economic aspects of residential hybrid solar water heating systems. *Sustain Energy Technol Assessments* 2018;30:139–49. doi:10.1016/J.SETA.2018.09.008.
- [139] Wu W, Dai S, Liu Z, Dou Y, Hua J, Li M, et al. Experimental study on the performance of a novel solar water heating system with and without PCM. *Sol Energy* 2018;171:604–12. doi:10.1016/J.SOLENER.2018.07.005.
- [140] Hashim WM, Shomran AT, Jurmut HA, Gaaz TS, Kadhum AAH, Al-Amiery AA. Case study on solar water heating for flat plate collector. *Case Stud Therm Eng* 2018;12:666–71. doi:10.1016/J.CSITE.2018.09.002.
- [141] Endale A. Analysis of status, potential and economic significance of solar water heating system in Ethiopia. *Renew Energy* 2019;132:1167–76. doi:10.1016/j.renene.2018.08.094.
- [142] García JL, Porras-Prieto CJ, Benavente RM, Gómez-Villarino MT, Mazarrón FR. Profitability of a solar water heating system with evacuated tube collector in the meat industry. *Renew Energy* 2019;131:966–76. doi:10.1016/j.renene.2018.07.113.
- [143] Plaza Gomariz F, Cejudo López JM, Domínguez Muñoz F. An analysis of low flow for solar thermal system for water heating. *Sol Energy* 2019;179:67–73. doi:10.1016/J.SOLENER.2018.12.060.
- [144] Hohne PA, Kusakana K, Numbi BP. Optimal energy management and economic analysis of a grid-connected hybrid solar water heating system: A case of Bloemfontein, South Africa. *Sustain Energy Technol Assessments* 2019;31:273–91. doi:10.1016/j.seta.2018.12.027.
- [145] Prakash J, Roan D, Tauqir W, Nazir H, Ali M, Kannan A. Off-grid solar thermal water heating system using phase-change materials: design, integration and real environment investigation. *Appl Energy* 2019;240:73–83. doi:10.1016/j.apenergy.2019.02.058.
- [146] Giglio T, Santos V, Lamberts R. Analyzing the impact of small solar water heating systems on peak demand and on emissions in the Brazilian context. *Renew Energy* 2019;133:1404–13. doi:10.1016/j.renene.2018.08.104.
- [147] Nwaji GN, Okoronkwo CA, Ogueke N V., Anyanwu EE. Hybrid solar water heating/nocturnal radiation cooling system I: A review of the progress, prospects and challenges. *Energy Build* 2019;198:412–30. doi:10.1016/j.enbuild.2019.06.017.

- [148] Abas N, Kalair AR, Seyedmahmoudian M, Naqvi M, Campana PE, Khan N. Dynamic simulation of solar water heating system using supercritical CO<sub>2</sub> as mediating fluid under sub-zero temperature conditions. *Appl Therm Eng* 2019;161:114152. doi:10.1016/j.applthermaleng.2019.114152.
- [149] Shafieian A, Khiadani M, Nosrati A. Thermal performance of an evacuated tube heat pipe solar water heating system in cold season. *Appl Therm Eng* 2019;149:644–57. doi:10.1016/j.applthermaleng.2018.12.078.
- [150] Mehmood A, Waqas A, Said Z, Rahman SMA, Akram M. Performance evaluation of solar water heating system with heat pipe evacuated tubes provided with natural gas backup. *Energy Reports* 2019;5:1432–44. doi:10.1016/j.egy.2019.10.002.
- [151] Beausoleil-Morrison I, Kemery B, Wills AD, Meister C. Design and simulated performance of a solar-thermal system employing seasonal storage for providing the majority of space heating and domestic hot water heating needs to a single-family house in a cold climate. *Sol Energy* 2019;191:57–69. doi:10.1016/j.solener.2019.08.034.
- [152] Allouhi A, Benzakour Amine M, Buker MS, Kousksou T, Jamil A. Forced-circulation solar water heating system using heat pipe-flat plate collectors: Energy and exergy analysis. *Energy* 2019;180:429–43. doi:10.1016/j.energy.2019.05.063.
- [153] Modi K, Shukla D, Bhargav B, Devaganiya J, Deshler R, Dhodi J, et al. Efficacy of organic and inorganic nanofluid on thermal performance of solar water heating system. *Clean Eng Technol* 2020;1:100020. doi:10.1016/j.clet.2020.100020.
- [154] Kulkarni MV, Deshmukh DS, Shekhawat S. An innovative design approach of hot water storage tank for solar water heating system using artificial neural network. *Mater Today Proc* 2020. doi:10.1016/j.matpr.2020.09.058.
- [155] Shafieian A, Khiadani M. Integration of heat pipe solar water heating systems with different residential households: An energy, environmental, and economic evaluation. *Case Stud Therm Eng* 2020;21:100662. doi:10.1016/j.csite.2020.100662.
- [156] Mohamed K, Michel H. Design optimisation of a combined pellets and solar heating systems for water heating in a public bathhouse. *Energy Reports* 2020;6:1628–35. doi:10.1016/j.egy.2020.12.031.
- [157] Li WT, Tushar W, Yuen C, Ng BKK, Tai S, Chew KT. Energy efficiency improvement of solar water heating systems – An IoT based commissioning methodology. *Energy Build* 2020;224:110231. doi:10.1016/j.enbuild.2020.110231.
- [158] Xiao Q, Cao J, Zhang Y, Li L, Xu T, Yuan W. The application of solar-to-thermal conversion phase change material in novel solar water heating system. *Sol Energy* 2020;199:484–90. doi:10.1016/j.solener.2020.02.054.
- [159] Heidari A, Khovalyg D. Short-term energy use prediction of solar-assisted water heating system: Application case of combined attention-based LSTM and time-series decomposition. *Sol Energy* 2020;207:626–39. doi:10.1016/j.solener.2020.07.008.
- [160] Ding Z, Wu W, Chen Y, Li Y. Dynamic simulation and parametric study of solar water heating system with phase change materials in different climate zones. *Sol Energy* 2020;205:399–408. doi:10.1016/j.solener.2020.05.075.
- [161] Huang J, Fan J, Furbo S, Li Q. A policy study on the mandatory installation of solar water heating systems – Lessons from the experience in China. *Sol Energy* 2020;206:614–27. doi:10.1016/j.solener.2020.06.049.
- [162] Wu W, Wang X, Xia M, Dou Y, Yin Z, Wang J, et al. A novel composite PCM for seasonal thermal energy storage of solar water heating system. *Renew Energy* 2020;161:457–69. doi:10.1016/j.renene.2020.06.147.
- [163] Khargotra R, Kumar R, Kumar S. Impact of perforated shapes in delta type hindrance promoter on thermo-hydraulic performance of solar water heating system (An experimental study). *Case Stud Therm Eng* 2021;24:100831. doi:10.1016/j.csite.2020.100831.
- [164] Nasirov S, Carredano N, Agostini CA, Silva C. Public perception and adoption of Solar Water Heating systems in Chile: The role of supply side income tax credits. *Renew Sustain Energy Rev* 2021;135:110389. doi:10.1016/j.rser.2020.110389.
- [165] Singh S, Anand A, Shukla A, Sharma A. Environmental, technical and financial feasibility study of domestic solar water heating system in India. *Sustain Energy Technol Assessments* 2021;43:100965. doi:10.1016/j.seta.2020.100965.
- [166] Long J, Xia K, Zhong H, Lu H, A Y. Study on energy-saving operation of a combined heating system of solar hot water and air source heat pump. *Energy Convers Manag* 2021;229:113624. doi:10.1016/j.enconman.2020.113624.
- [167] Ibrahim O, Fardoun F, Younes R, Louahlia-Gualous H. Optimal management proposal for hybrid water heating system. *Energy Build* 2014;75:342–57. doi:10.1016/j.enbuild.2014.02.023.
- [168] El-Fadel RH, Hammond GP, Harajli HA, Jones CI, Kabakian VK, Winnett AB. The Lebanese electricity system in the context of sustainable development. *Energy Policy* 2010;38:751–61. doi:10.1016/j.enpol.2009.10.020.
- [169] Yathreb S. Analysis of a Residential Building Energy Consumption as Base Model in Tripoli, Lebanon. *Int J Energy Prod Mgmt* 2016;1:359–70. doi:10.3390/en4030475.
- [170] Bank W. World Bank Energy Efficiency Study in Lebanon 2009.
- [171] Martinopoulos G, Tsalikis G. Active solar heating systems for energy efficient buildings in Greece: A technical economic and environmental evaluation. *Energy Build* 2014;68:130–7. doi:10.1016/j.enbuild.2013.09.024.
- [172] Lévesque B, Lavoie M, Joly J. Residential water heater temperature: 49 or 60 degrees Celsius? *Can J Infect Dis* 2004;15:11–2. doi:10.1155/2004/109051.
- [173] JRC Photovoltaic Geographical Information System (PVGIS) - European Commission n.d. [https://re.jrc.ec.europa.eu/pvg\\_tools/en/tools.html](https://re.jrc.ec.europa.eu/pvg_tools/en/tools.html).
- [174] Jaber H, Ramadan M, Iemenand T, Khaled M. Domestic thermoelectric cogeneration system optimization analysis, energy consumption and CO<sub>2</sub> emissions reduction. *Appl Therm Eng* 2018;130:279–95. doi:10.1016/j.applthermaleng.2017.10.148.
- [175] Elbaba W. Army Sustainability Workshop. How To Increase Energy Efficiency in Buildings For Domestic Hot Water



- Heating system ( Including Solar Renewable Energy ) n.d.
- [176] Electricity Of Lebanon - Public Institution n.d. <http://www.edl.gov.lb/page.php?pid=39&lang=en>.
- [177] GEE Green Energy n.d. <http://www.gee-greenenergy.net/>.
- [178] Koroneos CJ, Nanaki EA. Life cycle environmental impact assessment of a solar water heater. *J Clean Prod* 2012;37:154–61. doi:10.1016/j.jclepro.2012.07.001.
- [179] Furundzic AK, Kosoric V, Golic K. Potential for reduction of CO2 emissions by integration of solar water heating systems on student dormitories through building refurbishment. *Sustain Cities Soc* 2012;2:50–62. doi:10.1016/j.scs.2011.10.005.
- [180] Bessa VMT, Prado RTA. Reduction of carbon dioxide emissions by solar water heating systems and passive technologies in social housing. *Energy Policy* 2015;83:138–50. doi:10.1016/j.enpol.2015.04.010.

## **1.4 Solaire photovoltaïque : bilan avec étude économique et environnementale au Liban**

Il est prévu de soumettre cet article à « **Solar Energy** »

**Résumé** - Le système photovoltaïque (PV) est l'une des principales applications de l'énergie solaire qui concerne la production d'électricité. Le rôle principal de ce système est de convertir la lumière solaire en électricité par absorption de photons. L'objectif de ce travail est de présenter une revue des systèmes et technologies solaires photovoltaïques. Le principe du système solaire PV est exposé en plus de ses principaux composants. En outre, les types de système PV et ses trois générations sont passés en revue dans cet article. En outre, des analyses économiques et environnementales sont mises en œuvre pour mettre en évidence le rôle vital de l'utilisation des systèmes solaires photovoltaïques pour produire de l'électricité au Liban pour plusieurs scénarii (maison, salle de sport, restaurant et hôtel). Le but des analyses susmentionnées est d'évaluer le montant d'argent économisé lors de l'utilisation du système solaire photovoltaïque ainsi que sa durée d'amortissement et d'évaluer la réduction des émissions de dioxyde de carbone. Les résultats montrent que pour une utilisation élevée du système PV ( $Pr = 0,9$ ), la durée d'amortissement du système et le montant annuel des émissions de  $CO_2$  atténuées sont de 16,2 ans et 4,7 tonnes pour la maison, 2,1 ans et 97,7 tonnes pour la salle de sport, 4,1 ans et 154 tonnes pour le restaurant, et 13,0 ans et 383 tonnes pour l'hôtel.

## Solar photovoltaic: A review with economic and environmental study on Lebanon

Amal Herez<sup>1,2</sup>, Hicham El Hage<sup>1</sup>, Thierry Lemenand<sup>2</sup>, Mohamad Ramadan<sup>3,4</sup>, and Mahmoud Khaled<sup>3,5,\*</sup>

<sup>1</sup>Energy and Thermofluid Group, Lebanese International University LIU, Bekaa, Lebanon

<sup>2</sup>LARIS EA 7315, University of Angers, Polytech Angers, Angers, France

<sup>3</sup>Energy and Thermofluid Group, International University of Beirut BIU, Beirut, Lebanon

<sup>4</sup>Associate member at FCLAB, CNRS, Univ. Bourgogne Franche-Comté, Belfort cedex, France

<sup>5</sup>University Paris Diderot, Sorbonne Paris Cité, Interdisciplinary Energy Research Institute (PIERI), Paris, France

\*Corresponding author email: [mahmoud.khaled@liu.edu.lb](mailto:mahmoud.khaled@liu.edu.lb)

**Abstract.** Photovoltaic (PV) system is one of the main applications of solar energy which is concerned in generating electricity. The main role of this system is to convert sun light to electricity by the absorption of photons. The aim of this work is to present a review on solar photovoltaic systems and technologies. The principle of solar PV system is exposed in addition to its main components. Also, types of PV system and its three generations are reviewed in this paper. Besides, economic and environmental analyses are implemented to highlight the vital role of utilizing solar PV systems for generating electricity in Lebanon for several scenarios (home, gym, restaurant and hotel). The aim of the aforementioned analyses is to assess the amount of saved money when utilizing solar photovoltaic system as well as its payback period and to evaluate the reduction in the amount of carbon dioxide emission. The results show that for a high usage of PV system (for a percentage of time where solar photovoltaic is utilized  $Pr=90\%$ ), the payback period of the system and the annual amount of mitigated  $CO_2$  emissions are 16.2 years and 4.7 tons in house, 2.1 years and 97 tons for gym, 4.1 years and 154 tons for restaurant, and 13.0 years and 383 tons for hotel.

**Keywords:** Solar Energy, Photovoltaic Systems, Renewable Energy, Review, Classification, Environment, Economy.

## 1. INTRODUCTION

In recent decades, energy request has raised continuously due to its importance. It became the key for economic progress of any country. The depletion of conventional energy sources and the continuous variation of fossil fuel prices, in addition to the context of environmental issues [1–4], have encouraged intense researches on energy management or renewable energy resources. Energy recovery [5–10] is one of the major technologies of energy management which rely on reusing wasted energy. Renewable energy is green, clean and sustainable source of energy. At present time, it is supplying about 13.5% of the world energy request [11,12]. Wind [13,14], geothermal [15], solar [16–21], biomass [22,23], tidal [24,25], hydropower [26,27] are the main sources of renewable energy. Indeed, solar energy occupies the throne of renewable energy sources. It became popular renewable source of energy due to the fact that the amount of solar energy absorbed by the earth is about  $1.8 \times 10^{11}$  MW which is more than the world energy request by 10000 times [28,29].

Solar energy provides wide range of applications to exploit such renewable energy. Solar energy can be categorized into two main systems: the first converts solar energy into thermal energy, while the other transforms solar energy into electrical energy. Figure 1 illustrates a schematic of the main categories of solar energy. There are several applications that are integrated from solar energy which produce thermal energy to be used for drying, cooking, heating water, heating and cooling space or refrigerating. Among the applications which produce thermal energy, solar chimney and concentrated solar power are categorized also under the type of generating electricity. Solar chimney exploits solar energy to supply ventilation (cooling and heating) for buildings or to generate electricity. Concentrated solar power uses solar energy to transform it into thermal energy and then into electric energy. However, solar photovoltaic produces electricity directly from solar radiations. Solar photovoltaic system can be combined with thermal system to produce both thermal and electric energy simultaneously. There are numerous studies [30–34] that are conducted on combined photovoltaic solar thermal collector systems.

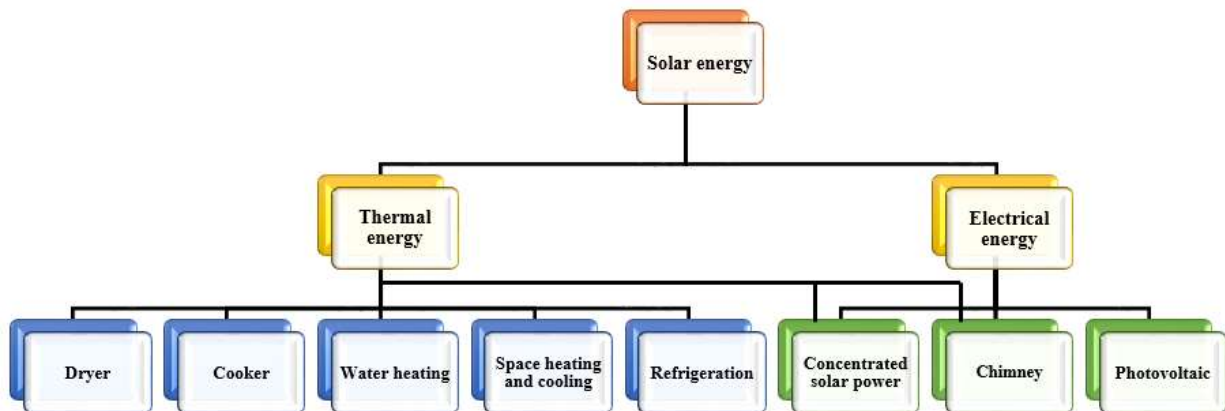

Figure 1. Categories of solar energy.

Solar photovoltaic systems [35–38] are excellent choice technology for generating electricity in a clean way without harming environment. Photovoltaic cells are made up of semi-conductive

material which absorb spread and concentrated solar radiation to convert solar energy into direct current electricity.

From many years ago several scientists studied and worked on solar photovoltaic mechanism [39,40]. In 1839, Alexandre Edmond Becquerel, a French physicist, discovered the photovoltaic effect. In 1877, Adams and Day observed the photovoltaic effect where they developed the first selenium cell. Later on in 1883, Charles Fritts constructed the first photovoltaic cell of 1% maximum efficiency. Albert Einstein published a paper which describes the photoelectric effect in 1905. A new photovoltaic cell was built in 1927 using copper and the semiconductor copper oxide, its efficiency was also less than 1%. In 1941, Russell Ohl constructed the silicon photovoltaic cell. Further progress served in attaining 6% efficiency in direct sunlight which was also raised to 11% by Bell laboratories in 1954.

Recently, photovoltaic has revealed a vital potential in meeting the progressing global energy demand. During 2011, growth rate of photovoltaic attained about 70% which is distinguished level over renewable applications [41]. In 2012, the whole operating capacity of photovoltaic was 100 GW [42].

Electricity shortage is one of the most serious problems facing Lebanon since many years ago. Every year, there is an increase in electricity consumption per capita by 7%, meanwhile the electricity production is underdeveloped [43]. Hence, solar PV systems are the most suitable option which serves in generating more electricity to meet the demand and in a clean way.

The present work aims to present a review on solar photovoltaic regarding its principle, components, systems and technologies with the advantages and disadvantages of each one. Moreover, economic and environmental studies are conducted to demonstrate the influence of utilization of solar PV systems in Lebanon.

The rest of the paper is organized as follows: section 2 of the paper details the PV systems: principle, components, systems and technologies, section 3 enumerates previous works that have been performed on solar PV, section 4 is devoted for economic and environmental analyses and section 5 summarizes the main conclusions of this work.

## **2. PHOTOVOLTAIC SYSTEMS**

### **2.1 Principle of PV system**

The word photovoltaic comes from the combination of word photon (particle in light) and volt which is a unit for electric potential [44,45].

The sun surface temperature is about 6,000 °C, the gases found on sun at this temperature emits light which are received by the earth at different wavelengths starting from the ultraviolet to the visible, to the infrared light. Light can behave as wave or as a particle depending in the specific interaction with matter, this phenomenon is called wave-particle duality of light. One of the main particles found in light is photons, which have energy whose unit is electron volt (eV). When light which contains photons hits solar cell, the cell will just absorb photons above a threshold energy, called energy gap ( $E_g$ ) or band gap. Photons below the band gap will pass the cell while photons higher than the band gap will be absorbed.

Mainly the solar cell consists of three layer of semi-conductors: the upper layer is the N-type semiconductor, it is called N-type relative to the negative charge formation in this layer. The second layer is the semiconductor band gap, and the third is the P-type semi-conductor which is

relative to the positive charge in this layer. When the photon is absorbed it forms in the semiconductors electrons (e-) and holes (h+) which are responsible for generating electricity [46]. Figure 2 is a schematic that shows the structure of a PV solar cell and the mechanism of electricity generation.

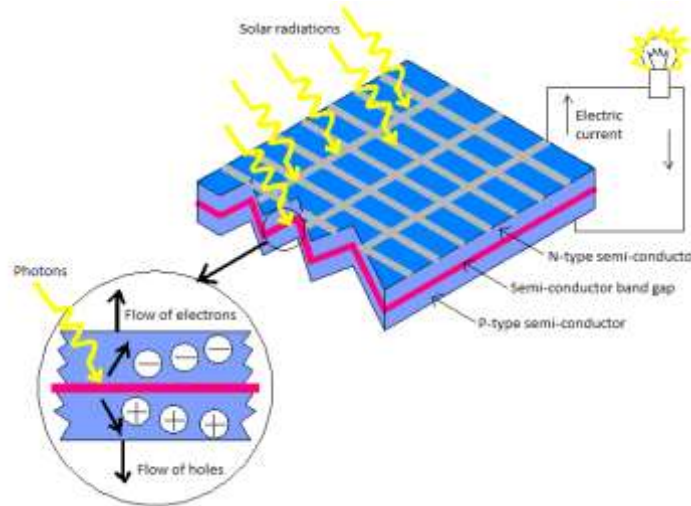

Figure 2. Solar photovoltaic cell.

Numerous researches [47–50] were conducted to study solar photovoltaic systems in several countries all over the world. Mundo-Hernández et al. [49] presented an overview of energy policies and solar photovoltaic energy potential in Germany and Mexico, where the first is the world leader in producing photovoltaic technology and the second has great potential of solar photovoltaic. Besides, the authors reviewed the characteristics, advantages and disadvantages of photovoltaic technology. Also, Lin et al. [50] performed a study which supplies policy makers with evaluation agents to stimulate concrete scenarios and optimal conditions that serve in progressing photovoltaic power as an applicable renewable energy source in Taiwan. Besides, Paiano [47] stimulated the exponential growth in the installed photovoltaic system. The aim of this work is to evaluate the prospective waste emerging in Italy from utilizing end-of-life phases of these renewable energy systems in the coming years and their recycling or/and elimination. Moreover, Khan and Pervaiz [48] presented a technological review on solar photovoltaic in Pakistan. The optimum components and technology which is appropriate for producing energy in the remote places within the country are identified.

## 2.2 Components of PV systems

Photovoltaic systems consist mainly of three parts: PV module, power electronics, and balance of system (BOS) [51].

The PV module is the heart of the solar system. It is made up of solar cells, formed from semiconductor materials, that their role is to convert light into electricity by collecting photons from sun light [52]. When these photons hit the surface of the semiconductor materials they produce pairs of electrons and holes that diffuse in electric field, generating direct current (DC).

When solar modules are connected together in series they form strings [53]. Strings of modules are connected in parallel to form an array [54].

Power electronics is important in PV installation, since the solar cell produces DC and all electrical applications found at home need alternating current (AC). Power electronics are mainly DC/AC inverters [55], or regulators for the voltage. Chen et al. [56] showed that the ideal size of the inverter can be either less than or equal to the rated size of PV array. This is due to several factors such as meteorological and economic factor, in addition to the intrinsic parameters of the inverter. The remaining components to produce a complete PV system is called the “BOS”. It includes wiring, switches, a mounting system, a battery bank and battery charger, and other installation component.

Several reviews [57–59] were performed to describe solar photovoltaic technology and maintain the optimum performance of the system. Khatib et al. [57] presented a review including the present research on size optimization of PV systems and the size optimization techniques for the inverter in the photovoltaic systems. The authors concluded from the review that the optimization of PV system is significantly affected by the meteorological variables such as solar energy, ambient temperature and wind speed. Also, Makki et al. [58] performed a comprehensive review which describes different design and operating parameters that affect the cooling capacity for photovoltaic systems which serves in progressing its performance. Besides, Jordehi [59] developed a review which comprises the existent research works on photovoltaic cell parameter evaluation problem in addition to some recommendations for future works based on this review.

### **2.3 Photovoltaic systems**

At the start of photovoltaic technology, PV cells were able to power small applications which need low power. Nowadays photovoltaic systems can power a whole building, center, or even a town (PV power plants). PV solar technology is installed today for build environment and for homes that are difficult to be connected to the grid. Photovoltaic systems have two major types: grid-connected PV, and off-grid PV system.

Grid connected PV system [57,60,61] is a system which is connected to the local electricity network. This system can take electricity from grid when the PV cells are not producing sufficient power and it feedbacks the electricity grid when there is an excess of power generated. Wong et al. [62] presented a review to study the voltage issues of grid-connected photovoltaic system in Malaysia, where a 7.2 kW grid connected PV system has been installed. Figure 3 shows a schematic for grid-connected PV system.



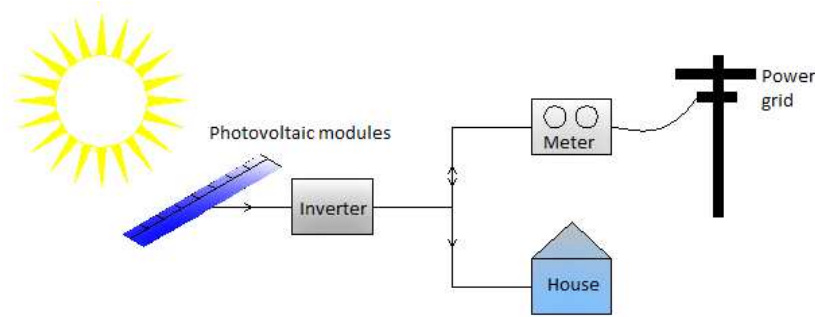

Figure 3. Grid connected solar PV systems.

Whereas, off-grid PV system or stand-alone system [63–67] is referred to systems which are not connected to local electricity network. Large markets on PV systems are available [12,68] and development has been made for the spread of small off-grid PV systems [69,70]. Figure 4 presents a schematic for off-grid PV system. Stand-alone system mainly composed of number of photovoltaic modules that are connected to form a single array that supplies the desired power output, charge controller, inverter and batteries.

Charge controller is also known as charge regulator, it is connected between the solar panel and the batteries. It controls and regulates the output from the solar array to prohibit the overcharging or over discharging of the batteries which causes its damage. The inverter is utilized to transform the direct current (DC) from the solar array and batteries into an alternating current (AC) to power the AC main appliances such as TV's, washing machines, freezers, etc. Furthermore, such systems need a backup battery to overcome the insufficient power production by the solar cell due to low irradiation or at night.

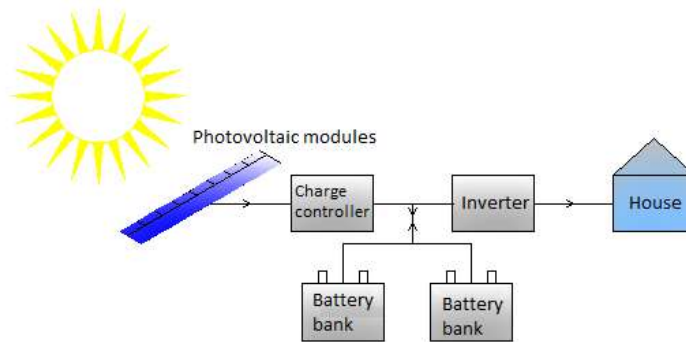

Figure 4. Off-grid connected solar PV systems.

## 2.4 Photovoltaic technologies

The photovoltaic technology can be classified in many ways, according to its operational way, flexibility, power generated, or even according to materials used in fabricating the solar cell. In this work PV technologies will be classified according to their generation [71–76]. First generation PV system is crystalline silicon, second generation is based on thin film PV technology, while the

third generation include technologies such as Dye-sensitized solar cell, organic cell, and the concentrated photovoltaic system (CPV). Figure 5 illustrates types of each generation of PV technology.

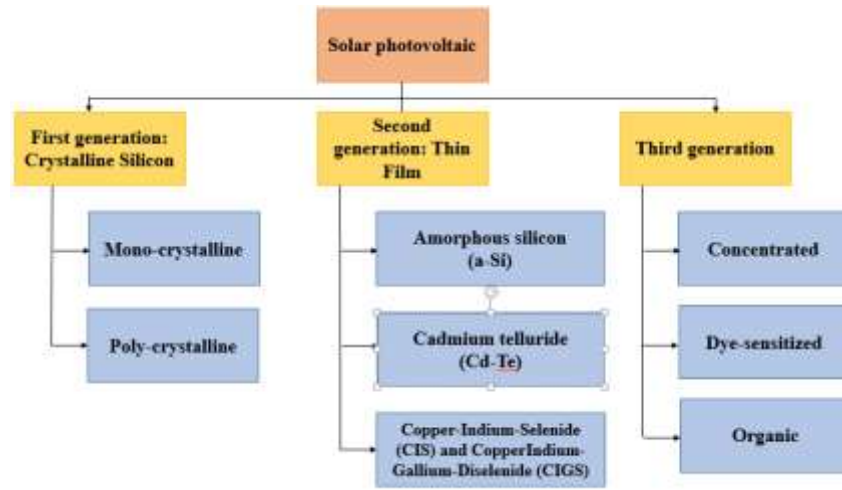

Figure 5. Solar photovoltaic technologies.

The performance and overall efficiency vary greatly from one generation and other due to the difference in type of semi-conductive materials utilized in each one. The first and the second generations are being commercially matured, however the third one is still in pre-maturation. Parida et al. [77] presented a review of solar photovoltaic technologies, which includes the power generating capability, the distinct existing light absorbing materials utilized and its environmental aspect combined with various applications. Table 1 illustrates the commercial and maximum PV module efficiency for each type of the three technologies [78].

Table 1. Commercial and maximum PV module efficiency of photovoltaic technologies [78].

Technology		Commercial PV module efficiency (%)	Maximum PV module efficiency (%)
First generation: Crystalline silicon	Mono-crystalline	15-19	25
	Poly-crystalline	13-15	20.4
Second generation: Thin film	a-Si	5-8	12.2
	CdTe	8-11	19.6
	CIS/CIGS	7-11	19.8
Third generation	Concentrated	25-30	40
	Dye-sensitized	1-5	-
	Organic	1	-

### 2.4.1 First generation PV technology: Crystalline silicon cells

Silicon is one of the plentiful elements found on the surface of our planet. It is a semi-conductive material that can be utilized in PV applications with energy band gap 1.1 eV. Crystalline silicon [73,75,79] mainly consists of two types, monocrystalline and polycrystalline. In the world market, the most manufactured type of the photovoltaic solar cell is the crystalline silicon. It occupies about 90% of the market, one third is monocrystalline silicon and two third is polycrystalline silicon. The power output of monocrystalline and polycrystalline modules of the same area is similar. Both are efficient, very durable and have stable power output over time. Monocrystalline has commercial module efficiency (15-19%) greater than that of the polycrystalline (13-15%), this difference is related to the grains found in the polycrystalline which are not found in monocrystalline [80]. But monocrystalline is more expensive than polycrystalline due to hard formation of single crystal. Figure 6 presents monocrystalline and polycrystalline PV modules.



Figure 6. Monocrystalline and polycrystalline PV modules.

Such generation is stable, simple and environmentally friendly. But it requires thick absorber area in order to achieve high efficiency. Also, the cell is made up of silicon of high purity which is expensive, thus crystalline silicon cell requires high cost.

### 2.4.2 Second generation PV technology: Thin film solar cells

First type of thin film solar cell is perfectly suitable for curves and flat surfaces as industrial roofs, its commercial module efficiency is 5-8%. Micro-crystalline silicon ( $\mu\text{c-Si}$ ) can be added to a-Si cell in which it becomes thicker and more stable and increases its module efficiency to 9.5%. CdTe [81–83] is the most economical and currently available thin film technology due to its manufacturing low cost and solar cell efficiency up to 11%. CdTe-based PV panel does not have any hazardous effect on human health. CIGS and CIS manufacturing process is expensive due to its complexity. It has module efficiency of 7-11%.

Thin film solar cell requires low raw material. It has good performance at high ambient temperature and low sensitivity against overheating. On the other hand, it has low efficiency and it needs large area to attain high power, which increases its cost.

### **2.4.3 Third generation PV technology**

Concentrated PV technology requires lenses that must be constantly oriented towards the sun in order to concentrate the sunlight to the solar cell and generate electricity. Thus, it needs less semi-conductive materials to absorb solar radiation. It has the highest commercial module efficiency (25-30%). It requires sun tracking systems which increase its capital cost. Concentrated PV may become a vital technology in the near future. However, at present time it has a small market share, and it is dependent on areas of high sunshine and low pollution due to the fact that only direct rays can be concentrated. Concentrated PV can be merged with concentrating solar thermal power because both systems have common elements in structure such as trackers, lenses, mirrors, etc.

Dye sensitized solar cells [84–86] utilize photo-electrochemical solar cells of semiconductor structures formed between photo sensitized anode and electrolyte. It has 1-5% commercial module efficiency [87]. Dye sensitized solar cells are recently attracting the interest at the scientific and technological level due to its high efficiency, simplicity in fabrication and cheaper than other photovoltaic appliances [88]. However, it has limited life time and stability since the dye degrade when exposed to ultraviolet rays.

Organic photovoltaic solar cell is composed of organic or polymer P-N junction mainly perlyene and phthalocyanine. When photons hit the organic material they produce electrons and holes that bond together to form excitons, which have no net electrical charge. When the excitons diffuse to the area between P-N junctions, they split and form electrons and holes free, and become ready to make electric field when they are connected to load. Its commercial module efficiency is 1%. Organic photovoltaic materials are not expensive, abundant and nontoxic. But such technology is not stable and it has low efficiency.

## **3. PREVIOUS RESEARCHES ON SOLAR PHOTOVOLTAIC**

Many researches spent long years in studying solar photovoltaic in order to enhance its performance and achieve the optimum system. This section exposes various previous works that have been conducted on solar photovoltaic during several years. Table 2 illustrates several studies that have been performed on solar photovoltaic systems.

Table 2. Performed studies on solar photovoltaic systems.

Author`s	Journal	Year	Title	Type of study	Topic(s)
Jackson and Oliver [89]	Energy Policy	2000	The viability of solar photovoltaics	Review	➤ Summarize the contributions to a special issue of Energy Policy in order to evaluate the viability of solar photovoltaics as a mainstream electricity supply technology for the 21 <sup>st</sup> century.
Bilgen [90]	Energy Conversion and Management	2001	Solar Hydrogen from photovoltaic-electrolyzer systems	Modeling and case study	➤ Conduct a mathematical model to estimate and enhance the thermal and economic performance of large scale photovoltaic-electrolyzer systems, either with fixed or sun tracking panels using hourly solar radiation data.
Kolhe [91]	Energy Economics	2002	Economic viability of stand-alone solar photovoltaic system in comparison with diesel-powered system for India	Analytical	➤ Using a life-cycle cost computation, analyze the economic viability of a stand-alone solar photovoltaic in comparison to diesel powered system, the most likely conventional source.
Khedari et al. [92]	Building and Environment	2002	A PV system enhanced the performance of roof solar collector	Experimental	➤ Improve the performance of the roof solar collector system by installing a PV powered DC fan in the air gap in order to rise the ventilation rate.
Murata et al. [93]	Solar Energy Materials & Solar Cells	2003	New type of photovoltaic module integrated with roofing material (highly fire-resistant PV tile)	Experimental	➤ Implement a new type of PV module combined with roofing material (a high fire-resistant PV tile), and confirm both PV performance and its sustainability as a roofing material.
Nagano et al. [94]	Solar Energy Materials & Solar Cells	2003	Development of thermal-photovoltaic hybrid exterior wallboards incorporating PV cells in and their winter performances	Experimental	➤ Assess the electrical power producing ability and the solar heat collection capacity during winter of six variations of the experimental thermal-PV hybrid wallboard. ➤ Perform exergy analyses.
Yamaguchi et al. [95]	Solar Energy Materials & Solar Cells	2003	Investigation on abundant photovoltaic power generated by 40 kW PV system in Wakayama National College of Technology	Experimental	➤ Demonstrate the output properties of a 40 kW photovoltaic power system and use the relationship among the output performance, the solar irradiation and the module temperature during 1 year period (August 1999–July 2000).

Wild-Scholten and Alsema [96]	Refocus	2004	Towards Cleaner Solar PV: Environmental and health impacts of crystalline silicon photovoltaics	Review	<ul style="list-style-type: none"> <li>➤ Review the developments that are achieved, the expected ones in the near future and the issues that require to be managed for the progress of crystalline silicon photovoltaics.</li> </ul>
Waldau [97]	Refocus	2005	PV Status Research, Solar cell Production and Market Implementation of Photovoltaics	Review	<ul style="list-style-type: none"> <li>➤ Review the recent findings from a study assessing the whole status of solar photovoltaic.</li> </ul>
Othman et al. [98]	Renewable Energy	2005	Performance analysis of a double-pass photovoltaic/thermal (PV/T) solar collector with CPC and fins	Experimental	<ul style="list-style-type: none"> <li>➤ Design and fabricate a prototype double-pass photovoltaic thermal solar air collector with CPC and fins.</li> <li>➤ Study the performance of the prototype over a range of operating conditions.</li> </ul>
Zahedi [99]	Renewable Energy	2006	Solar photovoltaic (PV) energy; latest developments in the building integrated and hybrid PV systems	Review	<ul style="list-style-type: none"> <li>➤ Expose the recent progresses in the area of solar photovoltaic energy systems.</li> <li>➤ Investigate the long-term prospect of the solar photovoltaic energy as a sustainable energy supply.</li> </ul>
Denholm and Margolis [100]	Energy Policy	2007	Evaluating the limits of solar photovoltaics (PV) in electric power systems utilizing energy storage and other enabling technologies	Numerical	<ul style="list-style-type: none"> <li>➤ Evaluate the technologies that enable solar photovoltaic to overcome the limits of conventional electric power systems.</li> </ul>
Denholm and Margolis [101]	Energy Policy	2007	Evaluating the limits of solar photovoltaics (PV) in traditional electric power systems	Analytical	<ul style="list-style-type: none"> <li>➤ Analyze some of the limits to large-scale deployment of solar photovoltaic in conventional electric power systems.</li> <li>➤ Compare the hourly output of a simulated large PV system to the amount of electricity actually usable to assess the ability of PV to supply a large fraction of utility system's energy.</li> </ul>
Jiang et al. [102]	Renewable Energy	2008	The influence of PV coverage ratio on thermal and electrical performance of photovoltaic-Trombe wall	Analytical and numerical	<ul style="list-style-type: none"> <li>➤ Present a novel photovoltaic-Trombe wall (PV_TW)</li> <li>➤ Perform a detailed simulation model for PV_TW based on the actual measured weather data in Hefei.</li> </ul>

Mala et al. [103]	Renewable Energy	2009	Better or worse? The role of solar photovoltaic (PV) systems in sustainable development: Case studies of remote atoll communities in Kiribati	Case study	<ul style="list-style-type: none"> <li>➤ Investigate the role of PV technologies in the sustainable development process in Kiribati, with particular reference to remote atoll communities.</li> <li>➤ Present the initial results from on-site surveys that are carried out, identify the reasons why people use or do not use PV systems.</li> </ul>
Shum and Watanabe [104]	Energy Policy	2009	An innovation management approach for renewable energy deployment - the case of solar photovoltaic (PV) technology	Review	<ul style="list-style-type: none"> <li>➤ Explain the two strategic financial policies concerning grid-connected residential distributed PV systems in Japan and the United States.</li> </ul>
Park et al. [105]	Energy	2010	Analysis of thermal and electrical performance of semi-transparent photovoltaic (PV) module	Analytical and experimental	<ul style="list-style-type: none"> <li>➤ Study the electrical and thermal performance of a semi-transparent PV module that was designed as a glazing component.</li> <li>➤ Assess the impacts of the PV module thermal properties on its electrical generation performance.</li> </ul>
Mani and Pillai [106]	Renewable and Sustainable Energy Reviews	2010	Impact of dust on solar photovoltaic (PV) performance: Research status, challenges and recommendations	Review	<ul style="list-style-type: none"> <li>➤ Evaluate the current status of research in studying the effect of dust on PV system performance and identify challenges to further pertinent research.</li> <li>➤ Discuss a framework to understand the several parameters that govern the settling/assimilation of dust and likely mitigation measures.</li> </ul>
DeBenedictis et al. [107]	Energy	2010	Statistically adjusted engineering (SAE) modeling of metered roof-top photovoltaic (PV) output: California evidence	Modeling and numerical	<ul style="list-style-type: none"> <li>➤ Present a statistically adjusted engineering (SAE) modeling of metered output of 327 roof-top PV installations in California for the 12-month period of January-December 2008.</li> </ul>
Parida et al. [77]	Renewable and Sustainable Energy Reviews	2011	A review of solar photovoltaic technologies	Review	<ul style="list-style-type: none"> <li>➤ Review of photovoltaic technology regarding its power generating capability, the different existing light absorbing materials used and its environmental aspect coupled with a variety of its applications.</li> </ul>
Marwede and Reller [4]	Resources, Conservation and Recycling	2012	Future recycling flows of tellurium from cadmium telluride photovoltaic waste	Analytical	<ul style="list-style-type: none"> <li>➤ Estimate the range of which recycling and efforts to rise material efficiency can reduce the request for primary tellurium.</li> </ul>

Pang et al. [108]	Physics Procedia	2012	Preparation and characteristics of MoSe <sub>2</sub> interlayer in bifacial Cu(In,Ga)Se <sub>2</sub> solar cells	Experimental	<ul style="list-style-type: none"> <li>➤ Study the influence of MoSe<sub>2</sub> layer inserted at the ZnO:Ga/CIGS interface on electrical properties of CIGS with back contacts.</li> </ul>
Singh [39]	Energy	2013	Solar power generation by PV (photovoltaic) technology: A review	Review	<ul style="list-style-type: none"> <li>➤ Review the development attained in solar power generation study and progress since its onset.</li> </ul>
Tyagi et al. [69]	Renewable and Sustainable Energy Reviews	2013	Progress in solar PV technology: Research and achievement	Review	<ul style="list-style-type: none"> <li>➤ Review of the present overall status of PV technology, research in materials for solar cell, parameters impacting PV efficiency, current cost of solar cell and environmental impact.</li> </ul>
Sinha [3]	Solar Energy Materials & Solar Cells	2013	Life cycle materials and water management for CdTe photovoltaics	Case study	<ul style="list-style-type: none"> <li>➤ Overview of the present status of CdTe solar cells and modules with respect to life cycle management of raw materials.</li> <li>➤ Present a case study of life cycle materials management related to the energy–water nexus.</li> </ul>
Khatib et al. [70]	Renewable and Sustainable Energy Reviews	2013	A review of photovoltaic systems size optimization techniques	Review	<ul style="list-style-type: none"> <li>➤ Review the present status of study on PV systems size optimization taking into consideration stand-alone PV systems, hybrid PV/diesel generator systems, hybrid PV/wind systems, hybrid PV/wind/diesel generator systems as well as grid connected systems.</li> <li>➤ Review size optimization techniques for the inverter in PV systems</li> </ul>
Chiang et al. [86]	Renewable Energy	2013	Non-color distortion for visible light transmitted tandem solid state dye-sensitized solar cells	Experimental	<ul style="list-style-type: none"> <li>➤ Elucidate a parallel connected tandem solid-state dye-sensitized solar cell without color deformation with the use of two transparent devices made of complementary sensitizers in each individual sub-cell.</li> </ul>
Kamarzaman and Tan [42]	Renewable and Sustainable Energy Reviews	2014	A comprehensive review of maximum power point tracking algorithms for photovoltaic systems	Review	<ul style="list-style-type: none"> <li>➤ Comparative review of the available maximum power point tracking algorithms for PV systems, ordering from the traditional techniques to the newest progressed random based algorithms.</li> </ul>



Mundo-Hernández et al. [49]	Renewable and Sustainable Energy Reviews	2014	An overview of solar photovoltaic energy in Mexico and Germany	Review	<ul style="list-style-type: none"> <li>➤ Overview of energy policies and the potential of photovoltaic energy in Germany and Mexico.</li> <li>➤ Describe the characteristic, advantages and disadvantages of photovoltaic technology including building integrated photovoltaic.</li> </ul>
El Alimi et al. [33]	Renewable and Sustainable Energy Reviews	2014	Break-even analysis and optimization of a stand-alone hybrid system with battery storage for residential load consumption - A case study	Case study	<ul style="list-style-type: none"> <li>➤ Develop and analyze a PV/wind hybrid energy system which is designed to supply residential household located in Monastir city, Tunisia.</li> </ul>
Wong et al. [62]	Renewable and Sustainable Energy Reviews	2014	Grid-connected photovoltaic system in Malaysia: A review on voltage issues	Review	<ul style="list-style-type: none"> <li>➤ Present the characteristics of voltage quality on the point of common coupling of the distribution networks with photovoltaic systems in Malaysia.</li> </ul>
Tao and Yu [80]	Solar Energy Materials & Solar Cells	2015	Review on feasible recycling pathways and technologies of solar photovoltaic modules	Review	<ul style="list-style-type: none"> <li>➤ Investigate the feasibility of PV module recycling.</li> <li>➤ Study three recycling pathways: manufacturing waste recycling, disposed PV module recycling and PV module remanufacturing and reuse are investigated.</li> </ul>
Zarmai et al. [109]	Applied Energy	2015	A review of interconnection technologies for improved crystalline silicon solar cell photovoltaic module assembly	Review	<ul style="list-style-type: none"> <li>➤ Present a review on contacts and interconnection technologies utilized to assemble and progress crystalline silicon solar cells.</li> </ul>
Sugathan et al. [85]	Renewable and Sustainable Energy Reviews	2015	Recent improvements in dye sensitized solar cells: A review	Review	<ul style="list-style-type: none"> <li>➤ Summarize all works and researches performed to enhance the performance of dye sensitized solar cells.</li> </ul>
El-Khozondar et al. [52]	Energy Procedia	2015	Parameters influence on MPP value of the photovoltaic cell	Numerical and parametric study	<ul style="list-style-type: none"> <li>➤ Conduct a parametric study using Matlab simulation to investigate the characteristics of a PV array under different conditions.</li> </ul>
Ramli et al. [61]	Renewable Energy	2015	Optimal sizing of grid-connected photovoltaic energy system in Saudi Arabia	Numerical	<ul style="list-style-type: none"> <li>➤ Analyze the optimal photovoltaic array and inverter sizes for a grid-connected PV system.</li> </ul>

Hernández-Moro and M. Martínez-Duart [110]	Renewable and Sustainable Energy Reviews	2015	Economic analysis of the contribution of photovoltaics to the decarbonization of the power sector	Analytical	<ul style="list-style-type: none"> <li>➤ Implement an analytical method to estimate the future (2013-2050) mitigation of CO<sub>2</sub> emissions when deploying solar photovoltaic systems according to three scenarios from IEA.</li> <li>➤ Estimate the financial extra-cost endured in the installation of photovoltaic systems which could be used instead of traditional power production systems.</li> </ul>
Tyagi [40]	International Journal of Advanced Technology in Engineering and Science	2015	Review on photovoltaic technology based power generation	Review	<ul style="list-style-type: none"> <li>➤ Review of the studies and improvements performed on PV technology in general and its status in India in particular.</li> </ul>
Sahoo [12]	Renewable and Sustainable Energy Reviews	2016	Renewable and sustainable energy reviews solar photovoltaic energy progress in India: A review	Review	<ul style="list-style-type: none"> <li>➤ Discuss the development of current solar photovoltaic energy in India.</li> <li>➤ Expose the renewable energy trend in India with analysis of solar parks and industrial applications.</li> <li>➤ Discuss the government policies in India to support solar energy.</li> </ul>
Guerrero-Lemus et al. [111]	Renewable and Sustainable Energy Reviews	2016	Bifacial solar photovoltaics – A technology review	Review	<ul style="list-style-type: none"> <li>➤ Describe the state-of-art in bifacial PV technology and specify areas where future study may promote introduction of PV technology to the market.</li> </ul>
Kow et al. [112]	Renewable and Sustainable Energy Reviews	2016	A review on performance of artificial intelligence and conventional method in mitigating PV grid-tied related power quality events	Review	<ul style="list-style-type: none"> <li>➤ Study the negative influence of photovoltaic grid-tied system on the power networks</li> <li>➤ Investigate the performance of artificial intelligence and traditional methods in reducing power quality event.</li> </ul>
Sengupta et al. [84]	Renewable and Sustainable Energy Reviews	2016	Effects of doping, morphology and film-thickness of photo-anode materials for dye sensitized solar cell application – A review	Review	<ul style="list-style-type: none"> <li>➤ Discuss the impact of affecting parameters on the photovoltaic characteristics of photo anode for dye sensitized solar cell application.</li> </ul>

Humada et al. [28]	Energy and Buildings	2016	Performance evaluation of two PV technologies (c-Si and CIS) for building integrated photovoltaic based on tropical climate condition: A case study in Malaysia	Case study	<ul style="list-style-type: none"> <li>➤ Analyze and compare the performance of two major technologies of PV modules: monocrystalline silicon (c-Si) and copper–indium–diselenide (CIS).</li> </ul>
Forcan et al. [53]	Solar Energy	2016	An algorithm for elimination of partial shading effect based on a Theory of Reference PV String	Numerical	<ul style="list-style-type: none"> <li>➤ Investigate a new theoretical approach named “theory of reference PV string” to analyze the influence of partial shading of a PV string system.</li> </ul>
Jordehi [59]	Renewable and Sustainable Energy Reviews	2016	Parameter estimation of solar photovoltaic (PV) cells: A review	Review	<ul style="list-style-type: none"> <li>➤ Review of the present research works on PV model parameter estimation problems.</li> </ul>
Teffah and Zhang [113]	Solar Energy	2017	Modeling and experimental research of hybrid PV-thermoelectric system for high concentrated solar energy conversion	Modeling, experimental and numerical	<ul style="list-style-type: none"> <li>➤ Suggest a model which gathers in a roof multi-junction solar cell (MJSC) with TEG-TEG module.</li> <li>➤ Investigate the behavior of the MJSC under distinct high sun concentration factor.</li> <li>➤ Demonstrate the ability of using the whole hybrid system to attain a high efficiency.</li> <li>➤ Conduct experiments to illustrate the cooling and the electric contribution of the TEC-TEG to the system overall efficiency.</li> </ul>
Singh and Banerjee [114]	Solar Energy	2017	Impact of large-scale rooftop solar PV integration: An algorithm for hydrothermal-solar scheduling (HTSS)	Numerical	<ul style="list-style-type: none"> <li>➤ Discuss a suggested Hydrothermal-Solar scheduling (HTSS) algorithm in order to combine solar photovoltaic generation with an available hydrothermal system at grid level.</li> </ul>
Qureshi et al. [115]	Renewable and Sustainable Energy Reviews	2017	Factors responsible for solar PV adoption at household level: A case of Lahore, Pakistan	Review and modeling	<ul style="list-style-type: none"> <li>➤ Demonstrate the issue of diffusion of solar PV at household level by using Rogers’ Theory of Innovation Diffusion - a more systematic analytical framework.</li> </ul>

Jayaraman et al. [116]	Renewable and Sustainable Energy Reviews	2017	Reasons for low penetration on the purchase of photovoltaic (PV) panel system among Malaysian landed property owners	Review	<ul style="list-style-type: none"> <li>➤ Discuss the parameters that affect utilization of the natural solar energy resources through the installation of PV panel system.</li> <li>➤ Evaluate the role of customer acceptance and efforts to demonstrate its effects on photovoltaic panel usage.</li> </ul>
Vasel and Iakovidis [117]	Energy Conversion and Management	2017	The effect of wind direction on the performance of solar PV plants	Analytical and case study	<ul style="list-style-type: none"> <li>➤ Analyze the field data from a solar farm to study the influence of wind direction on the overall performance of a utility-scale PV plant.</li> <li>➤ Determine the best orientation of the area of solar PV plants.</li> </ul>
Quansah et al. [118]	international journal of hydrogen energy	2017	Performance analysis of different grid-connected solar photovoltaic (PV) system technologies with combined capacity of 20 kW located in humid tropical climate	Analytical	<ul style="list-style-type: none"> <li>➤ Analyze the outdoor performance of five solar photovoltaic (PV) systems with five different solar cell technologies: polycrystalline (pc-Si) and monocrystalline (mc-Si), Copper Indium disulfide (CIS) thin-film, Amorphous Silicon (a-Si), and Heterojunction Incorporating thin (HIT) film.</li> </ul>
Ram and Rajasekar [119]	Energy	2017	A new global maximum power point tracking technique for solar photovoltaic (PV) system under partial shading conditions (PSC)	Modeling, numerical and experimental	<ul style="list-style-type: none"> <li>➤ Suggest a new flower pollination algorithm for solar PV maximum power point tracking.</li> </ul>
Jordehi [120]	Solar Energy	2018	Enhanced leader particle swarm optimisation (ELPSO): An efficient algorithm for parameter estimation of photovoltaic (PV) cells and modules	Modeling, numerical and case study	<ul style="list-style-type: none"> <li>➤ Estimate the PV cells and modules parameter by utilizing an improved PSO variant, named as enhanced leader PSO (ELPSO).</li> </ul>
Dhanalakshmi and Rajasekar [121]	Energy Conversion and Management	2018	Dominance square based array reconfiguration scheme for power loss reduction in solar Photovoltaic (PV) systems	Modeling and numerical	<ul style="list-style-type: none"> <li>➤ Suggest a new mathematical methodology following dominant square puzzle procedure with inherent ability to perform row and column wise shade dispersion.</li> <li>➤ Validate the suggested approach by analyzing a shade dispersion on a 5x5 PV array for different shade conditions.</li> </ul>

Palm et al. [122]	Energy Research & Social Science	2018	Sufficiency, change, and flexibility: Critically examining the energy consumption profiles of solar PV prosumers in Sweden	Analytical	<ul style="list-style-type: none"> <li>➤ Analyze the electricity consumption and energy-saving behaviors of households that own photovoltaic (PV) systems in Sweden.</li> </ul>
Honrubia-Escribano et al. [123]	Renewable and Sustainable Energy Reviews	2018	Influence of solar technology in the economic performance of PV power plants in Europe. A comprehensive analysis	Analytical and modeling	<ul style="list-style-type: none"> <li>➤ Analyze the impact of solar technology on the economic performance of distinct topologies of PV power plants.</li> <li>➤ Suggest an economic model to determine the most convenient type of installation for a wide range of input parameters.</li> </ul>
Andenæs et al. [124]	Solar Energy	2018	The influence of snow and ice coverage on the energy generation from photovoltaic solar cells	Review	<ul style="list-style-type: none"> <li>➤ Present a review to study the effect of snow and ice coverage on the energy generation from photovoltaic solar cells.</li> </ul>
Moslehi et al. [125]	Energy	2018	Evaluation of data-driven models for predicting solar photovoltaics power output	Modeling	<ul style="list-style-type: none"> <li>➤ Assess the distinct inverse models for estimating the power output of solar photovoltaic systems under different practical scenarios.</li> </ul>
Dehghani et al. [126]	Energy	2018	Robust design and optimization of solar photovoltaic supply chain in an uncertain environment	Modeling and case study	<ul style="list-style-type: none"> <li>➤ Implement a two-phase approach according to data envelopment analysis and robust optimization models to design and plan a solar photovoltaic supply chain in an uncertain environment.</li> </ul>
Xu et al. [127]	Journal of Cleaner Production	2018	Environmental effects of China's solar photovoltaic industry during 2011-2016: A life cycle assessment approach	Analytical	<ul style="list-style-type: none"> <li>➤ Analyze the environmental costs and benefits of China's solar PV industry for the period of 2011-2016.</li> </ul>
Saxena et al. [128]	Renewable Energy	2018	Laboratory based Experimental Investigation of Photovoltaic (PV) Thermo-control with Water and its Proposed Real-time Implementation	Experimental and analytical	<ul style="list-style-type: none"> <li>➤ Conduct a laboratory scale experimental study for continuous and interrupted water cooling, which is tested for distinct flow rates.</li> <li>➤ Perform mathematical analysis of temperature over PV panel with and without water cooling system.</li> </ul>

Hoffmann et al. [129]	Renewable Energy	2018	Monthly profile analysis based on a two-axis solar tracker proposal for photovoltaic panels	Analytical	<ul style="list-style-type: none"> <li>➤ Develop a two-axis solar tracker and assess the performances of a solar panel in comparison with a fixed system.</li> </ul>
Jakica [130]	Renewable and Sustainable Energy Reviews	2018	State-of-the-art review of solar design tools and methods for assessing daylighting and solar potential for building-integrated photovoltaics	Review	<ul style="list-style-type: none"> <li>➤ Overview of almost 200 solar design tools, analyze their numerous features regarding accuracy, complexity, scale, computation speed, representation as well as build design process integration in about 50 2D/3D, CAD/CAM and BIM software environments.</li> </ul>
Ram et al. [131]	Renewable and Sustainable Energy Reviews	2018	Analysis on solar PV emulators: A review	Review	<ul style="list-style-type: none"> <li>➤ Review on different PV emulator topologies.</li> <li>➤ Present a detailed analysis of each technique emphasizing on its realization cost, accuracy and level of complexity, sensitiveness to varying environmental conditions, hardware implementation and efficiency.</li> </ul>
Belarbi et al. [132]	Renewable and Sustainable Energy Reviews	2018	Self-reconfiguring MPPT to avoid buck-converter limits in solar photovoltaic systems	Modeling and numerical	<ul style="list-style-type: none"> <li>➤ Suggest a new Maximum Power Point Tracking (MPPT) architecture that enables significant improvement of the system output.</li> </ul>
Hyder et al. [133]	Renewable and Sustainable Energy Reviews	2018	Solar PV tree design: A review	Review	<ul style="list-style-type: none"> <li>➤ Review the components of the solar tree and its design.</li> <li>➤ Discuss the various commercial designs along with applications of the solar tree.</li> <li>➤ Present the limitations involved with this technology.</li> </ul>
Shayestegan et al. [134]	Renewable and Sustainable Energy Reviews	2018	An overview on prospects of new generation single-phase transformerless inverters for grid-connected photovoltaic (PV) systems	Review	<ul style="list-style-type: none"> <li>➤ Discuss the main challenges in transformerless topologies.</li> <li>➤ Present a review on new single-phase grid-connected PV systems, which are classified into six groups based on the number of switches required in the system.</li> </ul>

Novaes Pires Leite et al. [135]	Energy Conversion and Management	2019	An economic analysis of the integration between air-conditioning and solar photovoltaic systems	Modeling and analytical	<ul style="list-style-type: none"> <li>➤ Present an economic analysis taking into consideration technical sides concerning the integrated utilization of solar PV as a complement energy source and air conditioning systems connected to the utility grid.</li> <li>➤ Implement a mathematical model to assess the economic avail of the integrated use of PV systems.</li> </ul>
Rahnama et al. [136]	Energy Conversion and Management	2019	Spatio-temporal solar exergoeconomic and exergoenvironmental maps for photovoltaic systems	Analytical	<ul style="list-style-type: none"> <li>➤ Suggest and implement the approach of solar exergo-economic and exergo-environmental maps for PV systems.</li> <li>➤ Carry out a detailed case study to investigate how the suggested concept can be practically applied to enhance PV systems.</li> </ul>
Zhao et al. [137]	Renewable and Sustainable Energy Reviews	2019	An adaptive PID control method to improve the power tracking performance of solar photovoltaic air-conditioning systems	Analytical	<ul style="list-style-type: none"> <li>➤ Propose an adaptive PID control method to enhance the performance of power tracking of solar PV air conditioners.</li> </ul>
Fernández et al. [138]	Energy Conversion and Management	2019	Dispatchability of solar photovoltaics from thermochemical energy storage	Analytical	<ul style="list-style-type: none"> <li>➤ Suggest a new concept to integrate thermochemical energy storage in PV plants.</li> <li>➤ Analyze the sustainability of the calcium Looping process as thermochemical energy storage system in solar PV plants.</li> <li>➤ Develop an economic analysis to compare the suggested system with batteries.</li> </ul>
Rosas-Flores et al. [139]	Renewable and Sustainable Energy Reviews	2019	Potential energy saving in urban and rural households of Mexico with solar photovoltaic systems using geographical information system	Review and analytical	<ul style="list-style-type: none"> <li>➤ Verify the state of the art implementation of an interconnected PV system network.</li> <li>➤ Review the current legislation for PV energy in Mexico.</li> <li>➤ Conduct an energy savings analysis for solar PV technology execution on a large scale in rural and urban residences in Mexico.</li> </ul>

Rajvikram and Sivasankar [140]	Solar Energy	2019	Experimental study conducted for the identification of best heat absorption and dissipation methodology in solar photovoltaic panel	Experimental	<ul style="list-style-type: none"> <li>➤ Suggest a method to enhance the efficiency of solar PV panel by controlling the temperature and utilizing phase change material which is integrated to external finned sink to enhance its thermal conductivity.</li> <li>➤ Investigate the concept by experimental setup under direct sun rays for four different cases in the environmental conditions.</li> </ul>
Troncoso et al. [141]	Energy Procedia	2019	Economic decision-making tool for distributed solar photovoltaic panels and storage: The case of Chile	Numerical	<ul style="list-style-type: none"> <li>➤ Develop an economic decision making tool for the case of Chile which calculates the number of solar PV panels and batteries that optimize the economic return.</li> <li>➤ Conduct a personal computer implementation and numerical example.</li> </ul>
Trindade and Cordeiro [142]	Solar Energy	2019	Automated formal verification of stand-alone solar photovoltaic systems	Numerical	<ul style="list-style-type: none"> <li>➤ Suggest an algorithm which conducts the automated verification method to formally check the sizing and operation of a certain stand-alone PV system.</li> <li>➤ Assess the verification method by comparing three states of the art model checkers in five real case studies.</li> </ul>
Liu et al. [143]	Energy Conversion and Management	2019	Overview on hybrid solar photovoltaic-electrical energy storage technologies for power supply to buildings	Review	<ul style="list-style-type: none"> <li>➤ Present the recent progress in hybrid PV electrical energy storage systems for buildings regarding the whole installation status and research development on the system optimization and performance analysis.</li> </ul>
Kiyaninia et al. [144]	Solar Energy	2019	Exergoeconomic analysis of a solar photovoltaic-based direct evaporative air-cooling system	Modeling and experimental	<ul style="list-style-type: none"> <li>➤ Perform experimental investigation on direct evaporative air cooling base solar PV system with different thicknesses of cellulose and straw pads</li> <li>➤ Conduct a mathematical model and exergo-economic analysis for the system.</li> </ul>
Sow et al. [145]	Sustainable Energy Technologies and Assessments	2019	Economic analysis of residential solar photovoltaic electricity production in Canada	Analytical	<ul style="list-style-type: none"> <li>➤ Present an economical comparative analysis of solar PV systems for the provinces and territories of Canada for 2013 and 2016.</li> </ul>



Zafrilla et al. [146]	Renewable and Sustainable Energy Reviews	2019	Triple bottom line analysis of the Spanish solar photovoltaic sector: A footprint assessment	Analytical	<ul style="list-style-type: none"> <li>➤ Present a comprehensive sustainability assessment of the solar PV sector.</li> </ul>
Falama et al. [147]	Optik	2019	A promising concept to push efficiency of pn-junction photovoltaic solar cell beyond Shockley and Queisser limit based on impact ionization due to high electric field	Modeling	<ul style="list-style-type: none"> <li>➤ Demonstrate carriers' multiplication in PV cell and its implication to enhance the efficiency of solar cell.</li> </ul>
Sadanand and Dwived [148]	Optical Materials	2020	Numerical modeling for earth-abundant highly efficient solar photovoltaic cell of non-toxic buffer layer	Numerical	<ul style="list-style-type: none"> <li>➤ Study the influence of photoactive layer thickness on the photocurrent of <math>\text{Cu}_2\text{ZnSnS}_4\text{Se}_4</math> based PV cell.</li> <li>➤ Implement simulation study to study several parameters of device layout <math>\text{MoS}_2/\text{CZTSSe}/\text{ZnS}/\text{ITO}</math> to optimize the solar devices.</li> </ul>
Ren et al. [149]	Energy	2020	Analysis of $\text{CO}_2$ emission reduction contribution and efficiency of China's solar photovoltaic industry: Based on Input-output perspective	Analytical	<ul style="list-style-type: none"> <li>➤ Demonstrate the contribution of solar PV industry to reduce <math>\text{CO}_2</math> emissions based on the relationship between efficiency of installed capacity and efficiency of <math>\text{CO}_2</math> emission mitigation.</li> </ul>
Qi et al. [150]	Energy Conversion and Management	2020	A celestial motion-based solar photovoltaics installed on a cooling tower	Analytical	<ul style="list-style-type: none"> <li>➤ Suggest a new PV utilization in which PV cells are installed on the cooling towers of a thermal power plant.</li> <li>➤ Compare and study four configurations of PV in three power plants to assess the technical and economic performances of the suggested design.</li> </ul>
Jan et al. [151]	Journal of Cleaner Production	2020	Social acceptability of solar photovoltaic system in Pakistan: Key determinants and policy implications	Analytical	<ul style="list-style-type: none"> <li>➤ Determine the parameters that have a vital role in the social acceptability of solar PV system and proffer reasonable impacts of solar energy policy in Pakistan.</li> </ul>

Janardhan et al. [152]	Energy Reports	2020	Performance investigation of stand-alone solar photovoltaic system with single phase micro multilevel inverter	Modeling and numerical	<ul style="list-style-type: none"> <li>➤ Model and simulate solar PV system with micro multilevel inverter.</li> <li>➤ Investigate the effect of solar PV input parameters (solar irradiance and panel temperature) on the output parameters (DC voltage and current).</li> </ul>
Kumar et al. [153]	Sustainable Energy Technologies and Assessments	2020	Performance analysis and evaluation of 10 kWp solar photovoltaic array for remote islands of Andaman and Nicobar	Analytical	<ul style="list-style-type: none"> <li>➤ Proffer the solar PV performance analysis, resource assessment and normalized performance indices evaluation for 10 kWp solar PV array taken at climatic conditions of five islands of Andaman and Nicobar.</li> </ul>
Ali et al. [154]	Energy Reports	2020	Performance of solar pond integrated with photovoltaic/thermal collectors	Experimental	<ul style="list-style-type: none"> <li>➤ Suggest and investigate a new system design for PV/solar pond.</li> <li>➤ Implement experimental evaluation study of the thermal performance of mini PV/solar pond.</li> </ul>
Yang et al. [155]	Applied Energy	2020	Potential analysis of roof-mounted solar photovoltaics in Sweden	Analytical	<ul style="list-style-type: none"> <li>➤ Present a Geographical Information System (GIS)-based comprehensive methodology with energy system modeling techniques to integrate the potential geographical assessment, technical assessment, and subsidy feasibility analysis for solar PV systems.</li> </ul>
Anand et al. [156]	Renewable and Sustainable Energy Reviews	2021	A review on solar photovoltaic thermal integrated desalination technologies	Review	<ul style="list-style-type: none"> <li>➤ Present a review on photovoltaic thermal (PVT) collector combined with desalination technologies such as humidification dehumidification, solar still, reverse osmosis, multiple effect distillation, multiple stage flash and membrane distillation.</li> </ul>
Syahputra and Soesanti [157]	Energy Reports	2021	Renewable energy systems based on micro-hydro and solar photovoltaic for rural areas: A case study in Yogyakarta, Indonesia	Analytical	<ul style="list-style-type: none"> <li>➤ Carry out the renewable energy systems planning based on micro hydro and solar photovoltaic for rural areas.</li> <li>➤ Implement a case study in the Yogyakarta area, Indonesia.</li> </ul>
Alipour et al. [158]	Renewable Energy	2021	Residential solar photovoltaic adoption behaviour: End-to-end review of theories, methods and approaches	Analytical	<ul style="list-style-type: none"> <li>➤ Present a critical analysis of studies on the utilization of solar PV, solar home systems, and solar PV combined with battery energy storage system.</li> </ul>

Kazemian et al. [159]	Solar Energy	2021	Optimization of a novel photovoltaic thermal module in series with a solar collector using Taguchi based grey relational analysis	Modeling and numerical	<ul style="list-style-type: none"> <li>➤ Propose a new compound system which comprises a solar collector combined in series with PVT module.</li> <li>➤ Develop a transient 3-D model to numerically compare the performance of four systems to assess the feasibility of the suggested novel system.</li> <li>➤ Perform parametric analysis to study the effect of distinct operating conditions on the output power of the compound system module.</li> </ul>
Bhavsar and Pitchumani [160]	Applied Energy	2021	A novel machine learning based identification of potential adopter of rooftop solar photovoltaics	Modeling	<ul style="list-style-type: none"> <li>➤ Proffer a new data driven modeling methodology that prunes a wide range of consumer profile features utilizing a machine learning framework to drill a model for expecting possibility of solar exploitation.</li> </ul>
De and Ganguly [161]	Journal of Cleaner Production	2021	Modeling and analysis of a solar thermal-photovoltaic-hydrogen-based hybrid power system for running a standalone cold storage	Modeling	<ul style="list-style-type: none"> <li>➤ Propose a solar hydrogen hybrid power system to drive a remotely existing cold storage facility for progressing countries on the sustainable basis.</li> <li>➤ Develop a mathematical model on the proposed system.</li> <li>➤ Analyze the suggested system from energy, economic and environmental point of view.</li> </ul>
Wang et al. [162]	Renewable and Sustainable Energy Reviews	2021	Distributed solar photovoltaic development potential and a roadmap at the city level in China	Analytical	<ul style="list-style-type: none"> <li>➤ Determine the feasibility and availability of implementing distributed solar PV system in China's cities.</li> </ul>
Rodziewicz et al. [163]	Energy Reports	2021	Modelling and analysis of the influence of solar spectrum on the efficiency of photovoltaic modules	Analytical	<ul style="list-style-type: none"> <li>➤ Study the effect of changes in the distribution of the solar radiation spectrum on the characteristics of several PV modules.</li> <li>➤ Compare the relative efficiency of PV modules with different semiconductor absorbers during bright and sunny, and cloudy summer days.</li> <li>➤ Investigate the influence of module tilt angle on the magnitude of surface incident scattered component and module efficiency.</li> </ul>

## 4. ECONOMIC AND ENVIRONMENTAL ANALYSES

PV is considered a clean, sustainable and renewable energy conversion technology that can help meet energy requests of the world's growing population. Indeed, generating electricity by adopting photovoltaic is a financially and environmentally intelligent decision [164]. Dusonchet and Telaretti [165] presented a comparative economic analysis of support policies for solar PV in the most representative European countries such as France, Germany, Greece, Italy and the U.K. the analysis helps to evaluate the influence of PV energy policies and portend how the PV market could progress in the aforementioned European countries. Hernández-Moro and Martínez-Duart [110] conducted analytical method to compute the amount of CO<sub>2</sub> that will be reduced by adopting photovoltaic systems according to three scenarios from the International Energy Agency. Besides, by taking European Union, United States, China, and the world's average as a reference, the authors estimated the financial extra-cost afforded in the installation of photovoltaic systems which could be used instead of the conventional power production systems.

In countries such as Lebanon where there is permanent electricity shortage, it is beneficial to utilize such renewable energy system to generate electricity. Solar PV system reduces consumption of conventional sources of energy, which are harmful to the environment and at the same time they are not found in Lebanon. Therefore, there will be no need to spend large amounts of money to import fuels, and the opportunity to keep environment clean will be higher. In this context, economic and environmental studies are performed to expose the significance of solar PV systems in Lebanon.

### 4.1 Economic analysis

To evaluate the economic influence of using solar photovoltaic, a study is conducted by utilizing off-grid PV system of monocrystalline silicon technology. The study is performed to calculate the price of electric energy consumed in several scenarios in Lebanon country (house, gym, restaurant and hotel). Therefore, the amount of money saved, when utilizing solar photovoltaic to generate the required electricity instead of using the supplied electricity from conventional sources, will be also estimated. Besides, the payback period of the studied solar photovoltaic systems is calculated depending on the amount of saved money and the cost of a solar PV system.

#### 4.1.1 Amount of saved money

To calculate the price of electricity consumed in each scenario, the amount of consumed energy must be known. Table 3 illustrates the amount of monthly consumed electric energy by each scenario. The data given in table 3 were obtained from a survey that was performed with several number of people having houses, gyms, restaurants and hotels in Lebanon where each scenario includes distinct sizes.

Table 3. Monthly consumed electricity by each scenario.

Scenario	Electricity consumption (kWh)
House	926
Gym	19125
Restaurant	30400
Hotel	75500

The price of electric energy consumed can be calculated by equation (1).

$$P_{E/month} = EE_{month} \cdot P_{1kWh} \quad (1)$$

where  $P_{E/month}$  is the price of electric energy consumed (\$/month),  $EE_{month}$  is the electric energy consumed (kWh/month) and  $P_{1kWh}$  is the price of 1 kWh. Table 4 illustrates the price of kWh in Lebanon.

Table 4. Price of kWh in Lebanon [166].

Range	Price (\$)
Below 100 kWh	0.023
100 – 300 kWh	0.040
300 – 400 kWh	0.053
400 – 500 kWh	0.080
500 kWh and above	0.133

By using tables 3 and 4 and equation (1), the price of monthly consumed electricity for each scenario is estimated and presented in table 5.

Table 5. Price of the monthly consumed electricity for each scenario.

Scenario	Price (\$/month)
House	80
Gym	2500
Restaurant	4000
Hotel	10000

To evaluate the amount of money saved when utilizing solar photovoltaic systems, equation (2) can be utilized.

$$SM_{year} = 12 \cdot Pr \cdot P_{E/month} \quad (2)$$

where  $SM_{year}$  is the amount of saved money per year (\$/year),  $Pr$  is the percentage of time where solar photovoltaic is utilized and 12 is the number of months per year.

Figure 7 shows the variation of saved money as a function of  $Pr$  for each of the studied scenarios. It is clear there is a direct and linear relationship between saved money and  $Pr$  in all cases. To illustrate, the amount of saved money increases linearly in all scenarios as the percentage of time when solar photovoltaic is used increases. Besides, the amount of saved money depends on the electricity consumed in each case which explains the difference in the amount of saved money between the studied cases. For a moderate usage of PV system ( $Pr=60\%$ ), the amount of saved money is 576, 18000, 28800, and 72000 \$/year for house, gym, restaurant and hotel respectively. While for a high dependence on PV system ( $Pr=90\%$ ), higher amount of saved money is obtained which is 864, 27000, 43200, and 108000 \$/year for house, gym, restaurant and hotel respectively.

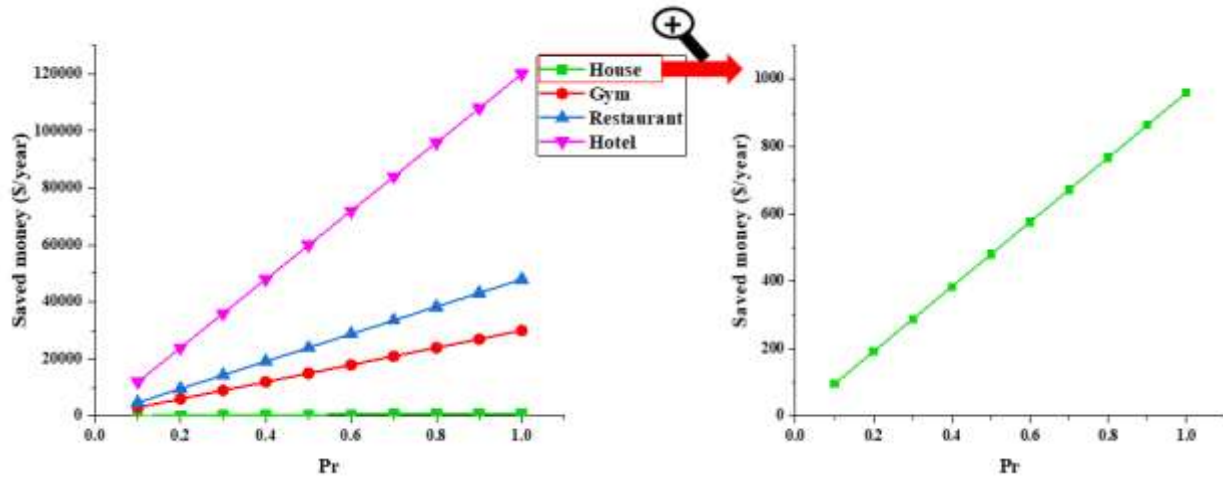

Figure 7. Variation of saved money as a function of  $Pr$  for house, gym, restaurant and hotel where the results for the house are zoomed in.

#### 4.1.2 Payback period

To estimate the payback period of monocrystalline silicon PV system, equation (3) is utilized.

$$Pbp = \frac{P_{PV}}{SM_{year}} \quad (3)$$

where  $Pbp$  is the payback period (year) and  $P_{PV}$  is the price of solar photovoltaic system (\$).

$P_{PV}$  is presented in table 6 for each scenario.

Table 6. Price of monocrystalline solar photovoltaic system for each scenario [167].

Scenario	Price (\$)
House	14 000
Gym	55 000
Restaurant	175 000
Hotel	1 400 000

Figure 8 presents the payback period as a function of  $Pr$  for house, gym, restaurant and hotel. It can be concluded from the results that in all scenarios the payback period decreases as the percentage of time when solar PV is utilized increases. Furthermore, the payback period depends on the price of PV system divided by the amount of saved money as shown in equation (3). This explains the difference in payback period between the four cases where the greatest payback period is for house while the lowest is for gym. For a moderately efficient case where  $Pr=60\%$ , the payback period is 24.3, 3.1, 6.1, and 19.4 years for house, gym, restaurant and hotel respectively. While for highly efficient case where  $Pr=90\%$ , lower payback period is obtained which is 16.2, 2.1, 4.1, and 13.0 years for house, gym, restaurant and hotel respectively.

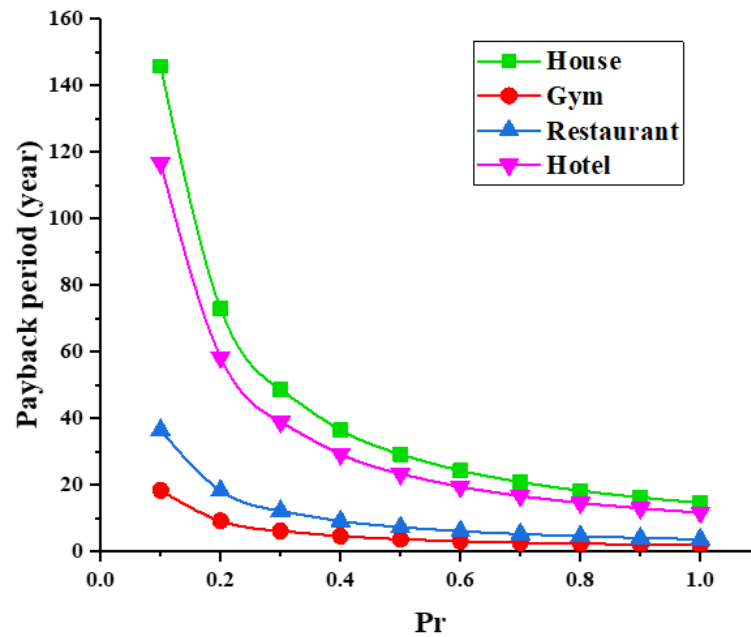
Figure 8. Variation of payback period as a function of  $Pr$  for house, gym, restaurant and hotel.

#### 4.2 Environmental analysis

In order to show that solar energy is environmentally friendly and mainly assess the environmental effect of solar photovoltaic systems in Lebanon, a study is conducted to calculate the amount of carbon dioxide released per month when a photovoltaic system is used. Then, compute the amount

of carbon dioxide emission that will be reduced by utilizing PV system to produce electricity instead of conventional energy.

The amount of CO<sub>2</sub> produced and amount of reduction in carbon dioxide emission per month can be calculated from formulas of equations (4) and (5) respectively.

$$MP_{CO_2/month} = EE_{month} \cdot M_{CO_2/1kWh} \quad (4)$$

where  $MP_{CO_2/month}$  is the amount of monthly produced CO<sub>2</sub> (kg/month) and  $M_{CO_2/1kWh}$  is the amount of CO<sub>2</sub> produced from 1 kWh electricity. In Lebanon country, the amount of produced CO<sub>2</sub> from 1 kWh is estimated to be about 0.47 kg CO<sub>2</sub>/1 kWh [168].

$$MM_{CO_2/month} = Pr \cdot MP_{CO_2/month} \quad (5)$$

where  $MM_{CO_2/month}$  is the amount of CO<sub>2</sub> mitigated (kg/month).

Hence, the annual mitigated amount of CO<sub>2</sub> can be obtained by multiplying the monthly mitigated amount of CO<sub>2</sub> by 12.

Figure 9 illustrates the amount of mitigated CO<sub>2</sub> as a function of Pr for house, gym, restaurant and hotel. The obtained results reveal that as Pr increases the minimized amount of CO<sub>2</sub> raises linearly in all scenarios. Moreover, there is a direct relation between the amount of CO<sub>2</sub> reduced and the consumed electricity in each case. The amount of mitigated CO<sub>2</sub> increases from 3.1 to 4.7 ton/year, 65 to 97 ton/year, 103 to 154 ton/year, and from 256 to 383 ton/year when the percentage of time when PV system is used increases from 60% to 90% for house, gym, restaurant and hotel, respectively. Hence, the more efficient utilization of PV system leads to alleviate more amount of CO<sub>2</sub> emissions.

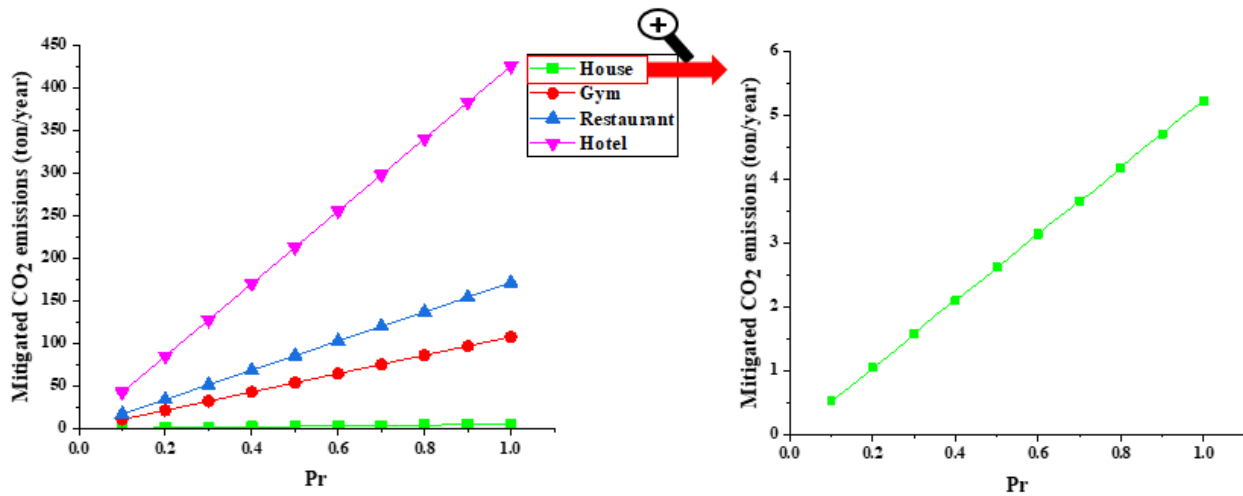

Figure 9. Variation of the amount of mitigated CO<sub>2</sub> as a function of Pr for house, gym, restaurant and hotel where the results for the house are zoomed in.



## 5. CONCLUSION

Solar energy is a green, sustainable, wide and ubiquitous renewable source of energy. It has a great influence on reducing or even eliminating utilization of fossil fuel in the future and at low cost. Solar photovoltaic system is an elegant application of solar energy. It generates electricity directly from the sun, thus it minimizes consumption of fossil fuels and emissions of greenhouse gases.

In this work, a short review on solar photovoltaic is presented. Principle of solar photovoltaic, components and types of solar photovoltaic is covered. In addition, classification of photovoltaic technologies is carried on with a detailed description for each type. Furthermore, economic and environmental studies have been conducted to assess the influence of using solar PV system in Lebanon for several scenarios including home, gym, restaurant and hotel.

The economic analyses were performed by first evaluating the amount of electricity consumed by each scenario per month. Then, the amount of saved money is calculated. On the other hand, an off-grid PV system of monocrystalline silicon first generation technology is taken under study to compute its payback period for each scenario. It was concluded from the results that there is inversely relationship between Pr and payback period. It was obtained that for a moderate (60%) and high (90%) utilization of PV the payback period of the system is 24.3 years and 16.2 years for house, 3.1 years and 2.1 years for gym, 6.1 years and 4.1 years for a restaurant, and 19.4 years and 13.0 years for hotel.

Moreover, the environmental study was carried on to calculate the mitigation in CO<sub>2</sub> production for the aforementioned scenarios when utilizing solar photovoltaic system. It was obtained that utilizing PV system reinforces alleviation of CO<sub>2</sub> emissions in which there is a proportional relationship between Pr and amount of reduced CO<sub>2</sub>. It was also shown that for moderate (60%) and high (90%) usage of PV, the annual amount of CO<sub>2</sub> mitigated is about 3.1 and 4.7 tons in house, 65 and 97 tons in gym, 103 and 154 tons in restaurant, and 256 and 383 tons in hotel.

This work strongly highlights the significance of utilizing PV technology on the economic and environmental issues and consequently on human health. Therefore, it is expected that solar PV systems will have a great potential to become one of the priorities in human's life and will be exploited all over the world, especially in Lebanon.

## REFERENCES

- [1] Marwede M, Reller A. Estimation of Life Cycle Material Costs of Cadmium Telluride- and Copper Indium Gallium Diselenide-Photovoltaic Absorber Materials based on Life Cycle Material Flows. *J Ind Ecol* 2014;18:254–67. doi:10.1111/jiec.12108.
- [2] Goodrich A, Hacke P, Wang Q, Sopori B, Margolis R, James TL, et al. A wafer-based monocrystalline silicon photovoltaics road map: Utilizing known technology improvement opportunities for further reductions in manufacturing costs. *Sol Energy Mater Sol Cells* 2013;114:110–35. doi:10.1016/j.solmat.2013.01.030.
- [3] Sinha P. Life cycle materials and water management for CdTe photovoltaics. *Sol Energy Mater Sol Cells* 2013;119:271–5. doi:10.1016/j.solmat.2013.08.022.
- [4] Marwede M, Reller A. Future recycling flows of tellurium from cadmium telluride photovoltaic waste. *Resour Conserv Recycl* 2012;69:35–49. doi:10.1016/j.resconrec.2012.09.003.
- [5] Jaber H, Khaled M, Lemend T, Faraj J, Bazzi H, Ramadan M. Effect of Exhaust Gases Temperature on the Performance of a Hybrid Heat Recovery System. *Energy Procedia* 2017;119:775–82. doi:10.1016/J.EGYPRO.2017.07.110.

- [6] Jaber H, Khaled M, Lemenand T, Faraj J, Bazzi H, Ramadan M, et al. Short review on heat recovery from exhaust gas. *Case Stud Therm Eng* 2015;119:95–110. doi:10.1016/J.RSER.2017.08.016.
- [7] Faraj A, Jaber H, Chahine K, Faraj J, Ramadan M, Hage H El, et al. New concept of power generation using TEGs: Thermal modeling, parametric analysis, and case study. *Entropy* 2020;22. doi:10.3390/E22050503.
- [8] Jaber H, Lemenand T, Ramadan M, Khaled M. Hybrid Heat Recovery System Applied To Exhaust Gases–Thermal Modeling And Case Study. *Heat Transf Eng* 2019;0:1–14. doi:10.1080/01457632.2019.1692495.
- [9] Jaber H, Lemenand T, Ramadan M, Khaled M. Hybrid Heat Recovery System Applied To Exhaust Gases–Thermal Modeling And Case Study. *Heat Transf Eng* 2019. doi:10.1080/01457632.2019.1692495.
- [10] Jaber H, El Hage H, Ramadan M, Khaled M, Olabi AG. A short review on the techniques of waste heat recovery from domestic applications. *Energy Sources, Part A Recover Util Environ Eff* 2019:1–16. doi:10.1080/15567036.2019.1623940.
- [11] Branker K, Pathak M, Pearce JM, Pathak MJM, Pearce JM. A Review of Solar Photovoltaic Levelized Cost of Electricity A Review of Solar Photovoltaic Levelized Cost of Electricity A Review of Solar Photovoltaic Levelized Cost of Electricity. *Renew Sustain Energy Rev* 2011;15:4470–82. doi:10.1016/j.rser.2011.07.104.
- [12] Sahoo SK. Renewable and sustainable energy reviews solar photovoltaic energy progress in India: A review. *Renew Sustain Energy Rev* 2016;59:927–39. doi:10.1016/j.rser.2016.01.049.
- [13] Cevasco D, Koukoura S, Kolios AJ. Reliability, availability, maintainability data review for the identification of trends in offshore wind energy applications. *Renew Sustain Energy Rev* 2021;136:110414. doi:10.1016/j.rser.2020.110414.
- [14] Wei Y, Zou Q-P, Lin X. Evolution of price policy for offshore wind energy in China: Trilemma of capacity, price and subsidy. *Renew Sustain Energy Rev* 2021;136:110366. doi:10.1016/j.rser.2020.110366.
- [15] Herez A, Khaled M, Murr R, Haddad A, Elhage H, Ramadan M. Using Geothermal Energy for cooling - Parametric study. *Energy Procedia* 2017;119:783–91. doi:10.1016/J.EGYPRO.2017.07.111.
- [16] El Hage H, Herez A, Ramadan M, Bazzi H, Khaled M. An investigation on solar drying: A review with economic and environmental assessment. *Energy* 2018;157:815–29. doi:10.1016/j.energy.2018.05.197.
- [17] Herez A, Ramadan M, Khaled M. Review on solar cooker systems: Economic and environmental study for different Lebanese scenarios. *Renew Sustain Energy Rev* 2018;81:421–32. doi:10.1016/J.RSER.2017.08.021.
- [18] Herez A, El Hage H, Lemenand T, Ramadan M, Khaled M. Review on photovoltaic/thermal hybrid solar collectors: Classifications, applications and new systems. *Sol Energy* 2020;207:1321–47. doi:10.1016/j.solener.2020.07.062.
- [19] Herez A, Ramadan M, Abdulhay B, Khaled M. Short review on solar energy systems. *AIP Conf. Proc.*, vol. 1758, AIP Publishing LLC; 2016, p. 030041. doi:10.1063/1.4959437.
- [20] Khaled M, Herez A, El Hage H, Lemenand T, Ramadan M. Review on Solar Water Heating System. 6th Int. Conf. Emerg. Renew. Energy Gener. Autom. ICEREGA, Sousse, Tunisia: 2018.
- [21] Herez A, Ramadan M, Khaled M, Bazzi H. A Review on Solar Dryer - Economic and Environmental Investigation for the Lebanese Case. 10TH Int. Conf. Sustain. Energy Environ. Prot., Slovenia: 2017.
- [22] Cui X, Guo L, Li C, Liu M, Wu G, Jiang G. The total biomass nitrogen reservoir and its potential of replacing chemical fertilizers in China. *Renew Sustain Energy Rev* 2021;135:110215. doi:10.1016/j.rser.2020.110215.
- [23] Solarte-Toro JC, González-Aguirre JA, Poveda Giraldo JA, Cardona Alzate CA. Thermochemical

- processing of woody biomass: A review focused on energy-driven applications and catalytic upgrading. *Renew Sustain Energy Rev* 2021;136:110376. doi:10.1016/j.rser.2020.110376.
- [24] López A, Morán JL, Núñez LR, Somolinos JA. Study of a cost model of tidal energy farms in early design phases with parametrization and numerical values. Application to a second-generation device. *Renew Sustain Energy Rev* 2020;117:109497. doi:10.1016/j.rser.2019.109497.
- [25] Qian P, Feng B, Liu H, Tian X, Si Y, Zhang D. Review on configuration and control methods of tidal current turbines. *Renew Sustain Energy Rev* 2019;108:125–39. doi:10.1016/j.rser.2019.03.051.
- [26] Oladosu GA, Werble J, Tingen W, Witt A, Mobley M, O’Connor P. Costs of mitigating the environmental impacts of hydropower projects in the United States. *Renew Sustain Energy Rev* 2021;135:110121. doi:10.1016/j.rser.2020.110121.
- [27] Barbaros E, Aydin I, Celebioglu K. Feasibility of pumped storage hydropower with existing pricing policy in Turkey. *Renew Sustain Energy Rev* 2021;136:110449. doi:10.1016/j.rser.2020.110449.
- [28] Humada AM, Hojabri M, Hamada HM, Samsuri FB, Ahmed MN. Performance evaluation of two PV technologies (c-Si and CIS) for building integrated photovoltaic based on tropical climate condition: A case study in Malaysia. *Energy Build* 2016;119:233–41. doi:10.1016/j.enbuild.2016.03.052.
- [29] Armendariz-Lopez JF, Luna-Leon A, Gonzalez-Trevizo ME, Arena-Granados AP, Bojorquez-Morales G. Life cycle cost of photovoltaic technologies in commercial buildings in Baja California, Mexico. *Renew Energy* 2016;87:564–71. doi:10.1016/j.renene.2015.10.051.
- [30] Gulhane A NP, Chavan A B A K V. A critical technological literature review of-Photovoltaic / Thermal Solar Collectors System. *Int J Curr Eng Technol* 2014;258–64.
- [31] Abdul Hamid S, Yusof Othman M, Sopian K, Zaidi SH. An overview of photovoltaic thermal combination (PV/T combi) technology. *Renew Sustain Energy Rev* 2014;38:212–22. doi:10.1016/j.rser.2014.05.083.
- [32] Kumar A, Baredar P, Qureshi U. Historical and recent development of photovoltaic thermal (PVT) technologies. *Renew Sustain Energy Rev* 2015;42:1428–36. doi:10.1016/j.rser.2014.11.044.
- [33] El Alimi S, Maatallah T, Ben Nasrallah S. Break-even analysis and optimization of a stand-alone hybrid system with battery storage for residential load consumption - A case study. *Renew Sustain Energy Rev* 2014;37:408–23. doi:10.1016/j.rser.2014.04.059.
- [34] Zhang X, Zhao X, Smith S, Xu J, Yu X. Review of R&D progress and practical application of the solar photovoltaic/thermal (PV/T) technologies. *Renew Sustain Energy Rev* 2012;16:599–617. doi:10.1016/j.rser.2011.08.026.
- [35] Ming Z, Shaojie O, Hui S, Yujian G. Is the “sun” still hot in China? the study of the present situation, problems and trends of the photovoltaic industry in China. *Renew Sustain Energy Rev* 2015;43:1224–37. doi:10.1016/j.rser.2014.12.004.
- [36] Amanlou Y, Hashjin TT, Ghobadian B, Najafi G, Mamat R. A comprehensive review of Uniform Solar Illumination at Low Concentration Photovoltaic (LCPV) Systems. *Renew Sustain Energy Rev* 2016;60:1430–41. doi:10.1016/j.rser.2016.03.032.
- [37] Gao XZ, Hou ZX, Guo Z, Chen XQ. Reviews of methods to extract and store energy for solar-powered aircraft. *Renew Sustain Energy Rev* 2015;44:96–108. doi:10.1016/j.rser.2014.11.025.
- [38] Byrne J, Taminiu J, Kurdgelashvili L, Kim KN. A review of the solar city concept and methods to assess rooftop solar electric potential, with an illustrative application to the city of Seoul. *Renew Sustain Energy Rev* 2015;41:830–44. doi:10.1016/j.rser.2014.08.023.
- [39] Singh GK. Solar power generation by PV (photovoltaic) technology: A review. *Energy* 2013;53:1–13. doi:10.1016/j.energy.2013.02.057.
- [40] Dean AD. Review on Phtovoltaic Technology Based. *Int J Adv Technol Eng Sci* 2015;03:215–20.
- [41] Masson G, Latour M. Global Market Outlook for Photovoltaics until 2016. EPIA, Biancardi, 2012 n.d.

- [https://www.scirp.org/\(S\(i43dyn45teexjx455qlt3d2q\)\)/reference/ReferencesPapers.aspx?ReferenceID=1124597](https://www.scirp.org/(S(i43dyn45teexjx455qlt3d2q))/reference/ReferencesPapers.aspx?ReferenceID=1124597) (accessed November 13, 2020).
- [42] Kamarzaman NA, Tan CW. A comprehensive review of maximum power point tracking algorithms for photovoltaic systems. *Renew Sustain Energy Rev* 2014;37:585–98. doi:10.1016/j.rser.2014.05.045.
- [43] Bouri E, Assad J El. The lebanese electricity woes: An estimation of the economical costs of power interruptions. *Energies* 2016;9. doi:10.3390/en9080583.
- [44] Blakers A. Sustainable Energy Options. *Asian Perspect* 2015;39:559–90. doi:10.5555/0258-9184-39.4.559.
- [45] Algazar MM, Al-Monier H, El-Halim HA, Salem MEEK. Maximum power point tracking using fuzzy logic control. *Int J Electr Power Energy Syst* 2012;39:21–8. doi:10.1016/j.ijepes.2011.12.006.
- [46] Islam T. Household level innovation diffusion model of photo-voltaic (PV) solar cells from stated preference data. *Energy Policy* 2014;65:340–50. doi:10.1016/j.enpol.2013.10.004.
- [47] Paiano A. Photovoltaic waste assessment in Italy. *Renew Sustain Energy Rev* 2015;41:99–112. doi:10.1016/j.rser.2014.07.208.
- [48] Khan HA, Pervaiz S. Technological review on solar PV in Pakistan: Scope, practices and recommendations for optimized system design. *Renew Sustain Energy Rev* 2013;23:147–54. doi:10.1016/j.rser.2013.02.031.
- [49] Mundo-Hernández J, De Celis Alonso B, Hernández-Álvarez J, De Celis-Carrillo B. An overview of solar photovoltaic energy in Mexico and Germany. *Renew Sustain Energy Rev* 2014;31:639–49. doi:10.1016/j.rser.2013.12.029.
- [50] Lin JX, Wen PL, Feng CC, Lin SM, Ko FK. Policy target, feed-in tariff, and technological progress of PV in Taiwan. *Renew Sustain Energy Rev* 2014;39:628–39. doi:10.1016/j.rser.2014.07.112.
- [51] Sontake VC, Kalamkar VR. Solar photovoltaic water pumping system - A comprehensive review. *Renew Sustain Energy Rev* 2016;59:1038–67. doi:10.1016/j.rser.2016.01.021.
- [52] El-Khozondar HJ, El-Khozondar RJ, Matter K. Parameters Influence on MPP Value of the Photo Voltaic Cell. *Energy Procedia* 2015;74:1142–9. doi:10.1016/j.egypro.2015.07.756.
- [53] Forcan M, Durišić Ž, Mikulović J. An algorithm for elimination of partial shading effect based on a Theory of Reference PV String. *Sol Energy* 2016;132:51–63. doi:10.1016/j.solener.2016.03.003.
- [54] Wendt J, Träger M, Klengel R, Petzold M, Schade D, Sykes R. Improved quality test method for solder ribbon interconnects on silicon solar cells. 2010 12th IEEE Intersoc. Conf. Therm. Thermomechanical Phenom. Electron. Syst. ITherm 2010, 2010. doi:10.1109/ITHERM.2010.5501299.
- [55] Luoma J, Kleissl J, Murray K. Optimal inverter sizing considering cloud enhancement. *Sol Energy* 2012;86:421–9. doi:10.1016/j.solener.2011.10.012.
- [56] Chen S, Li P, Brady D, Lehman B. Determining the optimum grid-connected photovoltaic inverter size. *Sol Energy* 2013;87:96–116. doi:10.1016/j.solener.2012.09.012.
- [57] Khatib T, Mohamed A, Sopian K. A review of photovoltaic systems size optimization techniques. *Renew Sustain Energy Rev* 2013;22:454–65. doi:10.1016/j.rser.2013.02.023.
- [58] Makki A, Omer S, Sabir H. Advancements in hybrid photovoltaic systems for enhanced solar cells performance. *Renew Sustain Energy Rev* 2015;41:658–84. doi:10.1016/j.rser.2014.08.069.
- [59] Jordehi AR. Parameter estimation of solar photovoltaic (PV) cells: A review. *Renew Sustain Energy Rev* 2016;61:354–71. doi:10.1016/j.rser.2016.03.049.
- [60] Luoma J, Kleissl J, Murray K. Optimal inverter sizing considering cloud enhancement. *Sol Energy* 2012;86:421–9. doi:10.1016/j.solener.2011.10.012.
- [61] Ramli MAM, Hiendro A, Sedraoui K, Twaha S. Optimal sizing of grid-connected photovoltaic energy system in Saudi Arabia. *Renew Energy* 2015;75:489–95. doi:10.1016/j.renene.2014.10.028.

- [62] Wong J, Lim YS, Tang JH, Morris E. Grid-connected photovoltaic system in Malaysia: A review on voltage issues. *Renew Sustain Energy Rev* 2014;29:535–45. doi:10.1016/j.rser.2013.08.087.
- [63] Arvizu D, Balaya P, Cabeza L, Hollands T, Jørgensen Waldau A, Kondo M, et al. Direct solar energy 2011.
- [64] Khan HA, Pervaiz S. Technological review on solar PV in Pakistan: Scope, practices and recommendations for optimized system design. *Renew Sustain Energy Rev* 2013;23:147–54. doi:10.1016/j.rser.2013.02.031.
- [65] Abdin Z, Webb CJ, Gray EMA. Solar hydrogen hybrid energy systems for off-grid electricity supply: A critical review. *Renew Sustain Energy Rev* 2015;52:1791–808. doi:10.1016/j.rser.2015.08.011.
- [66] Sandwell P, Chan NLA, Foster S, Nagpal D, Emmott CJM, Candelise C, et al. Off-grid solar photovoltaic systems for rural electrification and emissions mitigation in India. *Sol Energy Mater Sol Cells* 2016;156:147–56. doi:10.1016/j.solmat.2016.04.030.
- [67] Muneer T, Asif M, Munawwar S. Sustainable production of solar electricity with particular reference to the Indian economy. *Renew Sustain Energy Rev* 2005;9:444–73. doi:10.1016/j.rser.2004.03.004.
- [68] Chattopadhyay D. Modelling renewable energy impact on the electricity market in India. *Renew Sustain Energy Rev* 2014;31:9–22. doi:10.1016/j.rser.2013.11.035.
- [69] Tyagi V V., Rahim NAA, Rahim NA, Selvaraj JAL. Progress in solar PV technology: Research and achievement. *Renew Sustain Energy Rev* 2013;20:443–61. doi:10.1016/j.rser.2012.09.028.
- [70] Khatib T, Mohamed A, Sopian K. A review of photovoltaic systems size optimization techniques. *Renew Sustain Energy Rev* 2013;22:454–65. doi:10.1016/j.rser.2013.02.023.
- [71] Gorgolis G, Karamanis D. Solar energy materials for glazing technologies. *Sol Energy Mater Sol Cells* 2016;144:559–78. doi:10.1016/j.solmat.2015.09.040.
- [72] Wu CY, Mathews JA. Knowledge flows in the solar photovoltaic industry: Insights from patenting by Taiwan, Korea, and China. *Res Policy* 2012;41:524–40. doi:10.1016/j.respol.2011.10.007.
- [73] Daghigh R, Ibrahim A, Jin GL, Ruslan MH, Sopian K. Predicting the performance of amorphous and crystalline silicon based photovoltaic solar thermal collectors. *Energy Convers Manag* 2011;52:1741–7. doi:10.1016/j.enconman.2010.10.039.
- [74] Kamat P V. Quantum dot solar cells. The next big thing in photovoltaics. *J Phys Chem Lett* 2013;4:908–18. doi:10.1021/jz400052e.
- [75] Gardelis S, Nassiopoulou AG, Manousiadis P, Vouroutzis N, Frangis N. A silicon-wafer based p-n junction solar cell by aluminum-induced recrystallization and doping. *Appl Phys Lett* 2013;103:241114. doi:10.1063/1.4846595.
- [76] Ranabhat K, Patrikeev L, Revina AA, Andrianov K, Lapshinsky V, Sofronova E. An introduction to solar cell technology. *J Appl Eng Sci* 2016;14:481–91. doi:10.5937/jaes14-10879.
- [77] Parida B, Iniyar S, Goic R. A review of solar photovoltaic technologies. *Renew Sustain Energy Rev* 2011;15:1625–36. doi:10.1016/j.rser.2010.11.032.
- [78] Khan J, Arsalan MH. Solar power technologies for sustainable electricity generation - A review. *Renew Sustain Energy Rev* 2016;55:414–25. doi:10.1016/j.rser.2015.10.135.
- [79] Badawy WA. A review on solar cells from Si-single crystals to porous materials and Quantum dots. *J Adv Res* 2015;6:123–32. doi:10.1016/j.jare.2013.10.001.
- [80] Tao J, Yu S. Review on feasible recycling pathways and technologies of solar photovoltaic modules. *Sol Energy Mater Sol Cells* 2015;141:108–24. doi:10.1016/j.solmat.2015.05.005.
- [81] Sinha P. Life cycle materials and water management for CdTe photovoltaics. *Sol Energy Mater Sol Cells* 2013;119:271–5. doi:10.1016/j.solmat.2013.08.022.
- [82] Marwede M, Reller A. Future recycling flows of tellurium from cadmium telluride photovoltaic waste. *Resour Conserv Recycl* 2012;69:35–49. doi:10.1016/j.resconrec.2012.09.003.
- [83] Cyrs WD, Avens HJ, Capshaw ZA, Kingsbury RA, Sahmel J, Tvermoes BE. Landfill waste and recycling: Use of a screening-level risk assessment tool for end-of-life cadmium telluride (CdTe)

- thin-film photovoltaic (PV) panels. *Energy Policy* 2014;68:524–33. doi:10.1016/j.enpol.2014.01.025.
- [84] Sengupta D, Das P, Mondal B, Mukherjee K. Effects of doping, morphology and film-thickness of photo-anode materials for dye sensitized solar cell application - A review. *Renew Sustain Energy Rev* 2016;60:356–76. doi:10.1016/j.rser.2016.01.104.
- [85] Sugathan V, John E, Sudhakar K. Recent improvements in dye sensitized solar cells: A review. *Renew Sustain Energy Rev* 2015;52:54–64. doi:10.1016/j.rser.2015.07.076.
- [86] Chiang YF, Chen RT, Burke A, Bach U, Chen P, Guo TF. Non-color distortion for visible light transmitted tandem solid state dye-sensitized solar cells. *Renew Energy* 2013;59:136–40. doi:10.1016/j.renene.2013.03.018.
- [87] Mathew S, Yella A, Gao P, Humphry-Baker R, Curchod BFE, Ashari-Astani N, et al. Dye-sensitized solar cells with 13% efficiency achieved through the molecular engineering of porphyrin sensitizers. *Nat Chem* 2014;6:242–7. doi:10.1038/nchem.1861.
- [88] Stambouli AB, Koinuma H. A primary study on a long-term vision and strategy for the realisation and the development of the Sahara Solar Breeder project in Algeria. *Renew Sustain Energy Rev* 2012;16:591–8. doi:10.1016/j.rser.2011.08.025.
- [89] Jackson T, Oliver M. The viability of solar photovoltaics. *Energy Policy* 2000;28:983–8. doi:10.1016/S0301-4215(00)00085-9.
- [90] Bilgen E. Solar hydrogen from photovoltaic-electrolyzer systems. *Energy Convers Manag* 2001;42:1047–57. doi:10.1016/S0196-8904(00)00131-X.
- [91] Kolhe M, Kolhe S, Joshi JC. Economic viability of stand-alone solar photovoltaic system in comparison with diesel-powered system for India. *Energy Econ* 2002;24:155–65. doi:10.1016/S0140-9883(01)00095-0.
- [92] Khedari J, Ingkawanich S, Waewsak J, Hirunlabh J. A PV system enhanced the performance of roof solar collector. *Build Environ* 2002;37:1317–20. doi:10.1016/S0360-1323(01)00119-6.
- [93] Murata K, Yagiura T, Takeda K, Tanaka M, Kiyama S. New type of photovoltaic module integrated with roofing material (highly fire-resistant PV tile). *Sol Energy Mater Sol Cells* 2003;75:647–53. doi:10.1016/S0927-0248(02)00150-2.
- [94] Nagano K, Mochida T, Shimakura K, Murashita K, Takeda S. Development of thermal-photovoltaic hybrid exterior wallboards incorporating PV cells in and their winter performances. *Sol Energy Mater Sol Cells* 2003;77:265–82. doi:10.1016/S0927-0248(02)00348-3.
- [95] Yamaguchi T, Okamoto Y, Taberi M. Investigation on abundant photovoltaic power generated by 40 kW PV system in Wakayama National College of Technology. *Sol Energy Mater Sol Cells* 2003;75:597–601. doi:10.1016/S0927-0248(02)00158-7.
- [96] De Wild-Scholten M, Alsema E. Towards cleaner solar PV - Environmental and health impacts of crystalline silicon photovoltaics. *Refocus* 2004;5:46–9. doi:10.1016/S1471-0846(04)00225-2.
- [97] Waldau AJ. PV status. *Refocus* 2005;6:20–3. doi:10.1016/S1471-0846(05)70394-2.
- [98] Othman MYH, Yatim B, Sopian K, Abu Bakar MN. Performance analysis of a double-pass photovoltaic/thermal (PV/T) solar collector with CPC and fins. *Renew Energy* 2005;30:2005–17. doi:10.1016/j.renene.2004.10.007.
- [99] Zahedi A. Solar photovoltaic (PV) energy; latest developments in the building integrated and hybrid PV systems. *Renew Energy* 2006;31:711–8. doi:10.1016/j.renene.2005.08.007.
- [100] Denholm P, Margolis RM. Evaluating the limits of solar photovoltaics (PV) in electric power systems utilizing energy storage and other enabling technologies. *Energy Policy* 2007;35:4424–33. doi:10.1016/j.enpol.2007.03.004.
- [101] Denholm P, Margolis RM. Evaluating the limits of solar photovoltaics (PV) in traditional electric power systems. *Energy Policy* 2007;35:2852–61. doi:10.1016/j.enpol.2006.10.014.
- [102] Jiang B, Ji J, Yi H. The influence of PV coverage ratio on thermal and electrical performance of photovoltaic-Trombe wall. *Renew Energy* 2008;33:2491–8. doi:10.1016/j.renene.2008.02.001.
- [103] Mala K, Schläpfer A, Pryor T. Better or worse? The role of solar photovoltaic (PV) systems in

- sustainable development: Case studies of remote atoll communities in Kiribati. *Renew Energy* 2009;34:358–61. doi:10.1016/j.renene.2008.05.013.
- [104] Shum KL, Watanabe C. An innovation management approach for renewable energy deployment—the case of solar photovoltaic (PV) technology. *Energy Policy* 2009;37:3535–44. doi:10.1016/j.enpol.2009.04.007.
- [105] Park KE, Kang GH, Kim HI, Yu GJ, Kim JT. Analysis of thermal and electrical performance of semi-transparent photovoltaic (PV) module. *Energy* 2010;35:2681–7. doi:10.1016/j.energy.2009.07.019.
- [106] Mani M, Pillai R. Impact of dust on solar photovoltaic (PV) performance: Research status, challenges and recommendations. *Renew Sustain Energy Rev* 2010;14:3124–31. doi:10.1016/j.rser.2010.07.065.
- [107] DeBenedictis A, Hoff TE, Price S, Woo CK. Statistically adjusted engineering (SAE) modeling of metered roof-top photovoltaic (PV) output: California evidence. *Energy* 2010;35:4178–83. doi:10.1016/j.energy.2010.06.041.
- [108] Pang JB, Cai YA, He Q, Wang H, Jiang WL, He JJ, et al. Preparation and Characteristics of MoSe<sub>2</sub> Interlayer in Bifacial Cu(In,Ga)Se<sub>2</sub> Solar Cells. *Phys Procedia* 2012;32:372–8. doi:10.1016/j.phpro.2012.03.571.
- [109] Zarmai MT, Ekere NN, Oduoza CF, Amalu EH. A review of interconnection technologies for improved crystalline silicon solar cell photovoltaic module assembly. *Appl Energy* 2015;154:173–82. doi:10.1016/j.apenergy.2015.04.120.
- [110] Hernández-Moro J, Martínez-Duart JM. Economic analysis of the contribution of photovoltaics to the decarbonization of the power sector. *Renew Sustain Energy Rev* 2015;41:1288–97. doi:10.1016/j.rser.2014.09.025.
- [111] Guerrero-Lemus R, Vega R, Kim T, Kimm A, Shephard LE. Bifacial solar photovoltaics - A technology review. *Renew Sustain Energy Rev* 2016;60:1533–49. doi:10.1016/j.rser.2016.03.041.
- [112] Kow KW, Wong YW, Rajkumar RK, Rajkumar RK. A review on performance of artificial intelligence and conventional method in mitigating PV grid-tied related power quality events. *Renew Sustain Energy Rev* 2016;56:334–46. doi:10.1016/j.rser.2015.11.064.
- [113] Teffah K, Zhang Y. Modeling and experimental research of hybrid PV-thermoelectric system for high concentrated solar energy conversion. *Sol Energy* 2017;157:10–9. doi:10.1016/j.solener.2017.08.017.
- [114] Singh R, Banerjee R. Impact of large-scale rooftop solar PV integration: An algorithm for hydrothermal-solar scheduling (HTSS). *Sol Energy* 2017;157:988–1004. doi:10.1016/j.solener.2017.09.021.
- [115] Qureshi TM, Ullah K, Arentsen MJ. Factors responsible for solar PV adoption at household level: A case of Lahore, Pakistan. *Renew Sustain Energy Rev* 2017;78:754–63. doi:10.1016/j.rser.2017.04.020.
- [116] Jayaraman K, Paramasivan L, Kiumarsi S. Reasons for low penetration on the purchase of photovoltaic (PV) panel system among Malaysian landed property owners. *Renew Sustain Energy Rev* 2017;80:562–71. doi:10.1016/j.rser.2017.05.213.
- [117] Vasel A, Iakovidis F. The effect of wind direction on the performance of solar PV plants. *Energy Convers Manag* 2017;153:455–61. doi:10.1016/j.enconman.2017.09.077.
- [118] Quansah DA, Adaramola MS, Appiah GK, Edwin IA. Performance analysis of different grid-connected solar photovoltaic (PV) system technologies with combined capacity of 20 kW located in humid tropical climate. *Int J Hydrogen Energy* 2017;42:4626–35. doi:10.1016/j.ijhydene.2016.10.119.
- [119] Prasanth Ram J, Rajasekar N. A new global maximum power point tracking technique for solar photovoltaic (PV) system under partial shading conditions (PSC). *Energy* 2017;118:512–25. doi:10.1016/j.energy.2016.10.084.
- [120] Rezaee Jordehi A. Enhanced leader particle swarm optimisation (ELPSO): An efficient algorithm

- for parameter estimation of photovoltaic (PV) cells and modules. *Sol Energy* 2018;159:78–87. doi:10.1016/j.solener.2017.10.063.
- [121] Dhanalakshmi B, Rajasekar N. Dominance square based array reconfiguration scheme for power loss reduction in solar PhotoVoltaic (PV) systems. *Energy Convers Manag* 2018;156:84–102. doi:10.1016/j.enconman.2017.10.080.
- [122] Palm J, Eidenskog M, Luthander R. Sufficiency, change, and flexibility: Critically examining the energy consumption profiles of solar PV prosumers in Sweden. *Energy Res Soc Sci* 2018;39:12–8. doi:10.1016/j.erss.2017.10.006.
- [123] Honrubia-Escribano A, Ramirez FJ, Gómez-Lázaro E, Garcia-Villaverde PM, Ruiz-Ortega MJ, Parra-Requena G. Influence of solar technology in the economic performance of PV power plants in Europe. A comprehensive analysis. *Renew Sustain Energy Rev* 2018;82:488–501. doi:10.1016/j.rser.2017.09.061.
- [124] Andenæs E, Jelle BP, Ramlo K, Kolås T, Selj J, Foss SE. The influence of snow and ice coverage on the energy generation from photovoltaic solar cells. *Sol Energy* 2018;159:318–28. doi:10.1016/j.solener.2017.10.078.
- [125] Moslehi S, Reddy TA, Katipamula S. Evaluation of data-driven models for predicting solar photovoltaics power output. *Energy* 2018;142:1057–65. doi:10.1016/j.energy.2017.09.042.
- [126] Dehghani E, Jabalameli MS, Jabbarzadeh A. Robust design and optimization of solar photovoltaic supply chain in an uncertain environment. *Energy* 2018;142:139–56. doi:10.1016/j.energy.2017.10.004.
- [127] Xu L, Zhang S, Yang M, Li W, Xu J. Environmental effects of China’s solar photovoltaic industry during 2011–2016: A life cycle assessment approach. *J Clean Prod* 2018;170:310–29. doi:10.1016/j.jclepro.2017.09.129.
- [128] Saxena A, Deshmukh S, Nirali S, Wani S. Laboratory based Experimental Investigation of Photovoltaic (PV) Thermo-control with Water and its Proposed Real-time Implementation. *Renew Energy* 2018;115:128–38. doi:10.1016/j.renene.2017.08.029.
- [129] Hoffmann FM, Molz RF, Kothe JV, Nara EOB, Tedesco LPC. Monthly profile analysis based on a two-axis solar tracker proposal for photovoltaic panels. *Renew Energy* 2018;115:750–9. doi:10.1016/j.renene.2017.08.079.
- [130] Jakica N. State-of-the-art review of solar design tools and methods for assessing daylighting and solar potential for building-integrated photovoltaics. *Renew Sustain Energy Rev* 2018;81:1296–328. doi:10.1016/j.rser.2017.05.080.
- [131] Ram JP, Manghani H, Pillai DS, Babu TS, Miyatake M, Rajasekar N. Analysis on solar PV emulators: A review. *Renew Sustain Energy Rev* 2018;81:149–60. doi:10.1016/j.rser.2017.07.039.
- [132] Belarbi M, Haddouche K, Sahli B, Belarbi EH, Boudghene-Stambouli A, Khiali B. Self-reconfiguring MPPT to avoid buck-converter limits in solar photovoltaic systems. *Renew Sustain Energy Rev* 2018;82:187–93. doi:10.1016/j.rser.2017.09.019.
- [133] Hyder F, Sudhakar K, Mamat R. Solar PV tree design: A review. *Renew Sustain Energy Rev* 2018;82:1079–96. doi:10.1016/j.rser.2017.09.025.
- [134] Shayestegan M, Shakeri M, Abunima H, Reza SMS, Akhtaruzzaman M, Bais B, et al. An overview on prospects of new generation single-phase transformerless inverters for grid-connected photovoltaic (PV) systems. *Renew Sustain Energy Rev* 2018;82:515–30. doi:10.1016/j.rser.2017.09.055.
- [135] Novaes Pires Leite G de, Weschenfelder F, Araújo AM, Villa Ochoa AA, Franca Prestrelo Neto N da, Kraj A. An economic analysis of the integration between air-conditioning and solar photovoltaic systems. *Energy Convers Manag* 2019;185:836–49. doi:10.1016/j.enconman.2019.02.037.
- [136] Rahnama E, Aghbashlo M, Tabatabaei M, Khanali M, Rosen MA. Spatio-temporal solar exergoeconomic and exergoenvironmental maps for photovoltaic systems. *Energy Convers Manag* 2019;195:701–11. doi:10.1016/j.enconman.2019.05.051.



- [137] Zhao BY, Zhao ZG, Li Y, Wang RZ, Taylor RA. An adaptive PID control method to improve the power tracking performance of solar photovoltaic air-conditioning systems. *Renew Sustain Energy Rev* 2019;113:109250. doi:10.1016/j.rser.2019.109250.
- [138] Fernández R, Ortiz C, Chacartegui R, Valverde JM, Becerra JA. Dispatchability of solar photovoltaics from thermochemical energy storage. *Energy Convers Manag* 2019;191:237–46. doi:10.1016/j.enconman.2019.03.074.
- [139] Rosas-Flores JA, Zenón-Olvera E, Gálvez DM. Potential energy saving in urban and rural households of Mexico with solar photovoltaic systems using geographical information system. *Renew Sustain Energy Rev* 2019;116:109412. doi:10.1016/j.rser.2019.109412.
- [140] Rajvikram M, Sivasankar G. Experimental study conducted for the identification of best heat absorption and dissipation methodology in solar photovoltaic panel. *Sol Energy* 2019;193:283–92. doi:10.1016/j.solener.2019.09.053.
- [141] Troncoso N, Rojo-González L, Villalobos M, Vásquez ÓC, Chávez H. Economic decision-making tool for distributed solar photovoltaic panels and storage: The case of Chile. *Energy Procedia*, vol. 159, Elsevier Ltd; 2019, p. 388–93. doi:10.1016/j.egypro.2018.12.071.
- [142] Trindade A, Cordeiro L. Automated formal verification of stand-alone solar photovoltaic systems. *Sol Energy* 2019;193:684–91. doi:10.1016/j.solener.2019.09.093.
- [143] Liu J, Chen X, Cao S, Yang H. Overview on hybrid solar photovoltaic-electrical energy storage technologies for power supply to buildings. *Energy Convers Manag* 2019;187:103–21. doi:10.1016/j.enconman.2019.02.080.
- [144] Kiyania A, Karimi H, Madadi Avargani V. Exergoeconomic analysis of a solar photovoltaic-based direct evaporative air-cooling system. *Sol Energy* 2019;193:253–66. doi:10.1016/j.solener.2019.09.068.
- [145] Sow A, Mehrtash M, Rousse DR, Haillet D. Economic analysis of residential solar photovoltaic electricity production in Canada. *Sustain Energy Technol Assessments* 2019;33:83–94. doi:10.1016/j.seta.2019.03.003.
- [146] Zafrilla JE, Arce G, Cadarso MÁ, Córcoles C, Gómez N, López LA, et al. Triple bottom line analysis of the Spanish solar photovoltaic sector: A footprint assessment. *Renew Sustain Energy Rev* 2019;114:109311. doi:10.1016/j.rser.2019.109311.
- [147] Zieba Falama R, Hidayatullah, Doka SY. A promising concept to push efficiency of pn-junction photovoltaic solar cell beyond Shockley and Queisser limit based on impact ionization due to high electric field. *Optik (Stuttg)* 2019;187:39–48. doi:10.1016/j.ijleo.2019.04.136.
- [148] Sadanand, Dwivedi DK. Numerical modeling for earth-abundant highly efficient solar photovoltaic cell of non-toxic buffer layer. *Opt Mater (Amst)* 2020;109:110409. doi:10.1016/j.optmat.2020.110409.
- [149] Ren F rong, Tian Z, Liu J, Shen Y ting. Analysis of CO<sub>2</sub> emission reduction contribution and efficiency of China's solar photovoltaic industry: Based on Input-output perspective. *Energy* 2020;199:117493. doi:10.1016/j.energy.2020.117493.
- [150] Qi L, Jiang M, Lv Y, Yan J. A celestial motion-based solar photovoltaics installed on a cooling tower. *Energy Convers Manag* 2020;216:112957. doi:10.1016/j.enconman.2020.112957.
- [151] Jan I, Ullah W, Ashfaq M. Social acceptability of solar photovoltaic system in Pakistan: Key determinants and policy implications. *J Clean Prod* 2020;274:123140. doi:10.1016/j.jclepro.2020.123140.
- [152] Janardhan K, Mittal A, Ojha A. Performance investigation of stand-alone solar photovoltaic system with single phase micro multilevel inverter. *Energy Reports* 2020;6:2044–55. doi:10.1016/j.egy.2020.07.006.
- [153] Kumar P, Pal N, Sharma H. Performance analysis and evaluation of 10 kWp solar photovoltaic array for remote islands of Andaman and Nicobar. *Sustain Energy Technol Assessments* 2020;42:100889. doi:10.1016/j.seta.2020.100889.
- [154] Ali MM, Ahmed OK, Abbas EF. Performance of solar pond integrated with photovoltaic/thermal

- collectors. *Energy Reports* 2020;6:3200–11. doi:10.1016/j.egy.2020.11.037.
- [155] Yang Y, Campana PE, Stridh B, Yan J. Potential analysis of roof-mounted solar photovoltaics in Sweden. *Appl Energy* 2020;279:115786. doi:10.1016/j.apenergy.2020.115786.
- [156] Anand B, Shankar R, Murugavelh S, Rivera W, Midhun Prasad K, Nagarajan R. A review on solar photovoltaic thermal integrated desalination technologies. *Renew Sustain Energy Rev* 2021;141:110787. doi:10.1016/j.rser.2021.110787.
- [157] Syahputra R, Soesanti I. Renewable energy systems based on micro-hydro and solar photovoltaic for rural areas: A case study in Yogyakarta, Indonesia. *Energy Reports* 2021;7:472–90. doi:10.1016/j.egy.2021.01.015.
- [158] Alipour M, Salim H, Stewart RA, Sahin O. Residential solar photovoltaic adoption behaviour: End-to-end review of theories, methods and approaches. *Renew Energy* 2021;170:471–86. doi:10.1016/j.renene.2021.01.128.
- [159] Kazemian A, Parcheforosh A, Salari A, Ma T. Optimization of a novel photovoltaic thermal module in series with a solar collector using Taguchi based grey relational analysis. *Sol Energy* 2021;215:492–507. doi:10.1016/j.solener.2021.01.006.
- [160] Bhavsar S, Pitchumani R. A novel machine learning based identification of potential adopter of rooftop solar photovoltaics. *Appl Energy* 2021;286:116503. doi:10.1016/j.apenergy.2021.116503.
- [161] De RK, Ganguly A. Modeling and analysis of a solar thermal-photovoltaic-hydrogen-based hybrid power system for running a standalone cold storage. *J Clean Prod* 2021;293:126202. doi:10.1016/j.jclepro.2021.126202.
- [162] Wang Y, He J, Chen W. Distributed solar photovoltaic development potential and a roadmap at the city level in China. *Renew Sustain Energy Rev* 2021;141:110772. doi:10.1016/j.rser.2021.110772.
- [163] Rodziewicz T, Rajfur M, Teneta J, Świsłowski P, Waclawek M. Modelling and analysis of the influence of solar spectrum on the efficiency of photovoltaic modules. *Energy Reports* 2021;7:565–74. doi:10.1016/j.egy.2021.01.013.
- [164] Cole W, Lewis H, Sigrin B, Margolis R. Interactions of rooftop PV deployment with the capacity expansion of the bulk power system. *Appl Energy* 2016;168:473–81. doi:10.1016/j.apenergy.2016.02.004.
- [165] Dusonchet L, Telaretti E. Comparative economic analysis of support policies for solar PV in the most representative EU countries. *Renew Sustain Energy Rev* 2015;42:986–98. doi:10.1016/j.rser.2014.10.054.
- [166] Electricity Of Lebanon - Public Institution n.d. <http://www.edl.gov.lb/page.php?pid=39&lang=en>.
- [167] GEE Green Energy n.d. <http://www.gee-greenenergy.net/>.
- [168] Jaber H, Ramadan M, Iemenand T, Khaled M. Domestic thermoelectric cogeneration system optimization analysis, energy consumption and CO<sub>2</sub> emissions reduction. *Appl Therm Eng* 2018;130:279–95. doi:10.1016/j.applthermaleng.2017.10.148.

## **1.5 Capteurs solaires hybrides photovoltaïques / thermiques : classifications, applications et nouveaux systèmes**

Cet article est publié dans « **Solar Energy** »

[doi.org/10.1016/j.solener.2020.07.062](https://doi.org/10.1016/j.solener.2020.07.062)

**Résumé** - L'aggravation continue des pollutions environnementales et l'augmentation rapide des prix des sources conventionnelles de l'énergie ont incité les scientifiques à explorer des solutions telles que la récupération de chaleur et des sources d'énergie alternatives. L'un des types d'énergie renouvelable les plus distingués est l'énergie solaire, qui est une énergie renouvelable pure, gratuite et respectueuse de l'environnement, ainsi plusieurs systèmes d'énergie solaire doivent être étudiés. Dans le même temps, combiner les systèmes d'énergie solaire est une tendance de nos jours qui vise à optimiser les bénéfices des radiations solaires. Le système solaire hybride Photovoltaïque / Thermique (PVT) est obtenu en combinant des collecteurs solaires thermiques et du solaire photovoltaïque pour permettre une production simultanée d'électricité et de chaleur. L'objectif de cet article est de proposer une revue sur les capteurs solaires hybrides PVT qui comprend l'histoire des systèmes solaires hybrides PVT, le concept principal, les avantages et les classifications selon différentes manières en plus de l'intégration des générateurs thermoélectriques avec le système PVT.

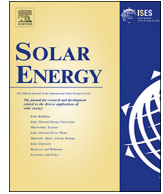

# Review on photovoltaic/thermal hybrid solar collectors: Classifications, applications and new systems

Amal Herez<sup>a,b</sup>, Hicham El Hage<sup>a</sup>, Thierry Lemenand<sup>b</sup>, Mohamad Ramadan<sup>c,d</sup>, Mahmoud Khaled<sup>c,e,\*</sup>

<sup>a</sup> Energy and Thermo-fluid Group, Lebanese International University LIU, Bekaa, Lebanon

<sup>b</sup> LARIS EA 7315, University of Angers – Polytech Angers, Angers, France

<sup>c</sup> Energy and Thermo-fluid Group, International University of Beirut BIU, Beirut, Lebanon

<sup>d</sup> Associate Member at FCLAB, CNRS, Univ. Bourgogne Franche-Comté, Belfort Cedex, France

<sup>e</sup> University Paris Diderot, Sorbonne Paris Cité, Interdisciplinary Energy Research Institute (PIERI), Paris, France

## ARTICLE INFO

### Keywords:

Photovoltaic  
Thermal  
Hybrid  
Solar Energy  
Classifications  
Applications

## ABSTRACT

The continuous aggravation of environmental pollutions and the rapid increase in the conventional sources of energy price advocated scientists to search for solutions such as heat recovery and continual sources of energy. One of the most distinguished types of renewable energy is solar energy which is neat, free and environmentally friendly renewable energy. Indeed, there are several solar energy systems that need to be studied. At the same time, combining solar energy systems is a trend these days which aims to optimize the benefits from solar radiations. Photovoltaic/Thermal (PVT) hybrid solar system is obtained by combining solar thermal collectors and solar photovoltaics to enable a simultaneous generation of electricity and production of heat. The target of this paper is to proffer a review on PVT hybrid solar collectors which comprises the history of PVT hybrid solar systems, main concept, benefits and classifications according to various manners in addition to integration of thermoelectric generators with PVT system.

## 1. Introduction

The stability and firmness provenience of human life is energy. It is tremendously needed in progress and development for a better life. However, the increase in energy demand with simultaneous aggravation of environmental problems and depletion of conventional energy sources contribute to the search for clean and sustainable sources of energy. Renewable sources of energy (Afrand et al., 2019; Ananno et al., 2020; Carvalho et al., 2019; Dong et al., 2020; Fernández-González et al., 2019a, 2019b; Guo et al., 2020; Herez et al., 2017a; Jurasz et al., 2020; Shah and Ali, 2019a; Valančius and Mikučionienė, 2020; Yahya et al., 2018) are abundantly existing and capable to provide energy in a clean way. Solar Energy (SE) (El Hage et al., 2018; Elsheikh et al., 2019; Herez et al., 2018, 2017b, 2016; Khaled et al., 2018; Molaei, 2020; Naves et al., 2019) is a type of renewable energy that can be exploited using Solar Thermal Collectors (STC) or solar PhotoVoltaic (PV).

Solar collector absorbs SE and transfers it into heat to be harnessed for various aims including heating water or/and space, cooling space and/or refrigeration, drying, cooking, etc. Solar PV (Abdul-Wahab

et al., 2019; Dhoke et al., 2019; Kiyania et al., 2019; Lindsay et al., 2020; Olaleru et al., 2020; Paul Ayeng'o et al., 2019; Rajvikram and Sivasankar, 2019; Robledo et al., 2019; Trindade and Cordeiro, 2019; Yang et al., 2020) is a technology which gathers solar radiations to transform it into electrical energy. Indeed, the efficiency of electricity conversion by solar PV system from solar energy is about 15 to 18%, whereas the remaining part (82–85%) is either absorbed by PV cell and thus heating it or reflected to the environment (Browne et al., 2016). Furthermore, it is approximated that the increase in the module temperature by one degree leads to mitigation in the efficiency of PV Module (PVM) by 0.4 to 0.65% (Brahim and Jemni, 2017). Hence, PV systems captivated the efforts of scientists in order to enhance its efficiency.

Nevertheless, there is a great receptivity to amalgamate solar energy systems to optimize the avail of SE. Hence, PhotoVoltaic/Thermal (PVT) hybrid solar collector was suggested as a solution for promoting the PV efficiency and the benefit of solar radiation. It is incorporation of solar PV with the STC that serves in the simultaneous generation of electricity and heat with half the area needed and little extra cost. Numerous investigations are conducted since the development of solar

\* Corresponding author.

E-mail address: [mahmoud.khaled@liu.edu.lb](mailto:mahmoud.khaled@liu.edu.lb) (M. Khaled).

<https://doi.org/10.1016/j.solener.2020.07.062>

Received 27 February 2020; Received in revised form 22 May 2020; Accepted 19 July 2020

0038-092X/ © 2020 International Solar Energy Society. Published by Elsevier Ltd. All rights reserved.

hybrid systems (Chow, 2010; Gaur et al., 2017; Greppi and Fabbri, 2018; Ju et al., 2017; Qiu et al., 2015; Sahota and Tiwari, 2017; Sathe and Dhoble, 2017; Shah and Ali, 2019b).

(Jia et al., 2019) proffered a comprehensive review of the progress and application of PVT systems. The review comprises the classification of PVT collectors and a description of suitable applications and conditions for various types of PVT systems.

(Yazdanifard and Ameri, 2018) had reviewed researches that were performed during the last decade to assess the exergetic performance of several kinds of PVT hybrid systems. The review concentrates on describing the performance of water based, air based and thermoelectric based PVT systems. Also, a comparison of the exergy analysis between distinct PVT systems of various studies is performed.

(Abdelrazik et al., 2018) presented a comprehensive review including the latest works that investigated the design and cooling parameters that are employed to construct a hybrid PVT system with high performance.

(Sultan and Ervina Efzan, 2018) conducted a review that exposes the recent literature on PVT technology by describing its types, fabrication, design, simulation and experimental assessment of its performance. Also, the authors reviewed the applications of PVT technology such as water desalination, solar still, PVT heat pump, solar cooling, and solar greenhouse.

(Sahota and Tiwari, 2017) performed a review to assess and compare the economic and energy performance of several photovoltaic hybrid systems which are: photovoltaic thermal compound parabolic concentrator (PVT-CPC), photovoltaic thermal flat plate collector (PVT-FPC), PVT-FPC solar still and greenhouse dryer PVT; they concluded that integrating photovoltaic in solar systems is beneficial and more economical for the rural sector.

(George et al., 2019) presented a review on the concentrated PVT systems including the design components, medium of heat transfer and the latest applications like heating water, dyeing tissue and organic Rankine cycle as well as the economic side.

(Kasaiean et al., 2018) performed a review which comprises the literature of integrated solar collectors and photovoltaic systems for the simultaneous heat and power generation. The review included solar PVT systems, concentrated PVT systems with several combinations and applications.

(Jonas et al., 2019) established a novel PVT model to compare the impact of several factors on the system effectiveness. The model was simulated and validated using TRNSYS software.

(Huide et al., 2017) developed simulation models on solar photovoltaic, solar thermal and solar hybrid PVT systems. The authors validated the results of models simulation by performing experiments. The results revealed that for the urban residences where space is limited, the hybrid PVT system is the best choice to mitigate energy consumption.

Fine et al. (2019) demonstrated a novel methodology to assess the thermal performance of hybrid solar panel by utilizing only the supplied data by the industrialist. The authors computed the thermal performance by using the second order efficiency model and the electrical efficiency by using the temperature dependent electrical properties. They also utilized a solar simulator to carry out an indoor testing.

In this context, the main purpose of the current work is to present a

detailed review on PVT hybrid solar collectors. The background of the PVT system is presented, which mainly includes the history, concept and advantages of the system. Also, the classifications of such systems are exposed depending on different methods. Besides, the review comprises the main applications that are involved in the studied system. Moreover, new systems are reviewed such as adding Thermoelectric Generators (TEGs) to the PVT system. The new contribution of this work resides in the following points:

- (1) Presenting a new classification of PVT systems;
- (2) Describing the applications using PVT systems;
- (3) Presentation of PVT systems using TEGs (PVT-TE) with their types and operations;
- (4) Summary of numerous works conducted on PVT systems regarding each classification, application and type of PVT-TE systems;
- (5) Description of the most commonly used systems according to the classifications, applications and PVT-TE system.

Although this work may have partially similar points with those treated in other review papers, it combines all information on PVT systems and presents them in a categorized manner in order to constitute a valuable guide for studying PVT systems.

## 2. Background on PVT hybrid systems

The idea of PVT system was discovered during the mid-1970s where several studies had been conducted (Joshi and Dhoble, 2018). In 1976, Wolf (1976) investigated the liquid type PVT solar collector by monitoring the collector performance for single-family residence over a full year. In 1979, Florschuetz (1979) modified the original parameters of “Hottel Whillier model” which is thermal modeling for flat plate collector and studied the electrical and thermal performance of PVT collectors. Despite the fact that the concept of PVT solar collectors had been established for more than four decades, it is not totally commercialized yet. Several types of research had been performed recently to optimize the PVT collectors performance and minimize its cost (Fine et al., 2019; Khelifa et al., 2015; Magrassi et al., 2019; Yazdanifard and Ameri, 2018). Nowadays, PVT systems have become an appealing invention that is environment friendly and mitigates dependence on conventional sources of energy.

A PVT collector is a hybrid system which is obtained by merging solar PV cell with a STC to provide electricity and heat simultaneously. Solar PV converts the absorbed SE into electricity, whereas the STC converts it into heat. Such a system maximizes the avail of SE; so, it is more efficient and can produce higher amount of energy per unit area in comparison to solar PV or solar thermal systems alone. Fig. 1 shows a schematic of the concept of PVT hybrid solar collector.

PVT hybrid solar collector was established mainly to optimize the SE exploitation. The utilized region by PVT is greater than that used by traditional PV or thermal collectors. To clarify, with the same area, PVT can generate heat and electricity more than that produced by conventional PV or thermal collectors. This explains the fact that PVT has greater efficiency than both systems when operating separately. Also, it is suitable for places where there is a limited surface area. Besides, PVT

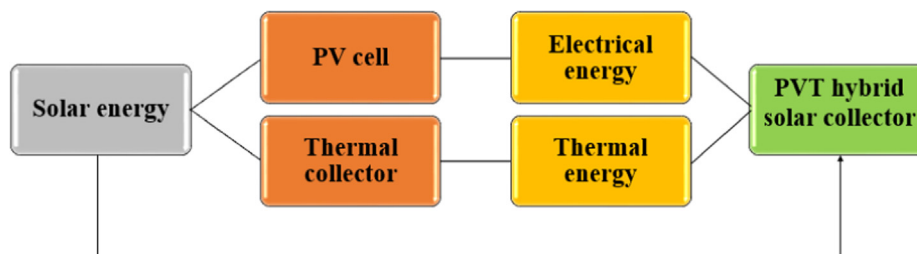

Fig. 1. Concept of PVT solar collector.

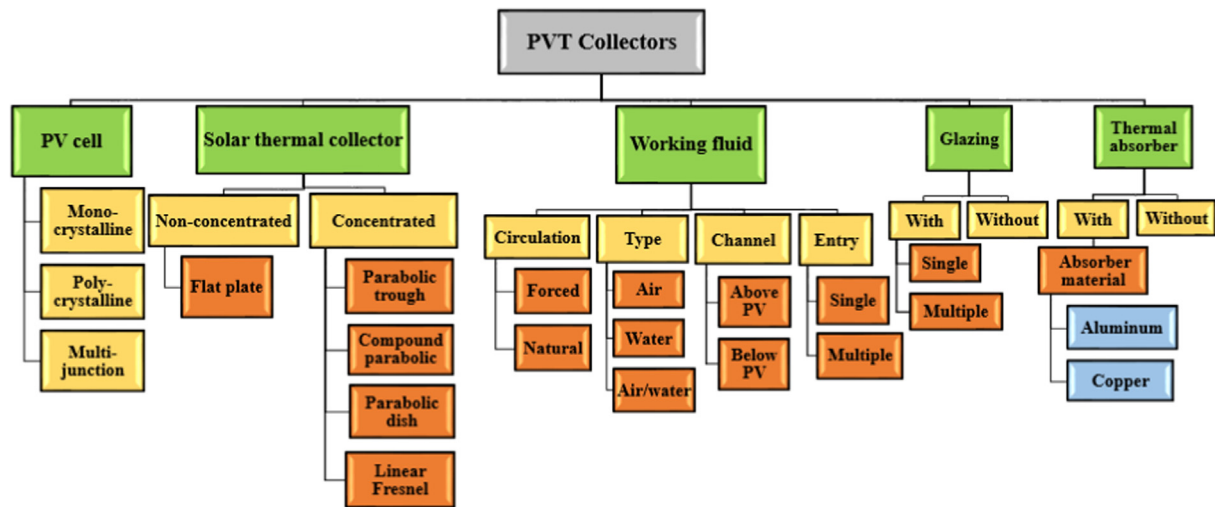

Fig. 2. Classification of PVT solar collectors.

system combines two systems with each other, and this leads to a reduction in the installation cost. Furthermore, the payback period of PVT has been obviously less than both systems since it exploits more energy.

### 3. Classifications of PVT

PVT hybrid solar systems can be categorized based on various characteristics. Several researchers carried out studies including the classification of PVT (Abdullah et al., 2018; Diwania et al., 2019; Evangelisti et al., 2019; Joshi and Dhoble, 2018; Lamnatou and Chemisana, 2017; Riffat and Cuce, 2011). In this work, sorting PVT is demonstrated by taking into account the type of PV cell, thermal collector, working fluid, glazing and thermal absorber (Babu and Ponnambalam, 2017; Joshi and Dhoble, 2018). Fig. 2 presents a wide classification of PVT.

#### 3.1. PV cell

PVT collectors can be categorized regarding the type of PV cell. The most commonly used PV cells are mono-crystalline silicon (mono c-Si), poly-crystalline silicon (poly c-Si) or multi-junction. Mono c-Si and poly c-Si belong to the first generation of PV technologies while multi-function thin-film silicon belongs to the second PV generation. Mono-crystalline and poly-crystalline generate the same power when using same area; however, mono-crystalline has higher efficiency (about 20%) (Cappelletti et al., 2016) than poly-crystalline (15%) due to the grains existing in the poly-crystalline (Tao and Yu, 2015). Nevertheless, mono-crystalline silicon is more expensive than poly-crystalline due to the complex formation of a single crystal. Pang et al. (2019) experimentally demonstrated the performance of the poly-crystalline silicon and PVT module. A steady state thermal modeling was conducted to simulate the pressure, temperature, and velocity along the PVT module. The performances of PV and PVT module were compared. It was observed that the electricity generated by PVT system augmented by 3.25%.

A multi-junction solar cell is formed of more than one p-n junction. It mainly utilizes three semiconductors: germanium (Ge), gallium indium phosphide (GaInP) and indium gallium arsenide (InGaAs). It is more efficient than silicon cells (around 40%) and less sensitive to temperature variation (Mittelman et al., 2007; Nishioka et al., 2006; Renno and Petito, 2016). Nishioka et al. (2006) demonstrated the influence of temperature and concentration ratio on nGaP/InGaAs/Ge triple junction electrical performance. It was obtained that the PV cells efficiency mitigates with temperature rise and augments with concentration ratio increase because of the rise in the open circuit voltage.

Renno et al. (2018) considered a specific structure of a CPV system and performed experimental analysis on the system with degraded triple junction InGaP/GaAs/Ge solar cells. The degradation of the PV cell is caused by the excessive augmentation in the light intensity which causes its overheating. The results revealed that the degradation of the cells reduces the power conversion efficiency of the CPV system by 50% and the electric power by 30%.

Table 1 illustrates the latest researches conducted on PVT hybrid systems according to the type of PV cell used.

Analysis of Table 1 yields to the following concluding points:

- Crystalline silicon and InGaP/GaAs/Ge triple junction solar cells are broadly used in PVT systems in comparison to other PV cells.
- InGaP/GaAs/Ge triple junction PV cell yields to higher electrical efficiency of PVT system compared to crystalline silicon. This is due to the fact that it has higher electrical efficiency than crystalline silicon.
- PVT system thermal efficiency is approximately similar when using crystalline silicon or InGaP/GaAs/Ge triple junction PV cell.

#### 3.2. Solar thermal collector

PVT hybrid solar systems are sorted according to the type of STC combined with PV cell whether it is a non-concentrated collector like a Flat Plate Collector (FPC) (Michael et al., 2015; Moss et al., 2018; Sakellariou and Axaopoulos, 2018; Zhang et al., 2019) or concentrated like a parabolic trough collector (PTC) (Karathanassis et al., 2017; Kunnemeyer et al., 2014; Manokar et al., 2016; Mittelman et al., 2007; Widyolar et al., 2017), Compound Parabolic Concentrator (CPC) (Atheaya et al., 2016a; Li et al., 2019; Saini et al., 2018; Singh et al., 2016; Tiwari et al., 2018; Tripathi et al., 2016; Tripathi and Tiwari, 2016), Parabolic Dish Collector (PDC) (Singh and Reddy, 2020) and Linear Fresnel Reflector (LFR) (Pham et al., 2018; Shanks et al., 2018; Sharshir et al., 2016).

FPC is made up of flat absorber plate, transparent cover, working fluid, tubes, insulation and protective case. It is used for applications that require low temperature (30–80 °C) (Herrando et al., 2014). It is widely utilized in Solar Space Heating (SSH) and Solar Water Heating (SWH) systems. Das et al. (2018) presented a detailed review on the PVT systems coupled to a flat plate collector. Their review includes an environmental and economic assessment of PVT systems that were established by several researchers. Also, it comprises listing thermodynamic ways for assessing efficiency of the system such as energy and exergy analysis. Guarracino et al. (2019) studied the performance characteristics of a non-concentrating flat plate PVT collector which is

**Table 1**  
Conducted researches on hybrid systems according to the type of PV cell.

St. Nb	Reference (Author/s, year)	PV cell	Operating conditions	Efficiency			Type of study
				Thermal	Electrical	Total	
	Ibrahim et al. (2009a)	Poly-crystalline silicon	<ul style="list-style-type: none"> <li>● Solar radiation of 800 W/ m<sup>2</sup></li> <li>● Ambient temperature of 25 °C</li> </ul>	45%	10%	55%	● Experimental
	Bernardo et al. (2011)	Mono-crystalline silicon	<ul style="list-style-type: none"> <li>● Incident beam radiation of 997 W/ m<sup>2</sup></li> <li>● Water inlet temperature of 28 °C</li> </ul>	45%	6.4%	–	● Experimental
	Chemisana et al. (2011)	Crystalline silicon	–	65%	–	–	● Experimental ● Theoretical
	Sonneveld et al. (2011)	Mono-crystalline silicon	<ul style="list-style-type: none"> <li>● Solar radiation of 630 W/ m<sup>2</sup> and 792 W/ m<sup>2</sup></li> </ul>	56%	11%	67%	● Experimental
	Dupeyrat et al. (2011)	Mono-crystalline silicon	<ul style="list-style-type: none"> <li>● Total radiation of 960 W/ m<sup>2</sup></li> <li>● Ambient temperature varied between 30 and 33 °C</li> <li>● Wind velocity of 3 m/s</li> </ul>	79%	8.8%	86.8%	● Theoretical ● Experimental
	Calise and Vanoli (2012)	InGaP/InGaAs/Ge	<ul style="list-style-type: none"> <li>● Inlet water temperature of 70 °C</li> <li>● Ambient and sky temperature of 25 °C</li> <li>● Wind velocity of 5 m/s</li> <li>● Total and beam radiation of 1000 W/ m<sup>2</sup> and 800 W/ m<sup>2</sup> respectively</li> </ul>	56%-63%	20%–23%	77%-83%	● Theoretical
	Buonomano et al. (2013)	InGaP/InGaAs/Ge triple junction	<ul style="list-style-type: none"> <li>● Inlet fluid temperature of 150 °C</li> <li>● Ambient and sky temperature of 25 °C</li> <li>● Wind velocity of 5 m/s</li> <li>● Total and beam radiation of 1000 W/ m<sup>2</sup> and 800 W/ m<sup>2</sup> respectively</li> </ul>	27%-58%	18%-24%	45%-82%	● Theoretical
	Renno and Petito (2013)	InGaP/InGaAs/Ge triple junction	–	67%-70%	19%-21%	86%-91%	● Theoretical
	Del Col et al. (2014)	InGaP/InGaAs/Ge triple junction	<ul style="list-style-type: none"> <li>● Inlet water temperature ranges between 20 and 80 °C</li> <li>● Beam radiation of 1000 W/ m<sup>2</sup></li> <li>● Solar radiation of 900 W/ m<sup>2</sup></li> <li>● Fluid inlet temperature of 25 °C</li> </ul>	41.6%	23.1%	64.7%	● Theoretical ● Experimental
	Hussain and Lee (2015)	GuAs and Ge	<ul style="list-style-type: none"> <li>● Ambient temperature between 15 and 17 °C</li> </ul>	68%	–	–	● Theoretical ● Experimental ● Experimental
	Xu et al. (2015)	InGaP/InGaAs/Ge triple junction	<ul style="list-style-type: none"> <li>● Beam radiation of 700 W/ m<sup>2</sup></li> <li>● Solar irradiance of 1000 W/ m<sup>2</sup></li> <li>● Default temperature of 25 °C</li> </ul>	54%	28%	84%	● Theoretical
	Yew et al. (2015)	Triple junction	<ul style="list-style-type: none"> <li>● Solar irradiance of 900 W/ m<sup>2</sup></li> <li>● Ambient temperature of 25 °C</li> </ul>	34.1%-38.7%	20%-25%	–	● Theoretical
	Mi et al. (2016)	GaInP/GaInAs/Ge triple junction	<ul style="list-style-type: none"> <li>● Ambient temperature of 27 °C</li> <li>● Water inlet temperature of 20 °C</li> <li>● PV cell temperature between 21 and 35 °C</li> <li>● Total solar irradiance of 1000 W/m<sup>2</sup></li> </ul>	–	–	25%-27%	● Experimental ● Theoretical ● Theoretical
	Cui et al. (2016)	GaInP/InGaAs/G, c-Si, CIGS and GaAs	–	–	–	–	● Theoretical
	Mojiri et al. (2016)	Silicon	–	50%	3.8%	–	● Theoretical ● Experimental
	Widyolar et al. (2017)	GaAs	<ul style="list-style-type: none"> <li>● Beam radiation of 700 W/m<sup>2</sup></li> <li>● Fluid inlet temperature between 100 and 500 °C</li> </ul>	37%	8%	–	● Theoretical ● Theoretical ● Experimental
	Ceylan et al. (2016)	Silicon	<ul style="list-style-type: none"> <li>● Ambient temperature between 20 and 40 °C</li> </ul>	–	11%	–	● Theoretical ● Experimental
	Gürel (2016)	Silicon	<ul style="list-style-type: none"> <li>● Total radiation of 1000 W/m<sup>2</sup></li> <li>● PV cell temperature of 25 °C</li> </ul>	–	–	11%-16%	● Experimental
	Xu et al. (2016)	InGaP/InGaAs/Ge	<ul style="list-style-type: none"> <li>● Ambient temperature of 25 °C</li> <li>● Wind velocity of 4 m/s</li> <li>● Beam radiation of 1000 W/m<sup>2</sup></li> </ul>	60%	28%	–	● Theoretical
	Karimi et al. (2017)	Mono-crystalline	<ul style="list-style-type: none"> <li>● Solar radiation of 920 W/m<sup>2</sup></li> <li>● PV cell temperature of 20 °C</li> </ul>	43.6%	14.5%	53%	● Experimental
	Burhan et al. (2017)	Mono-crystalline, polycrystalline and thin-films CIS	–	–	22%	23%	● Theoretical
	Srivastava and Reddy (2017)	InGaP/GaAs/Ge	<ul style="list-style-type: none"> <li>● Fluid inlet temperature and ambient temperature of 27 °C</li> <li>● Beam radiation of 650 W/m<sup>2</sup></li> </ul>	69.68%	18.91%	85.82%	● Theoretical ● Experimental
	Yazdanifard et al. (2017)	GaAs	<ul style="list-style-type: none"> <li>● Fluid inlet temperature and ambient temperature of 25 °C</li> <li>● Solar radiation of 700 W/m<sup>2</sup></li> <li>● Wind velocity of 1.5 m/s</li> </ul>	52.58%-56.37%	7.12%-7.94%	61%-63.5%	● Theoretical
	Proell et al. (2017)	Crystalline silicon	<ul style="list-style-type: none"> <li>● Ambient temperature between 17 and 29 °C</li> <li>● PV cell temperature of 22.9 °C</li> <li>● Total radiation of 1000 W/m<sup>2</sup></li> </ul>	34%	9%	–	● Experimental
	Chong et al. (2017a)	Triple junction	<ul style="list-style-type: none"> <li>● Solar irradiance of 1000 W/m<sup>2</sup></li> </ul>	–	–	–	● Experimental

(continued on next page)



Table 1 (continued)

St. Nb	Reference (Author/s, year)	PV cell	Operating conditions	Efficiency Thermal	Electrical	Total	Type of study
						16.1%-17.4%	● Theoretical
	Schmitz et al. (2017) Lu et al. (2018)	InGaP/GaAs/Ge Crystalline silicon	<ul style="list-style-type: none"> <li>● Fluid inlet temperature of 85 °C</li> <li>● Incident radiation intensity of 280 W/m2</li> <li>● Ambient temperature of 23.9 °C</li> </ul>	–	26.6%	–	● Theoretical ● Theoretical ● Experimental
	Sakellariou and Axaopoulos (2018)	Poly-crystallinesilicon	<ul style="list-style-type: none"> <li>● Wind speed between 0 and 6 m/s</li> <li>● Ambient temperature between 24 and 28 °C</li> <li>● Incident solar irradiance between 200 and 900 W/m2</li> </ul>	–	–	–	● Theoretical ● Experimental
	Aoul et al. (2018)	Mono-crystalline	<ul style="list-style-type: none"> <li>● Ambient temperature between 21 and 45 °C</li> <li>● Wind speed between 0 and 5 m/s</li> </ul>	24%-36%	20%-24%	30%-47%	● Experimental
	Jaaz et al. (2018)	Poly-crystalline silicon	<ul style="list-style-type: none"> <li>● Ambient temperature of 33 °C</li> <li>● Solar radiation of 800 W/m2</li> </ul>	81%	13.75%	91%	● Experimental
	Soltani et al. (2018)	Crystalline silicon	<ul style="list-style-type: none"> <li>● Ambient temperature of 36.2 °C</li> <li>● Water inlet temperature of 28 °C</li> <li>● Solar radiation of 900 W/m2</li> </ul>	57%	–	–	● Theoretical
	Adam et al. (2019)	Silicon	<ul style="list-style-type: none"> <li>● Ambient temperature of 25 °C</li> <li>● fluid inlet temperature of 20 °C</li> <li>● Direct normal irradiance of 1000 W/m2</li> </ul>	55%-70%	5%-18%	66%-85%	● Theoretical
	Bellos and Tzivanidis (2019)	Mono-crystalline silicon	<ul style="list-style-type: none"> <li>● Solar irradiation of 1000 W/m2</li> <li>● Reference temperature of 25 °C</li> </ul>	46.84%	6.6%	–	● Theoretical
	El-samie et al. (2019) Shittu et al. (2019)	Poly-crystalline silicon Poly-crystalline silicon	<ul style="list-style-type: none"> <li>● Reference temperature of 25.15 °C</li> <li>● Ambient temperature between 15 and 55 °C</li> </ul>	48%-50.6%	6.9%-7.3%	80%-89%	● Theoretical ● Theoretical
	Yu et al. (2019)	Poly-crystalline silicon	<ul style="list-style-type: none"> <li>● Wind speed between 0 and 7 m/s</li> <li>● Ambient temperature between 21.6 and 23.6 °C</li> <li>● Wind speed between 2.2 and 3 m/s</li> <li>● Solar irradiance between 880 and 940 W/m2</li> <li>● PV cell temperature between 20 and 45 °C</li> </ul>	24.2%-25.2%	11.8%	36%-37%	● Theoretical ● Experimental
	Zhang et al. (2019)	Poly-crystalline silicon	<ul style="list-style-type: none"> <li>● Ambient temperature of 18 °C</li> <li>● Wind speed of 0.1 m/s</li> <li>● Solar irradiance of 900 W/m2</li> <li>● Inlet fluid temperature of 14.5 °C</li> </ul>	56.7%	11.8%	66.4%	● Theoretical
	Valizadeh et al. (2019)	InGaP/GaAs/Ge	<ul style="list-style-type: none"> <li>● Ambient temperature of 25 °C</li> <li>● Sky temperature of 19 °C</li> <li>● Wind speed of 5 m/s</li> <li>● Beam radiation of 800 W/m2</li> <li>● Total radiation of 1000 W/m2</li> <li>● Inlet fluid temperature of 70 °C</li> </ul>	59%-67%	15%–22%	–	● Theoretical
	Bamroongkhan et al. (2019)	Mono-crystalline silicon	<ul style="list-style-type: none"> <li>● Solar intensity between 300 and 826 W/m2</li> <li>● Ambient temperature around 30 °C</li> </ul>	–	19.65%	–	● Theoretical
	Wang et al. (2019)	Mono-crystalline silicon	<ul style="list-style-type: none"> <li>● Ambient temperature between 30 and 33 °C</li> <li>● Wind speed of 3 m/s</li> <li>● Solar radiation of 960 W/m2</li> </ul>	79%	8.7%	88%	● Theoretical

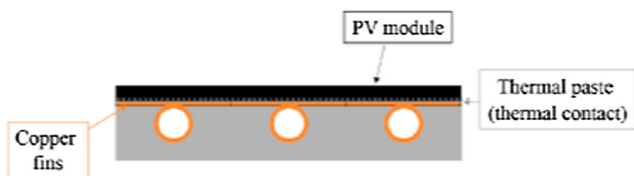

Fig. 3. Flat plate PVT collector (Guarracino et al., 2019).

presented in Fig. 3. Experimental tests were carried out on four PVT collectors: commercial PVT module, unglazed PVT module with 65% PV covering factor and glazed PVT modules with 65% and 100% PV covering factor. It was obtained that the PVT collector thermal efficiency alleviates by 10% when the electricity conversion is relatively maximized compared to open-circuit mode. Also, the collector thermal performance deteriorates when there is weak thermal contact of the

thermal absorber with the PV layer. Besides, it was shown that the glazing enhances thermal efficiency and mitigates electrical efficiency.

Moreno et al. (2017) studied an unglazed flat plate PVT system by analyzing its performance at distinct operating conditions. A finite element modeling was carried out, simulated and compared with an existing theoretical mathematical model. The results revealed that the PVT system overall performance is higher than that of the thermal system and it is significant for places with limited areas even though the outlet temperature is relatively moderate. Lämmle et al. (2017) developed, validated and simulated, by using TRNSYS, an empirical model to evaluate the performance of glazed, unglazed and hybrid PVT-FPCs of low emissivity coatings. It was detected that the glazed PVT collector attains the highest global yields and the best energetic exploitation of the collector area. In addition, it was observed that with the same thermal output, the electrical output of these collectors is greater than that of PVM and FPC operating separately by about 3 times. Rashmi



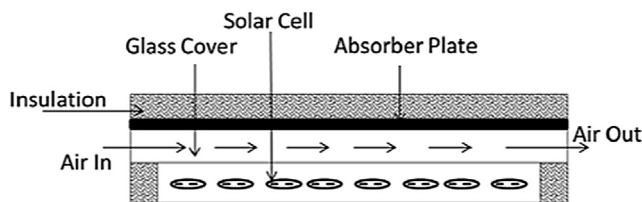

Fig. 4. Flat plate PVT collector (Rashmi et al., 2019).

et al. (2019) established an analytical model to evaluate the performance of semi-transparent PVT with inverted absorber (IA) FPC (SPVT-IAFPC) (Fig. 4) from exergetic point of view for three cases: conventional inverted absorber FPC, partially covered SPVT-IAFPC air collector, and fully covered SPVT-IAFPC-air collector. The authors simulated the conducted model using MATLAB software to demonstrate the effect of mass flow rate on the outlet temperature, rate of thermal efficiency, cell temperature and electrical efficiency, and to evaluate the thermal energy performance with the global exergy efficiency.

PTC is made up of a parabolic concentrator of reflective material, supporting structure, tracking system, metal glazed receiver tube adjusted at the focus of the concentrator and working fluid passing through it. Karathanassis et al. (2019) conducted a theoretical dynamic model to demonstrate the impact of several geometrical system components, materials and functional parameters on the energetic and exergetic performance of a parabolic trough PVT system. It was concluded that the exergetic efficiency of the system augmented from 12% to 24% when rising the optical efficiency of the parabolic trough and the electrical efficiency of the PVM to 75% and 25% respectively. Calise and Vanoli (2012) designed and established thermal modeling of a novel concentrating PVT system where the structure was integrated from an existing prototype in the literature. The system is made up of parabolic trough collector and triangular receiver containing fluid channel, two PV layers facing the concentrator and absorber at the top of the receiver. Fig. 5 illustrates the layout of the system. The model was simulated to investigate the electrical and thermal performance of the system. It was concluded that the thermal and electrical efficiencies mitigate with the alleviation in the incident beam radiation. Also, the authors developed a detailed finite volume model of the parabolic trough PVT to assess its thermodynamic and electrical parameters.

Furthermore, Valizadeh et al. (2019) conducted thermal modeling to evaluate the exergy performance of the system studied by Calise and Vanoli (2012). The developed thermal modeling is simulated by varying several design parameters such as channel diameter, fluid velocity, receiver width, collector length and boundary conditions such as fluid inlet temperature, ambient temperature and incident beam radiation. Yazdanifard et al. (2017) conducted thermal modeling on parabolic trough PVT system to study its energetic and exergetic performance in laminar and turbulent flows (Fig. 6). The thermal modeling was validated using experimental results existing in the literature and then it is used to investigate the effect of concentration ratio, pipe diameter, and length on the performance of the studied system. The

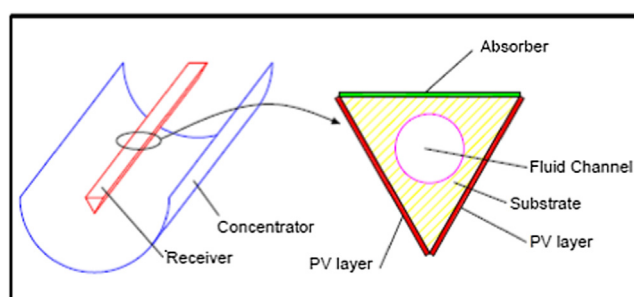

Fig. 5. Parabolic trough PVT system investigated by (Calise and Vanoli, 2012).

outcomes revealed that the total energy efficiency is mitigated by approximately 1.09% and 9.33% in the turbulent and laminar regime respectively when pipe length rises from 0.5 to 5 m, while the exergy efficiency augments by about 10.37% and 33.65% in the turbulent and laminar regime respectively. The authors also compared the system performance with that of a flat plate PVT system.

CPC is composed of two meeting parabolic concentrators, transparent cover from the top, absorber, and insulation around the fluid passages. There are two main types of compound parabolic concentrators which are: symmetric and asymmetric. Also, two types of absorbers are utilized: fin type with a pipe and tubular absorbers. Lu et al. (2018) designed and developed a Building Facade Integrated Asymmetric Compound Parabolic Photovoltaic concentrator (BFI-ACPPV) system. A comprehensive indoor test was performed to assess the electrical and thermal performance of the system as well as the parameters that influence the power output of the system. It was observed, from the experimental results, that the power output per unit solar cell area is raised by a factor of two by utilizing the BFI-ACPPV system in comparison to the conventional PV system. Jaaz et al. (2017) reviewed the various kinds of compound parabolic concentrator PVT system including the design benefits and barriers. The authors compared the utilized materials, the range of acceptance angle, optical tolerance and efficiency. Tiwari et al. (2018a) investigated and analyzed the operating parameters of a fully covered PVT-CPC based on applying the energy balance on each part of the system. The system is shown in Fig. 7 where it is mainly made up of solar cells, absorber plate, concentrator and flowing fluid. The system performance was compared to PVT-FPC, conventional flat plate-CPC and conventional FPC. It was concluded that the PVT compound parabolic concentrator and the PVT-FPC are appropriate to be used in an absorption refrigeration system.

Also, Tiwari et al. (2020) carried out an hourly thermodynamic investigation on solar-powered organic Rankine cycle integrated with a hybrid reversed absorber partially covered PVT-CPC system. The aim of this study was to enhance the performance of the system to compensate for the increasing energy demand and alleviate environmental problems. The collector output temperature, combined thermal and exergy efficiency and the heat gain in evaporator were evaluated for different concentration ratios. It was observed that at 13:00hr and for concentration ratio equal to six, the highest collector outlet temperature, heat gain, combined thermal efficiency, and exergy efficiency were 125.45 °C,  $3.21 \times 10^5$  W, 7.8%, and 14.38% respectively.

PDC mainly comprises a parabolic dish, absorber, flexible pipe and tracking axis. The parabolic dish is made up of reflective mirrors that direct sunlight towards the receiver which a container of water. Sharaf and Orhan (2018) designed and analyzed the optical and thermodynamic performance of two configurations of PDC-PVT: in parallel and in series thermal configurations. The two arrangements are evaluated from the exergo-economic and environmental point of view and then compared. It was concluded that the thermally-parallel design supplies significant electrical and thermal outputs and it is favorable for applications that request simultaneously high electricity and temperature thermal energy. On the other hand, the thermally-series configuration is less flexible and is suitable for applications of low temperature thermal energy. Kribus et al. (2006) designed and assessed a new miniature PDC-PVT system presented in Fig. 8. The authors analyzed the manufacturing cost and the cost of energy required for domestic water heating applications in addition to the electrical and thermal performance. The results revealed that the miniature parabolic dish PVT system can be constructed at a low competitive cost and it has relatively high thermal and electrical efficiencies in comparison to the flat plate PVT system.

Buonomano et al. (2013) designed and analyzed the thermodynamic performance of a parabolic dish PVT system which is mainly composed of parabolic dish concentrator, PV layer and fluid channel, metallic substrate and thermal insulation (Fig. 9). The authors conducted and simulated a mathematical model which enables to compute the

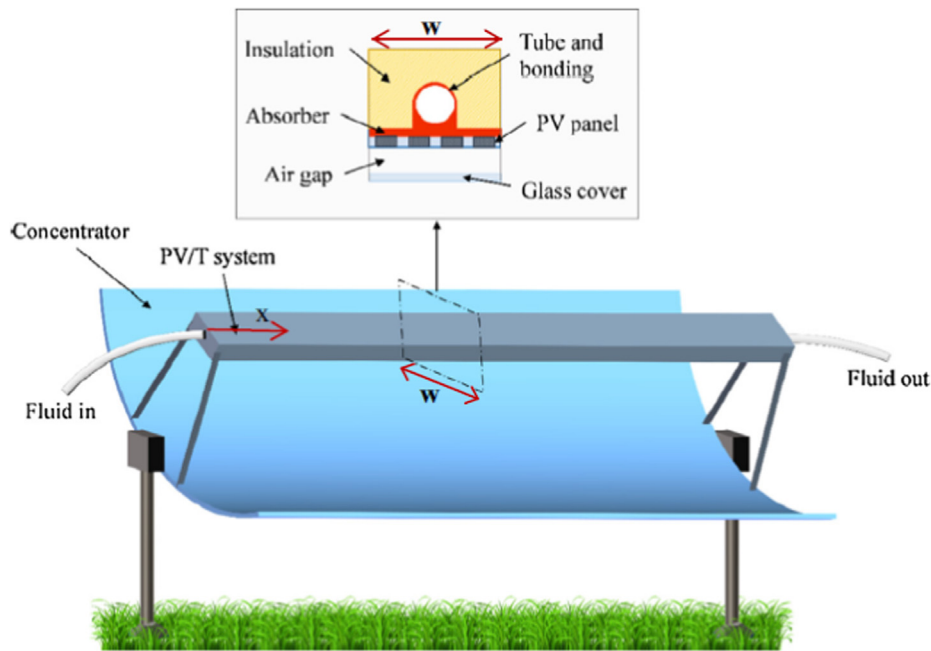

Fig. 6. Parabolic trough PVT system investigated by (Yazdanifard et al., 2017).

temperature of the system main components and the main energy flows such as useful thermal and electrical energy and the losses by convection and by radiation. Renno and Petito (2013) implemented a theoretical modeling of a parabolic dish PVT system that aims to size the system and assess its thermal and electrical operation in providing cooling, heating, and electricity to domestic application.

LFR is composed of an array of linear mirrors that track the sun, receiver tube that is fixed on the top of a tower and heat transfer fluid. Renno and Petito (2016) conducted experimental and theoretical analyses on the linear Fresnel PVT system to assess the electrical parameters as well as the thermal parameters such as the concentration factor, the fluid temperature and the cell temperature at distinct operating conditions. The aim of this analysis is to compute the potential

energy generated by the studied system. Fig. 10 shows a schematic of the studied system.

Karimi et al. (2017) analyzed the performance of a pure thermal and PVT solar system using a concentrated linear Fresnel lens. The results showed that the total efficiency of the pure and PVT systems achieved 46.6% and 53% respectively. Wu et al. (2012) developed extensive indoor experimental testing to evaluate the heat loss from a Fresnel lens concentrator PVT collector where the concentration ratio is 100. The tests were simulated for solar radiation ranging from 200 to 1000 W/m<sup>2</sup>, natural or forced convection and distinct ambient air temperature. It was shown that solar cell temperature rises when the solar radiation intensity increases. Sonneveld et al. (2011) developed and tested a linear Fresnel lens PVT collector with greenhouse for agriculture. The

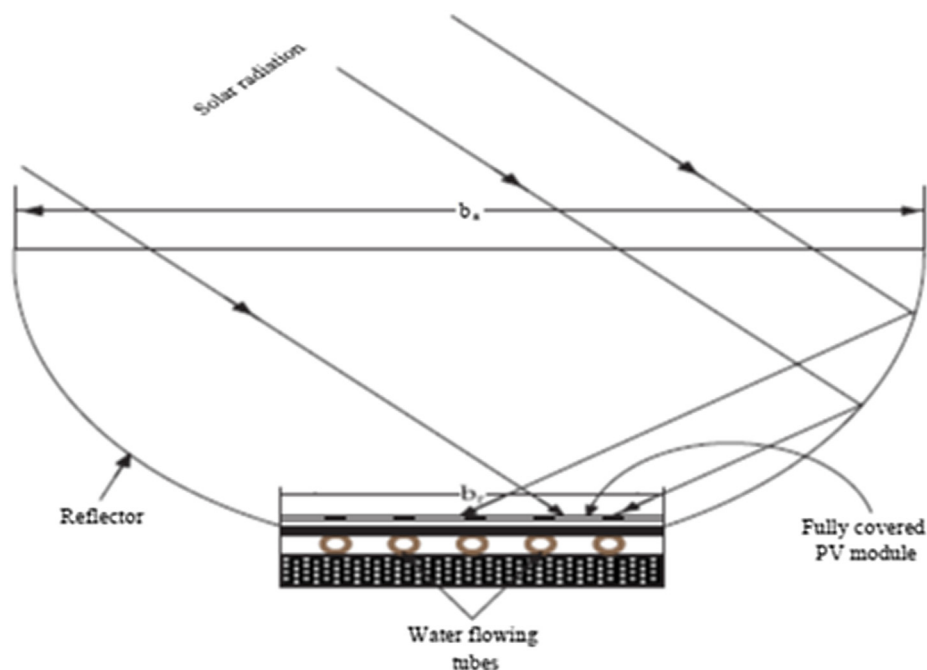

Fig. 7. Compound parabolic concentrator PVT system (Tiwari et al., 2018).

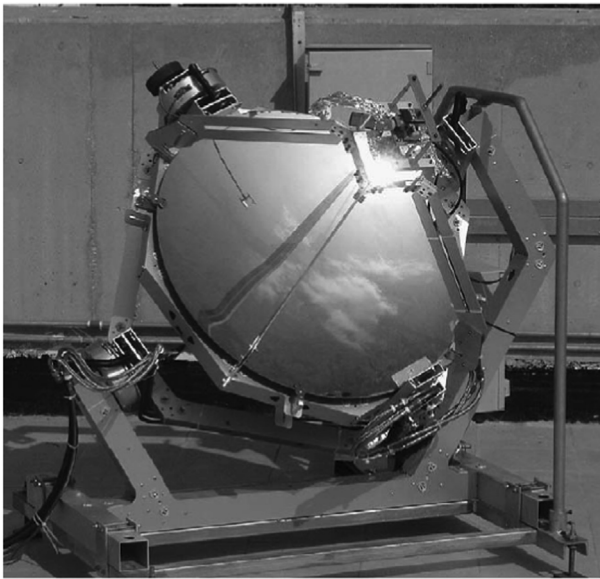

Fig. 8. Parabolic dish PVT collector designed by (Kribus et al., 2006).

results revealed that the electricity generated was 2% greater than the energy consumed by the tracking system. It was obtained that the thermal and electrical efficiencies of the system are 56% and 11% respectively.

Table 2 presents recent studies that were performed on PVT hybrid systems according to the type of solar collector used.

Analysis of Table 2 yields to the following concluding points:

- All solar collectors including the concentrated and non-concentrated types can operate at high solar radiation (about 1000 W/m<sup>2</sup>)
- The selection of the solar collector depends on the type of application where each one requires certain range of outlet temperature.
- Concentrated type of STC; mainly parabolic trough and linear Fresnel are the most commonly utilized types in PVT systems.
- The electrical efficiency is negligibly affected by the type of the STC.

### 3.3. Working fluid

Photovoltaic thermal systems can be classified relying on the working fluid circulation (natural or forced circulation), working fluid type (water, air or water/air), location of fluid channel (above or below PV layer) and fluid entry (single or multiple). Forced circulation of the

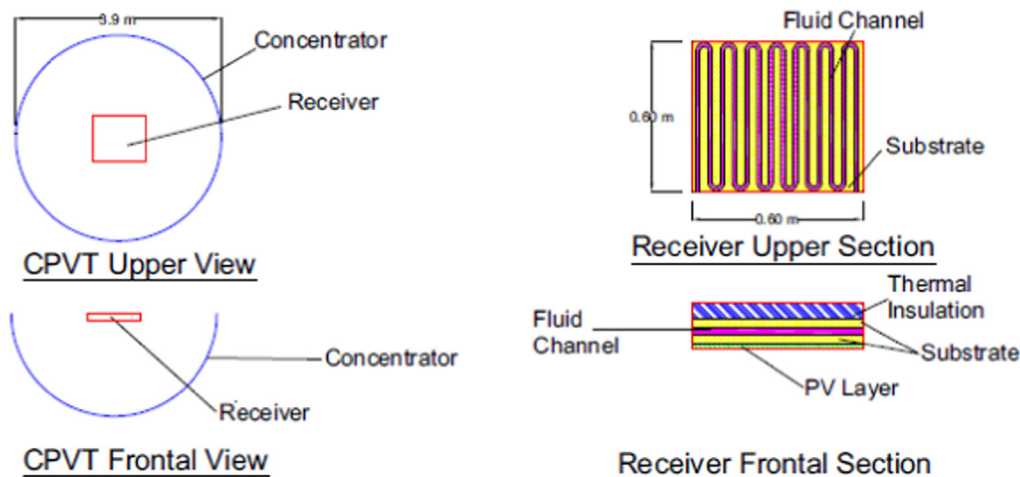

Fig. 9. Parabolic dish PVT collector investigated by (Buonomano et al., 2013).

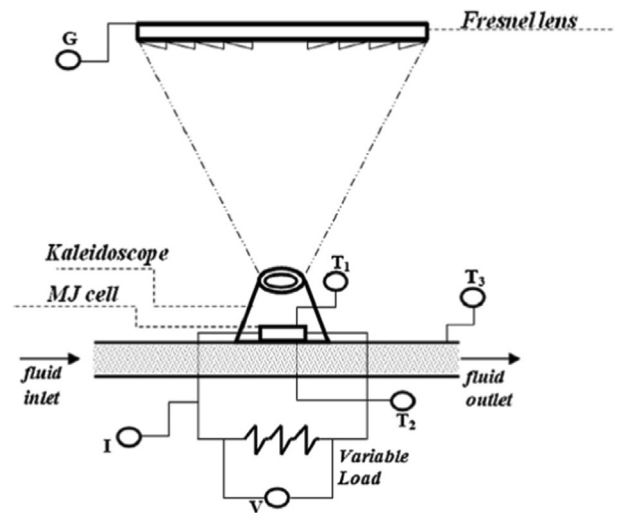

Fig. 10. Fresnel lens PVT system (Renno and Petito, 2016).

working fluid is more efficient than natural flow circulation. However, the required power by the fan mitigates the net electric power generated by PVT system.

Air was firstly used as a working fluid in PVT systems with natural circulation where after that forced convection of air is adopted. PVT air collector has similar structure to solar air collector in which the thermal absorber sheet is replaced by PV layer. In such collector, air passes behind the PV layer and removes heat from it to be utilized in several applications such as drying or space heating. PVT air system has no leakage and freezing problems and it has low cost. However, air is not preferred as a heat transfer working fluid since it has low density, thermal conductivity and specific heat.

Barone et al. (2019a) established a dynamic simulation model to assess the energy performance and economic feasibility of low cost air based PVT collector. Experimental tests were carried out to validate the results of model simulation.

Fudholi et al. (2019) proffered a review to study the sustainability index and exergy of PVT air system. The authors established a model to investigate the performance of the system where the results are verified by conducting experimental tests.

Numan and Kaya (2019) demonstrated the energy and exergy analyses for PVT air collector. Using ANSYS Fluent, the authors investigated the distribution of temperature along the panel surface and the air velocity of the cooling channel. The results were compared to experimental results.

**Table 2**  
Studies performed on hybrid systems according to the type of solar collector.

St. Nb	Reference(Author/s, Year)	Thermal collector	Operating conditions	Efficiency			Type of study
				Thermal	Electrical	Total	
	Ibrahim et al. (2009a)	● Flat plate	● Solar radiation of 800 W/m <sup>2</sup> ● Ambient temperature of 25 °C	45%	10%	55%	● Experimental
	Bernardo et al. (2011)	● Parabolic trough	● Incident beam radiation of 997 W/m <sup>2</sup> ● Water inlet temperature of 28 °C	45%	6.4%	–	● Experimental
	Chemisana et al. (2011)	● Fresnel ● Compound parabolic	● Solar irradiance between 7000 and 10000 W/m <sup>2</sup>	65%	–	–	● Experimental ● Theoretical
	Sonneveld et al. (2011)	● Fresnel	● Solar radiation of 630 W/m <sup>2</sup> and 792 W/m <sup>2</sup>	56%	11%	67%	● Experimental
	Dupeyrat et al. (2011)	● Flat plate	● Total radiation of 960 W/m <sup>2</sup> ● Ambient temperature varied between 30 and 33 °C	79%	8.8%	–	● Theoretical ● Experimental
	Calise and Vanoli (2012)	● Parabolic trough	● Wind velocity of 3 m/s ● Inlet water temperature of 70 °C ● Ambient and sky temperature of 25 °C ● Wind velocity of 5 m/s ● Total and beam radiation of 1000 W/m <sup>2</sup> and 800 W/m <sup>2</sup> respectively	56%-63%	20%–23%	77%-83%	● Theoretical
	Buonomano et al. (2013)	● Parabolic dish	● Inlet fluid temperature of 150 °C ● Ambient and sky temperature of 25 °C ● Wind velocity of 5 m/s ● Total and beam radiation of 1000 W/m <sup>2</sup> and 800 W/m <sup>2</sup> respectively	27%-58%	18%-24%	45%-82%	● Theoretical
	Renno and Petitto (2013)	● Parabolic dish	–	67%-70%	19%-21%	86%-91%	● Theoretical
	Del Col et al. (2014)	● Parabolic trough	● Inlet water temperature ranges between 20 and 80 °C ● Beam radiation of 1000 W/m <sup>2</sup>	41.6%	23.1%	64.7%	● Theoretical ● Experimental
	Hussain and Lee (2015)	● Fresnel	● Solar radiation of 900 W/m <sup>2</sup> ● Fluid inlet temperature of 25 °C	68%	–	–	● Theoretical ● Experimental
	Xu et al. (2015)	● Fresnel	● Ambient temperature between 15 and 17 °C ● Beam radiation of 700 W/m <sup>2</sup>	54%	28%	84%	● Experimental
	Yew et al. (2015)	● Compound parabolic ● Parabolic dish	● Solar irradiance of 1000 W/m <sup>2</sup> ● Default temperature of 25 °C	34.1%-38.7%	20%-25%	–	● Theoretical
	Mi et al. (2016)	● Fresnel	● Solar irradiance of 900 W/m <sup>2</sup> ● Ambient temperature of 25 °C	–	–	–	● Experimental ● Theoretical
	Feng et al. (2016)	● Fresnel	● Solar irradiation between 925 and 1006 W/m <sup>2</sup>	45%	18%	55%	● Experimental
	Cui et al. (2016)	● Fresnel	● Ambient temperature of 27 °C ● Water inlet temperature of 20 °C ● PV cell temperature between 21 and 35 °C ● Total solar irradiance of 1000 W/m <sup>2</sup>	–	–	25%-27%	● Theoretical
	Mojiri et al. (2016)	● Fresnel	–	50%	3.8%	–	● Theoretical ● Experimental
	Widyolar et al. (2017)	● Parabolic trough ● Compound parabolic	● Beam radiation of 700 W/m <sup>2</sup> ● Fluid inlet temperature between 100 and 500 °C	37%	8%	–	● Theoretical ● Experimental
	Ceylan et al. (2016)	● Compound parabolic	● Ambient temperature between 20 and 40 °C ● Total radiation of 1000 W/m <sup>2</sup>	–	11%	–	● Theoretical ● Experimental
	Gürel (2016)	● Compound parabolic	● Total radiation of 1000 W/m <sup>2</sup> ● Cell temperature of 25 °C	–	–	11%-16%	● Experimental
	Xu et al. (2016)	● Fresnel	● Ambient temperature of 25 °C ● Wind velocity of 4 m/s ● Beam radiation of 1000 W/m <sup>2</sup>	60%	28%	–	● Theoretical
	Atheaya et al. (2016b)	● Compound parabolic	● Beam radiation between 100 and 600 W/m <sup>2</sup> ● Total radiation between 150 and 750 W/m <sup>2</sup>	–	6.5%-13.4%	–	● Theoretical
	Karathanassis et al. (2017)	● Parabolic trough	● Ambient temperature between 15 and 35 °C ● Wind velocity between 0 and 2 m/s ● Beam radiation between 760 and 970 W/m <sup>2</sup>	44%	6%	50%	● Experimental
	Karimi et al. (2017)	● Fresnel	● Solar radiation of 920 W/m <sup>2</sup> ● PV cell temperature of 20 °C	43.6%	14.5%	53%	● Experimental
	Burhan et al. (2017)	● Flat plate ● Fresnel ● Parabolic dish	–	–	22%	23%	● Theoretical
	Srivastava and Reddy (2017)	● Parabolic trough ● Compound parabolic	● Fluid inlet temperature and ambient temperature of 27 °C ● Beam radiation of 650 W/m <sup>2</sup>	69.68%	18.91%	85.82%	● Theoretical ● Experimental

(continued on next page)

Table 2 (continued)

St. Nb	Reference(Author/s, Year)	Thermal collector	Operating conditions	Efficiency			Type of study
				Thermal	Electrical	Total	
	Tripathi and Tiwari (2017)	● Compound parabolic	● Ambient temperature between 25 and 34 °C ● Beam radiation between 300 and 860 W/m <sup>2</sup>	37.1%-37.5%	2.7%-3.9%	–	● Experimental ● Theoretical
	Yazdanifard et al. (2017)	● Parabolic trough ● Flat plate	● Fluid inlet temperature and ambient temperature of 25 °C ● Solar radiation of 700 W/m <sup>2</sup> ● Wind velocity of 1.5 m/s	52.58%-56.37%	7.12%-7.94%	61%-63.5%	● Theoretical
	Proell et al. (2017)	● Compound parabolic ● Flat plate	● Ambient temperature between 17 and 29 °C ● PV cell temperature of 22.9 °C ● Total radiation of 1000 W/m <sup>2</sup>	34%	9%	–	● Experimental
	Chong et al. (2017b) Chong et al. (2017a)	● Parabolic dish ● Parabolic dish	● Direct normal irradiance of 1000 W/m <sup>2</sup> ● Solar irradiance of 1000 W/m <sup>2</sup>	–	17% –	– 16.1%-17.4%	● Experimental ● Experimental ● Theoretical
	Schmitz et al. (2017) Lu et al. (2018)	● Parabolic dish ● Compound parabolic	● Fluid inlet temperature of 85 °C ● Incident radiation intensity of 280 W/m <sup>2</sup> ● Ambient temperature of 23.9 °C	–	26.6% 14.8%	–	● Theoretical ● Theoretical ● Experimental
	Sakellariou and Axaopoulos (2018)	● Flat plate	● Wind speed between 0 and 6 m/s ● Ambient temperature between 24 and 28 °C ● Incident solar irradiance between 200 and 900 W/m <sup>2</sup>	–	–	–	● Theoretical ● Experimental
	Tiwari et al. (2018a)	● Compound parabolic ● Flat plate	● PV cell temperature of 25 °C ● Total solar radiation of 1000 W/m <sup>2</sup>	–	● 0.1% ● 0.11%	–	● Theoretical
	Aoul et al. (2018)	● Flat plate ● Fresnel	● Ambient temperature between 21 and 45 °C ● Wind speed between 0 and 5 m/s	24%-36%	20%-24%	30%-47%	● Experimental
	Jaaz et al. (2018)	● Compound parabolic	● Ambient temperature of 33 °C ● Solar radiation of 800 W/m <sup>2</sup>	81%	13.75%	91%	● Experimental
	Soltani et al. (2018)	● Parabolic trough	● Ambient temperature of 36.2 °C ● Water inlet temperature of 28 °C ● Solar radiation of 900 W/m <sup>2</sup>	57%	–	–	● Theoretical
	Adam et al. (2019)	● Fresnel ● Parabolic trough	● Ambient temperature of 25 °C ● fluid inlet temperature of 20 °C ● Direct normal irradiance of 1000 W/m <sup>2</sup>	55%-70%	5%-18%	66%-85%	● Theoretical
	Bellos and Tzivanidis (2019)	● Parabolic trough	● Solar irradiation of 1000 W/m <sup>2</sup> ● Reference temperature of 25 °C ● Reference temperature of 25.15 °C	46.84%	6.6%	–	● Theoretical
	El-samie et al. (2019)	● Compound parabolic	● Reference temperature of 25.15 °C	48%-50.6%	6.9%-7.3%	80%-89%	● Theoretical
	Shittu et al. (2019)	● Flat plate	● Ambient temperature between 15 and 55 °C ● Wind speed between 0 and 7 m/s	–	–	16%-17%	● Theoretical
	Yu et al. (2019)	● Flat plate	● Ambient temperature between 21.6 and 23.6 °C ● Wind speed between 2.2 and 3 m/s ● Solar irradiance between 880 and 940 W/m <sup>2</sup>	24.2%-25.2%	11.8%	36%-37%	● Theoretical ● Experimental
	Zhang et al. (2019)	● Compound parabolic	● PV cell temperature between 20 and 45 °C ● Ambient temperature of 18 °C ● Wind speed of 0.1 m/s ● Solar irradiance of 900 W/m <sup>2</sup> ● Inlet fluid temperature of 14.5 °C	56.7%	11.8%	66.4%	● Theoretical
	Valizadeh et al. (2019)	● Parabolic trough	● Ambient temperature of 25 °C ● Sky temperature of 19 °C ● Wind speed of 5 m/s ● Beam radiation of 800 W/m <sup>2</sup> ● Total radiation of 1000 W/m <sup>2</sup> ● Inlet fluid temperature of 70 °C	59%-67%	15%–22%	–	● Theoretical
	Bamroongkhan et al. (2019)	● Parabolic dish	● Solar intensity between 300 and 826 W/m <sup>2</sup> ● Ambient temperature around 30 °C	–	19.65%	–	● Theoretical
	Wang et al. (2019)	● Fresnel	● Ambient temperature between 30 and 33 °C ● Wind speed of 3 m/s ● Solar radiation of 960 W/m <sup>2</sup>	79%	8.7%	88%	● Theoretical

Fan et al. (2018) presented a novel design for PVT solar air heating which aims to optimize the thermal energy utilized and the gained electrical energy. The authors studied several parameters that are related to geometry, construction materials and operation. Uncertainty study was also conducted which revealed that the useful thermal

efficiency ranges between 48.8% and 56.9%.

Aste et al. (2008) overviewed the development and research program which was developed at the Politecnico di Milano by presenting its experimental and theoretical results. The program was carried out on the development, design and monitoring the performance of air



**Table 3**  
Theoretical and experimental works on water or/and air PVT systems.

St. Nb	Reference(Author/s, Year)	Working fluid	Operating conditions	Efficiency			Type of study
				Thermal	Electrical	Total	
	Hung et al. (2001)	Water	<ul style="list-style-type: none"> <li>● Total radiation between 200 and 900 W/m<sup>2</sup></li> <li>● Ambient temperature between 25 and 35 °C</li> </ul>	44.5%	9.1%	53.5%	● Experimental
	Zondag et al. (2003)	Water	<ul style="list-style-type: none"> <li>● Ambient temperature of 20 °C</li> <li>● Sky temperature of 4 °C</li> <li>● Incident angle 45°</li> <li>● Wind velocity of 1 m/s</li> <li>● Total radiation of 800 W/m<sup>2</sup></li> <li>● Solar radiation of 600 W/m<sup>2</sup></li> <li>● Inlet fluid temperature of 38 °C</li> </ul>	52%-58%	8.1%-9.7%	–	● Theoretical ● Experimental
	Solanki et al. (2009)	Air	<ul style="list-style-type: none"> <li>● Solar radiation of 600 W/m<sup>2</sup></li> <li>● Inlet fluid temperature of 38 °C</li> </ul>	42%	8.4%	51%	● Theoretical ● Experimental
	Aste et al. (2017)	Water	–	22%-29%	6%-14%	–	● Theoretical
	Ibrahim et al. (2009b)	Water	<ul style="list-style-type: none"> <li>● Solar radiation of 800 W/m<sup>2</sup></li> <li>● Wind velocity of 1 m/s</li> <li>● Ambient temperature of 26 °C</li> </ul>	50.12%	11.98%	68%	● Theoretical
	Xu et al. (2011)	Water	<ul style="list-style-type: none"> <li>● Solar radiation between 500 and 900 W/m<sup>2</sup></li> <li>● Wind velocity of 0.75 m/s</li> <li>● Ambient temperature between 34.2 and 38.5 °C</li> </ul>	–	17.5%	–	● Experimental
	Bambrook and Sproul (2012)	Air	<ul style="list-style-type: none"> <li>● Solar radiation of 800 W/m<sup>2</sup></li> <li>● Ambient temperature of 17 °C</li> </ul>	28%-55%	10.6%-12.2%	–	● Experimental
	Kim et al. (2014)	Water	–	30%	17%	47%	● Experimental
	Alobaid et al. (2017)	Water	–	–	10–35%	–	● Theoretical
	Fan et al. (2018)	Air	<ul style="list-style-type: none"> <li>● Wind velocity between 0 and 8 m/s</li> <li>● Sky temperature between 10 and 22 °C</li> <li>● Beam radiation up to 810 W/m<sup>2</sup></li> </ul>	48.8%-56.9%	–	–	● Theoretical ● Experimental
	Kazemian et al. (2018)	Water	<ul style="list-style-type: none"> <li>● Total radiation between 400 and 580 W/m<sup>2</sup></li> <li>● Ambient temperature between 28 and 32 °C</li> </ul>	63.37%-70.89%	13.15%-14.35%	76%-84%	● Theoretical ● Experimental
	Tiwari et al. (2018b)	Air	<ul style="list-style-type: none"> <li>● Ambient temperature between 35 and 43 °C</li> <li>● Total radiation between 100 and 900 W/m<sup>2</sup></li> <li>● Incident angle of 30°</li> </ul>	11.26%	26.68%	56.3%	● Theoretical
	Maatallah et al. (2019)	Water	<ul style="list-style-type: none"> <li>● Ambient temperature between 32 and 38 °C</li> <li>● Total radiation between 390 and 560 W/m<sup>2</sup></li> </ul>	26.87%	13.72%	40.59%	● Experimental
	Misha et al. (2019)	Water	<ul style="list-style-type: none"> <li>● Inlet water temperature of 26 °C</li> <li>● Solar irradiance of 600, 800 and 1000 W/m<sup>2</sup></li> <li>● Wind velocity of 1 m/s</li> <li>● Ambient temperature of 30 °C</li> </ul>	59.6%	11.71%	–	● Theoretical ● Experimental
	Senthilraja et al. (2019)	WaterAir	<ul style="list-style-type: none"> <li>● Ambient temperature between 34 and 38.6 °C</li> <li>● Wind velocity between 0.6 and 2.3 m/s</li> <li>● Total radiation between 420 and 940 W/m<sup>2</sup></li> </ul>	33.8%31.1%	8.5%8%	42%38%	● Theoretical ● Experimental

based PVT collector. Also, the research included a simulation model for predicting and evaluating the performance of air PVT system.

Bambrook and Sproul (2012) studied the parameters that affect thermal performance of PVT air collector to determine the optimum design that suits the climate. The authors designed and conducted experiments on PVT system. The experimental results clarified that at midday the thermal and electrical efficiencies are in the range of 28–55% and 10.6–12.2% respectively.

Solanki et al. (2009) designed, fabricated and evaluated the performance of air based PVT collectors by performing indoor testing procedure. The authors established a steady state thermal model by applying energy balance equations. The results showed that the maximum thermal and electrical efficiencies achieved by PVT air collector are 42% and 8.4% respectively.

On the other side, water is more efficient than air since it has higher thermal properties than air, but the cost of leakage detector and maintenance, the electrically insulated thermal device and the water circulation pipes make it more expensive compared to PVT air system. Such system is used for space heating, desalination and water heating.

Hung et al. (2001) assessed the performance of solar water based PVT collector and compared it to traditional solar water heater. It was observed that the maximum thermal and electrical efficiencies of PVT water collector are 44.5% and 9.1% respectively.

Barone et al. (2019b) developed a dynamic simulation model to assess the energy, economic, and environmental performance of a low cost water based PVT collector. The authors designed, build and carried out experimental tests on a prototype of air water PVT collector to validate the results of the model.

Maatallah et al. (2019) compared the performance of water based

PVT panel using phase change material with conventional PV panel by performing experimental tests under the weather conditions of Kottayam, India. It was observed that the electrical efficiency of PVT panel augmented by 17.33% in comparison to the traditional PV technology. The thermal and electrical efficiencies of PVT system are 26.87% and 13.72% respectively.

Yazdanpanahi et al. (2015) accomplished numerical and experimental demonstration on the exergy efficiency of PVT water collector. The authors performed experimental testing where the measured parameters comprise the wind speed, intensity of solar radiation, open circuit voltage and solar short circuit current, maximum power point voltage and maximum power point current, ambient temperature, fluid inlet and outlet temperature. Also, they conducted numerical simulation using four parameter current voltage model and thermal model of one dimensional steady state. The results revealed similarity between the numerical and experimental results.

Shyam et al. (2015) analyzed and compared the performance of two water collectors partially covered with PVM where the two collectors differs by the position of the PVM whether it is at the lower or upper portion of the collector. It was shown from the analytical analysis that at moderate mass flow rate and for large number of PVT water based collectors connected in series, both configurations have close results.

Aste et al. (2015) designed a covered PVT water collector which is composed of thin film PV cell integrated with flat plate absorber of roll-bond configuration. A simulation model was developed based on various mathematical equations. The aim of the model is to assess the performance of the designed PVT water based collector.

Misha et al. (2019) designed and implemented a PVT water system. The authors conducted a numerical simulations using ANSYS 19.2 to

**Table 4**  
Theoretical and experimental works on PVT systems according to glazing.

St. Nb	Reference(Author/s, Year)	Glazing	Operating conditions	Efficiency			Type of study
				Thermal	Electrical	Total	
	Hung et al. (2001)	No glazing	<ul style="list-style-type: none"> <li>● Total radiation between 200 and 900 W/m<sup>2</sup></li> <li>● Ambient temperature between 25 and 35 °C</li> </ul>	44.5%	9.1%	53.5%	● Experimental
	Zondag et al. (2003)	No glazing Single glazing Double glazing	<ul style="list-style-type: none"> <li>● Ambient temperature of 20 °C</li> <li>● Sky temperature of 4 °C</li> <li>● Incident angle 45°</li> <li>● Wind velocity of 1 m/s</li> <li>● Total radiation of 800 W/m<sup>2</sup></li> <li>● Solar radiation of 600 W/m<sup>2</sup></li> <li>● Inlet fluid temperature of 38 °C</li> </ul>	52% 58% 58%	9.7% 8.9% 8.1%	–	● Theoretical ● Experimental
	Solanki et al. (2009)	Single glazing	<ul style="list-style-type: none"> <li>● Solar radiation of 600 W/m<sup>2</sup></li> <li>● Inlet fluid temperature of 38 °C</li> </ul>	42%	8.4%	51%	● Theoretical ● Experimental
	Aste et al. (2017)	Single glazing No glazing	–	29% 22%	6% 14%	–	● Theoretical ● Theoretical
	Ibrahim et al. (2009b)	Single glazing	<ul style="list-style-type: none"> <li>● Solar radiation of 800 W/m<sup>2</sup></li> <li>● Wind velocity of 1 m/s</li> <li>● Ambient temperature of 26 °C</li> <li>● Solar radiation between 500 and 900 W/m<sup>2</sup></li> <li>● Wind velocity of 0.75 m/s</li> <li>● Ambient temperature between 34.2 and 38.5 °C</li> <li>● Solar radiation of 800 W/m<sup>2</sup></li> <li>● Ambient temperature of 17 °C</li> </ul>	50.12%	11.98%	68%	● Theoretical
	Xu et al. (2011)	Single glazing	<ul style="list-style-type: none"> <li>● Solar radiation between 500 and 900 W/m<sup>2</sup></li> <li>● Wind velocity of 0.75 m/s</li> <li>● Ambient temperature between 34.2 and 38.5 °C</li> <li>● Solar radiation of 800 W/m<sup>2</sup></li> <li>● Ambient temperature of 17 °C</li> </ul>	–	17.5%	–	● Experimental
	Bambrook and Sproul (2012)	No glazing	<ul style="list-style-type: none"> <li>● Solar radiation of 800 W/m<sup>2</sup></li> <li>● Ambient temperature of 17 °C</li> </ul>	28%-55%	10.6%-12.2%	–	● Experimental
	Kim et al. (2014)	No glazing	–	30%	17%	47%	● Experimental
	Slimani et al. (2016)	No glazing Single glazing Double glazing	<ul style="list-style-type: none"> <li>● Solar radiation between 190 and 700 W/m<sup>2</sup></li> <li>● Inlet air temperature between 305 and 318 °C</li> <li>● Wind velocity between 0 and 8 m/s</li> <li>● Sky temperature between 10 and 22 °C</li> <li>● Beam radiation up to 810 W/m<sup>2</sup></li> <li>● Total radiation between 400 and 580 W/m<sup>2</sup></li> <li>● Ambient temperature between 28 and 32 °C</li> <li>● Ambient temperature between 32 and 38 °C</li> <li>● Total radiation between 390 and 560 W/m<sup>2</sup></li> <li>● Inlet water temperature of 26 °C</li> <li>● Solar irradiance of 600, 800 and 1000 W/m<sup>2</sup></li> <li>● Wind velocity of 1 m/s</li> <li>● Ambient temperature of 30 °C</li> </ul>	21.19% 40.77% 44.41%	10.73% 10.33% 10.56%	51.02% 69.47% 74%	● Theoretical ● Experimental ● Theoretical ● Experimental
	Fan et al. (2018)	Single glazing	<ul style="list-style-type: none"> <li>● Wind velocity between 0 and 8 m/s</li> <li>● Sky temperature between 10 and 22 °C</li> <li>● Beam radiation up to 810 W/m<sup>2</sup></li> <li>● Total radiation between 400 and 580 W/m<sup>2</sup></li> <li>● Ambient temperature between 28 and 32 °C</li> <li>● Ambient temperature between 32 and 38 °C</li> <li>● Total radiation between 390 and 560 W/m<sup>2</sup></li> <li>● Inlet water temperature of 26 °C</li> <li>● Solar irradiance of 600, 800 and 1000 W/m<sup>2</sup></li> <li>● Wind velocity of 1 m/s</li> <li>● Ambient temperature of 30 °C</li> </ul>	48.8%-56.9%	–	–	● Theoretical ● Experimental
	Kazemian et al. (2018)	Single glazing No glazing	<ul style="list-style-type: none"> <li>● Total radiation between 400 and 580 W/m<sup>2</sup></li> <li>● Ambient temperature between 28 and 32 °C</li> <li>● Ambient temperature between 32 and 38 °C</li> <li>● Total radiation between 390 and 560 W/m<sup>2</sup></li> <li>● Inlet water temperature of 26 °C</li> <li>● Solar irradiance of 600, 800 and 1000 W/m<sup>2</sup></li> <li>● Wind velocity of 1 m/s</li> <li>● Ambient temperature of 30 °C</li> </ul>	70.89% 63.37%	13.15% 14.35%	84% 76%	● Theoretical ● Experimental
	Maatallah et al. (2019)	No glazing	<ul style="list-style-type: none"> <li>● Ambient temperature between 32 and 38 °C</li> <li>● Total radiation between 390 and 560 W/m<sup>2</sup></li> <li>● Inlet water temperature of 26 °C</li> <li>● Solar irradiance of 600, 800 and 1000 W/m<sup>2</sup></li> <li>● Wind velocity of 1 m/s</li> <li>● Ambient temperature of 30 °C</li> </ul>	26.87%	13.72%	40.59%	● Experimental
	Misha et al. (2019)	No glazing	<ul style="list-style-type: none"> <li>● Inlet water temperature of 26 °C</li> <li>● Solar irradiance of 600, 800 and 1000 W/m<sup>2</sup></li> <li>● Wind velocity of 1 m/s</li> <li>● Ambient temperature of 30 °C</li> </ul>	59.6%	11.71%	–	● Theoretical ● Experimental

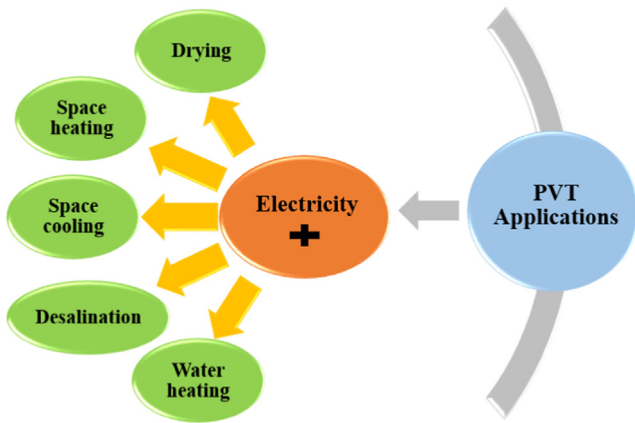

Fig. 11. Main applications used in PVT hybrid system.

evaluate the outlet temperature of water and the surface temperature of PV layer for various values of solar irradiation (600, 800 and 1000 W/m<sup>2</sup>), different mass flow rate (2, 4 and 5 L/min) and 26 °C water inlet temperature. The simulation results were validated by experimental tests. It was revealed that the maximum electrical efficiency achieved by PVT system is 11.71% at 6 L/min mass flow rate. Also, it was concluded that the thermal efficiency augments with the increase in the solar irradiation, mass flow rate and alleviation in the variance between water outlet and inlet temperature.

Senthilraja et al. (2019) assessed and compared the performance of air and water based PVT collector for hydrogen production application. Experimental testing was performed in which a PVM was considered as a reference in comparing the two systems. It was obtained that at noon and for 0.011 kg/s mass flow rate, the electrical and thermal efficiencies are 8% and 31.1% for air based PVT collector and 8.5% and 33.8% for water based PVT collector respectively.

Table 3 presents the theoretical and experimental studies on water or/and air PVT systems.

Analysis of Table 3 yields to the following concluding points:

- Water is utilized more than air in PVT systems
- Water based system is more restricted by the operating conditions than air based system due to the freezing of water at low operating temperatures.
- Higher electrical, thermal and total efficiencies are obtained in water based PVT system.

### 3.4. Glazing

Glazing is a vital component of PVT collector in which it protects the panels from various environmental impacts. On the other hand, glazing may prohibit absorption of part of solar radiations by the PV cells depending on its transmissivity. If the cooling fluid is at the top side of the PV layer, a glazing may be utilized which acts as a channel for the fluid. Glazing is essential for maximizing the produced thermal energy, but it is not favorable in case high amount of electrical energy is aimed to be generated.

Kazemian et al. (2018) proffered a comparison in the performance of unglazed and glazed water based PVT system. The obtained results declared that the thermal efficiency of glazed and unglazed system is 70.89% and 63.37% respectively while the electrical efficiency is 13.15% for glazed system and 14.35% for unglazed system. It was concluded that if the aim is to obtain higher overall efficiency, the glazed system is preferred, but if the aim is to produce more electrical energy the unglazed system is more suitable to be used.

Also, Guarracino et al. (2019) performed experimental study to compare the impact of glazing on the PVT collector performance. It was proved that in the glazed system, electrical efficiency is relatively 20% lower than that of the unglazed system. Also, it was shown that adding the glass cover yields to augment the thermal efficiency.

Besides, Zondag et al. (2003) assessed the performance of several flat plate PVT collectors. The results showed that the thermal efficiency is 52% for unglazed collector while 58% for single and double glazed collector, while the electrical efficiencies are 9.7%, 8.9% and 8.1% for unglazed, single and double glazed collector respectively.

Chaysaz et al. (2019) evaluated the performance of small-scale greenhouse PVT system with three different covers: glass, plastic and polycarbonate. It was detected that the highest overall system efficiency was achieved when utilizing glass cover and the lowest one was attained when using polycarbonate cover. This is because the glass, plastic and polycarbonate glazing have transmissivity of 90, 85 and 75% respectively.

Chow et al. (2009) conducted a study to specify if glass cover is appropriate to be used in thermosiphon water heating PVT system. The study was performed by relying on experimental results and legitimized numerical models. It was concluded that the glazing can be utilized if the aim is to maximize the thermal energy or the global energy produced.

Yazdanifard et al. (2016) studied the effect of collector length, pipes diameter and number, Reynolds number, solar irradiation and packing factor on the performance of glazed and unglazed flat plate water PVT collector in turbulent and laminar flow. The results showed that the energy efficiency is higher in collector with glazing while the exergy efficiency depends on the collector length, packing factor and Reynolds

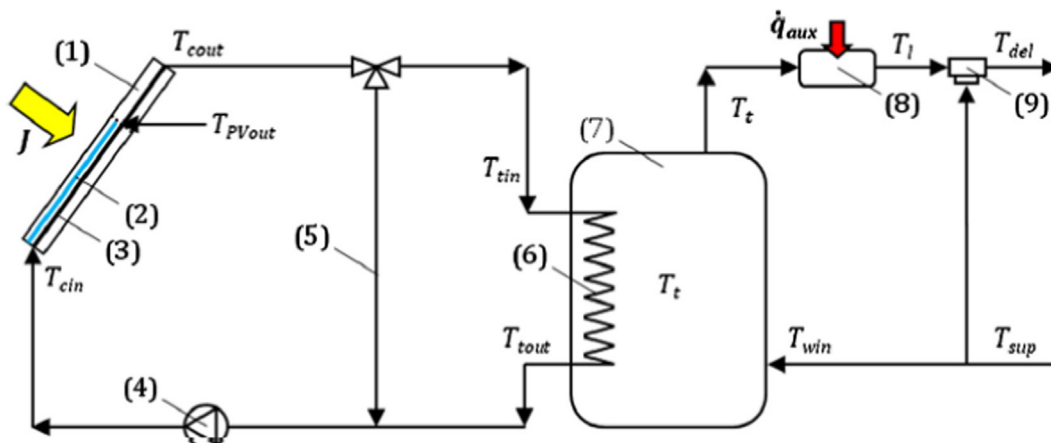

Fig. 12. PVT domestic hot water system (Herrando et al., 2014).



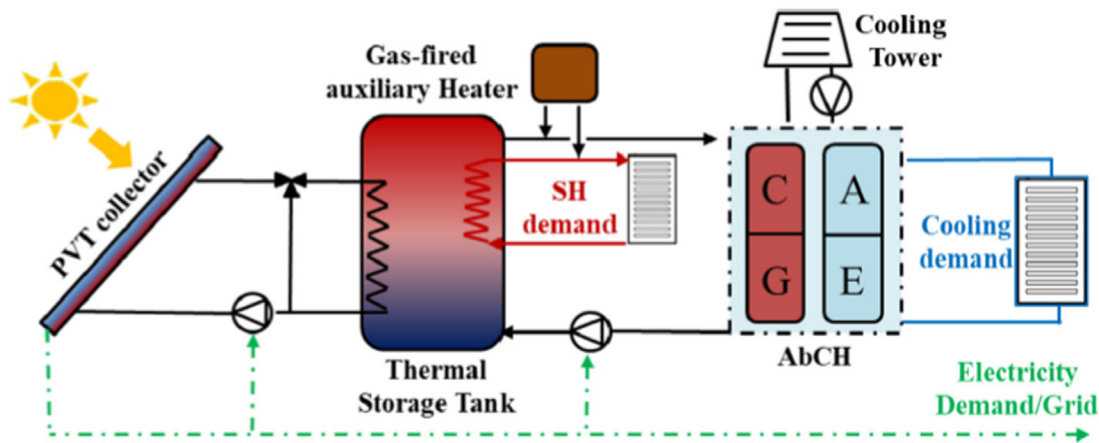

Fig. 13. Space cooling/heating PVT system (Herrando et al., 2019a).

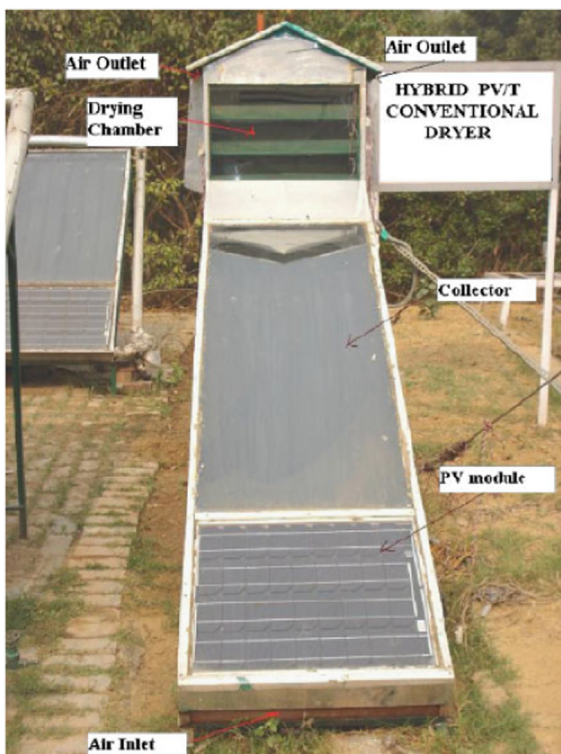

Fig. 14. Mixed solar dryer with PV module designed by (Tiwari et al., 2009).

number.

Aste et al. (2017) evaluated the effect of glazing on the performance of flat plate PVT collector by testing and comparing collectors with and without cover. It was shown that the electrical efficiency is 6% for covered collector and 14% with uncovered collector, while the thermal efficiency was 29% and 22% for covered and uncovered collector respectively.

Table 4 summarizes the theoretical and experimental works that were conducted during the last several years on solar PVT systems using single or double glazing or with no glazing.

Analysis of Table 4 yields to the following concluding points:

- The usage of glazing leads to increase the thermal efficiency and slightly decrease the electrical efficiency.
- Higher total efficiency of PVT system is obtained when utilizing glazing.
- Unglazed PVT system is more favorable if high electrical output is

required.

- Glazing is more preferred to be used in PVT systems in case high thermal or overall system efficiency is required.
- Single glazing is more preferable than double glazing.

### 3.5. Thermal absorber

PVT system is generally constructed by attaching PV cells to the thermal absorber of a solar collector. Hence, thermal absorbers are the complement of solar cells in PVT system in which they absorb SE to exploit it. The thermal absorber has a vital impact on the thermal and electrical efficiency of PVT system. Thermal absorber is mainly located between the PVM and the fluid, so it has an important role in transferring the heat from PV layer to the fluid. The model of the thermal absorber depends on the type of solar collector used in PVT system. The main materials utilized in thermal absorbers are aluminum and copper.

Wu et al. (2016) proffered a review including the thermal absorbers of solar PVT system and their ways of integration with PVMs. The review describes the main types of PVT technology regarding their structure, efficiencies and applications. Also, the review comprises the types of thermal absorbers, their methods of integration, their advantages and disadvantages as well as the applications for several PVT modules.

Herrando et al. (2019b) investigated the potential of progressing hybrid PVT collectors with optimum performance, cost, weight and manufacturing simplicity. The authors proposed 26 alternative absorber-exchanger designs which are made up of various materials and assessed their thermal and electrical performance.

Singh et al. (2019) conducted a mathematical modeling to investigate the impact of mass flow rate and absorber shape factor in order to optimize the flat plate PVT system efficiency. It was concluded that for low and high mass flow rates, the curve grooves in the absorber plate are suitable to be used.

Ibrahim et al. (2009b) designed, investigated and compared seven novel design configurations of thermal absorber to study the influence of thermal absorber structure on the electrical and thermal performance of PVT system. It was revealed that the spiral flow configuration was the best choice for flat plate collector thermal absorber, where it achieved 50.12% thermal efficiency and 11.98% electrical efficiency.

Charalambous et al. (2011) conducted a new mathematical investigation to precise the best design of absorber plate which has least cost but higher efficiency. A steady state model was established to assess the optimum layouts performance. The results of the model were also validated by experimental test. It was obtained that the optimum configurations have comparable thermal and electrical efficiencies with the non-optimum designs which have greater mass and cost.

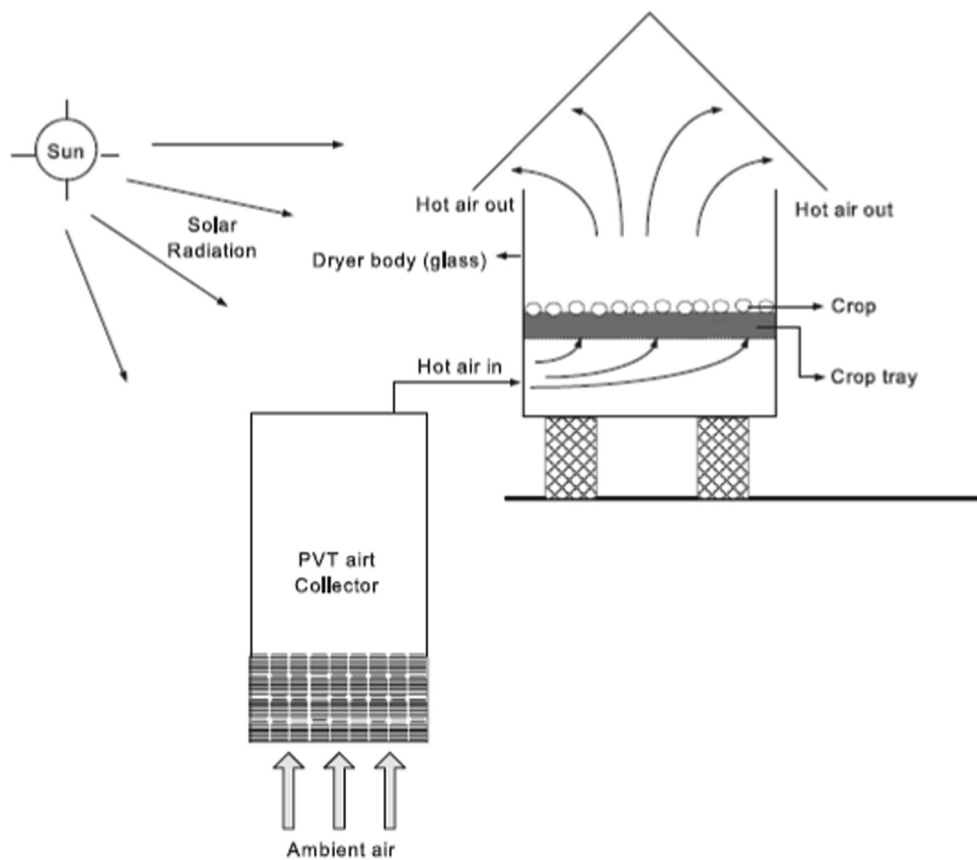

Fig. 15. Schematic of greenhouse dryer with air PVT collector designed by (Tiwari et al., 2018).

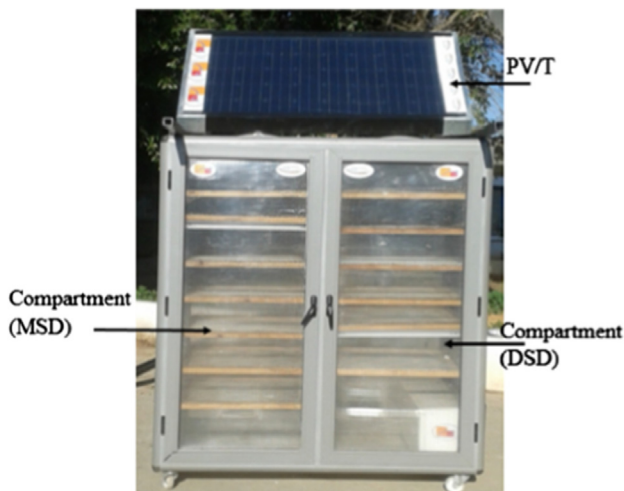

Fig. 16. Mixed solar dryer with PV module designed by (Fterich et al., 2018).

#### 4. Applications

Mainly, PVT is used for the aim of producing electricity and heat. Heat energy can be exploited in various applications such as heating water (Li and Sun, 2018a, 2018b; Taboada et al., 2017; Zhang et al., 2014, 2013), space heating and cooling (Buonomano et al., 2018, 2017; Cremers et al., 2015; He et al., 2014; Herrando et al., 2018; Kazanci et al., 2014; Moaleman et al., 2018; Xu and Kleinstreuer, 2014), drying (Tiwari and Tiwari, 2017a, 2017b, 2016a, 2016b) and desalination (Ammous and Chaabene, 2015; Bilton, 2018; Calise et al., 2019; Kelley and Dubowsky, 2013; Lee et al., 2012; Li et al., 2019; Manokar et al., 2017; Modi and Shukla, 2018). Fig. 11 illustrates the main applications

used in PVT hybrid system.

SWH is an application of solar energy which exploits thermal energy from solar radiation to heat water for domestic and industrial aims. Generally, SWH system is made up of three major components: STC, storage tank and heat transfer fluid. SWH systems are commonly classified into active and passive systems. Xu et al. (2011) established a new heat pump technology integrated with a parabolic concentrator PVT collector and carried out several experiments on it in Nanjing, China. It was detected that the novel system attained 4.8 mean Coefficient of Performance while water was heated from 30 °C to 70 °C during a sunny summer day with 17.5% electrical efficiency. Fu et al. (2019) conducted a comparative study of the performance of PVT-SWH systems with the direct-coupled photovoltaic pump, the conventional pump, and natural circulation by analyzing their performances through experimental tests. The results showed that the best thermal performance between the three systems is achieved by the PVT system with the photovoltaic pump. The natural circulation system attained net energy close to that attained by the photovoltaic pump, while the conventional pump system produced energy much less than the two systems. In addition, it was shown that the highest energy and exergy efficiencies are 69.63% and 12.84% respectively, obtained by the natural circulation system. Martin-Escudero et al. (2019) established a study to investigate the performance of a novel system that comprises heat pump coupled with a photovoltaic ventilated facade. The system is utilized for supplying heating and hot water. The authors established a mathematical model to evaluate the system outputs. They concluded that the PV panel provides about 70% of the electricity exploited by the heat pump and fans of the PV ventilated facade. Kim et al. (2014) implemented a study which analyzes the experimental performance of building PVT heating system. It was concluded, from the experimental results, that the average thermal and electrical efficiencies are 30% and 17% respectively. Herrando et al. (2014) established a model (Fig. 12) to evaluate

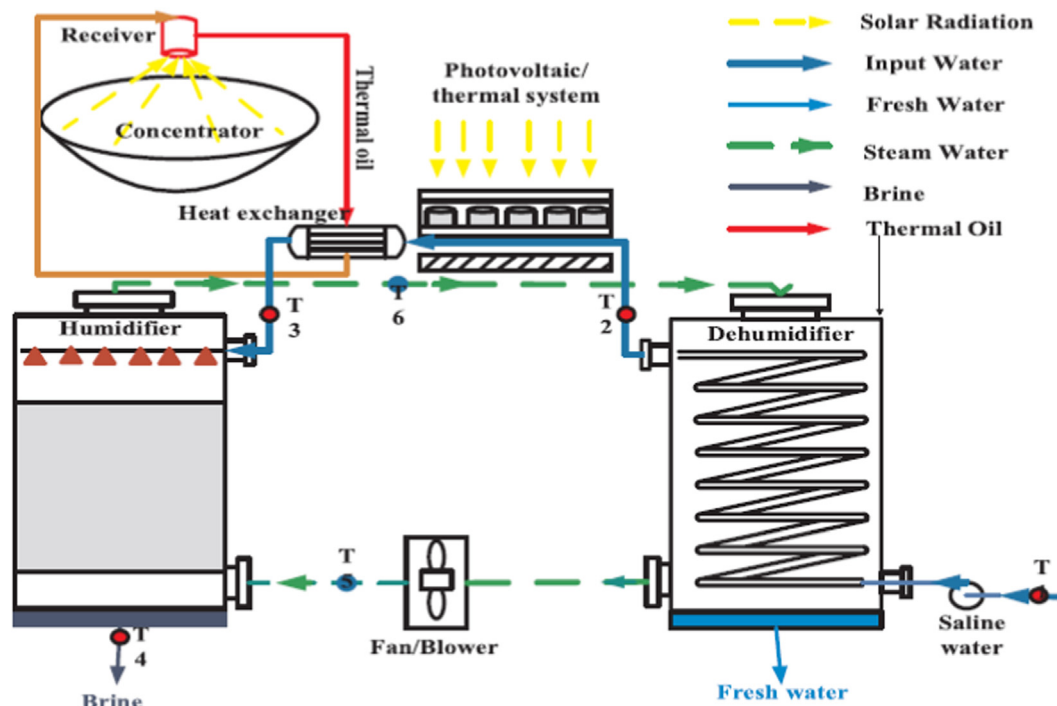

Fig. 17. Hybrid PVT desalination system (Rafiei et al., 2019).

the sustainability and performance of a PVT water heating system in a terraced house in London. The model is simulated by varying several design parameters of the studied collector, mainly the covering factor and the flow rate of the PVT collector, which enables to demonstrate the system overall performance. It was observed that for 20 L/h flow rate and completely covered collector, the hybrid PVT system can cover 36% and 51% of the annual global hot water and electricity demands respectively. Also, the hybrid PVT system serves in mitigating the CO<sub>2</sub> emission over 20 years lifetime by 16 tons which is 36% greater than the value saved by a PV system.

Space cooling/heating refers to the reduction/increase of the temperature of a room or workspace by removing/supplying heat from/to it. Solar cooling/heating system mainly includes a solar collector, heat rejection loop and thermal energy storage. Jani et al. (2018) presented a review on a solar solid desiccant vapor compression hybrid cooling system. The author described the principle of the solar solid desiccant hybrid cooling system and the recent progress in air-conditioning and built environment using hybrid cooling. Alobaid et al. (2017) presented a review on solar PVT absorption cooling systems to evaluate the latest progress in the solar collectors types used in solar absorption cooling systems. The review comprises experimental and computational previous works that studied the types of solar collectors, their efficiencies and performance. It was concluded from the comparison between vapor compression air conditioning and solar absorption cooling system that the usage of the latter saves 50% of the primary energy where the maximum electrical efficiency achieved by PVT is 35%. Noro and Lazzarin (2014) considered several distinct cooling systems and conducted analysis to determine the most favorable system. The authors performed dynamic simulation for two different climates during summer to assess the systems from energetic and economic point of view. Herrando et al. (2019a) developed a modeling methodology on hybrid PVT solar system for space heating and cooling and electricity generation (Fig. 13). The aim of this methodology is to assess the techno-economic performance of the system. It was observed that 16.3%, 20.9% and 55.1%, of the electricity, space heating and space cooling requirements, respectively, of the University Campus of Bari, can be provided by 1.68 MW system. The system payback period is

16.7 years which is 2.7 times greater than that of traditional PV system, and it can reduce 911 tons of CO<sub>2</sub> emission per year.

Wang et al. (2019) suggested and investigated the performance of a new PVT-CPC system for cooling, heating and power generation. The authors conducted thermodynamic models, compared and validated them from results of existing studies and then studied the impact of several factors on the system performance. The results showed that at design conditions, the energy and exergy efficiencies are respectively 61.8% and 27.1% in winter and 63.3% and 21.8% in summer. Also, Chen et al. (2019) studied a novel hybrid system for cooling, heating and power production using PVT-CPC collector to optimize and minimize its thermo-ecological cost. To achieve this aim, the authors proposed a methodology to optimize the configurations and installations of internal combustion engine and compound parabolic concentrator PVT collector.

Drying is the process of conveying heat energy from heat source to a material and transmitting moisture from its surface to the environment. Typically, solar dryer mainly consists of air heater, drying chamber, and airflow system. Active or passive, direct, indirect or mixed solar dryers are the main categories of the solar dryers. Also, there are three main types of drying chambers: tent, cabinet, and greenhouse. Tiwari et al. (2009) proposed a design of mixed type PVT solar dryer as shown in Fig. 14. The dryer mainly consists of FPC, drying chamber, PV cells, and DC fan. The authors assessed the performance of the designed solar dryer by analyzing the thermal energy, exergy, and electrical energy gain of the system. The analysis was conducted under no load conditions for four distinct weather conditions and five different cities (Jodhpur, Bangalore, New Delhi, Srinagar, and Mumbai). The results showed that the best place to install PVT mixed solar dryer is Jodhpur.

In addition, Tiwari et al. (2018b) conducted a thermal modeling on PVT greenhouse solar drying system which is composed of PVT air collector and greenhouse solar dryer (Fig. 15). It was found that at 0.01 kg/s mass flow rate of air the electrical, thermal and overall efficiency are 11.26%, 26.68% and 56.3% respectively.

Fterich et al. (2018) developed an active mixed PVT solar dryer which is shown in Fig. 16. Experimental testing was performed to examine the system performance. The results revealed that the

**Table 5**  
Theoretical and experimental works on PVT systems' applications.

St. Nb	Reference(Author/s, Year)	Application	Operating conditions	Efficiency			Type of study
				Thermal	Electrical	Total	
	Hung et al. (2001)	Water heating	<ul style="list-style-type: none"> <li>Total radiation between 200 and 900 W/m<sup>2</sup></li> <li>Ambient temperature between 25 and 35 °C</li> </ul>	44.5%	9.1%	53.5%	● Experimental
	Zondag et al. (2003)	Water heating	<ul style="list-style-type: none"> <li>Ambient temperature of 20 °C</li> <li>Sky temperature of 4 °C</li> <li>Incident angle 45°</li> <li>Wind velocity of 1 m/s</li> <li>Total radiation of 800 W/m<sup>2</sup></li> </ul>	52%-58%	8.1%-9.7%	–	● Theoretical ● Experimental
	Mittelman et al. (2007)	Space cooling	–	59%	20%	–	● Theoretical
	Barnwal and Tiwari (2008)	Drying	<ul style="list-style-type: none"> <li>Ambient temperature between 31 and 40 °C</li> <li>Total solar intensity 148 and 398 W/m<sup>2</sup></li> </ul>	28.4%	10.8%	–	● Theoretical ● Experimental
	Kumar and Tiwari (2008)	Desalination	<ul style="list-style-type: none"> <li>Wind velocity between 1 and 10.2 m/s</li> <li>Ambient temperature between 19.6 and 28.2 °C</li> </ul>	15%-20%	–	–	● Theoretical ● Experimental
	Solanki et al. (2009)	Space heating	<ul style="list-style-type: none"> <li>Solar radiation of 600 W/m<sup>2</sup></li> <li>Inlet fluid temperature of 38 °C</li> </ul>	42.0%	8.4%	51%	● Theoretical ● Experimental
	Ibrahim et al. (2009b)	Water heating	<ul style="list-style-type: none"> <li>Solar radiation of 800 W/m<sup>2</sup></li> <li>Wind velocity of 1 m/s</li> <li>Ambient temperature of 26 °C</li> </ul>	50.12%	11.98%	68%	● Theoretical
	Adelaja et al. (2009)	Drying	<ul style="list-style-type: none"> <li>Ambient temperature of 28.3 °C</li> </ul>	83.2%	–	–	● Experimental
	Xu et al. (2011)	Water heating	<ul style="list-style-type: none"> <li>Solar radiation between 500 and 900 W/m<sup>2</sup></li> <li>Wind velocity of 0.75 m/s</li> <li>Ambient temperature between 34.2 and 38.5 °C</li> </ul>	–	17.5%	–	● Experimental
	Dupeyrat et al. (2011)	Water heating	<ul style="list-style-type: none"> <li>Total radiation of 960 W/m<sup>2</sup></li> <li>Ambient temperature between 30 and 33 °C</li> <li>Wind velocity of 3 m/s</li> </ul>	79%	8.8%	–	● Theoretical ● Experimental
	Eicker and Dalibard (2011)	Space cooling	<ul style="list-style-type: none"> <li>Total irradiance up to 400 W/m<sup>2</sup></li> <li>Ambient temperature between 5 and 15 °C</li> <li>Ambient temperature between – 15 and – 3°C</li> </ul>	–	13%	–	● Theoretical ● Experimental
	Bambrook and Sproul (2012)	Space heating	<ul style="list-style-type: none"> <li>Solar radiation of 800 W/m<sup>2</sup></li> <li>Ambient temperature of 17 °C</li> </ul>	28.0%-55.0%	10.6%-12.2%	–	● Experimental
	Aktas et al. (2012)	Drying	–	49.33%	–	–	● Experimental
	Bennamoun (2013)	Drying	<ul style="list-style-type: none"> <li>Solar radiation between 600 and 1000 W/m<sup>2</sup></li> </ul>	58%	–	70%	● Theoretical
	Kim et al. (2014)	<ul style="list-style-type: none"> <li>Water heating</li> <li>Space heating</li> </ul>	–	30%	17%	47%	● Experimental
	Kiran and Devadiga (2014)	Water heating	<ul style="list-style-type: none"> <li>Inlet water temperature between 28.6 and 32.9 °C</li> <li>Total radiation between 473.1 and 951.6 W/m<sup>2</sup></li> <li>Ambient temperature of 25 °C</li> <li>Sky temperature of 19 °C</li> </ul>	50.81%	8.16%	58.9%	● Experimental
	Calise et al. (2014)	Desalination	–	50%	20%	–	● Theoretical
	Saeedi et al. (2015)	Desalination	<ul style="list-style-type: none"> <li>Total radiation between 80 and 890 W/m<sup>2</sup></li> <li>Ambient temperature between 27 and 47 °C</li> <li>Wind velocity of 1 m/s</li> </ul>	17%	–	–	● Theoretical ● Experimental
	Singh et al. (2016)	Desalination	<ul style="list-style-type: none"> <li>Wind velocity between 0 and 1 m/s</li> <li>Solar radiation up to 500 W/m<sup>2</sup></li> <li>Ambient temperature between 9 and 24.5 °C</li> </ul>	69.06%	–	–	● Theoretical ● Experimental
	Alobaid et al. (2017)	Space cooling	–	–	10–35%	–	● Theoretical
	Ong et al. (2017)	Water heating	<ul style="list-style-type: none"> <li>Ambient temperature between 29 and 39 °C</li> <li>Solar radiation between 20 and 880 W/m<sup>2</sup></li> <li>Inlet water temperature between 30 and 35 °C</li> </ul>	–	0.16%	–	● Experimental
	Singh (2017)	Desalination	<ul style="list-style-type: none"> <li>Ambient temperature between 20 and 35 °C</li> <li>Wind velocity between 1.83 and 4.11 m/s</li> </ul>	–	12%	28%	● Theoretical
	Fan et al. (2018)	Space heating	<ul style="list-style-type: none"> <li>Wind velocity between 0 and 8 m/s</li> <li>Sky temperature between 10 and 22 °C</li> <li>Beam radiation up to 810 W/m<sup>2</sup></li> </ul>	48.8%-56.9%	–	–	● Theoretical ● Experimental
	Naroei et al. (2018)	Desalination	<ul style="list-style-type: none"> <li>Ambient temperature between 20 and 30 °C</li> <li>Wind velocity between 0.5 and 3.7 m/s</li> <li>Solar radiation between 150 and 800 W/m<sup>2</sup></li> </ul>	19%	9.5%	33%	● Theoretical ● Experimental
	Eltawil et al. (2018)	Drying	<ul style="list-style-type: none"> <li>Ambient temperature between 29 and 39 °C</li> <li>Wind velocity between 0.1 and 1.3 m/s</li> </ul>	41.2%-52.2%	–	14.05%-19.07%	● Theoretical ● Experimental
	Tiwari et al. (2018b)	Drying	<ul style="list-style-type: none"> <li>Ambient temperature between 35 and 43 °C</li> <li>Total radiation between 100 and 900 W/m<sup>2</sup></li> <li>Incident angle of 30°</li> </ul>	11.26%	26.68%	56.3%	● Theoretical
	Maatallah et al. (2019)	Water heating	<ul style="list-style-type: none"> <li>Ambient temperature between 32 and 38 °C</li> <li>Total radiation between 390 and 560 W/m<sup>2</sup></li> </ul>	26.87%	13.72%	40.59%	● Experimental

(continued on next page)



Table 5 (continued)

St. Nb	Reference(Author/s, Year)	Application	Operating conditions	Efficiency			Type of study
				Thermal	Electrical	Total	
	Misha et al. (2019)	Water heating	<ul style="list-style-type: none"> <li>● Inlet water temperature of 26 °C</li> <li>● Solar irradiance of 600, 800 and 1000 W/m<sup>2</sup></li> <li>● Wind velocity of 1 m/s</li> <li>● Ambient temperature of 30 °C</li> </ul>	59.6%	11.71%	–	<ul style="list-style-type: none"> <li>● Theoretical</li> <li>● Experimental</li> </ul>
	Fu et al. (2019)	Water heating	<ul style="list-style-type: none"> <li>● Ambient temperature between 25 and 35 °C</li> <li>● Solar radiation between 100 and 900 W/m<sup>2</sup></li> </ul>	45.46%–60.11%	–	–	● Experimental
	Haiping et al. (2019)	Desalination	<ul style="list-style-type: none"> <li>● Wind velocity of 1.8 m/s</li> <li>● Ambient temperature between 31.72 and 40.12 °C</li> </ul>	–	13.28%	–	● Experimental

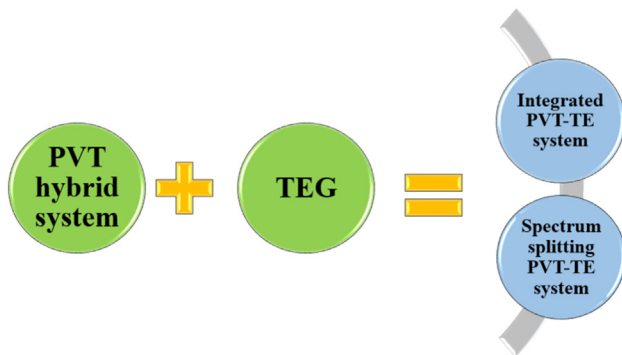

Fig. 18. Types of PVT-TE system.

combination of PVT air collector enhanced the drying rate of the solar dryer.

Tiwari et al. (2016) suggested PVT greenhouse solar dryer and assessed several parameters for the climatic condition of the Indian Institute of Technology. A thermal model is developed on the studied system based on several parameters such as crop, greenhouse, and solar cell temperatures. It was revealed that the experimental and theoretical global thermal energies are 2.03 kWh and 1.92 kWh respectively.

Solar desalination is a technology which utilizes SE to desalinate water by providing heat from sunlight for evaporative desalination process. Rafiei et al. (2019) investigated and analyzed the effect of the shape of the receiver on the performance of solar PVT desalination system. The system consists of parabolic dish collector, PV panel and humidification-dehumidification desalination unit as shown in Fig. 17. The three examined shapes of the receiver are cylindrical, cubical and hemispherical. It was obtained that the hemispherical cavity receiver produces the highest amount of freshwater and the lowest gain output ratio.

Also, Elsafi (2017) conducted mathematical model to demonstrate the performance of air-heated humidification-dehumidification

desalination system combined with concentrated PVT collector. The cost of the system components was estimated by performing exergy-costing method. The results revealed that for a certain location having annual solar irradiance of 1.88 MWh/year, the system is capable to generate 960 kWh electricity and produce 12 m<sup>3</sup> of freshwater. Also, it was obtained that the unit cost for generating electricity is 0.289 \$/kWh and for producing fresh water is 0.01 \$/L. Mittelman et al. (2009) suggested a system which combines multi-effect evaporative desalination plant with concentrating PVT collector. The system generates electricity and simultaneously absorbs waste heat from PVM for desalination process. The authors conducted an elaborated simulation to calculate the electricity and water produced per year. Taking into consideration various economic cases, the water cost was computed and compared to that of traditional solar desalination plants. It was observed that the suggested system is more beneficial and in some scenarios it is more cost-effective compared to traditional system. Palomino-resendiz et al. (2018) proposed, constructed and tested a solar desalination system amalgamated with Fresnel lens PVT collector. It was concluded that the use of sun tracking system increases the concentrator efficiency leading to the rise in the thermal energy used and thus accelerating the desalination process even in the presence of environmental disturbances. Sotehi et al. (2016) implemented a prototype of solar energy system which covers the annual air conditioning and heating, domestic hot water and lightening in addition to driving several home appliances and solar still. The authors established a numerical simulation on TRNSYS software to simulate the performance of solar still. It was concluded that solar PVT system can cover the required thermal and electrical energy needed.

Table 5 elucidates the theoretical and experimental researches that were established on solar PVT systems' applications.

Analysis of Table 5 yields to the following concluding points:

- PVT systems are mostly utilized for heating water in comparison to the other applications.
- PVT systems are suitable for applications that require thermal

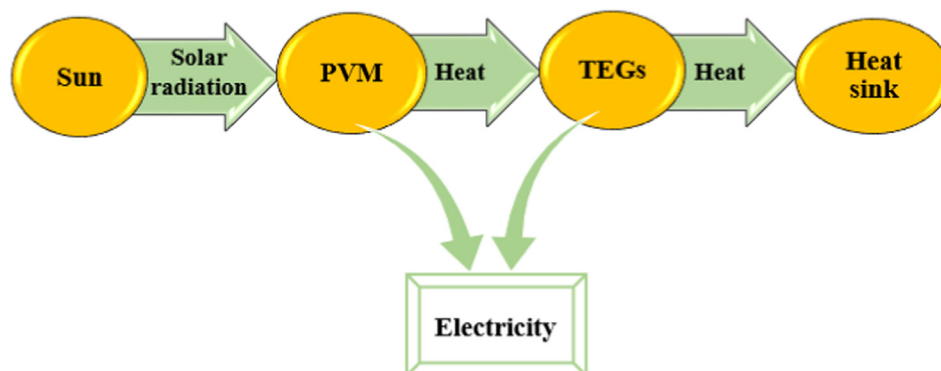

Fig. 19. Integrated PVT-TE system.

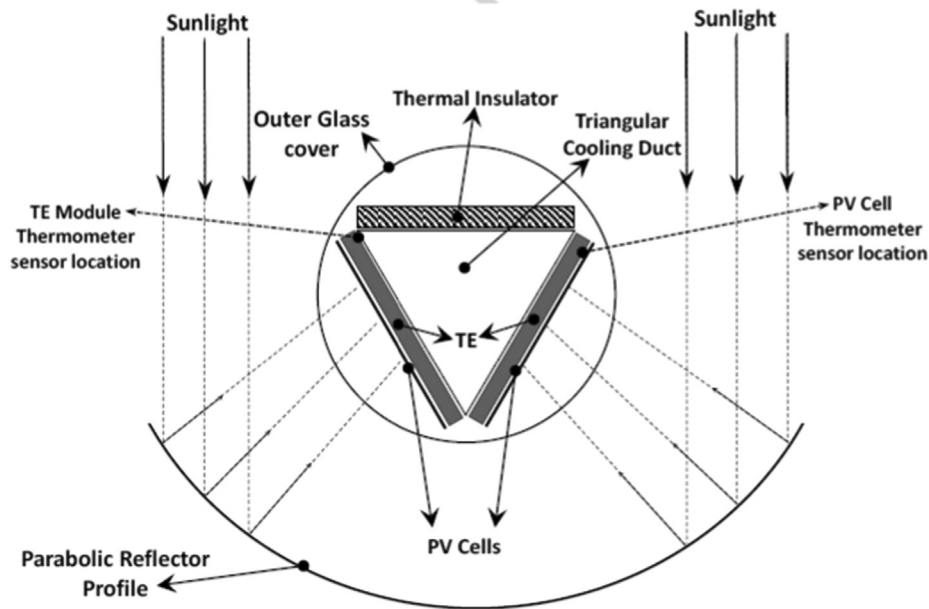

Fig. 20. Parabolic trough PVT-TE suggested by (Mohsenzadeh et al., 2017).

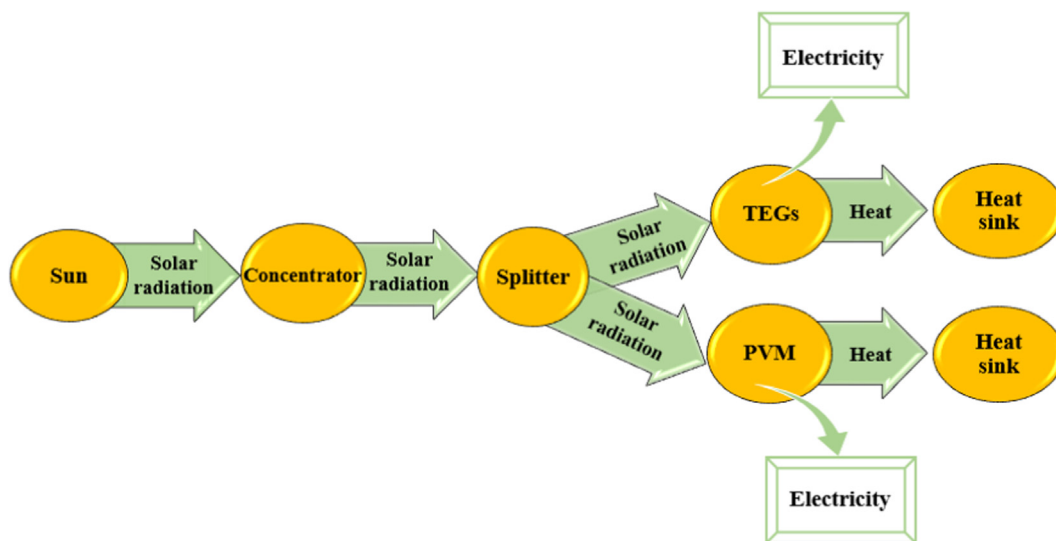

Fig. 21. Spectrum splitting PVT-TE system.

energy more than electrical energy.

- The outputs and performances of the PVT systems in all applications are better than that of thermal systems and PV systems working alone.
- In most applications, PVT systems are capable to cover the thermal and electrical energy required.

### 5. PVT system using thermoelectric generators

The integration of ThermoElectric Generators (TEGs) into solar PVT system has been recently adopted for the sake of optimizing the use of SE. The role of TEG is to transform thermal energy into electrical energy by Seebeck effect. The principle of this effect states that the existence of temperature difference on the junction of two different metals leads to production of an induced voltage. TEG can utilize the excess heat produced by PV cell and generate electricity. Thus, the electric conversion efficiency of the system can increase. Such technology is more preferred to be used in concentrated systems since it generates higher

electricity at higher operating temperatures.

The main advantages of TEGs is that they operate with no moving parts and they have small sizes. Also, TEG integration rises the energy produced per area since TEG does not require additional place. In addition, the amount of generated power is extremely higher than that produced by standalone PV system, solar TEG system or PVT system.

The two main technologies that are adopted to amalgamate TEG with PVT system are: integrated PVT-TE system and spectrum splitting PVT-TE system (Fig. 18).

Integrated PVT-TE system mainly consists of solar thermal collector, PVM and TE module. In most systems the TEG is fitted on the back face of the PV cell to exploit heat from it and generate electricity (Fig. 19).

Mohsenzadeh et al. (2017) suggested a new layout for parabolic trough PVT collector and performed an experimental investigation to analyze the global system performance. The receiver of the collector includes a triangular channel covered with PV cell and TEGs as shown in Fig. 20. It was observed that the daily average electrical and thermal efficiencies achieved by the hybrid system are 4.83% and 46.16%

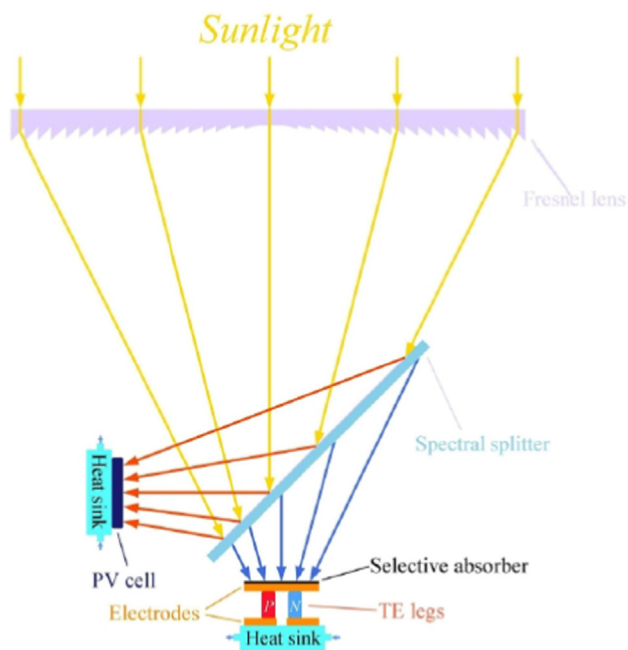

Fig. 22. Concentrated spectrum splitting PVT-TE system studied by (Yin et al., 2018).

respectively.

Yin et al. (2019) suggested a new hybrid cogeneration concentrating PVT thermoelectric system. The authors compared the operating temperature, energy efficiency and exergy efficiency of the proposed system and the existing systems in order to expose the notability of the new system. Also the influence of thermoelectric structure and controlled temperature on the system performance were demonstrated by the study as well.

Kohan et al. (2018) established three dimensional numerical models for PVM and TEG to analyze the performance of PVT system with TEGs located at the PV layer back part. Results showed that the power generated by the hybrid system is higher than that generated by traditional PV and the TEG are not efficient in cooling the PVM.

Shadmehri et al. (2018) developed a detailed three-dimensional computational model and numerical simulations on a novel

concentrating PVT system coupled with TEG. The impact of temperature and cooling on the PVM performance is discussed. Also, the influence of varying the reflector aperture width and the absorber apex angle on distribution of solar energy flux and output power of PVM were investigated.

Nazri et al. (2019) conducted experimental and theoretical study to investigate the performance of PVT-TE air collector. Air outlet temperature and PV temperature are computed using a steady state thermal model. The model was also used to evaluate the influence of mass flow rate on exergy efficiency. In addition, Syakirah et al. (2018) performed a theoretical analysis to investigate the performance of PVT-TE collector by suggesting and solving a mathematical model based on iterative procedure.

Li et al. (2018) presented a review on PVT-TE system including the operation and feasibility of the system. Also, the review comprises the main types, characteristics and performance of PVT-TE systems. Moreover, the methods of optimizing and developing such system are exposed in the review.

Chávez-Urbiola et al. (2012) demonstrated the potential of integrating TEG into hybrid PVT system. The authors examined four systems of different configurations. It was detected that the thermal stability and electrical efficiency were optimized when TEG are combined to the PVT system.

Besides, Arturo et al. (2013) carried out experimental investigation on concentrating PVT system with six series connected thermoelectric generators. It was found that the system produced 200 W thermal energy and 20 W electrical energy.

Jadin et al. (2017) developed a hybrid PVT-TE system to increase the power generation efficiency of the system. It was observed that the maximum power output was 99.27 W which was higher than that generated in case of individual system.

Dimri et al. (2018) investigated the effect of working fluid and type of PVM on the performance of PVT-TE collector. The studied working fluids are water and air, while the considered PVM are opaque aluminum base, and semitransparent. It was noticed that the electrical and thermal efficiencies of opaque water system had higher thermal and electrical efficiencies compared to opaque air system. Also, it was found that the daily gained electrical energy, thermal energy and exergy were the highest for aluminum base PVT-TE water collector. Moreover, Dimri et al. (2017) developed thermal modeling for semitransparent PVT-TE collector by utilizing energy balance. The authors compared the electrical efficiency of the system with that of semitransparent PV and PVT-TE collectors. They concluded that the semitransparent PVT-TE

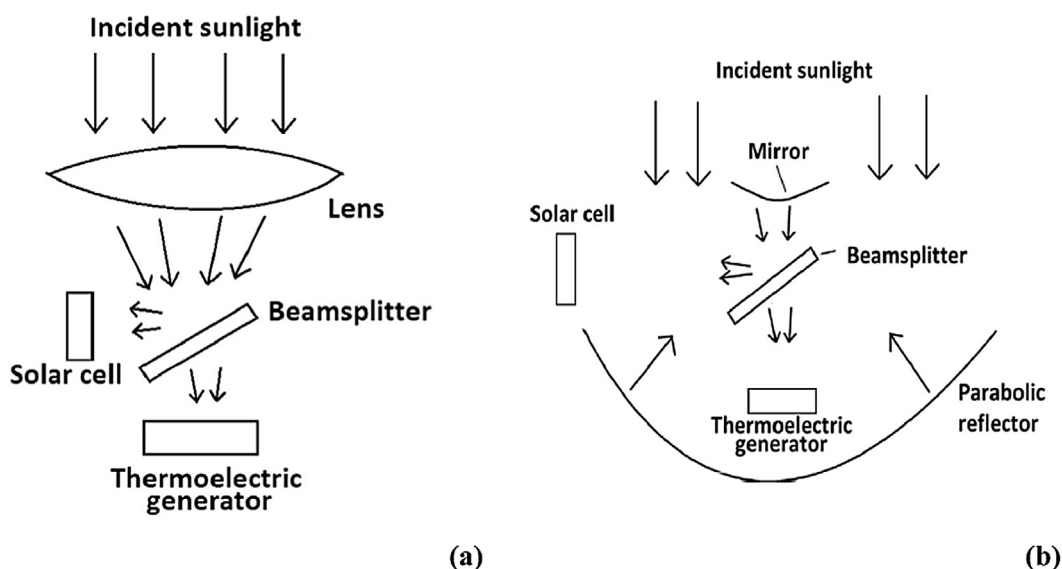

Fig. 23. Spectrum splitting PVT-TE system studied by (Skjølstrup and Søndergaard, 2016).

**Table 6**  
Researches performed on PVT-TE hybrid systems.

St. Nb	Reference(Author/s, Year)	PVT-TE system	Operating conditions	System performance	Type of study
	Sark (2011)	Integrated	<ul style="list-style-type: none"> <li>● Ambient temperature of 25 °C</li> <li>● PVM temperature of 80 °C</li> <li>● Solar radiation of 1000 W/m<sup>2</sup></li> </ul>	<ul style="list-style-type: none"> <li>● Maximum TE efficiency of 5%</li> <li>● PV electrical efficiency of 14.03%</li> </ul>	<ul style="list-style-type: none"> <li>● Theoretical</li> </ul>
	Ju et al. (2012)	Spectrum splitting	<ul style="list-style-type: none"> <li>● Ambient temperature of 25 °C</li> <li>● Maximum TEG temperature of 527 °C</li> <li>● Maximum PVM temperature of 227 °C</li> </ul>	<ul style="list-style-type: none"> <li>● PV-TE hybrid system efficiency ranges between 26.62% and 27.49%</li> <li>● TEG generates 10% of the overall output power of the system</li> </ul>	<ul style="list-style-type: none"> <li>● Theoretical</li> </ul>
	Xu et al. (2015)	Integrated	–	<ul style="list-style-type: none"> <li>● TE electrical efficiency of 2.2%</li> <li>● PVT-TE electrical efficiency of 18%</li> </ul>	<ul style="list-style-type: none"> <li>● Theoretical</li> </ul>
	Attivissimo et al. (2015)	Integrated	<ul style="list-style-type: none"> <li>● PVM temperature between 50 and 60 °C</li> </ul>	<ul style="list-style-type: none"> <li>● Electrical efficiency ranges between 13% and 16%</li> <li>● Total efficiency ranges between 45% and 70%</li> </ul>	<ul style="list-style-type: none"> <li>● Theoretical</li> </ul>
	Cui et al. (2016)	Integrated	<ul style="list-style-type: none"> <li>● Ambient temperature of 27 °C</li> <li>● PV cell temperature between 21 and 35 °C</li> <li>● Water inlet temperature of 20 °C</li> <li>● Total solar irradiance of 1000 W/m<sup>2</sup></li> </ul>	<ul style="list-style-type: none"> <li>● Experimental TE efficiency between 2.1 and 2.58% while the simulated result between 2.1 and 2.8%</li> <li>● Performance of PV-PCM-TE system is better than that of PV system and PV-TE system.</li> </ul>	<ul style="list-style-type: none"> <li>● Theoretical</li> </ul>
	Zhu et al. (2016)	Integrated	<ul style="list-style-type: none"> <li>● Ambient temperature of 27 °C</li> <li>● Solar irradiance of 1000 W/m<sup>2</sup></li> </ul>	<ul style="list-style-type: none"> <li>● Peak PV-TE system efficiency of 23%</li> </ul>	<ul style="list-style-type: none"> <li>● Experimental</li> <li>● Theoretical</li> </ul>
	Cotfas et al. (2016)	Integrated	<ul style="list-style-type: none"> <li>● Solar irradiance between 720 and 1080 W/m<sup>2</sup></li> </ul>	<ul style="list-style-type: none"> <li>● The PV cell efficiency is 18.65% for mono-crystalline silicon and 16.43% for poly-crystalline silicon at solar irradiance of 1000 W/m<sup>2</sup></li> </ul>	<ul style="list-style-type: none"> <li>● Theoretical</li> </ul>
	Kossyvakis et al. (2016)	Integrated	<ul style="list-style-type: none"> <li>● Cold side temperature of TEG of 20 °C</li> <li>● Solar irradiance of 1000 W/m<sup>2</sup></li> </ul>	<ul style="list-style-type: none"> <li>● Power output enhancement using poly-crystalline silicon reaches 22.5%</li> </ul>	<ul style="list-style-type: none"> <li>● Experimental</li> </ul>
	Li et al. (2016)	Integrated	<ul style="list-style-type: none"> <li>● Solar radiation between 100 and 1000 W/m<sup>2</sup></li> <li>● Wind speed between 1 and 8 m/s</li> <li>● Ambient temperature between 15 and 40 °C</li> </ul>	<ul style="list-style-type: none"> <li>● Electrical efficiency is 18% higher than that of PV system</li> <li>● TE efficiency of 2%</li> <li>● Maximum PV-TE system efficiency of 11.3%</li> <li>● Efficiency of hybrid system is higher than that of PV system by 21.4%</li> </ul>	<ul style="list-style-type: none"> <li>● Theoretical</li> </ul>
	Skjølstrup and Søndergaard (2016)	Spectrum splitting	–	<ul style="list-style-type: none"> <li>● Efficiency of hybrid system is higher than that of PV system by 21.4%</li> </ul>	<ul style="list-style-type: none"> <li>● Theoretical</li> </ul>
	Ong et al. (2017)	Integrated	<ul style="list-style-type: none"> <li>● Ambient temperature between 29 and 39 °C</li> <li>● Solar radiation between 20 and 880 W/m<sup>2</sup></li> <li>● Inlet water temperature between 30 and 35 °C</li> </ul>	<ul style="list-style-type: none"> <li>● Total electrical efficiency of 0.16%</li> </ul>	<ul style="list-style-type: none"> <li>● Experimental</li> </ul>
	Li et al. (2017)	Integrated	<ul style="list-style-type: none"> <li>● Ambient temperature of 27 °C</li> <li>● Water inlet temperature of 27 °C</li> <li>● Solar radiation of 1000 W/m<sup>2</sup></li> </ul>	<ul style="list-style-type: none"> <li>● Maximum module TE efficiency is 6.1%</li> <li>● Peak PV-TE electrical efficiency of 21.6%</li> </ul>	<ul style="list-style-type: none"> <li>● Theoretical</li> </ul>
	Soltani et al. (2018)	Integrated	<ul style="list-style-type: none"> <li>● Ambient temperature of 36.2 °C</li> <li>● Water inlet temperature of 28 °C</li> <li>● Solar radiation of 900 W/m<sup>2</sup></li> </ul>	<ul style="list-style-type: none"> <li>● Maximum thermal efficiency of 57%</li> <li>● Maximum TE efficiency of 5.6%</li> </ul>	<ul style="list-style-type: none"> <li>● Theoretical</li> </ul>
	Sharaf and Orhan (2018)	Integrated	<ul style="list-style-type: none"> <li>● Ambient temperature between 19.9 and 34.9 °C</li> <li>● Inlet water temperature equal to ambient temperature</li> </ul>	<ul style="list-style-type: none"> <li>● Thermal efficiency of 78.9% for parallel configuration and 76.3% for series configuration</li> </ul>	<ul style="list-style-type: none"> <li>● Theoretical</li> </ul>
	Yang et al. (2018)	Spectrum splitting	–	<ul style="list-style-type: none"> <li>● PVT-TE system efficiency is 39.5% and 40.2% at concentration ratio of 30 and 100 respectively</li> </ul>	<ul style="list-style-type: none"> <li>● Theoretical</li> </ul>
	Yin et al. (2018)	Spectrum splitting	<ul style="list-style-type: none"> <li>● Ambient temperature of 27 °C</li> <li>● Cooling fluid temperature of 20.13 °C</li> <li>● TEG hot side temperature of 527 °C</li> </ul>	<ul style="list-style-type: none"> <li>● TE efficiency of 13.9%</li> <li>● PVT-TE maximum efficiency of 30%</li> </ul>	<ul style="list-style-type: none"> <li>● Theoretical</li> </ul>
	Shittu et al. (2019)	Integrated	<ul style="list-style-type: none"> <li>● Ambient temperature between 15 and 55 °C</li> <li>● Wind speed between 0 and 7 m/s</li> </ul>	<ul style="list-style-type: none"> <li>● PVT-TE system efficiency is higher than that of PV-TE system by 1.47% and PV system by 61.01% at concentration ratio of 6</li> </ul>	<ul style="list-style-type: none"> <li>● Theoretical</li> </ul>
	Tiwari et al. (2020)	Integrated	<ul style="list-style-type: none"> <li>● Ambient temperature between 10 and 38 °C</li> <li>● Solar intensity up to 1000 W/m<sup>2</sup></li> </ul>	<ul style="list-style-type: none"> <li>● Hourly electrical gain ranges between 3.96 and 14.38 W</li> <li>● Hourly rate of thermal energy gain ranges between 41.14 and 148.72 W</li> </ul>	<ul style="list-style-type: none"> <li>● Experimental</li> <li>● Theoretical</li> </ul>
	Riahia et al. (2020)	Integrated	<ul style="list-style-type: none"> <li>● 760 and 925 W/m<sup>2</sup></li> <li>● Inlet fluid temperature between 28.8 and 35.8 °C</li> <li>● Ambient temperature between 36.5 and 33 °C</li> </ul>	<ul style="list-style-type: none"> <li>● Daily electrical efficiency of PVT-TE is higher than that of PVT system by 7.46%</li> </ul>	<ul style="list-style-type: none"> <li>● Experimental</li> <li>● Theoretical</li> </ul>
	Shittu et al. (2020)	Integrated	<ul style="list-style-type: none"> <li>● Solar irradiance of 1000 W/m<sup>2</sup></li> </ul>	<ul style="list-style-type: none"> <li>● Maximum PVT-TE electric efficiency of 15%</li> </ul>	<ul style="list-style-type: none"> <li>● Theoretical</li> </ul>



collector had electrical efficiency greater than semitransparent PV-TE collector by 4.723% and semitransparent PV collector by 7.266%.

Temperature has an opposing influence on the performance of TEG and PV. Higher temperature difference raises the efficiency of TEG but at the same time increases the temperature of PV cell leading to alleviate the PV efficiency. Due to this, spectrum splitting system has been suggested which reflects the appropriate solar radiation to the PVM and the remaining out of range radiation to the TE module (Fig. 21). Spectrum splitting PVT-TE system is generally composed of solar concentrator, PVM, TEG and spectrum splitter.

Compared to integrated PVT-TE system, rare are the studies that are conducted on spectrum splitting PVT-TE system. Ju et al. (2012) developed a numerical modeling and optimization analysis of spectrum splitting PV-TE system. The authors conducted a simulation model taking into account the solar concentration and various heat loss rates. They also carried out analysis to estimate the electrical and thermal performance for distinct conditions. It was obtained that the efficiency of the studied system ranges between 26.62% and 27.49%.

Yang et al. (2018) conducted analytical expression of the system efficiency by utilizing an updated model of solar spectrum PV-TE system. They optimized the cell voltage, cutoff energy of the system and dimensionless current of the TEG. Also, they studied the impact of the ratio of the collector area to PV cell area on the performance of spectrum splitting system. The results revealed that for concentration ratio of 30 and 100, the maximum system efficiency achieved is 39.5% and 40.2% respectively where it increased by about 2.67% and 2.19% in comparison to PV system.

Yin et al. (2018) suggested a new design method to optimize the solar energy distribution of concentrated spectrum splitting PV-TE hybrid system. The system comprises concentrator (Fresnel lens), PV cell, TE module and cooling system (Fig. 22). A model was conducted in order to investigate the performance of the system and reach the optimum design. The results showed that the maximum system efficiency attained is 30% and the TEG efficiency is 13.9%.

Skjølstrup and Søndergaard (2016) designed and optimized a thin-film multilayer spectrum beam splitter for PV-TE hybrid system. The authors considered two configurations where the first one uses lens and the second one uses reflector (Fig. 23). It was obtained that the studied system efficiency is greater than the efficiency of PVM by 21.4%.

Table 6 summarizes the latest experimental and theoretical researches performed on PVT-TE hybrid systems.

Several points can be concluded after analysis of the outputs of the previous studies:

- The most commonly used type of PVT-TE system is the integrated type where it is simple in construction compared to the spectrum splitting.
- Utilizing TEG serves in increasing the power output and the electrical efficiency of PVT system.
- PVT-TE systems exhibit better performances than PVT systems.

## 6. Closure and discussion

The present work comprises a review on hybrid solar system which amalgamates solar PV with solar thermal collectors. The hybrid PVT system simultaneously provides thermal and electrical energy. Hence, the main aim of this cogeneration system is to maximize the avail of solar energy.

The review includes general background which states the history, concept and advantages of PVT systems. Also, the main classifications of PVT system are presented where it is categorized in this study according to the type of PV cell and solar collector, working fluid, glazing and absorber. Besides, solar applications derived from PVT hybrid system are described in this work. The main application of such systems is producing electricity in addition to other purposes such as drying, heating water, heating and cooling space and desalination. In addition,

the review includes the description of hybrid PVT system with thermoelectric generators in which the TEG can be integrated with PV cell or they can operate separately using spectral beam splitter.

The main outputs of the review are:

- Crystalline silicon and InGaP/GaAs/Ge triple junction solar cells most utilized PV cells in PVT systems, and high electrical efficiency is obtained when utilizing InGaP/GaAs/Ge triple junction PV cell compared to crystalline silicon.
- Thermal efficiency of PVT system is slightly affected by the type of PV cell.
- The selection of the solar collector depends on the type of application where each one requires certain range of outlet temperature.
- Concentrated type of STC; mainly parabolic trough and linear Fresnel are the most utilized in PVT systems. The electrical efficiency is negligibly affected by the type of the STC.
- Water based system is limited by the operating conditions due to freezing at low operating temperatures, but it is preferred to use water since it has high thermal characteristics compared to air. Water based PVT system has higher electrical and thermal efficiencies compared to air based PVT system.
- Glazing is suitable for increasing the thermal efficiency but it leads to mitigate the electrical efficiency of the system. Unglazed PVT system is more favorable if high electrical output is required while glazing is more preferred to be used in PVT systems in case high thermal or overall system efficiency is required. However, single glazing is more preferable than double glazing.
- The type of absorber plays a great role in exploiting solar energy where aluminum and copper are the commonly used materials in the solar thermal absorbers.
- PVT systems are suitable for applications that require thermal energy more than electrical energy. Water heating is relatively the most application that exploits PVT system.
- In all applications, the performance PVT systems is better than that of thermal systems and PV systems working alone. PVT systems can cover the thermal and electrical energy required by most applications.
- The most commonly utilized type is the integrated type of PVT-TE systems in which TEG are integrated at the PV cell back face. Using TEG serves in raising the electrical efficiency of the system and thus the overall efficiency.
- PVT-TE systems have better performance than PVT systems.

It is predicted that PVT systems will be capable to suffice the need for energy consumption in the near future. Also, these systems provide energy needed in a clean and environment friendly ways. This explains the significance of such systems and thus more researches and studies must be conducted in order to enhance and optimize the system for better efficiency and less costs.

## Declaration of Competing Interest

The authors declare that they have no known competing financial interests or personal relationships that could have appeared to influence the work reported in this paper.

## References

- Abdelrazik, A.S., Al-Sulaiman, F.A., Saidur, R., Ben-Mansour, R., 2018. A review on recent development for the design and packaging of hybrid photovoltaic/thermal (PV/T) solar systems. *Renew. Sustain. Energy Rev.* 95, 110–129. <https://doi.org/10.1016/j.rser.2018.07.013>.
- Abdul-Wahab, S., Charabi, Y., Al-Mahruqi, A.M., Osman, I., Osman, S., 2019. Selection of the best solar photovoltaic (PV) for Oman. *Sol. Energy* 188, 1156–1168. <https://doi.org/10.1016/j.solener.2019.07.018>.
- Abdullah, A.L., Misha, S., Tamaldin, N., Rosli, M.A.M., Sachit, F.A., 2018. Photovoltaic thermal /solar (PVT) collector (PVT) system based on fluid absorber design: A review.

- J. Adv. Res. Fluid Mech. Therm. Sci. 48, 196–208.
- Adam, S.A., Ju, X., Zhang, Z., El-samie, M.M.A., 2019. Theoretical investigation of different CPVT configurations based on liquid absorption spectral beam filter. *Energy* 189, 116259. <https://doi.org/10.1016/j.energy.2019.116259>.
- Adelaja, A.O., Ogunmola, B.Y., Akolade, P.O., 2009. Development of a photovoltaic powered forced convection solar dryer. *Adv. Mater. Res.* 62–64, 543–548. <https://doi.org/10.4028/www.scientific.net/AMR.62-64.543>.
- Afrand, M., Shahsavari, A., Sardari, P.T., Sopian, K., Salehpour, H., 2019. Energy and exergy analysis of two novel hybrid solar photovoltaic geothermal energy systems incorporating a building integrated photovoltaic thermal system and an earth air heat exchanger system. *Sol. Energy* 188, 83–95. <https://doi.org/10.1016/j.solener.2019.05.080>.
- Aktas, M., Sevik, S., Dogan, H., Ozturk, M., 2012. Fotovoltaik ve termal güneş enerjili süreklili bir kurutucuda domates kurutulması. *J. Agric. Sci.* 18, 287–298.
- Alobaid, M., Hughes, B., Kaiser, J., Connor, D.O., Heyes, A., 2017. A review of solar driven absorption cooling with photovoltaic thermal systems. *Renew. Sustain. Energy Rev.* 76, 728–742. <https://doi.org/10.1016/j.rser.2017.03.081>.
- Ammous, M., Chaabene, M., 2015. Multi criteria sizing approach for Photovoltaic Thermal collectors supplying desalination plant. *ENERGY Convers. Manage.* 94, 365–376. <https://doi.org/10.1016/j.enconman.2015.02.004>.
- Ananno, A.A., Masud, M.H., Dabnichki, P., Ahmed, A., 2020. Design and numerical analysis of a hybrid geothermal PCM flat plate solar collector dryer for developing countries. *Sol. Energy* 196, 270–286. <https://doi.org/10.1016/j.solener.2019.11.069>.
- Aoul, K.T., Hassan, A., Shah, A.H., Riaz, H., 2018. Energy performance comparison of concentrated photovoltaic – Phase change material thermal (CPV-PCM / T) system with flat plate collector (FPC). *Sol. Energy* 176, 453–464. <https://doi.org/10.1016/j.solener.2018.10.039>.
- Arturo, E., Urbiola, C., Vorobiev, Y., 2013. Investigation of Solar Hybrid Electric / Thermal System with Radiation Concentrator and Thermoelectric Generator. *Int. J. Photoenergy* 2013.
- Aste, A., Chiesa, G., Verri, F., 2008. Design, development and performance monitoring of a photovoltaic-thermal (PVT) air collector 33, 914–927. <https://doi.org/10.1016/j.renene.2007.06.022>.
- Aste, Leonforte, F., Pero, C. Del, 2015. Design, modeling and performance monitoring of a photovoltaic – thermal (PVT) water collector 112, 85–99. <https://doi.org/10.1016/j.solener.2014.11.025>.
- Aste, N., Pero, C. Del, Leonforte, F., 2017. Water PVT collectors performance comparison. *Energy Procedia* 105, 961–966. <https://doi.org/10.1016/j.egypro.2017.03.426>.
- Atheaya, D., Tiwari, A., Tiwari, G.N., 2016a. Exergy analysis of photovoltaic thermal (PVT) compound parabolic concentrator (CPC) for constant collection temperature mode. *Sol. Energy* 135, 222–231. <https://doi.org/10.1016/j.solener.2016.05.055>.
- Atheaya, D., Tiwari, A., Tiwari, G.N., Al-helal, I.M., 2016b. Performance evaluation of inverted absorber photovoltaic thermal compound parabolic concentrator (PVT-CPC): Constant flow rate mode. *Appl. Energy* 167, 70–79. <https://doi.org/10.1016/j.apenergy.2016.01.023>.
- Attivissimo, F., Nisio, A. Di, Maria, A., Lanzolla, L., Paul, M., 2015. Feasibility of a Photovoltaic – thermoelectric generator: performance analysis and simulation results. *Trans. Instrum. Meas.* 64, 1158–1169.
- Babu, C., Ponnambalam, P., 2017. The role of thermoelectric generators in the hybrid PV/T systems: a review. *Energy Convers. Manage.* 151, 368–385. <https://doi.org/10.1016/j.enconman.2017.08.060>.
- Bambrók, S.M., Sproul, A.B., 2012. Maximising the energy output of a PVT air system. *Sol. Energy* 86, 1857–1871. <https://doi.org/10.1016/j.solener.2012.02.038>.
- Bamroongkhan, P., Lertsatitthanakorn, C., Soponronnarit, S., 2019. Experimental performance study of parabolic dish Experimental performance study of a solar solar parabolic dish generator photovoltaic-thermoelectric generator Assessing the feasibility of using the a, heat demand-outdoor temperature function for a lon. *Energy Procedia* 158, 528–533. <https://doi.org/10.1016/j.egypro.2019.01.147>.
- Barnwal, P., Tiwari, A., 2008. Design, construction and testing of hybrid photovoltaic integrated greenhouse dryer. *Int. J. Agric. Res.* 3, 110–120.
- Barone, G., Buonomano, A., Forzano, C., Palombo, A., 2019a. Experimentation, modelling and applications of a novel low-cost air-based photovoltaic thermal collector prototype. *Energy Convers. Manage.* 195, 1079–1097. <https://doi.org/10.1016/j.enconman.2019.04.082>.
- Barone, G., Buonomano, A., Forzano, C., Palombo, A., Panagopoulos, O., 2019b. Photovoltaic thermal collectors: experimental analysis and simulation model of an innovative low-cost water-based prototype. *Energy*. <https://doi.org/10.1016/j.energy.2019.04.140>.
- Bellos, E., Tzivanidis, C., 2019. Alternative designs of parabolic trough solar collectors. *Prog. Energy Combust. Sci.* 71, 81–117. <https://doi.org/10.1016/j.pecs.2018.11.001>.
- Bennamoun, L., 2013. Integration of Photovoltaic Cells in Solar Drying Systems. *Dry. Technol. An Int. J.* 31, 1284–1296. <https://doi.org/10.1080/07373937.2013.788510>.
- Bernardo, L.R., Perers, B., Håkansson, H., Karlsson, B., 2011. Performance evaluation of low concentrating photovoltaic/thermal systems: A case study from Sweden. *Sol. Energy* 85, 1499–1510. <https://doi.org/10.1016/j.solener.2011.04.006>.
- Bilton, A.M., 2018. Design of photovoltaic powered reverse osmosis desalination systems considering membrane fouling caused by intermittent operation. *Renew. Energy*. <https://doi.org/10.1016/j.renene.2018.11.065>.
- Brahim, T., Jemni, A., 2017. Economical assessment and applications of photovoltaic/thermal hybrid solar technology: A review. *Sol. Energy* 153, 540–561. <https://doi.org/10.1016/j.solener.2017.05.081>.
- Browne, M.C., Norton, B., McCormack, S.J., 2016. Heat retention of a photovoltaic/thermal collector with PCM. *Sol. Energy* 133, 533–548. <https://doi.org/10.1016/j.solener.2016.04.024>.
- Buonomano, A., Calise, F., Dentice d'Accadia, M., Vanoli, L., 2013. A novel solar tri-generation system based on concentrating photovoltaic/thermal collectors. Part 1: Design and simulation model. *Energy* 61, 59–71. <https://doi.org/10.1016/j.energy.2013.02.009>.
- Buonomano, A., Calise, F., Palombo, A., 2018. Solar heating and cooling systems by absorption and adsorption chillers driven by stationary and concentrating photovoltaic / thermal solar collectors : modelling and simulation. *Renew. Sustain. Energy Rev.* 81, 1112–1146. <https://doi.org/10.1016/j.rser.2017.07.056>.
- Buonomano, A., Calise, F., Palombo, A., 2017. Solar heating and cooling systems by absorption and adsorption chillers driven by stationary and concentrating photovoltaic / thermal solar collectors : Modelling and simulation. *Renew. Sustain. Energy Rev.* 1. <https://doi.org/10.1016/j.rser.2017.10.059>.
- Burhan, M., Shahzad, M.W., Choon, N.K., 2017. Long-term performance potential of concentrated photovoltaic (CPV) systems. *Energy Convers. Manage.* 148, 90–99. <https://doi.org/10.1016/j.enconman.2017.05.072>.
- Calise, F., Cappiello, F.L., Vanoli, R., Vicidomini, M., 2019. Economic assessment of renewable energy systems integrating photovoltaic panels, seawater desalination and water storage. *Appl. Energy* 253, 113575. <https://doi.org/10.1016/j.apenergy.2019.113575>.
- Calise, F., Dentice, M., Piacentino, A., 2014. A novel solar trigeneration system integrating PVT (photovoltaic / thermal collectors) and SW (seawater) desalination : dynamic simulation and economic assessment. *Energy* 67, 129–148. <https://doi.org/10.1016/j.energy.2013.12.060>.
- Calise, F., Vanoli, L., 2012. Parabolic trough photovoltaic/thermal collectors: Design and simulation model. *Energies* 5, 4186–4208. <https://doi.org/10.3390/en5104186>.
- Cappelletti, A., Catelani, M., Ciani, L., Kazimierzczuk, M.K., Reatti, A., Member, S., 2016. Practical issues and characterization of a photovoltaic / thermal linear focus. *IEEE Trans. Instrum. Meas.* 65, 2464–2475.
- Carvalho, D.B., Guardia, E.C., Marangon Lima, J.W., 2019. Technical-economic analysis of the insertion of PV power into a wind-solar hybrid system. *Sol. Energy* 191, 530–539. <https://doi.org/10.1016/j.solener.2019.06.070>.
- Ceylan, I., Gurel, A.E., Ergun, A., Tabak, A., 2016. Performance analysis of a concentrated photovoltaic and thermal system. *Sol. Energy* 129, 217–223. <https://doi.org/10.1016/j.solener.2016.02.010>.
- Charalambous, P.G., Kalogirou, S.A., Maidment, G.G., Yiakoumetti, K., 2011. Optimization of the photovoltaic thermal (PV/T) collector absorber. *Sol. Energy* 85, 871–880. <https://doi.org/10.1016/j.solener.2011.02.003>.
- Chávez-Urbio, E.A., Vorobiev, Y.V., Bulat, L.P., 2012. Solar hybrid systems with thermoelectric generators. *Sol. Energy* 86, 369–378. <https://doi.org/10.1016/j.solener.2011.10.020>.
- Chaysaz, A., Reza, S., Seyedi, M., Motevali, A., 2019. Effects of different greenhouse coverings on energy parameters of a photovoltaic – thermal solar system. *Sol. Energy* 194, 519–529. <https://doi.org/10.1016/j.solener.2019.11.003>.
- Chemisana, D., Ibáñez, M., Rosell, J.L., 2011. Characterization of a photovoltaic-thermal module for Fresnel linear concentrator. *Energy Convers. Manage.* 52, 3234–3240. <https://doi.org/10.1016/j.enconman.2011.04.008>.
- Chen, Y., Wang, J., Ma, C., Gao, Y., 2019. Thermo-ecological cost assessment and optimization for a hybrid combined cooling, heating and power system coupled with compound parabolic concentrated-photovoltaic thermal solar collectors. *Energy* 176, 479–492. <https://doi.org/10.1016/j.energy.2019.03.185>.
- Chong, K., Yew, T., Wong, C., Tan, M., Tan, W., Lim, B., 2017a. Dense-array concentrator photovoltaic prototype using non-imaging dish concentrator and an array of cross compound parabolic concentrators. *Appl. Energy* 204, 898–911. <https://doi.org/10.1016/j.apenergy.2017.03.108>.
- Chong, K., Yew, T., Wong, C., Tan, M., Tan, W., Lim, B., Lai, A., 2017b. Prototype of dense-array concentrator photovoltaic system using non-imaging dish concentrators and cross compound parabolic concentrator. *Energy Procedia* 105, 131–136. <https://doi.org/10.1016/j.egypro.2017.03.291>.
- Chow, T.T., 2010. A review on photovoltaic/thermal hybrid solar technology. *Appl. Energy* 87, 365–379. <https://doi.org/10.1016/j.apenergy.2009.06.037>.
- Chow, T.T., Pei, G., Fong, K.F., Lin, Z., Chan, A.L.S., Ji, J., 2009. Energy and exergy analysis of photovoltaic – thermal collector with and without glass cover. *Appl. Energy* 86, 310–316. <https://doi.org/10.1016/j.apenergy.2008.04.016>.
- Cotfas, D.T., Cotfas, P.A., Machidon, O.M., Ciobanu, D., 2016. Investigation of the photovoltaic cell / thermoelectric element hybrid system performance. *Mater. Sci. Eng.* 133. <https://doi.org/10.1088/1757-899X/133/1/012037>.
- Cremers, J., Mitina, I., Palla, N., Klotz, F., Jobard, X., Eicker, U., 2015. Experimental analyses of different PVT collector designs for heating and cooling applications in buildings. *Energy Procedia* 78, 1889–1894. <https://doi.org/10.1016/j.egypro.2015.11.356>.
- Cui, T., Xuan, Y., Li, Q., 2016. Design of a novel concentrating photovoltaic – thermoelectric system incorporated with phase change materials. *ENERGY Convers. Manage.* 112, 49–60. <https://doi.org/10.1016/j.enconman.2016.01.008>.
- Das, D., Kalita, P., Roy, O., 2018. Flat plate hybrid photovoltaic-thermal (PV/T) system: a review on design and development. *Renew. Sustain. Energy Rev.* 84, 111–130. <https://doi.org/10.1016/j.rser.2018.01.002>.
- Del Col, D., Bortolato, M., Padovan, A., Quaggia, M., 2014. Experimental and numerical study of a parabolic trough linear CPVT system. *Energy Procedia* 57, 255–264. <https://doi.org/10.1016/j.egypro.2014.10.030>.
- Dhoke, A., Sharma, R., Saha, T.K., 2019. An approach for fault detection and location in solar PV systems. *Sol. Energy* 194, 197–208. <https://doi.org/10.1016/j.solener.2019.10.052>.
- Dimiri, N., Tiwari, A., Tiwari, G.N., 2018. Comparative Study of photovoltaic thermal (PVT) integrated thermoelectric cooler (TEC) fluid collectors. *Renew. Energy* 134, 343–356. <https://doi.org/10.1016/j.renene.2018.10.105>.
- Dimiri, N., Tiwari, A., Tiwari, G.N., 2017. Thermal modelling of semitransparent

- photovoltaic thermal (PVT) with thermoelectric cooler (TEC) collector. Energy Convers. Manag. 146, 68–77. <https://doi.org/10.1016/j.enconman.2017.05.017>.
- Diwanian, S., Agrawal, S., Siddiqui, A.S., Singh, S., 2019. Photovoltaic–thermal (PV/T) technology: a comprehensive review on applications and its advancement. Int. J. Energy Environ. Eng. <https://doi.org/10.1007/s40095-019-00327-y>.
- Dong, Z., Bingyang, L., Qintong, Z., Jinping, L., 2020. Thermal performance and energy characteristic analysis of multiple renewable energy complementary heat pump system. Sol. Energy 196, 287–294. <https://doi.org/10.1016/j.solener.2019.12.030>.
- Dupeyrat, P., Menezes, C., Rommel, M., Henning, H., 2011. Efficient single glazed flat plate photovoltaic – thermal hybrid collector for domestic hot water system. Sol. Energy 85, 1457–1468. <https://doi.org/10.1016/j.solener.2011.04.002>.
- Eicker, U., Dalibard, A., 2011. Photovoltaic thermal collectors for night radiative cooling of buildings. Sol. Energy 85, 1322–1335.
- El-samie, M.M.A., Ju, X., Zhang, Z., Adam, S.A., Pan, X., Xu, C., 2019. Three-dimensional numerical investigation of a hybrid low concentrated photovoltaic/thermal system. Energy 190, 116436. <https://doi.org/10.1016/j.energy.2019.116436>.
- El Hage, H., Herez, A., Ramadan, M., Bazzi, H., Khaled, M., 2018. An investigation on solar drying: A review with economic and environmental assessment. Energy 157, 815–829. <https://doi.org/10.1016/j.energy.2018.05.197>.
- Elsafi, A.M., 2017. Integration of humidifi cation-dehumidifi cation desalination and concentrated photovoltaic-thermal collectors : Energy and exergy-costing analysis. Desalination 424, 17–26. <https://doi.org/10.1016/j.desal.2017.09.022>.
- Elsheikh, A.H., Sharshir, S.W., Abd Elaziz, M., Kabel, A.E., Guilan, W., Haiou, Z., 2019. Modeling of solar energy systems using artificial neural network: A comprehensive review. Sol. Energy. <https://doi.org/10.1016/j.solener.2019.01.037>.
- Eltawil, M.A., Azam, M.M., Alghannam, A.O., 2018. Solar PV powered mixed-mode tunnel dryer for drying potato chips. Renew. Energy 116, 594–605. <https://doi.org/10.1016/j.renene.2017.10.007>.
- Evangelisti, L., De Lieto Vollaro, R., Asdrubali, F., 2019. Latest advances on solar thermal collectors: A comprehensive review. Renew. Sustain. Energy Rev. 114, 109318. <https://doi.org/10.1016/j.rser.2019.109318>.
- Fan, W., Kokogiannakis, G., Ma, Z., 2018. A multi-objective design optimisation strategy for hybrid photovoltaic thermal collector (PVT) -solar air heater (SAH) systems with fi ns. Sol. Energy 163, 315–328. <https://doi.org/10.1016/j.solener.2018.02.014>.
- Feng, C., Zheng, H., Wang, R., Ma, X., 2016. Performance investigation of a concentrating photovoltaic / thermal system with transmissive Fresnel solar concentrator. Energy Convers. Manage. 111, 401–408. <https://doi.org/10.1016/j.enconman.2015.12.086>.
- Fernández-González, D., Prazuch, J., Ruiz-Bustintza, I., González-Gasca, C., Piñuela-Noval, J., Verdeja, L.F., 2019a. Transformations in the Si-O-Ca system: Silicon-calcium via solar energy. Sol. Energy 181, 414–423. <https://doi.org/10.1016/j.solener.2019.02.026>.
- Fernández-González, D., Prazuch, J., Ruiz-Bustintza, I., González-Gasca, C., Piñuela-Noval, J., Verdeja, L.F., 2019b. Transformations in the Mn-O-Si system using concentrated solar energy. Sol. Energy 184, 148–152. <https://doi.org/10.1016/j.solener.2019.04.004>.
- Fine, J.P., Dworkin, S.B., Friedman, J., 2019. A methodology for predicting hybrid solar panel performance in different operating modes. Renew. Energy 130, 1198–1206. <https://doi.org/10.1016/j.renene.2018.08.082>.
- Florschuetz, 1979. Extension of the hottel-whillier model to the analysis of combined photovoltaic / thermal flat plate collectors. Sol. Energy 22, 361–366.
- Fterich, M., Chouikhi, H., Bentaher, H., Maalej, A., 2018. Experimental parametric study of a mixed-mode forced convection solar dryer equipped with a PV / T air collector. Sol. Energy 171, 751–760. <https://doi.org/10.1016/j.solener.2018.06.051>.
- Fu, H., Li, G., Li, F., 2019. Performance comparison of photovoltaic / thermal solar water heating systems with direct-coupled photovoltaic pump, traditional pump and natural circulation. Renew. Energy 136, 463–472. <https://doi.org/10.1016/j.renene.2019.01.028>.
- Fudholi, A., Zohri, M., Shahirah, N., Rukman, B., Syakirah, N., 2019. Exergy and sustainability index of photovoltaic thermal (PVT) air collector : A theoretical and experimental study. Renew. Sustain. Energy Rev. 100, 44–51. <https://doi.org/10.1016/j.rser.2018.10.019>.
- Gaur, A., Ménézo, C., Giroux-Julien, S., 2017. Numerical studies on thermal and electrical performance of a fully wetted absorber PVT collector with PCM as a storage medium. Renew. Energy 109, 168–187. <https://doi.org/10.1016/j.renene.2017.01.062>.
- George, M., Pandey, A.K., Abd Rahim, N., Tyagi, V.V., Shahabuddin, S., Saidur, R., 2019. Concentrated photovoltaic thermal systems: A component-by-component view on the developments in the design, heat transfer medium and applications. Energy Convers. Manag. 186, 15–41. <https://doi.org/10.1016/j.enconman.2019.02.052>.
- Greppi, M., Fabbri, G., 2018. Use of microspheres in thermally insulating hybrid solar panels. Energy Procedia 148, 948–953. <https://doi.org/10.1016/j.egypro.2018.08.090>.
- Guarracino, I., Freeman, J., Ramos, A., Kalogirou, S.A., Ekins-Daukes, N.J., Markides, C.N., 2019. Systematic testing of hybrid PV-thermal (PVT) solar collectors in steady-state and dynamic outdoor conditions. Appl. Energy 240, 1014–1030. <https://doi.org/10.1016/j.apenergy.2018.12.049>.
- Guo, S., He, Y., Pei, H., Wu, S., 2020. The multi-objective capacity optimization of wind-photovoltaic-thermal energy storage hybrid power system with electric heater. Sol. Energy 195, 138–149. <https://doi.org/10.1016/j.solener.2019.11.063>.
- Gürel, A.E., 2016. Exergetic assessment of a concentrated photovoltaic thermal (CPV / T) system. Int. J. exergy 21, 127–135.
- Haiping, C., Xinxin, G., Heng, Z., Yang, L., Haowen, L., Yuegang, B., 2019. Experimental study on a flash tank integrated with low concentrating PV / T (FT-LCPVT) hybrid system for desalination. Appl. Therm. Eng. 159, 113874. <https://doi.org/10.1016/j.applthermaleng.2019.113874>.
- He, W., Zhou, J., Chen, C., Ji, J., 2014. Experimental study and performance analysis of a thermoelectric cooling and heating system driven by a photovoltaic / thermal system in summer and winter operation modes. ENERGY Convers. Manag. 84, 41–49. <https://doi.org/10.1016/j.enconman.2014.04.019>.
- Herez, A., Khaled, M., Murr, R., Haddad, A., Elhage, H., Ramadan, M., 2017a. Using geothermal energy for cooling - parametric study. Energy Procedia 119, 783–791. <https://doi.org/10.1016/j.egypro.2017.07.111>.
- Herez, A., Khaled, M., Ramadan, M., Bazi, H., 2017b. A Review on Solar Dryer - Economic and Environmental Investigation for the Lebanese Case. In: 10TH International Conference on Sustainable Energy and Environmental Protection SEEP, pp. 561–574.
- Herez, A., Ramadan, M., Abdulhay, B., Khaled, M., 2016. Short review on solar energy systems, in. In: AIP Conference Proceedings. AIP Publishing LLC, pp. 030041. <https://doi.org/10.1063/1.4959437>.
- Herez, A., Ramadan, M., Khaled, M., 2018. Review on solar cooker systems: Economic and environmental study for different Lebanese scenarios. Renew. Sustain. Energy Rev. 81, 421–432. <https://doi.org/10.1016/j.rser.2017.08.021>.
- Herrando, M., Markides, C.N., Hellgardt, K., 2014. A UK-based assessment of hybrid PV and solar-thermal systems for domestic heating and power: System performance. Appl. Energy 122, 288–309. <https://doi.org/10.1016/j.apenergy.2014.01.061>.
- Herrando, M., Pantaleo, A.M., Wang, K., Markides, C.N., 2019a. Solar combined cooling, heating and power systems based on hybrid PVT, PV or solar-thermal collectors for building applications. Renew. Energy 143, 637–647. <https://doi.org/10.1016/j.renene.2019.05.004>.
- Herrando, M., Ramos, A., Zabalza, I., 2018. Cost competitiveness of a novel PVT-based solar combined heating and power system : In fl uence of economic parameters and fi nancial incentives 166, 758–770. <https://doi.org/10.1016/j.enconman.2018.04.005>.
- Herrando, M., Ramos, A., Zabalza, I., Markides, C.N., 2019b. A comprehensive assessment of alternative absorber-exchanger designs for hybrid PVT-water collectors. Appl. Energy 235, 1583–1602. <https://doi.org/10.1016/j.apenergy.2018.11.024>.
- Huide, F., Xuxin, Z., Lei, M., Tao, Z., Qixing, W., Hongyuan, S., 2017. A comparative study on three types of solar utilization technologies for buildings: Photovoltaic, solar thermal and hybrid photovoltaic/thermal systems. Energy Convers. Manag. 140, 1–13. <https://doi.org/10.1016/j.enconman.2017.02.059>.
- Hung, B.J., Lin, T.H., Hung, W.C., Sun, F.S., 2001. Performance evaluation of solar photovoltaic/thermal systems. Sol. Energy 70, 443–448.
- Hussain, M.I., Lee, G.H., 2015. Experimental and numerical studies of a U-shaped solar energy collector to track the maximum CPV / T system output by varying the fl ow rate. Renew. Energy 76, 735–742. <https://doi.org/10.1016/j.renene.2014.12.008>.
- Ibrahim, A., Jin, G.L., Daghigh, R., Salleh, M.H.M., Othman, M.Y., Ruslan, M.H., Mat, S., Sopian, K., 2009a. Hybrid photovoltaic thermal (PV/T) air and water based solar collectors suitable for building integrated applications. Am. J. Environ. Sci. 5, 618–624. <https://doi.org/10.3844/ajessp.2009.618.624>.
- Ibrahim, A., Othman, M.Y., Ruslan, M.H., Alghoul, M.A., Yahya, M., Zaharim, A., Sopian, K., 2009b. Performance of photovoltaic thermal collector (PVT) with different absorbers design. WSEAS Trans. Environ. Dev. 5, 321–330.
- Jaaz, A.H., Hasan, H.A., Sopian, K., Ha, M., Haji, B., Zaidi, S.H., 2017. Design and development of compound parabolic concentrating for photovoltaic solar collector : Review 76, 1108–1121. <https://doi.org/10.1016/j.rser.2017.03.127>.
- Jaaz, A.H., Sopian, K., Gaaz, T.S., 2018. Study of the electrical and thermal performances of photovoltaic thermal Collector-Compound parabolic concentrated. Results Phys. 9, 500–510. <https://doi.org/10.1016/j.rimp.2018.03.004>.
- Jadin, M.S., Setapa, N.A., Mohamed, A.I., 2017. Development of hybrid thermoelectric and photovoltaic power generation. J. Eng. Appl. Sci.
- Jani, D.B., Mishra, M., Sahoo, P.K., 2018. A critical review on application of solar energy as renewable regeneration heat source in solid desiccant – vapor compression hybrid cooling system. J. Build. Eng. <https://doi.org/10.1016/j.jobbe.2018.03.012>.
- Jia, Y., Alva, G., Fang, G., 2019. Development and applications of photovoltaic–thermal systems: A review. Renew. Sustain. Energy Rev. 102, 249–265. <https://doi.org/10.1016/j.rser.2018.12.030>.
- Jonas, D., Lämmle, M., Theis, D., Schneider, S., Frey, G., 2019. Performance modeling of PVT collectors: implementation, validation and parameter identification approach using TRNSYS. Sol. Energy 193, 51–64. <https://doi.org/10.1016/j.solener.2019.09.047>.
- Joshi, S.S., Dhoble, A.S., 2018. Photovoltaic – thermal systems (PVT): technology review and future trends. Renew. Sustain. Energy Rev. 92, 848–882. <https://doi.org/10.1016/j.rser.2018.04.067>.
- Ju, X., Wang, Z., Flamant, G., Li, P., Zhao, W., 2012. Numerical analysis and optimization of a spectrum splitting concentration photovoltaic – thermoelectric hybrid system. Sol. Energy 86, 1941–1954. <https://doi.org/10.1016/j.solener.2012.02.024>.
- Ju, X., Xu, C., Hu, Y., Han, X., Wei, G., Du, X., 2017. A review on the development of photovoltaic/concentrated solar power (PV-CSP) hybrid systems. Sol. Energy Mater. Sol. Cells 161, 305–327. <https://doi.org/10.1016/j.solmat.2016.12.004>.
- Jurasz, J., Canales, F.A., Kies, A., Guezgouz, M., Beluco, A., 2020. A review on the complementarity of renewable energy sources: Concept, metrics, application and future research directions. Sol. Energy. <https://doi.org/10.1016/j.solener.2019.11.087>.
- Karathanassis, I.K., Papanicolaou, E., Belessiotis, V., Bergeles, G.C., 2019. Dynamic simulation and exergetic optimization of a Concentrating Photovoltaic/ Thermal (CPVT) system. Renew. Energy 135, 1035–1047. <https://doi.org/10.1016/j.renene.2018.12.085>.
- Karathanassis, I.K., Papanicolaou, E., Belessiotis, V., Bergeles, G.C., 2017. Design and experimental evaluation of a parabolic-trough concentrating photovoltaic/thermal (CPVT) system with high-efficiency cooling. Renew. Energy 101, 467–483. <https://doi.org/10.1016/j.renene.2016.09.013>.
- Karimi, F., Xu, H., Wang, Z., Chen, J., Yang, M., 2017. Experimental study of a concentrated PV/T system using linear Fresnel lens. Energy 123, 402–412. <https://doi.org/10.1016/j.energy.2017.02.028>.
- Kasaiean, A., Nouri, G., Ranjbaran, P., Wen, D., 2018. Solar collectors and photovoltaics



- as combined heat and power systems: a critical review. *Energy Convers. Manage.* 156, 688–705. <https://doi.org/10.1016/j.enconman.2017.11.064>.
- Kazanci, O.B., Skrupskelis, M., Sevela, P., Pavlov, G.K., Olesen, B.W., 2014. Sustainable heating, cooling and ventilation of a plus-energy house via photovoltaic/thermal panels. *Energy Build.* <https://doi.org/10.1016/j.enbuild.2013.12.064>.
- Kazemian, A., Hosseinzadeh, M., Sardarabadi, M., 2018. Effect of glass cover and working fluid on the performance of photovoltaic thermal (PVT) system: an experimental study. *Sol. Energy* 173, 1002–1010. <https://doi.org/10.1016/j.solener.2018.07.051>.
- Kelley, L.C., Dubowsky, S., 2013. Thermal control to maximize photovoltaic powered reverse osmosis desalination systems productivity. *Desalination* 314, 10–19. <https://doi.org/10.1016/j.desal.2012.11.036>.
- Khaled, M., Herez, A., El Hage, H., Lemenand, T., Ramadan, M., 2018. Review on Solar Water Heating System, in: *Generation and Automation ICEREGA. Sousse, Tunisia*.
- Khelifa, A., Touafek, K., Moussa, H. Ben, Tabet, I., Hocine, H.B.C. El, Haloui, H., 2015. Analysis of a hybrid solar collector photovoltaic thermal (PVT). *Energy Procedia* 74, 835–843. <https://doi.org/10.1016/j.egypro.2015.07.819>.
- Kim, J., Park, S., Kang, J., Kim, J., 2014. Experimental performance of heating system with building-integrated PVT (BIPVT) collector. *Energy Procedia* 48, 1374–1384. <https://doi.org/10.1016/j.egypro.2014.02.155>.
- Kiran, S., Devadiga, U., 2014. Performance Analysis of Hybrid Photovoltaic / Thermal Systems. *Int. J. Emerg. Technol. Adv. Eng.* 4, 80–86.
- Kiyani, A., Karimi, H., Madadi Avargani, V., 2019. Exergoeconomic analysis of a solar photovoltaic-based direct evaporative air-cooling system. *Sol. Energy* 193, 253–266. <https://doi.org/10.1016/j.solener.2019.09.068>.
- Kohan, H.R.F., Lot, F., Eslami, M., 2018. Numerical simulation of a photovoltaic thermoelectric hybrid power generation system. *Sol. Energy* 174, 537–548. <https://doi.org/10.1016/j.solener.2018.09.046>.
- Kossyvakis, D.N., Voutsinas, G.D., Hristoforou, E.V., 2016. Experimental analysis and performance evaluation of a tandem photovoltaic – thermoelectric hybrid system. *Energy Convers. Manage.* 117, 490–500. <https://doi.org/10.1016/j.enconman.2016.03.023>.
- Kribus, A., Kaftori, D., Mittelman, G., Hirshfeld, A., Flitsanov, Y., Dayan, A., 2006. A miniature concentrating photovoltaic and thermal system. *Energy Convers. Manage.* 47, 3582–3590. <https://doi.org/10.1016/j.enconman.2006.01.013>.
- Kumar, S., Tiwari, A., 2008. An experimental study of hybrid photovoltaic thermal (PV / T) -active solar still. *Int. J. Energy Res.* 32, 847–858. <https://doi.org/10.1002/er.1016>.
- Kunemeyer, R., Anderson, T.N., Duke, M., Carson, J.K., 2014. Performance of a V-trough photovoltaic / thermal concentrator. *Sol. Energy* 101, 19–27. <https://doi.org/10.1016/j.solener.2013.11.024>.
- Lämmle, M., Oliva, A., Hermann, M., Kramer, K., Kramer, W., 2017. PVT collector technologies in solar thermal systems: A systematic assessment of electrical and thermal yields with the novel characteristic temperature approach. *Sol. Energy* 155, 867–879. <https://doi.org/10.1016/j.solener.2017.07.015>.
- Lamnatou, C., Chemisana, D., 2017. Photovoltaic/thermal (PVT) systems: A review with emphasis on environmental issues. *Renew. Energy* 105, 270–287. <https://doi.org/10.1016/j.renene.2016.12.009>.
- Lee, C., Escher, W., Paredes, S., Khalil, A.S.G., Michel, B., 2012. A novel concept of energy reuse from high concentration photovoltaic thermal (HCPVT) system for desalination. *Desalination* 295, 70–81. <https://doi.org/10.1016/j.desal.2012.04.005>.
- Li, D., Xuan, Y., Li, Q., Hong, H., 2017. Exergy and energy analysis of photovoltaic-thermoelectric hybrid systems. *Energy* 126, 343–351. <https://doi.org/10.1016/j.energy.2017.03.042>.
- Li, G., Shittu, S., Diallo, T.M.O., Yu, M., Zhao, X., Ji, J., 2018. A review of solar photovoltaic-thermoelectric hybrid system for electricity generation. *Energy* 158, 41–58. <https://doi.org/10.1016/j.energy.2018.06.021>.
- Li, G., Zhao, X., Ji, J., 2016. Conceptual development of a novel photovoltaic-thermoelectric system and preliminary economic analysis. *Energy Convers. Manage.* 126, 935–943. <https://doi.org/10.1016/j.enconman.2016.08.074>.
- Li, H., Sun, Y., 2018a. Operational performance study on a photovoltaic loop heat pipe / solar assisted heat pump water heating system. *Energy Build.* 158, 861–872. <https://doi.org/10.1016/j.enbuild.2017.10.075>.
- Li, H., Sun, Y., 2018b. Performance optimization and benefit analyses of a photovoltaic loop heat pipe/solar assisted heat pump water heating system. *Renew. Energy.* <https://doi.org/10.1016/j.renene.2018.09.055>.
- Li, S., Cai, Y., Schäfer, A.L., Richards, B.S., 2019a. Renewable energy powered membrane technology: a review of the reliability of photovoltaic-powered membrane system components for brackish water desalination. *Appl. Energy* 253, 113524. <https://doi.org/10.1016/j.apenergy.2019.113524>.
- Li, W., Paul, M.C., Baig, H., Siviter, J., Montecucco, A., Mallick, T.K., Knox, A.R., 2019b. A three-point-based electrical model and its application in a photovoltaic thermal hybrid roof-top system with crossed compound parabolic concentrator. *Renew. Energy* 130, 400–415. <https://doi.org/10.1016/j.renene.2018.06.021>.
- Lindsay, N., Libois, Q., Badosa, J., Migan-Dubois, A., Bourdin, V., 2020. Errors in PV power modelling due to the lack of spectral and angular details of solar irradiance inputs. *Sol. Energy* 197, 266–278. <https://doi.org/10.1016/j.solener.2019.12.042>.
- Lu, W., Wu, Y., Eames, P., 2018. Design and development of a building façade integrated asymmetric compound parabolic photovoltaic concentrator (BFI-ACP-PV). *Appl. Energy* 220, 325–336. <https://doi.org/10.1016/j.apenergy.2018.03.071>.
- Maatallah, T., Zachariah, R., Al-amri, F.G., 2019. Exergo-economic analysis of a serpentine flow type water based photovoltaic thermal system with phase change material (PVT-PCM / water). *Sol. Energy* 193, 195–204. <https://doi.org/10.1016/j.solener.2019.09.063>.
- Magrassi, F., Rocco, E., Barberis, S., Gallo, M., Del Borghi, A., 2019. Hybrid solar power system versus photovoltaic plant: A comparative analysis through a life cycle approach. *Renew. Energy* 130, 290–304. <https://doi.org/10.1016/j.renene.2018.06.072>.
- Manokar, A.M., Winston, D.P., Kabeel, A.E., El-agouz, S.A., Sathyamurthy, R., Arunkumar, T., Madhu, B., Ahsan, A., 2017. Integrated PV / T solar still- A mini-review. *Desalination* 0–1. <https://doi.org/10.1016/j.desal.2017.04.022>.
- Manokar, A.M., Winston, D.P., Vimala, M., 2016. Performance Analysis of Parabolic trough Concentrating Photovoltaic Thermal System. *Procedia Technol.* 24, 485–491. <https://doi.org/10.1016/j.protcy.2016.05.083>.
- Martin-Escudero, K., Salazar-Herran, E., Campos-Celador, A., Diarce-Belloso, G., Gomez-Arriaran, I., 2019. Solar energy system for heating and domestic hot water supply by means of a heat pump coupled to a photovoltaic ventilated façade. *Sol. Energy* 183, 453–462. <https://doi.org/10.1016/j.solener.2019.03.058>.
- Mi, Z., Chen, J., Chen, N., Bai, Y., Fu, R., Liu, H., 2016. Open-loop solar tracking strategy for high concentrating photovoltaic systems using variable tracking frequency. *ENERGY Convers. Manage.* 117, 142–149. <https://doi.org/10.1016/j.enconman.2016.03.009>.
- Michael, J.J., S, I., Goic, R., 2015. Flat plate solar photovoltaic-thermal (PV/T) systems: A reference guide. *Renew. Sustain. Energy Rev.* 51, 62–88. <https://doi.org/10.1016/j.rser.2015.06.022>.
- Misha, S., Lateef, A., Tamaladin, N., Rosli, M.A.M., Sachit, F.A., 2019. Simulation CFD and experimental investigation of PVT water system under natural Malaysian weather conditions. *Energy Reports* In press. <https://doi.org/10.1016/j.egypr.2019.11.162>.
- Mittelman, G., Kribus, A., Dayan, A., 2007. Solar cooling with concentrating photovoltaic/thermal (CPVT) systems. *Energy Convers. Manage.* 48, 2481–2490. <https://doi.org/10.1016/j.enconman.2007.04.004>.
- Mittelman, G., Kribus, A., Mouchtar, O., Dayan, A., 2009. Water desalination with concentrating photovoltaic / thermal (CPVT) systems. *Sol. Energy* 83, 1322–1334. <https://doi.org/10.1016/j.solener.2009.04.003>.
- Moaleman, A., Kasaeian, A., Aramesh, M., Mahian, O., Sahota, L., Nath, G., 2018. Simulation of the performance of a solar concentrating photovoltaic-thermal collector, applied in a combined cooling heating and power generation system. *Energy Convers. Manage.* 160, 191–208. <https://doi.org/10.1016/j.enconman.2017.12.057>.
- Modi, K.V., Shukla, D.L., 2018. Regeneration of liquid desiccant for solar air-conditioning and desalination using hybrid solar still. *Energy Convers. Manage.* 171, 1598–1616. <https://doi.org/10.1016/j.enconman.2018.06.096>.
- Mohsenzadeh, M., Shafii, M.B., Jafari, H., 2017. A novel concentrating photovoltaic/thermal solar system combined with thermoelectric module in an integrated design. *Renew. Energy* 113, 822–834. <https://doi.org/10.1016/j.renene.2017.06.047>.
- Mojiri, A., Stanley, C., Rodriguez-sanchez, D., Everett, V., Blakers, A., Rosengarten, G., 2016. A spectral-splitting PV – thermal volumetric solar receiver. *Appl. Energy* 169, 63–71. <https://doi.org/10.1016/j.apenergy.2016.02.027>.
- Molaei, M.J., 2020. The optical properties and solar energy conversion applications of carbon quantum dots: A review. *Sol. Energy.* <https://doi.org/10.1016/j.solener.2019.12.036>.
- Moreno, D., Fernández, M., Esquivias, P.M., 2017. A comparison of closed-form and finite-element solutions for heat transfer in a nearly horizontal, unglazed flat plate PVT water collector: Performance assessment. *Sol. Energy* 141, 11–24. <https://doi.org/10.1016/j.solener.2016.11.015>.
- Moss, R.W., Henshall, P., Arya, F., Shire, G.S.F., Hyde, T., Eames, P.C., 2018. Performance and operational effectiveness of evacuated flat plate solar collectors compared with conventional thermal, PVT and PV panels. *Appl. Energy* 216, 588–601. <https://doi.org/10.1016/j.apenergy.2018.01.001>.
- Narooei, M., Sarhaddi, F., Sobhnamayan, F., 2018. Efficiency of a photovoltaic thermal stepped solar still: Experimental and numerical analysis. *Desalination* 441, 87–95. <https://doi.org/10.1016/j.desal.2018.04.014>.
- Naves, A.X., Barreneche, C., Fernández, A.I., Cabeza, L.F., Haddad, A.N., Boer, D., 2019. Life cycle costing as a bottom line for the life cycle sustainability assessment in the solar energy sector: A review. *Sol. Energy* 192, 238–262. <https://doi.org/10.1016/j.solener.2018.04.011>.
- Nazri, N.S., Fudholi, A., Mustafa, W., Yen, C.H., Mohammad, M., Ruslan, M.H., Sopian, K., 2019. Exergy and improvement potential of hybrid photovoltaic thermal / thermoelectric (PVT/TE) air collector. *Renew. Sustain. Energy Rev.* 111, 132–144. <https://doi.org/10.1016/j.rser.2019.03.024>.
- Nishioka, K., Takamoto, T., Agui, T., Kaneiwa, M., Uraoka, Y., Fuyuki, T., 2006. Annual output estimation of concentrator photovoltaic systems using high-efficiency InGaP/InGaAs/Ge triple-junction solar cells based on experimental solar cell's characteristics and field-test meteorological data. *Sol. Energy Mater. Sol. Cells* 90, 57–67. <https://doi.org/10.1016/j.solmat.2005.01.011>.
- Noro, M., Lazzarin, R.M., 2014. Solar cooling between thermal and photovoltaic: An energy and economic comparative study in the Mediterranean conditions. *Energy.* <https://doi.org/10.1016/j.energy.2014.06.035>.
- Numan, A., Kaya, F., 2019. Effect on the exergy of the PVT system of fins added to an air-cooled channel: A study on temperature and air velocity with ANSYS Fluent 184, 561–569. <https://doi.org/10.1016/j.solener.2019.03.100>.
- Olaleru, S.A., Kirui, J.K., Wamwangi, D., Roro, K.T., Mwakikunga, B., 2020. Perovskite solar cells: The new epoch in photovoltaics. *Sol. Energy.* <https://doi.org/10.1016/j.solener.2019.12.025>.
- Ong, K.S., Naghavi, M.S., Lim, C., 2017. Thermal and electrical performance of a hybrid design of a solar-thermoelectric system. *Energy Convers. Manage.* 133, 31–40. <https://doi.org/10.1016/j.enconman.2016.11.052>.
- Palomino-resendiz, S.I., Flores-hernández, D.A., Lozada-castillo, N., Guzmán-vargas, L., 2018. Design and implementation of a robotic active solar distiller based on a Fresnel concentrator and a photovoltaic system. *Energy Convers. Manage.* 166, 637–647. <https://doi.org/10.1016/j.enconman.2018.04.069>.
- Pang, W., Zhang, Q., Cui, Y., Zhang, L., Yu, H., Zhang, X., Zhang, Y., Yan, H., 2019. Numerical simulation and experimental validation of a photovoltaic/thermal system based on a roll-bond aluminum collector. *Energy* 187, 115990. <https://doi.org/10.1016/j.energy.2019.115990>.

- Paul Ayeng'o, S., Axelsen, H., Haberschus, D., Sauer, D.U., 2019. A model for direct-coupled PV systems with batteries depending on solar radiation, temperature and number of serial connected PV cells. *Sol. Energy* 183, 120–131. <https://doi.org/10.1016/j.solener.2019.03.010>.
- Pham, T.T., Vu, N.H., Shin, S., 2018. Design of curved fresnel lens with high performance creating competitive price concentrator photovoltaic. *Energy Procedia* 144, 16–32. <https://doi.org/10.1016/j.egypro.2018.06.004>.
- Proell, M., Osgyan, P., Karrer, H., Brabec, C.J., 2017. Experimental efficiency of a low concentrating CPC PVT flat plate collector. *Sol. Energy* 147, 463–469. <https://doi.org/10.1016/j.solener.2017.03.055>.
- Qiu, Z., Zhao, X., Li, P., Zhang, X., Ali, S., Tan, J., 2015. Theoretical investigation of the energy performance of a novel MPCM (Microencapsulated Phase Change Material) slurry based PV/T module. *Energy* 87, 686–698. <https://doi.org/10.1016/j.energy.2015.05.040>.
- Rafiei, A., Sulaiman, A., Mahadzir, S., Loni, R., Naja, G., Kasaeian, A., 2019. Thermal analysis of a hybrid solar desalination system using various shapes of cavity receiver: cubical, cylindrical, and hemispherical. *Energy Convers. Manag.* 198, 111861. <https://doi.org/10.1016/j.enconman.2019.111861>.
- Rajvikram, M., Sivasankar, G., 2019. Experimental study conducted for the identification of best heat absorption and dissipation methodology in solar photovoltaic panel. *Sol. Energy* 193, 283–292. <https://doi.org/10.1016/j.solener.2019.09.053>.
- Rashmi, Tiwari, A., Tiwari, G.N., Bhatti, T.S., 2019. Performance evaluation of a semi-transparent photovoltaic thermal (SPVT) inverted absorber flat plate collector (IAFPC) for constant collection temperature (CCT) mode. *Sol. Energy* 186, 382–391. <https://doi.org/10.1016/j.solener.2019.05.022>.
- Renno, C., Landi, G., Petito, F., Neitzert, H.C., 2018. Influence of a degraded triple-junction solar cell on the CPV system performances. *Energy Convers. Manag.* 160, 326–340. <https://doi.org/10.1016/j.enconman.2018.01.026>.
- Renno, C., Petito, F., 2016. Experimental and theoretical model of a concentrating photovoltaic and thermal system. *Energy Convers. Manag.* 126, 516–525. <https://doi.org/10.1016/j.enconman.2016.08.027>.
- Renno, C., Petito, F., 2013. Design and modeling of a concentrating photovoltaic thermal (CPV / T) system for a domestic application. *Energy Build.* 62, 392–402. <https://doi.org/10.1016/j.enbuild.2013.02.040>.
- Riahia, A., Ali, A.H., Fadhel, A., Guizania, A., Balghouthi, M., 2020. Performance investigation of a concentrating photovoltaic thermal hybrid solar system combined with thermoelectric generators. *Energy Convers. Manag.* 205, 112377. <https://doi.org/10.1016/j.enconman.2019.112377>.
- Riffat, S.B., Cuce, E., 2011. A review on hybrid photovoltaic/thermal collectors and systems. *Int. J. Low-Carbon Technol.* 6, 212–241. <https://doi.org/10.1093/ijlct/ctr016>.
- Robledo, J., Leloux, J., Lorenzo, E., Gueymard, C.A., 2019. From video games to solar energy: 3D shading simulation for PV using GPU. *Sol. Energy* 193, 962–980. <https://doi.org/10.1016/j.solener.2019.09.041>.
- Saeedi, F., Sarhaddi, F., Behzadmehr, A., 2015. Optimization of a PV / T (photovoltaic / thermal) active solar still. *Energy* 87, 142–152. <https://doi.org/10.1016/j.energy.2015.04.062>.
- Sahota, L., Tiwari, G.N., 2017. Review on series connected photovoltaic thermal (PVT) systems: Analytical and experimental studies. *Sol. Energy* 150, 96–127. <https://doi.org/10.1016/j.solener.2017.04.023>.
- Saini, V., Tripathi, R., Tiwari, G.N., Al-Helal, I.M., 2018. Electrical and thermal energy assessment of series connected N partially covered photovoltaic thermal (PVT)-compound parabolic concentrator (CPC) collector for different solar cell materials. *Appl. Therm. Eng.* 128, 1611–1623. <https://doi.org/10.1016/j.applthermaleng.2017.09.119>.
- Sakellariou, E., Axapoulos, P., 2018. An experimentally validated, transient model for sheet and tube PVT collector. *Sol. Energy* 174, 709–718. <https://doi.org/10.1016/j.solener.2018.09.058>.
- Sark, W.G.J.H.M. Van, 2011. Feasibility of photovoltaic – Thermoelectric hybrid modules. *Appl. Energy* 88, 2785–2790. <https://doi.org/10.1016/j.apenergy.2011.02.008>.
- Sathe, T.M., Dhoble, A.S., 2017. A review on recent advancements in photovoltaic thermal techniques. *Renew. Sustain. Energy Rev.* 76, 645–672. <https://doi.org/10.1016/j.rser.2017.03.075>.
- Schmitz, M., Wiik, N., Ambrosetti, G., Pedretti, A., Paredes, S., Ruch, P., Michel, B., Steinfeld, A., 2017. A 6-focus high-concentration photovoltaic-thermal dish system. *Sol. Energy* 155, 445–463. <https://doi.org/10.1016/j.solener.2017.05.087>.
- Senthilraja, S., Gangadevi, R., Marimuthu, R., Baskaran, M., 2019. Performance evaluation of water and air based PVT solar collector for hydrogen production application. *Int. J. Hydrogen Energy In Press.* <https://doi.org/10.1016/j.ijhydene.2019.02.223>.
- Shadmehri, M., Narei, H., Ghasempour, R., Behshad, M., 2018. Numerical simulation of a concentrating photovoltaic-thermal solar system combined with thermoelectric modules by coupling Finite Volume and Monte Carlo Ray-Tracing methods. *Energy Convers. Manag.* 172, 343–356. <https://doi.org/10.1016/j.enconman.2018.07.034>.
- Shah, T.R., Ali, H.M., 2019a. Applications of hybrid nanofluids in solar energy, practical limitations and challenges: A critical review. *Sol. Energy*. <https://doi.org/10.1016/j.solener.2019.03.012>.
- Shah, T.R., Ali, H.M., 2019b. Applications of hybrid nanofluids in solar energy, practical limitations and challenges: A critical review. *Sol. Energy* 183, 173–203. <https://doi.org/10.1016/j.solener.2019.03.012>.
- Shanks, K., Ferrer-Rodríguez, J.P., Fernández, E.F., Almonacid, F., Pérez-Higueras, P., Senthilarasu, S., Mallick, T., 2018. A > 3000 suns high concentrator photovoltaic design based on multiple Fresnel lens primaries focusing to one central solar cell. *Sol. Energy* 169, 457–467. <https://doi.org/10.1016/j.solener.2018.05.016>.
- Sharaf, O.Z., Orhan, M.F., 2018. Comparative thermodynamic analysis of densely-packed concentrated photovoltaic thermal (CPVT) solar collectors in thermally in-series and in-parallel receiver configurations. *Renew. Energy* 126, 296–321. <https://doi.org/10.1016/j.renene.2018.03.026>.
- Sharshir, S.W., Peng, G., Yang, N., Eltawil, M.A., Ali, M.K.A., Kabeel, A.E., 2016. A hybrid desalination system using humidification-dehumidification and solar stills integrated with evacuated solar water heater. *Energy Convers. Manag.* 124, 287–296. <https://doi.org/10.1016/j.enconman.2016.07.028>.
- Shittu, S., Li, G., Zhao, X., Akhlaghi, Y.G., Ma, X., Yu, M., 2019. Comparative study of a concentrated photovoltaic-thermoelectric system with and without fl at plate heat pipe. *Energy Convers. Manag.* 193, 1–14. <https://doi.org/10.1016/j.enconman.2019.04.055>.
- Shittu, S., Li, G., Zhao, X., Ma, X., Golizadeh, Y., Fan, Y., 2020. Comprehensive study and optimization of concentrated photovoltaic-thermoelectric considering all contact resistances. *Energy Convers. Manag.* 205, 112422. <https://doi.org/10.1016/j.enconman.2019.112422>.
- Shyam, Tiwari, G.N., Al-helal, I.M., 2015. Analytical expression of temperature dependent electrical efficiency of N-PVT water collectors connected in series. *Sol. ENERGY* 114, 61–76. <https://doi.org/10.1016/j.solener.2015.01.026>.
- Singh, D.B., 2017. Improving the performance of single slope solar still by including N identical PVT collectors. *Appl. Therm. Eng.* 131, 167–179. <https://doi.org/10.1016/j.applthermaleng.2017.11.146>.
- Singh, D.B., Yadav, J.K., Dwivedi, V.K., Kumar, S., Tiwari, G.N., Al-helal, I.M., 2016a. ScienceDirect Experimental studies of active solar still integrated with two hybrid PVT collectors. *Sol. ENERGY* 130, 207–223. <https://doi.org/10.1016/j.solener.2016.02.024>.
- Singh, H., Sabry, M., Redpath, D.A.G., 2016b. Experimental investigations into low concentrating line axis solar concentrators for CPV applications. *Sol. Energy* 136, 421–427. <https://doi.org/10.1016/j.solener.2016.07.029>.
- Singh, H.P., Jain, A., Singh, A., Arora, S., 2019. Influence of absorber plate shape factor and mass flow influence of absorber plate shape factor and mass flow rate on the performance. *Appl. Therm. Eng.* <https://doi.org/10.1016/j.applthermaleng.2019.04.070>.
- Singh, N.P., Reddy, K.S., 2020. Inverse heat transfer technique for estimation of focal flux distribution for a concentrating photovoltaic (CPV) square solar parabola dish collector. *Renew. Energy* 145, 2783–2795. <https://doi.org/10.1016/j.renene.2019.07.122>.
- Skjølstrup, E.J.H., Søndergaard, T., 2016. Design and optimization of spectral beamsplitter for hybrid thermoelectric-photovoltaic concentrated solar energy devices. *Sol. Energy* 139, 149–156. <https://doi.org/10.1016/j.solener.2016.09.036>.
- Slimani, M.E.A., Amirat, M., Kurucz, I., Bahria, S., Hamidat, A., Chaouch, B.W., 2016. A detailed thermal-electrical model of three photovoltaic / thermal (PV / T) hybrid air collectors and photovoltaic (PV) module : Comparative study under Algiers climatic conditions. *Energy Convers. Manag.* 133, 458–476. <https://doi.org/10.1016/j.enconman.2016.10.066>.
- Solanki, S.C., Dubey, S., Tiwari, A., 2009. Indoor simulation and testing of photovoltaic thermal (PV / T) air collectors. *Appl. Energy* 86, 2421–2428. <https://doi.org/10.1016/j.apenergy.2009.03.013>.
- Soltani, S., Kasaeian, A., Sokhansefat, T., Behshad, M., 2018. Performance investigation of a hybrid photovoltaic / thermoelectric system integrated with parabolic trough collector. *Energy Convers. Manag.* 159, 371–380. <https://doi.org/10.1016/j.enconman.2017.12.091>.
- Sonneveld, P.J., Swinkels, G.L.A.M., Tuijl, B.A.J. Van, Janssen, H.J.J., Campen, J., Bot, G.P.A., 2011. Performance of a concentrated photovoltaic energy system with static linear Fresnel lenses. *Sol. Energy* 85, 432–442. <https://doi.org/10.1016/j.solener.2010.12.001>.
- Sotehi, O., Chaker, A., Maalouf, C., 2016. Hybrid PV / T water solar collector for net zero energy building and fresh water production : A theoretical approach. *Desalination* 385, 1–11. <https://doi.org/10.1016/j.desal.2016.01.034>.
- Srivastava, S., Reddy, K.S., 2017. Simulation studies of thermal and electrical performance of solar linear parabolic trough concentrating photovoltaic system. *Sol. Energy* 149, 195–213. <https://doi.org/10.1016/j.solener.2017.04.004>.
- Sultan, S.M., Ervina Efzan, M.N., 2018. Review on recent Photovoltaic/Thermal (PV/T) technology advances and applications. *Sol. Energy* 173, 939–954. <https://doi.org/10.1016/j.solener.2018.08.032>.
- Syakirah, N., Fudholi, A., Bakhtyar, B., Hoy, C., Ibrahim, A., Ha, M., Mat, S., Sopian, K., 2018. Energy economic analysis of photovoltaic – thermal-thermoelectric (PVT-TE) air collectors. *Renew. Sustain. Energy Rev.* 92, 187–197. <https://doi.org/10.1016/j.rser.2018.04.061>.
- Taboada, M.E., Graber, T., Galleguillos, H., Cabeza, L.F., Rojas, R., Graber, T., Galleguillos, H., Cabeza, L.F., 2017. Solar water heating system and photovoltaic floating cover to reduce evaporation: Experimental results and modeling. *Renew. Energy* 105, 601–615. <https://doi.org/10.1016/j.renene.2016.12.094>.
- Tao, J., Yu, S., 2015. Review on feasible recycling pathways and technologies of solar photovoltaic modules. *Sol. Energy Mater. Sol. Cells* 141, 108–124. <https://doi.org/10.1016/j.solmat.2015.05.005>.
- Tiwari, A., Alashqar, O.A., Dimri, N., 2020a. Modeling and validation of photovoltaic thermoelectric flat plate collector. *Energy Convers. Manag.* 205, 112378. <https://doi.org/10.1016/j.enconman.2019.112378>.
- Tiwari, D., Sherwani, A.F., Atheaya, D., Kumar, A., Kumar, N., 2020b. Thermodynamic analysis of Organic Rankine cycle driven by reversed absorber hybrid photovoltaic thermal compound parabolic concentrator system. *Renew. Energy* 147, 2118–2127. <https://doi.org/10.1016/j.renene.2019.10.018>.
- Tiwari, G.N., Khan, M.E., Mishra, R.K., Garg, V., 2018a. Improved Hottel-Whillier-Bliss equation for N-photovoltaic thermal- compound parabolic concentrator (N-PVT-CPC) collector. *Sol. Energy* 166, 203–212. <https://doi.org/10.1016/j.solener.2018.02.058>.
- Tiwari, G.N., Meraj, M., Khan, M.E., 2018b. Energy analysis of N-photovoltaic thermal-compound parabolic concentrator (N-PVT-CPC) collector for constant collection temperature for vapor absorption refrigeration (VAR) system. *Sol. Energy* 173,

- 1032–1042. <https://doi.org/10.1016/j.solener.2018.08.031>.
- Tiwari, G.N., Nayak, S., Dubey, S., Solanki, S.C., Singh, R.D., 2009. Performance analysis of a conventional PV / T mixed mode dryer under no load condition. *Int. J. ENERGY Res.* 33, 919–930. <https://doi.org/10.1002/er.152>.
- Tiwari, S., Tiwari, G.N., 2017a. Grapes (*Vitis vinifera*) drying by semitransparent photovoltaic module (SPVM) integrated solar dryer : an experimental study. *heat mass Transf.*
- Tiwari, S., Tiwari, G.N., 2017. Energy and exergy analysis of a mixed-mode greenhouse-type solar dryer, integrated with partially covered N-PVT air collector. *Energy*. <https://doi.org/10.1016/j.energy.2017.04.022>.
- Tiwari, S., Tiwari, G.N., 2016a. Exergoeconomic analysis of photovoltaic-thermal (PVT) mixed mode greenhouse solar dryer. *Energy* 114, 155–164. <https://doi.org/10.1016/j.energy.2016.07.132>.
- Tiwari, S., Tiwari, G.N., 2016b. Thermal analysis of photovoltaic-thermal (PVT) single slope roof integrated greenhouse solar dryer. *Sol. Energy* 138, 128–136. <https://doi.org/10.1016/j.solener.2016.09.014>.
- Tiwari, S., Tiwari, G.N., Al-helal, I.M., 2016. Performance analysis of photovoltaic – thermal (PVT) mixed mode greenhouse solar dryer. *Sol. Energy* 133, 421–428. <https://doi.org/10.1016/j.solener.2016.04.033>.
- Trindade, A., Cordeiro, L., 2019. Automated formal verification of stand-alone solar photovoltaic systems. *Sol. Energy* 193, 684–691. <https://doi.org/10.1016/j.solener.2019.09.093>.
- Tripathi, R., Tiwari, G.N., 2017. Annual performance evaluation (energy and exergy) of fully covered concentrated photovoltaic thermal (PVT) water collector : An experimental validation. *Sol. Energy* 146, 180–190. <https://doi.org/10.1016/j.solener.2017.02.041>.
- Tripathi, R., Tiwari, G.N., 2016. Energetic and exergetic analysis of N partially covered photovoltaic thermal-compound parabolic concentrator (PVT-CPC) collectors connected in series. *Sol. Energy* 137, 441–451. <https://doi.org/10.1016/j.solener.2016.08.048>.
- Tripathi, R., Tiwari, G.N., Al-Helal, I.M., 2016. Thermal modelling of N partially covered photovoltaic thermal (PVT) - Compound parabolic concentrator (CPC) collectors connected in series. *Sol. Energy* 123, 174–184. <https://doi.org/10.1016/j.solener.2015.11.014>.
- Valančius, K., Mikučionienė, R., 2020. Solar energy as a tool of renovating soviet-type multi apartment buildings. *Sol. Energy* 198, 93–100. <https://doi.org/10.1016/j.solener.2020.01.046>.
- Valizadeh, M., Sarhaddi, F., Adeli, Mahdavi, 2019. Exergy performance assessment of a linear parabolic trough photovoltaic thermal collector. *Renew. Energy* 138, 1028–1041. <https://doi.org/10.1016/j.renene.2019.02.039>.
- Wang, G., Wang, F., Shen, F., Chen, Z., Hu, P., 2019a. Novel design and thermodynamic analysis of a solar concentration PV and thermal combined system based on compact linear Fresnel reflector. *Energy* 180, 133–148. <https://doi.org/10.1016/j.energy.2019.05.082>.
- Wang, J., Chen, Y., Lior, N., Li, W., 2019b. Energy, exergy and environmental analysis of a hybrid combined cooling heating and power system integrated with compound parabolic concentrated-photovoltaic thermal solar collectors. *Energy* 185, 463–476. <https://doi.org/10.1016/j.energy.2019.07.027>.
- Widyolar, B.K., Abdelhamid, M., Jiang, L., Winston, R., Yablonoitch, E., Scranton, G., Cygan, D., Abbasi, H., Kozlov, A., 2017. Design, simulation and experimental characterization of a novel parabolic trough hybrid solar photovoltaic/thermal (PV/T) collector. *Renew. Energy* 101, 1379–1389. <https://doi.org/10.1016/j.renene.2016.10.014>.
- Wolf, M., 1976. Performance analyses of combined heating and photovoltaic power systems for residences. *energy Convers.* 16, 79–90.
- Wu, J., Zhang, X., Shen, J., Wu, Y., Connelly, K., Yang, T., Tang, L., Xiao, M., Wei, Y., Jiang, K., Chen, C., Xu, P., Wang, H., 2016. A review of thermal absorbers and their integration methods for the combined solar photovoltaic / thermal (PV / T) modules. *Renew. Sustain. Energy Rev.* 1–15. <https://doi.org/10.1016/j.rser.2016.11.063>.
- Wu, Y., Eames, P., Mallick, T., Sabry, M., 2012. Experimental characterisation of a Fresnel lens photovoltaic concentrating system. *Sol. Energy* 86, 430–440. <https://doi.org/10.1016/j.solener.2011.10.032>.
- Xu, G., Zhang, X., Deng, S., 2011. Experimental study on the operating characteristics of a novel low-concentrating solar photovoltaic / thermal integrated heat pump water heating system. *Appl. Therm. Eng.* 31, 3689–3695. <https://doi.org/10.1016/j.applthermaleng.2011.01.030>.
- Xu, N., Ji, J., Sun, W., Huang, W., Li, J., Jin, Z., 2016. Numerical simulation and experimental validation of a high concentration photovoltaic / thermal module based on point-focus Fresnel lens. *Appl. Energy* 168, 269–281. <https://doi.org/10.1016/j.apenergy.2016.01.077>.
- Xu, Z., Kleinstreuer, C., 2014. Concentration photovoltaic – thermal energy co-generation system using nanofluids for cooling and heating. *ENERGY Convers. Manag.* 87, 504–512. <https://doi.org/10.1016/j.enconman.2014.07.047>.
- Yahya, M., Fahmi, H., Fudholi, A., Sopian, K., 2018. Performance and economic analyses on solar-assisted heat pump fluidised bed dryer integrated with biomass furnace for rice drying. *Sol. Energy* 174, 1058–1067. <https://doi.org/10.1016/j.solener.2018.10.002>.
- Yang, K.Y., Lee, W., Jeon, J.Y., Ha, T.J., Kim, Y.H., 2020. Controlling the visibility of embedded silicon solar cells in building-integrated photovoltaic windows using surface structure modification and metal-oxide back coating. *Sol. Energy* 197, 99–104. <https://doi.org/10.1016/j.solener.2019.12.058>.
- Yang, Z., Li, W., Chen, X., Su, S., Lin, G., Chen, J., 2018. Maximum efficiency and parametric optimum selection of a concentrated solar spectrum splitting photovoltaic cell-thermoelectric generator system. *Energy Convers. Manag.* 174, 65–71. <https://doi.org/10.1016/j.enconman.2018.08.038>.
- Yazdanifard, F., Ameri, M., 2018. Exergetic advancement of photovoltaic/thermal systems (PV/T): A review. *Renew. Sustain. Energy Rev.* 97, 529–553. <https://doi.org/10.1016/j.rser.2018.08.053>.
- Yazdanifard, F., Ebrahimi-bajestan, E., Ameri, M., 2016. Investigating the performance of a water-based photovoltaic / thermal (PV / T) collector in laminar and turbulent flow regime. *Renew. Energy* 99, 295–306. <https://doi.org/10.1016/j.renene.2016.07.004>.
- Yazdanifard, F., Ebrahimi-bajestan, E., Ameri, M., 2017. Performance of a parabolic trough concentrating photovoltaic/thermal system: Effects of flow regime, design parameters, and using nanofluids. *Energy Convers. Manag.* 148, 1265–1277. <https://doi.org/10.1016/j.enconman.2017.06.075>.
- Yazdanpanahi, J., Sarhaddi, F., Adeli, M.M., 2015. Experimental investigation of exergy efficiency of a solar photovoltaic thermal (PVT) water collector based on exergy losses. *Sol. ENERGY* 118, 197–208. <https://doi.org/10.1016/j.solener.2015.04.038>.
- Yew, T., Chong, K., Lim, B., 2015. Performance study of crossed compound parabolic concentrator as secondary optics in non-imaging dish concentrator for the application of dense-array concentrator photovoltaic system. *Sol. ENERGY* 120, 296–309. <https://doi.org/10.1016/j.solener.2015.07.026>.
- Yin, E., Li, Q., Xuan, Y., 2019. Feasibility analysis of a concentrating photovoltaic-thermoelectric-thermal cogeneration. *Appl. Energy* 236, 560–573. <https://doi.org/10.1016/j.apenergy.2018.12.019>.
- Yin, E., Li, Q., Xuan, Y., 2018. A novel optimal design method for concentration spectrum splitting photovoltaic-thermoelectric hybrid system. *Energy* 163, 519–532. <https://doi.org/10.1016/j.energy.2018.08.138>.
- Yu, Y., Yang, H., Peng, J., Long, E., 2019. Performance comparisons of two flatplate photovoltaic thermal collectors with different channel configurations. *Energy* 175, 300–308. <https://doi.org/10.1016/j.energy.2019.03.054>.
- Zhang, G., Wei, J., Wang, Z., Xie, H., Xi, Y., Khalid, M., 2019a. Investigation into effects of non-uniform irradiance and photovoltaic temperature on performances of photovoltaic / thermal systems coupled with truncated compound parabolic concentrators ☆. *Appl. Energy* 250, 245–256. <https://doi.org/10.1016/j.apenergy.2019.05.022>.
- Zhang, H., Liang, K., Chen, H., Gao, D., Guo, X., 2019b. Thermal and electrical performance of low-concentrating PV/T and flat-plate PV/T systems: A comparative study. *Energy* 177, 66–76. <https://doi.org/10.1016/j.energy.2019.04.056>.
- Zhang, X., Shen, J., Xu, P., Zhao, X., Xu, Y., 2014. Socio-economic performance of a novel solar photovoltaic / loop-heat-pipe heat pump water heating system in three different climatic regions. *Appl. Energy* 135, 20–34. <https://doi.org/10.1016/j.apenergy.2014.08.074>.
- Zhang, X., Zhao, X., Xu, J., Yu, X., 2013. Characterization of a solar photovoltaic / loop-heat-pipe heat pump water heating system. *Appl. Energy* 102, 1229–1245. <https://doi.org/10.1016/j.apenergy.2012.06.039>.
- Zhu, W., Deng, Y., Wang, Y., Shen, S., Gullam, R., 2016. High-performance photovoltaic-thermoelectric hybrid power generation system with optimized thermal management. *Energy* 100, 91–101. <https://doi.org/10.1016/j.energy.2016.01.055>.

## Chapitre 2

### **Système hybride photovoltaïque/thermique à concentrateur parabolique : modélisation thermique et analyse paramétrique**

Comme mentionné dans l'introduction, il existe une tendance à « fusionner » des systèmes d'énergie solaire tels que le PV avec le PTC (Parabolic Trough Collector) pour obtenir un système solaire hybride PTPVT (Parabolic Trough Photovoltaïque/Thermal). Dans ce chapitre, le système hybride PTPVT est considéré. C'est un système solaire hybride qui permet la génération simultanée d'énergie électrique et d'énergie thermique. L'objectif principal de ce système est d'exploiter l'énergie solaire pour produire de l'eau chaude et de l'électricité.

Cette étude consiste, dans la **section 1**, en une introduction générale sur l'énergie solaire et la tendance à combiner les systèmes solaires pour obtenir des systèmes solaires hybrides, en particulier le système PTPVT. La **section 2** décrit le concept du système PTPVT. Dans la **section 3**, une modélisation thermique des systèmes est réalisée en utilisant l'analogie de la résistance électrique, simulée à l'aide d'une procédure itérative et validée par comparaison avec des travaux antérieurs. La **section 4** est consacrée à la réalisation d'analyses paramétriques afin d'étudier l'influence de paramètres importants comme le nombre de Reynolds, la longueur du côté du récepteur, la longueur du tube récepteur et l'épaisseur de l'absorbeur thermique sur les performances thermiques et électriques du système. Enfin, la **section 5** tire les principales



conclusions et énonce quelques recommandations fondées sur les résultats de l'analyse paramétrique.

Le système (Figure 1) est de structure similaire au PTC conventionnel (Parabolic Trough Collector) dans lequel il est composé d'une feuille parabolique de matériau réfléchissant, d'un système de suivi, d'une structure de support et d'un tube absorbeur thermique qui est placé au foyer de la parabole réfléchissante.

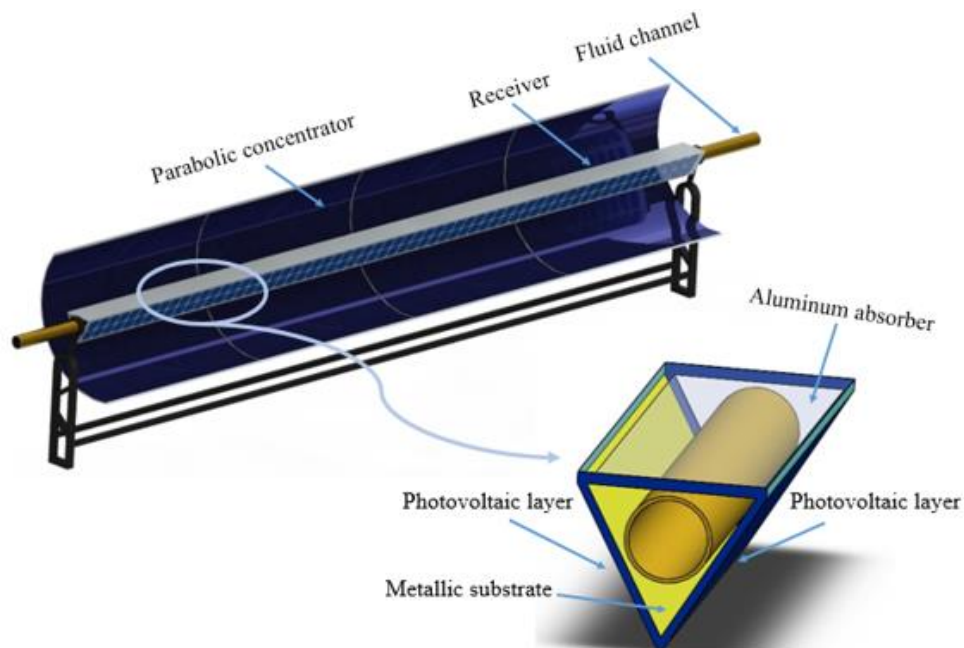

*Figure 1: Système hybride photovoltaïque/thermique à concentrateur parabolique étudié.*

Cependant, l'absorbeur thermique du PTC est un tube vitré métallique contenant le fluide de travail, tandis que celui du PTPVT étudié est un récepteur de forme triangulaire composé de cellules PV et d'un absorbeur thermique. Les couches PV sont situées des deux côtés du triangle qui rencontrent le concentrateur parabolique, tandis que l'absorbeur thermique est situé sur la face supérieure du récepteur triangulaire. De plus, le récepteur triangulaire comprend un canal de fluide circulaire où s'écoule le fluide de travail (fluide à chauffer) à l'intérieur. L'objectif du système



PTPV est de générer simultanément de l'énergie électrique à partir des couches PV et de l'énergie thermique à partir de l'absorbeur thermique et des couches PV. Cette étude porte sur une nouvelle méthodologie pour établir une modélisation thermique appropriée avec sa procédure itérative associée et une étude paramétrique complète des performances du système pour émettre des recommandations pratiques.

Les résultats révèlent que l'augmentation du nombre de Reynolds de 1000 à 10000 conduit à une diminution du rendement thermique de 65,10% à 56,88% et à une augmentation du rendement électrique de 15,74% à 24,87%. De plus, on a obtenu qu'en écoulement laminaire le rendement électrique augmente de 38,25% et le rendement thermique diminue de 8,31%, tandis qu'en écoulement turbulent, le rendement électrique augmente de 5,78% et le rendement thermique diminue de 2,12%. Cela signifie que le nombre de Reynolds a une influence sur les deux rendements dans le régime laminaire plus que dans le régime turbulent. Cependant, le rendement électrique diminue de 10,5% (de 23,24% à 20,81%) et le rendement thermique augmente de 35% (de 47,1% à 63,62%) lorsque la longueur du côté du récepteur augmente de 0,03 m à 0,2 m, ce qui montre l'importance de ce paramètre. De plus, lorsque la longueur du tube récepteur augmente de 4 m à 20 m, cela affecte légèrement le rendement électrique qui diminue de 25,46% à 24,97%, et le rendement thermique qui augmente de 56,35% à 56,79%. Ainsi, le rendement électrique est abaissé de 2% par rapport à sa valeur initiale, et le rendement thermique augmente de 0,78%, ce qui peut être considéré comme négligeable. De plus, l'augmentation de l'épaisseur de l'absorbeur de 0,02 m à 0,2 m n'a pas d'impact sur les deux rendements du système, les rendements thermique et électrique restent constants à 56,46% et 25,34% respectivement.

En conclusion le nombre de Reynolds et la longueur du côté du récepteur ont une influence significative par rapport à la longueur du tube récepteur et à l'épaisseur de l'absorbeur qui ont un

effet négligeable sur les performances du système. Par conséquent, pour les applications qui visent à maximiser l'efficacité électrique, le nombre de Reynolds doit être maximisé (le débit de fluide doit être augmenté) et/ou la longueur du côté du récepteur doit être minimisée. D'autre part, si l'amélioration de l'efficacité thermique est l'objectif de certaines applications, la longueur du côté du récepteur doit être maximisée et le nombre de Reynolds doit être minimisé. Cependant, si le but est d'obtenir une efficacité totale maximale du système, la longueur du côté récepteur doit être augmentée.

## **Système hybride photovoltaïque / thermique à concentrateur parabolique : modélisation thermique et analyse paramétrique**

Cet article est publié dans « **Renewable Energy** »

[doi.org/10.1016/j.renene.2020.11.009](https://doi.org/10.1016/j.renene.2020.11.009)

**Résumé** - La combinaison de systèmes d'énergie solaire qui conduisent à la maximisation de l'énergie solaire disponible est devenue une tendance au cours des dernières années. Dans ce contexte, le collecteur à concentrateur parabolique et le solaire photovoltaïque sont combinés entre eux pour obtenir un système hybride Photovoltaïque / Thermique à concentrateur parabolique qui permet simultanément la production d'électricité et la production d'eau chaude. La disposition et la cogénération du système sont décrites en détail dans cet article. La nouveauté de ce travail est de proposer une nouvelle méthodologie pour conduire la modélisation thermique de ce système qui est l'analogie de la résistance thermique et la simuler à l'aide d'une procédure itérative. Une analyse paramétrique est effectuée afin d'étudier l'influence du nombre de Reynolds, de la longueur du côté du récepteur et de la longueur du tube récepteur et de l'épaisseur de l'absorbeur sur les performances thermiques et électriques du système. Les résultats montrent que l'efficacité thermique diminue avec l'augmentation du nombre de Reynolds, respectivement de 8.31% et 2.12% dans l'écoulement laminaire et turbulent. Cependant, elle augmente d'environ 35% lorsque la longueur du côté récepteur augmente de 0.03 m à 0.2 m, et de 0.78% lorsque la longueur du tube récepteur augmente de 4 m à 20 m. En revanche, le rendement électrique augmente avec l'augmentation du nombre de Reynolds où il augmente de 38.25% dans le flux laminaire et de 5.78% dans le flux turbulent, alors qu'il diminue de 10.5% et 2% lorsque la longueur du côté récepteur et la longueur du tube récepteur augmentent. De plus, l'épaisseur de l'absorbeur n'a aucun effet sur le comportement thermique et électrique du système car les deux rendements restent presque constants (rendement thermique de 56.46% et rendement électrique de 25.34%) avec l'augmentation de l'épaisseur de l'absorbeur de 0.02 m à 0.2 m.

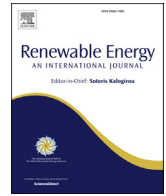

# Parabolic trough photovoltaic/thermal hybrid system: Thermal modeling and parametric analysis

Amal Herez <sup>a, b</sup>, Hicham El Hage <sup>a</sup>, Thierry Lemenand <sup>b</sup>, Mohamad Ramadan <sup>c, d</sup>, Mahmoud Khaled <sup>c, e, \*</sup>

<sup>a</sup> Energy and Thermo-fluid Group, Lebanese International University LIU, Bekaa, Lebanon

<sup>b</sup> LARIS EA 7315, University of Angers, ISTIA, Angers, France

<sup>c</sup> Energy and Thermo-fluid Group, International University of Beirut BIU, Beirut, Lebanon

<sup>d</sup> FCLAB, CNRS, Univ. Bourgogne Franche-Comté, Belfort Cedex, France

<sup>e</sup> University Paris Diderot, Sorbonne Paris Cité, Interdisciplinary Energy Research Institute (PIERI), Paris, France

## ARTICLE INFO

### Article history:

Received 13 June 2020

Received in revised form

8 October 2020

Accepted 3 November 2020

Available online 10 November 2020

### Keywords:

Parametric analysis

Hybrid system

PTC

PTPV

Modeling

Solar energy

Triple-junction PV cells

## ABSTRACT

Combining solar energy systems that lead to the maximization of the avail solar energy have become a trend during the recent years. In this context, parabolic trough collector and solar photovoltaics are combined with each other to obtain parabolic trough Photovoltaic/Thermal hybrid system which enables simultaneous generation of electricity and production of hot water. The layout and cogeneration of the system are described comprehensively in this work. The novelty of this work is suggesting a new methodology for conducting thermal modeling of this system which is the thermal resistance analogy and simulating it using iterative procedure. Parametric analysis is carried out in order to investigate the influence of Reynolds number, receiver side length and receiver tube length and absorber thickness on the thermal and electrical performance of the system. The results show that the thermal efficiency decreases with the increase in Reynolds number, where it diminishes by 8.31% and 2.12% in the laminar and turbulent flow, respectively. However, it increases by about 35% when the receiver side length augments from 0.03 m to 0.2 m, and by 0.78% when receiver tube length increases from 4 m to 20 m. On the other hand, the electrical efficiency augments with the rise in Reynolds number where it increases by 38.25% in the laminar flow and 5.78% in the turbulent flow, while it decreases by 10.5% and 2% when the receiver side length and receiver tube length increases. Furthermore, the absorber thickness has no effect on the thermal and electrical behavior of the system where both efficiencies remains almost constant (thermal efficiency of 56.46% and electrical efficiency of 25.34%) with the increase in the absorber thickness from 0.02 m to 0.2 m.

© 2020 Elsevier Ltd. All rights reserved.

## 1. Introduction

Adequate and safe energy is the main enabler for welfare and economic development of a society. As energy-related activities have significant environmental impacts, it is crucial to provide an energy system which covers the needs of the economies and conserves the environment. However, numerous are the existing sources of energy all over the world but a few of them are free from CO<sub>2</sub> emissions. Renewable energy [1–6] is the energy which is integrated from naturally replenished resources with approximately

null greenhouse gases and pollution emissions. Solar energy [7–11] is a type of renewable energy which is green, sustainable and environmentally friendly. It exploits solar radiation to either generate electric energy using solar photovoltaic (PV) or produce heat energy by solar thermal systems.

Parabolic trough collector (PTC) [12–17] is one of the most progressed and utilized type of solar collectors which is used for several applications mainly heating water. It is made up of reflective parabolic sheet, tracking system, supporting structure and a thermal receiver located at the focus of the reflective parabola. On the other hand, the trend in generating electricity all over the world is toward using solar PV [18–22]. Furthermore, there is a great tendency for utilizing hybrid solar systems in order to optimize the benefits from solar energy. Hence, utilizing a solar hybrid system

\* Corresponding author. Energy and Thermo-fluid Group, International University of Beirut BIU, Beirut, Lebanon.

E-mail address: [mahmoud.khaled@liu.edu.lb](mailto:mahmoud.khaled@liu.edu.lb) (M. Khaled).

Nomenclature			
A	Area	B	Beam
B	Curve coefficient	CO <sub>2</sub>	Carbon dioxide gas
C	Specific heat at constant pressure	Conc	Concentrator
CR	Concentration ratio	cond	Conduction
D	Diameter	conv	Convection
H	Convection heat transfer coefficient	CPC	Compound parabolic collector
I	Solar radiation	Elec	Electric
IAM	Incident angle modifier	F	Fluid
K	Thermal conductivity	HX	Heat exchanger
L	Tube length	Opt	Optical
NTU	Number of transfer unit	PTC	Parabolic trough collector
<i>Nu</i>	Nusselt number	PTPVT	Parabolic trough photovoltaic/thermal system
P	Power	PV	Photovoltaic
Pr	Prandtl number	Rad	Radiation
Q	Heat flow rate	Rec	Receiver
R	Thermal resistance	Sub	Substrate
Re	Reynolds number	Th	Thermal
S	Side length	Tot	Total
T	Temperature		
T	Thickness		
V	Velocity		
<i>Subscripts/abbreviations</i>		<i>Greek symbols</i>	
A	Air	<i>m</i>	Mass flow rate
abs	Absorber	$\epsilon$	Heat transfer effectiveness
Amb	Ambient	$\epsilon$	Emissivity
Ap	Aperture	$\Theta$	Incident angle
		$\sigma$	Stephan-Botzmann constant
		$\alpha$	Absorptance
		$\eta$	Efficiency

which combines parabolic trough solar collector with solar PV allows producing heat energy and electric energy simultaneously. This combination is known as parabolic trough photovoltaic thermal hybrid system in which PV layer is located at the absorber of the parabolic trough. Fig. 1 presents the concept of parabolic trough photovoltaic thermal collector.

Several researchers and scientists conducted studies on Parabolic Trough Photovoltaic Thermal systems (PTPVT) [23–25].

Calise and Vanoli [26] presented and simulated a mathematical modeling of parabolic trough photovoltaic/thermal collector. A

parametric study was conducted to study the effect of receiver side length, tube length, tube diameter, absorber area specific thermal resistance and aperture length. The results showed that the thermal and electrical efficiencies decrease with the increase in tube length and diameter. In addition, the increase in the receiver side length lead to increase in the thermal efficiency and decrease in the electrical efficiency. While the increase in the aperture length and the area specific thermal resistance of the thermal absorber lead to increase in the electrical efficiency and decrease in the thermal efficiency. In addition, Calise et al. [27] conducted a detailed finite-

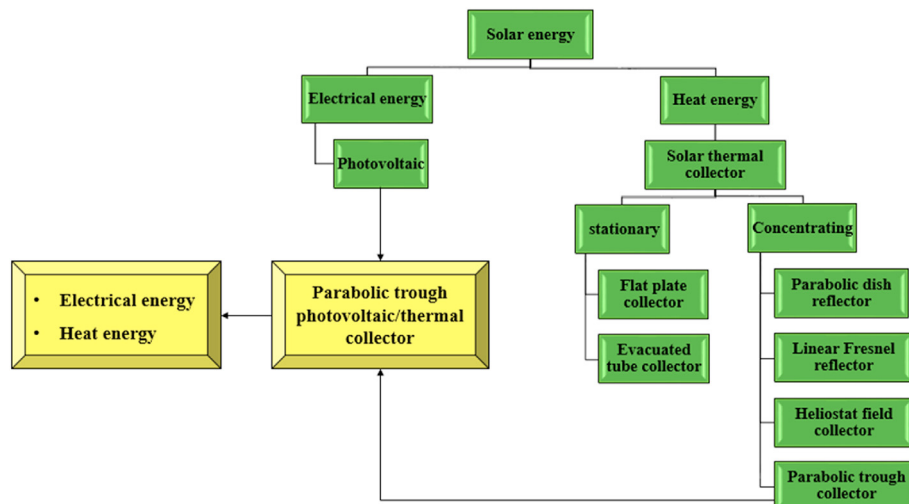

Fig. 1. Concept of parabolic trough photovoltaic thermal collector.

volume model of a concentrating photovoltaic/thermal solar collector in order to assess the thermodynamic and electrical parameters through the axis of the studied collector. Also, the authors performed a sensitivity analysis to study the influence of the main design/environmental parameters on the energetic and exergetic performance of the system.

Bernardo et al. [28] suggested a complete methodology to simulate, characterize and assess the performance of parabolic trough photovoltaic thermal hybrid solar system. The methodology relies on comparing the system with conventional system composed of traditional PV modules and flat plate collectors working side-by-side. The results revealed that the hybrid electrical efficiency is 6.4% and the optical efficiency is 45%.

Srivastava and Reddy [29] analyzed the thermal and electrical performance of PTPVT system according to distinct design and operating conditions. A compound parabolic collector (CPC) is installed in the system as a secondary reflector. Several configurations of the system are studied including 3-cell and 4 cell strings with CPC and 2-cell and 3-cell strings without CPC. Nano fluids and synthetic fluids are utilized in the analysis as working fluids. Results showed that the substitution of Nano-fluids by synthetic fluids leads to alleviation in the thermal output by 0.91–1.16% and mitigation in the electrical output by about 7.2–9.8%.

Ben Youssef et al. [30] conducted a simulation model on PTPVT system in order to evaluate the electrical and thermal performance of water loads for textile industrial application. The authors assessed the energy feasibility and performed economic analysis of PTPVT system.

Maatallah and Ben Youssef [31] developed a three dimensional models based on energy flow balance equations for PTPVT system using triple junction solar cells. Finite volume method simulation and Ray-Tracing 3D–4 Rays method are used to simulate the model. It was obtained that the thermal efficiency of the system decreases by slightly more than 6% and the electrical efficiency is noticeably influenced due to the discontinuity of the thermal conductivity along the absorber tube duct, post shading and non-uniformities in the distributions of PV cells temperature.

Cappelletti et al. [32] presented experimental investigation to characterize a small-scale photovoltaic thermal concentrated solar panel utilized in buildings for electricity generation and hot water production. The authors presented a description of a monitoring system that allows measuring the system electricity and hot water production. The predicted numerical values are validated by their experimental counterparts.

Karathanassis et al. [33] developed a dynamic theoretical model for predicting the long-term performance of a parabolic trough concentrating photovoltaic thermal system. The authors conducted exergy analysis to assess the influence of the main system sub-components on the exergy efficiency and exergy output of the studied system. It was concluded that the optical quality of the parabolic trough and the electrical efficiency of the PV module have a great effect on the exergetic performance of the system. For example, increase in optical quality to 0.75 and electric efficiency to 0.25 lead to increase the exergetic efficiency from 12% to 24%.

PTPVT system is a hybrid system which has a great potential to supply thermal and electrical energy in order to meet the world energy requirements with the least environmental side effects. Hence, it is an elegant solution that contribute in solving energy crisis and reduces environmental pollution. Nevertheless, the literature above shows that such system heavily depends on widely variety of parameters. However, studies and researches on this system are still rare. Therefore, PTPVT systems along with the effect of the different parameters on their performance deserve more investigations to be performed. In this context, the present work concerns a new methodology for establishing an appropriate

thermal modeling along with its associated iterative procedure and a complete parametric study of the system performance to raise practical recommendations. The originality of the work resides in the following points:

1. It suggests a new methodology for developing thermal modeling of PTPVT that permits to perform easily parametric studies with low computational time.
2. The material presented is important since the performance of PTPVT systems is analyzed using an appropriate thermal modeling and parametric analysis.
3. This work provides useful modeling and parametric analysis for PTPVT community. This advantage will be by using the developed thermal modeling in any study aiming to optimize the performance of PTPVT systems. It also offers the possibility to study the effect of a wide range of parameters on the performance of the system, particularly when it comes to study the feasibility of new concepts.
4. The parametric analysis performed provide practical recommendations based on the effect of the Reynolds number, receiver side and receiver tube length, and absorber thickness on the thermal and electrical performance of the system.

The paper is organized as follows: Section 2 describes the concept of the employed system. Section 3 demonstrates the thermal modeling and iterative procedure of the PTPVT system and section 4 presents the parametric analysis. Section 5 lists some conclusions and recommendations.

## 2. Concept of the system

The concept of the system is similar to that of the traditional parabolic trough collector; however, the metal glazed tube containing the working fluid (thermal absorber) of the PTC is replaced by a triangular shaped receiver (Fig. 2) which consists of two PV layers and one thermal absorber. The thermal absorber is placed on the top side of the triangular receiver while the other side of the triangle facing the parabolic concentrator contains the PV layers. This explains the fact that the thermal absorber absorbs the direct and the diffuse radiation in contrast to the PV layers which absorb only the direct beam radiation reflected by the parabolic concentrator. Triple-junction PV cell are used in the system studied in this work. Furthermore, a circular channel is placed inside the receiver in which fluid passing through it will be heated. Moreover, a metallic substrate is suited between the triangular receiver and the fluid tube for better heat transfer conduction. Fig. 2 exposes a schematic of the system layout.

In such system, solar radiation is directed towards the parabolic concentrator that reflects the direct beam irradiance to the two sides of triangular receiver that contains the PV layers (which act also as thermal absorber). Simultaneously, the thermal absorber lying on the top of the triangular receiver absorbs solar radiation. Hence, PTPVT system generates concurrently electrical energy from the PV layers and thermal energy from the thermal absorber and the PV layers. The produced electricity can be used directly to operate several applications, while the generated thermal energy is utilized to heat the flowing fluid inside the channel.

## 3. Thermal modeling and iterative procedure

### 3.1. Thermal modeling

The thermal modeling of the studied system is developed based on thermal resistance analogy. Fig. 3 presents the thermal resistances of the system. Several assumptions are adopted in this

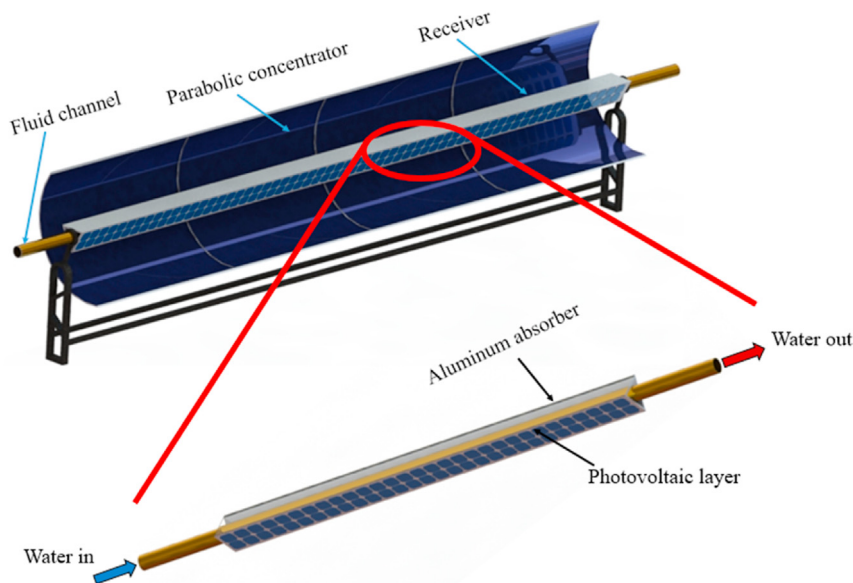

Fig. 2. PTPVT system layout.

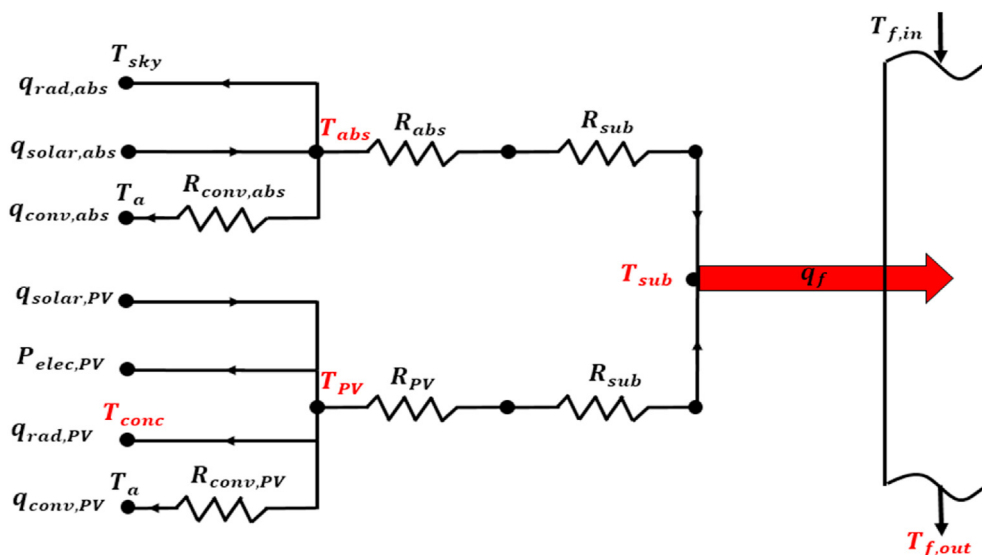

Fig. 3. Thermal resistances of the system where the unknown temperatures are presented in red. (For interpretation of the references to colour in this figure legend, the reader is referred to the Web version of this article.)

model such as:

- Thermodynamic equilibrium
- Steady state
- Uniform concentration of solar radiation along PV layer
- Negligible kinetic and potential energies
- Negligible temperature gradient in PV layer and metallic substrate

It is important to note that the thermal modeling suggested doesn't adopt an assumption that the thermal behavior is steady since the ambient temperature and solar radiation intensity are variable.

Instead, the thermal modeling concerns the steady state part of the thermal behavior where the ambient temperature and solar radiation variations are negligible and when quasi-stationary

yearly simulations are performed. It is a very useful tool especially when it comes to perform parametric studies or case studies. With respect to the simplified models used for the calculation of CPVT performance, it permits to take into account a larger number of operational parameters particularly those related to the solar concentration. On the other hand and with respect to higher dimensional models used in commercial software, the suggested thermal modeling along with associated iterative procedure permits it to be sufficiently fast and cheaper from a computational point of view and it permits to show in a very explicit way the relation between the different parameters that influence the performance of the PVT system.

The energy balance for the control volume including the PV layer and the absorber with the fluid channel is illustrated in Eq. (1):



$$q_{solar,PV} - P_{elec,PV} - q_{conv,PV} - q_{rad,PV} + q_{solar,abs} - q_{conv,abs} - q_{rad,abs} = q_f \quad (1)$$

where  $q_{solar,PV}$  and  $q_{solar,abs}$  are the available solar irradiation directed to the PV and thermal absorber respectively.  $q_{conv,PV}$  and  $q_{conv,abs}$  are the convective heat losses from the PV layer and thermal absorber respectively.  $q_{rad,PV}$  and  $q_{rad,abs}$  are the radiative heat losses from the PV layer and thermal absorber respectively.  $P_{elec,PV}$  is the electrical power generated by the PV cells.

The available solar irradiation directed to the PV is:

$$q_{solar,PV} = I_b A_{PV} CR_{PV} \alpha_{PV} \eta_{opt} IAM_{th} \quad (2)$$

where  $I_b$  is the beam radiation,  $A_{PV}$  is the area of PV layer,  $CR_{PV}$  is the concentration ratio which is calculated according to Eq. (3),  $\alpha_{PV}$  is the absorptance of PV layer,  $\eta_{opt}$  is the optical efficiency of the PV layer,  $IAM_{th}$  is the thermal incident angle modifier which can be obtained from Eq. (4) [28,34].

$$CR_{PV} = \frac{A_{ap}}{A_{PV}} \quad (3)$$

where  $A_{ap}$  is the aperture area.

$$IAM_{th} = 1 - b_{0,th} \left( \frac{1}{\cos\theta} - 1 \right) \text{ If } \theta < 60^\circ \quad IAM_{th} = \left[ 1 - b_{0,th} \left( \frac{1}{\cos\theta} - 1 \right) \right] \left( 1 - \frac{\theta - 60}{30} \right) \text{ If } \theta \geq 60^\circ \quad (4)$$

where  $b_{0,th}$  is the  $IAM_{th}$  curve coefficient and  $\theta$  is the incident angle.

$$P_{elec,PV} = I_b A_{PV} CR_{PV} \eta_{opt} IAM_{elec} \eta_{PV} \quad (5)$$

where  $IAM_{elec}$  is the electrical incident angle modifier which can be calculated from Eq. (6) [28,34] and  $\eta_{PV}$  is the efficiency of PV layer which can be obtained from Eq. (7) [26,35–37].

$$IAM_{elec} = 1 - b_{0,elec} \left( \frac{1}{\cos\theta} - 1 \right) \text{ If } \theta < 60^\circ \quad IAM_{elec} = \left[ 1 - b_{0,elec} \left( \frac{1}{\cos\theta} - 1 \right) \right] \left( 1 - \frac{\theta - 60}{30} \right) \text{ If } \theta \geq 60^\circ \quad (6)$$

where  $b_{0,elec}$  is the  $IAM_{elec}$  curve coefficient.

$$\eta_{PV,T} = 0.298 + 0.0142 \ln(CR_{PV}) + [-0.000715 + 0.0000697 \ln(CR_{PV})] (T_{PV} - 298) \quad (7)$$

The convective heat loss from the PV layer is:

$$q_{conv,PV} = \frac{T_{PV} - T_{amb}}{R_{conv,PV}} \quad (8)$$

with

$$R_{conv,PV} = \frac{1}{h_{PV} A_{PV}} \quad (9)$$

where  $T_a$  is the ambient temperature,  $R_{conv,PV}$  is the convection

thermal resistance of PV layer and  $h_{PV}$  is the convective heat transfer coefficient of PV layer.  $h_{PV}$  can be calculated using the following correlation where forced convection is assumed where the flow of wind is parallel to the plate [38].

$$Nu_f = 0.664 Pr_f^{1/3} Re_f^{1/2} \quad (10)$$

where  $Nu_f$ ,  $Re_f$  and  $Pr_f$  are the fluid Nusselt number, Reynolds number and Prandtl number respectively.

Since the PV is small with respect to the concentrator and enclosed totally by the latter, the concentrator is considered a large surrounding and then the view factors vanish and the radiation equation for heat losses from the PV layers can be written [38] as:

$$q_{rad,PV} = \varepsilon_{PV} \sigma A_{PV} (T_{PV}^4 - T_{conc}^4) \quad (11)$$

where  $T_{conc}$  is the concentrator temperature,  $\varepsilon_{PV}$  is the PV layer emissivity,  $\sigma$  is the Stephan-Boltzmann constant.

The available solar irradiation directed to the thermal absorber is:

$$q_{solar,abs} = I_{tot} A_{abs} \alpha_{abs} \quad (12)$$

where  $I_{tot}$  is the total radiation,  $A_{abs}$  and  $\alpha_{abs}$  are the thermal

absorber area and the thermal absorber absorptance respectively.

The convective heat losses from the thermal absorber is:

$$q_{conv,abs} = \frac{T_{abs} - T_{amb}}{R_{conv,abs}} \quad (13)$$

where  $T_{abs}$  is the absorber temperature and  $R_{conv,abs}$  is the convection thermal resistance of thermal absorber.

$$R_{conv,abs} = \frac{1}{h_{abs} A_{abs}} \quad (14)$$

where  $h_{abs}$  is the absorber convective heat transfer coefficient which is also calculated using the correlation in Eq. (10).

Since the absorber is very small with respect to the sky, the sky is considered a very large surrounding and then the view factors vanish and the radiation equation for heat losses from the absorber can be written [38] as:

$$q_{rad,abs} = \varepsilon_{abs} \sigma A_{abs} (T_{abs}^4 - T_{sky}^4) \quad (15)$$

where  $\varepsilon_{abs}$  is the absorber emissivity and  $T_{sky}$  the sky temperature.

The energy balance on the fluid gives:

$$q_f = \dot{m}_f C_f (T_{f,out} - T_{f,in}) \quad (16)$$

where  $\dot{m}_f$  is the fluid mass flow rate,  $C_f$  is fluid specific heat and  $T_{f,out}$  and  $T_{f,in}$  are the fluid outlet and inlet temperatures respectively.

The energy balance of the second control volume includes the thermal absorber and the substrate which is illustrated in Eq. (17).

$$q_{solar,abs} - q_{conv,abs} - q_{rad,abs} = q_{cond,abs-sub} \quad (17)$$

where  $q_{cond,abs-sub}$  is the conductive heat loss between the substrate and the thermal absorber.

$$q_{cond,abs-sub} = \frac{T_{abs} - T_{sub}}{R_{cond,abs} + R_{cond,sub}} \quad (18)$$

where  $R_{cond,abs}$  and  $R_{cond,sub}$  are the conductive thermal resistances for the absorber and the substrate respectively.

$$R_{cond,abs} = \frac{t_{abs}}{K_{abs} \cdot A_{abs}} \quad (19)$$

and

$$R_{cond,sub} = \frac{t_{sub}}{K_{sub} \cdot A_{sub}} \quad (20)$$

where  $t_{abs}$  and  $t_{sub}$  are respectively the absorber and the substrate thicknesses, and  $K_{abs}$  and  $K_{sub}$  are the thermal conductivity of the absorber and the substrate.

The energy balance of the control volume containing the substrate and the fluid channel is shown in Eq. (21).

$$q_{cond,PV-sub} + q_{cond,abs-sub} = q_f \quad (21)$$

where  $q_{cond,PV-sub}$  is the conductive heat loss between the substrate and the PV layer.

$$q_{cond,PV-sub} = \frac{T_{PV} - T_{sub}}{R_{cond,PV} + R_{cond,sub}} \quad (22)$$

where  $R_{cond,PV}$  is the conductive thermal resistances for the PV layer.

$$R_{cond,PV} = \frac{t_{PV}}{K_{PV} \cdot A_{PV}} \quad (23)$$

where  $t_{PV}$  and  $K_{PV}$  are the thickness and thermal conductivity of PV layer, respectively.

The energy balance on the parabolic concentrator is:

$$q_{solar,conc} + q_{rad,PV} = q_{conv,conc,front} + q_{conv,conc,back} + q_{rad,conc} \quad (24)$$

where  $q_{solar,conc}$  is the available solar radiation directed towards the concentrator,  $q_{conv,conc,front}$  and  $q_{conv,conc,back}$  are the convective heat losses from the concentrator front and back respectively, and  $q_{rad,conc}$  is the radiative heat losses from the concentrator.

The available solar radiation directed towards the concentrator is:

$$q_{solar,conc} = I_{tot} A_{conc} \alpha_{conc} \quad (25)$$

where  $A_{conc}$  and  $\alpha_{conc}$  are the concentrator area and absorptance

respectively.

The convective heat losses from the concentrator front and back are:

$$q_{conv,conc,front} = A_{conc} h_{conv,conc,front} (T_{conc} - T_{amb}) \quad (26)$$

and

$$q_{conv,conc,back} = A_{conc} h_{conv,conc,back} (T_{conc} - T_{amb}) \quad (27)$$

where  $h_{conv,conc,front}$  and  $h_{conv,conc,back}$  are respectively the front and back convective heat transfer coefficient of the concentrator.

The radiative heat losses from the concentrator is:

$$q_{rad,conc} = \epsilon_{conc} \sigma A_{conc} (T_{conc}^4 - T_{sky}^4) \quad (28)$$

where  $\epsilon_{conc}$  is the concentrator emissivity.

The last energy balance is presented in Eq. (29) which is conducted on the control volume comprising the substrate and the fluid channel where it is considered as a heat exchanger. Due to the high thermal conductivity of the metallic substrate, its temperature is assumed to be constant.

$$\dot{m}_f C_f (T_{f,out} - T_{f,in}) = \epsilon \dot{m}_f C_f (T_{sub} - T_{f,in}) \quad (29)$$

where  $\epsilon$  is the heat transfer effectiveness which can be calculated using NTU number:

$$\epsilon = 1 - e^{-NTU} \quad (30)$$

and

$$NTU = \frac{1}{\frac{1}{h_f} + R_{sub}} \frac{A_{HX}}{\dot{m}_f C_f} \quad (31)$$

where  $A_{HX}$  is the area of the heat exchanger and  $h_f$  is the fluid heat transfer coefficient which can be computed using the below correlation:

$$Nu_f = 0.023 Re_f^{0.4} Pr_f^{0.2} \quad (32)$$

Finally, the efficiencies of the system are computed by:

$$\eta_{elec} = \frac{P_{elec,PV}}{I_b A_{ap}} \quad (33)$$

where  $\eta_{elec}$  is the electrical efficiency

$$\eta_{th} = \frac{q_f}{I_b A_{ap}} \quad (34)$$

and  $\eta_{th}$  is the thermal efficiency.

### 3.2. Iterative procedure

As shown in Fig. 3, there are five unknown parameters which are:  $T_{f,out}$ ,  $T_{sub}$ ,  $T_{conc}$ ,  $T_{PV}$  and  $T_{abs}$ . Hence, five equations which present the thermal modeling of the system must be used in order to calculate these unknowns. However, since the equations are not linear, an iterative procedure is adopted as shown in Fig. 4 in which  $T_{PV}$  is first assumed, then by using Eq. (24)  $T_{conc}$  is calculated. After that, using Eqs (1), (17) and (29)  $T_{f,out}$ ,  $T_{sub}$  and  $T_{abs}$  are computed. Then,  $T_{PV}$  is calculated using Eq. (21) and compared with the assumed one. The system is repeated itself till the calculated and

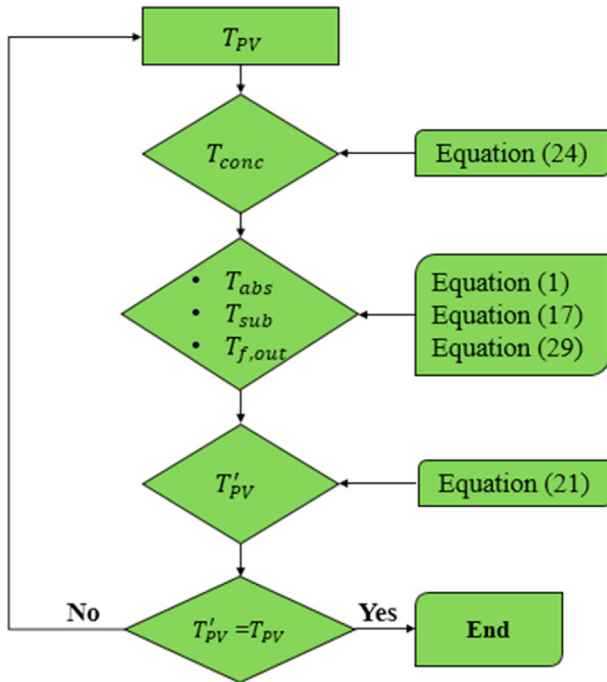

Fig. 4. Iterative procedure flow chart.

the assumed values of  $T_{PV}$  are equal to each other.

3.3. Model validation

The above proposed model is compared and validated with studies from the literature. The system used is similar to the system utilized by Calise and Vanoli [26], Bernardo et al. [28]. Table 1 presents the validation of the model by comparing the calculated PV and fluid outlet temperature, heat rate and electrical power with those of reference [26]. It is clear that the relative error with respect to the reference does not exceed 8% while varying receiver tube length and receiver side length.

4. Parametric analysis

A parametric analysis is conducted on the system in order to explore the effect of Reynolds number, receiver tube length and receiver side length, and absorber thickness (thermal resistance) on the performance of the system by calculating the overall thermal and electrical efficiencies. Table 2 clarifies the design parameters of PTPVT system [26,27,30,31].

Table 3 illustrates the boundary conditions that are considered

Table 1 Results from the conducted thermal model compared to data from Ref. [26].

Parameter	Value	$T_{f,out}$ (°C)	$T_{f,out}$ [26]	Deviation	$T_{PV}$ (°C)	$T_{PV}$ [26]	Deviation	$Q_{th}$ (W)	$Q_{th}$ [26]	Deviation	$P_{elec}$ (W)	$P_{elec}$ [26]	Deviation
Receiver side length (m)	0.04	77.4	79.1	2.1	83.9	82.9	-1.2	4800	5200	7.7	2200	2140	-2.8
	0.08	78	79.3	1.6	81.6	81.9	0.4	5100	5300	3.8	2100	2050	-2.4
	0.12	78.6	79.4	1.0	81.2	81.6	0.5	5400	5400	0.0	2060	2010	-2.5
	0.16	79.2	79.5	0.4	81.3	81.5	0.2	5500	5600	1.8	2000	1970	-1.5
	0.2	79.7	79.6	-0.1	81.6	81.4	-0.2	6000	6050	0.8	1900	1940	2.1
Receiver tube length (m)	4	73.5	76.6	4.0	81.2	78.4	-3.6	2300	2500	8.0	900	840	-7.1
	8	77	79.1	2.7	82.5	80.9	-2.0	4300	4600	6.5	1900	1900	0.0
	12	80.4	82.1	2.1	85.1	83.4	-2.0	6500	6800	4.4	2900	2900	0.0
	16	84	85.3	1.5	88.2	87	-1.4	8700	9100	4.4	3900	4000	2.5
	20	87.5	88.6	1.2	91.6	90.4	-1.3	11,000	11,700	6.0	4800	5000	4.0

Table 2 PTPVT system design parameters [26,27,30,31].

Parameter	Symbol	Value	Unit
Concentrator aperture area	$A_{ap}$	12.0	m <sup>2</sup>
Absorber area	$A_{abs}$	0.6	m <sup>2</sup>
PV layer area	$A_{pv}$	1.2	m <sup>2</sup>
Concentration ratio	$CR_{pv}$	10	–
Receiver side length	$S_{rec}$	0.06	m
Fluid channel diameter	$d_f$	0.03	m
Fluid specific heat	$C_f$	4187	J/kg K
Fluid flow rate	$\dot{m}_f$	0.15	kg/s
PV thermal conductivity	$K_{pv}$	50	W/m <sup>2</sup>
Absorber thermal conductivity	$K_{abs}$	205	W/m <sup>2</sup>
Substrate thermal conductivity	$K_{sub}$	250	W/m <sup>2</sup>
Absorber absorptance	$\alpha_{abs}$	0.90	–
Concentrator absorptance	$\alpha_{conc}$	0.03	–
PV absorptance	$\alpha_{pv}$	0.97	–
Absorber emissivity	$\epsilon_{abs}$	0.20	–
Concentrator emissivity	$\epsilon_{conc}$	0.30	–
PV emissivity	$\epsilon_{pv}$	0.20	–
IAM electrical coefficient	$b_{0,elec}$	0.28	–
IAM thermal coefficient	$b_{0,th}$	0.14	–

Table 3 PTPVT system boundary conditions [26].

Parameter	Symbol	Value	Unit
Fluid inlet temperature	$T_{f,in}$	70	°C
Sky temperature	$T_{sky}$	25	°C
Ambient temperature	$T_{amb}$	25	°C
Air velocity	$V_a$	5	m/s
Total radiation	$I_{tot}$	1000	W/m <sup>2</sup>
Beam radiation	$I_{beam}$	800	W/m <sup>2</sup>
Incident angle	$\theta$	0	deg

in the study [26]. The boundary conditions include the fluid inlet temperature, ambient and sky temperature, air velocity, total and beam incident radiation as well as the incident angle.

4.1. Results and discussion

Based on the thermal modeling, system design parameters and boundary conditions discussed previously, the variation of the thermal and electrical efficiencies as well as the system temperatures (outlet temperature, PV temperature, absorber temperature and substrate temperature) are presented as function of the considered parameters (Reynolds number, receiver side length, receiver tube length and absorber thickness).

Fig. 5 (a) below shows the variation of electrical and thermal efficiency as function of Reynolds number. It is clear that the raise in Reynolds number increases the electrical efficiency while decreases

the thermal efficiency. When Reynolds number increased from 1000 to 2300, the thermal efficiency decreased rapidly from 65.10% to 59.69% respectively. After that, it continued to decrease slightly with the increase in Reynolds number where it decreased from 58.11% to 56.88% when Reynolds number augments from 4000 to 10,000 respectively. This means that the thermal efficiency decreased by 8.31% in the laminar flow and by 2.12% in the turbulent flow. On the other hand, the electrical efficiency strictly augmented from 15.74% to 21.76% when Reynolds number increased from 1000 to 2300 respectively. Then, the mitigation in electrical efficiency continued in a slow manner where it decreased from 23.51% to 24.87% when Reynolds number increased from 4000 to 10,000. Therefore, the electrical efficiency increased by 38.25% and 5.78% in the laminar and turbulent flow respectively. Hence, the electrical and thermal efficiencies are affected by Reynolds number in the laminar flow more than the turbulent flow. However, it is noticeable that the minimum total efficiency, which is the summation of the electrical and thermal efficiencies, is achieved at the lowest value of Reynolds number (1000) which is equal to 80.8%, while the maximum value is achieved at highest Reynolds number (10,000) which is about 81.8%. this reveals that the augmentation in Reynolds number increases the system total efficiency.

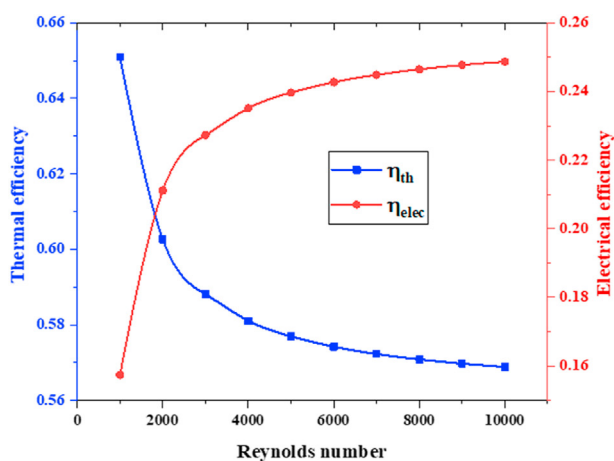

(a)

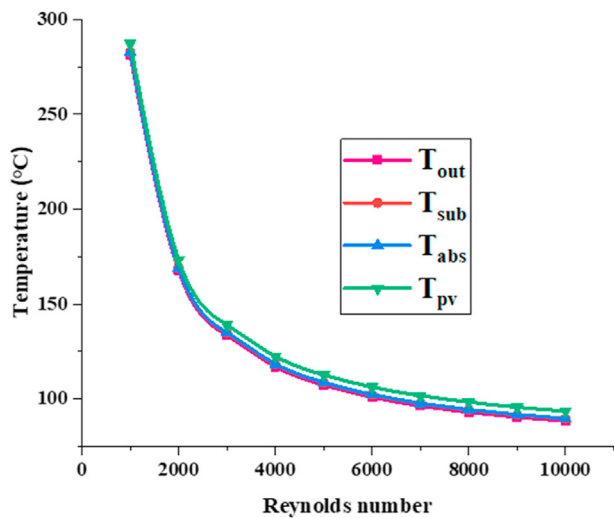

(b)

Fig. 5. (a) Variation of electrical and thermal efficiency as function of Reynolds number. (b) Variation of system temperatures as function of Reynolds number.

Fig. 5 (b) below shows the variation of system temperatures as function of Reynolds number. It is obvious that as Reynolds number increase, all system temperatures decrease. When Reynolds number increases from 1000 to 2300, the outlet temperature, substrate temperature, absorber temperature and PV temperature alleviate strictly from 281.36 °C, 282.59 °C, 282.78 °C and 287.33 °C—154.26 °C, 155.47 °C, 155.66 °C and 159.78 °C respectively which means that the percentage decrease in the laminar flow is 45.17%, 44.98%, 44.95% and 44.39% respectively. However, in the turbulent region (Reynolds between 4000 and 10,000), the outlet temperature, substrate temperature, absorber temperature and PV temperature mitigate by about 24.49%, 24.30%, 24.26% and 23.55%. In spite the fact that the Reynolds number has more impact on the system temperature in the laminar flow than the turbulent flow, the percentage decrease in the system temperature in the turbulent flow still significant.

Fig. 6 (a) below presents the variation of electrical and thermal efficiency as function of receiver side length. It is clear that the electrical and thermal efficiencies are highly affected by the variation of the receiver side length. When the receiver side length increases from 0.03 m to 0.2 m the electric efficiency mitigates from 23.24% to 20.81%, while the thermal efficiency increases from 47.1% to 20.81%.

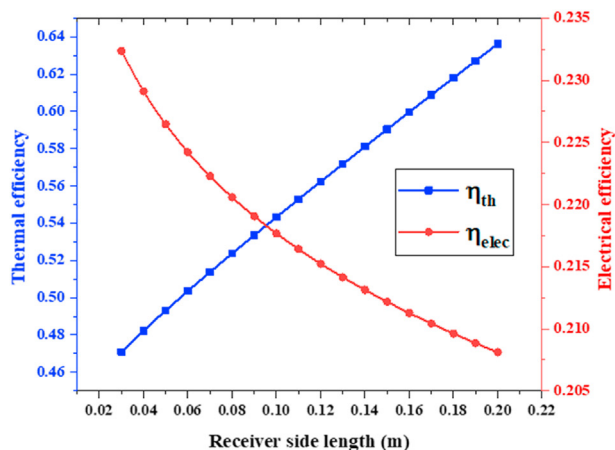

(a)

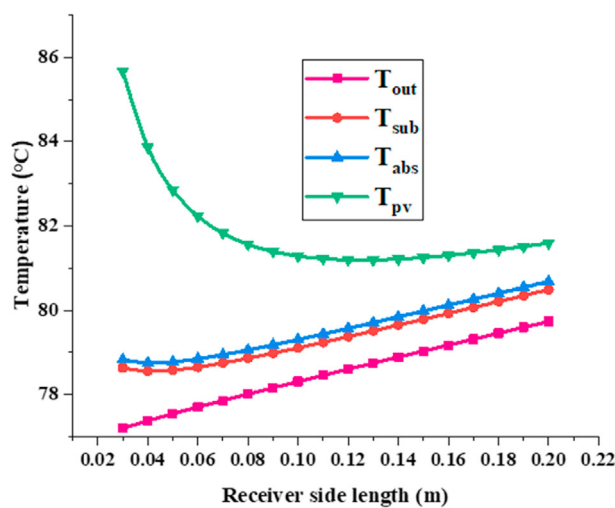

(b)

Fig. 6. (a) Variation of electrical and thermal efficiency as function of receiver side length. (b) Variation of system temperatures as function of receiver side length.

to 63.62%. Hence, increasing the receiver side length by about 7 times leads to mitigation in electric efficiency by about 10.5% while augmentation of thermal efficiency by 35% from its initial value. It can be observed that the minimum total efficiency of the system is 70.3% which is obtained when receiver side length is equal to 0.02 m, while the maximum value is 84.4% which is achieved at higher receiver side length (0.2 m). Therefore, the increase in the receiver side length raises the total efficiency of the system.

Fig. 6 (b) above presents the variation of system temperatures as function of receiver side length. As receiver side length increased from 0.04 m to 0.2 m, the outlet temperature, substrate temperature and absorber temperature augmented from 77.4 °C, 78.6 °C and 78.8 °C–79.7 °C, 80.5 °C and 80.7 °C respectively. While PV temperature decreased from 83.9 °C to 81.2 °C when receiver side length increased from 0.04 m to 0.13 m, then it slightly started to increase till it reached 81.6 °C for 0.2 m receiver side length.

It is obvious that the increase in the receiver side length has a vital influence since it affects the area of absorber and PV cell as well as the concentration ratio. The increase in the receiver side length lessens the concentration ratio which leads to decrease the radiative flow on PV cells and hence decrease in PV temperature. Furthermore, it is well known that the decrease in PV temperature

causes mitigation in the electric efficiency which is not shown in Fig. 8 (b). This is due to the fact that the electric efficiency is also affected by the concentration ratio based on equation (3). Thus, the decrease in the electric efficiency is due to the lessening in the concentration ratio which has more significant effect over the PV temperature. On the other side, the thermal efficiency increases more noticeably than the decrease in the electric efficiency. This can be explained by the increase in the amount of heat exploited for thermal transformation, and the increase in the absorber area which augments the amount of utilized solar energy.

Fig. 7 (a) below shows the variation of electrical and thermal efficiency as function of receiver tube length. When the length is 1 m, the electrical efficiency is 25.21% and it increases to 25.46% when the length increases to 4 m. Then, with the increase in the length, the electric efficiency lessens reaching 24.97% at length of 20 m. However, the thermal efficiency is 56.58% when the length is 1 m and it mitigates to 56.35% when the length extends to 4 m. After that, the thermal energy increases as length increases till it achieves 56.79% at length of 20 m. This reveals that as receiver tube length is increased by fivefold (4 m–20 m), the electric efficiency alleviates slightly by about 2% and the thermal efficiency increases

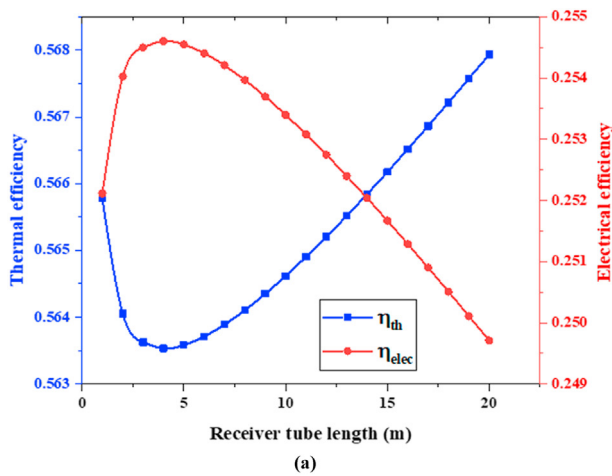

(a)

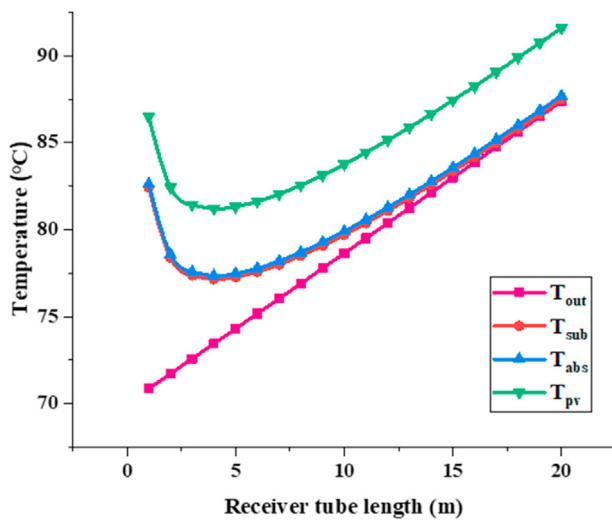

(b)

Fig. 7. (a) Variation of electrical and thermal efficiency as function of receiver tube length. (b) Variation of system temperatures as function of receiver tube length.

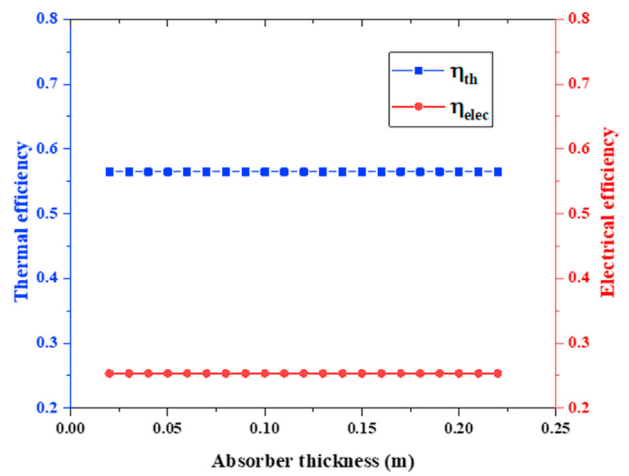

(a)

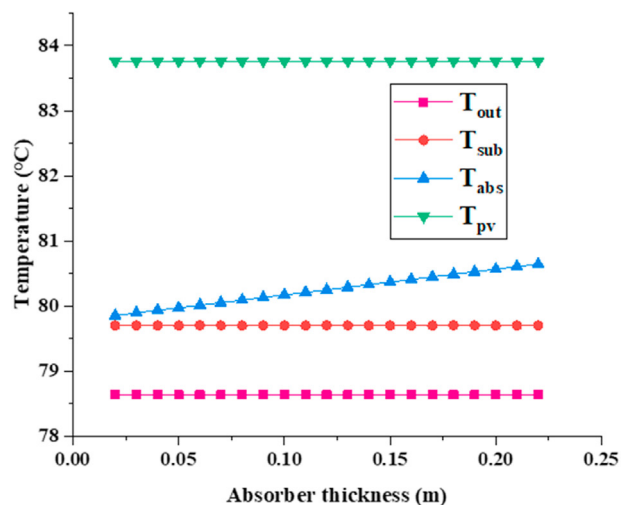

(b)

Fig. 8. (a) Variation of electrical and thermal efficiency as function of absorber thickness. (b) Variation of system temperatures as function of absorber thickness.

**Table 4**  
Summary of the main results obtained from the parametric analysis.

Parameter	Range	Outlet temperature (°C)	Electrical power (W)	Heat rate (W)	Electrical efficiency	Thermal efficiency	Total efficiency
Reynolds number	1000–10,000	281.4 to 88.5	1511.5 to 2387.8	6249.3 to 5460.7	15.7 to 24.9	65.1 to 56.9	80.8 to 81.8
Receiver tube length	0.03–0.2 m	70.9 to 87.4	242.1 to 4794.4	543.1 to 10904.4	25.2 to 25.0	56.6 to 56.8	81.8 to 81.7
Receiver side length	1–20 m	77.2 to 79.7	2230.8 to 1997.8	4521.0 to 6107.6	23.2 to 20.8	47.1 to 63.6	70.3 to 84.4
Absorber thickness	0.02–0.22 m	Constant at 78.6	Constant at 2432.6	Constant at 5420.3	Constant at 25.3	Constant at 56.5	Constant at 81.8

negligibly by approximately 0.78%.

Fig. 7 (b) above presents the variation of system temperatures as function of receiver tube length. When the length increases from 1 m to 4 m, the outlet temperature raises while all other system temperatures mitigates slightly and after that they start to increase with increasing length. At length of 4 m, the outlet temperature, substrate temperature, absorber temperature and PV temperature are 73.45 °C, 77.15 °C, 77.35 °C and 81.2 °C respectively. When the length is increased by five times (20 m), the outlet temperature, substrate temperature, absorber temperature and PV temperature increase significantly by about 19%, 13.4%, 13.4% and 12.8% respectively.

In spite the fact that as the length increases the losses increase, the amount of absorbed heat by the fluid exceeds the amount of losses which leads to increase its temperature. Hence, all system temperatures and thermal efficiency will increase. However, the slight increase is due to the increase in the aperture area when the length increases. Also, the temperature of PV cell increases with the increase in the length since PV area increases, this leads to the decrease in the electric efficiency of PV cell. Nevertheless, the change in the thermal and electrical efficiencies can be considered negligible.

Fig. 8 (a) below presents the variation of electrical and thermal efficiency as function of absorber thickness. It is obvious that the

absorber thickness has no influence on the electrical and thermal efficiencies where both remain constant (25.34% and 56.46% respectively) with the increase in the absorber thickness from 0.02 m to 0.2 m.

Fig. 8 (b) above presents the variation of system temperatures as function of absorber thickness. As the absorber thickness augments from 0.02 m to 0.2 m the outlet temperature, substrate temperature and PV temperature remain constant at 78.64 °C, 79.7 °C and 83.76 °C respectively, while the absorber temperature increases slightly by about 1.1% (from 79.86 °C to 80.75 °C).

4.2. Closure

The summary of the results obtained from the conducted parametric analysis are illustrated in Table 4. The table shows the variation of the outlet temperature, electrical power and thermal rate, in addition to electrical, thermal and total efficiencies when varying the four studied parameters (Reynolds number, receiver side length, receiver tube length and absorber thickness).

Figs. 9–11 represents the maximum and minimum values of thermal, electrical and total efficiencies that are achieved when varying the different influencing parameters: Reynolds number, receiver side length, receiver tube length and absorber thickness. At maximum Reynolds number (10,000), the thermal efficiency is

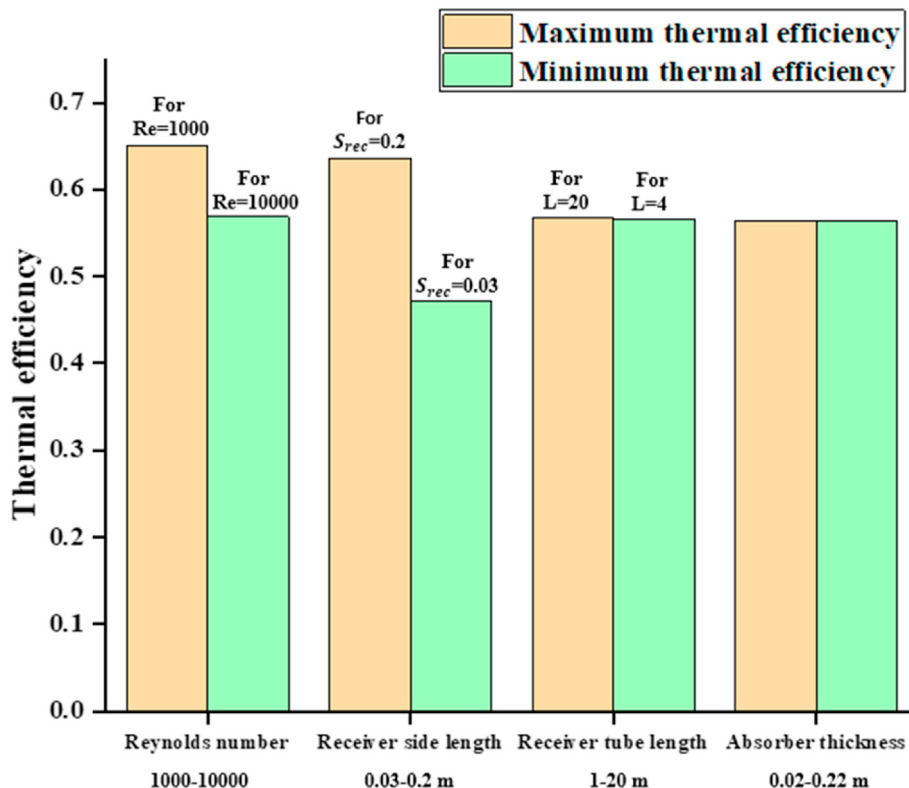

Fig. 9. Maximum and minimum thermal efficiency for the different studied parameters.



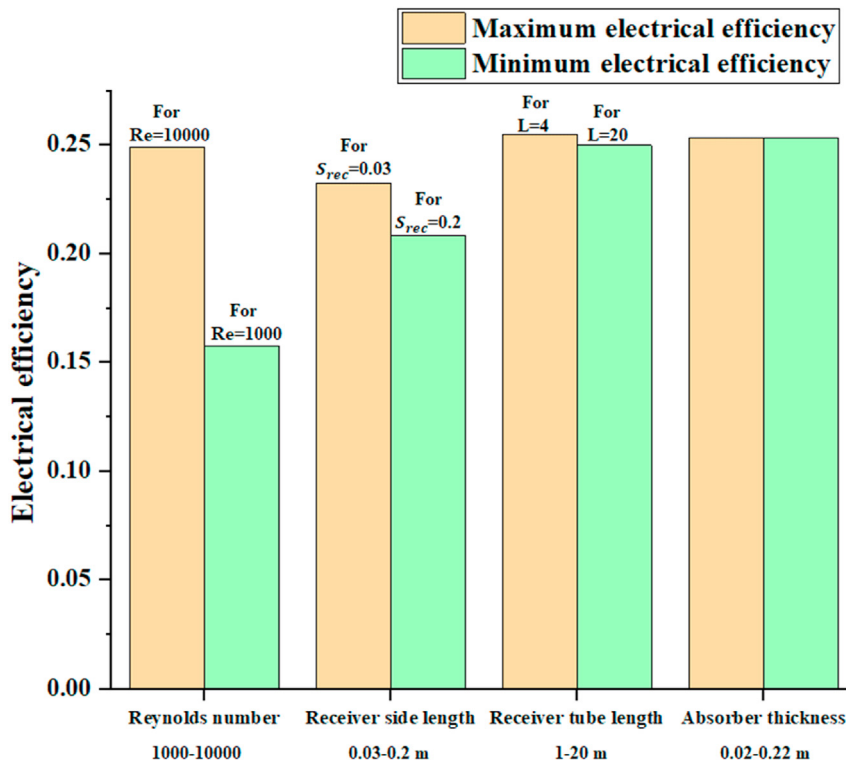

Fig. 10. Maximum and minimum electrical efficiency for the different studied parameters.

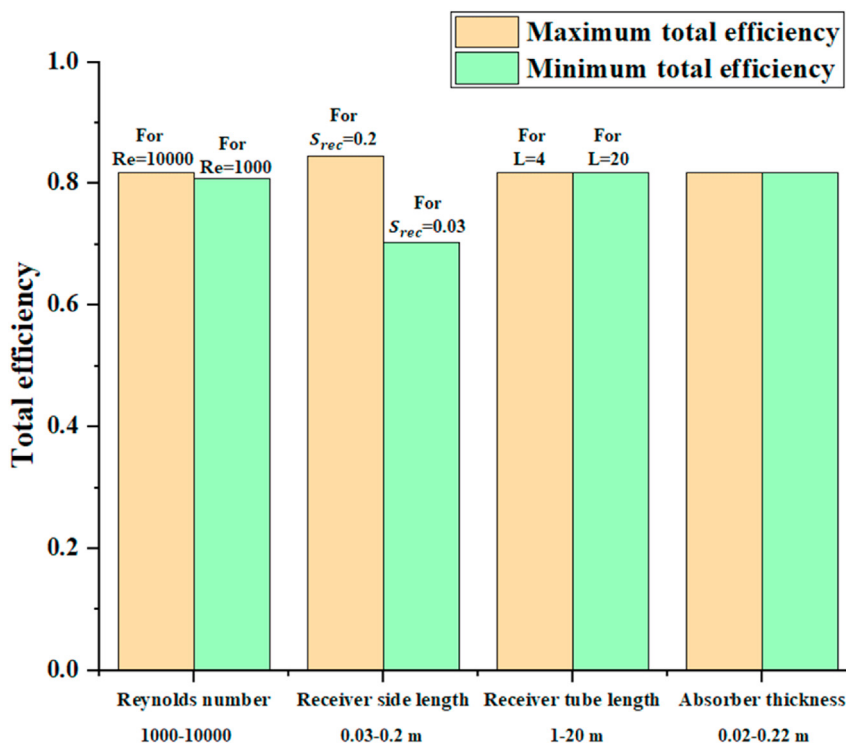

Fig. 11. Maximum and minimum total efficiency for the different studied parameters.

minimum while the electrical and total efficiencies are maximum. But it is clear that the influence of Reynold number is negligible on the total efficiency. On the other hand, at maximum value of receiver side length (0.2 m) and receiver tube length (20 m), the

electrical efficiency is minimum while the thermal and total efficiencies are maximum. However, the receiver side length has a significant influence on all efficiencies of the system while the impact of receiver tube length is negligible. Moreover, the thermal,



electrical and total efficiencies of the system are not affected by the variation of the absorber thickness. Therefore, the target of the system decides the variation of the parameters, in which if the aim is to maximize the heat output, the system must operate at low Reynolds number and maximum receiver side length. Nevertheless, if the desire is to maximize the electrical power generated, the system must operate at high Reynolds number and minimum receiver side length. However, if the target of the system is to obtain high total efficiency, the receiver side length must be maximized.

## 5. Conclusions and recommendations

The parametric study conducted in this work on Parabolic trough Photovoltaic/Thermal hybrid system reveals that the increase in the Reynolds number from 1000 to 10,000 leads to decrease in thermal efficiency from 65.10% to 56.88% and augmentation in the electrical efficiency from 15.74% to 24.87%. Moreover, it was obtained that in the laminar flow the electrical efficiency increases by 38.25% and the thermal efficiency decreases by 8.31%, while in the turbulent flow, the electrical efficiency augments by 5.78% and the thermal efficiency alleviate by 2.12%. This means that Reynolds number has influence on both efficiencies in the laminar region more than turbulent region. However, the electric efficiency decreases by 10.5% (from 23.24% to 20.81%) and the thermal efficiency increases by 35% (from 47.1% to 63.62%) when the receiver side length increases from 0.03 m to 0.2 m, which shows the significance of this parameter. Furthermore, when the receiver tube length increases from 4 m to 20 m it slightly affects the electric efficiency which lessens from 25.46% to 24.97%, and the thermal efficiency which raises from 56.35% to 56.79%. Hence, the electrical efficiency is lowered by 2% from its initial value, and the thermal efficiency increases by 0.78% which can be considered negligible. Furthermore, the augmentation of the absorber thickness from 0.02 m to 0.2 m has no impact on both efficiencies of the system where the thermal and the electrical efficiencies remain constant at 56.46% and 25.34% respectively.

By studying the effect of four parameters on the performance of PVTPT system, it was obtained that Reynold number and receiver side length have significant influence in contrast to receiver tube length and absorber thickness which has negligible effect on the system performance. Since Reynolds number and receiver side length have opposite effects, for applications that aim to maximize the electric efficiency, Reynolds number must be maximized (the fluid flow rate must be augmented) and/or receiver side length must be minimized. On the other hand, if enhancing the thermal efficiency is the goal of some applications, the receiver side length and must be maximized and Reynolds number must be minimized. However, if the aim is to obtain maximum total efficiency of the system the receiver side length must be increased.

## CRedit authorship contribution statement

**Amal Herez:** Data curation, Formal analysis, Investigation, Methodology, Validation, Writing - original draft. **Hicham El Hage:** Formal analysis, Investigation, Supervision, Writing - review & editing. **Thierry Lemenand:** Formal analysis, Investigation, Supervision, Writing - review & editing. **Mohamad Ramadan:** Formal analysis, Investigation, Supervision, Writing - review & editing. **Mahmoud Khaled:** Conceptualization, Formal analysis, Investigation, Methodology, Project administration, Supervision, Writing - review & editing.

## Declaration of competing interest

The authors declare that they have no known competing

financial interests or personal relationships that could have appeared to influence the work reported in this paper.

## References

- [1] J. Huang, W. Li, L. Guo, X. Hu, J.W. Hall, Renewable energy and household economy in rural China, *Renew. Energy* 155 (2020) 669–676, <https://doi.org/10.1016/j.renene.2020.03.151>.
- [2] M. Murshed, Are trade liberalization policies aligned with renewable energy transition in low and middle income countries? An instrumental variable approach, *Renew. Energy* 151 (2020) 1110–1123, <https://doi.org/10.1016/j.renene.2019.11.106>.
- [3] U. Uzar, Political economy of renewable energy: does institutional quality make a difference in renewable energy consumption? *Renew. Energy* 155 (2020) 591–603, <https://doi.org/10.1016/j.renene.2020.03.172>.
- [4] N. Bamati, A. Raofi, Development level and the impact of technological factor on renewable energy production, *Renew. Energy* 151 (2020) 946–955, <https://doi.org/10.1016/j.renene.2019.11.098>.
- [5] A. Gulagi, M. Ram, A.A. Solomon, M. Khan, C. Breyer, Current energy policies and possible transition scenarios adopting renewable energy: a case study for Bangladesh, *Renew. Energy* 155 (2020) 899–920, <https://doi.org/10.1016/j.renene.2020.03.119>.
- [6] X. Zhao, H. Chen, S. Liu, X. Ye, Economic & environmental effects of priority dispatch of renewable energy considering fluctuating power output of coal-fired units, *Renew. Energy* 157 (2020) 695–707, <https://doi.org/10.1016/j.renene.2020.05.033>.
- [7] H. El Hage, A. Herez, M. Ramadan, H. Bazzi, M. Khaled, An investigation on solar drying: a review with economic and environmental assessment, *Energy* 157 (2018) 815–829, <https://doi.org/10.1016/j.energy.2018.05.197>.
- [8] A. Herez, M. Ramadan, M. Khaled, Review on solar cooker systems: economic and environmental study for different Lebanese scenarios, *Renew. Sustain. Energy Rev.* 81 (2018) 421–432, <https://doi.org/10.1016/j.rser.2017.08.021>.
- [9] A. Herez, M. Ramadan, B. Abdullhay, M. Khaled, Short review on solar energy systems, in: *AIP Conf. Proc.*, AIP Publishing LLC, 2016, 030041, <https://doi.org/10.1063/1.4959437>.
- [10] M. Khaled, A. Herez, H. El Hage, T. Lemenand, M. Ramadan, Review on solar water heating system, in: *The 6th International Conference on Emerging and Renewable Energy: Generation and Automation ICEREGA'18*, Sousse, Tunisia, 2018.
- [11] A. Herez, M. Khaled, M. Ramadan, H. Bazi, A review on solar dryer - economic and environmental investigation for the Lebanese case, in: *10TH International Conference on Sustainable Energy and Environmental Protection SEEP*, 2017, pp. 561–574, <https://doi.org/10.18690/978-961-286-061-5.49>. Bled, Slovenia.
- [12] J. hu Gong, J. Wang, P.D. Lund, E. yi Hu, Z. cheng Xu, G. peng Liu, G. shuai Li, Improving the performance of a 2-stage large aperture parabolic trough solar concentrator using a secondary reflector designed by adaptive method, *Renew. Energy* 152 (2020) 23–33, <https://doi.org/10.1016/j.renene.2020.01.019>.
- [13] Z. Wu, S. Yan, Z. Wang, T. Ming, X. Zhao, R. Ma, Y. Wu, The effect of dust accumulation on the cleanliness factor of a parabolic trough solar concentrator, *Renew. Energy* 152 (2020) 529–539, <https://doi.org/10.1016/j.renene.2020.01.091>.
- [14] D. Lei, X. Fu, Y. Ren, F. Yao, Z. Wang, Temperature and thermal stress analysis of parabolic trough receivers, *Renew. Energy* 136 (2019) 403–413, <https://doi.org/10.1016/j.renene.2019.01.021>.
- [15] U. Winkelmann, C. Kämper, R. Höffer, P. Forman, M.A. Ahrens, P. Mark, Wind actions on large-aperture parabolic trough solar collectors: wind tunnel tests and structural analysis, *Renew. Energy* 146 (2020) 2390–2407, <https://doi.org/10.1016/j.renene.2019.08.057>.
- [16] C. Qin, J.B. Kim, B.J. Lee, Performance analysis of a direct-absorption parabolic-trough solar collector using plasmonic nanofluids, *Renew. Energy* 143 (2019) 24–33, <https://doi.org/10.1016/j.renene.2019.04.146>.
- [17] S. Akbarzadeh, M.S. Valipour, Energy and exergy analysis of a parabolic trough collector using helically corrugated absorber tube, *Renew. Energy* 155 (2020) 735–747, <https://doi.org/10.1016/j.renene.2020.03.127>.
- [18] H. Xu, X. Ji, L. Wang, J. Huang, J. Han, Y. Wang, Performance study on a small-scale photovoltaic electro dialysis system for desalination, *Renew. Energy* 154 (2020) 1008–1013, <https://doi.org/10.1016/j.renene.2020.03.066>.
- [19] I. Lillo-Bravo, M.A. Bobadilla, S. Moreno-Tejera, M. Silva-Pérez, A novel storage system for cooling stand-alone photovoltaic installations, *Renew. Energy* 155 (2020) 23–37, <https://doi.org/10.1016/j.renene.2020.03.128>.
- [20] Z. Meng, Y. Zhao, S. Tang, Y. Sun, An efficient datasheet-based parameters extraction method for two-diode photovoltaic cell and cells model, *Renew. Energy* 153 (2020) 1174–1182, <https://doi.org/10.1016/j.renene.2020.02.084>.
- [21] G. Trzmiel, D. Gluchy, D. Kurz, The impact of shading on the exploitation of photovoltaic installations, *Renew. Energy* 153 (2020) 480–498, <https://doi.org/10.1016/j.renene.2020.02.010>.
- [22] J. Robertson, B. Riggs, K. Islam, Y.V. Ji, C.M. Spittler, N. Gupta, D. Krut, J. Ermer, F. Miller, D. Codd, M. Escarra, Field testing of a spectrum-splitting transmissive concentrator photovoltaic module, *Renew. Energy* 139 (2019) 806–814, <https://doi.org/10.1016/j.renene.2019.02.117>.
- [23] M. Valizadeh, F. Sarhaddi, Mahdavi Adeli, Exergy performance assessment of a linear parabolic trough photovoltaic thermal collector, *Renew. Energy* 138

- (2019) 1028–1041, <https://doi.org/10.1016/j.renene.2019.02.039>.
- [24] M. Hakimi, E. Baniasadi, E. Afshari, Thermo-economic analysis of photovoltaic, central tower receiver and parabolic trough power plants for Herat city in Afghanistan, *Renew. Energy* 150 (2020) 840–853, <https://doi.org/10.1016/j.renene.2020.01.009>.
- [25] B.K. Widyolar, M. Abdelhamid, L. Jiang, R. Winston, E. Yablonovitch, G. Scranton, D. Cygan, H. Abbasi, A. Kozlov, Design, simulation and experimental characterization of a novel parabolic trough hybrid solar photovoltaic/thermal (PV/T) collector, *Renew. Energy* 101 (2017) 1379–1389, <https://doi.org/10.1016/j.renene.2016.10.014>.
- [26] F. Calise, L. Vanoli, Parabolic trough photovoltaic/thermal collectors: design and simulation model, *Energies* 5 (2012) 4186–4208, <https://doi.org/10.3390/en5104186>.
- [27] F. Calise, A. Palombo, L. Vanoli, A finite-volume model of a parabolic trough photovoltaic/thermal collector: energetic and exergetic analyses, *Energy* 46 (2012) 283–294, <https://doi.org/10.1016/j.energy.2012.08.021>.
- [28] L.R. Bernardo, B. Perers, H. Håkansson, B. Karlsson, Performance evaluation of low concentrating photovoltaic/thermal systems: a case study from Sweden, *Sol. Energy* 85 (2011) 1499–1510, <https://doi.org/10.1016/j.solener.2011.04.006>.
- [29] S. Srivastava, K.S. Reddy, Simulation studies of thermal and electrical performance of solar linear parabolic trough concentrating photovoltaic system, *Sol. Energy* 149 (2017) 195–213, <https://doi.org/10.1016/j.solener.2017.04.004>.
- [30] W. Ben Youssef, T. Maatallah, C. Menezo, S. Ben Nasrallah, Assessment viability of a concentrating photovoltaic/thermal-energy cogeneration system (CPV/T) with storage for a textile industry application, *Sol. Energy* 159 (2018) 841–851, <https://doi.org/10.1016/j.solener.2017.11.058>.
- [31] T. Maatallah, W. Ben, Simulation and performance analysis of concentrating photovoltaic/thermal collector (CPV/T) with three-sided thermal insulation based on coupled optothermal model, *Sol. Energy* 181 (2019) 308–324, <https://doi.org/10.1016/j.solener.2019.02.002>.
- [32] A. Cappellotti, M. Catelani, L. Ciani, M.K. Kazimierczuk, A. Reatti, S. Member, Practical issues and characterization of a photovoltaic/thermal linear focus, *IEEE Trans. Instrum. Meas.* 65 (2016) 2464–2475.
- [33] I.K. Karathanassis, E. Papanicolaou, V. Belessiotis, G.C. Bergeles, Dynamic simulation and exergetic optimization of a Concentrating Photovoltaic/Thermal (CPVT) system, *Renew. Energy* 135 (2019) 1035–1047, <https://doi.org/10.1016/j.renene.2018.12.085>.
- [34] R. Bernardo, *Retrofitted Solar Domestic Hot Water System for Single-Family Electrically-Heated Houses Development and Testing*, Faculty of engineering, Lund University, Lund, Sweden, 2010.
- [35] A. Buonomano, F. Calise, M. Dentice d'Accadia, L. Vanoli, A novel solar tri-generation system based on concentrating photovoltaic/thermal collectors. Part 1: design and simulation model, *Energy* 61 (2013) 59–71, <https://doi.org/10.1016/j.energy.2013.02.009>.
- [36] A. Kribus, D. Kaftori, G. Mittelman, A. Hirshfeld, Y. Flitsanov, A. Dayan, A miniature concentrating photovoltaic and thermal system, *Energy Convers. Manag.* 47 (2006) 3582–3590, <https://doi.org/10.1016/j.enconman.2006.01.013>.
- [37] M. Li, X. Ji, G. Li, S. Wei, Y.F. Li, F. Shi, Performance study of solar cell arrays based on a Trough Concentrating Photovoltaic/Thermal system, *Appl. Energy* 88 (2011) 3218–3227, <https://doi.org/10.1016/j.apenergy.2011.03.030>.
- [38] F.P. Incropera, D.P. DeWitt, *Fundamentals of Heat and Mass Transfer*, sixth ed., John Wiley & Sons, 2007.

## Chapitre 3

### **Système hybride photovoltaïque/thermique à concentrateur parabolique : modélisation thermique, études de cas et études économiques et environnementales**

Dans ce chapitre, le système PTPVT qui est étudié au chapitre 2 est repris en appliquant des études de cas dans trois pays de climats différents : le Liban (climat méditerranéen), la France (climat modéré) et les Emirats Arabes Unis (climat chaud) afin d'étudier les performances thermiques et électriques du système. En outre, des analyses environnementales et économiques sont effectuées pour chaque pays afin d'évaluer le coût économisé, la période de retour sur investissement et la réduction des émissions de CO<sub>2</sub> lors de l'utilisation du système proposé dans les trois pays.

Cette étude comprend, dans la **section 1**, une introduction à l'énergie solaire et aux systèmes solaires hybrides en général et au système PTPVT en particulier. La **section 2** décrit la structure et le mode de fonctionnement du système considéré. La **section 3** présente la modélisation thermique suggérée du système PTPVT, la procédure d'itération et la validation. La **section 4** est consacrée à des études de cas permettant de comparer les performances du système dans trois pays (Liban, France et EAU) de climats différents. La **section 5** comprend une analyse économique et environnementale. Enfin, la **section 6** présente les conclusions du travail.

La température de sortie maximale obtenue est de 95,0°C au Liban en juillet avec une température d'entrée d'eau de 32,1°C, de 53,8°C en France en août avec une température d'entrée d'eau de 23,5°C et de 91,0°C aux EAU en juin avec une température d'entrée d'eau de 33,9°C. Par ailleurs, les rendements thermiques et électriques les plus élevés obtenus sont respectivement de 50,7% en août et 27,5% en janvier au Liban, 50,8% en juin et 27,9% en décembre en France et 51,1% en juillet et 25,9% en janvier aux EAU.

Les résultats de l'étude de cas révèlent que les principaux paramètres qui affectent les performances du système sont le rayonnement total et de faisceau (Direct Normal Insolation) et la température d'entrée du fluide. Il a été obtenu que la température de sortie la plus élevée atteinte parmi les trois cas est de 95°C au Liban, tandis que le rendement thermique le plus élevé est atteint aux EAU (51,1%) et le rendement électrique le plus élevé est de 27,9% en France.

En outre, les résultats montrent que le système proposé, qui coûte 28 400 dollars, nécessite environ 1,4 ans pour compenser son surcoût au Liban, 1,6 ans en France et 1,7 ans aux EAU. En outre, la réduction des émissions de CO<sub>2</sub> lors de l'exploitation du système PTPVT est de 72,9 tonnes, 5,1 tonnes et 71,1 tonnes pour les cas du Liban, de la France et des EAU respectivement.

Cette étude est acceptée dans la revue "Renewable Energy Focus".

# **Systeme hybride photovoltaïque / thermique à concentrateur parabolique : modélisation thermique, études de cas et analyse économique et environnementale**

Cet article est accepté pour« **Renewable Energy Focus** »

**Résumé** - Ce travail concerne une nouvelle modélisation thermique pour un système hybride photovoltaïque / thermique à concentrateur parabolique (PTPVT) ainsi que des études de cas. Une nouvelle modélisation thermique utilisant l'analogie de la résistance est menée sur le système, comparée et validée par rapport aux travaux antérieurs. Des études de cas sont réalisées sur trois pays de climats différents que sont le Liban (climat méditerranéen), la France (climat modéré) et les Emirats Arabes Unis (climat chaud) afin d'étudier les performances électriques et thermiques du système. Les résultats révèlent que la température de sortie la plus élevée atteinte parmi les trois cas est de 95°C au Liban, tandis que le rendement thermique le plus élevé est atteint aux EAU (51,1%) et le rendement électrique le plus élevé est de 27,9% en France. Par ailleurs, des analyses environnementales et économiques sont menées pour chaque pays afin d'éclairer l'importance du système étudié. On observe que la durée d'amortissement au Liban, en France et aux Émirats arabes unis est de 1,4 ans, 1,6 ans et 1,7 ans respectivement, tandis que le montant annuel des réductions des émissions de dioxyde de carbone est de 72,9 tonnes, 5,1 tonnes et 71,1 tonnes respectivement.

# Parabolic trough Photovoltaic/Thermal hybrid system: Thermal Modeling, case studies, and economic and environmental analyzes

Amal Herez<sup>1,2</sup>, Hicham El Hage<sup>1</sup>, Thierry Lemenand<sup>2</sup>, Mohamad Ramadan<sup>3,4</sup>,  
and Mahmoud Khaled<sup>3,5,\*</sup>

<sup>1</sup>Energy and Thermofluid Group, Lebanese International University LIU, Bekaa, Lebanon

<sup>2</sup>LARIS EA 7315, University of Angers - ISTIA, Angers, France

<sup>3</sup>Energy and Thermofluid Group, International University of Beirut BIU, Beirut, Lebanon

<sup>4</sup>Associate member at FCLAB, CNRS, Univ. Bourgogne Franche-Comté, Belfort cedex, France

<sup>5</sup>University Paris Diderot, Sorbonne Paris Cité, Interdisciplinary Energy Research Institute (PIERI), Paris, France

\*Corresponding author email: [mahmoud.khaled@liu.edu.lb](mailto:mahmoud.khaled@liu.edu.lb)

**Abstract.** This work concerns a new thermal modeling for parabolic trough photovoltaic/thermal hybrid system along with case studies. A new thermal modeling using resistance analogy is conducted on the system, compared and validated against previous works. Case studies are performed on three countries of different climates which are Lebanon (Mild climate), France (Cold climate) and United Arab Emirates (warm climate) in order to study the electrical and thermal performance of the system. Results reveal that the highest achieved outlet temperature among the three cases is 95°C in Lebanon, while the highest thermal efficiency is attained in United Arab Emirates (51.1%), and the highest electrical efficiency is 27.9% in France. Besides, environmental and economic analyses are carried out for each country to shed light on the significance of the studied system. It is observed that the payback period in Lebanon, France and United Arab Emirates is 1.4 years, 1.6 years and 1.7 years respectively, while the annual amount of alleviated carbon dioxide emissions is 72.9 tons, 5.1 tons and 71.1 tons respectively.

**Keywords:** Parabolic Trough, Photovoltaic, Hybrid System, Thermal Modeling, Case studies.

## 1. Introduction

For decades the world has been witnessing several critical problems in the level of energy domain. These problems are summarized by the depletion of fossil fuel accompanied by the increase in electricity demand, global warming and environmental pollutions. To reduce the implications of these problems, scientists and technicians started to investigate renewable energy sources that are abundantly available and sound environmentally. Indeed, renewable energy sources are mainly utilized in the form of solar energy [1–8], wind energy [9,10], geothermal [11,12] and biomass [13,14].

Solar energy is certainly the most potential renewable energy sources which provides a huge amount of solar radiations to the Earth [15], each year the Earth receives approximately  $10^{15}$ Wh, more than 8,000 times the annual global energy consumption. Hence, it is the ideal solution for

compensating the worldwide energy deficiency in a renewable, clean and sustainable way. Solar energy can be harnessed by photovoltaic technology (PV) to generate electricity for driving numerous applications, or by solar thermal collector (STC) to produce heat energy that could be utilized for numerous applications such as heating water, heating/cooling space, refrigeration, cooking, drying, etc.

Indeed, the combination of STC with PV is a significant enhancement that allows to increase the benefit of exploiting solar energy [16]. This improvement can be illustrated in photovoltaic/thermal collector (PVT) which consists of a STC and a PV layer covering its absorber. Hence, PVT merges the role of STC and PV cells by generating heat and electric energy simultaneously. Besides, it serves in cooling the PV cells by the cooling fluid and thus improves the electrical production and cell stability.

Figure 1 illustrates the combination of PV and parabolic trough collector (PTC) for simultaneous electricity and heat production. Parabolic Trough Photovoltaic/Thermal (PTPVT) hybrid system is one of the most important systems which integrates PV cells to the receiver of PTC. Numerous researches [17–20] are conducted on this system to study and assess the electrical and/or thermal performance of hybrid solar PTPVT system.

Calise and Vanoli [21] developed mathematical model on a newly suggested PTPVT system. The authors carried out parametric study to investigate the impact of side length of the receiver, tube length and diameter, aperture length, and area specific thermal resistance of the absorber. It was observed that the augmentation in tube diameter and length alleviates the overall system performance. Besides, the thermal efficiency increases with the increase in the receiver side length and decreases with the increase in the absorber area specific thermal resistance the aperture length, while the electrical efficiency evolution is the opposite. Similarly, Calise et al. [22] presented a finite-volume model for the same system which aims to evaluate the thermodynamic and electrical parameters through the axis of the proposed system.

Otanicar et al. [23] designed, constructed and tested a secondary optical stage which can be combined with an existing PT architecture. The authors conducted an optical model which uses ray tracing and validated it by experimental testing that utilizes photographic technique to assure the flux distribution. Besides, they implemented a thermal and electrical model to estimate the performance, temperature and levelized cost of electricity (LCOE) of the system. Moreover, the authors constructed the prototype of the system and carried out experimental setup to evaluate the optical performance and electrical efficiency of the suggested design. It was obtained that the cells attained an average cell efficiency of 21% at operating temperatures between 55 and 120 °C. The LCOE calculations estimated the system to have a potential below 7¢/kWh and 13¢/kWh based on the predicted efficiencies and the measured values at cell costs of 5\$/cm<sup>2</sup> respectively.

Bellos and Tzivanidis [24] studied PVT concentrating collector with parabolic reflector operating with pure thermal oil and nano-fluid (Syltherm 800/CuO with 5% volumetric concentration). The authors performed the simulation using SolidWorks Flow Simulation to conduct thermal, optical and flow analysis. It was concluded that utilization of nano-fluid promotes the thermal and electrical performance of the system for all cases including distinct flow rates and inlet temperatures. It was also obtained that the electrical, thermal total and exergy efficiencies augmented by 5.17%, 1.66%, 2.08% and 3.05% respectively when the inlet temperature and flow rate were 100°C and 540L/h respectively.



Bernardo et al. [25] established a simulation to evaluate the performance of PTPVT collector by comparing the system with side-by-side PV modules and flat plate. It was shown that the studied hybrid system has electrical and optical efficiency of 6.4% and 45% respectively.

Widyolar et al. [26] designed, fabricated and tested hybrid solar PTPVT system. The PV cells used are single junction Gallium Arsenide (GaAs). The experimental results revealed that the maximum temperature attained was 365°C, the thermal efficiency was about 37% and the electrical efficiency of GaAs cells was 8%.

Karathanassis et al. [27] predicted the long-term performance of PTPVT system by conducting a dynamic model on the studied system. An exergy analysis was performed to evaluate the effect of sun components of the system on its exergy efficiency and output. The results revealed that rising the optical quality and electrical efficiency to value of 0.75 and 0.25 respectively, lead to augmentation in the exergy efficiency from 12% to 24%. Also, Karathanassis et al. [28] designed, manufactured and assessed the performance of a parabolic trough concentrating PVT system. The experimental analysis of the system prototype showed an overall efficiency of 50% in which the thermal efficiency was 44% and the electrical efficiency was 6%.

Besides, Yazdanifard et al. [29] modeled and simulated a PT concentrating PVT system. The authors investigated the impact of several geometrical parameters such as pipe diameter and length as well as concentration ratio on the behavior of the system in turbulent and laminar flows. The obtained results revealed a decrease in the overall energy efficiency by approximately 9.33% and 1.09% in the laminar and turbulent regimes respectively, and an increase in the overall exergy efficiency by about 33.5% in the laminar regime and 10.37% in the turbulent regime, when raising the pipe length from 0.5 to 5 m, while the raise in the diameter of the pipe has a negligible influence on the system performance.

Moreover, Del Col et al. [30] conducted an experimental investigation to demonstrate the electric and thermal performance of a PT concentrating PVT system existing in Padova (Italy). It was observed that the overall efficiency of the system reached about 65% with 23% and 42% for electric and thermal efficiencies, respectively.

Li et al. [31] developed experimental and theoretical calculations to evaluate the performance of solar cell array of trough concentrating photovoltaic thermal system. Experimental tests were performed to investigate the optimum concentration ratio for single crystalline silicon PV cell, super cells and GaAs PV cells. It was concluded that the triple junction GaAs cell can operate better at higher concentration ratio; whereas for single silicon cell and super cell, the best concentration ratio were 4.23 and 8.46 respectively.

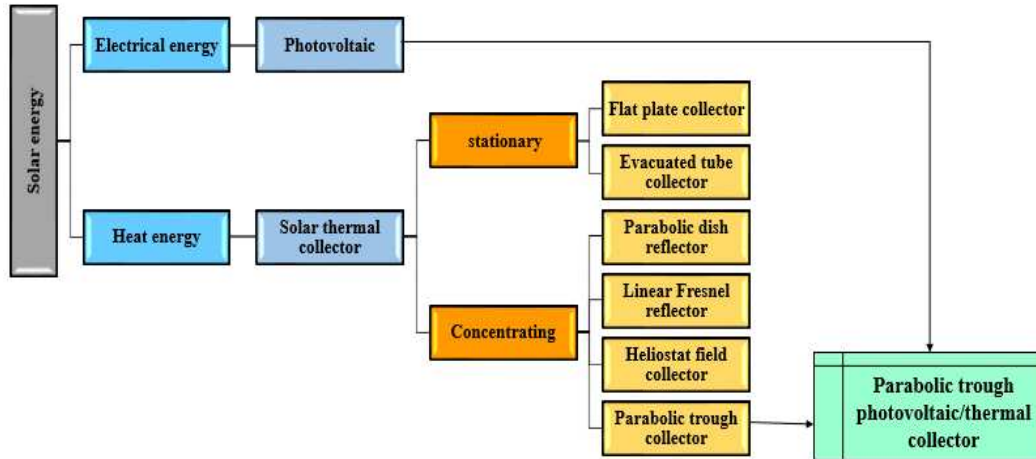

Figure 1. Combination of PV and PTC for simultaneous electricity and heat production.

The main conclusion of the literature review exposed above is that PTPVT hybrid systems are trending systems that depend heavily on a wide variety of parameters and weather conditions. However, it is clear that few are the studies that conduct thermal modeling on such system which saves time in implementing case studies or parametric analyses and analyzing the system performance. Besides, rare are the studies which include case studies on such system which aims to optimize the system performance by investigating the effect of various parameters and weather conditions. Furthermore, economic and environmental analysis for countries of different climates are not implemented on PTPVT system.

Therefore, such systems with the impact of several parameters on their performance require more researches and studies to be conducted. Relying on this context, this paper is devoted to conduct a new thermal modeling of PTPVT to investigate the performance of the system. Case studies are performed on Mediterranean, mild and warm climate countries which are respectively Lebanon, France and United Arab Emirates (UAE) to compare the efficiency and the effect of this system in each country. The modeling is simulated with MATLAB software to perform the case studies. The originality of this work is summarized as follows:

- 1) This work proposes a new appropriate thermal modeling of PTPVT that facilitates performing case studies with low computational time.
- 2) It offers a beneficial modeling and case studies for PTPVT community. This avail appears when utilizing the conducted thermal model in studies that aim to enhance PTPVT performance. It also provides the potential to investigate the impact of wide variety of parameters and weather conditions on the system performance, especially when studying the feasibility of the new concepts.
- 3) It presents a significant material in which PTPVT system performance is analyzed by conducting a suitable thermal modeling and performing case studies.
- 4) It provides useful economic and environmental analyzes of the PTPVT system performance for three different weather conditions: Mediterranean, mild and warm climate countries which are respectively Lebanon, France and UAE.

Section 2 of the paper describes the PTPVT structure and mode of operation. Section 3 presents the PTPVT system new thermal modeling, iteration procedure and validation. Section 4 is

devoted for case studies to compare the performance of the system in three countries (Lebanon, France and UAE) of different climates. Section 5 includes economic and environmental analysis. Finally, section 6 demonstrates the conclusions of this work.

## Nomenclature

A	Area [ $m^2$ ]
$b_0$	curve coefficient
C	Cost
$C_p$	Specific heat at constant pressure [J/KgK]
CR	concentration ratio
d	Diameter [m]
E	Energy [Wh]
h	Convection heat transfer coefficient [ $W/m^2K$ ]
I	Solar radiation [ $W/m^2$ ]
IAM	incident angle modifier
K	Thermal conductivity [W/mK]
L	Receiver tube length [m]
$\dot{m}$	Mass flow rate [Kg/s]
M	Mass [Kg]
MS	Money saved [\$]
N	Number
NTU	Number of transfer unit
PBP	Payback period [year]
Pr	Prandtl number
q	Heat flow rate [W]
R	Thermal resistance [K/w]
Re	Reynolds number
S	Receiver side length [m]
T	Temperature [C]
t	Thickness [m]
V	Velocity [m/s]

## Abbreviations

CO <sub>2</sub>	Carbon dioxide
GaAs	Gallium arsenide
PTC	Parabolic trough collector
PTPVT	Parabolic trough photovoltaic/thermal collector
PV	Photovoltaic
PVT	photovoltaic/thermal collector
STC	solar thermal collector
UAE	United Arabian Emirates

**Subscript**

1kWh	one killo watt hour
a	Ambient
abs	absorber
ap	Aperture
b	beam
conc	concentrator
cond	conduction
conv	convection
d	days
EH	Electric heater
elec	electric
f	fluid
h,w	heat water
hr	hours
HX	Heat exchanger
opt	Optical
rad	radiation
rec	receiver
S	Saved
sub	substrate
th	thermal
tot	total
yr	years

**Greek symbols**

$\epsilon$	Heat transfer effectiveness
$\varepsilon$	Emissivity
$\Theta$	Incident angle
$\sigma$	Stephan-Botzmann constant
$\alpha$	Absorptance
$\eta$	Efficiency

**2. Structure and mode of operation**

The considered PTPVT system is similar in structure to the conventional (PTC) in which it is composed of parabolic sheet of reflective material, supporting structure, tracking system, and a thermal absorber tube that is placed at the reflective parabola focus (Fig. 2). However, the PTC thermal absorber is made up of a metal glazed tube which contains the working fluid, while that of the studied PTPVT is a triangular shaped receiver that is made up of PV cells and thermal absorber. The PV cells used in this system are InGaP/InGaAs/Ge triple-junction PV cells that are efficient (and has low sensitivity to the fluctuations of the operating temperatures. The PV layers

are located at the triangle two sides that are encountering the parabolic concentrator, while the thermal absorber are situated on the triangular receiver top side. Hence, the thermal absorber (triangular receiver top side) is capable to absorb the direct and the diffuse radiation contrary to the PV layer which can only absorb the direct beam radiation reflected from the parabolic concentrator. In addition, the triangular receiver comprises a circular fluid channel where the working fluid (fluid to be heated) flows inside it. In this system, the adopted working fluid is water. Furthermore, between the triangular receiver (thermal absorber and PV cells) and the fluid channel, a metallic substrate is equipped to enhance the conductive heat transfer.

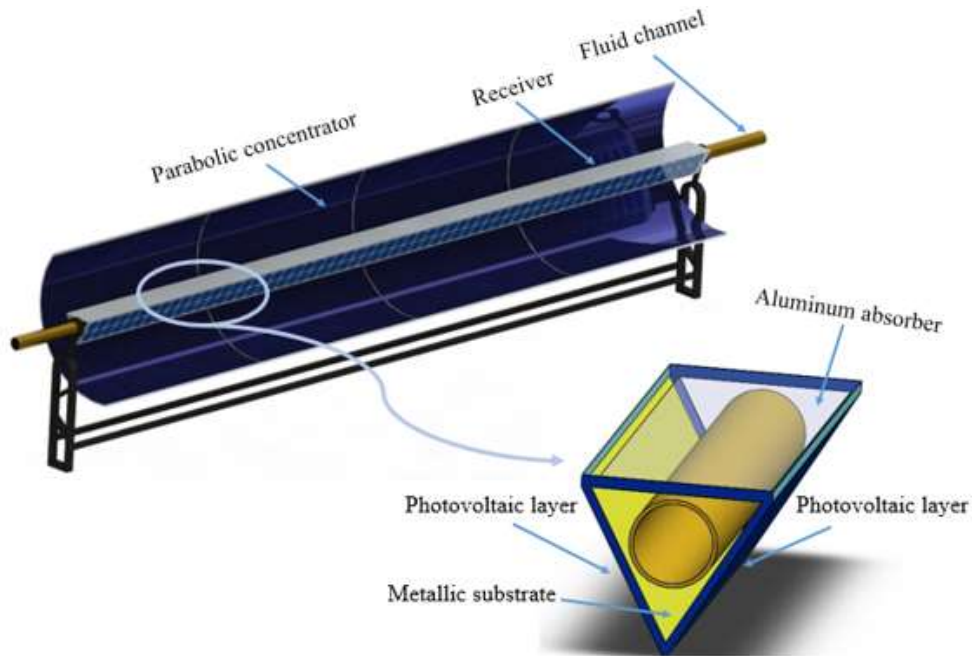

Figure 2. Structure of the studied PTPVT system.

When the parabolic concentrators receives solar radiation it reflects the direct beam radiation to the facing sides of the receiver which includes the PV modules that in their turn act as thermal absorber. Meanwhile, the thermal absorber which is located at the top side of the receiver absorbs solar radiation. Therefore, thermal energy is produced by the PV layer and the thermal absorber and electrical energy is generated by the PV layer. The generated electrical energy can be utilized to drive various applications while the produced thermal energy is exploited to heat the fluid passing through the tube.

### 3. Thermal modeling and iterative process

#### 3.1- Thermal modeling

The thermal modeling of the aforementioned PTPVT system relies on energy balance of several control volumes that takes into account all components of the system. The model is established by relying on several assumptions including steady state, negligible kinetic and potential energies, thermodynamic equilibrium, uniform concentration of solar radiation along the PV layer, negligible temperature gradients in the PV cells (due to its small thickness) and in the metallic substrate (due to its high thermal conductivity).

It is significant to note that the proposed thermal modeling doesn't assume steady state thermal behavior since the solar intensity and ambient temperature are variable. Indeed, it adopts the steady state part of the thermal behavior in which the variation of the solar radiation and ambient temperature are negligible and when implementing quasi-stationary annual simulations. This concern is beneficial particularly when conducting case studies or parametric analyses.

Also, it is assumed that the sky temperature, ambient temperature and water inlet temperature are uniform [21,29,32]. Figure 3 illustrates the thermal resistance at each part of the system.

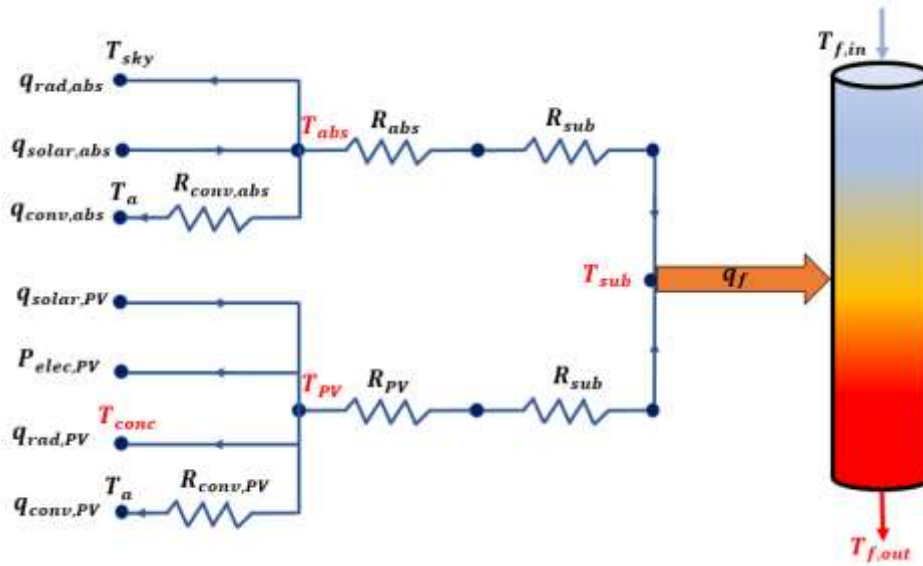

Figure 3. Thermal resistance at each part of the system where the unknown temperatures are shown in red.

The first considered control volume includes the absorber, the PV layer and the fluid tube. The energy balance for this control volume is shown in equation (1):

$$q_{solar,PV} - P_{elec,PV} - q_{conv,PV} - q_{rad,PV} + q_{solar,abs} - q_{conv,abs} - q_{rad,abs} = q_f \quad (1)$$

where  $q_{solar,PV}$  and  $q_{solar,abs}$  are the available solar irradiation which is directed towards the PV layer and thermal absorber respectively.  $P_{elec,PV}$  is the generated electric power by PV layer.  $q_{conv,PV}$  and  $q_{conv,abs}$  are respectively the PV layer and thermal absorber convective heat losses.  $q_{rad,PV}$  and  $q_{rad,abs}$  are respectively the PV layer and thermal absorber radiative heat losses.

The directed solar irradiation towards PV layer [21] is:

$$q_{solar,PV} = I_b A_{PV} CR_{PV} \eta_{opt} IAM_{th} \alpha_{PV} \quad (2)$$

where  $I_b$  is the direct beam radiation,  $A_{PV}$  is the PV layer area,  $CR_{PV}$  is the concentration ratio which is the ratio of the concentrator aperture area ( $A_{ap}$ ) to the PV layer area ( $A_{PV}$ ) [21],  $\eta_{opt}$  is the PV layer optical efficiency,  $\alpha_{PV}$  is the absorptance of PV layer,  $IAM_{th}$  is the thermal incident angle modifier which is computed based on the experimental data presented by [25,33], it is function of the incident angle ( $\theta$ ) whether it is less than or greater than 60, and the thermal IAM curve coefficient ( $b_{0,th}$ ) which is equal to 0.14 [25].

$$CR_{PV} = \frac{A_{ap}}{A_{PV}} \quad (3)$$

where  $A_{ap}$  is the aperture area.

$$\begin{aligned} IAM_{th} &= 1 - b_{0,th} \left( \frac{1}{\cos\theta} - 1 \right) && \text{If } \theta < 60^\circ \\ IAM_{th} &= \left[ 1 - b_{0,th} \left( \frac{1}{\cos\theta} - 1 \right) \right] \left( 1 - \frac{\theta-60}{30} \right) && \text{If } \theta \geq 60^\circ \end{aligned} \quad (4)$$

where  $b_{0,th}$  is the  $IAM_{th}$  curve coefficient and  $\theta$  is the angle of incidence.

$$P_{elec,PV} = I_b A_{PV} CR_{PV} \eta_{opt} IAM_{elec} \eta_{PV} \quad (5)$$

where  $IAM_{elec}$  is the electrical incident angle modifier which is calculated based on the experimental data presented by [25,33], it is function of the incident angle ( $\theta$ ) whether it is less than or greater than 60, and the electrical IAM curve coefficient ( $b_{0,elec}$ ) which is equal to 0.28 [25].  $\eta_{PV}$  is the efficiency of PV layer which is function of the concentration ratio ( $CR_{PV}$ ) and the PV layer temperature ( $T_{PV}$ ) [31,34].

$$\begin{aligned} IAM_{elec} &= 1 - b_{0,elec} \left( \frac{1}{\cos\theta} - 1 \right) && \text{If } \theta < 60^\circ \\ IAM_{elec} &= \left[ 1 - b_{0,elec} \left( \frac{1}{\cos\theta} - 1 \right) \right] \left( 1 - \frac{\theta-60}{30} \right) && \text{If } \theta \geq 60^\circ \end{aligned} \quad (6)$$

where  $b_{0,elec}$  is the  $IAM_{elec}$  curve coefficient.

$$\eta_{PV} = 0.298 + 0.0142 \ln(CR_{PV}) + [-0.000715 + 0.0000697 \ln(CR_{PV})](T_{PV} - 298) \quad (7)$$

The PV layer convective heat loss is:

$$q_{conv,PV} = \frac{T_{PV} - T_a}{R_{conv,PV}} \quad (8)$$

with

$$R_{conv,PV} = \frac{1}{h_{PV} A_{PV}} \quad (9)$$

where  $T_a$  is the ambient temperature,  $R_{conv,PV}$  is the PV convection thermal resistance [35] and  $h_{PV}$  is the PV convective heat transfer coefficient. By assuming a forced convection, in which the wind velocity ranges between 4-5 m/s,  $h_{PV}$  can be computed by the below correlation [35]:

$$Nu_f = 0.664 Pr_f^{\frac{1}{3}} Re_f^{\frac{1}{2}} \quad (10)$$

where  $Nu_f$  is the Nusselt number of the fluid,  $Re_f$  is the Reynolds number of the fluid and  $Pr_f$  is the Prandtl number.

The PV radiative heat losses [35] is:

$$q_{rad,PV} = \varepsilon_{PV} \sigma A_{PV} (T_{PV}^4 - T_{conc}^4) \quad (11)$$



where  $\varepsilon_{PV}$  is the emissivity of PV layer,  $\sigma$  is the Stephan-Boltzmann constant,  $T_{conc}$  is the concentrator temperature.

The directed solar irradiation towards the thermal absorber [21] is:

$$q_{solar,abs} = I_{tot} A_{abs} \alpha_{abs} \quad (12)$$

where  $I_{tot}$  is the total radiation,  $A_{abs}$  is the area of the thermal absorber and  $\alpha_{abs}$  is its absorptance.

The thermal absorber convective heat losses [35] is:

$$q_{conv,abs} = \frac{T_{abs} - T_a}{R_{conv,abs}} \quad (13)$$

where  $T_{abs}$  is the absorber temperature and  $R_{conv,abs}$  is the thermal absorber convection thermal resistance.

$$R_{conv,abs} = \frac{1}{h_{abs} A_{abs}} \quad (14)$$

where  $h_{abs}$  is the convective heat transfer coefficient of the absorber which is computed using correlation in equation (10).

The PV layer and thermal absorber radiative heat losses is:

$$q_{rad,abs} = \varepsilon_{abs} \sigma A_{abs} (T_{abs}^4 - T_{sky}^4) \quad (15)$$

where  $\varepsilon_{abs}$  is the absorber emissivity and  $T_{sky}$  is the sky temperature.

Applying energy balance on the fluid results the following equation:

$$q_f = \dot{m}_f C_{p,f} (T_{f,out} - T_{f,in}) \quad (16)$$

where  $\dot{m}_f$  is the mass flow rate of the fluid,  $C_{p,f}$  is its specific heat and  $T_{f,out}$  and  $T_{f,in}$  are the its outlet and inlet temperatures respectively.

The thermal absorber and the substrate represents the second control volume. Its energy balance is presented in equation (17).

$$q_{solar,abs} - q_{conv,abs} - q_{rad,abs} = q_{cond,abs-sub} \quad (17)$$

where  $q_{cond,abs-sub}$  is the heat loss by conduction between the substrate and the thermal absorber.

$$q_{cond,abs-sub} = \frac{T_{abs} - T_{sub}}{R_{cond,abs} + R_{cond,sub}} \quad (18)$$

where  $R_{cond,abs}$  and  $R_{cond,sub}$  are respectively the absorber and the substrate conductive thermal resistances.

$$R_{cond,abs} = \frac{t_{abs}}{K_{abs} \cdot A_{abs}} \quad (19)$$

and

$$R_{cond,sub} = \frac{t_{sub}}{K_{sub} \cdot A_{sub}} \quad (20)$$

where  $t_{abs}$ ,  $t_{sub}$ ,  $K_{abs}$  and  $K_{sub}$  are thicknesses and thermal conductivities of the absorber and the substrate, respectively.

The energy balance of the control volume containing the substrate and the fluid channel is shown in equation (21).

$$q_{cond,PV-sub} + q_{cond,abs-sub} = q_f \quad (21)$$

where  $q_{cond,PV-sub}$  is the heat loss by conduction between the metallic substrate and PV layer.

$$q_{cond,PV-sub} = \frac{T_{PV} - T_{sub}}{R_{cond,PV} + R_{cond,sub}} \quad (22)$$

where  $R_{cond,PV}$  is the PV layer conductive thermal resistance.

$$R_{cond,PV} = \frac{t_{PV}}{K_{PV} \cdot A_{PV}} \quad (23)$$

where  $t_{PV}$  and  $K_{PV}$  are respectively the PV layer thickness and thermal conductivity.

Equation (24) presents the applied energy balance on the concentrator:

$$q_{solar,conc} + q_{rad,PV} = q_{conv,conc,front} + q_{conv,conc,back} + q_{rad,conc} \quad (24)$$

where  $q_{solar,conc}$  is the directed solar radiation towards the concentrator.  $q_{conv,conc,front}$  and  $q_{conv,conc,back}$  are respectively the concentrator front and back convective heat losses and  $q_{rad,conc}$  is the concentrator radiative heat losses.

The parabolic concentrator available solar radiation [21] is:

$$q_{solar,conc} = I_{tot} A_{conc} \alpha_{conc} \quad (25)$$

where  $A_{conc}$  and  $\alpha_{conc}$  are the area and absorptance of the concentrator respectively.

The concentrator front and back convective heat losses are presented in the following equations [35]:

$$q_{con,conc,front} = A_{conc} h_{conv,conc,front} (T_{conc} - T_a) \quad (26)$$

and

$$q_{conv,conc,back} = A_{conc} h_{conv,conc,back} (T_{conc} - T_a) \quad (27)$$

where  $h_{conv,conc,front}$  and  $h_{conv,conc,back}$  are the convective heat transfer coefficient from the front and back of the concentrator, respectively.

The radiative heat losses from the concentrator is:

$$q_{rad,conc} = \varepsilon_{conc} \sigma A_{conc} (T_{conc}^4 - T_{sky}^4) \quad (28)$$

where  $\varepsilon_{conc}$  is the emissivity of the concentrator.

Equation (29) represents the energy balance applied on the control volume including the metallic substrate and the fluid tube in which it is treated as heat exchanger.

$$\dot{m}_f C_{p,f} (T_{f,out} - T_{f,in}) = \in \dot{m}_f C_{p,f} (T_{sub} - T_{f,in}) \quad (29)$$

where  $\in$  is the effectiveness of heat transfer which can be computed using NTU number [21]:

$$\in = 1 - e^{-NTU} \quad (30)$$

and

$$NTU = \frac{1}{\frac{1}{h_f} + R_{sub}} \frac{A_{HX}}{\dot{m}_f C_{p,f}} \quad (31)$$

where  $A_{HX}$  is the heat exchanger area and  $h_f$  is the heat transfer coefficient of the fluid, it can be calculated by the following correlation [35]:

$$Nu_f = 0.023 Re_f^{\frac{4}{5}} Pr_f^{\frac{2}{5}} \quad (32)$$

The system electrical and thermal efficiencies are:

$$\eta_{elec} = \frac{P_{elec,PV}}{I_b A_{ap}} \quad (33)$$

where  $\eta_{elec}$  is the electrical efficiency

$$\eta_{th} = \frac{q_f}{I_b A_{ap}} \quad (34)$$

where  $\eta_{th}$  is the thermal efficiency.

In this work, an economic and environmental analyses are conducted to estimate the amount of saved money, payback period and the amount of CO<sub>2</sub> emissions mitigated when utilizing the suggested system in Lebanon, France and UAE.

In order to estimate the money saved by the system, the total power saved should be calculated. This total power is the summation of the electric power generated by PV layer and the equivalent power required of the thermal heat gained by water.

$$P_s^{tot} = P_{elec,PV} + P_{h,w} \quad (35)$$

where  $P_s^{tot}$  is the total power saved and  $P_{h,w}$  is the equivalent power required to heat water. This equivalent power is estimated using the following equation:

$$P_{h,w} = \frac{q_f}{\eta_{EH}} \quad (36)$$

where  $\eta_{EH}$  is the electric heater efficiency.

The total energy saved  $E_s^{tot}$  is estimated by the following equation which takes into consideration the average number of day light hours and number of days of each month.

$$E_s^{tot} = P_s^{tot} \cdot N_d \cdot N_{hr} \quad (37)$$

where  $N_d$  is the number of days per month and  $N_{hr}$  is the number of day light hours for each month.

The money saved,  $MS$ , is estimated by multiplying the total energy saved by the price of one kilo-watt hour for each country as shown in equation (38).

$$MS = E_s^{tot} \cdot C_{1kWh} \quad (38)$$

where  $C_{1kWh}$  is the cost of 1 kWh.

Finally the payback period  $PBP$  is estimated by the cost of the parabolic trough photovoltaic thermal system  $C_{PTPVT}$  over the annual money saved  $MS_{yr}$ .

$$PBP = \frac{C_{PTPVT}}{MS_{yr}} \quad (39)$$

Regarding the environmental study, the amount of carbon dioxide emissions reduced  $M_{Co2}^{red}$  is estimated by the following equation.

$$M_{Co2}^{red} = E_s^{tot} \cdot M_{Co2}^{1kWh} \quad (40)$$

where  $M_{Co2}^{1kWh}$  is the mass of carbon dioxide produced in order to generate one kilowatt hour.

### 3.2- Iterative process

Using this thermal modeling and the given boundary conditions (mass flow rate and inlet temperature of the fluid, direct beam radiation and total radiation, incident angle, ambient and sky temperatures), a system of five equations, Eq. (1), (17), (21), (24), (29) and five unknowns is formed. The five unknowns are the temperatures of the outlet fluid, PV layer, metallic substrate, concentrator and the thermal absorber. An iteration can be performed in order to compute these five unknowns. Figure 4 illustrates a schematic of the procedure of the iteration that is conducted to find the five aforementioned unknowns.

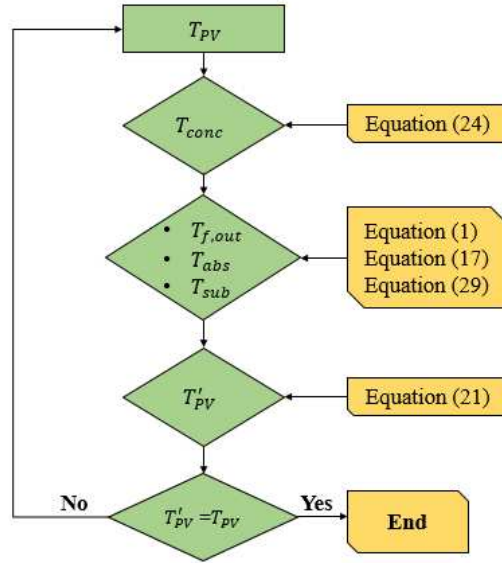

Figure 4. Simulation procedure of thermal modeling.

First, assume the value of the temperature of PV layer ( $T_{PV}$ ). Using equation (24) the concentrator temperature ( $T_{conc}$ ) can be computed. After that, a system of three equations, Eq. (1), (17), (29) and three unknowns can be utilized to calculate the temperature of the thermal absorber ( $T_{abs}$ ), temperature of the metallic substrate ( $T_{sub}$ ) and the fluid outlet temperature ( $T_{f,out}$ ). Then, we compute the value of  $T_{PV}$  using the formula of equation (21) and compare it with the assumed value. If the two values differ, several iterations must be performed to reach the same value.

### 3.3- Validation

The new conducted thermal modeling described above is compared with previous works from the literature in order to show its validation. The system of this work and the system investigated by [21] and [25] are similar. The design parameters shown in table 1 [21] are used for model validation.

Table 1. Design parameters for model validation [21].

Parameter	Symbol	Value	Unit
Concentrator aperture area	$A_{ap}$	12.0	m <sup>2</sup>
Absorber area	$A_{abs}$	0.6	m <sup>2</sup>
PV layer area	$A_{PV}$	1.2	m <sup>2</sup>
Concentration ratio	$CR_{PV}$	10	-
Receiver side length	$S_{rec}$	0.06	m
Fluid channel diameter	$d_f$	0.03	m
Fluid specific heat	$C_{p,f}$	4183	J/kg K
Fluid flow rate	$\dot{m}_f$	0.15	kg/s
PV thermal conductivity	$K_{PV}$	50	W/m <sup>2</sup>
Absorber thermal conductivity	$K_{abs}$	205	W/m <sup>2</sup>
Substrate thermal conductivity	$K_{sub}$	250	W/m <sup>2</sup>

Absorber absorptance	$\alpha_{abs}$	0.90	-
Concentrator absorptance	$\alpha_{conc}$	0.03	-
PV absorptance	$\alpha_{PV}$	0.97	-
Absorber emissivity	$\varepsilon_{abs}$	0.20	-
Concentrator emissivity	$\varepsilon_{conc}$	0.30	-
PV emissivity	$\varepsilon_{PV}$	0.20	-
IAM electrical coefficient	$b_{0,elec}$	0.28	-
IAM thermal coefficient	$b_{0,th}$	0.14	-

Table 2 presents the boundary conditions adopted in the validation process which are similar to that utilized in [21]. It comprise the incident angle, air velocity, sky and ambient temperature, beam and total incident radiation as well as the fluid inlet temperature.

Table 2. Boundary conditions [21].

Parameter	Symbol	Value	Unit
Incident angle	$\theta$	0	deg
Air velocity	$V_{air}$	5	m/s
Sky temperature	$T_{sky}$	25	°C
Ambient temperature	$T_a$	25	°C
Total radiation	$I_{tot}$	1000	W/m <sup>2</sup>
Beam radiation	$I_b$	800	W/m <sup>2</sup>
Fluid inlet temperature	$T_{f,in}$	70	°C

Table 3 presents the system temperatures obtained by the conducted thermal model and data from [21]. It is obvious that the model is validated with maximum deviation of 3.4% on  $T_{abs}$  and 0.8% on  $T_{f,out}$ . This reveals that the conducted thermal modeling is validated.

Table 3. Obtained system temperatures by the conducted thermal model and data from [21].

Parameter	Calculated	From [21]	Deviation
$T_{f,out}$ (°C)	78.64	79.30	0.80%
$T_{PV}$ (°C)	83.75	82.30	-1.76%
$T_{abs}$ (°C)	79.90	82.70	3.40%
$T_{sub}$ (°C)	79.70	80.50	0.99%

#### 4. Case studies and discussions

In this section, the thermal model and the iteration procedure described above is implemented using MATLAB software to investigate the thermal and electrical behavior of the considered system. Hence several case studies are conducted on Lebanon, France and UAE countries which have distinct climate regions (Mediterranean, mild and warm respectively) to compare the performance of the PTPVT system as function of climate. Table 4 elucidates the design parameters of PTPVT system.

Table 4. Design parameters of PTPVT system.

Parameter	Symbol	Value	Unit
PV layer area	$A_{PV}$	6	m <sup>2</sup>

Absorber area	$A_{abs}$	3	$m^2$
Concentrator aperture area	$A_{ap}$	60	$m^2$
Receiver side length	$S_{rec}$	0.1	m
Fluid tube diameter	$d_f$	0.06	m
Fluid flow rate	$\dot{m}_f$	0.1	kg/s
Receiver tube length	L	30	m

Tables 5, 6 and 7 illustrate the boundary conditions for Lebanon (Baalbek), France (Angers) and UAE (Abu Dhabi) respectively. The boundary conditions include the ambient temperature, sky temperature and fluid inlet temperature which are assumed to be equal as well as the total and beam incident radiations.

Table 5. Boundary conditions for Lebanon (Baalbek) [36].

Month	$T_a$ (°C)	$T_{sky}$ (°C)	$T_{fin}$ (°C)	$I_{tot}$ (W/m <sup>2</sup> )	$I_b$ (W/m <sup>2</sup> )
January	8.85	8.85	8.85	578.67	374.75
February	10.86	10.86	10.86	592.09	355.42
March	14.76	14.76	14.76	815.48	544.63
April	19.74	19.74	19.74	905.33	636.32
May	24.23	24.23	24.23	957.88	714.83
June	29.19	29.19	29.19	1045.08	856.56
July	32.13	32.13	32.13	1044.82	865.96
August	32.02	32.02	32.02	1042.33	853.44
September	28	28	28	1016.43	814.77
October	22.58	22.58	22.58	928.72	695.96
November	15.45	15.45	15.45	814.74	591.26
December	10.51	10.51	10.51	694.15	482.1

Table 6. Boundary conditions for France (Angers) [36].

Month	$T_a$ (°C)	$T_{sky}$ (°C)	$T_{fin}$ (°C)	$I_{tot}$ (W/m <sup>2</sup> )	$I_b$ (W/m <sup>2</sup> )
January	7.77	7.77	7.77	356.45	225.15
February	8.53	8.53	8.53	472.85	299.33
March	11.83	11.83	11.83	580.6	361.21
April	15.33	15.33	15.33	679.57	432.82
May	18.07	18.07	18.07	644.11	356.06
June	21.66	21.66	21.66	670.98	383.1
July	23.89	23.89	23.89	695.56	408.63
August	23.45	23.45	23.45	697.95	417.09
September	21.32	21.32	21.32	676.25	436.14
October	16.9	16.9	16.9	525.64	331.23
November	11.63	11.63	11.63	448.42	299.01
December	7.81	7.81	7.81	434.85	297.97

Table 7. Boundary conditions for UAE (Abu Dhabi) [36].

Month	$T_a$ (°C)	$T_{sky}$ (°C)	$T_{fin}$ (°C)	$I_{tot}$ (W/m <sup>2</sup> )	$I_b$ (W/m <sup>2</sup> )
-------	------------	----------------	----------------	-------------------------------	---------------------------



January	19.98	19.98	19.98	926.43	665.77
February	21.4	21.4	21.4	993.59	726.6
March	23.78	23.78	23.78	986.9	715.99
April	27.16	27.16	27.16	977.22	709.64
May	31.85	31.85	31.85	1011.83	759.85
June	33.86	33.86	33.86	1024.29	783.7
July	35.34	35.34	35.34	978.46	682.92
August	36.21	36.21	36.21	991	714.57
September	34.24	34.24	34.24	1025.79	774.07
October	31.17	31.17	31.17	1042.88	810.04
November	27.35	27.35	27.35	979.59	731.89
December	22.91	22.91	22.91	931.47	672.13

Using the above shown thermal model, system design parameters and the boundary conditions for each country, three case studies are conducted to investigate the performance of the suggested system with respect to the climate change (beam and total radiation and water inlet temperature vary from country to another).

Figures 5, 6 and 7 present the system temperatures for Lebanon, France and UAE respectively.

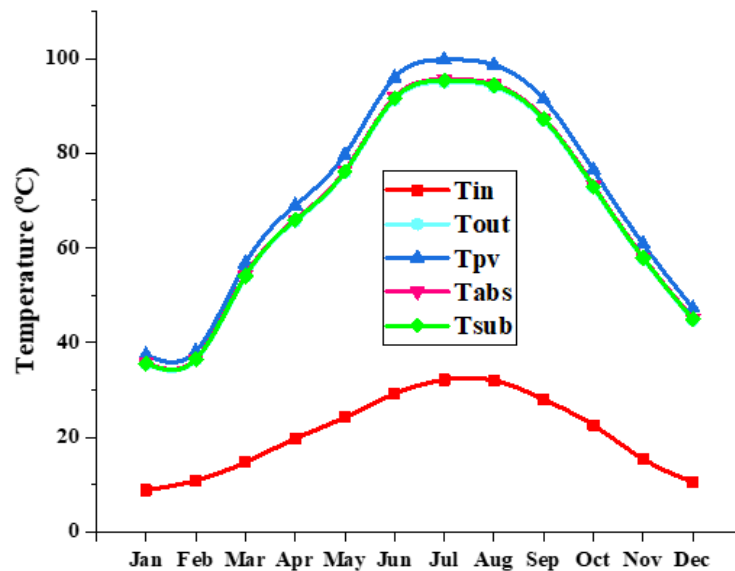

Figure 5. System temperatures for Lebanon.

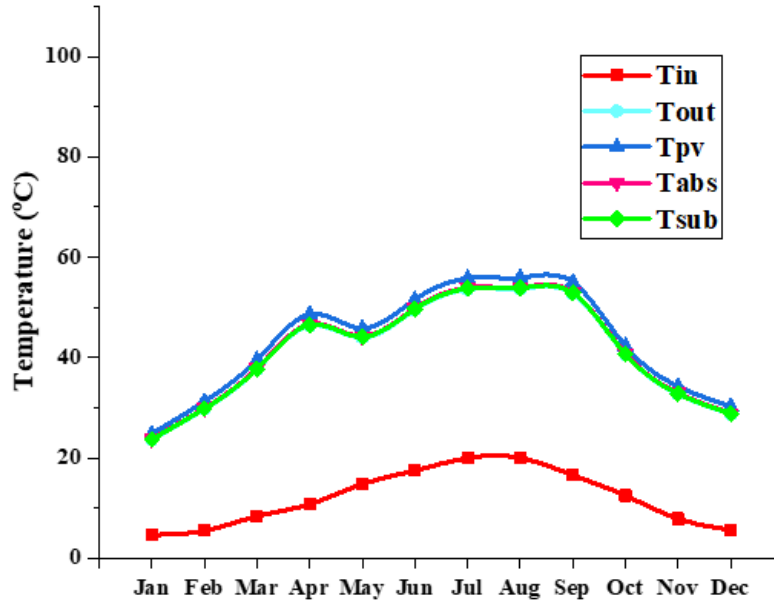

Figure 6. System temperatures for France.

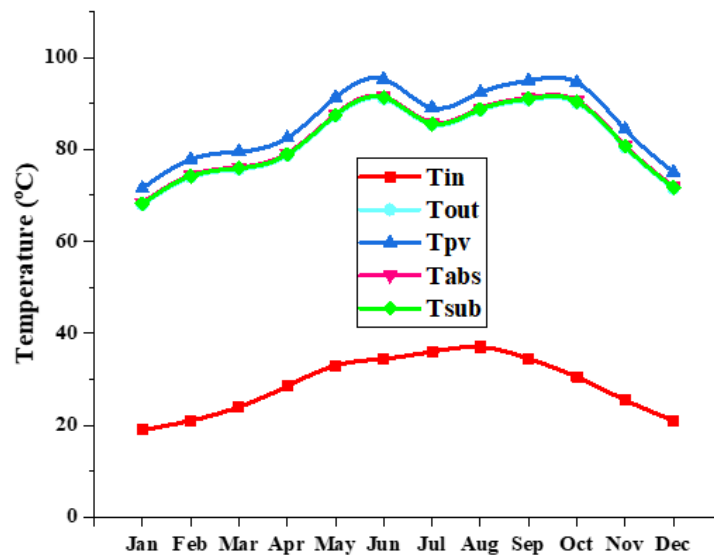

Figure 7. System temperatures for UAE.

It is clear that the temperatures of PV cell, absorber, substrate and fluid outlet are close to each other. This is due to the fact that heat is transferred by conduction and the thermal resistance of each component of the system is low. Besides, the fluid outlet temperatures are relatively high compared to the fluid inlet temperature. The average increase of fluid outlet temperature per month is about 46.8°C, 25.4 °C, and 52.9 °C for Lebanon, France and UAE respectively. The average of fluid outlet temperature augmentation during spring and summer seasons for Lebanon, France and UAE is 57.2 °C, 28.5 °C and 54.2 °C respectively, while during autumn and winter it is 36.3 °C, 22.4 °C and 50.5 °C respectively. The average increase in the temperature in

spring and summer is greater than in autumn and winter since the total and beam radiation in spring and summer are relatively higher than that in autumn and winter.

Furthermore, it is shown that the maximum outlet temperature obtained is 95.0°C in Lebanon during July where the water inlet temperature is 32.1°C, 53.8°C in France during August where the water inlet temperature is 23.5°C, and 91.0°C in UAE during June where the water inlet temperature is 33.9°C. This can be explained by the highest beam radiation and ambient temperature attained during July in Lebanon with relatively high total radiation. However, in France the highest total radiation is during August with relatively high beam radiation and ambient temperature. For UAE, a relatively high total and beam radiation and ambient temperature are attained during June.

On the other side, the minimum outlet temperature achieved is during January in Lebanon, France and UAE (35.5°C , 23.6°C and 68.0°C respectively) where the inlet water temperature is 8.9°C, 7.8°C and 20.0°C respectively. The lowest outlet temperature is due to the fact that the lowest ambient temperature, total and beam radiation are obtained in the three countries during January.

Figure 8 shows the achieved water outlet temperature during each month in the three countries. It is obvious that the climate has a significant influence on the obtained water temperature where the main parameters are the beam radiation, total radiation and the water inlet temperature which is affected by the ambient temperature.

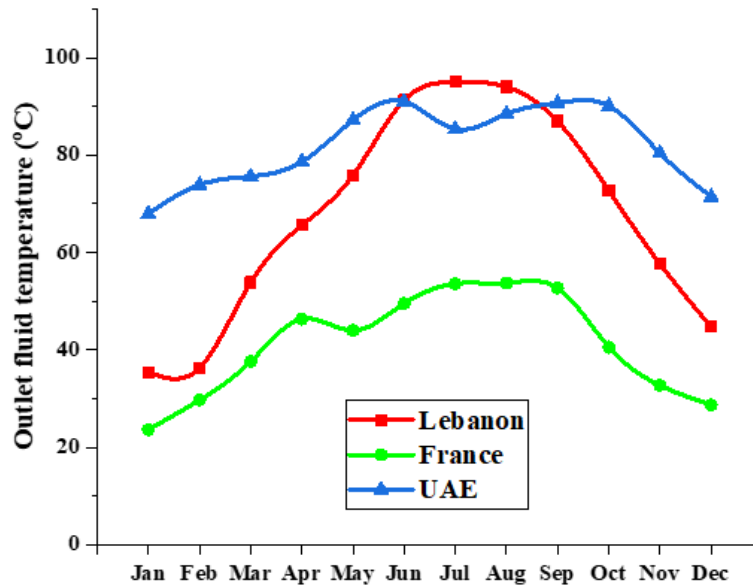

Figure 8. Fluid outlet temperature for Lebanon, France and UAE.

Hence, France which has the lowest values of these parameters achieved the lowest water temperature in contrast to UAE which attains the highest results. While Lebanon which has relatively moderate climate achieved outlet water temperature lower than UAE and higher than France. However, there is exception during June, July and August where Lebanon achieves water outlet temperature higher than that obtained in UAE. This is due to the higher total and beam radiation obtained in Lebanon during these three months in comparison to UAE.

Figure 9 (a) presents the thermal efficiency for Lebanon, France and UAE as function of month. The highest thermal efficiency achieved is during August in Lebanon (50.7%), during June in France (50.8%) and during July in UAE (51.1%), while the lowest thermal efficiency attained is during January in Lebanon (49.5%) and UAE (50.2%) and during December in France (48.9%).

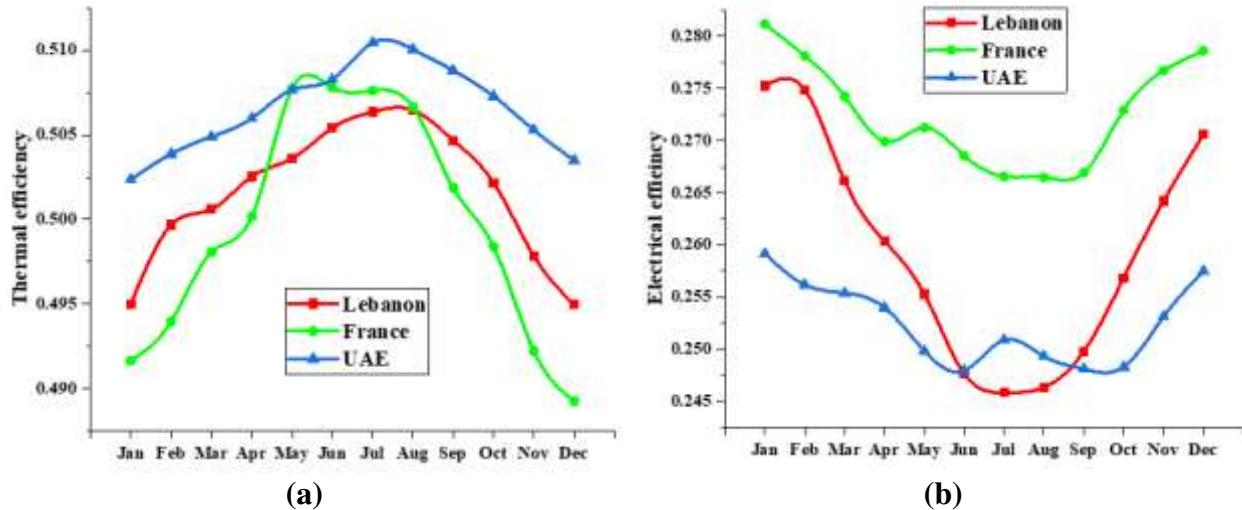

Figure 9. (a) Thermal efficiency for Lebanon, France and UAE. (b) Electrical efficiency for Lebanon, France and UAE.

It is obvious that UAE which has relatively hot climate has the highest thermal efficiency and France which has relatively cold climate has the lowest thermal efficiency. However, there is exception during May, June, July, and August where the thermal efficiency of France is higher than that of UAE during May and higher than that of Lebanon and UAE during June, July and August. These results can be explained based on equations (16) and (34) where the thermal efficiency is the ratio of multiplication of mass flow rate, specific heat and temperature difference to the multiplication of beam incident radiation and aperture area. Since the mass flow rate, specific heat and aperture area are the same in the three countries, the comparison will rely on the ratio of temperature difference to the beam radiation. During May, the ratio of temperature difference to beam radiation in Lebanon, France and UAE is 0.07224, 0.07282 and 0.07281 which explains the high thermal efficiency of France compared to Lebanon and UAE. During June, July and August France has the ratio higher than Lebanon and lower than UAE.

Figure 9 (b) shows the electric efficiency for each country as function of month. The highest electrical efficiency achieved is during January in Lebanon (27.5%) and UAE (25.9%) and during December in France (27.9%). While the lowest electrical efficiency attained is during July in Lebanon (24.6%), during August in France (26.7%) and during June in UAE (24.8%). It is obvious that France has the highest electric efficiency while UAE has the lowest value. As the temperature increases the electric efficiency deteriorates, this is what happens in case of UAE where all system temperatures are the highest compared to France and Lebanon. The highest electric efficiencies are achieved during January and December which are the coldest months where the system temperatures are the lowest and the thermal efficiencies are relatively low, while the lowest electric efficiencies are obtained in months where system temperatures are at

the highest values and the thermal efficiencies are relatively high. Nevertheless, during June, July and August the electric efficiency attained in Lebanon is lower than that obtained in UAE due to the high beam and total radiation in Lebanon compared to UAE, which leads to higher system temperatures and thus reducing the electric efficiency of the system.

Figures 10 (a) and (b) show the generated thermal and electrical energy respectively by each country as function of month. It is clear that both graphs have relatively the same trend since the main parameter that affect the thermal and electric powers is the beam radiation and hence the thermal and electric energies are affected. Furthermore, the case of France which has the lowest beam and total radiation generates the lowest thermal and electrical energy, while in Lebanon and UAE the amount of thermal and electrical energy produced depends on the month since in some months Lebanon has higher total and/or beam radiation than UAE. The below graphs show that the maximum thermal energy produced is 11.4 MWh and 6.2 MWh during July in Lebanon and France respectively, and 10.0 MWh during June in UAE. While the maximum generated electric energy by the hybrid system is 5.5 MWh and 3.2 MWh during July in Lebanon and France respectively, and 4.9 MWh during June in UAE. Since Lebanon attain beam radiation higher than UAE in some months, the maximum thermal and electrical energies in Lebanon are higher than that in UAE. However, UAE attain the highest annual thermal and electrical energies (99.2 MWh and 49.4 MWh respectively) while France generates the lowest energies (49.2 MWh and 26.6 MWh respectively) and Lebanon generates energies less than UAE by about 10% (88.2 MWh and 44.9 MWh respectively).

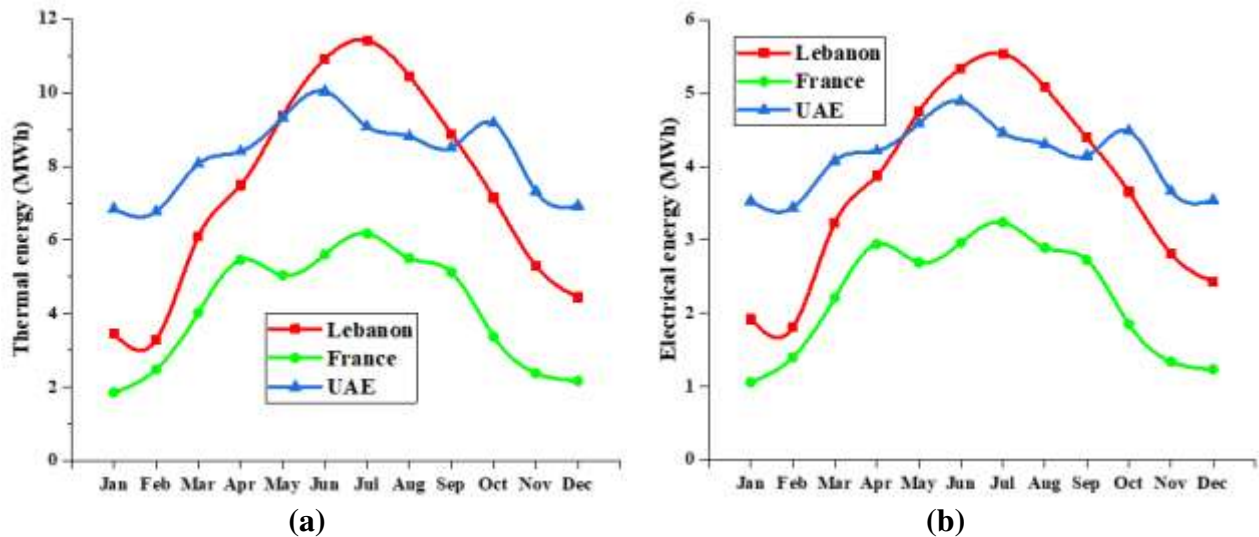

Figure 10. (a) Thermal energy for Lebanon, France and UAE. (b) Electrical energy for Lebanon, France and UAE.

It can be concluded from the above results that the system thermal and electrical performance is highly influenced by the water inlet temperature which in it turn is affected by the ambient temperature, in addition to the beam and total radiation. Hence, climate conditions are vital parameters that should be taken into consideration when evaluating the performance of PTPVT system.

## 5. Economic and environmental analyses

This section is devoted for presenting the results of the economic and environmental analyses in which the amount of saved money, payback period and the amount of CO<sub>2</sub> emissions mitigated when utilizing the suggested system in Lebanon, France and UAE are estimated. Table 8 shows the average day light hours per month for Lebanon, France and UAE [37–39].

Table 8. Average day light hours per month for Lebanon, France and UAE [37–39].

Month	Lebanon	France	UAE
Jan	10	9	11
Feb	11	10	11
Mar	12	12	12
Apr	13	14	13
May	14	15	13
Jun	14	16	14
Jul	14	16	14
Aug	13	14	13
Sep	12	13	12
Oct	11	11	12
Nov	10	9	11
Dec	10	8	11

The average cost of electric kWh for Lebanon, France and UAE is presented in table 9 [40].

Table 9. Average electric kWh cost for Lebanon, France and UAE [40].

Country	Cost (\$/kWh)
Lebanon	0.133
France	0.2
UAE	0.1

The cost of the system is summarized in table 10 [32,41]. It is assumed that the cost of building the photovoltaic thermal system is equal in the three countries.

Table 10. Cost of the parabolic trough photovoltaic thermal system [32,41].

PVT system components	Price (\$)
PV module	6200
Parabolic concentrator	4250
Additional components	3450
Tracking system	1600
Inverter	3400
Design and tank	9500

Total cost	28400
------------	-------

Figure 11 shows the total power saved by the system each month for the three different countries. The maximum total power saved is achieved in Lebanon which is 45.7 kW during July (32.9 kW from water heating and 12.8 kW from PV module). In Lebanon, about six months the saved power is in a range of 40 kW, four months in the range of 30 kW and two months in the range of 20 kW. For France case, the maximum power saved is during September with 23.4 kW (16.4 kW from heating water and 7.0 kW from PV module). In addition, the range of power saved by the system is more than 20 kW during five months and between 12 kW and 20 kW during the other months. Whereas, for UAE case, the maximum power saved is during October with 42.9 kW (30.8 kW from heating water and 12.1 kW from PV module). The range of power saved is between 35 kW and 43 kW during all months.

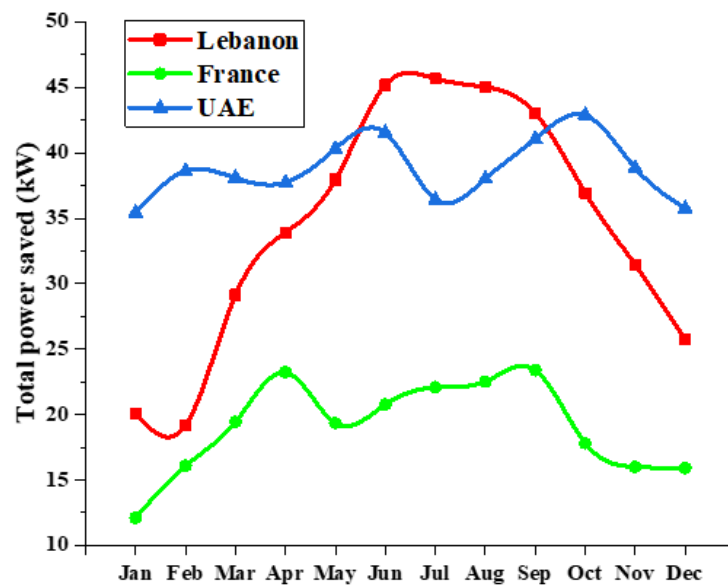

Figure 11. Total power saved each month for Lebanon, France and UAE.

Figure 12 shows the amount of energy saved each month for the three countries. Lebanon case exhibits the highest amount of energy saved, is approximately 19.8 MWh during July. The highest energy saved in France is 11.0 MWh during July, the lowest among the three countries, and 17.4 MWh during June in UAE. The main parameter that affects the energy saved is the amount of power saved since Lebanon attains the highest values of power and energy saved during July compared to France and UAE. However, since UAE achieves relatively high amount of energy saved during all months, it saves the highest value of cumulative energy, around 17.3 MWh. Lebanon has relatively high values of energy saved per month and saves 15.5 MWh per year, whereas France saves the lowest energy, 8.8 MWh, since it has relatively low values of energy saved during all months.

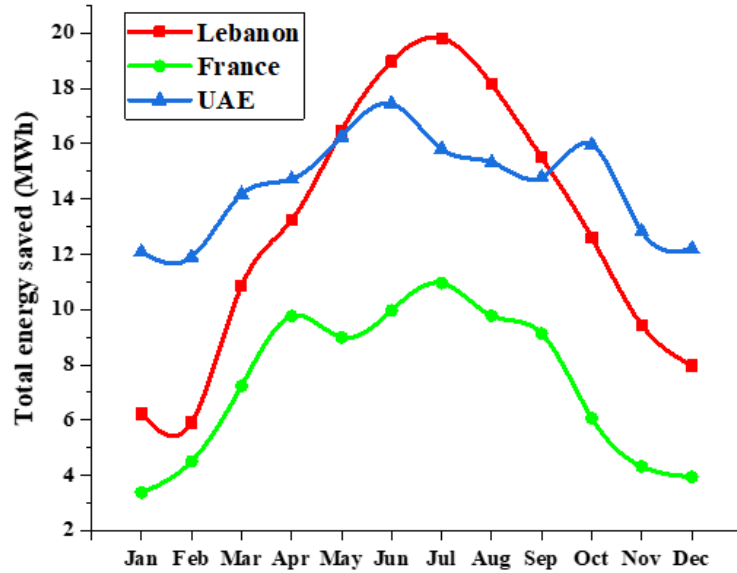

Figure 12. Amount of energy saved each month for Lebanon, France and UAE.

Figure 13 shows the amount of money saved per month. The highest amount of money saved is 2636 \$/month and 2192 \$/month in Lebanon and France respectively during July and 1744 \$/month in UAE during June. The annual saved money in Lebanon, France and UAE are approximately 20600 \$, 17600 \$ and 17400 \$. In fact, the amount of money saved is affected by the energy saved and the cost of electric kWh. This explains the highest amount of annual saved money in Lebanon since it has relatively high cost of 1 kWh and amount of energy saved. On the other hand, despite the fact that UAE has the highest annual energy saved, the lowest cost of 1 kWh made it achieve the lowest value of money saved, while for France case which saves the lowest energy per year attains the intermediate value of annual money saved due to the high cost of 1 kWh.

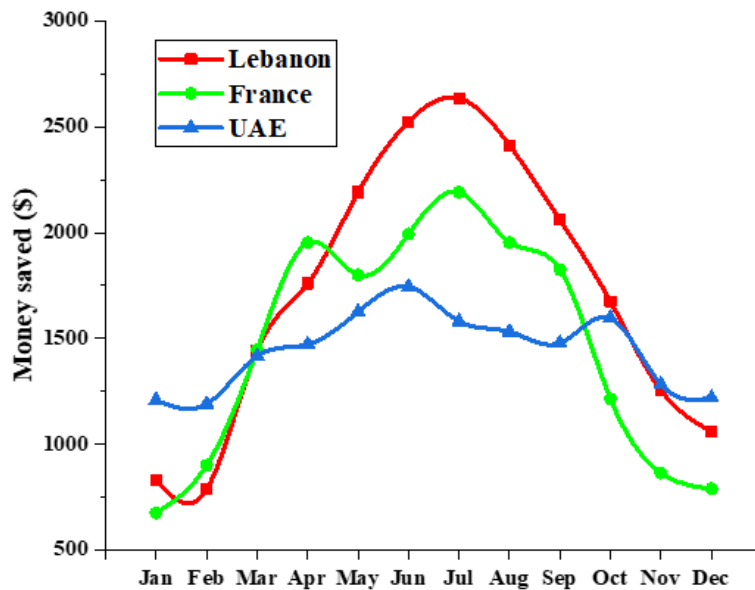



Figure 13. Amount of money saved per month for Lebanon, France and UAE.

Table 11 presents the annual money saved and payback period for the three countries. Lebanon has the lowest payback period due to two main reasons, the cost of electricity which is high and the high amount of energy gained by system. Whereas for UAE case, even though the annual amount of energy saved by the system is greater than that of Lebanon, the system requires about two years to return its cost since UAE has lower cost of one kilowatt hour compared to Lebanon. For France, it achieves high amount of saved money due to the high cost of electric kWh, it needs about year and a half year to return its cost, which is slightly greater than that of Lebanon.

Table 11. Annual money saved and payback period for the three countries.

Country	Annual money saved (\$/year)	Payback period (Years)
Lebanon	20632	1.4
France	17607	1.6
UAE	17345	1.7

According to [42–44] the amount of carbon dioxide produced to generate 1 kilowatt hour in Lebanon, France and UAE are 0.47 kg/kWh, 0.058 kg/kWh and 0.42 kg/kWh respectively. Figure 14 shows the variation of the amount of carbon dioxide emissions reduced each month for the three countries.

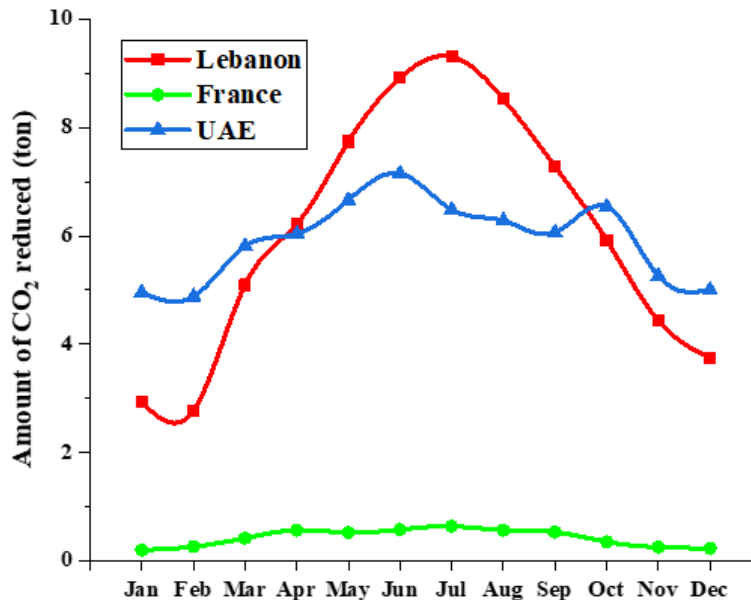
Figure 14. Amount of CO<sub>2</sub> emissions reduced each month for Lebanon, France and UAE.

It shows a noticeable low amount of reduction in CO<sub>2</sub> emissions in France, which mainly results from the low amount of CO<sub>2</sub> generated per kilowatt hour. France relies mainly on generating electricity using nuclear power plants, around 75%, which makes the amount of CO<sub>2</sub> emission much less compared to Lebanon and United Arab Emirates. The highest amount of CO<sub>2</sub> gases mitigated is 9.3 tons during July in Lebanon and 7.2 tons during June in UAE. Regarding the annual decreased amount of CO<sub>2</sub> gas, results show that in Lebanon and UAE the system alleviates up to 72.9 tons and 71.1 tons per year respectively. Whereas, for France case which

depends mainly on energy with low greenhouse gas emissions to generate electricity, the annual reduction of CO<sub>2</sub> emissions is about 5.1 tons only.

The obtained results of the economic and environmental analyses assures the importance of PTPVT system in saving money and preserving environment. The payback period of the system is relatively low in the three countries, while the amount of mitigated CO<sub>2</sub> emissions is considerably high in Lebanon and UAE while it is low in France since it uses nuclear power plants in generating electricity.

## **6. Conclusions**

PTPVT is a hybrid solar system which amalgamates PTC with solar PV. Its main goal is to optimize the usage of solar energy by simultaneously generating electricity and heating water for various applications such as solar heating, solar cooling, residential, industry, etc. In this paper this cogeneration system layout and mode of operation are described. Then, a new thermal modeling is developed using thermal resistance analogy and applying energy balance at several control volumes including different parts of the system. The developed thermal modeling is simulated and validated against previous work from the literature and the maximum deviation obtained is 3.4%.

Three case studies are conducted to demonstrate the impact of the climate on the performance of the system. Three countries of different climates are considered for the study Lebanon, France and United Arabian Emirate. The main factors that affect the system performance are the total and beam radiation and the fluid inlet temperature. The maximum outlet temperature obtained is 95.0°C in Lebanon during July with 32.1°C water inlet temperature, 53.8°C in France during August with 23.5°C water inlet temperature and 91.0°C in UAE during June with 33.9°C water inlet temperature. Besides, the highest thermal and electrical efficiency obtained are respectively 50.7%, during August, and 27.5% during January in Lebanon, 50.8%, during June, and 27.9%, during December, in France and 51.1% during July and 25.9% during January in UAE.

Furthermore, an economic and environmental analysis is conducted to assess the amount of saved money, payback period and the amount of CO<sub>2</sub> emissions reduced when using the suggested system in the three countries. The results show that the annual amount of saved money is about \$20600, \$17600 and \$17400 in Lebanon, France and UAE respectively. The proposed system costs \$28400 and it requires about 1.4 years to return its cost in Lebanon, 1.6 years in France and 1.7 years in UAE. Furthermore, the amount of CO<sub>2</sub> mitigated when exploiting PTPVT system is 72.9 tons, 5.1 tons and 71.1 tons for Lebanon, France and UAE cases respectively.

It is clear that PTPVT hybrid solar system is a vital system which has a great potential to engage in supplying the world energy requirements, conserving energy and alleviating greenhouse gases. Hence, it is worth to increase the number of studies and researches on such system in order to optimize it. As a future work, it is recommended to compare the performance of such system with the common photovoltaic thermal system. Besides, adding phase change material to the system and investigating its impact on the system performance is a target that should be achieved. Also, it is aimed to implement a prototype of the system and carry out experimental tests to study and compare the aforementioned systems which serves in reaching the optimum structure of the system.

## References

- [1] A. Herez, M. Ramadan, B. Abdulhay, M. Khaled, Short review on solar energy systems, in: AIP Conf. Proc., AIP Publishing LLC, 2016: p. 030041. <https://doi.org/10.1063/1.4959437>.
- [2] A. Herez, M. Ramadan, M. Khaled, Review on solar cooker systems: Economic and environmental study for different Lebanese scenarios, *Renew. Sustain. Energy Rev.* 81 (2018) 421–432. <https://doi.org/10.1016/J.RSER.2017.08.021>.
- [3] H. El Hage, A. Herez, M. Ramadan, H. Bazzi, M. Khaled, An investigation on solar drying: A review with economic and environmental assessment, *Energy*. 157 (2018) 815–829. <https://doi.org/10.1016/j.energy.2018.05.197>.
- [4] A. Herez, M. Khaled, M. Ramadan, H. Bazi, A Review on Solar Dryer - Economic and Environmental Investigation for the Lebanese Case, in: 10TH International Conference on Sustainable Energy and Environmental Protection SEEP, Bled, Slovenia, 2017: pp. 561–574. <https://doi.org/10.18690/978-961-286-061-5.49>.
- [5] M. Khaled, A. Herez, H. El Hage, T. Lemenand, M. Ramadan, Review on Solar Water Heating System, in: 6th Int. Conf. Emerg. Renew. Energy Gener. Autom. ICEREGA, Sousse, Tunisia, 2018.
- [6] A. Boretti, S. Castelletto, W. Al-Kouz, J. Nayfeh, Enclosed trough solar thermal power plant with thermal energy storage and saltwater condenser in Al Khobar, Kingdom of Saudi Arabia, *Renew. Energy Focus*. 35 (2020) 132–147. <https://doi.org/10.1016/j.ref.2020.09.005>.
- [7] L.S. Sundar, A.H. Misganaw, M.K. Singh, A.M.B. Pereira, A.C.M. Sousa, Efficiency, energy and economic analysis of twisted tape inserts in a thermosyphon solar flat plate collector with Cu nanofluids, *Renew. Energy Focus*. 35 (2020) 10–31. <https://doi.org/10.1016/j.ref.2020.06.004>.
- [8] K.D. Yadav, R.K. Prasad, Erratum to “Performance analysis of parallel flow flat plate solar air heater having arc shaped wire roughened absorber plate, *Renew. Energy Focus*. 34 (2020) 59. <https://doi.org/10.1016/j.ref.2020.06.011>.
- [9] A. Routray, K.D. Mistry, S.R. Arya, Wake Analysis on Wind Farm Power Generation for Loss Minimization in Radial Distribution System, *Renew. Energy Focus*. 34 (2020) 99–108. <https://doi.org/10.1016/j.ref.2020.06.001>.
- [10] P.K. Behera, B. Mendi, S.K. Sarangi, M. Pattnaik, Robust wind turbine emulator design using sliding mode controller, *Renew. Energy Focus*. 36 (2021) 79–88. <https://doi.org/10.1016/j.ref.2020.12.004>.
- [11] A. Herez, M. Khaled, R. Murr, A. Haddad, H. Elhage, M. Ramadan, Using Geothermal Energy for cooling - Parametric study, *Energy Procedia*. 119 (2017) 783–791. <https://doi.org/10.1016/J.EGYPRO.2017.07.111>.
- [12] S. Janczik, M. Kaltschmitt, After a major dive, geothermal power is growing rapidly, *Renew. Energy Focus*. 16 (2015) 177–179. <https://doi.org/10.1016/j.ref.2015.10.025>.
- [13] A.S. Bisht, N.S. Thakur, Small scale biomass gasification plants for electricity generation in India: Resources, installation, technical aspects, sustainability criteria & policy, *Renew. Energy Focus*. 28 (2019) 112–126. <https://doi.org/10.1016/j.ref.2018.12.004>.
- [14] R. Amirante, S. Bruno, E. Distaso, M. La Scala, P. Tamburrano, A biomass small-scale externally fired combined cycle plant for heat and power generation in rural communities, *Renew. Energy Focus*. 28 (2019) 36–46. <https://doi.org/10.1016/j.ref.2018.10.002>.
- [15] W. Fuqiang, C. Ziming, T. Jianyu, Y. Yuan, S. Yong, L. Linhua, Progress in concentrated solar power technology with parabolic trough collector system: A comprehensive review, *Renew. Sustain. Energy Rev.* 79 (2017) 1314–1328. <https://doi.org/10.1016/j.rser.2017.05.174>.
- [16] A. Herez, H. El Hage, T. Lemenand, M. Ramadan, M. Khaled, Review on photovoltaic/thermal hybrid solar collectors: Classifications, applications and new systems, *Sol. Energy*. 207 (2020) 1321–1347. <https://doi.org/10.1016/j.solener.2020.07.062>.
- [17] C. Renno, G. Landi, F. Petito, H.C. Neitzert, Influence of a degraded triple-junction solar cell on the CPV system performances, *Energy Convers. Manag.* 160 (2018) 326–340. <https://doi.org/10.1016/j.enconman.2018.01.026>.
- [18] R. Tripathi, G.N. Tiwari, Energy matrices, life cycle cost, carbon mitigation and credits of open-loop N concentrated photovoltaic thermal (CPVT) collector at cold climate in India: A comparative study, *Sol. Energy*. 186 (2019) 347–359. <https://doi.org/10.1016/j.solener.2019.05.023>.
- [19] B. Widyolar, L. Jiang, R. Winston, Spectral beam splitting in hybrid PV/T parabolic trough systems for power generation, *Appl. Energy*. 209 (2018) 236–250. <https://doi.org/10.1016/j.apenergy.2017.10.078>.

- [20] A.B. Awan, M. Zubair, R.P. Praveen, A.R. Bhatti, Design and comparative analysis of photovoltaic and parabolic trough based CSP plants, *Sol. Energy*. 183 (2019) 551–565. <https://doi.org/10.1016/j.solener.2019.03.037>.
- [21] F. Calise, L. Vanoli, Parabolic trough photovoltaic/thermal collectors: Design and simulation model, *Energies*. 5 (2012) 4186–4208. <https://doi.org/10.3390/en5104186>.
- [22] F. Calise, A. Palombo, L. Vanoli, A finite-volume model of a parabolic trough photovoltaic/thermal collector: Energetic and exergetic analyses, *Energy*. 46 (2012) 283–294. <https://doi.org/10.1016/j.energy.2012.08.021>.
- [23] T.P. Otanicar, R. Wingert, M. Orosz, C. McPheeters, Concentrating photovoltaic retrofit for existing parabolic trough solar collectors: Design, experiments, and levelized cost of electricity, *Appl. Energy*. 265 (2020) 114751. <https://doi.org/10.1016/j.apenergy.2020.114751>.
- [24] E. Bellos, C. Tzivanidis, Investigation of a nanofluid-based concentrating thermal photovoltaic with a parabolic reflector, *Energy Convers. Manag.* 180 (2019) 171–182. <https://doi.org/10.1016/j.enconman.2018.11.008>.
- [25] L.R. Bernardo, B. Perers, H. Håkansson, B. Karlsson, Performance evaluation of low concentrating photovoltaic/thermal systems: A case study from Sweden, *Sol. Energy*. 85 (2011) 1499–1510. <https://doi.org/10.1016/j.solener.2011.04.006>.
- [26] B.K. Widyolar, M. Abdelhamid, L. Jiang, R. Winston, E. Yablonoitch, G. Scranton, D. Cygan, H. Abbasi, A. Kozlov, Design, simulation and experimental characterization of a novel parabolic trough hybrid solar photovoltaic/thermal (PV/T) collector, *Renew. Energy*. 101 (2017) 1379–1389. <https://doi.org/10.1016/j.renene.2016.10.014>.
- [27] I.K. Karathanassis, E. Papanicolaou, V. Belessiotis, G.C. Bergeles, Dynamic simulation and exergetic optimization of a Concentrating Photovoltaic/ Thermal (CPVT) system, *Renew. Energy*. 135 (2019) 1035–1047. <https://doi.org/10.1016/j.renene.2018.12.085>.
- [28] I.K. Karathanassis, E. Papanicolaou, V. Belessiotis, G.C. Bergeles, Design and experimental evaluation of a parabolic-trough concentrating photovoltaic/thermal (CPVT) system with high-efficiency cooling, *Renew. Energy*. 101 (2017) 467–483. <https://doi.org/10.1016/j.renene.2016.09.013>.
- [29] F. Yazdanifard, E. Ebrahimnia-Bajestan, M. Ameri, Performance of a parabolic trough concentrating photovoltaic/thermal system: Effects of flow regime, design parameters, and using nanofluids, *Energy Convers. Manag.* 148 (2017) 1265–1277. <https://doi.org/10.1016/j.enconman.2017.06.075>.
- [30] D. Del Col, M. Bortolato, A. Padovan, M. Quaggia, Experimental and numerical study of a parabolic trough linear CPVT system, *Energy Procedia*. 57 (2014) 255–264. <https://doi.org/10.1016/j.egypro.2014.10.030>.
- [31] M. Li, X. Ji, G. Li, S. Wei, Y.F. Li, F. Shi, Performance study of solar cell arrays based on a Trough Concentrating Photovoltaic/Thermal system, *Appl. Energy*. 88 (2011) 3218–3227. <https://doi.org/10.1016/j.apenergy.2011.03.030>.
- [32] W. Ben Youssef, T. Maatallah, C. Menezo, S. Ben Nasrallah, Assessment viability of a concentrating photovoltaic/thermal-energy cogeneration system (CPV/T) with storage for a textile industry application, *Sol. Energy*. 159 (2018) 841–851. <https://doi.org/10.1016/j.solener.2017.11.058>.
- [33] R. Bernardo, Retrofitted Solar Domestic Hot Water System for Single-Family Electrically-Heated Houses Development and testing, Faculty of engineering, Lund University, Lund, Sweden, 2010.
- [34] A. Kribus, D. Kaftori, G. Mittelman, A. Hirshfeld, Y. Flitsanov, A. Dayan, A miniature concentrating photovoltaic and thermal system, *Energy Convers. Manag.* 47 (2006) 3582–3590. <https://doi.org/10.1016/j.enconman.2006.01.013>.
- [35] F.P. Incropera, D.P. DeWitt, *Fundamentals of Momentum, Heat and Mass Transfer*, 5th Edition, New York, USA, 2001. <http://bcs.wiley.com/he-bcs/Books?action=index&itemId=0471386502&itemTypeId=BKS&bcsId=1737> (accessed January 12, 2020).
- [36] JRC Photovoltaic Geographical Information System (PVGIS) - European Commission, (n.d.). [https://re.jrc.ec.europa.eu/pvg\\_tools/en/tools.html](https://re.jrc.ec.europa.eu/pvg_tools/en/tools.html).
- [37] Paris, France - Detailed climate information and monthly weather forecast / Weather Atlas, (n.d.). <https://www.weather-atlas.com/en/france/paris-climate>.
- [38] Beirut, Lebanon - Detailed climate information and monthly weather forecast / Weather Atlas, (n.d.). <https://www.weather-atlas.com/en/lebanon/beirut-climate>.
- [39] Dubai, United Arab Emirates - Detailed climate information and monthly weather forecast / Weather Atlas, (n.d.). <https://www.weather-are.com/en/united-arab-emirates/dubai-climate>.

- [40] Electricity prices around the world / Global Petrol Prices, (2019). [https://www.globalpetrolprices.com/electricity\\_prices/](https://www.globalpetrolprices.com/electricity_prices/).
- [41] C. Renno, F. Petito, Design and modeling of a concentrating photovoltaic thermal ( CPV / T ) system for a domestic application, *Energy Build.* 62 (2013) 392–402. <https://doi.org/10.1016/j.enbuild.2013.02.040>.
- [42] Overview of electricity production and use in Europe — European Environment Agency, (2017). <https://www.eea.europa.eu/data-and-maps/indicators/overview-of-the-electricity-production-2/assessment-4>.
- [43] H. Jaber, T. Lemenand, M. Ramadan, M. Khaled, Hybrid Heat Recovery System Applied To Exhaust Gases—Thermal Modeling And Case Study, *Heat Transf. Eng.* 0 (2019) 1–14. <https://doi.org/10.1080/01457632.2019.1692495>.
- [44] EAD, Abu Dhabi State of Environment Report 2017, Environ. Agency – Abu Dhabi. (2017) 97.

## Chapitre 4

### **Système hybride triple photovoltaïque/thermique/thermoélectrique à concentrateur parabolique : modélisation thermique, études de cas, et analyses économiques et environnementales**

Dans ce chapitre, un nouveau système hybride triple PTPVT-TE (Parabolic Trough Photovoltaic / Thermal / Thermoelectric) est suggéré. C'est un système solaire hybride qui génère simultanément de l'énergie électrique par les cellules PV et des générateurs thermoélectriques, et de l'énergie thermique par l'absorbeur thermique, les cellules PV et les générateurs thermoélectriques.

Cette étude consiste, dans la **section 1**, en une introduction générale sur les systèmes solaires hybrides PTPVT et sur l'intégration de générateurs thermoélectriques. Le concept de système PTPVT-TE est décrit dans la **section 2**. La modélisation thermique du système considéré est présentée dans la **section 3**. La **section 4** est consacrée à la validation du modèle thermique. Les **sections 5 et 6** présentent respectivement des études de cas et des analyses économiques et environnementales. Enfin, la **section 7** résume les principales conclusions de ce travail.

Le système PTPVT-TE (Figure 2) est composé d'un collecteur à concentrateur parabolique avec récepteur triangulaire. Les modules PV sont situés sur les deux côtés du récepteur faisant face au concentrateur, un absorbeur thermique se trouve sur le côté supérieur du récepteur et les TEG (thermoelectric generator) sont situés à l'arrière de la couche PV. À l'intérieur du récepteur

triangulaire, un canal circulaire est placé dans lequel le fluide à chauffer circule. De plus, un substrat métallique est ajouté entre le canal de fluide et le récepteur triangulaire pour améliorer la chaleur transférée par conduction. Cette étude applique une modélisation thermique appropriée avec sa procédure itérative associée et des études de cas sur trois pays de climats distincts : le Liban (méditerranéen), la France (modéré) et les EAU (chaud) pour étudier les performances du système PTPVT-TE. De plus, l'influence économique et environnementale de l'utilisation du système hybride est évaluée en calculant la période de retour sur investissement et la réduction des émissions de CO<sub>2</sub>.

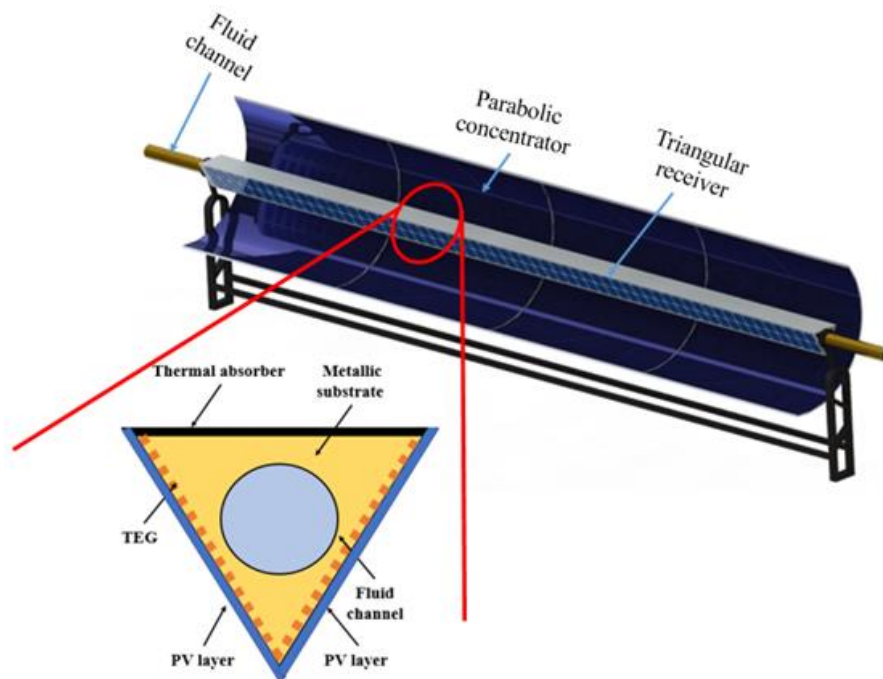

*Figure 2 : Système hybride triple photovoltaïque/thermique/thermoélectrique à concentrateur parabolique étudié.*

Les résultats montrent que la température de sortie maximale atteinte est de 80,4°C et 46,8°C en juillet au Liban et en France, et de 77,7°C en août aux EAU. Par ailleurs, l'énergie électrique et

thermique annuelle produite par le système est de 46,5 MWh et 101,4 MWh au Liban, 27,4 MWh et 56,7 MWh en France et 51,1 MWh et 114,2 MWh aux EAU où 1,8 MWh, 0,8 MWh et 1,9 MWh sont générés à partir des TEG en Liban, France et EAU respectivement. De plus, les rendements électriques et thermiques les plus élevés obtenus sont de 28,5% et 58,3% au Liban, 29,0% et 58,6% en France, 26,9% et 58,8% aux EAU. En outre, il a été conclu que l'ajout de TEG au système PTPVT permet d'augmenter la puissance électrique en moyenne de 1,8%, 2,2% et 1,4% au Liban, en France et aux Émirats Arabes Unis respectivement tout en réduisant la puissance thermique en moyenne de 1,9%, 2,1% et 1,7% au Liban, en France et aux EAU respectivement.

Le système proposé nécessite environ 2,1 ans, 2,4 ans et 2,5 ans pour compenser son surcoût au Liban, en France et aux Émirats Arabes Unis respectivement. De plus, l'adoption d'un tel système hybride permet de réduire les émissions de CO<sub>2</sub> par an d'environ 81,4 tonnes, 5,7 tonnes et 79,5 tonnes au Liban, en France et aux EAU respectivement.

Cette étude est soumise pour publication dans le journal *Sustainable Energy Technologies and Assessments*.





## **Système hybride thermoélectrique photovoltaïque à concentrateur parabolique : modélisation thermique, études de cas et analyses économiques et environnementales**

Cet article est soumis au journal « **Sustainable Energy Technologies and Assessment** »

**Résumé** - Dans ce travail, un système solaire hybride, qui consiste en un collecteur à concentrateur parabolique équipé d'un module photovoltaïque (PV) et de générateurs thermoélectriques (TEG), est étudié. L'objectif de ce travail est de développer une nouvelle modélisation thermique pour un système photovoltaïque / thermique / thermoélectrique à concentrateur parabolique (PTPVT-TE). La modélisation thermique est simulée, comparée et validée par rapport aux travaux antérieurs de la littérature. Des études de cas ont été menées sur trois pays aux climats différents : le Liban (Méditerranée), la France (modéré) et les EAU (chaud) pour étudier les performances du système. On observe que l'énergie totale annuelle produite par le module PV et les TEG est respectivement de 44,7 MWh et 1,8 MWh au Liban, 26,5 MWh et 0,8 MWh en France, 49,2 MWh et 1,9 MWh aux Emirats Arabes Unis. De plus, les résultats révèlent que l'intégration des TEG au système PTPVT conduit à augmenter la puissance électrique totale annuelle moyenne générée par le système d'environ 1,8% et à diminuer la puissance thermique annuelle moyenne fournie au fluide de 1,9%. Par ailleurs, des analyses économiques et environnementales ont été réalisées pour mettre en évidence l'importance significative de ce système. Il est démontré que la durée d'amortissement du système est de 2,1 ans, 2,4 ans et 2,5 ans et que le montant annuel des émissions de CO<sub>2</sub> atténuées est de 81,4 tonnes, 5,7 tonnes et 79,5 tonnes pour le Liban, la France et les EAU respectivement.

# Parabolic trough Photovoltaic Thermoelectric Hybrid system: Thermal modeling, case studies and economic and environmental analyses

Amal Herez<sup>1,2</sup>, Hicham El Hage<sup>1</sup>, Thierry Lemenand<sup>2</sup>, Mohamad Ramadan<sup>3,4</sup>, and Mahmoud Khaled<sup>3,5,\*</sup>

<sup>1</sup>Energy and Thermofluid Group, Lebanese International University LIU, Bekaa, Lebanon

<sup>2</sup>LARIS EA 7315, University of Angers - ISTIA, Angers, France

<sup>3</sup>Energy and Thermofluid Group, International University of Beirut BIU, Beirut, Lebanon

<sup>4</sup>Associate member at FCLAB, CNRS, Univ. Bourgogne Franche-Comté, Belfort cedex, France

<sup>5</sup>University Paris Diderot, Sorbonne Paris Cité, Interdisciplinary Energy Research Institute (PIERI), Paris, France

\*Corresponding author email: [mahmoud.khaled@liu.edu.lb](mailto:mahmoud.khaled@liu.edu.lb)

**Abstract.** In this work, a hybrid solar system, which consists of parabolic trough collector equipped with photovoltaic (PV) module and thermoelectric generators (TEGs), is studied. The aim of this work is to develop a new thermal modeling for parabolic trough photovoltaic thermoelectric (PTPVT-TE) system using thermal resistance analogy. The thermal modeling is simulated using MATLAB software, compared and validated against previous works from the literature. Case studies have been conducted on three countries of different climates: Lebanon (moderate), France (mild) and UAE (warm) to investigate the system performance. It is observed that the total annual energy generated by PV module and TEGs are 44.7 MWh and 1.8 MWh in Lebanon, 26.5 MWh and 0.8 MWh in France, 49.2 MWh and 1.9 MWh in UAE respectively. Also, the results reveal that the integration of TEGs to the PTPVT system leads to increase the average annual generated total electrical power by the system by about 1.8% and decrease the average annual heat rate delivered to the fluid by 1.9%. Furthermore, it was obtained that the PV layer increases the average total efficiency of the system by approximately 44.4%. Besides, economic and environmental analyses have been performed to expose the significant importance of this system. It is shown that the payback period of the system is 2.1 years, 2.4 years and 2.5 years and the annual amount of mitigated CO<sub>2</sub> emissions is 81.4 tons, 5.7 tons and 79.5 tons for Lebanon, France and UAE respectively.

**Keywords:** hybrid system, parabolic trough, photovoltaic, parabolic trough photovoltaic thermal, solar energy, thermal modeling, thermoelectric.

## Nomenclature

A	area [ $m^2$ ]
$b_0$	curve coefficient
C	cost
CO <sub>2</sub>	Carbon dioxide
C <sub>p</sub>	specific heat at constant pressure [J/KgK]
CR	concentration ratio

d	diameter [m]
E	energy [Wh]
GaAs	Gallium arsenide
h	convection heat transfer coefficient [ $W/m^2K$ ]
I	solar radiation [ $W/m^2$ ]
IAM	incident angle modifier
K	thermal conductivity [ $W/mK$ ]
L	receiver tube length [m]
$\dot{m}$	mass flow rate [kg/s]
M	mass [kg]
N	number
NTU	number of transfer unit
Nu	Nusselt number
P	power [W]
PBP	payback period [year]
Pr	Prandtl number
PTC	parabolic trough collector
PTPV	parabolic trough photovoltaic/thermal collector
PTPV-TE	parabolic trough photovoltaic thermoelectric
PV	photovoltaic
PVT	photovoltaic/thermal collector
q	heat flow rate [W]
R	thermal resistance [ $K/w$ ]
Re	reynolds number
S	receiver side length [m]
SM	saved money [\$]
STC	solar thermal collector
T	temperature [C]
t	thickness [m]
TEG	thermoelectric generator
UAE	United Arabian Emirates
V	velocity [m/s]

### Subscript

1kWh	one killo watt hour
a	air
abs	absorber
am	ambient
an	annual
ap	aperture
AS	between absorber and substrate
b	beam

C	cold
conc	concentrator
cond	conduction
conv	convection
d	days
dec	decrease
EH	electric heater
el	electric
f	fluid
h	hours
H	hot
HX	heat exchanger
in	inlet
inc	increase
opt	optical
out	outlet
rad	radiation
rec	receiver
red	reduced
sub	substrate
th	thermal
WH	heat water

### **Greek symbols**

%	percentage
ε	heat transfer effectiveness
ε	emissivity
Θ	incident angle
σ	Stephan-Botzmann constant
α	absorptance
η	efficiency

## 1. Introduction

The world energy consumption increased at rate of 2.9% in year 2018 which is about double its average increase since 10 years, which was about 1.5% per year [1]. This noticeable growth in energy demand is the main cause of energy depletion, continuous and rapid increase in the cost of energy and harmful environmental problems such as pollution and global warming. To alleviate the impacts of such problems, scientists started to depend on heat recovery and renewable energy as main solutions. Heat recovery [2–5] is defined as the reutilization of dissipated energy from various applications to increase the efficiency of the system. Renewable energy comprises several types of energy such as wind [6,7], tidal [8,9], solar [10–14], geothermal [10,15], and biomass [16,17].

During the recent years, solar energy (SE) garnered a great interest by researchers due to its significant potential to compensate energy shortages. Various applications are derived from such energy in which the main purpose is to absorb solar energy and transfer it to either thermal or electrical energy. Furthermore, there is a notable tendency for using hybrid SE systems which allows the simultaneous production of thermal and electrical energy. Parabolic trough photovoltaic/thermal (PTPVT) system is a distinguished type of hybrid solar systems which combines parabolic trough solar collector (PTC) with photovoltaic modules. The initial investment of such systems is high compared to with alone systems. However, regardless to the expensive cost, they are more efficient than the individual technologies. Also, despite that there is an increase in the number of studies and researches on such systems, a lot of studies are required in order to achieve the optimized structure in which the system attains the highest thermal and electrical efficiencies simultaneously. Besides, there are few manufacturers of these systems and their utilization is not spread as the individual technologies.

Nevertheless, parabolic trough photovoltaic thermal system can be coupled with thermoelectric generators (TEGs) in order to increase the electrical conversion efficiency of the system. TEGs are instruments utilized to convert thermal energy into electrical energy by Seebeck effect which is defined by the phenomenon in which the temperature difference between the terminals of two distinct conductors or metals causes the generation of small induced voltage. The amalgamation of TEGs into the cogeneration system is a trend that is investigated and studied worldwide by various researchers [18–20].

Soltani *et al.* [21] demonstrated the performance of tri-generation system which comprises parabolic trough collector, solar PV module and thermoelectric generator. A non-dimensional model was conducted using MATLAB software to study the influence of ambient temperature and solar irradiance on the system performance. It was resulted that the system electrical was enhanced when locating PV cells and TEGs on the lateral area of the receiver tube. It was also obtained that at 998 W/m<sup>2</sup> solar concentration the electrical power generated is 22.7 W. The authors validated the established thermal model by comparing it with two previous researches.

Riahi *et al* [22] studied the performance of PTPVT and parabolic trough photovoltaic thermoelectric (PTPVT-TE) systems. The authors designed, manufactured and tested the hybrid systems. Also, mathematical models of the systems were developed and validated to evaluate the thermal and electrical performance of the two systems. The results revealed that the PTPVT-TE system output electrical power and electrical efficiency are higher than that of the PTPVT system.

Shadmehri *et al.* [23] conducted a three-dimensional model on parabolic trough photovoltaic thermal system coupled with thermoelectric generators. The authors performed a numerical simulation and validated the model to study the effect of cooling and temperature on the performance of photovoltaic modules and the influence of aperture width of reflector and apex angle of absorber on the generated power by photovoltaic cells and the solar energy flux.

A new system was suggested by Yin *et al.* [24] which integrates PV cell and TEGs with PTC. The new system was compared with the existing systems regarding the energy and exergy efficiency as well as the operating temperature. It was shown that the proposed system has higher exergy efficiency compared to the existing systems.

Mohsenzadeh *et al.* [25] proposed a new structure of PTPVT system in which the receiver consists of triangular channel surrounded by photovoltaic and thermoelectric generators. The authors developed an experimental investigation to study the system thermal and electrical performance. The results show that the system can attain a daily average thermal and electrical efficiency of 46.16% and 4.83% respectively.

Kohan *et al.* [26] investigated the performance of parabolic trough photovoltaic thermal system with thermoelectric generators integrated at the backside of the PV cells. To fulfill this target, the authors established a three-dimensional numerical models for PV and thermoelectric generators. Results showed that the studied hybrid system is able to produce power more than that generated by conventional PV system according to certain environmental conditions.

As a summary for the previous conducted studied, the integration of TEGs to PTPVT system enhances its electrical performance. Also, it can be concluded that PTPVT-TE is a promising system which is highly affected by several parameters and weather conditions. Nevertheless, it is obvious that there are few studies including thermal modeling on this system that facilitates analyzing the performance of the system and conducting parametric analyses or case studies. Furthermore, scarce are the studies which investigate the effect of weather conditions and distinct parameters on the performance of the system by carrying out case studies. Moreover, analyzing the performance of PTPVT-TE system from economic and environmental views is not implemented.

On the basis of this context, the main purpose of this paper is to perform case studies on three countries of distinct climates which are Lebanon (moderate), France (mild) and UAE (warm) to study the performance of PTPVT-TE system. This purpose is achieved by developing a new thermal modeling of the system, simulating it using MATLAB software and validating it against previous work. Hence, the following points summarize the originality of this work:

- 1) This work proposes a novel suitable thermal modelling for PTPVT-TE system which facilitates performing case studies with least computational time.
- 2) The importance of this work is illustrated by the implementation of thermal modeling and case studies which serve in analyzing the performance of PTPVT-TE system.
- 3) It proffers significant modeling and case studies for PTPVT researchers. Hence, the conducted thermal modelling can be used in any study that aims to enhance PTPVT system performance by studying the effect of weather conditions in addition to distinct parameters as well as the effect of using TEGs on the system performance.
- 4) It offers significant economic and environmental analyzes of the PTPVT-TE system performance.

The concept of the studied hybrid system is described in section 2. The thermal modeling of the considered system is presented in section 3. Section 4 is devoted to validating the thermal model. Section 5 and 6 proffer case studies and economic and environmental analyses respectively. Finally, section 7 summarizes the main conclusions of this work.

## 2. Concept of Parabolic trough PVT-TE hybrid system

PTPVT-TE system is generally composed of parabolic trough collector with triangular receiver. Figure 1 presents a schematic of PTPVT-TE system. PV modules are located on the two sides of the receiver opposing the concentrator, a thermal absorber is at the receiver top side and TEGs are located at the PV layer back side. Inside the triangular receiver, a circular channel is placed where the fluid to be heated passes through it. Moreover, a metallic substrate is added between the fluid channel and the triangular receiver to enhance heat transferred by conduction.

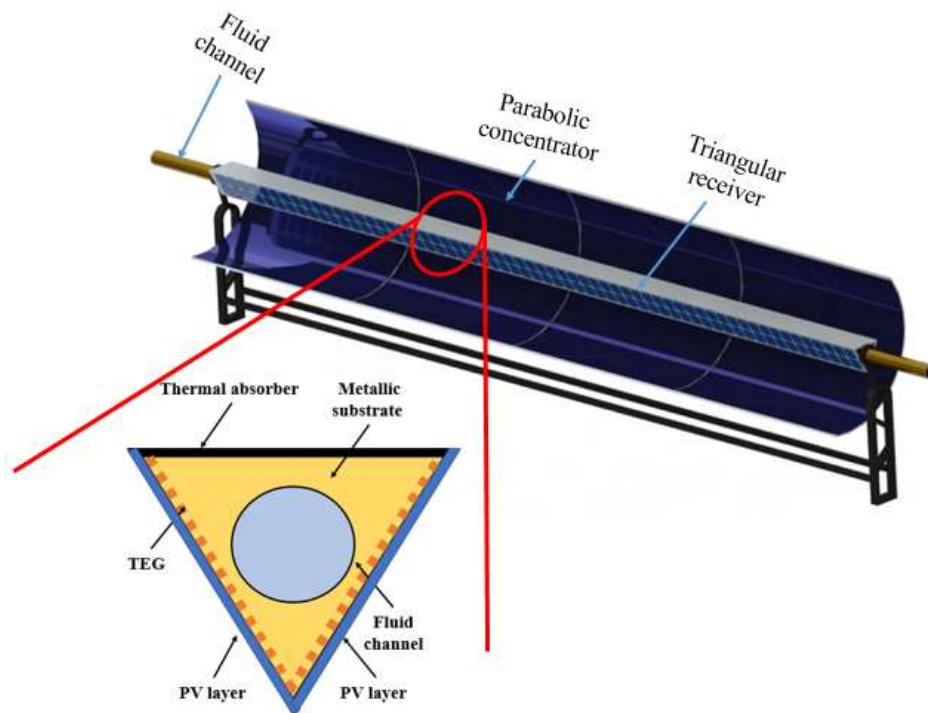

Figure 1. PTPVT-TE system.

This system is characterized by the simultaneous generation of electrical and thermal energy. At the top part of the triangular receiver, the thermal absorber absorbs the solar radiation and converts it into thermal energy to be delivered to the fluid inside the channel. Meanwhile, PV modules receive solar radiation reflected by the parabolic concentrator. The main role of PV cells is to transform part of the absorbed solar energy into electrical energy and the remaining part will be released from the back part of the PV cell. Hence, this released heat will be absorbed by the TEGs which in their turn transform part of it into electric energy and the remaining part will be delivered to the fluid inside the circular tube. Therefore, thermal energy is transferred to the fluid from two ways: thermal absorber and PV cell + TEGs, and the electrical energy is generated by the PV module and TEGs.



### 3. Thermal modeling

In this section a thermal model of the hybrid system is established using thermal resistance analogy and based on several assumptions such as steady state, negligible temperature gradient in PV layer and metallic substrate, uniform concentration of solar radiation along PV layer, thermodynamic equilibrium and negligible kinetic and potential energies. Also, it is assumed that the sky temperature, ambient temperature and water inlet temperature are uniform [27].

Indeed, the steady state thermal behavior is not adopted in this proposed thermal modeling due to the change in the ambient temperature and the solar radiation. However, the steady state part of the thermal behavior is considered in which the aforementioned parameters vary negligibly and when quasi-stationary annually simulations are conducted. This is very beneficial in establishing parametric analyses or case studies. The simplified models that are utilized for estimating the performance of concentrating PVT system allows to take into consideration a wide range of operational parameters especially those related to the solar concentration. However, the proposed thermal model with the iterative procedure is sufficiently fast and cheap compared to the higher dimensional models which are used in commercial software.

Figure 2 shows a schematic of the thermal resistance of the system where the unknown parameters are shown in red color. There are eight unknowns in the system which are: absorber temperature  $T_{abs}$ , substrate temperature  $T_{sub}$ , PV temperature  $T_{PV}$ , concentrator temperature  $T_{conc}$ , hot and cold temperatures of the TEG  $T_H$  and  $T_C$  respectively, fluid outlet temperature  $T_{f,out}$  and the temperature between the absorber and the substrate  $T_{AS}$ . These unknowns can be computed using 8 equations which can be obtained by applying energy balance on several nodes and parts of the system.

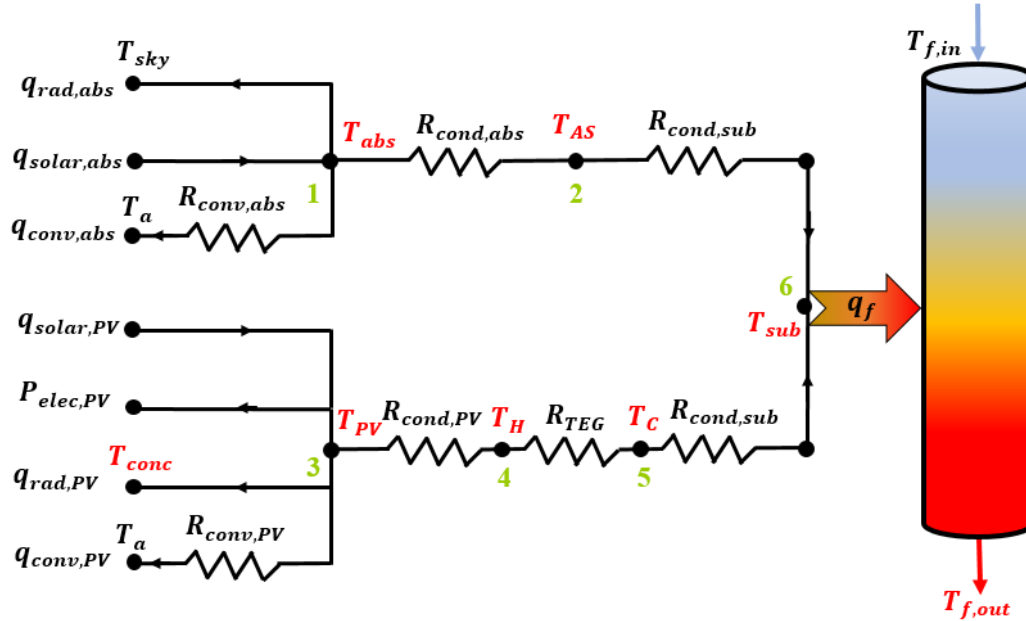

Figure 2. Thermal resistances of the system. The unknown parameters are shown in red color and the nodes are located in green color.

Energy balance on node 1:

$$q_{solar,abs} - q_{conv,abs} - q_{rad,abs} = \frac{T_{abs} - T_{AS}}{R_{cond,abs}} \quad (1)$$

where  $q_{solar,abs}$  is the available solar irradiation directed to the thermal absorber,  $q_{conv,abs}$  and  $q_{rad,abs}$  are the heat losses from the absorber by convection and radiation respectively,  $T_{abs}$  and  $T_{AS}$  are the absorber temperature and the temperature between the absorber and substrate respectively, and  $R_{cond,abs}$  is the thermal absorber conductive thermal resistance.

The solar irradiation oriented towards the thermal absorber is:

$$q_{solar,abs} = I_{total} A_{abs} \alpha_{abs} \quad (2)$$

where  $I_{total}$  is the total radiation,  $A_{abs}$  and  $\alpha_{abs}$  are the area and the absorptance of the thermal absorber, respectively.

The thermal absorber convective heat losses are:

$$q_{conv,abs} = \frac{T_{abs} - T_{am}}{R_{conv,abs}} \quad (3)$$

with

$$R_{conv,abs} = \frac{1}{h_{abs} A_{abs}} \quad (4)$$

where  $R_{conv,abs}$  is the absorber convection thermal resistance of,  $T_{am}$  is the ambient temperature and  $h_{abs}$  is the convective heat transfer coefficient of absorber.  $h_{abs}$  can be calculated from the Nusselt number, where the following correlation can be used by assuming forced convection [28]:

$$Nu = \left(0.037 Re^{\frac{4}{5}} - 871\right) Pr^{\frac{1}{3}} \quad (5)$$

where  $Nu$ ,  $Pr$ , and  $Re$  are the Nusselt number Prandtl number, and Reynolds number of the fluid, respectively.

The thermal absorber radiative heat losses are:

$$q_{rad,abs} = \varepsilon_{abs} \sigma A_{abs} (T_{abs}^4 - T_{sky}^4) \quad (6)$$

where  $\varepsilon_{abs}$  is the absorber emissivity,  $\sigma$  is the Stephan-Boltzmann constant and  $T_{sky}$  is the sky temperature.

The conductive thermal resistance of the thermal absorber is:

$$R_{cond,abs} = \frac{t_{abs}}{K_{abs} A_{abs}} \quad (7)$$

where  $K_{abs}$  is the absorber thermal conductivity and  $t_{abs}$  is the absorber thicknesses.

Energy balance on node 2:

$$\frac{T_{abs} - T_{AS}}{R_{cond,abs}} = \frac{T_{AS} - T_{sub}}{R_{cond,sub}} \quad (8)$$

where  $T_{sub}$  and  $R_{cond,sub}$  are the substrate temperature and conductive thermal resistance respectively.

Energy balance on node 3:

$$q_{solar,PV} - P_{el,PV} - q_{conv,PV} - q_{rad,PV} = \frac{T_{PV} - T_H}{R_{cond,PV}} \quad (9)$$

where  $q_{solar,PV}$  is the available solar irradiation directed towards the PV layer,  $P_{el,PV}$  is the electrical power produced by PV cells,  $q_{conv,PV}$  and  $q_{rad,PV}$  are the PV modules convective and radiative heat losses respectively,  $T_{PV}$  and  $T_H$  are the PV and TEG hot side temperatures.

The solar irradiation oriented to the PV is:

$$q_{solar,PV} = I_b A_{PV} CR_{PV} \alpha_{PV} \eta_{opt} IAM_{th} \quad (10)$$

where  $A_{PV}$  is the PV layer area,  $I_b$  is the beam radiation,  $\eta_{opt}$  is the PV layer optical efficiency,  $\alpha_{PV}$  is the PV layer absorptance,  $IAM_{th}$  is the thermal incident angle modifier and  $CR_{PV}$  is the concentration ratio.  $IAM_{th}$  is given by [29]:

$$IAM_{th} = 1 - b_{0,th} \left( \frac{1}{\cos\theta} - 1 \right) \quad \text{If } \theta < 60^\circ \quad (11)$$

$$IAM_{th} = \left[ 1 - b_{0,th} \left( \frac{1}{\cos\theta} - 1 \right) \right] \left( 1 - \frac{\theta-60}{30} \right) \quad \text{If } \theta \geq 60^\circ$$

where  $b_{0,th}$  is the  $IAM_{th}$  curve coefficient and  $\theta$  is the angle of incidence.  $CR_{PV}$  is given by:

$$CR_{PV} = \frac{A_{ap}}{A_{PV}} \quad (12)$$

where  $A_{ap}$  is the aperture area.

The generated PV cells electrical power is:

$$P_{el,PV} = I_b A_{PV} CR_{PV} \eta_{opt} IAM_{el} \eta_{PV} \quad (13)$$

where  $\eta_{PV}$  is the PV layer efficiency and  $IAM_{el}$  is the electrical incident angle modifier.  $\eta_{PV}$  is given by [27,30–32]:

$$\eta_{PV} = 0.298 + 0.0142 \ln(CR_{PV}) + [-0.000715 + 0.0000697 \ln(CR_{PV})](T_{PV} - 298) \quad (14)$$

$IAM_{el}$  is given by [29,33]:

$$IAM_{el} = 1 - b_{0,el} \left( \frac{1}{\cos\theta} - 1 \right) \quad \text{If } \theta < 60^\circ \quad (15)$$

$$IAM_{el} = \left[ 1 - b_{0,el} \left( \frac{1}{\cos\theta} - 1 \right) \right] \left( 1 - \frac{\theta-60}{30} \right) \quad \text{If } \theta \geq 60^\circ$$

where  $b_{0,el}$  is the  $IAM_{el}$  curve coefficient.

The PV layer convective heat loss is:

$$q_{conv,PV} = \frac{T_{PV} - T_{am}}{R_{conv,PV}} \quad (16)$$

with

$$R_{conv,PV} = \frac{1}{h_{PV} A_{PV}} \quad (17)$$

where  $R_{conv,PV}$  is the PV layer convection thermal resistance,  $h_{PV}$  is the PV layer convective heat transfer coefficient which can be computed by the correlation in equation (5).

The PV layer radiative heat losses are:

$$q_{rad,PV} = \varepsilon_{PV} \sigma A_{PV} (T_{PV}^4 - T_{conc}^4) \quad (18)$$

where  $T_{conc}$  is the temperature of concentrator and  $\varepsilon_{PV}$  is the emissivity of PV layer.

The conductive thermal resistance of PV is:

$$R_{cond,PV} = \frac{t_{PV}}{K_{PV} A_{PV}} \quad (19)$$

Where  $K_{PV}$  and  $t_{PV}$  are the PV layer thermal conductivity and thickness, respectively.

Energy balance on node 4:

$$\frac{T_{PV}-T_H}{R_{cond,PV}} = \frac{T_H-T_C}{R_{TEG}} + P_{TEG} \quad (20)$$

where  $T_C$  and  $R_{TEG}$  are the cold temperature and thermal resistance of the TEG respectively.  $P_{TEG}$  is the power generated by TEG.

Energy balance on node 5:

$$\frac{T_H-T_C}{R_{TEG}} = \frac{T_C-T_{sub}}{R_{cond,sub}} \quad (21)$$

where  $T_{sub}$  and  $R_{cond,sub}$  are the substrate temperature and thermal resistance respectively. The conductive thermal resistance of substrate is:

$$R_{cond,sub} = \frac{t_{sub}}{K_{sub} A_{sub}} \quad (22)$$

where  $K_{sub}$  is the substrate thermal conductivity and  $t_{sub}$  is the substrate thickness.

Energy balance on node 6:

$$\frac{T_{AS}-T_{sub}}{R_{cond,sub}} + \frac{T_C-T_{sub}}{R_{cond,sub}} = q_f \quad (23)$$

where  $q_f$  is the heat transferred to the fluid:

$$q_f = \dot{m}_f C_{p,f} (T_{f,out} - T_{f,in}) \quad (24)$$

where  $\dot{m}_f$  is the mass flow rate of the fluid,  $C_{p,f}$  is the specific heat of the fluid and  $T_{f,out}$  and  $T_{f,in}$  are the outlet and inlet temperatures of the fluid, respectively.

The energy balance on the parabolic concentrator is:

$$q_{solar,conc} + q_{rad,PV} = q_{conv,conc,front} + q_{conv,conc,back} + q_{rad,conc} \quad (25)$$

where  $q_{solar,conc}$  is the solar radiation oriented towards the concentrator,  $q_{conv,conc,front}$  and  $q_{conv,conc,back}$  are respectively the front and back concentrator convective heat losses, and  $q_{rad,conc}$  is the concentrator radiative heat losses.

The available solar radiation oriented to the concentrator is:

$$q_{solar,conc} = I_{tot} A_{conc} \alpha_{conc} \quad (26)$$

where  $A_{conc}$  and  $\alpha_{conc}$  are the area and absorptance of the concentrator respectively.

The convective heat losses from the concentrator front and back are:

$$q_{conv,conc,front} = A_{conc} h_{conv,conc,front} (T_{conc} - T_{am}) \quad (27)$$

and

$$q_{conv,conc,back} = A_{conc} h_{conv,conc,back} (T_{conc} - T_{am}) \quad (28)$$

where  $h_{conv,conc,front}$  and  $h_{conv,conc,back}$  are the convective heat transfer coefficients of the concentrator from the front and back respectively.

The concentrator radiative heat losses is:

$$q_{rad,conc} = \varepsilon_{conc} \sigma A_{conc} (T_{conc}^4 - T_{sky}^4) \quad (29)$$

where  $\varepsilon_{conc}$  is the concentrator emissivity.

The final energy balance is performed on a control volume including the fluid channel and the substrate which is treated as a heat exchanger. The temperature of the metallic substrate is assumed to be constant due to its high thermal conductivity.

$$\dot{m}_f C_{p,f} (T_{f,out} - T_{f,in}) = \varepsilon \dot{m}_f C_{p,f} (T_{sub} - T_{f,in}) \quad (30)$$

where  $\varepsilon$  is the heat transfer effectiveness which can be computed using NTU number:

$$\varepsilon = 1 - e^{-NTU} \quad (31)$$

and

$$NTU = \frac{\frac{1}{\frac{1}{h_f} + R_{sub}} A_{HX}}{\dot{m}_f C_{p,f}} \quad (32)$$

where  $A_{HX}$  is the heat exchanger area and  $h_f$  is the heat transfer coefficient of the fluid which can be calculated using the following correlation:

$$Nu_f = 0.023 Re_f^{\frac{4}{5}} Pr_f^{\frac{2}{5}} \quad (33)$$

The electrical efficiency of the system can be computed by:

$$\eta_{el} = \frac{P_{el,total}}{I_b A_{ap}} \quad (34)$$

where  $\eta_{el}$  is the electrical efficiency and  $P_{el,total}$  is the total electrical power produced by the hybrid system:

$$P_{el,total} = P_{el,PV} + P_{TEG} \quad (35)$$

The thermal efficiency of the system can be computed by:

$$\eta_{th} = \frac{q_f}{I_b A_{ap}} \quad (36)$$

where  $\eta_{th}$  is the thermal efficiency.

Matlab software is utilized and the eight aforementioned unknowns are computed using the Iterative Convergence Method (ICM) which is represented in figure 3. A three stage calculation will be performed. First stage, PV temperature  $T_{PV}$  is assumed and substituted in equation (25) to calculate the concentrator temperature  $T_{conc}$ . Then, using system of six equations (1, 8, 9, 20, 21 and 30), six unknowns will be computed which are: absorber temperature  $T_{abs}$ , substrate temperature  $T_{sub}$ , hot and cold temperatures of the TEG  $T_H$  and  $T_C$  respectively, fluid outlet temperature  $T_{f,out}$  and the temperature between the absorber and the substrate  $T_{AS}$ . In the third stage, using equation (23) the PV temperature  $T'_{PV}$  is calculated and compared with the assumed value

$T_{PV}$ . If the assumed value is equal to the calculated one, the iterative ends; otherwise, it repeats itself.

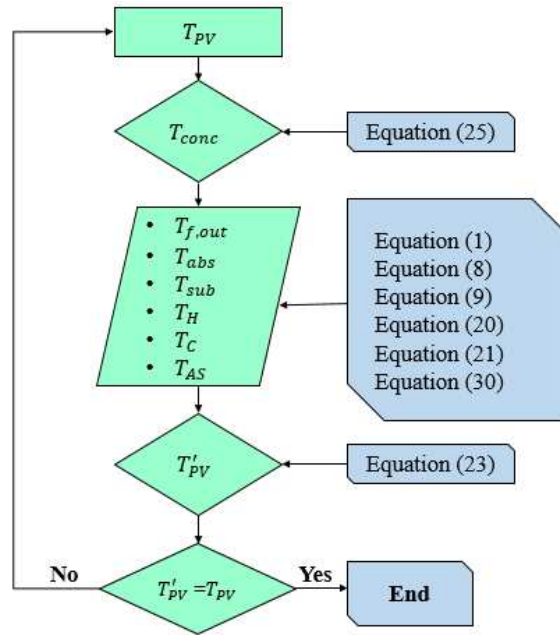

Figure 3. ICM Iteration procedure of the thermal modeling.

#### 4. Thermal model validation

The developed thermal modeling is compared with experimental results from Mohsenzadeh et al [25] and numerical results from Calise and Vanoli [27] in order to be validated accurately. The system in [25] is similar to the studied system, however, the triangular receiver consists of triangular duct where the fluid flows inside it. On the top of the triangular receiver, thermal insulator is located while on the sides facing the concentrator TEGs and PV module are positioned. While the system in [27] has the same structure as the studied system but without using TEGs. Table 1 shows the difference in the structure of the system studied and the systems in [25] and [27].

Table 1. The structure of the studied system and the systems from [25] and [27].

Studied system	System from [25]	System from [27]

Table 2 and 3 comprise the comparison between the obtained results of the developed thermal model and results of Mohsenzadeh et al [25] Calise and Vanoli [27], respectively. It is clear that the results are similar to the two studies since the maximum deviation is 6.6%. This indicates that the conducted thermal modeling is validated and it has enough accuracy and precision to be used in parametric analysis, case study or feasibility study.

Table 2. Obtained system temperatures by the conducted thermal model and data from [25].

Parameter	Results from thermal modeling	Results from [25]	Deviation
$q_f$	177.9 W	176.3 W	-0.9%
$P_{el,total}$	20.9 W	19.6 W	-6.6%
$T_{PV}$	367.9 K	363.9	-1.1%

Table 3. Obtained system temperatures by the conducted thermal model and data from [27].

Parameter	Results from thermal modeling	Results from [27]	Deviation
$T_{f,out}$	350.85 K	352.45 K	0.45%
$T_{PV}$	355.71 K	355.45 K	-0.07%
$T_{abs}$	351.95 K	355.85 K	1.10%
$T_{sub}$	351.85 K	353.65 K	0.51%

## 5. Case studies and discussions

This section is devoted to implement the suggested thermal model using MATLAB software in order to demonstrate the thermal and electrical performance of the aforementioned hybrid system. To fulfill this aim, case studies are conducted on Lebanon, France and United Arabian Emirate which have different climate weathers (moderate, mild and warm respectively) to investigate the effect of climate on the performance of PTPVT-TE system. Table 4 elucidates the design parameters of the system.

Table 4. Design parameters of PTPVT-TE system [27,34–37].

Parameter	Symbol	Value	Unit
<b>Concentrator</b>			
Concentrator aperture area	$A_{ap}$	60.0	m <sup>2</sup>
Concentrator absorptance	$\alpha_{conc}$	0.03	-
Concentrator emissivity	$\varepsilon_{conc}$	0.30	-
Concentration ratio	$CR_{PV}$	10	-
<b>Photovoltaic</b>			
PV layer area	$A_{PV}$	6.0	m <sup>2</sup>
PV thermal conductivity	$K_{PV}$	50	W/m <sup>2</sup>
PV absorptance	$\alpha_{PV}$	0.97	-
PV emissivity	$\varepsilon_{PV}$	0.20	-
<b>Absorber</b>			
Absorber area	$A_{abs}$	3.0	m <sup>2</sup>
Absorber thermal conductivity	$K_{abs}$	205	W/m <sup>2</sup>
Absorber absorptance	$\alpha_{abs}$	0.90	-
Absorber emissivity	$\varepsilon_{abs}$	0.20	-
<b>Substrate</b>			
Substrate thermal conductivity	$K_{sub}$	250	W/m <sup>2</sup>
<b>TEG</b>			
Area of 1 TEG	$A_{TEG}$	0.05×0.05	m <sup>2</sup>
TEG thermal conductivity	$K_{TEG}$	1.4	W/m <sup>2</sup>
TEG emissivity	$\varepsilon_{TEG}$	0.60	-
TEG absorptance	$\alpha_{TEG}$	0.4	-

<b>Fluid channel</b>			
Fluid channel diameter	$d_f$	0.06	m
Fluid specific heat	$C_{p,f}$	4183	J/kg K
Fluid flow rate	$\dot{m}_f$	0.15	kg/s
IAM electrical coefficient	$b_{0,elec}$	0.28	-
IAM thermal coefficient	$b_{0,th}$	0.14	-

Table 5 illustrates the latitude and longitude of the three cities that are taken under study in the three aforementioned countries: Baalbek in Lebanon, Angers in France and Abu Dhabi in UAE.

Table 5. latitude and longitude of Baalbek, Angers and Abu Dhabi [38].

Country	City	Latitude	Longitude
Lebanon	Baalbek	24.005	36.218
France	Angers	47.471	0.551
UAE	Abu Dhabi	24.476	54.366

Figures 4, 5 and 6 illustrate the boundary conditions in 2016 for Lebanon (Baalbek), France (Angers) and UAE (Abu Dhabi) respectively [38]. The boundary conditions include the beam and total incident radiation, and the ambient temperature.

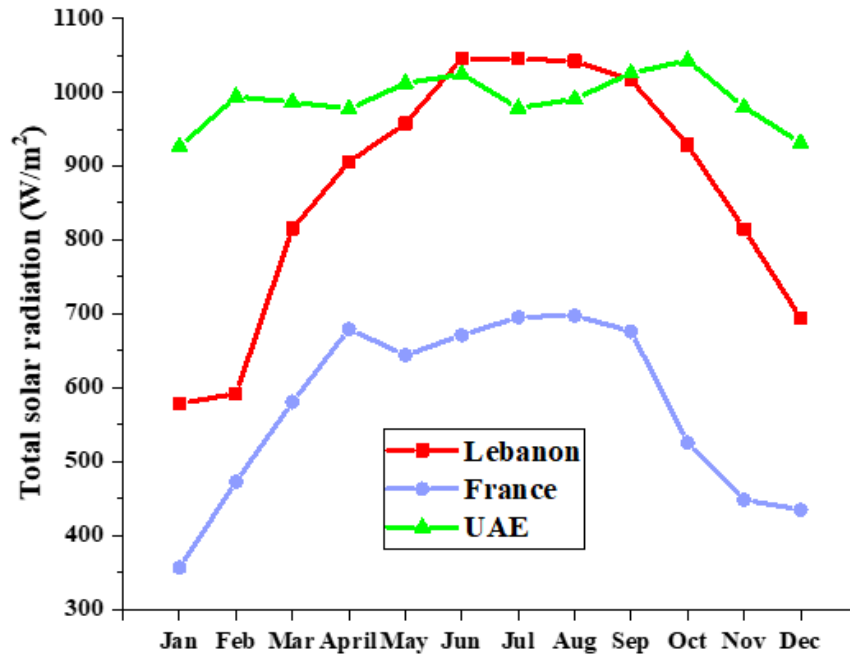

Figure 4. Total solar radiation for Lebanon, France and UAE [38].



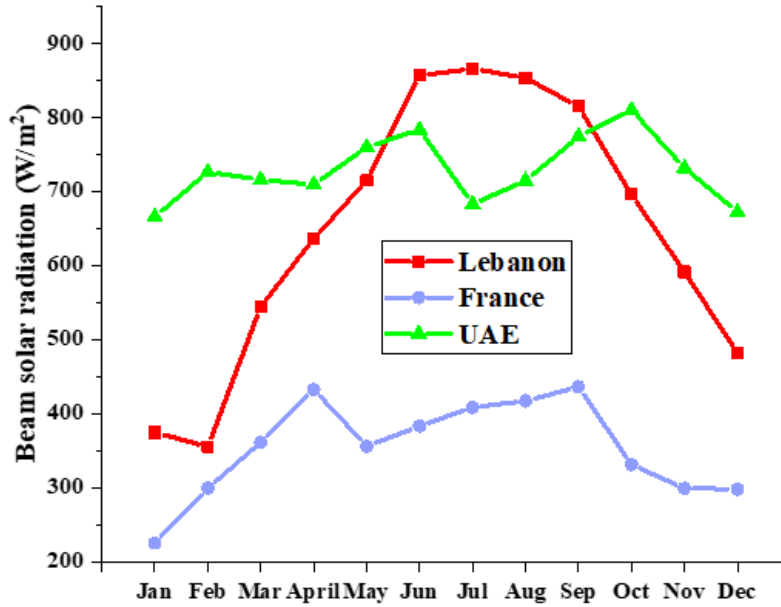

Figure 5. Beam radiation for Lebanon, France and UAE [38].

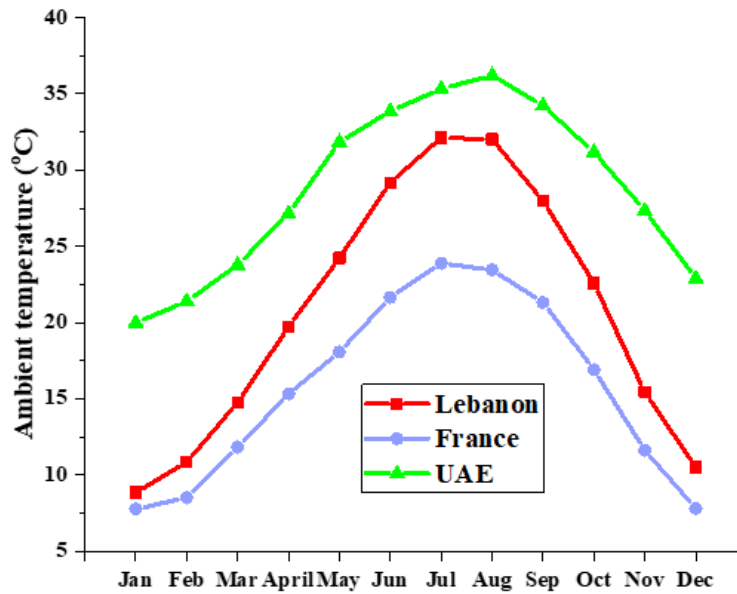

Figure 6. Ambient temperature for Lebanon, France and UAE [38].

Figures 7, 8 and 9 present the system temperatures for Lebanon, France and UAE respectively. It is noticeable that the system temperatures including the fluid outlet temperature, absorber and substrate temperature, temperature between the absorber and substrate and the cold temperature side of TEG are close to each other, and the hot temperature and PV temperature are close to each other and greater than the other temperatures. This reveals that the heat is transmitted by conduction and the thermal resistance of each component of the system is low. Also, the temperature of PV and hot side of TEG are greater than the other system temperatures due to the fact that the solar radiation absorbed by the PV layer is concentrated which is greater than that

absorbed by the thermal absorber. The concentrator temperature is a low temperature of the system due to its high reflectance, and the fluid inlet temperature is the lowest temperature of the system.

The fluid outlet temperatures are relatively high compared to the fluid inlet temperature where its average increase per month in Lebanon, France and UAE is approximately 35.8°C, 19.5°C and 40.6°C respectively. Besides, it is clear that the maximum fluid outlet temperature achieved in Lebanon and France are obtained during July with 80.4°C and 46.8°C respectively, and 32.1°C and 23.9°C for inlet temperatures respectively, while in UAE the maximum fluid outlet temperature is reached during June with 77.7°C, and 33.9°C for water inlet temperature. This can be explained by the highest beam radiation and water inlet temperature and relatively high total radiation during July in Lebanon. In France, the highest inlet water temperature is obtained during July with relatively high beam and total radiations. In UAE, relatively high beam and total radiation and water inlet temperatures are obtained in June.

On the other hand, the minimum outlet temperature attained is during January in Lebanon, France and UAE (29.2°C, 20.0°C and 56.7°C respectively) where the inlet water temperature is 8.9°C, 7.8°C and 20.0°C respectively. This is due to the lowest beam and total radiations and water inlet temperature obtained during January in the three countries. Hence, the initial conditions have a great influence on the water outlet temperature achieved by the hybrid system.

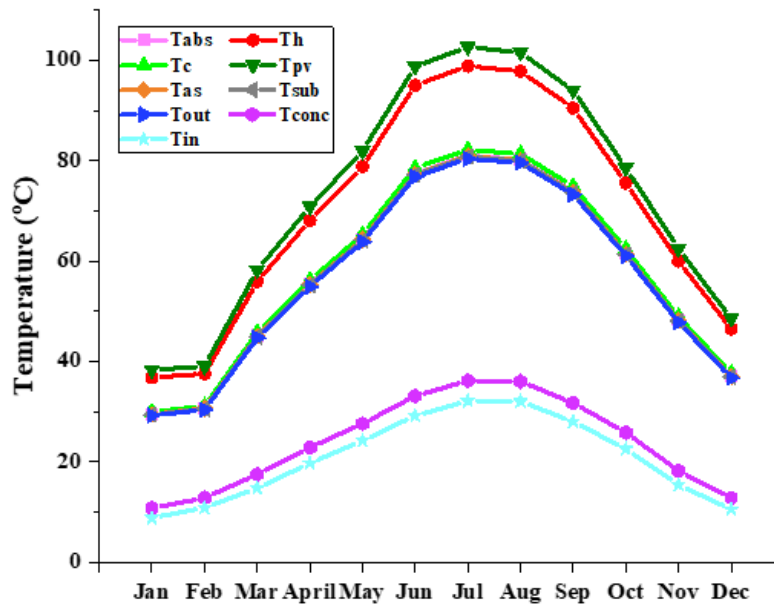

Figure 7. System temperatures for Lebanon.

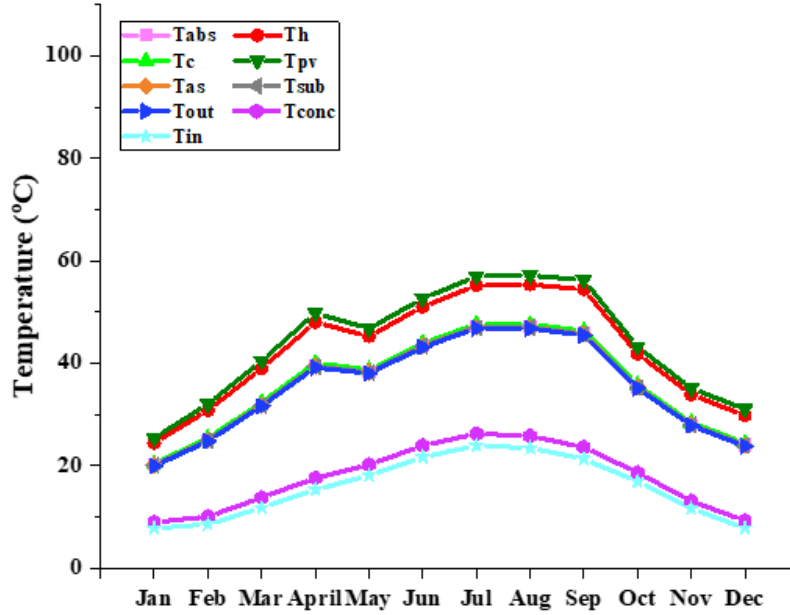

Figure 8. System temperatures for France.

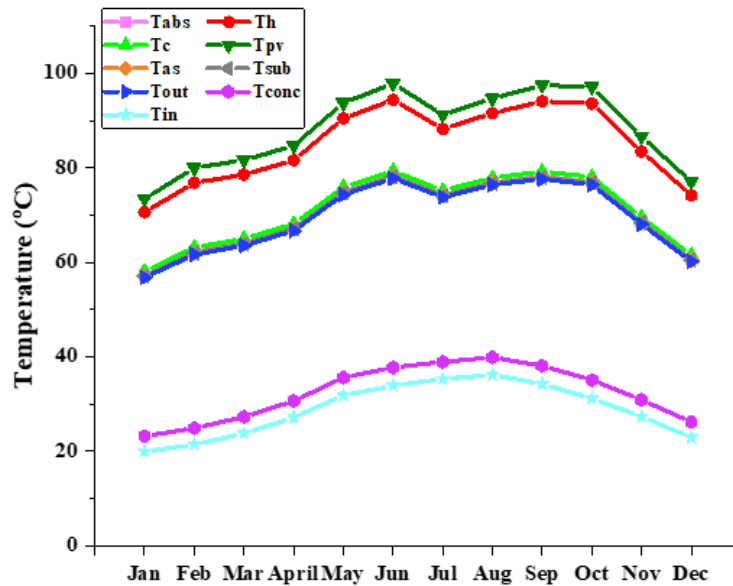

Figure 9. System temperatures for UAE.

Figure 10 shows the fluid outlet temperature during each month in the three countries. It is clear that the outlet fluid temperature is highly influenced by the climate conditions such as beam and total radiation as well as the ambient temperature which affects the water inlet temperature. The lowest water outlet temperature is observed in France which has the lowest values of these parameters in contrast to UAE which has the highest ones. While Lebanon obtained results lower than UAE and greater than France due to its moderate climate. However, the higher values of beam and total radiation in Lebanon compared to UAE lead to exception in the results during July and August for which the outlet temperature in Lebanon is higher than that of UAE.

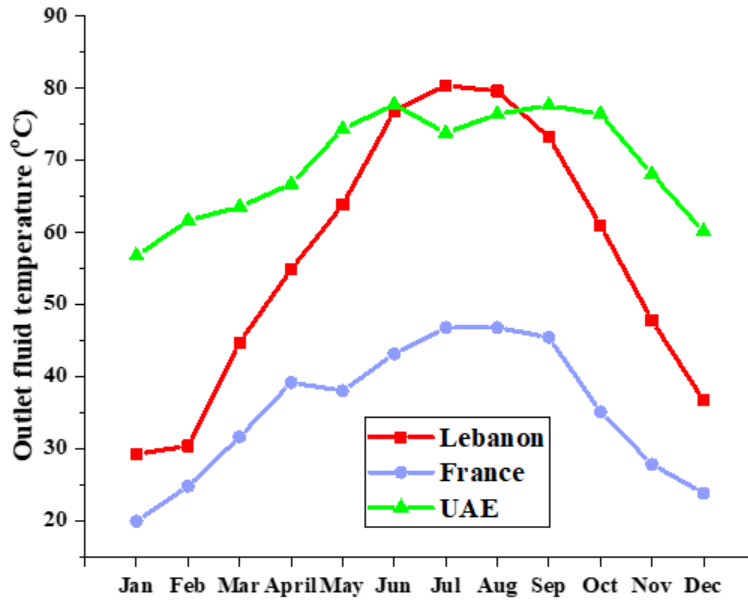

Figure 10. Fluid outlet temperature for Lebanon, France and UAE.

Figure 11 presents the monthly generated energy by TEGs for Lebanon, France and UAE. The maximum attained energy generated by TEG is 228.2 kWh in Lebanon during July, 103.8 kWh in France during April and 187.2 kWh in UAE during June. While the minimum achieved value is 64.5 kWh in Lebanon during February, 35.1 kWh in France during January and 138.0 kWh in UAE during December. The annual energy generated by Lebanon, France and UAE is 1806.2 kWh, 848.1 kWh and 1893.7 kWh respectively.

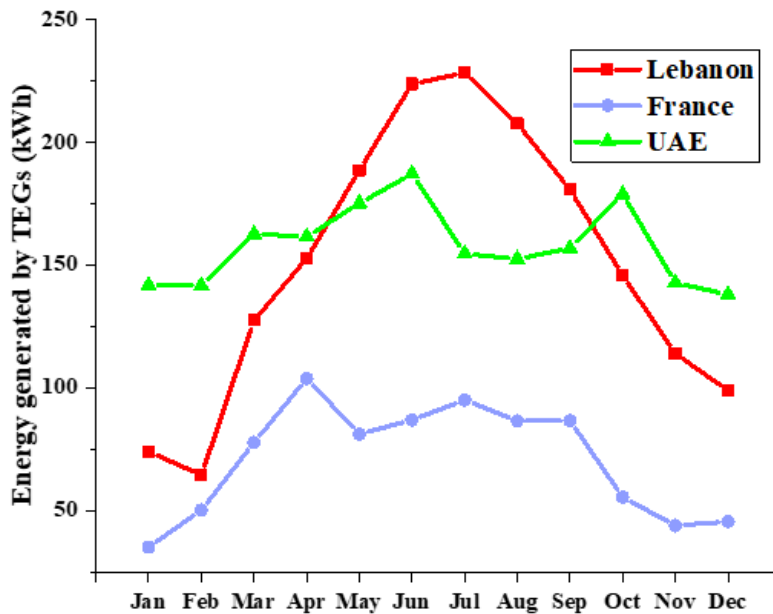

Figure 11. Energy generated by TEGs for Lebanon, France and UAE.

It is clear that the graph of the energy generated by TEGs has similar shape to that of beam radiation. This reveals that the beam radiation has a direct and significant influence on the energy generated by TEG. This explains the fluctuation of the amount of energy between the three countries, where during May to September Lebanon generates energy more than UAE and France, while during other months UAE attains the highest amount of energy produced. France which has the lowest beam radiation generates the lowest energy.

The suggested thermal model is implemented on PTPVT system when no TEGs are utilized and the heat rate and electrical power generated by the system are compared with that produced by the considered PTPVT-TE system. The integration of TEGs to the hybrid system lead to decrease the heat rate transferred to the fluid and increase the electrical power generated. Equations (37) and (38) show the expression of the percentage decrease in the heat rate and percentage increase in the electrical power.

$$\%_{dec} = \frac{q_{f_{PTPVT}} - q_{f_{PTPVT-TE}}}{q_{f_{PTPVT}}} \times 100 \quad (37)$$

Where  $\%_{dec}$  is the percentage decrease in the heat rate,  $q_{f_{PTPVT}}$  and  $q_{f_{PTPVT-TE}}$  are the heat rate from system without and with TEGs respectively.

$$\%_{inc} = \frac{P_{el,total_{PTPVT-TE}} - P_{el,total_{PTPVT}}}{P_{el,total_{PTPVT}}} \times 100 \quad (38)$$

Where  $\%_{inc}$  is the percentage increase in the electrical power,  $P_{el,total_{PTPVT}}$  and  $P_{el,total_{PTPVT-TE}}$  are the electrical power generated by system without and with TEGs respectively.

Figure 12 shows the percentage decrease in the heat rate and increase in the electrical power for Lebanon, France and UAE when TEGs are used in PTPVT system.

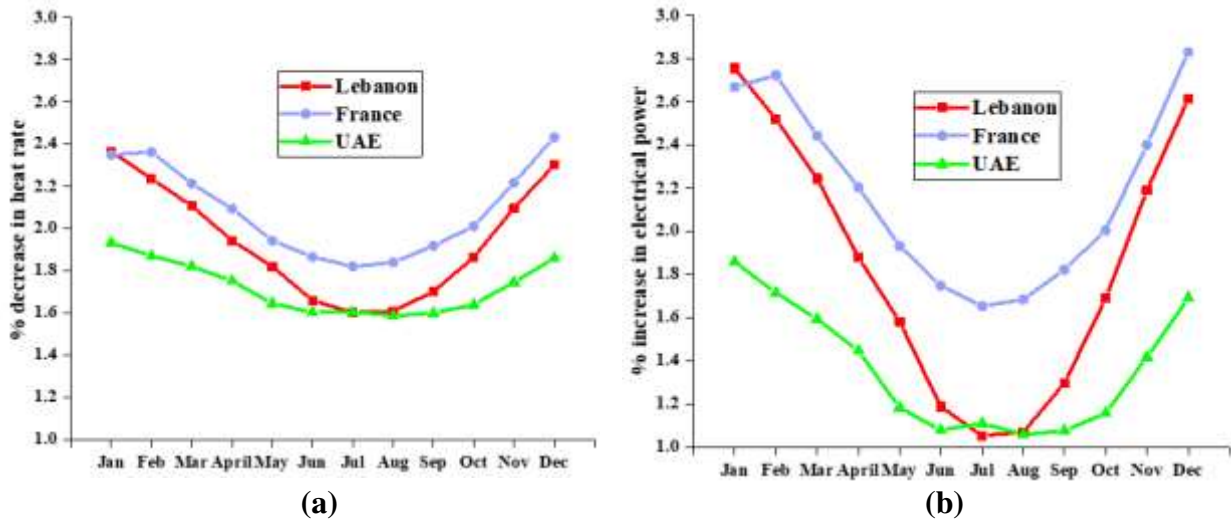

*Figure 12. (a) Percentage decrease in the heat rate (b) Percentage increase in the electrical power for Lebanon, France and UAE when TEGs are used in PTPVT system, i.e; PTPVT-TE system compared to PTPVT.*

The annual average increase in the electrical power is 1.8%, 2.2% and 1.4% and the yearly average alleviation in the heat rate is 1.9%, 2.1% and 1.7% in Lebanon, France and UAE respectively. It is axiomatic that the electrical power is increased since the system is generating power by TEGs and PV module instead of PV module alone. While the addition of TEGs mitigated the heat rate due to the thermal resistance added to the system which is the thermal resistance of the TEGs. However, it is noticeable that there is slight effect of TEG implementation on the heat rate and electrical power due to the low value of the TEG thermal resistance and the temperature difference between hot and cold sides. Also, the addition of TEGs affects the system performance in winter seasons more than summer seasons. Since during summer the ambient temperature is high, and although the addition of TEGs will decrease the temperature of PV cells, but it will remain relatively high which means that the electrical and thermal performance of the system will be slightly affected. In contrast to the case during winter where the system temperatures are low, hence decreasing the temperature of PV will enhance the electrical performance and decrease the amount of heat transferred to the fluid and thus affect the system performance more than in summer. Moreover, France which has the lowest climate conditions is affected more than Lebanon and UAE by the addition of TEGs to the system. In contrast, UAE which has the warmest weather is the least country that the system is influenced by integrating TEGs. This is due to the fact that the solar radiation controls the variations of parameters in the system, hence, at low solar radiation the parameters are affected by adding TEGs more than the case when solar radiation is high. This reveals that the addition of TEGs in PTPVT-TE system has more influence on its performance at low climate boundary conditions.

Figure 13 shows the annual total electrical and thermal energy generated by the PTPVT-TE system for Lebanon, France and UAE. The annual amount of total electrical energy generated by PV and TEGs is 46.5 MWh, 27.4 MWh and 51.1 MWh for Lebanon, France and UAE respectively. While the annual thermal energy produced by the hybrid system is 101.4 MWh, 56.7 MWh and 114.2 MWh. The results assure that the climate has a vital impact on the electrical and thermal performance of the considered system. UAE which has warm climate has the best system performance which generates the highest amount of electrical and thermal energy, Lebanon which has moderate climate achieves relatively good performance of the system (electrical and thermal energy attained in Lebanon are slightly less than that attained by UAE by about 9 and 11.2%) and France which has mild climate achieves the lowest system performance in which it generates thermal and electrical energy less than that generated by UAE by 46.4% and 50.4%.

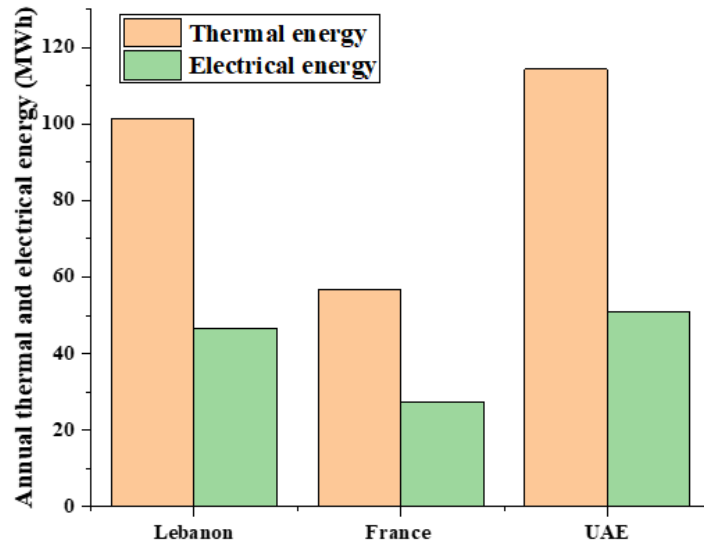

Figure 13. Annual thermal and electrical energies generated by the PTPVT-TE system for Lebanon, France and UAE.

Figure 14 (a) presents the variation of the thermal efficiency with respect to the month for Lebanon, France and UAE. The highest thermal efficiency achieved is during August in Lebanon (58.3%), during June in France (58.6%) and during July in UAE (58.8%), while the lowest thermal efficiency attained is during December in Lebanon (56.8%) and France (56.2%) and during January in UAE (57.7%).

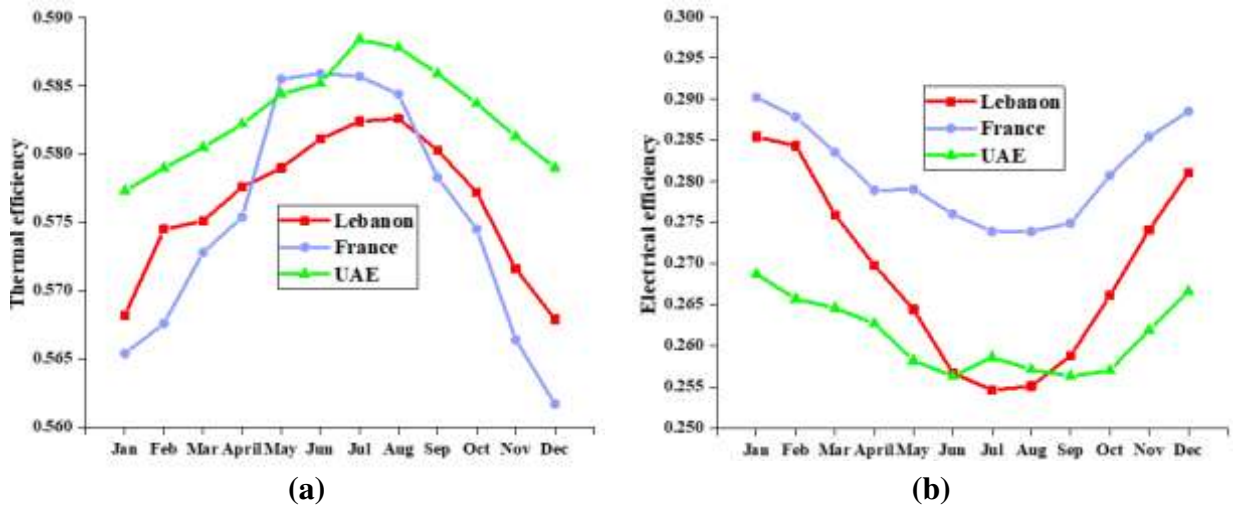

Figure 14. (a) Thermal efficiency for Lebanon, France and UAE. (b) Electrical efficiency for Lebanon, France and UAE.

Indeed, since France and UAE has the coldest and warmest climate among the three countries, they must obtain the lowest and highest thermal efficiencies respectively. However, the thermal efficiency of France is higher than that of Lebanon during July and August, and even higher than the thermal efficiency of Lebanon and UAE during May and June. This exception can be clarified

by referring to equations (24) and (36) where the thermal efficiency is obtained from the ratio of multiplication of fluid specific heat and mass flow rate with the temperature difference to the multiplication of beam incident radiation and aperture area. Hence, the thermal efficiency is function of the ratio of temperature difference to the beam radiation since the fluid specific heat and mass flow rate and the aperture area are constant. Therefore, the high thermal efficiency of France is due to the high ratio between the water temperature difference and the beam radiation compared to Lebanon and UAE. To clarify, during May and June, the ratio of water temperature difference to beam radiation is 0.0553 and 0.0555 for Lebanon, 0.0559 and 0.0560 for France, and 0.0558 and 0.0559 for UAE.

Figure 14 (b) shows the electrical efficiency for each country as function of month. The highest electrical efficiency attained is during January in Lebanon (28.5%), France (29.0%) and UAE (26.9%). While the lowest electrical efficiency attained is during July in Lebanon (25.5%), during August in France (27.4%) and during June in UAE (25.6%). It is obvious that France exhibits the highest electrical efficiency while UAE has the lowest value. In fact, the rise in the temperature leads to deterioration in the electrical efficiency which is the case of UAE that attains the highest system temperatures compared to France and Lebanon. However, the electrical efficiency in Lebanon is the lowest among the three countries during July and August due to the fact that during these months Lebanon attains beam and total radiation higher than UAE. During January, the highest electrical efficiency is obtained in the three countries since it is the coldest month where the lowest system temperatures and thermal efficiency are attained. While the lowest value is obtained during months where the system temperatures and thermal efficiency are relatively high.

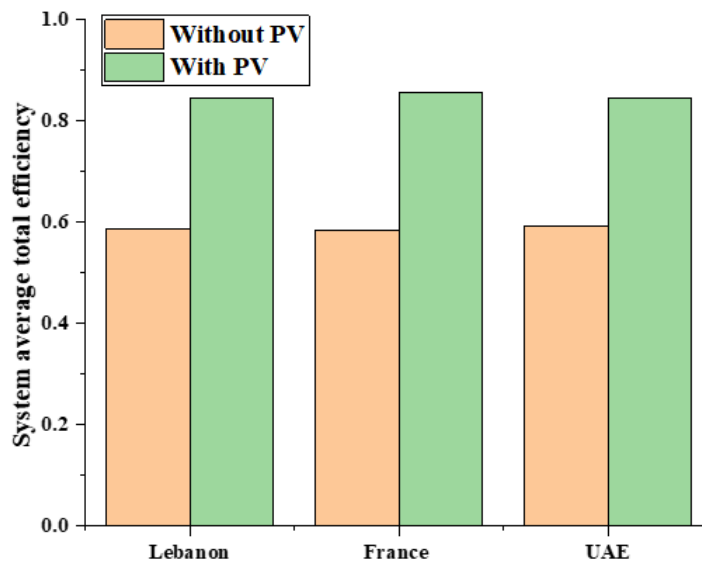

Figure 15. Average total efficiency of the system with and without PV for Lebanon, France and UAE.

Figure 15 presents the average total efficiency of the system with and without PV layer. It is obvious that the PV has a significant effect on the system total efficiency. To clarify, the total efficiency of the system without PV is 58.7%, 58.3% and 59.3% in Lebanon, France and UAE respectively. While the total efficiency of the system with PV is 84.5% in Lebanon, 85.6% in France and 84.4% in UAE. This reveals that the PV layer noticeably increases the system average total efficiency by about 44.4%.



## 6. Economic and environmental analyses

In this section, economic and environmental analyses are established to compute the payback period and the amount of CO<sub>2</sub> emissions reduced when PTPVT-TE system is used in Lebanon, France and UAE.

### *Economic analysis:*

In order to compute the payback period, the total power saved must be computed to obtain the total energy saved and then the amount of saved money.

The total power saved is the summation of the electrical power produced by PV layer and TEGs and the equivalent power required of the thermal heat gained by water:

$$P_{tot} = P_{el,PV} + P_{TEG} + P_{WH} \quad (39)$$

where  $P_{tot}$  is the total power saved and  $P_{WH}$  is the equivalent power required for water heating which can be obtained using the following equation:

$$P_{WH} = \frac{q_f}{\eta_{EH}} \quad (40)$$

where  $\eta_{EH}$  is the efficiency of the electric heater that can be used to heat water.

The total energy saved  $E_{tot}$  is calculated using equation (41) where the average number of day light hours ( $N_h$ ) and number of days ( $N_d$ ) of each month must be taken into consideration. Table 6 presents the average number of day light hours per month for the three countries [39–41].

$$E_{tot} = P_{tot} \cdot N_d \cdot N_h \quad (41)$$

Table 6. Average day light hours per month for Lebanon, France and UAE [39–41].

Month	Lebanon	France	UAE
Jan	10	9	11
Feb	11	10	11
Mar	12	12	12
Apr	13	14	13
May	14	15	13
Jun	14	16	14
Jul	14	16	14
Aug	13	14	13
Sep	12	13	12
Oct	11	11	12
Nov	10	9	11
Dec	10	8	11

The total amount of saved money ( $SM$ ) is computed by multiplying the total energy saved by the price of one kilo-watt hour:

$$SM = E_{tot} \cdot Pr_{1kWh} \quad (42)$$

where  $Pr_{1kWh}$  is the price of one kWh which is presented in Table 7 for the three considered countries [42].

Table 7. Average electrical kWh cost for Lebanon, France and UAE [42].

Country	Price (\$/kWh)
Lebanon	0.133
France	0.200
UAE	0.100

After estimating the amount of saved money, the payback period ( $PBP$ ) is obtained by dividing the cost of the considered hybrid system ( $C_{PTPVT-TE}$ ) over the annual money saved ( $SM_{an}$ ).

$$PBP = \frac{C_{PTPVT-TE}}{SM_{an}} \quad (43)$$

Table 8 summarizes the cost of PTPVT-TE system where the cost of building the photovoltaic thermal system and the TEGs are found equal in the three countries [43–45].

Table 8. Cost of PTPVT-TE system [43–45].

PVT system components	Price (\$)
PV module	6200
TEGs	19200
Parabolic concentrator	4250
Additional components	3450
Tracking system	1600
Inverter	3400
Design and tank	9500
<b>Total cost</b>	<b>47600</b>

Table 9 presents the annual amount of saved energy, power and money and the payback period for each country. Despite the fact that UAE achieves the highest energy saved among the three countries (around 194 000 kWh), it attains the lowest amount of annual money saved (\$19 400) due to the low cost of one kWh in this country. While Lebanon saves the highest amount of money (\$ 23 000) since it attains relatively high amount of saved energy and it has higher cost of one kWh than UAE. Then, UAE requires the highest duration which is 2.5 years to return the price of the system while the payback period of Lebanon is the least, with 2.1 years. For France case, it has relatively low amount of saved energy (about half as much) but quite similar amount of saved money (thanks to the higher price of one kWh in this country), the system payback period is 2.4 years.

Table 9. Annual amount of saved energy, power and money and the payback period for each country.

Country	Annual amount of energy saved (kWh)	Annual amount of money saved (\$)	Payback period (year)
<b>Lebanon</b>	173 238	23 041	2.1
<b>France</b>	98 184	19 637	2.4

UAE	193 846	19 385	2.5
-----	---------	--------	-----

### Environment analysis:

The amount of reduced carbon dioxide emissions ( $M_{CO_2,red}$ ) is estimated by the following equation:

$$M_{CO_2,red} = E_{tot} \cdot M_{CO_2/1kWh} \quad (44)$$

where  $M_{CO_2/1kWh}$  is the mass of carbon dioxide produced for the generation of one kilowatt hour electricity.

The amount of carbon dioxide produced to generate 1 kilowatt hour in Lebanon, France and UAE are 0.47 kg/kWh, 0.058 kg/kWh and 0.42 kg/kWh respectively [46–48]. Figure 15 shows the variation of the amount of carbon dioxide emissions alleviated each month for the three countries.

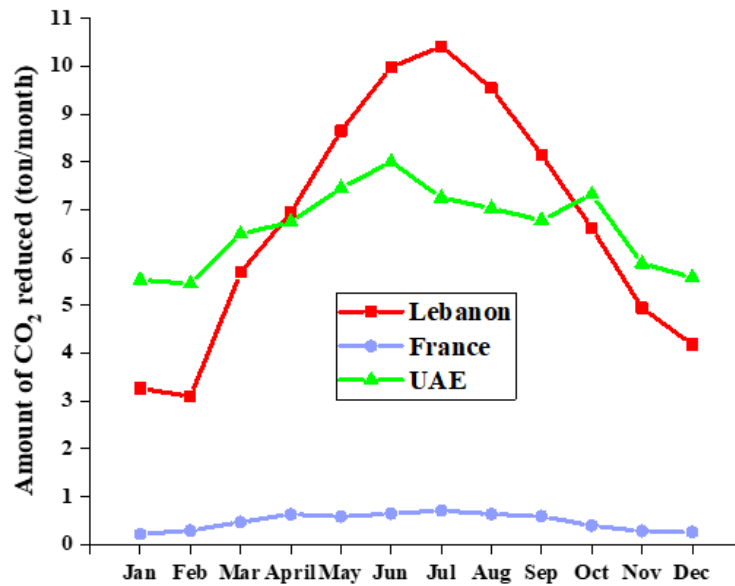

Figure 15. Amount of CO<sub>2</sub> emissions mitigated per month for Lebanon, France and UAE.

It is noticeable that the amount of reduced CO<sub>2</sub> emissions are low in France which is due to the low amount of CO<sub>2</sub> produced when generating one kWh electricity. Indeed, this amount is greatly less than that mitigated in Lebanon and UAE since France generates around 75% of its electricity using nuclear power plants. The maximum amount of CO<sub>2</sub> gases reduced is 10.4 tons and 0.7 tons in Lebanon and France during July, and 8.0 tons in UAE during June. For the annual amount of alleviated CO<sub>2</sub> emissions, it is obtained that the system reduces about 81.4 tons, 5.7 tons and 79.5 tons in Lebanon, France and UAE respectively. It is obvious that the amount reduced in France is negligible compared to the results of Lebanon and UAE since France relies on energy with low greenhouse gas emissions to produce electricity.

## 7. Conclusions

The tri-generation system structure and concept are described in this work. A new suggested thermal modeling is established using thermal resistance analogy and energy balance at several

nodes and parts of the system. The thermal model is simulated using MATLAB software and validated against previous work with maximum deviation of 6.6%.

To investigate the effect of climate conditions on the performance of the studied system, case studies are implemented in this paper considering three countries of distinct climates which are Lebanon (moderate), France (mild) and United Arab Emirate (warm). The results show that the system annual generated electrical and thermal energy are 46.5 MWh and 101.4 MWh in Lebanon, 27.4 MWh and 56.7 MWh in France and 51.1 MWh and 114.2 MWh in UAE where 1.8 MWh, 0.8 MWh and 1.9 MWh are generated from TEGs in Lebanon, France and UAE respectively. Moreover, the highest electrical and thermal efficiencies obtained are 28.5% and 58.3% in Lebanon, 29.0% and 58.6% in France, 26.9% and 58.8% in UAE. Furthermore, it was concluded that the addition of TEGs to PTPVT system serves in augmenting the electrical power by an average of 1.8%, 2.2% and 1.4% in Lebanon, France and UAE respectively while alleviating the heat rate by an average of 1.9%, 2.1% and 1.7% in Lebanon, France and UAE respectively. Besides, it was observed that PV layer has vital effect on total efficiency of the system in which it rises it by about 44.4%.

To assess the economic and environmental influence of utilizing the hybrid system, the payback period and the amount of reduced CO<sub>2</sub> emissions are evaluated. The proposed system requires about 2.1 years, 2.4 years and 2.5 years to return its cost in Lebanon, France and UAE respectively where it costs \$ 47 600. Besides, adopting such hybrid system serves in mitigating CO<sub>2</sub> emissions annually by about 81.4 tons, 5.7 tons and 79.5 tons in Lebanon, France and UAE respectively.

It is obvious that PTPVT-TE system is a promising system which can contribute to the global efforts in providing the world energy requirements. Also, there is a great potential to play a vital role in conserving energy and mitigating greenhouse gases which reduces pollution. Such system requires more studies and researches in order to achieve system optimization with the lowest possible cost, since the augmentation in the conversion efficiency and the alleviation in the cost of the system authorize it to be one of the most adopted system in the world.

## References

- [1] Statistical Review of World Energy .Energy economics n.d. <https://www.bp.com/en/global/corporate/energy-economics/statistical-review-of-world-energy.html> (accessed July 26, 2020).
- [2] Koç A, Yağlı H, Bilgic HH, Koç Y, Özdemir A. Performance analysis of a novel organic fluid filled regenerative heat exchanger used heat recovery ventilation (OHeX-HRV) system. *Sustain Energy Technol Assessments* 2020;41:100787. doi:10.1016/j.seta.2020.100787.
- [3] Jaber H, Khaled M, Lemenand T, Faraj J, Bazzi H, Ramadan M. Effect of Exhaust Gases Temperature on the Performance of a Hybrid Heat Recovery System. *Energy Procedia* 2017;119:775–82. doi:10.1016/J.EGYPRO.2017.07.110.
- [4] Jaber H, Khaled M, Lemenand T, Ramadan M. Short review on heat recovery from exhaust gas. *AIP Conf. Proc.*, vol. 1758, AIP Publishing LLC; 2016, p. 030045. doi:10.1063/1.4959441.
- [5] Jaber H, El Hage H, Ramadan M, Khaled M, Olabi AG. A short review on the techniques of waste heat recovery from domestic applications. *Energy Sources, Part A Recover Util Environ Eff* 2019:1–16. doi:10.1080/15567036.2019.1623940.
- [6] Chamandoust H, Bahramara S, Derakhshan G. Day-ahead scheduling problem of smart micro-grid with high penetration of wind energy and demand side management strategies. *Sustain Energy Technol Assessments* 2020;40:100747. doi:10.1016/j.seta.2020.100747.
- [7] Mehrjerdi H, Hemmati R. Stochastic model for electric vehicle charging station integrated with wind energy. *Sustain Energy Technol Assessments* 2020;37:100577. doi:10.1016/j.seta.2019.100577.
- [8] Yoshida T, Zhou J, Park S, Muto H, Kitazawa D. Use of a model turbine to investigate the high striking risk of fish with tidal and oceanic current turbine blades under slow rotational speed. *Sustain Energy Technol Assessments* 2020;37:100634. doi:10.1016/j.seta.2020.100634.
- [9] Goh HB, Lai SH, Jameel M, Teh HM, Chin RJ. Feasibility assessment of tidal energy extraction at the Tg Tuan coastal headland: A numerical simulation study. *Sustain Energy Technol Assessments* 2020;38:100633. doi:10.1016/j.seta.2020.100633.
- [10] Herez A, Khaled M, Murr R, Haddad A, Elhage H, Ramadan M. Using Geothermal Energy for cooling - Parametric study. *Energy Procedia* 2017;119:783–91. doi:10.1016/J.EGYPRO.2017.07.111.
- [11] Herez A, Ramadan M, Abdulhay B, Khaled M. Short review on solar energy systems. *AIP Conf. Proc.*, vol. 1758, AIP Publishing LLC; 2016, p. 030041. doi:10.1063/1.4959437.
- [12] El Hage H, Herez A, Ramadan M, Bazzi H, Khaled M. An investigation on solar drying: A review with economic and environmental assessment. *Energy* 2018;157:815–29. doi:10.1016/j.energy.2018.05.197.
- [13] Herez A, Ramadan M, Khaled M. Review on solar cooker systems: Economic and environmental study for different Lebanese scenarios. *Renew Sustain Energy Rev* 2018;81:421–32. doi:10.1016/J.RSER.2017.08.021.
- [14] Vijayanandan AS, Kandath Valappil RS, Balakrishnan RM. Evaluation of photothermal properties for absorption of solar energy by Co3O4 nanofluids synthesized using endophytic fungus *Aspergillus nidulans*. *Sustain Energy Technol Assessments* 2020;37:100598. doi:10.1016/j.seta.2019.100598.
- [15] Hassanpour A, Borji M, Ziapour BM, Kazemi A. Performance analysis of a cascade PCM heat exchanger and two-phase closed thermosiphon: A case study of geothermal district heating system. *Sustain Energy Technol Assessments* 2020;40:100755. doi:10.1016/j.seta.2020.100755.
- [16] Solmaz A, Işık M. Polishing the secondary effluent and biomass production by microalgae submerged membrane photo bioreactor. *Sustain Energy Technol Assessments* 2019;34:1–8. doi:10.1016/j.seta.2019.04.002.
- [17] Sanaye S, Khakpaay N, Chitsaz A. Thermo-economic and environmental multi-objective optimization of a novel arranged biomass-fueled gas engine and backpressure steam turbine combined system for pulp and paper mills. *Sustain Energy Technol Assessments* 2020;40:100778. doi:10.1016/j.seta.2020.100778.
- [18] Herez A, El Hage H, Lemenand T, Ramadan M, Khaled M. Review on photovoltaic/thermal hybrid solar collectors: Classifications, applications and new systems. *Sol Energy* 2020;207:1321–47. doi:10.1016/j.solener.2020.07.062.
- [19] Al-Nimr MA, Mugdadi B. A hybrid absorption/thermo-electric cooling system driven by a concentrated photovoltaic/thermal unit. *Sustain Energy Technol Assessments* 2020;40:100769. doi:10.1016/j.seta.2020.100769.
- [20] Leon MT De, Chong H, Kraft M, Stafford J, Walsh E, Egan V, et al. Experimental and theoretical analysis of a hybrid solar thermoelectric generator with forced convection cooling. *J Phys D Appl Phys* 2017;50:15501. doi:10.1088/1361-6463/50/1/015501.
- [21] Soltani S, Kasaiean A, Sokhansefat T, Behshad M. Performance investigation of a hybrid photovoltaic / thermoelectric system integrated with parabolic trough collector. *Energy Convers Manag* 2018;159:371–80. doi:10.1016/j.enconman.2017.12.091.
- [22] Riahia A, Ali AH, Fadhel A, Guizania A, Balghouthi M. Performance investigation of a concentrating photovoltaic thermal hybrid solar system combined with thermoelectric generators. *Energy Convers Manag* 2020;205:112377. doi:10.1016/j.enconman.2019.112377.
- [23] Shadmehri M, Narei H, Ghasempour R, Behshad M. Numerical simulation of a concentrating photovoltaic-thermal solar system combined with thermoelectric modules by coupling Finite Volume and Monte Carlo Ray-Tracing methods. *Energy Convers Manag* 2018;172:343–56. doi:10.1016/j.enconman.2018.07.034.

- [24] Yin E, Li Q, Xuan Y. Feasibility analysis of a concentrating photovoltaic-thermoelectric-thermal cogeneration. *Appl Energy* 2019;236:560–73. doi:10.1016/j.apenergy.2018.12.019.
- [25] Mohsenzadeh M, Shafii MB, Jafari H. A novel concentrating photovoltaic/thermal solar system combined with thermoelectric module in an integrated design. *Renew Energy* 2017;113:822–34. doi:10.1016/j.renene.2017.06.047.
- [26] Kohan HRF, Lot F, Eslami M. Numerical simulation of a photovoltaic thermoelectric hybrid power generation system 2018;174:537–48. doi:10.1016/j.solener.2018.09.046.
- [27] Calise F, Vanoli L. Parabolic trough photovoltaic/thermal collectors: Design and simulation model. *Energies* 2012;5:4186–208. doi:10.3390/en5104186.
- [28] Incropera FP, DeWitt DP. *Fundamentals of Momentum, Heat and Mass Transfer*, 5th Edition. New York, USA: 2001.
- [29] Bernardo LR, Perers B, Håkansson H, Karlsson B. Performance evaluation of low concentrating photovoltaic/thermal systems: A case study from Sweden. *Sol Energy* 2011;85:1499–510. doi:10.1016/j.solener.2011.04.006.
- [30] Buonomano A, Calise F, Dentice d'Accadia M, Vanoli L. A novel solar trigeneration system based on concentrating photovoltaic/thermal collectors. Part 1: Design and simulation model. *Energy* 2013;61:59–71. doi:10.1016/j.energy.2013.02.009.
- [31] Li M, Ji X, Li G, Wei S, Li YF, Shi F. Performance study of solar cell arrays based on a Trough Concentrating Photovoltaic/Thermal system. *Appl Energy* 2011;88:3218–27. doi:10.1016/j.apenergy.2011.03.030.
- [32] Kribus A, Kaftori D, Mittelman G, Hirshfeld A, Flitsanov Y, Dayan A. A miniature concentrating photovoltaic and thermal system. *Energy Convers Manag* 2006;47:3582–90. doi:10.1016/j.enconman.2006.01.013.
- [33] Bernardo R. *Retrofitted Solar Domestic Hot Water System for Single-Family Electrically-Heated Houses Development and testing*. Lund, Sweden: Faculty of engineering, Lund University; 2010.
- [34] Dornelles K, Roriz V, Roriz M. Solar Absorptance of Building Opaque Surfaces. *CISBAT 2007 Proc* 2007;3. doi:10.13140/RG.2.1.4465.3285.
- [35] Liebert CH. Emittance and absorptance of NASA ceramic thermal barrier coating system, NASA Technical Paper 1190. *Int Conf Met Coatings*, San Fr California, April 3-7 1978:235–40.
- [36] Maatallah T, Ben W. Simulation and performance analysis of concentrating photovoltaic / thermal collector ( CPV / T ) with three-sided thermal insulation based on coupled optothermal model. *Sol Energy* 2019;181:308–24. doi:10.1016/j.solener.2019.02.002.
- [37] Li W, Paul MC, Montecucco A, Siviter J, Knox AR, Sweet T, et al. Multiphysics simulations of thermoelectric generator modules with cold and hot blocks and effects of some factors. *Case Stud Therm Eng* 2017;10:63–72. doi:10.1016/j.csite.2017.03.005.
- [38] JRC Photovoltaic Geographical Information System (PVGIS) - European Commission n.d. [https://re.jrc.ec.europa.eu/pvg\\_tools/en/tools.html](https://re.jrc.ec.europa.eu/pvg_tools/en/tools.html).
- [39] Paris, France - Detailed climate information and monthly weather forecast / Weather Atlas n.d. <https://www.weather-atlas.com/en/france/paris-climate>.
- [40] Beirut, Lebanon - Detailed climate information and monthly weather forecast / Weather Atlas n.d. <https://www.weather-atlas.com/en/lebanon/beirut-climate>.
- [41] Dubai, United Arab Emirates - Detailed climate information and monthly weather forecast / Weather Atlas n.d. <https://www.weather-are.com/en/united-arab-emirates/dubai-climate>.
- [42] Electricity prices around the world / Global Petrol Prices 2019. [https://www.globalpetrolprices.com/electricity\\_prices/](https://www.globalpetrolprices.com/electricity_prices/).
- [43] Ben Youssef W, Maatallah T, Menezo C, Ben Nasrallah S. Assessment viability of a concentrating photovoltaic/thermal-energy cogeneration system (CPV/T) with storage for a textile industry application. *Sol Energy* 2018;159:841–51. doi:10.1016/j.solener.2017.11.058.
- [44] Renno C, Petito F. Design and modeling of a concentrating photovoltaic thermal ( CPV / T ) system for a domestic application. *Energy Build* 2013;62:392–402. doi:10.1016/j.enbuild.2013.02.040.
- [45] Tecteg, Manufacturer of thermoelectric modules, 2016 n.d. <https://tecteg.com/>.
- [46] Overview of electricity production and use in Europe — European Environment Agency 2017. <https://www.eea.europa.eu/data-and-maps/indicators/overview-of-the-electricity-production-2/assessment-4>.
- [47] Jaber H, Lemenand T, Ramadan M, Khaled M. Hybrid Heat Recovery System Applied To Exhaust Gases—Thermal Modeling And Case Study. *Heat Transf Eng* 2019;0:1–14. doi:10.1080/01457632.2019.1692495.
- [48] EAD. Abu Dhabi State of Environment Report 2017. Environ Agency – Abu Dhabi 2017:97.



## Chapitre 5

### Conclusions et perspectives

La diminution de la consommation d'énergie est une tendance forte à encourager de nos jours pour plusieurs raisons : le coût élevé des sources d'énergie, le réchauffement climatique, les émissions élevées de gaz toxiques, les lois gouvernementales obligatoires, etc. Les combustibles fossiles qui sont les principales sources d'énergie, s'épuisent rapidement et leur coût augmente continuellement. Pour cette raison, les sources d'énergie renouvelables, durables, alternatives et propres ont attiré l'attention des scientifiques et des chercheurs au cours des dernières décennies. Les sources d'énergie renouvelables comprennent principalement le solaire, l'éolien, la géothermie, l'hydroélectricité, etc. L'énergie solaire est l'une des sources d'énergie renouvelable les plus prometteuses, ainsi le rayonnement solaire est absorbé par les systèmes solaires et transformé en chaleur ou en électricité pour être utilisé dans diverses applications. De plus, il y a un grand intérêt à utiliser des systèmes solaires hybrides qui sont le résultat de la combinaison de systèmes solaires entre eux. Ces systèmes visent à maximiser l'utilisation de l'énergie solaire. En plus de cela, l'intégration de générateurs thermoélectriques à ces systèmes est devenu un intérêt pour beaucoup de chercheurs récemment. C'est ainsi que cette thèse a porté sur les systèmes solaires hybrides dans lesquels le système hybride photovoltaïque / thermique à concentrateur parabolique (PTPVT) et le système hybride photovoltaïque / thermique / thermoélectrique à concentrateur parabolique (PTPVT-TE) ont été étudiés en détails.



Sur la base de ce qui a été mentionné, une vaste revue de la littérature sur l'énergie solaire est réalisée.

En outre, les systèmes hybrides PTPVT sont considérés dans lesquels une méthodologie pour développer la modélisation thermique est suggérée. Le concept du système est illustré par la production simultanée d'eau chaude et d'électricité lors de l'exploitation de l'énergie solaire. Des analyses paramétriques et des études de cas avec analyses économiques et environnementales ont été réalisées pour étudier les performances du système. De plus, l'intégration de générateurs thermoélectriques dans le système PTPVT est étudiée et la méthodologie suggérée est utilisée pour effectuer la modélisation thermique du système PTPVT-TE. La performance du système est étudiée en réalisant des études de cas, des analyses économiques et environnementales.

Les principaux résultats de cette thèse de doctorat sont résumés dans le tableau suivant :

Titre de l'étude	Méthodologie de l'étude	Résultats principaux
<p>1.1 Systèmes de cuiseurs solaires: étude économique et environnementale pour différents scénarii libanais</p>	<ul style="list-style-type: none"> <li>➤ Présenter une revue sur le cuiseur solaire qui comprend le principe et la classification, les paramètres influençant les performances d'un cuiseur solaire, et l'analyse d'énergie et d'exergie liée aux systèmes de cuiseur solaire.</li> <li>➤ Réaliser une étude économique pour différents scénarii au Liban (maison, hôtel, restaurant et snack) et pour plusieurs catégories de cuiseurs solaires (cuiseur à caisson solaire, cuiseur à panneaux solaires, cuiseur solaire parabolique et cuiseur solaire à tube sous vide avec stockage thermique).</li> <li>➤ Effectuer une analyse environnementale pour calculer la réduction des émissions de dioxyde de carbone dans les différents scénarii en pourcentage du temps pendant lequel la cuisinière solaire est utilisée (Pr).</li> </ul>	<ul style="list-style-type: none"> <li>✓ Les cuiseurs solaires peuvent être classés en type direct et indirect en fonction du mécanisme de transfert de chaleur vers la marmite.</li> <li>✓ Une plus grande utilisation du cuiseur solaire réduit la période de retour sur investissement dans tous les scénarii et augmente la réduction des émissions de CO<sub>2</sub>.</li> <li>✓ La quantité de dioxyde de carbone économisée passe de 30,3 à 60,6 kg/mois, 3027 à 6055 kg/mois, 1998 à 3996 kg/mois et de 454 à 908 kg/mois à la maison, au restaurant, à l'hôtel et au snack respectivement lorsque le Pr augmente de 0,5 à 1.</li> </ul>

<p style="text-align: center;">1.2 Séchage solaire : revue avec des évaluations environnementales</p>	<ul style="list-style-type: none"> <li>➤ Présenter une revue sur le sécheur solaire qui comprend les principaux composants, les classifications et les paramètres affectant les performances ainsi que les avantages, les inconvénients et les limites de cette technologie.</li> <li>➤ Réaliser des études économiques et environnementales pour le cas libanais afin d'évaluer la période de retour sur investissement (PP) et la réduction d'émissions de CO<sub>2</sub> en fonction du pourcentage de temps d'utilisation du séchoir solaire (Pr), de la masse d'aliments séchés et du type d'aliments.</li> </ul>	<ul style="list-style-type: none"> <li>✓ Les séchoirs solaires sont évalués en fonction de trois éléments clés : le mode de circulation de l'air (passif et actif), le mode de transfert de chaleur (direct et indirect, hybride et mixte) et le type de chambre de séchage (armoire, serre et tente).</li> <li>✓ Une plus grande utilisation du séchoir solaire réduit la période de retour sur investissement dans tous les scénarii et augmente la réduction d'émissions de CO<sub>2</sub>.</li> <li>✓ Pour le Pr égal à 0,6, lors du séchage de 120 kg de carottes à l'aide d'un séchoir solaire, le coût économisé (SM) est de 780 \$/mois, PP est de 10 mois et les émissions de CO<sub>2</sub> diminuent de 6400 kg/mois.</li> </ul>
<p style="text-align: center;">1.3 Chauffage solaire de l'eau: vers une utilisation optimale au Liban</p>	<ul style="list-style-type: none"> <li>➤ Présenter une revue des systèmes de chauffage solaire de l'eau (SWHS) qui comprend le principe, les composants et la classification, les études menées sur les SWHS ainsi que les avantages et inconvénients de ces systèmes.</li> <li>➤ Établir un aperçu des problèmes d'électricité au Liban, y compris des études économiques et environnementales.</li> <li>➤ Développer des études pour plusieurs cas libanais (famille et école, restaurant, hôtel et salle de sport) dont le but est d'estimer le coût économisé en utilisant SWHS au lieu du radiateur électrique et sa période de retour sur investissement ainsi que la réduction des émissions de dioxyde de carbone.</li> </ul>	<ul style="list-style-type: none"> <li>✓ Les SWHS peuvent être classés selon la méthode de circulation du flux à l'intérieur du système (entre le réservoir de stockage et le capteur solaire) en systèmes passifs et actifs, et selon le type de capteur solaire utilisé, qu'il s'agisse d'un capteur à plaque plane, d'un capteur à tube sous vide ou collecteur à concentrateur parabolique.</li> <li>✓ Une plus grande utilisation des SWHS diminue la période de retour sur investissement dans tous les scénarii et augmente la réduction d'émissions de CO<sub>2</sub>.</li> <li>✓ Pour une utilisation élevée de SWHS (Pr = 0,9), la durée d'amortissement moyenne du système pour une maison, une école, un restaurant, un hôtel et une salle de sport est respectivement de 14,2 ans, 4,6 ans, 9,2 ans, 4,4 ans et 5,3 ans.</li> <li>✓ La réduction d'émissions annuelle de CO<sub>2</sub> est de 0,16 tonne/personne, 0,016 tonne/élève, 0,04 tonne/service, 0,37 tonne/lit et 0,11 tonne/personne si un SWHS est utilisé respectivement dans la maison, l'école, le restaurant, l'hôtel et la salle de sport.</li> </ul>

<p>1.4 Solaire photovoltaïque : bilan avec étude économique et environnementale sur le Liban</p>	<ul style="list-style-type: none"> <li>➤ Présenter une revue des systèmes et technologies solaires photovoltaïques qui incluent le principe du solaire PV, ses principaux composants ainsi que les types et générations de technologie PV.</li> <li>➤ Mettre en œuvre des mesures économiques et environnementales pour mettre en évidence le rôle vital de l'utilisation des systèmes solaires photovoltaïques pour produire de l'électricité au Liban pour plusieurs scénarii (maison, salle de sport, restaurant et hôtel).</li> </ul>	<ul style="list-style-type: none"> <li>✓ Les systèmes photovoltaïques sont de deux types principaux : les systèmes photovoltaïques connectés au réseau et les systèmes photovoltaïques hors réseau.</li> <li>✓ Les systèmes photovoltaïques peuvent être classés suivant la génération : la première génération est du silicium cristallin, la deuxième génération est basée sur la technologie PV à couche mince, tandis que la troisième génération comprend des technologies telles que la cellule solaire à colorant, la cellule organique et le système photovoltaïque concentré (CPV).</li> <li>✓ Une plus grande utilisation des systèmes PV réduit la période de retour sur investissement dans tous les scénarii et augmente la réduction d'émissions de CO<sub>2</sub>.</li> <li>✓ Pour une utilisation élevée du système PV (Pr = 0,9), la durée d'amortissement du système et le montant annuel de réduction des émissions de CO<sub>2</sub> sont de 16,2 ans et 4,7 tonnes pour la maison, 2,1 ans et 97,7 tonnes pour la salle de sport, 4,1 ans et 154,3 tonnes pour restaurant, et 13,0 ans et 383,2 tonnes pour l'hôtel.</li> </ul>
<p>1.5 Capteurs solaires hybrides photovoltaïques / thermiques : classifications, applications et nouveaux systèmes</p>	<ul style="list-style-type: none"> <li>➤ Etablir une revue sur les capteurs solaires hybrides PVT qui comprend l'histoire des systèmes solaires hybrides PVT, le concept principal, les avantages et les classifications selon différentes manières en plus de l'intégration de générateurs thermoélectriques avec le système PVT.</li> </ul>	<ul style="list-style-type: none"> <li>✓ Le tri PVT est démontré en tenant compte du type de cellule PV, de capteur thermique, de fluide de travail, de vitrage et d'absorbeur thermique.</li> <li>✓ Dans toutes les applications, les performances des systèmes PVT sont meilleures que celles des systèmes thermiques et des systèmes PV fonctionnant seuls. Les systèmes PVT peuvent couvrir l'énergie thermique et électrique requise par la plupart des applications.</li> <li>✓ Le type le plus couramment utilisé est le type intégré de systèmes PVT-TE dans lesquels des TEG sont intégrés à la face arrière de la cellule PV. L'utilisation de TEG sert à augmenter l'efficacité électrique du système et donc l'efficacité globale.</li> </ul>

<p>2. Système hybride photovoltaïque / thermique à concentrateur parabolique : modélisation thermique et analyse paramétrique</p>	<ul style="list-style-type: none"> <li>➤ Suggérer une nouvelle méthodologie pour conduire la modélisation thermique du système hybride photovoltaïque / thermique à concentrateur parabolique, une analogie de la résistance thermique et la simuler en utilisant une procédure itérative.</li> <li>➤ Effectuer une analyse paramétrique pour étudier l'influence de paramètres importants comme le nombre de Reynolds, la longueur du côté du récepteur, la longueur du tube récepteur et l'épaisseur de l'absorbeur sur les performances thermiques et électriques du système.</li> </ul>	<ul style="list-style-type: none"> <li>✓ L'efficacité thermique diminue avec l'augmentation du nombre de Reynolds, elle diminue respectivement de 8,31% et 2,12% dans l'écoulement laminaire et turbulent.</li> <li>✓ L'efficacité thermique augmente d'environ 35% lorsque la longueur du côté récepteur passe de 0,03 m à 0,2 m et de 0,78% lorsque la longueur du tube récepteur augmente de 4 m à 20 m.</li> <li>✓ Le rendement électrique augmente avec l'augmentation du nombre de Reynolds, de 38,25% dans l'écoulement laminaire et de 5,78% dans l'écoulement turbulent.</li> <li>✓ L'efficacité électrique diminue de 10,5% et 2% lorsque la longueur du côté récepteur et la longueur du tube récepteur augmentent, respectivement.</li> <li>✓ L'épaisseur de l'absorbeur n'a aucun effet sur le comportement thermique et électrique du système : les deux rendements restent presque constants (rendement thermique de 56,46% et rendement électrique de 25,34%) avec l'augmentation de l'épaisseur de l'absorbeur de 0,02 m à 0,2 m.</li> </ul>
<p>3. Système hybride photovoltaïque/thermique à concentrateur parabolique : modélisation thermique, études de cas, analyses économiques et environnementales</p>	<ul style="list-style-type: none"> <li>➤ Suggérer une nouvelle méthodologie pour conduire la modélisation thermique du système hybride photovoltaïque/thermique à concentrateur parabolique, une analogie de la résistance thermique et la simuler en utilisant une procédure itérative.</li> <li>➤ Réaliser des études de cas sur trois pays de climats différents que sont le Liban (climat méditerranéen), la France (climat modéré) et les Emirats Arabes Unis (climat chaud) afin d'étudier les performances thermiques et électriques du système.</li> <li>➤ Réaliser des analyses environnementales et économiques pour chaque pays pour construire des conclusions pratiques sur l'importance du système étudié.</li> </ul>	<ul style="list-style-type: none"> <li>✓ La température de sortie la plus élevée parmi les trois cas est de 95°C au Liban, tandis que le rendement thermique le plus élevé est atteint aux EAU (51,1%) et le rendement électrique le plus élevé est de 27,9% en France.</li> <li>✓ La période de retour sur investissement au Liban, en France et aux EAU est de 1,4 ans, 1,6 ans et 1,7 ans respectivement.</li> <li>✓ Le montant annuel des réductions d'émissions de dioxyde de carbone est de 72,9 tonnes, 5,1 tonnes et 71,1 tonnes au Liban, en France et aux Emirats Arabes Unis, respectivement.</li> </ul>

<p>4. Système hybride triple photovoltaïque/thermique/thermoélectrique à concentrateur parabolique : modélisation thermique, études de cas, analyses économiques et environnementales</p>	<ul style="list-style-type: none"> <li>➤ Suggérer une nouvelle méthodologie pour conduire la modélisation thermique du système hybride thermoélectrique photovoltaïque à concentrateur parabolique, une analogie de la résistance thermique et la simuler en utilisant une procédure itérative.</li> <li>➤ Réaliser des études de cas sur trois pays aux climats différents : le Liban (méditerranéen), la France (modéré) et les EAU (chaud) pour étudier les performances du système.</li> <li>➤ Effectuer des analyses économiques et environnementales pour exposer l'importance significative de ce système.</li> </ul>	<ul style="list-style-type: none"> <li>✓ L'énergie totale annuelle produite par le module PV et les TEG est respectivement de 44,7 MWh et 1,8 MWh au Liban, 26,5 MWh et 0,8 MWh en France, 49,2 MWh et 1,9 MWh aux EAU.</li> <li>✓ L'ajout de TEG au système PTPVT permet d'augmenter la puissance électrique en moyenne de 1,8%, 2,2% et 1,4% au Liban, en France et aux Émirats arabes unis respectivement tout en réduisant la puissance thermique en moyenne de 1,9%, 2,1% et 1,7% au Liban, en France et aux EAU respectivement.</li> <li>✓ La période de retour sur investissement du système est de 2,1 ans, 2,4 ans et 2,5 ans au Liban, en France et aux EAU respectivement.</li> <li>✓ Le montant annuel des réductions d'émissions de CO<sub>2</sub> est de 81,4 tonnes, 5,7 tonnes et 79,5 tonnes pour le Liban, la France et les EAU respectivement.</li> </ul>
---	--	--

Enfin, comme perspectives de recherche pour ce travail, nous prévoyons de réaliser une étude dans laquelle les performances du système thermique photovoltaïque commun sont comparées à celles du système photovoltaïque / thermique à concentrateur parabolique (PTPVT) et du système photovoltaïque / thermique / thermoélectrique à concentrateur parabolique (PTPVT-TE). Nous prévoyons également d'ajouter des matériaux à changement de phase (PCM) et d'étudier leur effet sur les performances du système. Des études de cas peuvent être mises en œuvre sur ce système afin de comparer l'influence du climat sur les performances du système (de manière similaire aux chapitres 3 et 4). Par ailleurs, un prototype peut être mis en œuvre pour réaliser des études expérimentales pour étudier et comparer les performances des systèmes cités précédemment afin d'atteindre la conception optimale du système hybride.

## Références

- [1] Statistical Review of World Energy 2020;69 th edit.
- [2] Jacobson MZ, Delucchi MA, Cameron MA, Frew BA. Low-cost solution to the grid reliability problem with 100 % penetration of intermittent wind , water , and solar for all purposes 2015:1–6. doi:10.1073/pnas.1510028112.
- [3] Peng C, Huang Y, Wu Z. Building-integrated photovoltaics ( BIPV ) in architectural design in China. Energy Build 2011;43:3592–8. doi:10.1016/j.enbuild.2011.09.032.
- [4] Browne MC, Norton B, McCormack SJ. Heat retention of a photovoltaic/thermal collector with PCM. Sol Energy 2016;133:533–48. doi:10.1016/j.solener.2016.04.024.
- [5] Brahim T, Jemni A. Economical assessment and applications of photovoltaic/thermal hybrid solar technology: A review. Sol Energy 2017;153:540–61. doi:10.1016/j.solener.2017.05.081.

**Titre :** Systèmes hybrides photovoltaïque / thermique / thermoélectrique à concentrateur parabolique : modélisation thermique, analyse paramétrique et études de cas

**Mots clés :** Énergie solaire, système hybride photovoltaïque / thermique à concentrateur parabolique, système hybride photovoltaïque / thermique / thermoélectrique à concentrateur parabolique.

**Résumé :** Au cours des dernières années, l'énergie solaire a retenu une attention cruciale de la part des chercheurs en raison de son grand potentiel à compenser les carences de production d'énergie. Les recherches et études menées sur l'énergie solaire visent non seulement à optimiser les systèmes d'énergie solaire existants, mais aussi à les combiner pour obtenir des systèmes d'énergie solaire hybrides qui permettent de produire de l'énergie thermique et de générer de l'énergie électrique simultanément. Dans ce contexte, le but de cette étude est d'examiner de manière extensive la littérature liée aux études d'énergie solaire, particulièrement les systèmes hybrides, mais aussi de suggérer de nouveaux systèmes hybrides et d'analyser d'autres systèmes existants en utilisant des modélisations thermiques appropriées ainsi que des analyses paramétriques et études de cas.

En premier lieu, nous présentons une nouvelle méthodologie pour établir un modèle photovoltaïque / thermique à concentrateur

parabolique (PTPVT « Parabolic Trough Photovoltaic/Thermal »). Une analyse paramétrique est réalisée pour étudier les performances du système et l'influence de plusieurs paramètres. Des études de cas sont mises en œuvre dans trois pays différents pour étudier l'effet des conditions climatiques sur les performances du système. En outre, des analyses économiques et environnementales sont menées pour calculer la période de retour sur investissement du système et la réduction des émissions de CO<sub>2</sub> dans les trois pays.

De plus, un système photovoltaïque / thermique / thermoélectrique à concentrateur parabolique (PTPVT-TE « Parabolic Trough Photovoltaic Thermal Thermoelectric ») est décrit, dans lequel une modélisation thermique est développée à l'aide d'une nouvelle méthodologie et des études de cas sont réalisées sur trois pays différents avec des analyses économiques et environnementales.

**Title :** Hybrid Photovoltaic/Parabolic trough thermal/Thermoelectric systems: Thermal modeling, parametric analysis, and case studies

**Keywords:** Solar Energy, PTPVT Solar Hybrid System, PTPVT-TE Solar Hybrid System.

**Abstract:** In recent years, solar energy has gained crucial attention from researchers due to its great potential to compensate for energy deficiencies. Solar energy research and studies aim not only to optimize existing solar energy systems, but also to combine them to obtain hybrid solar energy systems that produce thermal energy and generate electric power simultaneously. In this context, the aim of the present doctoral study is to extensively examine the literature related to solar energy studies, particularly hybrid systems, but also to suggest new hybrid systems and to deeply analyze other existing systems using appropriate thermal modeling as well as parametric analyzes and case studies. It all started with a new<sup>246</sup> methodology to drive a thermal model for the Parabolic Trough Photovoltaic Thermal system

(PTPVT). A parametric analysis is performed to study the performance of the system and the influence of several parameters on it. Case studies are implemented in three different countries to study the effect of climatic conditions on system performance. In addition, economic and environmental analyzes are carried out to calculate the payback period of the system and the amount of CO<sub>2</sub> emissions reduced in the three countries.

In addition, a Parabolic Trough Photovoltaic Thermal Thermoelectric system (PTPVT-TE) is demonstrated where thermal modeling is developed using a new methodology and case studies are performed on three different countries with economic and environmental analyzes.