



**HAL**  
open science

# Low latency radio and visible light communications for autonomous driving

Mohamed Fouzi Boukhalfa

► **To cite this version:**

Mohamed Fouzi Boukhalfa. Low latency radio and visible light communications for autonomous driving. Networking and Internet Architecture [cs.NI]. Sorbonne Université, 2021. English. NNT : 2021SORUS164 . tel-03482163

**HAL Id: tel-03482163**

**<https://theses.hal.science/tel-03482163>**

Submitted on 15 Dec 2021

**HAL** is a multi-disciplinary open access archive for the deposit and dissemination of scientific research documents, whether they are published or not. The documents may come from teaching and research institutions in France or abroad, or from public or private research centers.

L'archive ouverte pluridisciplinaire **HAL**, est destinée au dépôt et à la diffusion de documents scientifiques de niveau recherche, publiés ou non, émanant des établissements d'enseignement et de recherche français ou étrangers, des laboratoires publics ou privés.

---

Sorbonne University  
Ecole Doctorale Informatique, Télécommunications et  
Électronique de Paris

@

Inria - Paris

@

VEDECOM - Versailles



## Thesis Report

TO OBTAIN THE DEGREE OF DOCTEUR D'UNIVERSITÉ

## Subject

***LOW LATENCY RADIO AND VISIBLE LIGHT  
COMMUNICATIONS FOR AUTONOMOUS DRIVING***

PRESENTED BY

**Fouzi BOUKHALFA**

**Thesis Advisor :** Mr Paul Muhlethaler

**Thesis Co-advisors :** Ms Oyunchimeg Shagdar and Mr Mohamed Hadded

**Host teams :** EVA-INRIA Paris and REVECOM-VEDECOM

## Jury

Mr Nadjib Achir - Reviewer - L2TI, University of Paris 13

Ms Kinda Khawam - Reviewer - NGN, University of Versailles

Mr Vania Conan - Examiner - Research Director, Thales Group

Ms Houda Labiod - Examiner - INFRES, Telecom ParisTech

Mr Sidi Mohammed Senouci - Examiner - DRIVE, University of Bourgogne

# Acknowledgments

First of all, I would like to thank Ms. Kinda Khawam and Mr. Nadjib Achir for kindly accepting to review my thesis. Also, my thanks go to the members of the jury for the interest they showed in my research: Mr Vania Conan, Ms. Houda Labiod, and Mr Sidi Mohammed Senouci.

I would like to express my deepest gratitude to my advisor, Mr Paul Muhlethaler, and co-advisor, Mr Mohamed Hadded, for their excellent guidance and their continuous support of my PhD study. I have enjoyed working with them over the last three years. Without their help, advice, and kindness I would not have been able to write this dissertation. They inspired me to do my best to accomplish my goals. They helped me to grow professionally and I learned much from them that will be of the greatest assistance in my future career.

My thanks also go to Ms. Oyunshimeg Shagdard for her great team management, and for giving me continuous, often practical, support throughout my PhD studies. She provided me with much useful scientific advice, and helped me to broaden not only my scientific knowledge, but also my contacts in the field.

I thank Richard James for his support during these three years for helping me to develop my spoken and written skills in English, as well as interesting discussions about the future of vehicle technology.

I would like to thank all the members of my teams (at INRIA and VEDECOM), specially Jeremie Leska, Luis Emmanuel Plascencia, Younes Bouchaala, Ameni Ch-tourou, and Yasuyuki Tanaka, with whom I had such fruitful discussions and who created such a pleasant working atmosphere. I am particularly grateful to Cedric Adjih and Marcelo Dias de Amorim, whose guidance and commitment to my work proved invaluable. Thanks to Agon Memedi & Yakub Abualhoul for sharing with me their expert knowledge in the V-VLC field.

My special thoughts go to my family, especially my parents and grandparents, who instilled in me the virtues of preference, commitment, and relentlessly encouraged me to strive for excellence, and nothing but excellence. This dissertation is dedicated to them.

# Abstract

From the beginning of the automotive industry, the car was long seen as simply another means of transport. Now, inside a vehicle we can listen to music, regulate the temperature, open the windows automatically, charge a smartphone, benefit from acoustic insulation from the noisy outside with a silent electric motor. All this makes the journey more pleasant, but safety applications are still not the main focus. Although vehicles already have a certain number of passive safety systems such as seat belts, air bags, etc, and more recently, cars are being equipped with active safety systems such as Advanced Driver-Assistance Systems (ADAS), these systems remain basic in the sense that they are not connected. The automotive field is currently undergoing a massive transformation, with the car becoming a connected device and efforts are being made to develop automated driving vehicles with sophisticated active safety systems. In this context, Vehicular Ad hoc Networks (VANETs) will play an essential role in the future of the automotive industry, allowing new usages and new services to be offered, the main focus being on their support of safety applications.

Nowadays, the number of road accidents is continuing to increase, and the human losses are becoming more and more considerable. In a connected vehicle, receiving a message within a few milliseconds can be enough to save a life, if the driver receives a Decentralized Environmental Notification Message (DENM) in time. Thus, latency is a very important metric to be taken into account in the design of the new generation of VANETs. Also, for critical applications, the system must be ultra-reliable since any failure may have fatal consequences. For example, augmented perception for autonomous vehicles will be revolutionized by the upcoming technologies for Vehicle-to-Everything (V2X): 5G (The fifth generation) NR (New Radio) & 802.11bd. In fact, the database for autonomous driving, which initially contains information obtained from sensors (radar, camera, etc.), will be completed with information coming from Cooperative Awareness Messages (CAMs) and Collective Perception Messages (CPMs). Thus, the supervision system of the vehicle will be able to react more efficiently to any situation on the road, and maneuver quickly if any unexpected event occurs.

As our highways become increasingly congested, for a better traveling experience, Intelligent Transportation Systems (ITSs) organizations plan to optimize road utilization and traffic management. To address current mobility issues, conventional vehicle systems for traffic flow like Adaptive Cruise Control (ACC) are not sufficient. This ACC system adjusts the vehicle's speed automatically based on information from ve-

---

hicles in front. A more dynamic regulation strategy requires a cooperative system which will provide more information on the positions, speeds and accelerations of neighboring vehicles. Thanks to this cooperative system, new vehicular applications can be established (an example of such a system being Cooperative Adaptive Cruise Control (CACC)). Platooning is one of the best known applications that can enhance road capacity. In fact, by optimizing the distance between vehicles, road infrastructure capacity can increase by over 30%. By using the same concept, the air drag is reduced: researchers have shown that up to 20% of energy can be saved. From a network point of view, reducing the distance between vehicles will make it possible to establish new point-to-point communication links between the vehicles in front and behind, thus providing an opportunity to have a hybrid communication.

The subject of this thesis is vehicular wireless networks and, more precisely, the use of radio transmission and communication by light to improve vehicle safety. The thesis is motivated by the unreliability and scalability issues of the IEEE 802.11p standard. The idea is to move towards new techniques, particularly within future 803.11bd standards, and associate radio transmission with Visible Light Communication (VLC) to allow for hybrid communication.

The first part of the thesis concerns the development of low latency access techniques in vehicular networks within the framework of future standards. The aim of this first part is to propose a Medium Access Control (MAC) layer that is based on the Time Division Multiple Access (TDMA) technique, enhanced with a mechanism that allows nodes to benefit from reliable, low latency access on demand. This part also introduces a special access scheme for high-priority emergency packets, while still ensuring reliable, low latency access. We complete this study by a mathematical analysis of the performance of this scheme, to show its high performances. In addition, we propose an original message forwarding strategy based on a Cross-Layer solution for disseminating Emergency Messages in a multi-hop manner (exploiting the relation between the MAC and network layers).

The second part of the thesis deals with VLC to coordinate maneuvers in vehicular networks. The advantages of wireless communications for platoon control are, among other things, improved chain stability (which consequently improves safety and allows a smaller gap between vehicles), vehicle grouping as well as maneuvering of separation. While the importance of wireless communications to the platoon is well recognized, certain aspects of communications have not been thoroughly investigated in previous projects. One such aspect is the coexistence of VLC with radio vehicular communication technologies in a heterogeneous system to improve the overall performance (each vector of communication compensating for the drawbacks of the other). The idea is to develop an algorithm that selects the radio communication proposed in Part 1, and visible light communication for autonomous driving, based on the state of the radio channel and platoon alignment.

**Key words:** Autonomous & Connected vehicles, Next-generation V2X, VANETs, MAC, TDMA, VLC, Real-time, Low latency, Ultra-reliable.

# Résumé de Thèse

Depuis le début de l'industrie automobile, la voiture a longtemps été considérée comme un simple moyen de transport. Désormais, à l'intérieur d'un véhicule, on peut écouter de la musique, réguler la température, ouvrir les vitres automatiquement, recharger un smartphone, bénéficier d'une isolation acoustique de l'extérieur bruyant avec un moteur électrique silencieux.

Tout cela rend le voyage plus agréable, mais les applications de sécurité ne sont toujours pas au centre des préoccupations. Bien que les véhicules disposent déjà d'un certain nombre de systèmes de sécurité passive tels que ceintures de sécurité, coussins gonflables, etc., et plus récemment, les voitures sont équipées de systèmes de sécurité active tels que les systèmes avancés d'assistance à la conduite ADAS (Advanced Driver Assistance System), ces systèmes restent fondamentaux dans le sens qu'ils ne sont pas connectés. Le domaine de l'automobile subit actuellement une transformation massive; la voiture devenant un appareil connecté et des efforts sont déployés pour développer des véhicules à conduite automatisée dotés de systèmes de sécurité active sophistiqués. Dans ce contexte, les réseaux véhiculaires appelés VANETs (Vehicular Ad hoc Networks) joueront un rôle essentiel dans l'avenir de l'industrie automobile, permettant de proposer de nouveaux usages et de nouveaux services. L'accent étant mis principalement sur la prise en charge des applications de sécurité.

De nos jours, le nombre d'accidents de la route continue d'augmenter et les pertes humaines sont de plus en plus importantes. Dans un véhicule connecté, recevoir un message en quelques millisecondes peut suffire à sauver une vie si le conducteur reçoit à temps un message DENM (Decentralized Environmental Notification Message). Ainsi, la latence est une métrique très importante à prendre en compte dans la conception de la nouvelle génération de VANET.

Aussi, pour les applications critiques, le système doit être ultra-fiable car toute panne peut avoir des conséquences fatales. Par exemple, la perception augmentée pour les véhicules autonomes sera révolutionnée par les technologies à venir pour Véhicule-à-Tout (V2X, Vehicle-to-Everything): 5G NR & 802.11bd. En effet, la base de données pour la conduite autonome, qui contient initialement des informations obtenues à partir de capteurs (radar, caméra, etc.), sera complétée par des informations provenant des messages CAMs (Cooperative Awareness Messages) et des messages de perception collective CPMs (Collective Perception Messages). Ainsi, le système de supervision du véhicule pourra réagir plus efficacement à toute situation sur la route, et manœuvrer rapidement en cas d'événement inattendu.

Alors que nos autoroutes deviennent de plus en plus encombrées, pour une meilleure expérience de voyage, les organisations des ITSs (Intelligent Transportation Systems) prévoient d'optimiser l'utilisation des routes et la gestion du trafic. Pour faire face aux problèmes de mobilité actuels, les systèmes de véhicules conventionnels pour la circulation comme le régulateur de vitesse adaptatif ACC (Adaptive Cruise Control) ne sont pas suffisants. Ce dernier système ajuste automatiquement la vitesse du véhicule en fonction des informations des véhicules qui précèdent. Une stratégie de régulation plus dynamique nécessite un système coopératif qui fournira plus d'informations sur les positions, les vitesses et les accélérations des véhicules voisins. Grâce à ce système coopératif, de nouvelles applications véhiculaires peuvent être établies (un exemple d'un tel système étant le régulateur de vitesse adaptatif coopératif CACC (Cooperative Adaptive Cruise Control)). Le peloton est l'une des applications les plus connues qui peuvent améliorer la capacité routière. En effet, en optimisant la distance entre les véhicules, la capacité des infrastructures routières peut augmenter de plus de 30%. En utilisant le même concept, la traînée de l'air est réduite tel que démontré par les chercheurs qui ont affirmé que jusqu'à 20% d'énergie peut être économisée. D'un point de vue réseau, la réduction de la distance entre les véhicules permettra d'établir de nouvelles liaisons de communication point à point, entre les véhicules à l'avant et à l'arrière, offrant ainsi l'opportunité d'avoir une communication hybride.

Le sujet de cette thèse porte sur les réseaux sans fil véhiculaires et, plus précisément, sur l'utilisation de la transmission radio et de la communication par la lumière pour améliorer la sécurité des véhicules. La thèse est motivée par les problèmes de fiabilité et d'évolutivité de la norme IEEE 802.11p. L'idée est d'évoluer vers de nouvelles techniques, notamment dans les futures normes 803.11bd, et d'associer la transmission radio à la communication en lumière visible (VLC, visible light communication) pour permettre une communication hybride.

La première partie de la thèse concerne le développement de techniques d'accès à faible latence dans les réseaux véhiculaires dans le cadre des futures normes. L'objectif de cette première partie est de proposer une couche MAC (Medium Access Control) basée sur la technique TDMA (Time Division Multiple Access), enrichie d'un mécanisme permettant aux nœuds de bénéficier d'un accès fiable et à faible latence à la demande. Cette partie introduit également un schéma d'accès spécial pour les paquets d'urgence de haute priorité, tout en garantissant un accès fiable et à faible latence. Nous complétons cette étude par une analyse mathématique des performances de ce schéma, pour montrer ses hautes performances. De plus, nous proposons une stratégie originale de transmission de messages basée sur une solution Cross-Layer pour diffuser les messages d'urgence de manière multi-hop (exploitant la relation entre les couches MAC et réseau).

La deuxième partie de la thèse traite de VLC pour coordonner les manœuvres dans les réseaux de véhicules. Les avantages des communications sans fil pour le contrôle des pelotons sont, entre autres, une meilleure stabilité de la chaîne (qui améliore par conséquent la sécurité et permet un plus petit écart entre les véhicules), le regroupement des véhicules ainsi que les manœuvres de séparation. Bien que l'importance des communications sans fil pour le peloton soit bien reconnue, certains aspects des communications n'ont pas été étudiés en profondeur dans les projets précédents. Un de ces aspects est la coexistence de VLC avec les technologies de communication ra-

dio véhiculaire dans un système hétérogène pour améliorer les performances globales (chaque vecteur de communication compensant les inconvénients de l'autre). L'idée est de développer un algorithme qui sélectionne la communication radio proposée dans la partie 1, et la communication en lumière visible pour la conduite autonome, en fonction de l'état du canal radio et de l'alignement du peloton.

**Mots clés:** Véhicules autonomes et connectés, Nouvelle génération de V2X, VANET, MAC, TDMA, VLC, temps réel, faible latence, ultra-fiable.



# Thesis Publications

## Journal Paper

- **Fouzi Boukhalfa**, Mohamed Hadded, Paul Muhlethaler, Oyunchimeg Shagdar, *Performance Evaluation of an Active Signaling based Time-Slot Scheduling Scheme for connected vehicles*, Annals of Telecommunications, Springer, Jan. 2020.

## Conference Papers

- **Fouzi Boukhalfa**, Mohamed Hadded, Paul Muhlethaler, Oyunchimeg Shagdar, *An Active Signaling Mechanism to Reduce Access Collisions in a Distributed TDMA Based MAC Protocol for Vehicular Networks*, The 33rd International Conference on Advanced Information Networking and Applications (AINA-2019), Mar 2019, Kunibiki Messe, Matsue, Japan.
- **Fouzi Boukhalfa**, Mohamed Hadded, Paul Muhlethaler, Oyunchimeg Shagdar, *An Analytical Model for Performance Analysis of an Active Signaling-based TDMA MAC Protocol for Vehicular Networks*, IEEE 90th Vehicular Technology Conference (VTC2019-Fall), Honolulu, Hawaii, USA, Sep. 2019.
- **Fouzi Boukhalfa**, Cedric Adjih, Paul Muhlethaler, Mohamed Hadded and Oyunchimeg Shagdar, *Physical and MAC Layer Design for Active Signaling Schemes in Vehicular Networks*, 16th International Conference on Wireless and Mobile Computing, Networking and Communications (WiMob), Thessaloniki, Greece, pp. 86-92, Oct. 2020.
- **Fouzi Boukhalfa**, Mohamed Hadded, Paul Muhlethaler, Oyunchimeg Shagdar, *Coexistence of IEEE 802.11p and the TDMA-based AS-DTMAC Protocol*, International Conference on Software, Telecommunications and Computer Networks (SoftCOM), Split, Hvar, Croatia, pp. 1-6, Oct. 2020.
- **Fouzi Boukhalfa**, Mohamed Hadded, Paul Muhlethaler, Oyunchimeg Shagdar, *Using visible light links in combination with radio communication in a*

*vehicular network*, 9th IFIP International Conference on Performance Evaluation and Modeling in Wireless Networks (PEMWN), Berlin, Germany, pp. 1-6, Nov. 2020.

- Abir Rebei, Mohamed Hadded, Haifa Touati, **Fouzi Boukhalfa**, Paul Muhlethaler. *MAC-aware Routing Protocols for Vehicular Ad Hoc Networks: A Survey*. In International Conference on Software, Telecommunications and Computer Networks (SoftCOM), pp. 1-6, Sep. 2020.
- Abir Rebei, **Fouzi Boukhalfa**, Haifa Touati, Mohamed Hadded, Paul Muhlethaler, *An Efficient Cross-Layer Design for Multi-hop Broadcast of Emergency Warning Messages in Vehicular Networks*, AINA, Springer, Ryerson University, Toronto, Canada, May 2021.
- **Fouzi Boukhalfa**, Mohamed Hadded, Paul Muhlethaler, *Evaluation of a new Radio Technology and Visible Light Communication for a Platooning Application*, ISNCC, Dubai, UAE, Oct 2021.

# Contents

<b>Table of Contents</b>	<b>ix</b>
<b>List of Figures</b>	<b>xiii</b>
<b>List of Tables</b>	<b>xvii</b>
<b>1 General Introduction</b>	<b>1</b>
1.1 Context and motivation . . . . .	1
1.2 Main contributions . . . . .	3
1.3 Manuscript organization . . . . .	5
<b>I State-of-the-Art</b>	<b>7</b>
<b>2 Vehicular Ad hoc NETWORKS: State-of-the-Art</b>	<b>8</b>
2.1 Motivation and objectives . . . . .	9
2.2 Architectures . . . . .	10
2.3 Main features . . . . .	10
2.4 Main research topics . . . . .	14
2.5 QoS requirements of advanced V2X applications . . . . .	16
2.6 Vehicular Communications Technologies for V2X . . . . .	17
2.6.1 Radio Access Technologies: ITS-G5 . . . . .	17
2.6.2 Vehicular Visible light Communication (V-VLC) . . . . .	21
2.7 Evolution of Communications Technologies for V2X . . . . .	24
2.8 Conclusion . . . . .	25
<b>3 Fundamentals and Background</b>	<b>26</b>
3.1 Introduction . . . . .	27
3.2 Medium Access Control in VANETs . . . . .	27
3.2.1 Contention-based MAC protocols . . . . .	27
3.2.2 Contention-Free MAC protocols . . . . .	28
3.3 Overview of MAC protocols in VANETs . . . . .	30
3.3.1 Single-Channel MAC Protocols . . . . .	30
3.3.2 Multi-Channel MAC Protocols . . . . .	35

3.4	Cross-layer MAC and routing protocols in vehicular networks . . . . .	37
3.5	Hybrid communication . . . . .	41
3.6	Conclusion . . . . .	44
 <b>II Low Latency Radio Communication</b>		<b>45</b>
<b>4</b>	<b>New distributed TDMA based MAC protocol for vehicular networks</b>	<b>46</b>
4.1	Introduction . . . . .	47
4.2	Active signaling-based DTMAC protocol (AS-DTMAC) . . . . .	47
4.2.1	Hypotheses . . . . .	47
4.2.2	Slot scheduling principle of AS-DTMAC . . . . .	49
4.3	Simulation results and performance evaluation . . . . .	50
4.3.1	Simulation scenarios and parameters . . . . .	50
4.3.2	Simulation results . . . . .	51
4.3.2.1	Best length of the signaling interval . . . . .	52
4.3.2.2	Comparison of DTMAC and AS-DTMAC . . . . .	53
4.4	Analytical evaluation and simulation results validation . . . . .	57
4.4.1	Homogeneous arrival . . . . .	57
4.4.2	Bursts of traffic . . . . .	61
4.4.3	Analysis of the convergence speed to steady-state . . . . .	63
4.4.3.1	DTMAC with active signaling . . . . .	63
4.4.3.2	DTMAC alone . . . . .	64
4.5	Conclusion . . . . .	64
<b>5</b>	<b>Physical and MAC Layer Design for Active Signaling Schemes in Vehicular Networks</b>	<b>67</b>
5.1	Introduction . . . . .	68
5.2	Background and motivation . . . . .	68
5.3	AS-DTMAC with Homogeneous arrival and error in the signaling process mechanism . . . . .	69
5.4	Handling Emergency traffic in AS-DTMAC . . . . .	75
5.5	Evaluation of missed detection for an active signaling mechanism . . . . .	76
5.5.1	OFDM preamble . . . . .	76
5.5.2	Signal detection strategy . . . . .	76
5.5.2.1	Signal detection statistics . . . . .	77
5.5.2.2	Hypothesis Testing . . . . .	79
5.5.3	Simulation results . . . . .	81
5.5.3.1	Performance analysis of GLRT . . . . .	81
5.5.3.2	Application to AS-DTMAC . . . . .	83
5.6	Conclusion . . . . .	87
<b>6</b>	<b>Coexistence of IEEE 802.11p and the TDMA-based AS-DTMAC Protocol</b>	<b>89</b>
6.1	Introduction . . . . .	90
6.2	Coexistence of AS-DTMAC and IEEE 802.11p . . . . .	91

6.2.1	Behavior of the two protocols in coexistence mode . . . . .	91
6.2.2	Interaction of IEEE 802.11p in the AS-DTMAC selection process	92
6.2.3	Waiting time for AS-DTMAC after the beginning of an IEEE 802.11p transmission . . . . .	93
6.3	Results . . . . .	95
6.4	Conclusion . . . . .	96
<b>7</b>	<b>An Efficient Cross-Layer Design for Multi-hop Broadcast of Emer- gency Warning Messages in Vehicular Networks</b>	<b>99</b>
7.1	Introduction and motivation . . . . .	100
7.2	Cross-Layer solution for emergency messages multi-hop dissemination	100
7.2.1	MAC Strategy . . . . .	101
7.2.2	Forwarding Strategy . . . . .	103
7.3	Performance evaluation . . . . .	104
7.4	Conclusion . . . . .	111
<b>III</b>	<b>Vehicular Hybrid Communication</b>	<b>112</b>
<b>8</b>	<b>Evaluation of a new Radio Technology and Visible Light Communi- cation for a Platooning Application</b>	<b>113</b>
8.1	Introduction and motivation . . . . .	114
8.2	Performance analysis of AS-DTMAC for platooning control . . . . .	115
8.3	Simulation results . . . . .	120
8.3.1	V-VLC performance with the presence of interference . . . . .	121
8.3.2	Performance comparison between V-VLC and RF . . . . .	122
8.4	Conclusion . . . . .	125
<b>9</b>	<b>Using visible light links in combination with radio communication in a vehicular network</b>	<b>126</b>
9.1	Introduction . . . . .	127
9.2	Background and motivation . . . . .	127
9.3	Switching from radio transmission to VLC transmission . . . . .	129
9.4	Performance of the network when the VLC is used . . . . .	130
9.4.1	Gain in bandwidth . . . . .	130
9.4.2	Gain in access collision probability for the radio access . . . . .	133
9.4.3	Gain in reliability when the radio and the VLC links are used in combination . . . . .	135
9.5	Conclusion . . . . .	135
<b>10</b>	<b>Conclusion and Perspectives</b>	<b>137</b>
10.1	Synthesis . . . . .	137
10.2	Perspectives . . . . .	139
	<b>Appendix</b>	<b>140</b>

<b>11 Introduction générale</b>	<b>141</b>
11.1 Contexte et motivation . . . . .	141
11.2 Principales contributions . . . . .	143
11.3 Organisation du manuscrit . . . . .	145
<b>Bibliography</b>	<b>147</b>

# List of Figures

2.1	Example of V2X use cases in urban scenarios . . . . .	9
2.2	Hybrid architecture of a VANET with the relevant use cases (taken from the German project ConVeX:Deliverable D3.1) . . . . .	11
2.3	Complex intersection with several non-connected vehicles and pedestrians. . . . .	13
2.4	Motorway entrance assistance by using MCM messages. . . . .	13
2.5	Lane changing assistance use case using MCM . . . . .	14
2.6	VANET research topics: MAC and Physical layers (MAC-PHY), Complementary services (SERV), Routing protocols (ROUT), Data management (DATA), Tools and experimental platforms (TOOLS), Performance comparison analyses (PERF), Applications (APP), Mobility issues (MOB). . . . .	15
2.7	QoS requirements of the most advanced applications for connected and autonomous vehicles (from [8]) . . . . .	17
2.8	ITS-G5 stack architecture [130] . . . . .	18
2.9	ITS-G5 spectrum band and channels in Europe & USA . . . . .	18
2.10	New spectrum band channels reallocation for V2X in Europe & USA . . . . .	19
2.11	PLCP preamble training sequence in the 802.11p standard . . . . .	20
2.12	PPDU frame format of ITS-G5 . . . . .	20
2.13	Vehicle LED-based light . . . . .	22
2.14	A LOS & NLOS V-VLC scenario . . . . .	22
3.1	Channel access time for CCHI and SCHI in IEEE 802.11p standard . . . . .	28
3.2	Protocols operating on a fully distributed VANET . . . . .	29
3.3	Protocols operating on a centralized topology. . . . .	29
3.4	Protocols operating on a cluster-based topology . . . . .	30
3.5	Access collision problem . . . . .	31
3.6	Merging collision problem . . . . .	31
3.7	Classification of single-channel MAC protocols for VANETs . . . . .	34
3.8	Classification of multi-channel MAC protocols for VANETs . . . . .	38
3.9	Communication strategy based on RF-VLC . . . . .	43
3.10	Communication strategy based on one communication technology . . . . .	43

4.1	TDMA slots scheduling principle. . . . .	48
4.2	DTMAC protocol principle (FI Frame Information) . . . . .	48
4.3	Slot structure of the Active Signaling mechanism . . . . .	49
4.4	Active signaling . . . . .	50
4.5	Simulation framework. . . . .	51
4.6	VANET network topology captured from Google MAP. . . . .	51
4.7	Average access time versus the number of mini slots . . . . .	53
4.8	The overhead in bytes versus the number of mini slots . . . . .	54
4.9	Access collision versus the number of bits of the transmission key . . . . .	54
4.10	Number of vehicles acquiring a time slot within $N$ frames. . . . .	55
4.11	Access collision versus channel occupancy for DTMAC and AS-DTMAC with error bar (95% confidence interval). . . . .	56
4.12	Average access time versus channel occupancy for DTMAC and AS-DTMAC with error bar (95% confidence interval). . . . .	56
4.13	Collision probability versus channel load. . . . .	60
4.14	Collision probability versus channel load. . . . .	60
4.15	Cumulative distribution function of the number of slots required for the 10 urgent packets. . . . .	62
4.16	Convergence towards the steady state, $\lambda = 0.96$ . . . . .	65
5.1	Collision probability with error in detecting the signaling burst $\epsilon_1 = 0.01, 0.02, 0.05$ (missed detection). . . . .	72
5.2	Collision probability with error in detecting the signaling burst $\epsilon_1 = 0.01, 0.02, 0.05$ (missed detection). . . . .	72
5.3	TBD. Collision probability with error in detecting the signaling burst $\epsilon_2 = 0.01, 0.02, 0.05$ ( $\epsilon_1 = 0.0$ ). . . . .	73
5.4	TBD. Collision probability with error in detecting the signaling burst $\epsilon_2 = 0.01, 0.02, 0.05$ ( $\epsilon_1 = 0.0$ ). . . . .	73
5.5	Probability that the selection process for a non-empty slot ends up with a successful transmission for different values of $\epsilon_1$ and $\epsilon_2$ . . . . .	74
5.6	Probability that the selection process for a non-empty slot ends up with a successful transmission for different values of $\epsilon_1$ and $\epsilon_2$ , <b>simulation results</b> . . . . .	75
5.7	Three short preambles (real part). . . . .	77
5.8	Hypothesis testing for OFDM symbol detection: Empirical Probability Distribution Function (EPDF) histogram under $H_0$ and $H_1$ . $C$ is the correlation variable at the matched filter output. . . . .	78
5.9	Estimation of amplitude by minimization . . . . .	80
5.10	6. Block diagram of the Monte Carlo simulation algorithm to estimate the detection error. . . . .	81
5.11	ROC curves for different SNR values . . . . .	82
5.12	The probability of miss-detection $P_{md}$ in function of the SNR. . . . .	83
5.13	Performance of GLRT against ED . . . . .	84
5.14	Receiver detection and sensitivity area . . . . .	85
5.15	Impact of burst size on the access collision rate . . . . .	85
5.16	Impact of SNR on the access collision . . . . .	86



5.17	Impact of $P_{fa}$ on the access collision . . . . .	87
6.1	Coexistence scenario of AS-DTMAC with IEEE 802.11p . . . . .	90
6.2	Distribution function of the busy period $Pb(X > t)$ for $\lambda = 0.2$ , $t$ is in time unit ( $u$ ). . . . .	95
6.3	Distribution of the busy period $Pb(X > t)$ for $\lambda = 0.4$ , $t$ is in time unit ( $u$ ). . . . .	96
6.4	Distribution of the busy period $Pb(X > t)$ for $\lambda = 0.6$ , $t$ is in time unit ( $u$ ). . . . .	97
6.5	Distribution of the busy period $Pb(X > t)$ for $\lambda = 0.8$ , $t$ is in time unit ( $u$ ). . . . .	97
6.6	Average waiting time for an AS-DTMAC packet . . . . .	98
7.1	AS-DTMAC Multihop Architecture. . . . .	101
7.2	AS-DTMAC Multihop Frame. . . . .	102
7.3	Forwarding Strategy Flowchart. . . . .	103
7.4	Forwarding Strategy. . . . .	104
7.5	Latency versus channel occupancy for AS-DTMAC Multi-hop and Flooding with $SSD=20$ and error bar (95% confidence interval). . . . .	105
7.6	Latency versus channel occupancy for AS-DTMAC Multi-hop and Flooding with $SSD=30$ and error bar (95% confidence interval). . . . .	106
7.7	Packet Loss versus channel occupancy for AS-DTMAC Multi-hop and Flooding with error bar (95% confidence interval). . . . .	106
7.8	Number of forwarders versus channel occupancy for AS-DTMAC Multi-hop and Flooding with $SSD=20$ and error bar (95% confidence interval). . . . .	107
7.9	Number of forwarders versus channel occupancy for AS-DTMAC Multi-hop and Flooding with $SSD=30$ and error bar (95% confidence interval). . . . .	108
7.10	Used Bandwidth versus channel occupancy for AS-DTMAC Multi-hop and Flooding with $SSD=20$ and error bar (95% confidence interval). . . . .	108
7.11	Used Bandwidth versus channel occupancy for AS-DTMAC Multi-hop and Flooding with $SSD=30$ and error bar (95% confidence interval). . . . .	109
7.12	Message propagation based on TDMA slot information. . . . .	110
7.13	Estimated Delay versus distance for AS-DTMAC Multi-hop and Flooding with $SSD=30$ and error bar (95% confidence interval). . . . .	110
8.1	Platoon scenario with RF based on AS-DTMAC . . . . .	116
8.2	Probability of a platoon of 10 vehicles completely reserved before slot $N+1$ . . . . .	117
8.3	Probability of detecting & decoding versus RX-TX vehicle inter-distance . . . . .	118
8.4	Probability of detecting & decoding versus Rayleigh-fading variance $\sigma$ . . . . .	119
8.5	Probability of detecting & decoding versus the path loss exponent $\gamma$ . . . . .	119
8.6	Summary of the integration of the empirical model in VEINS-VLC (the images were taken from [110]): the measurements were done at the HELLA's Lichtkanal company in a light channel room of dimension $145m \times 11m$ . For the emissions, a real pair of headlights module was used, whereas the receiver side uses two PDs of type PDA100A placed at the same level as the license plate and the tail lights. . . . .	120

8.7	A highway scenario with a platoon in the lower lane, the other lanes are for connecting vehicles. . . . .	121
8.8	V-VLC PDR versus number of disturbing vehicles: Simulation time = 116s; platoon size = 8; platoon inter-vehicle distance = 10 m; Disturbing vehicles' speed = 100 km/h ; Platoon vehicles' speed = 15 km/h. . . . .	122
8.9	V-VLC PDR versus disturbing vehicle speed: Simulation time = 208s; platoon size = 8; platoon inter-vehicle distance = 10 m; Disturbing vehicles' speed = 100 km/h; Platoon vehicles' speed = 15 km/h; Headlight module = "HbSedan2". . . . .	123
8.10	V-VLC PDR versus platooning vehicle inter-distance: Simulation time = 116 s; platoon size = 8; Platoon vehicles' speed = 15 km/h; Disturbing vehicles' speed = 100 km/h; Headlight module = "HbSedan2".	123
8.11	V-VLC delay versus platoon beacon packet length . . . . .	124
8.12	V-VLC and RF PDR versus number of disturbing vehicles . . . . .	125
9.1	Switch to the VLC link . . . . .	130
9.2	Algorithm to switch from the radio to the VLC link . . . . .	131
9.3	Percentage in channel load versus percentage of vehicles with VLC modems . . . . .	132
9.4	Channel load used versus vehicle inter-distance for different percentages of vehicles with VLC modems . . . . .	132
9.5	Channel access collision versus percentage of vehicles with VLC modems	134
9.6	Channel load used versus vehicle inter-distance for different percentages of vehicles with VLC modems . . . . .	134
9.7	Packet error rate versus percentage of vehicles with VLC modems . . .	135

# List of Tables

2.1	The design requirements of each vehicular radio access technology for V2X . . . . .	25
3.1	Comparison of single-channel MAC Protocols . . . . .	34
3.2	Comparison of multi-channel MAC Protocols . . . . .	38
3.3	Qualitative comparison of cross layer routing protocols . . . . .	42
4.1	<i>Simulation parameters</i> . . . . .	52
4.2	Different phases of the selection process . . . . .	59
8.1	<i>Simulation parameters</i> . . . . .	121

# General Introduction

## 1.1 Context and motivation

Vehicular Adhoc NETWORKS (VANETs) have received considerable attention both in academic communities and industrial companies [1]. They aim to establish communication and collaboration between vehicles, and a number of safety, commercial and entertainment applications [1] have been developed. With the coming of autonomous driving, future networks will need to enable real-time services with immediate reaction to enhance safety. These applications must satisfy specific and stringent Quality of service (QoS) and safety requirements. To meet these requirements, efficient Medium Access Control (MAC) protocols must be developed in order to handle network access and transmission with minimum packet loss [2].

The channel access control is of prime importance for the performance of VANETs. As in traditional ad hoc networks, MAC protocols in VANET are classified according to the control scheme used to access the channel, namely: contention-based and contention-free. In contention-based protocols, the vehicles randomly access the channel when they need to transmit. This kind of protocol allows multiple access to the channel based on channel sensing [2]. But, for critical-applications, the lack of reliability of the broadcast mechanism means that the transmission of safety messages with bounded access delay is very challenging. For instance, this is true for the emerging standard in VANETs: IEEE802.11p [3], which uses a random algorithm based on both Enhanced Distributed Channel Access (EDCA) and Carrier Sense Multiple Access with Collision Avoidance (CSMA/CA) mechanisms. In the second category (i.e, contention free), only one vehicle in a two-hop neighborhood set is authorized to access the channel at a given time, which reduces the risk of collision. Hence, this

category of protocols is more suitable to manage real-time applications in VANETs as it can provide a bounded access delay and reliable communication for safety applications. Over the last few years, contention-free MAC protocols have remained one of the emerging areas of research and represent the majority of MAC protocols proposed in this field [4].

However, these schemes can suffer from access collision problem which occurs when two or more vehicles within the same two-hop neighborhood set attempt to access the same available time slot, a problem which is likely to happen when a distributed scheme is used [5] and merging collision problem which occurs when two vehicles in different two-hop sets accessing the same time slot become members of the same two-hop set due to changes in their position. Consequently all the contributions tend to focus on these problems which occur particularly in mobility scenario.

We believe that the **AS-DTMAC** protocol we introduced in [6] is the first protocol for VANETs which deeply intertwines an advanced random access scheme and a Time Division Multiple Access (TDMA) scheme for VANETs. AS-DTMAC shows the advantages of TDMA in the sense that when a slot is acquired by a vehicle this slot can be re-used synchronously and the transmissions do not suffer from the hidden-node problem as in IEEE 802.11p. In the same time, AS-TDMAC can offer a low latency access to urgent packets, property usually only devoted to random access techniques.

To satisfy the requirements of future safety applications, vehicular networks must show better performances than those achieved on existing networks; in particular, they require very low end-to-end latency, which can be less than 1ms, and a high transmission rate for huge data exchange. In addition, some use cases require ultra-reliability of 99.99% [8]. In order to succeed in designing low-latency and ultra-reliable communications, an additional vector of communications is needed since, in fact, the Radio Frequency (RF) presented above is not always sufficient. If there is a very high number of nodes, it is possible to reach the full capacity of the channel and some nodes will be unable to communicate with the rest of the network. Vehicular Visible Light Communication (V-VLC) is now a technology that has the potential to assist RF communication. However, V-VLC in an outdoor environment faces a number of challenges, due to mobility, weather conditions and ambient light. On the other hand, it provides a large free spectrum with a relatively low cost as the Emitting Diodes (LED) already embedded in modern light vehicular systems [9].

## 1.2 Main contributions

The main contributions of this thesis are summarized below:

1. **Contribution 1: An Active Signaling Mechanism to Reduce Access Collisions in a Distributed TDMA-Based MAC Protocol for Vehicular Networks**

A MAC layer based on a Time Division Multiple Access scheme is one of the most efficient ways to guarantee real-time communication. In this first contribution, we propose a new MAC protocol for vehicular networks, called **AS-DTMAC**, which operates on a fully distributed and location-based TDMA, strengthened by active signaling as a mechanism to prevent access collisions (this kind of collision is one of the main drawbacks of TDMA schemes in mobility scenarios). The simulation results show that AS-DTMAC can provide a low latency access with a priority scheme for urgent packets.

2. **Contribution 2: The development of an analytical model to analyze the performance of AS-DTMAC.**

The aim of this second contribution is to provide a complete mathematical analysis of the performance of the AS-DTMAC protocol, in order to confirm its high performances and to validate these results using simulations. This mathematical tool is based on generating functions that allow us to estimate the residual collision rate. Three cases are studied: homogeneous arrival, bursts of traffic, and analysis of the convergence speed to the steady-state.

3. **Contribution 3: Physical and MAC Layer Design for Active Signaling Schemes in Vehicular Networks**

When vehicles compete for a slot, it is possible that an error occurs. As active signaling is based on burst transmissions, depending on the channel conditions, the receiver may miss this short signal or, in the worst case, detect a false alarm. As a first study, we provide a complete analysis of the impact of these two kinds of error on the access collision rate by using the previous analytical model. Secondly, we evaluate the errors at the physical layer level. The proposed model is based on the Generalized Likelihood Ratio Test (GLRT) detection algorithm. This study helps us to fix the duration of the mini-slot in accordance with the access collision rate and other parameters related to the physical layer, leading to an important gain in the throughput compared with previous studies.

#### 4. **Contribution 4: Coexistence of IEEE 802.11p and the TDMA-based AS-DTMAC Protocol**

This contribution is motivated by the coming of the new vehicular DSRC standard IEEE 802.11bd. The evolution of IEEE 802.11 has been under development by the IEEE Task Group (TGbd) since Jan. 2019 and is expected to be published in 2021. The new design must show improved performances and coexistence with the previous technology to guarantee communication with the already deployed 802.11p nodes on our roads. Here, We provide a complete analysis to show that AS-DTMAC and CSMA/CA can operate simultaneously in the same scenario. We consider three cases: the general behavior of the two protocols when they coexist, the possible interaction in the AS-DTMAC selection process and, finally, the waiting time of AS-DTMAC after the beginning of an IEEE 802.11p transmission.

#### 5. **Contribution 5: An Efficient Cross-Layer Design for Multi-hop Broadcast of Emergency Warning Messages in Vehicular Networks**

The active signaling mechanism has shown its ability to prevent collisions when users are trying to access the same resource. In this part of the thesis, we propose an original message forwarding strategy based on the active signaling mechanism called **AS-DTMAC**, this new algorithm sets up the route from the source to other nodes with the best path possible. This new strategy minimizes the access delay and the number of relay nodes.

#### 6. **Contribution 6: Evaluation of a new Radio Technology and Visible Light Communication for a Platooning Application**

Controlling the platooning needs very high reliability communication; in some scenarios this can not be assured by only one wireless technology. Vehicular visible light communication is a promising technology which can lighten the load on the radio by freeing up bandwidth. This contribution aims to study the performance of each technology with regard to the Quality of Service (QoS) requirements of the platooning application.

#### 7. **Contribution 7: Using visible light links in combination with radio communication in a vehicular network**

This contribution describes our hybrid communication architecture which uses the radio technology developed in the first part of this thesis and visible light

communication. Our goal is to propose a reliable communication that responds to the requirements of the platooning application and reduces the load on the radio channel. The performance of the network when VLC is used is shown in terms of gain in bandwidth, gain in access collision probability for the radio access and gain in reliability when the radio and the VLC links are used in combination.

## 1.3 Manuscript organization

This chapter has introduced the context and the motivation of this first part of thesis and has outlined our contributions. The rest of this thesis is structured into three distinct parts: State-of-the-art, Low latency Radio communication, and Vehicular hybrid communication. The content is presented in eight chapters, following a logical progression between each.

The state-of-the-art contains two chapters, the first one starts from the general definition of a vehicular network, then the motivation behind this kind of network and its features. We also introduce the most common communication technologies used in the vehicular field, as well as their respective evolutions under the new standards. The second chapter concerns medium access control, cross-layer, and hybrid communication for platooning control in VANETs: this section presents the different approaches used to design efficient MAC and Cross-layer protocols and their classifications. We also identify and list the most interesting approaches for hybrid platooning control in the literature and provide a critical review.

The second part (i.e. Low latency Radio communication) contains four chapters that describe the design of a new radio access technique. We define (in Chapter 4) the specification of the background protocol used in our new MAC solution, introduce the active signaling technique and the proposed protocol. We also build a special access scheme for emergency messages. We then present our simulation studies that evaluate and compare the proposed **AS-DTMAC** protocol. After that, we develop an analytical model to analyze AS-DTMAC based on a generating function. We study the performance in terms of collision rate, the number of time frames needed to obtain a collision-free slot for all the vehicles, and the transmission conditions of urgent packets. In Chapter 5, we state which errors can occur during the active signaling competition to obtain the slot, and their impact on the access collision rate.



We then propose a physical model to evaluate the errors. This study will help us to fix the duration of a mini-slot in order to optimize the throughput.

Chapter 6 addresses the issue of the coexistence of our new MAC solution with the standard based on CSMA/CA. The objective of this study is to show that our new radio solution is completely suitable for a new standard proposal. Chapter 7 focuses on the design of a novel TDMA-aware Routing Protocol scheme for Multi-hop communication, named **AS-DTMAC multi-hop**. We complete our low-latency access solution by designing an efficient routing scheme to deliver emergency messages over long distances. Our routing scheme is based on a cross-layer approach between the MAC and the routing layers, in which the intermediate vehicles are selected using TDMA scheduling information.

The third part of this thesis moves toward the design of hybrid vehicular networks. It contains two chapters (i.e. Chapter 7 and Chapter 8), The idea is to add V-VLC to assist the radio communication developed in the first part of this thesis. In the first part, we analyse the capacity of the new radio to support platooning application, and we evaluate the communication loss on the two media to determine if light links are sufficiently stable to be used instead of the radio links or whether to use both communication links to improve the overall reliability. In the second part, we study how these two technologies can be combined. Two modes of communication are proposed: a redundant mode, which uses RF and VLC at the same time in order to enhance reliability, and a singular mode which will exploit only V-VLC to manage a platoon, thus enabling a significant gain in the radio bandwidth. We also build a simple switching protocol to enable the communication with VLC by grouping the vehicles with VLC capacity in one platoon.

Finally Chapter 10 concludes this thesis by summarizing our main contributions and key results and then presents our future work and open research issues regarding the integration of these new solutions and their proposal to the vehicular IEEE 802 standard.

# Part I

## State-of-the-Art

# Chapter 2

## Vehicular Ad hoc NETWORKS: State-of-the-Art

### Contents

---

<b>2.1</b>	<b>Motivation and objectives . . . . .</b>	<b>9</b>
<b>2.2</b>	<b>Architectures . . . . .</b>	<b>10</b>
<b>2.3</b>	<b>Main features . . . . .</b>	<b>10</b>
<b>2.4</b>	<b>Main research topics . . . . .</b>	<b>14</b>
<b>2.5</b>	<b>QoS requirements of advanced V2X applications . . . . .</b>	<b>16</b>
<b>2.6</b>	<b>Vehicular Communications Technologies for V2X . . . . .</b>	<b>17</b>
2.6.1	Radio Access Technologies: ITS-G5 . . . . .	17
2.6.2	Vehicular Visible light Communication (V-VLC) . . . . .	21
<b>2.7</b>	<b>Evolution of Communications Technologies for V2X . . . . .</b>	<b>24</b>
<b>2.8</b>	<b>Conclusion . . . . .</b>	<b>25</b>

---

## 2.1 Motivation and objectives

Vehicular Ad hoc Networks (VANETs) are composed of continuously moving nodes that are connected together by wireless links. VANETs do not need an infrastructure, which is why they are considered as a subclass of Mobile Ad hoc Networks (MANETs). To be connected to this network, vehicles must be equipped with On Board Units (OBUs), infrastructures must be equipped with Road Side Units (RSUs), and recently, to involve all kinds of road users, pedestrians can be connected using a specific application on their cell phones. All this equipment enables a variety of communication scenarios known as Vehicle-to-everything communication (V2X). Figure 2.1 shows some V2X use cases in an urban scenario. Connected vehicles can have three wireless technologies dedicated to vehicular networks: two radio access techniques, one for short-range communication and the other for long-range communication, and the third is visible light technology.

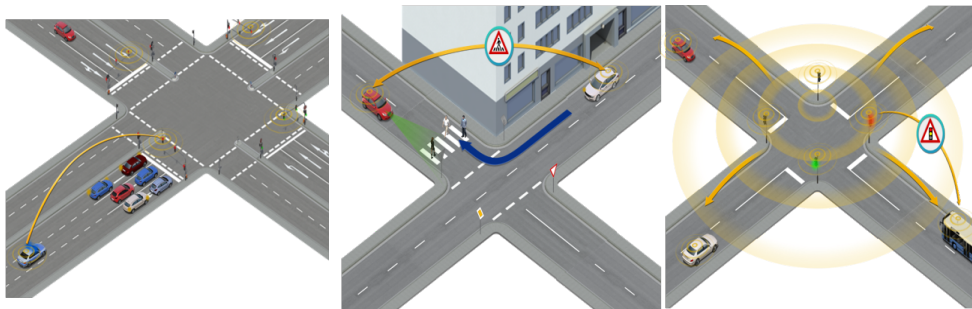

Figure 2.1: Example of V2X use cases in urban scenarios

VANET networks are intended to meet the aim of governments of various countries (in Europe, the USA and Japan, etc.) to achieve zero traffic accidents (no deaths or serious injuries on roads) and to ease traffic congestion. The ultimate goal of each region is to accelerate V2X deployment as typical ITS for safety. VANETs also support a variety of other applications, including those for intelligent navigation and entertainment. The coming of autonomous driving raises a number of challenges that involve a real evolution of the performance of the current network in terms of reliability, latency and throughput.

## 2.2 Architectures

The realization of the smart city project can not be done without using communication technologies to improve the quality of urban road services and reduce their costs. In this section, we describe the system architecture of VANETs. Then, in the next two sections, we summarize their main features and we specify the research issues involved.

In the literature, VANET systems are divided into three domains [98]. The first domain is Ad hoc, which includes the mobile nodes (vehicles) equipped with OBUs and application units (AUs) that are used to run the Internet and the applications supplied by the provider. These AUs are generally merged with the OBUs or connected to it (with a wired or a wireless connection). The Ad hoc domain also includes the mobile device domain (smartphones, smartwatches). The second domain is the infrastructure domain (RSU, Hot spot (HS), infrastructure management centers, vehicle management centers). The third domain is the generic domain (Internet infrastructure domains, private infrastructure domains) [99]. Figure 2.2 shows the architecture of a VANET with all its domains and the relevant technologies (ITS-G5 and C-V2X). Direct communication (Vehicle-to-Infrastructure (V2I), Vehicle-to-Vehicle (V2V), and Vehicle-to-Person (V2P)) passes through PC5<sup>1</sup> (ProSe Communication reference point 5). Vehicles also have the possibility to use ITS-G5 for short communications.

Examples of connected RSUs in the infrastructures can be traffic lights or connected road panels. The infrastructures exchange information directly or in a multihop manner. Vehicles can access the Internet via an HS or an RSU (through a gateway) in cities, or by using their own cellular radio networks (4G (The fourth-generation)/ 5G (The fifth generation) NR (New Radio) [133]) in the countryside.

## 2.3 Main features

The following list enumerates the main characteristics of this kind of network:

- **Self-organizing:** this characteristic was inherited from the MANET network (as VANETs are a subclass of MANETs). Vehicles do not need support from

---

<sup>1</sup>PC5 interface enables the direct communications mode of C-V2X. It uses RF sidelink dedicated to safety applications of the vehicles. With this mode the User Equipment (UE) can directly communicate with another UE over the direct channel [132]

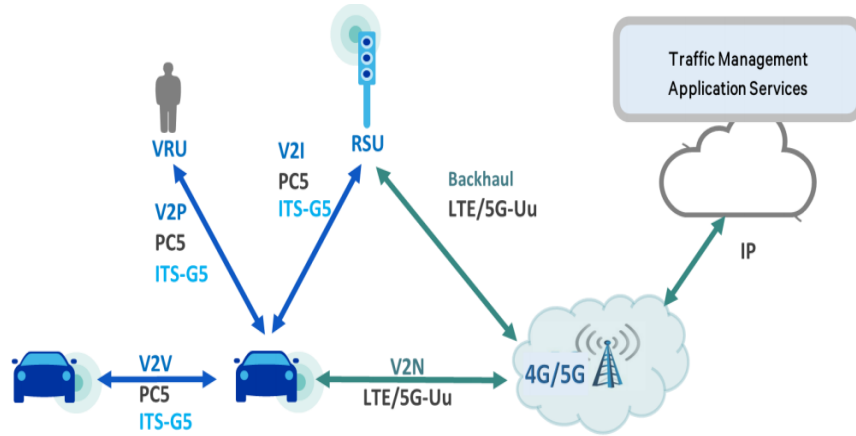

Figure 2.2: Hybrid architecture of a VANET with the relevant use cases (taken from the German project ConVeX:Deliverable D3.1)

any centralized authority (RSU, base station) for self-organization, as they are able to self organize.

- **Mobility:** the nodes of vehicular network present a wide range of movement speeds which are very high compared with other wireless networks (for instance, vehicles can have a speed on highways that can reach up to 120km/h or even higher). However, nodes have a limited trajectory as they are restricted to public roads, unlike traditional wireless networks (and road maps are available).
- **Small inter-contact times:** time to get inter-contact between vehicles is very small, especially when vehicles are traveling in opposite directions (a few ms). Thus, there is a delay constraint on the speed of data transmission (data must be fast so as to reach vehicles with high and constant speeds).
- **Topology:** due to mobility, the topology is dynamic in nature, and can change from one second to another. It is possible that at one moment a vehicle has a neighborhood in which it can communicate and a second later, it does not.
- **Energy:** the main issue of MANETs and wireless sensor networks is the battery that powers the devices and thus, they have to consume as little energy as possible when transmitting, listening, and processing information. However, energy is not an issue in VANETs, because vehicles can rely on energy coming from the battery of the vehicle, which is enough to transmit a message to another vehicle. Consequently, they can be equipped with more processing

power, storage, and energy than handhelds because there is no restriction on the energy consumed.

- **Bandwidth:** the bandwidth available for communication for VANETs is very small, and therefore it must be used efficiently.
- **Varying environment and density:** Vehicles operate in different areas: urban, rural, and on highways. It is not possible to anticipate the number of vehicles, sometimes there is a large number (like on a congested highway) and sometimes there is not much traffic on the road. The density of vehicles is dynamic and variable.
- **Network fragmentation:** VANETs can undergo frequent periods of disconnection. This is especially true when the traffic density is low: a vehicle may be alone in its neighborhood and thus it will not be able to communicate continuously. This transition period of connectivity loss depends on the movement and speed of the vehicles, and the availability of the connected infrastructure. This characteristic means that the vehicles are not always connected to the network.
- **Cybersecurity:** the data exchanged between Connected & Autonomous Vehicles are very sensitive. Any malicious action can lead to a dangerous situation on the road. The deployment of VANETs raises a number of high security challenges for researchers.
- **Several types of messages:** depending on the application, V2X includes critical services messages such as CAMs (Cooperative Awareness Messages)/DENMs (Decentralized Environmental Notification Messages) by ETSI, Collective Perception Messages (CPMs), Manoeuvre Coordination Messages (MCMs), messages for platooning CACCs, and messages for vulnerable Road Users (VRUs). Connected vehicles are continuously exchanging information about speed, heading and acceleration, etc. with the neighborhood by sending CAMs; if a dangerous situation is detected a DENM is sent. The use of CPMs allows vehicles to be aware of objects that they can not see due to obstructions such as bends and buildings. For example, connected infrastructures or connected vehicles can spot non-connected vehicles and non-connected vulnerable road users such as pedestrians, bicycles, scooters, motorcycles and road workers. That information is transmitted to other vehicles whose drivers do not have a line of sight to the non-connected objects, allowing the vehicle to react faster than it could do

otherwise. This advance warning can reduce accident frequency and potentially save lives (Figure 2.3 shows an example of a use case where sharing perception by using CPM is needed). MCM messages allow vehicles to know what other vehicles intend to do ( Figures 2.4 & 2.5 show two use cases where MCM messages can be used).

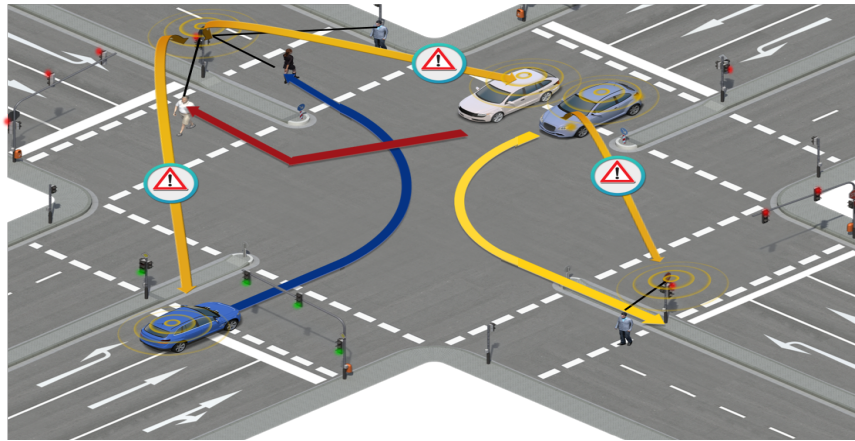

Figure 2.3: Complex intersection with several non-connected vehicles and pedestrians.

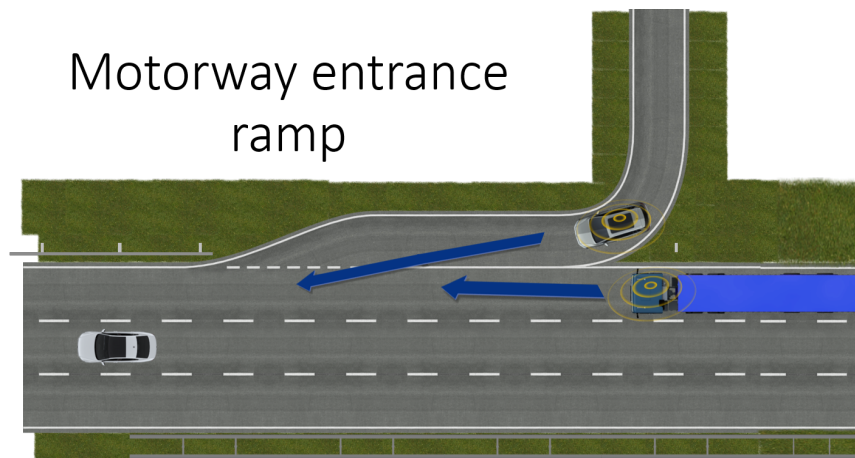

Figure 2.4: Motorway entrance assistance by using MCM messages.

- **Different types of applications** : VANETs are designed to support different kinds of applications with variable QoS requirements. Applications can be classified into two major categories: safety and non-safety applications. Safety applications aim to increase driver and passenger safety. Examples of such applications are post-crash notification, cooperative collision warning, lane change



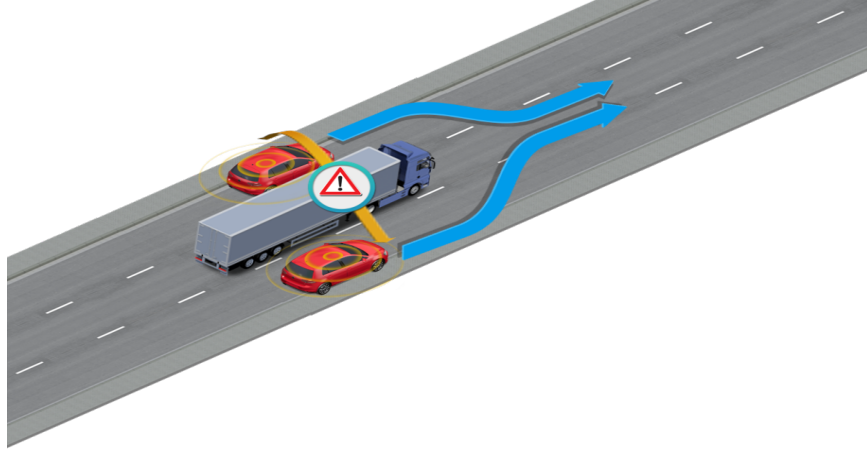

Figure 2.5: Lane changing assistance use case using MCM

assistance, blind spot warning, emergency electronic brake light, left or right turn assistance, traffic signal violation warning, automated driving etc. Non-safety applications intend to make the driving experience more pleasant and focus on passenger comfort and traffic efficiency. Examples of such services include parking information, Digital Map download and location-based services.

## 2.4 Main research topics

All the characteristics described above make VANETs extremely promising, very challenging, and some resemble the characteristics of MANETs. Elmano et al. [1] provide a survey of the current state of VANET research based on hundreds of papers, and the recent research topics are classified into eight categories. MAC and Physical layers; Routing protocols; User applications (such as V2V collision avoidance applications, robust video streaming and decoding for V2I, road optimization, etc.); Mobility issues (this topic covers all mobility issues and clustering algorithms in VANETs); Performance comparison analysis which shows the analytical and simulation results of the designed protocols; Data collection and message dissemination schemes; Papers proposing new simulation tools, prototypes and architectures with experimental results; Complementary services which deal with QoS, V2X cybersecurity, and vehicular tracking issues.

Figure 2.6 (taken from the reference [1]) represents the percentage of each category over ten years (2007 - 2017) based on 283 papers in the field of vehicular networks and under two temporal observation windows.

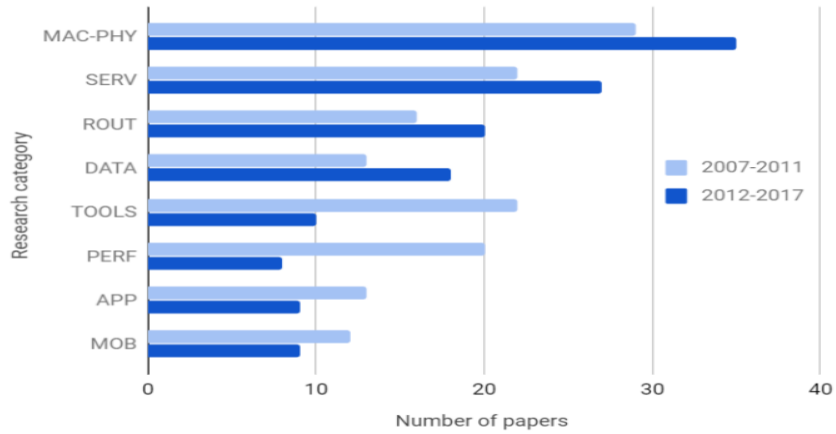

Figure 2.6: VANET research topics: MAC and Physical layers (MAC-PHY), Complementary services (SERV), Routing protocols (ROUT), Data management (DATA), Tools and experimental platforms (TOOLS), Performance comparison analyses (PERF), Applications (APP), Mobility issues (MOB).

Research on the MAC and physical layers takes first place: during the last decade researchers worked on the design of efficient PHY and MAC layers that support high-mobility. This is still true between (2018 - 2021) with the release of new standards (5G NR and 11bd [8]). For example, the new design is expected to double the throughput and transmission range of the previous technology i.e. IEEE 802.11bd and with high velocities (up to 500km/h) [124]. SERV is the second research topic (this category is focusing now on the integration of cellular communication (5G) with Wifi for vehicles in a unique platform architecture) followed by ROUT label, the authors identify at least 10 new protocols that take into account VANET scenarios and applications. The proposed solutions tend to geographic non-delay tolerant routing protocols (for dense scenarios) and delay-tolerant protocols which consider intermittent connectivity of VANETs. The literature for this topic includes articles presenting the above protocols and also papers that survey and compare them. DATA label occupies fourth place and has the greatest growth (VANETs require an efficient data dissemination mechanism for traffic safety). All the proposed approaches aim to achieve less redundancy and greater efficiency (i.e. reliable and low latency diffusion).

For PERF (6th place) and TOOL label (5th place), the authors noticed that there is a big drop in the number of publications tackling these topics between the two periods identified in Figure 2.6. With regard to the former, they justify this by the fact that the scientific community is moving towards new technologies instead

of trying to adapt old technologies and mechanisms to the vehicular environment. For the latter, the authors recall that during the first years of research in the field of VANETs, intensive efforts were made to develop tools to simulate the behavior of VANET networks and today we have many simulation tools mature enough to describe them (see Table 2 in [1]), but this does not prevent the release of new tools in the near future, such as the extension of the Veins framework: vehicular Visible light communication (veins-vlc [118]), platoon control (veins-plexo [119]), etc.

For the two last research topics in this classification, we have MOB label, the authors find that the mobility models proposed in [126] [127] are sufficiently realistic and this explains a slight drop in the topic during the second period of observation. However, they consider that future research will focus on geo-social mobility modeling, and three-dimensional connectivity analysis. For APP label, we can make the same observation as for TOOL: today there is a long list of V2X applications that need to rely on communication technologies providing the required level of QoS.

## 2.5 QoS requirements of advanced V2X applications

The Quality of Service of connected applications is in a way the specifications for building wireless communication technology. Most V2X applications have a real-time constraint and need very low latency. Some applications need to exchange periodic messages with an update rate varying between 1Hz to 10Hz. Such applications are usually sensitive to data loss and thus require very high reliability. In some cases, satisfying this requirement needs more than one communication technology (C-V2X, ITS-G5, V-VLC) and thus implies establishing hybrid communication. Unlike safety applications, non-safety applications have, on the one hand, fewer reliability demands but, on the other hand, they require high data rates. Autonomous driving requires a real evolution of current V2X technologies (high reliability, low latency and high throughput). Gaurang Naik et al have classified these new applications in four categories shown in the following Table 2.7 [8]. This table underlines the gap in performance with basic safety applications.

Use Case Group	Max. Latency (msec)	Payload Size (Bytes)	Reliability (%)	Data Rate (Mbps)	Min. Range (meters)
Vehicle Platooning	10 - 500	50 - 6000	90 - 99.99	50 - 65	80 - 350
Advanced Driving	3 - 100	300 - 12000	90 - 99.999	10 - 50	360 - 500
Extended Sensors	3 - 100	1600	90 - 99.999	10 - 1000	50 - 1000
Remote Driving	5	-	99.999	UL: 25 DL: 1	-

Figure 2.7: QoS requirements of the most advanced applications for connected and autonomous vehicles (from [8])

## 2.6 Vehicular Communications Technologies for V2X

### 2.6.1 Radio Access Technologies: ITS-G5

The development of IEEE 802.11p was engaged by the Task Group in 2004 [128], and the first Wireless Access in Vehicular Environments (WAVE) for medium-range communication approved version was published in July 2010 [129]. In Europe, this standard takes the name of ITS-G5; the equivalent technology in the USA is called Dedicated Short-Range Communication (DSRC). These two standards were developed respectively by the European Telecommunications Standards Institute (ETSI) and the Institute of Electrical and Electronics Engineers (IEEE). In Japan, the standardisation body was the Association of Radio Industries and Businesses (ARIB). Figure 2.8 shows the WAVE stack Layered architecture, the design follows the Open Systems Interconnection (OSI) layered model. Each layer has its own standard. The Physical and MAC layers use IEEE 802.11p with EDCA parameters based on its Decentralised Congestion Control (DCC), IEEE 802.2 at the LLC sublayer. Furthermore, it includes a facilities layer which is equivalent to 5 to 7 OSI layers (it is situated between the network and application layers), the main role of this layer is to provide various support for V2X applications, handle data coming from different sources [130].

ITS-G5 has operated on the 5.9 GHz carrier frequency since 2008, with 70 MHz of licensed and free bandwidth (5855 - 5905 MHz) for all road usages. The spectrum band in the USA, DSRC, is a little different (5850 - 5925 MHz) but the frequency is still close enough to allow communication with ITS-G5 devices. As shown in

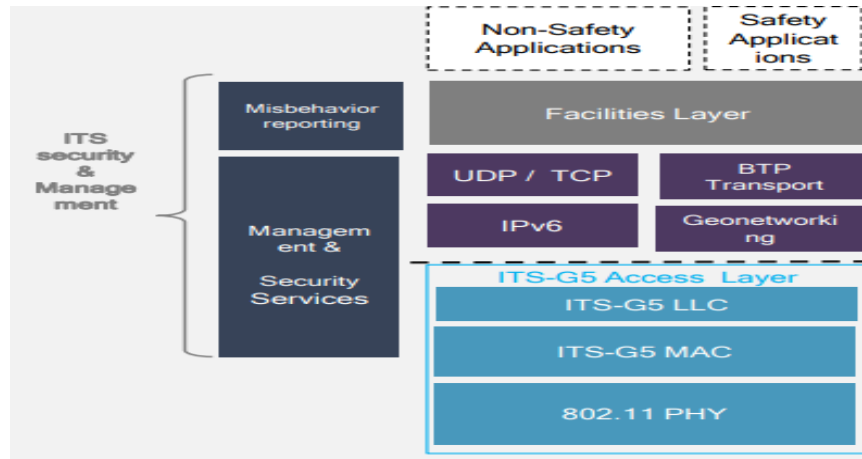

Figure 2.8: ITS-G5 stack architecture [130]

Figure 2.9, the available spectrum is divided into seven channels, each one having 10MHz of channel-spacing. Five of them are for Service CHannels (SCHs) (174, 176, 180, 182, 184), one of them is for the Control CHannel (CCH). The 172 channel is unused (reserved to avoid unlicensed WIFI interference).

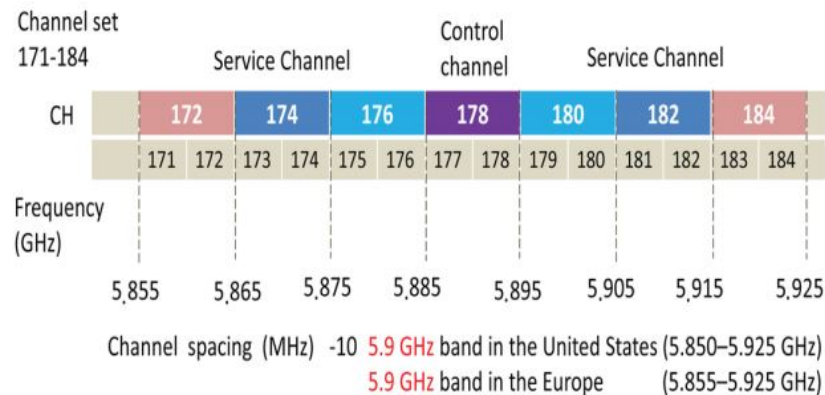

Figure 2.9: ITS-G5 spectrum band and channels in Europe &amp; USA

The ITS-G5 radio wavelength is about 5cm which makes the penetration of objects difficult. When the sender and receiver have no LOS, the receiver has to rely on the multipath coming from neighboring objects to receive the packets. European Automobile Manufacturers Association (ACEA) investigated the possibility to achieve V2X communication under the 3.4-3.8 GHz bands for both ITS-G5 and LTE-V2X or use separate frequency bands, which will enhance robustness [131]. Recently, the

Federal Communications Commission (FCC) proposed reallocating to 45 MHz from the 75 MHz band previously allocated to V2X communication to unlicensed devices such as WIFI (to deal with the growing number of wireless devices). This would be insufficient for the required V2X services to function. The European Union (EU) proposes 40 MHz for vehicle safety technologies and 10 MHz for both urban rail and ITS. At the moment, the EU allocates the 5.9 GHz for both C-V2X and ITS-G5, with on-going discussions to choose a unique radio solution or keep both solutions for V2X by developing the interoperability between DSRC and C-V2X. ETSI have a deadline of 2022 to propose interoperability or coexistence in the same band, after which, if no solution is found, the EU will have to choose one of the two technologies (see Figure 2.10 [103]).

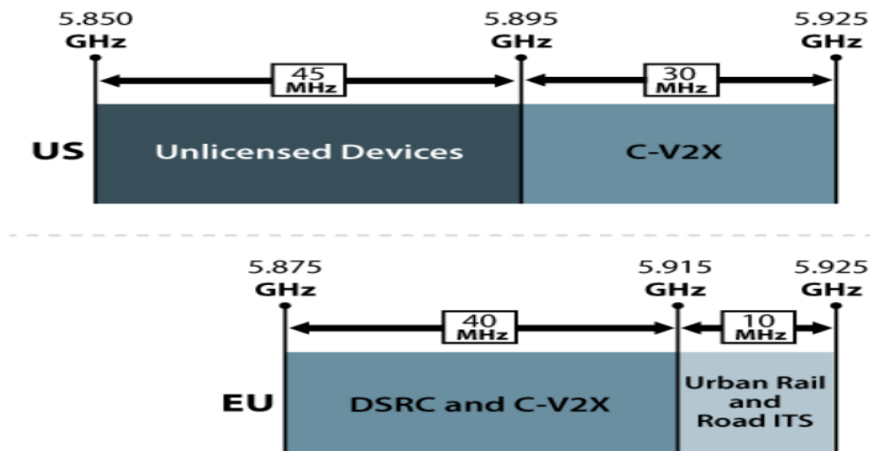

Figure 2.10: New spectrum band channels reallocation for V2X in Europe & USA

The MAC layer is divided into two sublayers: the lower layer handles the channel access, whereas the upper layer is responsible for channel coordination. To send data, before accessing the shared transmission medium, ITS-G5 nodes will listen to the medium. If the medium is busy, the nodes will back off and wait for a random amount of time and then try again. This access control method is called CSMA/CA. As described above, VANETs have to support various kinds of services with different priority levels, in order to give prioritization and ensure the timely sending of safety messages. ITS-G5 uses an EDCA mechanism to schedule the transmissions: message prioritization is achieved by varying the Contention Windows (CWs) and the Arbitration Inter-Frame Spaces (AIFS) (for more details see Equation 2.1 and Table 2.2 from reference [102]). ITS-G5 nodes exchange data frames without establishing any

prior communication. Two communication modes are used: Broadcast and Unicast. For the first one there is no acknowledgement, whereas in the second one there is.

The IEEE 802.11p physical (PHY) layer is composed of two sublayers: Physical Layer Convergence Procedure (PLCP) and Physical Medium Dependent (PMD). PLCP manages the communication with the MAC layer by taking the Packet Data Unit (PDU) coming from the MAC layer and transforming it to generate an Orthogonal Frequency Division Multiplexing (OFDM) frame [65]. In Figure 2.11, the training sequence of the PLCP consists of 10 short training symbols followed by a long preamble guard (LPG) and 2 long training symbols (LP1 and LP2). A short part of the training sequence is available for signal detection (around 3 symbols). The remaining symbols are used for diversity selection and automatic gain control (AGC).

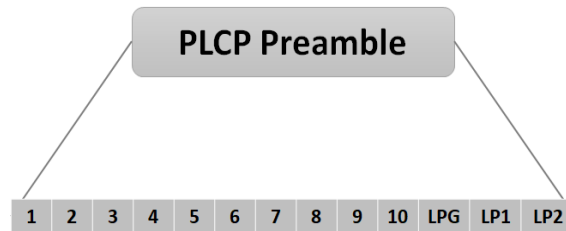

Figure 2.11: PLCP preamble training sequence in the 802.11p standard

The receiver measures the signal energy and compares it to the minimum sensitivity threshold. This threshold can vary depending on modulation schemes and coding rates. This mechanism is called channel sensing. Once the header frame is detected, the receiver decodes the information in the signal field of the PPDU Channel (see Figure 2.12).

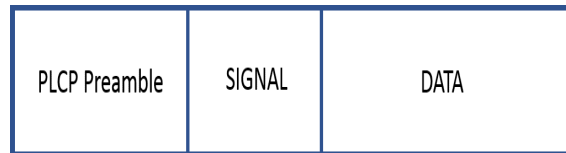

Figure 2.12: PPDU frame format of ITS-G5

The background structure of the physical layer for the 802.11p is derived from 802.11a. However, in order to guarantee resistance to the phenomena of attenuation and interference caused by Doppler shift and multi-path fading in VANET environments, the bandwidth was divided by two from 20 MHz to 10 MHz [65]. This involves

doubling all the timing parameters used in 802.11a, and the data rate from 6-54 Mbps to 3-27 Mbps. It uses 52 orthogonal subcarriers with 156.25 KHz subcarriers spacing: 48 of them are used for data and 4 are pilot carriers, the time duration of the OFDM symbol is equal to 8  $\mu$ s. The maximum communication range that this technology can cover is 1 km with a maximum speed of 200 km/h. The maximum allowed transmission power varies between 23 dbm and 33 dbm (depending on the maximum authorized in the channel: see Table 2 in [134] for more details).

### 2.6.2 Vehicular Visible light Communication (V-VLC)

The IEEE 802.15.7 [107], published in 2011, is the current standard for Short-Range Optical Wireless Communications. Although this standard includes outdoor communications, it is not specially designed for V-VLC, and there are no efforts being made in this direction; current standardisation efforts mainly focus on the system costs. Recent research shows the need for a dedicated new standard for vehicular networks [108].

Light communications are classified into two categories depending on the environment: indoor (mainly using LiFi applications [100] [101]), and outdoor (to establish communication between vehicles and the infrastructure). The V-VLC wavelength varies from 380nm to 780nm of the electromagnetic spectrum. V-VLC will benefit from a wide available spectrum, which will result in high data rates. A V-VLC receiver can be either a Photodiode (PD) or a camera-based receiver. The location of a vehicle's LED-based light makes the set-up of a full-duplex communication possible (see Figure 2.13: A vehicle has two tail lights and two headlights). Sunlight and outside light sources cause respectively a shot noise and interference. V-VLC requires a line-of-sight (LOS) scenario but some research shows that it is possible to use ground reflections to have V-VLC NLOS communication [106] (see Figure 2.14). However, a LOS scenario is not always available due to variations in the vehicle's heading or to adverse weather conditions.

Due to the propagation characteristics of light, which can not pass through objects, NLOS messages need to be forwarded in a multi-hop manner. Consequently, V-VLC uses multi-hop communication to reach vehicles that are not directly in front, resulting in high latency, whereas RF can reach all these vehicles immediately. On the other hand, in high density scenarios, V-VLC has good scalability compared to RF. If the RF band is restricted or banned due to safety applications (such as in the military),





Figure 2.13: Vehicle LED-based light

thanks to the directional radiation pattern of light, V-VLC will be a discreet and good alternative.

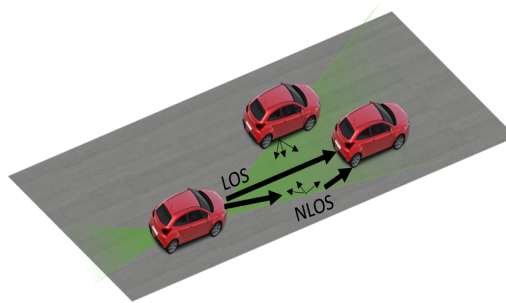

Figure 2.14: A LOS &amp; NLOS V-VLC scenario

In the literature, there are a number of research topics in this field. The following list enumerates the main research directions in V-VLC (based on the survey published by Agon et al. [9]):

- **Physical layer & channel modeling:** VLC conveys information by modulating the intensity of the light emitted by the LEDs. Because of its novelty, researchers have not yet finished exploring and understanding all these properties, such as the characterization of the V-VLC channel and the physical characteristics of the light waves. The PHY-I mode of the IEEE 802.15.7 is dedicated to outdoor applications but does not take into account all the specifications of the vehicular environment, and thus there still many open issues regarding the appropriate physical layer for V-VLC (modulation schemes, filtering, etc).

- **Medium Access Control:** In the literature, we can find only few contributions tackling MAC layer issues compared to the physical layer. An efficient MAC protocol is necessary for V-VLC, not only because of the interference caused by the presence of concurrent vehicles in the near lane of the road [114], but also to take into consideration the specifications of the receiver (LED or camera). In [115], the authors propose CSMA/CA, whereas in [116] the authors propose ALOHA. According to Emmanuel et al., as VLC is a directional and half-duplex communication technique, there is no need for such a protocol for V-VLC. Nevertheless, the author states that the design of the MAC layer should focus on the V-VLC properties.
- **V-VLC Positioning and distance measurement:** VLC technology can provide an alternative to GPS-based positioning technology, which is not always available (e.g. in a tunnel, an indoor environment). The precision of such a system is about a few centimeters, whereas GPS gives an error of  $10m$  [89]. V-VLC is also used as a range-finding system (by exploring the headlights and taillights of a vehicle). This functionality is very useful for a platooning application. Bastian et al. [117] propose a range-finding system based on the Manchester encoding clock signal, where the distance is measured by the difference in the time of flight of the received signals. The maximum distance measured by such a system is about  $25m$  with a resolution varying from  $24\text{ cm}$  to  $10m$ .
- **Coexistence of V-VLC with vehicular Radio technologies:** Researchers are focusing on proposing a new communication board that integrates all V2X communication technologies together in a single architecture (ITS-G5/LTE-V2X and V-VLC) in order to be used in a heterogeneous network. Recent studies are moving toward a vertical handover network selection architecture [120] [121]. This architecture includes a smart decision algorithm that switches between the V2X communication vectors based on the appropriate handover metrics, a fixed or dynamic threshold, and an efficient hybrid communication strategy.
- **V-VLC prototyping:** A number of real demonstrations of VLC prototypes for vehicular communication have been done. These prototypes have been designed in different manners and thus give variable performance levels. Abualhoul et al. [121], for example, demonstrated a V-VLC system that enables communication

at 30m while keeping a high Packet Delivery Ratio (PDR) with a latency of less than 36ms. However, the system gives a low data rate 9.5kps. This limitation is due to the use of Arduino low-cost hardware. Another study was conducted by Bastien et al. [117] who propose a V-VLC prototype that enables communication up to 30m with 500kpbs and less than  $10^{-6}$  of Bit Error Ratio (BER). Sebastian-Andrei et al. [123] have recently proposed a new prototype for both indoor and outdoor environments. Their system enhances the communication distance and the robustness (up to 50m with data rates between 3 to 50kpbs while ensuring less than  $10^{-6}$  BER and under perturbed optical and weather conditions).

## 2.7 Evolution of Communications Technologies for V2X

As described above, connected and autonomous vehicles have three communication technologies: two radio access technologies, one for short-range communication (ITS-G5) and the other for long-range communication (C-V2X), and the third is visible light technology. The high QoS requirements of new vehicular applications have led to new standardization efforts to develop the next generation of V2X communications which will support these new applications. IEEE 802.11bd is the evolution of IEEE 802.11p. The new standard has been under development by the IEEE Task Group (TGbd) since January 2019 and is expected to be published in 2021. The design requires coexistence, interoperability, and compatibility with IEEE 802.11p [8]. 3GPP is working toward the development of New Radio (NR) V2X for its Release 16: 5G NR, which will be the next development of C-V2X. The design requirements do not impose a backward compatibility [8]. The expected performances for both technologies are high reliability, low latency and high throughput.

C-V2X is technologically superior to ITS-G5. However, ITS-G5 is essential for some use cases: in the countryside there is often no cellular communication coverage. Also, the highway manager communicates with users via ITS-G5 (a cellular base station is very expensive). Parking a vehicle requires the owner's Wi-Fi. The future architecture is moving toward hybrid communication. The two radio access technologies have different ways to access the channel (i.e., each radio technology has its own approach to access the channel (this is due to medium access control (MAC) layer-

ing). Table 2.1 summarizes the design requirements of each vehicular radio access technology.

<b>Feature</b>	<b>IEEE 802.11bd</b>	<b>NR V2X</b>
<b>Base Technology</b>	IEEE 802.11n/ac	5G NR
<b>PHY layer</b>	OFDM	SC-FDMA, OFDM
<b>MAC layer</b>	CSMA	Mode 1: gNodeB scheduling Mode 2: Flexible sub-modes
<b>Interoperability</b>	Yes	Non co-channel
<b>Backward compatibility</b>	Co-channel	Not backward compatible
<b>mmWave support</b>	Yes	Yes

Table 2.1: The design requirements of each vehicular radio access technology for V2X

## 2.8 Conclusion

Vehicular communication is now a reality, but the coming of the autonomous driving raises a number of new challenges which require a real evolution for V2X communication technologies. In this chapter, we introduced VANETs and the motivation behind this kind of network. We then described in detail the recent architectures and the current state of VANET research. Moreover, we presented the communications technologies for V2X and their evolution. The next chapter completes the state of the art by describing the different issues relevant to this thesis.

# Chapter 3

## Fundamentals and Background

### Contents

---

<b>3.1</b>	<b>Introduction</b>	<b>27</b>
<b>3.2</b>	<b>Medium Access Control in VANETs</b>	<b>27</b>
3.2.1	Contention-based MAC protocols	27
3.2.2	Contention-Free MAC protocols	28
<b>3.3</b>	<b>Overview of MAC protocols in VANETs</b>	<b>30</b>
3.3.1	Single-Channel MAC Protocols	30
3.3.2	Multi-Channel MAC Protocols	35
<b>3.4</b>	<b>Cross-layer MAC and routing protocols in vehicular networks</b>	<b>37</b>
<b>3.5</b>	<b>Hybrid communication</b>	<b>41</b>
<b>3.6</b>	<b>Conclusion</b>	<b>44</b>

---

## 3.1 Introduction

The design of an efficient stack is essential to achieve efficient V2X communication. The ITS stack architecture uses layered communication protocols as in the OSI model. Each layer has a specific role in the transmission of information from one application to another. The first chapter of the state-of-the-art introduced the general context of this thesis, here in this chapter, we focus on introducing the different concepts and approaches that are essential to understanding the rest of this work. We start by an overview of the literature on the different techniques and protocols used in Medium Access Control in VANETs, then, Cross-layer QoS optimization in VANETs. Finally, we review the literature on the hybrid communication strategies, with a particular focus on platooning.

## 3.2 Medium Access Control in VANETs

In wireless communication, the radio channel is the most precious resource. The Medium Access Control (MAC) layer has the role of sharing this expensive resource by providing efficient and reliable access to the channel for each node present in the network. In VANETs, the continuous and fast changes of network topology due to high node mobility, and various QoS requirements: non-safety V2X applications need a high throughput, whereas safety applications need low latency, etc., make the design of the MAC more difficult to handle [104]. Furthermore, channel resource scheduling in VANETs faces a number of issues, such as the hidden<sup>1</sup> and exposed node problems<sup>2</sup>, network fragmentation and high density, multi-channel scheduling, with an unbalanced load distribution on the different channels.

As in traditional ad hoc networks, protocols are classified according to the control scheme used to access the channel [5], namely: contention-based or contention-free.

### 3.2.1 Contention-based MAC protocols

In contention-based protocols, the carrier sensing scheme [86] is used to coordinate the access to the channel. Thus, the risk of collision is still possible in this category, as

---

<sup>1</sup>The hidden node problem occurs when two vehicles that are not within transmission range of each other perform a simultaneous transmission [5].

<sup>2</sup>The exposed node problem occurs when a vehicle is prevented from sending packets to other vehicles due to a neighboring transmitter [5].

several vehicles may sense that the channel is free at the same time and then attempt to transmit their data simultaneously. The current IEEE 802.11p standard [3] developed for vehicular networks is a contention-based MAC using a priority-based access scheme that employs both Enhanced Distributed Channel Access (EDCA) and Carrier Sense Multiple Access with Collision Avoidance (CSMA/CA) mechanisms [43]. Furthermore, the channel access time is uniformly divided into different synchronization intervals (SI) of 100 ms in length [53], and each of them includes two intervals: a Control Channel Interval (CCHI) and a Service Channel Interval (SCHI), each of 50 ms in length, separated with a guard interval of 4  $\mu$ s (See Figure 3.1). Therefore, the lack of a dynamic interval in this configuration may penalize performance in terms of throughput and delay when the traffic density is high, especially for the CCH interval when it is not enough to transmit all the safety messages [54]. This feature makes this standard less suitable for real-time applications.

### 3.2.2 Contention-Free MAC protocols

In this category, only one vehicle in a two-hop neighborhood set is authorized to access the channel at a given time, which reduces the risk of collision. Hence, this category of protocols is more suitable to manage real-time applications in VANETs as it can provide a bounded access delay and reliable communication for safety applications. Over the last few years, contention-free MAC protocols have remained one of the emerging areas of research and represent the majority of MAC protocols proposed in this field [5].

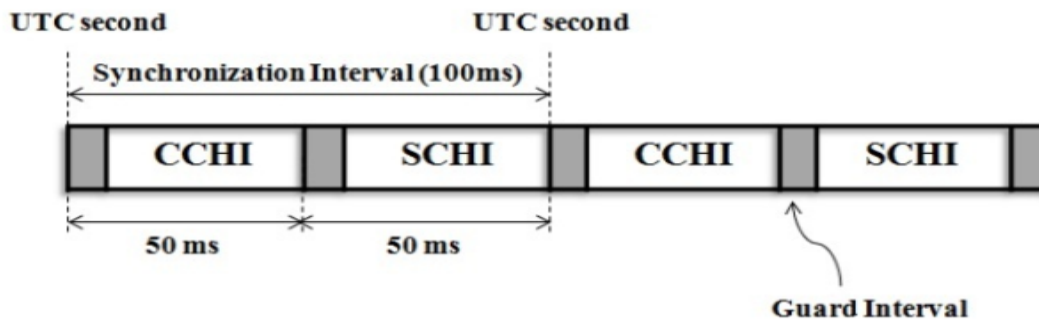

Figure 3.1: Channel access time for CCHI and SCHI in IEEE 802.11p standard

From a different point of view from the state-of-the-art, the proposed protocol belongs to two families: Single MAC channel and multi-channel MAC protocols [2].

The single-channel protocols focus on allocating the radio resource to all users. Different mechanisms can be used: Frequency Division Multiple Access (FDMA), Code Division Multiple Access (CDMA), Time Division Multiple Access (TDMA), space division multiple access (SDMA) and even the carrier sensing cited above. The second family of protocols (i.e. the multi-channel category) is designed to distribute the load on multiple channels, The nodes use either a multiple antenna or channel-switching mechanisms. Thanks to load balancing between channels, packet collisions are reduced and this results in a better throughput. Depending on the network topology used, each protocol in this last category is divided into distributed or centralized MAC protocols. With Distributed MAC protocols the communication between nodes is established without external entities to coordinate access to the channel (see Figure 3.2). As it requires less infrastructure, it is less costly. On the other hand, centralized MAC protocols pass through an RSU (see Figure 3.3) or cluster head (see Figure 3.4) as a channel coordinator.

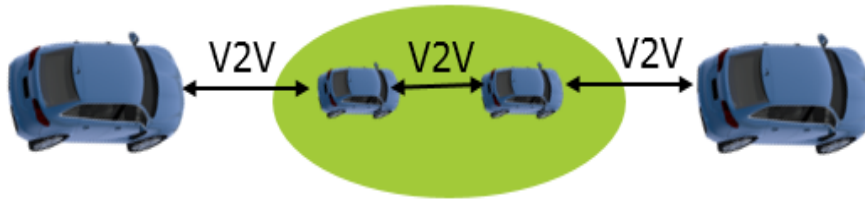

Figure 3.2: Protocols operating on a fully distributed VANET

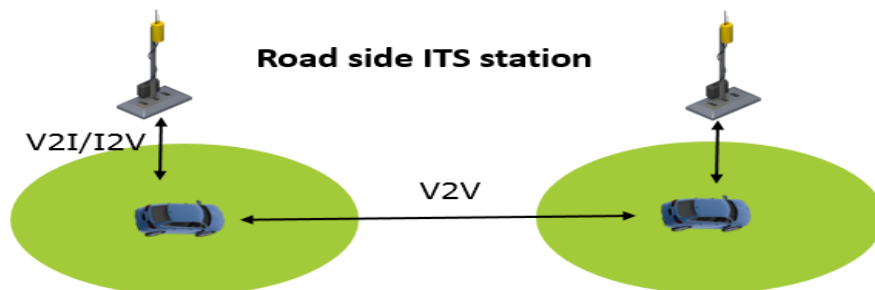

Figure 3.3: Protocols operating on a centralized topology.



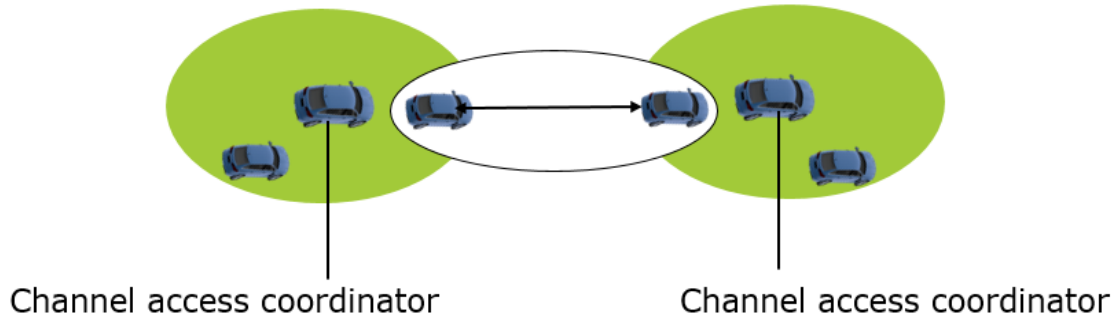

Figure 3.4: Protocols operating on a cluster-based topology

### 3.3 Overview of MAC protocols in VANETs

In this section, we overview different MAC protocols for the two categories discussed above.

#### 3.3.1 Single-Channel MAC Protocols

As described before, single-channel protocols are divided into distributed and centralized protocols. The authors in [2] maintain that the research on distributed protocols tends either to enhance the configuration of contention parameters or improve the TDMA access mechanism. The emerging standard deployed to enable vehicular communication (i.e. IEEE 802.11p standard) is an asynchronous single-channel distributed protocol. After sensing a busy channel, the nodes have to wait for the channel to be idle for a period to be able to access again and this is due to the adaptive mode of random back-off. Furthermore, there are no require-to-send/clear-to-send (RTS/CTS) handshake and acknowledgment (ACK) mechanisms for the safety message broadcasted on the CCH, and this not suitable for safety messages. The distributed-TDMA-based MAC protocols show improvements compared to the IEEE 802.11p standard and can support QoS requirements of safety applications (low delay, high packet delivery rate (PDR)), as the size of the VANET grows, time slot assignments to vehicles could suffer from access<sup>3</sup> and merging<sup>4</sup> collisions

<sup>3</sup>An access collision problem occurs when two or more vehicles within the same two-hop neighborhood set attempt to access the same available time slot, a problem which is likely to happen when a distributed scheme is used [5].

<sup>4</sup>A merging collision problem occurs when two vehicles in different two-hop sets accessing the same time slot become members of the same two-hop set due to changes in their position

(see Figure 3.5 and Figure 3.6). Figure 3.6 shows an example of the merging collision problem, which occurs when vehicles moving in opposite directions: vehicles A and B moving in opposite directions at  $t = 0$  are using the same time slot. Since A and B become members of the same set at instant  $t + dt$ , a collision occurs at vehicle C.



Figure 3.5: Access collision problem

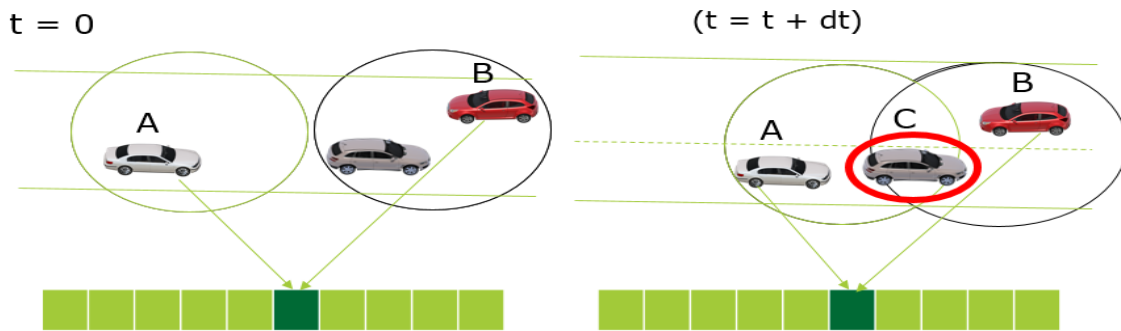

Figure 3.6: Merging collision problem

For instance, the authors in [19] have proposed an ADHOC Medium Access Control (ADHOC MAC) to provide an efficient broadcast service for inter-vehicle communications and solve issues such as the hidden-exposed terminal problem and QoS provision. ADHOC MAC is a contention-free medium access protocol which implements a dynamic TDMA mechanism that is able to provide prompt access based on a distributed access technique, R-ALOHA (Reliable R-ALOHA [20]). Each vehicle can access the channel at least once in each frame by randomly selecting a time slot as its Basic CHannel (BCH). Another protocol called ATSA [87] was proposed which uses VeMAC (introduced in the multi-channel MAC protocols category) as the background protocol and introduces a more complex mechanism to schedule the slots. It makes

the frame length dynamic using a binary tree algorithm to decrease the probability of collisions.

MoMac [21] is a TDMA-based mobility-aware and collision-avoidance, it divides a TDMA frame into three sets of slots. One for the vehicles moving to the right (R), one for vehicles moving in the left direction (L), and the last one is dedicated to RSUs. Furthermore, In comparison to VeMAC [29], this protocol adds a new set which depends on the lane the vehicle is in. Thus, the sets of slots reserved for vehicles are respectively divided into sets of lanes. For example, if there is highway of two lanes in each direction it will have the following frame organisation : R1 to R2 and L1 to L2. Vehicles can be aware of the status of the slots (busy, idle, in collision) of the two-hop neighbors and then choose one available slot in a completely distributed manner (this information is obtained from the one-hop neighbors). This scheme helps to avoid slot allocation collisions. However, the main drawback of this scheme is that it is very sensitive to the loss of a global positioning system (GPS) signal and needs very high GPS resolution to correctly detect changes of lane. Moreover, MoMAC can not handle the unbalanced density between the lanes.

The Distributed and location-based TDMA MAC (DTMAC) [22] exploits the linearity of the road and for this reason it is well-suited to highway scenarios. It divides the road into three zones and attributes a set of slots to each of them. These sets of slots are spatially reused without any interference. Following this scheme, it provides low access and a low merging collision rate. Moreover, thanks to the pre-assigned time slot sets, it prevents the hidden and exposed terminal problems. Thus, it enables a reliable broadcast service, bounded access delay, and maximizes the use of CCHs.

For MAC protocols that follow a centralized topology, thanks to the central coordinator, problems such as scheduling time slots without collisions and time synchronization are resolved. In the case where the coordinator is an RSU, it is easy to manage time-slot reservations. However, it requires deploying a considerable amount of infrastructure, which can increase the cost. Furthermore, the continuous movement and changes of vehicle density usually create an unbalanced occupation of time-slots. One of the efficient ways to resolve this is to use protocols that operate in a cluster-based topology which uses mobile CHs as coordinators.

VAT-MAC [23] is an adaptive TDMA following a centralized topology based on RSUs. These Road Side Units have the role of broadcasting a Time Management Frame (TMF) that includes the information about the duration of the Free Trans-

mission Period (FTP) and the Contention Period (CP). During the time management period, if the vehicle finds an available slot in the CP without collision, the RSU will assign this slot to it in the next FTP. VAT-MAC has the capacity to adapt and optimize the frame length according to the vehicular density (the coordinator, i.e. the RSU has the collision probability and by using the maximum likelihood it can estimate the network density), this faculty significantly improves the scalability of centralized schemes.

SAFE-MAC [24] is another centralized-based topology protocol, which adapts the centralized schemes to the mobile environment. It calculates the residence time of a vehicle in the service area of an RSU by using location, direction, and speed of the vehicles. This new algorithm works both for intersections and straight roads. Moreover, to guarantee a proportional fairness, it introduces a new batch selection with a unique MAC parameter. This parameter is adapted dynamically according to the duration of stay in the area.

CBT [25] is a cluster-based TDMA which uses cluster heads (CHs) as coordinators. The proposed CBT uses CHs to organize the access to the channel. To quickly elect a VC (VANET Coordinator) all VANET nodes (VNs) send a Compete-For-VC (CFV) message (see reference [2] [25] for more details about the Time frame structure of CBT). Furthermore, to avoid collisions between two clusters which become close to each other, the CBT can rapidly re-allocate time-slots in one of the clusters.

Priority-based Direction-Aware MAC (PDMAC) [26], is another cluster-based MAC protocol. This protocol focuses on the synchronization problem and prioritized message delivery, which are the main drawbacks of the TDMA. Therefore, after regrouping vehicles in clusters, PDMAC achieves inter-cluster and intra-cluster clock synchronization. For vehicles that have a message to send, PDMAC proposes prioritized message delivery based on three elements of the message: direction, the category of the message, and the security level. The authors of this protocol show that it responds to the QoS requirements of safety applications compared to other paramount protocols in the same field, in terms of clock synchronization, reliability, end-to-end timely transmission, and network throughput.

Figure 3.7 and Table 3.1 show respectively the classification and the comparison of single-channel MAC protocols among DTMAC, MoMAC, CBT, SAFE-MAC, VAT-MAC, PDMAC.

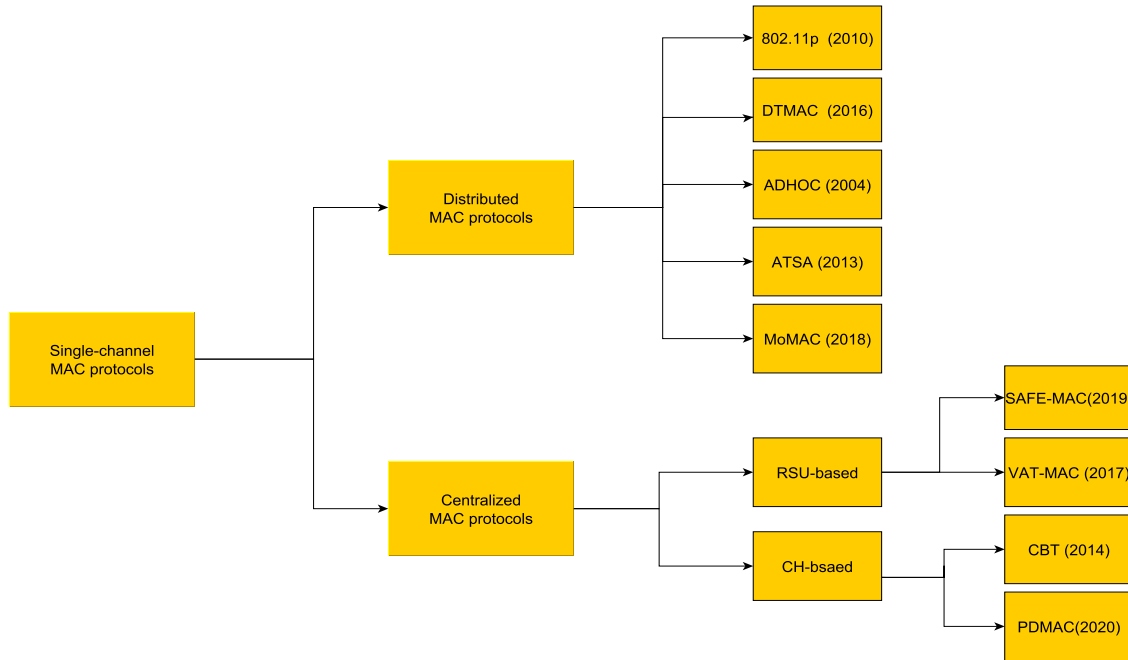

Figure 3.7: Classification of single-channel MAC protocols for VANETs

Features	DTMAC	MoMAC	PDMAC	CBT	VAT-MAC	SAFE-MAC
Centralized	No	No	Yes	Yes	Yes	Yes
Coordinator	-	-	CHs	CHs	RSU	RSU
Access mechanism	Contention-free	Contention-free	Contention-free	Contention-free	Contention-free	Contention-based
Dynamic access interval	No	No	No	No	Yes	No
Time synchronization	Yes	Yes	Yes	Yes	Yes	Yes

Table 3.1: Comparison of single-channel MAC Protocols

### 3.3.2 Multi-Channel MAC Protocols

Using Multi-Channel MAC Protocols has the benefit of doubling the spectrum efficiency, but designing a protocol that operates simultaneously on multiple channels requires taking care about adjacent channel interference and must avoid poor exploitation of the allocated frequency spectrum.

Following the distributed multi-channel MAC scheme, each vehicle can be aware of channel and time slot occupancy information of 2-hop range vehicles. This information is obtained by exchanging one-hop neighbor information of neighboring vehicles and based on it, two kinds of mechanisms can be deployed: TDMA or a random-access mechanism. [2] [5].

The MAC layer of the WAVE stack is composed of two sublayers, IEEE 802.11p and IEEE 1609.4. The IEEE 1609.4 is a MAC sublayer extension which regulates the channel coordination over IEEE 802.11. It defines four access categories: continuous access mode, alternating access mode, immediate access mode, and extended access mode. In the continuous access mode, there is no channel switching and, thus, no time synchronization issue. The second access mode (i.e. alternating access), uses CCH and SCH alternatively, each one taking half of the SI time. However, it causes unbalance, especially under high traffic density. To allow the transmission of more service messages, the immediate access mode is more appropriate. The last mode (i.e. extended access mode), enables continuous communications over the time interval of SCH and during multiple SIs. The WAVE handshake (including RTS/CTS/DATA/ACK) is done during the SCHI, moreover, during the CCHI, the service provider sends the WAVE Service Advertisement (WSA) including the ID channel of the SCH that will be used. In function of the service requirements of the vehicles that are in this range, after receiving the WSA, the vehicles decide if their radio switches to the specific SCH in the upcoming SCHI.

The authors in [27] designed an adaptive MAC based on Space Division TDMA (SD-TDMA). The allocation of time slots changes dynamically depending on the topology and the collisions. The channels coordination is as follows: the road is divided into four different segments, and it attributes for each of them one of the SCHs of IEEE 802.11p, and are spatially reused along the road. The segments are furthermore divided into  $N$  cells which represent a time slot that vehicles can obtain depending on their location. It also uses two secure channels (SeCHs) for each direction on the roads (vehicles use an IEEE 802.11p contention-based MAC approach to access the channel). Vehicles can use SeCHs and SCH simultaneously, depending on

which segment they are in. To avoid access collisions, the synchronization interval is divided into a User Detection Interval (UDI) and SCHI. Thus, vehicles are allocated slots without collisions by linking time slots and geographic locations. In the case where a collision occurs in UDI, it switches to SeCHs and uses a DCF mechanism to send a request access message. Otherwise, it participates in SCH time slot allocation during the SCHI. However, the main drawback of this protocol is the issue of scalability: when the density is high, the throughput significantly decrease as the SCHI time slots decrease.

The Black-burst-based MAC (BB-MAC) [28] protocol dynamically adapts the times slot reservation process. The time structure of BB-MAC is divided into a reservation period (RP) and a competition period (CP). The first one contains the black-burst part, during which vehicles send a black-burst after a random delay. This period is adjusted according to the density. This mechanism serves to determine whether a time slot is already reserved: if a vehicle detects a black-burst on the channel before its own sending time, it will attempt to select another free time slot. During the second period (i.e. CP), vehicles request access to SCHs. Vehicles use the handshake of WSA/RES/ACK packets during the competition period (CP).

The main challenge for centralized multi channel MAC protocols is to face the dynamic topology changes of vehicles while guarantee high QoS. For instance, Another well-known contention-free MAC protocol called VeMAC [29] has been proposed to solve the problem of merging collisions, VeMAC has the particularity of assigning disjoint sets of time slots to vehicles moving in opposite directions and to Road Side Units (RSUs). Although VeMAC supports multi-hop broadcast services on the control channel, it suffers from the access collision problem as its scheduling is fully distributed. Recently, several solutions such as in [55], [87], [57], and [58] have attempted to improve the performance of the VEMAC protocol by dynamically adjusting the size of the slot sets according to vehicle density in each direction.

Improved Coordinated Multi-channel MAC (IC-MAC) [30], The proposed IC-MAC protocol is a contention-free protocol that broadcasts messages by coordinating RSUs, which are responsible for access management and time synchronization. This protocol enhances the service channel reservation by adopting dynamic interval schemes instead of alternating access modes, thus, it can support highly dynamic traffic as it can exceed the half of the SI. It divides the CCHI into three intervals: the Control Interval (CI), Safety Message Broadcast Interval (SMBI) and Service Channel Reservation Interval (SCRI). During the CI, RSUs broadcast a control packet (includ-

ing information about the transmission order of the vehicles, and the lengths of the CCHI, SMBI, and SCHI). During the SMBI, mobile and fixed nodes (i.e. RSUs) use TDMA to broadcast their own safety messages. The last interval (i.e. SCRI) is dedicated to SCH allocation. There are three steps to access the SCH: first, the vehicles which are competing for the channel resources broadcast a WAVE Service Advertisement (WSA) packet. When a response from the destination vehicle is successfully received with the selected SCH ID and allocated time slots, the RSU broadcasts an RSU Coordinated (RC) packet containing the occupied time slots and SCHs. Following this scheme, IC-MAC improves the throughput and optimizes the use of SCHs. The authors also show that the delay is also improved in high-density scenarios.

Collision-Avoidance Directional Medium Access (CADMA) [31] is a cluster-based protocol. The control vehicle uses a polling-based technique in which it interrogates multiple vehicles and manages access by allocating the resources to cluster members (CMs) in a TDMA manner (based on a QoS threshold). On the road, each cluster has the size of the max transmission range of a vehicle. Moreover, to solve the network-hole problem<sup>5</sup>, it introduces an Assist Header (AH), which acts as a gateway to facilitate communication. For instance, it can work as a one-hop relay node controlled by the CH in the case where there is no poll response from a certain vehicle. Furthermore, it can separate the cluster according to the non-response rate and node speed, thus the formation and separation of clusters becomes much easier in VANETs.

From the literature, over the last few years, further protocols can be found in each of the above categories, such as PTMAC [32], ADPM [33], PCS-AMMAC [34], VEC-MAC [35], ETCM [36]. Figure 3.8 and Table 3.2 show respectively the classification and comparison of some recent multi-channel MAC protocols between 2016 and 2019.

### 3.4 Cross-layer MAC and routing protocols in vehicular networks

The routing protocols that are designed for VANETs are generally used to find the best route for end-to-end packet delivery between source and destination, and which can satisfy QoS requirements by considering the number of hops, link quality and

---

<sup>5</sup>In MAC protocols following a cluster-based scheme, the Network-hole problem occurs when some vehicles are leaving from the cluster coverage and they remain in the network-hole between the clusters [31].



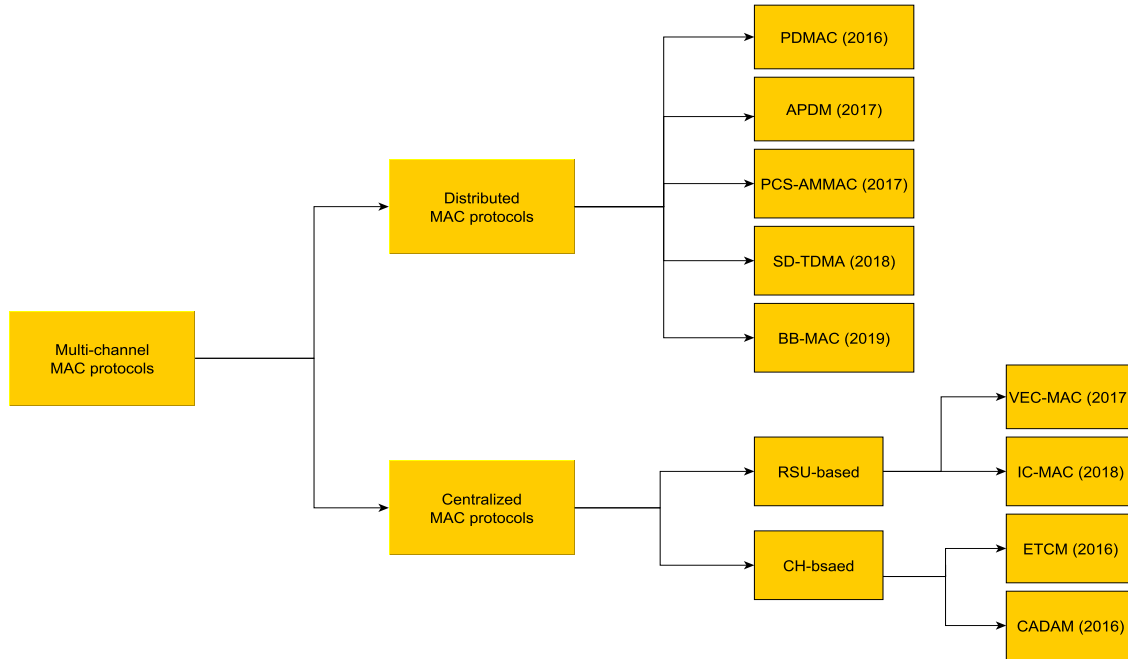

Figure 3.8: Classification of multi-channel MAC protocols for VANETs

Features	PTMAC	APDM	PCS-AMMAC	SD-TDMA	BB-MAC	VEC-MAC	IC-MAC	ETCM	CADAM
Centralized	No	No	No	No	No	Yes	Yes	Yes	Yes
Coordinator	-	-	-	-	-	RSU	RSU	CHs	CHs
Access mechanism	Contention free	Contention based	Contention based	Contention free	Hybrid	Hybrid	Hybrid	Contention free	Contention free
Dynamic access interval	No	Yes	No	No	Yes	Yes	No	No	No
Time synchronization	Yes	Yes	No	Yes	Yes	Yes	No	Yes	Yes

Table 3.2: Comparison of multi-channel MAC Protocols

lifetime. Although these protocols have achieved good performances in terms of the metrics studied, they are not simultaneously optimized to maximize the overall network performance [82]. In order to tackle this issue, several MAC-aware routing

protocols have recently been proposed in the literature to ensure coherent decisions between the MAC and routing layers.

These proposals make use of different parameters from the MAC layer, like transmission time slot allocation, channel state, and collision probability, to improve data dissemination in VANETs. A detailed review of these cross-layer routing approaches for VANETs is given in [82]. In this section, we focus on solutions dedicated to multi-hop emergency messages broadcast.

One of the earliest approaches to disseminating broadcast packets is called **OB-VAN** [93]. It is an opportunistic routing protocol that uses a modified 802.11 MAC layer. OB-VAN uses an acknowledgement scheme to choose relay nodes. Choosing the best relay node is performed by using an active signaling technique. Nodes that have captured the packet, transmit a short acknowledgement made up of signaling bursts, calculated based on the distance criterion just after receiving the packet. This scheme is a generalized CSMA/CA where the backoff technique is replaced by the active signaling technique. To prohibit interference on signaling bursts, OB-VAN uses the CDMA spreading code. Signaling bursts can be presented by 0 or 1. 0 denotes a listening interval and 1 denotes a transmission interval. This binary sequence is composed of two parts. The first part, is dedicated to optimizing the criterion for the best relay selection while the second is used to discriminate between nodes and permit the winner to relay the data packet.

Another TDMA-based routing protocol designed for warning message dissemination on bi-directional highways is proposed in [26]. This approach, called **Priority-Based Direction-Aware Media Access Control (PDMAC)**, classifies nodes as either cluster heads (CHs) or ordinary vehicles (OVs). To disseminate warning messages, PDMAC develops a three-tier priority assignment process. The first tier is Direction-Based Relay Selection. A source disseminates to its neighbors a request message (REQ) that indicates its direction, destination, etc. and reserves all available time slots in this frame for itself. Neighbors respond with an acknowledgment message (ACK) that contains all free time slots and the slot to be assigned for the transmission of the message according to the severity level of the message. The node selected as the best relay is the one that is closest in distance to the destination and is moving in the direction towards it. The second tier is the Priority on the Basis of Message Type. PDMAC prioritizes warning messages over non warning messages by adding a bit in the message header to indicate the type of the message. Finally, the third tier is Priority on the Basis of Severity Levels to differentiate between different warning

messages depending on their severity levels by computing the collision probability. In this case, warning messages are classified into 3 levels. In the case of a lowest priority message, the sender should wait for a free time slot to send. If it is a second level priority, it requests the release of a slot of another non-warning or warning message with lower priority. Otherwise, in the case of a highest priority level message, it is mandatory to release on the time slot of a non-warning or a lower-priority message.

A recent protocol called **Multi-Channel Token Ring Protocol (MCTRP)** is presented in [81]. MCTRP employs the multi-channel structure defined in IEEE 802.11p. The network is composed of multiple virtual rings. Nodes are classified into 5 types: Ring Founder Node (RFN), Token Holder Node (THN), Ring Member Node (RMN), Dissociative Node (DN), and Semi-Dissociative Node (SDN). There are 2 types of radio: Radio-I and Radio-II. A DN uses only Radio-I since it does not belong to any ring, but the other nodes use both of them. Also, the time system is partitioned into a control period and a data period.

The MCTRP protocol follows 3 sub-protocols. The first sub-protocol is the Ring Coordination Protocol, which manages rings and nodes and schedules Service Channels (SCH) for each ring. First, the Ring Initialization Process consists of sending a Ring Founding Message (RFM) that includes a selected SCH number for intraring data communications and waiting for an invitation. After establishing a ring, a Joining Invitation Message (JIM), which includes some information such as the SCH number, the speed, etc., will be broadcasted by the RFN to the DNs. The DN will reply to the RFN with a Joining Acknowledgement Message (JAM) if the difference between its moving speed and that of the RFN is smaller than a predefined speed threshold. Other messages will be exchanged between RFN, DN and RMN such as Connection Notification Messages (CNMs), Connecting Successor Messages (CSMs), etc. using the contention-based CSMA/CA scheme. The second sub-protocol is the Emergency message exchange protocol. To efficiently deliver emergency messages, MCTRP uses Radio-I or Radio-II, depending on the case. This can be done through 4 steps. Firstly, when an RMN detects an accident, it sends an emergency message to its RFN by adopting CSMA/CA and using Radio-II. Secondly, the RFN node replies with an acknowledgement to the RMN, and then broadcasts the emergency message to all its RMNs using Radio-II. Thirdly, it also broadcasts the message to its neighboring DNs, SDNs, RFNs using Radio-I. Finally, neighboring RFNs rebroadcast the emergency message again to their RMNs using Radio-II.

The third sub-protocol is the Data Exchange Protocol. Two types of data commu-

communications exist: inter-ring data communications where packets are transmitted using CSMA/CA and intra-ring data communications where data packets are transmitted using a token based mechanism. After receiving a token, a node can transmit data during a token holding time and then pass the token to its successor.

Khalid A. Darabkh et al. have proposed a cross-layer algorithm to improve the AODV protocol over VANETs, named Multi Rate Mobility Aware Routing (MRMAR) [92]. The goal of MRMAR is to decrease the large number of RREQ control packets and to ensure fast data forwarding. MRMAR starts with a route discovery phase. The first step is rate selection from the underlying MAC layer, that aims at choosing the transmission rate with the highest value, which will be included in the RREQ. Then, the source broadcasts an RREQ with the chosen transmission rate. In the second step, before the recipient sends the RREQ, some tests have to be done. The recipient checks that it is not the intended destination, the RREQ is not duplicated and that the destination does not exist in its routing table. Then, the transmission rate of nodes situated between the source and the recipient is verified to prove their compatibility with the RREQ's optimal rate. The third step is to test mobility, the recipient node checks if its speed is less than a predefined threshold. Therefore, a RREQ will be broadcasted. The data rate admission, speed and direction, will be tested over intermediate nodes until reaching the destination. If these checks are verified, the recipient will participate in the route discovery phase, if not it will discard the RREQ. The following Table 3.3 presents a qualitative comparison of the cross-layer routing protocols cited above.

## 3.5 Hybrid communication

In the first chapter of the state-of-the-art, we have seen that there are two Radio Access Technologies (RAT) for connected vehicles: Cellular and DSRC technologies such as LTE and IEEE 802.11p respectively. These two technologies are complementary, for example, Cellular coverage is not always available and thus DSRC is suitable and vice-versa. Moreover, when the traffic density is high, the whole capacity of the radio can be reached, and in this case, VLC can be a good alternative to maintain the communication between vehicles grouped in a platoon. Researchers and manufacturers are trying to develop V2X solutions that integrate all these communication standards under a common hardware and software platform.

In fact, the platooning application needs a robust control with an efficient com-

Table 3.3: Qualitative comparison of cross layer routing protocols

	PDMAC [26]	OB-VAN [93]	MRMAR [92]	MCTRP [94]
Published	2019	2008	2019	2009
MAC	TDMA	CSMA Active signaling	CSMA	Token Ring CSMA
QoS parameters	Delay Throughput Packet loss PDR	Delay Bandwidth PDR	PDR Route Losses	Delay Throughput
Multiple route	No	No	Yes	No
Routing metric	Distance Direction	Distance	Transmission Rate Distance Speed Direction	Token holding time
Link Repair	No	No	Yes	No
Overhead	High	Low	High	High
Security	No	No	No	No
Mobility scenario	Highway	Straight road	Urban	Highway
Density	High	Low Medium	Low	High
Simulator	Toolbox [95]	NS2	NS3	NS2

munication strategy. Due to high QoS requirements in terms of update frequency (at least 10Hz) with a recommended transmission latency of 20 ms [96] [97], and a reliability of 99.99%, research tends to combine more than one communication technology. In the literature, many communication strategies have been proposed. Figure 3.9 and Figure 3.10 summarize the main communication strategies.

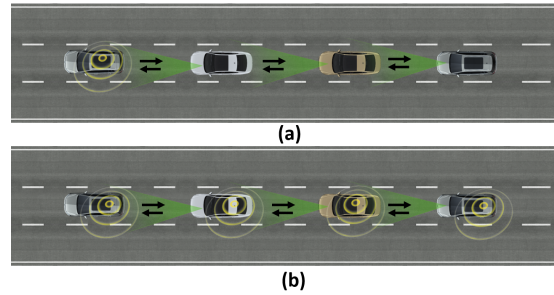

Figure 3.9: Communication strategy based on RF-VLC

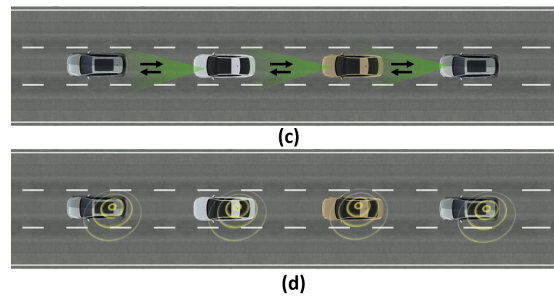

Figure 3.10: Communication strategy based on one communication technology

In Figure 3.9 (a) each platoon member is using V-VLC. Only the leader is using both V-VLC and RF to communicate with the followers. In Figure 3.9 (b) the platoon members are in redundant mode (both RF and V-VLC are being used). In Figure 3.10 (c) and (d) vehicles use only one vector at a time, either V-VLC or RF. Such an example can be found in [90] where Segata et al. propose IEEE 802.11p/IEEE 1609.4 PHY/MAC to manage the communication between vehicle members of a platoon. They suppose that each vehicle has the capacity to know its position in the platoon. The leader's beacon is used as a synchronisation signal to divide the time into slots. The number of slots depends on the size of the platoon, and the allocation of slots to vehicles will depend on their position with respect to the leader. The idea is to adapt the transmission power: the leader will use enough transmission power to reach

each follower, whereas the followers will adapt their power to reach only vehicles that need such data. This will reduce interference with other vehicles and increase spatial reuse.

Max Schettler et al. [91] propose implementing beaconing protocols for simulation following the above platooning communication strategies. The authors extend these V-VLC protocols with forwarding and acknowledgement mechanisms in order to enhance reliability. The acknowledgement is implemented at the application layer, the re-transmissions are done in the same way as in IEEE 802.11p (7 times). Several simulations were conducted based on a realistic model (Veins-vlc framework [109] [110]) and show the performance of each them in terms of received beacon ratio, beacon delay, critical time ratio, and VLC packet collisions.

On the one hand, strategy (b) is without any doubt the best in terms of performance, each platoon member relies on both RF and V-VLC. However, it is expensive in terms of radio bandwidth, which is a very valuable resource specially in the case of high density. On the other hand, strategy (a) can in fact give more packet losses, but it helps to enhance the quality of the radio channel as only the leader uses the radio resource. Strategies (c) and (d) suffer from packet loss, the acknowledgement introduced by the authors helps to reduce the packet loss.

## 3.6 Conclusion

In contrast to traditional networks, VANETs present special characteristics that lead to new networking problems. In particular, VANETs have very fast changes in network topology and density, and due to mobility, multi-hop routing is rarely available. There are a lot of other examples and phenomena that show that the classical architecture and protocol solutions adopted for MANETs become inefficient in a connected vehicular environment (MAC, routing, etc). All these features introduce new challenges for protocol designers, who tend to design fully distributed protocols (as they require less infrastructure and are, therefore, less costly). In this chapter we discuss protocols of different layers that have been tackled in this thesis, and provide a comparison between the most common protocols in the literature : MAC layer in VANETs, Cross-layer overview, and reliable hybrid communication for platooning control.

## Part II

# Low Latency Radio Communication



# New distributed TDMA based MAC protocol for vehicular networks

## Contents

---

<b>4.1</b>	<b>Introduction</b>	<b>47</b>
<b>4.2</b>	<b>Active signaling-based DTMAC protocol (AS-DTMAC)</b>	<b>47</b>
4.2.1	Hypotheses	47
4.2.2	Slot scheduling principle of AS-DTMAC	49
<b>4.3</b>	<b>Simulation results and performance evaluation</b>	<b>50</b>
4.3.1	Simulation scenarios and parameters	50
4.3.2	Simulation results	51
<b>4.4</b>	<b>Analytical evaluation and simulation results validation</b>	<b>57</b>
4.4.1	Homogeneous arrival	57
4.4.2	Bursts of traffic	61
4.4.3	Analysis of the convergence speed to steady-state	63
<b>4.5</b>	<b>Conclusion</b>	<b>64</b>

---

## 4.1 Introduction

As mentioned in the previous chapter, TDMA-based MAC protocols are advantageous for many aspects of VANETs. They can cope with the hidden-terminal problem, and guarantee a strict Quality-of-Service (QoS) to satisfy real-time applications. However, the initial assignment of time-slots to the vehicles can suffer from the access collision problem, which can frequently occur between vehicles trying to access the same time slots.

Motivated by this observation, in this chapter we focus on the problem of access collision in the time slot assignments of the DTMAC protocol, and present an enhanced version based on active signaling (AS-DTMAC, i.e. Active Signaling-DTMAC). Extensive simulations are conducted considering various traffic densities to demonstrate the performance of AS-DTMAC. In the second part of this chapter, we provide a detailed and accurate analytical model to study the performance of this protocol. As a by-product of our analysis, we show that AS-TDMAC is an excellent access scheme in VANETs with very good performance metrics.

## 4.2 Active signaling-based DTMAC protocol (AS-DTMAC)

### 4.2.1 Hypotheses

AS-DTMAC [6] is a fully distributed TDMA, which is mainly based on the DTMAC protocol [22]. Thanks to GPS technology, each vehicle is able to have information about its position and the exact time. This information is useful for the functionality of DTMAC. The main strategy of the DTMAC is to split the road into different zones ( $x_i, i = 1, \dots, N$ ) according to the communication range of the vehicles, denoted  $R$ . In this way, we can impose a new concept of slot reuse, which consists in reusing the slot spatially.

As shown in Figure 4.1, the vehicles in zone  $x_1$  can use the same set of slots as the vehicles in  $x_4$ . The only condition to this spatial reuse is that the distance between simultaneously transmitting vehicles must be greater than  $2 \times R$ . Furthermore, the slot scheduling table is updated each time a packet is sent by a vehicle. The packet sent contains a special field, named frame information, which specifies the status of the slots. Thus, it will be easy for all vehicles to select the available slots in the

next frame. DTMAC acts like a slotted Aloha protocol on the 'non-busy' slots of the frame. The principle of slot allocation in DTMAC is shown in Figure 4.2.

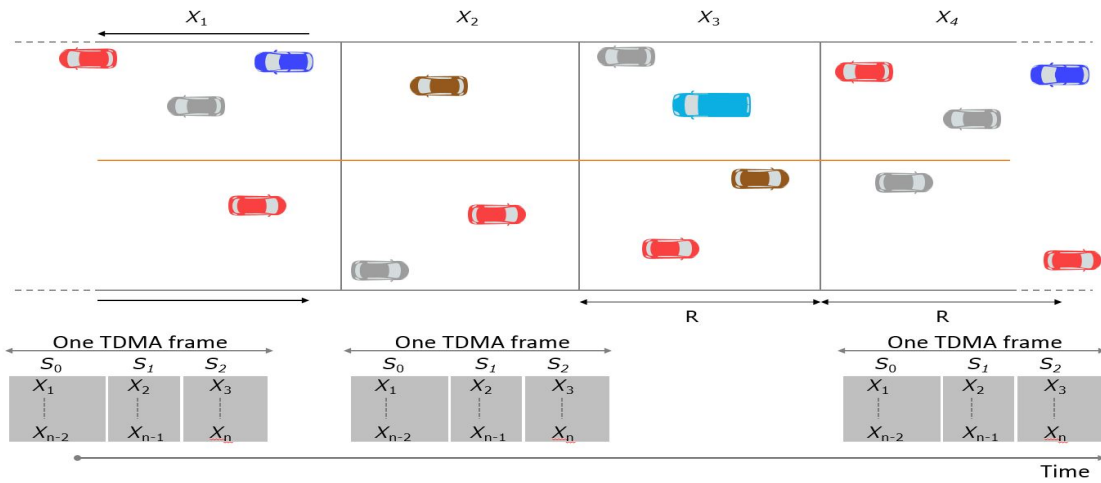

Figure 4.1: TDMA slots scheduling principle.

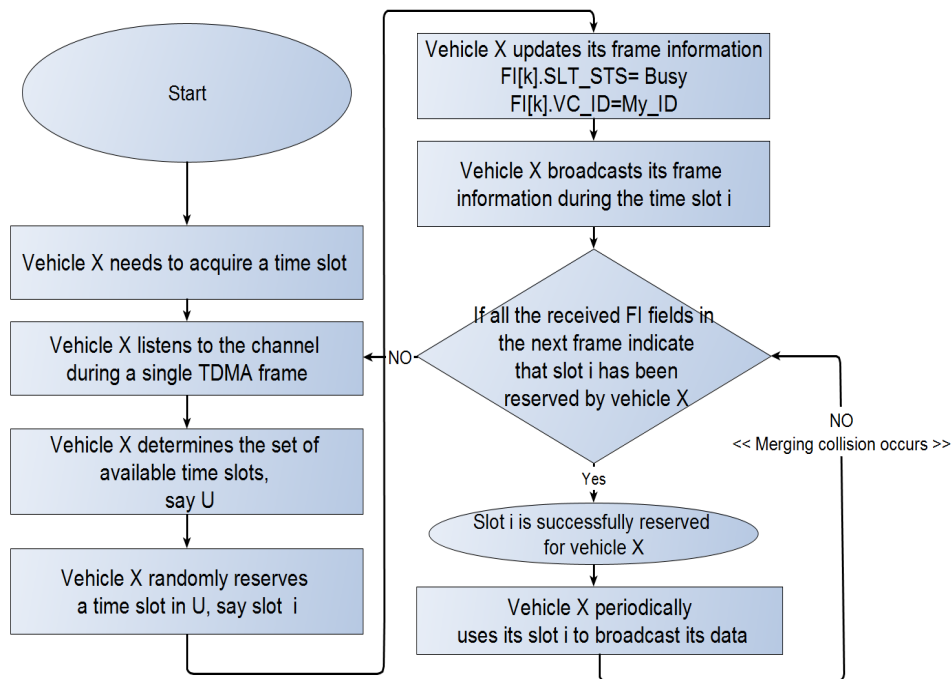

Figure 4.2: DTMAC protocol principle (FI Frame Information)

### 4.2.2 Slot scheduling principle of AS-DTMAC

The new version of the protocol (AS-DTMAC) aims to enhance the robustness of the background algorithm (DTMAC) against collisions by using the active signaling mechanism. Figure 4.3 illustrates the inclusion of this mechanism in the slot. During the signaling part of the packet, a selection process is carried out to obtain exactly one packet to be sent in the payload part of the slot. The active signaling part of the slot consists of  $n$  mini-slots, each of which could be a transmission or a listening period. This succession is dictated by a randomly generated binary key. ‘1’ means that the vehicle with a packet to send transmits during the signaling bursts. ‘0’ means that the vehicle with a packet to send senses the channel during this mini-slot. When a vehicle selects a listening period and senses a transmission, the competition to get the slot is over. For instance, a vehicle that draws the key ‘01001110’ will listen during the first mini-slot and if no competing transmission is sensed during this mini-slot, it will transmit during the next mini-slot. The following two steps in the selection process will be two listening periods. The selection process continues using the same rule until the key is completely used up, see Figure 4.4. We should note that the selection process depicted in this figure applies to a slot chosen using the random slot selection process of DTMAC (see Figure 4.2).

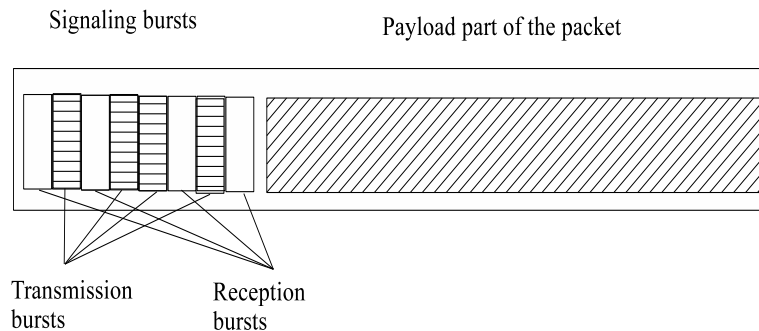

Figure 4.3: Slot structure of the Active Signaling mechanism

In the description above, we define the random standard access technique scheme for the active signaling. However, when a vehicle has an emergency message to transmit, the binary keys, which are initially completely random, will encompass a deterministic part represented by one bit. In this case, vehicles that require immediate access will set the first bit to ‘1’. Thus, these vehicles will have a guaranteed priority

access over the set of vehicles that are trying to get a slot using the standard scheme. These vehicles will keep the first bit set to '0'.

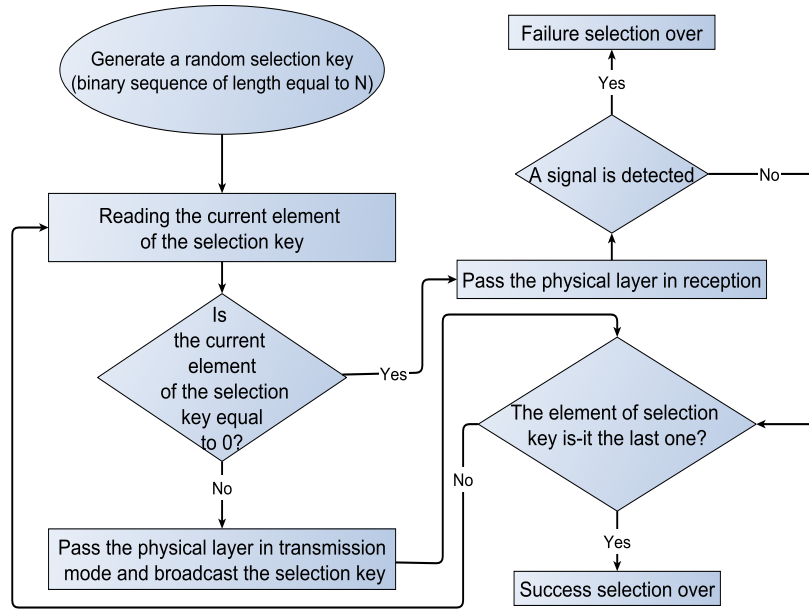

Figure 4.4: Active signaling

## 4.3 Simulation results and performance evaluation

In this section, we evaluate and compare the performance of AS-DTMAC and DT-MAC. The evaluation methodology and the scenarios are taken from [22].

### 4.3.1 Simulation scenarios and parameters

We use MOVE and SUMO [37] to generate vehicular traffic scenarios and to perform real vehicular mobility simulations, respectively (see Figure 4.5).

In our simulations, we consider a digital map to build a VANET environment close to real highway configurations taking into account lanes with different directions. In Figure 4.6, we can see a metropolitan area taken from a Map of San Jose (California) of size  $3000m \times 100m$ . This map was exported from OpenStreetMap (OSM) and adapted with the help of OpenStreetMap Editor (JOSM). The resulting roads are then populated with vehicles traveling in both directions. Each flow of vehicles is characterized by a set of parameters which consist of the starting and ending time of the flow, the initial point and the destination of the flow and the maximum

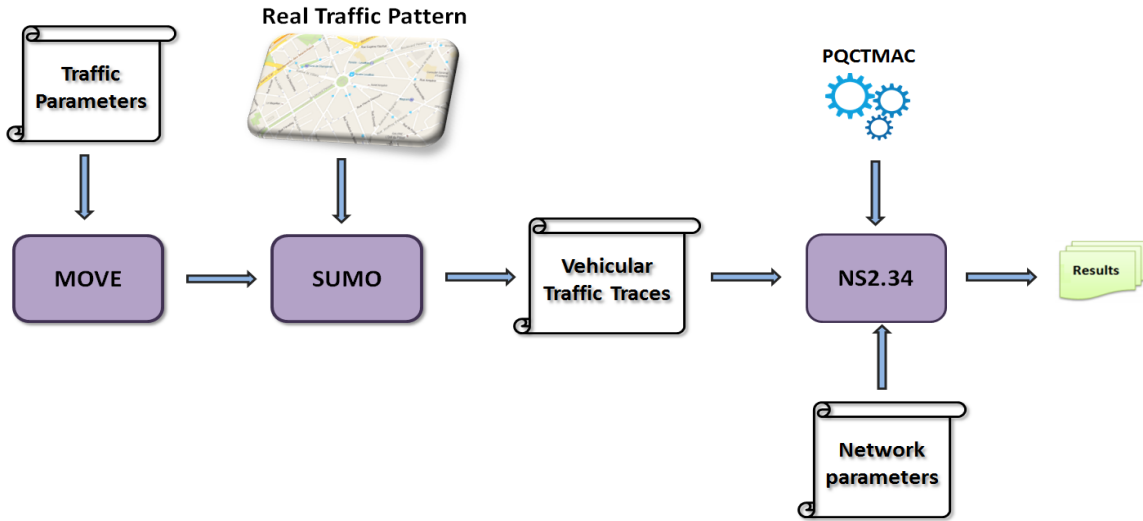

Figure 4.5: Simulation framework.

number of vehicles. In this environment, each vehicle is assigned a random speed between  $120\text{km/h}$  and  $150\text{km/h}$ . The resulting traffic traces generated by MOVE were injected into the Network Simulator *ns2.34*. Table I summarizes the simulation parameters used in our scenarios.

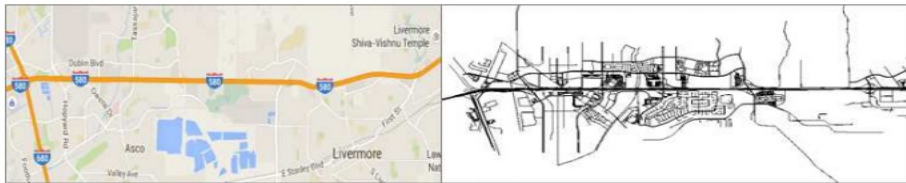

Figure 4.6: VANET network topology captured from Google MAP.

### 4.3.2 Simulation results

In this study, we use the same simulation parameters as those used in the previous study [22] and we vary the density of vehicles in the network. This parameter is called Area Occupancy (AO); the definition of this metric is given in [29]. We also introduce the following metrics:

- Overhead: is the total number (in bytes) of packets transmitted from one vehicle to another in order to maintain a collision-free schedule. It consists of the

Table 4.1: Simulation parameters

Parameter	Value
<i>Simulation duration</i>	120 (s)
<i>Speed</i>	120 (km/h)
<i>Speed standard deviation</i>	30 (km/h)
<i>Number of slots per frame (<math>\tau</math>)</i>	100
<i>Slot duration</i>	0.001 (s)
<i>Mini slot duration</i>	0.000025 (s)
<i>Highway length</i>	2.5 (km)
<i>The number of lanes per direction</i>	2
<i>The radio range (<math>R</math>)</i>	250 (m)

overhead of the basic protocol plus the additional bytes created in the burst of the signaling process. In our case, only the latter is computed.

- Number of slots acquired : this is the number of vehicles that have successfully acquired a time slot per frame.
- Average Access Time : this is the average time for a vehicle to access a slot in a given frame.
- Access collision rate : is defined as the average number of access collisions per slot and per area.

#### 4.3.2.1 Best length of the signaling interval

To tune the performance of our AS-DTMAC protocol, a preliminary study is necessary to determine the adequate number of mini-slots that will be used during the selection phase described in Section 4.2. In order to find that optimal number which guarantees a good compromise between the metrics, we plot the curves of the access collision rate, the overhead and the average access time versus the number of the mini-slots for different network loads. In fact, on the one hand, a high number provides a small access collision rate but, on the other hand, it significantly increases the number of control messages needed to establish and maintain a collision-free schedule.

The results of our study are given in Figures 4.7, 4.8 and 4.9. For example if we take

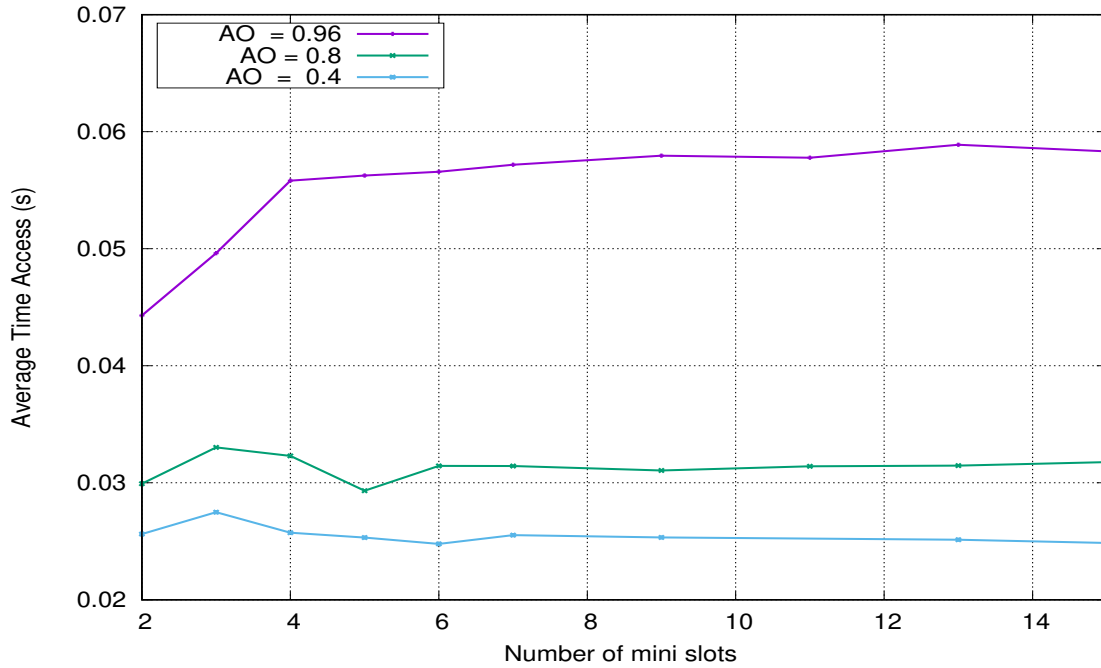

Figure 4.7: Average access time versus the number of mini slots

the value 4 as the number of mini slots, we have a lower access time and overhead, while the access collision is high. Also if we take a large  $n = 14$ , the access collision rate is very low but the overhead is significantly high. It is clear from these observations that the best compromise is located approximately for the number of bits in the transmission key:  $n \in [6, 10]$ , as there is an acceptable access latency, low access collision rate and it generates a reasonable overhead. For the rest of this section, using 9 mini-slots seems appropriate, as it requires less computing and presents good performance. In Figures 4.7, 4.8 and 4.9, we can also see that the network load significantly affects the above metrics, the more we increase it, the larger are the access time, the overhead, and the access collision rate.

#### 4.3.2.2 Comparison of DTMAC and AS-DTMAC

The aim of this sub-section is to compare the performance of DTMAC and AS-DTMAC in terms of the number of vehicles acquiring a time slot, access collision rate and, finally, the average access delay.

Figure 4.10 shows the slot allocation for the 10 first frames of DTMAC and AS-DTMAC with AO equal to 0.9. From this graph, we could conclude that DTMAC



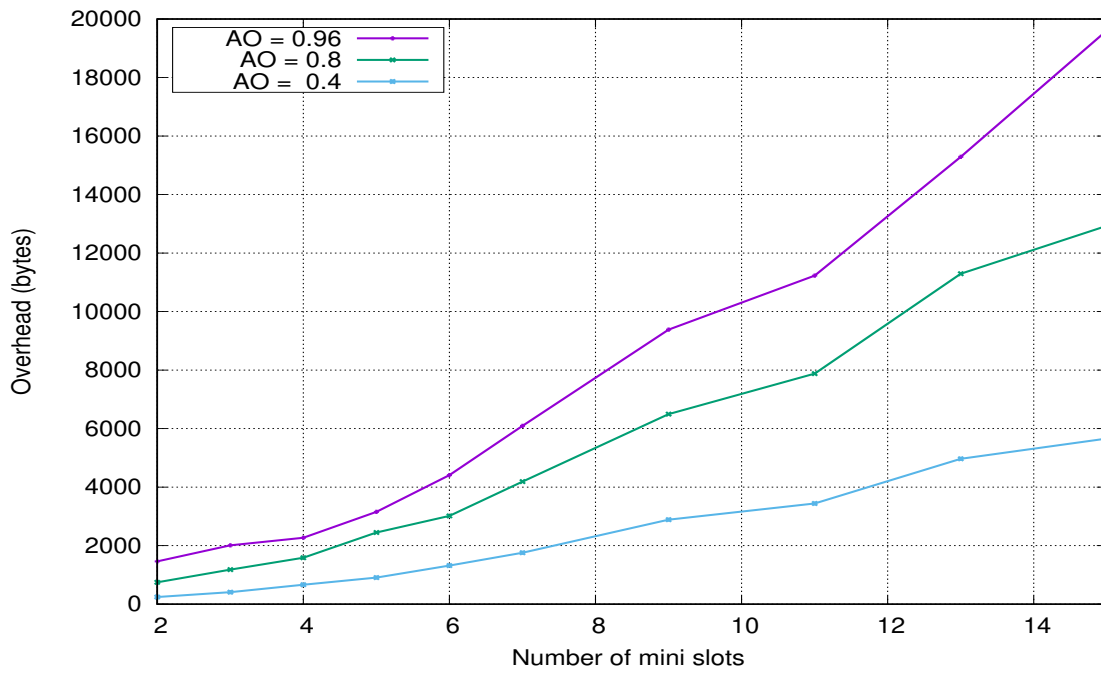

Figure 4.8: The overhead in bytes versus the number of mini slots

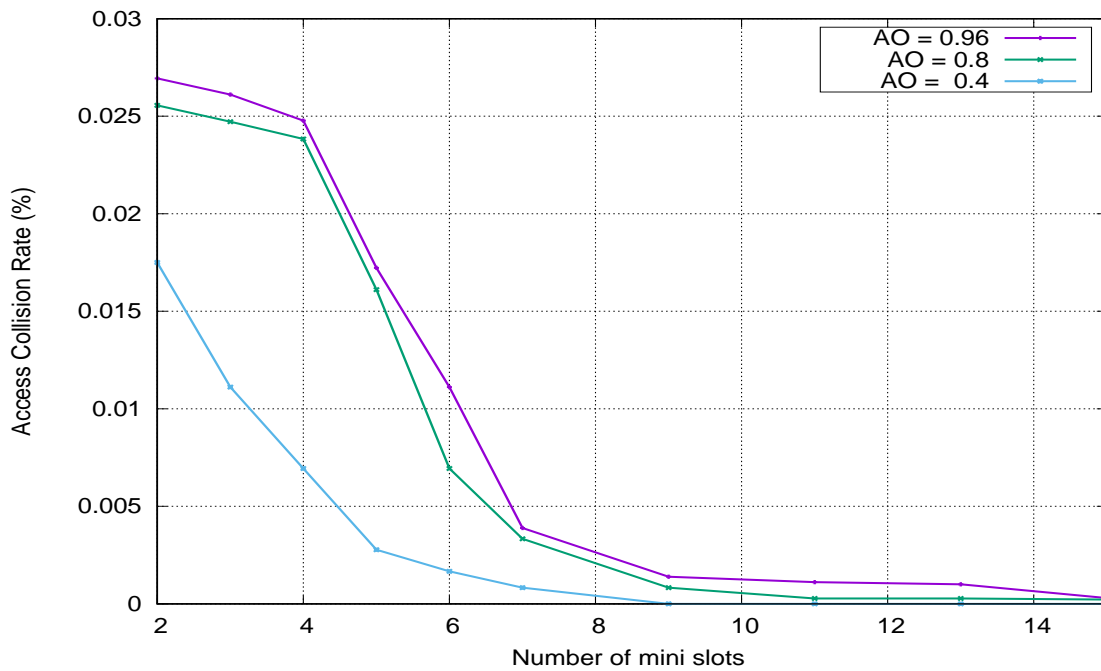

Figure 4.9: Access collision versus the number of bits of the transmission key

requires approximatively twice as many frames as AS-DTMAC to obtain a reservation for each vehicle in the network. In fact, when the number of frames is equal to 2 in AS-DTMAC, 93 % of vehicles have successfully reserved a slot, whereas only 5% of vehicles were able to reserve a slot using the DTMAC protocol.

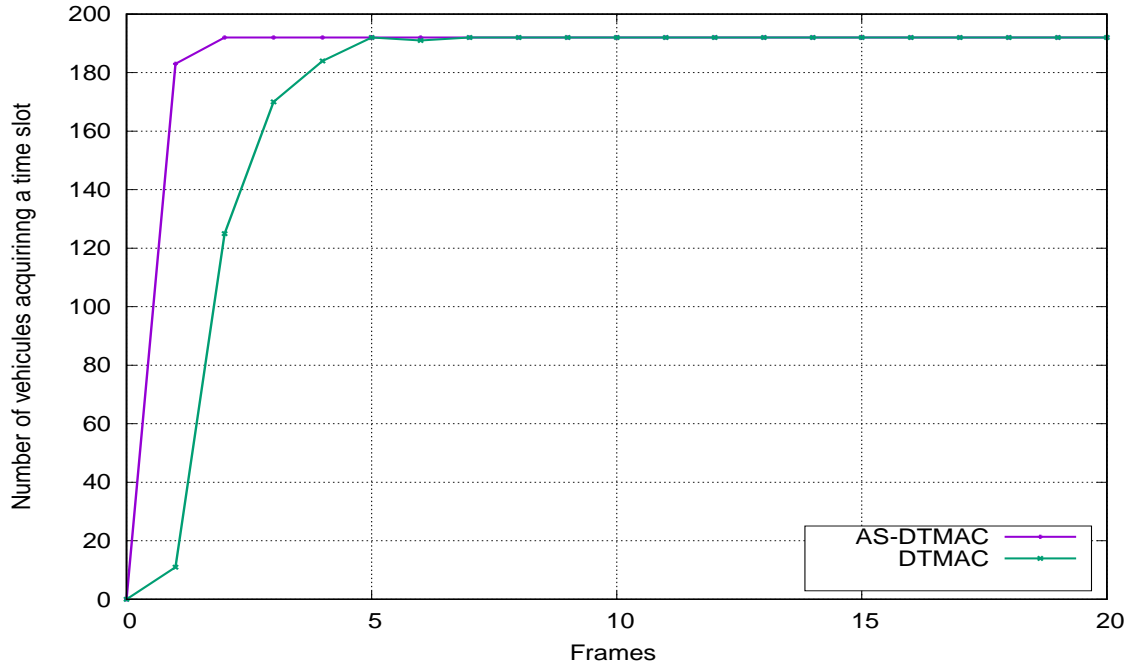

Figure 4.10: Number of vehicles acquiring a time slot within  $N$  frames.

Figure 4.11 (plotted in logscale) presents the percentage of access collisions for DTMAC and AS-DTMAC. It is clear that the difference between the two curves is roughly of three orders of magnitude, which is evidently a very significant result. For instance, if we take the  $[0.4, 0.7]$  interval of AO, we observe that the difference in the access collision rate using DTMAC and AS-DTMAC is very large and almost the same for all the values (e.g at the value 0.4, the access collision rate is 0.00015 for AS-DTMAC whereas it is nearly 0.03 when the DTMAC protocol is used).

Figure 4.12 illustrates that AS-DTMAC provides a significantly smaller access delay than DTMAC. As we can see, the difference in time between the two protocols stays relatively the same, except for the two last values where the load of the network AO is very high (0.9 and 0.96).

In [22] it is shown that DTMAC significantly outperforms VeMAC [29] which is very well-known TDMA protocol for VANETs in the literature. As we have used the

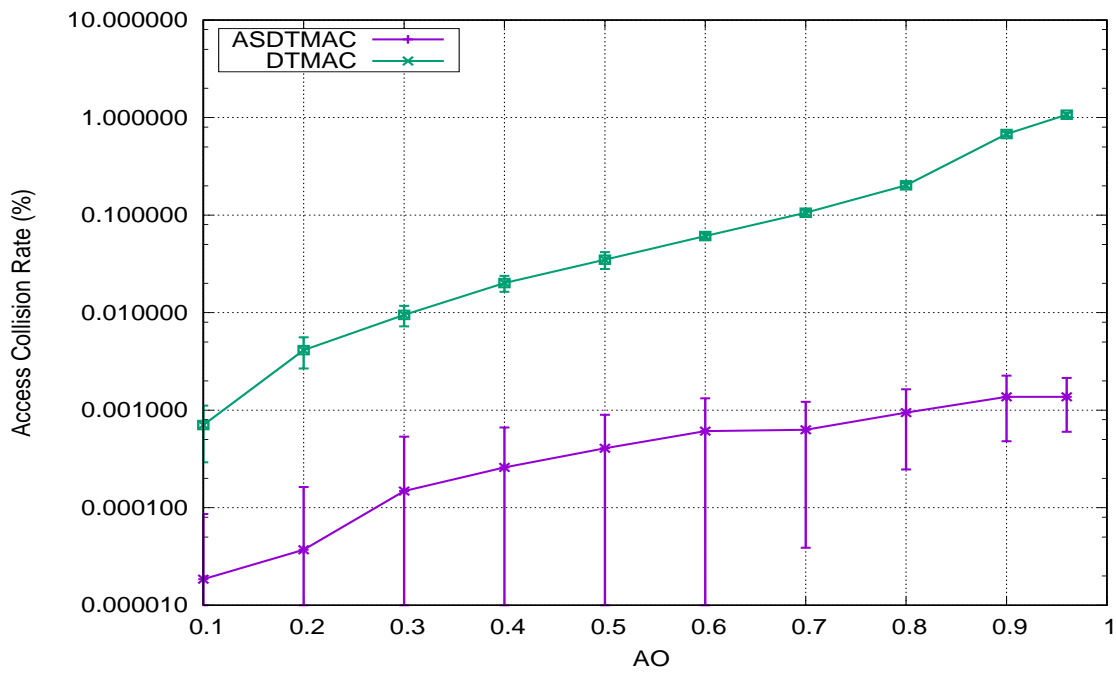

Figure 4.11: Access collision versus channel occupancy for DTMAC and AS-DTMAC with error bar (95% confidence interval).

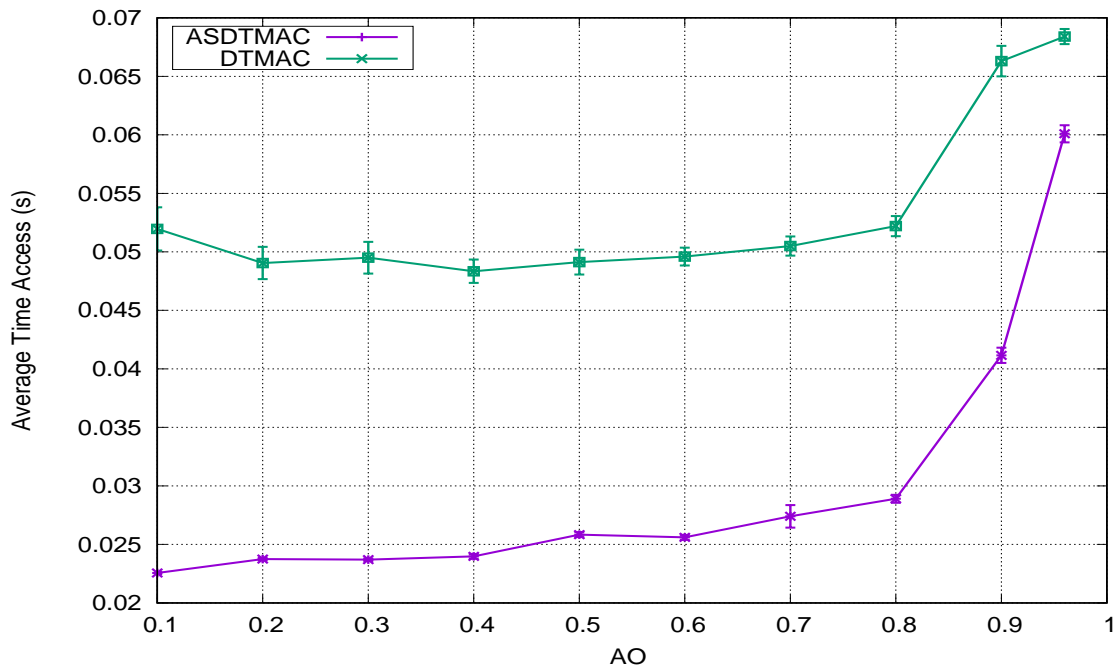

Figure 4.12: Average access time versus channel occupancy for DTMAC and AS-DTMAC with error bar (95% confidence interval).

same simulation tools and the same scenarios as those used in [22], we can ensure by transitivity that AS-DTMAC outperforms VeMAC and similar TDMA schemes.

## 4.4 Analytical evaluation and simulation results validation

In this section, we build an analytical model for AS-DTMAC and compare the performance given by this model to the simulation results. We use the same simulation scenario and parameters defined in [6], except for the time of the simulation, which was limited to 100ms (one frame).

We distinguish two cases: in the first case we have an homogeneous arrival on each slot; in the second case there is a burst of very urgent messages arriving. The first case covers the default case where the vehicles try to randomly select a free slot for their transmissions; active signaling is used to avoid a collision when two or more vehicles select the same slot. This is the access for ‘standard’ vehicles. The second case is to enable a low latency access to a few sporadic packets. In this second case a special choice of the transmission key must be made in order to favor the urgent packets. This is the access for ‘emergency’ vehicles. In the last part of this study, we evaluate the speed of convergence of the protocol i.e. the percentage of successfully reserved slots after each of the protocol frames.

### 4.4.1 Homogeneous arrival

The model uses a random access technique for each free slot. The vehicles use the FI field to discover the available free slots and select one of them at random. Thus the arrival of a transmission on each free slot can be modeled as a Poisson process of rate  $\lambda$ . The probability that there are  $k$  transmission attempts during this slot is:

$$\frac{\lambda^k}{k!} \exp(-\lambda).$$

We assume that we have a binary key of  $n$  bits or, in other words, the signaling scheme encompasses  $n$  mini-slot intervals. Our goal is to compute the probability that at the end of the selection only one vehicle has been selected to transmit.

To ease the computation, we will assume that the transmission key of a node is randomly generated between 0 and  $2^n - 1$ , which means that after each transmission

in a mini-slot a vehicle which is still in the selection process will transmit in the next mini-slot with probability  $1/2$  and will listen with probability  $1/2$ .

Let us suppose that we have  $k$  vehicles at the beginning. Our aim is to compute the probability that  $j$  vehicles are still in the selection process after the mini-slot  $i$ , we denote this probability by  $\alpha_i^j$ . To perform this task, we use the generating function  $A_i(x)$  of the remaining contenders after the  $i$ th selection mini-slot. By definition we have:

$$A_i(x) = \sum_{j=0}^{\infty} \alpha_i^j x^j.$$

It is easy to establish that

$$A_0(x) = x^k.$$

And we can observe that

$$A_1(x) = A_0\left(\frac{x}{2} + \frac{1}{2}\right) + A_0\left(\frac{x}{2}\right) - A_0\left(\frac{1}{2}\right).$$

The correction term  $A_0\left(\frac{x}{2}\right) - A_0\left(\frac{1}{2}\right)$  is just to take into account the fact that when the  $k$  vehicles select a listening period, none of them is rejected by the selection process and we still have  $k$  contenders after this step of the selection process.

Similarly we have the recursion for  $i \in 0, \dots, n-1$ :

$$A_{i+1}(x) = A_i\left(\frac{x}{2} + \frac{1}{2}\right) + A_i\left(\frac{x}{2}\right) - A_i\left(\frac{1}{2}\right)$$

Thus using this recursion formula, it is easy to compute  $A_1(x), A_2(x), \dots, A_n(x)$  for instance using Maple. To show one example, we can fix  $k = 3$  and  $n = 5$ . We obtain the results shown in Table 4.2 below. After the 5th round of mini-slot selection, the probability that there are still three contenders is  $\frac{1}{1024}$ , the probability that there are still two contenders is  $\frac{93}{2048}$  and exactly one contender  $\frac{1953}{2048}$ . If the selection process stops after the 5th round the probability that the process is successful is :

$$\frac{1953}{2048} \simeq 0.954,$$

and the probability of collision is:

$$1 - \frac{1953}{2048} \simeq 0.0464.$$

$i$	$a_k^i$	$a_0^i$	$a_1^i$	$a_2^i$	$a_3^i$
$i = 0$	0	0	0	0	1
$i = 1$	0	0	$\frac{3}{8}$	$\frac{3}{8}$	$\frac{1}{4}$
$i = 2$	0	0	$\frac{21}{32}$	$\frac{9}{32}$	$\frac{1}{16}$
$i = 3$	0	0	$\frac{105}{128}$	$\frac{21}{128}$	$\frac{1}{64}$
$i = 4$	0	0	$\frac{465}{512}$	$\frac{45}{512}$	$\frac{1}{256}$
$i = 5$	0	0	$\frac{1953}{2048}$	$\frac{93}{2048}$	$\frac{1}{1024}$

Table 4.2: Different phases of the selection process

In the general case, the probability of collision after the end of the signaling period is

$$\sum_{j=2}^{\infty} a_j^n = 1 - a_0^n - a_1^n = 1 - A_n(0) - A'_n(0)$$

since  $\sum_{j=0}^{\infty} a_j^n = 1$ . We can notice that  $A_n(0) = a_0^n = 0$ . Thus if we denote by  $A_n^k(x)$  the generating functions obtained with the above recursive procedure starting with  $A_0(x) = x^k$ , we can obtain  $P_n(\lambda)$  the probability of collision with a signaling burst of length  $n$  given that we have at least one vehicle attempting to transmit during a slot. We have the following formula:

$$P_n(\lambda) = \frac{1}{1 - \exp(-\lambda)} \sum_{k=0}^{\infty} \frac{\lambda^k}{k!} \exp(-\lambda) \left(1 - A_n^k(0) - A_n^{k'}(0)\right).$$

We use the model developed above to compute the collision probability versus the channel load. In Figure 4.13, we have the collision probability versus the channel load for  $n = 4, 6, 8, 10$ . The error bars in black are for a 95% confidence interval. We observe that for  $\lambda = 1$  and for  $n = 4$  the probability of collision is already small (around 0.02), This probability can be extremely small for  $n = 10$ : around 0.0005. In Figure 4.13 we also observe a very good matching between the analytical and simulation results.

In Figure 4.14, we compare the collision probability versus the channel load for DTMAC and for DTMAC enhanced by an active signaling scheme with  $n = 8$  mini-

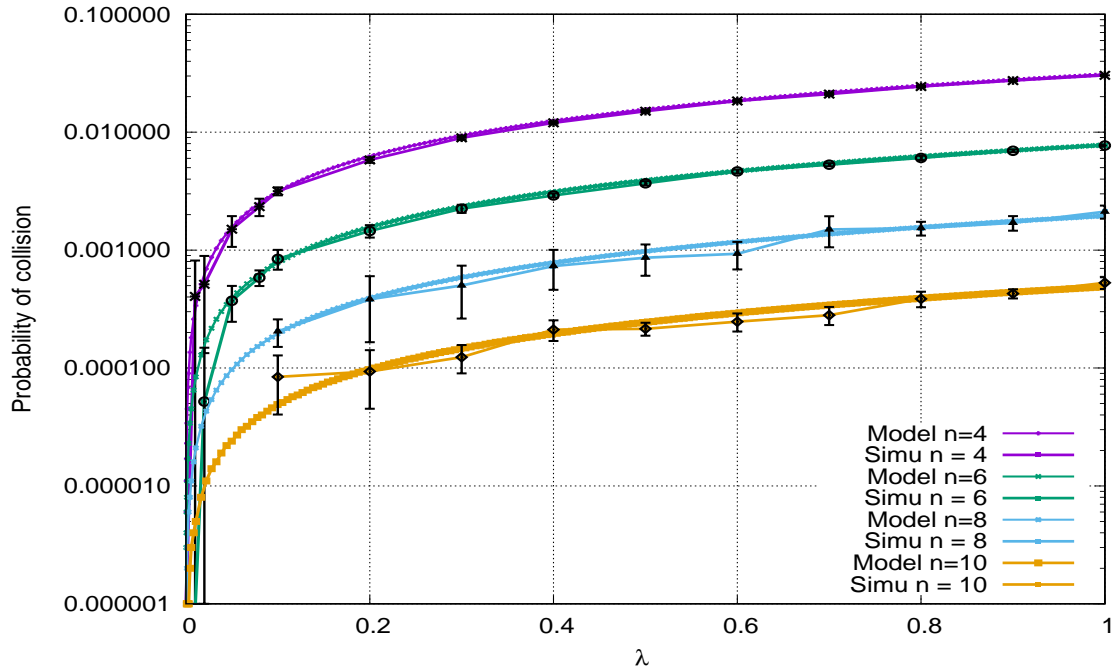

Figure 4.13: Collision probability versus channel load.

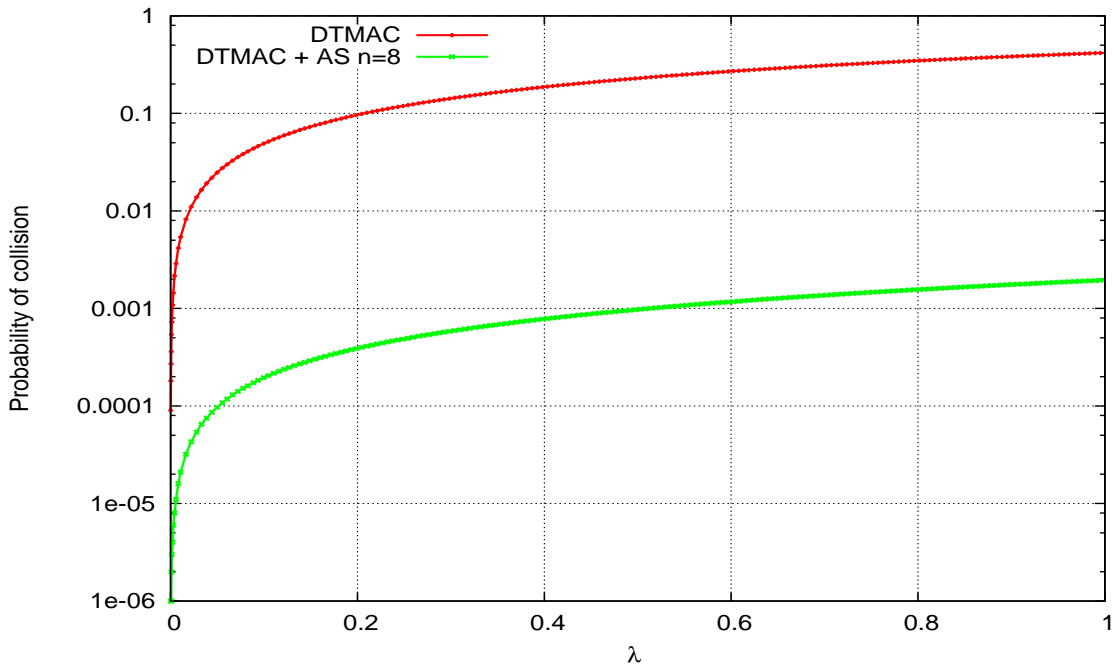

Figure 4.14: Collision probability versus channel load.

slots. We observe that the gain in the probability of collision is in the order of  $10^3$ . This is a huge gain which clearly shows the interest of the signaling scheme.

### 4.4.2 Bursts of traffic

In this case we have a burst of  $k$  arrivals of urgent (and sporadic) packets on a given slot and we assume that there are no other competitors. Such an effect can be obtained if we use a dedicated first bit in the transmission key. We use a first bit set to 1 in the transmission key for the  $k$  urgent packets whereas the first bit is set to 0 for the default packets. Doing so, after the first signaling interval, there will be competition between  $k$  urgent packets. In this part we focus on the transmission of these  $k$  urgent packets. We use the simple persistent protocol in which each of the  $k$  pending packets successively uses the coming slot until the packets are successfully transmitted. According to the computations above, the probability of collision when there are  $k$  packets competing for a slot is:

$$\epsilon_k = 1 - A_k(0) - A'_k(0)$$

We call  $T_k$  the mean number of slots until the  $k$  packets are successfully transmitted. We have the following recursion

$$T_k = 1 + (1 - \epsilon_k)T_{k-1} + \epsilon_k T_k$$

Thus we have the following equation:

$$T_k = T_{k-1} + \frac{1}{(1 - \epsilon_k)}.$$

Similarly for  $2 \leq j \leq k$  we obtain:

$$T_j = T_{j-1} + \frac{1}{(1 - \epsilon_j)}$$

and of course  $T_1 = 1$ . The resolution leads to

$$T_k = 1 + \sum_{j=2}^k \frac{1}{(1 - \epsilon_j)} = \sum_{j=1}^k \frac{1}{(1 - \epsilon_j)}.$$

Note that since  $\epsilon_1 = 0$ ,  $\frac{1}{(1 - \epsilon_1)} = 1$ .

The exact distribution of  $T$ , the necessary number of slots until all the  $k$  transmissions are successful is given below:

$$Prob(T = k) = \prod_{j=1}^k (1 - \epsilon_j)$$



$$Prob(T = k + m) = \prod_{j=1}^k (1 - \epsilon_j) \sum_{m_1 + \dots + m_k = m} \epsilon_1^{m_1} \dots \epsilon_k^{m_k}$$

The proofs of these formulas are simple. For the first formula the probability is exactly the probability that during the  $k$  successive transmissions there is no collision. Since at each transmission the number of contending nodes decreases by 1, the result is straightforward. Note that  $\epsilon_1 = 0$  is left for the symmetry of the formula.

For the second formula the probability is exactly the probability that, to obtain  $k$  successful transmissions, we encounter exactly  $m$  collisions. We have to distribute these  $m$  collisions into  $m_1, \dots, m_k$  collisions such as  $m_1 + \dots + m_k = m$  and some transmissions  $j$  can be without collision in that case  $m_j = 0$ . Note that  $\epsilon_1 = 0$  and that necessarily  $m_1 = 0$  the terms  $(1 - \epsilon_1)$  and  $\epsilon_1^{m_1} = 1$  are left for the symmetry of the formula.

Figure 4.15 presents the cumulative distribution function of the number of slots required for a burst of 10 urgent packets for  $n = 6$  and  $n = 10$ . We observe that AS-TDMAC is very quick to successfully send all the packets even with  $n = 6$ .

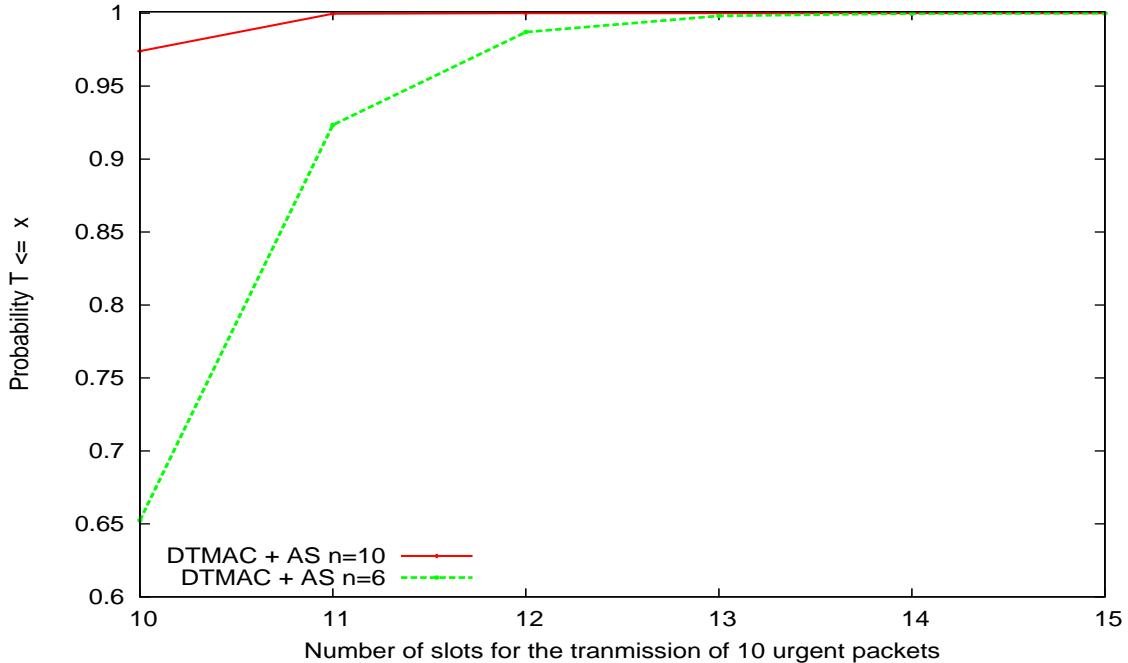

Figure 4.15: Cumulative distribution function of the number of slots required for the 10 urgent packets.

### 4.4.3 Analysis of the convergence speed to steady-state

For DTMAC and AS-DTMAC, the access is organized in frames of slots. For the first frame we assume that the vehicles select a slot in the first frame at random. To simplify the analysis, we assume that the transmission attempts on the slots follow a Poisson process. Some competitors acquire a slot in this first frame. The competitors in collision during the first frame perform another attempt in the second frame in the remaining free slots.

#### 4.4.3.1 DTMAC with active signaling

This analysis is for the first transmission attempt when the vehicles compete to obtain a slot. We observe that the probability of collision is very small, which means that nearly all the slots where there is at least one transmission is a success. The mean number of successful transmissions on a given slot is  $S_r$ :

$$S_r(\lambda) = \sum_{k=1}^{\infty} \frac{\lambda^k}{k!} \exp(-\lambda) A_n^{k'}(0) \simeq 1 - \exp(-\lambda)$$

We initialize  $S_r = S_r(\lambda)$  which is the success rate during the first frame. We assume that the competitors that have not been able to find a slot during the first frame still form a Poisson process of rate

$$\lambda - S_r$$

but are competing on the slots not already acquired by the selection process. We compute the intensity of this process (step 1); it is:

$$\lambda_1 = \frac{\lambda - S_r}{1 - S_r}$$

and the success rate is:

$$S_r(\lambda_1)$$

and the additional packet success rate is:

$$S'_r = \frac{S_r(\lambda_1)}{\lambda_1} * (\lambda - S_r)$$

$$S'_r = S_r(\lambda_1) * (1 - S_r(\lambda)).$$

We can continue the algorithm by updating  $S_r$  :

$$S_r = S_r + S'_r$$

which is the total success rate during the second frame. We can return to step 1 to compute the total success rate in the coming frame. The process continues iteratively.

### 4.4.3.2 DTMAC alone

The analysis is the same except that the success rate with DTMAC appears when a slot is only requested by a single competitor, thus the success rate is:

$$S_r(\lambda) = \lambda \exp(-\lambda).$$

We initialize  $S_r = S_r(\lambda)$  which is the success rate in the first frame. We compute the intensity of the competitors requesting a slot<sup>1</sup> in the next frame: frame 2 (step 1), it is still:

$$\lambda_1 = \frac{\lambda - S_r}{1 - S_r}$$

and the success rate is:

$$S_r(\lambda_1)$$

and the additional packet success rate is:

$$S'_r = \frac{S_r(\lambda_1)}{\lambda_1} * (\lambda - S_r)$$

$$S'_r = S_r(\lambda_1) * (1 - S_r(\lambda)).$$

We can continue the algorithm by updating  $S_r$  :

$$S_r = S_r + S'_r.$$

We can return to step 1 to compute the total success rate in the coming frame. The process continues iteratively.

We can see in Figure 4.16 below the percentage of slots acquired by DTMAC and DTMAC with AS with respect to the index of the frame; the error bars in black are for a 95% confidence interval. We have assumed a highly loaded channel ( $\lambda = 0.96$ ). DTMAC with AS requires 5 frames to successfully reserve the input load. DTMAC alone requires twice as many frames i.e. 10 frames. We note a good matching between the simulation and analytical results.

## 4.5 Conclusion

In this chapter, we enhanced the DTMAC protocol by integrating active signaling. The simulation results show that AS-DTMAC drastically reduces the access collision

<sup>1</sup>not already acquired during the previous frames.

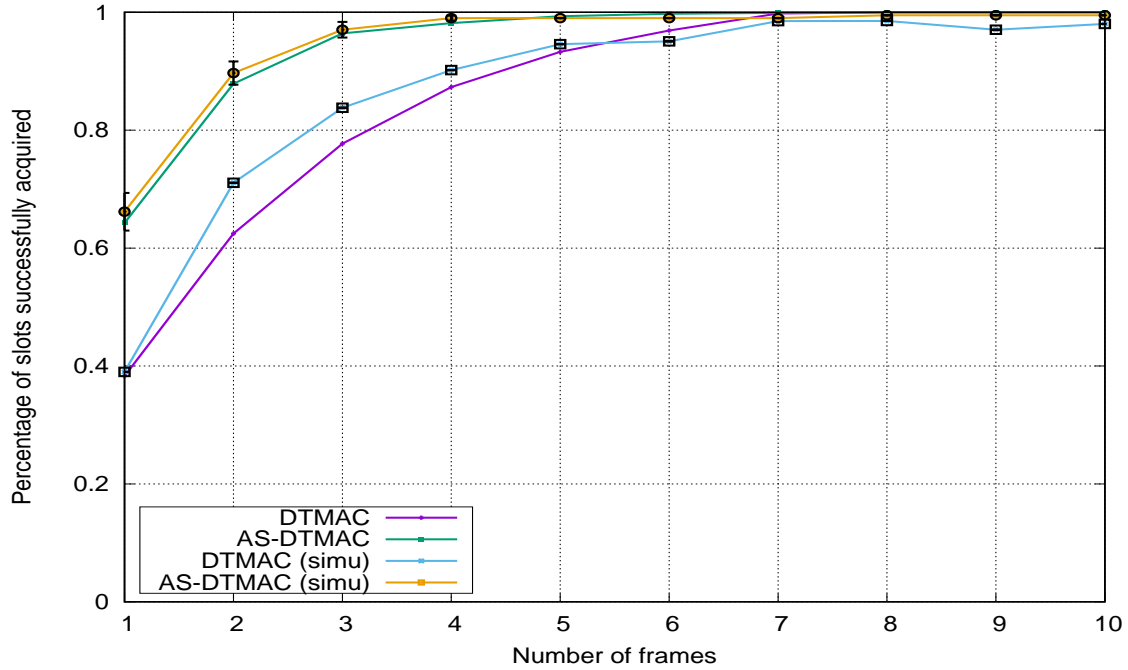

Figure 4.16: Convergence towards the steady state,  $\lambda = 0.96$ .

rate and allocates slots to all the vehicles in the network in half the time it takes DTMAC to do so. We also presented a use case in the V2V for urgent and high priority traffic messages like DENMs, that can help to avoid an accident. All these new features are very important for the future technology.

Furthermore, we developed an analytical model to analyze the AS-DTMAC protocol and to compared it with DTMAC. This model, based on the use of generating functions, can be very simply exploited to obtain very good performances. We studied the collision rate of AS-DTMAC when the vehicles randomly select their slots in the time frame (the normal condition of the protocol). We also investigated the number of time frames needed to obtain a collision free slot for all the vehicles in the network. The transmission conditions of urgent packets which are sent persistently until successful were also studied with an analytical model. The distribution of the duration of such a process was computed. The simulations confirm the results of the analytical model and the very good performances of AS-DTMAC in terms of collisions and convergence to a steady state. The transmission of urgent packets is also very efficient.

In the next chapter we focus on the study of the AS-DTMAC protocol in more specific conditions, especially by introducing error into the analytical model presented

---

in this chapter during the selection process. Moreover, we will provide the exact definition of the signaling burst with the computation of miss detection in the selection process by using a detection model based on the Generalized Likelihood Ratio Test (GLRT) detection algorithm.

# Chapter 5

## Physical and MAC Layer Design for Active Signaling Schemes in Vehicular Networks

### Contents

---

<b>5.1</b>	<b>Introduction</b>	<b>68</b>
<b>5.2</b>	<b>Background and motivation</b>	<b>68</b>
<b>5.3</b>	<b>AS-DTMAC with Homogeneous arrival and error in the signaling process mechanism</b>	<b>69</b>
<b>5.4</b>	<b>Handling Emergency traffic in AS-DTMAC</b>	<b>75</b>
<b>5.5</b>	<b>Evaluation of missed detection for an active signaling mechanism</b>	<b>76</b>
5.5.1	OFDM preamble	76
5.5.2	Signal detection strategy	76
5.5.3	Simulation results	81
<b>5.6</b>	<b>Conclusion</b>	<b>87</b>

---

## 5.1 Introduction

Nowadays, many telecommunication systems (wifi, cable systems and 4G, 5G cellular networks) use Orthogonal Frequency Division Multiplexing (OFDM) as the physical layer standard. The design of efficient OFDM signal detection algorithms is very important to provide reliable systems, and this is particularly true for Vehicular Ad-hoc Networks (VANETs) involving autonomous vehicles, where missing a signal or detecting a false one may cause a dangerous situation. The performance of these algorithms is generally evaluated in terms of their robustness against noise. As described before, the Active Signaling mechanism uses short signals (bursts), and thus needs a reliable detection on the receiver side in order to guarantee good functionality of the selection process.

In this chapter, we first analytically study the performance of AS-DMTAC when we have a homogeneous arrival on each time slot with an error in the signaling process. After, we evaluate the probability of error in signal detection in order to establish the minimum length of the preamble needed for the active signaling process. Thus, by reducing the length of the preamble, greater time is left for the payload part of the packet, resulting in increased throughput.

## 5.2 Background and motivation

In the previous chapter, we proposed an active signaling DTMAC protocol (AS-DTMAC), which is an improved version of a fully distributed TDMA-based MAC protocol for VANETs named DTMAC [22]. This active signaling mechanism drastically reduces the access collision rate, thereby leading to major gains in latency. In addition, we also built a special access scheme for emergency messages.

The performance of AS-DTMAC was confirmed through simulation. In previous chapter, we developed an analytical model to analyze AS-DTMAC based on a generating function. We studied the performance in terms of collision rate, the number of time frames needed to obtain a collision free slot for all the vehicles and the transmission conditions of urgent packets. The simulations confirmed the results of the analytical model and the very high performances of AS-DTMAC in terms of collisions and convergence to a steady state. The transmission of urgent packets is also very efficient. In this chapter, we complete this study by injecting into the model the errors that can occur during the signaling process. The model takes into account a

missed detection of the burst in the transmission and shows the effect of this on the collision rate.

Detecting a weak signal from a transmitter is very challenging. In the literature, researchers have tackled this issue by using different techniques. We can cite at least three well-known algorithms [66]: Energy Detector (ED), Matched Filter Detector (MFD) and Cyclostationary. ED, as its name implies, uses energy detection of the received signal and compares it to a threshold in order to obtain the sensing decision. The main drawback of this technique is that it gives low precision [67]. Due to low computational cost, this technique is used in IEEE 802.11p. The matched filter, uses the cross-correlation between the received signal and the saved pilot to detect the presence of the signal. This means that we must know the signal that we want to detect, and therefore, it is not suitable for all signal detection applications. Auto-correlation between the received signal and a delayed version of it, makes the kind of signal to detect less important. As the noise is uncorrelated, this technique can easily take the decision from the observation. But this process needs a large number of samples to insure a good performance. The cyclostationary detector exploits the cyclical aspect of signals over time.

### 5.3 AS-DTMAC with Homogeneous arrival and error in the signaling process mechanism

In this section, we use the same simulation tools and scenarios as those used in the last chapter. We also take the same assumptions for the model. We complete this study by injecting into the model the errors that occur during the signaling process.

We assume again that the arrival in each slot is a Poisson process of rate  $\lambda$ . Thus the probability that there are  $k$  transmission attempts during this slot is still

$$\frac{\lambda^k}{k!} \exp(-\lambda).$$

We assume that we have a binary key of  $n$  bits or, in other words, the signaling scheme encompasses  $n$  mini-slot intervals. We want to compute the probability that at the end of the selection process only one vehicle has been selected to transmit. We still assume that the transmission key of a node is randomly generated between 0 and  $2^n$ , which means that after each transmission in a mini-slot a vehicle that is still in the selection process will transmit in the next mini-slot with probability  $1/2$  and will listen with probability  $1/2$ .



But, here, we introduce error into the selection process. We assume that during a mini-slot selection a vehicle that is listening can miss the transmission of another vehicle with probability  $\epsilon_1$ , in other words the concurrent transmission in the mini-slot will be sensed with probability  $1 - \epsilon_1$ . Conversely, during a listening period, we assume that with probability  $\epsilon_2$  a vehicle in a listening period will sense a concurrent transmission during the mini-slot whereas there is actually no transmission. We assume that the errors occur independently.

Let us suppose that we have  $k$  vehicles at the beginning. Our aim is to compute the probability that  $j$  vehicles are still in the selection process after mini-slot  $i$ . We denote this probability by  $b_i^j$ . To perform this task, we use the generating function  $B_i(x)$  of the remaining contenders after the  $i$ 'th selection mini-slot. By definition we have:

$$B_i(x) = \sum_{j=0}^{\infty} b_i^j x^j$$

It is easy to establish that

$$B_0(x) = x^k$$

and we can observe that

$$B_1(x) = B_0\left(\frac{1}{2}x + \frac{1}{2}((1 - \epsilon_1) + \epsilon_1 x)\right) - B_0\left(\frac{1}{2}((1 - \epsilon_1) + \epsilon_1 x)\right) + B_0\left(\frac{1}{2}(\epsilon_2 + (1 - \epsilon_2)x)\right).$$

We have:

$$B_1\left(\frac{x}{2} + \frac{1}{2}((1 - \epsilon_1) + \epsilon_1 x)\right) = \sum_{j=1}^k \binom{k}{j} \frac{1}{2^{k-j}} x^{k-j} \frac{1}{2^j} ((1 - \epsilon_1) + \epsilon_1 x)^j.$$

$\binom{k}{j} \frac{1}{2^{k-j}} \frac{1}{2^j}$  gives the probability that  $k - j$  contenders transmit a burst whereas  $j$  contenders are in listening mode. With this probability, the generating function must be  $x^{k-j}((1 - \epsilon_1) + \epsilon_1 x)^j$  for  $j \neq k$ . In fact, we have directly  $k - j$  selected nodes but, among the  $j$  nodes which are in listening mode, with a probability  $\epsilon_1$  they remain selected, whereas, with probability  $1 - \epsilon_1$ , they are rejected. This explains the transition formula except for the case where  $j = k$  and we need a correction term to handle this. The correction term is:

$$-B_0\left(\frac{1}{2}\left((1 - \epsilon_1) + \epsilon_1 x\right)\right) + B_0\left(\frac{1}{2}\left(\epsilon_2 + (1 - \epsilon_2)x\right)\right)$$

$-B_0\left(\frac{1}{2}\left((1 - \epsilon_1) + \epsilon_1 x\right)\right)$  is just to remove the case where  $j = k$  in the development of  $B_1\left(\frac{x}{2} + \frac{1}{2}\left((1 - \epsilon_1) + \epsilon_1 x\right)\right)$ . The other term corresponds to the case where all  $k$  contenders are in listening mode. Since we have assumed the probability of false alarms on burst detection, for the  $k$  remaining contenders, they are rejected with probability  $\epsilon_2$  and they remain in the selection process with probability  $1 - \epsilon_2$ . This explains the contribution  $B_0\left(\frac{1}{2}\left(\epsilon_2 + (1 - \epsilon_2)x\right)\right)$  in the transition formula.

Similarly, by linearity, we have the recursion for  $i \in 0, \dots, n - 1$ :

$$\begin{aligned}
 B_{i+1}(x) = & B_i\left(\frac{1}{2}x + \frac{1}{2}\left((1 - \epsilon_1) + \epsilon_1 x\right)\right) - B_i\left(\frac{1}{2}\left((1 - \epsilon_1) + \epsilon_1 x\right)\right) \\
 & + B_i\left(\frac{1}{2}\left(\epsilon_2 + (1 - \epsilon_2)x\right)\right).
 \end{aligned}$$

Using this recursion formula, it is easy to compute  $B_1(x), B_2(x), \dots, B_n(x)$  using, for instance, Maple.

In Figure 5.1 we plot the collision probability versus the channel load for different values of the missed detection probability  $\epsilon_1$  for  $n = 8$  and  $\epsilon_2 = 0$ . We observe a noticeable decrease in the collision probability when  $\epsilon_1$  increases, however the performance remains good even with  $\epsilon_1 = 0.05$ .

In Figure 5.2, we add the curves of the simulation results with the respective confidence interval of 95% and we keep the results of the analytical model for comparison. For the sake of clarity in this chapter, we keep Figure 5.1. We can observe that there is a very good matching between the simulation results and the analytical model. In Figure 5.3 we plot the collision probability versus the channel load for different values of the missed detection probability  $\epsilon_2$  and for  $n = 8$  and  $\epsilon_1 = 0$ . We observe a noticeable improvement in the collision probability when  $\epsilon_2$  increases. This is strange since it seems that the performance improves when  $\epsilon_2$  increases. But this can be explained by the fact that when  $\epsilon_2 > 0$  there is a non-zero probability that the selection process leads to an empty slot and ends up with no transmission although there are pending packets for this slot. Figure 5.4 presents the comparison between the simulation results and the analytical model for the scenarios of Figure 5.3 and confirms the very good matching between the two approaches.

We can compute the probability that, for a given non-empty slot, the selection process ends up with a successful transmission.

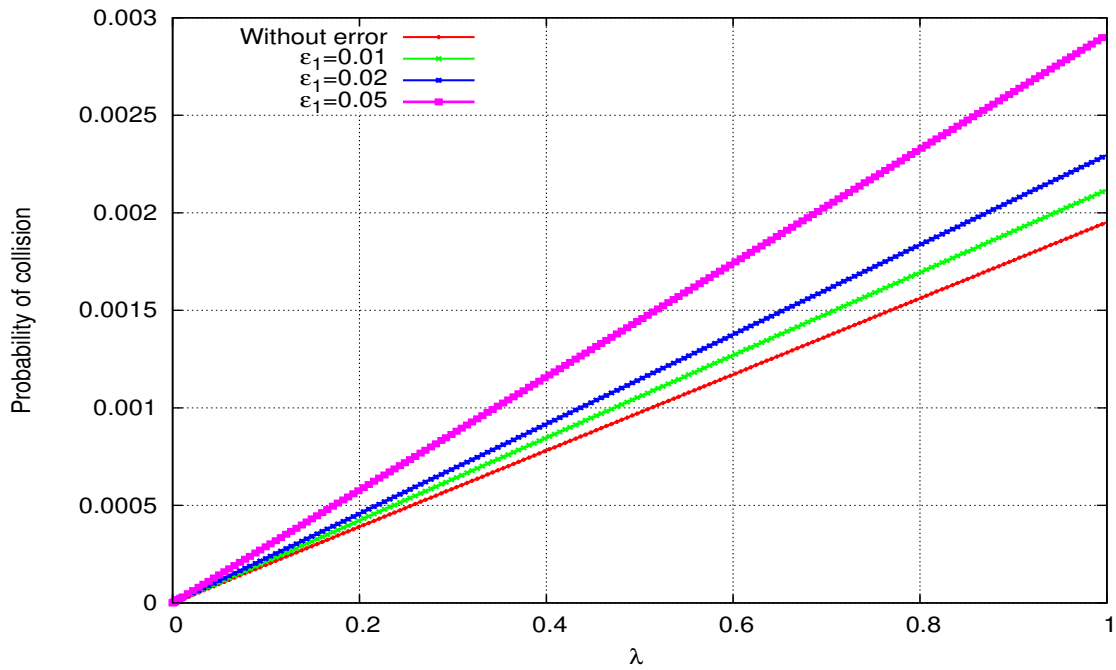

Figure 5.1: Collision probability with error in detecting the signaling burst  $\epsilon_1 = 0.01, 0.02, 0.05$  (missed detection).

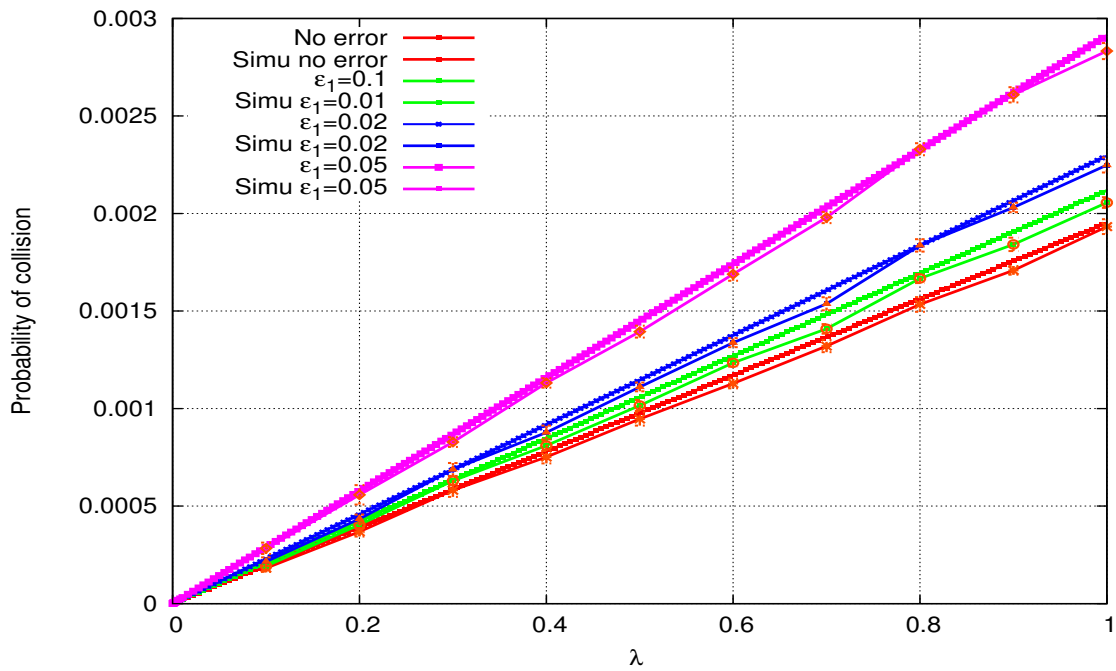

Figure 5.2: Collision probability with error in detecting the signaling burst  $\epsilon_1 = 0.01, 0.02, 0.05$  (missed detection).

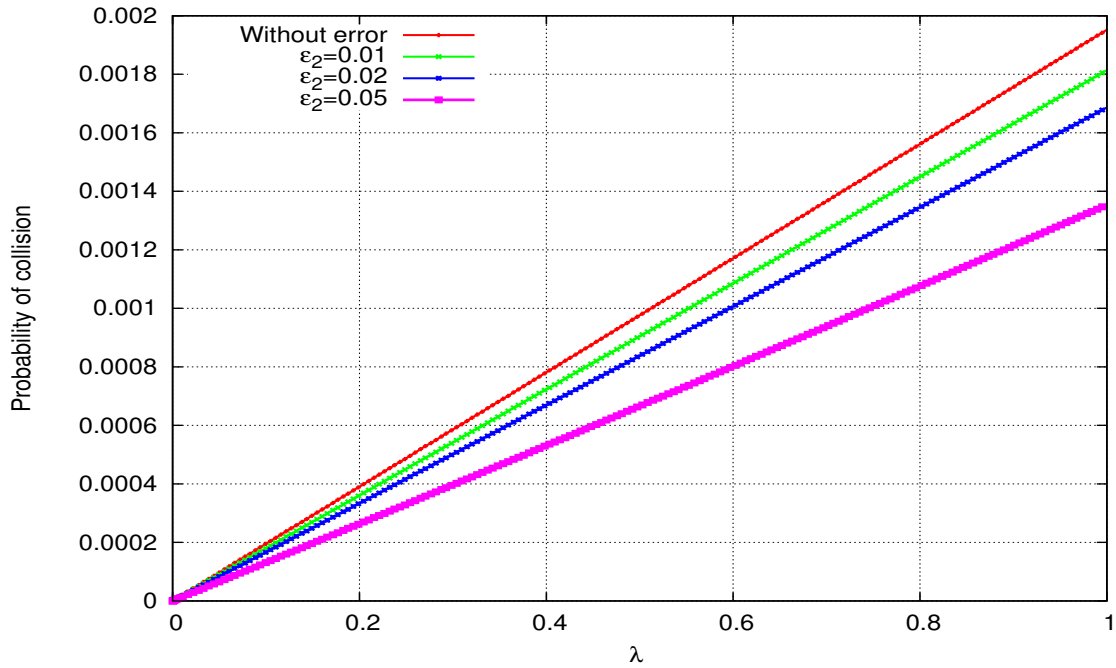

Figure 5.3: TBD. Collision probability with error in detecting the signaling burst  $\epsilon_2 = 0.01, 0.02, 0.05$  ( $\epsilon_1 = 0.0$ ).

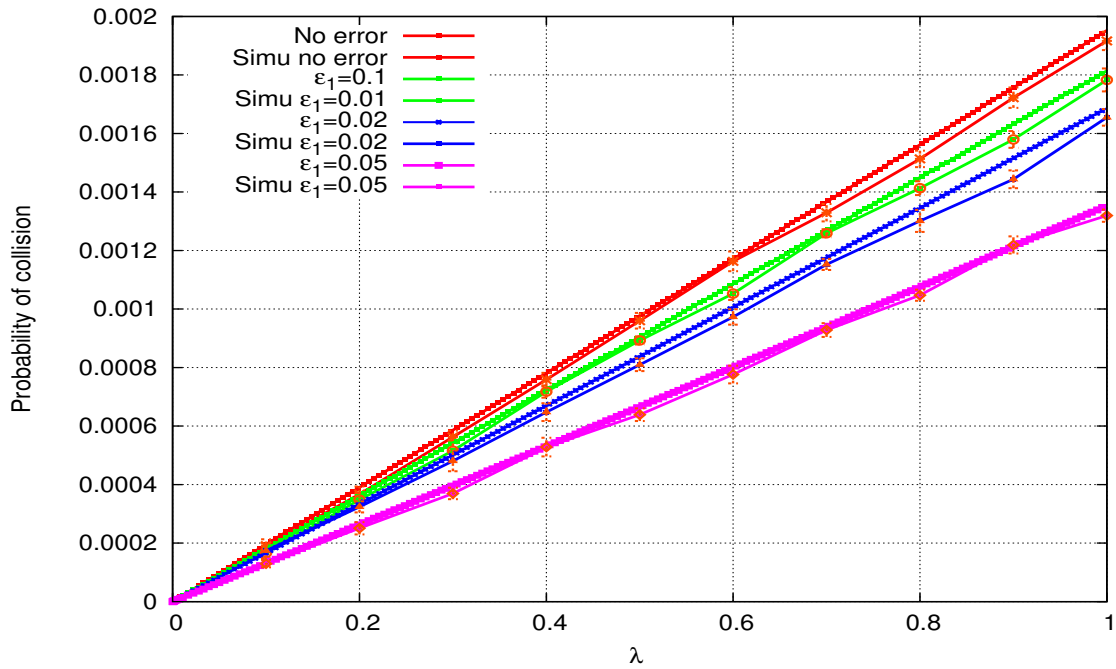

Figure 5.4: TBD. Collision probability with error in detecting the signaling burst  $\epsilon_2 = 0.01, 0.02, 0.05$  ( $\epsilon_1 = 0.0$ ).

$$Pr(\lambda) = \frac{1}{1 - \exp(-\lambda)} \sum_{k=0}^{\infty} \frac{\lambda^k}{k!} \exp(-\lambda) B'_k(0).$$

The results of this computation are given in Figure 5.5. We observe that the probability of a successful transmission is nearly 1 when there is no error in the detection of the signaling sequence or when  $\epsilon_1 \leq 0.05$  and  $\epsilon_2 = 0$ , but, when  $\epsilon_2 = 0.05$  the probability of a successful transmission falls to around 0.83. The reason for this large decrease is not the collision rate but the occurrence of empty slots where the selection process ends with no transmission although there are pending packets for this slot. We observe that the error where phantom signaling bursts are detected is much more detrimental for the selection than the missed detection of a signaling burst. Figure 5.6 presents a comparison between the simulation results and the analytical model for the scenarios of Figure 5.5 and confirms the very good matching between the two approaches.

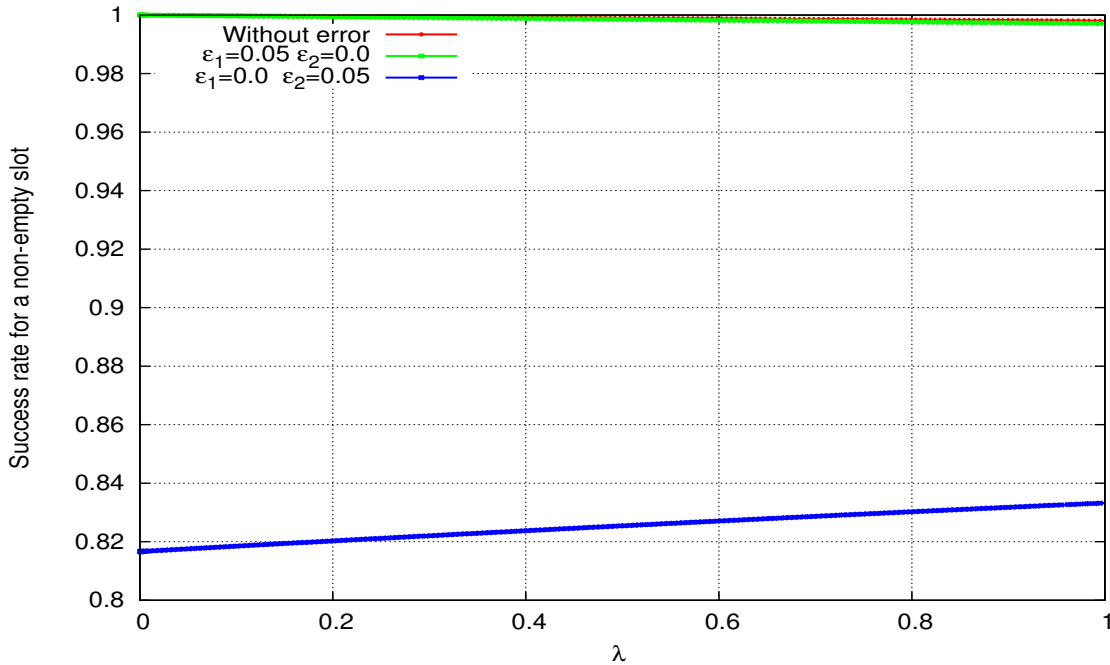

Figure 5.5: Probability that the selection process for a non-empty slot ends up with a successful transmission for different values of  $\epsilon_1$  and  $\epsilon_2$ .

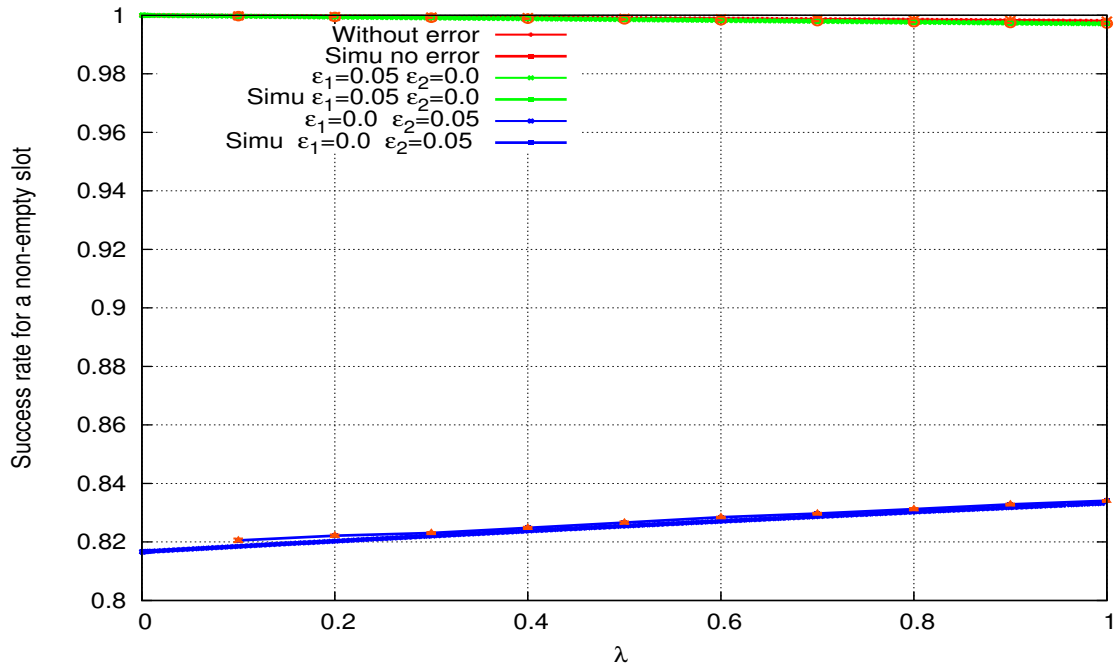

Figure 5.6: Probability that the selection process for a non-empty slot ends up with a successful transmission for different values of  $\epsilon_1$  and  $\epsilon_2$ , **simulation results** .

## 5.4 Handling Emergency traffic in AS-DTMAC

To handle emergency traffic, we can use the mini-slot of the signaling burst. With one mini-slot devoted to priority we can have two priority levels. The default (low priority) traffic will always be listening during the first mini-slot of the signaling burst whereas the (high priority) emergency traffic will always be transmitting during this mini-slot. In this way, high priority traffic will always have priority over a low priority packet. If we use two mini-slots devoted to priority, we can have four priority levels. These priority levels will be hierarchically independent in the sense that a packet of a higher priority will always win the competition against a packet of a lower priority

To handle bursts of emergency traffic many options are available. The simplest technique is to use the empty slots to send these packets. The vehicles can listen to the FI field of the slots to learn the status of a slot : Free, Occupied , Collided. The emergency packets will be sent on the free or collided slots. But if a special need in terms of access delay is required, the emergency packets can be sent on occupied slots. The node whose slot has been preempted knows that its reserved slot has been used by an emergency packet and thus it can wait for the next AS-DTMAC frame

to send its packet in its reserved slot. If the emergency traffic has been sent during the previous AS-DTMAC frame, the slot will be free again for the vehicle that had an AS-DTMAC reservation for this slot.

## 5.5 Evaluation of missed detection for an active signaling mechanism

### 5.5.1 OFDM preamble

The duration of the short symbol for 802.11p is fixed to  $1.6\mu s$ . For the next generation V2X of IEEE 802.11, the IEEE Task Group bd (TGbd) [8] is working toward the development of the new standard 802.11bd. The physical layer will be based on the OFDM system and will keep the same preamble structure except for the location. The idea is to put it between the OFDM data symbols instead of putting it only at the beginning of the frame, as this will take into consideration the case of fast-varying channels. The samples and the characteristics of the short training symbol in the frequency domain can be found in [65]. In Figure 5.7, we plot the real part of the three first short preambles obtained by inverse FFT (IFFT). Hereafter in this chapter, the signaling bursts refer to the OFDM symbols.

### 5.5.2 Signal detection strategy

During a listening period, the mini-slot selection process has to choose between two hypotheses: either the signal detected contains only noise ( $H_0$ ), or there is a signal hidden in this noise ( $H_1$ ), see [62]. This process may fail; it can fail to detect an existing signal (missed detection) or it can detect a signal whereas there is actually only noise (false alarm).

In order to evaluate these two kinds of error, we need statistical knowledge about the distribution of the observation. Figure 5.8 gives an example of statistical hypothesis testing for one OFDM symbol under  $H_0$  and  $H_1$  (with variance = 1, amplitude = 4, samples =  $10^5$ ). In the decision process, it is not uncommon that these two hypotheses are erroneously rejected. In a communication system, each detector can be characterized by the couple of  $P_{fa}$  and  $P_d$ <sup>1</sup> which are respectively the probability of a false alarm and the probability of detection. In practice, the probability of a false

<sup>1</sup>The probability of a missed detection is  $P_{md} = 1 - P_d$

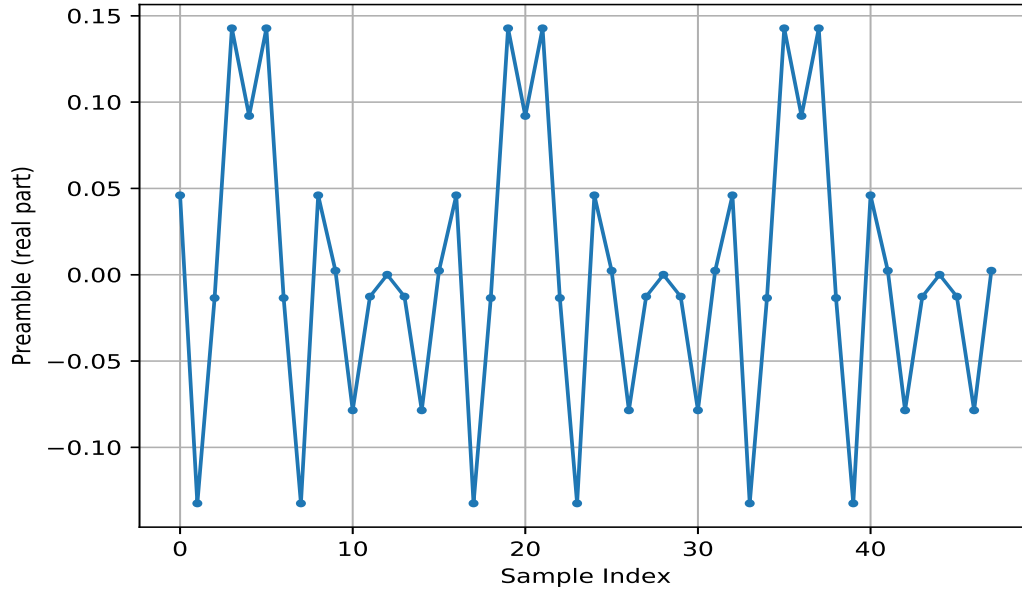

Figure 5.7: Three short preambles (real part).

alarm is always low (less than  $10^{-2}$ ) [63] while the probability of detection is much greater (generally near 1) and is sensitive to the condition of the channel. According to the Neyman-Pearson lemma [62], the optimal detection is a Likelihood Ratio Test (LRT) given the maximum possible  $P_d$  for any given  $P_{fa}$ . This test consists of comparing the likelihood ratio to a threshold in order to make a decision. Consequently, fixing the threshold is the key to correct signal detection. For a number of applications, some parameters could be unknown while the signal is known. In this condition, we introduce a composite test approach, namely the Generalized Likelihood Ratio Test (GLRT) [62]. Generally, to improve our signal detection capability, we pass the signal through a matched filter with the best possible Signal-to-Noise Ratio (SNR) given.

### 5.5.2.1 Signal detection statistics

The scenario discussed in this chapter considers the case where a deterministic signal is present in an additive white Gaussian noise (AWGN). Both signal ( $s(t)$ ) and noise ( $n(t)$ ) are complex valued. The received signal is modeled as follows :

$$y(t) = s(t) + n(t) \quad (5.1)$$



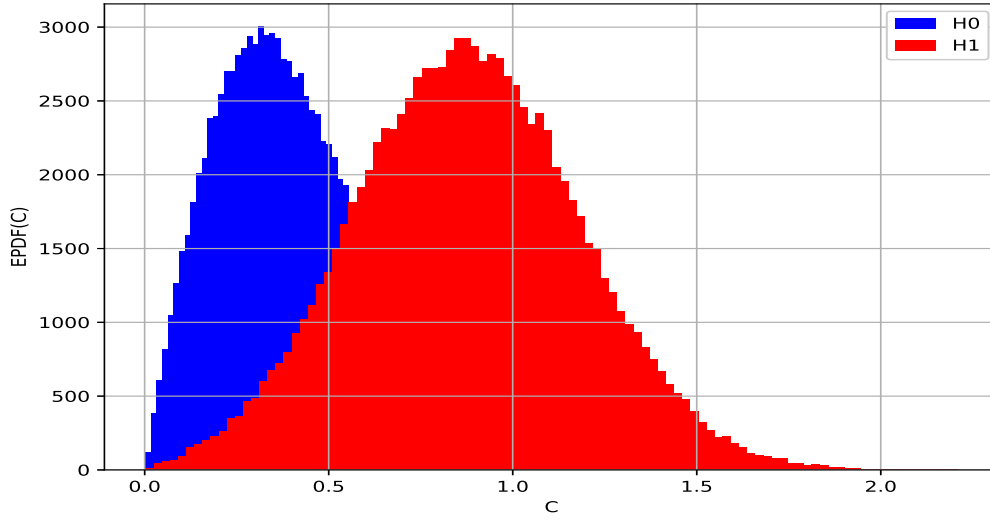

Figure 5.8: Hypothesis testing for OFDM symbol detection: Empirical Probability Distribution Function (EPDF) histogram under  $H_0$  and  $H_1$ .  $C$  is the correlation variable at the matched filter output.

where  $s(t)$  holds the signal:

$$s(t) = ax(t) \quad (5.2)$$

$a$  is a complex amplitude,  $x$  is a complex vector (OFDM preamble) and  $n$  is Gaussian vector of the same size as  $x$ . In this section, we study the statistical characterization of the observation ( $c$ ) coming from the matched filter :

$$c = yx^* = a|x|^2 + nx^* \quad (5.3)$$

Under  $H_0$ , only the second term of  $c$  is non-zero:

$$c_0 = \sum_i n_i x_i^* \quad (5.4)$$

we know that :

$$n_i \sim CN(0, \sigma_n^2)$$

where  $CN(0, \sigma_n^2)$  is circularly symmetric complex Gaussian noise with mean 0 and variance  $\sigma_n$ . The sum of the product in (4) gives:

$$c_0 \sim CN(0, |x|^2 \sigma_n^2)$$

It is easy to establish that

$$c_0 \sim N(0, \frac{|x|^2 \sigma_n^2}{2}) + jN(0, \frac{|x|^2 \sigma_n^2}{2})$$

Finally, by taking the absolute value of  $c_0$  we obtain the following distribution:

$$|c_0| \sim \text{Rayleigh}(\frac{|x| \sigma_n}{\sqrt{2}}) \quad (5.5)$$

In the second case, the two parts of the formula(3) are non-zero. Thus, by taking this into account, we can find the distribution under  $H_1$  with the same methodology:

$$\begin{aligned} c_1 &\sim |a||x|^2 + CN(0, |x|^2 \sigma_n^2) \\ c_1 &\sim N(|a||x|^2 \cos \phi, \frac{|x|^2 \sigma_n^2}{2}) + jN(|a||x|^2 \sin \phi, \frac{|x|^2 \sigma_n^2}{2}) \\ |c_1| &\sim \text{Rice}(|a||x|^2, \frac{|x| \sigma_n}{\sqrt{2}}) \end{aligned} \quad (5.6)$$

### 5.5.2.2 Hypothesis Testing

In the section above, we found that the probability density functions (PDFs) of the observations follow a Rayleigh distribution under  $H_0$  and Rician distribution under  $H_1$  :

$$H_0 : |c_0| \sim \text{Rayleigh}(\frac{|x| \sigma_n}{\sqrt{2}}) \quad (5.7)$$

$$H_1 : |c_1| \sim \text{Rice}(|a||x|^2, \frac{|x| \sigma_n}{\sqrt{2}}) \quad (5.8)$$

The corresponding likelihood ratio is given by :

$$\lambda(c) = \frac{\max_{a \in \theta^*} f_{H_1}(c, a)}{f_{H_0}(c)} = \frac{f_{H_1}(c, \hat{a})}{f_{H_0}(c)} \quad (5.9)$$

$f_{H_1}$  is the likelihood corresponding to the Rician distribution in eq. (8) and  $\theta^*$  is the set of values that the parameter  $a$  can take (here it is the received signal amplitude: because there is no power control in IEEE 802.11, hence an interval  $\theta^* = ]0, a_{\max}]$ ).  $f_{H_0}$  is the likelihood corresponding to the Rayleigh distribution in eq. (7).

The Maximum Likelihood Estimation (MLE) of the amplitude was solved numerically (due to the complexity of the calculation). Figure 5.9 represents the estimation of the amplitude as a function of the observation. We can observe that the amplitude

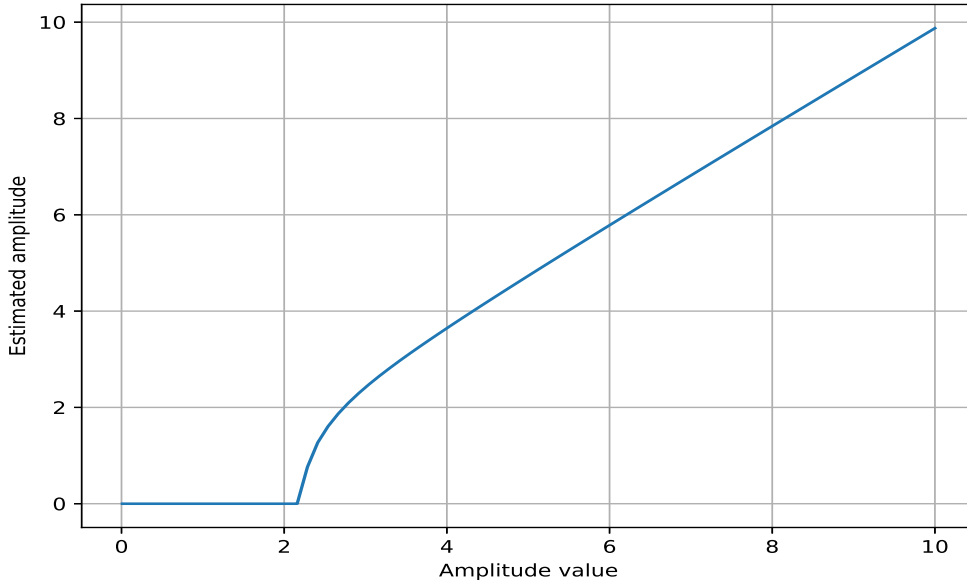

Figure 5.9: Estimation of amplitude by minimization

is correctly estimated, except for the small values. The detection threshold is derived by using the formula of false alarm probability and fixing a level of this probability at  $\alpha$ . We can then easily determine the threshold by inverting the PDF of a Rayleigh distribution:

$$Pr(\lambda(c) > \gamma | c \sim Rayleigh) = \alpha \quad (5.10)$$

We introduce a change of variable with  $Y$ :

$$Y = \lambda(c)$$

$$Pr(Y > \gamma | c \sim Rayleigh) = 1 - F_Y(\gamma) = \alpha \quad (5.11)$$

Where  $F_Y$  is the cumulative distribution function. The last expression becomes:

$$F_Y(\gamma) = F_{c_0}(\lambda^{-1}(\gamma))$$

$$\gamma = \lambda(F_{c_0}^{-1}(1 - \alpha)) \quad (5.12)$$

This formula shows that the threshold depends on the likelihood ratio and the level of false alarm. Once statistical knowledge about each hypothesis and the threshold ( $\gamma$ ) is available, we can establish the following composite hypothesis test:

$$\lambda(c) = \frac{f_{H_1}(c, \hat{a})}{f_{H_0}(c)} > \gamma \quad (5.13)$$

### 5.5.3 Simulation results

In this section, we use simulations to evaluate the performance of our detector for different metrics. After, we extend these simulations to show how this model can estimate the error in the signaling process of our new MAC solution AS-DTMAC. Table I summarizes the simulation parameters used in our model. Figure 5.10 shows the block diagram flowchart for the simulation to estimate the error using the Monte-Carlo method.

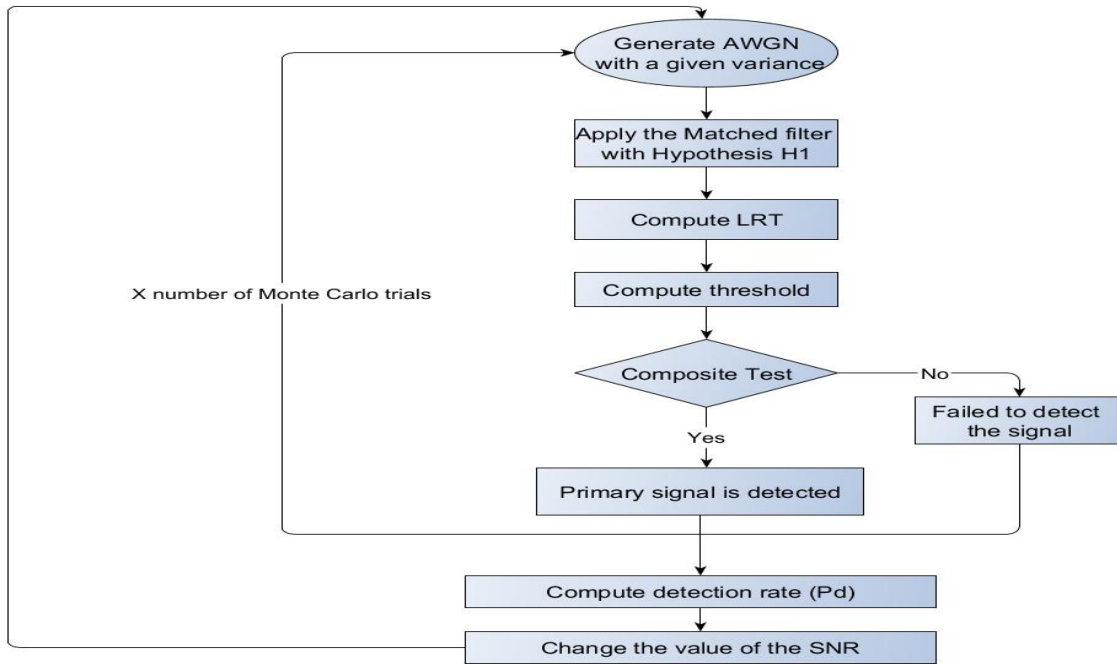

Figure 5.10: 6. Block diagram of the Monte Carlo simulation algorithm to estimate the detection error.

#### 5.5.3.1 Performance analysis of GLRT

In this section, we show some simulation results that validate our signal detection methodology. In Figure 5.11, we plot the Receiver Operating Characteristics (ROC)

curves for different SNR values: the probability of detection versus  $P_{fa}$ . The accumulation length used is 3 OFDM symbols. We can observe from this figure that even with a low level of signal-to-noise ratio (SNR), especially at -13dB when the level of  $P_{fa}$  is 0.05, the probability of detection is still high (almost 90%).

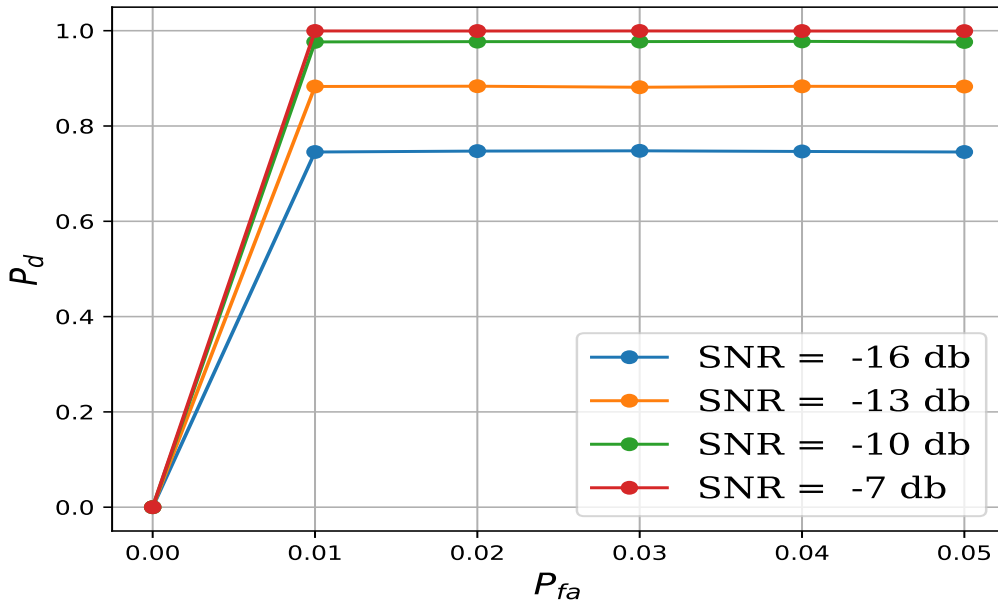

Figure 5.11: ROC curves for different SNR values

Figure 5.12 presents the missed detection probability versus SNR for different sizes of burst. We observe that the error is very small and decreases with the level of SNR. Moreover, these results show that the larger the size of the burst is, the better the detection is.

In the literature, most detection implementations are based on the Energy Detection (ED) model. In order to show how efficient the GLRT-based detection method is in comparison with ED, in Figure 5.13 we plot the probability of missed detection for both ED and GLRT for one OFDM symbol. These results illustrate that GLRT provides a significantly smaller  $P_{md}$  than ED. As we can see, the difference between the two curves is roughly of four orders of magnitude for a high level of SNR. The version of the ED detector that we implement here is the basic version using a static threshold. This technique depends on the noise variance which requires prior knowledge of the noise level. Thus, the performance of this detector can be slightly

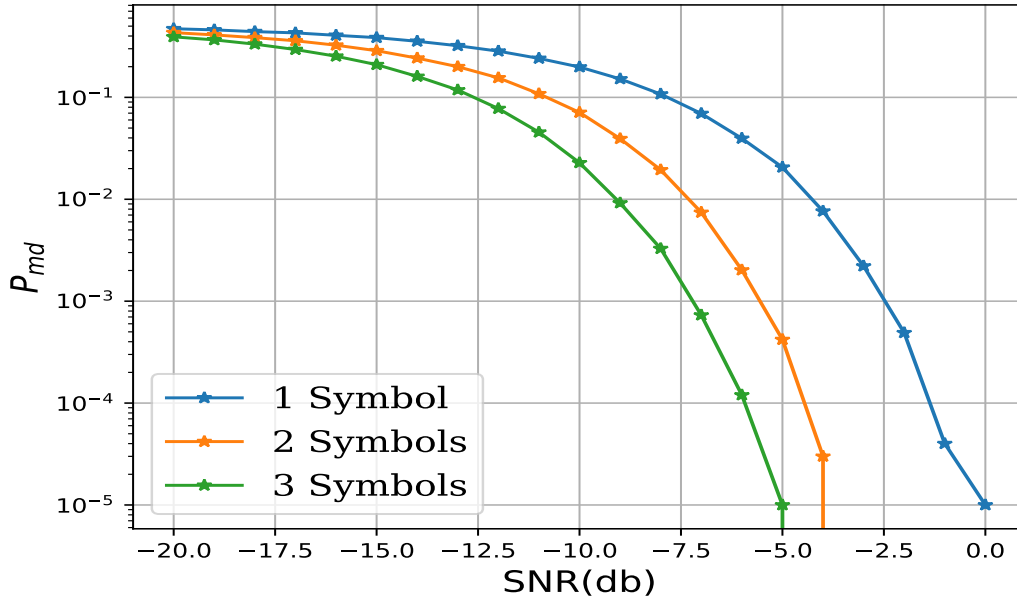

Figure 5.12: The probability of miss-detection  $P_{md}$  in function of the SNR.

enhanced by a reliable estimation of the level of noise, but as we can see in [67] the performance remains far below that of GLRT.

### 5.5.3.2 Application to AS-DTMAC

In our previous work [6], we performed several experiments in order to determine the best compromise interval in which the best number of mini-slots can be located. Three metrics of QoS were studied (i.e, access collision, packet overhead and average access time) in order to achieve this task. In this section, we complete this study by using the model presented above in order to:

- find the optimal number of symbols in the active signaling mini-slot that can ensure suitable detection reliability,
- determine the best number of mini-slots used by the active signaling mechanism,
- study the impact of the number symbols,  $P_{fa}$  and SNR variation on AS-DTMAC performance in terms of access collision.

The computation of the access collision rate is obtained by the following formula:

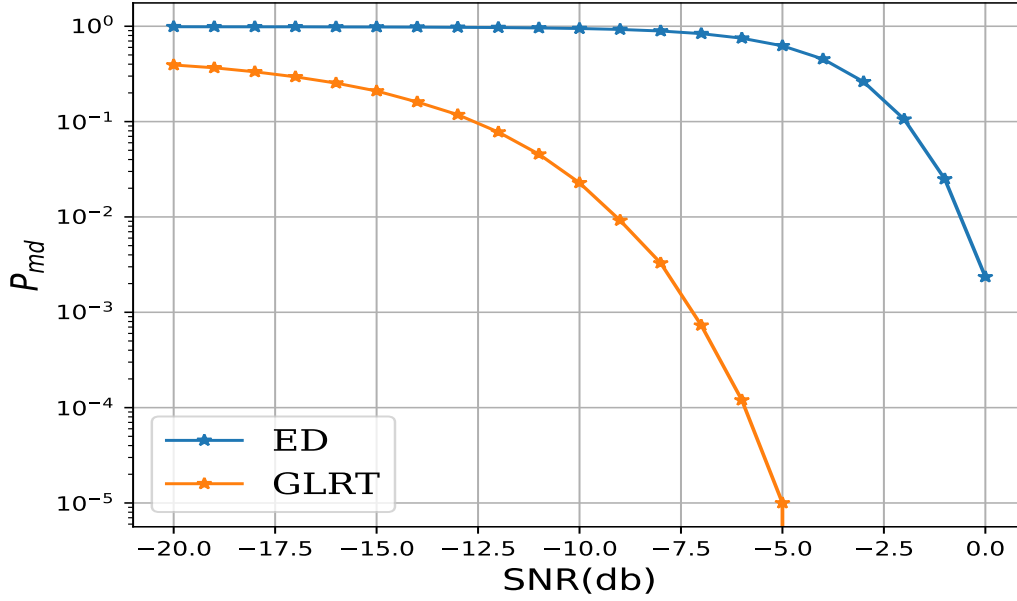

Figure 5.13: Performance of GLRT against ED

$$Pr(\lambda) = \frac{1}{1 - \exp(-\lambda)} \sum_{k=0}^{\infty} \frac{\lambda^k}{k!} \exp(-\lambda) (1 - B_n^k(0) - B_n^{k'}(0)).$$

where  $\lambda$  is the arrival rate of the traffic,  $k$  the number of competitors for the slot, and  $B_n^k(x)$  the generating function of the number of remaining packets after the selection process of  $n$  mini-slots if there are  $k$  packets competing for the slot. The recursion for  $B_i^k(x)$   $i \in 0, \dots, n-1$  is given by the following formula<sup>2</sup>

$$\begin{aligned} B_{i+1}^k(x) &= B_i^k \left( \frac{1}{2}x + \frac{1}{2}((1 - P_{md}) + P_{md}x) \right) \\ &\quad - B_i^k \left( \frac{1}{2}((1 - P_{md}) + P_{md}x) \right) \\ &\quad + B_i^k \left( \frac{1}{2}(P_{fa} + (1 - P_{fa})x) \right). \end{aligned}$$

and

$$B_0^k(x) = x^k$$

<sup>2</sup>Actually, the model introduces detection error but the reasoning technique with the generating function remains the same with these errors as in [7].

The  $P_{md}$  obtained from the GLRT model and the fixed level of  $P_{fa}$  are used as input for this formula. For all the simulations, we define a reference scenario with the following parameters:  $P_{fa} = 10^{-2}$ ,  $SNR = -10dB$ , burst size of one symbol, and the traffic density is maintained at the maximum value. In order to show the impact of each parameter on the access collision rate, we vary one parameter per simulation. It is clear that at  $-10dB$  the receiver is not able to achieve a correct demodulation and decoding. This is possible in the detection area. With active signaling, we must detect the presence of vehicles in a larger area (detection area). Figure 5.14 illustrates a transmitting vehicle (A) ; its closest neighbor (B) is in the demodulation area and the further vehicle (C) is in the detection area.

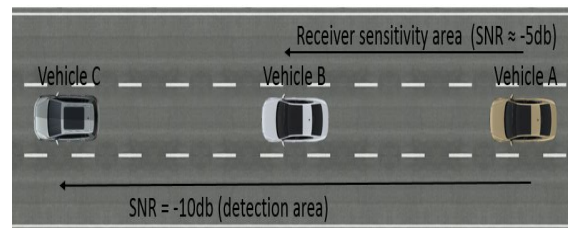

Figure 5.14: Receiver detection and sensitivity area

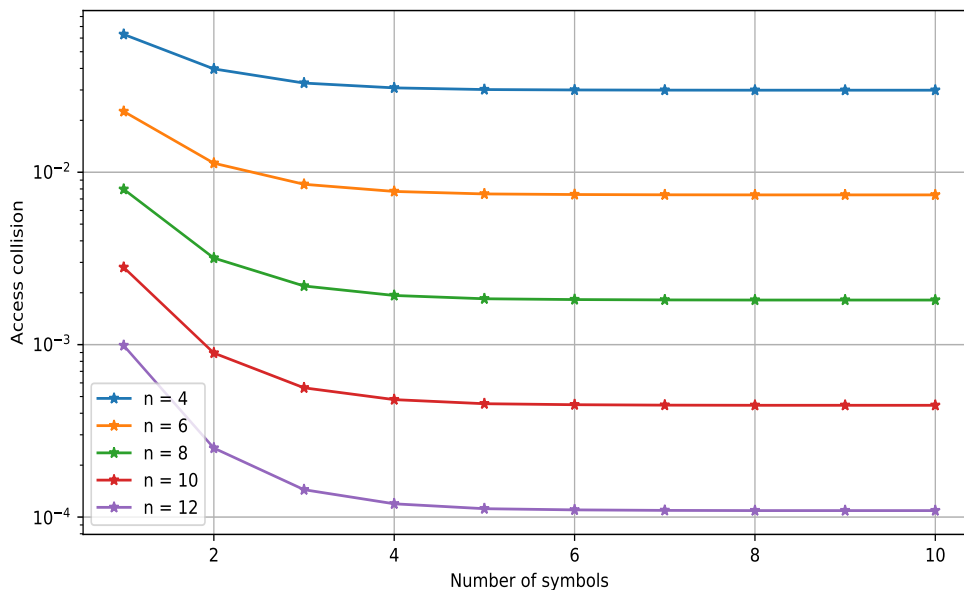

Figure 5.15: Impact of burst size on the access collision rate



In Figure 5.15, we show the access collision rate as a function of the number of OFDM symbols and for different numbers of mini-slots (4, 6, 8, 10, 12). We can observe from this figure that the access collision rate decreases as the number of symbols and mini-slots increases. We also note that 3 OFDM symbols are sufficient to obtain a nearly optimal detection. Moreover, it is clear that  $n = 6$  of active signaling is a good choice as it insures low overhead and an access collision rate of less than 1%. As described before, the active signaling process also provides a priority scheme for emergency messages such as Decentralized Environmental Notification Messages (DENMs [68]). These messages are usually classified into four categories according to their priority. Thus, a signaling length of  $n = 8$  is more suitable, in order to take into account this requirement (2 bits will be left to code up to four priority levels). In Figure 5.16, we plot the access collision level versus SNR (in  $dB$ ). We can note from this figure that the access collision level remains acceptable up to  $-10dB$ .

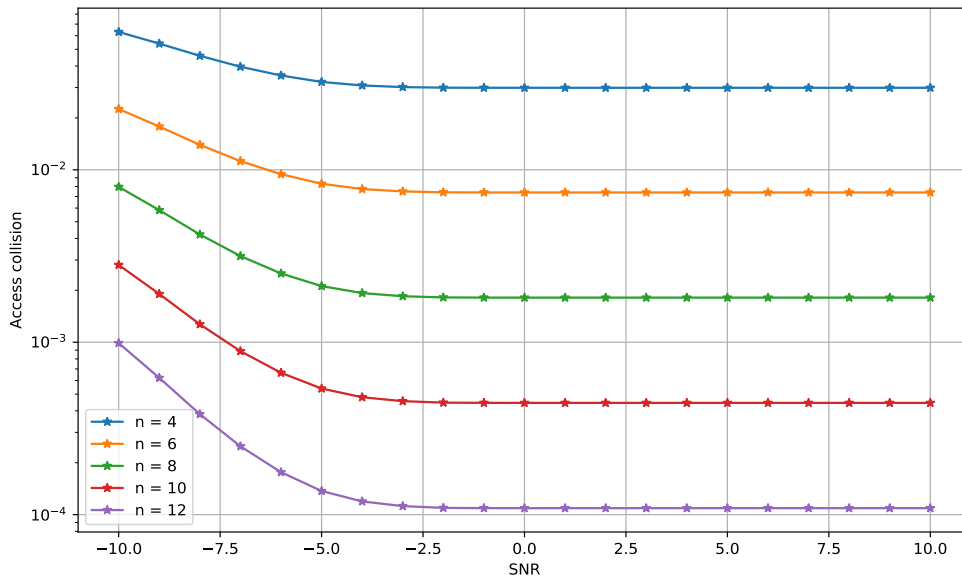

Figure 5.16: Impact of SNR on the access collision

During a mini-slot, if a false alarm is detected, the slot can be left without any competitor selected to transmit. This observation can explain why the access collision rate decreases for a high value of this parameter, as we can see in Figure 5.17.

We can observe from the results presented in this section that AS-DTMAC can maintain a good performance even when the signal is ten times smaller than the

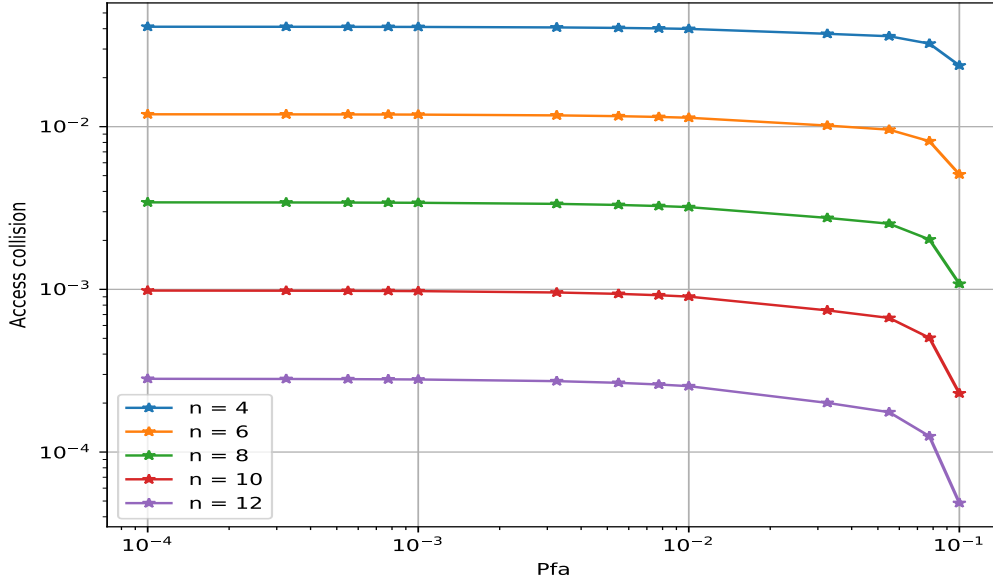

Figure 5.17: Impact of  $P_{fa}$  on the access collision

noise. These results also explain the choice of GLRT, because ED gives a very high probability of error. In [6], we have shown that AS-DTMAC significantly reduces the average access time with 9 mini-slots of duration equal to  $225\mu s$ . The study that we established in this chapter has demonstrated that 3 OFDM symbols are enough to insure a very low access collision rate. Thus, we can conclude from this study that  $4.8\mu s$  of mini-slot duration (i.e,  $3 \times 1.6\mu s$ ) is sufficient to make the AS-DTMAC protocol work well with a low access collision rate. Moreover, optimizing the duration of a mini-slot (82% smaller than the value used in [6] by taking into account the guard interval) will significantly reduce the overhead of this mechanism as well as providing a better throughput rate as the duration of the payload part of the packet in the active signaling mechanism will be increased.

## 5.6 Conclusion

In this chapter, we first presented an extension of our previous analytical model in order to study the performance of the AS-DTMAC protocol. To make our analytical model as complete as possible, we introduced error into the model during the selection process. We defined two kinds of error that can occur in the detection process: vehicles

can miss a transmission or sense a false transmission. With the first kind of error, the performance remains very good even with up to 5% of error, whereas in the second kind of error, the selection process may end up with no transmission on the payload slot, which is much more detrimental to the whole performance.

In the second part of this chapter, the exact definition of the signaling burst was proposed with the computation of missed detection in the selection process, by using a detection model based on GLRT. We estimate that the minimum length of preamble required for the active signaling process is 3 OFDM symbols. We show that the active signaling part of the slot in AS-DTMAC must encompass 8 mini-slots and thus the signaling burst will last  $4.8\mu s$ . This proposed configuration will optimize the time left for the payload part of the packet, resulting in increased throughput compared to that proposed in [6]. This study takes into account the structure of the physical layer of the current IEEE 802.11p standard, making it well-suited to the next generation of IEEE 802.11bd proposal. In the next chapter, we focus on the issue of combining AS-DTMAC with another radio technology and, in particular, we show analytically how our protocol can coexist with the IEEE 802.11p standard.

# Chapter 6

## Coexistence of IEEE 802.11p and the TDMA-based AS-DTMAC Protocol

### Contents

---

<b>6.1</b>	<b>Introduction</b>	<b>90</b>
<b>6.2</b>	<b>Coexistence of AS-DTMAC and IEEE 802.11p</b>	<b>91</b>
6.2.1	Behavior of the two protocols in coexistence mode	91
6.2.2	Interaction of IEEE 802.11p in the AS-DTMAC selection process	92
6.2.3	Waiting time for AS-DTMAC after the beginning of an IEEE 802.11p transmission	93
<b>6.3</b>	<b>Results</b>	<b>95</b>
<b>6.4</b>	<b>Conclusion</b>	<b>96</b>

---

## 6.1 Introduction

Advanced vehicular applications such as autonomous driving are leading to a new evolution in vehicular radio access technologies. The Task Group BD on the Next-Generation V2X (NGV) have defined IEEE 802.11bd as the new standard for the DSRC. Notwithstanding its promising performances in terms of high reliability, low latency and high throughput, the design must also respect certain specifications, such as coexistence, interoperability, and compatibility with the previous standard. In this chapter, we study how the IEEE 802.11p protocol could coexist with our TDMA-based MAC protocol named AS-DTMAC, which we have proposed to control access in VANETs. We carry out several analyses to show that the two protocols can coexist when both are operating simultaneously on the same network (see Figure 6.1). We also propose a modification of AS-DTMAC to handle the situation where both IEEE 802.11p and AS-DTMAC have to send urgent packets.

We compute two metrics related to this coexistence. The first one represents the probability that an IEEE 802.11p packet will interfere in the selection process of AS-DTMAC, while the second one refers to the waiting time for an AS-DTMAC vehicle to access the channel. The remainder of the chapter is organized as follows. Section 6.2 explains the coexistence between the IEEE 802.11p protocol and AS-DTMAC and derives performance metrics related to this coexistence. Section 6.4 concludes this chapter.

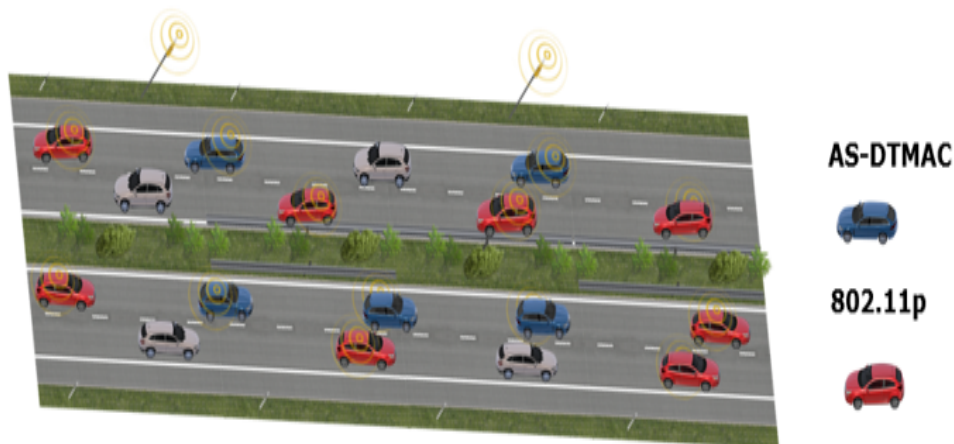

Figure 6.1: Coexistence scenario of AS-DTMAC with IEEE 802.11p

## 6.2 Coexistence of AS-DTMAC and IEEE 802.11p

We start by studying the general behavior of the two protocols when they coexist. That is the focus of Section 7.2.1. In Section 6.2.2 we determine the possible interaction in the AS-DTMAC selection process. Then we study the waiting time of AS-DTMAC after the beginning of an IEEE 802.11p transmission. This task is the subject of Section 6.2.3.

### 6.2.1 Behavior of the two protocols in coexistence mode

The IEEE 802.11p protocol is a CSMA/CA carrier sense-based protocol and thus coexistence with another protocol is possible. When an IEEE 802.11p vehicle senses a busy channel, it waits for the end of the transmission and then, after a given idle time interval, it sends its packet. If AS-DTMAC packets are sent in the channel, the IEEE 802.11p vehicles will wait for an empty slot to start their transmissions. Thus, on the one hand the IEEE 802.11p can coexist with the transmission of AS-DTMAC packets. On the other hand, if an AS-DTMAC transmission has started on a given slot, the selection procedure will continue even if IEEE 802.11p vehicles try to send packets, as we will show more precisely in the next sub-section. In fact, the interference of an IEEE 802.11p transmission in the AS-DTMAC selection process is very unlikely. Equally importantly, AS-DTMAC will not affect the IEEE 802.11p transmission. With active signaling, AS-DTMAC will rapidly detect an IEEE 802.11p transmission during the sensing interval of the selection phase. Thus the interference produced by AS-DTMAC will be of short duration and the IEEE 802.11p transmission is likely to remain successful even if there is some interference by short transmission bursts.

When a slot initially reserved by a vehicle using AS-DTMAC is used by another vehicle (thus, in principle a vehicle using IEEE 802.11p) we propose to use AS-DTMAC on the coming slot of the synchronous frame using a greedy approach and to maintain the slot reserved on the next frame of the AS-TDMAC protocol. If the load of the IEEE 802.11p vehicles is not too high, there is a high probability that the AS-TDMAC vehicle will recover its slot on the next frame of AS-TDMAC.

If we suppose that the load of the IEEE 802.11p vehicles is high then the reservation protocol of AS-TDMAC can be seriously affected by the IEEE 802.11p traffic. In this case we propose to use AS-TDMAC in a fully asynchronous mode. The protocol will operate completely asynchronously. At the arrival of one packet in a vehicle, the

radio modem will sense the channel. If the channel is idle the packet is sent with the active signaling sent as a preamble to resolve any possible collision. If the channel is busy, the node senses the channel until it is free and then sends the packet, also sending the active signaling bursts before the transmission. At high loads, we observe that the AS-DTMAC protocol preempts the channel to IEEE 802.11. This can be explained by the generalized CSMA scheme embedded in AS-DTMAC, which is a more efficient access scheme than the simple CSMA backoff technique of IEEE 802.11p.

### 6.2.2 Interaction of IEEE 802.11p in the AS-DTMAC selection process

The model we assume is that an AS-DTMAC node starts its transmission at the beginning of a slot, and we also assume that at the beginning of the slot there is no IEEE 802.11p transmission present. The IEEE 802.11p nodes can interfere with the AS-DTMAC transmission if an IEEE 802.11p packet can start during the listening period of the selection phase of the AS-DTMAC transmission. We know that the IEEE 802.11p protocol starts sending a packet after sensing that the channel has been continuously idle for an inter-frame period (DIFS) plus possibly the backoff time.

To give an idea of how this works, we use the following values  $DIFS=58\mu s$  and we assume that the mini-slot time of the selection process of AS-DTMAC is of the same duration as a short inter-frame in IEEE 802.11p (SIFS), thus this duration is  $13\mu s$ . A duration greater than or equal to DIFS will exist in the AS-DTMAC selection process if a listening interval of at least  $a = \lceil \frac{DIFS}{SIFS} \rceil$  consecutive SIFSs occurs in the AS-DTMAC selection bursts. This is a necessary condition for IEEE 802.11p to interfere with an AS-DTMAC transmission<sup>1</sup>. We suppose that  $n$  is the number of AS-DTMAC contending vehicles. The probability  $P_r$  that an IEEE 802.11p node can interfere in the AS-DTMAC selection process is thus

$$P_r = 1/2^{na}.$$

This probability  $P_r$  is given below for  $\lceil \frac{DIFS}{SIFS} \rceil = 5$  which corresponds to the figures we has chosen:

$n$	1	2	3	4
$P_r$	$3.1e^{-2}$	$9.7e^{-4}$	$3.0e^{-5}$	$9.5e^{-7}$

<sup>1</sup>We omit the backoff time of IEEE 802.11p

We observe that this probability is very small, thus the IEEE 802.11p protocol is very unlikely to interfere in the AS-DTMAC selection process if the IEEE 802.11p transmission has not started previously, even if an AS-DTMAC stable mode is established where most of the nodes already have a reserved slot in the AS-DTMAC frame. In this condition we have  $n = 1$ . Moreover, in the previous computation we ignored the backoff time of IEEE 802.11p, thus the probability of an IEEE 802.11p packet interfering with AS-DTMAC is less than  $3.1e^{-2}$ .

In the next section we study the waiting time of AS-DTMAC if an IEEE 802.11p transmission has started.

### 6.2.3 Waiting time for AS-DTMAC after the beginning of an IEEE 802.11p transmission

We adopt the following simplified model. The IEEE 802.11p transmission traffic is a Poisson distribution of rate  $\lambda$ . We suppose that the duration of an IEEE 802.11p packet is one unit and we include in this duration the packet itself and the duration of the MAC overhead: inter-frame and possible backoff. If the IEEE 802.11p activity is such that the inter-frame between the IEEE 802.11p does not coincide with the beginning of the AS-DTMAC slots, the IEEE 802.11p will block the access of the AS-DTMAC packets. We will assume that to be the case in the following development where we evaluate a busy period of IEEE 802.11p packets.

To carry out such a task, we use the M/D/1 queue model. With our assumptions, the duration of the busy period of IEEE 802.11p packets is exactly the duration of the busy period of the M/D/1 queue. It is possible to compute the Laplace transform  $\beta(s)$  of the density of the busy period of the M/D/1 queue noted  $f(t)$ .

For  $s$  such that  $\Re(s) \geq 0$ ,  $\beta(s)$  is equal to the root with the smallest absolute value in  $z$  of the equation:

$$z = \exp(-s - \lambda(1 - z)).$$

We can introduce the Lambert function which is denoted by  $W(\cdot)$  and we have  $z = we^w \iff w = W(z)$ . With this function we can easily show that the Laplace transform of the busy period is:

$$\beta(s) = -\frac{1}{\lambda} W(-\lambda e^{-\lambda-s}).$$

If we note by  $X$  the duration of the busy period for the M/D/1 queue, and  $g(x) =$



$Pb(X > x) = \int_x^\infty f(t)dt$  ( $x$  is the busy period in time units, in other words the waiting time for the AS-DTMAC packet), the Laplace transform of  $g(x)$  is:

$$G(s) = \frac{1 - F(s)}{s} = \frac{1 - \beta(s)}{s}.$$

Since it is not possible to recognize in  $G(s)$  the Laplace transform of some known functions, we have to rely on numerical techniques. We use the well-known inverse formula named the Bromwich-Mellin transform and we have:

$$F(p) = \int_0^\infty e^{-pt} f(t)dt \iff f(t) = \frac{1}{2i\pi} \int_{c-i\infty}^{c+i\infty} e^{ts} F(s)ds$$

where  $c$  is a real number such that all the singularities of  $F(s)$  have a real part that is smaller than  $c$ . We can show using the prevision formula and [76] that for  $A > 0$ :

$$\begin{aligned} g(t) &= \frac{e^{A/2}}{2t} \sum_{k=-\infty}^{k=\infty} (-1)^k \Re\left(G\left(\frac{A + 2k\pi i}{2t}\right)\right) \\ &\quad - \sum_{k=1}^{k=\infty} e^{-kA} g((2k+1)t). \end{aligned} \tag{6.1}$$

Since  $|g(t)| < 1$ , the last term of the previous equation, is bounded by:

$$\frac{e^{-A}}{1 - e^{-A}} \simeq e^{-A}.$$

Thus  $g(t)$  can be approximated by  $g_n(t)$  with :

$$\begin{aligned} g_n(t) &= \frac{e^{A/2}}{2t} \Re\left(G\left(\frac{A}{2t}\right)\right) \\ &\quad + \frac{e^{A/2}}{t} \sum_{k=1}^{k=n} (-1)^k \Re\left(G\left(\frac{A + 2k\pi i}{2t}\right)\right) \end{aligned} \tag{6.2}$$

The sequence  $g_n(t)$  is usually an alternate sequence and so it is useful to consider an acceleration technique. It is shown in [76] that the Euler summation is generally a good choice. Thus, we use the following approximation:

$$g(t) \simeq \sum_{k=0}^m \binom{m}{k} 2^{-m} g_{n+m}(t) \tag{6.3}$$

In our numerical result we use  $A = 18$ ,  $n = 11$  and  $m = 10$  as in [76].

## 6.3 Results

In Figure 6.2, we show the distribution function of the busy period for  $\lambda = 0.2$ . This busy period corresponds to the waiting time for an AS-DTMAC packet which is waiting to access when IEEE 802.11p packets are being sent. As expected, we observe a step function that comes as a result of the transmission time of 1 unit ( $u$ ). In Figures 6.3, 6.4 and 6.5 we show the distribution functions of the busy period for  $\lambda = 0.4, 0.6$  and  $\lambda = 0.8$ , respectively. We look for the smallest duration  $T$  for which the probability is less than 0.05 that the waiting time for a free channel exceeds  $T$ . In other words,  $T$  will give for AS-DTMAC the maximum access delay to the channel with a priority greater than 0.95 when a Poisson traffic of load  $\lambda$  is using the IEEE 802.11p access protocol. For  $\lambda = 0.2$  we obtain  $T = 3$ , for  $\lambda = 0.4$  we have  $T = 5$ , for  $\lambda = 0.6$  we have  $T = 9$  and for  $\lambda = 0.8$  we have  $T = 21$ . We observe that except for a high load  $\lambda = 0.8$ , the maximum waiting time remains small. If we need to reduce this delay, we can adapt AS-DTMAC. Instead of using a synchronous access, we can use AS-DTMAC in an asynchronous mode. In that case, AS-DTMAC will preempt the channel, as shown by the evaluation in Subsection 6.2.2.

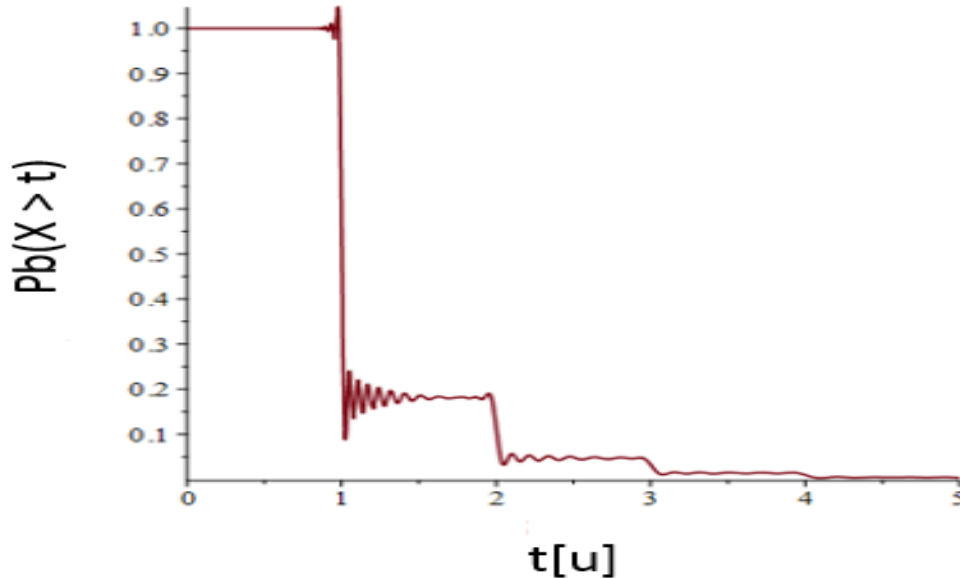

Figure 6.2: Distribution function of the busy period  $Pb(X > t)$  for  $\lambda = 0.2$ ,  $t$  is in time unit ( $u$ ).

In Figure 6.6, we show the average waiting time for AS-DTMAC packets versus the channel load. This result is deduced from the distribution function of the busy period for each  $\lambda$ . As we can see this delay remains reasonable up to load  $\lambda = 0.8$ , which shows the good performances of the AS-DTMAC protocol.

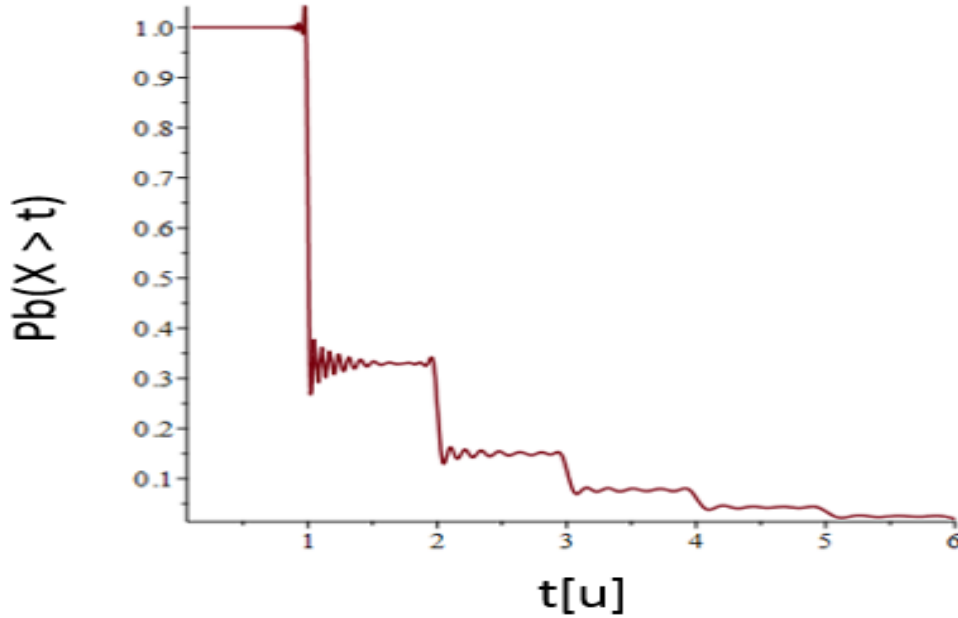

Figure 6.3: Distribution of the busy period  $P_b(X > t)$  for  $\lambda = 0.4$ ,  $t$  is in time unit (u).

## 6.4 Conclusion

We have shown that the contention-based IEEE 802.11p protocol can coexist with the contention-free AS-DTMAC protocol. We have studied the probability that an IEEE 802.11p transmission can interfere with the AS-DTMAC selection process and preempt an AS-DTMAC transmission. This probability is very small, indicating, on the one hand, that an AS-DTMAC transmission is very unlikely to be preempted by an IEEE 802.11p transmission. On the other hand, when IEEE 802.11p transmissions are established, the AS-DTMAC, being a TDMA system, can not in principle preempt the transmission. We have studied the distribution of the waiting time for an AS-DTMAC user to be able to access the channel. We have shown that, if needed, AS-DTMAC can possibly preempt the flow of IEEE 802.11p transmissions if AS-

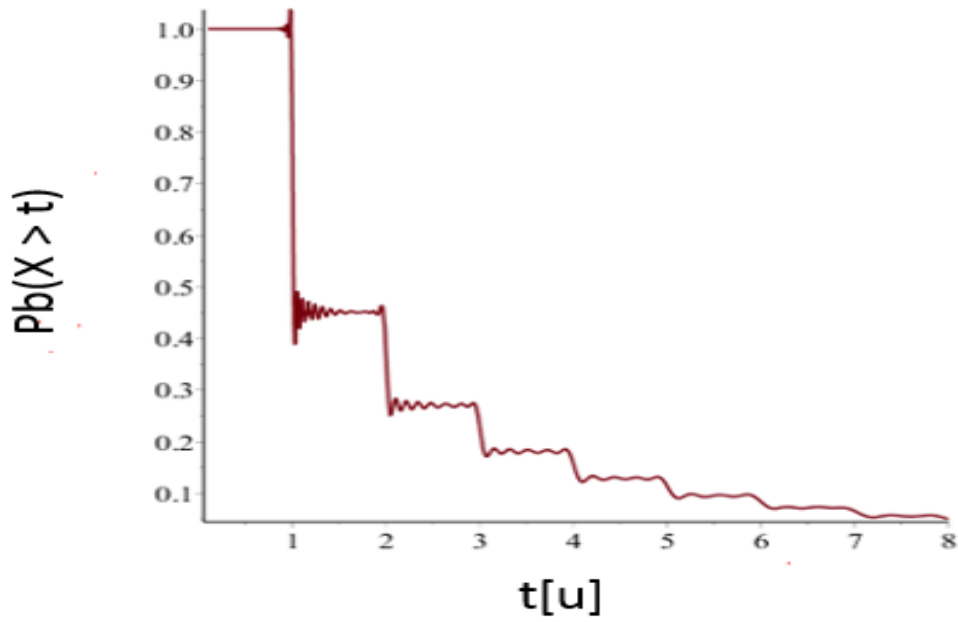

Figure 6.4: Distribution of the busy period  $Pb(X > t)$  for  $\lambda = 0.6$ ,  $t$  is in time unit (u).

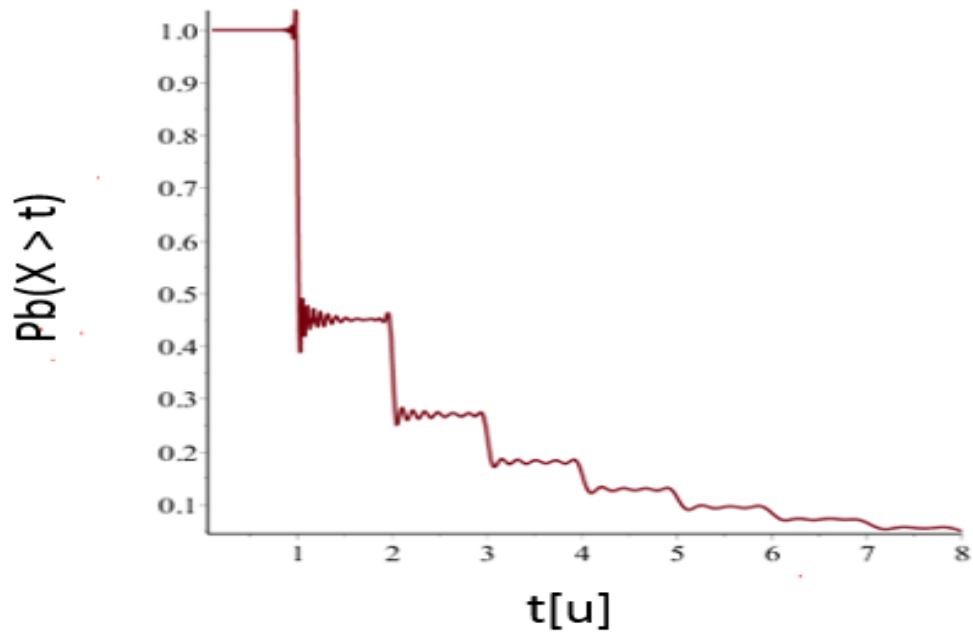

Figure 6.5: Distribution of the busy period  $Pb(X > t)$  for  $\lambda = 0.8$ ,  $t$  is in time unit (u).

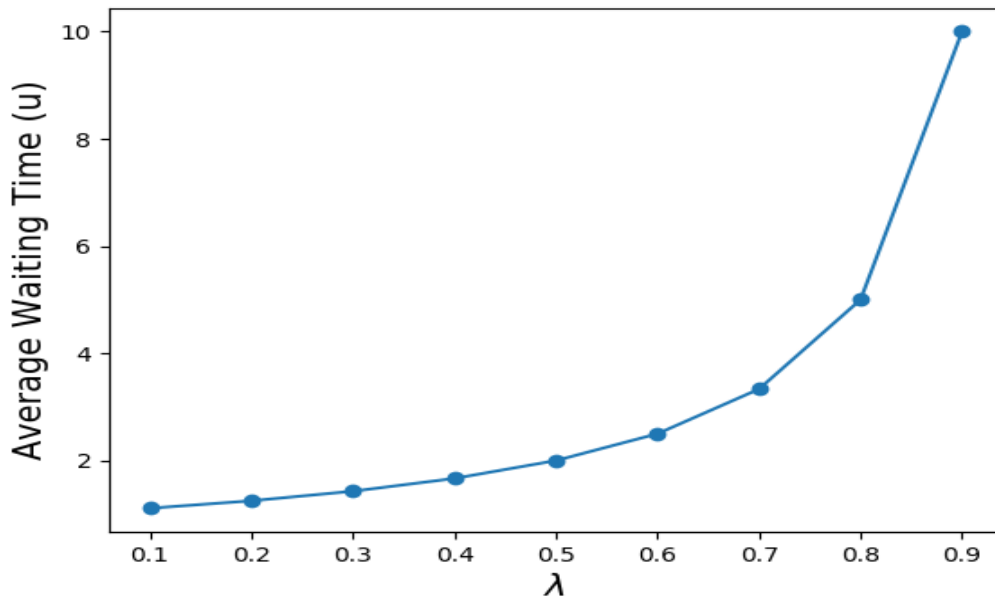

Figure 6.6: Average waiting time for an AS-DTMAC packet

DTMAC operates asynchronously. In this case, the AS-DTMAC user has only to transmit just after the IEEE 802.11p transmission. If we use this operating mode, AS-DTMAC has priority over IEEE 802.11p transmissions. Moreover, the first bit of the transmission key in AS-DTMAC allows one to prioritize access for AS-DTMAC users.

In the three previous chapters, the active signaling mechanism has shown its ability to prevent collisions between vehicles trying to access the same resource. In the next chapter, we extend our AS-DTMAC protocol to support multi-hop communication and we propose an efficient cross-layer design for multi-hop broadcast of emergency warning messages in vehicular networks based on the active signaling mechanism. The proposed protocol is called **AS-DTMAC Multihop**.

# An Efficient Cross-Layer Design for Multi-hop Broadcast of Emergency Warning Messages in Vehicular Networks

## Contents

---

<b>7.1</b>	<b>Introduction and motivation . . . . .</b>	<b>100</b>
<b>7.2</b>	<b>Cross-Layer solution for emergency messages multi-hop dissemination . . . . .</b>	<b>100</b>
7.2.1	MAC Strategy . . . . .	101
7.2.2	Forwarding Strategy . . . . .	103
<b>7.3</b>	<b>Performance evaluation . . . . .</b>	<b>104</b>
<b>7.4</b>	<b>Conclusion . . . . .</b>	<b>111</b>

---

## 7.1 Introduction and motivation

Safety applications impose stringent requirements in terms of QoS, given the need to achieve bounded delays and reliable communications. Guaranteeing high QoS is an major challenge in VANETs due to the high mobility of nodes, frequent changes in network topology and lack of a central control. In order to satisfy these requirements, therefore, it is necessary to have a QoS model provisioning. Moreover, different layers should cooperate to make correct routing decisions. An efficient MAC is required to provide a broadcast service that respects the necessary requirements. Contention-free MAC protocols based on the TDMA technique provide considerable benefits, such as collision prevention [22]. Since central coordination is absent in a VANET topology, the propagation of a safety messages to the set of vehicles must be relayed through multiple relay vehicles. Furthermore, building a new multi-hop broadcast scheme of emergency messages seems difficult due to the very nature of VANETs. Many MAC-aware routing and broadcasting protocols have been designed in order to provide multi-hop communications and disseminate safety messages in a timely manner. In this chapter, we present a cross-layer design for multi-hop broadcast of emergency warning messages called **AS-DTMAC Multihop**. Our approach mixes MAC and routing layers together for an efficient dissemination by selecting the best relay based on the **AS-DTMAC** protocol [6, 7], which uses an active signaling technique to eliminate the problem of access collisions during the slot assignment process. In AS-DTMAC Multihop, we adjusted the active signaling process to let the furthest vehicle acquire the dedicated forwarding slot and thus to speed up the dissemination of warning messages.

The remainder of this chapter is organized in 3 sections. The next section 7.2, we present our message broadcast cross-layer solution by presenting first the proposed MAC strategy and then the forwarding strategy. In Section 7.3, we evaluate the performance of our protocol by presenting simulations results. Finally, in Section 7.4, we conclude the chapter.

## 7.2 Cross-Layer solution for emergency messages multi-hop dissemination

Cross-Layer design is an emerging proposal to support flexible layer approaches in VANETs [82]. As described above, the recent ongoing research has shown increased

interest in protocols that rely on interactions between different layers. In this chapter, we propose to exploit the relation between MAC and network layers, in an effort to improve the performance of the Multi-hop Broadcast of DENM in Vehicular Networks. We propose the idea of combining an approach based on a MAC layer protocol named AS-DTMAC with a forwarding strategy. Figure 7.1 represents the general architecture of our message broadcast cross-layer solution. In this section, we first focus on the MAC protocol principle and then we describe the forwarding strategy adopted.

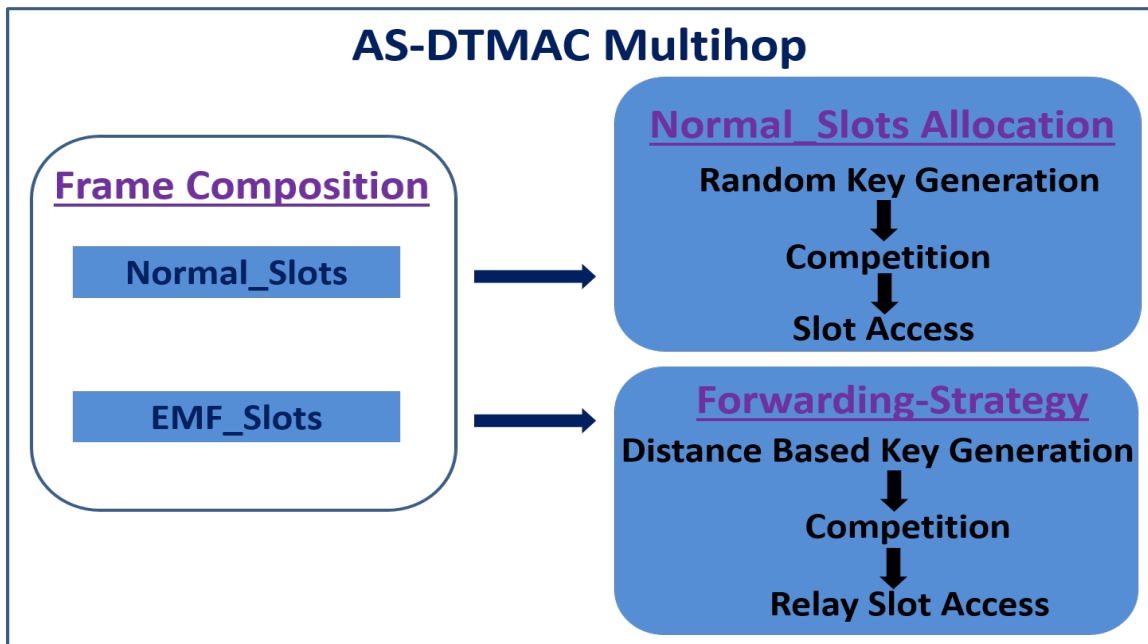

Figure 7.1: AS-DTMAC Multihop Architecture.

### 7.2.1 MAC Strategy

As shown in Figure 7.2, frame composition in AS-DTMAC Multihop is slightly different from that of AS-DTMAC [6]. In AS-DTMAC Multihop, each frame is composed of 100 slots and it is divided into three sets denoted as  $S_0$ ,  $S_1$  and  $S_2$ , corresponding to three successive zones. AS-DTMAC Multihop defines two types of slots: *Normal\_Slot* and *Emergency\_Message\_Forwarding\_Slot* or *EMF\_Slot*. Normal\_slots are used by each vehicle to send data, as in AS-DTMAC. However, *EMF\_Slots* are special slots dedicated, by AS-DTMAC Multihop, to forwarding emergency messages. In each frame, three slots, namely the first slot of each set  $S_i$  (i.e.  $Slot_0$ ,  $Slot_{34}$  and  $Slot_{67}$ ), are defined as *EMF\_Slots*. This choice can be explained by the fact that emergency



messages are time-sensitive, hence choosing the first slot in each set to forward them will speed up warning message dissemination.

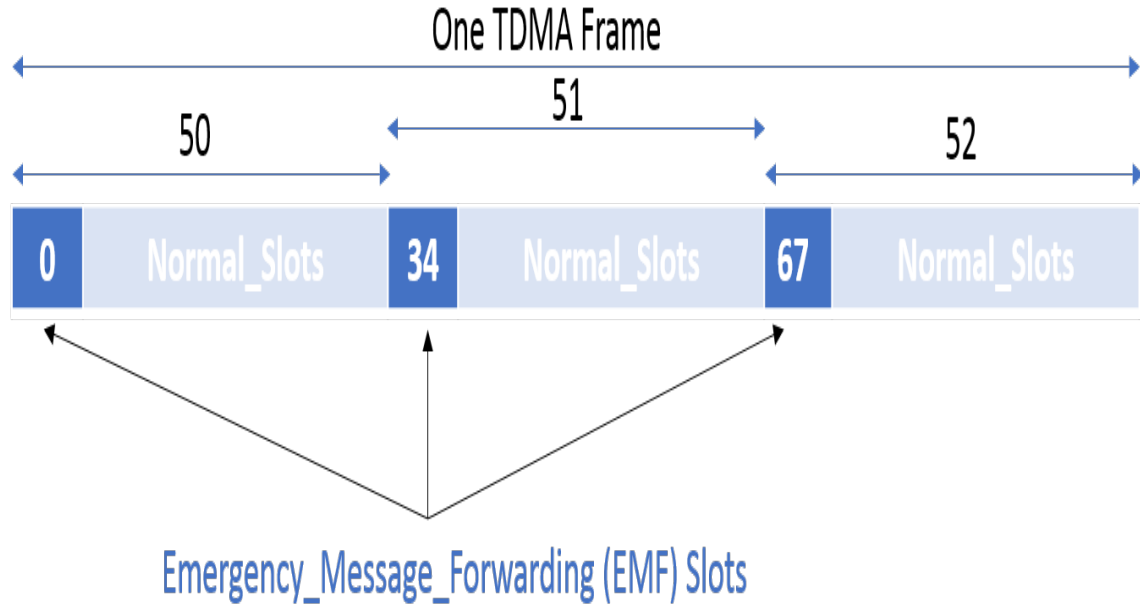

Figure 7.2: AS-DTMAC Multihop Frame.

As illustrated in Figure 4.3, whether normal or EMF, a slot is usually formed by two time intervals. The first one, is dedicated to the selection process. However, the second is held by the winner of the competition to transmit its payload packet. In the first interval, a random binary key is generated by every node to compete for a slot. Hopefully, at the end of the time interval, only one node will remain as the winner. The key is a succession of bits (0,1). '1' means that the vehicle with a packet to send will transmit during the signaling bursts. '0' means that the vehicle with a packet to send senses the channel during this mini-slot. When a vehicle selects a listening period and senses a transmission, the competition to get the slot is over. For instance, a vehicle that draws the key '01001110' will listen during the first mini-slot and if no competing transmission is sensed during this mini-slot, it will transmit during the next mini-slot. The following two steps of the selection process in our example, will be two listening periods. The selection process continues using the same rule until the key is completely used up.

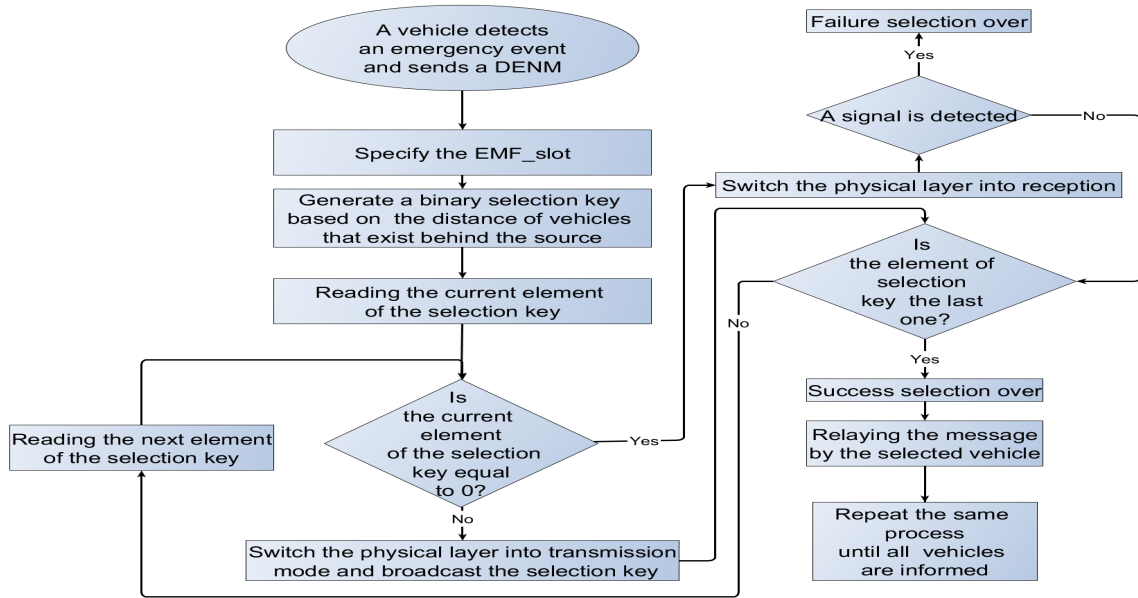

Figure 7.3: Forwarding Strategy Flowchart.

## 7.2.2 Forwarding Strategy

Given the high sensitivity of emergency messages to delay constraints and collisions, it is crucial to propose an efficient multi-hop dissemination scheme that avoids these problems. Since the active signaling technique solves the collision problem, our forwarding strategy is based on an adapted version of the Active Signaling-DTMAC protocol.

As shown in Figure 7.3, when a source node,  $S_N$ , detects a warning event it has to broadcast an emergency message. Vehicle  $S_N$  sends the message during its reserved *Normal\_Slot*. All nodes that receive the message and that are located behind the sender: situated in the sender's zone or in the adjacent one (in the sender's transmission range), will compete to forward the received emergency message to other vehicles during the *EMF\_Slot*. To avoid access collision on this slot, each vehicle generates a binary key based on the distance that separates it from the sender. The key is composed of mini-slots. As explained in the previous section, these mini-slots take the value '1' or '0'. '1' means that the node is in a transmission mode and '0' means that the node is in a listening mode. The forwarding strategy consists of selecting the best next relay from the list of vehicles that have generated keys. The winner node will forward the message to the rest of the nodes situated in the opposite direction of the sender vehicle in order to propagate the message as far as possible.

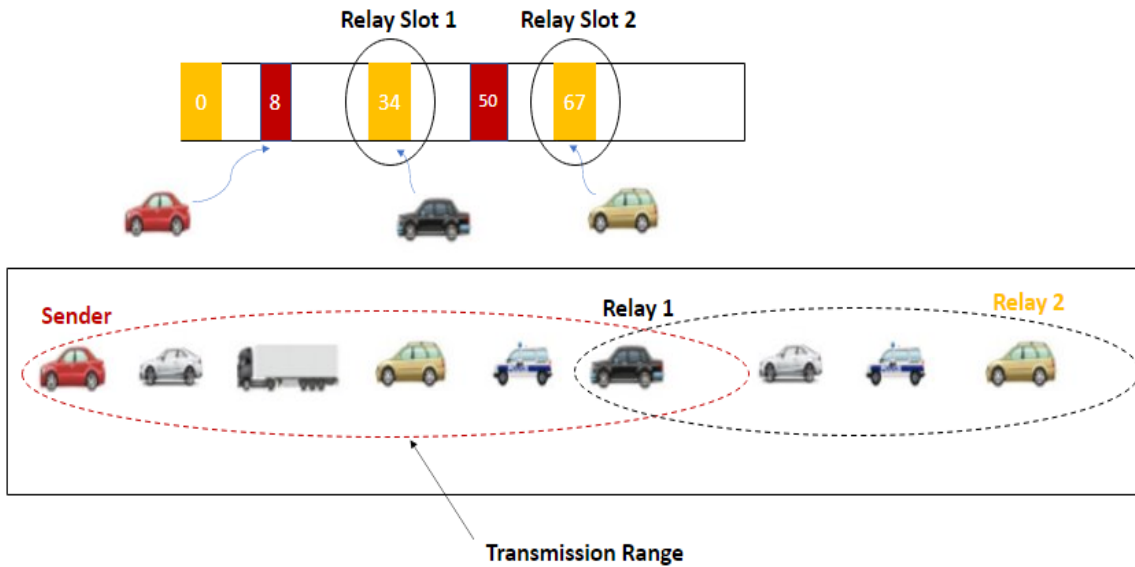

Figure 7.4: Forwarding Strategy.

In practice, the winner is always the furthest vehicle from the transmitter. This is counted as a benefit in terms of packet propagation since the emergency message will be quickly broadcasted and the danger will be avoided. The transmitter sends a message in its own slot reserved in the set dedicated for the zone to which it belongs. So, the forwarding will take place in the first slot of the next set.

To give a clearer idea of our forwarding strategy, we consider the example shown in Figure 7.4. In this example, the sender, which is the red vehicle, sends an emergency message during its slot (slot 8). In this case, the competition and the first relay of the message will take place in the slot 34. The black vehicle (which is the furthest vehicle) is the winner of the competition and it will forward the message to the other nodes. The same process will be repeated in the next hop until all vehicles have been informed of the potentially dangerous situation.

## 7.3 Performance evaluation

We evaluate the performance of AS-DTMAC multihop protocol based on the following metrics:

- **Latency:** this defines the time between the first broadcast of the message and the time of its reception by the last vehicle on the road.

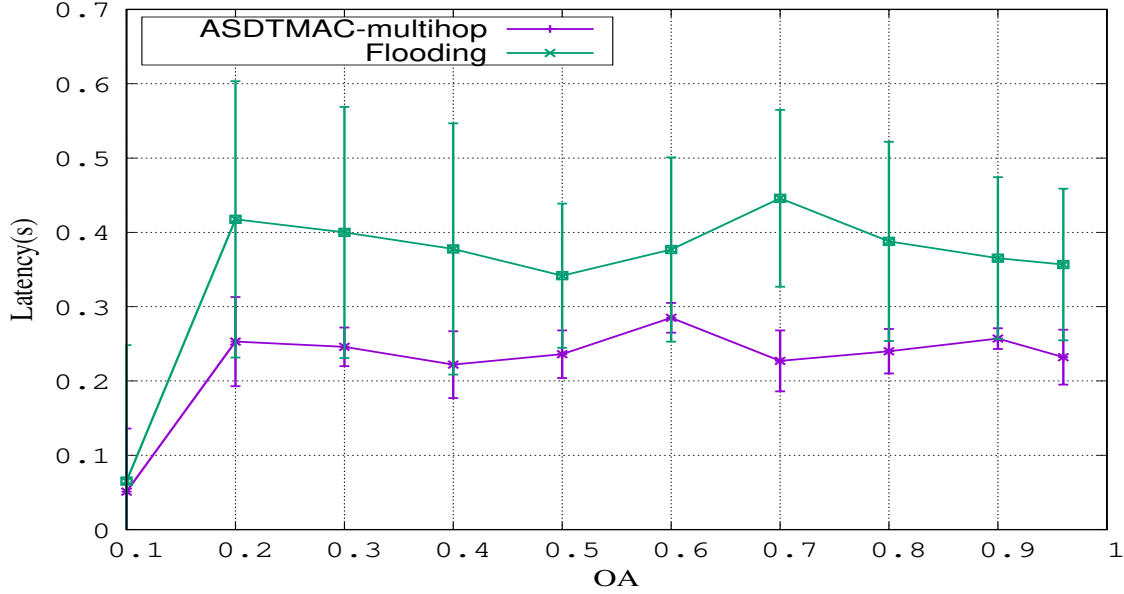

Figure 7.5: Latency versus channel occupancy for AS-DTMAC Multi-hop and Flooding with  $SSD=20$  and error bar (95% confidence interval).

- **Packet Loss:** as shown below in the equation, the packet loss percentage defines the number of lost packets that are not received, divided by the total number of packets that should be received. The formula to compute the packet loss is defined as follows:

$$Packet\ Loss(\%) = \frac{Number\ of\ Lost\ Packets}{Total\ Number\ of\ Packets}$$

- **Number of Forwarders:** this metric defines the number of forwarders (relays) needed to relay a message.
- **Used Bandwidth:** the used bandwidth metric represents the total number of packets received by vehicles.

Now, We move on to the **Packet Loss** metric. Figure 7.7 presents the packet loss versus OA in percent. The error bars are for a 95% confidence interval. It is clear that AS-DTMAC Multihop has 0% of packet losses, whereas in Flooding we find a considerable packet loss rate that can reach more than 80% in high traffic level density conditions. As we have explained above, in the Flooding mechanism, every vehicle that has received the message will attempt to forward it and this will cause a high interference in the Flooding scheme. As a result, many packets will be lost.

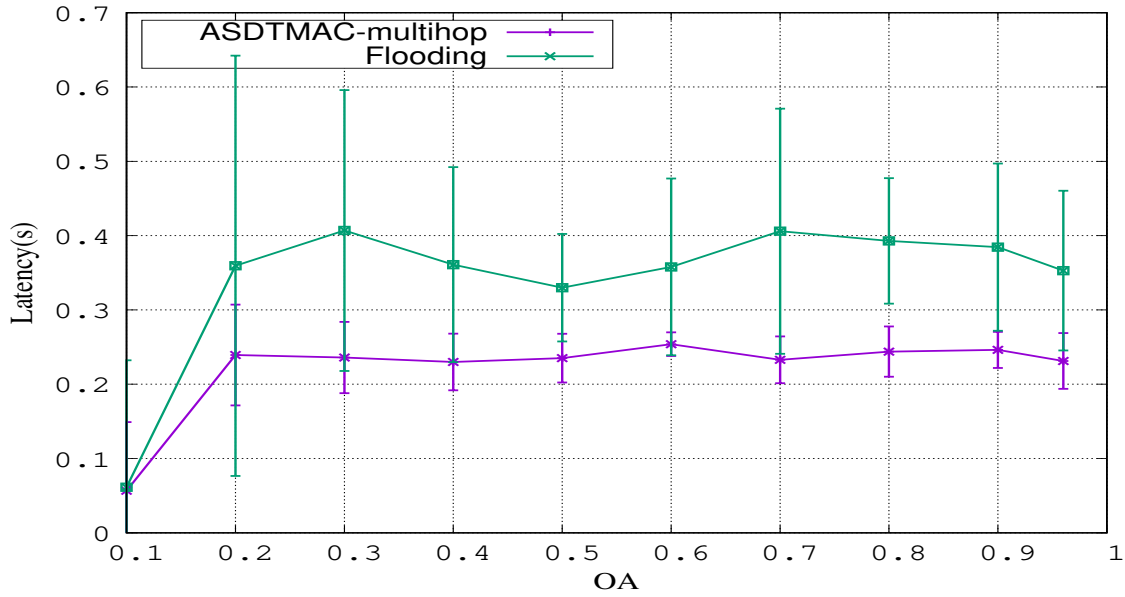

Figure 7.6: Latency versus channel occupancy for AS-DTMAC Multi-hop and Flooding with  $SSD=30$  and error bar (95% confidence interval).

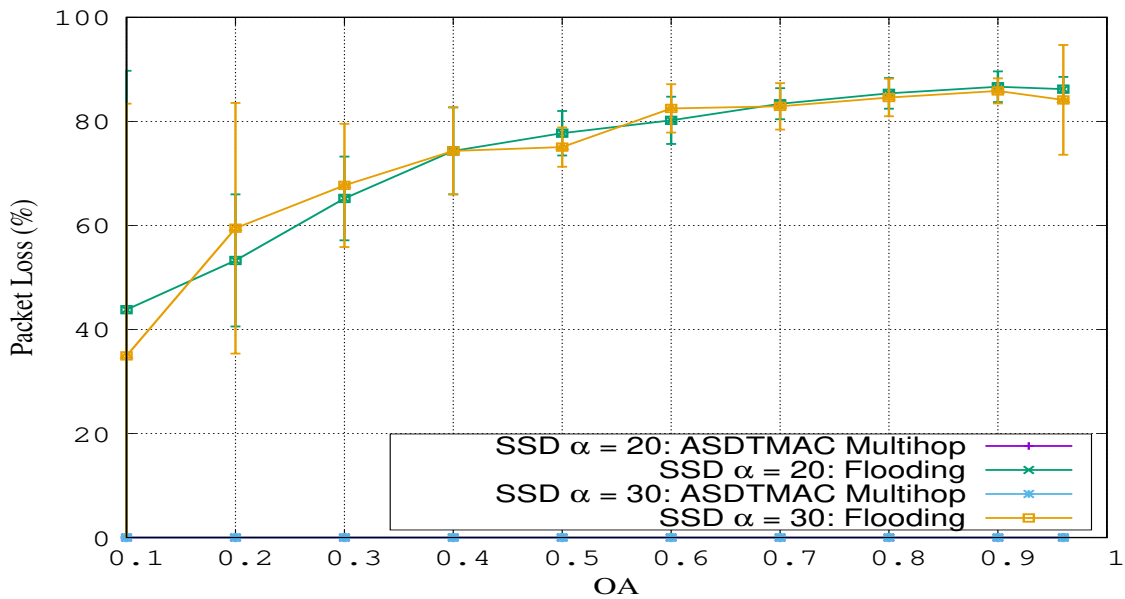

Figure 7.7: Packet Loss versus channel occupancy for AS-DTMAC Multi-hop and Flooding with error bar (95% confidence interval).

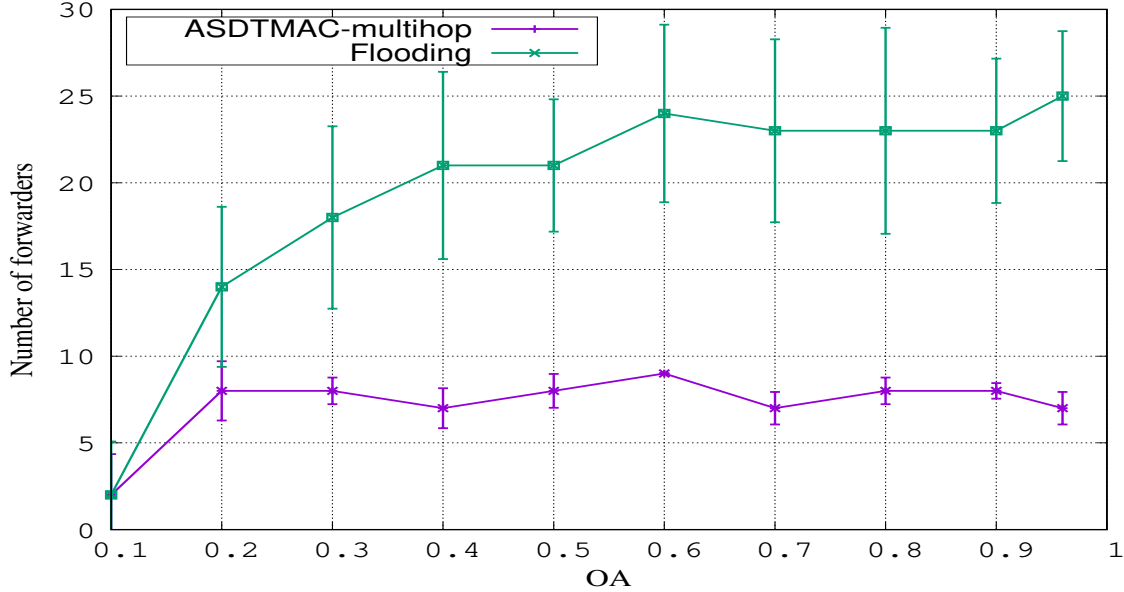

Figure 7.8: Number of forwarders versus channel occupancy for AS-DTMAC Multihop and Flooding with  $SSD=20$  and error bar (95% confidence interval).

We now evaluate **the Number of Forwarders** metric. In Figure 7.8 and Figure 7.9, we show the number of forwarders needed for each approach (AS-DTMAC Multihop and flooding) to warn of an emergency event versus OA. Figure 7.8 represents results with a  $SSD$  equal to 20 ( $km/h$ ) while Figure 7.9 with a  $SSD$  equal to 30 ( $km/h$ ). As we can see, AS-DTMAC Multihop requires fewer resources, this will reduce the channel occupancy. In contrast, the flooding technique uses more resources because all the vehicles that received the packet will attempt to forward it.

We move on to **the Used Bandwidth** metric results. In Figures 7.10 and 7.11, we plot the used bandwidth versus OA for both AS-DTMAC Multihop and flooding. This metric, represents the total number of received packets. In flooding, we notice that it provides a high value compared to AS-DTMAC Multihop. In our approach, at every hop, only one winner vehicle will relay the packet to its neighbors, whereas in flooding every receiver will relay the packet and thus vehicles could receive the packet several times.

Finally, we compare the dissemination delay achieved by AS-DTMAC Multihop and Flooding to the estimated delay. We begin by deriving an analytic expression of the estimated delay. As illustrated in Figure 7.12, to deliver an emergency message from  $V_1$  to  $V_4$ , one frame is sufficient. In fact, the message is relayed 3 times ( $n_0 + n_1 + n_2 = \tau slots = one\ frame$ ). Based on this information, we derived an ana-

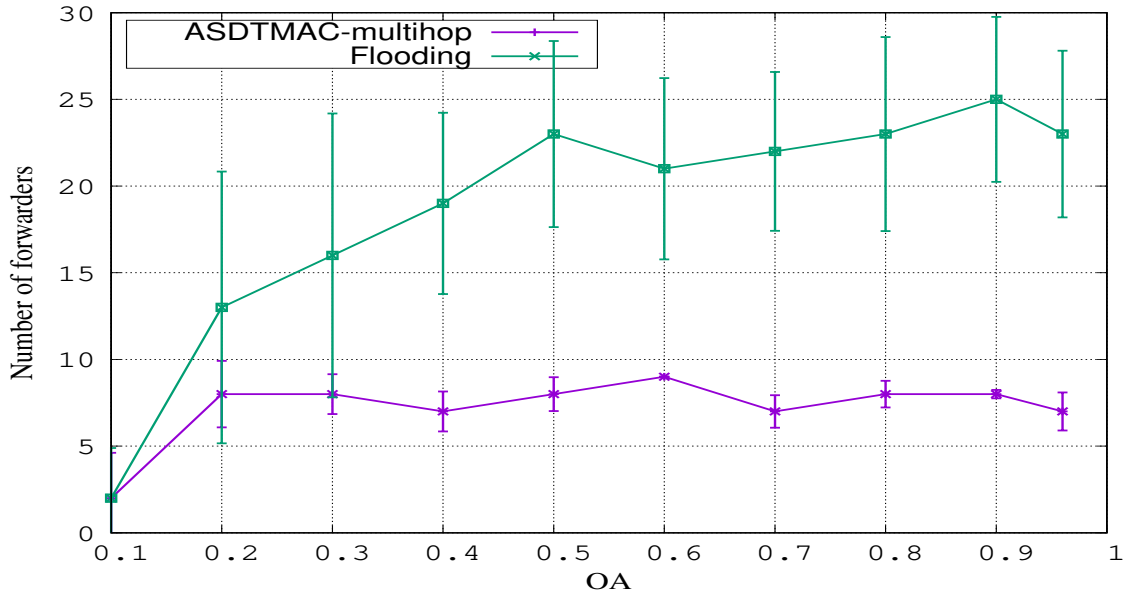

Figure 7.9: Number of forwarders versus channel occupancy for AS-DTMAC Multi-hop and Flooding with  $SSD=30$  and error bar (95% confidence interval).

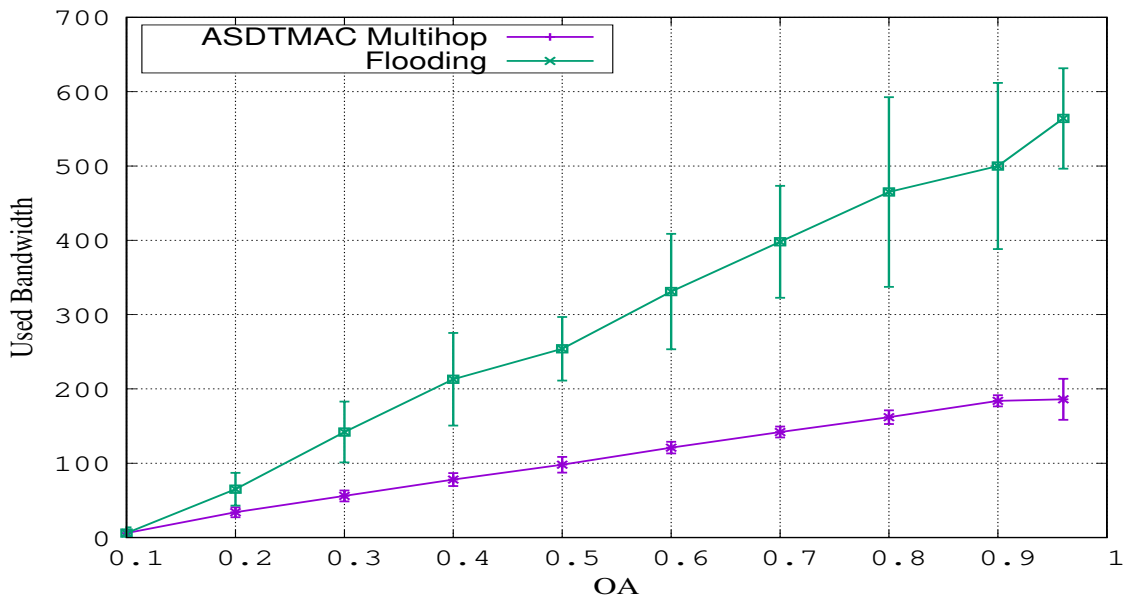

Figure 7.10: Used Bandwidth versus channel occupancy for AS-DTMAC Multi-hop and Flooding with  $SSD=20$  and error bar (95% confidence interval).

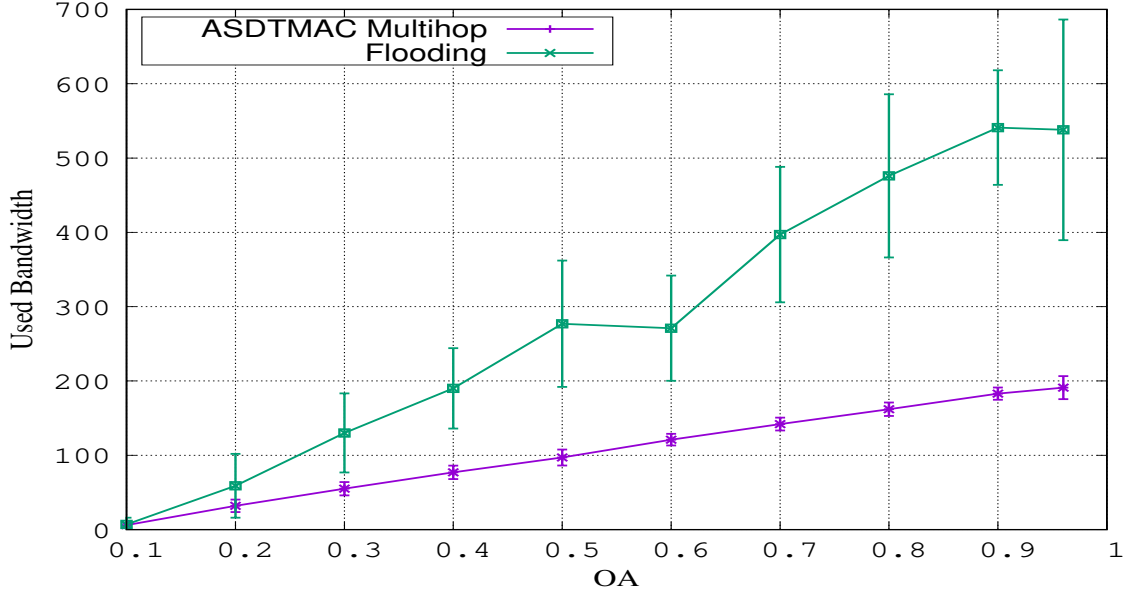

Figure 7.11: Used Bandwidth versus channel occupancy for AS-DTMAC Multi-hop and Flooding with  $SSD=30$  and error bar (95% confidence interval).

lytical formula to compute **the estimated delay** needed to deliver a message from a source  $i$  to a vehicle  $j$  separated by such a distance. As defined in [39], the ED is defined in the equation as following:

$$ED = \frac{Dist_{i,j}}{3 * R} * \tau * s_d \quad (7.1)$$

Where  $i, j, R, \tau, Dist_{i,j}$  and  $s_d$  are respectively the sender, the receiver, the transmission range, the length of the frame, the distance between the sender and the receiver and the duration of the slot.

Figure 7.13 presents the estimated delay to propagate a packet from a source to a receiver versus the distance between them.

We can observe from this figure that AS-DTMAC Multihop can provide a shorter delay than the estimated one. This can be explained by the fact that the forwarder will send in one of the reserved slots of forwarding ( $Slot_0$  or  $Slot_{34}$  or  $Slot_{67}$ ). The delay will depend on the vehicle's position (following the AS-DMAC Multihop scheme: vehicles can access only the set of slot of their area): they can reserve at the beginning, at the middle or at the end. However, due to the interference in the flooding approach, the forwarding operation may not occur in the same frame. If this happens, a vehicle will relay on the next frame. This hypothesis can explain the results obtained.



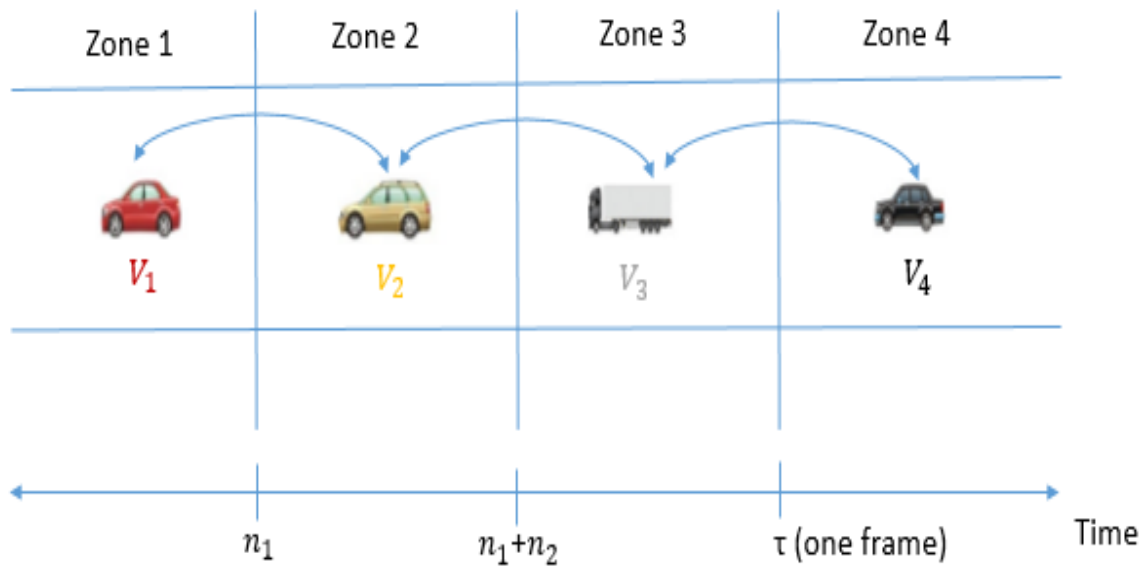

Figure 7.12: Message propagation based on TDMA slot information.

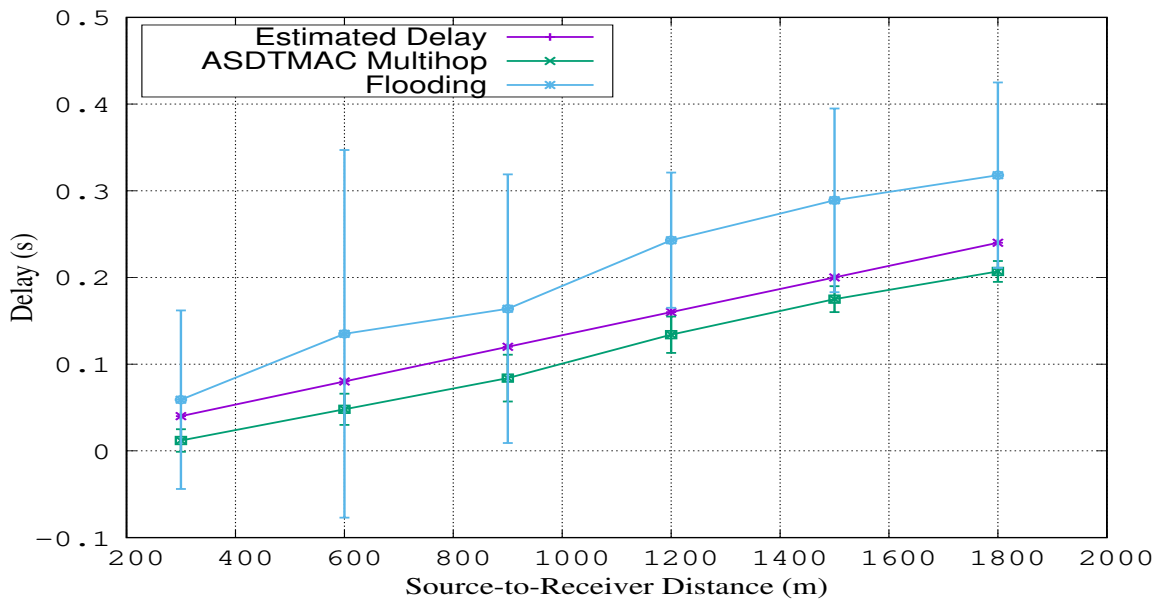

Figure 7.13: Estimated Delay versus distance for AS-DTMAC Multi-hop and Flooding with  $SSD=30$  and error bar (95% confidence interval).

## 7.4 Conclusion

Due to the dynamic topology, lack of infrastructure and restrictive requirements of VANET technology, it seems clear that designing a protocol for disseminating safety messages in a fast and efficient way is by no means a simple task. This is why, in this chapter, we have proposed an original message forwarding strategy called AS-DTMAC Multihop for broadcasting DENM messages from a source vehicle to the rest of the vehicles through multiple relays. Our approach uses the vehicles' geographic positions and it is based on the MAC protocol AS-DTMAC. Furthermore, it uses the active signaling technique in the relay selection process in order to choose the best forwarder at each hop. Simulation results showed that our approach performs much better than flooding by providing lower values in terms of latency, bandwidth used, number of forwarders, packet loss and estimated delay.

## Part III

# Vehicular Hybrid Communication

# Evaluation of a new Radio Technology and Visible Light Communication for a Platooning Application

## Contents

---

<b>8.1</b>	<b>Introduction and motivation . . . . .</b>	<b>114</b>
<b>8.2</b>	<b>Performance analysis of AS-DTMAC for platooning control . . . . .</b>	<b>115</b>
<b>8.3</b>	<b>Simulation results . . . . .</b>	<b>120</b>
8.3.1	V-VLC performance with the presence of interference . . .	121
8.3.2	Performance comparison between V-VLC and RF . . . . .	122
<b>8.4</b>	<b>Conclusion . . . . .</b>	<b>125</b>

---

## 8.1 Introduction and motivation

Nowadays, our highways are becoming increasingly congested. For the best traveling experience, ITS aim to optimize road utilization and traffic management. To address congestion issues, conventional vehicle systems for traffic flow like the Adaptive Cruise Control (ACC) are not sufficient. This system automatically adjusts a vehicle's speed based on information from vehicles ahead. A more dynamic regulation strategy requires a cooperative system which will provide more information on the positions, speeds and accelerations of neighboring vehicles. Thanks to these cooperative systems, new vehicular applications can be established (an example of such a system being Cooperative Adaptive Cruise Control (CACC)). Platooning is one of the best-known applications that can enhance road capacity.

A Platooning application involves a robust control with an efficient communication strategy. Due to high QoS requirements in terms of update frequency (at least 10Hz) with a recommended transmission latency of 20 ms and a reliability of 99.99%, researchers are looking to combine more than one communication technology. In the literature, many communication strategies have been proposed. To achieve low-latency and ultra-reliable communication, an additional vector of communication is required since relying only on the RF link, as we developed in Chapters 1, 2, 3, 4 ([6] [7] [59] [60] [61]), may not be sufficient. With a very high number of nodes, there is a risk of reaching the full capacity of the channel and, if that occurs, some nodes will be unable to communicate with the rest of the network. In such a case, V-VLC is a potential technology that could assist RF communication. However, V-VLC in outdoor environments faces a number of challenges due to mobility, weather conditions and ambient light [9]. Nonetheless, it provides a large free spectrum at a relatively low cost as the Light Emitting Diodes (LEDs) are already embedded in modern vehicular light systems [9].

Our goal is twofold: first, to show that our new RF design is able to support platooning applications (to our best knowledge, we are the first to propose a radio technology based on a fully distributed TDMA which meets the QoS requirements necessary for platooning communication). Secondly, we set out to test the maturity of the V-VLC standard in large-scale simulations for dynamic V-VLC scenarios such as platooning in the presence of interfering vehicles. For this, we have chosen to use a simulator based on a fairly realistic empirical model that takes into account the impact of the type of vehicle (the features of this framework are explained below). This study helps us to determine whether light links are sufficiently stable to be used

in place of radio links, or whether we should use both communication links to improve the overall reliability.

The remainder of this chapter is organized as follows. In Section 8.2, we discuss and prove analytically the capacity of our new radio design to support a platooning application. For this task, we select suitable metrics, namely average access time and path loss (under NLOS conditions). In Section 8.3, we show the performance of the V-VLC link in the presence of disturbing vehicles. We evaluate the PDR for various network conditions, different headlight modules (provided by Veins VLC [109] [110]) and speeds. We also compare the performance between RF and VLC in terms of PDR and delay. Finally, in Section 8.4, we conclude the chapter.

## 8.2 Performance analysis of AS-DTMAC for platooning control

Following the AS-DTMAC scheme described in Chapter 4 and Chapter 5, a vehicle loses its slot when it changes zones (see Figure 8.1:  $R$  equals the transmission range). Thanks to the active signaling mechanism, reserving another slot in the new area will take only a few milliseconds. Now, considering a platooning scenario, the members of the platoon are considered as a single entity. Therefore, in order to maintain communication between the leader and the followers, all platoon members must be allocated a slot in less than  $100ms$  (platoon update rate), otherwise, data are lost and this can affect the platoon's stability.

We assume that we have  $n$  vehicles in the platoon and we wish to compute the average time needed for all the members of the platoon to obtain a slot in the new area, thus in a new DTMAC frame. We assume that the slots in the new areas are occupied with probability  $\lambda$  and free with probability  $1 - \lambda$ <sup>1</sup>. We also assume that the free slots are obtained by AS-DTMAC in a greedy mode (the first slot available is reserved by a vehicle with AS-DTMAC without any collision since the collision rate is extremely small). We note by

$I_1, I_1 + I_2, \dots, I_1 + I_2 + \dots + I_n$  the slots successfully obtained by the vehicles in the platoon. The probability that  $I_1 = i_1, I_2 = i_2, \dots, I_n = i_n$  is

$$(1 - \lambda)\lambda^{i_1}(1 - \lambda)\lambda^{i_2} \dots (1 - \lambda)\lambda^{i_n} \quad (8.1)$$

<sup>1</sup>This is a simplified model for AS-DTMAC which assumes that the DTMAC frame is infinite

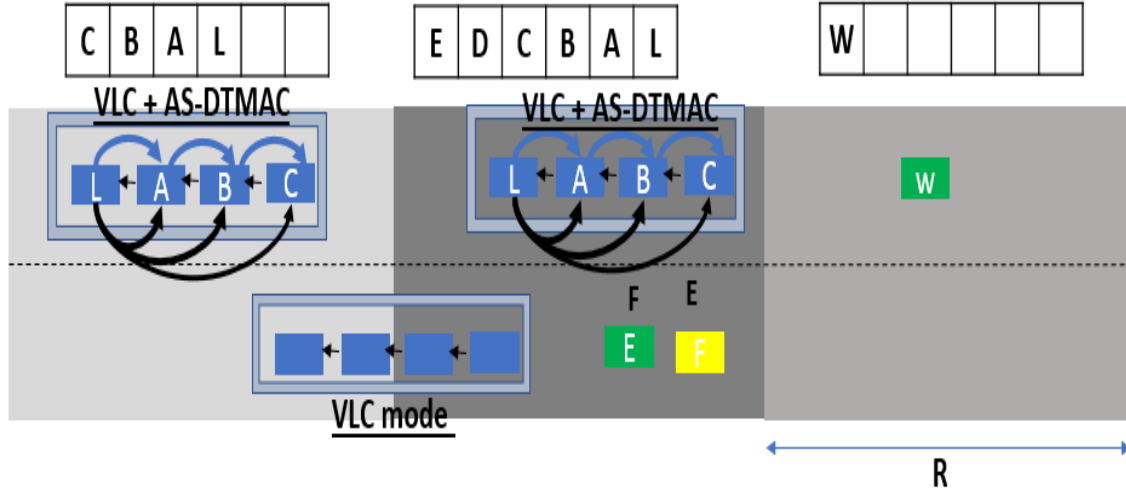

Figure 8.1: Platoon scenario with RF based on AS-DTMAC

and the total time needed for all the nodes to obtain a slot in the next frame is  $n + I_1 + I_2 + \dots + I_n$ .

The average time required for all the nodes to obtain a slot is thus

$$E((1 + I_1) + (1 + I_2) + \dots + (1 + I_{n-1}) + (1 + I_n)) \quad (8.2)$$

where  $E$  means the expectation on all the possible events.

But all the  $I_j$  with  $j \in 1, 2, \dots, n$  are independent with the same law and we have:

$$E((1 + I_1) + \dots + (1 + I_n)) = nE(1 + I_1) = \frac{n}{1 - \lambda}. \quad (8.3)$$

We also have

$$P((n + I_1 + \dots + I_n = p)) = \binom{n - 1 + p}{n - 1} \lambda^p (1 - \lambda)^n. \quad (8.4)$$

Thus we can easily compute the distribution of  $n + I_1 + \dots + I_n$ .

In Figure 8.2, we plot the probability that the last slot successfully reserved by a platoon of 10 vehicles is at most slot number  $N$ . We observe that unless there is a high load, the reservation stops before the end of the AS-DTMAC frame, whose duration is 33 slots.

In order to further investigate the capacity of our new radio technology design to support the platoon application, we analyze the connectivity between platoon members in fading channel conditions, and under our active signaling mechanism.

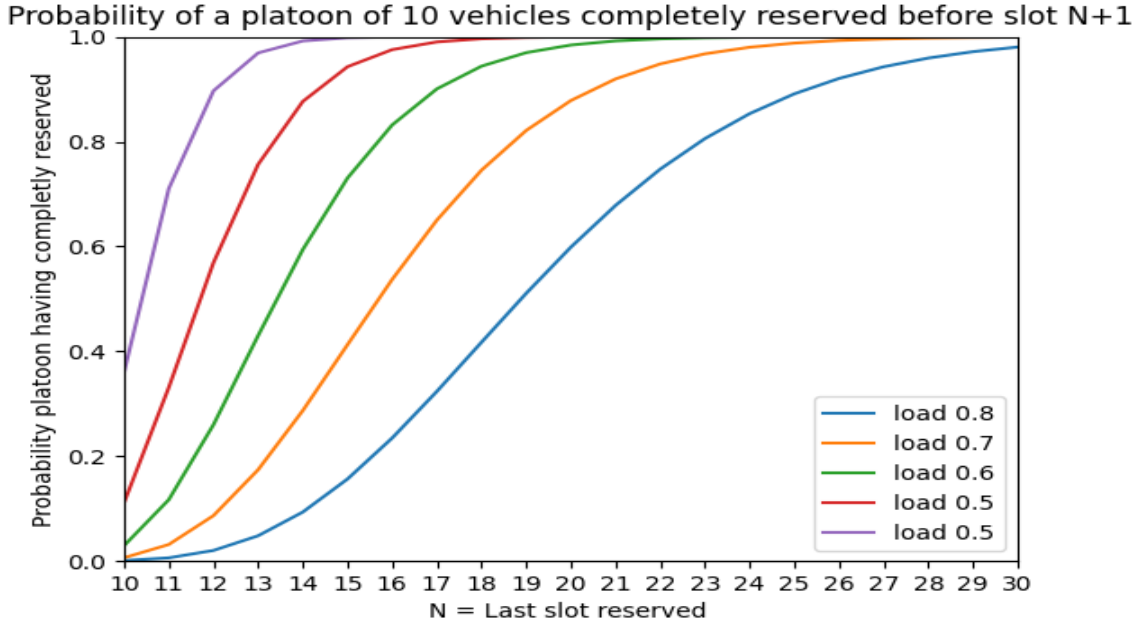

Figure 8.2: Probability of a platoon of 10 vehicles completely reserved before slot  $N+1$

V2X applications operate on the 5.9GHz bandwidth, and the platooning application requires a safety distance ( $d$ ) between platoon members of between  $10m$  and  $30m$ . We can consider that  $d \gg \lambda$  ( $\lambda$  here refers to the radio wave length) and thus we use statistical models to take into account the fading effect (including the random channel gain and random phase shift). The following formula gives the path loss with channel fading:

$$PL(d) = 10 * \gamma * \log(d/d_0) + PL_0(d_0) + X \quad (8.5)$$

$X$  is a zero mean complex normal distribution variable with standard deviation  $\sigma$ . The  $\gamma$  is the path loss exponent. The values of  $\sigma$  and  $\gamma$  were taken from [111]. AS-DTMAC uses the physical layer of the IEEE 802.11p thus the RX sensitivity is  $-85\text{dbm}$  (add modulation scheme) [112]. In a previous study [59], we determined the detection threshold for the AS-DTMAC transceiver:  $\text{dbm}$ . The following results were obtained by using the Monte-Carlo simulation.

Figure 8.3 shows the probability of correctly detecting and decoding ( $P_d$ ) a packet under fading conditions versus the distance between the transmitter and the receiver. From this curve we can see that up to  $150 m$ , 100% of packets are received correctly.



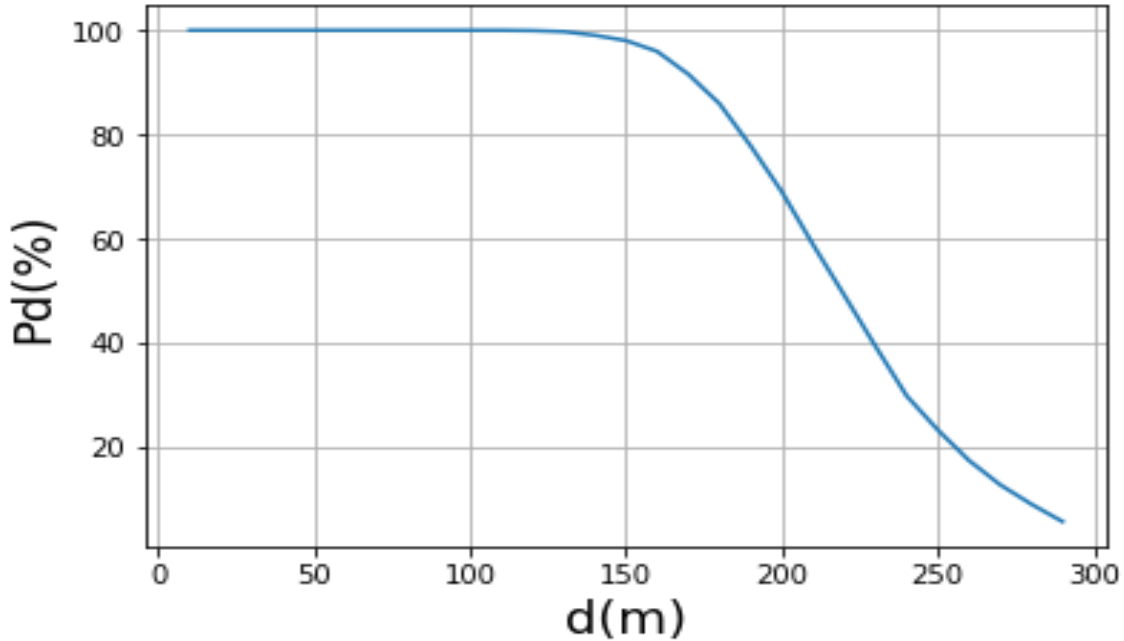
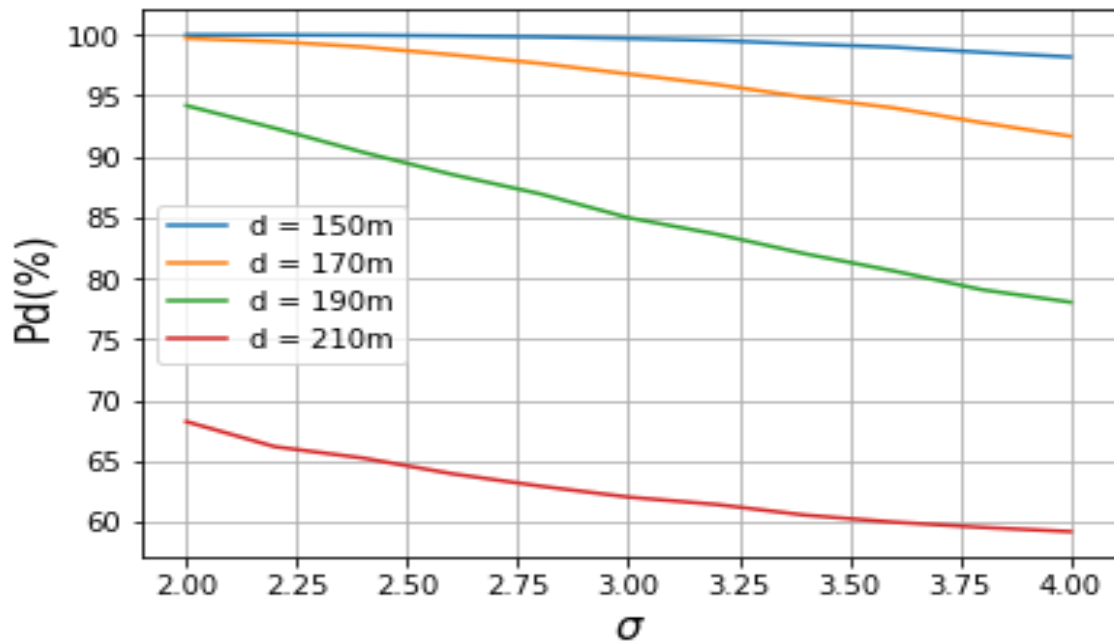
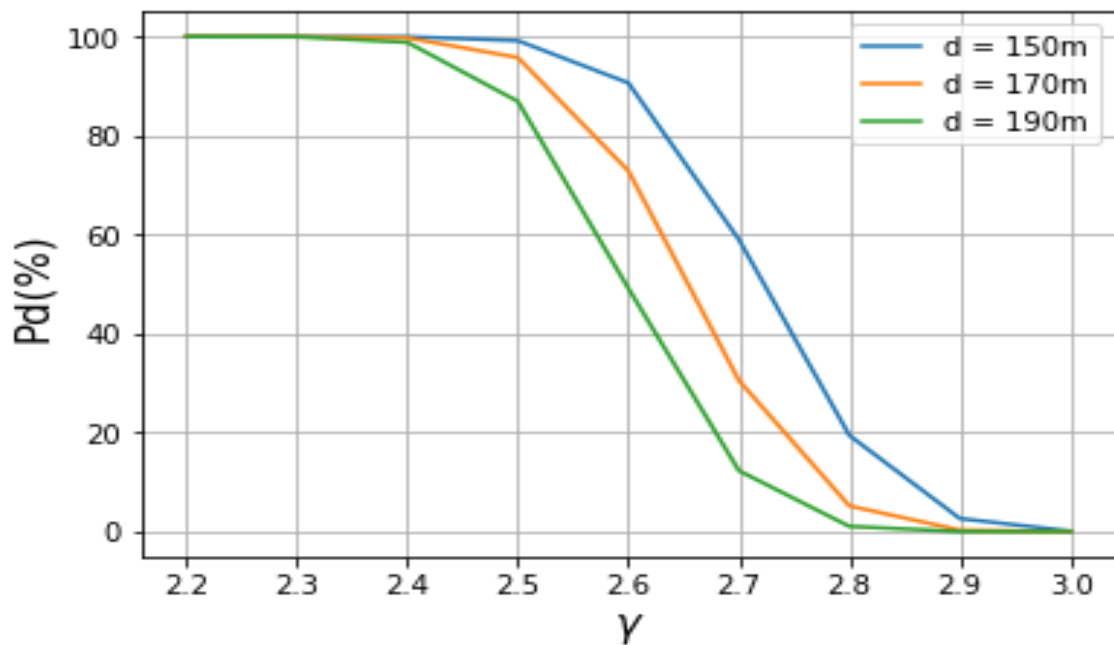

Figure 8.3: Probability of detecting & decoding versus RX-TX vehicle inter-distance

Beyond this value, the  $P_d$  gradually decreases as the distance increases. In Figure 8.4, we vary the variance ( $\sigma$ ) of the fading (the sweep values were taken from the reference [113]) and show their impact on  $P_d$ . We plot four curves, each one corresponding to a particular distance (150 m, 170 m, 190 m, 210 m). The results show that there is an impact of this parameter on the detection: by raising  $\sigma$ , the probability decreases; however, the probability decreases more rapidly when the distance grows. Finally, in Figure 8.5 we vary the path loss exponent ( $\gamma$ ) from 2.2 to 3 [113]. As we can observe, this last parameter also has an impact on  $P_d$ . Furthermore, for each curve plotted, we can see that the threshold to have 100% of packets moves with the distance (i.e. the greater the distance is, the more the threshold moves to the left).

From this connectivity analysis, we can conclude that safe connectivity can be achieved at a distance of 150 m. However, the above study (i.e. the probability of a platoon having a completely reserved slot) shows that due to the AS-DTMAC scheme we limit the platoon size to 10 vehicles with an assumed inter-vehicle distance of 10 m and a mean vehicle length of 4-5 m.

Figure 8.4: Probability of detecting & decoding versus Rayleigh-fading variance  $\sigma$ Figure 8.5: Probability of detecting & decoding versus the path loss exponent  $\gamma$

## 8.3 Simulation results

The simulation tool for V-VLC used in this section is based on **VEINS-VLC** [109] [110]. This simulator uses an empirical model (i.e. it uses photometric data and thus takes into account the NLOS component coming from the ground). As the data are collected from a real headlight module, this radiation pattern includes the effect of a high and low beam<sup>2</sup> in the headlight coming from real vehicular headlight modules. These modules are from **HELLA GmbH & Co. KGaA**. Figure 8.6 summarizes the integration of the empirical model into the VEINS framework (for more details see [110]).

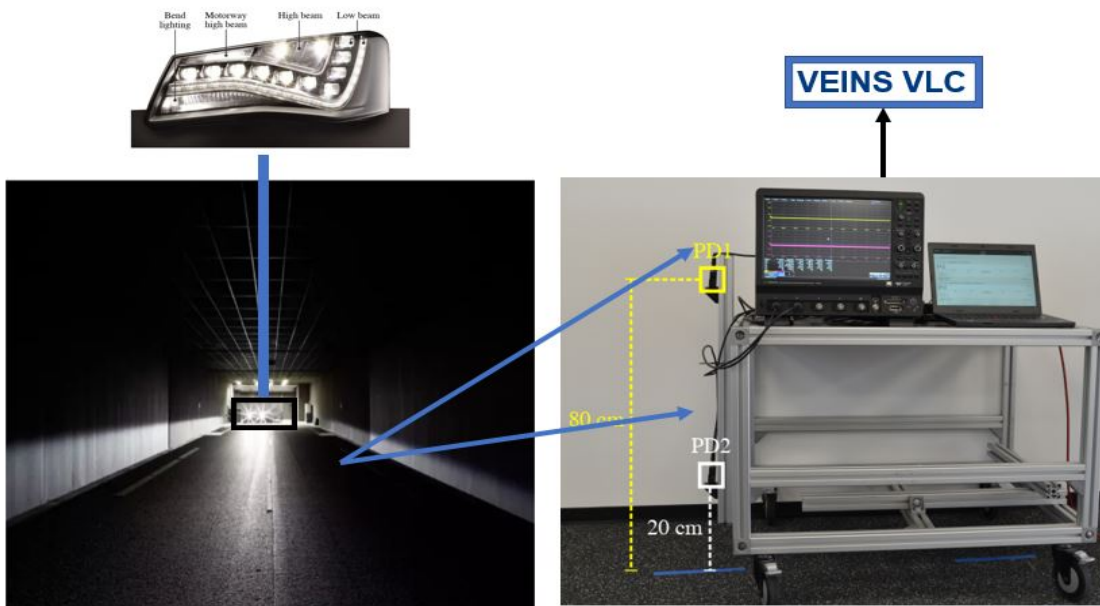

Figure 8.6: Summary of the integration of the empirical model in VEINS-VLC (the images were taken from [110]): the measurements were done at the HELLA’s Lichtkanal company in a light channel room of dimension  $145m \times 11m$ . For the emissions, a real pair of headlights module was used, whereas the receiver side uses two PDs of type PDA100A placed at the same level as the license plate and the tail lights.

<sup>2</sup>The low beam in the headlight is to implement an asymmetric light distribution.

Table 8.1: Simulation parameters

Parameter	Value
<i>PacketBytelength</i>	1024byte
<i>BeaconingFrequency</i>	10Hz
<i>Channel model</i>	veins-vlc
<i>Car-Following-Model</i>	CACC
<i>Bitrate</i>	1Mbps
<i>Disturbing vehicles speed</i>	50-120km/h

### 8.3.1 V-VLC performance with the presence of interference

In this section, we show the impact of interference on the performance of visible light communication in a vehicular platoon. Our study focuses on the vehicles that are arriving in parallel to the platoon's lane. When there is packet in the channel transmitted between the platoon vehicles, the channel is disturbed by the light of these arriving vehicles. This will continue to be the case until all the disturbing vehicles have overtaken the platoon (see Figure 8.7).

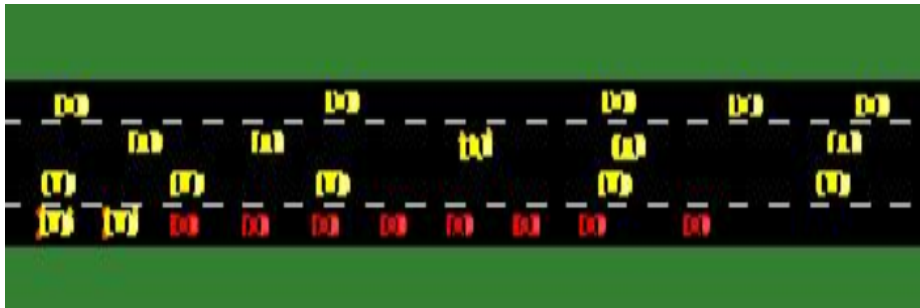

Figure 8.7: A highway scenario with a platoon in the lower lane, the other lanes are for connecting vehicles.

Figure 8.8 shows the Packet Delivery Ratio (PDR) versus the number of disturbing vehicles. We plot different curves, each one using a particular model available on the market (LbSedan1, LbSedan2, Lbsuv1, HbSedan2, HbSedan1). All the curves decrease as a function of the number of disturbing vehicles. As we can observe, the interference caused by the vehicles' lights has an important impact, particularly for high numbers of disturbing vehicles (for 100 disturbing vehicles: 40% of the packets are lost). We also see that the types of vehicles in platoon impact the PDR and the difference can reach 10% for high densities.

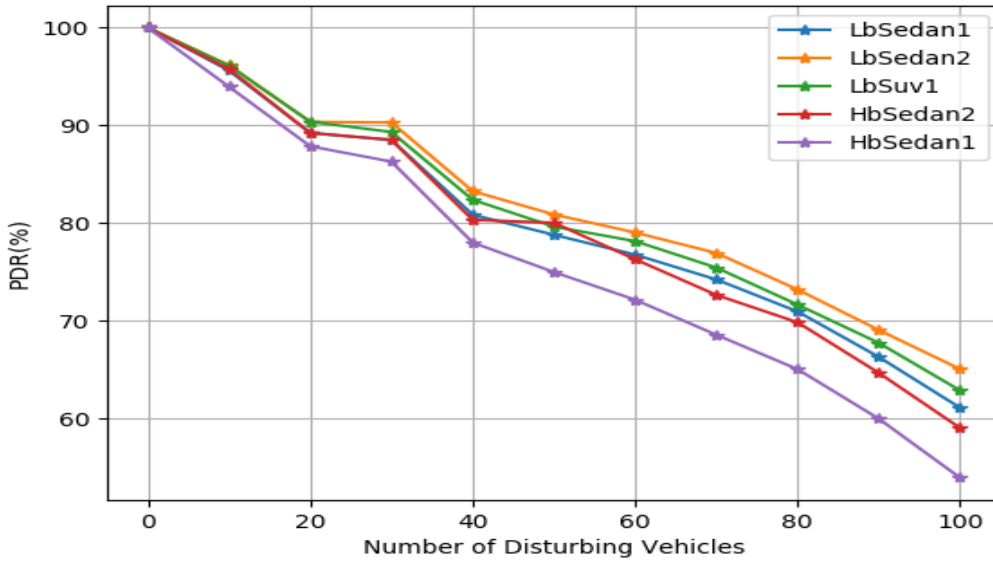

Figure 8.8: V-VLC PDR versus number of disturbing vehicles: Simulation time = 116s; platoon size = 8; platoon inter-vehicle distance = 10 m; Disturbing vehicles' speed = 100 km/h ; Platoon vehicles' speed = 15 km/h.

Figure 8.9 shows the impact of the speed of disturbing vehicles on the PDR. We vary the speed between 50 km/h to 120 km/h, and we plot three curves for 40, 70, and 100 disturbing vehicles respectively. The results show that the PDR is better when the speed increases. In fact, the greater the speed of the disturbing vehicles, the shorter the interference time is, which results in a better PDR.

Figure 8.10 shows the impact of platoon vehicle inter-distance on the PDR. We vary the distance between 10 m to 40 m, and we plot three curves for 40, 70, and 100 disturbing vehicles respectively. The results show that the PDR is better when the communication is under 10 m. In fact, beyond 10 m, the PDR decreases rapidly until reaching a communication distance of 25 m, then the PDR becomes more stable for all curves.

### 8.3.2 Performance comparison between V-VLC and RF

In this section, we discuss and compare the performance of RF and V-VLC in terms of PDR and delays. We consider the same scenario as in Figure 8.7 extended by a parallel lane for vehicles moving on the opposite side. As concerns VLC propagation, only the

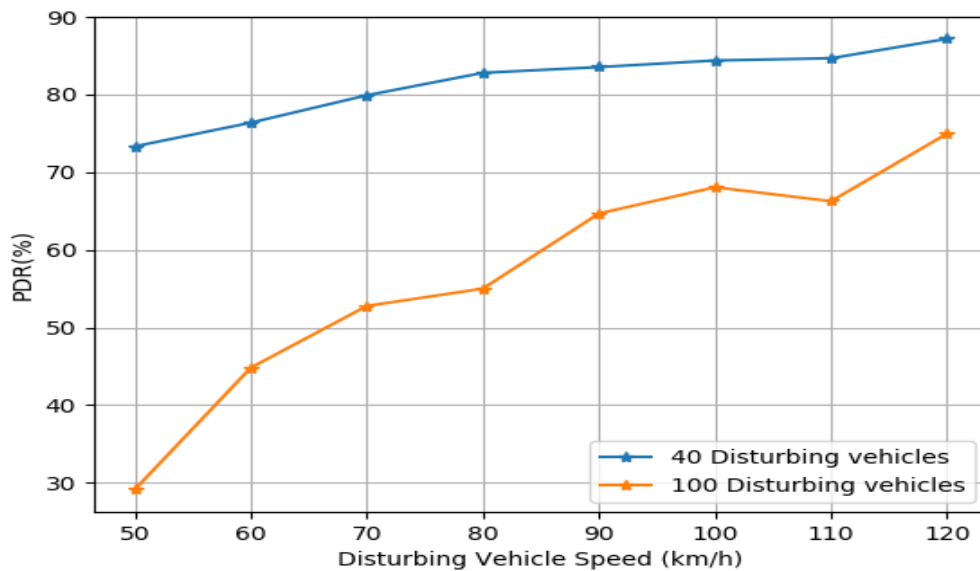

Figure 8.9: V-VLC PDR versus disturbing vehicle speed: Simulation time = 208s; platoon size = 8; platoon inter-vehicle distance = 10 m; Disturbing vehicles' speed = 100 km/h; Platoon vehicles' speed = 15 km/h; Headlight module = "HbSedan2".

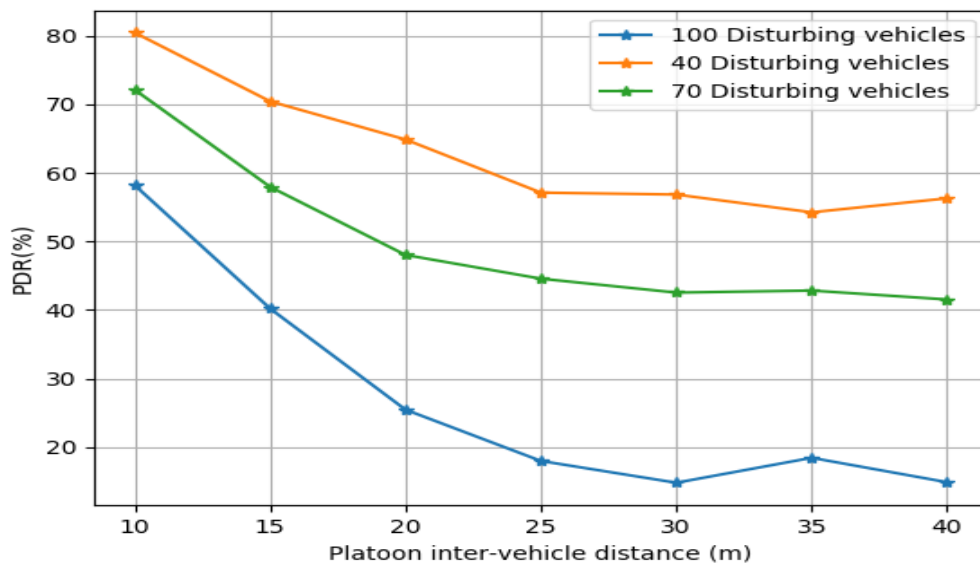

Figure 8.10: V-VLC PDR versus platooning vehicle inter-distance: Simulation time = 116 s; platoon size = 8; Platoon vehicles' speed = 15 km/h; Disturbing vehicles' speed = 100 km/h; Headlight module = "HbSedan2".

two lanes near the platoon lane will have an impact on the performance, the rest will have no impact, whatever the density is. As described before, AS-DTMAC divides the road into different zones, and each zone has a set of slots (about 33 slots per zone), thus, the performance of the RF can be impacted when the number of vehicles rises since more vehicles are reserving a slot and there is a risk of reaching the total resource capacity. Figure 8.11 shows the delay for V-VLC versus platoon beacon packet length. Obviously, the delay increases as the packet length increases. The delay varies from 1 ms to 9 ms for packets with lengths ranging from 100 to 1200 bytes. Moreover, in a platoon, if, for example, the last member attempts to communicate with the leader via V-VLC (see Figure 8.7), messages need to be forwarded via multihop communication, which increases the latency. Thus, to respect the QoS requirements of this application, the platoon size must be taken into consideration.

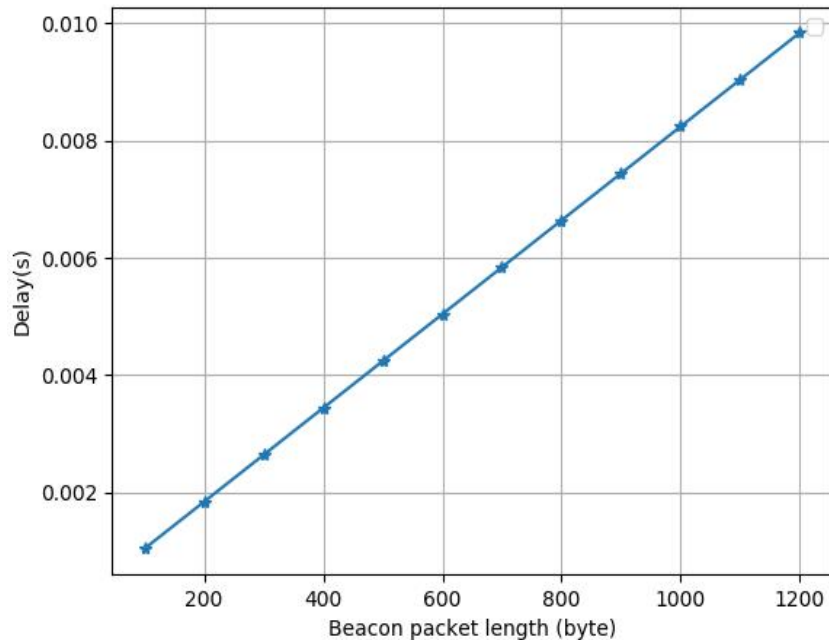

Figure 8.11: V-VLC delay versus platoon beacon packet length

In Figure 8.12, we plot the PDR versus the number of disturbing vehicle for both RF and VLC. As we can see in this scenario, RF is more reliable than V-VLC. In fact, even for high numbers of disturbing vehicles, RF is not greatly affected (less than 3% of packets are lost) whereas the PDR for V-VLC decreases more and more (as explained above, this due to light interference).

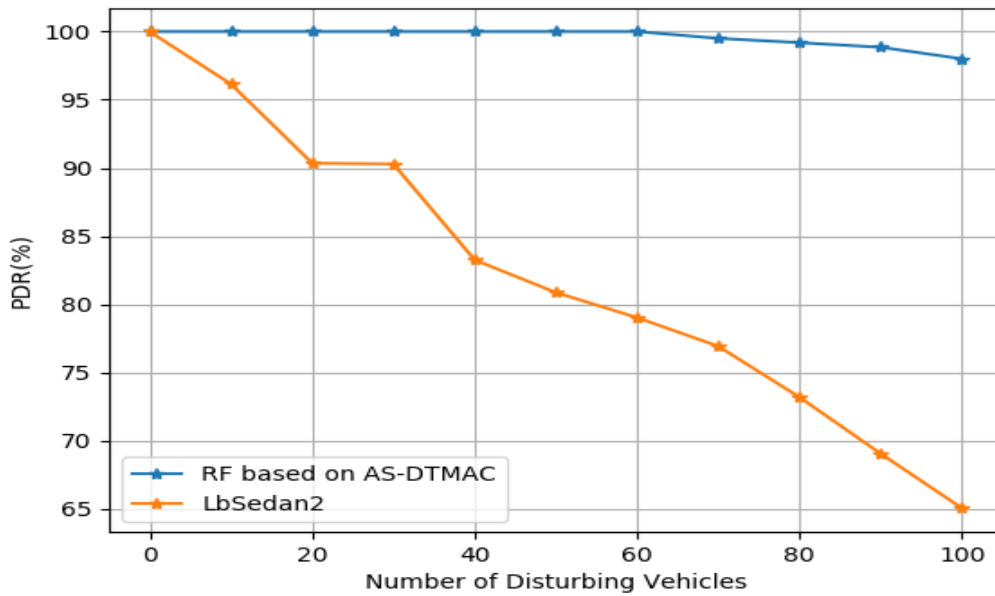

Figure 8.12: V-VLC and RF PDR versus number of disturbing vehicles

## 8.4 Conclusion

In this chapter, we showed the ability of our radio technology, based on AS-DTMAC, to respond to the QoS requirements of the platooning application. We conducted large-scale platoon simulations based on the Veins-VLC framework, which uses a realistic V-VLC model. The simulation results showed the lack of maturity of this technology compared to RF. However, V-VLC is still an excellent assistant technology in the platoon use case. By highlighting the limitations of this technology, we will challenge them in the future in order to achieve the full capacity of this technology in terms of data rate, latency and inter vehicular distance. Finally, we compared the performance of RF and V-VLC in the platooning scenario in terms of PDR and delay.

In conclusion, V-VLC is a good assistant technology to RF communication. It provides a wide free spectrum with a relatively low cost. In the next chapter, we carry out an analytical study to assess the benefits of combining VLC with our new radio technology for the platooning use case. We also present a simple algorithm to switch from the radio link to the VLC link, based on CAM information.



# Chapter 9

## Using visible light links in combination with radio communication in a vehicular network

### Contents

---

<b>9.1</b>	<b>Introduction</b>	<b>127</b>
<b>9.2</b>	<b>Background and motivation</b>	<b>127</b>
<b>9.3</b>	<b>Switching from radio transmission to VLC transmission</b>	<b>129</b>
<b>9.4</b>	<b>Performance of the network when the VLC is used</b>	<b>130</b>
9.4.1	Gain in bandwidth	130
9.4.2	Gain in access collision probability for the radio access	133
9.4.3	Gain in reliability when the radio and the VLC links are used in combination	135
<b>9.5</b>	<b>Conclusion</b>	<b>135</b>

---

## 9.1 Introduction

In this chapter we will assume that VLC technology is available in some given vehicles. Our aim is to show how this technology can be used in place of, or in combination with, radio communication and to evaluate the gain if those vehicles use VLC instead of the radio link. The main idea we put forward in this chapter is to assume that the vehicles are randomly distributed with a given probability to encompass the VLC capability. If some vehicles that are following each other have a VLC layer, they can create a platoon where the vehicles in this platoon communicate using the VLC link - the exception being the leading vehicle, which will continue to use radio communication.

The chapter is organized as follows. Section 9.2 outlines the background and motivation. Section 9.3 explains our assumptions and how VLC links can be created in platoons where vehicles are using a TDMA protocol. We present the protocol that enables a switch between a radio link and a VLC link. We also propose several operating modes: when the VLC links are used instead of the radio link, and when VLC links and radio transmissions are used in combination in order to improve the reliability of the network. In Section 9.4 we study the gain that is achieved by using VLC communication. We will first compute the gain in the total channel load and reduction in (radio) access collisions when the nodes in the platoon switch from a radio link to a VLC link. When, on the other hand, VLC and the radio communication are used in combination, we evaluate the improvement in packet delivery ratio. Section 9.5 concludes this chapter.

## 9.2 Background and motivation

We find two types of related work. The first concerns communication in VANETs. The high mobility of nodes in these networks and the high variability of vehicle density make it very difficult to ensure timely transmissions. Thus special mechanisms are necessary to meet the stringent requirements of safety applications in VANETs and there have been several proposals of dedicated schemes for these applications. These proposals present special techniques to handle radio communication and can even combine the use of radio communication with VLC.

The second type of related work concerns VLC in the area of outdoor communication. Whereas indoor VLC is better established and can even reach a very high data rate, outdoor communication, where the sunlight can produce unavoidable noise for the communication, has been far less investigated. In this already challenging

context, the mobility of nodes is an additional difficulty that must be dealt with. Below we review some studies in this field.

In [83] the authors show that the communication system is a fundamental building block to manage and maintain platoons of vehicles. To keep the system stable, strict constraints in terms of update frequency and reliability must be met. To meet these requirements, these authors develop a protocol that exploits synchronized communication slots as well as transmit power adaptation. The authors show that a combined use of a slotted scheduling mechanism and transmit power control is highly beneficial to ensure a timely transmission in the platoon, whereas dynamic approaches meant for generic information dissemination are not adequate. The content of this article confirms the idea that the communication within platoons must satisfy stringent requirements and thus must be isolated in a given communication system.

VLC transmissions have mainly been studied for indoor transmissions without mobility, and there are few studies that deal with outdoor transmissions, with or without mobility. In [84] the authors demonstrate that VLC using a single type of photodetector at the receiver can not establish a reliable link. The authors show that photodetectors with complementary properties, in terms of optical spectral response and field-of-view, are necessary to handle the wide dynamic range of optical noise, for instance in the presence of sunlight and other unwanted light sources and with mobile users.

The advantage of VLC communication is that it operates in point-to-point and thus there is no sharing of the transmission media. This is in contrast to radio communication where a Medium Access Control (MAC) scheme is required to share the medium. The default technique used to perform this task is an adaptation of the IEEE 802.11 standard to VANETs called IEEE 802.11p [3]. The underlying technique is CSMA/CA (Carrier Sense Multiple Access with Collision Avoidance) [86] in other words the carrier must be sensed “free” before any transmission can be started. In VANETs, the continuous and fast change of network topology due to high node mobility, and the possibility of a high density of nodes make the proper functioning of IEEE 802.11p in every condition tough and they also make the design of the MAC more difficult [5]. To improve the performance of CSMA techniques, several MAC protocols for VANETs based on TDMA schemes have been proposed in the literature [22] [29] [87] [88], each of them treating a particular problem in a specific mobility scenario. However these techniques suffer from a lack of high reactivity when an urgent packet is generated in the network. The access delay is of the order

of magnitude of the TDMA frames. Recently a new proposal AS-DTMAC [6] has been published which combines the advantages of a TDMA scheme but also allows emergency messages to have a very low access delay. Moreover this protocol shows a very low access collision rate. Such collisions occur when two nodes attempt to reserve the same slot in the TDMA frame.

The contribution of this chapter is to show how VLC links can be used instead of, or in combination with, a radio protocol. We chose AS-DTMAC as the radio protocol used in combination with VLC. In this chapter we study the benefit of having VLC communications combined with the AS-DTMAC protocol in terms of metrics such as the radio bandwidth saved, the improvement in the collision rate on the radio medium, and the improvement in packet delivery ratio.

### 9.3 Switching from radio transmission to VLC transmission

We will assume that our vehicular network is composed of platoons of vehicles and thus that communication is only required between successive vehicles. With such an assumption, we can allow a car with VLC capabilities to use it instead of the radio link. We assume that the VANET is organized in platoons and that all the vehicles first use radio communication and AS-DTMAC to communicate. The idea is to build a protocol that enables vehicles using the radio link to switch to the VLC link whenever it is possible. To perform this task, we propose to use information sent in the radio packets. If we assume that the vehicles send Cooperative Awareness Messages (CAMs), we can add to these messages the vehicles' VLC capability. If a vehicle has front and rear VLC modems, it indicates this in the CAM messages that it periodically sends. Thus when a vehicle receives the CAMs sent by another vehicle, it can determine whether its neighboring vehicles, the one in front and the other behind, are equipped with VLC modems. If so, the vehicles can start to send their packets on the VLC interfaces: one to the front of the vehicle and the other to the rear. We can assume that the radio links will be kept by the vehicles until the VLC has been successfully set up by the vehicles. When the VLC links have been tested, the vehicle can stop using radio transmission and communicate with its neighboring vehicles using only the VLC link.

If the vehicles are not sending CAMs, then they can send special packets dedicated,

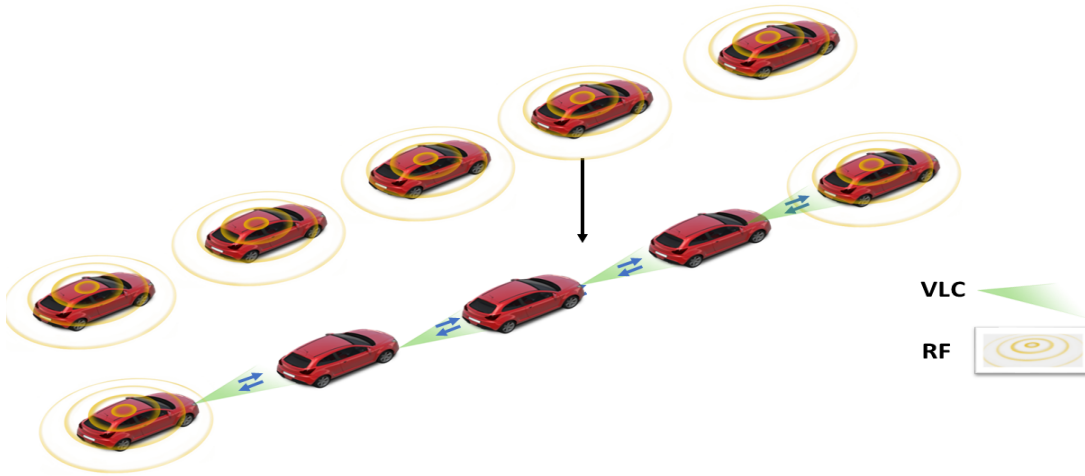

Figure 9.1: Switch to the VLC link

for instance, to the platoon management. In these packets, the vehicles will indicate their GPS position and their communication capability : radio modem, VLC modems front and/or rear. With such information, the vehicles can determine whether or not their neighboring vehicles have VLC modems and if so, start their transmission with them. Once these transmissions have been established they can stop using their radio link. Figure 9.1 explains the transition from transmission using only the radio link to a combination of transmission with radio and with VLC links. The algorithm to switch from the radio to the VLC transmission is shown in Figure 9.2. The important point to observe is that the vehicular network must first be setup. By analyzing the CAM messages or messages for the platoon management a vehicle can determine whether two neighboring vehicles are equipped with VLC modems. If that is the case, then as soon as the VLC links of a vehicle have been established with its front and rear neighbors, the vehicle can stop using radio transmissions.

## 9.4 Performance of the network when the VLC is used

### 9.4.1 Gain in bandwidth

In the following, we evaluate the gain in bandwidth if the vehicles use VLC instead of the radio link. We assume that the vehicles are equipped with VLC modems (front

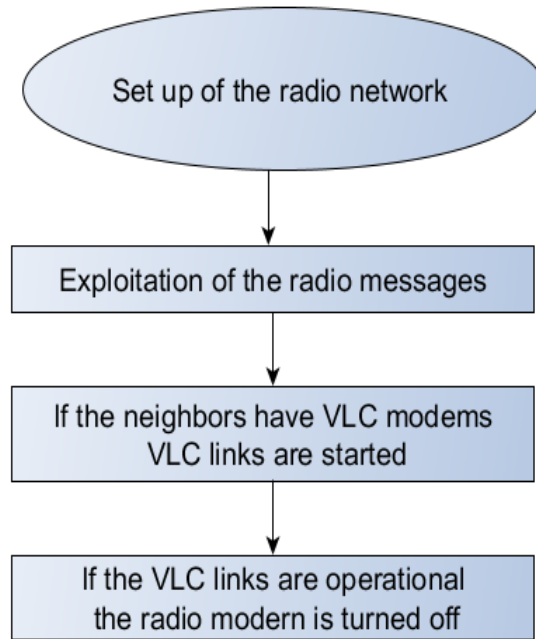

Figure 9.2: Algorithm to switch from the radio to the VLC link

and rear) with a given probability  $p$ . We have to evaluate the number of successive vehicles with VLC capabilities in a lane of a given road. If we have  $n$  successive vehicles then  $n - 2$  vehicles can switch from the radio modem to the VLC modem.

In the following figures, we assume that if a VLC link is available, it is used instead of the radio link. In Figure 9.3, we present the gain in channel bandwidth when we vary the percentage of vehicles with VLC capabilities. We assume that the protocol to switch from radio communication to VLC is finished and that the VLC links have been set up without any failure. We define the gain as the percentage of vehicles that can actually use the light links instead of the radio link. We simulate this gain on a 1 km section of road. We observe that the gain is very notable when the percentage of vehicles equipped with VLC capabilities is greater than 50%.

In Figure 9.4 we present the channel load versus the vehicles inter-distance when we vary the percentage of vehicles with VLC capabilities. The vehicles are on a 1 km section of road with the three sections defined in the DTMAC protocol. The length of the total frame is 0.1 s and the packet duration is 1 ms. Again, we assume that the protocol to switch from radio communication to VLC is finished and that the VLC links have been set up without any failure. We observe that the gain is very notable when the percentage of vehicles equipped with VLC capabilities is greater than 50%.

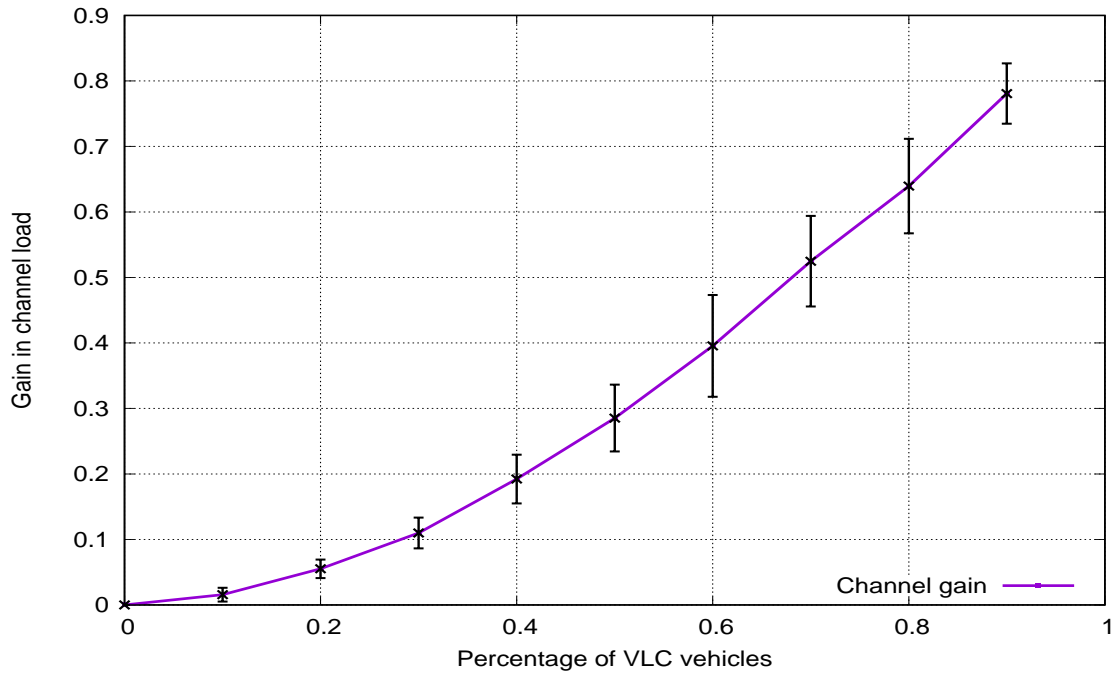

Figure 9.3: Percentage in channel load versus percentage of vehicles with VLC modems

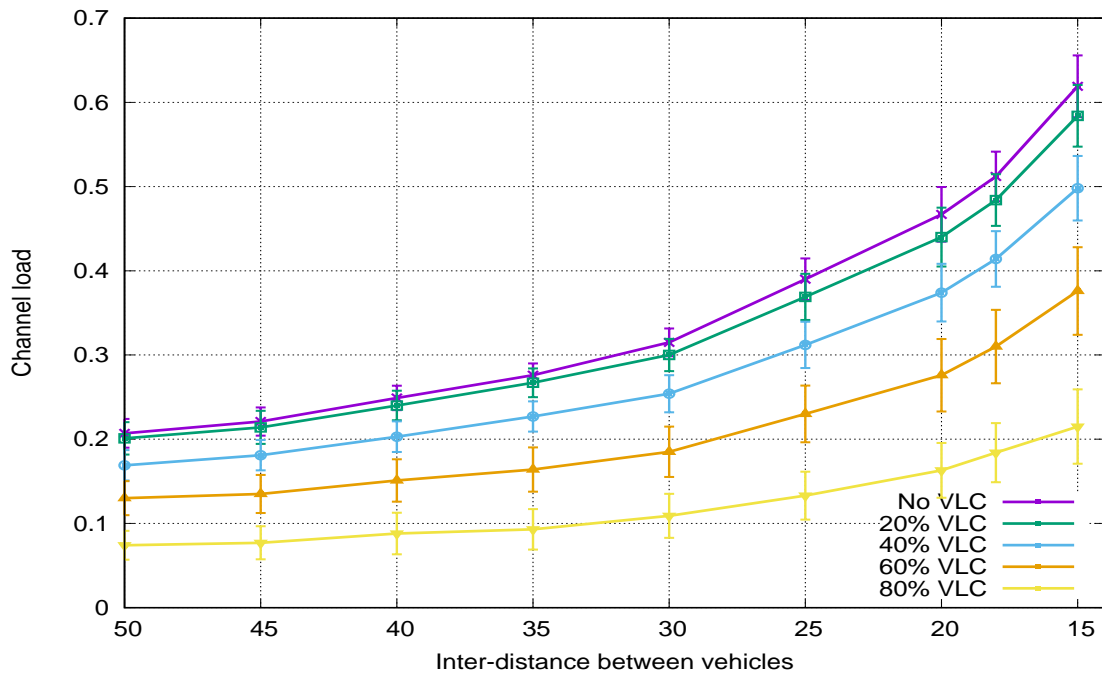

Figure 9.4: Channel load used versus vehicle inter-distance for different percentages of vehicles with VLC modems

### 9.4.2 Gain in access collision probability for the radio access

We wish to compute the gain in access collision probability for the radio access when the input load is  $\lambda$ . We assume that the selection process in AS-DTMAC uses  $n$  signaling bursts. The access probability of AS-DTMAC for a transmission with a input load  $\lambda$  is given by the following equation [85]

$$P_n(\lambda) = \frac{1}{1 - \exp(-\lambda)} \sum_{k=0}^{\infty} \frac{\lambda^k}{k!} \exp(-\lambda) \left(1 - A_n^k(0) - (A_n^k)'(0)\right).$$

Where the  $A_n^k(x)$  are the polynomials defined by the following recursive equations

$$A_0^k(x) = x^k$$

for  $i \in 0, \dots, n-1$ :

$$A_{i+1}^k(x) = A_i^k\left(\frac{x}{2} + \frac{1}{2}\right) + A_i^k\left(\frac{x}{2}\right) - A_i^k\left(\frac{1}{2}\right).$$

and

$$(A_n^k)'(0) = \frac{dA_n^k}{dx}(0).$$

The gain in the access collision process results from the fact that the input load  $\lambda$  will become  $\lambda_1$  with  $\lambda_1 < \lambda$ . In Figure 9.5 we present the gain in the access collision probability when we vary the percentage of vehicles with VLC capability. We assume that  $n = 0$  and thus, in other words, we do not use any signaling; the radio protocol is thus only DTMAC. The load corresponds to the transmission of 1 packet of 1 ms every 0.1 s. The frame encompasses 100 slots and is divided into three parts for three spatial sections. We assume that the inter-vehicle distance is 20 m. We observe that the access probability decreases when the VLC links replace the radio link. Although the gain is notable, it is not extremely large.

In Figure 9.6 we again present the gain in the access collision probability when we vary the percentage of vehicles with VLC capability and assume that  $n = 10$  and the other parameters are the same as those in the previous figure. We again observe a notable decrease in the access probability when the VLC links are used instead of the radio links. However it is mostly the gain when we use the signaling mechanism of AS-DTMAC that decreases the access collision probability.



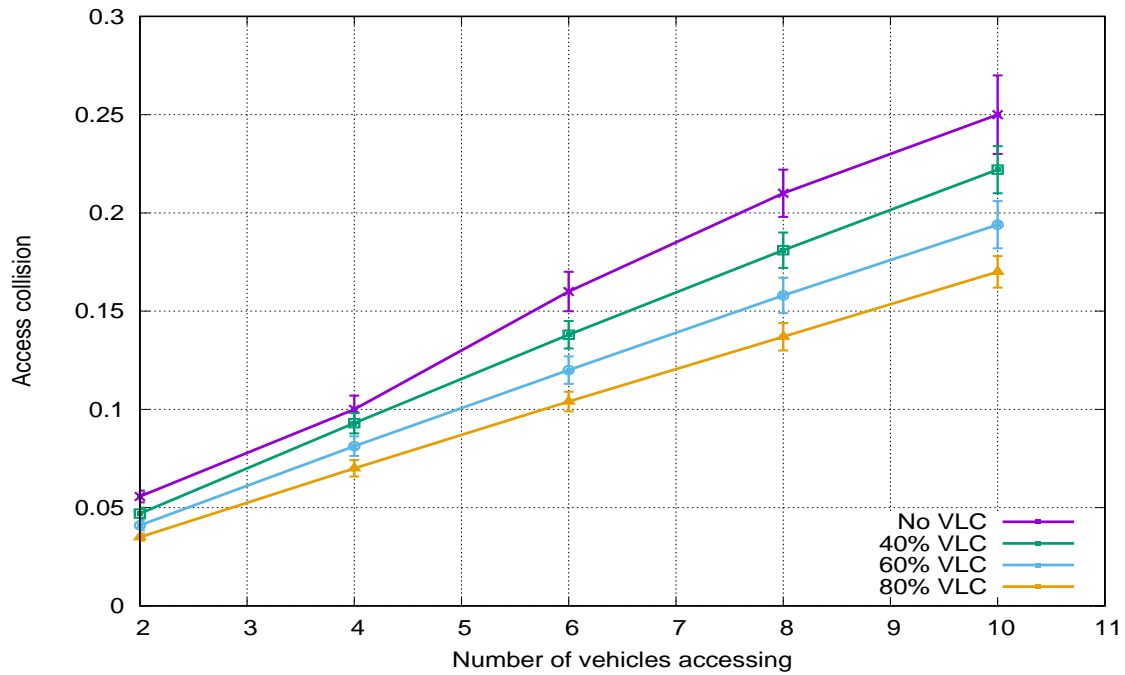

Figure 9.5: Channel access collision versus percentage of vehicles with VLC modems

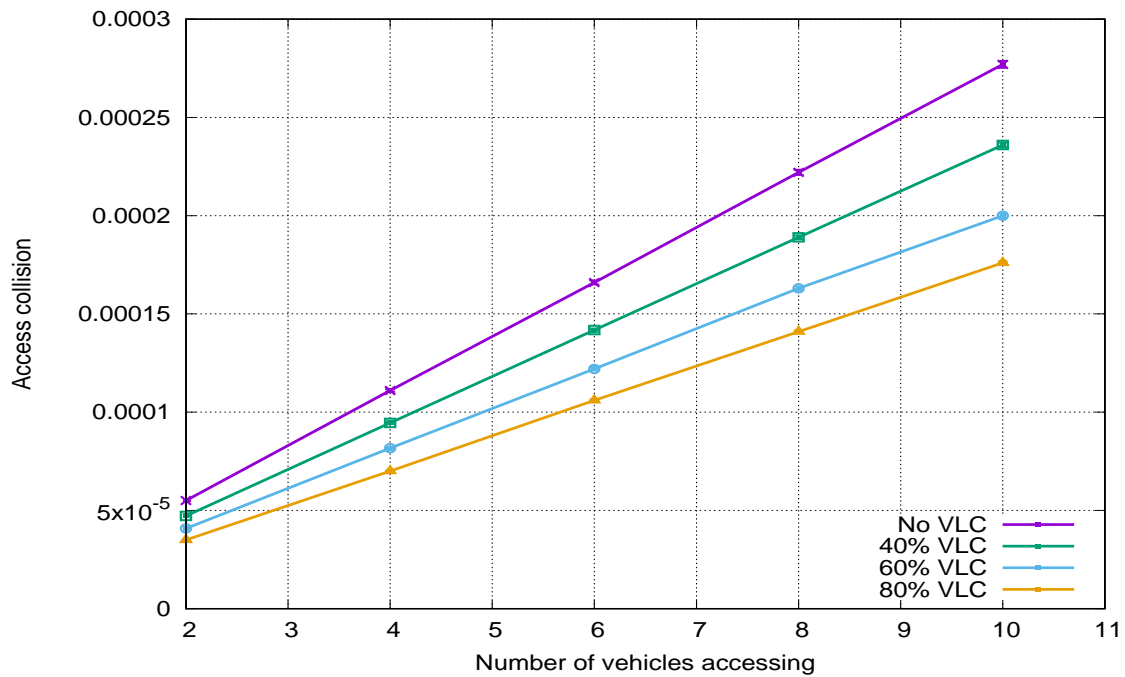

Figure 9.6: Channel load used versus vehicle inter-distance for different percentages of vehicles with VLC modems

### 9.4.3 Gain in reliability when the radio and the VLC links are used in combination

In this subsection we assume that the radio links and the VLC links are used simultaneously. Thus the network reliability increases since a packet loss occurs if and only if both the radio and light packets are lost. We assume that the radio link error rate is 0.0001 and that the light link error rate is 0.01; the errors on the two links are assumed to be independent. Thus the combination of the two links has an error rate of  $10^{-6}$ . In Figure 9.7, we represent the mean error for a vehicular network that uses the radio and light links simultaneously versus the percentage of vehicles using the radio link. We observe that the percentage of radio links strongly determines the mean reliability of the vehicular network.

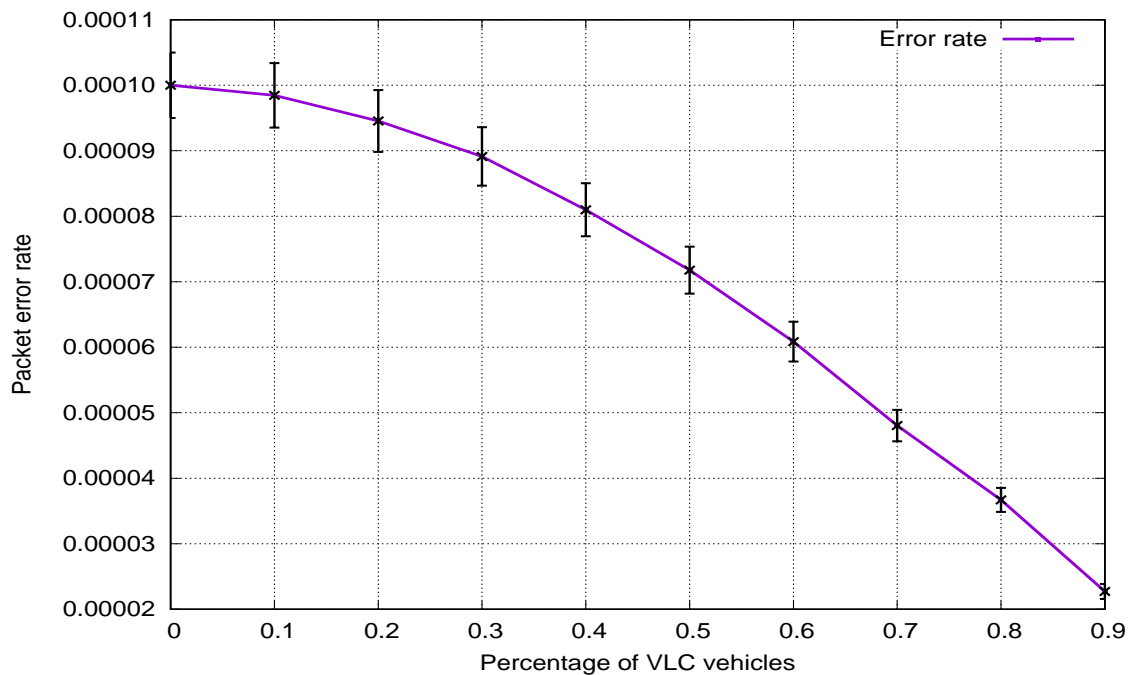

Figure 9.7: Packet error rate versus percentage of vehicles with VLC modems

## 9.5 Conclusion

We have shown how VLC can be used in combination with a vehicular radio network. We have studied how the messages sent using the radio link and which contain the vehicles' position and their VLC transmission capability, front and/or rear light

modems, can be used to set up a light link between neighboring vehicles. Once the light links have been established, the radio link can be turned off and thus some radio bandwidth can be saved.

When the VLC network is used, we have studied the percentage of bandwidth used in the radio network versus the percentage of vehicles with VLC modems (front and rear). We have also studied the gain in channel load versus the percentage of vehicles with VLC modems (front and rear). We observe that the gain in bandwidth is considerable even if, as we have assumed, there is no re-ordering of the platoon of vehicles with VLC modems.

We have evaluated the gain for the channel collision when the VLC modems are used instead of the radio modems. We have shown that there is a notable gain when the VLC modems are used instead of the radio modem. However, an even higher gain can be obtained if we use more signaling bursts in the AS-DTMAC protocol.

The VLC modems can be used in addition to the radio links. In that case, we can increase the probability of successful transmission. A message will be lost only if both the radio link and the VLC link are lost. We have shown that, in this way, we can obtain a very significant increase in the network's reliability and we have evaluated it with respect to the percentage of vehicles with VLC modems.

# Chapter 10

## Conclusion and Perspectives

### Contents

---

10.1 Synthesis . . . . .	137
10.2 Perspectives . . . . .	139

---

### 10.1 Synthesis

Vehicular mobility is facing a growing number of challenges. The rapid increase in traffic density, the number of road accidents (according to the world Health Organization (WHO), 1.35 million people die on the roads each year) and the lack of transportation services to make traveling more comfortable, have motivated both the research and industrial communities to invest in Vehicular Ad hoc NETWORKS (VANETs). VANETs are especially being developed to meet the challenges mentioned above and to have the ability to support applications for road safety, traffic management and entertainment. Different types of communications can be established in VANETs, namely: Vehicle-to-Infrastructure and vice versa (V2I2V), Vehicle-to-Vehicle (V2V) and Infrastructure to Infrastructure (I2I).

The connected vehicle has now become a reality. Many manufacturers have produced their own connected vehicles and a fleet of them are already in service. Each of these vehicles is equipped with an On Board Unit (OBU) to allow connection to a VANET. The vehicular communication is carried over the 5.9 GHz spectrum utilising one or both of the two technologies: Dedicated Short Range Communications (DSRC), which uses the IEEE 802.11p standard, and Cellular Vehicle-to-Everything (C-V2X), which uses LTE-V2X. The coming of the autonomous vehicle has brought

with its new challenges and perspectives regarding the successors to these technologies. These new developments must present better throughput with low latency and high reliability in order to support advanced autonomous vehicular applications.

In this thesis we first proposed a new MAC solution specially designed for the QoS requirements of VANETs, called **AS-DTMAC**. We showed the performance of this protocol by means of an analytical model and simulations. Furthermore, we adapted the physical layer based on the OFDM standard to our new MAC protocol in order to insure high throughput and reliability. We also demonstrated the possibility for new nodes equipped with our system to coexist with the old version (i.e. IEEE 802.11p) in a heterogeneous network. These features are required by the Task group of IEEE 802.11bd for any new proposition.

The key to enabling low latency in the first part of the thesis focused on the use of the active signaling mechanism as an efficient solution to avoid access collisions at the MAC level during the slot assignment process. The efficiency of the active signaling mechanism inspired us to exploit this mechanism to establish an original message forwarding strategy. We designed a new cross-layer called **AS-DTMAC Multihop**, based on mixing the MAC and routing layers together for the multi-hop broadcast of emergency warning messages. This protocol adjusted the active signaling process to let the furthest vehicle acquire the dedicated forwarding slot and take the role of the relay, thus speeding up the dissemination of warning messages.

The second part of the thesis contains two chapters and focused on hybrid communication for the platooning use case. The autonomous platoon is today one of the key tools for better road utilization. In fact, by optimizing the distance between vehicles, the air drag is reduced, and researchers have shown that 20% of energy can be saved by using this concept. From a network point of view, reducing the distance between vehicles will allow a new point-to-point communication link between the vehicles in front and behind by using Vehicular Visible Light Communication (V-VLC), thus providing an opportunity to have a hybrid communication. Our new radio design based on the AS-DTMAC protocol guarantees a high Quality of Service for real-time applications. However, with a very high density, we can reach the total bandwidth capacity dedicated to V2X radio. In the case of a platoon, this scenario can cause dangerous platoon instability. Assisting the radio with another communication vector such as V-VLC can help to maintain the high level of reliability that is necessary for the control of a platoon. In the first chapter of this part of the thesis, we carried out an analytical study to investigate the capacity of our new radio technology to support

the platoon control use case in terms of the Quality of Service (QoS) required for this type of application. Then, we showed through extensive simulations the current level of V-VLC technology, compared to radio technology, in terms of packet loss and delay.

In the second chapter, we showed the benefits of using visible light links in combination with radio communication in a vehicular network in terms of bandwidth and probability of collisions during an initial access, and also considered the redundant mode (i.e. where both RF and VLC are used). We also proposed a simple switching protocol from Radio transmission to VLC transmission to form a platoon based on information coming from Cooperative Awareness Messages (CAM)s.

## 10.2 Perspectives

The objectives of the thesis have been achieved. The proposed solutions in this manuscript have shown very good performances. Nevertheless, we believe there are still some open questions that need to be further investigated and thus lead to several new future research directions in order to improve these solutions, enabling them to perform better in realistic mobility scenarios.

- **Enhance the AS-DTMAC protocol:**

Although AS-DTMAC has very good performances, it is still possible to make it more efficient. For example, the background protocol, DTMAC, is designed for linear scenarios such as highways and we can use other MAC access techniques such as CDMA to extend the scheme to encompass non-linear scenarios, such as intersections. Furthermore, to insure a backward compatibility mode with old vehicles equipped with 802.11p, adopting hybrid methods which mix random access techniques and TDMA access techniques could be very useful. By combining the two techniques, the drawbacks of contention-based access in the former and resource reservation in the latter can be overcome. Moreover, to enhance the scalability we could investigate multi-channel MAC with dynamic intervals.

- **Design an ultra-reliable receiver for the active-signaling mechanism:**

The good performance of GLRT shown in Chapter 4, motivates us to further investigate the robustness of this algorithm in real implementations, using the GNU Radio Software and USRP units. Implementing this kind of detector in the receiver would significantly enhance the reliability of the communication. The

constraint of this task is to optimize and reduce the computational complexity of the GLRT algorithm.

- **Standardization efforts:**

A fairness index showing the ability of IEEE 802.11p devices to have the same opportunities as NGV devices to access the channel would be a good perspective for the study presented in Chapter 5 as the subject of another contribution. Also, the coexistence model proposed in Chapter 5 assumes a perfectly symmetric transmission (reception) range situation. Therefore, it would be interesting to show how an asymmetric scenario would affect the coexistence of the two protocols. Moreover, we plan to continue to investigate the other specifications required for the design of the IEEE 802.11bd, such as the ability of NGV devices to run in a mode in which they can interoperate with IEEE 802.11p devices, a property that is referred to in the literature as backward compatibility.

- **Misbehavior detection:**

VANETs are vulnerable to many types of attacks that can alter the content of messages, cause dangerous situations in the network and threaten human lives. In future work, we intend to make the network more controllable and secure by studying these attacks in depth and applying suitable security mechanisms for our new radio design.

- **RF-VLC Smart switching protocol:**

More experimental studies showing how the light links can be combined with RF in a heterogeneous network in order to keep the reliability as high as possible are very appropriate. Do we need a special process to control the operation of the communication modem or can we rely only on the CAM messages? For example, a smart switching protocol at the handover level could choose the best communication technology depending on the mobility scenario. This protocol will use a dynamic threshold and make decisions based on a vehicular real-time system such as the Channel Busy Ratio (CBR), which gives information about the radio channel quality, but also on V2X by exploiting the information obtained from CAMs to estimate the network load. Thus, the protocol will be able to propose a redundant mode based on the use of RF and V-VLC together when the network load is low.

# Chapter 1

## Introduction générale

### Contents

---

11.1 Contexte et motivation . . . . .	141
11.2 Principales contributions . . . . .	143
11.3 Organisation du manuscrit . . . . .	145

---

### 11.1 Contexte et motivation

Les VANETs (Vehicular Ad hoc Networks) ont fait l'objet d'une attention particulière tant dans les communautés académiques que dans les entreprises industrielles [1]. Ils visent à établir la communication et la collaboration entre les véhicules et un certain nombre d'applications de sécurité commerciales et de divertissement [1] qui ont été développées. Avec l'avènement de la conduite autonome, les futurs réseaux devront permettre des services en temps réel avec une réaction immédiate pour améliorer la sécurité. Ces applications doivent répondre à des exigences spécifiques et strictes en matière de qualité de service (QoS, Quality of service) et de sécurité. Pour répondre à ces exigences, des protocoles de contrôle d'accès MAC (Medium Access Control) efficaces doivent être développés afin de gérer l'accès au réseau et la transmission avec un minimum de perte de paquets [2].

Le contrôle d'accès aux canaux est d'une importance primordiale pour les performances des VANETs. Comme dans les réseaux ad hoc traditionnels, les protocoles MAC dans VANET sont classés selon le schéma de contrôle utilisé pour accéder au canal à savoir, basé sur la contention et sans contention [5]. Dans les protocoles basés sur la contention, les véhicules accèdent de manière aléatoire au canal lorsqu'ils



ont besoin de transmettre. Ce type de protocole permet un accès multiple au canal basé sur la détection de canal [2]. Mais, pour les applications critiques, le manque de fiabilité du mécanisme de diffusion signifie que la transmission des messages de sécurité avec un délai d'accès limité, est très difficile. Par exemple, cela est vrai pour la norme émergente dans les VANET: IEEE802.11p [3], qui utilise un algorithme aléatoire basé sur les mécanismes EDCA (Enhanced Distributed Channel Access) et CSMA/CA (Carrier Sense Multiple Access with Collision Avoidance). Dans la deuxième catégorie (c'est-à-dire sans contention), un seul véhicule dans un ensemble de voisinage à deux sauts est autorisé à accéder au canal à un instant donné, ce qui réduit le risque de collision.

Par conséquent, cette catégorie de protocoles est plus appropriée pour gérer les applications en temps réel dans les VANETs car elle peut fournir un délai d'accès limité et une communication fiable pour les applications de sécurité. Au cours des dernières années, les protocoles MAC sans contention sont restés l'un des domaines de recherche émergents et représentent la majorité des protocoles MAC proposés dans ce domaine [4].

Cependant, ces schémas peuvent souffrir d'un problème de collision d'accès qui se produit lorsque deux véhicules ou plus dans le même ensemble de voisinage à deux sauts, tentent d'accéder au même intervalle de temps disponible; un problème qui est susceptible de se produire lorsqu'un schéma distribué est utilisé [5] et un problème de collision de fusion qui se produit lorsque deux véhicules dans des ensembles de deux sauts différents accédant au même intervalle de temps deviennent membres du même ensemble de deux sauts en raison de changements de leur position. Par conséquent, toutes les contributions ont tendance à se concentrer sur ces problèmes qui surviennent particulièrement dans le scénario de mobilité.

Nous pensons que le protocole AS-TDMAC que nous avons introduit dans [6] est le premier protocole pour les VANETs qui entrelace profondément un schéma d'accès aléatoire avancé et un schéma d'accès multiple par répartition dans le temps (TDMA, Time Division Multiple Access) pour les VANET. AS-TDMAC montre les avantages du TDMA en ce sens que lorsqu'un slot est acquis par un véhicule, ce slot peut être réutilisé de manière synchrone et les transmissions ne souffrent pas du problème du nœud caché comme dans IEEE 802.11p.

Dans le même temps, AS-TDMAC peut offrir un accès à faible latence aux paquets urgents, propriété généralement uniquement consacrée aux techniques d'accès aléatoire. Pour répondre aux exigences des futures applications de sécurité, les réseaux

véhiculaires doivent montrer de meilleures performances que celles obtenues sur les réseaux existants; en particulier, ils nécessitent une latence de bout en bout très faible, qui peut être inférieure à 1 ms, et un taux de transmission élevé pour un échange de données énorme. De plus, certains cas d'utilisation nécessitent une ultra-fiabilité de 99,99% [8]. Pour réussir à concevoir des communications à faible latence et ultra-fiables, un vecteur de communication supplémentaire est nécessaire car, en fait, la radiofréquence (RF) présentée ci-dessus n'est pas toujours suffisante. S'il y a un nombre très élevé de nœuds, il est possible d'atteindre la pleine capacité du canal et certains nœuds ne pourront pas communiquer avec le reste du réseau. La communication par lumière visible véhiculaire (V-VLC) est maintenant une technologie qui a le potentiel d'aider la communication RF. Cependant, le V-VLC dans un environnement extérieur est confronté à un certain nombre de défis, en raison de la mobilité, des conditions météorologiques et de la lumière ambiante. D'autre part, il fournit un large spectre libre avec un coût relativement faible comme les diodes émettrices (LED) déjà intégrées dans les systèmes de véhicules légers modernes [9].

## 11.2 Principales contributions

Les principales contributions de cette thèse sont résumées ci-dessous:

1. **Contribution 1: Un mécanisme de signalisation actif pour réduire les collisions d'accès dans un protocole MAC distribué, basé sur TDMA pour les réseaux de véhicules.**

Une couche MAC basée sur un schéma d'accès multiple par répartition dans le temps est l'un des moyens les plus efficaces pour garantir une communication en temps réel. Dans cette première contribution, nous proposons un nouveau protocole MAC pour les réseaux de véhicules, appelé ASDTMAC, qui fonctionne sur un TDMA entièrement distribué et basé sur la localisation et renforcé par la signalisation active comme mécanisme de prévention des collisions d'accès (ce type de collision est l'un des principaux inconvénients des schémas TDMA dans les scénarios de mobilité). Les résultats de la simulation montrent que AS-DTMAC peut fournir un accès à faible latence avec un schéma de priorité pour les paquets urgents.

2. **Contribution 2: Le développement d'un modèle analytique pour analyser les performances d'AS-DTMAC.**

L'objectif de cette seconde contribution est de fournir une analyse mathématique complète des performances du protocole AS-DTMAC, afin de confirmer ses hautes performances et de valider ces résultats à l'aide de simulations. Cet outil mathématique est basé sur des fonctions de génération qui permettent d'estimer le taux de collision résiduel. Trois cas sont étudiés: arrivée homogène, bursts de trafic et analyse de la vitesse de convergence vers l'état stationnaire.

### 3. Contribution 3: Conception de couches physiques et MAC pour les schémas de signalisation actifs dans les réseaux de véhicules.

Lorsque les véhicules se disputent un emplacement, il est possible qu'une erreur se produise. Comme la signalisation active est basée sur des transmissions en bursts, en fonction des conditions du canal, le récepteur peut manquer ce signal court ou, dans le pire des cas, détecter une fausse alarme. Dans une première étude, nous fournissons une analyse complète de l'impact de ces deux types d'erreurs sur le taux de collision d'accès, en utilisant le modèle analytique précédent. Deuxièmement, nous évaluons les erreurs au niveau de la couche physique. Le modèle proposé est basé sur l'algorithme de détection du test du rapport de vraisemblance généralisé (GLRT). Cette étude nous aide à fixer la durée du mini-slot en fonction du taux de collision d'accès et d'autres paramètres liés à la couche physique, conduisant à un gain important de débit par rapport aux études précédentes.

### 4. Contribution 4: Coexistence de IEEE 802.11p et du protocole AS-DTMAC basé sur TDMA.

Cette contribution est motivée par l'arrivée de la nouvelle norme véhicule DSRC IEEE 802.11bd. L'évolution de l'IEEE 802.11 est en cours de développement par le groupe de travail IEEE (TGbd) depuis janvier 2019 et devrait être publiée en 2021. Le nouveau design doit montrer des performances améliorées et une coexistence avec la technologie précédente pour garantir la communication avec le déjà déployé. Nœuds 802.11p sur nos routes. Ici, nous fournissons une analyse complète pour montrer que AS-DTMAC et CSMA/CA peuvent fonctionner simultanément dans le même scénario. Trois cas sont considérés : le comportement général des deux protocoles lorsqu'ils coexistent, l'interaction possible dans le processus de sélection AS-DTMAC et, enfin, le temps d'attente d'AS-DTMAC après le début d'une transmission IEEE 802.11p.

5. **Contribution 5: Une conception efficace de couches croisées pour la diffusion multi-sauts de messages d'avertissement d'urgence dans les réseaux de véhicules.**

Le mécanisme de signalisation active a montré sa capacité à éviter les collisions lorsque les utilisateurs tentent d'accéder à la même ressource. Dans cette partie de la thèse, nous proposons une stratégie originale de transmission de message basée sur le mécanisme de signalisation actif. Ce nouvel algorithme met en place la route de la source vers les autres nœuds avec le meilleur chemin possible. Cette nouvelle stratégie minimise le délai d'accès et le nombre de nœuds relais.

6. **Contribution 6: Évaluation d'une nouvelle technologie radio associée au V-VLC pour les applications de peloton.**

Le contrôle du peloton nécessite une communication de très haute fiabilité, dans certains cas, cela ne peut être assuré par une seule technologie sans fil. La communication par lumière visible véhiculaire est une technologie prometteuse qui peut alléger la charge de la radio en libérant de la bande passante. Cette contribution vise à étudier les performances de chaque technologie au regard de l'exigence de Qualité de Service (QoS) de l'application de peloton.

7. **Contribution 7: Utilisation de liaisons de lumière visible en combinaison avec la communication radio dans un réseau de véhicules.**

Cette contribution décrit notre architecture de communication hybride qui utilise la technologie radio développée dans la première partie de cette thèse et la communication en lumière visible. Notre objectif est de proposer une communication fiable qui répond aux exigences de l'application de peloton et réduit la charge sur le canal radio. Les performances du réseau lorsque VLC est utilisé sont indiquées en termes de gain de bande passante, de gain de probabilité de collision d'accès pour l'accès radio et de gain de fiabilité lorsque la radio et les liaisons VLC sont utilisées en combinaison.

## 11.3 Organisation du manuscrit

Ce chapitre a présenté le contexte et la motivation de cette première partie de thèse et a esquissé nos contributions. Le reste de cette thèse est structuré en trois parties distinctes : l'état de l'art, la communication radio à faible latence et la communication

hybride véhiculaire. Le contenu est présenté en huit chapitres, suivant une progression logique entre chacun d'entre eux.

La deuxième partie (c'est-à-dire la communication radio à faible latence) contient quatre chapitres qui décrivent la conception d'une nouvelle technique d'accès radio. Nous définissons (au chapitre 4) la spécification du protocole de fond utilisé dans notre nouvelle solution MAC et introduisons la technique de signalisation active et le protocole proposé. Nous construisons également un système d'accès spécial pour les messages d'urgence. Nous présentons ensuite nos études de simulation qui évaluent et comparent le protocole AS-DTMAC proposé. Ensuite, nous développons un modèle analytique pour analyser AS-DTMAC basé sur une fonction génératrice. Nous étudions en outre les performances en termes de taux de collision, le nombre de trames de temps nécessaires pour obtenir un créneau sans collision pour tous les véhicules, et les conditions de transmission des paquets urgents. Dans le chapitre 5, nous indiquons quelles erreurs peuvent survenir lors de la compétition de signalisation active pour obtenir le créneau et leur impact sur le taux de collision d'accès. Nous proposons ensuite un modèle physique pour évaluer les erreurs. Cette étude va nous aider à fixer la durée d'un mini-slot afin d'optimiser le débit.

Le chapitre 6 aborde la question de la coexistence de notre nouvelle solution MAC avec le standard basé sur CSMA/CA. L'objectif de cette étude est de montrer que notre nouvelle solution radio est parfaitement adaptée à une nouvelle proposition standard. Le chapitre 7 est dédié à la conception d'un nouveau schéma de protocole de routage compatible TDMA pour la communication multi-hop, appelé multi-hop AS-DTMAC. Nous complétons notre solution d'accès à faible latence en concevant un schéma de routage efficace pour délivrer des messages d'urgence sur de longues distances. Notre schéma de routage est basé sur une approche multicouche entre le MAC et les couches de routage, dans laquelle les véhicules intermédiaires sont sélectionnés à l'aide des informations de planification TDMA.

La troisième partie de cette thèse est axée sur la conception de réseaux de véhicules hybrides. L'idée est d'ajouter V-VLC pour assister la communication radio développée dans la première partie de cette thèse. Deux modes de communication sont proposés à savoir, un mode redondant qui utilise à la fois RF et VLC afin d'améliorer la fiabilité et le mode singulier qui exploitera uniquement V-VLC pour gérer un peloton, permettant ainsi un gain important en bande passante radio. Nous construisons également un protocole de commutation simple pour permettre la communication avec VLC en regroupant les véhicules avec une capacité VLC dans un peloton.

Enfin, le chapitre 10 conclut cette thèse en résumant nos principales contributions et résultats clés, puis présente nos travaux futurs et les questions de recherche ouvertes concernant l'intégration de ces nouvelles solutions et leur proposition à la norme véhiculaire IEEE 802.11.

# Bibliography

- [1] E. R. Cavalcanti, J. A. R. de Souza, M. A. Spohn, R. C. de Morais Gomes and A. F. B. F. da Costa, "VANETs research over the past decade: Overview credibility and trends", SIGCOMM Comput. Commun. Rev., vol. 48, no. 2, pp. 31-39, May 2018.
- [2] M. Ma, K. Liu, X. Luo, T. Zhang, and F. Liu, "Review of MAC Protocols for Vehicular Ad Hoc Networks," Sensors, vol. 20, no. 23, p. 6709, 2020.
- [3] *802.11p-2010*, IEEE standard for information technology - Telecommunications and information exchange between systems - local and metropolitan area networks - specific requirements part 11 : Wireless LAN medium access control (MAC) and physical layer (PHY) and physical layer (PHY) specifications amendment 6 : Wireless access in vehicular environments Std., 2010.
- [4] S. Johari and M. B. Krishna, "TDMA based contention-free MAC protocols for vehicular ad hoc networks: A survey," Vehicular Communications, vol. 28, p. 100308, 2021.
- [5] M. Hadded, P. Muhlethaler, A. Laouiti, R. Zagrouba, and L. A. Saidane, "*TDMA-based MAC protocols for vehicular ad hoc networks a survey, qualitative analysis and open research issues*", IEEE Communications Surveys Tutorials, vol. 17, no. 4, pp. 2461-2492, Jun. 2015.
- [6] F. Boukhalfa, M. Hadded, P. Muhlethaler and O. Shagdar, *An active signaling mechanism to reduce access collisions in a distributed TDMA based MAC protocol for vehicular networks*, Advanced Information Networking and Applications (AINA-2019), Matsue, Japan, pp. 286-300, Mar. 2019.

- [7] F. Boukhalfa, M. Hadded, P. Muhlethaler and O. Shagdar, *An Analytical Model for Performance Analysis of An active Signaling-based MAC Protocol for Vehicular Networks*, in Vehicular Technology Conference VTC-FALL, Honolulu, Hawaii, USA, Sept. 2019.
- [8] G. Naik, B. Choudhury and J. M Park, *IEEE 802.11 bd & 5G NR V2X: Evolution of Radio Access Technologies for V2X Communications*, IEEE Access journal, vol. 7, pp. 70169-70184, May. 2019.
- [9] A. Memedi and F. Dressler, "Vehicular Visible Light Communications: A Survey," in IEEE Communications Surveys & Tutorials, vol. 23, no. 1, pp. 161-181, Firstquarter 2021, doi: 10.1109/COMST.2020.3034224.
- [10] Liang, W., Li, Z., Zhang, H., Wang, S., & Bie, R. (2015). Vehicular ad hoc networks: architectures, research issues, methodologies, challenges, and trends. International Journal of Distributed Sensor Networks, 11(8), 745303.
- [11] S. A. A. Shah, E. Ahmed, M. Imran, S. Zeadally, *5g for vehicular communications*, IEEE Communications Magazine, vol. 56, no. 1, pp. 111-117, 2018.
- [12] J. Jakubiak, Y. Koucheryavy, *State of the art and research challenges for VANETs*, In IEEE Consumer communications and networking conference (CCNC) , pp. 912-916, Las-Vegas, USA, Jan. 2008.
- [13] J. J. Huang, Y. S. Chiu, *A scheme to reduce merging collisions in TDMA-based VANETs*, In International Symposium on Wireless and Pervasive Computing (ISWPC), pp. 1-4, Nov. 2013.
- [14] K. Bilstrup, E. Uhlemann, E. G. Strom, U. Bilstrup, *Evaluation of the IEEE 802.11 p MAC method for vehicle-to-vehicle communication*, In Wireless and Pervasive Computing (ISWPC) IEEE, In Vehicular Technology Conference, VTC-Fall. IEEE 68th (pp. 1-5), Sep. 2008.
- [15] A. N. Dharsandiya and R. M. Patel, *A review on MAC protocols of Vehicular Ad Hoc Networks*, IEEE International Conference on Wireless Communications, Signal Processing and Networking (WiSPNET), pp. 1040-1045, Mar. 2016.
- [16] M. Hadded, A. Laouiti, P. Muhlethaler, and L. A. Saidane, *An Infrastructure-Free Slot Assignment Algorithm for Reliable Broadcast of Periodic Messages in*



- Vehicular Ad hoc Networks*, VTC FALL 2016, Sep 2016, Montreal Canada. PROCEEDINGS of VTC Fall 2016.
- [17] H. Baccouch, C. Adjih, P. Muhlethaler, *Active Signaling for 802.11 Networks in the ns-3 Simulator*, PEMWN 2012: First International Workshop on Performance Evaluation and Modeling in Wireless Networks, Nov 2012, Tunis, Tunisia.2012.
- [18] F. Ye, R. Yim, J. Zhang, and S. Roy, *Congestion control to achieve optimal broadcast efficiency in vanets*, in IEEE International Conference on Communications (ICC), Cape Town, South Africa, May 2010, pp. 1-5.
- [19] F. Borgonovo, A. Capone, M. Cesana, and L. Fratta, *Adhoc mac: new mac architecture for ad hoc networks providing efficient and reliable point-to-point and broadcast services*, *Wireless Networks*, vol. 10, no.4, pp. 359-366, 2004.
- [20] F. Borgonovo, A. Capone, M. Cesana, and L. Fratta, *RR-aloha, a reliable r-aloha broadcast channel for ad-hoc intervehicle communication networks*, in IEEE IFIP Annual Mediterranean Ad Hoc Networking Workshop (Med-Hoc-Net), Baia Chia, Italy, 2002.
- [21] F. Lyu et al., *MoMAC: Mobility-aware and collision-avoidance MAC for safety applications in VANETs*, *IEEE Trans. Veh. Technol.*, vol. 67, no. 11, pp. 10590-10602, Nov. 2018.
- [22] M. Hadded, A. Laouiti, P. Muhlethaler, and L. A. Saidane, *An infrastructure-free slot assignment algorithm for reliable broadcast of periodic messages in vehicular ad hoc networks*, in *Vehicular Technology Conference VTC-Fall*, Montreal, Canada, Sep. 2016.
- [23] S. Cao and V. C. S. Lee, *A novel adaptive TDMA-based MAC protocol for VANETs*, *IEEE Commun. Lett.*, vol. 22, no. 3, pp. 614-617, Mar. 2017.
- [24] M. Siddik, S.S. Moni, M.S. Alam, W.A. Johnson, *SAFE-MAC: speed aware fairness enabled MAC protocol for vehicular ad-hoc networks Sensors, 19 (10) (2019), p. 2405*
- [25] T. L. Sheu and Y. H. Lin, *A cluster-based TDMA system for inter-vehicle communications*, *J. Inf. Sci.*, vol. 30, no. 1, pp. 213-231, Jan. 2014.

- [26] G. Abbas, Z. H. Abbas, S. Haider, T. Baker, S. Boudjit and F. Muhammad, *PDMAC: A priority-based enhanced TDMA protocol for warning message dissemination in VANETs*, *Sensors*, vol. 20, no. 1, pp. 45, 2020.
- [27] Z. Xu, M. Wang, Y. Wu and X. Lin, *Adaptive Multichannel MAC Protocol Based on SD-TDMA Mechanism for the Vehicular Ad Hoc Network*, *IET Communications*, 2018.
- [28] X. Zhang, X. Jiang and M. Zhang, *A black-burst based time slot acquisition scheme for the hybrid TDMA/CSMA multichannel MAC in VANETs*, *IEEE Wireless Commun. Lett.*, vol. 8, no. 1, pp. 137-140, Feb. 2019.
- [29] W. Zhuang, H. A. Omar, and L. Lio, *Vemac: A novel multichannel mac protocol for vehicular ad hoc networks*, in *IEEE Conference on Computer Communications Workshops (INFOCOM WKSHPS)*, Shanghai, China, Aug. 2011, pp. 413-418.
- [30] Y. Ma, L. Yang, P. Fan, S. Fang and Y. Hu, *An improved coordinated multichannel mac scheme by efficient use of idle service channels for vanets*, 2018 *IEEE 87th Vehicular Technology Conference (VTC Spring)*, pp. 1-5, June 2018.
- [31] Ji, S.; Kim, J.; You, C. CADMA: Collision-avoidance directional medium access for vehicular ad hoc networks. *Wirel. Netw.* 2016, 22, 1181-1197.
- [32] X. Jiang, , D. H. Du, *PTMAC: A Prediction-Based TDMA MAC Protocol for Reducing Packet Collisions in VANET*, *IEEE Trans. Vehicular Technology*, vol. 65, no. 11, pp. 9209-9223, 2016.
- [33] C. Song, G. Tan, C. Yu, N. Ding and F. Zhang, *APDM: An adaptive multi-priority distributed multichannel MAC protocol for vehicular ad hoc networks in unsaturated conditions*, *Comput. Commun.*, vol. 104, pp. 119-133, May 2016, [online] Available: <http://www.sciencedirect.com/science/article/pii/S0140366416302675>.
- [34] T. C and M. R, "An asynchronous multi-channel MAC for improving channel utilization in VANET," *Procedia Computer Science*, vol. 115, pp. 607-614, 2017.
- [35] Y. Mao, F. Yan, and L. Shen, "Multi-round elimination contention-based multi-channel MAC scheme for vehicular ad hoc networks," *IET Communications*, vol. 11, no. 3, pp. 421-427, 2017.

- 
- [36] N. Shahin and Y.-T. Kim, An enhanced TDMA Cluster-based MAC (ETCM) for multichannel vehicular networks, 2016 International Conference on Selected Topics in Mobile Wireless Networking (MoWNeT), 2016.
- [37] F. Karnadi, Z. Mo, and K. chan Lan, *Rapid generation of realistic mobility models for VANET*, in IEEE WCNC, Hong Kong, China, Mar. 2007, pp. 2506-2511.
- [38] A. Laouiti, A. Qayyum and M-N-M. Saad, *Vehicular Ad-Hoc Networks for Smart Cities*, In Proceedings of the Second International Workshop of Advances in Intelligent Systems and Computing, Vol. 548, Springer, 2017.
- [39] M. Hadded, P. Muhlethaler, and A. Laouiti, *Performance evaluation of a TDMA-based multi-hop communication scheme for reliable delivery of warning messages in vehicular networks*, in Proc. Wireless Commun. Mobile Comput. Conf. (IWCMC), 2017, pp. 1029-1034.
- [40] F. Boukhalfa, M. Hadded, P. Muhlethaler and O. Shagdar, *An Analytical Model for Performance Analysis of An active Signaling based MAC Protocol for Vehicular Networks*, in Vehicular Technology Conference VTC-FALL, Honolulu, Hawaii, USA, Sept. 2019.
- [41] M. Hadded, P. Muhlethaler, A. Laouiti and L. A. Saidane, *"An Infrastructure-Free Slot Assignment Algorithm for Reliable Broadcast of Periodic Messages in Vehicular Ad Hoc Networks"*, 2016 IEEE 84th Vehicular Technology Conference (VTC-Fall), Montreal, QC, Canada, pp. 1-7, Sept. 2016.
- [42] F. Ye, R. Yim, J. Zhang, and S. Roy, *"Congestion control to achieve optimal broadcast efficiency in vanets"*, in IEEE International Conference on Communications (ICC), Cape Town, South Africa, May 2010, pp. 1-5.
- [43] R. Uzcategui and G. Acosta-Marum, *"Wave: A tutorial"*, IEEE Communications Magazine, vol. 47, no. 5, pp. 126-133, May 2009.
- [44] W. Ke, Y. Weidong, L. Pan, and Z. Hongsong, *"A decentralized adaptive TDMA scheduling strategy for VANET"*, in IEEE Wireless Communications and Networking Conference Workshops (WCNCW), Shanghai, China, Apr. 2013, pp. 216-221.

- [45] N. Lu, N. Cheng, N. Zhang, X. Shen and J. W. Mark, *Connected vehicles: Solutions and challenges*, IEEE internet of things journal, vol. 1, no. 4, pp. 289-299. 2014.
- [46] C.D. Wang, and J.P. Thompson, *Apparatus and method for motion detection and tracking of objects in a region for collision avoidance utilizing a real-time adaptive probabilistic neural network*, U.S patent no. 5.613.039, 1997.
- [47] K. Pi. Chen and P. A. Hsiung, *Vehicle Collision Prediction under Reduced Visibility Conditions*, Sensors journal, Vol. 18, no. 9, Sep 2018.
- [48] S. A. Mohammad, A. Rasheed and A. Qayyum, *VANET architectures and protocol stacks: a survey*, In International Workshop on Communication Technologies for Vehicles, Berlin, Heidelberg, pp. 95-105, Mar. 2011.
- [49] Y. Maalej, S. Sorour, A. Abdel-Rahim and M. Guizani, *Vanets meet autonomous vehicles: Multimodal surrounding recognition using manifold alignment*, IEEE Access, vol. 6, pp. 29026-29040, May. 2018.
- [50] H. Menouar, F. Filali and M. Lenardi, *A survey and qualitative analysis of MAC protocols for vehicular ad hoc networks*, IEEE wireless communications, vol. 13, no. 5, pp. 30-35, 2006.
- [51] D. N. M. Dang, H. N. Dang, V. Nguyen, Z. Htike and C. S. Hong, *HER-MAC: A hybrid efficient and reliable MAC for vehicular ad hoc networks*, IEEE 28th International Conference on Advanced Information Networking and Applications, pp. 186-193, May. 2014.
- [52] F. Ye, R. Yim, J. Zhang, and S. Roy, *Congestion control to achieve optimal broadcast efficiency in vanets*, in IEEE International Conference on Communications (ICC), Cape Town, South Africa pp. 1-5, May 2010.
- [53] Q. Chen, D. Jiang and L. Delgrossi, *IEEE 1609.4 DSRC multi-channel operations and its implications on vehicle safety communications*, IEEE vehicular networking conference (VNC), pp. 1-8, Oct. 2009.
- [54] V. Nguyen, C. Pham, T. Z. Oo, N. H. Tran, E. N. Huh and C. S. Hong, *MAC protocols with dynamic interval schemes for VANETs*, Vehicular Communications, vol. 15, pp. 40-62, 2019.

- [55] R. Zou, Z. Liu, L. Zhang and M. Kamil, *A near collision free reservation based MAC protocol for VANETs*, IEEE Wireless Communications and Networking Conference (WCNC), pp. 1538-1543, Apr. 2014.
- [56] W. D. YANG, L. I. Pan and H. S. ZHU, *Adaptive TDMA slot assignment protocol for vehicular ad-hoc networks*, The Journal of China Universities of Posts and Telecommunications, vol. 20, no. 1, pp. 11-25, 2013.
- [57] W. Yang, W. Liu, P. Li and L. Sun, *TDMA-based control channel access for IEEE 802.11 p in VANETs*, International Journal of Distributed Sensor Networks, vol. 10, no. 8, pp. 579-791, 2014.
- [58] S. Babu, M. Patra and C. S. R. Murthy, *An efficient TDMA-based variable interval multichannel MAC protocol for vehicular networks*, Wireless Networks, vol. 22, no. 44, pp. 1365-1380, 2016.
- [59] F. Boukhalfa, C. Adjih, P. Muhlethaler, M. Hadded and O. Shagdar, "Physical and MAC Layer Design for Active Signaling Schemes in Vehicular Networks," 2020 16th International Conference on Wireless and Mobile Computing, Networking and Communications (WiMob), Thessaloniki, Greece, 2020, pp. 86-92, doi: 10.1109/WiMob50308.2020.9253440.
- [60] F. Boukhalfa, M. Hadded, P. Muhlethaler and O. Shagdar, "Performance Evaluation of an Active Signaling based Time-Slot Scheduling Scheme for connected vehicles;" Annals of Telecommunications - annales des telecommunications, Springer, 2020.
- [61] F. Boukhalfa, M. Hadded, P. Muhlethaler and O. Shagdar, "Coexistence of IEEE 802.11p and the TDMA-based AS-DTMAC Protocol," 2020 International Conference on Software, Telecommunications and Computer Networks (SoftCOM), Split, Croatia, 2020, pp. 1-6, doi: 10.23919/SoftCOM50211.2020.9238279.
- [62] H. V. Poor, *An introduction to signal detection and estimation*, Springer Science & Business Media, 2013.
- [63] G. S. M. Motorola, *10-Estimation de probabilités faibles en détection*, 1998.
- [64] C. H. Liu, *On the design of OFDM signal detection algorithms for hardware implementation*, IEEE Global Telecommunications Conference (Globecom), vol. 2, pp. 596-599, Dec. 2003.

- [65] A. M. Abdelgader and W. Lenan, *The physical layer of the IEEE 802.11 p WAVE communication standard: the specifications and challenges*, In Proceedings of the world congress on engineering and computer science, vol. 2, pp. 22-24.
- [66] D. Bhargavi and C. R. Murthy, *Performance comparison of energy, matched-filter and cyclostationarity-based spectrum sensing*, IEEE 11th International Workshop on Signal Processing Advances in Wireless Communications (SPAWC), pp. 1-5, Jun. 2010.
- [67] Y. Arjoune, Z. El Mrabet, H. El Ghazi and A. Tamtaoui, *Spectrum sensing: Enhanced energy detection technique based on noise measurement*, In 2018 IEEE 8th Annual Computing and Communication Workshop and Conference (CCWC), pp. 828-834, Jan. 2018.
- [68] ETSI EN 302 637, *Intelligent Transport Systems (ITS); Vehicular Communications; Basic Set of Applications; Part 3: Specifications of Decentralized Environmental Notification Basic Service*, 2014.
- [69] F. Hu, "Security and Privacy in Internet of Things (IoTs)," Security and Privacy in Internet of Things (IoTs): Models, Algorithms, and Implementations, 2016.
- [70] F. Boukhalfa, M. Hadded, P. Muhlethaler, and O. Shagdar, *An Analytical Model for Performance Analysis of an Active Signaling-based TDMA MAC Protocol for Vehicular Networks*, In Proceedings of the 2019 IEEE 90th Vehicular Technology Conference (VTC2019-Fall), Honolulu, HI, USA, Sep. 2019.
- [71] J. Abate and W. Whitt, *Numerical Inversion of Laplace Transforms of Probability Distributions*, ORSA Journal on Computing, Vol 7, no 1, pp 38-43, 1995.
- [72] M. Hadded, R. Zagrouba, A. Laouiti, P. Muhlethaler, and L. A. Saidane, *An optimal strategy for collision-free slots allocations in vehicular adhoc networks*, in Advances in Intelligent Systems and Computing, vol. 306, Kuala Lumpur, Malaysia, Jun. 2015, pp. 15-30.
- [73] F. Ye, R. Yim, J. Zhang, and S. Roy, *Congestion control to achieve optimal broadcast efficiency in vanets*, in IEEE International Conference on Communications (ICC), Cape Town, South Africa, May 2010, pp. 1-5.

- [74] Y. Weidong, L. Pan, L. Yan, and Z. Hongsong, *Adaptive TDMA slot assignment protocol for vehicular ad-hoc networks*, Journal of China Universities of Posts and Telecommunications, vol. 20, no. 1, pp. 11–18, Feb. 2013.
- [75] W. Ke, Y. Weidong, L. Pan, and Z. Hongsong, *A decentralized adaptive TDMA scheduling strategy for VANETs*, in IEEE Wireless Communications and Networking Conference Workshops (WCNCW), Shanghai, China, Apr. 2013, pp. 216–221.
- [76] J. Abate and W. Whitt, *Numerical Inversion of Laplace Transforms of Probability Distributions*, ORSA Journal on Computing, Vol 7, no 1, pp 38–43, year 1995
- [77] F. Ye, R. Yim, J. Zhang, and S. Roy, *Congestion control to achieve optimal broadcast efficiency in vanets*, in IEEE International Conference on Communications (ICC), Cape Town, South Africa, May 2010, pp. 1-5.
- [78] Y. Weidong, L. Pan, L. Yan, and Z. Hongsong, *Adaptive TDMA slot assignment protocol for vehicular ad-hoc networks*, Journal of China Universities of Posts and Telecommunications, vol. 20, no. 1, pp. 11–18, Feb. 2013.
- [79] W. Ke, Y. Weidong, L. Pan, and Z. Hongsong, *A decentralized adaptive TDMA scheduling strategy for VANETs*, in IEEE Wireless Communications and Networking Conference Workshops (WCNCW), Shanghai, China, Apr. 2013, pp. 216–221.
- [80] F. Karnadi, Z. Mo, and K. chan Lan, *Rapid generation of realistic mobility models for VANET*, in IEEE WCNC, Hong Kong, China, Mar. 2007, pp. 2506-2511.
- [81] Y. Bi, K.H. Liu, L.X. Cai, and X. Shen, *A Multi-Channel Token Ring Protocol for QoS Provisioning in Inter-Vehicle Communications*, IEEE Transactions on Wireless Communications, vol. 8, no. 11, pp. 5621-5631, Nov. 2009
- [82] A. Rebei, M. Hadded, H. Touati, F. Boukhalfa and P. Muhlethaler, *"MAC-aware Routing Protocols for Vehicular Ad Hoc Networks: A Survey,"* 2020 International Conference on Software, Telecommunications and Computer Networks (SoftCOM), Split, Hvar, Croatia, 2020, pp. 1-6, doi: 10.23919/SoftCOM50211.2020.9238249.

- [83] M. Segata and B. Bloessl and S. Joerer and C. Sommer and M. Gerla and R. Cigno and F. Dressler, *Towards inter-vehicle communication strategies for platooning support* 7th International Workshop on Communication Technologies for Vehicles (Nets4Cars-Fall) 2014,
- [84] Q. Wang, D. Giustiniano, and M. Zuniga, "In Light and In Darkness, In Motion and In Stillness: A Reliable and Adaptive Receiver for the Internet of Lights," *IEEE Journal on Selected Areas in Communications*, vol. 36, no. 1, pp. 149â161, 2018.
- [85] F. Boukhalfa, M. Hadded, P. Muhlethaler, and O. Shagdar, "Performance evaluation of an active signaling based time-slot scheduling scheme for connected vehicles," *Annals of Telecommunications*, 2021.
- [86] F. Ye, R. Yim, J. Zhang, and S. Roy, *Congestion control to achieve optimal broadcast efficiency in vanets*, in *IEEE International Conference on Communications (ICC)*, Cape Town, South Africa, May 2010, pp. 1-5.
- [87] Y. Weidong, L. Pan, L. Yan, and Z. Hongsong, *Adaptive TDMA slot assignment protocol for vehicular ad-hoc networks*, *Journal of China Universities of Posts and Telecommunications*, vol. 20, no. 1, pp. 11â18, Feb. 2013.
- [88] W. Ke, Y. Weidong, L. Pan, and Z. Hongsong, *A decentralized adaptive TDMA scheduling strategy for VANETs*, in *IEEE Wireless Communications and Networking Conference Workshops (WCNCW)*, Shanghai, China, Apr. 2013, pp. 216â221.
- [89] M. Uysal, Z. Ghassemlooy, A. Bekkali, A. Kadri and H. Menouar, "Visible Light Communication for Vehicular Networking: Performance Study of a V2V System Using a Measured Headlamp Beam Pattern Model," in *IEEE Vehicular Technology Magazine*, vol. 10, no. 4, pp. 45-53, Dec. 2015, doi: 10.1109/MVT.2015.2481561.
- [90] M. Segata et al., "Towards inter-vehicle communication strategies for platooning support," 2014 7th International Workshop on Communication Technologies for Vehicles (Nets4Cars-Fall), St. Petersburg, Russia, 2014, pp. 1-6, doi: 10.1109/Nets4CarsFall.2014.7000903.
- [91] M. Schettler, A. Memedi and F. Dressler, "Deeply Integrating Visible Light and Radio Communication for Ultra-High Reliable Platooning," 2019 15th Annual



- Conference on Wireless On-demand Network Systems and Services (WONS), 2019, pp. 36-43, doi: 10.23919/WONS.2019.8795496.
- [92] K. Darabkh, M. Alfawares, S Althunibat, and A. Khalifeh, "A Cross-layer Algorithm for Improving AODV Protocol over Vehicular Ad-hoc Networks," International Conference on Wireless Communications Signal Processing and Networking (WiSPNET), Mar. 2019
- [93] B. Blaszczyszyn, A. Laouiti, P. Muhlethaler, and Y. Toor, "Opportunistic broadcast in VANETs (OB-VAN) using active signaling for relays selection," IEEE International Conference on ITS Telecommunications (ITST'08), pp. 384-389, Oct. 2008.
- [94] Y. Bi, K.H. Liu, L.X. Cai, and X. Shen, "A Multi-Channel Token Ring Protocol for QoS Provisioning in Inter-Vehicle Communications," IEEE Transactions on Wireless Communications, vol. 8, no. 11, pp. 5621-5631, Nov. 2009
- [95] L. Wang, VANET Toolbox: A Vehicular Network Simulator Based on DES, Sep. 2019, Available online.
- [96] S. Bechadergue, H. Guan, L. Chassagne, S. Tohme, and J.-L. Franchineau, "Visible light communication system for platooning applications," in Proc. Vehicle Infrastruct. Safety Improvement Adverse Conditions Night Driving, Oct. 2016
- [97] L. Cheng, W. Viriyasitavat, M. Boban and H. Tsai, "Comparison of Radio Frequency and Visible Light Propagation Channels for Vehicular Communications," in IEEE Access, vol. 6, pp. 2634-2644, 2018, doi: 10.1109/ACCESS.2017.2784620.
- [98] W. Liang, Z. Li, H. Zhang, S. Wang and R. Bie, "Vehicular ad hoc networks: Architectures research issues methodologies challenges and trends", Int. J. Distrib. Sensor Netw., vol. 15, no. 1, pp. 1-17, 2015.
- [99] T. Kosch, M. Strassberger, C. Schroth and M. Bechler, Automotive Internetworking, Wiley, New York, 2012.
- [100] H. Haas, L. Yin, Y. Wang and C. Chen, "What is LiFi?", J. Lightw. Technol., vol. 34, no. 6, pp. 1533-1544, Mar. 2016.
- [101] H. Haas, "LiFi: Conceptions misconceptions and opportunities", Proc. IEEE Photon. Conf. (IPC), pp. 680-681, 2016.

- [102] A. K. Gulia, "A simulation study on the performance comparison of the V2X communication systems: ITSG5 and C-V2X", Feb. 2020.
- [103] Canis, B., & Gallagher, J. C. (2019). Smart Cars and Trucks: Spectrum Use for Vehicle Safety (No. IF11260).
- [104] F. Cunha et al., "Data communication in VANETs: Protocols applications and challenges", *Ad Hoc Netw.*, vol. 44, pp. 90-103, Jul. 2016.
- [105] C. Tebruegge, A. Memedi, and F. Dressler, "Empirical Characterization of the NLOS Component for Vehicular Visible Light Communication," in 11th IEEE Vehicular Networking Conference (VNC 2019), Los Angeles, CA: IEEE, Dec. 2019, pp. 64-67.
- [106] C. Tebruegge, A. Memedi, and F. Dressler, "Empirical Characterization of the NLOS Component for Vehicular Visible Light Communication," in 11th IEEE Vehicular Networking Conference (VNC 2019), Los Angeles, CA: IEEE, Dec. 2019, pp. 64-67.
- [107] IEEE Standard for Local and metropolitan area networks. Part 15.7: Short-Range Wireless Optical Communication Using Visible Light, IEEE, Std 802.15.7-2011, Sep. 2011
- [108] A.-M. Cailean and M. Dimian, "Impact of IEEE 802.15.7 Standard on Visible Light Communications Usage in Automotive Applications," *IEEE Communications Magazine (COMMAG)*, 2017.
- [109] A. Memedi, H.-M. Tsai and F. Dressler, "Impact of Realistic Light Radiation Pattern on Vehicular Visible Light Communication", *IEEE GLOBECOM 2017*, Dec. 2017.
- [110] A. Memedi, C. Tebruegge, J. Jahneke and F. Dressler, "Impact of vehicle type and headlight characteristics on vehicular VLC performance", *Proc. 10th IEEE Veh. Netw. Conf. (VNC)*, pp. 1-8, Dec. 2018.
- [111] H. Fernandez, L. Rubio, V. M. Rodrigo-Penarrocha and J. Reig, "Path Loss Characterization for Vehicular Communications at 700 MHz and 5.9 GHz Under LOS and NLOS Conditions," in *IEEE Antennas and Wireless Propagation Letters*, vol. 13, pp. 931-934, 2014, doi: 10.1109/LAWP.2014.2322261.

- [112] Yacheur, B. Y., Ahmed, T., & Mosbah, M. (2020, November). Analysis and Comparison of IEEE 802.11 p and IEEE 802.11 bd. In International Workshop on Communication Technologies for Vehicles (pp. 55-65). Springer, Cham.
- [113] N. P. Chandrasekharamenon and B. Ancharev, "Connectivity analysis of one-dimensional vehicular ad hoc networks in fading channels", *EURASIP J. Wireless Commun. Netw.*, vol. 2012, no. 1, pp. 1, Jan. 2012.
- [114] Plascencia, E., Shagdar, O., Guan, H., & Chassagne, L. Study on Multi-Users Interference in Vehicle to Vehicle Visible Light Communications.
- [115] V. Van Huynh, Y. M. Jang et al., Priority mac based on multi-parameter for IEEE 802.15. 7 vlc, in *ICTC 2011. IEEE*, 2011, pp. 257-260.
- [116] S. Ishihara, R. V. Rabsatt, and M. Gerla, "Improving reliability of platooning control messages using radio and visible light hybrid communication," in *2015 IEEE Vehicular Networking Conference (VNC)*. IEEE, 2015, pp. 96-103
- [117] B. Bechadergue, L. Chassagne and H. Guan, "Simultaneous visible light communication and distance measurement based on the automotive lighting", *IEEE Trans. Intell. Veh.*, vol. 4, no. 4, pp. 532-547, Dec. 2019.
- [118] Realistic Simulation of Vehicular Visible Light Communication: <https://www.ccs-labs.org/software/veins-vlc/>
- [119] Realistic simulation of platooning systems: <https://plexe.car2x.org/>
- [120] R. Khoder, R. Naja, N. Mouawad, and S. Tojme, "Vertical Handover Network Selection Architecture for VLC Vehicular Platoon Driving Assistance," *2020 IEEE 31st Annual International Symposium on Personal, Indoor and Mobile Radio Communications*, 2020.
- [121] Abualhoul, M., Al-Bado, M., Shagdar, O., & Nashashibi, F. (2018, November). A Proposal for VLC-Assisting IEEE802. 11p Communication for Vehicular Environment Using a Prediction-based Handover. In *ITSC 2018-21st IEEE International Conference on Intelligent Transportation Systems*.
- [122] M. Y. Abualhoul, O. Shagdar, and F. Nashashibi, "Visible Light intervehicle Communication for platooning of autonomous vehicles," in *IEEE Intelligent Vehicles Symposium (IV 2016)*, Gothenburg, Sweden: IEEE, Jun. 2016, 508-513.

- [123] S.A. AvatamaniÈei, A.M. Cailean, A. Done, M. Dimian, V. Popa and M. Pre- lipceanu, "Design and Intensive Experimental Evaluation of an Enhanced Visible Light Communication System for Automotive Applications", *Sensors*, vol. 20, pp. 3190, 2020.
- [124] H. Z. Bo Sun, *802.11 NGV Proposed PAR*. IEEE NGV Meeting, Nov. 2019.
- [125] Michael Behrisch, Laura Bieker, Jakob Erdmann, and Daniel Krajzewicz. 2011. SUMO—simulation of urban mobility: an overview. In *Proceedings of SIMUL 2011, The Third International Conference on Advances in System Simulation*. ThinkMind
- [126] Jerome Harri, Fethi Filali, Christian Bonnet, and Marco Fiore. 2006. Vanet MobiSim: generating realistic mobility patterns for VANETs. In *Proceedings of the 3rd international workshop on Vehicular ad hoc networks*. ACM, 96â97. <https://doi.org/10.1145/1161064.1161084>
- [127] J. Harri, F. Filali, C. Bonnet, and M. Fiore, VanetMobiSim: generating realistic mobility patterns for VANETs *Proceedings of the 3rd international workshop on Vehicular ad hoc networks - VANET 06*, 2006.
- [128] "Status of Project IEEE 802.11 Task Group p: Wireless Access in Vehicular Environments". IEEE. 2004 - 2010. Retrieved August 10, 2011.
- [129] "IEEE Standard for Information technology— Local and metropolitan area networks— Specific requirements— Part 11: Wireless LAN Medium Access Control (MAC) and Physical Layer (PHY) Specifications Amendment 6: Wireless Access in Vehicular Environments," in *IEEE Std 802.11p-2010 (Amendment to IEEE Std 802.11-2007 as amended by IEEE Std 802.11k-2008, IEEE Std 802.11r-2008, IEEE Std 802.11y-2008, IEEE Std 802.11n-2009, and IEEE Std 802.11w-2009)* , vol., no., pp.1-51, 15 July 2010, doi: 10.1109/IEEESTD.2010.5514475.
- [130] ITS Stack - Qualcomm: "<https://www.qualcomm.com/media/documents/files/c-v2x-its-stack.pdf>"
- [131] ACEA Position Paper Frequency bands for V2X: "[https://www.acea.be/uploads/publications/ACEA\\_position\\_paper\\_Frequency\\_bands\\_for\\_V2X.pdf](https://www.acea.be/uploads/publications/ACEA_position_paper_Frequency_bands_for_V2X.pdf)"

- 
- [132] L. Miao, J. J. Virtusio, and K.-L. Hua, PC5-Based Cellular-V2X Evolution and Deployment, *Sensors*, vol. 21, no. 3, p. 843, 2021.
- [133] 3GPP, 3GPP TR 22.886: Study on enhancement of 3GPP Support for 5G V2X Services (v16.2.0, Release 16), Dec. 2018
- [134] ETSI, T. Intelligent Transport Systems (ITS); Access layer specification for Intelligent Transport Systems operating in the 5 GHz frequency band. EN 302 663 V1. 2.1, July 2013.