



HAL
open science

Revisiting sensorimotor adaptation : new insights from inter-task transfer of after-effects in prism adaptation

Lisa Fleury

► **To cite this version:**

Lisa Fleury. Revisiting sensorimotor adaptation : new insights from inter-task transfer of after-effects in prism adaptation. Neuroscience. Université de Lyon, 2020. English. NNT : 2020LYSE1322 . tel-03525038

HAL Id: tel-03525038

<https://theses.hal.science/tel-03525038>

Submitted on 13 Jan 2022

HAL is a multi-disciplinary open access archive for the deposit and dissemination of scientific research documents, whether they are published or not. The documents may come from teaching and research institutions in France or abroad, or from public or private research centers.

L'archive ouverte pluridisciplinaire **HAL**, est destinée au dépôt et à la diffusion de documents scientifiques de niveau recherche, publiés ou non, émanant des établissements d'enseignement et de recherche français ou étrangers, des laboratoires publics ou privés.



THESE de DOCTORAT DE L'UNIVERSITE DE LYON
opérée au sein de
l'Université Claude Bernard Lyon 1

Ecole Doctorale NSCo N° 476
Neurosciences et Cognition

SPECIALITE DE DOCTORAT : NEUROSCIENCES

Soutenue publiquement le 11/12/2020, par :
Lisa FLEURY

REVISITING SENSORIMOTOR ADAPTATION
New insights from inter-task transfer of after-effects in
prism adaptation

Devant le jury composé de :

Pr BASTIAN, Amy	The Johns Hopkins University, Baltimore	Rapporteure
Pr NIJBOER, Tanja	University Medical Center, Utrecht	Rapporteure
Dr BLOUIN, Jean	CNRS Marseille	Examineur
Pr GUILLOT, Aymeric	Université Claude Bernard Lyon 1	Examineur
Pr HUMMEL, Friedhelm	EPFL Genève	Examineur
Dr REILLY, Karen	CNRS Lyon	Examinatrice
Pr ROSSETTI, Yves	Université Claude Bernard Lyon 1	Directeur de thèse
Pr COLLET, Christian	Université Claude Bernard Lyon 1	Co-directeur de thèse
Dr SARLEGNA, Fabrice	CNRS Marseille	Membre invité

UNIVERSITE CLAUDE BERNARD – LYON 1

Administrateur provisoire de l'Université	M. Frédéric FLEURY
Président du Conseil Académique	M. Hamda BEN HADID
Vice-Président du Conseil d'Administration	M. Didier REVEL
Vice-Président du Conseil des Etudes et de la Vie Universitaire	M. Philippe CHEVALLIER
Vice-Président de la Commission de Recherche	M. Jean-François MORNEX
Directeur Général des Services	M. Pierre ROLLAND

COMPOSANTES SANTE

Département de Formation et Centre de Recherche en Biologie Humaine	Directrice : Mme Anne-Marie SCHOTT
Faculté d'Odontologie	Doyenne : Mme Dominique SEUX
Faculté de Médecine et Maïeutique Lyon Sud – Charles Mérieux	Doyenne : Mme Carole BURILLON
Faculté de Médecine Lyon-Est	Doyen : M. Gilles RODE
Institut des Sciences et Techniques de la Réadaptation (ISTR)	Directeur : M. Xavier PERROT
Institut des Sciences Pharmaceutiques et Biologiques (ISBP)	Directrice : Mme Christine VINCIGUERRA

COMPOSANTES & DEPARTEMENTS DE SCIENCES & TECHNOLOGIE

Département Génie Electrique et des Procédés (GEP)	Directrice : Mme Rosaria FERRIGNO
Département Informatique	Directeur : M. Behazad SHARIAT
Département Mécanique	Directeur : M. Marc BUFFAT
Ecole Supérieure de Chimie, Physique, Electronique (CPE Lyon)	Directeur : M. Gérard PIGNAULT
Institut de Science Financière et d'Assurances (ISFA)	Directeur : M. Nicolas LEBOISNE
Institut National du Professorat et de l'Education	Administrateur provisoire : M. Pierre CHAREYRON
Institut Universitaire de Technologie de Lyon 1	Directeur : M. Christophe VIRON
Observatoire de Lyon	Directrice : Mme Isabelle DANIEL
Polytechnique Lyon	Directeur : Emmanuel PERRIN
UFR Biosciences	Administrateur provisoire : Mme Kathrin GIESELER
UFR des Sciences et Techniques des Activités Physiques et Sportives (STAPS)	Directeur : M. Yannick VANPOULLE
UFR Faculté des Sciences	Directeur : M. Bruno ANDRIOLETTI

Student: “*Dr Einstein, aren't these the same questions as last year's final exam?*”

Dr. Einstein: “*Yes, but this year the answers are different.*”

Acknowledgments

First of all, I would like to thank all the members of the jury for agreeing to evaluate this dissertation. Special thanks to Amy Bastian & Tanja Nijboer for agreeing to review the manuscript. This is a great honour for me to have the opportunity to share this work with all of you. Now let's switch to French for a few lines!

L'expérience d'une thèse n'étant pas une aventure que l'on entreprend en solitaire, je tiens à remercier l'ensemble des personnes qui ont contribué, de près ou de loin, à l'accomplissement de ce travail.

En premier lieu, j'adresse toute ma gratitude à Yves. Merci de m'avoir accueillie au laboratoire les bras ouverts. Merci pour ta grande humanité, ta bienveillance, ta créativité et ton enthousiasme. Merci également de m'avoir transmis une vision de la recherche qui m'est devenue chère, et d'avoir su m'accompagner, m'encourager et me guider avec justesse dans toutes les étapes de cette thèse.

Un grand merci également à Christian pour avoir accepté de codiriger cette thèse et pour m'avoir accordé ta confiance. Merci pour ta disponibilité, et surtout pour tes relectures attentives et tes corrections qui m'ont été très précieuses.

J'aimerais remercier les membres de mon comité de suivi de thèse François Osiurak et Fabrice. Merci aussi à Fabrice de nous avoir accueillis à Luminy le temps d'une journée et pour nos échanges, qui, je l'espère, se poursuivront.

Je tiens par ailleurs à remercier l'ENS de Rennes pour le financement ayant permis le déroulement de cette thèse, ainsi que les enseignants du département 2SEP pour m'avoir confortée dans la volonté de poursuivre en doctorat et pour m'en avoir donné les moyens.

Un grand merci à l'ensemble des personnes avec qui j'ai collaboré à travers les différentes études de cette thèse. Je souhaiterais remercier Patrice, avec qui j'ai passé de nombreuses heures en salle d'expérimentation, toujours dans une humeur joyeuse. Francesco, *grazie mille* pour m'avoir formée à la tDCS, pour ton immense aide dans les passations et sur les articles. Merci également à Alexandre pour sa gentillesse et sa disponibilité ainsi que son aide précieuse sur les statistiques. Merci beaucoup à Sonia, pour son efficacité dans toute la gestion administrative, toujours avec un grand sourire, ainsi qu'à Jean-Louis. Merci à Claude et Anne-Emmanuelle pour notre travail de revue en commun. Au sein du labo, j'aimerais également remercier Ludovic, Eric, Romeo et Fred.

J'ai bien évidemment une pensée pour mes collègues doctorants. Merci à vous tous pour votre esprit de solidarité et votre grain de folie, notamment Alexis, Samy, Leslie, Audrey, Audrey, Simon, Laura, sans oublier Camille et Éric les ingénieurs. Une pensée également pour François, merci pour tes conseils toujours avisés et bienveillants.

Mes remerciements s'adressent aussi aux stagiaires que j'ai pu superviser, en particulier Pierre, Léa, Rola et Elise. Merci de m'avoir permis de vivre l'expérience de l'encadrement, et merci pour votre aide précieuse lors des expérimentations.

Au-delà des portes du laboratoire, j'aimerais finalement adresser un merci spécial à l'ensemble de mes proches qui ont contribué à mon épanouissement dans cette vie de doctorante.

Merci à la famille des écureuils volants, éparpillée aux quatre coins de la France. Quatre ans déjà que nous avons quitté Rennes, et j'attends à chaque fois nos retrouvailles avec impatience ! Avec une pensée chaleureuse pour mes copines du club P&Co, Mildrey, Laurane et Alizé, devenues des amies si précieuses : merci pour votre soutien sans faille ! Merci également à Willy, avec qui j'ai l'honneur de partager les moments forts de nos thèses respectives, ainsi qu'à Alex, pour vos nombreux encouragements surtout en cette dernière ligne droite. Sans oublier une petite dédicace à la meilleure partenaire de la team Prélab, Manon !

Je remercie aussi mes copines de plus longue date, Clélia et Delphine, toujours fidèles au poste depuis toutes ces années, ainsi que ma cousine Nawel pour leur présence et leurs bonnes ondes.

Je souhaiterais par ailleurs adresser un grand merci à tous les copains du bad, partenaires devenus amis, pour avoir su faire de cette passion sportive des moments remplis de partage et de rigolades et propices à s'évader du quotidien parfois chargé d'une thésarde.

Enfin, j'aimerais adresser ma grande gratitude à mes parents, pour votre amour et votre fierté inconditionnels et parce que vous trouvez toujours les moyens de me les témoigner. Vous êtes mes super-héros ! Merci également à mes trois frères de toujours veiller sur moi et me protéger, peu importe la distance qui nous sépare.

Pour terminer, ma reconnaissance la plus profonde te revient Valérian. Pour ton amour indéfectible, et parce qu'avec toi rien ne me semble insurmontable. Merci de toujours m'écouter et me soutenir avec sérénité. Et surtout, merci de faire de moi une personne incroyablement chanceuse. Hâte de vivre nos prochaines aventures, car ce n'est que le début !

Résumé¹

La plasticité qui caractérise notre système nerveux nous permet de réaliser des mouvements fluides et précis malgré des conditions changeantes. La compréhension et la distinction des processus permettant de modifier un mouvement pour faire face à une perturbation (adaptation) et d'en apprendre de nouveaux (apprentissage) représentent un défi majeur. L'adaptation sensorimotrice se reflète non seulement par la réduction graduelle d'erreurs induites par la perturbation mais surtout par la présence d'effets consécutifs une fois la perturbation supprimée. Les caractéristiques de ces effets consécutifs renseignent sur la nature des modifications opérées au sein du système nerveux central et ainsi sur le type de processus mis en jeu pour faire face à la perturbation.

L'objectif de cette thèse était d'apporter des éléments théoriques à la compréhension et à la distinction des processus de plasticité sensorimotrice. Plus spécifiquement, nous faisons l'hypothèse que l'étude de transfert des effets consécutifs vers une tâche motrice n'ayant pas été pratiquée pendant la perturbation pouvait révéler la contribution de processus distincts durant l'adaptation sensorimotrice. Il s'agissait notamment d'investiguer les conditions favorisant le transfert des effets consécutifs. De plus, il était question d'étudier le rôle du cervelet dans les mécanismes du transfert.

Au sein de nos différentes études, nous avons employé une approche comportementale à travers le paradigme de l'adaptation prismatique, en utilisant des lunettes qui dévient le champ visuel. Les résultats de notre première étude ont montré que les effets consécutifs développés lors de l'adaptation prismatique impliquant une tâche de pointage étaient transférables vers une tâche de lancer. Néanmoins, le transfert du lancer vers le pointage n'était possible que pour les experts en lancer. Ainsi, l'expertise sur la tâche pratiquée durant l'exposition prismatique conditionnait la nature des processus sollicités pour faire face à la perturbation. Dans une seconde étude, nous avons montré que l'adaptation prismatique par imagerie motrice permettait le transfert des effets consécutifs depuis le pointage vers le lancer, mais seulement pour les individus présentant de bonnes capacités d'imagerie motrice. Grâce à l'utilisation de la stimulation cérébrale transcrânienne à courant direct, les deux dernières études ont permis de souligner le possible rôle du cervelet dans le transfert des effets consécutifs.

Au regard de ces apports, cette thèse souligne l'intérêt du transfert inter-tâche pour mettre en évidence la contribution de différents processus durant l'adaptation sensorimotrice, au-delà de la mesure classique des effets consécutifs. Le développement d'effets consécutifs transférables reposerait sur l'ajustement durable des modèles internes du système sensorimoteur. Ces modifications seraient guidées par les erreurs de prédiction sensorielle et impliqueraient des structures cérébelleuses. Ces résultats fondamentaux permettent d'envisager des pistes d'applications dans le domaine clinique, visant à améliorer le transfert des compensations acquises en rééducation vers d'autres contextes.

Mots clés : plasticité sensorimotrice, adaptation, apprentissage, effets consécutifs, transfert, adaptation prismatique, modèles internes, cervelet, tDCS, imagerie motrice

¹ Un résumé substantiel rédigé en français et décrivant le contenu de la thèse et les résultats des différentes contributions expérimentales est disponible à la fin du manuscrit (p. 249-253).

Abstract

The plasticity that characterizes our nervous system enables us to realize smooth and precise movement despite varying demands. The understanding and distinction of processes enabling to modify existing movements when facing a perturbation (adaptation) or to learn new ones (learning) represents a crucial challenge. Sensorimotor adaptation is reflected not only by the gradual error reduction during the perturbation but mostly by the presence of after-effects once the perturbation is removed. The nature of after-effects provides information concerning the modifications entailed in the sensorimotor system and thus the type of processes involved.

The aim of this thesis was to shed light on the comprehension of sensorimotor plasticity processes. More precisely, we hypothesized that the transfer of after-effects to a task that has not been performed under the perturbation might uncover the contribution of distinct processes during sensorimotor adaptation. Therefore, the objective was to isolate the characteristics of processes favouring transfer. In addition, we aimed at investigating the role of the cerebellum in these processes.

To complete these objectives, we used a behavioural approach through a prism adaptation paradigm, using goggles laterally shifting the visual field. Our first study showed a transfer of after-effects acquired during pointing prism exposure to a throwing task. However, the transfer from throwing to pointing was possible only for experts in throwing. Thus, the expertise on the task performed during prism exposure strongly influenced the nature of processes at work to face the perturbation. In the second study, we demonstrated that prism adaptation by motor imagery of pointing movements under exposure led to substantial transfer to throwing movements. This was the case only for participants with high motor imagery abilities. Finally, using tDCS, the two last studies emphasized the possible role of the cerebellum in after-effects transfer.

Altogether, these results underline the interest to study inter-task transfer of after-effects to unravel the contribution of distinct processes during sensorimotor adaptation, beyond the classical measure of after-effects. We propose that the development of transferable after-effects relies on sustained adjustments of the internal models in the sensorimotor system. These modifications may be guided by sensory prediction errors and controlled by cerebellar regions. In a translational view, these fundamental findings pave the way for clinical perspectives of research to optimize the transfer of compensations from rehabilitation context to other daily life situations in patients with motor disorders.

Key words: sensorimotor plasticity, adaptation, learning, after-effects, transfer, prism adaptation, internal models, cerebellum, tDCS, motor imagery

Table of contents

Acknowledgments	7
Résumé	11
Abstract	13
List of figures	19
List of tables	21
List of abbreviations	23
General introduction	25
Chapter 1 - Theoretical background	33
Overview of the chapter	34
A. General principles of sensorimotor control	35
1. Elaboration of motor command in voluntary movements	35
2. Insights from Motor Imagery	36
3. Movement evaluation and its consequences: the role of internal models.....	37
4. Error signals in action.....	39
5. Neural plasticity underlying sensorimotor transformations.....	40
B. Sensorimotor plasticity processes: learning and adaptation	42
C. Prism adaptation	53
1. Typical experimental procedures.....	53
2. What drives and influences prism adaptation?	55
3. Processes operating during PA.....	57
4. Neural substrates of PA	59
D. Transfer/Generalization of after-effects	68
1. Clarifying transfer and generalization	68
2. Transfer/Generalization of after-effects in Prism Adaptation.....	69
3. Neural substrates of transfer	80
E. Synthesis and objectives	82
Chapter 2 - Methodological background	85

Overview of the chapter	86
A. Prism Adaptation (studies 1, 2, 3, and 4)	87
1. A brief history of prism lenses	87
2. How do prisms deviate the visual field?	88
3. From classical procedures to assessment of inter-task transfer of after-effects	89
B. Kinematics of pointing movements (studies 1, 3, and 4)	94
1. Why being interesting in kinematics?	94
2. Kinematic description of a reaching movement	94
3. Kinematics changes during PA and variables of interest	96
4. Motion capture	98
C. Motor Imagery (study 2)	100
1. Characteristics of motor imagery	100
2. Assessment of Motor Imagery	102
3. Requirements for PA by motor imagery	104
D. Transcranial direct Current Stimulation (studies 3 and 4)	105
1. Description	105
2. Physiological effects of tDCS	106
3. Targeting the cerebellum	108
4. Safety	110
5. Sham procedures	110
6. PA procedure combined with tDCS	111
Chapter 3 - Experimental Contributions	113
Overview of the chapter	114
A. Axis 1: Expertise and Transfer	115
1. Study 1: Manuscript	115
2. Study 1: Synthesis	132
B. Axis 2: Transfer and Motor Imagery	133
1. Study 2: Manuscript	133
2. Study 2: Synthesis	154

C. Axis 3: Transfer and tDCS.....	155
1. Study 3: Manuscript.....	155
2. Study 3: Synthesis.....	190
3. Study 4: Manuscript.....	191
4. Study 4: Synthesis.....	221
Chapter 4 - General discussion	223
Overview of the chapter	224
A. Summary of major findings.....	225
1. Axis 1: Influence of the exposed task on after-effects transfer (Study 1).....	225
2. Axis 2: Motor Imagery and transfer of after-effects during PA (Study 2)	226
3. Axis 3: Cerebellar neuromodulation and transfer of after-effects (Studies 3 & 4) ..	226
B. Fundamental implications for sensorimotor adaptation.....	228
1. Studying the transfer to unravel distinct processes in sensorimotor adaptation	228
2. Which conditions are needed to trigger after-effects transfer?.....	231
3. The role of the cerebellum in after-effects transfer	233
4. Theoretical working propositions for the distinction of processes underlying sensorimotor adaption.....	235
C. Open questions, limitations, and perspectives for further research.....	240
1. Open questions and research perspectives.....	240
2. Limitations and considerations for further experiments.....	242
D. Toward rehabilitation: perspectives and challenges for clinical research and application.....	243
Conclusion	245
Résumé substantiel.....	249
Bibliography.....	255

List of figures

- Figure 1** – Neglect symptoms improvement following Prism Adaptation
- Figure 2** – Brain regions activated during Motor Imagery
- Figure 3** – Schematics of the internal models
- Figure 4** – Serial Reaction Time Task paradigm
- Figure 5** – Illustrations of the different type of perturbation in adaptation paradigms
- Figure 6** – Two components in adaptation
- Figure 7** – After-effects magnitude and transfer to other feedback viewing conditions
- Figure 8** – Comparison between Coriolis forces and robotic force-field paradigms
- Figure 9** – Classical PA procedure
- Figure 10** – Impaired PA in patients with cerebellar lesions
- Figure 11** – Main results from neuro-imaging and neuro-stimulation studies in PA
- Figure 12** – Synthetic illustration of brain areas involved during Prism Adaptation
- Figure 13** – Spatial generalization of after-effects
- Figure 14** – Illustration of an inter-task transfer set-up
- Figure 15** – After-effects transfer to pointing movements with different velocity
- Figure 16** – After-effects transfer between two types of throws
- Figure 17** – Classical sets-up of PA procedure
- Figure 18** – Light bending through prism lens
- Figure 19** – Prismatic goggles
- Figure 20** – Basic PA procedure
- Figure 21** – PA procedure for testing inter-task transfer of after-effects
- Figure 22** – Illustrations of the tasks
- Figure 23** – Illustration of the complete PA procedure for inter-task transfer
- Figure 24** – Movements and processing events during a goal-directed reaching movement

Figure 25 – Position, velocity and acceleration profiles of the index during a pointing movement

Figure 26 – Analysis of pointing kinematics: trajectory orientations

Figure 27 – Illustration of the motion analysis set-up

Figure 28 – Influence of MI ability on the brain activations during MI

Figure 29 – Pointing task set-up for Motor Imagery

Figure 30 – tDCS montage for cathodal tDCS

Figure 31 – Illustration of the procedure for PA combined with tDCS

Figure 32 – Hypothetical relationships between multiple sensorimotor plasticity processes

Figure 33 – Schematic illustrations of the balance between multiple processes during sensorimotor adaptation

List of tables

Table 1 – Summary of outcomes from studies investigating after-effects transfer between two tasks in healthy subjects

List of abbreviations

CNS : Central Nervous System

PA : Prism Adaptation

MI : Motor Imagery

M1 : Primary Motor Cortex

PPC : Posterior Parietal Cortex

LTP : Long-Term Potentiation

LTD : Long-Term Depression

SRTT : Serial Reaction Time Task

PET : Positron Emission Tomography

fMRI : functional Magnetic Resonance Imaging

RSFC : Resting-State Functional Connectivity

TMS : Transcranial Magnetic Stimulation

tDCS : transcranial Direct Current Stimulation

TPA : Time at Acceleration Peak

TPV : Time at Velocity Peak

TPD : Time at Deceleration Peak

MIQ : Movement Imagery Questionnaire

MIQ-R : Movement Imagery Questionnaire Revised

KVIQ : Kinesthetic and Visual Imagery Questionnaire

EEG : Electroencephalogram

GABA : Gamma aminobutyric acid

NMDA : N-methyl-D-aspartate

MRS : Magnetic Resonance Spectroscopy

fNIRS : Functional Near-Infrared Spectroscopy

General introduction

A fundamental aspect of life is movement. Our capacity to move enables us to interact with the environment and to survive in. Moving is not just a convenience to walk or to play but a critical aspect of human evolutionary development (Schmidt et al., 2018). Breathing, feeding, reproducing, protecting oneself, communicating... All is a matter of movement. Movements can be separated in two major categories: movements that are genetically defined and identify a specie as such (for example walking, reflexes...) and those that are learnt by individual experience (i.e. performing a forehand stroke in tennis; Schmidt et al., 2018). A fascinating aspect of neurosciences research investigates how these various movements are controlled. The central nervous system (CNS) is organized in a way that over 600 muscles are coordinated to produce smooth and precise movements. To do so, the CNS integrates sensory information from the environment, the body, or both, to generate an estimation of the initial situation in view of the elaboration and execution of appropriate motor commands. Alternatively, the mental representation of movement may come from its own memory systems before being actually executed or just kept as a motor image. The CNS also controls the good execution of the elaborated movement and evaluates its consequences on the environment (Rossetti & Rode, 2016). Furthermore, when errors are detected during the execution of movement or when its consequences are not compatible with the expected ones due to unanticipated perturbations, the CNS sets up adaptive modifications that allow to regain movement accuracy. This capacity refers to the concept of adaptation (Prablanc et al., 2019).

From a biological perspective and in a technical sense, adaptation refers to the processes that allow biological organisms to be alive today, i.e. the physical and behavioural characteristics needed to survive and to procreate in their present environment (Smith, 1996). This definition relies on the evolutionary theory that describes adaptation as the functional adjustment of an organism to the environment, i.e. the modification of an anatomical characteristic, physiological process, or a behavioural capacity in a given population under the effect of natural selection: the novel state improves the survival and the reproductive success for individuals that carry it (Heams-Ogus, 2013).

More broadly, adaptation is a general term used in biology to describe the processes that turn an organism from one stable state to another when facing sustained modifications in their environment or the interplay with their environment (Prablanc et al., 2019), so as to maintain performance back to its optimal level. Therefore, the term adaptation covers all nervous system changes that allow to solve a conflict concerning relationships between sensory inputs and outputs to adopt a novel functional balance regarding the environment. Thus, unless it is precisely specified, the term adaptation becomes a particularly convenient notion to describe biological processes that are difficult to understand.

In the field of cognitive neurosciences and motor control, motor adaptation (or sensorimotor adaptation) is the process by which individuals change existing movements to face sustained perturbations arising from the environment or from their own body (Krakauer et al., 2019; Prablanc et al., 2019). For example, a tennis player who faces external perturbations, e.g. a strong wind, initially performs inaccurate forehand strokes even though this movement usually leads to successful outcomes. If the perturbation is sustained (i.e. if the wind persists), the player will gradually modify her initial and usual movement to integrate the wind conditions to regain her optimal accuracy. The player can also face internal perturbations, e.g. fatigue, that will disrupt her usual performance and require adaptive modifications. Hence, sensorimotor adaptation firstly refers to the changes that allow the movement to return to baseline levels of performance in the context of systematic errors (Krakauer et al., 2019). Interestingly, when the tennis player has adapted to the strong wind and the wind stops blowing abruptly, she will commit unsuccessful strokes again because her adapted visuomotor coordination will continue to compensate the wind although it has disappeared. These subsequent errors might appear even though the player consciously observes the absence of wind. In the field of sensorimotor adaptation studies, these compensatory errors are named after-effects, and constitute the experimental probe that an adaptation of the sensorimotor system occurred (Harris, 1963; Prablanc et al., 2019; Roemmich & Bastian, 2018).

Another aspect of sensorimotor transformations refers to the capacity to learn new movements. For example, when the tennis player had her first forehand lessons, her performance must have been initially variable and inaccurate. Gradually and through repetition, she probably reduced her miscalculations, and improved accuracy with more efficient and more stable postures and gestures. These progressive and slow changes lead to performance improvements that are better than baseline and can be referred to as a process of sensorimotor learning (Schmidt et al., 2018; Bastian, 2008).

Therefore, individuals can change existing movements or learn new ones when facing changing demands. Both processes are observable through changes in behaviour which are made possible due to the CNS capacity to modify its structural and functional connectivity within its different neural networks. This stupendous capacity is named plasticity or neuroplasticity (Zilles, 1992). Initially, neuroscientists described neuroplasticity as present solely in the developing brain during childhood (Doidge, 2007). Once the brain has finished its development, specific regions would be related to defined functions, and no more changes in neural connectivity would be conceivable. Starting from the early 1960's, small-scale research and case studies revealed that the developed brain is also "plastic" i.e. could be subjected to both structural and functional modifications (e.g. Merzenich et al., 1984). The evidence of such modifications based on experiences and activities represented a major breakthrough in the

field of cognitive neurosciences and lifted all hopes: the brain structures and functions can evolve throughout the lifespan. Crucially, neuroplasticity offers the possibility to change in any case, including following brain damages (Doidge, 2007).

Let us return to the processes of sensorimotor transformations – which can be named sensorimotor plasticity processes. While the capacity to modify and learn movements is fundamental in daily life for everyone, such processes are even more crucial for people suffering from a lesion in the sensorimotor system. Following a stroke, individuals showed major impairments related to motor capacities which impact considerably the quality of daily life. Neuroplasticity thus allows to set up adaptive transformations to regain the possibility to perform smooth and precise movements and to improve quality of life (Carey et al., 2019).

Processes of sensorimotor adaptation showed potential benefits in the field of neurorehabilitation. A remarkable example is the use of Prism Adaptation (PA; von Helmholtz, 1962) in neglect recovery (Rossetti et al., 1998; **Figure 1**). Unilateral spatial neglect is observed after a right brain lesion: patients do not perceive and investigate the right part of their visual field. Following adaptation to prisms goggles that displace the visual field laterally to the right, neglect patients showed after-effects and substantial improvements of neglect symptoms (Jacquin-Courtois et al., 2013).

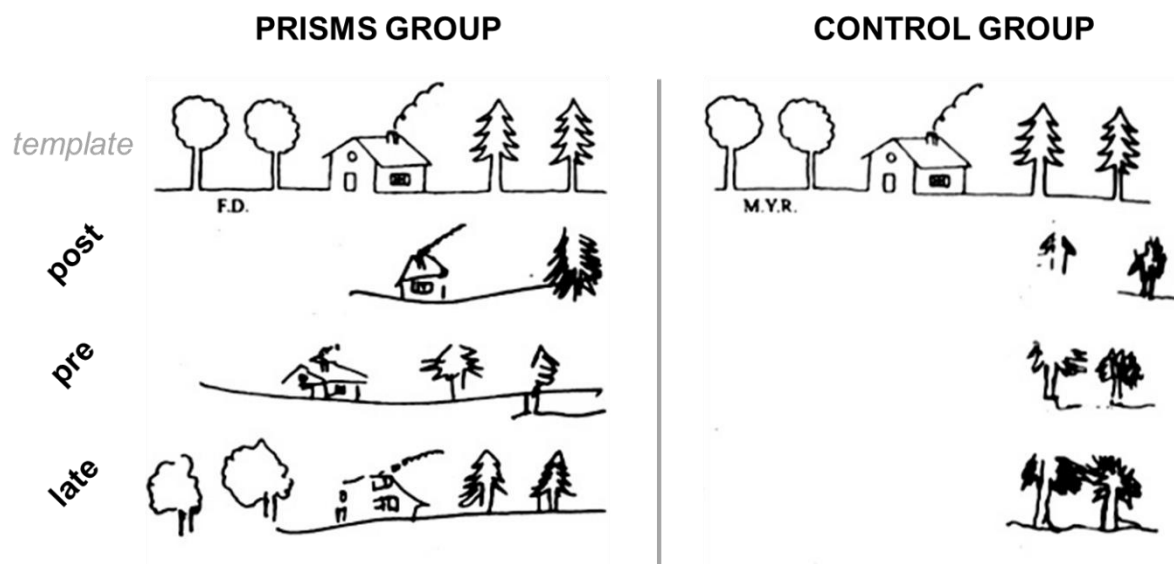

Figure 1 – Neglect symptoms improvement following Prism Adaptation. *Left: Drawing performance evolution following righthward PA for one representative neglect patient in the Prisms group (10° right prismatic goggles). Right: drawing performance evolution for a neglect patient in the Control group (exposure with neutral goggles). Adapted from Rossetti et al., 1998.*

Therefore, the after-effects that characterize adaptation processes may be beneficial for rehabilitation. A major advantage of therapies relying on adaptation processes is that practitioners can control the perturbation by manipulating environmental changes that drive adaptation. In addition, it is not necessary for individuals to think about how to correct their movements: adaptation is implicit and occurs beyond patients' consciousness (Roemmich & Bastian, 2018). However, the limited time course related to adaptation and its subsequent after-effects, which both occur in a short timescale, represents a major limit for induced benefits (Roemmich & Bastian, 2018). Substantial work aims to investigate how to produce sustained and long-lasting after-effects (e.g. Nijboer et al., 2011; Rode et al., 2015).

Another decisive aspect for neurorehabilitation is the necessity to favour transfer/generalization of adapted movements to different contexts or untrained movements. Let us envisage the possibility for a patient to apply sensorimotor modifications acquired during rehabilitation sessions onto all other daily life situations. The transfer/generalization of after-effects is not straight-forward and some studies showed that improvements of patients during therapies do not always lead to improvements in real life (Torres-Oviedo & Bastian, 2010). Thus, a crucial challenge is to understand how to solicit processes that lead to a generalization/transfer of after-effects from the context in which they were produced to other situations that were not experienced under the perturbation. This question will be central in the present work.

Nevertheless, it might be tough to disentangle between sensorimotor plasticity processes because both are behaviourally described as a practice-related change or improvement (Fleury et al., 2019). Additionally, both adaptation and learning are not unitary processes and should be composed by multiple mechanisms relying on different CNS structures (Roemmich & Bastian, 2018). Assuming that, isolating the contribution of these mechanisms might be even more difficult in individuals whose any brain structure is damaged. Finally, in any situation, it is likely that several motor transformation mechanisms are operating and that one process probably interacts with each other (Roemmich & Bastian, 2018; Spampinato & Celnik, 2020). In this context, transfer properties of each process might be an interesting and clinically relevant feature to disentangle between them (Censor, 2013; Redding & Wallace, 2006).

Sensorimotor adaptation and skill learning studies are promising for neurorehabilitation therapies. In turn, therapists look for inspirations and scientific justifications of their strategies in studies involving healthy participants. However, the loop between the two fields is not fluently and clearly constructed (Bastian, 2008; Roemmich & Bastian, 2018). Translational research or "bench-to-bedside" research describes a dynamical construct of scientific research built on

fundamental research in order to develop new therapies or rehabilitation procedures (Krueger et al., 2019). Nijboer et al. (2020) presented Prism Adaptation as a particularly interesting example of what they named *circular translational research*. Trends of neuroscientific research in neurorehabilitation led to important evidences showing the benefits of PA in neglect recovery. Another bulk of research investigated the fundamental aspects and neural bases of PA. Results from basic PA research in healthy control subsequently offered to improve rehabilitation. This thesis lies on the range of fundamental research aiming at understanding the mechanisms and neural bases of sensorimotor plasticity induced by PA through the notion of transfer.

Purpose of the thesis

The aim of the present work was is better understand the **sensorimotor plasticity processes** at work when facing a **prismatic perturbation**, and particularly those that give raise to the **transfer of after-effects**. We will consider such properties as a characteristic that might help to **uncover the contribution of distinct adaptive subprocesses**. Concurrently, our other main objective is to investigate which conditions are necessary to favour **transfer** and to explore the underlying **neural substrates**. Therefore, this thesis aims to pave the way for further investigations that will aim to improve and reinforce transfer of motor transformations acquired during rehabilitation.

The overall structure of the thesis takes the form of four main parts.

First, the **THEORETICAL BACKGROUND** will present the main principles of voluntary movement control and describe the existing sensorimotor plasticity processes. Then, it will focus on Prism Adaptation (PA) and discuss the current literature concerning after-effects transfer.

Second, the **METHODOLOGICAL BACKGROUND** part will present the methodological aspects of the thesis, i.e. relative to prism adaptation paradigm, kinematics analysis, motor imagery, and transcranial direct current stimulation.

Then, **EXPERIMENTAL CONTRIBUTIONS** will be presented into three axes:

- The **AXIS 1** will address the cross-transfer of prism-acquired after-effects between two distinct goal-directed tasks: throwing and pointing.

- The **AXIS 2** will investigate the role of motor execution and sensory feedbacks on the transfer by testing whether prism adaptation by motor imagery leads to transferable after-effects.
- The **AXIS 3** will explore the role of the cerebellum in the mechanisms of after-effects transfer between throwing and pointing using transcranial direct current stimulation.

Finally, a **GENERAL DISCUSSION** will debate the findings of all experimental contributions relatively to the existing literature and propose main conclusions emerging from this.

Chapter 1

Theoretical background

OVERVIEW OF THE CHAPTER

The topics of sensorimotor learning and sensorimotor adaptation have been largely investigated in the field of neurosciences, medical sciences, and sport sciences. The writing of the theoretical background relies on the willingness to review and present previous works that will allow the reader to better follow the experimental contributions. Assuming that, the following section is not exhaustive. The immense body of literature dealing with these two concepts led us to selective choices that were driven by a pragmatic approach focused on aspects that could be clinically relevant beyond the thesis.

Therefore, the theoretical background is constructed to evolve from general principles of motor control to the discussion of specific works dealing with transfer and generalization of prism-acquired after-effects. More precisely, the first section will present the main principles underlying voluntary movements control and sensorimotor plasticity processes driven by error signals. The second section will describe the concepts of learning and adaptation before focusing on adaptation paradigms. The third section will present processes operating during Prism Adaptation (PA) as well as the underlying neural substrates. A fourth section will discuss the concept of transfer and generalization of after-effects in PA studies. Finally, a synthesis of the theoretical background will be followed by the aims of the present work and the presentation of the experimental contributions' purposes.

A. GENERAL PRINCIPLES OF SENSORIMOTOR CONTROL

The only way humans can interact with their environment and survive is to move. While growing, individuals acquire the capacity to perform an infinity range of movements, thanks to over 600 muscles acting together and controlled by the central nervous system (CNS). Controlling the musculoskeletal system to produce accurate and efficient movements is highly complex and solicit numerous cortical, sub-cortical, brainstem and spinal structures (Schmidt et al., 2018). Firstly, human beings perform several types of movement which require different neural structures to be executed and controlled. Here, we will focus on voluntary movements, which refer to goal-directed actions chosen properly by the individual. Voluntary movements are under a conscious nervous control, at least when initiated but are also mostly controlled by automated processes (Schmidt et al., 2018).

1. Elaboration of motor command in voluntary movements

The execution of a movement, for example reaching an apple, is preceded by several mental operations needed to prepare the motor command, both under the control of several cortical and sub-cortical structures (Collet, 2002). First, the aim of the voluntary movement (e. g. reaching the apple) is driven by a deliberate choice to act, i.e. an intention (Collet, 2002). To produce an appropriate motor command to achieve the formulated objective, the individual needs to appreciate the initial internal and external conditions. Posterior Parietal Cortex (PPC) areas integrate numerous sensory information issuing from several sensorial modalities (i.e. proprioceptive, visual, auditory, etc.) to evaluate and provide a whole representation of the current environmental (e.g. location of the target) and body conditions (e.g. location of the hand, see Hwang & Shadmehr, 2005). The location of the target generally mostly relies on visual information while the hand location requires to integrate visual and proprioceptive information (Rossetti et al., 1995). Multisensory integration provides a more reliable estimation of hand location (Desmurget, 1998; van Beers et al., 1996; van Beers et al., 1999). Estimations of hand and target location are transmitted to the frontal cortex and a behaviour in conceived, also involving basal ganglia. Then, the premotor area and the supplementary motor area establish the necessary motor program, i.e. specify movement parameters (i.e. muscles, amplitude and durations of contractions, coordination, etc.). The cerebellum also plays a role in movement programming. Finally, the motor command is transmitted to the motoneurons in the anterior horn of the spinal cord from the primary motor cortex (Purves & Coquery, 2002). The cerebellum receives a copy of this motor command, which is called corollary discharge or efference copy (Person, 2019).

2. Insights from Motor Imagery

Elaborating a specific motor command implies a mental representation of the movement goal together with representations of means (i.e. actions) to achieve it. Although these representations remain implicit most of the time, they could become explicitly established, thus leading to Motor Imagery (MI). This corresponds to the mental representation of an action without any concomitant execution (Denis, 1985). MI implies mental operations involved in the motor command elaboration with an inhibition of the execution.

Since Jeannerod (1994; 2001) and Decety (1994), it has been extensively reported that MI shared common neural functional activations with motor execution (for reviews, see Guillot et al., 2012; Lotze & Halsband, 2006; **Figure 2**). Numerous cortical regions have been reported to be active during MI such as the supplementary motor area, the premotor cortex (Dechent et al., 2004; Deiber et al., 1998; Gao et al., 2011; Gerardin et al., 2000; Lotze et al., 1999; Roth et al., 1996; Solodkin et al., 2004), the dorsolateral prefrontal cortex (Hanakawa et al., 2003; Malouin et al., 2003), and the parietal cortex (e.g. Dechent et al., 2004; Iseki et al., 2008; Macuga & Frey, 2012; Naito et al., 2002). Notably, the primary motor cortex (M1) seems also activated during MI (e.g. Guillot et al., 2009) although such findings have been controversial (see Héту et al., 2013 for a review). Furthermore, M1 activations during MI may follow the somatotopic organisation that characterizes the execution of actual movements (Ehrsson et al., 2003; Stippich et al., 2002; Szameitat et al., 2007). Besides, subcortical areas involved in actual movement preparation are also activated during MI such as the cingular cortex (Simos et al., 2017), the cerebellum (e.g. Burianová et al., 2013; Decety et al., 1990; Guillot et al., 2008, 2009; Hanakawa et al., 2008; Lacourse et al., 2005; Lotze et al., 1999; Macuga & Frey, 2012; Naito et al., 2002; Solodkin et al., 2004) and the basal ganglia (e.g. Gerardin et al., 2000; Hanakawa et al., 2003).

Although a clear neuro-equivalence between physical practice and MI has been shown, activations intensity during MI are substantially lower by 30 to 50% than during physical practice (Lotze & Halsband, 2006). Notwithstanding these differences, the study of MI processes provides an original way to access to movement cognition, i.e. preparation phases of the motor command such as planning and programming, while disregarding sensory and motor information related to its actual execution. In fact, actual execution provides feedback information allowing each individual to evaluate how it goes as well as its consequences.

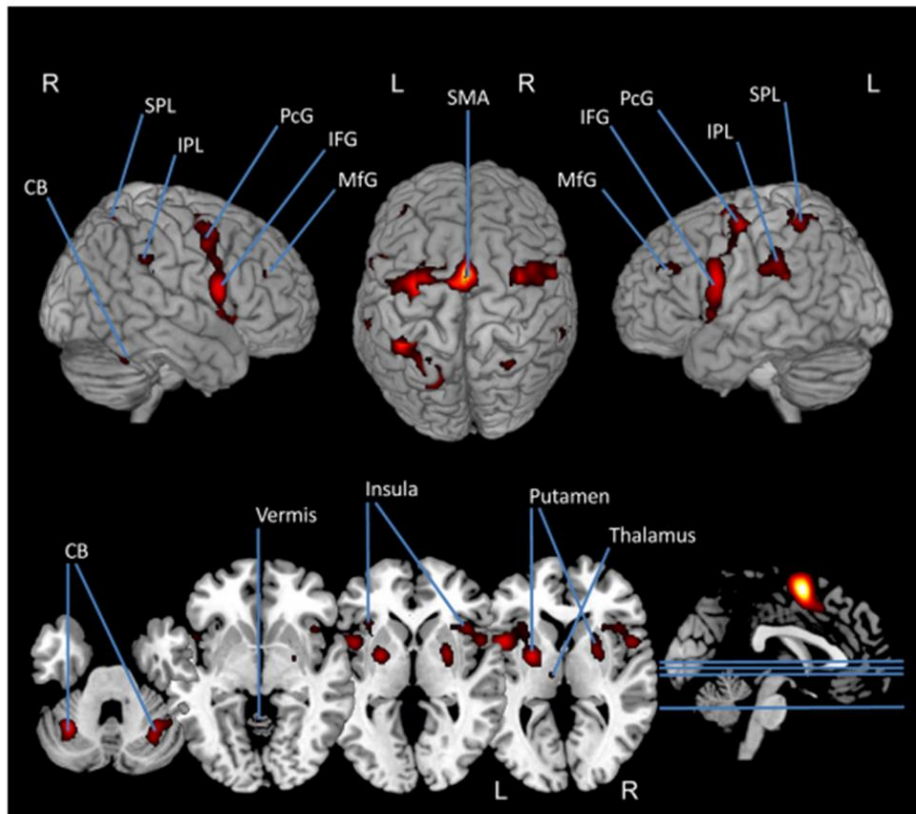

Figure 2 – Brain regions activated during Motor Imagery (from Héту et al., 2013). The map results from an ALE (Activation Likelihood Estimation) meta-analysis using data from 75 papers, conducted by Héту et al. (2013). MI consistently recruits a large fronto-parietal network in addition to subcortical and cerebellar regions. Therefore, MI network includes several regions known to play a role during actual motor execution. Notably, the primary motor cortex was not shown to be consistently activated. CB: cerebellum; IPL/SPL: inferior and superior parietal lobule; PcG: precentral gyrus; IFG: inferior frontal gyrus; MfG: middle frontal gyrus, SMA supplementary motor area.

3. Movement evaluation and its consequences: the role of internal models

After movement initiation, unexpected perturbation could occur and alter the execution of the selected motor command. Assuming that the duration of the movement is long enough, the CNS can detect “online” perturbations and adjust movement programming during its execution in response to these perturbations. Such mechanisms of online control refer to feedback control or retroactive control (Collet et al., 2002). To ensure this control, the CNS relies on the processing of sensory information (e.g. visual, proprioceptive, tactile feedbacks) arriving from sensory receptors in the periphery. A major issue is the time needed to process feedbacks during movement execution because of delays inherent in their transport by the nerves and their processing by the CNS. Then, the sensory feedbacks are noisy and delayed: information processed by the CNS at a certain instant would be related to past events (Therrien & Bastian, 2019). Another issue comes with movement execution evaluation: the relationship between the motor command and the resulting movement is dependent on the initial effector positions. For these reasons, online control relying solely on actual sensory feedback during execution would lead to poor motor control and result in inaccurate outcomes. This particularly concerns

ballistic (i.e. very fast) movements whose duration is lower than the needed time for online sensory feedbacks integration. Therefore, it is necessary to resort to anticipated or feedforward movement control, i.e. before its initiation. This type of control relies on the possibility to predict movement consequences both on the body and on the environment, given the initial state of the motor system and the environment.

The CNS is able to produce estimates about our own body's state as well as the external world. This information arises from internal models that can be specified into two categories: the inverse and the forward model (Kawato, 1999; Miall & Wolpert, 1996; Wolpert et al., 1995; **Figure 3**). Internal models represent a computational framework for motor control requirements by providing neural representations of input-output sensorimotor relationships, or their inverse (Kawato, 1999; Popa & Ebner, 2018).

Schematically, the inverse model allows to transform a desired behavioural goal (e.g. to grasp an apple) into an appropriate motor command needed for its execution, e.g. specifying the adequate motor program necessary to effectively grasp the apple. Working on the opposite direction, the forward model predicts the consequences of the elaborated motor command. Its output corresponds to the predicted feedbacks and depends mainly on the previous representation of our own body and the environment. When our brain generates a motor command, the forward model receives a copy of this motor command (or efference copy) and is able to predict the sensory consequences of the upcoming action, even when the actual sensory feedbacks are not yet available at movement onset. Thus, the forward model can make fast movement corrections prior to and in the early phase of execution.

Hence, combining inverse and forward models theoretically allows the CNS to carry out a desired action such as arm reaching and to accurately control the unfolding of the reach (Kawato, 1999). Predicted consequences are then compared with the actual consequences of the action, and both are integrated together to get up-to-date estimates of body-world interactions. The discrepancy between actual and predicted feedbacks, i.e. "prediction error", acts as an error signal triggering adaptive processes. In order to ensure accuracy of motor control, internal models need to be constantly updated (Popa & Ebner, 2018; Therrien & Bastian, 2019).

Therefore, the movement is controlled and evaluated both before and during its execution, respectively referring to feedforward and feedback control. Sensory feedback control also provides an *after execution* evaluation, by determining whether the movement achieved its objective or not. If the movement was unsuccessful, sensory feedbacks provide information related to the difference between initially targeted and actually performed movement. Crucially, generating sensory predictions of the upcoming movement, processing prediction errors and

consequently updating the internal models are both functions endorsed by the cerebellum (Popa & Ebner, 2018; Therrien & Bastian, 2019; Tseng et al., 2007).

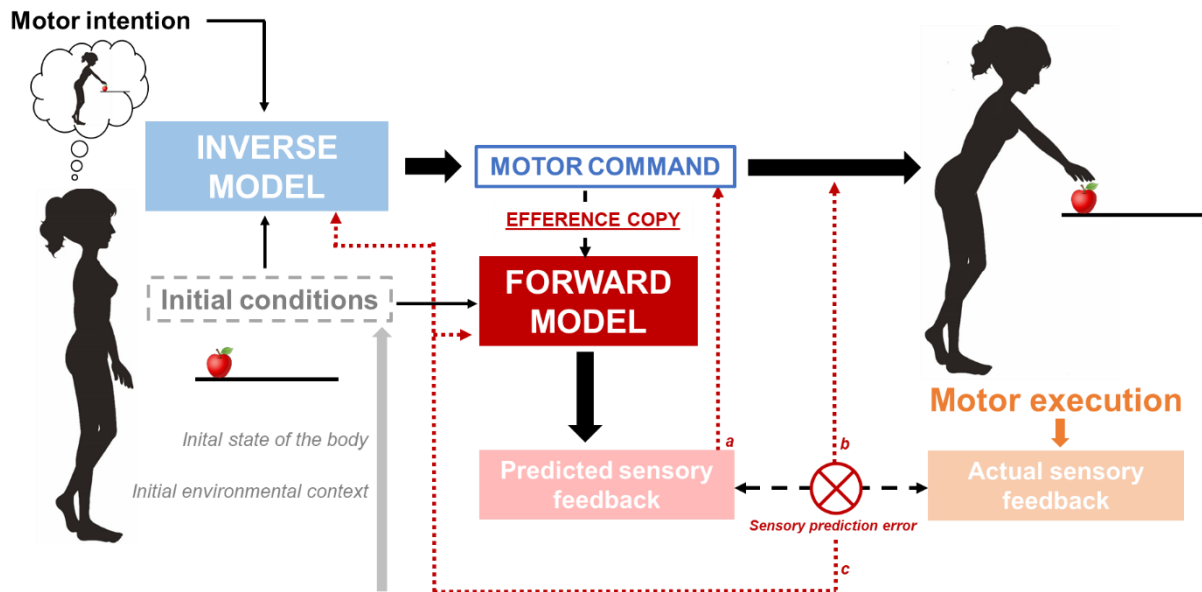

Figure 3 – Schematics of the internal models. The inverse model receives the motor intention (i.e. to goal to achieve) and generates the appropriate motor command regarding the initial conditions of the motor system and the environment. The forward model receives as inputs a copy of the motor command (efference copy) and information regarding the initial conditions of the body and the environment. By integrating these two inputs, the forward model generates predictions about the sensory consequences of the upcoming movement. These predicted sensory feedback allows to produce a feedforward control (i.e. before its execution) of the upcoming action (a). Upon movement onset, predicted sensory feedbacks are compared to actual sensory feedbacks. If a mismatch is detected (sensory prediction error), corrective signals can be applied during motor execution, provided that the movement is sufficiently long (b). Finally, sensory prediction errors could trigger updating of both the forward and the inverse model to maintain their accuracy (c).

4. Error signals in action

Altogether, the systems of control described above enable the detection of inadequacies between expected and achieved movement and provide error signals that could trigger adaptive processes. Error signals can be either external or internal errors. External errors refer to feedback errors between the external explicit goal of the movement (e.g. the aimed target) and the effector (e.g. the reaching arm) and are mostly provided by visual feedbacks (Prablanc et al., 2019). External errors can refer to explicit knowledge of movement outcomes. The knowledge of result is the information about the outcome of a movement in relation to its initial goal. The knowledge of performance is the information concerning the nature of movement that has been used to achieve the initial goal. Both are explicit, i.e. can be verbalized.

Conversely, internal errors refer to the implicit differences between expected and actual sensory feedbacks, i.e. sensory prediction errors we previously mentioned. Internal errors cannot be consciously detected. Both external and internal errors can be either dynamic (i.e.

available during the movement) or static (available at the start or at the end of the movement; Gaveau et al., 2014, 2018; Prablanc et al., 2019).

Experiencing sustained and repeated errors could trigger the need for modifying and adjusting motor commands and/or internal models, so that the movement can be successful again. Both internal and external errors play a crucial role in modifying existing behaviour or learning new ones. The adaptive processes that allow such behavioural transformations are underlied by structural and functional changes in the CNS, referring to neuroplasticity.

5. Neural plasticity underlying sensorimotor transformations

The CNS plasticity refers to its capacity to modulate and reorganize its own functional and/or structural state in response to extrinsic or intrinsic factors (Zilles, 1992). This capacity relates to the fact that structure and connectivity of the neural tissue are highly modifiable. Performing new actions leads to an activity-dependent plasticity, arising at multiple levels. At the neuronal level, changes in synaptic gain (i.e. the strength of the pre-synaptic structure to stimulate the post-synaptic membrane) and synaptogenesis (i.e. creation of novel synapses) occur but also alterations of local connections among distinct population of neurons. At the level of the CNS, plasticity also occurs itself at a topographic level by changes in the spatiotemporal pattern of activity of different brain region (e.g. reorganization of motor representation in the primary motor cortex). With repetition, the nervous system translates new knowledge into long lasting plastic changes that lead to the formation of memories (Della-Maggiore et al., 2015).

In addition, neuroplasticity can occur at varying timescales, ranging from few seconds to months or years. Short-term plasticity leads to rapid and transient modifications: in brief, synapses that have just been activated, show a transient increased strength following their activation due to alterations of calcium concentrations (Purves & Coquery, 2002). Other forms of plasticity lead to more persistent changes. Long-term potentiation (LTP) refers to a long-term increase of connections strength. Another process known as long-term depression (LTD) weaken other set of synapses, so the LTP can be a specific and efficient mechanism, i.e. all synapses cannot be strengthened simultaneously. LTP and LTD are related to neuronal mechanisms of neurotransmitter liberation in pre-synaptic termination, modification of the number or the sensitivity of post-synaptic receptors, or addition/removal of synapses in the neural circuits. These processes are the bases of changing behaviour or learning new original behaviour.

Therefore, neuroplasticity describes functional and structural changes that enable the CNS to maintain accuracy and smoothness of movements despite varying demands. At the behavioural level, sensorimotor plasticity processes can be described by the evolution of motor performances across varying situations and through practice repetition. Such processes,

triggered by error signals, are necessary to change existing movements and adjust behaviour to the environment, but also to learn new motor pattern that did not previously exist. Interestingly, motor imagery training has also been reported to elicit neural plasticity. Sensorimotor integration during motor imagery also leads to functional and structural changes in the CNS, indicating that motor preparation without concomitant execution stimulates activity-dependent plasticity (Di Rienzo et al., 2016; Ruffino et al., 2017, for reviews).

Synthesis

This general section presented the basic principles of motor control and plasticity of the CNS that allow to set up adaptive processes when sensorimotor transformations are needed. Internal or external errors signals, drive processes of motor transformations. Based on error signals, individuals are able to change existing movements or to learn new motor patterns. Such processes are possible thanks to the neuroplasticity, i.e. the capacity of the CNS to change its structure and functional properties. We also emphasized that motor imagery is a cognitive process that shares neural substrates with actual movements and has the ability to elicit plasticity through operations of motor preparation without actual execution.

In the next section, we will describe the processes of sensorimotor plasticity with reference to adaptation and learning. After defining both processes and presenting the main methods used for studying movements learning, the section will deeply focus on adaptation paradigms.

B. SENSORIMOTOR PLASTICITY PROCESSES: LEARNING AND ADAPTATION

The previous section presented the principles of control and regulation of voluntary movements. One outstanding faculty of the human beings is to maintain movement accuracy and smoothness even when facing changing conditions in the body (e.g. fatigue) or in the environment (e.g. a windy weather, wearing glasses, etc). Furthermore, individuals are also capable of acquiring new movements that did not previously belong in their genetic background (e.g. learning to ride a bicycle). Although observable in everyday life, such capacities still exert fascination. Their investigation is of high relevance particularly when looking for motor expertise (i.e. sports, music, etc) but especially when considering motor recovery (i.e. physical therapies, neurorehabilitation; Schmidt et al., 2018). In the two last decades, several reviews aimed at classifying and defining these adaptive processes used various concepts, e.g. *sensorimotor learning*, *motor adaptation* (Bastian, 2008; Kitago & Krakauer, 2013; Krakauer et al., 2019; Krakauer & Mazzoni, 2011; Roemmich & Bastian, 2018), *motor learning* (Bastian, 2008; Krakauer et al., 2019; Krakauer & Mazzoni, 2011; Schmidt et al., 2018), *skill learning* (Kitago & Krakauer, 2013; Krakauer & Mazzoni, 2011; Makino et al., 2016), *skill acquisition* (Kitago & Krakauer, 2013; Krakauer et al., 2019), *sensory perceptual learning* (Bedford, 1993; Makino et al., 2016), *sensorimotor associative learning* (Makino et al., 2016), etc. Despite the use of varying definitions, reviews converge towards two main concepts “adaptation” and “learning”, probably because these are easy to use with detailed explanations. Unfortunately, these terms are often used interchangeably without any precision.

1. Broad definitions of learning and adaptation

A practical and simple approach was suggested by Bastian (2008). Adaptation can be loosely defined as *the modification of a movement from trial-to-trial based on error feedback*. To fit the definition of adaptation, the movement maintains its identify as a specific action (e.g. “reaching”) but changes in terms of one or more parameters (e.g. direction, or amplitude), i.e. movement planning is kept but programming is adjusted to the changing conditions. In addition, the author indicated that this change occurs with repetition or training and is gradual over minutes to hours. Once adapted, individuals cannot retrieve prior behaviour immediately and show “after-effects” which are the “hallmark” of adaptation. They cannot simply switch back to the original behaviour and must de-adapt actively before going back to the original form.

On the other hand, motor learning refers to *the formation of a new motor pattern that occurs via long term practice*. This process includes the storing of new movement patterns, immediately available in the appropriate context. Individuals are thus capable of storing many learnt motor patterns allowing efficient switching from one to another. These characteristics may imply differences related to the context specificity of elicited transformations. In fact, the consequences of adaptation should apply to different movements as an adjustment of the sensorimotor system to new conditions. Thus, it would not be limited to the conditions experimented during exposure to the perturbation but should be extended beyond. Conversely, learning would be highly contextualized. Therefore, learning would not extend to other experimental conditions, as long as these conditions are different from those experienced during the learning session (e.g. smash in tennis should not interfere with the ability to ride a bicycle, see Fleury et al., 2019).

Glossary box – Adaptation and Learning

Adaptation is an error-driven process that modifies a movement through repetition in response to an external or internal perturbation. The presence of **after-effects** once the perturbation is removed is the hallmark of adaptation.

Learning is the formation of a new motor pattern and occurs via long-term practice. This process could be observed through the reduction of movement errors and variability and the stabilization of motor performance. Once it is learnt, the new motor pattern is immediately available.

Processes of adaptation and learning are potentially dependent. Repeated adaptation can lead to learn new motor calibration that will be stored and directly available when facing the perturbation (Martin et al., 1996a). Conversely, as motor adaptation changes current movements for new requirements, thus learnt movements can be adapted to changing conditions (Della-Maggiore et al., 2015). However, we do not know how these processes may interact, for example whether a movement in the process of learning (which takes longer time) can be subjected to the process of adaptation. Therefore, the two concepts might be confusing.

These basic definitions help to practically describe the broad range of sensorimotor plasticity processes at work when individuals face new requirements or changing conditions. Notably, several authors use “skill learning” or “skill acquisition” to describe the construction of a new motor pattern. “Motor learning” (or sensorimotor learning) is believed to encompass motor adaptation and skill learning (e.g. Krakauer et al., 2019; Kitago, 2013). In addition, skill learning is also related to *de novo learning*, recently proposed by Krakauer et al. (2019) or Telgen et al., (2014). Noticeably, explicit (i.e. conscious, strategic) and implicit (i.e. unconscious,

automatic) components are thus considered to be present in both learning and adaptation (Krakauer et al., 2019).

2. Studying sensorimotor plasticity processes in laboratory

The present section aims to discuss paradigms investigating adaptation and learning in laboratory. Firstly, an overview of paradigms studying the learning of new movements will be depicted, i.e. motor sequence learning, *de novo* learning, and motor skill acquisition through changes in motor accuracy (Krakauer et al., 2019). Then, the section will focus more deeply on motor adaptation paradigms, describing changes in existing movements in response to perturbations.

a. *Acquisition of a new motor pattern: learning*

Incremental acquisition of movements has been extensively studied through Motor Sequence Learning (MSL). This refers to the way in which a given set of actions is planned to achieve a task. The set of actions might be either a series of discrete movements (e.g. the series of actions required to peel an apple) or continuous and overlapping set of events within a single movement (i.e. the sequential muscles activations necessary to perform a sport skill such as an ice-skating spin; Krakauer et al., 2019). Sequence learning investigates the learning of a proper order of discrete sequential actions such that each is selected rapidly and executed accurately. The sequence elements themselves can be simple and over-learned, such as pressing buttons on a keyboard. The most classical paradigm used in (implicit) sequence learning is the Serial Reaction Time Task (SRTT; e.g. Robertson, 2007; **Figure 4**). In this task, participants perform movements in response to stimuli cueing the required response. The stimuli appear in a particular order that follows a specific fixed or random sequence and corresponds to the required order of movement responses. These responses are often simple movements for example finger presses on buttons. The required sequence order is not explicitly available for participants which remain unaware of the whole sequence although they exhibit performance improvements (Krakauer et al., 2019).

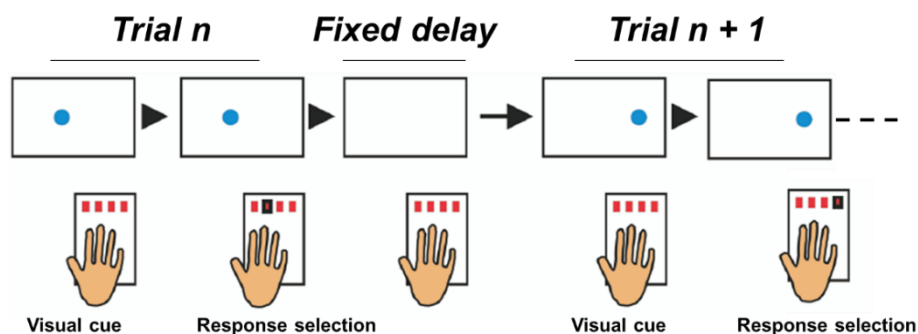

Figure 4 – Serial Reaction Time Task paradigm. A visual cue appears on the screen, and the participant selects the appropriate response button. Then, the visual cue disappears. After a fixed delay, another visual cue appears, etc. The number of correct answers and the reaction times are the usual variables of interest. Adapted from Robertson, 2007.

SRTT paradigms emphasize the exploration of action selection processes over action execution. In fact, sequence learning relates to the association of pre-existing set of actions. However, the acquisition of a new motor skill often requires learning new ways to respond to sensory inputs by means of an appropriately selected action suggesting the necessity to learn a novel feedback control policy. For example, when learning a tennis backhand for the first time, no previous resembling motor patterns can be used or organized to produce coordination necessary to hit the ball properly. *De novo* learning paradigms explore how the CNS learns entirely new movements (Krakauer et al., 2019). An example of *de novo* learning of arbitrary continuous skill is the mirror-reversal task that inverses the visual field across a mirroring axis (Telgen et al., 2014). Participants respond correctly to such constraints when they have enough time. However, when time to respond is reduced, participants do not act accurately in response to the mirror-reversal. This suggests that participants rely on a highly cognitive component to achieve the task which needs a new control policy (Krakauer et al., 2019).

Sequence learning and *de novo* learning paradigms explore how the CNS can build a new action responding to task constraints. A last body of work investigates how an action, when selected, can be more accurately executed through practice. These studies explore the execution component of motor learning, which can be assessed by task success of kinematics aspects, speed, accuracy, smoothness, etc. Studies of motor accuracy have been mostly conducted in animal with prehension and grasping task (e.g. Allred et al., 2008; Nudo et al., 1996). However, studies on humans remain rare. In the field of neurorehabilitation, most therapies are based on instructions, i.e. teaching or explicating patients how to perform movements to improve accuracy (Roemmich & Bastian, 2018) .

The above-mentioned paradigms showed elementary models to understand how new movements are learnt. All processes seem to rely on highly cognitive components needed to learn a new control policy to respond to a particular task context (Krakauer et al., 2019; McDougle et al., 2016). Therefore, new movement patterns might be appropriate to this specific context and probably less applicable in other situations. For example, *de novo* learning is not associated with after-effects in comparison to adaptation processes. Although learning is used in rehabilitation purposes through instruction-based therapy to learn new movements and to improve accuracy (Roemmich & Bastian, 2018), the following section will highlight why motor adaptation may offer substantial advantages.

b. Adaptation paradigms

Motor adaptation encompasses the adjustment of an automated movement to maintain performance responsively to changes in the body or the environment (Harris, 1965; Krakauer et al., 2019; Prablanc et al., 2019). This refers to modifications of the current action, or the

selection of an alternative action. In both cases, the goal of action remains unchanged, and, crucially, after-effects are observable once the perturbation is removed. Consequently, using motor adaptation in rehabilitation therapies shows clear benefits: practitioners can manipulate and control environmental changes driving adaptation, and adaptation occurs beyond patients conscious behaviour (Roemmich & Bastian, 2018).

In the laboratory, motor adaptation has been extensively studied through different paradigms which impose an external perturbation. Some paradigms used a visual perturbation. One of the oldest is wearing prism goggles that laterally shift the visual field (Redding et al., 2005; von Helmholtz, 1962). When participants attempt to reach a target, they initially experience pointing errors in the direction of the prismatic shift (i.e. in the direction of the prism-displaced image of the target). The pointing error is gradually reduced through trials repetition and performance regain baseline. Another commonly used visual perturbation is visuomotor rotation (Prablanc et al., 1975). Participants perform reaching movements where the index position is coupled with that of a cursor displayed on a screen. The relationship between the cursor and the hand positions is manipulated by means of clockwise or anticlockwise rotation of the moving hand visual feedbacks (Krakauer et al., 2000; Krakauer, 2009). Besides visuomotor perturbations, other common paradigms imposed dynamical perturbations. In Coriolis force-field experiments, participants sit on a rotating chair and perform goal-directed movements (Coello et al., 1996; Lackner & Dizio, 1994; Lackner & DiZio, 2002, 2005). In velocity-dependent force-field experiments, participants perform goal directed movements while manipulating a robotic arm that applies dynamic forces of the moving limb (Shadmehr & Mussa-Ivaldi, 1994). Several other paradigms, e.g. saccadic adaptation (Pélisson et al., 2010), target jump approach (Inoue & Kitazawa, 2018), gait adaptation (Reisman et al., 2010) have also been used. However, our analysis will be focused on common adaptation paradigms involving goal-directed voluntary movements (**Figure 5**).

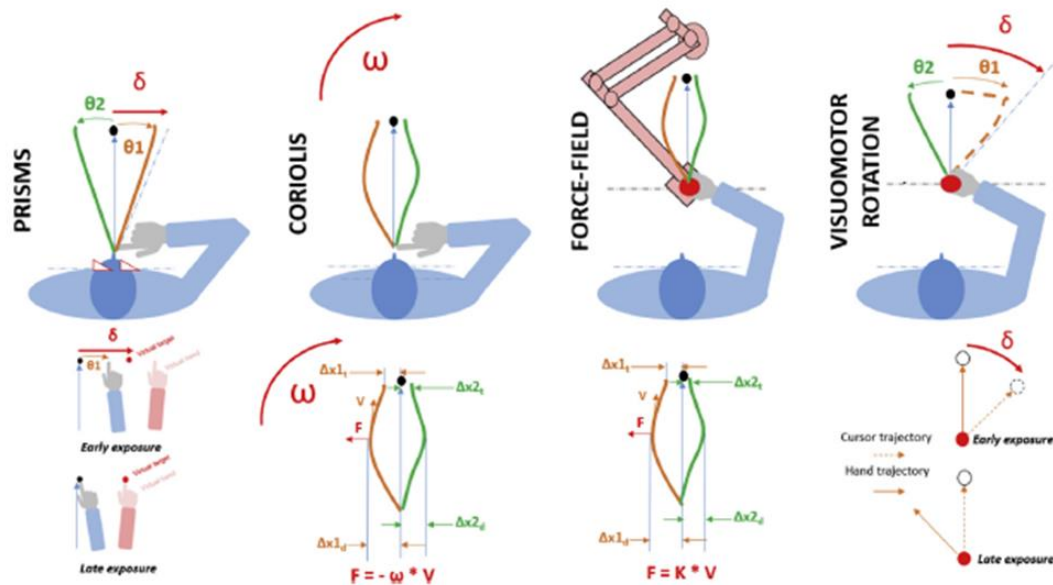

Figure 5 – Illustrations of the different type of perturbation in adaptation paradigms. From Fleury et al., 2019. Illustration of the different types of perturbation and the observed movement errors. Movement errors during exposure are represented in orange and after-effects are represented in green. 1: Prisms: prismatic lenses laterally deviate the visual field (i.e., both hand and target) by an optical shift (δ) while subject performs reaching movement (e.g., pointing). Virtual hand and virtual target (below) correspond to the images of hand and target seen through the prisms. θ_1 : initial error on first trials in the direction of the optical field. θ_2 : after-effects observed in the opposite direction (prisms removed). 2. Coriolis forces: inertial forces (F) are applied on the moving arm while subject performs reaching movement in a rotation environment. ω is the angular rotation of the chair and V is the velocity of the moving hand. First reaching under perturbation is deviated to the direction opposite to the rotation. After-effects are a mirror image of initial deviation. Δx_{1t} and Δx_{2t} : terminal errors respectively during initial trials of rotation and post-rotation phase. Δx_{1d} and Δx_{2d} : dynamic errors respectively during initial trials of rotation and during post rotation phase. 3: Force-field: a robotic manipulandum applies arm velocity-dependent orthogonal forces. Δx_{1t} and Δx_{2t} : terminal errors respectively during initial trials of force-field on and when the field is turned off (catch trials). Δx_{1d} and Δx_{2d} : dynamic error respectively during force-field on and when the field is turned off (catch trials). 4. Visuomotor rotations: a computer interface alters the relationship between hand movement and on screen displayed cursor during reaching movement by imposing a clockwise rotation of 45° . θ_1 : feedback error observed on the screen during the first trials of exposure (rotated by δ). θ_2 : after-effects: hand movement are deviated in the direction opposite to the rotation. Illustration of hand trajectory versus cursor trajectory (below). Note that subjects only see trajectories displayed on the screen, i.e., cursor trajectories.

All these paradigms study how previously existing motor controllers are adjusted to regain baseline performances in the context of errors induced by external perturbations. Similar features are common to these paradigms. They all induce error-based improvements which are thought to be driven by sensory predictions error: in both visuomotor (i.e. prisms, visuomotor rotation) and dynamical (i.e. force-field, Coriolis forces) paradigms, expected sensory consequences initially differ from actual consequences of movement, although the sensory modality initially perturbed varies across paradigms. Moreover, such error-based adaptation was reported to be cerebellum-dependent (Krakauer et al., 2019). Behavioural responses also present some similarities: when facing the perturbation, participants show similar error reduction curves (rapid then gradual decrease of errors). When the perturbation is removed, participants globally exhibit after-effects across all paradigms (Fleury et al., 2019; Krakauer et al., 2019; Prablanc et al., 2019). In addition, processes at work in adaptation

paradigms involve two components (**Figure 6**). A fast process would be responsible of rapid corrections of movement errors during early adaptation but would be associated with a poor retention (i.e. little after-effects). A slow process would then take place gradually in a second phase and lead to a stronger retention once the perturbation is removed (Krakauer et al., 2019; Smith et al., 2006). Therefore, the fast process allows error reduction in the very first trials but saturates rapidly while the slow process contribution is highly related to long-term retention (Joiner & Smith, 2008; Yin & Kitazawa, 2001) and the amplitude of after-effects (Inoue et al., 2015).

Another distinction describes explicit and implicit adaptive components. The explicit strategy would drive the fast error correction when exposure started while the implicit process would mainly contribute to after-effects and would probably be based on sensory prediction errors (Mazzoni & Krakauer, 2006; Shadmehr et al., 2010; Taylor et al., 2014a; Taylor & Ivry, 2012; Tseng et al., 2007) or on visuo-proprioceptive conflict (Redding et al., 2005). The explicit component would be related to cognitive components observed during learning *de novo* movements (Krakauer et al., 2019). In addition, McDougle showed that the slow/fast distinction can refer to the explicit/implicit difference (McDougle et al., 2015).

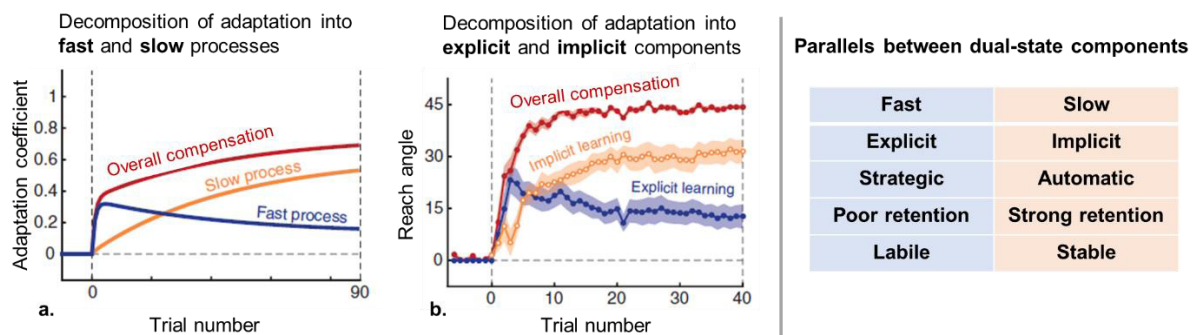

Figure 6 – Two components in adaptation. *Left: illustration of the decomposition of adaptation into fast versus slow (a) and explicit versus implicit components (adapted from Krakauer et al., 2019). Right: parallels between dual-state components reported in adaptation paradigms. The fast process can be related to an explicit and strategic component that learns and forgets rapidly. The slow process can be associated with an implicit and automatic component that takes longer time to act and that is more stable.*

A closer investigation comparing adaptation paradigms reveals that the contribution of both processes might be different depending on the perturbation. Indeed, as developed below, specific methodological aspects suggest that explicit components might better contribute in some paradigms than other (see Fleury et al., 2019, for details).

One source of differences relates to the application of the perturbation, notably its mechanical and/or visual interface. Lackner and Dizio (2005) compared the effect of inertial (Coriolis) and mechanical (force-field) perturbations. They reported that the mechanical contact on the reaching arm brought a crucial difference between the two paradigms. During force-field experiments, the robotic manipulandum locally applied the perturbation on the moving arm and

was an external interface. Conversely, Coriolis forces were globally applied without external contact. There are similar differences in visual perturbations paradigms: prismatic lenses laterally deviate the visual field without external contact on the reaching arm, while in visuomotor rotation paradigms, participants generally hold an instrument to reach the target. A related substantial distinction concerns the visual feedbacks during the perturbation. In most force-field and visuomotor rotation experiments, participants indirectly perceive their moving arm as a virtual cursor on a computer screen. Conversely, in Coriolis and prism paradigms, the participants have direct visual feedbacks of their moving arm. Norris et al. (2001) compared prism adaptation (PA) procedures with visual feedback of the hand versus its symbolic representation displayed on a screen (video and cursor). Results revealed that the abstract representation of the hand elicited lower after-effects. In addition, transfer of after-effects induced by exposure with the direct view to other conditions (video and cursor views) was considerable whereas after-effects induced by video and cursor view did not transfer to the direct view (**Figure 7**). Taken together, these results emphasize the importance of the way in which the perturbation is applied during exposure.

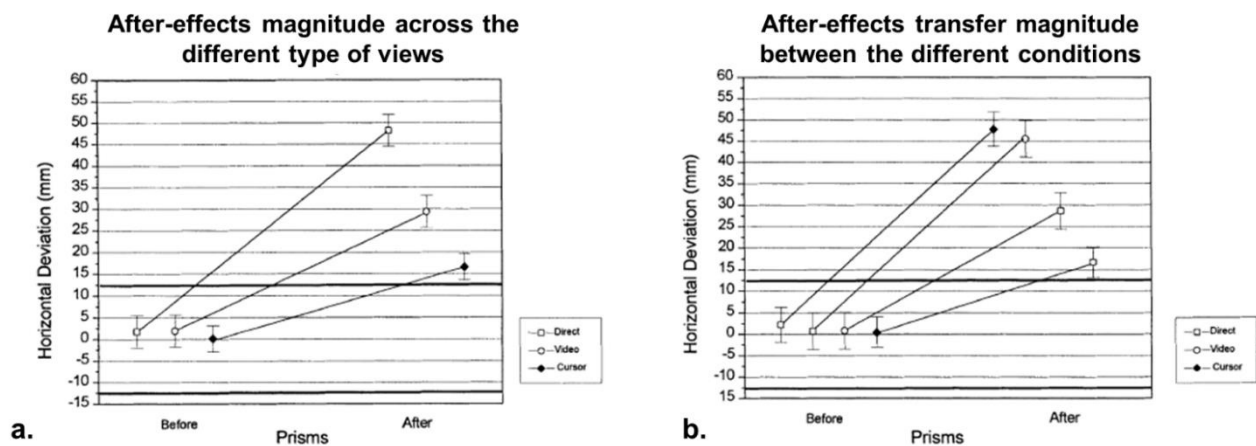

Figure 7 – After-effects magnitude and transfer to other feedback viewing conditions. *a. Horizontal deviations (with standard errors) before and after prism exposure with a direct, video or cursor view. b. After-effects transfer from prism exposure with a direct view to a cursor and a video view; from a video view to a direct view; and from a cursor view to a direct view. Adapted from Norris et al., 2001.*

Considering these differences, another methodological question deserves particular attention: how would the after-effect change if the contact with the manipulandum is cancelled while keeping the same movement? Most after-effects, when present, may result from the learning of the interface properties rather than a sensorimotor adaptation (Cothros et al., 2006; Kluzik et al., 2008). Conversely, in PA, after-effects remain comparable when assessed with sham prisms or when the prisms are removed (Michel, Pisella, et al., 2003). This observation underlines dissimilarities in after-effects assessment procedures across paradigms.

After-effects are typically assessed through sustainable compensations once the perturbation has been removed (Krakauer, 2009; Prablanc et al., 2019; Redding et al., 2005; Shadmehr et al., 2010). However, procedures employed to assess after-effects crucially vary among existing paradigms. During force-field experiments, the perturbation is suddenly removed on selected “catch trials” (i.e. the forces are turned off). Consequently, the movement path is deviated in the opposite direction relatively to initial errors. This procedure quantifies the lateral forces the participants apply on the manipulandum. This reflects adaptive compensations of expected lateral forces imposed by the robot and provides a measure of immediate after-effects. However, participants feel the force offset because they are not deprived of visual feedbacks. Therefore, comparison of open loop decay of after-effects with other paradigms is challenging. “Error-clamp” trials allow limiting the availability of visual feedback: during selected trials, forces are turned off and movement paths are constrained by novel forces to remain strictly straight toward the target, and it is rarely acknowledged that this may introduce variability and cognitive strategies. Thus, participants do not experience lateral errors while the manipulandum still records the lateral forces they apply (Smith et al., 2006). The crucial point is not only that the perturbation is not explicitly removed but also that after-effects are assessed on the same apparatus than during exposure, i.e. while participants are still holding the manipulandum. Due to differences in assessment procedures, after-effects do not refer to the same probe of adaptation.

These differences in the perturbation application among adaptation paradigms might influence the way the CNS interprets the experienced errors. Numerous potential factors may lead to movement errors. The CNS can attribute experienced errors to either internal or external causes. This process refers to the solving of a credit assignment problem (Wilke et al., 2013). The attribution of errors to external versus internal causes may influence the kind of processes involved during adaptation and the generalization properties associated. For example, if errors are attributed to change in limb properties (i.e. internal cause), modifications appear to generalize across the workspace but not across limbs. In addition, updating forward internal models to face perturbation is closely dependent on the attribution of prediction errors to internal causes (Wei & Körding, 2009). The credit assignment problem depends on the awareness of the perturbation. If the perturbation is consciously perceived, errors should be attributed to the external environment or a misrepresentation of the action (Berniker & Körding, 2011b). Therefore, modifications of the movement will be strongly associated with the initial context. By contrast, when awareness of the perturbation is absent, the CNS likely interprets errors as a result of its own variability (Fleury et al., 2019).

Given these disparities related to perturbation application and their consequences on the attribution of errors, the nature of processes involved may be different across paradigms as

shown by the difference between after-effects yet assessed with the same procedures. The extent to which after-effects can be found beyond exposure context also probes that contribution of adaptive processes is probably related to the paradigm used (Lackner & DiZio, 2005; **Figure 8**). This refers to transfer/generalization that will be specifically discussed in section D of the present theoretical background. For instance, after-effects, arising from exposure to velocity-dependent force-field, are poorly transferred to free-space and natural hand movements (Cothros et al., 2006; Kluzik et al., 2008) and remain strongly dependent on the context of exposure. Similarly, visuomotor rotation leads to a poor generalization of after-effects across multiple directions. For example, after training to a single direction, after-effects dropped off by a very large ratio when aiming at 45° apart from the learned direction (Krakauer, 2009). Conversely, after-effects in PA was substantially generalized beyond the exposure conditions, for example to other types of task such as goal-oriented walking task (Michel et al., 2008). Therefore, transfer and generalization properties could be a useful feature to understand which processes are at work in adaptation.

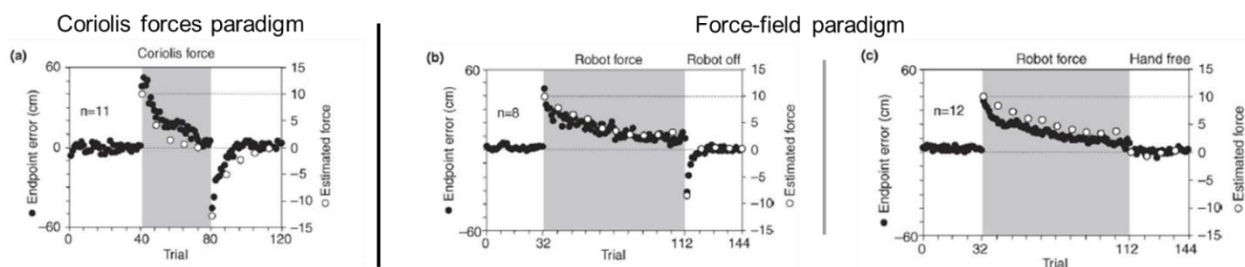

Figure 8 – Comparison between Coriolis forces and robotic force-field paradigms. *Left: following exposure to Coriolis forces (grey), participants showed consequent after-effects (white, trials 80 to 120). Right: following exposure to robotic force-field, after-effects were consequent when assessed on the robot with forces off (b) but became null when measured through hand free movements (c). Adapted from Lackner & Dizio (2005).*

Adaptation must be identified by robust and context-independent after-effects (Redding et al., 2005). Indeed, a reduction of errors without after-effects implies a compensation through strategic rather than adaptive mechanisms (Kluzik et al., 2008). Although generalization and transfer considerably depend on specific exposure conditions, body-centered perturbations applied without any movement interface (e.g. prisms) may facilitate self-attribution of errors. Consequently, compensating for such perturbations leads to after-effects, possibly transferable to other tasks, reflecting a broad contribution of context-independent adaptation. Conversely, mechanical contacts on the reaching arm and/or an interface are likely to favour the attribution of errors to external causes and lead to a major contribution of contextual learning processes.

Comparison between adaptation paradigms revealed the key role of the conditions of perturbation application and suggested that the nature of after-effects and their generalization properties provide substantial information about the contribution of adaptive processes. Prisms

induce visuomotor errors in a natural range and in a way providing direct visual feedbacks. PA procedures allow the assessment of after-effects outside the exposure context (i.e. prisms removing) and their transfer to other conditions, not experienced during exposure (i.e. other tasks). Moreover, PA already works in rehabilitation of neglect and after-effects showed substantial transfer to conditions differing from initial exposure conditions. Therefore, this paradigm appears particularly relevant in studying the contribution of multiple processes during sensorimotor adaptation through the assessment of robust after-effects and their transfer.

Synthesis

Learning and adaptation are common words describing sensorimotor plasticity processes. Sequence learning and learning *de novo* paradigms allow to study how new movements patterns are learnt through cognitive processes. Motor adaptation, as the modification of current movements, involves multiple components (i.e. fast versus slow, explicit versus implicit) and has been extensively studied through the application of dynamical and visuo-motor perturbations. Comparisons between adaptation paradigms reveals that they might not exactly involve the same processes depending on the way the application is applied. Generalization properties provided crucial information regarding the processes at work when facing a perturbation and might represent a discriminant feature to uncover the contribution of distinct processes. PA provides a body-centered and biologically plausible visuomotor perturbation favouring self-attribution of errors. Moreover, PA elicits after-effects that are possibly transferred beyond the context of exposure. PA thus represents a relevant paradigm to study generalization and transfer of after-effects and offers the conditions to induce a transferable adaptation.

The next part of the theoretical background will detail PA procedures. We will thus describe the processes at work during PA, and their neural correlates.

C. PRISM ADAPTATION

1. Typical experimental procedures

During standard PA procedures (von Helmholtz, 1962; Köhlerl, 1951; Held & Freedman, 1963; Harris, 1965; Kornheiser, 1976; Jacquin-Courtois et al., 2013; Petit et al., 2017; Prablanc et al., 2019; Redding et al., 2005; Rode et al; 2015, for detailed descriptions), participants perform several visuomotor tasks. The most classical task used is goal-directed pointing, although some studies involved other visuomotor tasks, e.g. throwing (Martin et al., 1996b, 1996b). Basic procedures usually include three distinct phases (**Figure 9**):

First, **pre-tests** measure participants' baseline performance. Individuals perform open loop pointing movements, i.e. with no visual feedback of their movement and its outcome. Pre-tests allow to measure a potential physiological deviation.

The second phase is **prism exposure** where participants attempt to point at a target while wearing prism goggles. Prisms lenses laterally shift the target in a direction determined by prisms structure (e.g. 10° rightward). This optical deviation leads to pointing errors in the same direction as the prismatic shift. If visual feedback is available, participants gradually reduce their errors and regain baseline performances through trial-by-trial repetitions. In this case, performance follows a typical exponential error reduction curve.

The third phase is made by **post-tests**. Open loop pointing movements are repeated under the same conditions as in the pre-test. The difference of pointing performance between the pre and the post-tests provides a measure of after-effects, occurring in the opposite direction as compared to exposure. Typically, after-effects are assessed after removing of prism lenses.

Glossary box – PA procedure terminology

Baseline refers to the initial performances on a given motor task. Baseline is assessed during pre-tests before any exposure to the perturbation and provides a reference taking into account any physiological initial deviation.

Error reduction refers to the decrease of terminal errors during prism exposure and reflects the compensations set up when facing the visual shift. In a typical PA procedure, error reduction follows a classic exponential learning curve: errors are quickly reduced in a first time and then gradually, until participants regain baseline performances.

After-effects refer to performance changes between pre-tests and post-tests and provide a measure of the remaining trace of adaptation once the perturbation is removed. After-effects are the hallmark of sensorimotor adaptation.

While open loop pointing provides a measure of the “total” shift after exposure, both proprioceptive and visual straight-ahead tests measure the proprioceptive and the visual shifts respectively (Templeton et al., 1974; Kornheiser, 1976; Welch, 1986; Redding et al., 2005). In the proprioceptive straight-ahead condition, participants are in the dark and are requested to point in the direction of an imaginary line splitting their body into two equal parts. In the visual straight-ahead test, they look at a led moving on a horizontal rail in the dark, in front of them and are requested to indicate when they perceive the led right in front of them. The sum of proprioceptive and visual shift is equivalent to the amount of total shift (Rode et al., 2015). Interestingly, if visual feedbacks are available during post-tests (i.e. closed-loop pointing), performance errors will be rapidly corrected to regain baseline accuracy. The suppression of visual feedback (i.e. open loop pointing) allows to limit this de-adaptation (Held & Gottlieb, 1958).

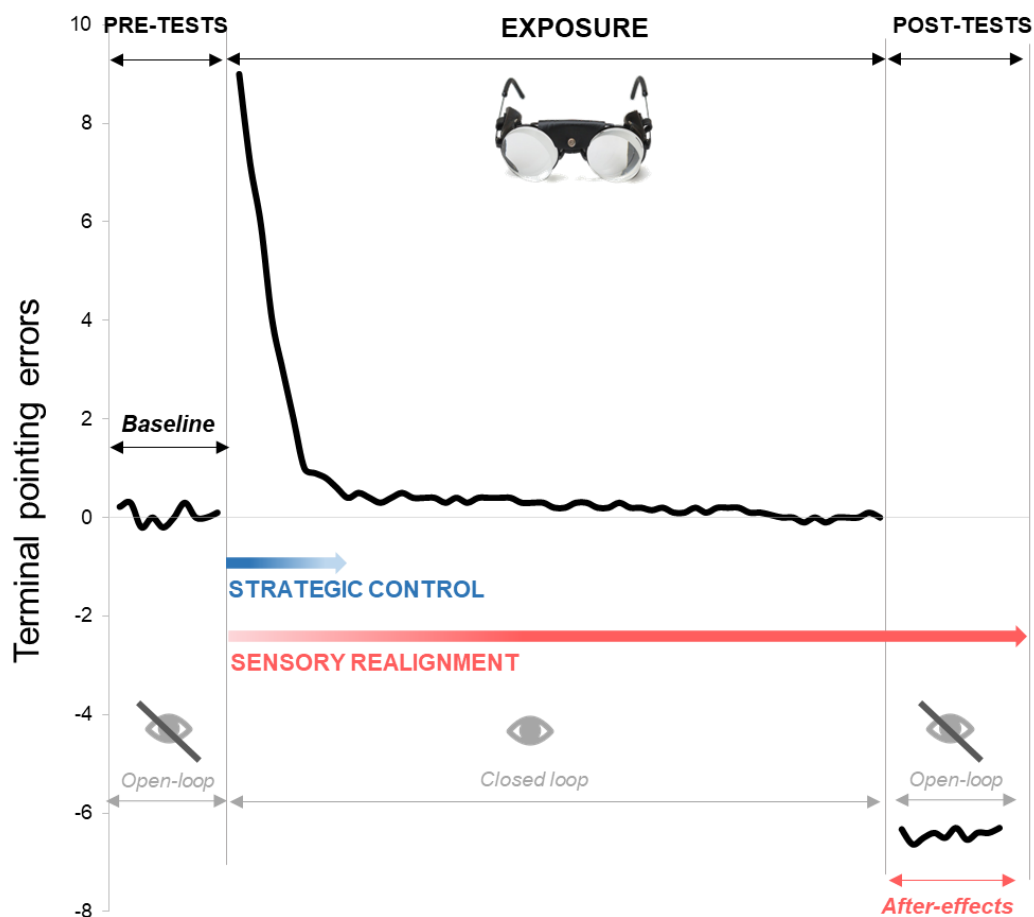

Figure 9 – Classical PA procedure. The figure illustrates the three distinct phases: pre-tests and post-tests that are measured in open loop conditions and exposure, under closed loop conditions. The general evolution of terminal pointing errors during the three phases is plotted. Meanwhile, the figure shows the contribution of the two classically described components of PA: strategic control, accounting for rapid error reduction, and sensory realignment responsible for the presence of after-effects.

2. What drives and influences prism adaptation?

Many error signals are available during prism exposure and drive adaptation (Gaveau, Pisella, et al., 2014; Gaveau et al., 2018a). External errors (or explicit feedback errors) are between the hand and the target location. This signal could be either dynamic (i.e. angle between the perceived hand and the direction of the seen target) or terminal (distance between hand endpoint and target). On the other hand, internal errors refer to the sensory prediction errors that have been described in a previous section (A-1). Sensory prediction errors are the implicit difference between expected feedbacks (visual and proprioceptive) and actually perceived feedbacks. Another source of internal errors relates to the inadequacy between visual and proprioceptive information (Kornheiser, 1976), which is difficult to disentangle from prediction errors. External and internal errors can be either initial (arising from the static starting position of the hand), dynamical (arising from the moving hand), or terminal (detected upon final movement) depending on visual feedbacks availability during exposure. Both types of errors play a role in prism adaptation, although these might condition the processes involved. Experimental factors strongly influence the error types. Interestingly, external errors (i.e. conscious detection of errors) are not required to trigger adaptation (Gaveau et al., 2018).

Numerous experimental conditions can impact the modality, magnitude, and persistence of both direct and after-effects of prism adaptation (Petitet et al., 2017; Redding et al., 2005). Seeing the starting position of the limb and getting visual feedbacks during exposure are factors of great importance. Concurrent exposure requires visual feedbacks during the whole movement and provides both dynamical and terminal errors (Prablanc et al., 2019). Conversely, only the terminal part of the movement and the distal part of the moving hand are visible during terminal exposure. Initial errors tend to decrease more rapidly under concurrent exposure. However, both types of exposure lead to significant after-effects, even though rehabilitative effects of PA in neglect patients vary as a function of visual feedback availability (Facchin et al., 2019; Fortis et al., 2010; Làdavas et al., 2011). The type of exposure also influences the modality of after-effects (Redding & Wallace, 1996, 2001). During concurrent exposure, both visual and proprioceptive information is available during reaching, whereas proprioceptive after-effects appear to be stronger than visual after-effects. In contrast, during terminal exposure, visual information is not available throughout the entire movement, and participants show stronger visual after-effects compared with proprioceptive ones (Redding & Wallace, 1988). This suggests that the modality in which the discrepancy between the predicted and observed hand location likely determines which coordinates reference frame is preferentially realigned. The directionality-of-guidance hypothesis proposed by Redding and Wallace (1985) suggests that one modality is being “guided” by the other, depending on exposure conditions, e.g. concurrent exposure allows the participants to visually orient their

arm toward the target. Consequently, proprioception is “guided” by vision and the realignment mostly occurs in the proprioceptive system. Conversely, during terminal exposure, vision is guided by proprioception as visual information is not available during the movement. Therefore, realignment mainly takes place in the visual system.

Although the starting position of the hand is hidden most time during terminal exposure, visual feedback of the hand before movement initiation could be available during concurrent exposure (Prablanc et al., 2019). When participants perceive their hand before pointing, the prismatic shift has no direct effect: there is no final error even in the first trial (Redding & Wallace, 1996, 1997, 2001). This is explained by the computation of a visuo-visual vector guiding the hand from its initial location to the visual goal. Redding & Wallace (2001) did not report any after-effects when participants perceived the entire movement path. However, both direct and after-effects occurred only when the starting and target positions were visible. Noticeably, after-effects were mostly influenced by visual feedback availability, independently of limb starting position viewing (Redding & Wallace, 2001). In addition, some studies showed after-effects even with visibility of the whole path, including the starting position of the hand (e.g. Michel et al., 2013). However, in most studies, visual feedbacks of the hand are prevented by hiding its starting position (e.g. by a chinrest) although proprioceptive feedback remain available. Furthermore, direct and after-effects are not closely related: direct effects can be observed without any after-effects and vice versa (Redding et al., 2005).

Another crucial aspect of PA is the introduction of the prismatic shift during exposure. Interestingly, after-effects are stronger when awareness of the visual displacement is prevented, i.e. in the absence of external errors (Michel, et al., 2003; Michel et al., 2007). The multiple-step procedure allows to progressively apply the full optical deviation through stepwise increases from no-shift to the complete optical shift (e.g. two by two degrees from 0° to 10°). Thus, participants do not consciously experience errors and remain unaware of the prismatic deviation (Michel et al., 2007; Panico, Sagliano, Nozzolillo, et al., 2018; Prablanc et al., 2019). Interestingly, Michel et al. (2013) reported that PA through motor imagery led to significant after-effects. In this study, some of the participants were exposed to the prismatic deviation while imagining pointing movements without concomitant action. Importantly, they perceived their hand during exposure, thus experiencing an intersensory conflict without any sensorimotor conflict, as the hand was not moving. This was likely to elicit after-effects measured by open loop pointing and suggested that actual reaching movements and associated sensory feedbacks were not essential to trigger adaptation.

As shown above, many factors have significant effect on both direct and after-effects. Despite its apparent simplicity, the PA paradigm involves multiple processes whose contribution might depend on the experimental conditions.

3. Processes operating during PA

The literature classically describes two processes at work during PA (Harris, 1965; Kornheiser, 1976; Held & Gottlieb, 1958; Weiner et al., 1983). Several models are consistent with the distinction between a fast-strategic component and a slow 'true' sensorimotor realignment component. These processes would contribute differently to the direct and after-effects (Redding et al., 2005; Redding & Wallace, 2002).

a. Strategic control

Strategic components of motor control guide our daily behaviour. When reaching a target or catching an object, the CNS use available sensory information to code the object location (e.g. visual and proprioceptive). Setting the appropriate reference frame according to the desired reach-to-grasp action is the 'calibration' process (Petitet et al., 2017; Prablanc et al., 2019; Redding et al., 2005; Redding & Wallace, 2002). Strategic control is related to spatial attention as also requires selection of task relevant regions of extra-personal space (i.e. the spatial support where the object is located). When the reaching command is unsuccessful, the next action needs to be "recalibrated". During PA, strategic control (or recalibration) allows the fast reduction of movement errors at the beginning of exposure. For example, when subjects miss the target in the very first trials under the prismatic perturbation, they would more or less consciously aim at the side of the target on the next trial to reduce the previous motor error. This cognitively demanding process is associated with a poor contribution to after-effects.

Strategic control does not reconfigure the different coordinate frames (i.e. proprioceptive-motor and visual-motor). Changes in motor programming for the next trials would quickly reduce motor errors. To illustrate this idea, Petitet et al. (2017) reported the commonly used analogy of the rifleman with a misaligned telescopic sight. If the scope of the rifle is misaligned with the barrel (e.g. by a couple of degrees on the right), the marksman would miss the target systematically. Re-aiming intentionally by the same amplitude on the left would make the marksman hitting the target without the need to realign the scope with the barrel. Strategic control, referring to a quick recalibration of the reference frame according to the movement goal, would rapidly lead to successful movement. Therefore, recalibrated movements should be specific to the trained context and should not generalize to another (e.g. other movement or other spatial locations). Strategic control mainly contributes to the early phase of prism exposure. Redding et al. (1992) described behavioural markers of this process, by reporting that a concomitant cognitive load imposed during prism exposure (e.g. by mental arithmetic

tasks) disrupted participants' ability to reduce pointing errors. Another marker relates to the time gaps between target foveation and the onset of the pointing. During the early phase of exposure, pointing errors are large and time gaps increase transiently until going back to baseline values after almost 10 trials (Rossetti et al., 1993). O'Shea et al., (2014) reported rapid trial-by-trial corrections of the initial direction of pointing during the first 10 trials of exposure. Altogether, fast cognitive allocation quickly reduces errors by re-aiming the motor command.

b. Spatial realignment

By contrast, "spatial realignment" (or sensory realignment) contributes mainly to after-effects. This automatic process reduces the mismatch between the eye-head visual motor system and head-hand proprioceptive motor system (Redding et al. 2005, Redding and Wallace 2002). The prismatic deviation elicits a discordance between the visual and the proprioceptive reference frames. Realignment aims at counteracting the perturbation by shifting the visual-motor and/or the proprioceptive motor system. The re-organisation of these two coordinate frames allows to regain hand-eye coordination accounting for the perturbation. With reference to the telescopic sight, it would refer to realigning the barrel with the rifle scope. A putative kinematic signature of this process is the gradual correction of the terminal (deceleration phase) pointing trajectory. This correction appears slowly during prism exposure and the magnitude of subsequent after-effects correlated with the magnitude of this correction (O'shea et al., 2014).

Several studies reported that conscious detection of endpoint errors is not necessary for sensory realignment. In fact, after-effects occurred even without any measurable endpoint errors as this the case in multiple-step PA, or in PA through motor imagery (Gaveau et al., 2014; Hanajima et al., 2015; Michel et al., 2007, 2013; Panico et al., 2018). Thus, we can study realignment without the interfering contribution of recalibration because participants remain unaware of prism deviation (Prablanc et al., 2019). Realignment is implicit and automatic by nature: during late exposure, when performance is back to baseline there is an overcompensation of the prisms effect (i.e. errors in the opposite direction from the initial deviation) which supposes additive effects of recalibration and realignment (Redding et al., 2005). Triggering these adaptive changes came from the discrepancy between the expected and observed position of the hand, i.e. sensory prediction errors (Redding et al., 2005).

Distinguishing the specific contribution of strategic recalibration and spatial realignment is not easy. O'shea et al. (2014) observed that each type of compensation could be assessed through kinematic patterns change during prism exposure. Thus, analysis of movement trajectories may offer additional information about processes at work. Manipulating exposure

conditions can also differentiate the contribution of each process (e.g. by using multiple-step exposure). Another method relies on the manipulation of post-tests conditions, i.e. the similarity between exposure and post-tests conditions. Indeed, Redding et al. (2006) showed that both recalibration and realignment can be generalized beyond the exposure conditions but in different ways. The first would depend upon similarity between exposure and post-tests conditions while the second would work under any conditions provided that exposed references frames (i.e. proprioceptive-motor and visual-motor) are still involved (Redding & Wallace, 2006). Generalization and transfer of after-effects in PA will be further discussed in the next section (Section D). The distinction between processes through their generalization properties is the main key aspects of the current thesis.

Glossary box – Strategic Control and Sensory Realignment

Strategic control or recalibration refers to the compensatory modifications of the motor commands to quickly reduce the terminal error by using explicit information from the previous trial. This includes conscious strategies such as pointing-off target voluntarily.

Sensory realignment or spatial realignment corresponds to the re-coordination of the visuomotor and the proprioceptive motor frames whose concordance has been disrupted by the prism deviation. This slower process is triggered by a mismatch between predicted and actual sensory consequences and account for after-effects.

“True” adaptation refers to the process of sensory realignment and is evidenced by the presence of after-effects. The term “true” is used to emphasize that compensating for errors during exposure should not be considered as adaptation unless it is associated with presence of after-effects. This accentuates the fact that the term adaptation might be confusing.

4. Neural substrates of PA

Within this theoretical dual framework, numerous studies have attempted to describe the neural correlates of PA (for review, see Roger Newport & Schenk, 2012; Panico et al., 2020; Petit et al., 2017; Striemer & Danckert, 2010). Studies related to brain lesions, neuro-imaging, and non-invasive brain stimulations are the three main methods that shed light on brain regions involved during prism adaptation.

a. Lesions studies

Classical studies report behavioural impairments of PA in individuals or animals suffering from specific CNS lesions. They usually associate the functional role of damaged structures with specific components of PA, i.e. error reduction during exposure and after-effects. Using Redding and Wallace’s framework, impairments in error reduction would reflect compromised

strategic control abilities while reduction or absence of after-effects would reflect a deficit of sensory realignment (Panico et al., 2020). The first study in the field is the work of Weiner et al. (1983, **Figure 10**), who explored PA components in about sixty patients with varying neurological conditions (e.g. cerebellar dysfunctions, Parkinson's and Alzheimer's diseases, cerebral hemispheres lesions, etc). Although this study suffered from the heterogeneity among patient groups, it pioneered numerous subsequent lesions studies in humans.

It has been extensively reported that cerebellar damage impaired error reduction as well as after-effects both in Humans (Hanajima et al., 2015; Martin et al., 1996b; Morton & Bastian, 2004; Pisella et al., 2005; Weiner et al., 1983) and non-Human primates (Baizer et al., 1999). However, Baizer et al. (1999) reported normal error reduction and normal after-effects in macaque monkeys with spared cerebellar caudal parts. Fernandez-Ruiz et al. (2007) observed decreased error reduction but normal after-effects in patients with spinocerebellar type 2 ataxia, suggesting that neural areas of sensory realignment are intact in this type of ataxia. Calzolari et al. (2015) found preserved reduction of errors during prism exposure but impaired after-effects in a patient with a bilateral occipital lesion and left lateral cerebellar damage. Taken together, these studies support the potential role of the cerebellum in sensory realignment but also in strategic control or on-line control as error reduction was at least partially impaired in patients with cerebellar damage. However, lesion studies did not evidence the contribution of specific cerebellum areas as impaired after-effects have been reported after anterior (Calzolari et al., 2015; Pisella et al., 2005) and posterior (Baizer et al., 1999; Martin et al., 1996b) cerebellar lesions.

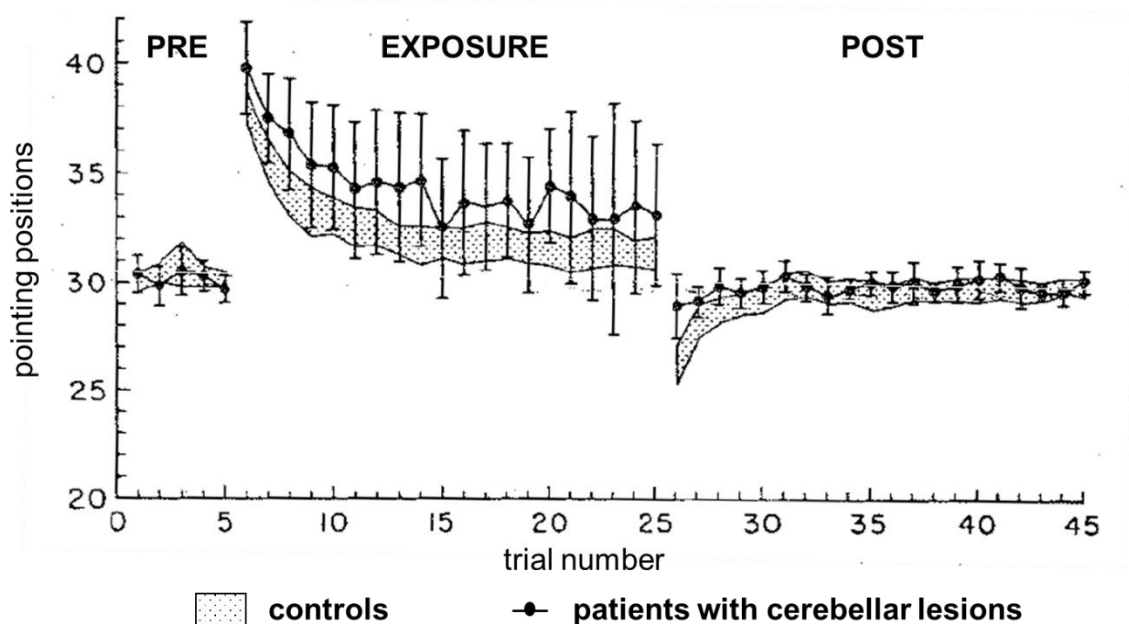

Figure 10 – Impaired PA in patients with cerebellar lesions. The graph shows pointing performance during a PA procedure. Patients with cerebellar lesions demonstrated impaired error reduction and no after-effect. Adapted from Weiner et al., 1983.

Besides, patient studies ascribed a role of the posterior parietal cortex (PPC) in error reduction (Petitet et al., 2017). In a case study, Pisella et al., (2004) reported impaired error reduction but intact after-effects in a patient with a bilateral optic ataxia (bilateral PPC lesion). In two case studies, Newport et al. (2006) found impaired error reduction but slightly divergent results concerning after-effects in a patient with a bilateral damage to the PPC. First, they reported no after-effects in the patient despite having performed four times more trials than in healthy adults (Newport et al., 2006). Authors argued that the contribution of the PPC in strategic control was necessary for realignment, i.e. that spatial discrepancy between gaze direction and reach direction would provide the required error signal for the cerebellum to trigger realignment. In the second study, they reported partial after-effects in the same patient. The patient did not reduce pointing errors with his right hand but showed normal after-effects (Newport & Jackson, 2006). However, he reduced errors with his left hand but did not show any after-effects with this hand. Considering these results, PPC may not be necessary for successful adaptation to prisms (i.e. after-effects) but plays a key role in strategic recalibration. Additional studies investigated other brain regions damage and supported the crucial involvement of the cerebral cortex in strategic control but with no evidence related to sensory realignment (Aimola et al., 2012; Canavan et al., 1990; Weiner et al., 1983). Besides, patients with Parkinson disease showed normal error reduction but impaired after-effects (Fernandez-Ruiz et al., 2003; Stern et al., 1988). In a recent study, Striemer et al. (2019) reported completely preserved error reduction and normal after-effects in a patient who was blind to static stimuli due to bilateral lesions of the occipital cortex and caudal areas of the ventrotemporal cortex. This outcome suggested that visual inputs from the geniculostriate pathway were not necessary for PA.

Studies of patient with CNS lesions provided crucial information about the neural substrates of PA notably by demonstrating impaired error reduction and after-effects in patients with cerebellar damage and impaired error reduction but spared after-effects in patients with PPC lesions. Subsequently, neuro-imaging studies allowed to explore complex networks involved brain areas in healthy subjects during PA.

b. Neuro-imaging studies

Neuro-imaging methods outlined the neural mechanisms of PA by systematically contrasting the amplitude of neural activity in specific brain regions in the “early” vs “late” phase of prism exposure. Such contrasts highlighted neural correlates of strategic control (active areas during early but not late exposure) and realignment (active areas during late versus early exposure, see Panico et al., 2020; Petitet et al., 2017).

Clower et al. (1996) first recorded brain activity during prism exposure by Positron Emission Tomography (PET). They used reversing prism glasses and the optical deviation was reversed

every 4 trials. Following this procedure, participants remained in a state of ongoing reduction of errors, so that prism exposure mainly solicited strategic control processes¹. Results showed a correlation between activations of the contralateral posterior parietal cortex to the exposed arm and pointing performance. No activation of other brain areas was reported. Danckert et al. (2008) reported contrasted brain activity between the 3 first trials and the 3 last trials among 10 trials of prism exposure, using functional Magnetic Resonance Imaging (fMRI). Authors reported increased activity in the primary motor cortex, the anterior cingulate cortex, and the anterior intraparietal region. These areas were involved in rapid error correction and in monitoring performance throughout the task. Besides, results also showed increased activity in the vermis during the first trials versus late trials. It was potentially related to the role of the cerebellum in the visuomotor transformations needed to adjust motor plans in response to the optical deviation. By contrast, no difference emerged from the culmen activity. In both studies, no measure of after-effects was provided and number of pointing trials was small. Consequently, they did not provide any information related to brain areas involved in the realignment process.

Luauté et al. (2009) increased the number of exposure trials up to 24 in a study using event-related fMRI method. They compared brain activity during early exposure (12 first trials) versus late exposure (12 last trials). The early phase activated the parietal areas, more specifically the left anterior intraparietal sulcus and left parieto-occipital sulcus supposed to be involved in error detection and error correction, respectively. The authors also reported a progressively increasing activation in lobules IV and V of the cerebellum during late exposure, which was related to realignment process. Additionally, a bilateral activation of the superior temporal sulcus was associated with sustained prism exposure, when pointing performances went back to baseline, indicating a possible role in realignment and longer-lasting changes. However, the weak number of trials prevent any strong conclusion to fully investigate slow mechanisms of realignment.

Chapman et al. (2010) compared dynamical brain activity changes during early and late exposure (18 trials each). Authors reported an activation of the left posterior and right anterior cerebellar regions during the initial trials of exposure. Concurrently, results revealed an activation in the right parietal cortex (superior and inferior parietal lobes), whereas the left hemisphere remained inactive. In late exposure, areas of both cerebellum and parietal cortex were active (left posterior lobe and right anterior and posterior lobe of the cerebellum and both superior and inferior lobes of the right parietal cortex). In addition, comparison between initial

¹ *Although authors used the term "adaptation" in their paper, it is noteworthy that the procedure used precluded the contribution of sensory realignment, i.e. the contribution of sensorimotor motor adaptation.*

versus last trials revealed increased activation in the left hemisphere during last trials (angular gyrus and anterior Inferior Posterior Lobule (IPL) in the parietal cortex; posterior region in the cerebellum). Noticeably, the procedure used a manipulandum to project stimuli, so the subjects perceived their movement outcome as a laser-projected image. Such interface may involve processes that are slightly different compared to those usually involved in PA, i.e. a greater part of cognitive processes. Because visual feedback is not directly perceived, the procedure might have enhanced the contribution of strategic control (Fleury et al., 2019). Another limitation comes with the segregation between early versus late exposure. As in Luauté et al., (2009) the authors split the number of trials in two equal parts whereas early exposure is generally reported as containing 3 to 7 trials (Rossetti et al., 1993).

By contrast, Küper et al. (2014) reported results that revealed a strong role of the cerebellum in recalibration but did not corroborate the hypothesis of a cerebellar contribution in spatial realignment. In this study, the authors compared activation in a control visuomotor condition (no prisms) to that in early versus late prism exposure (10 first and 10 last trials out of 20 trials, with a resting period between both). In early exposure, the anterior cerebellum was activated to the same extent as during the control condition while the posterior cerebellum activation increased in lobules VIII and IX, as well as in the ventro-caudal part of the dentate nucleus. During late exposure, the authors found a comparable pattern of activation as in the control condition with an activation of the posterior parts of the lobule VI. Activation in the dentate nucleus was stronger in the dorso-rostral part as compared to initial exposure. Altogether, these findings suggest that posterior cerebellum (lobule IX and VIII) and ventro-caudal dentate nucleus activation would control recalibration. On the other hand, realignment would rather rely on more superior parts of the posterior cerebellum (lobule VI).

Finally, recent neuro-imaging studies assessed changes in the task-free resting-state functional connectivity (RSFC) before and after PA. Tsujimoto et al. (2019) reported a temporary PA-induced change in connectivity between different nodes within the right dorsal attention network while decreases in RSFC were shown in the Default Mode Network and the left anterior insula in a comparable study by Wilf et al. (2019). Schintu et al. (2020) compared changes in RSFC following either rightward or leftward PA. The authors showed that rightward PA increased connectivity in the right frontoparietal network whereas left PA decreased RSFC between these regions. Interestingly, these studies provided information regarding functional connectivity changes induced by PA while disregarding activations related to motor execution, thus illustrating the short-term plasticity that occurred during exposure. However, such methods do not allow to ascribe a functional role of specific areas in the processes at work during exposure.

Results from neuro-imaging studies converge in ascribing a crucial role to the parietal cortex and the cerebellum in PA. This is compatible with lesions studies. Although neuro-imaging studies reported relevant findings about the neural bases of PA, such methods present two major issues (Panico et al. 2020). First, neuro-imaging constraints are toughly compatible with PA experimental settings (Bultitude et al., 2017). For example, the number of trials during exposure in neuro-imaging is often very small, so realignment cannot be fully studied. In addition, neuro-imaging studies are associated with strong spatial constraints. Notably, participants generally cannot perform movement in the horizontal plan and visual feedback are often provided indirectly. Secondly, neuro-imaging techniques assess brain activity during task completion but do not provide information about the causal relationships between active brain areas and observed behaviour. For these reasons, non-invasive brain stimulations studies could complement these methods. By interfering directly with brain activity, brain stimulation may reveal causal relationships between targeted brains areas and behaviour.

c. Non-invasive brain stimulations studies

Non-invasive brain stimulation methods (transcranial direct current stimulation – tDCS – or transcranial magnetic stimulation – TMS – particularly) are believed to modulate cerebral activity over different brain areas whose activity is stimulated during PA. Brain stimulation is aimed at directly investigating the link between brain regions and behaviour by interfering with inhibitory or facilitatory processes. A considerable advantage of these methods is their compatibility with PA experimental requirements: behavioural measures such as pointing performance can be easily conducted during exposure and after, as stimulation does not require specific spatial constraints. In such conditions, number of trials during exposure can be increased to match classical procedures (Panico et al., 2020).

To our own knowledge, the first attempt of combining tDCS and PA was conducted by Ladavas et al. (2015) in neglect patients. The authors reported that the rehabilitative effect of PA was boosted by 10 sessions of anodal tDCS (2.0 mA) of the right (ipsilesional) parietal cortex, with no effect of cathodal stimulation of the left (contralesional) parietal cortex. A possible interpretation was that anodal stimulation might have increased activation of the damaged hemisphere, thus restoring inter-hemispheric balance. However, the potential effect of this tDCS stimulation on PA was not demonstrated. Similarly, O’shea et al. (2017) reported no effect of the left posterior parietal cortex tDCS during PA for both anodal and cathodal polarity.

Panico et al. (2016) conducted a series of tDCS studies to better understand brain substrates of adaptive processes in PA. They targeted the cerebellum, the PPC and M1. First, they showed that cathodal cerebellar stimulation resulted in larger errors during early, middle, and late exposure, as well as during immediate post-test measures. This argues in favour of the

early contribution of the cerebellum lasting during the whole PA procedure, including after-effects testing. The authors proposed that the cerebellum controlled both recalibration and realignment from the very first trials of exposure without being able to disentangle between the two mechanisms. To complete these findings, Panico et al. (2018) applied a cathodal cerebellar stimulation during a multiple-step PA procedure. The participants were unaware of the optical deviation because the full visual shift was progressively induced by step of 2 degrees (Michel et al. 2015). Therefore, errors were not consciously perceived, and participants could not rely on strategic corrections of pointing movements (i.e. recalibration). Stimulated participants showed larger rightward pointing errors during both initial and late exposure and reduced after-effects following exposure. These results supported a causal role of the cerebellum in spatial realignment since the stimulation negatively influenced performances during both late exposure and after-effects. The authors also underlined the potential role of the cerebellum in online motor corrections which may explain the stimulation effect in early exposure. In a further study, Panico et al. (2018) tested the hypothesis of a specific relationship between the PPC and the cerebellum, i.e. the role of a cerebello-parietal circuit, in both processes of PA. To test this hypothesis, the authors simultaneously stimulated both the cerebellum and the PPC with opposite polarities: cathode on the PPC and anode on the cerebellum or vice-versa. Stimulated groups displayed larger errors during early exposure regardless the polarity applied, while no difference was found in late exposure and after-effects. The absence of any difference related to the polarity directly implies that a cerebello-parietal circuit plays a crucial role in processes involved during early exposure.

Finally, the primary motor cortex (M1) was investigated due to its particular involvement in motor memories storage (e.g. Galea et al., 2011). Panico et al. (2017) reported that anodal stimulation of M1 alone reactivated after-effects the day following prism adaptation. In addition, reactivated after-effects long lasted until the next day after stimulation. O'shea et al. (2017) also tested the effects of tDCS on the persistence of after-effects. Participants performed 100 trials under prism exposure interspersed by blocks of after-effects measurement while real or sham tDCS was applied on the left parietal cortex, the left M1 or the right cerebellum either during or after exposure. Block of exposure was followed by a washout and a retention phase. A specific effect of anodal M1 stimulation delivered during exposure was found through increased magnitude of after-effects during adaptation and enhanced after-effects persistence in the washout and retention phase. Conversely, results did not show such effects when tDCS was applied on the cerebellum or the parietal cortex. Both studies support the idea that M1

plays a crucial role in the storage and retention of after-effects. In sum, the main results from neuro-imaging and neuro-stimulation studies are illustrated in **Figure 11**.

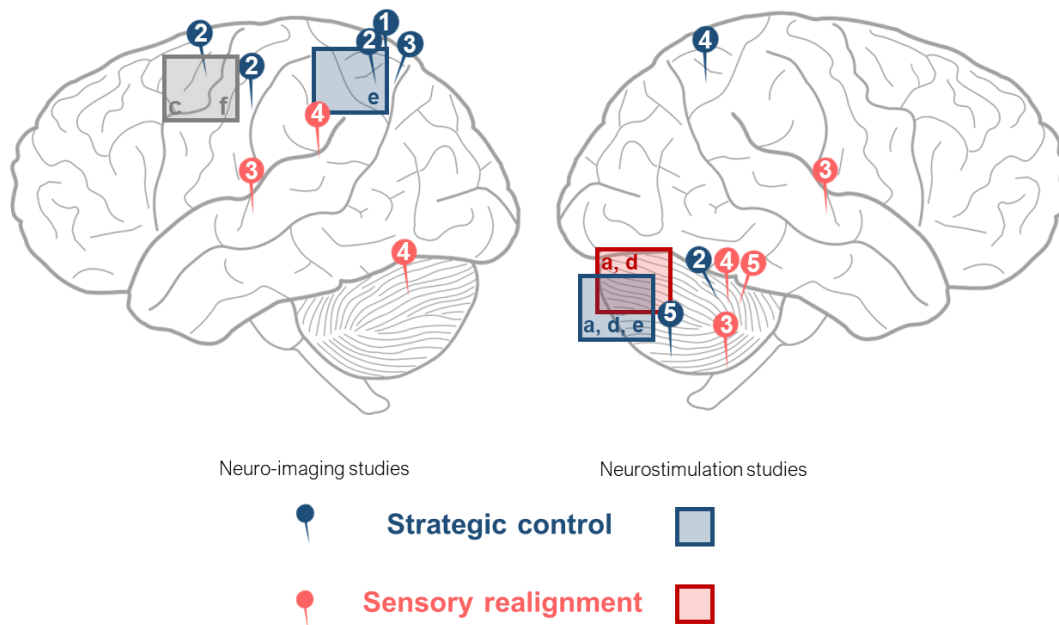

Figure 11 – Main results from neuro-imaging and neuro-stimulation studies in PA. The circles indicate approximately the main cortical peaks activation reported by neuro-imaging studies, whereas the squares refers to the areas stimulated by neuro-stimulation studies. The numbers and the letters refer to the papers as followed: 1: Clower et al., ;2.Danckert et al., 2008; 3. Luauté et al., 4. Chapman et al., 2019; 5. Küper et al., 2014; a. Panico et al., 2016 ; b. Panico et al., 2017; c. O’shea et al., 2017; d. Panico et al., 2018a; e. Panico et al., 2018b; f. Panico et al., 2017. Notably, results from c and f are in grey because they referred to the retention and the reactivation of after-effects which is not directly attributable to strategic control or realignment. Adapted from Panico et al., 2020.

d. Summary of neural substrates of PA

A growing body of literature investigated the neural substrates underlying mechanisms of PA. Complementary methods provided original knowledge about the functioning and the understanding of such mechanisms, i.e. patient studies, neuro-imaging studies and neuro-stimulation. In their recent review, Panico et al. (2020), proposed a new interpretative framework of PA by highlighting the potential contribution of a cerebello-parietal network in both recalibration and realignment (**Figure 12**). Cerebellum areas would participate in error processing (online correction) which would start in early exposure (online control is crucial in the very first trials). Besides, the cerebellum would play a crucial role in feedforward control and in the generation and processing of sensory feedback errors (Bastian, 2006; Popa & Ebner, 2018; Shadmehr et al., 2010; Therrien & Bastian, 2019) which are crucial during PA. In addition, cerebellar contribution in PA would last until after-effects. On the other hand, the parietal regions would be involved in movement correction based on previous errors. The

primary motor cortex is probably associated not only with recalibration but also with storage and consolidation of after-effects (O'shea, 2017; Panico 2017).

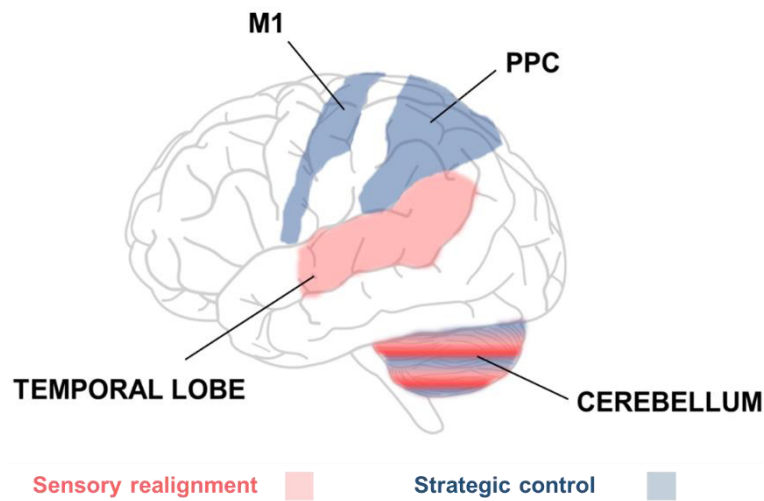

Figure 12 – Synthetic illustration of brain areas involved during Prism Adaptation. *Cerebellum would be implied from initial error reduction to the development of sensorimotor after-effects while Post Parietal Cortex (PPC) areas would be mainly involved in recalibration. The primary motor cortex (M1) would contribute to the consolidation and the reactivation of after-effects. Finally, the temporal lobe would participate in the effects of PA at the cognitive level. Inspired from Panico et al., 2020.*

Synthesis

PA is a useful paradigm to study the short-term adaptive plasticity. The literature distinguished two main processes operating during PA: recalibration which quickly reduce final errors, and realignment, referring to adjusting the misalignment elicited by prisms between visual-motor and proprioceptive motor references frames. Realignment is the process of “true” adaptation and mainly contributes to after-effects following prism exposure. Within this framework, several studies explored the neural substrates associated with PA and reported a clear contribution of a cerebello-parietal network in both recalibration and realignment. Particularly, the cerebellum plays a key role from the very early exposure until the entire after-effects occur. In addition, tDCS methods are compatible with PA procedure constraints.

One of the major issue on this topic is that contributions of realignment and recalibration remain tough to tease apart because of their temporal overlap. Whether the two processes could be distinguished through their transfer properties represents a decisive question. Realignment may show a dimensional generalization beyond exposure context. However, the mechanisms of generalization and transfer remain poorly understood, as well as their neural substrates. In the following section, we will describe generalization and transfer, and focus on transfer of after-effects.

D. TRANSFER/GENERALIZATION OF AFTER-EFFECTS

1. Clarifying transfer and generalization

Transfer refers to the process of applying sensorimotor changes acquired in one specific context to new conditions, e.g. other target location, effector, or task (Prablanc et al., 2019). This ability is crucial in daily life as we can reinvestigate what we have learnt during given conditions to other settings without developing other appropriate compensations, i.e. without going through entire adaptive processes *de novo* (Ghez, 2013). In the thesis context, transfer can be related to generalization with slight differences: transfer better refers to new task conditions (or limb use), while generalization classically refers to other locations in the workspace (Prablanc et al., 2019). Despite their common usage, transfer and generalization are used in different paradigms to refer to various behaviours. In the previous sections, we emphasized the concept of after-effects to evidence adaptation. As for after-effects, definition and assessment of transfer might vary across paradigms (Fleury et al., 2019). First, the frontier between after-effects and transfer may substantially be confusing. For example, Kluzik et al. (2008) reported measurements of after-effects in robot-null conditions (force-field turned off) as an assessment of generalization whereas it simply converged to after-effects measurement with the perturbation removed (as during post-tests in PA).

Another critical aspect is that transfer/generalization can refer to applying different components of adaptation to other settings. On the one hand, we can investigate how the compensations set up during exposure to a specific perturbation can be transferred to other settings under the same perturbation (e.g. Malfait et al., 2002; Tanaka et al., 2012). Similarly, some studies also examined the transfer of compensations under a specific perturbation to another perturbation (e.g. Kalenscher et al., 2003). On the other hand, transfer/generalization can be related to the extent to which after-effects can be applied in different settings, i.e. post-adaptation generalization or after-effects transfer. Throughout this thesis, transfer will refer to this latter description. Indeed, the focus of the current work is to investigate robust changes emerging in the nervous system to face a given perturbation, i.e. transferable after-effects.

Therefore, as for after-effects, transfer should be assessed once the perturbation has been removed and might not be confused with other parameters including *retention*, *savings* and *consolidation*. *Retention* refers to the capacity of the sensorimotor system to fully or partially maintain the adapted state. In other words, it refers to the persistence of after-effects. Thus, transfer might relate to retention in some extent. We can distinguish passive from active retention (Prablanc et al., 2019). The first refers to the persistence of after-effects after a passive period (e.g. in the dark with no movement and no visual information), while the second

corresponds to the maintenance of after-effects following a short period of active washout (e.g. movements performed under normal conditions). *Savings* are related to the recall of initially successful strategies and refer to a faster reduction of errors when individuals are re-exposed to the same perturbation (Huang et al., 2011; Kojima, 2004; Krakauer, 2005; Zarah et al., 2008). These distinctions are not just terminological, as components may be dissociated. Despite apparent loss of adaptation (i.e. regained baseline performance), individuals may keep a covert trace of the former adaptive processes, and consequently, adapt faster to further exposure to the same perturbation. Savings refer to contextual processes that are specific to the exposure condition and do not relate to after-effects (Morehead et al., 2015). Finally, *consolidation* of motor memory is the process of turning from evanescent motor memory to a robust and stable motor memory (Criscimagna-Hemminger & Shadmehr, 2008). Mechanisms underlying the transfer of after-effects likely involve stable, robust, and persistent after-effects that will relate to the issues of retention and consolidation. However, savings may be entirely independent because this phenomenon refers to error reduction during exposure to a perturbation.

In sum, transfer/generalization refers to the transfer of after-effects. After-effects are generally measured in the same context as the exposure-context, but without any perturbation, in which case they may include cognitive contributions specific to this context. Assessment of transfer relates to after-effects measurement with substantial changes in the context compared to the exposure context. These changes can relate to unpracticed targets or workspaces (spatial generalization), untrained effectors (e.g. interlimb transfer), untrained task features (e.g. different speeds, change in amplitude) or other tasks (inter-task transfer).

2. Transfer/Generalization of after-effects in Prism Adaptation

PA is particularly interesting to investigate after-effects transfer. Indeed, PA is applied to usual movements (e.g. pointing), the perturbation is simply applied through the prisms and feedback could be directly perceived, without using an external or artificial interface, as compared to force-field or visuomotor rotation. Therefore, transfer can easily be assessed during post-tests following exposure. Here, we will discuss studies dealing with the transfer of sensorimotor after-effects to unexposed targets, limbs, and tasks respectively referring to spatial generalization, inter-limb transfer, and inter-task transfer.

a. Spatial generalization

In PA literature, spatial generalization refers to the measurement of after-effects during movements directed to targets not used during exposure (i.e. unexposed or untrained targets) (Redding et al. 2005). In most studies, after-effects are systematically assessed on an unexposed target to report the probe of a “true” adaptation (Petitet et al., 2017; Prablanc et al.,

2019). For example, when tested on a target adjacent to the exposed target by 10 degrees, after-effects are similar to those tested on the exposed target (e.g. Renault et al., 2020). However, some studies have specifically investigated spatial generalization by testing other locations.

Gogel & Tietz (1974) reported a slight reduction of after-effects as one moves away from the areas explored during exposure. Bedford (1993; **Figure 13**) specifically investigated spatial generalization with an abstracted version of PA procedures. During exposure to a prismatic shift, participants were requested to point to a unique visual LED target in a dark room. When participants correctly reached the target, another LED placed on their finger was turned on. Only correct movements provided feedback: when pointing was incorrect, the finger LED remained turned off. Correct movements corresponded to a unique mismatch between the visually perceived biased position of the hand (shifted by the prisms) and the unbiased kinaesthetically perceived position of the finger. Consequently, a unique position pairing between the visual and proprioceptive coordinate systems was trained, in contrast to the classical PA procedures in which several pairings are experienced (the visual position is associated with the “felt” position each time the finger is seen). Thus, participants developed strong after-effects on the trained target but also a global generalization to untrained targets, characterized by a zero slope linear function. The same magnitude of after-effects occurred under the untrained targets conditions, ranging from -25° to $+25^\circ$ compared to the trained target (0°).

In a subsequent study, Bedford (1993) showed that when the same spatial mapping task was presented as a cognitive learning task, spatial generalization to untrained pairs showed a traditional associative generalization gradient: the more the distance between trained target and tested target was large, the less generalization was observed. These studies suggested that different processes (perceptual versus cognitive) were associated with distinct generalization functions.

In the same vein, Redding & Wallace, (2006; **Figure 13**) showed that recalibration and realignment were related to distinct generalization functions. Therefore, they proposed distinct measures for both processes. Recalibration after-effects were assessed through open loop pointing movements on the same apparatus than during exposure but with a null shift deviation (participants were not informed that deviation was removed). Realignment after-effects were separately assessed after removal of the perturbation as follow: visual shift, proprioceptive shift, and total shift. Pointing was performed to a unique central target during prism exposure while post-tests were performed to that target and two other new targets (left and right) for both recalibration and realignment after-effects. The authors showed that recalibration after-effects

measured on the exposed target were greater than realignment after-effects on the same targets, suggesting a context-dependent part in the former that was related to the exposure context. Crucially, recalibration after-effects showed associative generalization gradient, i.e. after-effects decreased when measured on untrained targets. Conversely, realignment after-effects showed a global generalization to untrained target, fitted by a zero slope linear function, comparable to that of Bedford's previous study. Therefore, some part of after-effects following prism exposure have been transferred across unexposed locations, provided that the exposure spatial maps (i.e. visual-motor and proprioceptive motor) were also involved during exposure (dimensional generalization). However, other components generalized only with respect to similarity between conditions during exposure and post-tests (associative generalization; Redding & Wallace, 2006). These context-dependent after-effects were related to a kind of cognitive learning (Bedford, 1993, 1999) and highlighted the different processes involved during PA (recalibration and realignment). Redding and Wallace (2006) suggested that distinct adaptive processes during PA can be isolated and compared by manipulating the conditions for spatial generalization of after-effects. However, assessment of after-effects on unexposed targets (i.e. spatial generalization) still contains components that are specific to exposure conditions as long as the same task is used.

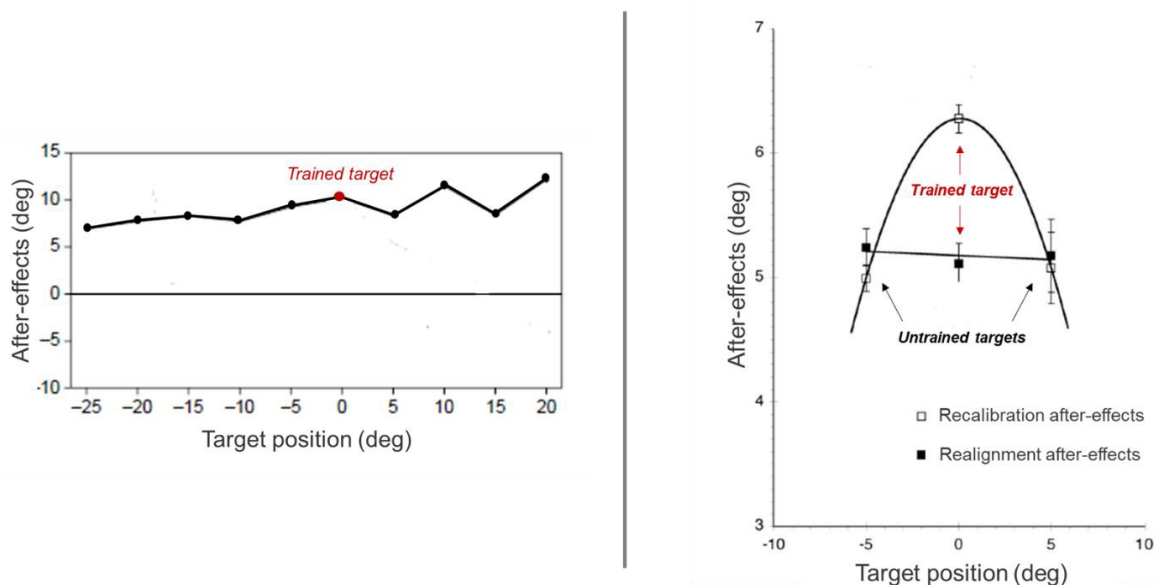

Figure 13 – Spatial generalization of after-effects. *Left* (adapted from Bedford et al., 1999): the magnitude of after-effects is plotted as a function of the target position. Only one target has been trained under the perturbation (red). *Right* (adapted from Redding & Wallace, 2006): Recalibration after-effects are assessed with null-deviation goggles whereas realignment after-effects are tested upon explicit removal of the prisms. The central target only was trained during exposure.

b. Inter-limb transfer

Inter-limb (or inter-manual) transfer of after-effects has been studied for several decades. This type of transfer tests the magnitude of after-effects with the limb that has not been used during exposure. In a pioneering study, Harris (1963) reported a significant but slight transfer to the

arm that was not used during exposure (20% of after-effects found on the exposed arm). Since this first study, a large body of literature highlighted the conditions favouring inter-manual transfer.

Hamilton (1964) showed that inter-manual transfer occurred only when head and trunk were unconstrained. However, several other studies reported inter-manual transfer while using a chinrest maintaining head and trunk positions (Choe & Welch, 1974; Cohen, 1973; Cohen, 1967; Kalil & Freedman, 1966; Taub & Goldberg, 1973). The practice distribution (massed versus distributed) is another factor that seemed to influence inter-manual transfer. Few studies reported that distributed practice during exposure (bins of trials interspersed by quick breaks) better favoured transfer than massed practice (continuous training with no break) which resulted in no transfer (Cohen, 1973; Taub & Goldberg, 1973). However, Choe and Welch (1974) reported inter-manual transfer even with massed practice during exposure. These contrasting findings suggested that other factors probably influenced inter-limb transfer.

Crucially, only the visual shift seems to be transferred to the unexposed hand (Templeton et al., 1974; Wilkinson, 1971), while the proprioceptive shift would be local. We previously reported that terminal exposure favoured the change in visual shift compared to proprioceptive shift (Redding and Wallace, 2001). Yet, the feedback condition during exposure have also been reported as a determining factor in the generation of inter-manual transfer: Cohen (1967) showed that inter-manual transfer occurred after terminal exposure but not after concurrent exposure. However, other studies reported no transfer in terminal exposure (Walsh & Freedman, 1966) and substantial transfer following concurrent exposure (Choe & Welch, 1974). Altogether, studies about inter-manual transfer reveal substantial inconsistencies probably related to differences in experimental procedures. Such studies did not cover all conditions usually requested for inter-manual transfer.

More recently, Renault et al. (2020) investigated whether specific features of movements can influence the inter-manual transfer of prism acquired after-effects. The authors reported no inter-manual transfer at the group level, and a large heterogeneity across participants. More precisely, 4 participants showed no transfer while 9 showed a significant transfer (leftward after-effects on the non-dominant arm). Interestingly, 7 other participants reported a rightward after-effects on the non-dominant arm) which were assigned to a transfer in intrinsic coordinates (shoulder adduction) consistent with recent descriptions of an intrinsic coordinate system in other learning paradigms (Criscimagna-Hemminger et al., 2003; Galea et al., 2007; Wiestler et al., 2014). Additional analyses of kinematic variables revealed that peak acceleration and peak velocity during exposure, together with variability in initial direction during late exposure were correlated to inter-manual transfer. This may eventually reveal how

transformations have been encoded, either in extrinsic coordinates or in intrinsic coordinates and seemed to be dependent on individuals' characteristics. This study highlighted a strong inter-individual variability that could account for the contrasting results reported in former studies.

Substantial inter-limb transfer (mostly from the dominant to the non-dominant arm) should exist, suggesting that adaptive alterations occurring with one arm are available for the other. However, this kind of transfer might emerge from a cognitive component as a general rule integrated by the nervous system and applicable to other effectors as suggested in other paradigms (Malfait & Ostry, 2004; Wang & Sainburg, 2004). Inter-limb transfer relies on an arbitrary high-level transformation which may reveal changes different from those reflected by spatial generalization and transfer to other tasks (Fleury et al., 2019).

c. Inter-task transfer

Another body of literature investigated the transfer of after-effects to movements that differed from those experienced during exposure. This type of transfer will be central in the present thesis because it ensures the capture of exposure context-independent after-effects as the testing task differs from the exposed task. Results from studies investigating inter-task transfer in healthy participants are combined in **Table 1**.

Although reaching is usual in PA procedures, Redding & Wallace, (1988) early probed the possibility to adapt to a prismatic shift during walking. Studies exploring after-effects transfer in PA subsequently used locomotion tasks. Alexander et al., (2011) reported a significant and reciprocal transfer between a stepping task requiring precision and an obstacle avoidance task. However, the transfer pattern was unilaterally symmetric: the left but not the right lower limb indicated after-effects transfer between the two locomotor tasks (Alexander et al., 2011). These findings were supplemented by a subsequent study which showed a contribution of the stepping sequence (i.e. the order in which steps were taken) during the adapted task on transfer pattern: only the leg that took the second step on the stepping sequence showed transfer to the unexposed task (Alexander et al., 2013). Interestingly, only transfer patterns differed regardless the type of task practiced under exposure. This indicates that transfer provided complementary information beyond the after-effects.

Other studies explored the cross-transfer between walking and reaching. Morton & Bastian, (2004) found asymmetric transfer from walking to reaching but not from reaching to walking. They suggested that PA during whole body movements provoked the recalibration of higher order brain regions between legs: both legs showed comparable after-effects on the exposed task, that are not dependent to a specific body part. Conversely, PA during isolated movements

Sensorimotor after-effects transfer between two motor tasks

<i>Authors</i>	<i>Task A</i>	<i>Task B</i>	<i>Outcomes</i>
<i>Inter-task transfer involving a walking task</i>			
Morton & Bastian, 2004	Pointing	Walking	Transfer from walking to pointing but not from pointing to walking
Savin & Morton, 2008	Arm pointing	Leg pointing	Transfer from arm to leg but less from leg to arm, either during seated or standing postures
Michel et al., 2008	Pointing	Goal-oriented walking task	Reciprocal transfer between the two tasks.
Alexander et al., 2011	Precision stepping task	Obstacle avoidance walking task	Reciprocal transfer between the two tasks for the left foot but no transfer for the right foot.
Alexander et al., 2013	Precision stepping task	Obstacle avoidance walking task	Reciprocal but unilateral transfer between the two tasks (i.e. only one leg transferred), explained by a contribution of the stepping sequence. Only the leg that took the second step during the exposed stepping sequence showed transfer to the unexposed task.
Bakkum et al., 2020	Pointing	Precision stepping task	Reciprocal transfer between the two tasks. Additional balance challenging manipulation during exposure resulted in greater transfer between the two tasks.
<i>Inter-task transfer between similar movements with changes in velocity or postures</i>			
Freedman et al., 1965	Sagittal pointing movements	Transverse pointing movements	Reciprocal transfer between sagittal and transverse pointing movements.
Kitazawa et al., 1997	Fast pointing movements	Slow pointing movements	Transfer from Fast movements to other velocities and from Slow movement to other velocities. The magnitude of transfer decreased when differences between velocities increased, especially for transfer from Slow movements.
Baraduc et al., 2002	Pointing	Pointing starting from different position	Transfer to other starting positions with a gradient of decrease for the furthest starting positions as compared to the exposed one.
Redding & Wallace, 2006	Pointing	Pointing starting from different position	Linear transfer pattern between the different starting positions conditions.
<i>Inter-task transfer between throwing movements</i>			
Martin et al., 1996	Overhand throwing	Underhand throwing	After-effects specific to the type of throwing performed during exposure.
Fernandez-Ruiz et al., 2000	Throwing	Throwing with weighed limb	After-effects specific to the weight condition experienced during exposure – poor to null transfer to non-weight throwing.

Table 1 – Summary of outcomes from studies investigating after-effects transfer between two tasks in healthy subjects.

using one particular limb (i.e. pointing) was probably ensued by effector-specific mechanisms, i.e. the after-effects were specific to the limb used during exposure (Morton & Bastian, 2004).

However, the opposite pattern was found in a subsequent study, i.e. a clear and consistent generalization from arm to leg but much less from leg to arm during either seated or standing conditions, suggesting that neither the adaptation of leg movements specifically, nor standing posture, nor the bilateral component of walking could be the salient feature allowing for a broad transfer across body parts (Savin & Morton, 2008; **Figure 14**). Notably, this study could have been considered as inter-limb transfer between the leg and the arm.

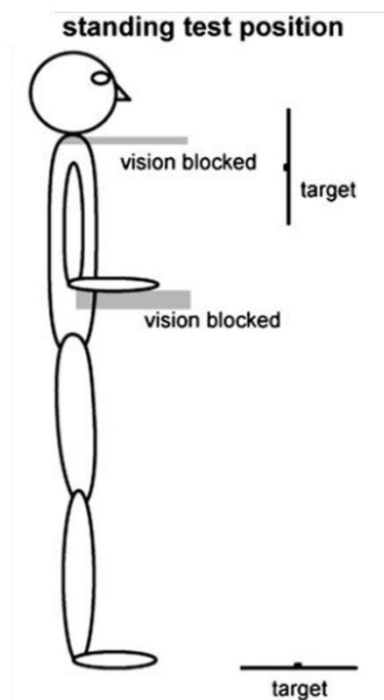

Figure 14 – Illustration of an inter-task transfer set-up. From Savin & Morton, 2008. After-effects transfer was assessed from arm pointing to leg pointing and vice versa. For the arm pointing task, participants were required to reach the target with their index. For the leg pointing task, participants had to touch the target on the ground with their foot. The authors also tested the same tasks with participants sitting instead of standing.

Michel et al., (2008) tested the cross-transfer of after-effects between a manual pointing task and a goal-oriented locomotor task, following adaptation to either leftward or rightward prismatic shift. The locomotor task consisted in a blindfolded straightforward locomotor displacement to a target in front of the subjects. The authors reported a substantial transfer of after-effects from manual adaptation to the locomotor task and vice versa. In addition, results revealed larger after-effects for rightward locomotor (following adaptation to a leftward deviation) than for leftward locomotor after-effects (following adaptation to a rightward deviation). They associated these findings with the following hypothesis: locomotor task might

enable the assessment of representational after-effects, i.e. relying on expansion of after-effects to higher-level functions of spatial cognition.

Finally, Bakkum et al., (2020) explored the cross-transfer between a precision walking task and a pointing task. The authors also tested additional effect of challenging participants' balance during exposure by means of inflatable rubber attached to the soles of their shoes. Both the reaching and walking balance-challenged groups showed greater transfer to the equivalent unexposed task compared to balance-unchallenged groups, although generalization was found in all groups (Bakkum et al., 2020). The authors suggested that challenging participants' balance during PA increased the relevance (i.e. the importance) of the updated internal model in the CNS, thus leading to increased transfer of after-effects to another task.

Altogether, studies investigating after-effects between two walking tasks or between walking and pointing revealed that prism adaptation led to the transfer of after-effects to other tasks that differed from the initial exposure task. In addition, such transfer might be unidirectional (i.e. arising from one task to the second but non vice versa) and should depend on the task features during exposure. However, once triggered, walking does not exactly remain a voluntary movement *per se* but rather a rhythmic movement that is controlled by specific central nervous system regions. Therefore, testing transfer between walking and reaching might implied different processes compared to classical reaching PA procedures.

Another body of work investigated the transfer of after-effects from a task performed during exposure to the same task with, however, modulation of motor programming (i.e. amplitude, direction, velocity, etc). Freedman (1965) reported that adaptation during sagittal movements was almost completely transferred to transverse movements (85%). After-effects following exposure while performing transverse movements were also transferred with a lesser extent to sagittal movements (62%). Following this study, several features have been investigated: notably velocity, constraints on the limb, and starting position. Kitazawa et al., (1997) investigated the extent of transfer from a different pointing velocity. Four experimental pointing conditions were associated with varying movement durations, i.e. varying pointing velocities: Fast (<300ms), Semi-Fast (800ms), Semi-Slow (2000ms) and Slow (5000ms). During exposure, participants performed either Slow or Fast pointing movements. Following exposure, participants were tested for after-effects under the four conditions. Results showed that transfer was stronger when the pointing velocity during post-tests was close to that during exposure. For example, when Fast pointing movements were performed during exposure, participants showed greater after-effects on the Fast condition during post-tests. The transfer of after-effects was substantial in the semi-Fast condition (71% of the initial magnitude of after-

effects) but also in the semi-slow and slow condition (63% and 54% respectively) although the magnitude was lesser in these two conditions (**Figure 15**). The decrease of transfer effect was more pronounced in participants who performed Slow pointing movements during exposure. Indeed, the percentage of transfer was around 73% for semi-slow movements, 68% for semi-fast movements and 26% for fast movements. Yet, this study highlighted the possibility to transfer pointing after-effects acquired during exposure from one velocity condition to others, with a decrease of transfer linked to an increase of differences between exposure and post-tests pointing velocities. These results were comparable to older data reporting weak transfer from fast ballistic to slow pointing movements, with, however, larger transfer from slow to fast movements (Baily, 1972).

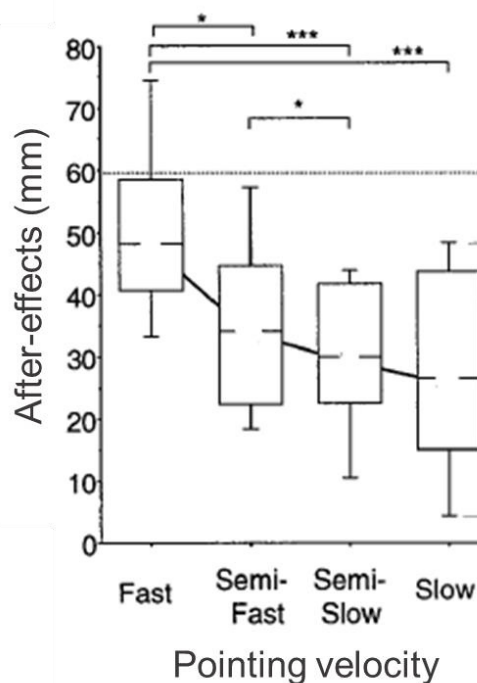

Figure 15 – After-effects transfer to pointing movements with different velocity. *The magnitude of after-effects is represented as a function of the velocity condition. Participants trained only Fast movements during exposure and were tested for transfer on the other velocity conditions. Adapted from Kitazawa et al., 1997.*

Beyond the kinematic task parameters, some studies also investigated the magnitude of after-effects transfer to tasks that were similar to exposure task but with varying starting position. Baraduc et al. (2002) investigated whether differences in initial posture could modify the extent of after-effects following adaptation to a lateral visuomotor-shift. Participants performed pointing during exposure to one central starting position. Graded transfer to other starting positions was reported during post-tests. Although transfer was observable in all tested starting positions, the pointing errors after exposure revealed a decrease of adaptation with increasing dissimilarities between exposed starting positions and others. Noticeably, although the

visuomotor shift was comparable to that induced by prisms, it was induced by a manipulation of terminal visual feedback in the absence of prisms. Similarly, Redding and Wallace (2006) trained participants to perform pointing movements under prismatic deviation and tested for after-effects when pointing in the same direction but under a different starting position, i.e. moved straight by a few centimetres. Pointing amplitudes then changed from 50 cm to 13 cm. The authors also tested the reverse combination (13 cm pointing movements during exposure vs 50 cm pointing movements during post-tests) and reported a substantial transfer of after-effects in both conditions to the untrained movement amplitude. As for spatial generalization, the authors provided measures for recalibration and realignment. The first remained greater when tested on the exposed movement amplitude while the second, controlled by the visual system (larger part of visual shift compared to proprioceptive shift, related to a terminal exposure) was unrelated to the similarity between exposure and post-tests amplitudes. This linear transfer pattern contrasted with Baraduc et al.'s findings, probing that the procedure used in the latter probably engaged mostly the recalibration process.

The above-mentioned studies involved a pointing task with various movement features. Few studies using throwing under prism adaptation, specifically tested inter-task transfer. Martin et al. (1996a) reported that after-effects were partially specific to postural configuration of throwing during prism exposure (**Figure 16**). Participants performed overhand throwing under a prismatic deviation. More than half of the participants did not show any transfer of after-effects on underhand throwing, although they showed substantial after-effects on overhand throwing. Overhand throwing after-effects were assessed after underhand throwing after-effects and visual feedback were available during post-tests. Other participants (n=2) showed partial transfer to underhand throwing and the two last participants demonstrated full transfer. Although some participants showed substantial transfer, the authors argued that adaptation and after-effects were specific to the muscle synergies engaged during prism exposure.

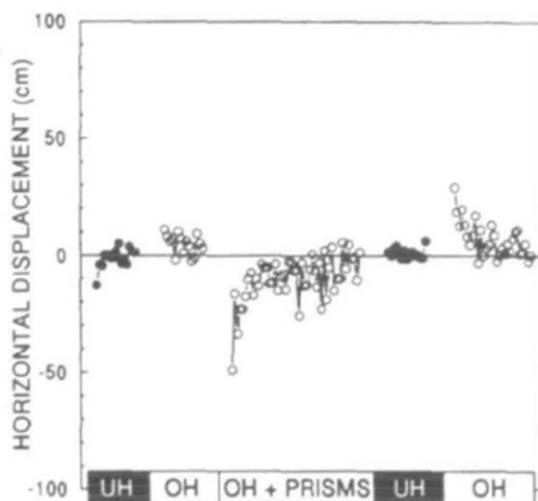

Figure 16 – After-effects transfer between two types of throws. From Martin et al., 1996a. Illustration of performances for one representative subjects that showed no transfer of after-effects from Overhand throwing (OH) to Underhand throwing (UH). Note that the participant showed after-effects on the trained OH throwing task whereas transfer was null.

After-effects transfer during throwing PA was also investigated by Fernández-Ruiz et al., (2000). The participants were exposed to the prismatic deviation during throwing movements while wearing a 750- or 1500-grams bracelets. They were tested for after-effects under the same weighting condition and for transfer with no added weight. When tested first on the non-weighted condition, the participants showed substantial but reduced transferred after-effects compared to control – who experienced PA in a non-weighted condition. In addition, when weighted in the same way again the participants showed late and stable after-effects. When participants were tested on the weighted condition first (following a weighted exposure), they showed strong after-effects on this condition but no substantial transfer to the non-weighted condition. The authors concluded that information related to load condition were integrated during PA and that after-effects learnt under a particular weight condition should be fully retrieved when this particular condition was restored. Together with Martin et al.'s findings, these results suggest that throwing exposure leads to normal after-effects, whereas remaining mostly specific to the exposure conditions.

Finally, a small body of work can be found about the transfer of sensorimotor after-effects from pointing (classical PA procedure used in rehabilitation) to other task or function. In neglect patients, after-effects gained during PA have been transferred to unusual daily life tasks such as wheelchair driving (Jacquin-Courtois et al., 2008; Watanabe et al. 2010). Tilikete et al. (2001) also reported an improvement of postural imbalance following PA in left-hemiparetic patients, suggesting that adaptation generalized to the postural system. Similar outcomes were also reported in healthy subjects (Michel et al., 2003). Bultitude et al., (2012) showed that adaptation to upward-shifting prisms resulted in downward after-effects and in a consequent transfer to Parkinson's Disease related gait disorders. Following pointing PA, patients showed significant improvement on gait initiation, suggesting that arm proprioception adaptation in the vertical plane may generalized to anterior-posterior postural control. These studies probe the possibility to transfer sensorimotor after-effects from one task to another and its potential benefits in rehabilitation. Therefore, understanding such transfer is a crucially relevant challenge.

Patients' studies investigating sensorimotor after-effects transfer echo a large literature concerning the beneficial effects of PA in neglect patients. In a first prism rehabilitation study involving neglect patients, Rossetti et al. (1998) demonstrated a spectacular reduction of the rightward bias observed in visuo-manual tasks such as line cancellation, line bisection and drawing from memory following a short active exposure to a 10° rightward prismatic displacement. This pioneering work showed that neglect patients adapted to prisms in the same direction than healthy controls, and that the shift of the proprioceptive reference frame toward the neglect side elicited considerable improvements of neglect related disorders in

visuospatial functions. This study paved the way for subsequent numerous studies investigating the puzzling effects of spatial cognition, and revealing transfer of low-level sensorimotor after-effects to high-level cognitive functions and also other sensory modalities such as auditory sense (see Jacquin-Courtois et al., 2013 and McIntosh, 2019 for a review). This type of transfer has been named *expansion* (Jacquin-Courtois et al. 2013), and has also been reported in healthy individuals (for reviews, see Michel, 2006, 2015). Although expansion revealed the interesting potential of PA in rehabilitation and emphasizes the interest to study after-effects transfer using this paradigm, this type of transfer goes beyond the scope of this thesis as we focused on purely sensorimotor after-effects.

3. Neural substrates of transfer

An open question relates to the neural substrates underlying after-effects transfer. Neural correlates of adaptive processes at work during PA have been thoroughly investigated but this is not the case for transfer/generalization of after-effects. A body of work is available about the neural correlates underlying the expansion of after-effects (for a review, see Panico et al., 2020). However, to our knowledge, data about neural substrates of spatial generalization and inter-task transfer of sensorimotor after-effects are almost inexistent in the PA literature. In a unique study previously mentioned, Morton & Bastian, (2004) suggested the involvement of the cerebellum in transfer of PA to a walking task as patients with cerebellar damage showed poor transfer. Investigating neural correlates of after-effects transfer raises up several challenges. A substantial question relates to the temporality of transfer mechanisms. A first hypothesis is that processes at work during exposure thus conditioning the feature of after-effects would also determine whether these would be transferable to other conditions or not. Although this needs to be experimentally tested, it is likely that transfer of after-effects would be intrinsically related to initial after-effects (i.e. on the task performed during exposure) and thus would involve the cerebellum. Another possibility is that transfer mechanisms would partially operate, during after-effects. Transfer to another task would be thus conditioned by a kind of retention of initial after-effects and potentially controlled by the primary motor cortex. One of the hypotheses is that realignment would probably be related to transfer properties. It is likely that if after-effects as usually measured are absent, transfer to another task would also be null. Therefore, the cerebellum appears as the major candidate for controlling transfer of after-effects. Inter-task transfer assessment adds constraints to classical PA procedures and increase the difficulty to combine them with neuro-imaging studies such as fMRI. Consequently, non-invasive brain stimulations with tDCS appear more relevant to explore brain regions involved in after-effects transfer.

Synthesis

In the sensorimotor adaptation literature, it is crucial to clearly define transfer and generalization. The present work will focus on transfer and generalization of after-effects during PA, i.e. the way in which after-effects extend beyond the task features experienced during exposure. In that sense, PA is a useful scientific design to study transfer. In turn, transfer can provide substantial information about the processes at work in PA (i.e. recalibration and realignment). Beyond the classical measure of after-effects, transfer might provide a stronger probe of realignment, in particular inter-task transfer. In addition, understanding the transfer processes between tasks represents a crucial interest in the field of rehabilitation. Most studies investigating inter-task transfer involved walking. However, the processes of after-effects transfer between two distinct reaching tasks remain unclear. Moreover, although neural substrates of PA and underlying processes have been thoroughly investigated, this is not the case for specific transfer mechanisms. tDCS provides relevant conditions to explore brain regions involved in PA due to its very weak intrusiveness and its compatibility with PA procedures. Given its role in realignment and after-effects, it is likely that the cerebellum participates in the after-effects transfer to other tasks.

E. SYNTHESIS AND OBJECTIVES

This review of the literature described the main principles underlying the control of voluntary movement. The integration on sensory information is crucial to elaborate motor commands and to control their execution and their consequences on the environment. Sensorimotor integration can be referred to the theory of internal models. Such models are fundamental to perform accurate movements.

The existing literature depicts several sensorimotor plasticity processes that lead to motor transformations when individuals face changing demands, i.e. adaptation and learning. We pointed out that some confusion might exist between these processes, which are themselves composed of sub-processes.

When focusing on adaptation, a key factor is after-effects. The comparison between the main adaptation paradigms reveals that different sub-processes might work under laboratory induced perturbations. Generalization/Transfer properties are essential in understanding the processes at work when facing perturbation.

We then focused the theoretical background on the paradigm of PA. The most prominent classification suggests two major adaptive processes at work: recalibration and realignment. The first quickly reduces errors during exposure to the prismatic deviation while the second leads to after-effects. However, the original contribution of both processes remains difficult to disentangle. A body of neuro-imaging, lesions and neuro-stimulation studies helped to identify the major CNS structures involved: the cerebellum and posterior parietal areas.

Sensorimotor adaptation, and particularly PA, presents major advantages in the field of neurorehabilitation through beneficial after-effects, e.g. in neglect patients. However, it is not clearly understood to which extent after-effects can be transferred to situations that are different from the initial context in which they occurred. PA is a useful paradigm to study adaptive processes through transfer, which, in turn, might help to disentangle between processes. Indeed, transfer properties related to after-effects following PA may provide crucial information regarding the nature of the processes involved.

This **THEORETICAL BACKGROUND** clearly defined transfer and generalization. We particularly discussed transfer of after-effects in the PA literature and emphasized a lack of knowledge concerning inter-task transfer. Although after-effects transfer between two distinct tasks might provide crucial clues regarding the process at work to face the perturbation, the conditions leading to transfer remain poorly understood. Moreover, their neural substrates have never

been investigated. Neuro-stimulation methods are particularly interesting to explore neural correlates of after-effects transfer.

In view of this background, this thesis aims at studying inter-task transfer of after-effects due to PA and to investigate transfer properties as a feature that might allow to isolate the contribution of a true adaptation. Thus, we aim to question the knowledge related to sensorimotor plasticity processes at work during PA through inter-task transfer properties. Moreover, the purpose is to highlight the required conditions giving rise to after-effects transfer and to explore the potential role of the cerebellum in these mechanisms.

The experimental contributions of the thesis will be divided into three axes.

AXIS 1 (STUDY 1) explores **the cross-transfer of after-effects** between throwing and pointing task. We aimed to determine whether the nature of the task performed during exposure influenced the abilities to transfer after-effects to another task that has not been experienced during exposure. This study notably underlined that throwing, if not intensively trained, provides data that are more variable than pointing. Results provided useful criteria for designing the subsequent studies.

AXIS 2 (STUDY 2) investigates the **mechanisms of PA through motor imagery**. The aim of the study was to test whether motor imagery of pointing movements under prism exposure led to transferable after-effects to a throwing task that has not been performed under exposure. We also tested whether motor imagery capacities influenced after-effects transfer. This axis questions the importance of motor execution and the role of feedbacks in a transferable adaptation.

Finally, the purpose of **AXIS 3 (STUDIES 3 AND 4)** is to explore the **neural substrates underlying after-effects transfer**. More specifically, we tested whether cerebellar transcranial direct current stimulation during PA influenced inter-task after-effects transfer. **STUDY 3** tested whether a cathodal stimulation decreased the transfer of after-effects from pointing to throwing. **STUDY 4** investigated whether anodal cerebellar stimulation favoured the transfer of after-effect from throwing to pointing.

The **EXPERIMENTAL CONTRIBUTIONS** part will present the 4 experimental studies across the 3 above mentioned axis, in the form of journal articles. Prior to this, the **METHODOLOGICAL BACKGROUND** will describe the methods we used in the various designs we explored.

Chapter 2

Methodological background

OVERVIEW OF THE CHAPTER

The *THEORETICAL BACKGROUND* aimed at providing relevant information to grasp the purposes of the upcoming experimental contributions. The objective of this *METHODOLOGICAL BACKGROUND* is to briefly describe the various methods used in our experiments and to justify their choices with regard to the scientific literature and the purposes of the thesis. Four sections will constitute this *METHODOLOGICAL BACKGROUND*. The section A deals with **Prism Adaptation (PA)** procedures and broadly presents the protocol used to assess inter-task transfer of after-effects throughout all experiments of the thesis (i.e. *STUDIES 1, 2, 3 AND 4*). The section B presents the main interests and methods of **kinematics analysis** of pointing movements that are used in *STUDIES 1, 3 AND 4*. The section C depicts the methodological aspects of **motor imagery (MI)**, a mental process involved in *STUDY 2*, in particular the different types of MI and the assessment of MI quality and ability. Finally, the section D describes **transcranial Direct Current Stimulation** methods (tDCS; technique used in *STUDIES 3 AND 4*) with an emphasize on tDCS targeting the cerebellum.

A. PRISM ADAPTATION (STUDIES 1, 2, 3, AND 4)

Prism Adaptation (PA) is the paradigm used to study sensorimotor plasticity processes in all studies that constitute the present thesis. The **CHAPTER 1** (section C) provided a description of the classical procedures used in PA studies and detailed the adaptive processes at work. The present section aims at describing some methodological aspects of PA. The first subsection will present a brief history of the use of prismatic lenses in psychological and neurosciences research. Then, we will rapidly describe the optical properties of wedge prisms. Finally, we will present the main procedures used in the experimental contributions to assess inter-task transfer of after-effects.

1. A brief history of prism lenses

For over a century and a half, scientists have been using optical devices to displace, reverse or invert the retinal image. Using these methods to alter the visual field provided the most classical mean to investigate sensorimotor plasticity processes. Stratton is usually acknowledged to be the first researcher who experimentally used lenses inverting and reversing the image (Stratton, 1897). When subjects initially wear the reversing lenses, they could not even stand on their feet because of the perturbation. Although these modifications of the visual field were considerable, adaptive or compensatory processes even took place within a few minutes and baseline coordination was retrieved following several consecutive days of continual exposure (Stratton, 1897). However, Stratton's procedures implied many inherent difficulties: the perturbation was huge and required a long period of exposure for the subject to adapt (Kornheiser, 1976). Therefore, only a few laboratory worldwide carried on the exploration of this radical alteration of the visual field through several weeks exposure protocols (e.g. Sekiyama et al., 2000; Sekiyama et al., 2012). A more convenient and simpler procedure relies on the use of prisms that displace an image in one direction. PA was first described by von Helmholtz at the end of the nineteenth century (1867). His first investigations were followed by numerous classical studies (e.g. von Helmholtz, 1962; Köhlerl, 1951; Held & Freedman, 1963; Harris, 1965; Kornheiser, 1976; **Figure 17**) and pursued by an increasing number of research from the 70's to the 90's (e.g. Redding & Wallace, 1985; Redding & Wallace, 1988, 1993) until the clinical use of PA procedures, which we have mentioned previously (Rossetti et al., 1998). Although it has a long-standing history, PA has remained highly used in recent years studies and represents a simply method to study sensorimotor plasticity that was completed by more recent techniques such as motion capture analysis, functional brain imaging or neuromodulation techniques.

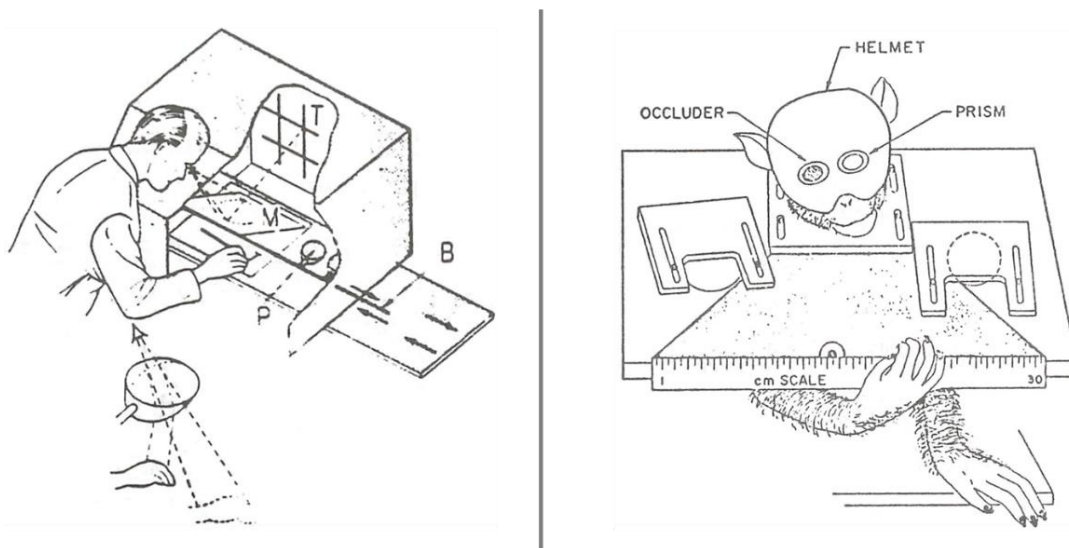

Figure 17 – Classical sets-up of PA procedure. *Left:* device used by Held & Gottlieb (1958) allowing to measure after-effects with a mirror preventing vision of the hand. *Right:* PA procedure in monkeys by Bossom & Hamilton (1963). The device allows terminal exposure conditions: the vision of the moving limb is possible only at the end of the movement.

2. How do prisms deviate the visual field?

In optical sciences, the term “prism” designates a wedge-shaped component with a larger edge (the base) and a thinner one (the apex). A ray of light passing through a prism is deviated toward the base of the prism (**Figure 18**). By contrast, when subjects look through the prism, the image is displaced toward the apex because the image appears to originate from the direction of the deviated light ray. Displacement of the visual field through prisms is possible thanks to the optical phenomenon of refraction, i.e. the bending of the light passing from one medium to another (e.g. from the air to the prism). The orientation of the prismatic effect relative to the line of sight of the subject depends on the direction of the prism base.

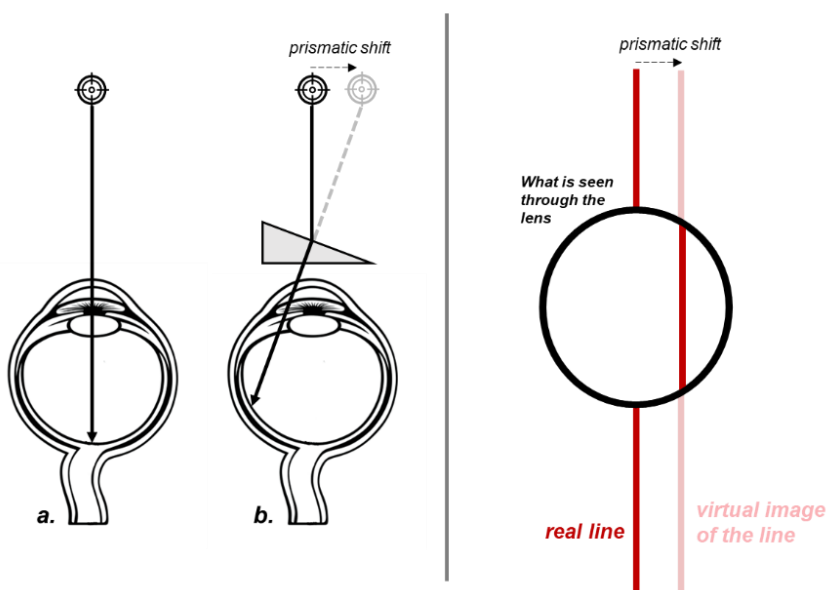

Figure 18 – Light bending through prism lens. *Left:* the prism lens deviates the visual field (here by ten degrees rightward). The subject sees a “virtual” image of the target that is displaced on the right. *Right:* illustration of what is seen through the prismatic lens. The shift is homogeneous and deformations are minor: the subject does not immediately perceive the displacement.

In most of PA studies, prismatic lenses are fitted in spectacles that prevent unshifted lateral vision thanks to lateral blinders such as glacier goggles (e.g. Rossetti et al., 1998). The amplitude of the deviation depends on the thickness of the base: the more the base is thick, the more the deviation is important. The most classical deviation used is 10 degrees rightward (Jacquin-Courtois et al., 2013), which corresponds to a deviation of a sufficient magnitude to produce visuomotor errors, but which remains in the range of physiological errors (Fleury et al., 2019; Rossetti & Rode, 2016). Therefore, studies included in the present thesis involved prisms goggles with a 10 degrees rightward deviation (Optique Peter.com, Lyon, France; **Figure 19**) that are also commonly used in the rehabilitation field.



Figure 19 – Prismatic goggles. *Adjustable glacier goggles preventing lateral vision of the unshifted environment (OptiquePeter.com, Lyon, France).*

3. From classical procedures to assessment of inter-task transfer of after-effects

a. Starting from a classical PA procedure

The classical PA procedures entail three distinct phases (Petitet et al., 2017; Prablanc et al., 2019; Redding et al., 2005): pre-tests (measure of baseline performances), exposure (period during which participants are actively exposed to the prismatic deviation), and post-tests (to assess the presence of after-effects). Pointing is the classical visuomotor task used during PA procedure although other tasks as been used (e.g. throwing, Martin et al., 1996a, 1996b).

The PA literature (see Redding & Wallace, 2005; Petitet et al., 2017; Prablanc et al., 2019 for reviews) enables to highlight essential conditions relative to the assessment of after-effects during post-tests (see **THEORETICAL BACKGROUND; section C**). The procedures developed in the present thesis will take into account the following requirements (**Figure 20**).

Pre-tests and Post-tests

- Pre-tests and post-tests must be strictly similar to enable comparisons. Pre-tests allow to provide a baseline measure of pointing performances to get a reference that will be

compared with post-tests performances to assess after-effects. Therefore, pre-tests conditions will match conditions required during post-tests.

- Participants need to be deprived of visual feedback during post-tests to prevent de-adaptation. Consequently, participants will be able to see the target between each trial whereas they will not see their hand neither the target upon initiation of the pointing movement and during its whole duration for each trial (open-loop pointing). In addition a chinrest will be used to prevent vision of the hand at the starting position to prevent any static recalibration. The chinrest will also enable to restrain the head position.
- Post-tests conditions are necessarily different from those during exposure. Therefore, post-tests assessment may use a different target and must be performed in the absence of any goggles. They are traditionally performed after explicitly removing the glasses, but the use of sham glasses may be useful to measure cognitive compensations (e.g. Redding & Wallace, 2006).
- To assess the presence and the robustness of sustainable after-effects, post-tests should contain more than a few pointing trials (at least 10 trials).

Exposure

Conditions during exposure strongly influence the development of sustainable after-effects (see Redding & Wallace, 2005; Petit et al., 2017; Prablanc et al., 2019 for reviews and **CHAPTER 1** for discussion of the literature). In the present thesis, ecological exposure conditions will be set-up in **STUDIES 1, 3 AND 4**¹.

- Participants will wear prismatic goggles that deviate the visual field by 10 degrees toward the right (OptiquePeter.com, Lyon, France).
- Visual feedback will be available during exposure (closed-loop pointing), in order to keep both dynamical and terminal errors (i.e. concurrent exposure). However, vision of the hand at the starting position will be prevented to avoid any static recalibration. For this purpose, the head of the participant will be constrained using a chinrest that will block vision of the hand starting position.
- The number of pointing trials needs to be sufficient to allow the development of realignment process, i.e. at least 50 trials.
- Pointing movements must be rapid enough to limit online corrections and to favour adaptation. Participants will be required to point the target as fast and accurate as possible.

¹ **STUDY 2** involves PA by motor imagery. Consequently, exposure conditions will differ compared to **STUDIES 1, 3 AND 4**. Changes in **STUDY 2** are presented in the following subsection A.3.c and are detailed in subsection C.3 of the present **METHODOLOGICAL BACKGROUND**.

- Participants will aim at a unique central target during exposure (namely the “exposed target”). During pre-tests and post-tests, performances will be assessed on the same central target but also on a right target that is not used during exposure (“unexposed” target).

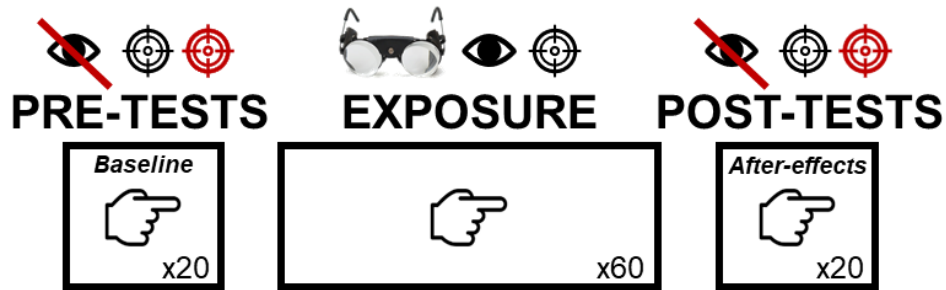

Figure 20 – Basic PA procedure. Pre-tests and post-tests consist in 20 pointing trials in open-loop conditions (no visual feedback during each pointing movement) and alternatively directed to a central target and a right target. Exposure requires 60 pointing trials under the prismatic perturbation in closed loop condition (i.e. vision of the movement allowed). Movements during exposure are directed to the central target and are performed as fast and accurate as possible.

b. Assessment of inter-task transfer of after-effects

Measuring after-effects transfer should necessarily be conducted during post-tests. The assessment of after-effects on a second task will be added during post-tests (and consequently also during pre-tests) under conditions matching those of the pointing task (i.e. goal-directed task, open-loop condition, two targets). However, a unique task will be performed during exposure, as in a classical PA procedure. The task performed during exposure will be referred to as the “exposed” task while the task used to assess transfer of after-effects will be the “unexposed” task (Figure 21).

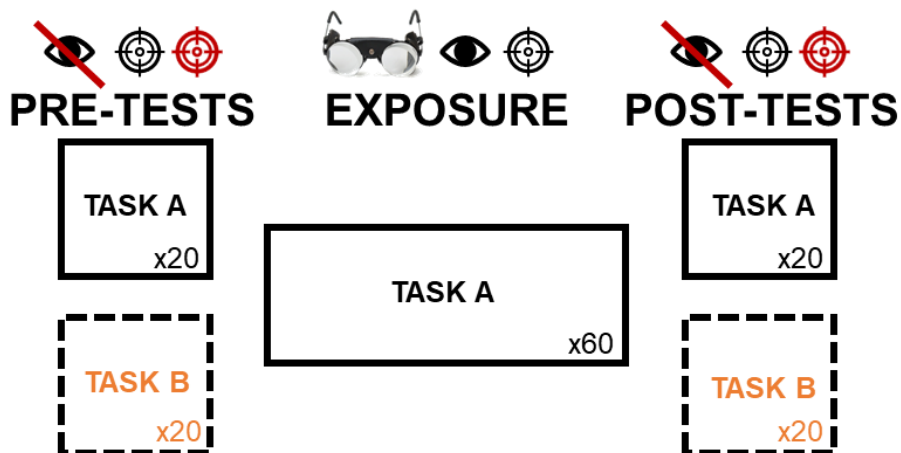

Figure 21 – PA procedure for testing inter-task transfer of after-effects. Assessment of performances on a second task (task B; “unexposed” task) are added during pre-tests and post-tests, under similar conditions as the task A (i.e. open loop conditions and two targets). Only one task (A) is performed during exposure.

c. Why choosing throwing to assess inter-task transfer?

Pointing is the conventional task used in PA literature and leads to sustainable and transferable after-effects. Throwing has also been used in some studies that showed more specific sensorimotor after-effects (e.g. Martin et al., 1996). Pointing and throwing share common features: both are goal-directed tasks performed with the upper limb and involve visual-motor and proprioceptive-motor reference frames. In addition, visual feedback availability can also be manipulated during a throwing task. By contrast, pointing and throwing present some different characteristics. While pointing is an over-practiced and mastered task, throwing is highly variable unless it is specifically trained: in most individuals, throwing is not fully acquired while pointing is. In daily life, pointing is close from reaching and grasping movements which are developed very early in humans. Conversely, throwing represents a precise ability that requires specific training. Throwing is a ballistic movement: the releasing of the projectile occurs close from a velocity peak. The duration of the movement makes the use of online sensory feedback more difficult, which could explain the inherent greater variability. Another difference between the two tasks is that pointing is usually performed in the peri-personal space whereas throwing is aimed at reaching in a farther space.

Given these similarities and differences, the current thesis will investigate the cross-transfer between pointing and throwing (**Figure 22**). As throwing is not over-practiced, we included a familiarization phase before pre-tests in both tasks. Across the different studies, two main conditions will be set-up depending on the task performed during exposure. In the pointing condition, participants will perform the pointing task during exposure, while after-effects will be assessed on the pointing task and transfer of after-effects tested on the throwing task (**STUDIES 1, 2 AND 3**). In the throwing condition, participants will perform the throwing task during exposure, while after-effects will be assessed on the throwing task and pointing (**STUDIES 1 AND 4**).

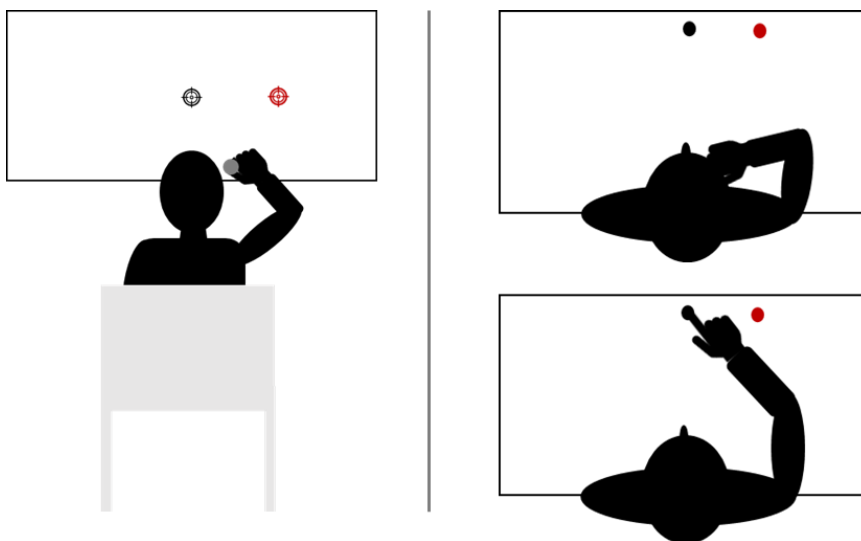

Figure 22 – Illustrations of the tasks. *Left: throwing task. Participants throw small projectiles in the direction of a target situated on a vertical board in front of them (distance: 2 meters). Right: pointing task. Participants make pointing movements to reach a target on an horizontal board in front of them (distance: 57.5 cm from the eyes). For both tasks, participants do not see their hand in the starting position. They are required to aim either the black or the red target depending on the phase of the experiment.*

d. Order of the tasks

Assessing after-effects transfer requires additional testing during pre-tests and post-tests, and consequently adds methodological constraints. A crucial aspect is that during post-tests, participants must not have access to vision and must not move except for performing the tasks. Consequently, the procedures should allow to perform the two tasks without any additional active displacement or movement and with no vision of the environment except before each throwing or pointing trial.

To ensure these requirements, participants in **STUDIES 1, 3 AND 4** will be sitting in a movable chair to be passively moved from the throwing task set-up to the pointing task set-up. Thus, the order of the tasks is determined as following to minimize the number of displacements between the two set-ups (**Figure 23**).

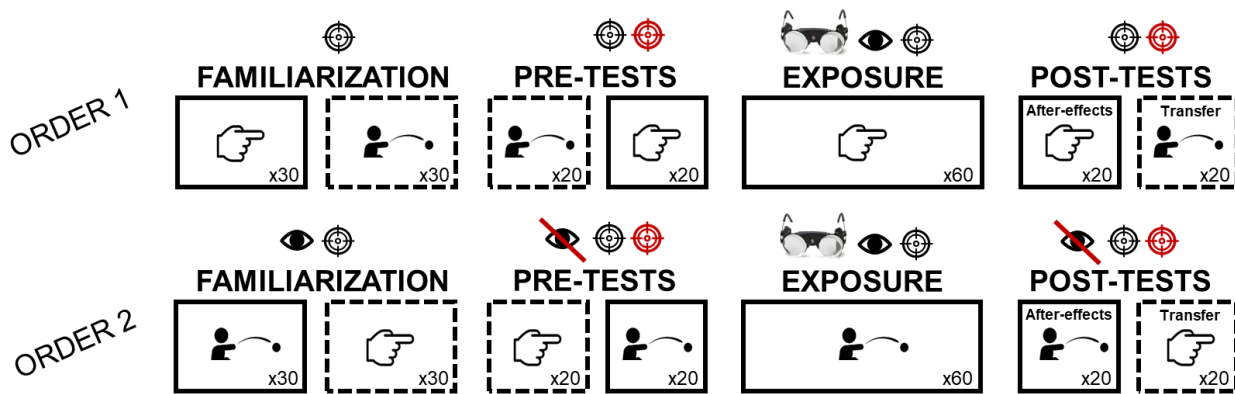

Figure 23 – Illustration of the complete PA procedure for inter-task transfer. A familiarization phase was added to the procedure and consists in 30 trials on each task. We determined two fixed order. The Order 1 refers to the “Pointing” condition and the Order 2 refers to the “Throwing” condition, with reference to the task performed during exposure.

e. Variations in Study 2

The above description of the protocol provides a brief overview of the procedures used in the present thesis to assess inter-task transfer of after-effects. These global procedures will be used in the four studies of the thesis. Notably, **STUDY 2** will investigate transfer from pointing to throwing only. In addition, pointing and throwing will be performed from the same position, and no displacement will be needed between the task set-ups. Therefore, **STUDY 2** also investigates the order of the tasks during pre-tests and post-tests, i.e. the order of the tasks will vary across the participants. Tasks set-ups and experimental conditions will be specified in the methods section of each study.

B. KINEMATICS OF POINTING MOVEMENTS (STUDIES 1, 3, AND 4)

A vast majority of PA studies investigated the endpoint errors of reaching movements to describe motor behaviour. Such classical measurements can be fruitfully complemented by kinematics analysis, i.e. study of reaching trajectories. In the present thesis, **STUDIES 1, 3 AND 4** analyse kinematics of pointing movements during PA.

1. Why being interesting in kinematics?

Kinematics refer to a subfield of physics that studies motion and trajectories of an object (or a limb e.g. the arm) with no consideration of the forces that cause movement. Therefore, kinematics refer to the description of position, velocity, and acceleration. Most studies in PA literature investigated only changes in movements endpoints, ignoring informative trajectory information (O'Shea et al., 2014). However, movement kinematics represent a considerable source of information concerning the underlying neural processes that drive motor behaviour (Jeannerod, 1984; 1989). During prism exposure, pointing performance may rapidly return to baseline performance even though endpoint accuracy can be retrieved without restoring the pre-exposure kinematics and trajectories (Redding & Wallace, 1996). Although after-effects assessment provides a measure of realignment, the investigation of pointing kinematics might also bring additional information as demonstrated by Jakobson & Goodale (1989) and O'shea et al. (2014). Firstly, it is crucial to describe the normal kinematics of a reaching movement.

2. Kinematic description of a reaching movement

Pointing to a target is a goal-directed reaching movement, also named aiming movement. In a seminal work, Woodworth (1899) proposed a model for describing goal-directed reaching movements. From this model, several other contributions enriched the model (see Jeannerod, 1989; Elliott, 2010 for a review). Two distinct phases compose a reaching movement. The initial part of the trajectory is a ballistic planned (pre-programmed) component that allows to lift and drive the limb to the target area. The terminal part of the movement is a corrective portion that allows to reduce any discrepancy between the limb and the target by integrating visual and proprioceptive feedback. This corrective portion is dependent on availability of feedback but also on the movement duration. If the movement is too fast, time will not be

sufficient to integrate sensory feedbacks properly. Therefore, slower movements are reported to be more accurate because more time is available for feedback adjustment.¹

Velocity and acceleration profiles of the limb allow to identify an acceleration phase (corresponding to the initial ballistic component) and a deceleration phase (referring to the corrective portion). Peak values of velocity, acceleration, and deceleration (i.e. negative acceleration) correspond to the classical kinematic landmarks. Thus, several key time points are identifiable during reaching trajectory (in addition to onset and endpoint times): time at acceleration peak (TPA), time at velocity peak (TPV), and time at deceleration peak (TPD). Time at velocity peak is the point between the acceleration and deceleration phase. At the end of the deceleration phase, i.e. when the limb is very close to the target, a final sub-movement is also identifiable which has the same profile of the global movement (i.e. an acceleration and a deceleration phases) but with minor amplitudes. It corresponds to the final limb-target regulation and cannot be expressed if the duration of movement is too short (Elliott et al., 2010; **Figure 24**; Gaveau et al., 2014)

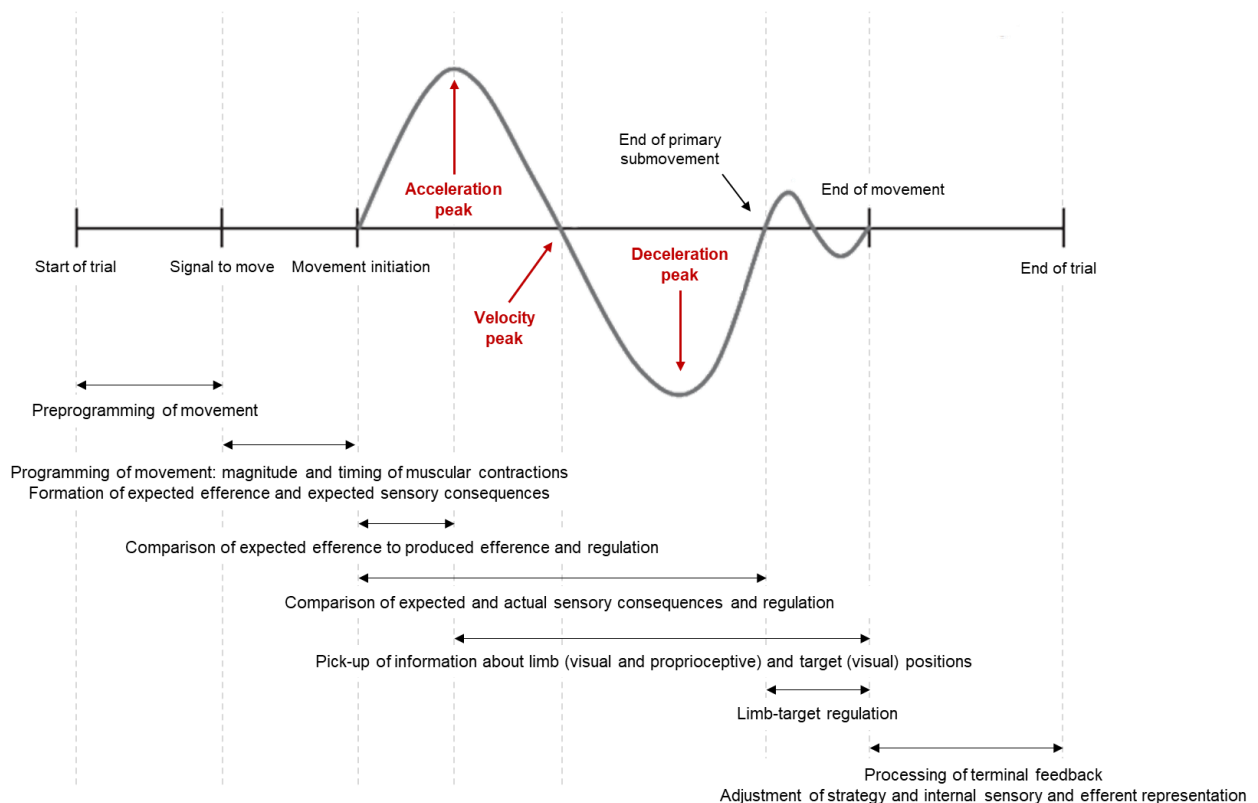

Figure 24 – Movements and processing events during a goal-directed reaching movement. The figure depicts the acceleration profile of the finger during a reaching movement directed to a small target. Multiple processing events are illustrated during the different parts of the movement. Adapted from Elliott et al., 2010

¹ Delays for processing visual feedbacks are approximately 150-200ms while delays for proprioceptive feedbacks are shorter; 100-150 ms (Cameron et al., 2014)

3. Kinematics changes during PA and variables of interest

Procedures of kinematics analysis in the present thesis are largely inspired from O'shea et al.'s work (2014). In this study, authors investigated kinematics of pointing movements during prism exposure: trajectories were analysed in the X-Y plan, i.e. the small curvature observed in the vertical axis was ignored. More precisely, they explored changes in the initial versus the terminal part of the trajectory and hypothesized that they would respectively reflect the different components of PA. To that purpose, trajectory orientations were computed for each point of individual trajectory for each pointing movement during exposure. Trajectory orientations referred to the instantaneous orientation of the tangential velocity vector at a given point of the trajectory, expressed relatively to the axis between the starting position and the target. Trajectory orientations for the initial phase of the pointing movements referred to the relative orientation of the tangential velocity vector at time of acceleration peak while trajectory orientation for the terminal phase corresponded to that at time of deceleration peak.

We will use the same methods to explore pointing trajectory orientation on-flight during prism exposure but also during familiarization, pre-tests and post-tests for **STUDIES 1, 3, AND 4**. We will analyse instantaneous trajectory orientation at times of acceleration and deceleration peaks and also at time of velocity peak in order to provide a more complete investigation. These measures will complement the analysis of the classical horizontal endpoint errors (i.e. difference between the finger's endpoint and the aimed target) and enable to investigate changes referring to feedforward control (initial part of the movement) versus feedback control (terminal part of the movement). Additional kinematic variables will be described, for instance movement durations, and values of times to acceleration, velocity and deceleration peaks. All kinematic variables of interest investigated in **STUDIES 1, 3 AND 4** are summarized and illustrated in **Figure 25 and 26**.

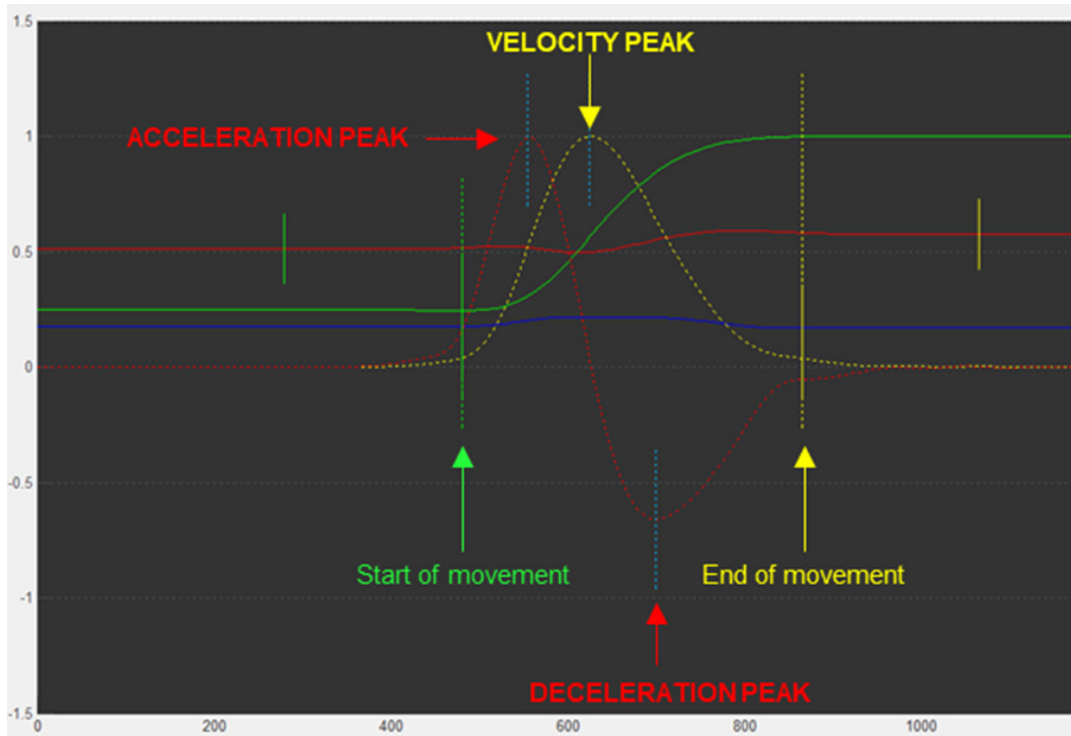

Figure 25 – Position, velocity and acceleration profiles of the index during a pointing movement. Red line: position in the horizontal X axis; Green line: position in the horizontal Y axis; Blue line: position in the vertical Z axis (not investigated). Red dotted line: acceleration profile. Yellow dotted line: velocity profile. The figure is issued from our in-house software written in MatLab and used to analyse pointing movements.

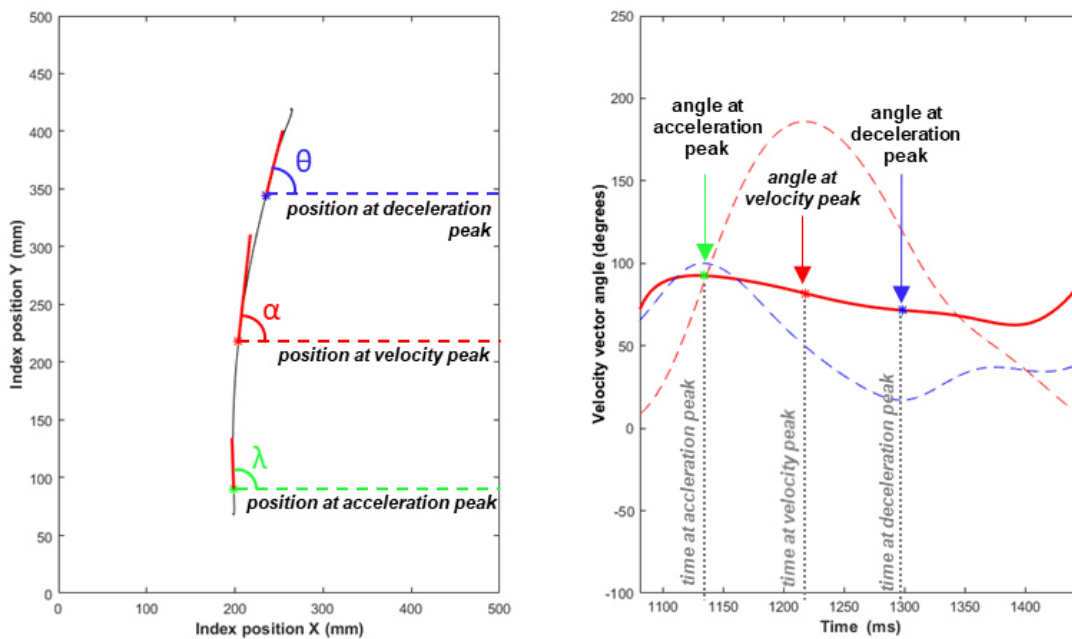

Figure 26 – Analysis of pointing kinematics: trajectory orientations. *Left:* illustration of a pointing trajectory with the velocity vector at acceleration, velocity, and deceleration peaks. Angles of the velocity vectors with the horizontal line are represented. *Right:* Evolution of the velocity vector angle during the pointing trajectory (red line). Red dotted line represents the acceleration profile. Blue dotted line represents the velocity profile.

4. Motion capture

Motion capture techniques allow to record, classify, and analyse human motion. A common technique is the use of reflective markers to triangulate the 3D position of the part of the body on which markers are placed between several cameras that have been calibrated to provide overlapping projections. In the present thesis, **STUDIES 1, 3 AND 4** will involve an optoelectronic motion capture system (9 cameras, Vicon Motions Systems Ltd, Oxford, 1984) to record kinematic measures using this triangulation technique. Reflective markers will be positioned on the index, the wrist, and the elbow of each subject. 9 cameras will surround the pointing and throwing experimental set-up (**Figure 27**). Each of these cameras is equipped with infrared light emitters and receptor. The reflective markers reflect the infrared light which is returned to the camera. Each camera records a 2D position of the markers. Records obtained by each camera are combined by the system to reconstruct the 3D position of markers for each sample of the pointing movement. This is possible thanks to an accurate calibration of the cameras preceding the data recording.

Then, trajectories are computed using in-house customized software written in Matlab. Pointing movements are detected using the following thresholds: onset of movement is defined as the point at which index velocity exceeds 80mm/s while offset of movement corresponds to the time-point at which velocity dropped below this threshold. Movements are automatically detected but all trials are cross-checked visually and adjusted manually if necessary. This data processing allows to obtain endpoint lateral errors and kinematics variables of interest that have previously been described. It is worth mentioning that we will only investigate pointing kinematics. As throwing are ballistic movement, we did not expect differential changes in the limb trajectory. However, the motion capture system will enable to compute throwing performances by recording the projectile trajectory. Data processing will allow us to detect the projectile impact on the board for each trial and to compute the lateral distance between the projectile and the aimed target.

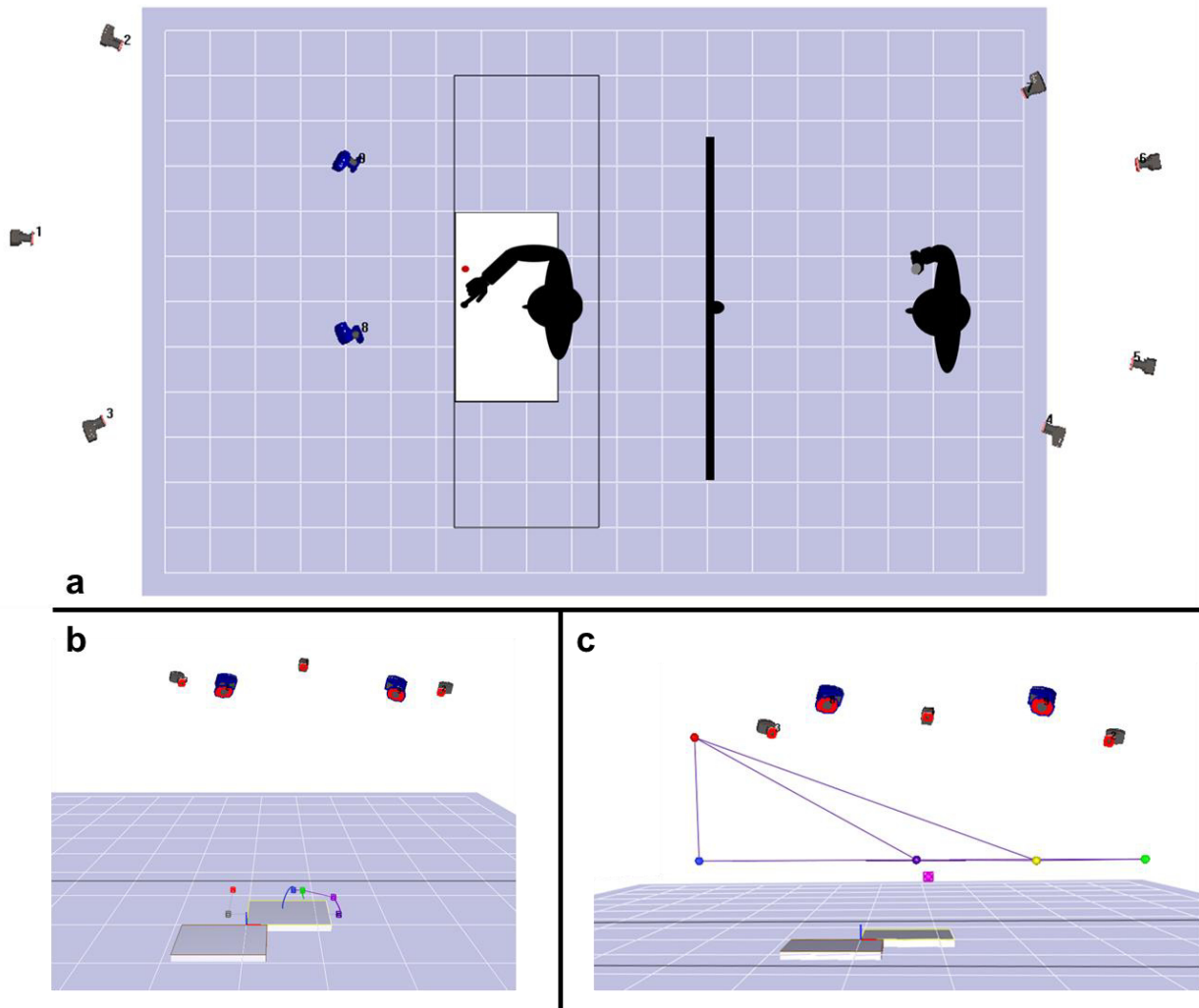

Figure 27 – Illustration of the motion analysis set-up. *a. Superior view of the motion capture set-up and illustration of the tasks set-up localization in the room. b. Model used for pointing movements with three markers positioned on the arm (blue: index, green: wrist, purple: elbow) and three markers on the pointing board. c. Model used for detecting the projectile (pink marker) impact on the board.*

C. MOTOR IMAGERY (STUDY 2)

Motor imagery MI is the mental representation of an action without its concomitant execution. In the *THEORETICAL BACKGROUND* we described this approach with a special focus on the neurofunctional equivalence: the mental representation of an action activates brain regions similar to those that are active during motor execution. Therefore, mental training with MI leads to an activity-dependent plasticity (see Guillot & Collet, 2010). Furthermore, we previously emphasized that PA through mental practice led to substantial after-effects (Michel et al., 2013).

Although MI is a research topic on its own, it also represents a way to investigate the cognitive operations at work to prepare an action regardless of sensory feedbacks from actual execution. During MI, the action is planned and programmed, involving sensory integration of initial body and environmental states together with an appropriate motor command. However, the actual execution is inhibited. Therefore, it offers an original way to investigate the role of motor planning and motor programming during PA, and particularly on after-effects transfer, while disregarding the influence of the actual execution, and related sensory and motor feedback and knowledge of movement outcomes. **STUDY 2** aims to investigate the characteristics of PA through MI, i.e. when the mental representations of pointing movements replace their actual execution during exposure to the prismatic deviation. The present section describes methodological aspects of MI that will be used in **STUDY 2**. Indeed, MI requires specific advices, e.g.:

- The main sensory system on which the image will have to be built, i.e. the recall of the information usually generated by the real action (mainly visual or kinesthetic),
- The initial and final positions which will correspond to the starting and ending points of the imagined action.

Furthermore, the quality of MI depends on the participants' ability to generate vivid and clear mental representations. MI abilities can be assessed by different means that will be described below. Finally, we will also present how to control the quality of motor imagery during prism exposure.

1. Characteristics of motor imagery

a. *Different types of motor imagery*

The mental representation of a given action requires the recall of sensory information usually associated with the actual action. This is a top-down process just as if the sensory information circulated antidromically (with reference to the usual direction of sensory information from the

peripheral to the central nervous system). The literature describes two main MI: visual and kinaesthetic. During visual MI, the participants recall the visual components of the action (tonic and phasic information related to static and dynamic cues, colours and shapes) while during kinaesthetic MI, they recall the physical sensations associated with the actual execution of the movement (tonic and phasic information related to body segments positions and movements, muscle stretching, joint pressure, body-environment contact). The kinaesthetic imagery better involves cerebral motor circuitry, e.g. the primary motor cortex, the pre-motor cortex, the basal ganglia and the cerebellum (Guillot et al., 2009) and better activates parietal areas (Grèzes & Decety, 2002).

Participants can perform visual MI with an internal perspective (in other words, imagining themselves performing the action i.e. first person) or with an external perspective (imagining someone else performing the action i.e. third person). In the internal perspective, participants recall the features of the action from their own view. From the external perspective, participants are required to visualize themselves performing the action as if they observed themselves from a posterior or lateral view. They can also imagine the action as being performed by someone else. Jackson et al., (2006) observed that visual MI through an internal perspective activated neuronal networks that are closer to those involved during actual execution.

b. Postural position

Motor imagery is dependent of sensory information integration regarding the initial state of the sensorimotor system (Toussaint & Blandin, 2010). The position in which individuals lie when imagining the movement influences the ability to form mental representations. For example, Guilbert et al., (2020) recently showed that MI of handwriting was facilitated when the initial position corresponded to the actual posture of this action. In incongruent posture, the participants reported greater difficulties with kinaesthetic mental representations

c. Motor Imagery ability

Expertise in a given motor task modulates the neuronal networks involved during motor execution (Doyon & Benali, 2005). Similarly, when individuals mentally represent an action as experienced performers, the cortical activation is more diffuse and the subcortical activation is more intense than in novices performers (Guillot et al., 2009; see Debarnot et al., 2014, for a review). The ability to form clear and vivid mental images is also different from one individual to another (Di Rienzo et al., 2014; Suica et al., 2018). As for actual motor performance, motor imagery ability activates different neural networks (**Figure 28**). Good imagers better activate motor areas during motor imagery whereas less activation occurs in individuals who have lower motor imagery ability (Guillot et al., 2008). As motor imagery ability modulates cerebral activation during motor imagery, it may influence the activity-dependent plasticity entailed by

mental practice (Suica et al., 2018). In **STUDY 2**, we will investigate the influence of MI ability on PA. A crucial challenge in MI studies is to assess MI ability. The next subsection will present the methods that can be used.

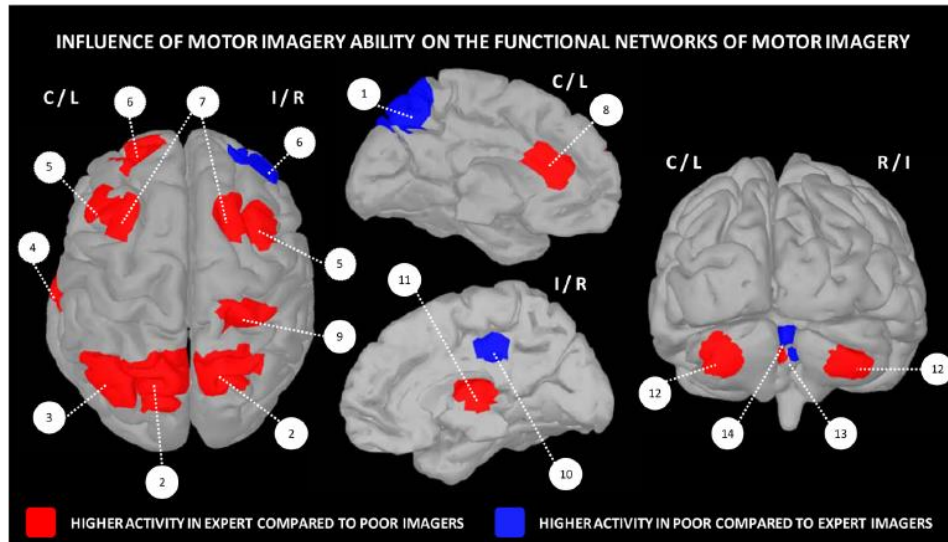

Figure 28 – Influence of MI ability on the brain activations during MI. From Debarnot et al., 2014. 1. Precuneus; 2. Superior parietal cortex; 3. Inferior parietal cortex; 4. Fusiform gyrus; 5. Lateral premotor cortex. 6. Frontal cortex; 7. Dorsal premotor cortex; 8. Anterior cingulate cortex; 9. Post-central gyrus; 10. Posterior cingulate cortex; 11. Thalamus; 12. Cerebellar cortex; 13. Cerebellar lobule IV, 14. Cerebellar lobules IV/V.

2. Assessment of Motor Imagery

Neuro-imaging enables to objectively quantify brain activations during motor MI and to differentiate neural networks involved in visual or kinaesthetic imagery (Guillot et al., 2009) or good versus bad imagers (Guillot et al., 2008). The more similar activations are between mental and physical practice, the more efficient is MI. A simpler method refers to autonomic nervous system responses during MI. Several studies showed that cardiovascular and electrodermal responses are highly correlated with MI quality (Collet et al., 2013). However, although neurovegetative responses are easier to record than metabolic brain responses to MI, both have strong constraints. Therefore, we will emphasize subjective methods to assess MI vividness (i.e. the clarity and richness of mental representations) and controllability (i.e. the ease to manipulate mental representations), two main qualitative abilities of MI.

a. Self-assessment of MI ability

The most used tool to assess MI ability is the Movement Imagery Questionnaire (MIQ) and its revised version (Gregg et al., 2010; Hall & Martin, 1997). The MIQ-R is composed of 4 visual imagery items and 4 kinaesthetic imagery items. Each item involves limbs or whole-body movements. The questionnaire describes the starting position for each movement. First, the

participant is required to actually perform the movement once. Then, the participant is asked to mentally perform the same movement without any concomitant execution. Each participant uses a 7-point Likert scale to self-report the ease or the difficulty to perceive the image visually or bodily (kinaesthetic items). The motor image is assessed from 1 (very easy to perceive) to 7 (very difficult to perceive). The KVIQ (Kinaesthetic – Visual Imagery Questionnaire) was elaborated by Malouin et al. (2007) to be suitable for participants with altered motor functions and implied gross motor movements.

Although psychometric evaluations of the MIQ and its revised version provided good reliability and validity (Atienza et al., 1994), its subjective nature encourages to associate paper and pencil tests with neuro-imaging (Lorey et al., 2011), EEG (e.g. Toriyama et al., 2018) or neurovegetative indices (e.g. Collet et al., 2013). Questionnaires scores were well correlated with level of cerebral activation during MI: participants that reported the highest scores of motor imagery ability showed the highest level of motor areas activations (Williams et al., 2012)

b. Self-assessment and chronometric measures to control MI quality

It is crucial to evaluate the vividness of mental representations, i.e. the clarity and sensory richness. Self-assessment of MI vividness can easily be obtained during experimental procedures through Likert scales. Saruco et al., (2018) used a 5 point Likert scale from 1 (no image/no sensation) to 5 (image as clear as in a movie/sensations as intense as during actual movement). This 5-level rating was that of KVIQ questionnaire (Malouin et al., 2007).

Mental chronometry compares the duration of imagined movements relatively to actual movements. Isochrony reveals that MI kept the temporal features of actual movement and is considered a pragmatic indicator of MI quality (Guillot & Collet, 2005; Guillot et al., 2012). Decety & Jeannerod (1995) previously showed that imagined and actual movements presented similar temporal patterns. Subsequent studies confirmed the strong correlation between imagery and actual movement durations. The capacity to preserve temporal aspect of the action during MI is related to the ability to produce precise mental representations. If the duration of the imagined movement is shorter than the duration needed to perform the same movement, this could attest inability to produce precise mental representation. By contrast, if the motor representation takes longer than its actual execution, this could reveal difficulties to generate mental representations (Guillot, Hoyek, et al., 2012). Actual movement duration might influence the temporal congruence between imagined and actual movements. Actions shorter than 5s. are often overestimated during MI while those longer than 30s. are generally underestimated (Guillot & Collet, 2005). Therefore, pointing movements during PA can be expected to be overestimated during MI. To overcome this difficulty, **STUDY 2** will involve series of pointing movements (i.e. sequences) in the in PA by motor imagery procedure.

3. Requirements for PA by motor imagery

In summary, several key methodological aspects need to be taken into account in **STUDY 2**. In order to produce the richest mental representations, participants will be instructed to imagine pointing movements from the first person perspective (i.e. as an actor), and to mentally recall the clearest perceptions (both kinaesthetic and visual) associated with actual execution. Both imagined and actual starting position of the hand will be congruent. As recommended by Michel et al. (2013) the immobile hand in its starting position will remain under visual control during exposure (**Figure 29**). To favour isochrony, imagined pointing movements during exposure will be sequential i.e. several unique ballistic pointing movements for one trial. Finally, we will control MI quality during exposure using the self-rating scales. Self-assessment of MI vividness and mental chronometry will allow to control motor imagery quality during prism exposure. We will more precisely described these conditions in the methods section of **STUDY 2**.

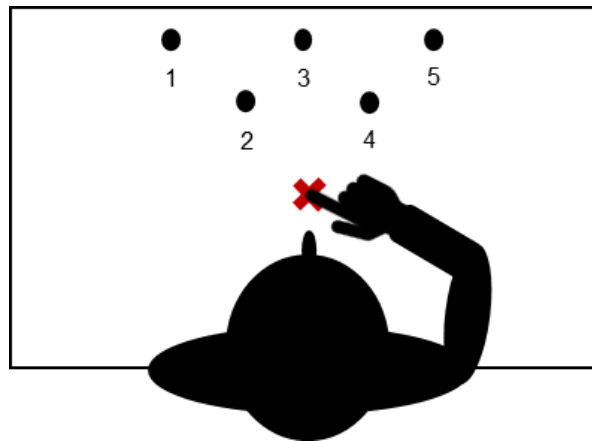

Figure 29 – Pointing task set-up for Motor Imagery. *The figure illustrates the modifications of the pointing task for Study 2. Starting position is visible and 5 targets are positioned in front of the subject in order to produce sequences of pointing.*

D. TRANSCRANIAL DIRECT CURRENT STIMULATION (STUDIES 3 AND 4)

One of the main objectives of the present thesis is to explore the influence of cerebellum neuromodulation on prism adaptation and specifically in inter-task transfer of after-effects following exposure. To achieve this objective, **STUDIES 3 AND 4** will use transcranial direct current stimulation (tDCS) of the cerebellum. The present subsection aims at describing tDCS and its physiological effects and to present tDCS procedures that will be used to target the cerebellum.

1. Description

Electrical brain stimulations techniques have been studied for around a few hundreds of years (Guleyupoglu et al., 2013; Stagg et al., 2018). In the early days, suprathreshold stimulations were used to provoke spontaneous electrical activity in the brain. tDCS differs from these approaches and consists in the subthreshold modulation of neuronal membrane potentials. The purpose is to alter the excitability and therefore the spontaneous activity of targeted neurons. Contrary to suprathreshold techniques (for instance Transcranial Magnetic Stimulation), stimulation induced by tDCS is too weak to cause a neuronal activity independent from afferent input arising from other sources. Non-invasive brain stimulation using direct current was first reported in the 1950's and subsequently explored in animal models and humans (Nitsche, Liebetanz, et al., 2003). However, the interest for direct current stimulation rapidly decreased certainly because of the lack of methods to investigate its effects. tDCS has known a renewed interest during the last two decades since the publication of a set of studies that demonstrated the physiological effects of the stimulation (Stagg et al., 2018). More interestingly, these studies probed the presence of after-effects lasting for several minutes after the stimulation has been turned off (Nitsche & Paulus, 2000, 2001; Nitsche, Nitsche, et al., 2003; Priori et al., 1998). From this point, tDCS became a promising approach for basic neurosciences, but also for clinicians as a potential tool to modulate behaviour. One of its advantage is that it is more physiological and therefore less subjected to ethical restrictions than TMS. Consequently, the recent years were marked by an increased number of publications probing cognitive, behavioural, and clinical effects of tDCS. More than a tool for rehabilitation treatment, tDCS techniques provide numerous advantages to understand brain functioning. This method represents a non-invasive way allowing researchers to infer about the neural processes underlying specific behaviour, for instance those related to sensorimotor adaptation (e.g. Panico et al., 2016). Indeed, tDCS studies offer the possibility to establish causal relationship between targeted brain areas and their functions (Filmer et al., 2014). An

additional advantage is that tDCS is painless and can be delivered during any motor task (Ferrucci et al., 2015).

2. Physiological effects of tDCS

b. From neuron level to network level

A main particularity of neurons is that they are electrically excitable: the generation of electric signals, i.e. mostly action potentials, determines their activity. The resting membrane of neurons is polarized. Action potentials are generated when the resting membrane is depolarized beyond a given potential threshold. Afferent activity induces variations in the potential of the neuronal membrane via electrical and chemical synapses and by extra synaptic substances, which activate specific ions channels and receptors. The purpose of tDCS is to directly modulate resting neuronal membranes potentials to alter the state of excitability, i.e. the probability that afferent activity of a specific amplitude results in generation of an action potential. If the current induces a depolarization of the neuronal membrane, less afferent activity will be necessary to provoke an action potential, i.e. excitatory stimulation. Conversely, if the membrane is hyperpolarized by the current, the neuronal excitability will decrease, and a more intense stimulation will be necessary to trigger spontaneous activity, i.e. inhibitory stimulation. tDCS is ensured by means of two electrodes: the anode (electrode with a positive charge) and the cathode (electrode with a negative charge). The current is applied from the anode to the cathode. The placement of the two electrodes determines the polarity of the stimulation. Anodal tDCS requires the placement of the anode over the targeted brain area and is generally associated with increased cortical excitability. Conversely, cathodal tDCS entails the placement of the cathode over the region of interest and generally induces a decreased cortical excitability (Filmer et al., 2014; Stagg et al., 2018).

Physiological effects of tDCS arising from changes at the neuron level are also observable at the whole targeted-area level. For example, anodal tDCS of the primary motor cortex provokes an increased spontaneous activity while cathodal stimulation of the same area decreases spontaneous activity and excitability (Bindman et al., 1964; Nitsche & Paulus, 2000). In addition, tDCS effects are also observable at the network level. For instance, Galea and colleagues (2009) reported a cerebellar tDCS-induced modulation of the cerebello-brain connectivity (i.e. in the cerebello-cortical connections with the primary motor cortex). To better understand the effects at the whole-brain level, it is crucial to depict the neurophysiological basis of the mechanisms of tDCS at the neuron and synaptic levels (for a recent review, see Stagg et al., 2018). To that purpose, tDCS can be describe as acute effects versus long-term effects (i.e. after-effects) that are not underpinned by the same mechanisms.

c. Acute versus long-term effects

Acute effects refer to the direct effects of tDCS observable during the stimulation and that do not outlast it. Interestingly, tDCS also induces after-effects whose direction is identical to that observed during stimulation. These long-term effects can be long-lasting from minutes up to 24 hours following the end of the stimulation and can be related to long-term potentiation and depression phenomenon (Malenka & Bear, 2004). Notably, acute effects and long-term effects are not mediated by the same neurobiological processes (Stagg et al., 2018). While acute effects would be driven by membrane potentials alteration, long-term effects would rather be supported by changes in synaptic efficacy (Nitsche et al., 2005), i.e. the capacity of the pre-synaptic neuron to transmit information to the post-synaptic cell. Indeed, Studies using transcranial magnetic stimulation to quantify modifications of synaptic efficacy did not show any synaptic changes underlying acute effects of short-lasting tDCS (Nitsche et al., 2005). Pharmacological studies confirmed these results: the blockade of voltage-dependent ion channels involved in neuronal membrane depolarization was reported as precluding any effect of anodal tDCS on motor cortex excitability which is in favour of membrane potentials changes in acute tDCS effects. By contrast, enhancing GABA receptors and blocking glutamate ones had no impact on acute effects, suggesting that changes in neuromodulators activity had no influence on acute effects of tDCS (Nitsche, Fricke, et al., 2003).

Long-term effects (i.e. after-effects) of tDCS are likely mediated by tDCS-induced changes in neuromodulators activity. The glutamate is the main excitatory neurotransmitter of the CNS while GABA is the principal inhibitory one. By enhancing or decreasing their activity, the pharmacological injection of agonist or antagonist to these neurotransmitters enables to investigate their role in the long-term effects of tDCS. Thus, it seems that tDCS induces a calcium-dependent plasticity in glutamatergic synapses. In fact, the blockade of NMDA (N-methyl-D-aspartate) glutamate receptors inhibits both cathodal and anodal tDCS induced excitability while the injection of NMDA agonists increases anodal tDCS-induced excitability enhancement (Nitsche, Fricke, et al., 2003; Nitsche et al., 2004). However, the modulation of the glutamatergic system induced by tDCS would not be sufficient if GABAergic inhibitory processes are still efficient. Yet, tDCS also modulate the activity of GABA receptors: Magnetic Resonance Spectroscopy (MRS) studies showed a reduction of GABA activity after both anodal and cathodal stimulation to M1 (Bachtiar et al., 2015; Stagg et al., 2011; Stagg et al., 2009) which was confirmed by TMS studies (Nitsche et al., 2005). tDCS-induced GABA reduction seems to gate the glutamatergic plasticity in tDCS after-effects (Stagg et al., 2018). Therefore, tDCS offers the possibility to modulate the cortical excitability (acute effects) but also the synaptic efficacy (after-effects) which is involved in neuroplasticity processes (long-term potentiation and depression) underlying sensorimotor plasticity processes.

3. Targeting the cerebellum

The understanding of the neurobiological effects underlying tDCS was mainly improved using primary motor cortex models. However, the cerebellum has an entirely different cytoarchitecture compared to the cerebral cortex. Therefore, findings from M1 tDCS should not directly apply to cerebellar tDCS. The cerebellum has the highest concentration of neurons of the brain: although it represents 10% of the brain volume, it contains 80% of its neurons (Herculano-Houzel, 2009). The position of the cerebellum immediately below the skull implies that this target should be particularly interesting for an efficient neuromodulation (van Dun et al., 2017).

a. Is cerebellar tDCS efficient in sensorimotor adaptation studies?

At the behavioural level, cerebellar tDCS has been shown to efficiently alter behavioural functions. In a recent meta-analysis, Oldrati & Schutter (2018) reported that 1-2 mA tDCS targeting the cerebellum was effective to modulate cognitive and motor performance in healthy individuals. However, the meta-analysis did not probe any significant polarity-dependent effects of anodal and cathodal cerebellar tDCS on respectively improving and disrupting targeted functions. Concerning sensorimotor adaptation, our **THEORETICAL BACKGROUND** depicted a set of studies probing evidence that cerebellar neuromodulation by tDCS influence prism adaptation components (e.g. Panico et al., 2016, 2018), with various polarity-dependent effects.

On the neurophysiological level, the physiological effects induced by cerebellar tDCS were related to functional changes in the cerebellum itself, probably by interfering with membrane potentials in Purkinje cells and other cerebellar neurons (mossy and climbing fibers; Ferrucci et al., 2015). Furthermore, modelling studies corroborated this hypothesis by suggesting that the homogeneous structure of the cerebellum enables a focused and effective direct current stimulation (e.g. Parazzini et al., 2014; Rampersad et al., 2014). Overall, the literature suggests that the cerebellum is a relevant target for an effective tDCS. A crucial aspect of cerebellar tDCS lies on the placement of the electrodes.

b. Montages: electrodes placement

tDCS is applied using a battery-driven stimulation that delivers the current via two rectangular sponge electrodes embedded in a saline-soaked solution (Dundas et al., 2007). In cerebellar tDCS studies, it is possible to stimulate either the entire cerebellum or half of the cerebellum. **STUDIES 3 AND 4** of the present work involve reaching movements performed with the right limb. Therefore, tDCS will target the right hemisphere of the cerebellum (Schlerf et al., 2015). Most protocols designed to stimulate half of the cerebellum use electrodes of a 25cm² area (5cm x 5cm; e.g. Galea et al., 2009; Panico et al., 2016; Pope & Miall, 2012). The placement

of the electrodes is crucial: it determines the direction of the current and ensures that the good area is targeted. In cerebellar montages, the stimulating electrode (the cathode for cathodal stimulation and the anode for anodal stimulation) is placed laterally over one cerebellum hemisphere, 1-2 cm below and 3-4cm lateral to the inion (e.g. Ferrucci et al., 2013; Herzfeld et al., 2014; Panico et al., 2016). The return electrode (i.e. the anode for cathodal stimulation and the cathode for anodal stimulation) is placed on a non-brain region, either over the buccinator muscle (e.g. Galea et al., 2009) or the right shoulder (i.e. deltoid muscle; e.g. Panico et al., 2016; Pope & Miall, 2012). In PA procedures coupled with tDCS, the stimulation has been shown to be effective for a placement using the inion-based shoulder montage (e.g. Panico et al., 2016, 2018). The placement of the electrodes requires the careful cleaning of the scalp and the shoulder skin and the identification of the exact place where the stimulating electrode needs to be placed, i.e. 1 cm below and 4 cm right to the inion for our studies (**Figure 30**), which is an anatomical landmark easy to identify (Ferrucci et al., 2015). For the placement of the return electrode over the shoulder, participants are required to realize an elevation of their right arm in the frontal plan to identify the deltoid muscle contraction. Once placed, electrodes can be secured in position with an elastic tubular netting or with an ergonomic cap. Although placement of electrodes should be individualized thanks to neuro-imaging data to optimize the efficacy of the stimulation, a modelling study showed that varying the position of the stimulating electrode about around 1 cm did not induce substantial changes in the electric field distribution suggesting that the use of neuro-navigation system may probably not be indispensable (Parazzini et al., 2014).

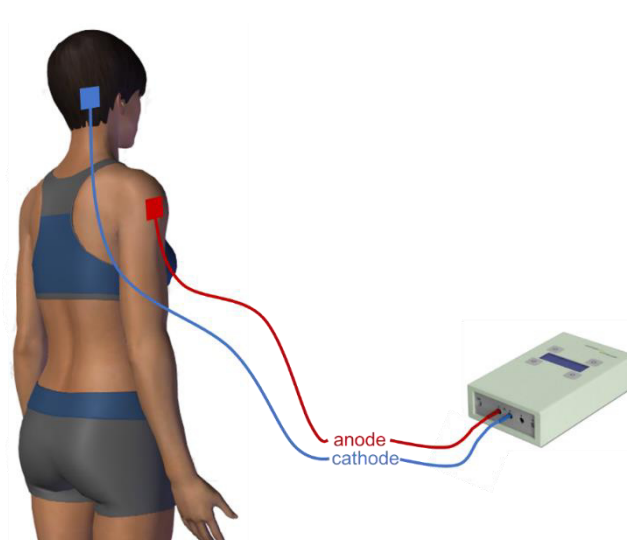

Figure 30 – tDCS montage for cathodal tDCS. The cathode is placed 1 cm below and 4 cm right to the inion and the anode is placed over the right deltoid muscle. The montage is reversed for anodal stimulation. Both electrodes are connected to the battery-driven stimulator (neuroConn, neuroCare group, Germany).

4. Safety

Although tDCS is a painless and safe technique to neuromodulate the brain, its application must follow some safety requirements (for a review of tDCS safety evidences, see Bikson et al., 2016). For a surface electrode of 25 cm² and an intensity of 2mA, the duration of the stimulation might not overlast 21 minutes (Nitsche & Paulus, 2000; Woods et al., 2016). To minimize the risk of burn below the electrodes, investigators should avoid the placement of electrodes over scars, nevi or other skin abnormalities that could alter skin resistance nor over skull holes or fractures. The stimulator that delivers the current offers a measure of the voltage and the impedance. The voltage monitoring allows controlling the safety of the stimulation while the impedance allows checking that the current actually goes from one electrode to the other. During stimulation, participants can feel a metallic taste and an itching or tingling sensation. If the participant complains of persistent pain or burning sensation below the electrodes, the stimulation must be immediately stopped and the skin below the electrodes inspected. If no lesion or redness is observed, more saline solution or conductive gel could be added below the electrodes and stimulation can be restarted. However, if the discomfort persists, stimulation needs to be definitively stopped (Ferrucci et al., 2015; Woods et al., 2016). Exclusion criteria that apply for tDCS studies require the participants to be free of any unstable medical conditions, to not be under a pharmacological treatment related to neurological conditions, to have no history of epilepsy and to have no metallic implants near the electrodes (Brunoni et al., 2012).

5. Sham procedures

Sham procedures are used to guarantee that effects of the stimulation are actually due to the stimulation and not to a practice or placebo effect. The most common sham procedure consists of ramping up the current to the similar intensity that is used in the active stimulation procedure. Then, the current is immediately ramped down. This leads to an active stimulation of approximately 30 to 60 seconds (van Dun et al., 2017; Woods et al., 2016). After that, the electrodes remain on the head of the subjects. The purpose is to blind the subjects for sham or active stimulation by producing the same initial itching and tingling sensations. In fact, Gandiga et al. (2006) reported that sensations associated with turning on the current usually disappear following the first 30 seconds of the stimulation while ramping down the current progressively does not induce perceivable sensations. Therefore, participants in sham and active conditions feel the same sensations and sham procedure with at least 30 seconds of active stimulation effectively blind the subjects (Kessler et al., 2012). An important observation is that active stimulation of 30 seconds is too short to induce tDCS after-effects, and it is necessary not to start the experimental task before the current has ramped down to zero.

6. PA procedure combined with tDCS

STUDY 3 AND STUDY 4 will combine PA procedure with tDCS to assess inter-task transfer of after-effects. PA procedure is similar as the one used in **STUDY 1**. tDCS will be turned on before the beginning of the pre-tests and turned off at the end of post-tests, with a maximal duration of 21 minutes (**Figure 31**).

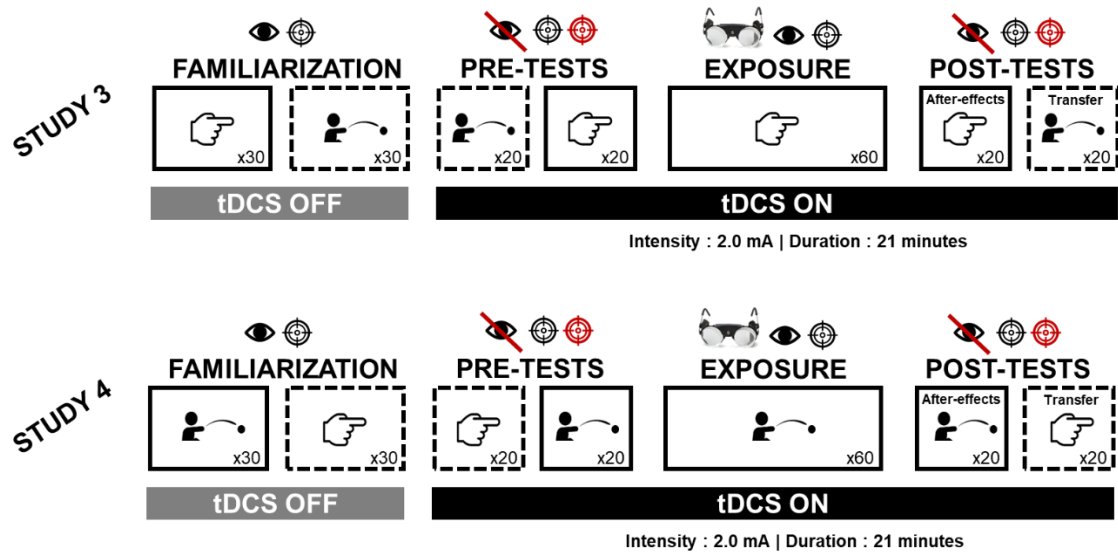

Figure 31 – Illustration of the procedure for PA combined with tDCS. tDCS is turned on before pre-tests and turned off at the end of post-tests, with a maximal duration of 21 minutes.

Chapter 3

Experimental Contributions

OVERVIEW OF THE CHAPTER

The **EXPERIMENTAL CONTRIBUTIONS** part aims at presenting the original experimental research conducted to achieve the objectives of the present thesis. This part is divided into three axes. The **AXIS 1, TRANSFER & EXPERTISE**, includes the **STUDY 1**. The **AXIS 2, TRANSFER & MOTOR IMAGERY**, comprises the **STUDY 2**. The **Axis 3, TRANSFER & tDCS**, consists of two studies: **STUDY 3** and **STUDY 4**. All the experimental contributions are presented in the form of scientific articles that can be read separately from the remainder of the document. For this reason, some aspects might be redundant between the different articles and with the **THEORETICAL** and **METHODOLOGICAL BACKGROUNDS**. The manuscripts presented below are either published (**STUDY 1**), in the process of revision (**STUDY 3**) or in preparation for submission (**STUDY 2** and **STUDY 4**).

A brief overview and a short synthesis of findings are proposed before and after each manuscript.

A. AXIS 1: EXPERTISE AND TRANSFER

1. Study 1: Manuscript

The purpose of this study was to investigate the influence of the task performed during prism exposure on the transfer of after-effects to a task that has not been performed under the prismatic shift. **STUDY 1** included a total of 50 healthy participants and was divided into three experiments. Experiment **1A** investigated the transfer between throwing and pointing and between pointing and throwing. Experiment **1B** tested whether expertise on the throwing task influenced the transfer of after-effects to the pointing task. Experiment **1C** replicated experiment **1A** and aimed at providing additional information concerning the mechanisms of transfer by investigating the temporal dynamics of after-effects and kinematics

This work has been accepted in *Scientific Reports*. The published version of the article is presented below.

OPEN

Inter-task transfer of prism adaptation depends on exposed task mastery

Lisa Fleury^{1,2,3*}, Damien Pastor¹, Patrice Revol^{1,2}, Ludovic Delporte^{1,2} & Yves Rossetti^{1,2,3} 

The sensorimotor system sets up plastic alterations to face new demands. Terms such as adaptation and learning are broadly used to describe a variety of processes underlying this aptitude. The mechanisms whereby transformations acquired to face a perturbation generalize to other situations or stay context-dependent remain weakly understood. Here, we compared the performance of hand pointing vs throwing to visual targets while facing an optical shift of the visual field (prismatic deviation). We found that the transfer of compensations was conditioned by the task performed during exposure to the perturbation: compensations transferred from pointing to throwing but not at all from throwing to pointing. Additionally, expertise on the task performed during exposure had a marked influence on the amount of transfer to the non-exposed task: throwing experts (dart players) remarkably transferred compensations to the pointing task. Our results reveal that different processes underlying these distinct transfer properties may be at work to face a given perturbation. Their solicitation depends on mastery for the exposed task, which is responsible for different patterns of inter-task transfer. An important implication is that transfer properties, and not only after-effects, should be included as a criterion for adaptation. At the theoretical level, we suggest that tasks may need to be mastered before they can be subjected to adaptation, which has new implications for the distinction between learning and adaptation.

The transfer of motor transformations remains a crucial issue both in the fields of cognitive neuroscience of action¹ and neurorehabilitation of movement disorders². Imagine a patient being able to transfer motor compensations acquired during an ideal, unique rehabilitation session onto all other daily life situations. Then, the aim for therapists would be to solicit sensorimotor plasticity processes implying transformations that can generalize beyond the context in which they were developed³.

Humans are remarkably capable of producing smooth and precise movements despite continuously varying demands and fluctuating internal resources. The plasticity that characterizes our nervous system encompasses the capacity to acquire new motor program and the capacity to modify existent pattern to face new conditions. Bastian relates these definitions respectively to learning and adaptation²⁻⁴. As such, skill learning is related to the establishment of a 'new control policy' while adaptation refers to the 'recalibration of an existing control policy'⁵. Practically, learning is characterized by error reduction curves and associated with transformations that are stored and directly available in the appropriate context: individuals can switch between acquired patterns of movement depending on the specific situation. By contrast, although it also involves an error reduction curve, adaptation specifically implies the presence of compensatory after-effects (i.e. the presence of behavioral changes once the perturbation ceased)^{3,4}. Few theoretical proposals have been made to clarify the terminology of learning and adaptation^{2-4,6,7}, and there seems to be no consensus on this issue. In addition, only few specific empirical research is available on this distinction^{5,8}. Consequently, these terms are widely used indiscriminately and interchangeably in sensorimotor plasticity literature. In an attempt to offer empirical bases on the distinction between learning and adaptation, we hypothesized that the presence of generalization beyond the exposure context may provide interesting clues about which process is predominantly used in a given situation. Patterns of transfer deliver clues about the nature of transformations that occurred in the central nervous system to face a given perturbation^{1,9}. We therefore explored whether transfer properties could distinguish between processes involved in the compensations set up during exposure to a visual distortion relatively to the expertise level on the exposed task.

¹INSERM U1028 CNRS UMR 5292, ImpAct Team, Lyon Neuroscience Research Center (CRNL), 69500, Bron, France.

²"Mouvement et Handicap" platform, Neurological Hospital, Hospices Civils de Lyon, 69500, Bron, France. ³Claude Bernard University of Lyon 1, 69100, Villeurbanne, France. *email: lisa.fleury@univ-lyon1.fr

Prism exposure is a classic and efficient paradigm that allows to study the implication of sensorimotor plasticity processes, respectively named as strategic recalibration and sensory realignment^{4,8,10}. In a typical prism exposure protocol, subjects are actively exposed to a shift of the visual field induced by prism spectacles while performing a pointing task at least until performance regains baseline level. Then, the compensatory after-effects are measured once the prisms are explicitly removed to assess visuo-motor compensations toward untrained locations (i.e. spatial generalization)¹¹. Caution for specific realignment assessment include pointing to untrained locations and explicitly removing the distorting glasses (e.g. Weiner *et al.*¹²). Recalibration allows to quickly reduce errors but not to generalize compensations. However, realignment enables to set up new body parameters and thus lead to a potential transfer of after-effects beyond the task context¹³. It is usually accepted that the respective contribution of strategic and realignment components of the compensation varies as a function of trial number, and that longer exposure increases the contribution of the sensory realignment^{14,15}.

Numerous studies have investigated the generalization of prism after-effects and contrasted results are drawn. Several authors argue that transformations are specific to the context in which the participant was exposed to the perturbation. For example, after-effects would remain relatively specific to the velocity of movement trained¹⁶, the starting position, and effector¹⁷ or the task pattern^{18,19}. However, other studies described alterations that transferred beyond the task context: to non-learned locations^{20,21} or to other effectors^{22–26}. Much variability in the similarity between exposure and after-effect testing conditions can be found across these studies. According to the classical view of prism adaptation, proper adaptation should give rise to modifications that remain visible when the exposure context has been removed^{4,6,7}. As such, cross-transfer between two tasks should provide a strong measure of context-independent adaptation by subtracting the part of after-effects potentially linked to exposure-contextual cues.

This study aimed to compare the transfer of visuo-motor transformations acquired during prism exposure between two oddly mastered tasks: throwing and pointing, the main two tasks used in the classical “prism adaptation” literature. Pointing is the most extensively used and is a casual, overlearned task associated with stable and precise performance. In contrast, throwing is far less practiced in everyday life, highly projectile dependent (e.g. dart vs basketball), usually with low accuracy constraints, and generally not fully mastered unless it is specifically trained. Despite their apparent similarities, these two aiming tasks are associated with very different level of mastery and therefore variability in performance^{27,28}. Our prediction was that the asymmetrical degree of mastery for these tasks should yield to an asymmetrical pattern of transfer. First, we showed that these two tasks produce highly comparable mean error-reduction curve and after-effects although variability was much higher for throwing than pointing. Crucially the transfer test revealed a unidirectional transfer from pointing to throwing and null transfer from throwing to pointing (Experiment 1). Second, throwing experts (dart players) transferred prism compensations from throwing to pointing. These findings suggest that expertise determines preference for context-independent processes to face sustained perturbation (Experiment 2). Finally, we attempted to investigate the mechanisms underlying the unidirectional transfer and showed that kinematics of pointing movements uncover potential mechanistic explanations for our results (Experiment 3).

Results

Experiment 1: Influence of the task performed during prism exposure on transfer. In experiment 1, we randomly assigned 24 participants to two groups according to the goal-directed task realized during exposure to the optical shift. The pointing group performed finger pointing during exposure while the throwing group threw small spheres during exposure. We first familiarized participants on both tasks. Then we measured participants’ performances on both tasks (pre-tests). Participants were then asked to wear prismatic glasses that induced a 10 degrees shift of the visual field toward the right while performing the exposed task (throwing or pointing). Immediately after exposure, we removed prisms and assessed after-effects with the exposed task (classical measure of adaptation) and then with the non-exposed task (transfer). The different steps of the experiment are illustrated in Fig. 1 and the specific conditions of each step are summarized in Table 1. Performance was measured as the lateral deviation between the index endpoint (pointing) or ball impact (throwing) and the aimed target and are reported in degrees (see Methods section for a precise description of measurements). Trial-by-trial average endpoint errors during the whole experiment are presented in Supplementary Figure 1 (Supplemental information). Statistical analysis results are detailed in Tables 2–5. Means are reported together with standard deviations.

No difference during familiarization except in variability. Average individuals’ performance, i.e. mean endpoint errors, was similar between groups ($F(1,22)=0.13$; $p=0.71$) and close to zero (non-significant t-test against zero for both groups and both tasks). However, the mean variability of endpoints errors was much larger for throwing movements (mean variance = 4.84 ± 3.25 degrees² for the throwing group; 3.83 ± 2.40 degrees² for the pointing group) than for pointing movements (mean variance = 0.26 ± 0.16 degrees² for the throwing group; 0.27 ± 0.43 degrees² for the pointing group) in both groups (significant task effect, $F(1,22) = 49.37$; $p < 10^{-7}$), see Fig. 2.

No difference in baseline performance. Participants showed the same average performance (close to zero) regardless of the task performed ($F(1,22) = 0.16$; $p=0.69$). The mean variability of throwing movements was also about 8 times larger than pointing movements for both groups.

Similar error reduction during prism exposure. Both groups exhibited similar error reduction curves. A repeated-measure ANOVA (rmANOVA) comparing mean individuals’ endpoint errors between groups (Pointing and Throwing) and across blocks (1 to 6) revealed a significant effect of Block ($F(1,22) = 36.46$; $p < 10^{-7}$) but no main effect of Group and no interaction. Thus, during exposure subjects reduced their errors similarly regardless of the task performed during exposure.

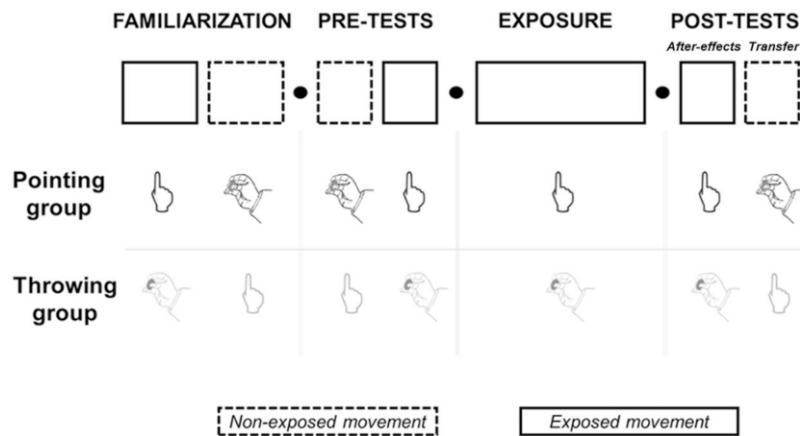

Figure 1. Different steps of the experimental protocol. Solid-line boxes represent the steps in which participants performed the exposed task and dotted-line boxes are related to the non-exposed task. For each step of the experiment, tasks performed are illustrated for the pointing and the throwing groups. Early tests (specific to experiment 3) are not represented.

	Familiarization	Pre-tests	Exposure	Early tests	Post-tests
Prisms	OFF	OFF	ON	OFF	OFF
Visual Feedback	Available	None	Available	None	None
Targets	Central	Central or Right	Central	Central or Right	Central or Right
Number of trials	2*30	2*20	60	2*20	2*20

Table 1. Summary of the specific conditions for each step of the experiment. Note: early tests are specific to experiment 2.

Noticeably, error reduction was not complete at the end of the exposure for both groups. Indeed, the mean endpoint error during late exposure (10 last trials) was significantly greater than during late familiarization (10 last trials) in both group (1.01 ± 0.85 vs 0.27 ± 1.05 in the throwing group, $t(11) = -2.68$, $p < 0.05$; 0.68 ± 0.38 vs 0.12 ± 0.23 in the pointing group, $t(11) = -4.42$, $p < 0.05$).

Similar after-effects. After-effects as well as transfer values are reported after subtracting mean baseline performances (pre-tests) for each subject. Participants showed significant errors opposite to the prismatic deviation in both Throwing (mean = -4.51 ± 1.68 degrees; $t_{\text{zero}}(11) = -9.26$, $p < 10^{-6}$) and Pointing group (mean = -4.43 ± 0.09 degrees; $t_{\text{zero}}(11) = -13.99$, $p < 10^{-7}$). Participants showed the same amount of after-effects on the exposed movement, regardless the task performed during exposure ($t(22) = 0.72$, $p = 0.48$), see Fig. 3.

Unidirectional transfer. The pointing group showed a significant transfer of compensations to the throwing task (mean = -1.76 ± 1.00 degrees, $t_{\text{zero}}(11) = -6.08$, $p < 10^{-5}$) while the Throwing group showed no transfer to the pointing task (mean = 0.01 ± 0.92 degrees, $t_{\text{zero}}(11) = 0.04$, $p = 0.97$), see Fig. 3. Thus, the amount of transfer was greater in the pointing group compared to the throwing group ($t(22) = 4.62$, $p < 10^{-4}$), see Fig. 3. We quantified the transfer of compensation as the percent of the average endpoint errors on the non-exposed movement divided by the average endpoint error on the exposed movement. The Pointing group demonstrated as much as $44.39 \pm 29.65\%$ transfer whereas the Throwing group did not exhibit any transfer ($-6.02 \pm 25.67\%$). Results from experiment 1 highlight a strictly unidirectional transfer of compensations from pointing to throwing but not from throwing to pointing. However, we did not find any apparent dissimilarities on baseline performances, neither on error reduction during exposure nor on the amount of after-effects on the exposed task. One possible explanation is that adaptation would not transfer from the far space of throwing to the near space of pointing. An alternative explanation relates to motor variability. Both groups showed a higher variability on the throwing task compared to the pointing task at all stages of the experiment, which confirms that throwing was less mastered than pointing in our sample. To specifically test for this mastery hypothesis, we recruited 6 high-level French dart players as experts in throwing (Experiment 2). If mastery rather than target distance explains the occurrence of transfer, then throwing experts should exhibit some transfer of after-effects from the throwing task to the pointing task.

Experiment 2 - Influence of the expertise degree on the transfer. Six high-level dart-players with practice experience ranging from eight to forty years (Expert group) completed the experimental protocol following the same steps as the Throwing group in experiment 1. They were exposed to the prismatic deviation while performing throwing and tested for the transfer to the pointing task. Statistical analysis results are detailed in Tables 2–5.

ANOVAs Familiarization and Pre-Tests										
Experiment 1										
		Throwing group		Pointing Group		Significant Effect	dl	F	p	Post-Hoc significant
		Throwing task	Pointing task	Pointing task	Throwing task					
		(A)	(B)	(C)	(D)					
Familiarization	Mean	0,19 ± 1,06	0,08 ± 0,22	0,12 ± 0,23	-0,01 ± 0,93	—	No significant effect			
	Variance	4,84 ± 3,25	0,25 ± 0,15	0,27 ± 0,43	3,82 ± 2,40	Task	(1, 22)	49.37	10 ⁻⁷	A, D > B, C**
Pre-Tests	Mean	-0,01 ± 2,40	-0,47 ± 2,40	-0,23 ± 1,68	-0,77 ± 1,37	—	No significant effect			
Experiment 2										
		Throwing Comfortable Experts		Throwing Uncomfortable Experts		Significant Effect	dl	F	p	Post-Hoc significant
		Throwing task	Pointing task	Throwing task	Pointing task					
		(E)	(F)	(G)	(H)					
Familiarization	Mean	0,16 ± 0,74	0,09 ± 1,16	0,21 ± 0,80	0,05 ± 0,14	—	No significant effect			
	Variance	1,48 ± 0,57	0,08 ± 0,04	2,00 ± 0,00	0,08 ± 0,05	Task	(3,26)	20.93	10 ⁻⁴	A, D, G > B, C, E, F, H**
Pre-Tests	Mean	-0,43 ± 1,54	0,32 ± 1,46	3,77 ± 1,83	-0,50 ± 0,07	Task*Group	(3,26)	3.37	0.03	G > E, F, H
Experiment 3										
		Throwing group		Pointing Group		Significant Effect	dl	F	p	Post-Hoc significant
		Throwing task	Pointing task	Pointing task	Throwing task					
		(A)	(B)	(C)	(D)					
Familiarization	Mean	0,18 ± 0,72	0,83 ± 0,57	0,99 ± 0,44	0,26 ± 0,65	Task	(1, 18)	15.59	10 ⁻⁴	B, C > A, D*
	Variance	5,41 ± 3,68	0,28 ± 0,22	0,32 ± 0,53	9,19 ± 6,55	Task	(1, 18)	34.21	10 ⁻⁵	A, D > B, C**
Pre-Tests	Mean	0,68 ± 1,25	0,06 ± 1,01	0,62 ± 0,88	0,84 ± 1,3	—	No significant effect			

Table 2. Statistical analysis: rMANOVAs during familiarization, and pre-tests in Experiments 1, 2, 3. Notes: HSD Tukey's were used for experiment 1 and 2. LSD Fisher's were used for experiment 3. Both were significant at $p < 0.05$ (*) and $p < 0.01$ (**). Only significant effects are reported. Mean values for each group are reported on the left side of the table in degrees (mean) and degrees² (variance) together with standard deviations.

Similarities between laboratory throwing task and dart throwing movement. Two expert participants reported very poor scores of task comfort and movement similarity relative to their usual dart throwing movements (see Table 6). Therefore, we divided our Experts group into two sub-groups: comfortable Experts ($n = 4$) and uncomfortable Experts ($n = 2$). Results from the two expert groups were compared to the results obtained in experiment 1. Trial-by-trial mean endpoint errors are represented in Supplementary Figure 2.

Motor variability associated with expertise. During familiarization trials, comfortable Experts showed a significantly lower variability on the throwing task compared to the control groups (Throwing and Pointing groups in experiment 1) (mean = 1.48 ± 0.57 degrees²; $F(3,26) = 20.96$, $p < 10^{-4}$). This stronger consistency in throwing movements compared to the throwing control group is related to the expertise on these throwing movements despite the dissimilarities between dart throwing and experimental throwing (see Fig. 4). Uncomfortable Experts showed an intermediate level of variability (mean = 2.00 ± 0.00 degrees²) that was also lower compared to the throwing control group.

No difference in baseline. Average endpoint errors were around zero and were not significantly different between Experts (both Comfortable and Uncomfortable) and controls (Pointing and Throwing groups) ($F(3,26) = 1.16$, $p = 0.34$).

Similar error reduction and after-effects. Expertise was not associated with a faster error reduction during exposure. Indeed, experts showed no difference in their performance while they were exposed to the prismatic deviation compared to the pointing and throwing control groups. The rMANOVA (Group*Block) revealed only a significant effect of blocks ($F(3,26) = 46.02$, $p < 10^{-7}$).

Concerning after-effects, comfortable Experts exhibited the same amount of after-effects on the trained task than the two other controls group (Pointing and Throwing) (mean = -4.48 ± 0.86 degrees; $F(3,26) = 0.78$, $p < 0.51$), see Fig. 5. Uncomfortable experts also showed a comparable amount of after-effects (mean = -6.00 ± 0.34 degrees).

Reciprocal transfer in experts. Except for variability, Experts did not display differences compared to the Pointing and Throwing control groups for the previous classical variables of prism adaptation. However, our results crucially revealed a significant presence of after-effects on the non-exposed task (i.e. pointing) in the comfortable Experts group ($t(3) = -5.49$, $p = 0.01$), see Fig. 5. In fact, comfortable Experts showed transfer to the task they did not practice during exposure (i.e. pointing) that was comparable to the Pointing group, and obviously greater than Throwing

T-Tests against zero: Pre-Tests, Early-Tests, Post-Tests					
Experiment 1					
Group	Task	Mean (degrees) ± SD	t	df	p
<i>Pre-tests</i>					
Throwing	Exposed task (Throwing)	-0,01 ± 2,40	-0.01	11	0.99
	Non exposed task (Pointing)	-0,47 ± 2,21	-0.72		0.48
Pointing	Exposed task (Pointing)	-0,23 ± 1,68	-0.47		0.64
	Non exposed task (Throwing)	-0,77 ± 1,37	-1.95		0.08
<i>Post-tests</i>					
Throwing	After-effects (Throwing)	-4,87 ± 1,81	-9.33	11	10⁻⁶
	Transfer (Pointing)	0,05 ± 0,97	0.19		0.85
	Transfer Ratio (%)	-6,02 ± 28,90	-0.72		0.48
Pointing	After-effects (Pointing)	-4,43 ± 1,09	-13.99		10⁻⁶
	Transfer (Throwing)	-1,80 ± 1,00	-5.49		10⁻⁵
	Transfer Ratio (%)	44,39 ± 30,33	5.07		10⁻⁴
Experiment 2					
Group	Task	Mean (degrees) ± SD	t	df	p
<i>Pre-tests</i>					
Comfortable Experts	Exposed task (Throwing)	-0,43 ± 1,54	-0.54	3	0.62
	Non exposed task (Pointing)	0,32 ± 1,46	0.45		0.69
Uncomfortable Experts	Exposed task (Throwing)	3,77 ± 1,83	2.9	1	0.21
	Non exposed task (Pointing)	-0,50 ± 0,07	-10		0.06
<i>Post-tests</i>					
Comfortable Experts	After-effects (Throwing)	-4,47 ± 0,86	-10.41	3	10⁻³
	Transfer (Pointing)	-1,72 ± 0,62	-5.49		0.01
	Transfer Ratio (%)	31,61 ± 12,99	4.86		0.01
Uncomfortable Experts	After-effects (Throwing)	-6 ± 0,34	-24.59	1	0.02
	Transfer (Pointing)	-0,12 ± 0,9	-0.19		0.87
	Transfer Ratio (%)	1,65 ± 14,92	0.16		0.91
Experiment 3					
Group	Task	Mean (degrees) ± SD	t	df	p
<i>Pre-tests</i>					
Throwing	Exposed task (Throwing)	0,68 ± 1,25	1.71	9	0.12
	Non exposed task (Pointing)	0,06 ± 1,01	0.32		0.85
Pointing	Exposed task (Pointing)	0,62 ± 0,88	2.21		0.06
	Non exposed task (Throwing)	0,84 ± 1,3	0.41		0.07
<i>Early Tests</i>					
Throwing	Exposed task (Throwing)	-2,82 ± 1,71	-5.23	9	10⁻⁴
Pointing	Exposed task (Pointing)	-3,79 ± 2,02	-5.91		10⁻⁴
<i>Post-tests</i>					
Throwing	After-effects (Throwing)	-4,88 ± 1,63	-9.48	9	10⁻⁵
	Transfer (Pointing)	-0,16 ± 0,87	-0.6		0.56
	Transfer Ratio	6,69 ± 38,24	0.55		0.59
Pointing	After-effects (Pointing)	-5,07 ± 1,08	-9.05		10⁻⁵
	Transfer (Throwing)	-3,08 ± 2,19	-4.45		10⁻³
	Transfer Ratio (%)	54,71 ± 53,78	3.22		0.01

Table 3. Statistical analysis: T-tests against zero during pre-tests, early-tests and post-tests in Experiments 1, 2, 3.

control group (mean = -1.72 ± 0.62 degrees, $F(3,26) = 9.13$, $p < 10^{-4}$). However, uncomfortable Experts did not show any significant transfer of after-effects to the non-exposed task (mean = -0.12 ± 0.90 degrees).

Relation between motor variability and transfer. As explained previously, during our laboratory throwing task, two expert participants were not able to fully reproduce the feelings and comfort associated to their usual dart-practice. Consistently, they displayed a greater variability than other experts in the group, meaning that their dart expertise was not entirely beneficial during our laboratory throwing task. Moreover, these two participants showed no transfer to the pointing task. In addition, a highly significant correlation ($R^2 = 0.89$) was found between variability during

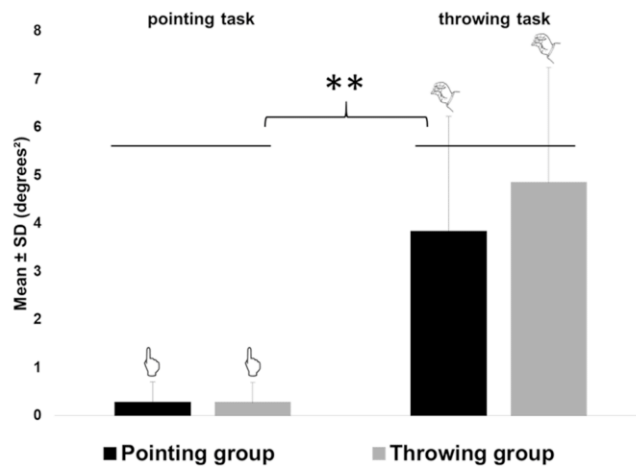

Figure 2. Experiment 1: mean variances during familiarization. Mean group variances are represented in black for the pointing group and in grey for the throwing group, respectively on the left for the pointing task and on the right for the throwing task. Error bars refers to standard deviations. **means $p < 0.01$.

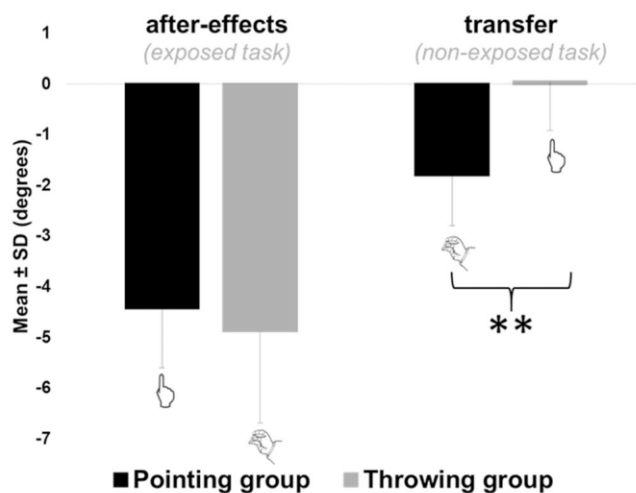

Figure 3. Experiment 1: mean endpoints errors during post-tests. Mean group endpoint errors during post-tests are represented in black for the pointing group and in grey for the throwing group, respectively on the left for after-effects (i.e. endpoint errors on the exposed task) and on the right for transfer (i.e. endpoint errors on the non-exposed task). Error bars refers to standard deviations. **means $p < 0.01$.

the last ten familiarization throwing movements and the transfer ratio in the whole expert group, indicating that the more variable the participants, the less they were able to transfer compensations to the non-exposed task, see Fig. 6. However, this correlation remained far from significance in the novice control throwing group.

As a matter of fact, the second experiment revealed that mastery of the exposed task (throwing) promotes the transfer of acquired compensations to the non-exposed task (pointing). Thus, context-independent processes seem to be involved to compensate for a given perturbation while performing a mastered motor task. Transfer exhibited by comfortable experts also allowed us to rule out the idea that transfer may operate only from near to far space. However, the previous experiments do not allow to understand the physiological mechanisms underlying the link between expertise and transfer. A third experiment was conducted in order to better understand the strict unidirectionality of transfer between throwing and pointing. In this experiment, we analyzed the kinematics of pointing movements performed during pointing task in order to investigate whether different phases of the trajectory may be differentially affected by prism adaptation (see O'Shea *et al.*⁸).

Experiment 3: Mechanisms underlying the unidirectional transfer between throwing and pointing. Our specific aim was to investigate whether differential after-effects would provide a predictive variable for transfer. We also provide kinematic analyses of pointing trajectories in order to better understand the mechanisms underlying the absence of transfer in the throwing group. The design of the experiment was the same except that we introduced early post-tests and measured pointing kinematics with motion capture (see Online methods for details). Statistical analysis results are detailed in Tables 2–5, 7, 8.

Statistical analysis of Post-tests - Experiments 1, 2, 3						
Experiment 1						
	Pointing group	Throwing group	t	dl	p	
After-effects	-4,43 ± 1,09	-4,87 ± 1,81	0.72	22	0.48	
Transfer	-1,80 ± 1,00	0,05 ± 0,97	4.62		10 ⁻⁴	
Experiment 2*						
	Comfortable Experts	Uncomfortable Experts	R²	dl	F	p
After-effects	-4,47 ± 0,86	-6 ± 0,34	0.08	3.26	0.78	0.51
Transfer	-1,72 ± 0,62	-0,12 ± 0,9	0.51	3.26	9.13	10 ⁻⁴
Experiment 3						
	Pointing group	Throwing group	t	dl	p	
Early-Tests	-5,07 ± 1,08	-4,88 ± 1,63	0.24	18	0.81	
After-effects	-5,07 ± 1,08	-4,88 ± 1,63	0.24		10 ⁻³	
Transfer	-3,08 ± 2,19	-0,16 ± 0,87	3.9		10 ⁻³	

Table 4. Statistical analysis: T-tests between groups during post-tests, in Experiments 1, 2, 3. *For experiment 2, reported values refer to a 1-way ANOVA comparing experts groups and throwing and pointing control groups. Post-Hoc analyses revealed significant differences between comfortable Experts and throwing controls group ($p < 0.05$).

rMANOVAs Exposure										
Experiment 1										
	Block 1	Block 2	Block 3	Block 4	Block 5	Block 6	dl	F	p	Significant effects
Throwing group	5,02 ± 2,40	2,91 ± 1,98	2,13 ± 1,42	1,65 ± 1,20	1,11 ± 0,58	1,01 ± 0,85	1, 22	36.46	10 ⁻⁷	Block
Pointing Group	4,29 ± 2,91	2,38 ± 2,95	1,57 ± 1,85	1,13 ± 1,04	0,78 ± 0,55	0,68 ± 0,37				
Experiment 2										
True Experts	5,38 ± 1,06	3,64 ± 1,70	1,88 ± 1,08	1,20 ± 0,83	0,96 ± 0,92	0,88 ± 0,94	3, 26	46.02	10 ⁻⁷	Block
False Experts	4,28 ± 1,33	2,72 ± 0,51	2,03 ± 0,19	0,89 ± 0,01	0,96 ± 0,38	0,47 ± 0,10				
Experiment 3										
Throwing group	4,16 ± 2,10	3,54 ± 1,40	1,24 ± 1,15	1,18 ± 0,88	0,90 ± 0,84	0,95 ± 0,80	1, 18	16.27 ¹	10 ⁻⁷	Group ¹ , Group*Block ²
Pointing Group	2,10 ± 0,81	1,77 ± 1,12	1,30 ± 0,74	1,21 ± 0,58	1,31 ± 0,54	1,31 ± 0,60		6.21 ²		

Table 5. Statistical analysis: rMANOVAs during exposure in Experiments 1, 2, 3.

Expert	Years of practice	Best rank	Comfort	Similarity
1	40	Reg (3rd)	2	2
2	8	Nat (2nd)	-3	-2
3	15	Nat (9th)	-1	-1
4	15	Nat (12th)	-1	2
5	15	Reg (10th)	-3	-3
6	13	Reg (20th)	3	1

Table 6. Throwing experts characteristics. Note: comfort and similarity scores refer to the self-rate performed by dart players so as to assess the likeness between dart throwing and our experimental throwing task. Comfort and Similarity were rated from from -3 (“not at all comfortable” and “very different”) to 3 (“very comfortable” and “very similar”).

As expected, the overall pattern of results was similar to experiment 1, i.e. similar average results through familiarization, pre-tests, exposure and post-tests. The transfer test also confirmed a unidirectional transfer from pointing to throwing but not from throwing to pointing (see Fig. 7).

A significant effect of Group on error reduction during exposure was observed during the first two blocks of exposure in which average endpoint errors were larger in the throwing group compared to the pointing group (4.16 ± 2.10 and 3.54 ± 1.40 degrees for block 1 and 2 in the throwing group vs 2.10 ± 0.81 and 1.77 ± 1.12 for the pointing group), which is compatible with lowering speed stress imposed on subjects (see supplementary information, Supplementary Figure 4).

As in experiment 1, a significant variability difference was found between throwing and pointing in both group during familiarization ($F(1,18) = 34.25$, $p < 10^{-5}$) (see supplementary information, Supplementary Figure 3).

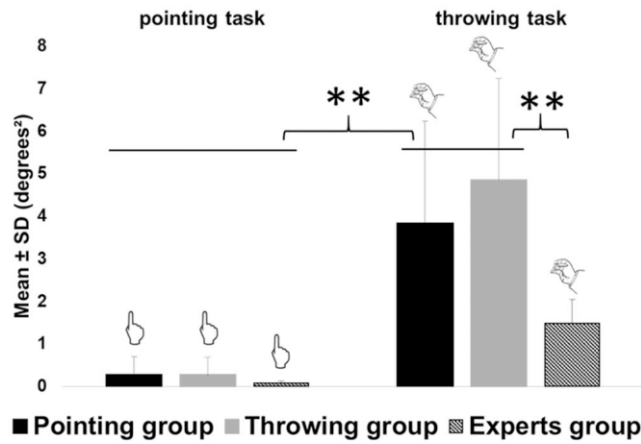

Figure 4. Experiment 2: mean variances during familiarization. Mean group endpoint errors during post-tests are represented in black for the pointing group, in grey for the throwing group, in hatched for the throwing expert group, respectively on the left for the pointing task and on the right for the throwing task. Experts group refer to the comfortable experts only. Uncomfortable experts' results are not represented. Error bars refers to standard deviations. **means $p < 0.01$.

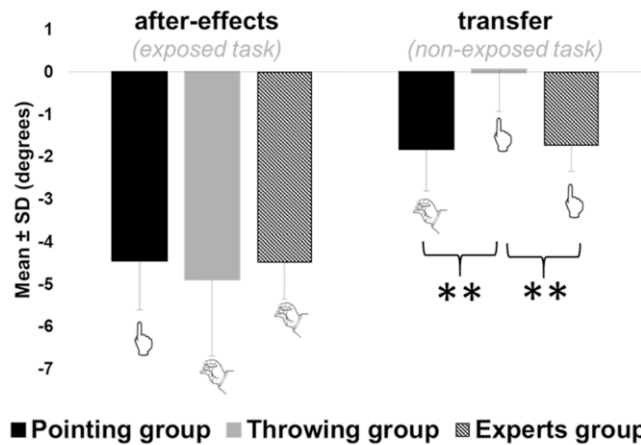

Figure 5. Experiment 2: mean endpoints errors during post-tests. Mean group endpoint errors during post-tests are represented in black for the pointing group, in grey for the throwing group, in hatched for the throwing experts group and respectively on the left for after-effects (i.e. endpoint errors on the exposed task) and on the right for transfer (i.e. endpoint errors on the non-exposed task). Experts group refer to the comfortable experts only. Uncomfortable experts' results are not represented. Error bars refers to standard deviations. **means $p < 0.01$.

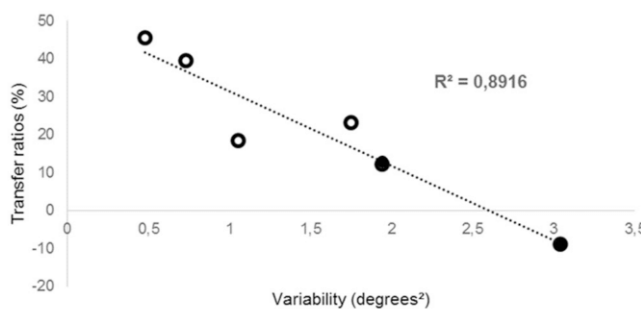

Figure 6. Experiment 2: correlation between transfer ratios and variability of throwing movements in the experts group. Variability refers to the mean variances of the ten last familiarization throwing trials for each subject. Both comfortable (empty marks) and uncomfortable (solid marks) experts are represented.

Kinematic alterations: T-Tests (Experiment 3)					
Movement directions during Pre-tests (both groups)					
	Pointing group	Throwing group	t	dl	p
Initial direction	-6,37 ± 7,02	-8,42 ± 3,95	0.8	18	0.43
Intermediate direction	2,62 ± 3,14	2,38 ± 2,08	0.19		0.85
Terminal direction	5,35 ± 5,42	3,62 ± 2,68	0.86		0.4
Movement directions alterations during Post-tests (both groups)					
	Pointing group	Throwing group	t	dl	p
Initial direction	-4,84 ± 3,25	-3,13 ± 1,48	-1,51	18	0.15
Intermediate direction	-6,25 ± 3,58	-6,13 ± 4,09	-0,07		0.94
Terminal direction	-5,69 ± 5,76	2,37 ± 2,72	-4,00		10 ⁻⁴
Movements direction alterations during Early-Tests and Post-Tests (Pointing group)					
	Early Tests	Post-tests	t	dl	p
Initial direction	-5,55	-4,84	-0,45	9	0.66
Intermediate direction	0,12 ± 3,58	-6,25 ± 3,58	3.89		10 ⁻³
Terminal direction	-3,77 ± 7,91	-5,69 ± 5,75	1.92		0.49

Table 7. Kinematic alterations of pointing movements: T-tests between Throwing and Pointing groups in Experiments 3.

Temporal dynamics of after-effects in early tests and post-tests: T-Tests (Experiment 3)					
Early-tests					
	Pointing group	Throwing group	t	dl	p
5 first trials	-4,49 ± 2,01	-3,36 ± 2,57	1.1	18	0.29
5 last trials	-3,45 ± 1,99	-1,17 ± 1,85	2.66		0.01
Post-tests					
	Pointing group	Throwing group	t	dl	p
5 first trials	-5,69 ± 1,72	-5,92 ± 1,89	0.29	18	0.77
5 last trials	-5,05 ± 1,99	-2,56 ± 2,87	2.24		0.03

Table 8. Temporal dynamics of after-effects: T-tests between Throwing and Pointing groups in Experiments 3.

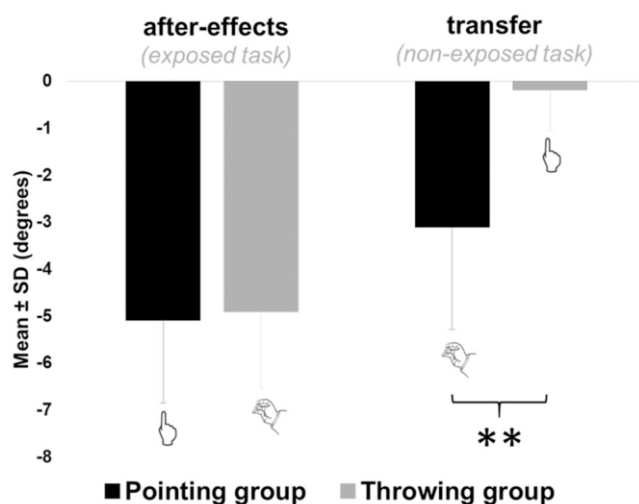

Figure 7. Experiment 3: mean endpoints errors during post-tests. Mean group endpoint errors during post-tests are represented in black for the pointing group, in grey for the throwing group, and respectively on the left for after-effects (i.e. endpoint errors on the exposed task) and on the right for transfer (i.e. endpoint errors on the non-exposed task). Error bars refers to standard deviations. **means $p < 0.01$.

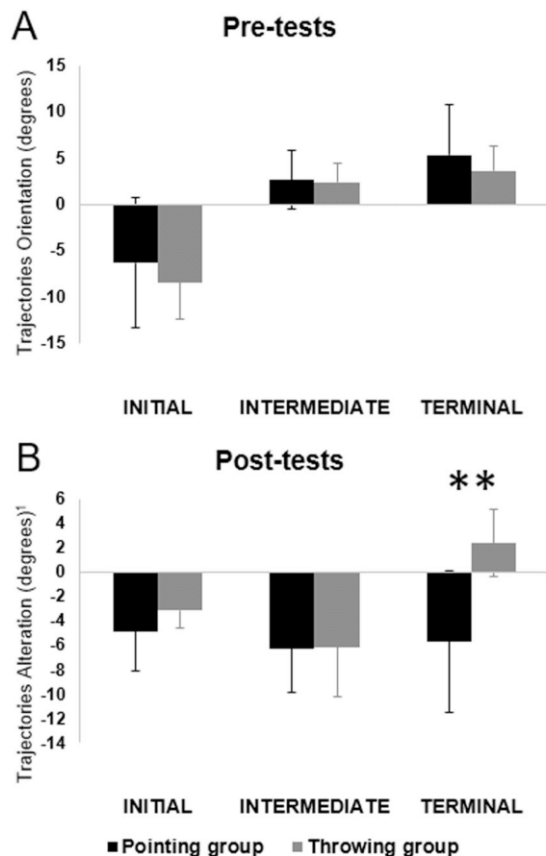

Figure 8. Experiment 3: mean pointing trajectory orientation and alteration during initial, intermediate and terminal) phases of movements. Comparison between pointing (in black) and throwing (in grey) groups during Pre-tests (PRE), and Post-tests (POST). **means $p < 0.01$. Note: for Post-tests, mean baseline trajectories orientation have been subtracted for each subject. Trajectories alterations are represented.

Concerning the early measures of compensation, no significant difference between groups were observed, which means that subjects showed apparently similar magnitude of after-effects on the exposed task after the first block of exposure independently from the trained task ($t(18) = 1.62$, $p = 0.12$).

Kinematics show a symmetrical transfer during initial direction. Mean pointing trajectories are reported in supplementary information (Supplementary Figure 5) for Throwing and Pointing groups. Movements' instantaneous directions were compared at the main kinematic landmarks: acceleration peak (initial direction), velocity peak (intermediate direction), and deceleration peak (terminal direction) between groups, during pre-tests, early tests and post-tests (Fig. 8). Directions were measured as the angle between instantaneous velocity vector at each peak and the straightforward line between the starting position and the target. Reported values only concern the central target. We first compared mean movement directions at each kinematic landmark during pre-tests for both groups. The results revealed that the mean movement direction at initial, intermediate and terminal phases of pointing movements did not differ between groups during Pre-Tests ($t(18) = 0.8$; 0.19 ; 0.86 respectively and $p = 0.43$, 0.85 ; 0.4 . Mean values are reported in Table 7), thus the two groups initially produced comparable trajectories.

Then, we compared alteration of movements' directions during Post-tests as the difference in movement directions between Pre-tests and Post-tests respectively for initial, intermediate, and terminal directions. After exposure, the same substantial alteration was observed during Post-tests on the pointing task in both groups for initial and intermediate directions ($t(18) = -1.51$; -0.07 and $p = 0.15$; 0.94 respectively). It suggests that a similar compensation took place in the two groups in term of initial motor commands. However, mean terminal direction of movements was altered differently in Throwing group compared to the Pointing group during Post-tests (mean = 2.37 ± 2.72 degrees for Throwing group and -5.69 ± 5.76 degrees for Pointing group, $t(18) = -4.00$, $p < 10^{-3}$). This again confirms that despite apparent similarities the nature of the compensation differed between the two groups. Results showed that participants in the Throwing group were able to transfer compensations in the initial and intermediate phase of movements but corrected trajectories in the final phase of movements, which lead to an absence of transfer when endpoints are considered. This analysis may provide explanations for the crucial differences observed between transfer of the two groups that are masked on the endpoint accuracy measures.

Discussion

In the present study we explored the cross-transfer between two manual visuo-motor tasks: throwing and pointing. Our observations yield four main findings: (1) prism exposure during pointing and throwing movements produced strikingly similar error reduction curves and after-effects after prism removal, (2) in spite of this apparent similarity, transfer of compensations was radically unidirectional, i.e. reliably present from pointing to throwing and fully absent from throwing to pointing, (3) kinematic analyses of pointing trajectories suggested plausible physiological mechanisms underlying findings 1 and 2, (4) expertise on the throwing task (dart throwers) was associated with the transfer of compensations from throwing to pointing task. Altogether we argue that a proper definition of adaptation should include transfer properties in addition to the classical after-effect criterion.

Unidirectional transfer provides a signature for different processes. Our results show that two manual aiming tasks yield to apparently similar results in terms of pre-tests performance, error reduction during prism exposure and after-effects, which may have suggested that similar compensation took place in the two groups. According to the classical definition of adaptation, i.e. simply based on the presence of compensatory after-effects upon explicit removal of the perturbation, throwing and pointing would be considered as producing identical adaptation. In spite of this apparent evidence, a strictly unidirectional transfer occurred, which suggests that compensation resulted from different process according to the task exposed. As a matter of fact, participants performing throwing during prism exposure showed no transfer to the pointing task upon prisms removal. It suggests that during exposure, participants set up visuomotor corrections to address the visual-motor discrepancy encountered and finally managed to compensate for the deviation to return to their baseline performances. Although participants showed after-effects on the trained task (i.e. throwing), these after-effects did not transfer to the non-exposed task (i.e. pointing). This implies that the underlying processes of this compensation remained context-specific. Whereas the compensations set up during classical prism exposure can be explained in terms of changes in the alignment of spatial maps (visual head-eye and proprioceptive head-hand)^{29,30}, the lack of transfer from throwing to pointing with the same limb instead suggests that compensation at work relied on motor commands rather than sensory realignment^{8,10}. One fundamental implication of this result is that the classical definition of adaptation, i.e. based on the presence of compensatory after-effects, may not be sufficient to clearly outline the boundary between different processes at work, which might be related to learning and adaptation. True adaptation may actually require further specifications in terms of spatial generalization³¹ and transfer to other contexts. This finding is reminiscent of the observation that compensations acquired during exposure to force-fields do not transfer to unconstrained arm movements³². We may speculate that participants in our throwing group solicited a more strategic level of compensation than true low-level realignment. Since post-test conditions for the exposed movement (classical after-effects) were close from the exposure condition even upon prism removal (same task, trained target), participants after-effects may result from associative generalization (i.e. toward close conditions). Conversely, the pointing group exhibited after-effects both on the exposed task and the non-exposed task, i.e. an associative and dimensional (i.e. above initial conditions) generalization at the same time. Thereby, the pointing group seemed to show a higher implication of the realignment processes while the throwing group seemed to rely mainly on strategic processes of error correction⁸.

Our third experiment was conducted to refine our analysis and to investigate potential explanations for this unidirectional transfer. We showed that early compensations were not different between Throwing and Pointing groups and thus could not explain the differences observed in transfer capacities across groups. However, analysis of pointing movement kinematics showed that a transfer from throwing to pointing seems to be present at the initial and intermediate phases of movements but disappears during the terminal phase of movements, which leads to an absence of transfer concerning the endpoint error. In a previous study, O'Shea *et al.*⁸ showed that kinematics allowed to distinguish two different error corrective processes during prism exposure: a strategic feedforward motor control process (initial part of the trajectory) and a slower feedback-driven correction process (terminal part of the trajectory). Echoing this previous study, the present analysis showed that kinematics reveal crucial information about the nature of processes involved in addition to endpoint errors. A possible explanation may be relative to the proprioceptive component in prism adaptation. The felt position of the hand is not shifted by the prism while the visually perceived location of the target is. As such, proprioceptive feedback will tend to guide the hand toward the virtual target location, away from the real target location^{8,10}. It is admitted that prism exposure of pointing movements alters the felt limb position sense^{13,30,33}. Our results suggest that novice participants in the throwing groups may not exhibit such change, and the available literature does not allow to know whether prism exposure by throwing produces a similar proprioceptive after-effect when throwing movements are exposed to the optical shift. Instead, they might have relied more on the feedforward motor control process, i.e. the adjustment of motor plan for the subsequent trial^{8,10}. Thus, when subjects from the throwing control group made pointing movement during post-tests, they were able to correct their trajectory once proprioceptive feedback was at work, as the proprioceptive modality was not altered during prism exposure.

Expertise enables transfer of compensations. Two differences between tasks might explain this unidirectional transfer: the space of action (near space for pointing vs far space for throwing) and the variability associated with each task. Motor variability related to throwing movement may have influenced the processes set up to compensate for the prismatic perturbation²⁷. Throwing experts enable us to address these two hypotheses.

In the first experiment, both groups showed a higher variance in throwing than pointing. This can be explained by the fact that pointing is a usual and highly mastered task while throwing needs a lot of practice to be controlled. Relationships between motor variability and learning capacities have been recently studied. Some authors suggested that variability, instead of being an unwanted noisy consequence, would rather be linked to the capacity of exploring multiple motor solutions. This action exploration would be associated with a better

performance in sensorimotor learning in a non-mastered manipulandum task movements^{34,35} and related to an increased interlimb transfer³⁶. In our second experiment, we recruited throwing experts to investigate the influence of expertise on the transfer of visuo-motor compensations acquired during prism exposure. Experts interestingly showed a significant transfer of compensations on the non-exposed task (i.e. pointing) while the control throwing group did not. In contrast to the aforementioned studies, our results showed that the less subjects were variable during the familiarization phase on the exposed task, the better they transferred visuomotor compensations to the non-exposed task. Darts experts showed a decreased variability compared to control groups which confirms that consistency (i.e. low variability) is a suitable marker of expertise^{28,37}. Moreover, we found that transfer rates are correlated with variability and expertise. Thus, expertise seems to influence the transfer properties following prism exposure. Indeed, the results suggest that a higher implication of sensorimotor adaptive processes was present in the expert group, similar to the pointing control group. The correlation between variability and transfer in the expert group may be interpreted cautiously due to the small number of experts. Nevertheless, the absence of correlation in the novice groups may suggest that an expertise threshold conditions transfer. As such, we speculate that novices have no option but opt for the establishment of a new control policy, i.e. prompt learning, in order to face a new sensorimotor situation. Conversely, sensorimotor expertise appears to be necessary to adjust an existing control policy to face a perturbation, i.e. to activate adaptation. Our results are congruent with previous findings that emphasized the influence of expertise on the processes used to face varying conditions^{38,39}.

Therefore, expertise on the task performed during prism exposure seems to play a role in conditioning the transfer of after-effects to an unexposed task. An interesting question is whether expertise on the transfer task also influences the amount of transfer on this task. Healthy individuals can be considered as natural experts on the pointing task. However, their pointing expertise did not allow those who performed the throwing task during prism exposure to transfer the acquired compensations to the pointing task. Hence, we can argue that performing an over trained task during prism exposure favors “true” adaptation and thus, the transfer of visuo-motor compensations to a non-trained task. Conversely, before the exposed task is fully controlled; one relies on cognitive strategies - strategic errors reduction⁴⁰ in a greater way and is not allowed to set up a “true” adaptation process in response to prismatic deviation.

A speculative explanation of the link between expertise and transfer relates to the role of proprioception in movement control. Kinematics analysis from experiment 3 suggest that proprioceptive modality was not altered when novice participants performed throwing under prism exposure. As such, prism exposure may have altered experts felt limb position in such a way that they exhibited transfer of after-effects over the whole pointing trajectory. Several studies showing that expertise in a given motor task modifies proprioceptive abilities already support this hypothesis (e.g. [Lin, Lien, Wang, & Tsauo, 2006](#))⁴¹ and it remains to be specifically tested. Future studies measuring kinematics data for experts will allow us to test whether transfer also appears in the terminal phase of movements in expert participants.

Implications for learning and adaptation. From a theoretical perspective, our results provide empirical arguments for the distinction of processes leading to context-dependent vs generalizable after-effects, congruent with several distinctions proposed earlier^{2-6,12}. We speculate that the context-dependent process which leads to local transformations obtained during exposure to throwing may be classified as learning, while transferable compensations in a different context would pertain to adaptation. Our study supports the fact that context-dependency of elicited transformations may be crucially related to the very nature of the plastic process involved in the compensation of the visual shift produce by prisms. The fact that throwing experts, who have over-learned the throwing movements, exhibit transfer from throwing to pointing (with a magnitude comparable to the transfer exhibited by subjects from pointing to throwing) strongly supports the idea that true adaptation can occur once a visuo-motor task has been sufficiently practiced to give rise to learning. In principle, it would not seem optimal to adapt sensorimotor transformation parameters before they have been defined in a sufficiently accurate way, i.e. adaptation may not be useful until the range of adaptation falls below the variability of the task performance. As a consequence, discrepancies experienced when practicing an unmastered task during prism exposure would not be relevant enough to give rise to adaptation⁴². Therefore, one may speculate that adaptation of a given task may only take place once this task has been sufficiently acquired through learning, and further investigations will be required to further test this hypothesis.

Conclusion

Our study compared two tasks during prism exposure, with a high level of similarity in terms of both compensations developed during the perturbation and classical after-effects. In spite of similar after-effects, transfer of compensations after the perturbation occurred only from the most mastered task to the least mastered task. This strictly unidirectional transfer was demonstrated by means of both traditional manual measurement (experiment 1) and sophisticated motion tracking technique (experiment 3). In addition, motor expertise in darts players for the exposed task appears to promote transfer capacities. In light of these results, we speculate that context-dependent learning (i.e. cognitive, strategic) processes are mainly at work to first stabilize performance in novice participants while experts use context-independent adaptation (i.e. sensorimotor) processes to face the perturbation. Thus, future full definitions of adaptation should include transfer properties in addition to after-effects.

Our study uncovered a unidirectional transfer of prism-acquired after-effects from pointing to throwing and we put forward several hypotheses (i.e. the role of proprioceptive feedbacks and the likely relationship between variability/expertise and transfer) that need to be tested. Open questions relate to the threshold of expertise needed to enable transfer, and to the neural substrates underlying such capacities. Further investigations are needed to explore how the brain switches from learning to adaptation over the course of expertise acquisition, to define optimal adaptation procedures and to design rehabilitation strategies based on the elicitation of context-independent adaptation that would transfer benefits to daily life situations.

Methods

Our study was divided into three distinct experiments illustrated in supplementary information (Supplementary Figure 6). Every participant gave informed consent to participate in these experiments. All procedures were designed following relevant guidelines and regulations and were approved by the ethics evaluation committee of Inserm (IRB of the French Institute of medical research and Health, IRB00003888, IORG003254, FWA00005831).

Experiment 1. Participants. 24 healthy volunteer subjects participated in the study. They had normal or corrected to normal vision, no neurological disorder and had never experienced prisms before the experiment. Participants were asked to perform two goal-directed visuo-motor tasks –throwing and pointing – which are detailed in the further section.

Participants were divided into two groups depending on the task performed during prism exposure (which was called « exposed movement » in contrast to « non-exposed movement »). Thus, for the first group, the exposed movement was pointing while the non-exposed movement was throwing (**Pointing** group, $n = 12$, 6 males and 6 females, mean age = 22.58 ± 1.73 years old). For the second group, the exposed movement was throwing, and the non-exposed movement was pointing (**Throwing** group, $n = 12$, 6 males and 6 females, mean age = 22.16 ± 2.79 years old), see Fig. 1.

Experimental paradigm. Participants followed the four stages illustrated in Fig. 1 with varying tasks performed. Tasks were performed either with vision allowed (closed-loop) or without (open-loop), and toward one central or two targets (central (0°) and right (10°)). Specific conditions for each step of the experimental are detailed in this section and summarized in Table 1.

Familiarization. The aim was to familiarize participants with both tasks and with experimental settings. They were asked to perform trials of the exposed movement then trials of the non-exposed movements. As pointing is an over-trained task, participants performed only 10 trials versus 30 trials for the throwing task. Trials were performed in a closed-loop condition (vision allowed) toward the central target.

Pre-tests. Participants performed two blocks of ten trials of the non-exposed movement and then two blocks of ten trials of the exposed movement. Trials were performed in open-loop condition (no vision) and toward both targets in a randomized order (which was the same for all participants).

Exposure. Participants were asked to perform six blocks of ten trials while wearing prismatic lenses that shifted the visual field ten degrees toward the right (OptiquePeter.com, Lyon). Trials were performed in a closed-loop condition (vision allowed) toward the central target at a maximal speed. Before positioning the goggles, participants were asked to keep their eyes closed. They were also instructed not to look at their own body or to move in any way (except to perform the task) while they were wearing the goggles.

Post-tests. Once the prisms were removed, participants were asked to perform two blocks of ten trials of the exposed movement to assess after-effects. Then, they performed two blocks of ten trials on the non-exposed task to measure the transfer of after-effects. The four blocks were realized in the same conditions than during pre-tests: no vision allowed, both right and central target in a randomized order.

Pointing and throwing task set-ups. At the beginning of the experiment, participants were asked to sit in an adjustable and movable chair and to stay on this chair for the whole duration of the experiment. Investigators were in charge to move the participant from the throwing experimental set-up to the pointing one when it was necessary. During each transitional phase, participants were wearing eye patches to be deprived of vision and to prevent influences of environmental vision on visuo-motor compensations. The experimental set-ups for each task are detailed in the following section.

Pointing task. Participants were sitting in front of a pointing desk, with their head on a chinrest. The starting position of the finger was situated below the chinrest, lined up with the body midline. Chinrest was used to avoid participants to see their hand starting position in order to prevent any static recalibration of the prism induced shift and thus slow down the error reduction, see supplementary information (Supplementary Figure 7).

Two targets were positioned on the pointing desk in front of participants, at a distance of 57.5 cm from their eyes. The central target (exposed target) was situated straight ahead of the participant's body midline (0°) and the right target (non-exposed target) at 10° to the right. During open-loop pointing (pre, early, post-tests), no vision was allowed during the entire movement. To control visual feedback, the investigator manipulated a cover board in front of the participants. Before each trial, the investigator lowered the cover board, so the participants were able to see the targets while their index lied on the starting position. Before the beginning of the trial, the investigator lifted the cover board to prevent vision of the targets and movements. This condition was used in order to reliably measure after-effects without the subject detecting and correcting for after-effect induced biases.

During closed-loop pointing (familiarization and exposure), the investigator did not manipulate the cover board and full vision was allowed. In both conditions, participants were asked to point as quickly as possible. To control movement duration, participants were previously trained to reach the target in less than 250 ms. The starting signal was given by the investigator for each trial. A color code indicated which target to reach in open-loop conditions and a vocal « go! » was provided during closed-loop conditions (using only one target).

Throwing task. Participants sat on a comfortable, adjustable chair in front of a vertical board, at a distance of 2 meters. They were wearing a ball-dispenser helmet illustrated in Supplementary Figure 7. Two targets were materialized on the board. The central target (exposed target) was situated forward the participant's body midline (0 degrees) and the right target (non-exposed target) at 10 degrees to the right. All the setting was surrounded by light spots connected to a switch placed on the helmet. During open-loop throwing, participants had to pick a ball and to press down the light-switch mounted on the helmet, so as to be able to see the target. Once they initiated movement and released the switch, lights were immediately turned off so they were not able to see anymore. Thus, participants had no visual feedback concerning their movements and consequences. During closed-loop throwing (familiarization and exposure), lights were turned on and participants were able to see their movement all time. As for pointing, in both conditions, participants were asked to throw as fast and accurate as possible. The starting signal was given by the investigator for each trial: the target color to reach in open-loop conditions and « go » during closed-loop conditions.

Data collection. For the pointing task, graduations were present on the pointing desk, opposite to the subject. The investigator reported manually the endpoint error of each reaching trial. For the throwing task, an optoelectronic motion capture system (9 cameras, Vicon Motion Systems Ltd, Oxford, 1984) was used to record the ball impact on the vertical board for each throwing trial. Reflective markers were placed on the throwing board to identify the targets. Moreover, the projectiles were reflective themselves.

Data processing. Markers trajectories were recorded for each trial and filtered with a Butterworth low-band pass filter at a cut-off frequency of 6 Hz. For the throwing trials, the time-point corresponding to the contact between the projectile and the board was automatically detected. This time point was used to compute the lateral errors between the impact of the projectile and the aimed target using MatLab customized routines.

Thus, we computed performances on each trial, i.e. angular deviation between the ball impact and the aimed target.

Statistical analysis. Dependent variable was the endpoint lateral error for each trial, expressed in degrees. The distance between the aimed target and either the final position of the index (pointing trials) or the ball impact (throwing trials) in centimeters was converted into degrees through classical trigonometric rules, taking in account the distance between the eyes and the target. rMANOVAs (Group*Task) were performed to assess differences between groups during familiarization and pre-tests in terms of endpoints errors and variability (comparisons of variances during familiarization). A rMANOVA (Group*Block) was performed to assess differences during exposure. For post-tests measurements, mean baseline performances (during pre-tests) were subtracted to after-effects and transfer values individually for each subject so as to correct for any baseline deviation. T-tests against zero were used to identify significant alterations during post-tests (after-effects and transfer). T-tests were also to compare both group during after-effects and transfer assessment. Statistical analysis was performed on Statistica 7.1 (StatSoft Inc., Tulsa, 1984). All mean values are reported together with standard deviations.

Experiment 2. This second experiment aimed to test the influence of expertise on the task performed during exposure on the transfer of compensations to the non-exposed task. We recruited six dart players to constitute an Experts group (6 males, mean age = 32 ± 11.22 years old). They were all practicing darts for at least 8 years and ranked at a national (or excellent regional) level. Although dart throwing presents several high similarities with our throwing experimental set up, there were some differences concerning the distance (2.37 meters from the targets in dart throwing vs 2 m in our experimental protocol), the posture (standing up vs sitting facing forward), the starting position (hand seen vs hand hidden), and of course the projectile (dart vs ball). To check whether dart expertise correlated with expertise in our throwing task, we asked experts to self-rate the task comfort and the movement similarity between dart throwing and our throwing set up from -3 ("not at all comfortable" and "very different") to 3 ("very comfortable" and "very similar").

Then, they followed the same protocol as the Throwing group of experiment 1: they were exposed to the prismatic deviation while performing throwing and tested for the transfer of compensations on the pointing task.

Data from Experts were compared to control pointing and throwing groups whose data were recorded in experiment 1. All procedures concerning data collection and data processing were similar to procedures used in experiment 1. Statistical analysis was performed similarly to experiment 1, except that we used a 1-way ANOVA in order to test for differences between the three groups in terms of after-effects and transfer.

Experiment 3. The aim of this experiment was to identify the possible mechanisms underlying the unidirectional transfer pointed out in the first experiment. As such, we aimed to test the early compensations set up at the beginning of exposure. The two compensatory processes involved in prism exposure are known to be associated with different timings: recalibration would occur firstly while realignment would take a longer time to be set up (see O'shea *et al.*, 2017). Given these differences, we aimed to test whether the presence and the amount of early after-effects would highlight any difference in the implication of both processes. We also aimed to investigate pointing kinematics to refine our analysis of differences between groups. Our purpose was to examine pointing trajectories to shed light on potential clues appearing before the end of the movement, i.e. at initial and intermediate trajectory directions. The same general procedures and methods were used. Thereafter are detailed the changes operated.

Participants. We recruited 20 other healthy participants ($n = 10$, 5 males and 5 females, mean age = 38.3 ± 18.73 years old for the Pointing group, and $n = 10$, 5 males and 5 females, mean age = 37 ± 17.26 years old for the Throwing group) following the same inclusion criteria as in experiment 1.

Familiarization. We decided to keep to the same amount the number of trials for throwing and pointing task even though pointing is over-trained.

Early compensations. We can hypothesize that the amount of after-effects consecutively to the first trials during exposure may be different between the two groups, according to the task performed. In order to test for this hypothesis, we designed an experiment in which we introduced additional probe trials following the first block of exposure. Right after the ten first trials of exposure, we removed the goggles and asked participants to keep their eyes closed. Then, they immediately performed 20 trials of the exposed movement to assess the presence of early after-effects, in an open-loop conditions (with no vision allowed during movement) and toward the central or the right target.

Pointing task. In experiments 1 and 2, subjects were instructed to reach the target as quickly as possible and trained to perform movement under 250 ms. In order to investigate pointing trajectories in more ecological conditions, the investigator instructed the subject to point “as fast and accurate” as possible without training them to reach under a specific movement duration. In addition, we automatized the control of visual feedbacks during open-loop condition. Participants wore electronic liquid-crystal glasses connected to a switch placed on the starting position. The participants were able to see the targets while their index finger lied on the starting position. Upon movement initiation the glasses turned opaque and subjects were deprived of visual feedback. When they went back to the starting position, the glasses turned transparent again.

Data collection and data processing. The motion capture system were also used to record pointing trajectories. Reflective markers were positioned on the index, the wrist and the elbow of the subject. The endpoint of each pointing movement was computed automatically (using in-house custom software written in Matlab). Movements were detected using the following thresholds: onset was defined as the point at which hand velocity exceeded 80 mm/s while offset was defined as the time-point at which velocity dropped below this threshold. After automatic detection, all trials were cross-checked visually and adjusted manually if necessary. Index endpoints were then used to obtain lateral endpoint errors from the aimed target. Only pointing movement kinematics were analyzed.

Statistical analysis. The statistical analysis was performed similarly to previous experiments We added T-tests to test for differences in pointing movement directions between both groups. We compared initial, intermediate, and terminal directions between the throwing and the pointing group during pre-tests. We also compared movement direction alterations between groups as the difference between pre-tests and post-tests pointing movement directions. Finally, we also compared movement direction alterations between early tests and post-tests in the pointing group. Additionally, we analyzed the temporal dynamics of after-effects in early tests and post-tests for both groups. T-tests were performed to compare the mean deviations in the five first trials and in the five last trials between the throwing and the pointing group.

Received: 10 July 2019; Accepted: 5 March 2020;

Published online: 30 March 2020

References

- Poggio, T. & Bizzi, E. Generalization in vision and motor control. *Nature* **431**, 768–774 (2004).
- Bastian, A. J. Understanding sensorimotor adaptation and learning for rehabilitation. *Curr. Opin. Neurol.* **21**, 628–633 (2008).
- Flery, L., Prablanc, C. & Priot, A.-E. Do prism and other adaptation paradigms really measure the same processes? *Cortex J. Devoted Study Nerv. Syst. Behav.* **119**, 480–496 (2019).
- Redding, G. M., Rossetti, Y. & Wallace, B. Applications of prism adaptation: a tutorial in theory and method. *Neurosci. Biobehav. Rev.* **29**, 431–444 (2005).
- Telgen, S., Parvin, D. & Diedrichsen, J. Mirror reversal and visual rotation are learned and consolidated via separate mechanisms: recalibrating or learning de novo? *J. Neurosci. Off. J. Soc. Neurosci.* **34**, 13768–13779 (2014).
- Prablanc, C. *et al.* Adapting terminology: clarifying prism adaptation vocabulary, concepts, and methods. *Neurosci. Res.*, <https://doi.org/10.1016/j.neures.2019.03.003> (2019).
- Welch, R. B. Speculations on a Model of Prism Adaptation. *Perception* **3**, 451–460 (1974).
- O’Shea, J. *et al.* Kinematic markers dissociate error correction from sensorimotor realignment during prism adaptation. *Neuropsychologia* **55**, 15–24 (2014).
- Taylor, J. A. & Ivry, R. B. Context-dependent generalization. *Front. Hum. Neurosci.* **7** (2013).
- Rossetti, Y., Koga, K. & Mano, T. Prismatic displacement of vision induces transient changes in the timing of eye-hand coordination. *Percept. Psychophys.* **54**, 355–364 (1993).
- Held, R. & Gottlieb, N. Technique for Studying Adaptation to Disarranged Hand-Eye Coordination. *Percept. Mot. Skills* **8**, 83–86 (1958).
- Weiner, M. J., Hallett, M. & Funkenstein, H. H. Adaptation to lateral displacement of vision in patients with lesions of the central nervous system. *Neurology* **33**, 766–772 (1983).
- Rossetti, Y. *et al.* Prism adaptation to a rightward optical deviation rehabilitates left hemispatial neglect. *Nature* **395**, 166–169 (1998).
- Inoue, M. *et al.* Three timescales in prism adaptation. *J. Neurophysiol.* **113**, 328–338 (2015).
- Redding, G. M. & Wallace, B. Adaptive spatial alignment and strategic perceptual-motor control. *J. Exp. Psychol. Hum. Percept. Perform.* **22**, 379–394 (1996).
- Kitazawa, S., Kimura, T. & Uka, T. Prism adaptation of reaching movements: specificity for the velocity of reaching. *J. Neurosci. Off. J. Soc. Neurosci.* **17**, 1481–1492 (1997).
- Baraduc, P. & Wolpert, D. M. Adaptation to a Visuomotor Shift Depends on the Starting Posture. *J. Neurophysiol.* **88**, 973–981 (2002).
- Fernandez-Ruiz, J. *et al.* Normal prism adaptation but reduced after-effect in basal ganglia disorders using a throwing task. *Eur. J. Neurosci.* **18**, 689–694 (2003).

19. Martin, T. A., Keating, J. G., Goodkin, H. P., Bastian, A. J. & Thach, W. T. Throwing while looking through prisms. I. Focal olivocerebellar lesions impair adaptation. *Brain J. Neurol.* **119**(Pt 4), 1183–1198 (1996).
20. Bedford, F. Perceptual and cognitive spatial learning. *J. Exp. Psychol. Hum. Percept. Perform.* **19**, 517–530 (1993).
21. Redding, G. M. & Wallace, B. Generalization of prism adaptation. *J. Exp. Psychol. Hum. Percept. Perform.* **32**, 1006–1022 (2006).
22. Michel, C., Rossetti, Y., Rode, G. & Tilikete, C. After-effects of visuo-manual adaptation to prisms on body posture in normal subjects. *Exp. Brain Res.* **148**, 219–226 (2003).
23. Michel, C., Vernet, P., Courtine, G., Ballay, Y. & Pozzo, T. Asymmetrical after-effects of prism adaptation during goal oriented locomotion. *Exp. Brain Res.* **185**, 259–268 (2008).
24. Girardi, M., McIntosh, R. D., Michel, C., Vallar, G. & Rossetti, Y. Sensorimotor effects on central space representation: prism adaptation influences haptic and visual representations in normal subjects. *Neuropsychologia* **42**, 1477–1487 (2004).
25. Savin, D. N. & Morton, S. M. Asymmetric generalization between the arm and leg following prism-induced visuomotor adaptation. *Exp. Brain Res.* **186**, 175–182 (2008).
26. Morton, S. M. Prism Adaptation During Walking Generalizes to Reaching and Requires the Cerebellum. *J. Neurophysiol.* **92**, 2497–2509 (2004).
27. Spang, K., Wischhusen, S. & Fahle, M. Limited Plasticity of Prismatic Visuomotor Adaptation. *-Percept.* **8**, 2041669517701458 (2017).
28. Wagner, H., Pfusterschmied, J., Klous, M., von Duvillard, S. P. & Müller, E. Movement variability and skill level of various throwing techniques. *Hum. Mov. Sci.* **31**, 78–90 (2012).
29. Redding, G. M. & Wallace, B. Strategic calibration and spatial alignment: a model from prism adaptation. *J. Mot. Behav.* **34**, 126–138 (2002).
30. Jeannerod, M. & Rossetti, Y. Visuomotor coordination as a dissociable visual function: experimental and clinical evidence. *Baillieres Clin. Neurol.* **2**, 439–460 (1993).
31. Bedford, F. L. Constraints on perceptual learning: objects and dimensions. *Cognition* **54**, 253–297 (1995).
32. Cothros, N., Wong, J. D. & Gribble, P. L. Are there distinct neural representations of object and limb dynamics? *Exp. Brain Res.* **173**, 689–697 (2006).
33. Harris, C. S. Adaptation to Displaced Vision: Visual, Motor, or Proprioceptive Change? *Science* **140**, 812–813 (1963).
34. Herzfeld, D. J. & Shadmehr, R. Motor variability is not noise, but grist for the learning mill. *Nat. Neurosci.* **17**, 149–150 (2014).
35. Wu, H. G., Miyamoto, Y. R., Castro, L. N. G., Ólveczky, B. P. & Smith, M. A. Temporal structure of motor variability is dynamically regulated and predicts motor learning ability. *Nat. Neurosci.* **17**, 312–321 (2014).
36. Lefumat, H. Z. *et al.* To transfer or not to transfer? Kinematics and laterality quotient predict interlimb transfer of motor learning. *J. Neurophysiol.* jn.00749.2015, <https://doi.org/10.1152/jn.00749.2015> (2015).
37. Kast, V. & Leukel, C. Motor Experts Care about Consistency and Are Reluctant to Change Motor Outcome. *PLoS One* **11**, e0161798 (2016).
38. Fitts, P. M. & Posner, M. I. *Human Performance*. (Brooks/Cole Publishing Company, 1967).
39. Leukel, C., Gollhofer, A. & Taube, W. In Experts, underlying processes that drive visuomotor adaptation are different than in Novices. *Front. Hum. Neurosci.* **9** (2015).
40. Taylor, J. A. & Ivry, R. B. The role of strategies in motor learning. *Ann. N. Y. Acad. Sci.* **1251**, 1–12 (2012).
41. Lin, C.-H., Lien, Y.-H., Wang, S.-F. & Tsauo, J.-Y. Hip and knee proprioception in elite, amateur, and novice tennis players. *Am. J. Phys. Med. Rehabil.* **85**, 216–221 (2006).
42. Wei, K. & Körding, K. Relevance of error: what drives motor adaptation? *J. Neurophysiol.* **101**, 655–664 (2009).

Acknowledgements

The authors wish to thank Sonia Alouche, Jean-Louis Borach and Frédéric Volland for their precious help, Eric Koun and Roméo Salemme for their engineering skills. This work was supported by Hospices Civils de Lyon, Inserm, CNRS, Ecole Normale Supérieure of Rennes, and Labex Cortex (Labex/index ANR-11-LABX-0042).

Author contributions

L.F., D.P. and Y.R. designed the study, L.F., D.P., P.R., L.D. and Y.R. conducted data acquisitions, L.D. developed custom softwares for analysis, L.F., D.P. and Y.R. analysed and interpreted the data, L.F. drafted the manuscript, Y.R. and L.F. substantively revised it.

Competing interests

The authors declare no competing interests.

Additional information

Supplementary information is available for this paper at <https://doi.org/10.1038/s41598-020-62519-5>.

Correspondence and requests for materials should be addressed to L.F.

Reprints and permissions information is available at www.nature.com/reprints.

Publisher's note Springer Nature remains neutral with regard to jurisdictional claims in published maps and institutional affiliations.



Open Access This article is licensed under a Creative Commons Attribution 4.0 International License, which permits use, sharing, adaptation, distribution and reproduction in any medium or format, as long as you give appropriate credit to the original author(s) and the source, provide a link to the Creative Commons license, and indicate if changes were made. The images or other third party material in this article are included in the article's Creative Commons license, unless indicated otherwise in a credit line to the material. If material is not included in the article's Creative Commons license and your intended use is not permitted by statutory regulation or exceeds the permitted use, you will need to obtain permission directly from the copyright holder. To view a copy of this license, visit <http://creativecommons.org/licenses/by/4.0/>.

© The Author(s) 2020

2. Study 1: Synthesis

The first experiment (**1A**) showed a strictly unidirectional transfer from pointing to throwing but not from throwing to pointing. Notably, error reduction during exposure and after-effects on the exposed task were remarkably similar in the two groups, i.e. irrespective of the task performed during prism exposure.

The second experiment (**1B**) crucially revealed that expertise for throwing made transfer reciprocal: expert dart throwers transferred after-effects to pointing, unlike experiment 1A involving novice throwers.

Finally, the third experiment (**1C**) confirmed that no transfer occurred from throwing to pointing and provided additional insights from kinematics analysis of pointing behaviour. First, the initial direction of pointing during post-tests was biased to the left in both groups, i.e. regardless the task performed during exposure. However, the terminal direction of movements was corrected in the throwing group, so that there were no terminal errors and after-effects in the participants who performed throwing movements during prism exposure. Because proprioceptive feedback allows correction of the terminal part of pointing trajectory during post-tests, we hypothesized that the proprioceptive modality was not biased by prism exposure in the throwing group.

B. AXIS 2: TRANSFER AND MOTOR IMAGERY

1. Study 2: Manuscript

STUDY 2 aimed at testing whether prism adaptation (PA) by motor imagery (MI) of pointing led to transferable after-effects. In addition, the purpose of this study was to test the influence of MI abilities on after-effects and transfer. 44 healthy volunteers participated in the study. The procedure used in **STUDY 2** are mainly inspired from the first experiment of the **STUDY 1**, but only pointing prism exposure is involved. Besides, main changes are present concerning the conditions of prism exposure to match the requirements for PA procedure using MI. These modifications are detailed in the methods section.

The manuscript presented below is in preparation for submission.

Motor imagery of pointing during prism exposure enables the transfer of after-effects to throwing

Lisa Fleury (a, b), Léa Dreyer (a, c), Rola El Makkaoui (a, c), Elise Leroy (a, c), Yves Rossetti (a, b, d), Christian Collet (b,e)

(a) *INSERM UMR-S U1028, CNRS UMS 5292, ImpAct, Lyon Neuroscience Research Center (CRNL), 69500, Bron, France*

(b) *Claude Bernard University of Lyon 1, 69100, Villeurbanne, France*

(c) *University Lumière of Lyon 2, 69500, Bron, France*

(d) *“Mouvement et Handicap” platform, Neurological Hospital, Hospices Civils de Lyon, 69500, Bron, France*

(e) *Inter-University Laboratory of Human Movement Biology (EA 7424), 69100, Villeurbanne, France*

Abstract

Prism adaptation (PA) is a useful method to investigate short-term sensorimotor plasticity. Following active exposure to prisms, individuals show consistent after-effects probing that they adapted to the perturbation. Whether after-effects are transferable to another task or remain specific to the task performed under exposure represents a crucial interest to understand the adaptive processes at work. Motor Imagery (MI; i.e. the mental representation of an action without any concomitant execution) offers an original opportunity to investigate the role of cognitive aspects of the motor command preparation disregarding actual sensory and motor information related to its execution. The aim of the study was to test whether prism adaptation by motor imagery led to transferable after-effects. Forty healthy volunteers were exposed to a rightward prismatic deviation while performing actual (Active group) versus imagined (MI group) pointing movements, or while being inactive. Upon prisms removal, participants in the MI group showed consistent after-effects on pointing and, crucially, a significant transfer to throwing compared to the Inactive group. Interestingly, only participants with high MI abilities adapted to the prismatic shift. These findings suggest that exposure to an intersensory conflict is responsible for sensory realignment during prism adaptation. Conversely, the sensorimotor motor conflict driven by actual feedbacks related to motor execution is not necessary to develop a transferable adaptation.

Key-words: prism adaptation, motor imagery, transfer, after-effects, sensory realignment

Introduction

Sensorimotor plasticity allows human beings to set up adaptive processes to keep movement accuracy and smoothness when facing sustained perturbations or new situations. The processes involved to face perturbations can be reflected by transfer properties, i.e. the capacity to apply modified sensorimotor settings from the initial perturbation context to other situations (Fleury et al., 2019; Poggio & Bizzi, 2004). In addition, the understanding of such transfer mechanisms represents a crucial issue in the field of neuro-rehabilitation (Roemmich & Bastian, 2018).

Prism adaptation (PA) is one of the oldest paradigm aimed at investigating short-term sensorimotor plasticity processes (Prablanc et al., 2019; Redding et al., 2005, von Helmlitz, 1962). Individuals' baseline pointing performance is first assessed. Subsequently, individuals are actively exposed to a visual field shift through prismatic goggles. During the first pointing trials under prism exposure, they experience pointing errors in the direction of the prismatic deviation. Among a couple of trials, the participants rapidly compensate for errors until they turn back to their baseline performance. Once prisms are removed at the end of exposure, they make pointing errors in a direction opposite to the initial prismatic deviation, called "negative after-effects". The proof of a "true" adaptation is attested by after-effects assessment, relatively to baseline performances (Prablanc et al., 2019; Weiner et al., 1983).

Several interpretative frameworks have been proposed to describe processes at work during PA. Redding and Wallace (2002) supposed two distinct mechanisms: strategic control (recalibration) and sensory realignment. Strategic control is the process rapidly reducing errors as soon as the exposure began, by means of a strategic adjustments of motor plans. During the very first trials, the participants use previous errors to correct the subsequent pointing trial using cognitive-compensatory modifications of motor commands, even, for example, including voluntary pointing-off target strategies. Realignment is a slower and automatic process needed to re-organize the sensory references frames (visual and proprioceptive). Visual information is biased by the prismatic lenses while proprioceptive information remains unbiased, resulting in a mismatch between the two sensory maps. Realignment aims at reducing this mismatch by updating relationships between visual and proprioceptive reference frames. Realignment is at the origin of after-effects and is considered as "true" adaptation (Petitet et al., 2017; Prablanc et al., 2019; Redding et al., 2005).

However, disentangling strategic control and realignment and their specific contribution to prism adaptation is still not fully elucidated. The conditions required to develop after-effects have been deeply investigated but remained somewhat unclear.

Over the building of PA literature knowledge, conscious error detection and/or correction during prism exposure was needed to develop adaptation. Recent pieces of work challenged this assumption, for example, by developing adaptation with a multiple step paradigm, i.e. gradually inducing prismatic deviation by steps of two degrees (Michel et al., 2007). Therefore, participants remained unaware of the prismatic perturbation and did not detect errors although they showed substantial after-effects once prisms were removed (Gaveau et al., 2014; Hanajima et al., 2015; Hatada et al., 2006; Michel et al., 2007; Panico et al., 2018).

Another stronger assumption was that active movements were necessary to develop adaptation when exposed to prisms, in order to generate actual sensory feedbacks (Prablanc et al., 2019; Held & Freedman, 1963; Held & Mikaelian, 1964). This was shown by passive exposure (i.e. absence of movement) which did not elicit after-effects. However, Michel et al. (2013) demonstrated that MI was able to develop an adaptation when exposed to prisms.

Motor imagery (MI) is a mental representation of an action without any concomitant execution. MI shares temporal features with actual movement and activates common cortical areas (Guillot et al., 2012; Jeannerod, 2001). This neuro-equivalence is correlated with MI ability, i.e. the capacity to easily form vivid mental representations. Good imagers demonstrate greater activation of motor areas during MI compared to poor imagers (Debarnot et al., 2014). Importantly, MI has the potential to improve actual motor performance through mental training, leading to motor performance enhancement (Di Rienzo et al., 2016; Ruffino et al., 2017). MI also led to adaptation when exposed to a visual perturbation (Michel et al., 2013). In fact, participants who performed pointing movements through MI (i.e. with no actual execution of pointing movements) while exposed to a 15° prismatic deviation showed significant after-effects following exposure. After-effects were nevertheless less than half smaller compared to those following actual pointing. Crucially, no after-effect occurred in the control groups. Control groups data showed that in the Prisms-Imagery group, after-effects were not attributable: (1) to simple exposure to prisms (without MI, with or without focused attention on hand or targets), (2) neither to simple practice of MI (without wearing prisms). Importantly, the last control group probed that viewing the hand while imaging movements under prism exposure was necessary to develop after-effects: participants who performed pointing movements through MI under prism exposure but with no vision of their hand did not show any adaptation. This result evidenced that sensorimotor conflict (i.e. the mismatch between predicted and actual consequences of movements) was not required to develop an adaptation. However, the inter-sensory conflict between biased visual information and unbiased proprioceptive information was strong enough to produce after-effects.

A possible interpretation of such results relies on the internal models framework (Kawato, 1999; Miall & Wolpert, 1996). MI involves the internal forward model (Kilteni et al., 2018), which predicts the future sensorimotor state through the consequences of motor command, by integrating the efferent copy of the motor command and the current state of the sensorimotor system (Miall & Wolpert, 1996). In this case, while imagining pointing movements under prism exposure, the participants integrated the efferent copy of their successful pointing movement as well as the initial sensory information, i.e. the visually perceived position of the targets and the perception of their hand through visual and kinaesthetic information. Yet, seeing the target position and hand was biased by the prisms, while the kinaesthetic position of the hand was not. This inter-sensory conflict may have conducted participants to adopt an intermediary hand position between the visual shifted and the proprioceptive stable hand locations. Through the repetition of MI pointing trials, participants progressively realigned the hand toward the target, thus eliciting after-effects. A complementary experiment showed that proprioception was realigned on vision. Crucially, the process of strategic control was precluded in this study because no error correction was possible. These results showed that sensorimotor predictions were sufficient to update internal models and to generate adaptation (through sensory realignment) as long as the inter-sensory conflict goes on (Michel et al., 2013).

Nonetheless, although previous works determined which conditions are likely to trigger adaptation (i.e. after-effects), there is no information about the extent to which after-effects elicited through pointing mental practice are transferable to other tasks.

An important feature of PA methodology is the need to assess after-effects using a different context as to that of the exposure (without goggles and toward different targets). This is required to attest “true” adaptation (Petitet et al., 2017; Prablanc et al., 2019). Yet, testing after-effects transfer allows to better capture sensorimotor after-effects that are not specific to the context of exposure (Fleury et al., 2020) and provides crucial information related to the processes involved when facing the perturbation. During prism exposure, compensations could easily be measured in a different context by changing target locations (e.g. Bedford, 1993; Redding & Wallace, 2006), limbs (e.g. Girardi et al., 2004; Michel et al., 2008; Morton et al., 2001), or even tasks (e.g. Fernandez-Ruiz et al., 2003; Jacquin-Courtois et al., 2008). We recently tested how after-effects transferred between throwing and pointing in PA (Fleury et al., 2020). A first group of participants was exposed to the prismatic deviation while performing throwing, with the aim to test how after-effects transferred from throwing to pointing. Another group tested how after-effects developed during pointing prism exposure transferred to throwing. We reported a single transfer from pointing to throwing but not the other way around. However, expertise in throwing (i.e. reduced variability) made transfer reciprocal, suggesting that the absence of transfer from throwing in novices may be explained by a greater variability

trajectory during throwing than during pointing. This study revealed that transfer capacities may uncover the contribution of different processes at work when facing a similar perturbation. Therefore, transferable after-effects may imply “true” adaption due to sensory realignment. However, understanding the processes underlying inter-task transfer remains incomplete.

The present study aimed to test whether PA by MI (imagined pointing movements) triggers after-effects transfer to a task that has previously not been experienced under prism exposure (throwing). An additional aim was to test whether MI abilities influenced adaptation and transfer processes. Therefore, the purpose of this article is to provide additional knowledge about the conditions needed to develop transferable after-effects, but also to test whether MI has the potential to induce short-term plasticity when facing a visuomotor perturbation.

Methods

Participants

44 right-handed with normal vision participated in the present study. All participants had never been exposed to prisms and were naive about the paradigm. They had no history of neurological condition nor right upper limb orthopaedic trouble. All the procedures were conducted in accordance with relevant guidelines and regulations and were approved by an ethics evaluation committee (CEEI¹ n°19-578; IRB00003888). All participants gave their written informed consent before starting the protocol.

Participants were divided into three groups “Active” (ACT), “Inactive” (INA), “Motor Imagery” (MI). All participants were first assessed for their MI ability using a revised version of the Movement Imagery Questionnaire (MIQ-R, Hall & Martin, 1997). This questionnaire is made of 4 movements involving the upper limbs in visual and kinaesthetic modalities (8 items in total). The experimenter demonstrated each movement before the participant was asked to reproduce it once, then performing the mental representation of the movement either visually or kinaesthetically. Thereafter, they had to self-report on a 7-points Likert scale the ease to mentally represent the action, from 1 (very hard to see/feel) to 7 (very easy to see/feel). The 20 participants assigned to the MI group exhibited an average score of at least 4.5. This group was then subdivided into two subgroups depending on their MI ability: 10 participants with high MI ability (i.e. good imagers, mean = 6.51 ± 0.41) were assigned to the “Motor Imagery+” (MI+) group while the 10 others with lower scores (i.e. lower imagers, mean = 5.65 ± 0.59) were assigned to the “Motor Imagery-” (MI-) group. Participants of the “MI+” group also reported a MI vividness score of at least 3.5 over 5 during prism exposure (see section Exposure for details). 24 other participants were randomly assigned to the Active (“ACT”; n=13) or Inactive (“INA”; n=11) group.

Experimental procedure

Participants followed the four same stages as shown by **Figure 1**: pointing (« exposed » task) and throwing (« unexposed » task). Tasks were performed either with vision (closed-loop) or without (open-loop), and toward a central target (see the next section for details). Specific conditions are detailed hereafter. Familiarization, pre-tests, and post-tests were similar for all participants, regardless of their group. Both tasks were performed in a pseudo-randomized order. Exposure conditions varied depending on the group in which they were assigned.

¹ *Ethics Evaluation Committee of Inserm*

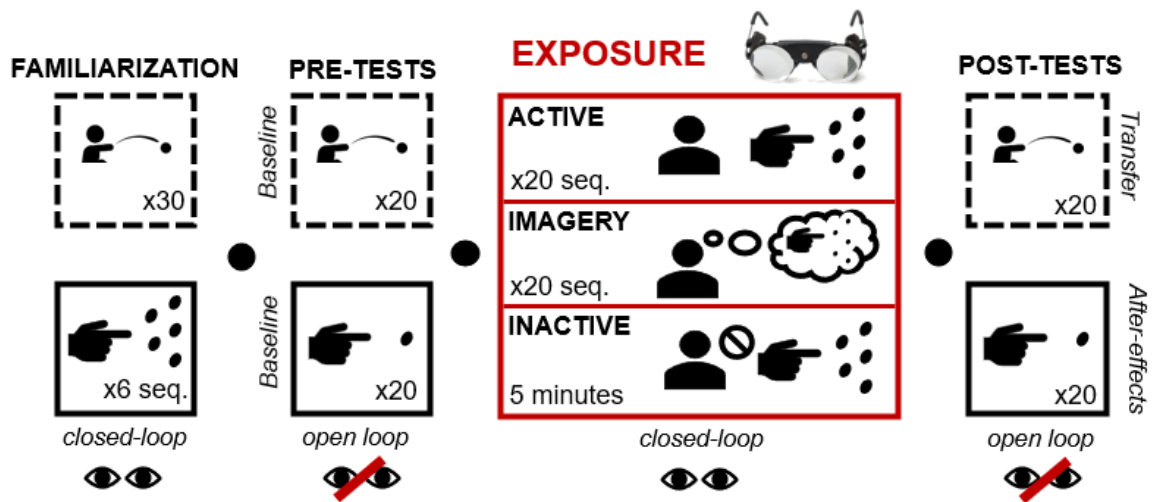

Figure 1 – Experimental procedures. Participants followed four steps: familiarization, pre-tests, exposure, and post-tests. Visual feedbacks were available during familiarization and post-tests and were precluded during pre-tests and post-tests. During exposure, participants in the Active group actively performed 20 sequences of pointing while participants in the Imagery groups (MI+ and MI-) imagined these 20 sequences. Participants in the Inactive group remained inactive during exposure and responded to trivial questions asked by the investigator.

Familiarization

To familiarize with both tasks and experimental settings, participants of each group performed 30 throwing movements, and 30 pointing movements (6 sequences of 5 pointing movements, as detailed in *Tasks* section). All trials were performed in a closed-loop condition, with vision toward the central target. Each sequence of 5 successive pointing was timed to be compared to that of MI pointing.

Pre-tests

Baseline was assessed on each task during pre-tests. Participants of both groups realized 20 throwing movements and 20 pointing movements performed one by one in open-loop condition (no vision).

Exposure

All participants wore prismatic goggles that shifted laterally the visual field 10 degrees toward the right (OptiquePeter.com, Lyon). Before wearing the goggles, participants were asked to keep their eyes closed. They were also instructed not to look at their own body or to move any limb (except to perform the task) while they wore the prismatic goggles. Before exposure, participants' right index was placed in the starting position (see **Figure 2**). All participants saw their right hand and targets.

In the Active group, participants performed 20 actual ballistic sequences of pointing (100 pointing movements in total) as fast and accurately as possible, in a closed-loop condition. Participants should act after a vocal signal provided by the investigator.

In the MI group, participants performed 20 sequences of mental representations of pointing. They should imagine themselves performing accurate pointing sequences toward the different targets, with both kinaesthetic and visual information. They were allowed to look at either their hand or the targets through the prisms and were asked not to look to other parts of their environment. Every 5 sequences, participants were asked to self-report MI vividness on a 5-points Likert scale. More precisely, they should report the intensity/clarity of their mental representations from 1 (no sensation/no image at all) to 5 (sensation as intense as during physical execution/images as clear as during watching a videoclip). Additionally, each pointing sequence was timed to test whether durations were close to those recorded during actual pointing sequences during familiarization.

In the Inactive group, participants saw both their hand and targets through the goggles and should watch their motionless hand with their index landing on the starting position, during 5 minutes. They were instructed to remain motionless, without looking at any part of the environment. They did not receive any other information. To ensure that participants did not imagine any movements, the investigator asked them trivial questions so they did not deal with any mental material during the experiment. At the end of exposure, all participants were asked to keep their eyes closed, before removing the goggles.

Post-tests

Once the prisms were removed, after-effects were assessed in both tasks under open-loop condition (no vision allowed). Participants performed 20 actual throwing and 20 actual pointing toward the central target.

Tasks

The participants sat in an adjustable chair during the whole experiment. They were in front of the pointing desk and kept this position with their head resting on a V-shaped chinrest until the end of the experiment. During each transitional phase, they were asked to close their eyes to be deprived of visual information and to prevent visuomotor compensations. The following section details the experimental set-up of each task.

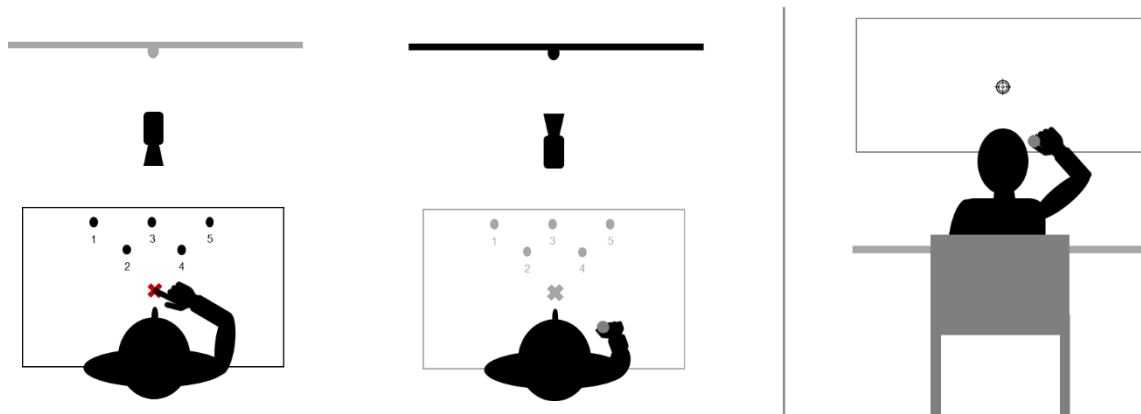

Figure 2 – Tasks set-up. *Left panel:* superior view of the experimental set-up of the pointing task (left) and the throwing task (right). *Right panel:* posterior view of the experimental set-up of the throwing task.

Pointing task

The starting position of the finger was lined up with the body midline either below the chinrest (out of view; pre-tests and post-tests) or a few centimetres ahead (visible; familiarization and exposure - **Figure 2**). Five targets were placed horizontally on the pointing desk (**Figure 2**). Participants had to perform two types of pointing depending on the step of the experiment: i) sequence of pointing directed to the five targets, and ii) unique straightforward pointing directed to a central target.

- **Sequences of ballistic pointing movements (familiarization and exposure)**

Full vision was allowed in this condition and participants saw both their hand and the targets. To complete the sequence, participants had to reach each target (starting from target 1 to target 5, see **Figure 2**) as fast and accurate as possible, while going back to the starting position between each target. Each sequence was made of 5 ballistic pointing movements (from starting position to each target) with no interruption. The starting signal was given by the experimenter before each sequence. During familiarization, all participants performed actual movements. During exposure, only participants in the Active group performed actual movements while those of the MI groups imagined movements. Finally, participants in the Inactive group did not execute nor imagine any movement during exposure. Sequential pointing provided sequences of appropriate duration to perform vivid MI. In fact, non-sequential movements lasting less than 5s make mental representations more difficult (Guillot & Collet, 2005).

- **Unique straight-forward pointing movements (pre and post-tests)**

During this type of pointing, no vision was allowed during the entire movement and participants had to produce a unique and straightforward reach toward the central target (target n°3, see **Figure 2**, left panel). To control visual feedback, the experimenter manipulated a cover board

in front of the participants. Before each trial, she lowered the cover board, so that the participants saw the targets while their index was still invisible in the starting position below the chinrest. Before each trial, the experimenter lifted the cover board to prevent target vision and movement. This procedure was used to reliably assess after-effects and to prevent de-adaptation (Petitet et al., 2017; Prablanc et al., 2019). During pre-tests and post-tests, all participants performed the same pointing task, irrespective of their group.

Throwing task

Participants were in the same position as during the pointing task, with their head in the chinrest. A vertical board was placed 2 meters in front of the participants. A central target was displayed on the board, at the height of participants' eyes. The starting position requested to keep the right hand close to their right ear. Before each trial, the experimenter placed a ball in the participant's right hand. He or she could then throw the ball toward the central target. There were two different conditions as for the pointing task, described just below

- **Closed-loop throwing movements (familiarization)**

The participants saw their movements and the associated result. None performed the throwing task during exposure.

Open-loop throwing movements (pre-tests and post-tests): Starting position was similar to that in the closed-loop condition. Before each trial, participants had to hold the ball placed in their right hand by the experimenter, and to look at the central target. Before initiating throwing, they were instructed to close their eyes and to throw the ball without visual feedback on execution and final outcome. They could open their eyes before the next trial and thus see the target before each trial. We also placed a cover board so that participants did not have any visual feedback during throwing.

Data collection and processing

We recorded pointing and throwing performance during pre-tests and post-tests with a high-resolution camera (4K digital camera HCVX990EF, Panasonic, Kadoma, Japan) placed between the pointing desk and the throwing board. We then processed the data with a motion analysis software (Kinovea, Charmant, 2004). The software provided the lateral distance between the target and the index or the distance between the ball impact and the target. Lateral distances were then converted into angular deviations before statistical analysis.

Statistical analysis

The variable of interest was the subjects' performance, i.e. the terminal errors on throwing and pointing before (pre-tests) and after (post-tests) exposure. First, we performed paired-sample

t-tests independently for each group, thus comparing pre-test and post-test performance during pointing and throwing.

Then, we computed after-effects for each task as the differences between pre-tests and post-tests performance. We conducted two independent ANOVAs to assess the effect of Group (ACT, MI+, MI-, INA) on pointing and throwing after-effects separately. Finally, we conducted an ANOVA with repeated measures with the task (pointing after-effects vs throwing after-effects) as a within-subject factor and the group (ACT, MI+, MI-, INA) and order of the tasks during post-tests (pointing first (1) vs throwing first (2)) as inter-subject factors.

Results

Comparisons between pre-tests and post-tests performances

Pointing performances

Post-tests pointing performance was significantly shifted leftward in the ACT ($t(12) = 9.50, p < .01$) and MI+ ($t(8) = 2.91, p = .01$) groups. However, post-test pointing errors did not differ from the pre-test in MI- ($t(9) = .89, p = .39$) and INA ($t(8) = 1.62, p = .14$) groups (see **Figure 3**). PA by physical practice and mental practice for individuals with high scores of MI abilities significantly increased negative errors in pointing while participants with lower scores of MI abilities showed no differences in their pointing performance after prism exposure compared to pre-tests.

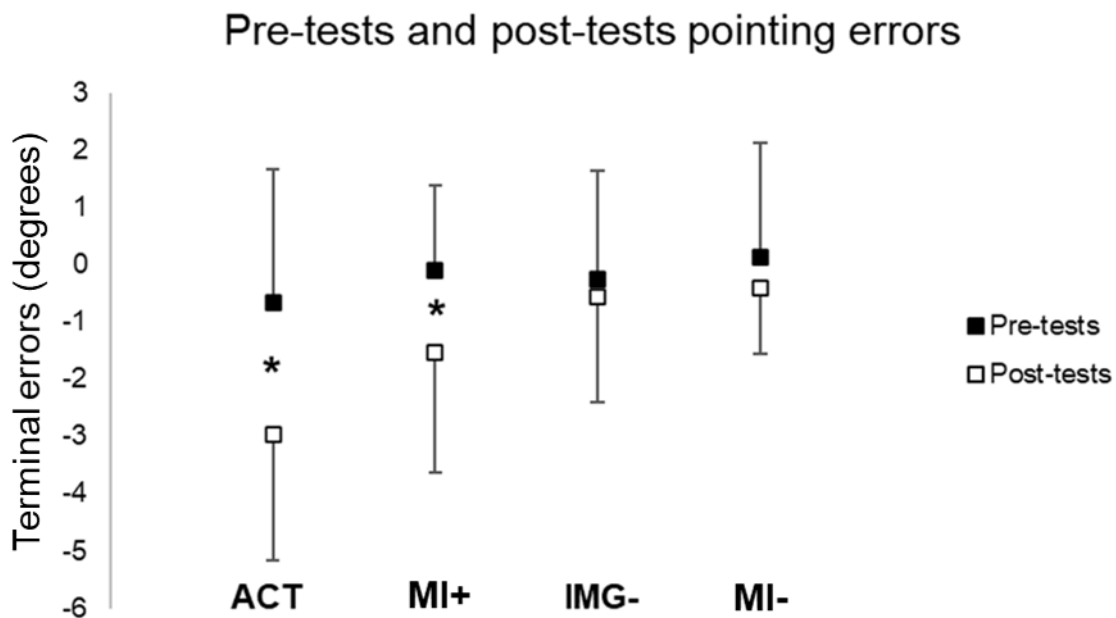

Figure 3 – Pointing terminal errors during pre and post-tests. Values are reported with standard deviations. * means significance at $p < .01$.

Throwing performance

Analyses revealed no differences between pre-tests and post-tests during throwing in the MI- ($t(9) = .72, p = .52$) and INA ($t(8) = .82, p = 0.43$) groups. Participants in the ACT group showed a non-significant leftward shift ($t(9) = 1.10, p = .30$). However, difference between pre-tests and post-tests was significant in the MI+ group ($t(9) = 2.43, p = .038$): throwing performance was significantly shifted leftward after PA by mental practice only for participants with high MI abilities (see **Figure 4**).

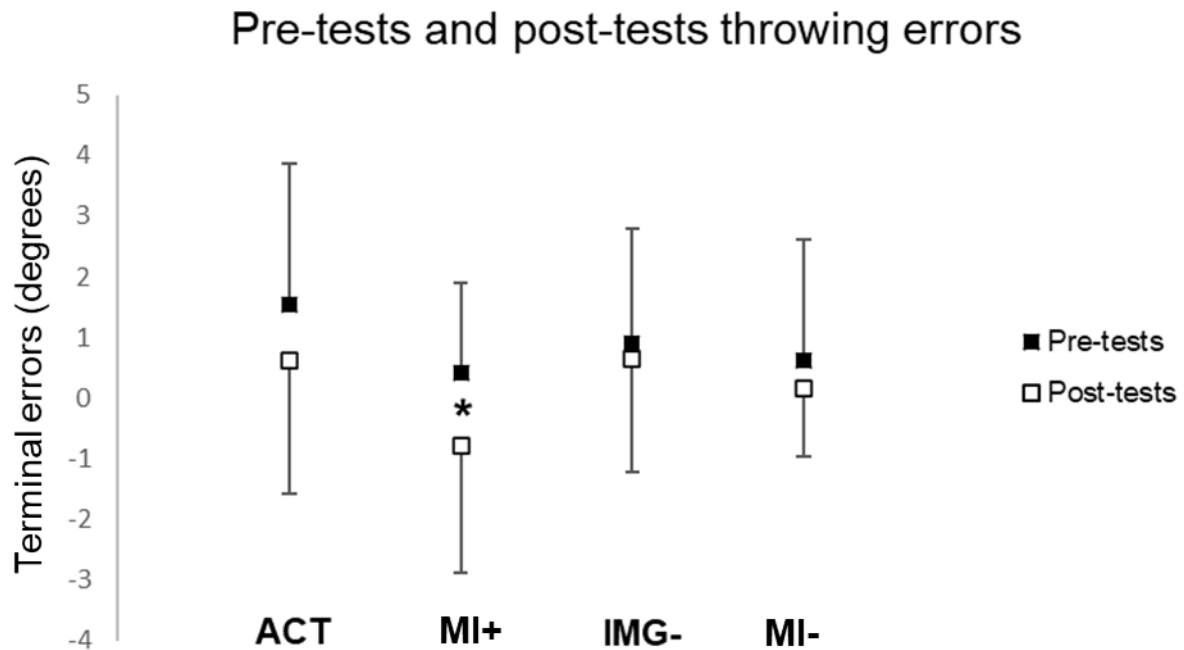

Figure 4 - Throwing terminal errors during pre and post-tests. Values are reported with standard deviations. * means significance at $p < .05$.

Comparisons between groups

We performed two independent ANOVAs to assess the differences between groups related to pointing and throwing after-effects (post-tests performances with baseline subtracted, **Figure 5**).

For pointing after-effects, ANOVA revealed a significant effect of Group ($F(3,37) = 6.71, p < .01$). Post-hoc analysis showed that pointing after-effects were larger in the ACT group (mean = $-2.18 \pm .90$ degrees) compared to the INA (mean = $-.54 \pm 1.01$ degrees, $p < .01$) and IMG-groups (mean = $-.31 \pm 1.10$ degrees; $p < .01$). Pointing after-effects in the MI+ group (mean = -1.39 ± 1.42 degrees) were larger compared to MI- and INA groups without reaching significance.

ANOVA for transfer to throwing did not reveal a significant difference between groups ($F(3,35) = .52, p = .67$).

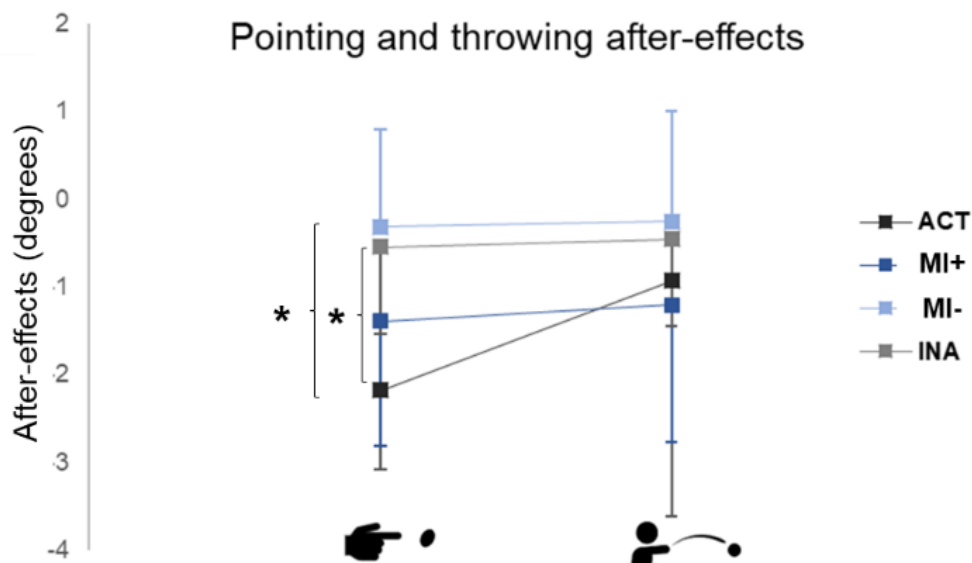

Figure 5 – Pointing and Throwing after-effects. Performances during post-tests with baseline subtracted. Values are reported with standard deviations. * means $p < .01$.

Task order influence on pointing and throwing after-effects

We conducted an ANOVA with repeated measures on after-effects performances with Task as a within-subjects factor (Pointing vs Throwing) and Group and Task Order (Pointing first vs Throwing first) as between-subject factors.

Task, Task*Group, Task*Task Order, Task*Group*Task Order and Group*Task Order interaction effects did not reach significance. However, results showed a Task Order main effect ($F(1,30) = 6.48, p = .01$) showing that averaged after-effects (over the levels of Group and Task) were significantly larger when Pointing after-effects were assessed firstly during post-tests.

Post-hoc analysis also showed a slight specific Task*Task order effects but no 3 way interaction. Specifically, mean pointing after-effects were larger when assessed firstly compared to mean throwing after-effects when assessed firstly ($p_{\text{tukey}} = .02$). In addition, mean throwing after-effects were larger when assessed in second compared to mean throwing after-effects when assessed in first ($p_{\text{tukey}} = .04$). None of these effects was significant when tested within each group.

Discussion

The aim of this study was to test whether PA by MI of pointing enabled to transfer after-effects to a throwing task that was not experienced under prism exposure. We also investigated the influence of MI abilities on adaptation and transfer.

This work showed that post-tests in pointing were significantly shifted leftward in “MI+” and “ACT” groups following prism exposure, demonstrating that adaptation took place. However, post-tests in pointing were similar to pre-tests in the “MI-” and “INA” groups, showing no adaptation. Participants who were actively exposed to prisms during pointing showed substantial negative after-effects during post-tests. This is consistent with classical prism adaptation, showing that active concurrent exposure (with hand vision during the whole movement) leads to adaptation and after-effects (Prablanc et al., 2019). In addition, mental representation of pointing by MI during prism exposure (without any concurrent movement) elicited a substantial leftward shift of pointing errors for participants with a high MI score. These results replicate the findings of Michel et al. study (2013) and provide an additional evidence that PA likely relies on sensory realignment based on inter-sensory conflict without the need of being exposed to sensorimotor conflict (Michel et al., 2013). It is noteworthy that exposure to prisms in absence of MI does not produce consistent after-effects as shown by the present experiment, consistently with classical studies using passive exposure (e.g. Held & Freedman, 1963). The sensory realignment was ensured by the comparison of computed initial hand position (between visual-shifted and proprioceptive unbiased locations; Rossetti et al., 1994) together with the efferent copy of pointing movements. Noticeably, participants in the “Active” group showed a greater magnitude of after-effects although it was not twice as large as in the “MI+” group as in Michel et al. study (2013).

The main objective of this study was to determine whether PA by mental practice transferred after-effects to throwing. Participants with high MI abilities who performed imagined pointing movements under prism exposure transferred after-effects to throwing, despite they did neither perform nor imagine throwing movements under prism exposure. Interestingly, this amount of transfer was comparable to the initial magnitude of after-effects during pointing. This result is all the more significant when considering that both participants in the MI- and INA group during exposure did not show any transfer to throwing. This provides evidence that sensory realignment elicited by MI during intersensory conflict resulted in strong, robust, and transferable after-effects. An interesting hypothesis emerging from such findings is that the process of recalibration (which was absent during prism exposure through motor imagery) may favour contextual sensorimotor alterations, i.e. poor transfer. Yet, recalibration is absent during prism exposure by MI because movements are not actually executed. Thus, we may

hypothesize that the relative contribution of sensory realignment increased when recalibration was suppressed. Assuming that, we propose that sensory realignment, by directly updating internal models inherent to the participants' intrinsic references frames, led to a "true" adaptation (Weiner et al., 1983) allowing to generalize after-effects to extended motor situations (Fleury et al., 2020).

Another interesting and original finding relates to the difference between good and poor imagers. Participants with high MI abilities showed substantial pointing and throwing after-effects while participants with lower abilities did not. Therefore, high MI abilities were needed for successful PA through mental practice and to generalize after-effects to the unexposed task. These differences may be explained by the relationships between MI abilities and the neuro-functional correlates of MI. When mentally representing movements, individuals with high MI capacities should recruit motor-related areas to a greater extent compared to participants with low MI abilities, suggesting a greater induced-plasticity (Debarnot et al., 2014; van der Meulen et al., 2014). Good imagers also showed better isochrony between actual and imagined movements (Guillot & Collet, 2005) and increased neurovegetative responses during mental practice (Roure et al., 1999).

Altogether, these findings are very encouraging in probing transferable adaptation by means of MI under prism exposure. Nevertheless, we did not show a significant difference between the "MI+" group and both the "MI-" and "INA" groups about the magnitude of pointing and throwing after-effects although pre and post-tests were significantly different in MI+ but not in the two other groups. A speculative hypothesis is that the magnitude of pointing after-effects exhibited by good imagers was lower in our study than in the study by Michel et al. (2013). A potential explanation may refer to several differences in experimental procedures. Optical deviation was 10° whereas it was 15° in the study by Michel et al. (2013). In addition, pointing movements imagined under prism exposure were slightly different: we used sequences of pointing while Michel et al. requested the participants to perform 100 ballistic pointing, each trial being interspersed by 5 seconds. Although the total number of trials was identical, exposure duration was shorter in our study than in that by Michel et al. (2013). A recent paper showed that slight differences in experimental procedures of motor adaptation can lead to inconsistent results (Jalali et al., 2017). We can hypothesize that a greater optical deviation and extended number of sequences of pointing during exposure (increased exposure duration) may lead to an increased magnitude in pointing and throwing after-effects. Accordingly, differences between after-effects in MI+ and other groups (MI- and INA) might have been under-evaluated in the present study.

Surprisingly, the difference between throwing pre-tests and post-tests did not reach significance in the ACT group. Contrary to expectations, the present study failed to show substantial transfer of after-effects from pointing to throwing for participants who performed active pointing movements under prism exposure. Although we observed increased throwing leftward errors following exposure compared to pre-tests errors, this difference was not significant. Yet, transfer from pointing to throwing has been strongly demonstrated and replicated in a previous study (Fleury et al., 2020). Possible explanations for such results may be related to the divergence in exposure conditions. In the current study, active exposure was concurrent: hand vision was available from the starting position and during the whole reaching. Concurrent exposure may lead to reduced after-effects (Redding & Wallace, 1992; Redding & Wallace, 1988). Moreover, movements were sequential, and not interspersed with consistent breaks, while in Fleury et al. study (2020), the participants performed six blocks of ten pointing movements. The total duration of exposure may have been reduced in the present study compared to the previous. Altogether, these observations provide additional features related to the exposure conditions needed to observe transferable after-effects following prism exposure.

A last point of discussion is the influence of task order during post-tests on the magnitude of pointing and throwing after-effects. We found a global task order effect during post-tests suggesting that mean overall after-effects (averaged over the levels of groups and tasks) were larger when the exposed task (pointing) after-effects were first assessed. This may suggest that a potential part of transfer is developed first by experiencing after-effects on the exposed task. In addition, mean throwing after-effects were higher when assessed in second, when compared to throwing after-effects tested first. This corroborates the previous hypothesis. Finally, mean pointing after-effects were larger when measured first as compared to mean throwing after-effects when measured first. A logical explanation is that after-effects on the exposed task would be greater than after-effects on the unexposed task when both are tested immediately after exposure. Nonetheless, these effects had no influence on differences between groups because task order during pre-tests varied within each group (task order effects disappeared when tested within each group).

Altogether, these findings provide encouraging support to develop PA and transfer through MI. This study emphasized the fact that the contribution of sensory realignment (through sensory prediction error-based processes) might be related to transferable after-effects. Crucially, the perception of external errors through actual feedback of pointing movements appears as not necessary to trigger transfer. Furthermore, the absence of execution might have increased the contribution of sensory realignment because good imagers showed a nearly complete transfer

of after-effects to the throwing task. In addition, we also highlighted the importance of MI abilities in such adaptation and transfer abilities.

The current conclusions will need to be confirmed and extended to larger samples and more powerful adaptation paradigm. In the meantime, they already pave the way for investigating sensorimotor adaptation by mental practice to develop transferable after-effects. Therefore, the present study raises the possible use of MI in neurological rehabilitation for patients with motor alteration but preserved motor imagery capacities (Di Rienzo et al., 2014). For example, PA by MI could be generalized in the rehabilitation schedule of neglect patients. Future work should test how the association of MI and physical practice under sensorimotor perturbation could enhance adaptation and transfer of sensorimotor after-effects.

References

- Bedford, F. L. (1993). Perceptual and cognitive spatial learning. *Journal of Experimental Psychology: Human Perception and Performance*, *19*(3), 517-530. <https://doi.org/10.1037/0096-1523.19.3.517>
- Debarnot, U., Sperduti, M., Di Rienzo, F., & Guillot, A. (2014). Experts bodies, experts minds : How physical and mental training shape the brain. *Frontiers in Human Neuroscience*, *8*, 280. <https://doi.org/10.3389/fnhum.2014.00280>
- Di Rienzo, F., Collet, C., Hoyek, N., & Guillot, A. (2014). Impact of neurologic deficits on motor imagery : A systematic review of clinical evaluations. *Neuropsychology Review*, *24*(2), 116-147. <https://doi.org/10.1007/s11065-014-9257-6>
- Fernandez-Ruiz, J., Diaz, R., Hall-Haro, C., Vergara, P., Mischner, J., Nuñez, L., Drucker-Colin, R., Ochoa, A., & Alonso, M. E. (2003). Normal prism adaptation but reduced after-effect in basal ganglia disorders using a throwing task. *The European Journal of Neuroscience*, *18*(3), 689-694. <https://doi.org/10.1046/j.1460-9568.2003.02785.x>
- Fleury, L., Pastor, D., Revol, P., Delporte, L., & Rossetti, Y. (2020). Inter-task transfer of prism adaptation depends on exposed task mastery. *Scientific Reports*, *10*(1), 5687. <https://doi.org/10.1038/s41598-020-62519-5>
- Fleury, L., Prablanc, C., & Priot, A.-E. (2019). Do prism and other adaptation paradigms really measure the same processes? *Cortex*, *119*, 480-496. <https://doi.org/10.1016/j.cortex.2019.07.012>
- Gaveau, V., Prablanc, C., Laurent, D., Rossetti, Y., & Priot, A.-E. (2014). Visuomotor adaptation needs a validation of prediction error by feedback error. *Frontiers in Human Neuroscience*, *8*. <https://doi.org/10.3389/fnhum.2014.00880>
- Girardi, M., McIntosh, R. D., Michel, C., Vallar, G., & Rossetti, Y. (2004). Sensorimotor effects on central space representation : Prism adaptation influences haptic and visual representations in normal subjects. *Neuropsychologia*, *42*(11), 1477-1487. <https://doi.org/10.1016/j.neuropsychologia.2004.03.008>
- Guillot, A., & Collet, C. (2005). Duration of mentally simulated movement : A review. *Journal of Motor Behavior*, *37*(1), 10-20. <https://doi.org/10.3200/JMBR.37.1.10-20>
- Hanajima, R., Shadmehr, R., Ohminami, S., Tsutsumi, R., Shirota, Y., Shimizu, T., Tanaka, N., Terao, Y., Tsuji, S., Ugawa, Y., Uchimura, M., Inoue, M., & Kitazawa, S. (2015). Modulation of error-sensitivity during a prism adaptation task in people with cerebellar degeneration. *Journal of Neurophysiology*, *114*(4), 2460-2471. <https://doi.org/10.1152/jn.00145.2015>
- Hatada, Y., Miall, R. C., & Rossetti, Y. (2006). Two waves of a long-lasting aftereffect of prism adaptation measured over 7 days. *Experimental Brain Research*, *169*(3), 417-426. <https://doi.org/10.1007/s00221-005-0159-y>
- Jacquin-Courtois, S., Rode, G., Pisella, L., Boisson, D., & Rossetti, Y. (2008). Wheel-chair driving improvement following visuo-manual prism adaptation. *Cortex*, *44*(1), 90-96. <https://doi.org/10.1016/j.cortex.2006.06.003>
- Jalali, R., Miall, R. C., & Galea, J. M. (2017). No consistent effect of cerebellar transcranial direct current stimulation on visuomotor adaptation. *Journal of Neurophysiology*, *118*(2), 655-665. <https://doi.org/10.1152/jn.00896.2016>
- Kawato, M. (1999). Internal models for motor control and trajectory planning. *Current Opinion in Neurobiology*, *9*(6), 718-727. [https://doi.org/10.1016/S0959-4388\(99\)00028-8](https://doi.org/10.1016/S0959-4388(99)00028-8)
- Làdavas, E., Bonifazi, S., Catena, L., & Serino, A. (2011). Neglect rehabilitation by prism adaptation : Different procedures have different impacts. *Neuropsychologia*, *49*(5), 1136-1145. <https://doi.org/10.1016/j.neuropsychologia.2011.01.044>
- Miall, R. C., & Wolpert, D. M. (1996). Forward Models for Physiological Motor Control. *Neural Networks*, *9*(8), 1265-1279. [https://doi.org/10.1016/S0893-6080\(96\)00035-4](https://doi.org/10.1016/S0893-6080(96)00035-4)
- Michel, C., Gaveau, J., Pozzo, T., & Papaxanthis, C. (2013). Prism adaptation by mental practice. *Cortex*, *49*(8), 2249-2259. <https://doi.org/10.1016/j.cortex.2012.11.008>
- Michel, C., Pisella, L., Prablanc, C., Rode, G., & Rossetti, Y. (2007). Enhancing Visuomotor Adaptation by Reducing Error Signals : Single-step (Aware) versus Multiple-step (Unaware) Exposure to Wedge Prisms. *Journal of Cognitive Neuroscience*, *19*(2), 341-350. <https://doi.org/10.1162/jocn.2007.19.2.341>
- Michel, C., Vernet, P., Courtine, G., Ballay, Y., & Pozzo, T. (2008). Asymmetrical after-effects of prism adaptation during goal oriented locomotion. *Experimental Brain Research*, *185*(2), 259-268. <https://doi.org/10.1007/s00221-007-1152-4>

- Morton, S. M., Lang, C. E., & Bastian, A. J. (2001). Inter- and intra-limb generalization of adaptation during catching. *Experimental Brain Research*, *141*(4), 438-445. <https://doi.org/10.1007/s002210100889>
- Panico, F., Sgalliano, L., Nozzolillo, C., Trojano, L., & Rossetti, Y. (2018). Cerebellar contribution to spatial realignment: A tDCS study during multiple-step prism adaptation. *Neuropsychologia*, *112*, 58-65. <https://doi.org/10.1016/j.neuropsychologia.2018.03.008>
- Petit, P., O'Reilly, J. X., & O'Shea, J. (2017). Towards a neuro-computational account of prism adaptation. *Neuropsychologia*. <https://doi.org/10.1016/j.neuropsychologia.2017.12.021>
- Poggio, T., & Bizzi, E. (2004, octobre 13). *Generalization in vision and motor control* [Special Features]. *Nature*. <https://doi.org/10.1038/nature03014>
- Prablanc, C., Panico, F., Fleury, L., Pisella, L., Nijboer, T., Kitazawa, S., & Rossetti, Y. (2019). Adapting terminology: Clarifying prism adaptation vocabulary, concepts, and methods. *Neuroscience Research*. <https://doi.org/10.1016/j.neures.2019.03.003>
- Redding, G. M., Rossetti, Y., & Wallace, B. (2005). Applications of prism adaptation : A tutorial in theory and method. *Neuroscience & Biobehavioral Reviews*, *29*(3), 431-444. <https://doi.org/10.1016/j.neubiorev.2004.12.004>
- Redding, G. M., & Wallace, B. (1988). Components of prism adaptation in terminal and concurrent exposure : Organization of the eye-hand coordination loop. *Perception & Psychophysics*, *44*(1), 59-68. <https://doi.org/10.3758/BF03207476>
- Redding, G. M., & Wallace, B. (2002). Strategie Calibration and Spatial Alignment : A Model From Prism Adaptation. *Journal of Motor Behavior*, *34*(2), 126-138. <https://doi.org/10.1080/00222890209601935>
- Redding, G. M., & Wallace, B. (2006). Generalization of prism adaptation. *Journal of Experimental Psychology. Human Perception and Performance*, *32*(4), 1006-1022. <https://doi.org/10.1037/0096-1523.32.4.1006>
- Roemmich, R. T., & Bastian, A. J. (2018). Closing the Loop : From Motor Neuroscience to Neurorehabilitation. *Annual Review of Neuroscience*, *41*, 415-429. <https://doi.org/10.1146/annurev-neuro-080317-062245>
- Roure, R., Collet, C., Deschaumes-Molinari, C., Delhomme, G., Dittmar, A., & Vernet-Maury, E. (1999). Imagery quality estimated by autonomic response is correlated to sporting performance enhancement. *Physiology & Behavior*, *66*(1), 63-72. [https://doi.org/10.1016/s0031-9384\(99\)00026-8](https://doi.org/10.1016/s0031-9384(99)00026-8)
- van der Meulen, M., Allali, G., Rieger, S. W., Assal, F., & Vuilleumier, P. (2014). The influence of individual motor imagery ability on cerebral recruitment during gait imagery. *Human Brain Mapping*, *35*(2), 455-470. <https://doi.org/10.1002/hbm.22192>
- Weiner, M. J., Hallett, M., & Funkenstein, H. H. (1983). Adaptation to lateral displacement of vision in patients with lesions of the central nervous system. *Neurology*, *33*(6), 766-772.

2. Study 2: Synthesis

The results showed that PA resulted in meaningful pointing after-effects in participants who actively performed pointing during exposure but also in participants who only imagined pointing without any concomitant physical execution. In comparison, those who wore the prismatic glasses while being inactive during exposure (no movement, no MI) did not show any after-effects in pointing. Decisively, PA by mental practice resulted in significant after-effects transfer to throwing, although throwing was not imagined neither executed during exposure. This was not observed in the Inactive group.

Crucially, only participants who displayed high MI abilities exhibited pointing after-effects following PA by mental practice as well as transfer to throwing. This was not observed in individuals with low MI abilities.

Altogether, these findings demonstrated that the intersensory conflict combined with MI during exposure was responsible for pointing after-effects and transfer to throwing.

C. AXIS 3: TRANSFER AND TDCS

The aim of the third axis was to investigate the potential role of the cerebellum in after-effects transfer. For this purpose, we used transcranial direct current stimulation applied to the right cerebellum during PA procedure, from pre-tests to the end of post-tests. The methods used were similar to **STUDY 1** (experiment **1C**) in the pointing condition for **STUDY 3** and in throwing condition for **STUDY 4**.

1. Study 3: Manuscript

Results from **STUDY 1** showed a transfer of after-effects from pointing to throwing. Assuming that, the aim of **STUDY 3** was to test whether cathodal stimulation of the cerebellum interfered with this transfer. 27 healthy volunteers participated in this study.

The manuscript presented below is currently on the process of a minor revision for *Brain & Cognition*.

Non-invasive brain stimulation shows possible cerebellar contribution in transfer of prism adaptation after-effects from pointing to throwing movements.

Lisa Fleury (a, b), Francesco Panico (c), Alexandre Foncelle (a), Patrice Revol (a, d), Ludovic Delporte (a, d), Sophie Jacquin-Courtois (a, d), Christian Collet (b, e), Yves Rossetti (a, d)

(a) *INSERM UMR-S U1028, CNRS UMS 5292, ImpAct, Lyon Neuroscience Research Center (CRNL), 69500, Bron, France*

(b) *Claude Bernard University of Lyon 1, 69100, Villeurbanne, France*

(c) *Department of Psychology, University of Campania "Luigi Vanvitelli", 81100 Caserta, Italy.*

(d) *"Mouvement et Handicap" platform, Neurological Hospital, Hospices Civils de Lyon, 69500, Bron*

(e) *Inter-University Laboratory of Human Movement Biology (EA 7424), 69100, Villeurbanne, France.*

Abstract

Whether sensorimotor adaptation can be generalized from one context to others represents a crucial interest in the field of neurological rehabilitation. Nonetheless, the mechanisms underlying transfer to another task remain unclear. Prism Adaptation (PA) is a useful method employed both to study short-term plasticity and for rehabilitation. Neuro-imaging and neuro-stimulation studies show that cerebellum plays a substantial role in online control, strategic control (rapid error reduction), and realignment (after-effects) in PA. However, the contribution of the cerebellum to transfer is still unknown. The aim of this study was to test whether interfering with the activity of the cerebellum affected transfer of prism after-effects from a pointing to a throwing task. For this purpose, we delivered cathodal cerebellar transcranial Direct Current Stimulation (tDCS) to healthy participants during PA while a control group received cerebellar Sham Stimulation. We assessed longitudinal evolutions of pointing and throwing errors and pointing trajectories orientations during pre-tests, exposure and post-tests. Results revealed that participants who received active cerebellar stimulation showed (1) altered error reduction and pointing trajectories during the first trials of exposure; (2) increased magnitude but reduced robustness of pointing after-effects; and, crucially, (3) slightly altered transfer of after-effects to the throwing task. Therefore, the present study confirmed that cathodal cerebellar tDCS interferes with processes at work during PA and provides evidence for a possible contribution of the cerebellum in after-effects transfer.

Key-words: prism adaptation, after-effects, transfer, cerebellum, tDCS, plasticity

Introduction

Over a lifetime, human beings remain capable of producing smooth and precise movements despite continuously varying demands. Indeed, the plasticity of the nervous system allows the acquisition of new motor programs and the modification of those previously acquired to face new conditions. The possibility to transfer formerly acquired motor transformations from one context to others brings important information on the nature of the processes involved to face perturbations (Poggio & Bizzi, 2004). Moreover, the understanding of the mechanisms underlying transfer represents a crucial interest in the field of neuro-rehabilitation (Roemmich & Bastian, 2018).

Prism Adaptation (PA) is an experimental paradigm used to study sensorimotor plasticity processes (Prablanc et al., 2019; Redding et al., 2005; Welch, 1974). In a typical PA protocol, individuals are actively exposed to a shift of the visual field induced by prismatic lenses while performing a pointing task. Initially, subjects make errors in the direction of the prismatic deviation (terminal error). Following a few trials, subjects rapidly reduce terminal error gaining accurate performance. When prisms are removed, following sustained exposure, subjects experience errors in the direction opposite to the initial prismatic deviation. These errors are called “after-effects” and attest the presence of “true” adaptation (Prablanc et al., 2019; Redding et al., 2005; Weiner et al., 1983).

According to several authors (O’Shea et al., 2014; Redding & Wallace, 2002; Rossetti et al., 1993; Weiner et al., 1983), two mechanisms seem to be at work during PA. The first mechanism aims to quickly reduce errors during the first trials of exposure by means of a strategic adjustment of motor plan on the subsequent trial based on the previous errors (O’Shea et al., 2014; Rossetti et al., 1993). These cognitive-compensatory modifications of motor commands are referred to with the term strategic control and include conscious and voluntary strategies such as pointing-off target or mental rotation. The second mechanism is a slow and automatic process that is necessary to re-organize the sensory maps (visual and proprioceptive references frames) that have been disrupted by the prismatic shift. This process, called realignment, is related to “true” adaptation and is thought to be relevant for developing after-effects (O’Shea et al., 2014; Petit et al., 2017; Prablanc et al., 2019; Redding et al., 2005).

Although these two processes are frequently described within the PA literature, distinguishing their specific contributions remains contentious. After-effects need to be assessed in a context that is different from the exposure context (without goggles and toward different unexposed target) to reflect the presence of true adaptation (Petit et al., 2017; Prablanc et al., 2019). However, after-effects may also contain a part of cognitive after-effects, related for example to

a pointing-off target strategy that leads to use-dependent modifications of movements' trajectory (McDougle et al., 2016; Redding & Wallace, 2002). Therefore, testing the transfer of after-effects allows to better capture sensorimotor after-effects that are not specific to the context of exposure (Fleury et al., 2020).

Using the classical prism exposure procedure, after-effects could be easily measured in a different context, as an instance by using other target locations (Bedford, 1993; Redding & Wallace, 2006), other limbs (Girardi et al., 2004; Michel et al., 2008; Morton et al., 2001), or other tasks (Fernandez-Ruiz et al., 2003; Jacquin-Courtois et al., 2008). Recently, inter-task transfer between a throwing and a pointing task was investigated in a prism exposure study (Fleury et al., 2020). Results revealed a clear-cut unidirectional transfer from pointing to throwing but not from throwing to pointing. The authors attributed the absence of transfer from throwing to the fact that throwing is more variable than pointing. Indeed, reduced variability in individuals with throwing expertise (expert dart throwers) made the transfer reciprocal (Fleury et al., 2020). The type of task practiced during exposure seemed to affect the transfer of after-effects to a task that was not practiced under the prismatic deviation, possibly suggesting that different processes have been involved to face the perturbation. Crucially, the classical assessment of after-effects on the task practiced during exposure (e.g. after-effects on pointing for participants who practiced pointing during prism exposure) did not allow to unravel the presence of different processes because the magnitude of after-effects was comparable regardless the task practiced during exposure. By contrast, the assessment of transfer might have revealed important information concerning the nature of processes involved in sensorimotor adaptation (Fleury et al., 2020). However, understanding the mechanisms underlying inter-task transfer remains unclear and brain regions involved in transfer properties are not clearly identified.

The neural correlates of PA have been examined through lesion studies, neuro-imaging studies, and recently by means of non-invasive brain stimulation techniques (see Panico et al., 2020 for a review on neuro-imaging and neuro-stimulation studies in PA). Neuro-imaging studies showed an involvement of several parietal areas in the processes of error detection and early error correction (Chapman et al., 2010; Clower et al., 1996; Danckert et al., 2008; Luauté et al., 2009). These studies also highlighted the role of cerebellar areas from early (Küper et al., 2014) to late exposure until the development of after-effects (Chapman et al., 2010; Luauté et al., 2009), i.e. realignment. Although neuro-imaging studies allow the correlational observation of dynamics changes in brain activity and are characterized by a high temporal and spatial resolution, some constraints of these methods are not compatible with optimal PA experimental settings (Bultitude et al., 2017). As a consequence, non-invasive brain stimulation methods represent a complementary approach that enables to directly

investigate causal relationships between brain and behaviour by modulating activity in targeted-brain areas in an inhibitory or facilitatory way. Although they suffer a weaker spatial resolution as compared to neuro-imaging, non-invasive brain stimulation techniques can be applied in ecological settings in a causal perspective, and are more compatible with prism exposure procedure experimental requirements (Panico et al., 2020).

Neuro-imaging findings were completed by neuro-stimulation studies, in which cathodal cerebellar stimulation during prism exposure resulted in larger errors during early, middle, and late exposure, as well as during post-test measures (increased after-effects; Panico et al., 2016). Moreover, in a multiple steps PA protocol (Panico, Sagliano, Nozzolillo, et al., 2018), cathodal cerebellar stimulation induced larger errors in the direction of the prismatic deviation during both initial and late exposure at each incremental step and reduced after-effects. In this procedure, participants were unaware of the optical deviation because of stepwise increases of the prismatic shift (Michel et al., 2007), thus preventing strategic corrections of pointing movements (i.e. recalibration). Findings from this study supported a causal role of the cerebellum in realignment since stimulation affected performance during late exposure and after-effects assessment. In addition, as stimulation affected also the initial component of exposure, authors pointed out a possible contribution of the cerebellum in online motor corrections and feedforward control of reaching movements (Panico, Sagliano, Nozzolillo, et al., 2018). Two neuro-stimulation studies also emphasized a possible role of the primary motor cortex in the persistence and the reactivation of after-effects (O'Shea et al., 2017; Panico et al., 2017). Altogether, findings from neuro-imaging and neuro-stimulation fields are compatible with results of patient studies concerning a cerebellar function in PA. Indeed, cerebellar damage impairs primarily after-effects and accessorially error-reduction (Baizer et al., 1999; Hanajima et al., 2015; Pisella et al., 2005; Weiner et al., 1983), while cortical injuries lead to altered error reduction during exposure but spared after-effects (Newport & Jackson, 2006; Pisella et al., 2004).

As a matter of fact, to date clinical neuropsychological, neuro-imaging, and neuro-stimulation studies have not provided detailed investigation of brain structures involved in inter-task transfer of prism acquired after-effects. The assessment of after-effects transfer should attest the presence of a "true" adaptation because the classical measure of after-effects might not be sufficient to unravel the presence of different processes at work during exposure (Fleury et al., 2020; Prablanc et al., 2019). A likely hypothesis is that transfer of after-effects might depend on the initial magnitude of after-effects on the task practiced during exposure. Therefore, processes involved during exposure might directly determine the nature of after-effects and whether they could be transferred to another task or not. Thus, given the above-mentioned evidences of a crucial role played by the cerebellum in the development of after-

effects (i.e. realignment), one possible hypothesis is that the cerebellum may also be involved in after-effects transfer.

Hence, a crucial unanswered question relates to the role of the cerebellum in generating after-effects that are transferable to a task that was not practiced under prism exposure. Therefore, the aim of the present study was to investigate the influence of cathodal cerebellar transcranial direct current stimulation (C-tDCS; Nitsche & Paulus, 2000) on the magnitude of inter-task transfer. As transfer was already observed from pointing to throwing (Fleury et al., 2020), we specifically tested whether cathodal stimulation of the cerebellum would decrease the magnitude of after-effects transfer from pointing to throwing. Our main hypothesis was that cathodal stimulation of the cerebellum would impair individuals' ability to transfer after-effects from pointing to throwing because it would alter adaptive processes during exposure that allow the development of transferable after-effects (i.e. "true" adaptation). Therefore, we also expected that cerebellar tDCS would affect PA mechanisms (i.e. error reduction during exposure and development of pointing after-effects) in line with previous studies (e.g. Panico et al. 2016).

Methods

The study followed a pre-post design including a total of 27 healthy participants. Every participant gave informed consent to take part in in this experiment. All procedures were designed following relevant guidelines and regulations and were approved by an ethics evaluation committee of Inserm (“CPP SUD-EST IV”, ID-RCB: 2010-A01180-39).

Participants

27 right-handed participants were involved in the study. They had normal or corrected to normal vision, no neurological disorder and had never experienced prisms before the experiment. Participants performed two goal-directed visuomotor tasks –throwing and pointing. They were divided into two groups accordingly to the tDCS parameters: an experimental “C-tDCS” group (n=16, 8 males and 8 females, mean age = 22.8 ± 3.0) and a control “SHAM” group (n=11, 5 males and 6 females, mean age = 26.7 ± 8.2). Both groups followed the same procedures except that participants in the C-tDCS group received a cathodal cerebellar stimulation while participants in the SHAM group received a placebo cathodal stimulation.

Experimental paradigm:

The experimental procedure involved four stages (familiarization pre-tests, exposure, and post-tests) as illustrated in **Figure 1**.

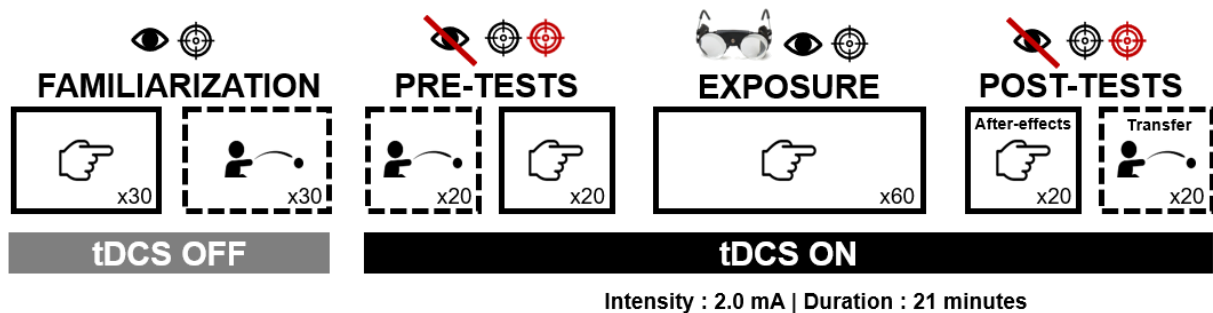

Figure 1 – Experimental procedures. The figure depicts the different steps of the study and the conditions of each step, i.e. the task performed (throwing or pointing), the availability of visual feedback (bared eye or normal eye), the number of trials (i.e. 20, 30 or 60), the presence of prism goggles the number of targets (one black target, or two targets – black and red), and tDCS conditions (Off or On). Solid boxes refer to the practice of the exposed task (i.e. pointing) while dotted boxes refer to the practiced of the unexposed task (i.e. throwing).

According to each specific experimental stage, pointing and throwing tasks were performed either with vision of the movement (except the starting position) and of endpoint accuracy (closed-loop) or without (open-loop). Depending on the stage, movements were directed to one central targets (0°) or alternatively to two targets (0° and 10° right).

Pointing task set-up

Participants sat in front of a pointing table, with their head on a chinrest. This was used to prevent participants to see their hand starting position, thus precluding any static recalibration of the prism-induced shift and slowing down the error reduction. The starting position of the finger was located below the chinrest, lined up with the body midline. Two targets were placed on the pointing table in front of the participants, at 57.5 cm from their eyes. The central target (exposed target) was situated straight-ahead of the participant's body midline (0 degrees) and the right target (non-exposed target) at 10 degrees to the right.

During open loop pointing (pre, early, post-tests), no vision was allowed during the entire movement. Participants wore electronic liquid-crystal glasses connected to a switch placed on the starting position. The participants were able to see the targets while their index lied on the starting position. Upon movement initiation, the glasses turned opaque and the subjects were deprived of visual feedback. When they went back to the starting position, the glasses turned transparent again.

During closed-loop condition (familiarization and post-tests), the participants had to reach the central target. They did not wear the liquid-crystal glasses and had visual feedbacks about their pointing movements (except the starting position) and their outcomes (endpoint errors). The investigator gave the starting signal for each trial. A colour code indicated which target to reach in open-loop conditions and a vocal « go! » was provided during closed-loop conditions (using only one target).

Throwing task set up

Participants sat in front of a vertical board, at 2 meters from their body axis and wore a ball-dispenser helmet. Similarly to the pointing set-up, two targets were presented on the board. The central target (exposed target) was situated forward the participant's body midline (0 degrees) and the right target (non-exposed target) at 10 degrees to the right. All the setting was surrounded by light spots connected to a switch placed on the helmet.

During open-loop throwing, participants had to pick a ball and to press down the light-switch mounted on the helmet, to be able to see the target. Once they initiated movement and released the switch, lights were immediately turned off so they had no visual feedback about their movement and its outcomes.

During closed-loop throwing (familiarization and exposure), lights were turned on and participants saw their movement all time. As for pointing, in both conditions, participants were asked to throw as fast and accurate as possible. The starting signal was given by the

investigator for each trial: the target colour to reach in open-loop conditions and « go » during closed-loop conditions.

General procedures

Specific pointing and throwing conditions for each stage of the experimental protocol are detailed in the following sections and illustrated in Figure 1.

Familiarization: to familiarize with both tasks and with experimental settings, participants in each group performed 30 trials of the pointing task, then 30 trials of the throwing task. All trials were performed in a closed-loop condition toward the central target.

Pre-tests: baseline performances were assessed for each task during pre-tests. Participants of both groups performed 20 trials of the throwing and the pointing tasks. Trials were performed in open-loop condition and toward both targets in a pseudo-randomized order (which was the same for all participants).

Exposure: participants performed 60 pointing trials while wearing prismatic goggles that shifted laterally the visual field 10 degrees toward the right (OptiquePeter.com, Lyon). Trials were performed in a closed-loop condition toward the central target, as fast and accurate as possible. Before positioning the goggles, participants were asked to keep their eyes closed. They were also instructed not to look at their own body or to move before starting the experimental tasks while they were wearing the prismatic goggles.

Post-tests: once the prisms were removed, after-effects were assessed on the pointing task: participants performed 20 pointing trials in an open-loop condition toward both targets. Then, transfer was measured on the throwing task. To this purpose, participants performed 20 throwing trials in an open-loop condition toward both targets.

Order of the tasks

The design of the study required testing participants in two distinct tasks during pre-tests and post-tests. The experimental set-up for the two tasks necessitated the participants to be moved from the throwing set-up to the pointing set-up. Yet, it was crucial that participants had no access to vision during these transitional phases and did not actively move, to prevent any de-adaptation during post-tests. To that purpose, participants sat in an adjustable and movable chair throughout the whole experiment and wore eyes patches during each transitional phase. They were not allowed to move the chair and investigators were in charge to move participants between the throwing and the pointing task set-up according to the experimental procedure. Nevertheless, to limit the number of transitional phases, we specified the order of the tasks throughout the experimental procedure in a fixed manner that was identical for all the

participants: pointing – throwing (familiarization); throwing – pointing (pre-tests); pointing (exposure); pointing – throwing (post-tests).

tDCS protocol

tDCS settings were based on the protocol used in a previous study by Panico et al. (2016). tDCS was turned on before pre-tests and turned off right after post-tests. A battery-driven stimulator (neuroConn, neuroCare Group, Germany) delivered a constant current of 2.0mA intensity through a pair of surface saline-soaked sponge electrodes (area = 25cm²).

The cathodal electrode was placed over the right cerebellum (1 cm below and 4 cm right to the inion) and the anodal electrode was placed over the right deltoid muscle, to ensure selective stimulation over the right cerebellum.

Stimulation was delivered over the right cerebellum as participants used their right arm to perform the tasks (Schlerf et al., 2015). Sham stimulation was performed in the same way as active stimulation, but the stimulator was turned off after 30 s. This procedure ensured that participants felt the same itching sensation at the beginning of tDCS as participants assigned to the experimental group, and were thus blinded for the stimulation condition they had been assigned to (Gandiga et al., 2006). For both sham and active conditions, stimulation was gradually increased to 2mA with a fade-in of 30 seconds.

Safety guidelines recommended a maximum stimulation time of 21 minutes (Nitsche & Paulus, 2000; Woods et al., 2016). Therefore, participants were timed to complete the experimental tasks within 21 minutes after the stimulation was turned on. Participants who did not manage to complete the procedure in the maximum stimulation time were excluded from the analysis.

Data collection

An opto-electronic motion capture system (9 cameras, Vicon Motion Systems Ltd, Oxford, 1984; *Mouvement et Handicap* platform, *Hospices Civils* of Lyon) was used to record ball impact on the vertical board for each throwing trial. Reflective markers were placed on the throwing board to localize the targets and the projectiles were reflective themselves. The motion capture system was also used to track movement trajectories during pointing trials. Reflective markers were positioned on the index, the wrist and the elbow of the subject

Data processing

Throwing and pointing terminal errors

Markers trajectories were recorded for each trial and filtered with a Butterworth low-band pass filter at a cut-off frequency of 6Hz. For the throwing trials, the time-point corresponding to the

contact between the projectile and the board was automatically detected. This time-point was used to compute the lateral errors between the impact of the projectile and the aimed target using MatLab customized routines. Thus, we computed performances on each trial, i.e. the angular deviation between the ball impact and the aimed target.

For pointing trials, the endpoint of each pointing movement was computed automatically (using in-house custom software written in Matlab). Movements were detected using the following threshold: onset was defined as the point at which hand velocity exceeded 80mm/s while offset was defined as the time-point at which velocity dropped below this threshold (O'Shea et al., 2014). After automatic detection, all trials were cross-checked visually and adjusted manually if necessary. Index endpoints were then used to obtain the lateral endpoints errors from the aimed target.

Pointing kinematics analysis

We used in-house software written in MatLab to compute kinematics of pointing movements. Two phases constitute a pointing movement: an acceleration phase (initial ballistic component) and a deceleration phase, referring to the target approach phase (Elliott et al., 2010). The initial part of the trajectory reflects feedforward movement planning while the second part of the trajectory involves online feedback corrections (O'Shea et al., 2014). We analysed trajectories of pointing movements by specifically investigating the orientations (i.e. angles between the velocity vector and the line formed by the starting position and the central target) of velocity vectors at acceleration, velocity and deceleration peaks. Only pointing movement kinematics were investigated.

Statistical analysis

We analysed two main dependent variables. First, we computed terminal errors between index endpoint (pointing task) or ball impact (throwing task) and the aimed target for each trial. Moreover, pointing trajectories orientations were computed as the magnitude of velocity vectors at acceleration peak (initial orientation), velocity peak (intermediate orientation) and deceleration peak (terminal orientation).

It is worth mentioning that all values for post-tests are baseline subtracted, i.e. for each group, we subtracted pre-tests values for each individual and for each task, as recommended in PA literature (Prablanc et al., 2019). In fact, quantifying after-effects requires to take into account the physiological baseline deviation within the same group of testing.

We calculated linear mixed models (Singer & Willett, 2003) separately for each stage of the experiment and for each dependent variable, i.e. terminal errors and pointing trajectories orientations at initial, intermediate, and terminal directions. Each trial during the different

phases of the procedure represented a time point. These time points were the level-one unit nested in the different individuals (level-two units). Random intercept models tested the longitudinal effect of trials' repetition (factor TIME) and the effect of the stimulation condition (factor GROUP; C-TDCS versus SHAM). The interaction GROUP*TIME assessed whether the slopes of the curves differed between groups. Results from these models provided estimates for each of the factors tested and indicate whether their effects were significant. All analyses were conducted using R package labelled lme4 (Bates et al., 2015) and the reference group was set up as the C-tDCS group. A p-value of 0.05 was used to indicate statistical significance.

These statistical analyses were chosen to analyse not only mean individuals' values (e.g. mean of 20 post-tests trials) but also their longitudinal evolution. Moreover, linear mixed models are a flexible method appropriate to deal with intra-individuals' variability within each group (Wright & London, 2009). This approach allows to assess inter-subject differences considering the intra-individual changes over time (through trial-by-trial repetition).

Moreover, to refine the longitudinal analysis of the variables, we also divided some phases of the experiment into multiples series of trials, particularly during exposure. PA literature describes several adaptive processes characterized by different timing (e.g. fast vs slow processes; Inoue et al., 2015; Petit et al., 2017; Rossetti et al., 1993; Smith et al., 2006). For this reason, we decided to analyse early exposure (trials 1 to 10) separately from the remaining trials during exposure (trials 11 to 60). We also analysed separately each block of 10 trials under exposure to obtain a complete description of pointing behaviour under prismatic perturbation, and to investigate effect of C-tDCS on this behaviour at different times of exposure. Furthermore, to provide a qualitative analysis of early exposure, we analysed the five first trials separately given that error reduction is greatest during the very first trials of exposure. Besides, we also cut post-tests phases into bins of five trials.

Finally, to test the differences between mean group terminal errors and mean group trajectories orientation during familiarization, we also performed independent samples T-test. As no stimulation and no prismatic deviation were present during familiarization, we considered no reason to test for any longitudinal variation across trials.

Results

The majority of participants, except two in the C-tDCS group, managed to complete the procedure within 21 minutes. These two participants were thus excluded from the following analysis. None participant reported any conscious awareness on the prismatic deviation during exposur. When verbally asked following the experiment, no one reported any knowledge about the stimulation condition they had been assigned to. **Table 1** presents the descriptive statistics of mean group terminal errors during the different phases of the procedure. **Figure 2** represents trial-by-trial mean group terminal errors during each step of the procedure.

Table 1 – Descriptive statistics of mean group terminal errors

		C-tDCS group		Sham group	
Pre-tDCS Familiarization	Pointing	-0.03	± 0.34	0.04	± 0.23
	Throwing	-0.37	± 1.11	-0.84	± 0.79
Pre-tests	Throwing	0.58	± 1.99	0.52	± 2.02
	Pointing	0.35	± 1.22	-0.51	± 1.45
Exposure Pointing	Trial 1	4.52	± 3.20	3.10	± 3.12
	Trial 2	2.99	± 1.81	2.17	± 1.65
	Trial 3	2.53	± 1.96	0.79	± 1.39
	Trial 4	1.28	± 1.49	0.54	± 1.07
	Trial 5	0.99	± 0.86	0.24	± 0.59
	Trials 6-10	0.67	± 0.66	0.51	± 0.59
	Trials 11-20	0.45	± 0.52	0.22	± 0.45
	Trials 21-30	0.25	± 0.58	0.28	± 0.34
	Trials 31-40	0.10	± 0.65	0.16	± 0.32
	Trials 41-50	0.20	± 0.63	0.13	± 0.30
	Trials 51-60	0.09	± 0.79	0.11	± 0.34
Post-tests	Pointing	-5.19	± 1.22	-4.38	± 0.91
	Throwing	-1.46	± 2.06	-1.65	± 1.55

Values are reported in degrees with standard deviations.

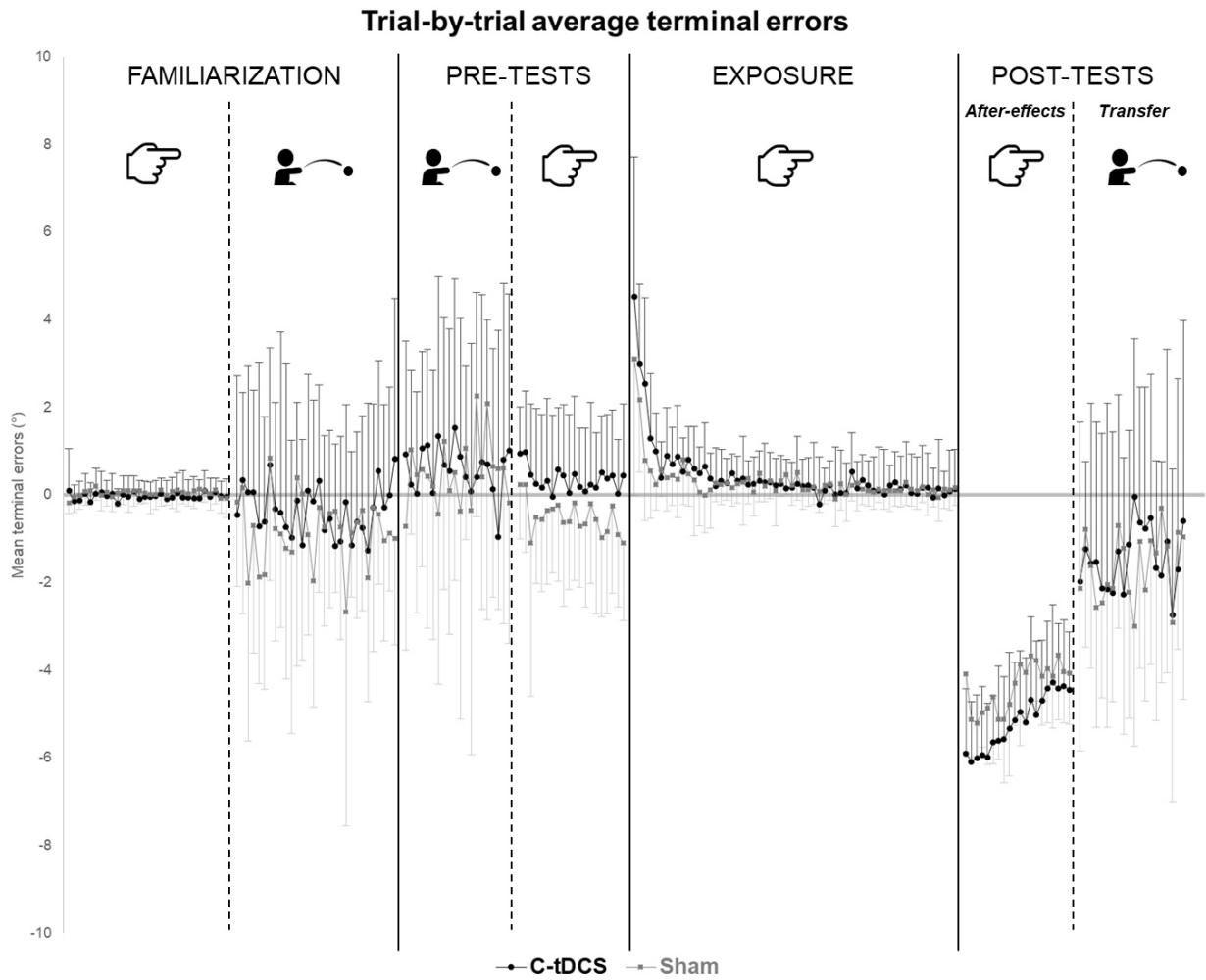

Figure 2 - Trial-by-trial average terminal errors. Trial-by-trial average group terminal errors are represented with standard deviations for each group (C-tDCS group in black, Sham group in grey) and for each step of the procedures.

Familiarization

Independent samples t-tests revealed no difference between group in the pointing task ($t(23)=-.632$; $p=.534$) and the throwing task ($t(23)=1.178$; $p=.251$) concerning terminal errors during familiarization (**Figure 3**). Moreover, no difference between groups in mean pointing trajectories orientations during familiarization was found. Results showed that there was no difference in the two groups during familiarization.

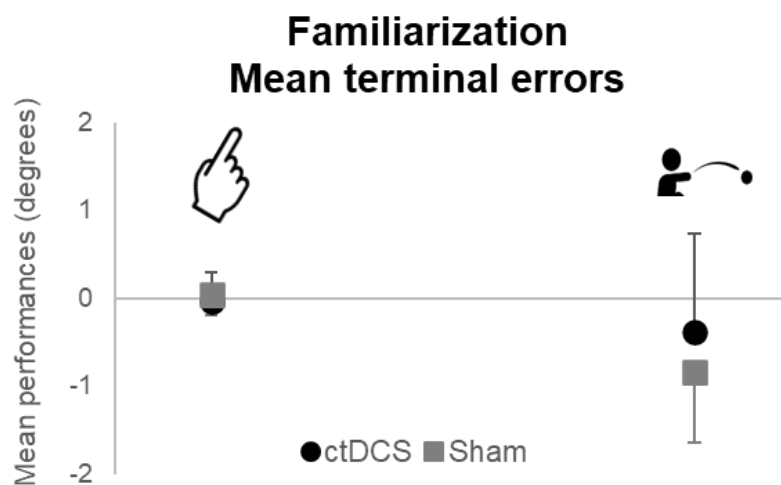

Figure 3 – Mean group terminal errors during familiarization. Mean group terminal errors are represented with standard deviations for each group (C-tDCS group in black, Sham group in grey) and for each task (pointing on the right, throwing on the left).

Pre-tests

Terminal errors

Models showed no effect of TIME, GROUP, nor TIME*GROUP interaction on trial-by-trial terminal errors (i.e. longitudinal values of terminal errors) during pre-tests both on the throwing and the pointing task (Supplementary materials, Table 2).

Pointing trajectories orientations

A significant negative linear effect of TIME was reported on pointing trajectory orientations at initial direction on both central ($\beta = -.35$, $SE = .15$, $t(223) = -2.27$, $p = .02$) and right ($\beta = -.47$, $SE = .14$, $t(225) = -3.30$, $p < 10^{-2}$) targets; without any group distinction (no effect of GROUP neither GROUP*TIME). Concerning intermediate and final trajectory orientations, results revealed no effect of TIME, GROUP, nor GROUP*TIME interaction (Supplementary Materials, tables 3-6). These results indicate that C-tDCS had no significant effect on terminal errors and

pointing trajectories during pre-tests. However, TIME had an influence on initial orientations of pointing trajectories without any group distinction: in both groups, the values of initial pointing orientations decreased across trial repetition, i.e. were slightly deviated to the left direction.

Exposure

Terminal errors

Models showed a negative main effect of TIME ($\beta < -10^{-3}$, SE = .00, $t(1475) = -10.76$, $p < 10^{-15}$) and a negative effect of GROUP*TIME interaction ($\beta = -10^{-3}$, SE = .00, $t(1475) = 3.15$, $p < 10^{-2}$) on the whole exposure (60 trials), but no significant effect of GROUP (Supplementary materials, **Table 2**). This indicates that terminal errors decreased across trial repetition, in both groups. In addition, the slope of the error reduction curve was lower in the Sham group as compared to the C-tDCS group. We may observe that both groups rapidly recovered practice level of accuracy, although both between-subjects (see Figure 1) and within-subject variability remained larger in the C-tDCS group.

During the 10 first trials of exposure, models showed significant effects of TIME ($\beta = -.03$, SE = .00, $t(225) = -6.86$, $p < 10^{-10}$), GROUP ($\beta = -1.09$, SE = .00, $t(42) = -2.63$, $p = .01$) and GROUP*TIME ($\beta = .02$, SE = .01, $t(225) = 2.27$, $p = .02$) on pointing terminal errors. This suggests that C-tDCS had an influence on terminal errors values and their evolution across time during early exposure (10 first trials): mean terminal errors were lower, and the slope of the error reduction curve was more pronounced in the Sham group as compared to the C-tDCS group. During the 50 subsequent trials (trials 11-60), results revealed a significant negative effect of TIME ($\beta = -.01$, SE = .00, $t(1225) = -6.58$, $p < 10^{-10}$) and GROUP*TIME interaction ($\beta < -10^{-2}$, SE = .00, $t(1225) = 2.28$, $p = .02$) but no effect of GROUP (Supplementary materials, Table 2). From trial 11 to trial 60, terminal errors decreased in both groups, although the slope of the curve was less pronounced in the Sham group.

Trajectories

The **Figure 4** plots the mean pointing trajectories during the five first trials of exposure. The **Figure 5** represents the mean group orientation of pointing trajectories at initial, intermediate and terminal direction. Significant results revealed by LMMA concerning pointing trajectories orientations are reported below (see Supplementary Materials, **Tables 3-6** for all effects).

Mean Pointing trajectories Exposure - Trial-by-trial n°1 to 5

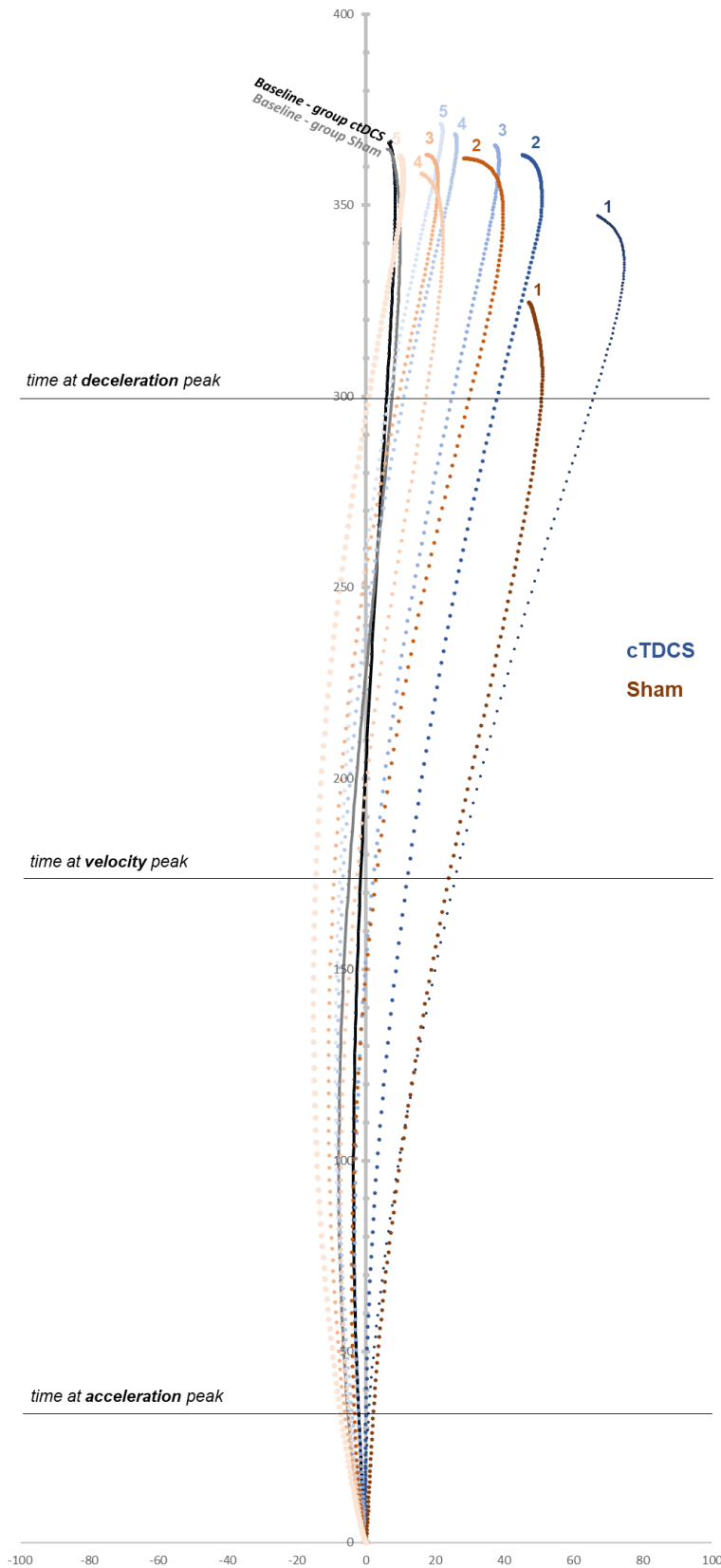

Figure 4 – Mean trial-by-trial pointing trajectories during exposure (trials 1 to 5). The figure represents trial-by-trial mean pointing trajectories for trial 1 to 5 (shades of blue for C-tDCS, shades of orange for Sham). Baseline mean trajectories are also represented for each group in black (C-tDCS group) and grey (Sham group) corresponding to mean pointing trajectories during familiarization. Times at acceleration (initial direction), velocity (intermediate direction) and deceleration (terminal direction) are represented approximately (mean between C-tDCS and Sham groups) showing no substantial difference between groups (see Table 7 for exact values).

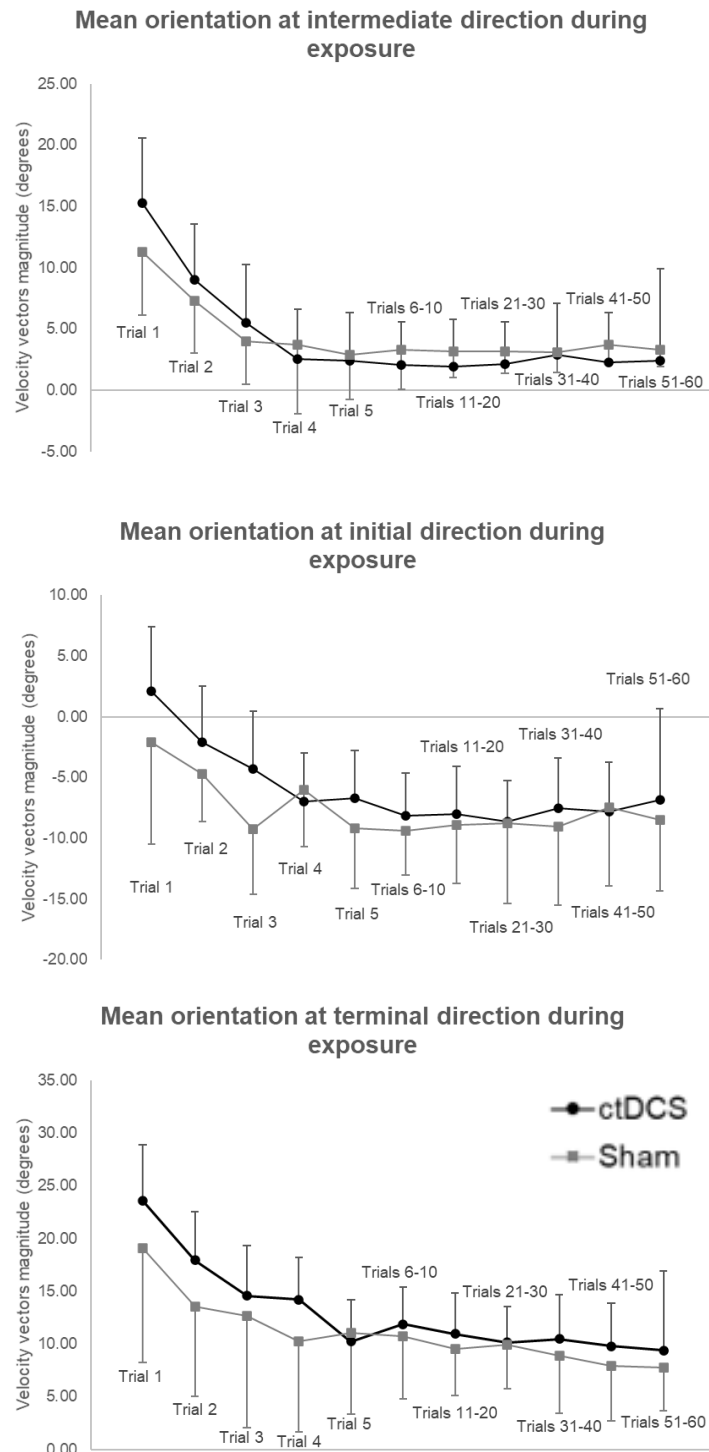

Figure 5: mean group orientation of pointing trajectories at initial, intermediate and terminal direction. *The figure depicts mean group orientations of velocity vectors at initial (acceleration peak), intermediate (velocity peak) and terminal (deceleration peak) direction of pointing movements during exposure. Group mean values are plotted for trial 1, 2, 3, 4, 5 and then for subsequent blocks (mean values for trials 6-10, 11-20, 21-30, 31-40, 41-50, 51-60). Analyses revealed no effect of TIME during trials 11 to 60 except for terminal direction. For initial and intermediate direction, values seem to rapidly reach a plateau. However, concerning terminal direction, values still decrease during late exposure, but without any difference between groups.*

Over the whole exposure (trials 1 to 60), analyses revealed a main effect of TIME ($\beta = -.04$, $SE = .01$, $t(1453) = -4.16$, $p < 10^{-4}$) and GROUP*TIME ($\beta = .04$, $SE = .01$, $t(1453) = 2.88$, $p < 10^{-2}$) for initial direction (at acceleration peak). This indicates that initial trajectory orientations were deviated toward the left in both groups across trial repetition. Moreover, the slope of the curve was more pronounced in the Sham group, as compared to the C-tDCS group. Additionally, results showed a main effect of TIME for intermediate ($\beta = -.03$, $SE = .01$, $t(1454) = -5.58$, $p < 10^{-7}$) and terminal ($\beta = -.08$, $SE = .01$, $t(1455) = -8.14$, $p < 10^{-15}$) directions: trajectory orientations at velocity and deceleration peaks were deviated toward the left across trial repetition without any group distinction.

During early exposure (trials 1 to 10), results showed an effect of TIME ($\beta = -.96$, $SE = .11$, $t(222) = -8.44$, $p < 10^{-14}$), GROUP ($\beta = -4.04$, $SE = 1.58$, $t(43) = -2.55$, $p = .01$) and GROUP*TIME ($\beta = .41$, $SE = .17$, $t(222) = 2.40$, $p = .02$) on initial direction. In both groups, trajectory orientations at acceleration peak were deviated to the left throughout the 10 first trials. However, the slope of the curve was more pronounced in the Sham group. In addition, the models showed that mean values were lower in the Sham group, i.e. mean initial trajectories were more deviated to the left. Concerning intermediate direction of trajectories, models showed a negative effect of TIME ($\beta = -1.13$, $SE = .10$, $t(222) = -11.16$, $p < 10^{-15}$), i.e. trajectory orientations at velocity peak were deviated to the left throughout the 10 first trials in both groups, with a higher slope for the Sham group (GROUP*TIME effect; $\beta = .46$, $SE = .15$, $t(222) = 3.01$, $p < 10^{-2}$). Finally, trajectories at deceleration peak were also deviated to the left during the 10 first trials in both groups without any distinction (TIME effect; $\beta = -1.04$, $SE = .17$, $t(222) = -6.24$, $p < 10^{-8}$).

During the remaining part of exposure (trials 11 to 60), we found no effect of TIME, GROUP, nor GROUP*TIME for initial and intermediate direction. However, results showed an effect of TIME ($\beta = -.04$, $SE = .01$, $t(1207) = -3.00$, $p < 10^{-2}$) on terminal direction without any effect of GROUP neither GROUP*TIME. This signifies that trajectory orientations at deceleration peak continued to be deviated toward the left across trial repetition until the end of exposure, without any group distinction.

Moreover, significant effects were found in late blocks of exposure: slight effects of TIME ($\beta = -.24$, $SE = .11$, $t(218) = -2.11$, $p = .04$), and GROUP*TIME ($\beta = .34$, $SE = .17$, $t(218) = 2.05$, $p = .04$) on initial direction during trials 41 to 50 and effects of GROUP ($\beta = 12.56$, $SE = 4.63$, $t(227) = 2.71$, $p = .01$) and GROUP*TIME ($\beta = -.21$, $SE = .08$, $t(219) = -2.54$, $p = .01$) on intermediate direction during the 10 last trials (trials 51 to 60). These results show that values of initial orientations decreased again from trials 41 to 50 in both groups with a greater slope for the Sham group. In addition, during the 10 last trials of exposure, mean intermediate

direction appeared to be more deviated to the left with a more marked evolution across trials in the Sham group.

Post tests

Pointing task: after-effects

Terminal errors

Analyses showed an effect of TIME ($\beta = .10$, SE = .01, $t(473) = 11.14$, $p < 10^{-15}$), GROUP ($\beta = 1.16$, SE = .44, $t(30) = 2.60$, $p = .01$) and GROUP*TIME interaction ($\beta = -.04$, SE = .01, $t(473) = -2.51$, $p = .01$) on pointing longitudinal terminal errors values during post-tests (see Table 2). The positive effect of TIME shows that terminal errors values increased across trial repetition while the effect of GROUP*TIME interaction indicates that this evolution was less pronounced in the Sham group. In addition, the GROUP effect suggests that mean values were more negative in the C-tDCS group. These results suggest that the stimulation had an influence on the magnitude of pointing after-effects and more specifically on their evolution across trials: in C-tDCS participants, after-effects were initially larger but decreased more rapidly compared to the Sham group. Therefore, we may conclude that after-effects in the C-tDCS group were about 20% larger but more labile, such that they turned similar at the end of the testing period.

Trajectories

Mean pointing trajectories are represented in Figure 6. Models analyses were performed on pointing movements' orientations at initial, intermediate, and terminal directions. All effects are reported in tables 3-6 (Supplementary Materials).

We found no effect of TIME, GROUP, nor GROUP*TIME for initial direction and for both targets. However, results showed effects of TIME ($\beta = .39$, SE = .08, $t(224) = 4.73$, $p < 10^{-5}$), GROUP ($\beta = 3.44$, SE = 1.23, $t(39) = 2.80$, $p = .01$) and GROUP*TIME ($\beta = -.36$, SE = .13, $t(224) = -2.84$, $p < 10^{-2}$) for intermediate direction concerning pointing movements performed toward the central target.

A significant effect of TIME only ($\beta = .22$, SE = .09, $t(223) = 2.40$, $p = .02$) was found for intermediate direction of pointing movements performed toward the right target. For terminal direction, analyses revealed an effect of TIME both on central ($\beta = .28$, SE = .12, $t(224) = 2.42$, $p = .02$) and right ($\beta = .40$, SE = .16, $t(224) = 2.54$, $p = .01$) targets.

These results reveal that initial direction of pointing movements during post-tests was similar between groups and did not evolve across trial repetition. Trajectories start to differ from intermediate direction, which is illustrated in **Figure 6**. In both groups, trajectory orientations at velocity peak were initially deviated to the left, and evolved to the right across post-tests

trials. This evolution was less pronounced in the Sham group. However, trajectory orientations were initially more deviated to the left in the C-tDCS group as compared to the Sham group.

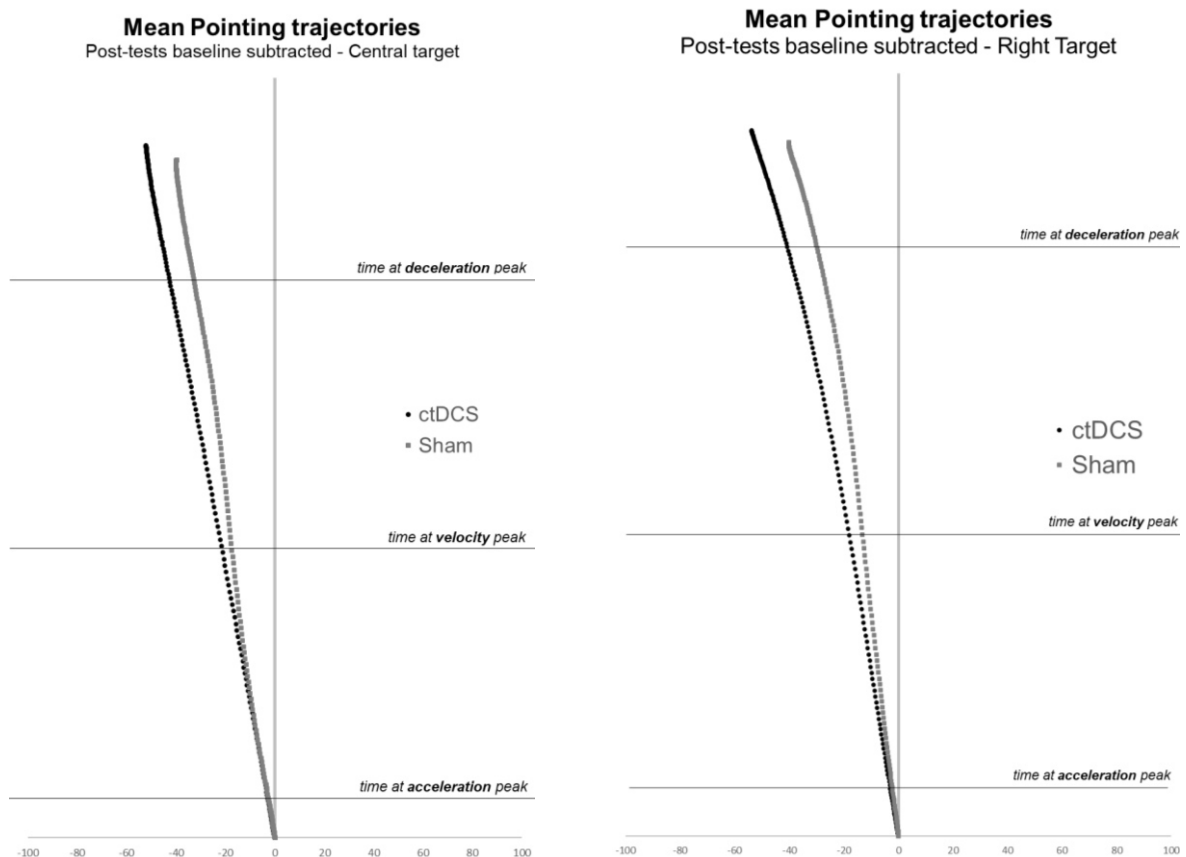

Figure 6 - Mean group pointing trajectories during post-tests. Mean pointing trajectories with baseline trajectories subtracted, central target (left) and right target (right).

Throwing task: transfer

Models showed no effect of TIME, GROUP or GROUP*TIME when considering the 20 throwing post-tests trials. However, we found moderate but significant effects of GROUP ($\beta = -4.13$, SE = 2.03, $t(239) = -2.03$, $p = .04$) and GROUP*TIME ($\beta = .26$, SE = .13, $t(222) = 2.03$, $p = .04$) when considering trials 11 to 20 and pooling the two targets. These effects may indicate that transfer was greater in the Sham group, with a slope of the curve that was steeper as compared to the C-tDCS group.

Analyses also revealed significant effects of TIME ($\beta = -.66$, SE = .21, $t(99) = -3.06$, $p < 10^{-2}$), GROUP ($\beta = -5.65$, SE = 2.44, $t(120) = -2.32$, $p = .02$), and GROUP*TIME ($\beta = .68$, SE = .32, $t(99) = 2.09$, $p = .04$) for trials 6 to 10 on the right target (see Supplementary materials; Table 2 for all values). Terminal errors during post-tests tended to decrease across these five trials on the right target in both groups. This evolution was more marked in the C-tDCS group.

However, mean values were more negative in the Sham group, i.e. throwing performances were more deviated to the left in this group.

Discussion

The aim of the study was to explore the effects of cathodal cerebellar tDCS on the transfer of prism-acquired after-effects from pointing to throwing. Results revealed that participants in the C-tDCS group showed (1) altered error reduction and pointing trajectories during exposure, mainly during the first trials; (2) increased magnitude but reduced robustness of pointing after-effects; and crucially, (3) slightly altered transfer of after-effects to the throwing task. These results will be discussed in the light of former neuro-stimulation studies to highlight the possible role of the cerebellum in prism adaptation mechanisms.

Cerebellar C-tDCS interferes with pointing deviations and trajectories during exposure.

C-tDCS interferes with pointing terminal errors during exposure.

During early exposure (10 first trials), error reduction (i.e., correction of the terminal error induced by the optical shift) was greater for the Sham group. This effect was visible from the very first pointing trial under prism deviation, which shows that error correction was also faster. As there was no difference in movement durations and movements velocities between groups, a slower movement execution cannot explain differences in error reduction during exposure. Moreover, trajectories during the first trials and the overall terminal errors reliably point to showing higher errors in the C-tDCS group. Therefore, it is unlikely that the presence of a transient speed-accuracy trade-off in the Sham group explain these differences although we cannot fully exclude this possibility.

Findings on early exposure suggest that C-tDCS impaired fast strategic adjustment (i.e. recalibration) in accordance with previous conclusions (Küper et al., 2014; Panico et al., 2016; Panico, Sagliano, Nozzolillo, et al., 2018). As far as data on the very first pointing trial are concerned, a possible interpretation is that the cerebellum plays a role in online control (Panico et al., 2018). In Panico et al. (2018), authors provided three measures of pointing deviations during exposure: initial, early, and late components, which reflected respectively online control, recalibration, and realignment. Interference of C-tDCS on the initial component (average of the 2 first trials and not only the first trial) was interpreted as a sign of impaired online control, which seems to be in line with the present results. Another possible explanation is that C-tDCS impaired feedforward control of pointing movements under exposure. This is compatible with recent evidences indicating that the cerebellum plays a major role in predictive (feedforward) control of movement and in adaptive mechanisms of sensory predictions needed to adjust movement commands based on previous experiences (Bastian, 2006; Therrien & Bastian,

2019). Nonetheless, the present study is the first in showing C-tDCS influence on the very first trial of exposure.

Surprisingly, the difference between groups in term of terminal errors was found only during early exposure (10 first trials) while in Panico et al.'s studies (2018, 2016), differences were found across the entire exposure phase. Importantly, the number of trials during exposure was smaller in our study compared to Panico et al.'s studies. However, a closer look to kinematics of pointing movements during exposure revealed differences of movements' orientations at intermediate direction during late exposure.

C-tDCS interferes with initial direction of pointing movements during early exposure and with intermediate direction during late exposure.

C-tDCS seemed to interfere with initial direction of pointing movements during early exposure (trials 1 to 10), which is in favour of an altered predictive control. However, on the first trial of exposure, initial direction of pointing movement was similar in both groups. Trajectories started to differ from intermediate direction, which is in favour of C-tDCS influence on online control rather than predictive control. Predictive control of a subsequent pointing movement depends on error feedbacks experienced at the end of the previous trial (Bastian, 2006; Rossetti et al., 1993). Moreover, feedforward control of movement could also be adjusted relatively to online feedback-dependent corrections implemented in the previous trial (Diedrichsen et al., 2005). Therefore, the role of the cerebellum in online versus predictive control under prismatic exposure remains difficult to disentangle. A closer examination of pointing trajectories during early exposure could provide additional information about the possible effects of C-tDCS in early exposure. While initial direction was similar across groups on the very first trials, it appears that feedforward correction of initial direction of subsequent pointing movements differed between groups: participants in the stimulated group implemented a smaller correction compared to the sham group. This observation becomes crucial when one also considers that subjects in the C-tDCS group experienced a larger endpoint error on the first trial. In fact, C-tDCS participants seemed to benefit less from feedback during the first trial (i.e. impaired online control), so they were exposed to a greater amount of errors. However, they still exhibited a minor correction on subsequent trials (i.e. impaired feedforward adjustment), compared to participants of the Sham group. Yet, C-tDCS may interfere with the integration of errors to adjust movements both during pointing movements (online control) and before each subsequent trial (feedforward control). Alternatively, impairment of feedforward control might also be related to difficulties in developing an aiming solution in response to the perturbation during exposure, as suggested by Butcher et al. (2017).

Another interesting finding is that C-tDCS did not interfere with the evolution of terminal direction of pointing movements during exposure (time effect only). However, stimulation altered the evolution of intermediate pointing directions during early exposure (group*time effect) and during late exposure (group effect). As in O'Shea et al. (2014), results suggest that terminal direction of pointing movements during exposure evolved until the end of exposure, while initial and intermediate directions seem to have reached a plateau. In fact, initial and intermediate deviations showed a quite stable trend following the very first trials but the slope in terminal direction was decreasing from the very first to the very last trials. These findings suggest that the adaptation of the terminal direction of pointing movements has not been completed by the end of exposure (60 trials). Either way, C-tDCS had no influence on this component. However, we may hypothesize that an increased number of trials during exposure would have led to a complete correction of terminal component, and potentially revealed an effect of C-tDCS on this very late component. These propositions are in line with Inoue et al.'s findings (Inoue et al., 2015) who suggested the existence of an ultra-slow process in PA.

Altogether, the above findings on deviations and pointing trajectories provide strong evidence of an impaired recalibration in C-tDCS participants compared to participants in the Sham group. The analysis of after-effects described in the next section will enable us to highlight the effects of C-tDCS on the realignment process (Prablanc et al., 2019; Redding et al., 2005).

C-tDCS interferes with the magnitude and the robustness of pointing after-effects.

C-tDCS participants seem to develop larger but labile after-effects.

A main objective of this study was to investigate the effects of C-tDCS on pointing after-effects and their transfer to throwing. Results showed larger after-effects in the pointing task in the C-tDCS group. Surprisingly, cathodal polarity of the stimulation did not lead to a reduction of after-effects. This finding is compatible with a previous study using similar procedures and reporting larger after-effects though larger errors during exposure (Panico et al., 2016). By contrast, this outcome is not coherent with a more recent study by Panico et al. (2018), in which reduced after-effects were found. However, the latter used a multiple-step prism adaptation procedure and C-tDCS was applied during exposure exclusively. These variations in the experimental procedures may have led to relevant differences in results concerning the observed effects of C-tDCS as previously described by Jalali et al. (2017). Strikingly, while after-effects in the present study were initially larger in the C-tDCS group, it seems that they were less stable and decreased more rapidly across post-tests trials compared to the Sham group. Although it is not straightforward to explain this apparently paradoxical result, we may speculate on several aspects. As suggested in Panico et al. (2016), as C-tDCS interfered with error reduction under prism exposure, it might also have impaired the restoration of non-

perturbed motor programs during post-tests, leading to greater after-effects. In addition, as error reduction was impaired in the C-tDCS group, participants were exposed to greater errors under prism deviation and possibly developed greater initial after-effects on the pointing task. Finally, the fact that after-effects looked less stable in the C-tDCS group may be related to a greater cognitive component in after-effects, which is known to be more labile (Redding & Wallace, 2006). An interesting prospective of this observation will be to prolong the after-effect assessment period to determine whether the weaker stability of the after-effects observed during tDCS would ultimately bring their magnitude below that of the control group.

C-tDCS interferes with intermediate direction of pointing trajectories during post-tests.

Results showed no difference between groups in initial direction of post-tests pointing trajectories. Trajectories started to differ from intermediate direction, thus leading to differences in endpoint terminal errors, and on the magnitude of after-effects. A possible explanation is that tDCS interfered with the processing of proprioceptive feedbacks during pointing movements. Participants in the Sham group applied a greater online proprioceptive correction as compared to participants in the C-tDCS group. These results may be in favour of an influence of C-tDCS on online control. Another possible explanation is that C-tDCS during exposure led to a different alteration of the proprioceptive modality. As suggested in a previous study (Fleury et al., 2020), reduced after-effects might be related to greater proprioceptive online corrections during post-tests. This may lead to speculate that proprioceptive modality was less affected by prism exposure in the Sham group. Therefore, the corrections would have been based on less biased proprioceptive feedbacks and would have been greater in this group. These corrections would have led to reduced terminal errors (lower after-effects) as compared to the C-tDCS group.

Does C-tDCS reduce transfer of after-effects to the throwing task?

A main purpose of this study was to test whether C-tDCS altered transfer of prism-acquired after-effects from pointing to throwing. Results showed a moderate but significant effect of C-tDCS on the magnitude of transfer for trials 11 to 20 and trials 6 to 10 on the right target, suggesting a slightly greater transfer in the Sham group.

The present results raise the possibility that cerebellar C-tDCS impaired transfer of prism acquired after-effects from pointing to throwing. Therefore, cerebellum might play a role in transferring visuo-motor transformations acquired in one context to another situation. A possible mechanism underlying this effect may be related to the role of the cerebellum in the development of realignment during exposure. In this light, C-tDCS may have impaired the development of true adaptation, thereby leading to reduce transfer on the non-exposed task (Fleury et al., 2020).

Although these findings provide the first evidence on the neural correlates of the transfer process, they need to be interpreted with caution. Data showed a strong heterogeneity within both groups, and particularly in the C-tDCS group. Individual responsiveness to C-tDCS may vary among participants as reported by previous studies (Chew et al., 2015; Wiethoff et al., 2014). This may account for a potential higher variability in the effects of active stimulation as compared to sham stimulation in the present results. In addition, rate of adaptation and transfer could also be initially variable within groups (Renault et al., 2018; Stark-Inbar et al., 2017).

Concluding remarks, limitations, and perspectives

In conclusion, the present study demonstrates that C-tDCS interferes with PA from the very beginning of prism exposure until the full deployment of after-effects. These data are compatible with a possible role of the cerebellum in online control, recalibration (feedforward control) and realignment (after-effects) in line with previous neuro-stimulation studies (Panico et al., 2016; Panico, et al., 2018). Our novel result is that the cerebellum appears to be involved in after-effect transfer, thus paving the way for more specific investigations. Here, we have to insist on the impact of this finding concerning a general role of the cerebellum in adaptive capacities. In fact, stimulation altered multiple PA components, i.e. error reduction during exposure, after-effects and crucially their transfer to another task. This suggests the likely existence of common mechanisms between several aspects of PA (both realignment and recalibration) and also transfer mechanisms, which probably reflects the involvement of true adaptation.

Some limitations of the present experiment must be underlined together with future directions. First, a greater number of trials during exposure may have led to stronger differences in after-effects and possibly to more robust findings on transfer. Second, a larger sample of participants and the use of high-definition tDCS protocols together with computational modelling of brain's impedances would improve the reliability and the robustness of the tDCS effects (Jalali et al., 2017). Third, although the cerebellum was a key candidate for transfer, the possibility that transfer properties are undertaken by brain circuits linking the cerebellum with other areas involved in PA (Panico, Sagliano, Grossi, et al., 2018) has to be addressed in further studies. In the same line, further investigation should also test a possible role of the primary motor cortex in transfer, as this area seem to be involved in the storage of motor memories (O'Shea et al., 2017; Panico et al., 2017). Fourth, the present study did not investigate whether cerebellar contribution in transfer occurred during exposure or during post-test testing. This should be clarified by modulating the timing of C-tDCS application. Finally, the use of additional methods such as electroencephalography (EEG) and ecological neuroimaging methods (functional Near Infrared Spectroscopy, fNIRS) during tDCS administration could help

monitoring the effect of stimulation during the task and check for individual variability in C-tDCS effects.

References

- Baizer, J. S., Kralj-Hans, I., & Glickstein, M. (1999). Cerebellar lesions and prism adaptation in macaque monkeys. *Journal of Neurophysiology*, *81*(4), 1960-1965. <https://doi.org/10.1152/jn.1999.81.4.1960>
- Bastian, A. J. (2006). Learning to predict the future : The cerebellum adapts feedforward movement control. *Current Opinion in Neurobiology*, *16*(6), 645-649. <https://doi.org/10.1016/j.conb.2006.08.016>
- Bates D, Mächler M, Bolker B, Walker S. (2015). Fitting linear mixed-effects models using lme4. *J Stat Softw.*, *67*, 1-48.
- Bedford, F. L. (1993). Perceptual and cognitive spatial learning. *Journal of Experimental Psychology: Human Perception and Performance*, *19*(3), 517-530. <https://doi.org/10.1037/0096-1523.19.3.517>
- Bultitude, J. H., Farnè, A., Salemme, R., Ibarrola, D., Urquizar, C., O'Shea, J., & Luauté, J. (2017). Studying the neural bases of prism adaptation using fMRI : A technical and design challenge. *Behavior Research Methods*, *49*(6), 2031-2043. <https://doi.org/10.3758/s13428-016-0840-z>
- Butcher, P. A., Ivry, R. B., Kuo, S.-H., Rydz, D., Krakauer, J. W., & Taylor, J. A. (2017). The cerebellum does more than sensory prediction error-based learning in sensorimotor adaptation tasks. *Journal of Neurophysiology*, *118*(3), 1622-1636. <https://doi.org/10.1152/jn.00451.2017>
- Chapman, H. L., Eramudugolla, R., Gavrilescu, M., Strudwick, M. W., Loftus, A., Cunnington, R., & Mattingley, J. B. (2010). Neural mechanisms underlying spatial realignment during adaptation to optical wedge prisms. *Neuropsychologia*, *48*(9), 2595-2601. <https://doi.org/10.1016/j.neuropsychologia.2010.05.006>
- Chew, T., Ho, K.-A., & Loo, C. K. (2015). Inter- and Intra-individual Variability in Response to Transcranial Direct Current Stimulation (tDCS) at Varying Current Intensities. *Brain Stimulation*, *8*(6), 1130-1137. <https://doi.org/10.1016/j.brs.2015.07.031>
- Clower, D. M., Hoffman, J. M., Votaw, J. R., Faber, T. L., Woods, R. P., & Alexander, G. E. (1996). Role of posterior parietal cortex in the recalibration of visually guided reaching. *Nature*, *383*(6601), 618-621. <https://doi.org/10.1038/383618a0>
- Danckert, J., Ferber, S., & Goodale, M. A. (2008). Direct effects of prismatic lenses on visuomotor control : An event-related functional MRI study. *European Journal of Neuroscience*, *28*(8), 1696-1704. <https://doi.org/10.1111/j.1460-9568.2008.06460.x>
- Diedrichsen, J., Hashambhoy, Y., Rane, T., & Shadmehr, R. (2005). Neural correlates of reach errors. *The Journal of Neuroscience: The Official Journal of the Society for Neuroscience*, *25*(43), 9919-9931. <https://doi.org/10.1523/JNEUROSCI.1874-05.2005>
- Elliott, D., Hansen, S., Grierson, L. E. M., Lyons, J., Bennett, S. J., & Hayes, S. J. (2010). Goal-directed aiming: Two components but multiple processes. *Psychological Bulletin*, *136*(6), 1023-1044. <https://doi.org/10.1037/a0020958>
- Fernandez-Ruiz, J., Diaz, R., Hall-Haro, C., Vergara, P., Mischner, J., Nuñez, L., Drucker-Colin, R., Ochoa, A., & Alonso, M. E. (2003). Normal prism adaptation but reduced after-effect in basal ganglia disorders using a throwing task. *The European Journal of Neuroscience*, *18*(3), 689-694. <https://doi.org/10.1046/j.1460-9568.2003.02785.x>
- Fleury, L., Pastor, D., Revol, P., Delporte, L., & Rossetti, Y. (2020). Inter-task transfer of prism adaptation depends on exposed task mastery. *Scientific Reports*, *10*(1), 5687. <https://doi.org/10.1038/s41598-020-62519-5>
- Gandiga, P. C., Hummel, F. C., & Cohen, L. G. (2006). Transcranial DC stimulation (tDCS): A tool for double-blind sham-controlled clinical studies in brain stimulation. *Clinical Neurophysiology: Official*

Journal of the International Federation of Clinical Neurophysiology, 117(4), 845-850.
<https://doi.org/10.1016/j.clinph.2005.12.003>

Girardi, M., McIntosh, R. D., Michel, C., Vallar, G., & Rossetti, Y. (2004). Sensorimotor effects on central space representation : Prism adaptation influences haptic and visual representations in normal subjects. *Neuropsychologia*, 42(11), 1477-1487. <https://doi.org/10.1016/j.neuropsychologia.2004.03.008>

Hanajima, R., Shadmehr, R., Ohminami, S., Tsutsumi, R., Shirota, Y., Shimizu, T., Tanaka, N., Terao, Y., Tsuji, S., Ugawa, Y., Uchimura, M., Inoue, M., & Kitazawa, S. (2015). Modulation of error-sensitivity during a prism adaptation task in people with cerebellar degeneration. *Journal of Neurophysiology*, 114(4), 2460-2471. <https://doi.org/10.1152/jn.00145.2015>

Inoue, M., Uchimura, M., Karibe, A., O'Shea, J., Rossetti, Y., & Kitazawa, S. (2015). Three timescales in prism adaptation. *Journal of Neurophysiology*, 113(1), 328-338. <https://doi.org/10.1152/jn.00803.2013>

Jacquin-Courtois, S., Rode, G., Pisella, L., Boisson, D., & Rossetti, Y. (2008). Wheel-chair driving improvement following visuo-manual prism adaptation. *Cortex*, 44(1), 90-96. <https://doi.org/10.1016/j.cortex.2006.06.003>

Jalali, R., Miall, R. C., & Galea, J. M. (2017). No consistent effect of cerebellar transcranial direct current stimulation on visuomotor adaptation. *Journal of Neurophysiology*, 118(2), 655-665. <https://doi.org/10.1152/jn.00896.2016>

Küper, M., Wünnemann, M. J. S., Thürling, M., Stefanescu, R. M., Maderwald, S., Elles, H. G., Göricke, S., Ladd, M. E., & Timmann, D. (2014). Activation of the cerebellar cortex and the dentate nucleus in a prism adaptation fMRI study. *Human Brain Mapping*, 35(4), 1574-1586. <https://doi.org/10.1002/hbm.22274>

Luauté, J., Schwartz, S., Rossetti, Y., Spiridon, M., Rode, G., Boisson, D., & Vuilleumier, P. (2009). Dynamic Changes in Brain Activity during Prism Adaptation. *Journal of Neuroscience*, 29(1), 169-178. <https://doi.org/10.1523/JNEUROSCI.3054-08.2009>

McDougle, S. D., Ivry, R. B., & Taylor, J. A. (2016). Taking Aim at the Cognitive Side of Learning in Sensorimotor Adaptation Tasks. *Trends in Cognitive Sciences*, 20(7), 535-544. <https://doi.org/10.1016/j.tics.2016.05.002>

Michel, C., Pisella, L., Prablanc, C., Rode, G., & Rossetti, Y. (2007). Enhancing Visuomotor Adaptation by Reducing Error Signals : Single-step (Aware) versus Multiple-step (Unaware) Exposure to Wedge Prisms. *Journal of Cognitive Neuroscience*, 19(2), 341-350. <https://doi.org/10.1162/jocn.2007.19.2.341>

Michel, C., Vernet, P., Courtine, G., Ballay, Y., & Pozzo, T. (2008). Asymmetrical after-effects of prism adaptation during goal oriented locomotion. *Experimental Brain Research*, 185(2), 259-268. <https://doi.org/10.1007/s00221-007-1152-4>

Morton, S. M., Lang, C. E., & Bastian, A. J. (2001). Inter- and intra-limb generalization of adaptation during catching. *Experimental Brain Research*, 141(4), 438-445. <https://doi.org/10.1007/s002210100889>

Newport, R., & Jackson, S. R. (2006). Posterior parietal cortex and the dissociable components of prism adaptation. *Neuropsychologia*, 44(13), 2757-2765. <https://doi.org/10.1016/j.neuropsychologia.2006.01.007>

Nitsche, M. A., & Paulus, W. (2000). Excitability changes induced in the human motor cortex by weak transcranial direct current stimulation. *The Journal of Physiology*, 527 Pt 3, 633-639. <https://doi.org/10.1111/j.1469-7793.2000.t01-1-00633.x>

O'Shea, J., Gaveau, V., Kandel, M., Koga, K., Susami, K., Prablanc, C., & Rossetti, Y. (2014). Kinematic markers dissociate error correction from sensorimotor realignment during prism adaptation. *Neuropsychologia*, 55, 15-24. <https://doi.org/10.1016/j.neuropsychologia.2013.09.021>

O'Shea, J., Revol, P., Cousijn, H., Near, J., Petitet, P., Jacquin-Courtois, S., Johansen-Berg, H., Rode, G., & Rossetti, Y. (2017). Induced sensorimotor cortex plasticity remediates chronic treatment-resistant visual neglect. *ELife*, 6. <https://doi.org/10.7554/eLife.26602>

- Panico, F., Jacquin-Courtois, S., Di Marco, J., Perrin, C., Trojano, L., & Rossetti, Y. (2017). TDCS reactivation of dormant adaptation circuits. *Cortex*, *94*, 196-199. <https://doi.org/10.1016/j.cortex.2017.02.003>
- Panico, F., Rossetti, Y., & Trojano, L. (2020). On the mechanisms underlying Prism Adaptation : A review of neuro-imaging and neuro-stimulation studies. *Cortex*, *123*, 57-71. <https://doi.org/10.1016/j.cortex.2019.10.003>
- Panico, F., Sagliano, L., Grossi, D., & Trojano, L. (2016). Cerebellar cathodal tDCS interferes with recalibration and spatial realignment during prism adaptation procedure in healthy subjects. *Brain and Cognition*, *105*, 1-8. <https://doi.org/10.1016/j.bandc.2016.03.002>
- Panico, F., Sagliano, L., Grossi, D., & Trojano, L. (2018). Bi-cephalic parietal and cerebellar direct current stimulation interferes with early error correction in prism adaptation : Toward a complex view of the neural mechanisms underlying visuomotor control. *Cortex*, *109*, 226-233. <https://doi.org/10.1016/j.cortex.2018.09.020>
- Panico, F., Sagliano, L., Nozzolillo, C., Trojano, L., & Rossetti, Y. (2018). Cerebellar contribution to spatial realignment : A tDCS study during multiple-step prism adaptation. *Neuropsychologia*, *112*, 58-65. <https://doi.org/10.1016/j.neuropsychologia.2018.03.008>
- Petitot, P., O'Reilly, J. X., & O'Shea, J. (2017). Towards a neuro-computational account of prism adaptation. *Neuropsychologia*. <https://doi.org/10.1016/j.neuropsychologia.2017.12.021>
- Pisella, L., Michel, C., Gréa, H., Tilikete, C., Vighetto, A., & Rossetti, Y. (2004). Preserved prism adaptation in bilateral optic ataxia : Strategic versus adaptive reaction to prisms. *Experimental Brain Research*, *156*(4), 399-408. <https://doi.org/10.1007/s00221-003-1746-4>
- Pisella, L., Rossetti, Y., Michel, C., Rode, G., Boisson, D., Pélisson, D., & Tilikete, C. (2005). Ipsidirectional impairment of prism adaptation after unilateral lesion of anterior cerebellum. *Neurology*, *65*(1), 150-152. <https://doi.org/10.1212/01.wnl.0000167945.34177.5e>
- Poggio, T., & Bizzi, E. (2004). Generalization in vision and motor control. *Nature*. <https://doi.org/10.1038/nature03014>
- Prablanc, C., Panico, F., Fleury, L., Pisella, L., Nijboer, T., Kitazawa, S., & Rossetti, Y. (2019). Adapting terminology : Clarifying prism adaptation vocabulary, concepts, and methods. *Neuroscience Research*. <https://doi.org/10.1016/j.neures.2019.03.003>
- Redding, G. M., Rossetti, Y., & Wallace, B. (2005). Applications of prism adaptation : A tutorial in theory and method. *Neuroscience & Biobehavioral Reviews*, *29*(3), 431-444. <https://doi.org/10.1016/j.neubiorev.2004.12.004>
- Redding, G. M., & Wallace, B. (2002). Strategie Calibration and Spatial Alignment : A Model From Prism Adaptation. *Journal of Motor Behavior*, *34*(2), 126-138. <https://doi.org/10.1080/00222890209601935>
- Redding, G. M., & Wallace, B. (2006). Generalization of prism adaptation. *Journal of Experimental Psychology. Human Perception and Performance*, *32*(4), 1006-1022. <https://doi.org/10.1037/0096-1523.32.4.1006>
- Renault, A. G., Lefumat, H., Miall, R. C., Bringoux, L., Bourdin, C., Vercher, J.-L., & Sarlegna, F. R. (2018). Individual movement features during prism adaptation correlate with after-effects and interlimb transfer. *Psychological Research*. <https://doi.org/10.1007/s00426-018-1110-8>
- Roemmich, R. T., & Bastian, A. J. (2018). Closing the Loop: From Motor Neuroscience to Neurorehabilitation. *Annual Review of Neuroscience*, *41*, 415-429. <https://doi.org/10.1146/annurev-neuro-080317-062245>
- Rossetti, Y., Koga, K., & Mano, T. (1993). Prismatic displacement of vision induces transient changes in the timing of eye-hand coordination. *Perception & Psychophysics*, *54*(3), 355-364. <https://doi.org/10.3758/BF03205270>
- Schlerf, J. E., Galea, J. M., Spampinato, D., & Celnik, P. A. (2015). Laterality Differences in Cerebellar-Motor Cortex Connectivity. *Cerebral Cortex*, *25*(7), 1827-1834. <https://doi.org/10.1093/cercor/bht422>

- Singer, J.D., Willett, J.B. (2003). Applied longitudinal data analysis: modeling change and event occurrence. Oxford: Oxford University Press
<https://doi.org/10.1093/acprof:oso/9780195152968.001.0001>.
- Smith, M. A., Ghazizadeh, A., & Shadmehr, R. (2006). Interacting Adaptive Processes with Different Timescales Underlie Short-Term Motor Learning. *PLOS Biology*, 4(6), e179.
<https://doi.org/10.1371/journal.pbio.0040179>
- Stark-Inbar, A., Raza, M., Taylor, J. A., & Ivry, R. B. (2017). Individual differences in implicit motor learning: Task specificity in sensorimotor adaptation and sequence learning. *Journal of Neurophysiology*, 117(1), 412-428. <https://doi.org/10.1152/jn.01141.2015>
- Therrien, A. S., & Bastian, A. J. (2019). The cerebellum as a movement sensor. *Neuroscience Letters*, 688, 37-40. <https://doi.org/10.1016/j.neulet.2018.06.055>
- Weiner, M. J., Hallett, M., & Funkenstein, H. H. (1983). Adaptation to lateral displacement of vision in patients with lesions of the central nervous system. *Neurology*, 33(6), 766-772.
- Welch, R. B. (1974). Speculations on a Model of Prism Adaptation
 Speculations on a Model of Prism Adaptation. *Perception*, 3(4), 451-460.
<https://doi.org/10.1068/p030451>
- Wiethoff, S., Hamada, M., & Rothwell, J. C. (2014). Variability in response to transcranial direct current stimulation of the motor cortex. *Brain Stimulation*, 7(3), 468-475.
<https://doi.org/10.1016/j.brs.2014.02.003>
- Woods, A. J., Antal, A., Bikson, M., Boggio, P. S., Brunoni, A. R., Celnik, P., Cohen, L. G., Fregni, F., Herrmann, C. S., Kappenman, E. S., Knotkova, H., Liebetanz, D., Miniussi, C., Miranda, P. C., Paulus, W., Priori, A., Reato, D., Stagg, C., Wenderoth, N., & Nitsche, M. A. (2016). A technical guide to tDCS, and related non-invasive brain stimulation tools. *Clinical Neurophysiology*, 127(2), 1031-1048.
<https://doi.org/10.1016/j.clinph.2015.11.012>
- Wright, D. B., & London, K. (2009). Multilevel modelling : Beyond the basic applications. *The British Journal of Mathematical and Statistical Psychology*, 62(Pt 2), 439-456.
<https://doi.org/10.1348/000711008X327632>

Supplementary materials

Terminal Errors - Linear Mixed Models Analysis

		Fixed Effects					Random effects / Model parameters			
		Estimate	Std Error	df	t	p	Variance		Std Err	
Fam Pointing	Intercept	-0.04	0.08	30.08	-0.53	0.60	Intercept (Id)		0.07547	0.27
	Time	0.00	0.00	724.00	0.31	0.76	Residual		0.08101	0.28
	Group	0.07	0.12	30.07	0.59	0.56	logLik	-163.6	ICC	
	Group*Time	0.00	0.00	724.00	0.16	0.88	Nb Obs	749	0.48	
Fam Throwing	Intercept	-0.30	0.33	68.87	-0.92	0.36	Intercept (Id)		0.6827	0.83
	Time	0.00	0.01	714.30	-0.34	0.74	Residual		6.4375	2.54
	Group	-0.47	0.49	69.20	-0.94	0.35	logLik	-1754.4	ICC	
	Group*Time	0.00	0.02	714.40	0.01	1.00	Nb Obs	739	0.10	
Pre-tests Throwing	Intercept	0.74	0.58	40.60	1.27	0.21	Intercept (Id)		3.331	1.83
	Time	-0.02	0.03	465.12	-0.61	0.55	Residual		7.372	2.72
	Group	-0.55	0.88	40.86	-0.62	0.54	logLik	-1213.3	ICC	
	Group*Time	0.05	0.04	465.14	1.18	0.24	Nb Obs	490	0.31	
Pre-tests Pointing	Intercept	0.51	0.36	30.09	1.45	0.16	Intercept (Id)		1.552	1.25
	Time	-0.02	0.01	474.00	-1.54	0.12	Residual		1.156	1.08
	Group	-0.72	0.54	30.11	-1.34	0.19	logLik	-785.9	ICC	
	Group*Time	-0.02	0.02	474.00	-0.93	0.35	Nb Obs	499	0.57	
Post-tests Pointing	Intercept	-6.17	0.29	30.14	-20.96	<2e-16***	Intercept (Id)		1.0648	1.03
	Time	0.10	0.01	473.01	11.14	<2e-16***	Residual		0.8005	0.89
	Group	1.16	0.44	30.17	2.60	0.01*	logLik	-692.7	ICC	
	Group*Time	-0.04	0.01	473.03	-2.58	0.01*	Nb Obs	492	0.57	
Post-tests Throwing	Intercept	-1.71	0.55	44.40	-3.10	0.00**	Intercept (Id)		2.782	1.67
	Time	0.03	0.03	472.11	0.91	0.36	Residual		7.836	2.80
	Group	-0.29	0.83	44.33	-0.35	0.73	logLik	-1242.9	ICC	
	Group*Time	0.01	0.04	472.06	0.24	0.81	Nb Obs	497	0.26	
Post-tests Throwing trials 11-20	Intercept	1.00	1.35	239.97	0.74	0.46	Intercept (Id)		3.033	1.74
	Time	-0.15	0.09	222.29	-1.74	0.08	Residual		8.291	2.88
	Group	-4.13	2.03	239.99	-2.03	0.04*	logLik	-630.8	ICC	
	Group*Time	0.26	0.13	222.24	2.03	0.04*	Nb Obs	247	0.27	
Post-tests Throwing Right target trials 6-10	Intercept	3.55	1.61	120.48	2.20	0.03**	Intercept (Id)		3.531	1.88
	Time	-0.66	0.21	99.05	-3.06	0.00**	Residual		6.428	2.54
	Group	-5.65	2.44	120.42	-2.32	0.02*	logLik	-307.7	ICC	
	Group*Time	0.68	0.32	99.12	2.09	0.04*	Nb Obs	124	0.35	
Exposure Pointing trials 1-60	Intercept	0.81	0.14	28.31	5.82	0.00***	Intercept (Id)		0.2415	0.49
	Time	0.00	0.00	1475.00	-10.76	< 2e-16***	Residual		0.8006	0.89
	Group	-0.30	0.21	28.31	-1.43	0.16	logLik	-1998.5	ICC	
	Group*Time	0.00	0.00	1475.00	3.15	0.00**	Nb Obs	1500	0.23	
Exposure Pointing trials 1-5	Intercept	3.61	0.40	41.31	9.03	0.00***	Intercept (Id)		1.224	1.11
	Time	-0.19	0.03	100.00	-5.98	0.00***	Residual		2.497	1.58
	Group	-1.31	0.60	41.31	-2.18	0.04*	logLik	-250	ICC	
	Group*Time	0.04	0.05	100.00	0.75	0.46	Nb Obs	125	0.33	
Exposure Pointing trials 1-10	Intercept	2.49	0.27	42.76	9.07	0.00***	Intercept (Id)		0.5765	0.76
	Time	-0.03	0.00	225.00	-6.86	0.00***	Residual		2.2375	1.50
	Group	-1.09	0.41	42.76	-2.63	0.01*	logLik	-471.3	ICC	
	Group*Time	0.02	0.01	225.00	2.27	0.02*	Nb Obs	250	0.20	
Exposure Pointing trials 11-60	Intercept	0.50	0.14	31.10	3.72	0.00***	Intercept (Id)		0.22	0.47
	Time	-0.01	0.00	1225.00	-6.58	0.00***	Residual		0.23	0.48
	Group	-0.19	0.20	31.10	-0.93	0.36	logLik	-910	ICC	
	Group*Time	0.00	0.00	1225.00	2.28	0.02*	Nb Obs	1250	0.49	

Table 2 - Linear Mixed Models Analysis results - Deviations. Effects of TIME, GROUP and GROUP*TIME on terminal errors at the different steps of the experimental procedure.

Pointing trajectories orientations - Descriptive statistics

		Mean orientation at initial direction						Mean orientation at intermediate direction						Mean orientation at final direction					
		ctDCS group			Sham group			ctDCS group			Sham group			ctDCS group			Sham group		
Familiarization	<i>Pointing</i>	-3.73	±	5.99	-7.06	±	5.67	2.17	±	2.04	3.88	±	2.31	4.97	±	5.56	6.94	±	4.21
Pre-tests	<i>Central</i>	-6.24	±	5.84	-10.04	±	7.30	2.92	±	2.75	2.27	±	3.28	7.54	±	5.52	5.95	±	4.10
	<i>Right</i>	-7.69	±	5.15	-11.25	±	6.94	7.70	±	3.02	6.95	±	3.15	17.56	±	6.38	17.07	±	6.16
	<i>Trial 1</i>	2.07	±	5.31	-2.09	±	8.42	15.29	±	3.91	11.27	±	5.14	23.57	±	8.33	19.09	±	10.82
Exposure	<i>Trial 2</i>	-2.07	±	4.57	-4.73	±	3.93	9.00	±	3.55	7.27	±	4.22	17.93	±	10.40	13.55	±	8.50
	<i>Trial 3</i>	-4.29	±	4.73	-9.27	±	5.31	5.50	±	3.44	4.00	±	3.55	14.57	±	9.44	12.64	±	10.54
	<i>Trial 4</i>	-7.00	±	4.02	-6.00	±	4.71	2.57	±	3.57	3.73	±	5.66	14.21	±	6.66	10.27	±	8.65
	<i>Trial 5</i>	-6.71	±	3.93	-9.18	±	4.96	2.43	±	3.41	2.91	±	3.67	10.21	±	10.14	11.09	±	7.73
	<i>Trials 6-10</i>	-8.16	±	3.53	-9.40	±	3.62	2.06	±	2.80	3.27	±	3.18	11.87	±	6.07	10.73	±	5.97
	<i>Trials 11-20</i>	-7.98	±	3.86	-8.91	±	4.82	1.92	±	2.11	3.19	±	2.19	10.94	±	6.81	9.56	±	4.45
	<i>Trials 21-30</i>	-8.65	±	3.41	-8.80	±	6.59	2.14	±	2.01	3.19	±	1.81	10.17	±	7.32	9.92	±	4.15
	<i>Trials 31-40</i>	-7.53	±	4.15	-9.03	±	6.47	2.92	±	3.50	3.10	±	1.63	10.48	±	6.73	8.88	±	5.45
	<i>Trials 41-50</i>	-7.79	±	4.05	-7.49	±	6.44	2.27	±	1.80	3.74	±	1.59	9.79	±	7.24	7.90	±	5.17
	<i>Trials 51-60</i>	-6.86	±	7.51	-8.50	±	5.83	2.42	±	1.81	3.34	±	1.43	9.40	±	7.43	7.80	±	4.15
Post-tests	<i>Central</i>	-8.60	±	4.01	-7.33	±	4.73	-8.53	±	2.84	-6.71	±	2.67	-7.64	±	4.65	-6.72	±	2.94
	<i>Right</i>	-6.38	±	3.30	-6.65	±	4.48	-7.81	±	1.89	-6.30	±	2.22	-8.70	±	4.85	-7.56	±	3.94

Table 3 – Pointing trajectories orientations at initial (acceleration peak), intermediate (velocity peak) and final (deceleration peak) directions. Values are reported in degrees with standard deviations.

Pointing trajectories orientations at initial direction - Linear Mixed Models Analysis										
		Fixed Effects					Random effects / Model parameters			
		Estimate	Std Error	df	t	p	Variance		Std Err	
Fam Pointing	Intercept	-3.25	1.59	26.31	-2.04	0.05	Intercept (Id)	30.97	5.57	
	Time	-0.03	0.02	689.01	-1.43	0.15	Residual	15.71	3.96	
	Group	-1.74	2.35	26.32	-0.74	0.47	logLik	-2042.7	ICC	
	Group*Time	-0.13	0.03	689.02	-3.81	0.00 ***	Nb Obs	713	0.66	
Pre-tests Pointing central target	Intercept	-5.39	1.72	35.02	-3.14	0.00 **	Intercept (Id)	32.12	5.67	
	Time	-0.35	0.15	223.08	-2.27	0.02 *	Residual	26.18	5.12	
	Group	-3.21	2.59	35.27	-1.24	0.22	logLik	-789	ICC	
	Group*Time	0.03	0.23	223.09	0.12	0.90	Nb Obs	248	0.55	
Pre-tests Pointing right target	Intercept	-5.58	1.66	34.26	-3.36	0.00 **	Intercept (Id)	30.72	5.54	
	Time	-0.47	0.14	225.00	-3.30	0.00 **	Residual	23.24	4.82	
	Group	-4.69	2.51	34.26	-1.87	0.07	logLik	-781.1	ICC	
	Group*Time	0.25	0.21	225.00	1.17	0.24	Nb Obs	250	0.57	
Post-tests Pointing central target	Intercept	-7.33	1.77	68.12	-4.13	0.00 ***	Intercept (Id)	18.63	4.32	
	Time	-0.28	0.25	225.00	-1.10	0.27	Residual	73.48	8.57	
	Group	1.90	2.67	68.12	0.71	0.48	logLik	-907.6	ICC	
	Group*Time	0.10	0.38	225.00	0.25	0.80	Nb Obs	250	0.20	
Post-tests Pointing right target	Intercept	-6.74	1.13	42.08	-5.97	0.00 ***	Intercept (Id)	11.96	3.46	
	Time	0.09	0.12	225.00	0.70	0.48	Residual	16.91	4.11	
	Group	-0.91	1.70	42.08	-0.53	0.60	logLik	-734.3	ICC	
	Group*Time	0.15	0.18	225.00	0.84	0.40	Nb Obs	250	0.41	
Exposure Pointing trials 1-60	Intercept	-6.72	1.05	28.26	-6.38	0.00 ***	Intercept (Id)	14.28	3.78	
	Time	-0.04	0.01	1453.00	-4.16	0.00 ***	Residual	19.06	4.37	
	Group	-1.81	1.59	28.30	-1.14	0.27	logLik	-4323.1	ICC	
	Group*Time	0.04	0.01	1453.00	2.88	0.00 **	Nb Obs	1478	0.43	
Exposure Pointing trials 1-10	Intercept	-1.56	1.05	42.44	-1.50	0.14	Intercept (Id)	10.15	3.19	
	Time	-0.96	0.11	221.92	-8.44	0.00 ***	Residual	14.91	3.86	
	Group	-4.04	1.58	43.20	-2.55	0.01 *	logLik	-709.8	ICC	
	Group*Time	0.41	0.17	222.00	2.40	0.02 *	Nb Obs	247	0.41	
Exposure Pointing trials 41-50	Intercept	2.81	5.21	239.93	0.54	0.59	Intercept (Id)	23.88	4.89	
	Time	-0.24	0.11	218.90	-2.11	0.04 *	Residual	13.53	3.68	
	Group	-14.93	7.69	240.27	-1.94	0.05 .	logLik	-697.5	ICC	
	Group*Time	0.34	0.17	218.46	2.05	0.04 *	Nb Obs	243	0.64	

Table 4 - Linear Mixed Models Analysis results – pointing trajectories orientations at initial direction. Effects of TIME, GROUP and GROUP*TIME on pointing trajectories orientations at initial direction and at the different steps of the experimental procedure.

Pointing trajectories orientations at intermediate direction - Linear Mixed Models Analysis										
		Fixed Effects					Random effects / Model parameters			
		Estimate	Std Error	df	t	p	Variance		Std Err	
Fam Pointing	Intercept	2.28	0.55	26.68	4.14	0.00 ***	Intercept (Id)	3.57	1.89	
	Time	0.00	0.00	688.00	-0.90	0.37	Residual	5.06	2.25	
	Group	1.40	0.81	26.71	1.72	0.10	logLik	-7624.30	ICC	
	Group*Time	0.00	0.00	688.10	-1.15	0.25	Nb Obs	712	0.41	
Pre-tests Pointing central target	Intercept	3.27	0.88	42.71	3.72	0.00 ***	Intercept (Id)	7.17	2.68	
	Time	-0.08	0.10	224.00	-0.81	0.42	Residual	10.56	3.25	
	Group	-0.66	1.33	43.25	-0.50	0.62	logLik	-672.4	ICC	
	Group*Time	0.00	0.15	224.08	0.01	0.99	Nb Obs	249	0.40	
Pre-tests Pointing right target	Intercept	8.65	0.91	43.85	9.49	0.00 ***	Intercept (Id)	7.55	2.75	
	Time	-0.21	0.10	225.00	-2.10	0.04 *	Residual	11.83	3.44	
	Group	-1.41	1.37	43.85	-1.03	0.31	logLik	-688.6	ICC	
	Group*Time	0.15	0.15	225.00	0.96	0.34	Nb Obs	250	0.39	
Post-tests Pointing central target	Intercept	-10.24	0.81	39.86	-12.58	0.00 ***	Intercept (Id)	6.52	2.55	
	Time	0.39	0.08	224.02	4.73	0.00 ***	Residual	7.98	2.83	
	Group	3.44	1.23	39.98	2.80	0.01 **	logLik	-639.6	ICC	
	Group*Time	-0.36	0.13	224.03	-2.84	0.00 **	Nb Obs	249	0.45	
Post-tests Pointing right target	Intercept	-8.64	0.70	58.44	-12.27	<2e-16 ***	Intercept (Id)	3.44	1.85	
	Time	0.22	0.09	223.95	2.40	0.02 *	Residual	10.12	3.18	
	Group	1.71	1.06	58.58	1.61	0.11	logLik	-659.9	ICC	
	Group*Time	-0.04	0.14	223.95	-0.27	0.79	Nb Obs	249	0.25	
Exposure Pointing trials 1-60	Intercept	3.54	0.48	32.49	7.31	0.00 ***	Intercept (Id)	2.74	1.66	
	Time	-0.03	0.01	1454.24	-5.58	0.00 ***	Residual	8.32	2.89	
	Group	0.53	0.73	32.51	0.72	0.48	logLik	-3703.4	ICC	
	Group*Time	0.01	0.01	1454.11	1.62	0.11	Nb Obs	1479	0.25	
Exposure Pointing trials 1-5	Intercept	13.36	0.95	48.19	14.14	<2e-16 ***	Intercept (Id)	6.95	2.64	
	Time	-3.19	0.26	97.55	-12.22	<2e-16 ***	Residual	9.20	3.03	
	Group	-2.86	1.44	49.36	-1.99	0.05	logLik	-327.8	ICC	
	Group*Time	1.00	0.40	97.68	2.53	0.01 *	Nb Obs	122	0.43	
Exposure Pointing trials 1-10	Intercept	9.62	0.87	46.52	11.03	0.00 ***	Intercept (Id)	6.57	2.56	
	Time	-1.13	0.10	222.09	-11.16	< 2e-16 ***	Residual	11.79	3.43	
	Group	-1.94	1.32	47.29	-1.47	0.15	logLik	-678.5	ICC	
	Group*Time	0.46	0.15	222.19	3.01	0.00 **	Nb Obs	247	0.36	
Exposure Pointing trials 51-60	Intercept	-0.07	3.08	227.23	-0.02	0.98	Intercept (Id)	6.57	2.56	
	Time	0.05	0.06	219.40	0.81	0.42	Residual	11.79	3.43	
	Group	12.56	4.63	227.26	2.71	0.01 **	logLik	-678.5	ICC	
	Group*Time	-0.21	0.08	219.40	-2.54	0.01 *	Nb Obs	247	0.36	

Table 5 - Linear Mixed Models Analysis results – pointing trajectories orientations at intermediate direction. Effects of TIME, GROUP and GROUP*TIME on pointing trajectories orientations at intermediate direction and at the different steps of the experimental procedure.

Pointing trajectories orientations at intermediary direction - Linear Mixed Models Analysis

		Fixed Effects					Random effects / Model parameters			
		Estimate	Std Error	df	t	p	Variance		Std Err	
Fam Pointing	Intercept	5.17	1.40	31.94	3.71	0.00 ***	Intercept (Id)	20.75	4.56	
	Time	-0.01	0.04	690.03	-0.40	0.69	Residual	35.93	5.99	
	Group	0.64	2.06	31.98	0.31	0.76	logLik	-2326.5	ICC	
	Group*Time	0.11	0.05	690.06	2.12	0.03 *	Nb Obs	714	0.37	
Pre-tests Pointing central target	Intercept	6.80	1.44	41.00	4.72	0.00 ***	Intercept (Id)	19.95	4.47	
	Time	0.16	0.15	224.02	1.08	0.28	Residual	26.37	5.14	
	Group	-0.84	2.18	41.48	-0.39	0.70	logLik	-787.5	ICC	
	Group*Time	-0.17	0.23	224.10	-0.72	0.47	Nb Obs	249	0.43	
Pre-tests Pointing right target	Intercept	17.96	1.77	36.40	10.13	0.00 ***	Intercept (Id)	33.26	5.77	
	Time	-0.09	0.16	225.00	-0.54	0.59	Residual	31.06	5.57	
	Group	-0.66	2.67	36.40	-0.25	0.81	logLik	-815	ICC	
	Group*Time	0.04	0.25	225.00	0.15	0.88	Nb Obs	250	0.52	
Post-tests Pointing central target	Intercept	-8.87	1.15	39.65	-7.74	0.00 ***	Intercept (Id)	12.98	3.60	
	Time	0.28	0.12	224.01	2.42	0.02 *	Residual	15.68	3.96	
	Group	0.23	1.73	39.77	0.13	0.90	logLik	-723.8	ICC	
	Group*Time	0.14	0.18	224.02	0.81	0.42	Nb Obs	249	0.45	
Post-tests Pointing right target	Intercept	-10.51	1.35	46.59	-7.80	0.00 ***	Intercept (Id)	15.62	3.95	
	Time	0.40	0.16	224.01	2.54	0.01 *	Residual	28.3	5.32	
	Group	1.19	2.03	46.68	0.58	0.56	logLik	-792.9	ICC	
	Group*Time	0.01	0.24	224.01	0.04	0.97	Nb Obs	249	0.36	
Exposure Pointing trials 1-60	Intercept	13.07	1.54	26.83	8.51	0.00 ***	Intercept (Id)	31.5	5.61	
	Time	-0.08	0.01	1455.00	-8.14	0.00 ***	Residual	23.6	4.86	
	Group	-1.47	2.32	26.84	-0.64	0.53	logLik	-4494.1	ICC	
	Group*Time	0.00	0.01	1455.00	-0.02	0.99	Nb Obs	1480	0.57	
Exposure Pointing trials 1-5	Intercept	22.19	2.19	34.70	10.13	0.00 ***	Intercept (Id)	51.34	7.17	
	Time	-3.04	0.43	97.94	-7.00	0.00 ***	Residual	26.43	5.14	
	Group	-4.62	3.32	35.29	-1.39	0.17	logLik	-405.4	ICC	
	Group*Time	1.03	0.67	98.09	1.55	0.12	Nb Obs	123	0.66	
Exposure Pointing trials 1-10	Intercept	18.66	1.87	35.20	9.95	0.00 ***	Intercept (Id)	38.14	6.18	
	Time	-1.04	0.17	222.98	-6.24	0.00 ***	Residual	32.04	5.66	
	Group	-3.26	2.83	35.60	-1.15	0.26	logLik	-813.7	ICC	
	Group*Time	0.32	0.25	223.04	1.27	0.21	Nb Obs	248	0.54	

Table 6 - Linear Mixed Models Analysis results – pointing trajectories orientations at terminal direction. Effects of TIME, GROUP and GROUP*TIME pointing trajectories orientations at terminal direction and at the different steps of the experimental procedure.

Pointing movements temporal aspects - Descriptive statistics

	ctDCS group									Sham group								
	duration	tpa	tpv	tpd	% tpa	% tpv	% tpd	duration	tpa	tpv	tpd	% tpa	% tpv	% tpd				
Pre-tests	382.23 ± 64.42	53.76 ± 5.28	145.71 ± 28.27	239.41 ± 54.60	14.54 ± 2.81	38.30 ± 3.36	62.53 ± 6.27	352.64 ± 158.95	54.37 ± 23.02	139.46 ± 65.89	236.19 ± 115.61	13.09 ± 5.38	33.24 ± 14.89	56.12 ± 25.77				
<i>All trials</i>	352.91 ± 58.51	56.54 ± 5.83	135.53 ± 13.77	223.12 ± 31.84	16.69 ± 3.91	39.18 ± 4.83	63.99 ± 5.91	385.64 ± 63.52	52.99 ± 7.21	147.14 ± 21.51	254.02 ± 54.49	13.64 ± 2.67	38.97 ± 6.65	66.03 ± 7.16				
<i>Trial 1</i>	414.29 ± 128.48	65.57 ± 17.12	145.57 ± 27.78	215.86 ± 40.48	17.23 ± 6.47	37.03 ± 8.10	55.06 ± 12.67	338.89 ± 220.62	42.00 ± 32.75	118.11 ± 79.64	213.11 ± 142.63	10.90 ± 9.70	28.26 ± 18.72	49.96 ± 30.79				
<i>Trial 2</i>	381.43 ± 101.59	55.14 ± 15.46	136.07 ± 28.89	224.36 ± 41.45	15.79 ± 7.34	37.13 ± 9.17	61.50 ± 15.13	414.44 ± 65.12	56.44 ± 15.54	137.44 ± 25.76	233.44 ± 54.09	13.77 ± 3.53	33.30 ± 4.30	56.02 ± 8.00				
<i>Trial 3</i>	335.00 ± 59.26	54.36 ± 11.25	129.64 ± 15.62	225.36 ± 37.07	16.92 ± 5.89	39.52 ± 6.92	67.82 ± 7.83	404.44 ± 89.18	60.56 ± 19.89	152.56 ± 32.18	278.22 ± 65.36	16.11 ± 8.18	38.76 ± 9.44	69.45 ± 11.20				
<i>Trial 4</i>	316.79 ± 107.55	43.43 ± 19.92	112.14 ± 51.22	198.79 ± 95.94	12.92 ± 6.20	32.78 ± 14.17	57.92 ± 26.06	357.78 ± 156.11	47.33 ± 19.60	130.22 ± 53.26	224.78 ± 102.74	12.30 ± 5.87	33.11 ± 13.82	55.69 ± 21.86				
Exposure	329.29 ± 110.19	51.64 ± 18.24	122.00 ± 40.26	199.79 ± 70.02	15.02 ± 6.21	35.03 ± 12.21	57.20 ± 20.18	330.56 ± 133.15	47.78 ± 22.94	123.33 ± 53.77	223.78 ± 97.43	13.06 ± 6.30	33.40 ± 13.98	60.14 ± 24.43				
<i>Pointing</i>	349.71 ± 55.70	56.01 ± 7.08	136.44 ± 17.98	230.10 ± 37.78	16.54 ± 3.85	39.62 ± 5.07	66.31 ± 6.50	376.28 ± 49.39	53.72 ± 8.25	143.35 ± 24.61	261.23 ± 59.94	14.49 ± 2.78	38.26 ± 4.76	68.91 ± 8.84				
<i>Trials 6-10</i>	350.11 ± 63.24	58.66 ± 6.87	139.06 ± 15.94	230.77 ± 35.50	17.52 ± 4.44	40.52 ± 5.07	66.60 ± 5.20	385.10 ± 38.65	51.98 ± 6.33	140.60 ± 16.52	248.97 ± 46.49	13.77 ± 2.51	36.99 ± 5.41	64.85 ± 9.44				
<i>Trials 11-20</i>	348.42 ± 59.97	55.47 ± 5.33	134.21 ± 16.01	217.82 ± 37.76	16.58 ± 3.67	39.26 ± 5.19	63.23 ± 8.07	401.52 ± 56.15	53.24 ± 8.09	146.85 ± 22.91	260.62 ± 53.41	13.66 ± 3.20	36.99 ± 5.04	64.98 ± 7.67				
<i>Trials 31-40</i>	347.73 ± 62.49	56.23 ± 9.88	133.26 ± 16.16	215.79 ± 35.84	16.97 ± 5.45	39.18 ± 5.93	62.67 ± 6.74	399.45 ± 55.91	51.78 ± 7.49	144.32 ± 20.27	261.56 ± 51.50	13.33 ± 2.76	36.47 ± 3.88	65.53 ± 7.48				
<i>Trials 41-50</i>	357.63 ± 58.61	57.71 ± 8.56	135.89 ± 12.65	224.50 ± 31.06	16.82 ± 4.66	38.85 ± 5.55	63.55 ± 6.75	407.93 ± 55.27	52.73 ± 5.49	156.07 ± 27.50	270.59 ± 54.65	13.20 ± 2.24	38.30 ± 4.23	66.12 ± 7.98				
<i>Trials 51-60</i>	354.41 ± 57.47	54.95 ± 6.30	134.60 ± 16.12	223.67 ± 36.05	15.88 ± 3.23	38.44 ± 4.66	63.58 ± 7.99	411.23 ± 63.75	53.32 ± 8.54	155.02 ± 35.19	269.16 ± 66.22	13.39 ± 3.08	37.62 ± 4.60	65.02 ± 9.29				
Post-tests	372.82 ± 57.46	55.40 ± 4.77	138.84 ± 18.74	225.92 ± 37.38	15.39 ± 3.11	37.80 ± 4.92	61.04 ± 6.00	388.27 ± 38.96	53.69 ± 10.34	157.21 ± 37.70	260.71 ± 56.14	14.03 ± 2.70	40.34 ± 6.39	66.94 ± 9.83				

Table 7 – Pointing trajectories – temporal aspects. Durations, times at acceleration peak (tpa), times at velocity peak (tpv), times at deceleration peak (tpd) in seconds and percentages of trajectories corresponding to these different times.

2. Study 3: Synthesis

STUDY 3 demonstrated that cathodal tDCS applied on the cerebellum during PA procedure resulted in altered error reduction and pointing trajectories during exposure, mainly during the first trials. Participants who received this stimulation showed less error reduction of pointing during prism exposure: terminal pointing errors were initially larger and diminished slower through the repetition of pointing in the stimulated group compared to the sham group.

The stimulated group also exhibited increased magnitude but reduced robustness of pointing after-effects; and crucially slightly altered transfer of after-effects to the throwing task. In addition, kinematic analyses indicated that the stimulation significantly altered pointing trajectories during post-tests. These outcomes suggest that the cerebellum contributes to after-effects transfer from pointing to throwing.

3. Study 4: Manuscript

Findings from **STUDY 1** demonstrated that practicing throwing during exposure led to significant throwing after-effects but no transfer to pointing for novice throwers. Besides, expertise in throwing made the transfer to pointing possible. Based on this assumption, we tested whether anodal stimulation of the cerebellum enhanced transfer from throwing to pointing in novice throwers. 26 healthy participants were involved in this study. Methods used in this study are very close from the **STUDY 3** except that participants received anodal or sham stimulation and were exposed to prism on the throwing task, thus testing for transfer on the pointing task.

The manuscript presented below is in preparation for submission.

Does anodal cerebellar tDCS boost transfer of after-effects from throwing to pointing during prism adaptation?

Lisa Fleury (a, b), Francesco Panico (c), Alexandre Foncelle (a), Patrice Revol (a, d), Ludovic Delporte (a, d), Sophie Jacquin-Courtois (a, d), Christian Collet (b, e), Yves Rossetti (a, d)

(f) *INSERM UMR-S U1028, CNRS UMS 5292, ImpAct, Lyon Neuroscience Research Center (CRNL), 69500, Bron, France*

(g) *Claude Bernard University of Lyon 1, 69100, Villeurbanne, France*

(h) *Department of Psychology, University of Campania “Luigi Vanvitelli”, 81100 Caserta, Italy.*

(i) *“Mouvement et Handicap” platform, Neurological Hospital, Hospices Civils de Lyon, 69500, Bron*

(j) *Inter-University Laboratory of Human Movement Biology (EA 7424), 69100, Villeurbanne, France.*

Abstract

Prism Adaptation (PA) is a useful method to study processes at work during sensorimotor adaptation. After-effects following exposure to the prismatic deviation constitute the probe that an adaptation occurred and require the activation of the cerebellum. Whether after-effects are transferable to another task is of great interest both for understanding the nature of sensorimotor transformations and for clinical purposes. However, the mechanisms of transfer and their underlying neural substrates remain poorly understood. Transfer from throwing to pointing is known to occur only for experts in throwing. Therefore, the aim of this study was to test whether anodal stimulation applied to the cerebellum had boosting effects on PA and after-effects transfer from throwing to pointing in novice participants. Healthy participants received anodal or sham transcranial direct current stimulation (tDCS) applied to the right cerebellum during a PA procedure involving a throwing task and were tested for transfer on a pointing task. Results showed that the active stimulation had no beneficial effects on error reduction neither on throwing after-effects. In addition, the overall magnitude of transfer to pointing was not increased. However, we found a marginal effect of the stimulation of pointing kinematic parameters. Altogether, these outcomes do not provide evidence for boosting effects of anodal tDCS on PA including after-effects transfer, when the task practiced during exposure is unmastered. Nevertheless, they offer the opportunity to speculate on the possibility to use anodal tDCS to enhance cerebellar contributions during PA in further investigations.

Key-words: prism adaptation, after-effects, transfer, cerebellum, anodal tDCS, plasticity

Introduction

The central nervous system acts as the conductor of over 600 muscles, to produce an infinity of smooth and precise movements across the lifespan. Sensorimotor adaptation is an error-driven process that enables to modify an existing movement in response to a perturbation (Bastian, 2008; Prablanc et al., 2019). When the perturbation is removed, individuals show a characteristic after-effect, i.e. an error in the direction opposite to the initial errors induced by the perturbation (Roemmich & Bastian, 2018). The presence of after-effects probes the involvement of sensorimotor adaptive processes to face the encountered perturbation (Prablanc et al., 2019; Redding et al., 2005). Beyond basic after-effects, we crucially need to understand what drives the exportation of the perturbation compensation to other locations, to other effectors or to other tasks. An important question relates to the transferability of after-effects i.e. whether they are specific to the situation in which the perturbation has been experienced or whether they are also present in another context, for example when practicing another task (Fleury et al., 2020; Poggio & Bizzi, 2004). Moreover, this represents a crucial interest in the field of neurorehabilitation. Indeed, adaptation processes could be highly relevant for patients who suffer sensorimotor disorders provided that sensorimotor transformations set-up during rehabilitation sessions could also apply beyond the context in which they emerged, i.e. in other daily life situations (Roemmich & Bastian, 2018).

Several paradigms enable to study motor adaptation in laboratory context. Among them, prism adaptation (PA; Redding et al., 2005; Welch, 1974) represents a relevant paradigm to study the transfer of after-effects (e.g. Alexander et al., 2013; Fleury et al., 2020). In a classical PA protocol, individuals wear prismatic goggles that induce a lateral visual shift. When performing reaching movements (e.g. pointing), they initially experience errors in the direction of the prismatic shift. Among a couple of repetitions, subjects rapidly regain their baseline accuracy. However, when prisms are removed, they generally show consistent after-effects, i.e. errors in the direction opposite to the prismatic shift (Petitet et al., 2017; Prablanc et al., 2019; Redding et al., 2005). PA procedures easily enable to measure after-effects transfer by testing several contexts once the prismatic shift has been removed. For example, participants can practice pointing during exposure to the prisms, and the presence of after-effects can be tested (once the perturbation is removed) both on the same task (i.e. pointing) but also on a different task (e.g. throwing) to assess the transfer of after-effects (Fleury et al., 2020). Measuring after-effects transfer could provide crucial information regarding the nature and locus of adaptive processes that allowed individuals to face the perturbation during exposure by providing clues about the internal representations that have been adjusted (Poggio & Bizzi, 2004; Redding & Wallace, 2006).

The literature reports two main processes at work during PA (Petitet et al., 2017; Redding et al., 2005; Redding & Wallace, 2001; Welch, 1974). A rapid process named strategic control would be responsible for quick error reduction during the very first trials of exposure by adjusting motor plans based on the previous errors. A slower process, realignment, would account for the complete correction of errors in the following trials and would allow the development of after-effects. While recalibration is thought to rely on cognitive-compensatory modifications, realignment is described as an automatic sensorimotor process that enables modifications of the coordination between proprioceptive and visual reference frames which has been disrupted by the prismatic shift. Assessment of after-effects classically provides a measure of realignment. For that purpose, after-effects need to be assessed in a context that differs from the exposure context, i.e. upon removal of prisms and toward unpracticed targets for example, in order to capture the part of after-effects that is not dependent to the specific context of exposure, i.e. pure of cognitive contributions (Prablanc et al., 2019). To that purpose, inter-task transfer of after-effects provides a measure of after-effects in conditions that are radically different from exposure.

A recent study investigated inter-task transfer of after-effects as a mean to unravel the contributions of different processes when facing a prismatic shift (Fleury et al., 2020). The type of task practiced during exposure affected after-effects transfer to another task: participants who practiced pointing during exposure showed substantial transfer to the throwing task while those who performed throwing under the prismatic shift did not demonstrate any transfer on the pointing task. However, experts in throwing (dart players) did show transfer from throwing to pointing. An important fact is that the classical measures of error-reduction and after-effects on the task practiced during exposure did not provide the mean to highlight the contribution of different processes during prism exposure: the magnitude of after-effects was very similar in both groups, i.e. independent from the task performed during exposure. Only the measure of inter-task transfer enabled to untangle the possible different nature of processes involved to face a similar perturbation (Fleury et al., 2020). Nevertheless, the mechanisms underlying the transfer of after-effects are still not perfectly understood, notably brain regions that contribute to it.

Lesion studies and neuro-imaging studies provided substantial knowledge about the brain regions involved during PA procedure, within the theoretical framework distinguishing recalibration and realignment (see Panico et al., 2020 for a review). Lesions studies showed that cortical lesions altered error reduction during prism exposure but spared after-effects (Newport & Jackson, 2006; Pisella et al., 2004). Besides, patients with cerebellar damage mostly presented altered after-effects and accessorially impaired error reduction (Baizer et al., 1999; Hanajima et al., 2015; Pisella et al., 2005; Weiner et al., 1983). Neuro-imaging studies

completed these results by reporting an involvement of several parietal areas in the processes of error detection and early error correction (Chapman et al., 2010; Clower et al., 1996; Danckert et al., 2008; Luauté et al., 2009). In addition, these studies also reported a crucial role of the cerebellum from early (Küper et al., 2014) to late exposure including the development of after-effects (Chapman et al., 2010; Luauté et al., 2009).

Recently, numerous non-invasive brain stimulation studies provided additional contribution in comprehending the neural substrates of PA (for a review, see Panico et al., 2020). Neuro-stimulation techniques (e.g. transcranial direct current stimulation; tDCS; Nitsche et al., 2003) are particularly interesting because they are compatible with PA procedures constraints (Panico et al., 2020). tDCS studies in PA literature notably targeted the cerebellum (O'Shea 2017; Panico et al., 2020). Interestingly, cerebellar cathodal stimulation during prism exposure caused increased terminal pointing errors during early, middle and late exposure as well as increased after-effects following exposure (Panico et al., 2016). In addition, a latter study investigated the consequences of cerebellar cathodal stimulation during a multiple steps PA protocol (Panico et al., 2018). This procedure allows to prevent strategic corrections of pointing movements by means of stepwise increases of the prismatic shift during exposure, so the participants do not perceive consciously the deviation (Michel et al., 2007). The stimulation affected pointing performance (larger errors) during initial and late exposure for each incremental step. Moreover, the stimulation was responsible for reduced after-effects following exposure. Altogether, these findings probe a causal role of the cerebellum in realignment (i.e. late exposure and after-effects development) but also in feedforward and online control of reaching movements under prism exposure as the stimulation affected performances in the initial component of exposure (Panico et al., 2020). However, to date, no data are available concerning neural substrates of PA induced after-effects transfer.

According to patient studies, neuro-imaging and neuro-stimulation studies, the cerebellum plays a crucial role in the multiple adaptive processes during PA, from early error reduction and particularly in the development of after-effects. It is likely that the processes involved during exposure might determine the nature of after-effects. For example, the involvement of realignment during exposure conditions the magnitude of after-effects. Therefore, a possible hypothesis is that processes at work during exposure also determine whether after-effects could be transferred to another task or not. Given that the cerebellum is implied in the process that leads to the development of after-effects, we can hypothesize that it is also involved in the transfer of after-effects.

In a previous study, we showed that cathodal cerebellar tDCS altered pointing error reduction during PA. Participants who received the active stimulation also demonstrated altered pointing

after-effects and partially reduced transfer of after-effects to a throwing task. If cerebellar cathodal tDCS led to a decrease of the substantial magnitude of transfer from pointing to throwing, a related interesting question is the following: does anodal cerebellar tDCS is able to boost the mechanisms of transfer? Using other sensorimotor adaptation paradigms, former studies investigated the enhancement of adaptation induced by anodal tDCS. For example, Galea et al. (2011) reported faster adaptation to visuomotor rotation, i.e. more rapid reduction of initial errors in participants who received anodal cerebellar tDCS. This was confirmed by a more recent study by Leow et al. (2017) who also reported increased after-effects in open loop reaching trials following explicit removal of the visuomotor rotation. Therefore, although no similar data are available in the PA literature, one may speculate that anodal tDCS applied to the cerebellum might boost adaptive capacities by favouring adaptive processes during exposure and influencing the nature of the consecutive after-effects. Yet, the possible implication of the cerebellum in mechanisms of inter-task transfer of PA remains unclear.

The aim of the present study was to investigate whether cerebellar anodal tDCS applied during prism adaptation may increase the inter-task transfer of after-effects. Inter-task transfer from throwing to pointing has been reported as inexistent for novices and substantial for experts (Fleury et al., 2020). Based on the boosting effect of anodal tDCS on adaptive processes, we tested whether anodal cerebellar tDCS allowed to produce some transfer from throwing to pointing in non-experts participants. One may predict that boosting cerebellar mechanisms during prism exposure will lead to increased transfer of after-effects to the pointing task, i.e. boosted cerebellum will become super-adapter.

Methods

26 healthy volunteer individuals took part in the study that followed a pre-post design. All procedures were approved by an ethics evaluation committee of Inserm (“CPP SUD-EST IV”, ID-RCB: 2010-A01180-39) and were consistent with relevant guidelines and regulations. We collected each participant’s written informed consent before starting the experiment and they were free to quit the experimental procedure at any time without reason.

Participants

All participants were right-handed and free of any neurological condition or any orthopaedic disorder. They were naïve of the PA paradigm and had normal or corrected to normal vision. We split participants into two groups, depending on the tDCS parameters used during the procedure. Participants in the experimental “A-tDCS” group (n=15, 7 males and 8 females, mean age = 23.2 ± 4.8) received an anodal cerebellar stimulation during PA procedures while participants in the control “SHAM” group (n=11, 4 males and 7 females, mean age = 26.9 ± 4.3) received a placebo anodal cerebellar stimulation. All participants followed the same experimental procedure except for tDCS parameters.

Experimental paradigm

The procedure was divided into four parts (familiarization, pre-tests, exposure, post-tests) that are illustrated in **Figure 1**.

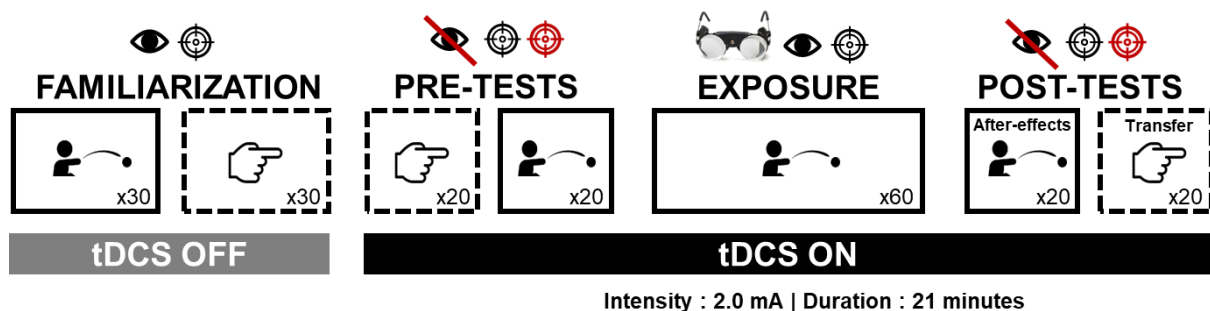

Figure 1 – Experimental procedures. The figure depicts the different steps of the study and the conditions of each step, i.e. the task performed (throwing or pointing), the availability of visual feedback (bared eye or normal eye), the number of trials (i.e. 20, 30 or 60), the presence of prism goggles, the number of targets (one black target, or two targets – black and red), and tDCS conditions (Off or On). Solid boxes refer to the practice of the exposed task (i.e. throwing) while dotted boxes refer to the practice of the unexposed task (i.e. pointing).

Depending on the stage of the procedure, the participants performed either pointing or throwing. These movements were achieved either with vision of the movement or without, (closed-loop versus open-loop conditions) and were directed to one central target or to two targets alternatively (central and right), depending on the stage (see **Figure 1**).

At the beginning of the procedure, participants sat in an adjustable and movable hospital chair, and remained seated throughout the entire experiment without being able to move the chair themselves. Investigators were in charge to displace participants between the pointing and the throwing task set-ups according to the specific order of the tasks. Participants wore eye patches during each transitional phase to prevent de-adaptation arising from environmental vision after exposure. Participants were also instructed to remain immobile between each task. To limit the number of transitional phases, all participants performed the task in a determined order (see **Figure 1**)

Pointing task set-up

Participants sat in front of a pointing table, with their head on a chinrest. This was used to prevent participants to see their hand starting position, thus precluding any static recalibration of the prism-induced shift and slowing down the error reduction. The starting position of the finger was located below the chinrest, lined up with the body midline. Two targets were placed on the pointing table in front of the participants, at 57.5 cm from their eyes. The central target (exposed target) was situated straight-ahead of the participant's body midline (0 degrees) and the right target (non-exposed target) at 10 degrees to the right.

During open loop pointing (pre, early, post-tests), no vision was allowed throughout the entire movement. Participants wore electronic liquid-crystal glasses connected to a switch placed on the starting position. The participants were able to see the targets while their index lied on the starting position. Upon movement initiation, the glasses turned opaque and the subjects were deprived of visual feedback. When they went back to the starting position, the glasses turned transparent again.

During closed-loop condition (familiarization and post-tests), the participants had to reach the central target. They did not wear the liquid-crystal glasses and had visual feedback about their pointing movements (except the starting position) and their outcomes (endpoint errors). The investigator gave the starting signal for each trial. A colour code indicated which target to reach in open-loop conditions and a vocal « go! » was provided during closed-loop conditions (using only one target).

Throwing task set up

Participants sat in front of a vertical board, at 2 meters from their body axis and wore a ball-dispenser helmet. As for the pointing set-up, two targets were presented on the board. The central target (exposed target) was situated forward the participant's body midline (0 degrees) and the right target (non-exposed target) at 10 degrees to the right. All the setting was surrounded by light spots connected to a switch placed on the helmet.

During open-loop throwing, participants had to pick a ball and to press down the light-switch mounted on the helmet, to be able to see the target. Once they initiated movement and released the switch, lights were immediately turned off so they had no visual feedback about their movement and its outcome.

During closed-loop throwing (familiarization and exposure), lights were turned on and participants saw their movement all time, except the starting position. As for pointing, in both conditions, participants were asked to throw as fast and accurate as possible. The starting signal was given by the investigator for each trial: the target colour to reach in open-loop conditions and « go » during closed-loop conditions.

General procedures

Specific pointing and throwing conditions for each stage of the experimental protocol are detailed in the following section and illustrated in **Figure 1**.

Familiarization: to familiarize with both tasks and with experimental settings, participants in each group performed 30 trials of the pointing task, then 30 trials of the throwing task. All trials were performed in a closed-loop condition toward the central target.

Pre-tests: baseline performances were assessed for each task during pre-tests. Participants of both groups performed 20 trials of the throwing and the pointing tasks. Trials were performed in open-loop condition and toward both targets in a pseudo-randomized order (which was the same for all participants).

Exposure: participants performed 60 pointing trials while wearing prismatic goggles that shifted laterally the visual field 10 degrees toward the right (OptiquePeter.com, Lyon). Trials were performed in a closed-loop condition toward the central target, as fast and accurate as possible. Before positioning the goggles, participants were asked to keep their eyes closed. They were also instructed not to look at their own body nor to move before starting the experimental tasks while they were wearing the prismatic goggles.

Post-tests: once the prisms were removed, after-effects were assessed on the pointing task: participants performed 20 pointing trials in an open-loop condition toward both targets. Then, transfer was measured on the throwing task. To this purpose, participants performed 20 throwing trials in an open-loop condition toward both targets.

Order of the tasks

The design of the study required testing participants in two distinct tasks during pre-tests and post-tests. The experimental set-up for the two tasks necessitated the participants to be moved from the throwing set-up to the pointing set-up. Yet, it was crucial that participants had no

access to vision during these transitional phases and did not actively move, to prevent any de-adaptation during post-tests. To that purpose, participants sat in an adjustable and movable chair throughout the whole experiment and wore eyes patches during each transitional phase. They were not allowed to move the chair and investigators were in charge to move participants between the throwing and the pointing task set-ups according to the experimental procedure. Nevertheless, to limit the number of transitional phases, we specified the order of the tasks throughout the experimental procedure in a fixed manner that was identical for all the participants: throwing – pointing (familiarization); pointing – throwing (pre-tests); throwing (exposure); throwing – pointing (post-tests).

tDCS protocol

tDCS settings were based on the protocol used in a previous study by Panico et al. (2016). The stimulation was turned on before pre-tests and turned off right after post-tests. A battery-driven stimulator (NeuroConn, neuroCare Group, Germany) delivered a constant current of 2.0mA intensity through a pair of surface saline-soaked sponge electrodes (area = 25cm²).

Safety guidelines recommended a maximum stimulation time of 21 minutes (Nitsche & Paulus, 2000; Woods et al., 2016). Therefore, participants were timed to complete the procedures until the end of post-tests before 21 minutes after the stimulation was turned on. Participants who did not manage to complete the procedure before the maximum stimulation time were excluded from the analysis.

The anodal electrode was placed over the right cerebellum (1 cm below and 4 cm right to theinion) and the cathodal electrode was placed over the right deltoid muscle, to ensure selective stimulation over the right cerebellum.

Stimulation was delivered over the right cerebellum, given that participants used their right arm to perform the tasks (Schlerf et al., 2015). Sham stimulation was performed in the same way as active stimulation, but the stimulator was turned off after 30 s. This procedure ensured that participants felt the same itching sensation at the beginning of tDCS as participants assigned to the experimental group, and were thus blinded for the stimulation condition they had been assigned to (Gandiga et al., 2006). For both sham and active conditions, stimulation was gradually increased to 2mA with a fade-in of 30 seconds.

Data collection

An opto-electronic motion capture system (9 cameras, Vicon Motion Systems Ltd, Oxford; *Mouvement et Handicap* platform, *Hospices Civils* of Lyon) was used to record the ball impact on the vertical board for each throwing trial. Reflective markers were placed on the throwing board to localize the targets and the projectiles were reflective themselves. The motion capture

system was also used to track movement trajectories during pointing trials. Reflective markers were positioned on the index, the wrist and the elbow of the subject

Data processing

Throwing and pointing terminal errors

Markers' trajectories were recorded for each trial and filtered with a Butterworth low-band pass filter at a cut-off frequency of 6Hz. For the throwing trials, the time-point corresponding to the contact between the projectile and the board was automatically detected. This time-point was used to compute the lateral errors between the impact of the projectile and the aimed target using MatLab customized routines. Thus, we computed performances on each trial, i.e. the angular deviation between the ball impact and the aimed target.

For pointing trials, the endpoint of each pointing movement was computed automatically (using in-house custom software written in Matlab). Movements were detected using the following threshold: onset was defined as the point at which hand velocity exceeded 80mm/s while offset was defined as the time-point at which velocity dropped below this threshold (O'Shea et al., 2014). After automatic detection, all trials were cross-checked visually and adjusted manually if necessary. Index endpoints were then used to obtain the lateral endpoints errors from the aimed target.

Pointing kinematics analysis

We used in-house software written in MatLab to compute kinematics of pointing movements. Two phases constitute a pointing movement: an acceleration phase (initial ballistic component) and a deceleration phase, referring to the target approach phase (Elliott et al., 2010). The initial part of the trajectory reflects feedforward movement planning while the second part of the trajectory involves online feedback corrections (O'Shea et al., 2014). We analysed trajectories of pointing movements by specifically investigating the orientations (i.e. angles between the velocity vector and the line formed by the starting position and the central target) of velocity vectors at acceleration, velocity and deceleration peaks. Only pointing movement kinematics were investigated.

We analysed two main dependent variables. First, we computed terminal errors between index endpoint (pointing task) or ball impact (throwing task) and the aimed target for each trial. Moreover, pointing trajectories orientations were computed as the magnitude of velocity vectors at acceleration peak (initial orientation), velocity peak (intermediate orientation) and deceleration peak (terminal orientation).

It is worth mentioning that all values for post-tests are baseline subtracted, i.e. for each group, we subtracted pre-tests values for each individual and for each task, as recommended in PA literature (Prablanc et al., 2019). In fact, quantifying after-effects requires to take into account the physiological baseline deviation within the same group of testing.

We calculated linear mixed models (Singer & Willett, 2003) separately for each stage of the experiment and for each dependent variable, i.e. terminal errors and pointing trajectories orientations at initial, intermediate, and terminal directions. Each trial during the different phases of the procedure represented a time point. These time points were the level-one unit nested in the different individuals (level-two units). Random intercept models tested the longitudinal effect of trials' repetition (factor TIME) and the effect of the stimulation condition (factor GROUP; A-TDCS versus SHAM). The interaction GROUP*TIME assessed whether the slopes of the curves differed between groups. All analyses were conducted using R package labelled lme4 (Bates et al., 2015). A p-value of 0.05 was used to indicate statistical significance.

These statistical analyses were chosen to analyse not only mean individuals' values (e.g. mean of 20 post-tests trials) but also their longitudinal evolution. Moreover, linear mixed models are a flexible method appropriate to deal with intra-individuals' variability within each group (Wright & London, 2009). This approach allows to assess inter-subject differences considering the intra-individual changes over time (through trial-by-trial repetition).

Additionally, to refine the longitudinal analysis of the variables, we also divided specific phases of the experiment into multiples series of trials, notably during exposure. PA literature describes several adaptive processes characterized by different timing (fast vs slow processes; Inoue et al., 2015; Petitet et al., 2017; Rossetti et al., 1993; Smith et al., 2006). For this reason, we decided to analyse early exposure (trials 1 to 10) separately from the remaining trials during exposure (trials 11 to 60). We also analysed separately each block of 10 trials under exposure to obtain a complete description of throwing behaviour under the prismatic perturbation, and to investigate the effect of tDCS on this behaviour at different times of exposure.

Finally, to test the differences between mean group terminal errors and mean group trajectories orientation during familiarization, we also performed independent samples T-test. As no stimulation and no prismatic deviation were present during familiarization, we considered no reason to test for any longitudinal variation across trials.

Results

Two participants in the A-tDCS group did not complete the procedure before the time limit (21 minutes) and were not included in the analysis. No participant spontaneously reported any conscious awareness of the prismatic shift during exposure neither knowledge concerning the tDCS condition. **Table 1** reports the descriptive statistics, i.e. mean group terminal errors for each phase of the procedure. Figure 2 plots the trial-by-trial mean group terminal errors for the whole experiment.

Table 1 – Descriptive statistics of mean group terminal errors

		A-tDCS group		Sham group	
Pre-tDCS Familiarization	Throwing	-0.44	± 1.52	-0.13	± 0.77
	Pointing	0.11	± 0.98	-0.19	± 0.34
Pre-tests	Pointing	-1.35	± 1.38	-0.73	± 1.25
	Throwing	0.68	± 1.84	0.56	± 1.40
Exposure Throwing	<i>Trial 1</i>	10.00	± 5.42	8.93	± 5.45
	<i>Trial 2</i>	7.98	± 0.32	7.51	± 4.69
	<i>Trial 3</i>	5.50	± 3.55	4.49	± 4.68
	<i>Trial 4</i>	4.22	± 3.38	3.78	± 3.30
	<i>Trial 5</i>	3.35	± 3.58	1.97	± 2.95
	<i>Trial 6</i>	2.81	± 2.86	0.78	± 4.06
	<i>Trial 7</i>	4.01	± 3.42	1.41	± 3.55
	<i>Trial 8</i>	4.53	± 4.22	2.01	± 3.64
	<i>Trial 9</i>	2.83	± 2.48	3.35	± 4.14
	<i>Trial 10</i>	4.11	± 4.10	2.26	± 3.87
	<i>Trials 6-10</i>	3.66	± 2.79	1.96	± 1.48
	<i>Trials 11-20</i>	1.85	± 1.32	1.66	± 0.86
	<i>Trials 21-30</i>	1.77	± 1.29	0.68	± 0.89
	<i>Trials 31-40</i>	1.03	± 1.17	1.10	± 0.83
	<i>Trials 41-50</i>	0.98	± 1.23	0.22	± 0.89
	<i>Trials 51-60</i>	0.83	± 0.89	0.19	± 1.16
Post-tests	Throwing	-5.18	± 2.07	-4.71	± 1.72
	Pointing	-0.01	± 1.59	0.09	± 0.92

Values are reported in degrees with standard deviations.

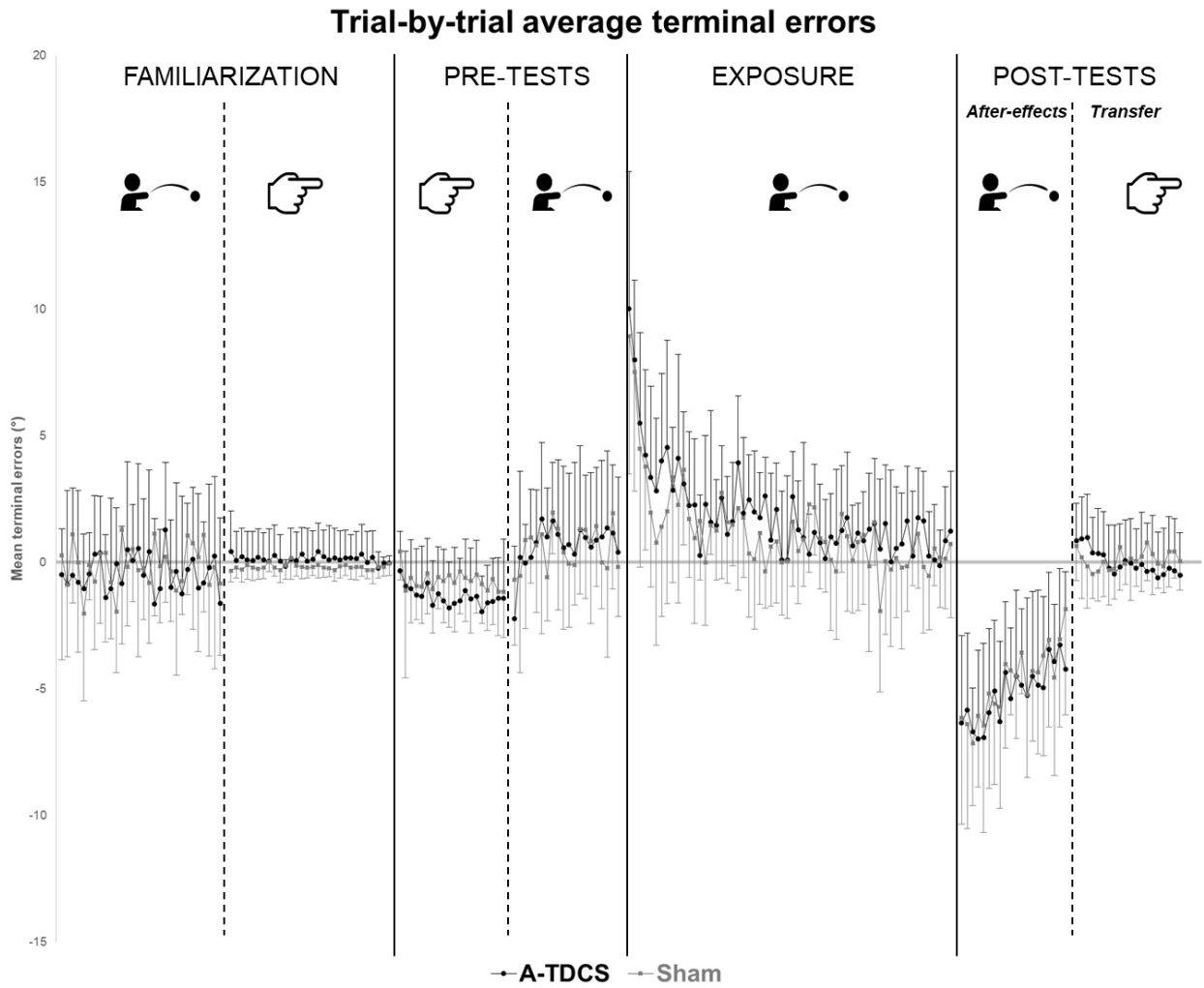

Figure 2 - Trial-by-trial average terminal errors. Trial-by-trial average group terminal errors are represented with standard deviations for each group (A-tDCS group in black, Sham group in grey) and for each step of the procedures.

Familiarization

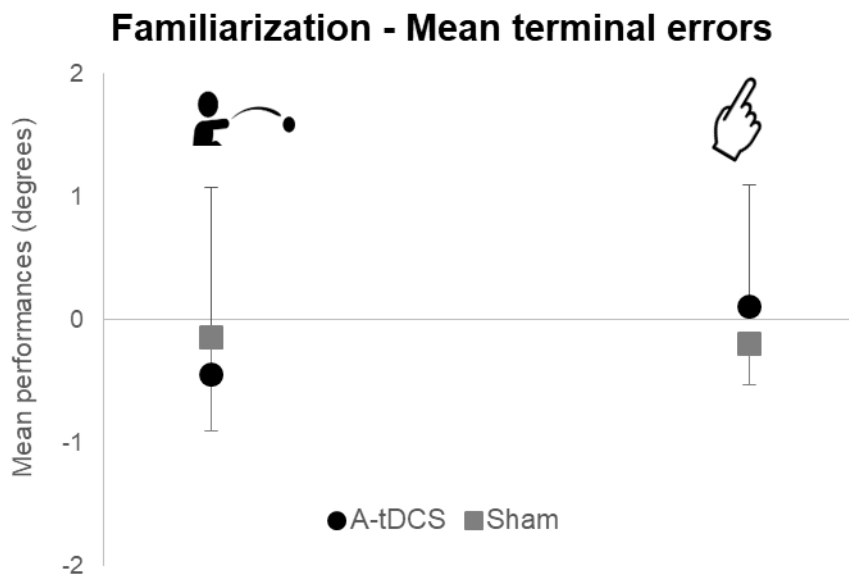

Figure 3 – Mean group terminal errors during familiarization. Mean group terminal errors are represented with standard deviations for each group (A-tDCS group in black, Sham group in grey) and for each task (pointing on the right, throwing on the left).

Independent samples t-tests revealed no difference between groups concerning mean terminal errors during familiarization both in the throwing task ($t(22)=0.61$; $p=0.55$) and the pointing task ($t(22)=-0.97$; $p=0.34$). Moreover, we observed no difference between groups in mean pointing trajectories orientations during familiarization. Therefore, both groups were comparable during Familiarization.

Pre-tests

Terminal errors

Models analysis showed no effect of TIME, GROUP nor GROUP*TIME interaction on the terminal errors during pre-tests both on the pointing and the throwing task (see Table 2; Supplementary Materials) indicating that baseline performances were comparable between groups.

Pointing trajectories orientations

We found no significant effect of GROUP nor GROUP*TIME interaction concerning pointing trajectories orientation at initial, intermediate, and terminal directions, showing no effect of the stimulation on these variables during pre-tests (Tables 3-6; Supplementary Materials). A significant effect of TIME was reported only for intermediate direction and for the central target ($\beta = -0.42$, $SE = 0.10$, $t(202) = -4.45$, $p < .01$) indicating that trajectory orientations values tend to decrease through repetition of trials. However, this effect was comparable in the two groups.

Exposure

Terminal errors

Over the whole exposure (60 trials), all participants significantly reduce their throwing errors as we observed the expected negative effect of TIME ($\beta = -0.06$, SE = 0.01, $t(1407) = -10.12$, $p < .01$). This effect was comparable in the two groups as we observed no effect of TIME*GROUP interaction. Noteworthy, although the effect of GROUP did not reach statistical significance, the analysis revealed a strong tendency ($\beta = 0.89$, SE = 0.47, $t(46) = 1.88$, $p = 0.06$).

During the early phase of exposure, as far as the 10 first trials of exposure are concerned, models showed a significant effect of TIME ($\beta = -0.67$, SE = 0.12, $t(213) = -5.63$, $p < .01$) that was similar between groups (no GROUP effect and no TIME*GROUP interaction effect). We found comparable results when considering trials 11 to 60 (TIME: $\beta = -0.04$, SE = 0.01, $t(1169) = -5.14$, $p < .01$) although the slope was reduced. No significant effect of TIME, GROUP neither their interaction was revealed when considering the 10 last trials of exposure (51 to 60).

Post-tests

Throwing task: after-effects

Concerning terminal errors on the throwing task, models showed a significant effect of TIME ($\beta = 0.20$, SE = 0.03, $t(443) = 6.08$, $p < .01$) without any GROUP nor GROUP*TIME interaction effect. The stimulation condition did not modify the magnitude of throwing after-effects and did not alter the longitudinal evolution of terminal errors: time impacted performance similarly in the two groups, i.e. after-effects diminished with repetition of trials without any group distinction.

Pointing task: transfer

Terminal errors

We found no effect of TIME neither GROUP on pointing terminal error during post-tests. In both group, average terminal errors are almost inexistent, i.e. very close to zero (mean = 0.43 ± 2.07 degrees for A-TDCS group; mean = 0.13 ± 0.94 for SHAM group). However, models showed a significant effect of GROUP*TIME interaction ($\beta = -0.08$, SE = 0.01, $t(456) = -5.78$, $p < .01$) indicating that the longitudinal evolution of terminal errors was not similar across groups: the negative slope was more pronounced in the A-tDCS group.

Pointing trajectories orientations

The analysis revealed several significant effects of TIME, GROUP and their interaction on trajectory orientations at initial, intermediate and terminal directions of pointing movements (Tables 4-6; Supplementary materials).

Initial direction: we found a slight but significant effect of TIME ($\beta = -0.33$, SE = 0.14, $t(204) = -2.31$, $p = 0.02$) that did not differ between groups (no effect of GROUP neither GROUP*TIME).

Intermediate direction: models showed a significant effect of GROUP*TIME interaction ($\beta = -0.27$, SE = 0.11, $t(202) = -2.57$, $p = 0.01$) indicating that the slopes of transfer curves differed between groups.

Terminal direction: we observed a significant effect of GROUP ($\beta = 3.64$, SE = 1.55, $t(47) = 2.36$, $p = 0.02$) and notable tendencies for the effect of TIME ($\beta = 0.28$, SE = 0.14, $t(200) = 1.96$, $p = 0.051$), and GROUP*TIME interaction ($\beta = -0.37$, SE = 0.19, $t(200) = -1.95$, $p = 0.052$) for the central target. All these effects were significant for the right target (see Tables 4-6; Supplementary materials, for statistical values). The **Figure 4** displays the longitudinal evolution (trial-by-trial) of mean group trajectory orientations at initial, intermediate, and terminal directions for both targets.

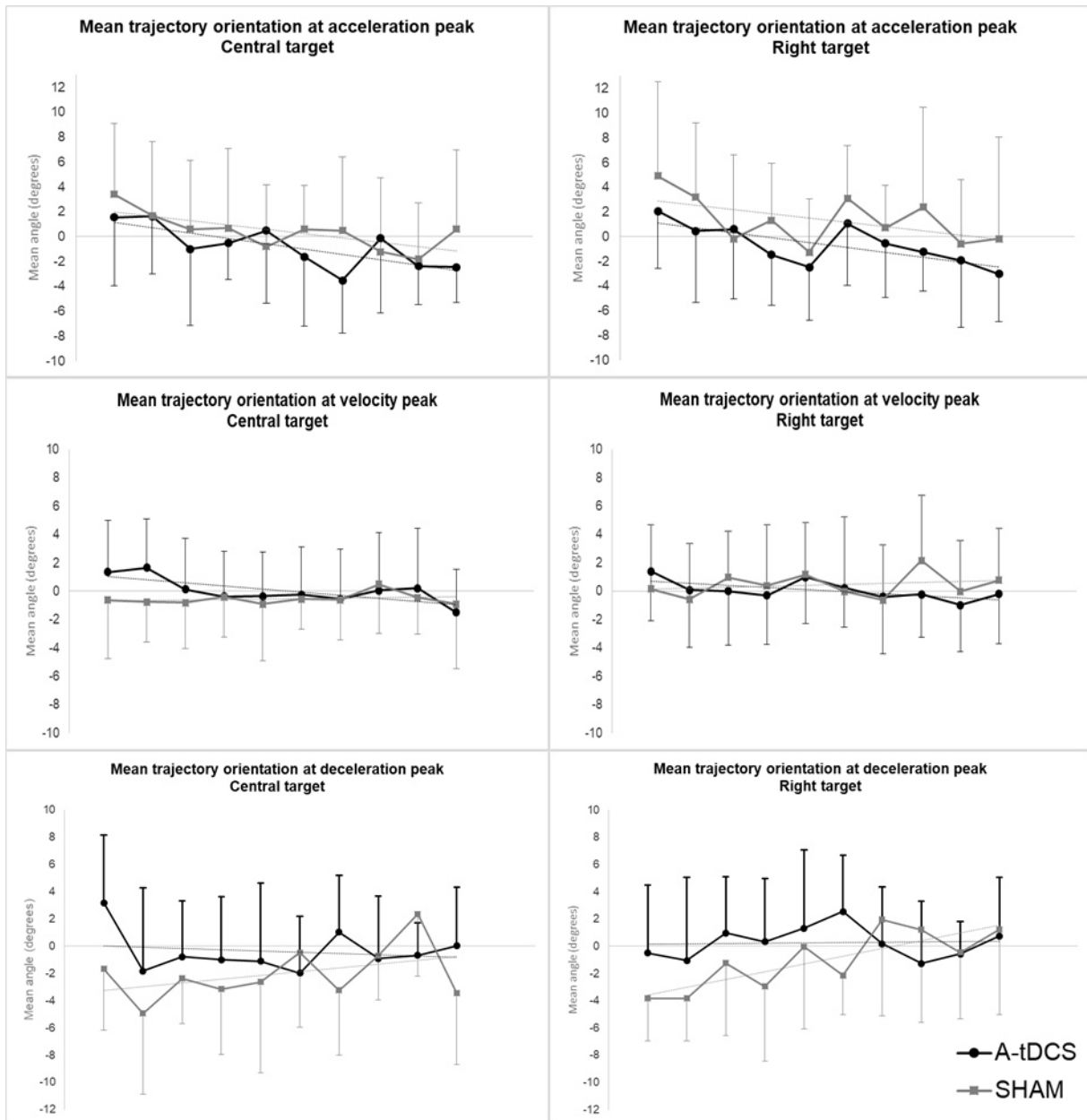

Figure 4: mean group orientation of pointing trajectories at initial, intermediate and terminal direction during post-tests. The figure depicts the evolution across trials of mean group orientations of velocity vectors at initial (acceleration peak), intermediate (velocity peak) and terminal (deceleration peak) direction of pointing movements during post-tests for the central target (left) and the right target (right). A-tDCS group mean values are represented in black; Sham group values are represented in grey. Values are baseline subtracted and plotted with standard deviations.

Discussion

The aim of the study was to test whether anodal tDCS applied to the cerebellum enabled to boost after-effects transfer from throwing to pointing during PA. Our results demonstrated that tDCS did not modify terminal error reduction during exposure nor did it impact the amplitude of throwing after-effects. Crucially, the stimulation did not increase the overall transfer of after-effects to the pointing task. However, we found marginal effects of the stimulation on longitudinal evolution of terminal pointing errors and slight changes in pointing kinematics during post-tests. We will discuss these contrasted findings bearing in mind that, overall and contrary to our initial hypothesis, the present study does not consistently probe any boosting effect of anodal tDCS on after-effects transfer.

Anodal tDCS did not ameliorate error reduction neither increased throwing after-effects

A first crucial finding of the present study is that applying anodal tDCS on the cerebellum did not interfere with the compensation of the prismatic shift during throwing exposure: both groups showed similar throwing error reduction. This was also true when considering only the ten first trials, trials 11 to 60 or the ten last trials of exposure. Participants who received the stimulation did not compensate the errors faster or by a larger amount during exposure. It is still worth mentioning that we observed a strong tendency for a group effect. This indicates that analyses were close to show a significant effect of the tDCS on throwing performances during exposure. Surprisingly, this trend suggested that errors were larger in the A-TDCS group. A second notable outcome is that both groups demonstrated similar throwing after-effects regardless the stimulation condition. The results showed that after-effects tend to decrease across repetitions of trials, showing that throwing after-effects were labile. This is reminiscent with our previous investigations of after-effects in throwing prism exposure (Fleury et al., 2020) and with previous studies using throwing during PA procedure (Fernández-Ruiz et al., 2000; Martin et al., 1996a). However, this decline was comparable in both groups. Therefore, the stimulation did not increase the strength neither the stability of the after-effects following throwing exposure. When considering the classical assessment of error reduction and after-effects, the present findings indicate no evidence for a significant effect of anodal cerebellar neuromodulation on PA using throwing movements.

Patient studies previously demonstrated the crucial role of the cerebellum in PA, both in error reduction and after-effects (e.g. Pisella et al., 2005; Weiner et al., 1983). This was also reported for throwing prism exposure (Martin et al., 1996b). The activation of cerebellar areas during PA have been reported in neuro-imaging studies and its activation has been confirmed by neuro-stimulation studies from early error reduction to the development of after-effects (Panico et al., 2020). Therefore, we should have expected that anodal tDCS applied to the cerebellum

had effects on error reduction and/or after-effects, which was not the case. These findings also contrast with the data reported by previous neuro-stimulation studies reporting beneficial effects of anodal tDCS on visuomotor adaptation (e.g. Galea et al., 2011; Jayaram et al., 2012; Leow et al., 2017). Nevertheless, as the classical measure of after-effects might not be sufficient to unravel the contribution of sensorimotor adaptation (Fleury et al., 2020), it also might be not sufficient to highlight the influence of anodal tDCS during PA.

Anodal tDCS did not increase the overall magnitude of after-effects transfer

Crucially, the stimulation did neither increase the overall magnitude of transfer to the pointing task. This outcome is in contrary with our initial hypothesis because we expected boosting effects of the anodal stimulation on adaptive processes at work during PA and therefore on after-effects transfer. Several lines of arguments can be raised to explain these findings.

Previous findings suggested that the practice of a non-mastered task during exposure to prisms influenced the nature of processes at work to face the perturbation (Fleury et al., 2020). Therefore, the contribution of strategic processes, i.e. recalibration, might be enhanced during throwing prism exposure compared to pointing prism exposure. In turn, the part of cerebellum-dependent realignment processes might have decreased. This aspect should partially explain why the stimulation did not lead to a greater adaptation reflected by boosted after-effects and transfer. Here, participants were not experts in throwing and solicited processes that did not lead to transferable after-effects. As throwing was not mastered, the initial contribution of the cerebellum during PA was perhaps too weak to be effectively increased by the stimulation. To figure out whether the absence of anodal stimulation influence is related to the practice of a non-mastered task, we should test the effect of an anodal stimulation in throwing experts, or on the transfer from pointing to throwing.

This hypothesis is in line with a former study that reported task-dependent effects of anodal tDCS (although applied to the primary motor cortex) across various motor learning tasks (Karak et al., 2017). The task characteristics modulated the neural state of the different brain regions and caused differential effects of the stimulation. Therefore, the state of cerebellar regions through our throwing PA procedure could have precluded a potential effect of the tDCS. We therefore hypothesize that the contribution of cerebellar mechanisms in the present throwing PA procedure was minor because of the task characteristics and the level of mastery. Nevertheless, a second piece of results concerning transfer somewhat contrast the absence of stimulation effect.

Anodal tDCS had marginal effects on pointing behaviour during transfer

Although the overall magnitude of transfer was not modified by tDCS, our results showed that the stimulation may have, however, marginally but significantly altered the evolution of pointing terminal errors during transfer assessment. Besides, we also observed significant alterations in some kinematics parameters of pointing movements during post-tests likely caused by the stimulation.

First, participants who received the anodal stimulation showed a non-stable longitudinal evolution of pointing terminal errors during post-tests. In fact, values tended to decrease across trials in the tDCS group while they remained stable around zero in the Sham group (GROUP*TIME interaction effect). One possible interpretation is that perhaps transfer needs more trials during post-tests to be effective and that if the number of pointing was greater, we should have observed a significant difference between groups caused by the stimulation.

Second, pointing kinematics data revealed that the initial direction of pointing movements significantly and negatively evolved across trial repetition during pointing post-tests. This effect of time was comparable in both groups, regardless the stimulation condition. When considering intermediate direction, results showed that the longitudinal evolution of trajectory orientation across trials at the peak of velocity was significantly different between groups, by showing stable values for the SHAM group and a slightly negative slope for the A-tDCS group. The longitudinal evolution of pointing trajectory orientation at terminal direction also differed between groups: results showed a steeper positive slope for the SHAM group. Notably, we found that mean trajectory orientation at terminal direction was substantially higher in the A-tDCS group, which suggests that the stimulation impacted the terminal part of the trajectory, i.e. the corrective part of the reaching. This is compatible with results from our previous tDCS study and could support the role of the cerebellum in online correction during PA (Panico et al., 2020). However, this terminal difference did not result in a significant difference in pointing accuracy. This might suggest that differences in terminal direction compensated an earlier difference produced by tDCS during initial and/or intermediate trajectory formation, although this hypothetical effect(s) remained below significance.

These marginal effects, together with the strong tendency observed during throwing exposure, might indicate that the stimulation could have produced partial effects on transfer mechanisms. Therefore, the influence of anodal tDCS on the nature of adaptive processes at work during exposure should have been hidden when looking at classical measures (error reduction and throwing after-effects) but uncovered by the analysis of after-effects transfer on the pointing task. However, although these evidence offer the possibility to speculate about a possible effect of the stimulation, they remain too weak to unquestionably attest that anodal tDCS modulated after-effects transfer.

Concluding remarks

The slightly significant effects above mentioned did not result in overall effects on the magnitude of transfer and are tough to interpret. The evolution of pointing terminal errors indicates that the effects of tDCS tended to an increase of transfer magnitude. However, the kinematic analysis showed differential modifications of pointing trajectories and did not convey in identifying a potential enhancement of after-effects transfer. In addition, the tendency we observed during exposure neither was compatible with any possible facilitating effect. Consequently, it is not straight-forward to determine whether anodal tDCS during throwing PA should be able to boost adaptation or should, conversely, alter it. Bortoletto et al. (2015) reported contrasted effects of anodal tDCS when interacting with varying motor tasks. They showed unexpected detrimental effects of the tDCS when combined with a task inducing learning and cortical excitability, thus reporting non-additive mechanisms between two sources of induced-plasticity. This is supported by the fact that no evidence is available concerning the polarity-dependent effects of cerebellar tDCS as reported in a previous meta-analysis (Summers et al., 2016). Therefore, further investigations will be required to test the additive effects of anodal tDCS and PA procedure using throwing or other tasks during exposure.

To conclude, although we observed some marginal effects of the stimulation, the present evidence are not strong enough to attest that anodal cerebellar tDCS modulated after-effects transfer either positively or negatively. Crucially, our results rather tend to invalidate the hypothesis of anodal tDCS boosting effects on transfer using throwing PA procedure. However, this study still represents an additional probe that the assessment of inter-task transfer brings supplemental information regarding the nature of adaptive processes at work to face a prismatic shift, beyond the classical measure of after-effects. In addition, this study emphasizes the interest of analyzing after-effects and transfer of after-effects across trial-by-trial evolution rather than averaging all post-tests trials. Nevertheless, further studies should test the possibility to use anodal stimulation to modulate the magnitude of inter-task transfer with expert throwers or using other mastered tasks during exposure.

References

- Alexander, M. S., Flodin, B. W. G., & Marigold, D. S. (2013). Changes in task parameters during walking prism adaptation influence the subsequent generalization pattern. *Journal of Neurophysiology*, *109*(10), 2495-2504. <https://doi.org/10.1152/jn.00810.2012>
- Baizer, J. S., Kralj-Hans, I., & Glickstein, M. (1999). Cerebellar lesions and prism adaptation in macaque monkeys. *Journal of Neurophysiology*, *81*(4), 1960-1965. <https://doi.org/10.1152/jn.1999.81.4.1960>
- Bates D, Mächler M, Bolker B, Walker S. (2015). Fitting linear mixed-effects models using lme4. *J Stat Softw.*, *67*, 1-48.
- Bastian, A. J. (2008). Understanding sensorimotor adaptation and learning for rehabilitation. *Current Opinion in Neurology*, *21*(6), 628-633. <https://doi.org/10.1097/WCO.0b013e328315a293>
- Bortoletto, M., Pellicciari, M. C., Rodella, C., & Miniussi, C. (2015). The Interaction With Task-induced Activity is More Important Than Polarization: A tDCS Study. *Brain Stimulation*, *8*(2), 269-276. <https://doi.org/10.1016/j.brs.2014.11.006>
- Chapman, H. L., Eramudugolla, R., Gavrilescu, M., Strudwick, M. W., Loftus, A., Cunnington, R., & Mattingley, J. B. (2010). Neural mechanisms underlying spatial realignment during adaptation to optical wedge prisms. *Neuropsychologia*, *48*(9), 2595-2601. <https://doi.org/10.1016/j.neuropsychologia.2010.05.006>
- Clower, D. M., Hoffman, J. M., Votaw, J. R., Faber, T. L., Woods, R. P., & Alexander, G. E. (1996). Role of posterior parietal cortex in the recalibration of visually guided reaching. *Nature*, *383*(6601), 618-621. <https://doi.org/10.1038/383618a0>
- Danckert, J., Ferber, S., & Goodale, M. A. (2008). Direct effects of prismatic lenses on visuomotor control: An event-related functional MRI study. *European Journal of Neuroscience*, *28*(8), 1696-1704. <https://doi.org/10.1111/j.1460-9568.2008.06460.x>
- Elliott, D., Hansen, S., Grierson, L. E. M., Lyons, J., Bennett, S. J., & Hayes, S. J. (2010). Goal-directed aiming: Two components but multiple processes. *Psychological Bulletin*, *136*(6), 1023-1044. <https://doi.org/10.1037/a0020958>
- Fernández-Ruiz, J., Hall-Haro, C., Díaz, R., Mischner, J., Vergara, P., & Lopez-Garcia, J. C. (2000). Learning motor synergies makes use of information on muscular load. *Learning & Memory (Cold Spring Harbor, N.Y.)*, *7*(4), 193-198. <https://doi.org/10.1101/lm.7.4.193>
- Fleury, L., Pastor, D., Revol, P., Delporte, L., & Rossetti, Y. (2020). Inter-task transfer of prism adaptation depends on exposed task mastery. *Scientific Reports*, *10*(1), 5687. <https://doi.org/10.1038/s41598-020-62519-5>
- Galea, J. M., Vazquez, A., Pasricha, N., Orban de Xivry, J.-J., & Celnik, P. (2011). Dissociating the Roles of the Cerebellum and Motor Cortex during Adaptive Learning: The Motor Cortex Retains What the Cerebellum Learns. *Cerebral Cortex*, *21*(8), 1761-1770. <https://doi.org/10.1093/cercor/bhq246>
- Galea, Joseph M., Vazquez, A., Pasricha, N., de Xivry, J.-J. O., & Celnik, P. (2011). Dissociating the roles of the cerebellum and motor cortex during adaptive learning: The motor cortex retains what the cerebellum learns. *Cerebral Cortex (New York, N.Y.: 1991)*, *21*(8), 1761-1770. <https://doi.org/10.1093/cercor/bhq246>
- Gandiga, P. C., Hummel, F. C., & Cohen, L. G. (2006). Transcranial DC stimulation (tDCS): A tool for double-blind sham-controlled clinical studies in brain stimulation. *Clinical Neurophysiology: Official Journal of the International Federation of Clinical Neurophysiology*, *117*(4), 845-850. <https://doi.org/10.1016/j.clinph.2005.12.003>
- Hanajima, R., Shadmehr, R., Ohminami, S., Tsutsumi, R., Shirota, Y., Shimizu, T., Tanaka, N., Terao, Y., Tsuji, S., Ugawa, Y., Uchimura, M., Inoue, M., & Kitazawa, S. (2015). Modulation of error-sensitivity during a prism adaptation task in people with cerebellar degeneration. *Journal of Neurophysiology*, *114*(4), 2460-2471. <https://doi.org/10.1152/jn.00145.2015>

- Inoue, M., Uchimura, M., Karibe, A., O'Shea, J., Rossetti, Y., & Kitazawa, S. (2015). Three timescales in prism adaptation. *Journal of Neurophysiology*, *113*(1), 328-338. <https://doi.org/10.1152/jn.00803.2013>
- Jayaram, G., Tang, B., Pallegadda, R., Vasudevan, E. V. L., Celnik, P., & Bastian, A. (2012). Modulating locomotor adaptation with cerebellar stimulation. *Journal of Neurophysiology*, *107*(11), 2950-2957. <https://doi.org/10.1152/jn.00645.2011>
- Karok, S., Fletcher, D., & Witney, A. G. (2017). Task-specificity of unilateral anodal and dual-M1 tDCS effects on motor learning. *Neuropsychologia*, *94*, 84-95. <https://doi.org/10.1016/j.neuropsychologia.2016.12.002>
- Küper, M., Wünnemann, M. J. S., Thürling, M., Stefanescu, R. M., Maderwald, S., Elles, H. G., Göricke, S., Ladd, M. E., & Timmann, D. (2014). Activation of the cerebellar cortex and the dentate nucleus in a prism adaptation fMRI study. *Human Brain Mapping*, *35*(4), 1574-1586. <https://doi.org/10.1002/hbm.22274>
- Leow, L.-A., Marinovic, W., Riek, S., & Carroll, T. J. (2017). Cerebellar anodal tDCS increases implicit learning when strategic re-aiming is suppressed in sensorimotor adaptation. *PLoS One*, *12*(7), e0179977. <https://doi.org/10.1371/journal.pone.0179977>
- Luauté, J., Schwartz, S., Rossetti, Y., Spiridon, M., Rode, G., Boisson, D., & Vuilleumier, P. (2009). Dynamic Changes in Brain Activity during Prism Adaptation. *Journal of Neuroscience*, *29*(1), 169-178. <https://doi.org/10.1523/JNEUROSCI.3054-08.2009>
- Martin, T. A., Keating, J. G., Goodkin, H. P., Bastian, A. J., & Thach, W. T. (1996a). Throwing while looking through prisms. II. Specificity and storage of multiple gaze-throw calibrations. *Brain: A Journal of Neurology*, *119* (Pt 4), 1199-1211. <https://doi.org/10.1093/brain/119.4.1199>
- Martin, T. A., Keating, J. G., Goodkin, H. P., Bastian, A. J., & Thach, W. T. (1996b). Throwing while looking through prisms I. Focal olivocerebellar lesions impair adaptation. *Brain*, *119*(4), 1183-1198. <https://doi.org/10.1093/brain/119.4.1183>
- Michel, C., Pisella, L., Prablanc, C., Rode, G., & Rossetti, Y. (2007). Enhancing Visuomotor Adaptation by Reducing Error Signals: Single-step (Aware) versus Multiple-step (Unaware) Exposure to Wedge Prisms. *Journal of Cognitive Neuroscience*, *19*(2), 341-350. <https://doi.org/10.1162/jocn.2007.19.2.341>
- Newport, R., & Jackson, S. R. (2006). Posterior parietal cortex and the dissociable components of prism adaptation. *Neuropsychologia*, *44*(13), 2757-2765. <https://doi.org/10.1016/j.neuropsychologia.2006.01.007>
- Nitsche, M. A., & Paulus, W. (2000). Excitability changes induced in the human motor cortex by weak transcranial direct current stimulation. *The Journal of Physiology*, *527* Pt 3, 633-639. <https://doi.org/10.1111/j.1469-7793.2000.t01-1-00633.x>
- Nitsche, Michael A., Liebetanz, D., Antal, A., Lang, N., Tergau, F., & Paulus, W. (2003). Modulation of cortical excitability by weak direct current stimulation—Technical, safety and functional aspects. *Supplements to Clinical Neurophysiology*, *56*, 255-276. [https://doi.org/10.1016/s1567-424x\(09\)70230-2](https://doi.org/10.1016/s1567-424x(09)70230-2)
- O'Shea, J., Gaveau, V., Kandel, M., Koga, K., Susami, K., Prablanc, C., & Rossetti, Y. (2014). Kinematic markers dissociate error correction from sensorimotor realignment during prism adaptation. *Neuropsychologia*, *55*, 15-24. <https://doi.org/10.1016/j.neuropsychologia.2013.09.021>
- Panico, F., Rossetti, Y., & Trojano, L. (2020). On the mechanisms underlying Prism Adaptation: A review of neuro-imaging and neuro-stimulation studies. *Cortex*, *123*, 57-71. <https://doi.org/10.1016/j.cortex.2019.10.003>
- Panico, F., Sagliano, L., Grossi, D., & Trojano, L. (2016). Cerebellar cathodal tDCS interferes with recalibration and spatial realignment during prism adaptation procedure in healthy subjects. *Brain and Cognition*, *105*, 1-8. <https://doi.org/10.1016/j.bandc.2016.03.002>
- Panico, F., Sagliano, L., Nozzolillo, C., Trojano, L., & Rossetti, Y. (2018). Cerebellar contribution to spatial realignment: A tDCS study during multiple-step prism adaptation. *Neuropsychologia*, *112*, 58-65. <https://doi.org/10.1016/j.neuropsychologia.2018.03.008>

- Petitot, P., O'Reilly, J. X., & O'Shea, J. (2017). Towards a neuro-computational account of prism adaptation. *Neuropsychologia*. <https://doi.org/10.1016/j.neuropsychologia.2017.12.021>
- Pisella, L., Michel, C., Gréa, H., Tilikete, C., Vighetto, A., & Rossetti, Y. (2004). Preserved prism adaptation in bilateral optic ataxia: Strategic versus adaptive reaction to prisms. *Experimental Brain Research*, *156*(4), 399-408. <https://doi.org/10.1007/s00221-003-1746-4>
- Pisella, L., Rossetti, Y., Michel, C., Rode, G., Boisson, D., Pélisson, D., & Tilikete, C. (2005). Ipsidirectional impairment of prism adaptation after unilateral lesion of anterior cerebellum. *Neurology*, *65*(1), 150-152. <https://doi.org/10.1212/01.wnl.0000167945.34177.5e>
- Poggio, T., & Bizzi, E. (2004, octobre 13). *Generalization in vision and motor control* [Special Features]. *Nature*. <https://doi.org/10.1038/nature03014>
- Prablanc, C., Panico, F., Fleury, L., Pisella, L., Nijboer, T., Kitazawa, S., & Rossetti, Y. (2019). Adapting terminology: Clarifying prism adaptation vocabulary, concepts, and methods. *Neuroscience Research*. <https://doi.org/10.1016/j.neures.2019.03.003>
- Redding, G. M., Rossetti, Y., & Wallace, B. (2005). Applications of prism adaptation: A tutorial in theory and method. *Neuroscience & Biobehavioral Reviews*, *29*(3), 431-444. <https://doi.org/10.1016/j.neubiorev.2004.12.004>
- Redding, G. M., & Wallace, B. (2001). Calibration and Alignment are Separable: Evidence From Prism Adaptation. *Journal of Motor Behavior*, *33*(4), 401-412. <https://doi.org/10.1080/00222890109601923>
- Redding, G. M., & Wallace, B. (2006). Generalization of prism adaptation. *Journal of Experimental Psychology: Human Perception and Performance*, *32*(4), 1006-1022. <https://doi.org/10.1037/0096-1523.32.4.1006>
- Roemmich, R. T., & Bastian, A. J. (2018). Closing the Loop: From Motor Neuroscience to Neurorehabilitation. *Annual Review of Neuroscience*, *41*, 415-429. <https://doi.org/10.1146/annurev-neuro-080317-062245>
- Rossetti, Y., Koga, K., & Mano, T. (1993). Prismatic displacement of vision induces transient changes in the timing of eye-hand coordination. *Perception & Psychophysics*, *54*(3), 355-364. <https://doi.org/10.3758/BF03205270>
- Schlerf, J. E., Galea, J. M., Spampinato, D., & Celnik, P. A. (2015). Laterality Differences in Cerebellar-Motor Cortex Connectivity. *Cerebral Cortex (New York, N.Y.: 1991)*, *25*(7), 1827-1834. <https://doi.org/10.1093/cercor/bht422>
- Singer, J.D., Willett, J.B. (2003). *Applied longitudinal data analysis: modeling change and event occurrence*. Oxford: Oxford University Press. <https://doi.org/10.1093/acprof:oso/9780195152968.001.0001>.
- Smith, M. A., Ghazizadeh, A., & Shadmehr, R. (2006). Interacting Adaptive Processes with Different Timescales Underlie Short-Term Motor Learning. *PLOS Biology*, *4*(6), e179. <https://doi.org/10.1371/journal.pbio.0040179>
- Summers, J. J., Kang, N., & Cauraugh, J. H. (2016). Does transcranial direct current stimulation enhance cognitive and motor functions in the ageing brain? A systematic review and meta-analysis. *Ageing Research Reviews*, *25*, 42-54. <https://doi.org/10.1016/j.arr.2015.11.004>
- Weiner, M. J., Hallett, M., & Funkenstein, H. H. (1983). Adaptation to lateral displacement of vision in patients with lesions of the central nervous system. *Neurology*, *33*(6), 766-772.
- Welch, R. B. (1974). Speculations on a Model of Prism Adaptation. *Perception*, *3*(4), 451-460. <https://doi.org/10.1068/p030451>
- Woods, A. J., Antal, A., Bikson, M., Boggio, P. S., Brunoni, A. R., Celnik, P., Cohen, L. G., Fregni, F., Herrmann, C. S., Kappenman, E. S., Knotkova, H., Liebetanz, D., Miniussi, C., Miranda, P. C., Paulus, W., Priori, A., Reato, D., Stagg, C., Wenderoth, N., & Nitsche, M. A. (2016). A technical guide to tDCS, and related non-invasive brain stimulation tools. *Clinical Neurophysiology*, *127*(2), 1031-1048. <https://doi.org/10.1016/j.clinph.2015.11.012>

Wright, D. B., & London, K. (2009). Multilevel modelling : Beyond the basic applications. *The British Journal of Mathematical and Statistical Psychology*, 62(Pt 2), 439-456.
<https://doi.org/10.1348/000711008X327632>

Supplementary Materials

Deviations - Linear Mixed Models Analysis

		Fixed Effects					Random effects / Model parameters			
		Estimate	Std Error	df	t	p	Variance		Std Err	
Fam Pointing	Intercept	-0.19	0.22	25.42	-0.85	0.40	Intercept (Id)	0.52	0.72	
	Time	0.00	0.00	688.00	0.01	0.99	Residual	0.16	0.40	
	Group	0.33	0.30	25.46	1.10	0.28	logLik	-419.30	ICC	
	Group*Time	0.00	0.00	688.00	-0.61	0.55	Nb Obs	712.00	0.76	
Fam Throwing	Intercept	-0.25	0.44	53.35	-0.57	0.57	Intercept (Id)	1.16	1.08	
	Time	0.01	0.02	688.12	0.46	0.65	Residual	7.32	2.71	
	Group	-0.20	0.59	53.29	-0.33	0.74	logLik	-1739.40	ICC	
	Group*Time	-0.01	0.02	688.15	-0.33	0.74	Nb Obs	712.00	0.14	
Pre-tests Throwing	Intercept	0.34	0.55	39.86	0.63	0.53	Intercept (Id)	2.25	1.50	
	Time	0.02	0.03	447.93	0.84	0.40	Residual	5.52	2.35	
	Group	-0.33	0.74	39.98	-0.45	0.66	logLik	-1099.30	ICC	
	Group*Time	0.05	0.04	448.03	1.29	0.20	Nb Obs	472.00	0.29	
Pre-tests Pointing	Intercept	-0.51	0.41	31.10	-1.25	0.22	Intercept (Id)	1.53	1.24	
	Time	-0.02	0.01	454.01	-1.55	0.12	Residual	1.62	1.27	
	Group	-0.49	0.55	31.05	-0.89	0.38	logLik	-829.80	ICC	
	Group*Time	-0.01	0.02	454.01	-0.67	0.50	Nb Obs	478.00	0.48	
Exposure Throwing 1-60	Intercept	3.14	0.35	46.86	8.98	0.00 ***	Intercept (Id)	0.83	0.91	
	Time	-0.06	0.01	1407.00	-10.12	< 2e-16 ***	Residual	7.79	2.79	
	Group	0.89	0.47	46.62	1.88	0.07 .	logLik	-3522.90	ICC	
	Group*Time	-0.01	0.01	1407.00	-0.96	0.34	Nb Obs	1431.00	0.10	
Post-tests Throwing	Intercept	-6.60	0.64	41.36	-10.40	0.00 ***	Intercept (Id)	3.00	1.73	
	Time	0.20	0.03	443.24	6.08	0.00 ***	Residual	7.26	2.70	
	Group	-0.12	0.86	40.86	-0.14	0.89	logLik	-1152.00	ICC	
	Group*Time	-0.04	0.04	443.20	-0.81	0.42	Nb Obs	467.00	0.29	
Post-tests Pointing	Intercept	-0.04	0.40	27.46	-0.11	0.91	Intercept (Id)	1.58	1.26	
	Time	0.02	0.01	456.00	1.41	0.16	Residual	0.84	0.91	
	Group	0.68	0.54	27.46	1.27	0.22	logLik	-681.70	ICC	
	Group*Time	-0.08	0.01	456.00	-5.78	0.00 ***	Nb Obs	480.00	0.65	

Table 2 - Linear Mixed Models Analysis results - Deviations. Effects of TIME, GROUP and GROUP*TIME on terminal errors at the different steps of the experimental procedure.

Pointing trajectories orientations - Descriptive statistics

		Mean orientation at initial direction				Mean orientation at intermediate direction				Mean orientation at final direction			
		ctDCS group		Sham group		ctDCS group		Sham group		ctDCS group		Sham group	
Familiarization	<i>Pointing</i>	-3.41	± 6.59	-5.01	± 5.98	3.86	± 2.17	2.60	± 1.74	3.28	± 7.48	4.47	± 7.00
Pre-tests	<i>Central</i>	-7.17	± 9.31	-9.49	± 8.22	2.11	± 2.35	2.00	± 4.14	4.29	± 5.73	5.91	± 5.92
	<i>Right</i>	-7.99	± 8.75	-11.48	± 6.79	6.61	± 3.40	6.20	± 3.68	14.19	± 4.15	17.19	± 7.72
Post-tests	<i>Central</i>	0.47	± 4.96	2.26	± 6.97	0.11	± 2.62	-0.44	± 2.61	0.48	± 4.19	-1.72	± 4.30
	<i>Right</i>	-0.04	± 3.01	2.21	± 5.83	-0.40	± 3.20	0.27	± 3.25	1.36	± 2.98	-1.32	± 4.73

Table 3 – Pointing trajectories orientations at initial (acceleration peak), intermediate (velocity peak) and final (deceleration peak) directions. Values are reported in degrees with standard deviations.

Pointing trajectories orientations at initial direction - Linear Mixed Models Analysis

		Fixed Effects					Random effects / Model parameters			
		Estimate	Std Error	df	t	p	Variance		Std Err	
Fam Pointing	Intercept	-3.91	1.82	25.56	-2.15	0.042 *	Intercept (Id)	35.09	5.924	
	Time	-0.11	0.02	687.02	-4.72	0.000 ***	Residual	12	3.464	
	Group	1.11	2.48	25.55	0.45	0.658	logLik	-1946	ICC	
	Group*Time	0.06	0.03	687.01	2.11	0.035 *	Nb Obs	711	0.75	
Pre-tests Pointing central target	Intercept	-8.14	2.65	27.16	-3.07	0.005 **	Intercept (Id)	69.91	8.361	
	Time	-0.29	0.15	200.44	-1.92	0.056 .	Residual	18.59	4.311	
	Group	1.71	3.59	27.00	0.48	0.637	logLik	-687.8	ICC	
	Group*Time	0.12	0.20	200.18	0.58	0.566	Nb Obs	224	0.79	
Pre-tests Pointing right target	Intercept	-11.59	2.40	27.75	-4.83	0.000 ***	Intercept (Id)	56.91	7.544	
	Time	0.04	0.14	204.19	0.27	0.791	Residual	15.78	3.973	
	Group	4.75	3.25	27.40	1.46	0.155	logLik	-680.5	ICC	
	Group*Time	-0.29	0.18	204.04	-1.55	0.123	Nb Obs	228	0.78	
Post-tests Pointing central target	Intercept	3.17	1.85	48.16	1.72	0.092 .	Intercept (Id)	21.63	4.651	
	Time	-0.22	0.23	216.00	-0.97	0.333	Residual	46.09	6.789	
	Group	-0.92	2.51	48.16	-0.37	0.716	logLik	-821.1	ICC	
	Group*Time	-0.33	0.31	216.00	-1.07	0.287	Nb Obs	240	0.32	
Post-tests Pointing right target	Intercept	3.58	1.66	30.89	2.15	0.039 *	Intercept (Id)	25.34	5.034	
	Time	-0.19	0.13	216.00	-1.52	0.131	Residual	14.82	3.85	
	Group	-2.46	2.26	30.89	-1.09	0.286	logLik	-698.8	ICC	
	Group*Time	-0.19	0.17	216.00	-1.11	0.269	Nb Obs	240	0.63	

Table 4 - Linear Mixed Models Analysis results – pointing trajectories orientations at initial direction. Effects of TIME, GROUP and GROUP*TIME on pointing trajectories orientations at initial direction and at the different steps of the experimental procedure.

Pointing trajectories orientations at intermediate direction - Linear Mixed Models Analysis

		Fixed Effects					Random effects / Model parameters			
		Estimate	Std Error	df	t	p	Variance		Std Err	
Fam Pointing	Intercept	3.09	0.62	31.43	5.00	0.000 ***	Intercept (Id)	3.48	1.87	
	Time	-0.04	0.02	688.04	-2.59	0.010 **	Residual	5.67	2.38	
	Group	0.35	0.84	31.39	0.42	0.678	logLik	-1663.60	ICC	
	Group*Time	0.07	0.02	688.00	3.30	0.001 **	Nb Obs	712.00	0.38	
Pre-tests Pointing central target	Intercept	3.83	1.25	30.41	3.05	0.005 **	Intercept (Id)	14.51	3.81	
	Time	-0.42	0.10	202.14	-4.45	0.000 ***	Residual	7.34	2.71	
	Group	-1.53	1.70	30.23	-0.90	0.375	logLik	-578.80	ICC	
	Group*Time	0.18	0.13	201.75	1.43	0.156	Nb Obs	225.00	0.66	
Pre-tests Pointing right target	Intercept	6.52	1.42	28.79	4.58	0.000 ***	Intercept (Id)	19.61	4.43	
	Time	-0.06	0.09	204.52	-0.74	0.462	Residual	6.44	2.54	
	Group	-0.85	1.92	28.37	-0.44	0.662	logLik	-576.40	ICC	
	Group*Time	-0.07	0.12	204.35	-0.61	0.541	Nb Obs	228.00	0.75	
Post-tests Pointing central target	Intercept	-0.72	0.86	35.42	-0.85	0.404	Intercept (Id)	6.08	2.47	
	Time	0.06	0.08	203.15	0.72	0.476	Residual	4.94	2.22	
	Group	1.67	1.16	34.54	1.45	0.158	logLik	-531.30	ICC	
	Group*Time	-0.27	0.10	202.73	-2.53	0.012 *	Nb Obs	226.00	0.55	
Post-tests Pointing right target	Intercept	0.22	0.96	31.31	0.23	0.816	Intercept (Id)	8.30	2.88	
	Time	0.08	0.08	204.69	1.09	0.278	Residual	5.06	2.25	
	Group	0.48	1.30	31.13	0.37	0.717	logLik	-541.80	ICC	
	Group*Time	-0.23	0.10	204.42	-2.24	0.026 *	Nb Obs	228.00	0.62	

Table 5 - Linear Mixed Models Analysis results – pointing trajectories orientations at intermediate direction. Effects of TIME, GROUP and GROUP*TIME pointing trajectories orientations at intermediate direction and at the different steps of the experimental procedure.

Pointing trajectories orientations at terminal direction - Linear Mixed Models Analysis

		Fixed Effects					Random effects / Model parameters			
		Estimate	Std Error	df	t	p	Variance		Std Err	
Fam Pointing	Intercept	3.34	2.10	26.63	1.59	0.124	Intercept (Id) 45.34		6.73	
	Time	0.08	0.03	685.04	2.37	0.018 *	Residual 26.12		5.11	
	Group	-0.52	2.86	26.64	-0.18	0.856	logLik -2210.10		ICC	
	Group*Time	-0.04	0.04	685.03	-0.96	0.336	Nb Obs 709.00		0.63	
Pre-tests Pointing central target	Intercept	6.26	1.79	34.92	3.50	0.001 **	Intercept (Id) 26.53		5.15	
	Time	-0.10	0.17	202.65	-0.57	0.568	Residual 22.97		4.79	
	Group	-0.75	2.42	34.65	-0.31	0.758	logLik -701.20		ICC	
	Group*Time	-0.25	0.23	202.14	-1.12	0.265	Nb Obs 225.00		0.54	
Pre-tests Pointing right target	Intercept	16.91	2.00	36.67	8.46	0.000 ***	Intercept (Id) 32.14		5.67	
	Time	0.05	0.19	205.01	0.24	0.808	Residual 29.24		5.41	
	Group	-2.67	2.69	35.67	-0.99	0.329	logLik -737.40		ICC	
	Group*Time	-0.01	0.25	204.64	-0.05	0.961	Nb Obs 228.00		0.52	
Post-tests Pointing central target	Intercept	-3.11	1.12	70.07	-2.78	0.007 **	Intercept (Id) 5.21		2.28	
	Time	0.34	0.16	203.63	2.08	0.039 *	Residual 21.26		4.61	
	Group	3.04	1.49	66.65	2.04	0.046 *	logLik -680.40		ICC	
	Group*Time	-0.44	0.22	202.54	-2.01	0.046 *	Nb Obs 226.00		0.20	
Post-tests Pointing right target	Intercept	-3.44	1.23	38.61	-2.79	0.008 **	Intercept (Id) 11.67		3.42	
	Time	0.49	0.13	205.40	3.80	0.000 ***	Residual 13.94		3.73	
	Group	3.39	1.67	38.28	2.03	0.049 *	logLik -650.00		ICC	
	Group*Time	-0.39	0.17	204.98	-2.28	0.024 *	Nb Obs 228.00		0.46	

Table 6 - Linear Mixed Models Analysis results – pointing trajectories orientations at terminal direction.
*Effects of TIME, GROUP and GROUP*TIME pointing trajectories orientations at terminal direction and at the different steps of the experimental procedure.*

4. Study 4: Synthesis

STUDY 4 showed that anodal tDCS applied to the cerebellum during PA did not ameliorate correction of throwing errors during exposure neither increase the magnitude of throwing after-effects. Crucially, the stimulation did not improve the magnitude of transfer to pointing, which remained almost existent in all the participants, regardless the stimulation condition. However, we found some marginal effects of the stimulation on the longitudinal evolution of pointing errors and on some pointing kinematics aspects. Although they offer to speculate on the possibility to modulate after-effects transfer through anodal tDCS, these effects are tough to interpret because they did not result in an overall increase of transfer. Further investigations are required to determine whether anodal stimulation can enhance after-effects transfer when performing a mastered task during exposure.

Chapter 4

General discussion

OVERVIEW OF THE CHAPTER

The general discussion aims at taking together all results from experimental contributions and discuss them to synthesize novel insights arising from the present series of experiments. Firstly, the general discussion will summarize the scientific questions of the three axes and the corresponding major results. Second, we will discuss the fundamental implications of our findings in the field of sensorimotor adaptation. Then, we will consider unanswered questions and limitations before depicting further and on-going fundamental research projects to address them. A last part will discuss potential clinical implications and perspectives of research concerning the rehabilitation field.

A. SUMMARY OF MAJOR FINDINGS

1. Axis 1: Influence of the exposed task on after-effects transfer (Study 1)

STUDY 1 investigated the transfer of after-effects between two tasks: throwing and pointing. The aim was to test the influence of the task performed during prism exposure (exposed task) on the transfer of after-effects to the non-exposed task (i.e. not experimented through the prismatic shift).

The first experiment (**1A**) showed a strictly unidirectional transfer from pointing to throwing but not from throwing to pointing. The participants who performed pointing during exposure showed significant transfer of after-effects on throwing, reaching approximately 50% of the initial pointing after-effects magnitude. Conversely, participants exposed to the prismatic shift while performing throwing did not exhibit transfer of after-effects to the pointing task. Notably, error reduction during exposure and after-effects on the exposed task were remarkably similar in the two groups, i.e. irrespective of the task performed during prism exposure.

The second experiment (**1B**) crucially revealed that expertise for throwing made transfer reciprocal: expert dart throwers transferred after-effects to pointing, unlike experiment **1A** involving novice throwers. Remarkably, the extent of transfer in throwing experts was equivalent to that observed from pointing to throwing in experiment **1A**.

Finally, the third experiment (**1C**) confirmed that no transfer occurred from throwing to pointing and provided additional insights from kinematics analysis of pointing behaviour. First, the initial direction of pointing during post-tests was biased to the left in both groups, i.e. regardless the task performed during exposure. However, the terminal direction of movements was corrected in the throwing group, so that there were no terminal errors and after-effects in the participants who performed throwing movements during prism exposure. Because proprioceptive feedback allows correction of the terminal part of pointing trajectory during post-tests, we hypothesized that the proprioceptive modality was not biased by prism exposure in the throwing group.

- Insights from Axis 1 -

Error reduction and after-effects on the exposed task were similar regardless the task (throwing or pointing) used during exposure.

The nature of the task performed during exposure influenced the transfer of after-effects: transfer was observed from pointing to throwing but not from throwing to pointing

Expertise in throwing made the transfer from throwing to pointing possible.

Kinematic analysis of pointing revealed that online corrective feedbacks during post-tests may explain the absence of transfer from throwing to pointing.

2. Axis 2: Motor Imagery and transfer of after-effects during PA (Study 2)

STUDY 2 aimed to test whether PA through motor imagery (MI) of pointing enabled the transfer of after-effects to throwing. A second aim of this study was to investigate the influence of MI abilities on transfer. The results showed that PA resulted in meaningful pointing after-effects in participants who actively performed pointing during exposure but also in participants who only imagined pointing without any concomitant physical execution. In comparison, those who wore the prismatic glasses while being inactive during exposure (no movement, no MI) did not show any after-effects in pointing. Decisively, PA by mental practice resulted in significant after-effects transfer to throwing, although throwing was not imagined neither executed during exposure. This was not observed in the Inactive group.

Surprisingly, participants in the active group did not exhibit significant transfer of after-effects during throwing, thus showing contrasted results with reference to **STUDY 1**. The differences of exposure conditions between **STUDY 1** and **STUDY 2** could explain this absence of transfer, notably the visual control of the hand in the starting position and the use of sequences of pointing instead of a single movement. Crucially, only participants who displayed high MI abilities exhibited pointing after-effects following PA by mental practice as well as transfer to throwing. This was not observed in individuals with low MI abilities.

Altogether, these findings demonstrated that the intersensory conflict combined with MI during exposure was responsible for pointing after-effects and transfer to throwing. The sensorimotor conflict, induced by actual sensory feedbacks, is not crucial in the observation of transferable after-effects. Finally, **STUDY 2** revealed the possible effect of task order during post-tests: transfer was paradoxically favored when after-effects on the exposed task were assessed in first.

- Insights from Axis 2 -

PA by MI of pointing involved processes leading to significant pointing after-effects and transfer to throwing.

High motor imagery abilities are necessary to adapt to a prismatic shift using imagined pointing.

After-effects transfer to an unexposed task is increased when after-effects are assessed firstly in the exposed task.

3. Axis 3: Cerebellar neuromodulation and transfer of after-effects (Studies 3 & 4)

The purpose of the third axis was to investigate the role of the cerebellum in after-effects transfer using non-invasive brain stimulation methods (tDCS). **STUDY 1** revealed a transfer from pointing to throwing but not from throwing to pointing. From this result, **STUDY 3** aimed at testing whether cathodal stimulation to the cerebellum during PA altered the transfer of after-effects from pointing to throwing. Participants who received this stimulation showed less error reduction of pointing during prism exposure: terminal pointing errors were initially larger and diminished slower through the repetition of pointing in the stimulated group compared to the sham group. The stimulated group also exhibited larger but less stable pointing after-effects. Crucially, **STUDY 3** also demonstrated a likely role of the cerebellum in after-effects transfer to throwing. Additionally, kinematic analyses indicated that the tDCS significantly altered pointing trajectories during exposure and post-tests, thus attesting the involvement of cerebellar areas both in error reduction during exposure and after-effects.

According to **STUDY 1**, the transfer of after-effects from throwing to pointing was null in novice throwers. The aim of **STUDY 4** was to investigate whether anodal tDCS on the cerebellum during PA procedure could boost adaptation in such a way as to upgrade lay participants at the transfer level exhibited by throwing experts. The data demonstrated that anodal tDCS affected neither throwing error reduction during prism exposure, nor throwing after-effects. Furthermore, there was no evidence for enhancement of the overall after-effects transfer induced by the stimulation. Additional analyses revealed several marginal effects. First, we observed changes in the longitudinal evolution of terminal pointing errors during post-tests. In addition, the stimulation also changed kinematic parameters of pointing. These findings suggested no impact on usual indicators of adaptation but slightly altered pointing during after-effects transfer. However, these marginal effects are tough to interpret given that overall transfer remained null, and therefore do not provide evidence for a boosting effect of the stimulation.

- Insights from Axis 3 -

Cerebellar neuromodulation by tDCS during PA affected sensorimotor adaptation.

Cathodal tDCS affected pointing error reduction during exposure, pointing after-effects and after-effects transfer to throwing.

Anodal tDCS improved neither throwing error reduction during exposure nor throwing after-effects.

Anodal tDCS had no boosting effects on after-effects transfer to pointing.

B. FUNDAMENTAL IMPLICATIONS FOR SENSORIMOTOR ADAPTATION

The main purpose of the thesis was to investigate inter-task transfer of after-effects during PA, as a way to gain knowledge about the processes at work to face the perturbation. Our main finding is that after-effects transfer can unravel the contribution of a “true” sensorimotor adaptation rather than apparent adaptation concealing specific learning processes. In addition, the different studies provided important information concerning the conditions triggering processes leading to after-effects transfer. Finally, findings from the two studies based on cerebellar tDCS provided reliable information about the potential involvement of the cerebellum in transfer mechanisms. All these aspects will be discussed to offer updated theoretical proposals to distinguish among processes involved in sensorimotor adaptation.

1. Studying the transfer to unravel distinct processes in sensorimotor adaptation

A current challenge in the field of sensorimotor plasticity is to disentangle between processes involved in changing movements when facing a perturbation (Spampinato & Celnik, 2020). Previous studies described several processes underlying sensorimotor adaptation using varying paradigms (Haith & Krakauer, 2013; Krakauer et al., 2019; Spampinato & Celnik, 2020; Taylor et al., 2014b). The specificities of the tasks and methods used in each laboratory context may differently weigh the relative contributions of distinct processes (Fleury et al., 2019; Spampinato & Celnik, 2020).

With reference to the ***THEORETICAL BACKGROUND***, the PA literature classically distinguishes two processes i.e. sensory realignment (or “true adaptation”) and strategic control (Petitet et al., 2017; Prablanc et al., 2019; Redding et al., 2005). Terminal error reduction during exposure reflects how the participants compensate for the prismatic shift but does not allow to stress the contribution of each process. The classical measure accounting for sensory realignment is sensorimotor after-effects upon explicit prism removal. It is recommended to assess after-effects under conditions that are different from the primary exposure context to isolate true adaptation from explicit and contextual sensorimotor transformations (Redding et al. 2005).

In the current work, we assumed that inter-task transfer of after-effects ensured to ascertain the presence of after-effects remaining in a context different from exposure. This allowed to establish whether after-effects are robust enough to extend outside the context of exposure and if some after-effects are intrinsically linked to the specific conditions experienced during exposure. Therefore, we hypothesized that transfer might provide supplementary information

related to the nature of after-effects and thus the nature of processes at work to face the perturbation. Our findings supported this idea by showing that inter-task transfer between throwing and pointing uncovered the involvement of distinct processes, which remained hidden as long as we only considered the usual measures of error reduction and after-effects.

STUDY 1 demonstrated a strictly unidirectional transfer from pointing to throwing but not from throwing to pointing. In both cases the classical measures of after-effects revealed similar results between groups: the breadth of after-effects on the task practiced during exposure was comparable between groups, regardless the task performed. Thus, if we consider the classical measures of after-effects as an indicator for realignment, the processes at work during exposure should be similar in the two tasks. Yet, considering the transfer to the unexposed task enabled to shed light on the likely different nature of after-effects regarding the task performed under exposure.

After-effects developed during pointing were transferable while those developed during throwing remained specific. Difference in transferability suggests that processes at work during exposure should also differ. Thus, the task performed under the perturbation might have influenced the processes in response to the prismatic shift. In the second experiment of **STUDY 1**, experts in throwing also developed transferable after-effects, comparable to those of the pointing group. However, the expertise level did not influence the after-effects in throwing which were similar regardless expertise. Therefore, data about transfer indicate that the task performed during exposure conditioned the relative contribution of processes solicited to face the prismatic perturbation because it influenced the transferability of after-effects. This idea is also backed up by findings from **STUDY 2** indicating that the conditions set-up during exposure led to similar after-effects associated with different range of transfer.

Results from **STUDY 4** also support the idea that transfer provides supplementary information beyond the usual after-effects. Throwing after-effects were similar in both stimulated and sham groups. However, we observed marginal effects on pointing trajectories caused by the stimulation. Although we cannot draw any strong conclusion from this because of the absence of an overall transfer increase, transfer still unmasked some effects of the stimulation while the classical after-effects (i.e. on the throwing task) were insufficient to detect those.

Based on these arguments, inter-task transfer might uncover the contribution of distinct processes during PA. Beyond this assumption, the results support the idea that the presence of transferable after-effects could point out a major contribution of true adaptation. Throwing movements are unmastered unless they have previously been specifically trained and learnt. Therefore, performance is subjected to high variability. During prism exposure, this variability in combined with errors caused by the visuomotor perturbation. For this reason, the necessity

to adapt to the perturbation may not be relevant for the central nervous system, until the initial performance variability has been enough reduced. Yet, the nervous system would not adapt successfully because adjustments of internal sensorimotor representations would be considered as not necessary to solve the motor problem (Berniker & Kording, 2011a; Wei & Körding, 2009). Consequently, processes involved to compensate for errors when facing the perturbation during throwing should mostly rely on strategic modifications of the motor commands that remained specific to the task characteristics. These changes should be mainly driven by external error signals, i.e. terminal throwing errors and on-flight errors (Gaveau et al., 2018a). The absence of transfer on the pointing task indicates that after-effects are dependent on the throwing task context only.

By contrast, as pointing is overlearned, errors caused by the prisms during pointing may be relevant and should trigger the adaptation of internal models that is driven by sensory prediction errors. In this case, changes would be generalizable beyond the task context, i.e. to another task. The transfer from throwing to pointing exhibited by expert throwers supports this interpretation. As throwing was mastered in the expert group, throwing exposure involved processes leading to sustained changes of internal models. Therefore, performing a mastered task during exposure might enhance the contribution of true adaptation during exposure. On the other hand, performing a non-mastered task should mostly engage the strategic control process to account for the perturbation. In **STUDY 2**, we found that PA with imagined pointing led to transferable after-effects for participants with high MI abilities. Strategic control was missing from this procedure as there was no actual execution and thus no actual sensory feedback. Therefore, processes involved during exposure relied on sensory prediction errors caused by integrating the biased hand starting position together with the efferent copy of the motor command (Michel et al., 2013). The intersensory conflict adjusted internal models and changed hand state estimations thus leading to transferable after-effects. These findings support the link between true adaptation and transferable after-effects.

Overall, our findings demonstrate that transfer should uncover differences in the relative contribution of each process which is masked when considering error reduction and after-effects only. Importantly, transferable after-effects highlighted true sensorimotor adaptation, driven by sensory prediction errors. This form of sensorimotor plasticity should mainly rely on cerebellar controls. Yet, **STUDY 3** and **STUDY 4** suggest that cerebellar neuromodulation by tDCS have possible effects on after-effects transfer. Before questioning the potential role of the cerebellum in after-effects transfer, a crucial question is to elucidate which conditions could trigger the processes leading to transferable after-effects.

2. Which conditions are needed to trigger after-effects transfer?

So far, we considered findings probing that transfer uncovered different processes contributing to face a single perturbation. In addition, we discussed the likely hypothesis according to which true adaptation could be related to transferable after-effects, independent from the context in which they were elicited. A critical question is to elucidate the conditions needed to trigger transfer of after-effects.

Findings from **STUDY 1** suggest that developing transferable after-effects depended upon the expertise on the task performed during exposure. Throwing entails highly variable movements that are not mastered unless they are specifically trained. This high variability is probably related to the ballistic aspect of throwing: due to its short duration, integrating actual online sensory feedbacks is likely tougher as compared to pointing. Novice participants who performed throwing under prism exposure did not show any after-effects on pointing. No-transfer was probably due to the high variability of throwing, i.e. the fact that they did not master the task. In fact, expertise in throwing reduced the variability along with repetition of throwing and thus probably increased the ability to transfer after-effects to pointing. Furthermore, the more experts performed throwing with comfort and ease, the more they transferred after-effects to pointing. Thus, we hypothesize that transfer of after-effects is favored only when the task during exposure is well mastered. Expertise might facilitate the use of sensory predictions errors to adjust internal models. This suggests that processes leading to transfer are enabled only when the task practiced under the perturbation is enough well-learned.

Besides, insights from kinematics analysis shed some light on the potential role of proprioception in transfer mechanisms. When we did not observe transfer on pointing (i.e. no-significant error in pointing terminal errors), trajectory analysis revealed that its initial part was altered after exposure (**STUDY 1** -experiment **1A**- and **STUDY 4**) however, without terminal errors as trajectory correction took place during its last part. These corrections probably relied on proprioceptive feedback as there was no visual feedback during post-tests. Motor commands were initially biased after exposure in the opposite direction of the prismatic shift. However, once online proprioceptive feedback became available, participants may correct the pointing trajectory. This suggests that the proprioceptive maps were not biased during exposure with no transfer of after-effects which extends O'shea et al.'s findings (2014). Conversely, we speculate that expertise referred to changes in the estimation of hand proprioceptive state by enabling adjustment of internal models during exposure despite the short duration of throwing movements. Therefore, throwing experts did not exhibit proprioceptive unbiased corrective feedback of their pointing trajectories during post-tests and showed a significant transfer of after-effects.

While throwing is ballistic by nature, pointing is not, although we instructed the participants to reach the targets as fast as possible. These differences may explain that proprioceptive changes caused by the perturbation probably differed between tasks during exposure. Nevertheless, experts probably did not use proprioceptive corrective feedback on pointing during post-tests. This rather supports the influence of expertise on transfer. A further study should specifically test this hypothesis, by investigating online motor control of throwing by high-level dart throwers and proprioceptive changes following exposure.

In **STUDY 2**, we changed exposure conditions in the active group, so they matched the exposure conditions for MI. Notably, we instructed the participants to make sequences of several pointing instead of unique pointing. Another crucial aspect was that the starting position of the hand was visible before movement onset. Yet, the active group in **STUDY 2** surprisingly did not exhibit any transfer from throwing to pointing while other studies did (**STUDIES 1** and **3**). The changes in exposure conditions in **STUDY 2** may be responsible of no transfer. First, it is noteworthy that the magnitude of pointing after-effects during active exposure was reduced as compared to other studies, and perhaps insufficient to be transferred to throwing. However, the fact that the MI group showed significant transfer despite the same amount of pointing after-effects does not support this hypothesis. The conditions of active exposure in **STUDY 2** probably favored processes that lead to context-dependent after-effects. This could be related to shorter exposure to the prismatic shift and massed practice of pointing movements (i.e. continuous practice with no break; Cohen, 1973; Taub & Goldberg, 1973). Another hypothesis relates to the visibility of the starting position of the hand. This probably favored strategic control and was detrimental to sensory realignment during exposure which resulted in a non-significant transfer. This is consistent with previous results showing reduced direct neither after-effects when the starting position of the hand was visible during exposure (Redding & Wallace, 1996, 2001).

STUDY 2 also tested a potential task order effect on transfer during pre- and post-tests. We observed that when after-effects on the exposed task are tested first, the transfer on the unexposed task is better, regardless the conditions of exposure. A possible explanation is that post-tests on the exposed task would strengthen sensorimotor transformations entailed during exposure by using a form of use-dependent process which will be discussed later. Notably, in the other studies (i.e. **STUDIES 1, 3 AND 4**), the task order during post-tests was kept, i.e. testing the exposed task first. In addition, a longitudinal investigation of post-tests values (**STUDIES 3 AND 4**) gave information about the dynamics of after-effects and transfer. Another possible condition for transfer may relate to the repetition of trials during post-tests on both tasks. This encourages to consider numerous trials during post-tests. This also requires to set up conditions that prevent de-adaptation in the laboratory context (i.e. open loop conditions).

3. The role of the cerebellum in after-effects transfer

One of our main objectives was to investigate the possible role of the cerebellum in the mechanisms of transfer by using non-invasive brain stimulation. In the **THEORETICAL BACKGROUND**, we reported that cerebellar lesions caused impaired PA (e.g. Pisella et al., 2005; Weiner et al., 1983). Activation of cerebellar areas was also reported through neuro-imaging studies and former neuro-stimulation studies highlighted the cerebellar contribution to several aspects of PA, starting from the very first trials of exposure until after-effects, i.e. in strategic control and sensory realignment (Panico et al., 2020). Therefore, we addressed this question experimentally in after-effects transfer.

The purpose of **STUDY 3** was to test whether cathodal stimulation altered after-effects transfer from pointing to throwing. The hypothesis was that an inhibitory neuromodulation of the cerebellum during PA procedure could decrease after-effects transfer. The first finding was that the cerebellar tDCS altered pointing accuracy during early exposure (terminal pointing errors were higher in the tDCS group). We thus discussed a possible involvement of the cerebellum in online control as errors mainly occurred during the first trials including the very first one. This observation is consistent with previous neuro-stimulation studies (Panico et al., 2016b). In addition, trial-by-trial corrections of the terminal errors (O'Shea et al., 2014) were reduced in the tDCS group during early exposure, suggesting that participants' capacity to find the appropriate aiming strategy was altered. Another hypothesis is that the stimulation interfered with the capacity to implement the terminal error in the correction of the subsequent trial, through the updating of internal models. Such updates rely on the processing of sensory predictions errors which are known to be endorsed by the cerebellum (Popa & Ebner, 2018; Shadmehr et al., 2010; Therrien & Bastian, 2019; Wolpert et al., 1998). The stimulation also influenced pointing after-effects and, crucially, transfer of after-effects to the throwing task thus indicating the cerebellar influence on transfer mechanisms.

STUDY 4 tested the effects of anodal cerebellar stimulation on after-effects transfer from throwing to pointing. Our hypothesis was ambitious. Although the task practiced during exposure was not mastered, which precludes after-effects transfer (**STUDY 1A**) the aim of this experiment was to test whether anodal facilitation was capable of boosting processes leading to transferable after-effects, i.e. mimic the effect of expertise. In contrast to **STUDY 3**, we found effect of anodal stimulation neither on error reduction during throwing exposure nor on throwing after-effects although numerous studies showed beneficial effects of anodal cerebellar stimulation (e.g. Galea et al., 2011; Jayaram et al., 2012; Leow et al., 2017). We suggested that performing a non-mastered task might engage processes that are not mainly cerebellum dependent, which could explain the absence of tDCS boosting effects. However, this does not

imply that cerebellar mechanisms were not involved at all during throwing PA procedure in novices. Although the stimulated group did not exhibit significant pointing after-effects, we reported marginal effects of the tDCS on the longitudinal evolution of pointing terminal errors and alterations of pointing kinematics during transfer. Therefore, one could speculate that the contribution of cerebellum-dependent processes, even minor in this procedure, could have been modulated by the stimulation. Nevertheless, these marginal effects were tough to interpret because they did not convey in indicating a boosting effect of the stimulation: the longitudinal evolution of pointing errors was in favour of increased after-effects in the stimulated group while effects on kinematics tended to show that pointing trajectories were less biased in the tDCS group. In addition, we have to insist on the fact that the overall transfer remained almost null for both groups. Outcomes from **STUDY 3** therefore tend to indicate that anodal tDCS has no boosting effects on adaptation and after-effects transfer during PA using throwing in novices.

Altogether, these findings do not unquestionably probe the efficacy of cerebellar tDCS in modulating transfer mechanisms and further studies are required to deeper investigate this hypothesis. However, they still open the possibility that tDCS impacts the contribution of cerebellum-dependent adaptive processes during exposure, thus resulting in modulation of transfer. How could we explain the potential role of cerebellum in transfer?

It is long known that the cerebellum plays a crucial role in generating predictions about the sensory consequences of motor outputs (Kawato, 1999; Miall & Wolpert, 1996; Popa & Ebner, 2018; Therrien & Bastian, 2019; Wolpert et al., 1998). Combining sensory information about the body current state and a copy of the motor command generates an estimation of the future state of the body, i.e. forward models. These models are continuously updated to maintain an accurate control of movement (Shadmehr et al., 2010). When predictions do not match the actual consequences of movement, which occurs during prism exposure, this sensory prediction error is used to update the forward model. In addition, studies involving participants with cerebellar damage show that cerebellum is also highly involved in adjusting internal models when predicted and actual consequences of movements do not match (e.g. Maschke et al., 2004; Morton & Bastian, 2006; Tseng et al., 2007). Therefore, the cerebellum plays a role in the generation of predictions (allowing a feedforward control), the detection of and the processing of sensory predictions errors (feedback control) and crucially in adjusting internal models based on sensory prediction errors. These mechanisms are responsible for triggering adaptation in PA because of the expected-achieved discrepancy (internal errors) induced by the prisms (Gaveau et al., 2018b; Gaveau, Prablanc, et al., 2014).

As we discussed above, the adjustment of internal models taking into account the visuomotor perturbation during prism exposure may lead to transferable after-effects. Yet, other processes are also involved during PA. The hypothesis of a balance between processes implies that these could be differently weighed depending on the experimental conditions (Krakauer et al., 2019; Roemmich & Bastian, 2018; Spampinato & Celnik, 2020). Thus, increasing the relative contribution of one process could reduce the contribution of others. For example, in PA, the multiple-step procedure reduces the contribution of strategic control by suppressing external errors thus leading to an increased contribution of sensory realignment. This results in greater after-effects when the perturbation is gradually imposed (Michel et al., 2007). Along this line, we hypothesize that cerebellar neuro-stimulation might modulate the contribution of sensory prediction error-based processes by increasing or reducing the excitability of underlying cerebellar mechanisms. Such modulation could have effects of both online feedback control and feedforward mechanisms through the adjustment of internal models. We propose that this could be responsible for modulation of after-effects transfer using tDCS, but this remains to be further investigated.

4. Theoretical working propositions for the distinction of processes underlying sensorimotor adaption

The *INTRODUCTION* and *THEORETICAL BACKGROUND* sections depicted the general concepts underlying our capacities to modify movements and to learn new skills, i.e. adaptation and learning. Overall, this thesis aimed at providing new insights in the understanding of sensorimotor adaptation, i.e. the processes changing our movements in response to sustained perturbations. We decided that PA was relevant for studying inter-task transfer of after-effects because this paradigm favours self-attribution of errors (Fleury et al., 2019). The literature classically describes two processes intervening during PA: strategic control and sensory realignment (Petitet et al., 2017; Prablanc et al., 2019; Redding & Wallace, 2002). This terminology is fairly specific to the PA literature although parallels can be made with other processes, e.g. the fast versus slow or the explicit versus implicit processes. The specific aim of this thesis was to study inter-task transfer of after-effects as a feature to uncover the contribution of different processes during sensorimotor adaptation. Our findings suggest that transferable after-effects probe the adjustment of forward models based on sensory prediction errors, which relates to a “true” sensorimotor adaptation (Weiner et al., 1983). Going beyond the specific processes of the PA literature requires to confront our findings to the broader context of sensorimotor adaptation and to discuss processes leading to transferable after-effects among other recently described as being involved in motor learning and adaptation.

Processes based on sensory prediction errors are driven by a mismatch between expected and achieved movement outcomes (Krakauer et al., 2019; Spampinato & Celnik, 2020). They refer to model-based mechanisms and suppose the adjustment of internal models (Haith & Krakauer, 2013). Other processes, not based on changes in internal models, can also contribute movement change when facing a perturbation. They could be referred to as non-model-based mechanisms because improvements of motor performance arise directly at the level of the controller, with no changes in internal models (Haith & Krakauer, 2013). Reinforcement relies on reward represented by successful action. Thus, a successful movement pattern will be reinforced whereas a movement associated with failure will be avoided. This kind of process could be at work during PA procedure (Schintu et al., 2018). Besides, use-dependent learning induces behavioural changes through movement repetition without considering whether they lead to errors or not (Reinkensmeyer et al., 2016; Wolpert et al., 2011). Finally, cognitive strategies (e.g. use of explicit knowledge or knowledge of result in solving a motor problem) in sensorimotor adaptation has also been extensively reported (e.g. McDougle et al., 2016), including during PA (Redding et al., 1992).

Each of these various forms of learning are continuously involved in guiding performance towards the adequate solution, including during PA. Their relative contributions may be weighed differently throughout the time course of the same motor task. Similarly, the contributions of these processes may also shift depending on the specific component of the motor task (Fleury et al., 2019; Spampinato & Celnik, 2020).

How can we relate and discuss our findings throughout this framework? We proposed that transferable after-effects would reflect sensory prediction error-based processes, i.e. the updating of internal models implying sensory changes in body state estimation (Statton et al., 2018). This could relate to the sensory realignment process. As long as changes in forward models entail those of internal representations relative to the body itself, these modifications still persist beyond the initial context, i.e. when performing another task. This change may refer to a true sensorimotor adaptation. This does not mean that these are the only processes. Notably, after-effects are not equal to the initial prismatic shift, and their transfer magnitude is different from that of initial after-effects. Thus, some processes at work during exposure entailed specific changes related to a particular context, i.e. some contextual learning processes. Transferable after-effects may indicate that true adaptation is the main process among others.

Conversely, non-mastered task may lead to a greater involvement of other processes during exposure that are not driven by sensory prediction errors. Thus, they do not imply changes in the forward model. As throwing is not enough skilful in novice participants, the relative

contribution of contextual learning during exposure might be increased whereas the contribution of true adaptation might decline. Changes in movements would be related to direct modifications of motor commands that are probably not accompanied by persistent sensory changes and modifications of internal models. These conditions likely lead to stronger contribution of cognitive strategies and reinforcement learning. Such processes relate to strategic control described in PA literature (Redding et al., 2005; Weiner et al., 1983). However, we cannot exclude the additional contribution of model-based processes. In fact, after-effects on the exposed task suggest that some internal models have been adjusted in a very specific way as there is no after-effects in another task. Nevertheless, models that are changed are specific to a particular situation, i.e. the throwing task. Interestingly, experts in throwing relied more on true adaptation than untrained individuals, suggesting that the contribution of sensory prediction error-based processes increased.

Use-dependent learning processes might have also been involved during both exposure and post-tests. The repetition of the same movement modifies performance by changing movements to become more similar to the previous movement (Reinkensmeyer et al., 2016; Wolpert et al., 2011). During late exposure, when errors compensation has occurred, less variability is observed and the same movement is repeated. This kind of learning could be involved and favour motor commands allowing to reach the target. Therefore, if the relative contribution of this process is important, the memorized movement pattern would not favour after-effects. Besides, use-dependent learning can also be involved during post-tests and strengthen the motor plan related to after-effects, thus increasing its stability if de-adaptation is prevented. Therefore, a high contribution of use-dependent learning during exposure might increase contextual learning, while its contribution during post-tests (i.e. outside the perturbation) should favour the durability and the strength of after-effects.

By discussing our findings in this hybrid framework, we propose that true adaptation processes would entail internal models' adjustment mainly dependent on the cerebellum and would be reflected by transferable after-effects. Besides, other contextual learning processes would also be involved during PA and rather reflected by changes in motor performance improvement during exposure (**Figure 32**). This seems a reasonable framework in studying processes at work during sensorimotor adaptation which could be consistent with previous contributions. It is noteworthy that isolating each of these processes may not be possible and that their relative contribution might be weighed depending on exposure conditions (Roemmich & Bastian, 2018; Spampinato & Celnik, 2020). A likely hypothesis is that increasing the contribution of true adaptation might decrease the contribution of other processes and vice-versa (Spampinato & Celnik, 2020). We propose that inter-task transfer of after-effects could help to uncover the relative contribution of these processes, suggesting that the more after-effects are

transferable, the more the contribution of true adaptation was high to face the perturbation (**Figure 33**). Noteworthy, other specific parameters could help identifying the contribution of the other processes. For example, the cognitive component of after-effects during prism could be identified by using Sham glasses during pre and post-tests (e.g. Redding & Wallace, 2006). In visuomotor paradigms, asking participants to explicitly report their aiming direction for each trial could provide a measure for cognitive strategies (e.g. McDougale et al., 2016; Taylor et al., 2014). Specific markers of the contribution of reinforcement and use-dependent learning remain to be investigated.

The findings we discussed so far are a first step towards a more thorough understanding of sensorimotor adaptation. Nevertheless, numerous pending questions still need further investigations to be answered. By approaching the problem with a broader perspective, this proposal provides a platform that could serve for further research and application.

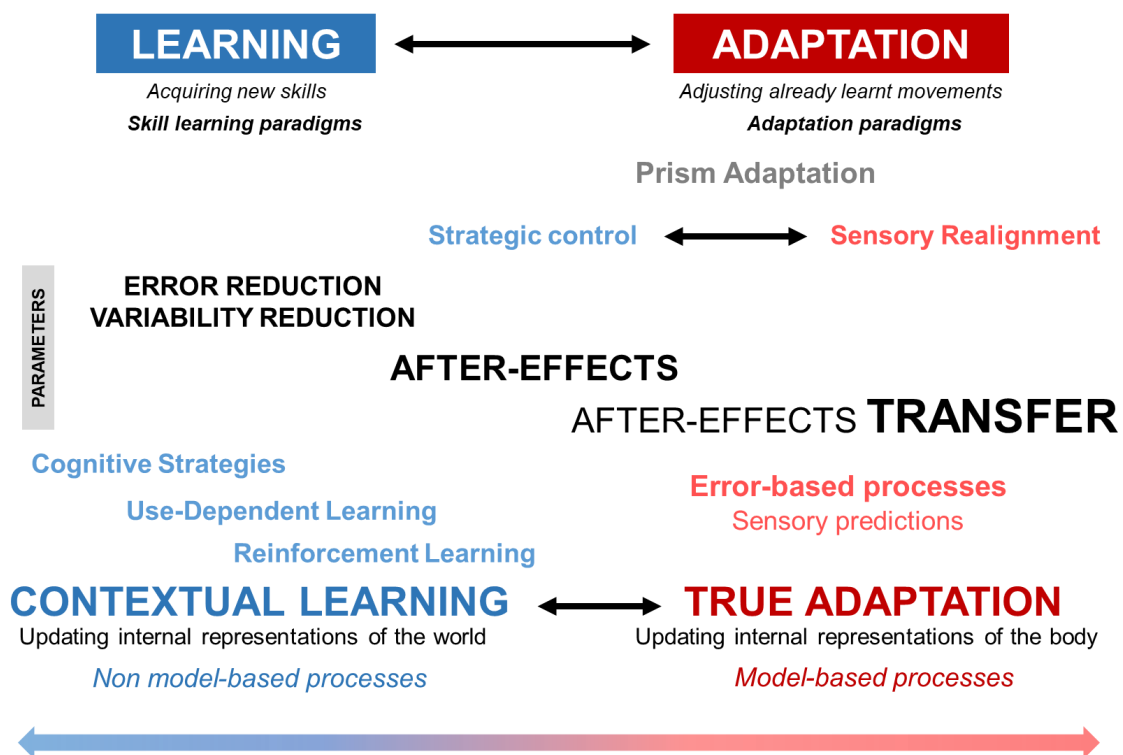

Figure 32 – Hypothetical relationships between multiple sensorimotor plasticity processes. *Learning and Adaptation are two sets of processes that could not be isolated from each other. During adaptation, multiple processes are at work, and some of them could be related to learning processes (i.e. cognitive strategies, use-dependent learning, and reinforcement) because they do not rely on sensory prediction errors. Conversely, we propose that processes relying on the updating of the forward model (i.e. model-based processes) entail modifications in our own body internal representations. This would lead to sensorimotor changes that can be applied in other settings. Nevertheless, each process may interact with others and the experimental conditions might differently weigh their relative contribution to the overall performance changes. We therefore consider contextual learning and true adaptation processes as interacting and relying on a continuum. Crucially, the parameters that we observe or measure (i.e. error and variability reduction, after-effects, and transfer) during sensorimotor adaptation provide decisive information concerning the nature of the representations that have been modified when facing the perturbation. We propose that after-effects transfer may uncover the contribution of true sensorimotor adaptation.*

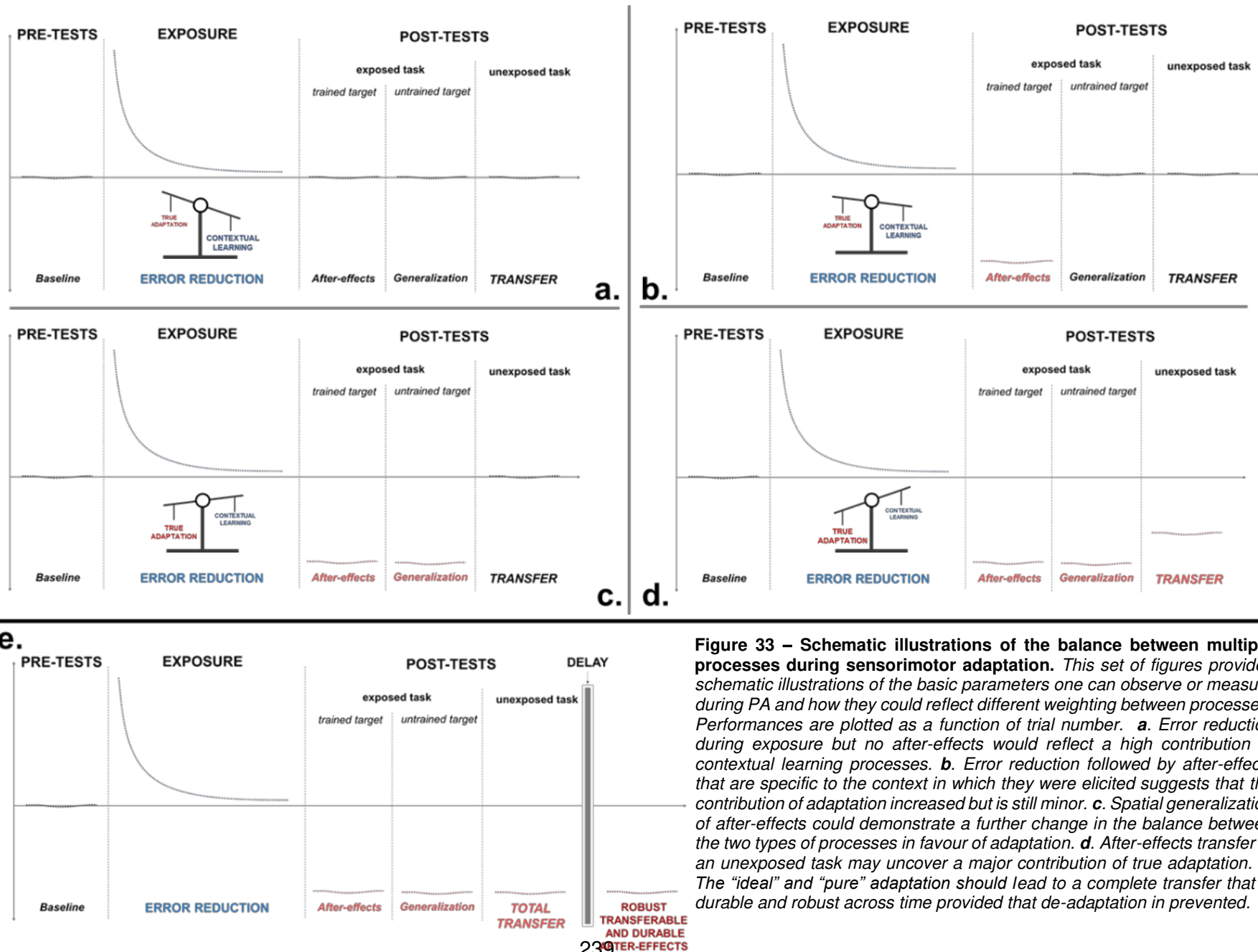

Figure 33 – Schematic illustrations of the balance between multiple processes during sensorimotor adaptation. This set of figures provides schematic illustrations of the basic parameters one can observe or measure during PA and how they could reflect different weighting between processes. Performances are plotted as a function of trial number. **a.** Error reduction during exposure but no after-effects would reflect a high contribution of contextual learning processes. **b.** Error reduction followed by after-effects that are specific to the context in which they were elicited suggests that the contribution of adaptation increased but is still minor. **c.** Spatial generalization of after-effects could demonstrate a further change in the balance between the two types of processes in favour of adaptation. **d.** After-effects transfer to an unexposed task may uncover a major contribution of true adaptation. **e.** The “ideal” and “pure” adaptation should lead to a complete transfer that is durable and robust across time provided that de-adaptation is prevented.

C. OPEN QUESTIONS, LIMITATIONS, AND PERSPECTIVES FOR FURTHER RESEARCH

The different experiments of the thesis offer several new insights on the fundamental aspect of sensorimotor motor adaptation:

- We presented after-effects transfer as a feature to unravel the contribution of true adaptation during PA.
- We summarized the conditions favouring the trigger of after-effects transfer.
- We discussed the potential involvement of the cerebellum as a rationale sustaining these processes through sensory prediction errors based mechanisms.

Nevertheless, many questions remain from our findings and need further investigations. Here, we will present and discuss open questions and limitations, together with on-going and further perspectives of research.

1. Open questions and research perspectives

A first crucial pending question relates to the degree of mastery needed to transferable adaptation. **STUDY 1** showed that high experts in throwing transferred after-effects to pointing while novice did not. However, we did not evidence the level to be reached in order to elicit adaptation. Thus, whether transfer is an on-off process, switching as early a given level of expertise is reached is worthy to be studied. An alternative hypothesis predicts a mere correlation between the expertise level and the amount of transfer. In this case, the more the participants are skilled, the more they develop transferable after-effects when exposed to perturbation. We shall specifically test between these two hypotheses by investigating the effect of table-tennis expertise.

On-going project – Transfer and expertise in table tennis
Purpose: this project aims to better address the relationship between expertise and true adaptation through the investigation of after-effects transfer.
Methods: using a table tennis skill (backhand shot), we could easily recruit participants of various expertise levels, objectively assessed by the ranking and the years of experience. This ability would substitute throwing in our inter-task transfer PA procedure and allow to establish the existence of an expertise threshold or a possible correlation between after-effects transfer and the level of expertise.

A second remaining question refers to the timing of transfer mechanisms. We assumed that after-effects were conditioned by the nature of processes at work when facing prismatic perturbation. This does not exclude that some transfer mechanisms may operate after exposure. Besides, **STUDY 2** highlighted that testing after-effects on the exposed task might firstly influence the transfer in another. In addition, transfer may need some delay or a given number of repetitions to emerge during post-tests. Thus, investigating whether transfer mechanisms may also take place after exposure should be considered.

In **STUDY 3** and **STUDY 4**, we investigated the role of the cerebellum in after-effects transfer. Our findings suggest that neuromodulation by cathodal tDCS interfered with PA and transfer, whether anodal tDCS had marginal effects only. This needs to be deeper investigated. Notably, it remains unknown whether anodal tDCS would boost transfer from pointing to throwing. Although the cerebellum seemed to play a crucial role in transfer, we must not exclude other brain regions, e.g. the primary motor cortex.

On-going project – Transfer and tDCS
Purpose: this project aims to complete our previous tDCS findings by providing a larger investigation of tDCS applied to the cerebellum or to M1 with anodal or cathodal polarity. The purpose is also to investigate different stimulation timelines (i.e. from pre-tests to post-tests versus during exposure only).
Methods: we will use methods similar to those of study 3 and 4 with additional manipulations i.e. the polarity, the stimulated area (M1 or Cerebellum), and the timeline of the stimulation.

Finally, another unresolved basic question refers to the balance between processes at work during prism exposure. The different processes involved during sensorimotor adaptation overlap in their time course and potentially share partially common neural substrates. We hypothesized that increasing the contribution of one process would reduce the contribution of others, suggesting a trade-off among them. However, further research is needed to check this hypothesis. Manipulating experimental conditions would probably weigh the relative contribution of each process. Future experiments may investigate how to differentially enhance processes leading to transferable after-effects. A crucial challenge will also to identify specific markers for assessing the contribution of each process. Further investigations should explore after-effects transfer with multiple step versus single step prism exposure to manipulate the contribution of sensory realignment and see whether transfer increases. It would be also interesting to provide direct measure of the cognitive strategies by using report of the aiming strategies during exposure, as mentioned above for visuomotor rotation paradigms. In addition, the contribution of reinforcement learning could also be investigated by manipulating rewards

associated with successful outcomes during exposure and/or post-tests to explore the consequences on transfer.

2. Limitations and considerations for further experiments

The findings of this thesis are subjected to limitations. First, data exhibited large inter and intra-subjects variability which could arise from various sources. Throwing caused high intra-subjects variability in novice participants (**STUDY 1**). In the experts group, this variability showed that expertise correlated with transfer. We did not find such relation in the novice group and variability may hide some effects. In addition, the rate of motor learning/adaptation showed high inter-individual differences (Lefumat et al., 2015; Renault et al., 2020). This could also be observed for transfer. To address this issue, we may add it in the inclusion criteria, for example by recruiting subjects across a large spectrum of variability. Alternatively, further studies should involve larger sample of participants. This would enable clusters analysis and the identification of subgroups showing variable magnitudes of transfer under the same experimental conditions. In addition, tDCS responsiveness may also change across participants (Chew et al., 2015; Wiethoff et al., 2014) which could also account for the large variability observed in our tDCS studies.

The kinematics analysis (**STUDIES 1, 3 and 4**) led to speculate on the role of corrections about proprioceptive feedback during after-effects in pointing. A limitation comes from studies which did not provide any measure in proprioceptive estimates. To include this variable, further studies should provide separate measures for proprioceptive versus visual shift during post-tests.

Another issue that was not addressed in our experiments is the long-term stability of after-effects and transfer of after-effects. Through all the experiments we conducted, we only addressed after-effects following a short acute session of prism exposure. In fact, the period of exposure was through a unique and relatively short session (60 trials) compared to other PA studies. Whether prolonged exposure leads to increased after-effects transfer should be investigated. Further research may also test whether transferred after-effects remain stable across time. For example, it would be convenient to assess after-effects and transfer several times after exposure from few hours until several days, in search for long-lasting effects (e.g. O'Shea et al., 2017). Finally, it is worth mentioning that significant after-effects transfer reported in our studies is never complete, and generally reaches the half of the initial after-effects magnitude, except in **STUDY 2** where participants with high MI abilities showed a complete transfer to throwing.

D. TOWARD REHABILITATION: PERSPECTIVES AND CHALLENGES FOR CLINICAL RESEARCH AND APPLICATION

So far, we discussed current findings associated with their basic implications for better understanding sensorimotor adaptation. While the main purpose of this thesis was to improve the theoretical knowledge in this field, our approach yet relies on translational research, viewed as inverted or circular in the case of PA (Nijboer et al., 2020). This is notably why after-effects generalization represented a relevant criterion in studying different processes. Therefore, several interesting aspects may be discussed to draw general perspectives for clinical research and applications.

Perhaps one of the first crucial question to arise is whether patients in rehabilitation show transferable after-effects. It has been argued that some neurological deficits are accompanied by a high-degree of generalization, whereas others are not (Roemmich & Bastian, 2018). Several arguments support the hypothesis of transferable after-effects in rehabilitation. Sensorimotor adaptation seems to be spared when cerebellar areas are preserved from brain lesions, e.g. in people with cerebral stroke (Reisman et al., 2007; Scheidt et al., 2000). We discussed the fact that processes underlying transferable after-effects could be mostly cerebellum dependent. Therefore, we believe that patients with lesions restricted to brain or basal ganglia might develop transferable after-effects through sensorimotor adaptation (Roemmich & Bastian, 2018).

Thus, the challenge for therapists and scientists would be to design rehabilitation strategies allowing the patients to solicit processes leading to transferable after-effects. However, transfer would be efficient only whether transferred after-effects are of enough amplitude and long-lasting. Thus, a crucial aspect is the breadth and the durability of transfer. We previously discussed the conditions needed to trigger transfer and increase its magnitude. Training in a familiar task during exposure would be more beneficial for patients to develop transfer, although this may appear counter-intuitive in the context of rehabilitation. Perhaps a gradual perturbation would also lead to a greater request of a transferable sensorimotor adaptation. Thereafter, it will be more than essential to make this durable. As suggested in recent papers and discussed above, the combination with other paradigms could enhance the strength and the durability of after-effects (Roemmich & Bastian, 2018). For example, the contribution of learning reinforcement and use-dependent learning during post-tests could be of great interest to stabilize the sensorimotor changes elicited by adaptation. We could provide a binary reward-based feedback during post-tests to reinforce “successful” trials, i.e. those associated with

after-effects. In combination, use-dependent learning could also participate in reinforcing the expected pattern thus favouring long-lasting after-effects. These hypotheses remain to be tested, both in healthy and pathological populations.

Although we used tDCS and MI as methods to better understand the contribution of transferable after-effects processes, these are well-accepted tools in rehabilitation. On the one hand, tDCS is increasingly used to stimulate functional recovery, e.g. in stroke patients (Santos Ferreira et al., 2019; Wessel & Hummel, 2018). While our results do not exclude that cerebellar tDCS could enhance after-effects transfer, further investigation is still required to better assess potential boosting effects. On the other hand, MI is believed to induce sensorimotor motor plasticity which could be particularly relevant for population with motor disorders (MacIntyre et al., 2018). Therefore, combining MI and PA can potentially represent a beneficial procedure for favoring transferable after-effects.

Finally, our observation related to the concepts of adaptation and learning may be discussed in parallel with those of restoration and compensation. While restoration refers to the restitution of the initial lost function, compensation rather depicts the use of other structure or function to supplant the damaged one. Compensation would therefore provide responses that are adequate in specific context, similarly to specific learning processes, while restoration would instead apply changes to different situations, comparably to true adaptation. For example, stroke patients generally develop compensatory strategies relying on the proximal paretic side or the use of the non-paretic limb. However, this behaviour could lead to maladaptive plasticity and does not favour the restoration of the sensorimotor functions that has been disrupted (Takeuchi & Izumi, 2012). In parallel, neurotechnology-assisted neurorehabilitation (e.g. cortical modulation or peripheral stimulation) offers a promising approach to promote adaptive brain plasticity and reorganization instead of reinforcing compensatory strategies (Micera et al., 2020). Thus, the objective for the therapists would be to favor restoration through processes leading to transferable changes. The stake for patients would not only be to compensate deficits in a particular situation at a specific time but rather to develop sensorimotor changes that could be applied beyond the context in which they were developed.

Therefore, we need further investigations to better understand how developing transferable after-effects and improving the retention duration of transfer. Based on results in healthy population, clinical studies should be designed to investigate transfer in populations with neurological impairments. The ultimate goal of this translational research would be to propose therapies designed to facilitate the transfer of sensorimotor improvements from rehabilitation to other daily life situations.

Conclusion

Sensorimotor adaptation has been extensively studied through numerous paradigms and for many years. The aim of this doctoral thesis was to investigate inter-task transfer of after-effects during prism adaptation as a way to gain knowledge about the processes at work when facing a perturbation. In turn, we aimed at identifying the conditions triggering after-effects transfer and the underlying neural substrates. To that purpose, we used various methods in complement to prism adaptation, i.e. motor imagery, kinematics analysis and transcranial direct current stimulation.

Through our analysis of the literature together with our original experimental contributions, we propose that after-effects transfer provides further information beyond the classical measure of after-effects to evidence adaptation. Furthermore, we suggest that the presence of transferable after-effects reflects the contribution of a true sensorimotor adaptation driven by sensory predictions error-based processes and relying on the updating of internal models. Therefore, the cerebellum might be a key structure in such process.

This work attempted to revisit sensorimotor adaptation by proposing updated lines of reflections concerning the parameters that could uncover the contribution of multiple processes when facing a single perturbation. Furthermore, our contributions outlined the influence of the task practiced when facing a perturbation, suggesting that one movement could not be adapted before it is sufficiently learnt. These outcomes pave the way for further investigations of the conditions needed to elicit transferable after-effects and the underlying neural substrates.

Finally, numerous questions arise from this thesis, both at the basic level but also concerning the translation to the clinical field. Favouring transfer is undoubtedly a relevant challenge for rehabilitation purposes. However, from another point of view, the capacity to adapt is intrinsically related to the capacity to de-adapt (i.e. to regain the initial behaviour) and refers to the possibility to interact optimally in variable environmental conditions. Therefore, one may wonder whether “pure” or “ideal” adaptation, i.e. robust, long-lasting and completely transferable after-effects is truly the ultimate goal to achieve. On this point, the shift from basic sciences to clinical practice should be sensitive. Further investigations should address how to find the right balance between the multiple sensorimotor plasticity processes in order to optimize patients’ benefits from rehabilitation to daily life.

*“I would rather have questions that cannot be answered
than answers that cannot be questioned.”*

Richard Feynman

Résumé substantiel

Revisiter l'adaptation sensorimotrice : étude du transfert inter-tâche des effets consécutifs durant l'adaptation prismatique

Introduction & Cadrage théorique

La plasticité qui caractérise notre système nerveux nous permet de réaliser des mouvements fluides et précis malgré des conditions changeantes. Cette capacité est d'autant plus cruciale dans le cadre de la rééducation neurologique et du recouvrement des fonctions motrices. Dès lors, l'objectif pour les cliniciens est de mettre en place des thérapies donnant lieu à des transformations durables et dont les bénéfices s'étendent du contexte clinique à des situations de la vie courante. Cette notion de transfert est au centre de ce travail doctoral.

L'intégration des informations sensorielles est indispensable dans l'élaboration de commandes motrices appropriées ainsi que dans le contrôle de l'exécution du mouvement et l'évaluation de ses conséquences sur l'environnement. La théorie des modèles internes offre un cadre permettant de comprendre ces mécanismes de contrôle. Les représentations internes dont nous disposons à propos de notre corps et de l'environnement nous permettraient de prédire les conséquences d'un mouvement et de comparer ces prédictions sensorielles aux conséquences réelles du mouvement. Ainsi, le système est capable de détecter des erreurs qui permettent de déclencher des processus de plasticité sensorimotrice.

Les processus de plasticité sensorimotrice englobent la capacité de modifier un mouvement pour faire face à une perturbation (adaptation), mais également l'acquisition de nouveaux mouvements (apprentissage). La compréhension de ces processus représente un défi majeur dans le domaine du contrôle moteur et dans le cadre clinique du recouvrement des fonctions motrices. Pourtant, les deux termes sont souvent utilisés de manière indifférenciée. L'adaptation sensorimotrice se reflète non seulement par la réduction graduelle des erreurs induites par la perturbation mais surtout par la présence d'effets consécutifs une fois la perturbation supprimée. Les caractéristiques de ces effets consécutifs renseignent sur la nature des modifications opérées au sein du système nerveux central et ainsi sur le type de processus mis en jeu pour faire face à la perturbation. Ainsi, la façon dont les effets consécutifs sont transférables vers d'autres contextes pourrait permettre de distinguer les processus mis en jeu durant l'adaptation.

L'adaptation prismatique est l'un des plus anciens paradigmes utilisés pour étudier l'adaptation sensorimotrice en laboratoire. Dans un protocole typique, les performances de base des sujets sont mesurées sur une tâche de pointage manuel dirigé vers une cible et sans rétroaction visuelle. Dans une seconde phase appelée exposition, les sujets portent des lunettes prismatiques qui induisent un décalage du champ visuel vers la droite. Lors des premiers essais, les sujets réalisent des erreurs de pointage dans la direction de la déviation prismatique. Les erreurs de pointage sont alors rapidement puis graduellement réduites et les performances de bases sont retrouvées. Au bout de quelques dizaines d'essais, les lunettes prismatiques sont retirées et les performances de pointage sont à nouveau mesurées durant les post-tests, dans des conditions identiques aux pré-tests. Les sujets réalisent alors des erreurs dans la direction opposée à la direction prismatique. Ces erreurs correspondent aux effets consécutifs et constituent la preuve qu'une adaptation sensorimotrice a eu lieu.

La littérature rapporte deux processus principalement impliqués durant l'adaptation prismatique. Un premier processus, la recalibration (ou contrôle stratégique) agirait durant les premiers essais d'exposition et permettrait de réduire rapidement les erreurs via des ajustements stratégiques de la commande motrice. Un second processus, le réalignement, interviendrait de manière plus lente et automatique, et permettrait la réorganisation des différentes cartes sensorielles, visuelle et proprioceptive, dont la coordination a été perturbée par la déviation prismatique. Le réalignement

serait responsable du développement des effets consécutifs et serait médié par des structures cérébelleuses tandis que la recalibration reposerait sur l'implication du cortex postérieur pariétal. Pour autant, il demeure difficile de distinguer la contribution respective exacte de chacun de ces processus ainsi que leurs substrats cérébraux.

La mesure des effets consécutifs est réalisée dans des conditions qui sont différentes des conditions d'exposition à la perturbation (e.g. cible non-exposée). Cela ne permet cependant pas d'isoler complètement la contribution du réalignement. L'étude du transfert inter-tâche assure la mesure des effets consécutifs dans un contexte différent : celui d'une tâche n'ayant pas été pratiquée durant l'exposition. L'adaptation prismatique apparaît comme particulièrement intéressante dans le cadre de l'étude du transfert des effets consécutifs. En effet, les procédures permettent d'intégrer aisément la mesure du transfert durant les post-tests. De plus, la littérature rapporte des effets consécutifs à l'adaptation prismatique pouvant être transférés vers d'autres contextes. Néanmoins, les conditions nécessaires au transfert inter-tâche des effets consécutifs ainsi que les substrats neuronaux sous-jacents sont encore méconnus.

Objectifs

L'objectif de cette thèse était d'apporter des éléments théoriques à la compréhension et à la distinction des processus de plasticité sensorimotrice. Plus spécifiquement, nous faisons l'hypothèse que l'étude de transfert des effets consécutifs vers une tâche motrice n'ayant pas été pratiquée pendant la perturbation pouvait révéler la contribution de processus distincts durant l'adaptation sensorimotrice. Il s'agissait notamment d'investiguer les conditions favorisant le transfert des effets consécutifs. De plus, il était question d'étudier le rôle du cervelet dans les mécanismes du transfert.

Méthodes

Au sein de nos différentes études, nous avons employé une approche comportementale à travers le paradigme de l'adaptation prismatique, en utilisant des lunettes qui dévient le champ visuel de dix degrés vers la droite. Nous avons construit une procédure permettant d'étudier le transfert inter-tâche entre le lancer et le pointage. Les performances sur les deux tâches étaient mesurées lors des pré-tests. L'exposition prismatique était ensuite réalisée sur l'une des deux tâches, ce qui déterminait la condition expérimentale testée (pointage versus lancer). Puis, lors du retrait des lunettes, les effets consécutifs étaient d'abord mesurés sur la tâche dite « exposée ». Le transfert des effets consécutifs était finalement mesuré sur la tâche « non-exposée », i.e. n'ayant pas été pratiquée durant l'exposition.

Les contributions expérimentales de ce travail doctoral sont divisées en trois axes impliquant la procédure d'adaptation prismatique précédemment décrite, et combinant des approches complémentaires telles que l'analyse cinématique des mouvements de pointage (**études 1, 3 et 4**), l'imagerie motrice (**étude 2**), et la stimulation cérébrale transcrânienne à courant direct (tDCS ; **études 3 et 4**).

Contributions expérimentales

Axe 1 : Expertise & Transfert.

Dans le premier axe, l'**étude 1** avait pour objectifs d'étudier l'influence du type de tâche pratiquée durant l'exposition aux prismes sur le transfert des effets consécutifs vers une autre tâche motrice n'ayant pas été pratiquée pendant l'exposition. L'étude était séparée en trois expérimentations impliquant un total de cinquante participants sains. Les résultats ont montré que les effets consécutifs développés lors de l'exposition prismatique impliquant une tâche de pointage étaient transférables vers une tâche de lancer (expérimentation A). Néanmoins, le transfert du lancer vers

le pointage n'était possible que pour les experts en lancer (lanceurs de fléchettes de niveau national ; expérimentation B). Ainsi, l'expertise sur la tâche pratiquée durant l'exposition prismatique conditionnait la nature des processus sollicités pour faire face à la perturbation. Il est important de souligner que l'amplitude des effets consécutifs mesurés sur la tâche exposée était comparable, quels que soient la tâche pratiquée durant l'exposition et le niveau d'expertise. Une troisième expérimentation (C) a permis de confirmer la présence d'un transfert unidirectionnel du pointage vers le lancer. De plus, l'analyse des mouvements de pointage a mis en évidence des aspects cinématiques pouvant expliquer l'absence de transfert depuis le lancer vers le pointage. En effet, durant les post-tests, la direction initiale des mouvements de pointage était biaisée (i.e. décalée vers la gauche) indépendamment de la tâche pratiquée durant l'exposition. En revanche, on observait dans le groupe lancer une correction de la direction terminale des pointages ce qui conduisait à une absence de transfert (i.e. erreurs terminales proches de zéro). L'intégration des feedbacks proprioceptifs permettant la correction des mouvements de pointage en cours d'exécution, nous suggérons que la modalité proprioceptive n'a pas été biaisée par l'exposition prismatique chez les individus ayant pratiqué la tâche de lancer lors du port des prismes.

Axe 2 : Imagerie Motrice & Transfert

Dans le deuxième axe, le but de l'**étude 2** était d'étudier les caractéristiques de l'adaptation prismatique réalisée par imagerie motrice. L'imagerie motrice correspond à la représentation mentale d'un mouvement sans exécution concomitante. Elle présente néanmoins une neuro-équivalence fonctionnelle avec la pratique physique : les zones cérébrales sollicitées durant l'imagerie motrice sont comparables à celle recrutées durant l'exécution effective d'un mouvement. Dès lors, l'imagerie motrice représente l'opportunité d'étudier la plasticité induite par les étapes de préparation du mouvement en s'affranchissant de son exécution réelle et des rétroactions sensorielles qui y sont associées. Quarante-quatre participants sains ont été exposés à une déviation prismatique en réalisant des pointages réels (groupe Actif), en imaginant des mouvements de pointage (groupe Imagerie) ou en restant passifs (pas de mouvement ni d'imagerie; groupe Inactif). Les performances de pointage en boucle ouverte étaient mesurées avant et après l'exposition prismatique pour mesurer les effets consécutifs, ainsi que le transfert sur une tâche de lancer. Nous avons montré que l'adaptation prismatique par imagerie motrice permettait le transfert des effets consécutifs depuis le pointage vers le lancer, uniquement pour les individus présentant des capacités d'imagerie motrice élevées. En revanche, les individus du groupe Inactif n'ont pas montré d'effets consécutifs sur la tâche de pointage, ni de transfert vers la tâche de lancer. Ainsi, les résultats de cette étude suggèrent que le conflit inter-sensoriel induit par les prismes, combiné à l'imagerie motrice des mouvements de pointage durant l'exposition est suffisant pour développer une adaptation transférable à condition de témoigner de bonnes capacités d'imagerie motrice. Le conflit sensorimoteur induit par l'exécution de mouvements de pointage réels durant l'exposition ne semble pas indispensable pour développer des effets consécutifs transférables.

Axe 3 : tDCS & Transfert

Dans un troisième axe, l'utilisation de la stimulation cérébrale transcrânienne appliquée sur le cervelet a permis d'étudier le rôle du cervelet dans le transfert des effets consécutifs à travers deux études. Cette méthode non-invasive permet de moduler l'excitabilité de la zone ciblée et ainsi de tester de manière fonctionnelle l'implication de cette zone dans les processus adaptatifs développés durant l'adaptation prismatique. L'**étude 3** testait l'influence d'une stimulation cathodale du cervelet durant l'adaptation prismatique (depuis les pré-tests jusqu'à la fin des post-tests) sur le transfert des effets consécutifs depuis le pointage vers le lancer. Vingt-sept participants ont suivi la même procédure d'adaptation prismatique (condition pointage) en recevant soit une stimulation cathodale active soit une stimulation placebo. Les participants ayant reçu la stimulation

active ont montré une altération de la réduction des erreurs durant les premiers essais de l'exposition : les erreurs de pointage étaient plus importantes dans le groupe stimulé et corrigées moins rapidement. De plus, les effets consécutifs sur la tâche de pointage étaient plus importants mais moins stables dans le groupe stimulé. Enfin, la stimulation a également affecté le transfert des effets consécutifs vers la tâche de lancer.

L'**étude 4** avait pour but d'investiguer les effets d'une stimulation anodale sur le transfert du lancer vers le pointage. L'**étude 1** ayant démontré l'absence de transfert dans cette condition, nous faisons l'hypothèse qu'une telle stimulation pouvait booster les processus adaptatifs et augmenter le transfert chez des participants non experts en lancer. Vingt-six participants sains ont suivi la procédure d'adaptation prismatique (condition lancer) et ont reçu soit une stimulation anodale active soit une stimulation placebo. Les résultats n'ont pas montré d'amélioration du processus de réduction d'erreurs durant l'exposition, ni d'augmentation des effets consécutifs sur la tâche de lancer dans le groupe stimulé. Par ailleurs, la stimulation anodale n'a pas eu d'effet facilitant sur le transfert des effets consécutifs vers la tâche de pointage. Bien que nous ayons observé des altérations marginales au niveau de la cinématique des mouvements de pointages, les erreurs terminales demeuraient proches de zéro dans les deux groupes, soulignant l'absence de transfert malgré la stimulation.

Dans l'ensemble, les résultats de l'axe 3 montrent une possible contribution du cervelet dans les mécanismes de transfert des effets consécutifs durant l'adaptation prismatique. Nous suggérons que la stimulation puisse moduler la contribution de processus dépendant du cervelet pour faire face à la perturbation prismatique. Néanmoins, des études complémentaires sont nécessaires pour confirmer ces résultats et pour déterminer si cette contribution intervient durant et/ou après l'exposition. De plus, des investigations supplémentaires pourront permettre de vérifier s'il est possible d'augmenter le transfert grâce à une stimulation facilitatrice.

Discussion générale et conclusion

Au regard de ces apports, cette thèse souligne l'intérêt du transfert inter-tâche pour mettre en évidence la contribution de différents processus durant l'adaptation sensorimotrice, au-delà de la mesure classique des effets consécutifs. Le développement d'effets consécutifs transférables reposerait sur l'ajustement durable des modèles internes du système sensorimoteur. Ces modifications seraient guidées par les erreurs de prédictions sensorielles et impliqueraient des structures cérébelleuses.

Ainsi, ce travail doctoral fournit de nouveaux apports théoriques relatifs à la contribution de processus distincts durant l'adaptation sensorimotrice à travers la notion de transfert. Ces éléments sont discutés au regard de la littérature spécifique à l'adaptation prismatique mais également dans le contexte plus large de l'adaptation sensorimotrice. De plus, les contributions expérimentales soulignent l'influence de la tâche pratiquée lors de l'exposition à la perturbation, suggérant notamment qu'un mouvement ne peut pas être adapté s'il n'est pas suffisamment appris. Des études complémentaires seront nécessaires pour poursuivre l'investigation des conditions favorisant le développement d'une adaptation transférable et pour préciser les mécanismes et substrats neuronaux sous-jacents. Ces résultats fondamentaux permettent également d'envisager des pistes de recherches et d'applications dans le domaine clinique, visant à améliorer le transfert des compensations acquises en rééducation vers d'autres contextes.

Mots clés : plasticité sensorimotrice, adaptation, apprentissage, effets consécutifs, transfert, adaptation prismatique, modèles internes, cervelet, tDCS, imagerie motrice

Bibliography

- Aimola, L., Rogers, G., Kerkhoff, G., Smith, D. T., & Schenk, T. (2012). Visuomotor adaptation is impaired in patients with unilateral neglect. *Neuropsychologia*, *50*(6), 1158-1163. <https://doi.org/10.1016/j.neuropsychologia.2011.09.029>
- Alexander, M. S., Flodin, B. W. G., & Marigold, D. S. (2011). Prism adaptation and generalization during visually guided locomotor tasks. *Journal of Neurophysiology*, *106*(2), 860-871. <https://doi.org/10.1152/jn.01040.2010>
- Alexander, M. S., Flodin, B. W. G., & Marigold, D. S. (2013). Changes in task parameters during walking prism adaptation influence the subsequent generalization pattern. *Journal of Neurophysiology*, *109*(10), 2495-2504. <https://doi.org/10.1152/jn.00810.2012>
- Allred, R. P., Adkins, D. L., Woodlee, M. T., Husbands, L. C., Maldonado, M. A., Kane, J. R., Schallert, T., & Jones, T. A. (2008). The vermicelli handling test: A simple quantitative measure of dexterous forepaw function in rats. *Journal of Neuroscience Methods*, *170*(2), 229-244. <https://doi.org/10.1016/j.jneumeth.2008.01.015>
- Atienza, F., Balaguer, I., & Garcia-Merita, M. L. (1994). Factor analysis and reliability of the Movement Imagery Questionnaire. *Perceptual and Motor Skills*, *78*(3 Pt 2), 1323-1328. <https://doi.org/10.2466/pms.1994.78.3c.1323>
- Bachtiar, V., Near, J., Johansen-Berg, H., & Stagg, C. J. (2015). Modulation of GABA and resting state functional connectivity by transcranial direct current stimulation. *eLife*, *4*, e08789. <https://doi.org/10.7554/eLife.08789>
- Baily, J. S. (1972). Adaptation to prisms: Do proprioceptive changes mediate adapted behaviour with ballistic arm movements? *The Quarterly Journal of Experimental Psychology*, *24*(1), 8-20. <https://doi.org/10.1080/14640747208400261>
- Baizer, J. S., Kralj-Hans, I., & Glickstein, M. (1999). Cerebellar lesions and prism adaptation in macaque monkeys. *Journal of Neurophysiology*, *81*(4), 1960-1965. <https://doi.org/10.1152/jn.1999.81.4.1960>
- Bakkum, A., Donelan, J. M., & Marigold, D. S. (2020). Challenging balance during sensorimotor adaptation increases generalization. *Journal of Neurophysiology*, *123*(4), 1342-1354. <https://doi.org/10.1152/jn.00687.2019>
- Baraduc, P., & Wolpert, D. M. (2002). Adaptation to a Visuomotor Shift Depends on the Starting Posture. *Journal of Neurophysiology*, *88*(2), 973-981. <https://doi.org/10.1152/jn.2002.88.2.973>
- Bastian, A. J. (2006). Learning to predict the future: The cerebellum adapts feedforward movement control. *Current Opinion in Neurobiology*, *16*(6), 645-649. <https://doi.org/10.1016/j.conb.2006.08.016>
- Bastian, A. J. (2008). Understanding sensorimotor adaptation and learning for rehabilitation. *Current Opinion in Neurology*, *21*(6), 628-633. <https://doi.org/10.1097/WCO.0b013e328315a293>
- Bedford, F. L. (1993). Perceptual and cognitive spatial learning. *Journal of Experimental Psychology: Human Perception and Performance*, *19*(3), 517-530. <https://doi.org/10.1037/0096-1523.19.3.517>
- Bedford, F. L. (1999). Keeping perception accurate. *Trends in Cognitive Sciences*, *3*(1), 4-11. [https://doi.org/10.1016/S1364-6613\(98\)01266-2](https://doi.org/10.1016/S1364-6613(98)01266-2)
- Berniker, M., & Kording, K. (2011a). Bayesian approaches to sensory integration for motor control. *Wiley Interdisciplinary Reviews. Cognitive Science*, *2*(4), 419-428. <https://doi.org/10.1002/wcs.125>
- Berniker, M., & Kording, K. P. (2011b). Estimating the relevance of world disturbances to explain savings, interference and long-term motor adaptation effects. *PLoS Computational Biology*, *7*(10), e1002210. <https://doi.org/10.1371/journal.pcbi.1002210>

- Bikson, M., Grossman, P., Thomas, C., Zannou, A. L., Jiang, J., Adnan, T., Mourdoukoutas, A. P., Kronberg, G., Truong, D., Boggio, P., Brunoni, A. R., Charvet, L., Fregni, F., Fritsch, B., Gillick, B., Hamilton, R. H., Hampstead, B. M., Jankord, R., Kirton, A., ... Woods, A. J. (2016). Safety of Transcranial Direct Current Stimulation: Evidence Based Update 2016. *Brain Stimulation, 9*(5), 641-661. <https://doi.org/10.1016/j.brs.2016.06.004>
- Bindman, L. J., Lippold, O. C., & Redfearn, J. W. (1964). The action of brief polarizing currents on the cerebral cortex of the rat (1) during current flow and (2) in the production of long-lasting after-effects. *The Journal of Physiology, 172*, 369-382. <https://doi.org/10.1113/jphysiol.1964.sp007425>
- Bossom, J., Hamilton, C.R. (1963). Interocular transfer of prism altered coordination in split brain monkeys. *J. Comp. Physiol. Psychol. 56*, 769-774.
- Brunoni, A. R., Nitsche, M. A., Bolognini, N., Bikson, M., Wagner, T., Merabet, L., Edwards, D. J., Valero-Cabre, A., Rotenberg, A., Pascual-Leone, A., Ferrucci, R., Priori, A., Boggio, P. S., & Fregni, F. (2012). Clinical research with transcranial direct current stimulation (tDCS): Challenges and future directions. *Brain Stimulation, 5*(3), 175-195. <https://doi.org/10.1016/j.brs.2011.03.002>
- Bultitude, J. H., Farnè, A., Salemme, R., Ibarrola, D., Urquizar, C., O'Shea, J., & Luauté, J. (2017). Studying the neural bases of prism adaptation using fMRI: A technical and design challenge. *Behavior Research Methods, 49*(6), 2031-2043. <https://doi.org/10.3758/s13428-016-0840-z>
- Bultitude, J. H., Rafal, R. D., & Tinker, C. (2012). Moving forward with prisms: Sensory-motor adaptation improves gait initiation in Parkinson's disease. *Frontiers in Neurology, 3*, 132. <https://doi.org/10.3389/fneur.2012.00132>
- Burianová, H., Marstaller, L., Sowman, P., Tesan, G., Rich, A. N., Williams, M., Savage, G., & Johnson, B. W. (2013). Multimodal functional imaging of motor imagery using a novel paradigm. *NeuroImage, 71*, 50-58. <https://doi.org/10.1016/j.neuroimage.2013.01.001>
- Calzolari, E., Bolognini, N., Casati, C., Marzoli, S. B., & Vallar, G. (2015). Restoring abnormal aftereffects of prismatic adaptation through neuromodulation. *Neuropsychologia, 74*, 162-169. <https://doi.org/10.1016/j.neuropsychologia.2015.04.022>
- Cameron, B. D., de la Malla, C., & López-Moliner, J. (2014). The role of differential delays in integrating transient visual and proprioceptive information. *Frontiers in Psychology, 5*. <https://doi.org/10.3389/fpsyg.2014.00050>
- Canavan, A. G., Passingham, R. E., Marsden, C. D., Quinn, N., Wyke, M., & Polkey, C. E. (1990). Prism adaptation and other tasks involving spatial abilities in patients with Parkinson's disease, patients with frontal lobe lesions and patients with unilateral temporal lobectomies. *Neuropsychologia, 28*(9), 969-984.
- Carey, L., Walsh, A., Adikari, A., Goodin, P., Alahakoon, D., De Silva, D., Ong, K.-L., Nilsson, M., & Boyd, L. (2019). Finding the Intersection of Neuroplasticity, Stroke Recovery, and Learning: Scope and Contributions to Stroke Rehabilitation. *Neural Plasticity, 2019*, 1-15. <https://doi.org/10.1155/2019/5232374>
- Censor, N. (2013). Generalization of perceptual and motor learning: A causal link with memory encoding and consolidation? *Neuroscience, 250*, 201-207. <https://doi.org/10.1016/j.neuroscience.2013.06.062>
- Chapman, H. L., Eramudugolla, R., Gavrilescu, M., Strudwick, M. W., Loftus, A., Cunnington, R., & Mattingley, J. B. (2010). Neural mechanisms underlying spatial realignment during adaptation to optical wedge prisms. *Neuropsychologia, 48*(9), 2595-2601. <https://doi.org/10.1016/j.neuropsychologia.2010.05.006>

- Chew, T., Ho, K.-A., & Loo, C. K. (2015). Inter- and Intra-individual Variability in Response to Transcranial Direct Current Stimulation (tDCS) at Varying Current Intensities. *Brain Stimulation, 8*(6), 1130-1137. <https://doi.org/10.1016/j.brs.2015.07.031>
- Choe, C. S., & Welch, R. B. (1974). Variables affecting the intermanual transfer and decay of prism adaptation. *Journal of Experimental Psychology, 102*(6), 1076-1084. <https://doi.org/10.1037/h0036325>
- Clower, D. M., Hoffman, J. M., Votaw, J. R., Faber, T. L., Woods, R. P., & Alexander, G. E. (1996). Role of posterior parietal cortex in the recalibration of visually guided reaching. *Nature, 383*(6601), 618-621. <https://doi.org/10.1038/383618a0>
- Coello, Y., Orliaguet, J. P., & Prablanc, C. (1996). Pointing movement in an artificial perturbing inertial field : A prospective paradigm for motor control study. *Neuropsychologia, 34*(9), 879-892.
- Cohen, M. M. (1973). Visual feedback, distribution of practice, and intermanual transfer of prism aftereffects. *Perceptual and Motor Skills, 37*(2), 599-609. <https://doi.org/10.2466/pms.1973.37.2.599>
- Cohen, Malcolm Martin. (1967). Continuous versus Terminal Visual Feedback in Prism Aftereffects. *Perceptual and Motor Skills, 24*(3_suppl), 1295-1302. <https://doi.org/10.2466/pms.1967.24.3c.1295>
- Collet, C., Di Rienzo, F., El Hoyek, N., & Guillot, A. (2013). Autonomic nervous system correlates in movement observation and motor imagery. *Frontiers in Human Neuroscience, 7*, 415. <https://doi.org/10.3389/fnhum.2013.00415>
- Collet, Christian. (2002). *Mouvements & cerveau : Neurophysiologie des activités physiques et sportives*. De Boeck Université.
- Cothros, N., Wong, J. D., & Gribble, P. L. (2006). Are there distinct neural representations of object and limb dynamics? *Experimental Brain Research, 173*(4), 689-697. <https://doi.org/10.1007/s00221-006-0411-0>
- Criscimagna-Hemminger, S. E., Donchin, O., Gazzaniga, M. S., & Shadmehr, R. (2003). Learned dynamics of reaching movements generalize from dominant to nondominant arm. *Journal of Neurophysiology, 89*(1), 168-176. <https://doi.org/10.1152/jn.00622.2002>
- Criscimagna-Hemminger, S. E., & Shadmehr, R. (2008). Consolidation patterns of human motor memory. *The Journal of Neuroscience: The Official Journal of the Society for Neuroscience, 28*(39), 9610-9618. <https://doi.org/10.1523/JNEUROSCI.3071-08.2008>
- Danckert, J., Ferber, S., & Goodale, M. A. (2008). Direct effects of prismatic lenses on visuomotor control : An event-related functional MRI study. *European Journal of Neuroscience, 28*(8), 1696-1704. <https://doi.org/10.1111/j.1460-9568.2008.06460.x>
- Debarnot, U., Sperduti, M., Di Rienzo, F., & Guillot, A. (2014). Experts bodies, experts minds : How physical and mental training shape the brain. *Frontiers in Human Neuroscience, 8*, 280. <https://doi.org/10.3389/fnhum.2014.00280>
- Decety, J., & Jeannerod, M. (1995). Mentally simulated movements in virtual reality : Does Fitts's law hold in motor imagery? *Behavioural Brain Research, 72*(1-2), 127-134. [https://doi.org/10.1016/0166-4328\(96\)00141-6](https://doi.org/10.1016/0166-4328(96)00141-6)
- Decety, J., Perani, D., Jeannerod, M., Bettinardi, V., Tadary, B., Woods, R., Mazziotta, J. C., & Fazio, F. (1994). Mapping motor representations with positron emission tomography. *Nature, 371*(6498), 600-602. <https://doi.org/10.1038/371600a0>
- Decety, J., Sjöholm, H., Ryding, E., Stenberg, G., & Ingvar, D. H. (1990). The cerebellum participates in mental activity : Tomographic measurements of regional cerebral blood flow. *Brain Research, 535*(2), 313-317. [https://doi.org/10.1016/0006-8993\(90\)91615-n](https://doi.org/10.1016/0006-8993(90)91615-n)

- Dechent, P., Merboldt, K.-D., & Frahm, J. (2004). Is the human primary motor cortex involved in motor imagery? *Brain Research. Cognitive Brain Research*, 19(2), 138-144. <https://doi.org/10.1016/j.cogbrainres.2003.11.012>
- Deiber, M. P., Ibañez, V., Honda, M., Sadato, N., Raman, R., & Hallett, M. (1998). Cerebral processes related to visuomotor imagery and generation of simple finger movements studied with positron emission tomography. *NeuroImage*, 7(2), 73-85. <https://doi.org/10.1006/nimg.1997.0314>
- Della-Maggiore, V., Landi, S. M., & Villalta, J. I. (2015). Sensorimotor adaptation: Multiple forms of plasticity in motor circuits. *The Neuroscientist: A Review Journal Bringing Neurobiology, Neurology and Psychiatry*, 21(2), 109-125. <https://doi.org/10.1177/1073858414545228>
- Denis, M. (1985). Visual imagery and the use of mental practice in the development of motor skills. *Canadian Journal of Applied Sport Sciences. Journal Canadien Des Sciences Appliquees Au Sport*, 10(4), 4S-16S.
- Desmurget, M. (1998). From Eye to Hand: Planning Goal-directed Movements. *Neuroscience & Biobehavioral Reviews*, 22(6), 761-788. [https://doi.org/10.1016/S0149-7634\(98\)00004-9](https://doi.org/10.1016/S0149-7634(98)00004-9)
- Di Rienzo, F., Collet, C., Hoyek, N., & Guillot, A. (2014). Impact of neurologic deficits on motor imagery: A systematic review of clinical evaluations. *Neuropsychology Review*, 24(2), 116-147. <https://doi.org/10.1007/s11065-014-9257-6>
- Di Rienzo, F., Debarnot, U., Daligault, S., Saruco, E., Delpuech, C., Doyon, J., Collet, C., & Guillot, A. (2016). Online and Offline Performance Gains Following Motor Imagery Practice: A Comprehensive Review of Behavioral and Neuroimaging Studies. *Frontiers in Human Neuroscience*, 10, 315. <https://doi.org/10.3389/fnhum.2016.00315>
- Doidge, N. (2007). *The brain that changes itself: Stories of personal triumph from the frontiers of brain science*. Viking.
- Doyon, J., & Benali, H. (2005). Reorganization and plasticity in the adult brain during learning of motor skills. *Current Opinion in Neurobiology*, 15(2), 161-167. <https://doi.org/10.1016/j.conb.2005.03.004>
- Dundas, J. E., Thickbroom, G. W., & Mastaglia, F. L. (2007). Perception of comfort during transcranial DC stimulation: Effect of NaCl solution concentration applied to sponge electrodes. *Clinical Neurophysiology: Official Journal of the International Federation of Clinical Neurophysiology*, 118(5), 1166-1170. <https://doi.org/10.1016/j.clinph.2007.01.010>
- Ehrsson, H. H., Geyer, S., & Naito, E. (2003). Imagery of voluntary movement of fingers, toes, and tongue activates corresponding body-part-specific motor representations. *Journal of Neurophysiology*, 90(5), 3304-3316. <https://doi.org/10.1152/jn.01113.2002>
- Elliott, D., Hansen, S., Grierson, L. E. M., Lyons, J., Bennett, S. J., & Hayes, S. J. (2010). Goal-directed aiming: Two components but multiple processes. *Psychological Bulletin*, 136(6), 1023-1044. <https://doi.org/10.1037/a0020958>
- Facchin, A., Folegatti, A., Rossetti, Y., & Farnè, A. (2019). The half of the story we did not know about prism adaptation. *Cortex*, 119, 141-157. <https://doi.org/10.1016/j.cortex.2019.04.012>
- Fernandez-Ruiz, J., Diaz, R., Hall-Haro, C., Vergara, P., Mischner, J., Nuñez, L., Drucker-Colin, R., Ochoa, A., & Alonso, M. E. (2003). Normal prism adaptation but reduced after-effect in basal ganglia disorders using a throwing task. *European Journal of Neuroscience*, 18(3), 689-694. <https://doi.org/10.1046/j.1460-9568.2003.02785.x>
- Fernández-Ruiz, J., Hall, C., Vergara, P., & Díaz, R. (2000). Prism adaptation in normal aging: Slower adaptation rate and larger aftereffect. *Brain Research. Cognitive Brain Research*, 9(3), 223-226. [https://doi.org/10.1016/S0926-6410\(99\)00057-9](https://doi.org/10.1016/S0926-6410(99)00057-9)

- Fernandez-Ruiz, Juan, Velásquez-Perez, L., Díaz, R., Drucker-Colín, R., Pérez-González, R., Canales, N., Sánchez-Cruz, G., Martínez-Góngora, E., Medrano, Y., Almaguer-Mederos, L., Seifried, C., & Auburger, G. (2007). Prism adaptation in spinocerebellar ataxia type 2. *Neuropsychologia*, *45*(12), 2692-2698. <https://doi.org/10.1016/j.neuropsychologia.2007.04.006>
- Ferrucci, R., Brunoni, A. R., Parazzini, M., Vergari, M., Rossi, E., Fumagalli, M., Mameli, F., Rosa, M., Giannicola, G., Zago, S., & Priori, A. (2013). Modulating Human Procedural Learning by Cerebellar Transcranial Direct Current Stimulation. *The Cerebellum*, *12*(4), 485-492. <https://doi.org/10.1007/s12311-012-0436-9>
- Ferrucci, R., Cortese, F., & Priori, A. (2015). Cerebellar tDCS : How to Do It. *The Cerebellum*, *14*(1), 27-30. <https://doi.org/10.1007/s12311-014-0599-7>
- Filmer, H. L., Dux, P. E., & Mattingley, J. B. (2014). Applications of transcranial direct current stimulation for understanding brain function. *Trends in Neurosciences*, *37*(12), 742-753. <https://doi.org/10.1016/j.tins.2014.08.003>
- Fleury, L., Pastor, D., Revol, P., Delporte, L., & Rossetti, Y. (2020). Inter-task transfer of prism adaptation depends on exposed task mastery. *Scientific Reports*, *10*(1), 5687. <https://doi.org/10.1038/s41598-020-62519-5>
- Fleury, L., Prablanc, C., & Priot, A.-E. (2019). Do prism and other adaptation paradigms really measure the same processes? *Cortex*, *119*, 480-496. <https://doi.org/10.1016/j.cortex.2019.07.012>
- Fortis, P., Maravita, A., Gallucci, M., Ronchi, R., Grassi, E., Senna, I., Olgiati, E., Perucca, L., Banco, E., Posteraro, L., Tesio, L., & Vallar, G. (2010). Rehabilitating patients with left spatial neglect by prism exposure during a visuomotor activity. *Neuropsychology*, *24*(6), 681-697. <https://doi.org/10.1037/a0019476>
- Galea, J. M., Jayaram, G., Ajagbe, L., & Celnik, P. (2009). Modulation of Cerebellar Excitability by Polarity-Specific Noninvasive Direct Current Stimulation. *Journal of Neuroscience*, *29*(28), 9115-9122. <https://doi.org/10.1523/JNEUROSCI.2184-09.2009>
- Galea, J. M., Miall, R. C., & Woolley, D. G. (2007). Asymmetric interlimb transfer of concurrent adaptation to opposing dynamic forces. *Experimental Brain Research*, *182*(2), 267-273. <https://doi.org/10.1007/s00221-007-1069-y>
- Galea, J. M., Vazquez, A., Pasricha, N., Orban de Xivry, J.-J., & Celnik, P. (2011). Dissociating the Roles of the Cerebellum and Motor Cortex during Adaptive Learning : The Motor Cortex Retains What the Cerebellum Learns. *Cerebral Cortex*, *21*(8), 1761-1770. <https://doi.org/10.1093/cercor/bhq246>
- Galea, Joseph M., Vazquez, A., Pasricha, N., de Xivry, J.-J. O., & Celnik, P. (2011). Dissociating the roles of the cerebellum and motor cortex during adaptive learning : The motor cortex retains what the cerebellum learns. *Cerebral Cortex (New York, N.Y.: 1991)*, *21*(8), 1761-1770. <https://doi.org/10.1093/cercor/bhq246>
- Gandiga, P. C., Hummel, F. C., & Cohen, L. G. (2006). Transcranial DC stimulation (tDCS) : A tool for double-blind sham-controlled clinical studies in brain stimulation. *Clinical Neurophysiology: Official Journal of the International Federation of Clinical Neurophysiology*, *117*(4), 845-850. <https://doi.org/10.1016/j.clinph.2005.12.003>
- Gao, Q., Duan, X., & Chen, H. (2011). Evaluation of effective connectivity of motor areas during motor imagery and execution using conditional Granger causality. *NeuroImage*, *54*(2), 1280-1288. <https://doi.org/10.1016/j.neuroimage.2010.08.071>

- Gaveau, V., Pisella, L., Priot, A.-E., Fukui, T., Rossetti, Y., Pélisson, D., & Prablanc, C. (2014). Automatic online control of motor adjustments in reaching and grasping. *Neuropsychologia*, *55*, 25-40. <https://doi.org/10.1016/j.neuropsychologia.2013.12.005>
- Gaveau, V., Prablanc, C., Laurent, D., Rossetti, Y., & Priot, A.-E. (2014). Visuomotor adaptation needs a validation of prediction error by feedback error. *Frontiers in Human Neuroscience*, *8*. <https://doi.org/10.3389/fnhum.2014.00880>
- Gaveau, V., Priot, A.-E., Pisella, L., Havé, L., Prablanc, C., & Rossetti, Y. (2018a). Paradoxical adaptation of successful movements: The crucial role of internal error signals. *Consciousness and Cognition*. <https://doi.org/10.1016/j.concog.2018.06.011>
- Gerardin, E., Sirigu, A., Lehericy, S., Poline, J. B., Gaymard, B., Marsault, C., Agid, Y., & Le Bihan, D. (2000). Partially overlapping neural networks for real and imagined hand movements. *Cerebral Cortex (New York, N.Y.: 1991)*, *10*(11), 1093-1104. <https://doi.org/10.1093/cercor/10.11.1093>
- Gogel, W. C., & Tietz, J. (1974). The effect of perceived distance on perceived movement. *Perception & Psychophysics*, *16*(1), 70-78. <https://doi.org/10.3758/BF03203253>
- Gregg, M., Hall, C., & Butler, A. (2010). The MIQ-RS: A Suitable Option for Examining Movement Imagery Ability. *Evidence-Based Complementary and Alternative Medicine: ECAM*, *7*(2), 249-257. <https://doi.org/10.1093/ecam/nem170>
- Grèzes, J., & Decety, J. (2002). Does visual perception of object afford action? Evidence from a neuroimaging study. *Neuropsychologia*, *40*(2), 212-222. [https://doi.org/10.1016/s0028-3932\(01\)00089-6](https://doi.org/10.1016/s0028-3932(01)00089-6)
- Guilbert, J., Fernandez, J., Molina, M., Morin, M.-F., & Alamargot, D. (2020). Imagining handwriting movements in a usual or unusual position: Effect of posture congruency on visual and kinesthetic motor imagery. *Psychological Research*. <https://doi.org/10.1007/s00426-020-01399-w>
- Guillot, A., & Collet, C. (2005). Duration of mentally simulated movement: A review. *Journal of Motor Behavior*, *37*(1), 10-20. <https://doi.org/10.3200/JMBR.37.1.10-20>
- Guillot, A., & Collet, C. (Éds.). (2010). *The neurophysiological foundations of mental and motor imagery*. Oxford University Press.
- Guillot, A., Collet, C., Nguyen, V. A., Malouin, F., Richards, C., & Doyon, J. (2008). Functional neuroanatomical networks associated with expertise in motor imagery. *NeuroImage*, *41*(4), 1471-1483. <https://doi.org/10.1016/j.neuroimage.2008.03.042>
- Guillot, A., Collet, C., Nguyen, V. A., Malouin, F., Richards, C., & Doyon, J. (2009). Brain activity during visual versus kinesthetic imagery: An fMRI study. *Human Brain Mapping*, *30*(7), 2157-2172. <https://doi.org/10.1002/hbm.20658>
- Guillot, A., Di Rienzo, F., Macintyre, T., Moran, A., & Collet, C. (2012). Imagining is Not Doing but Involves Specific Motor Commands: A Review of Experimental Data Related to Motor Inhibition. *Frontiers in Human Neuroscience*, *6*, 247. <https://doi.org/10.3389/fnhum.2012.00247>
- Guillot, A., Hoyek, N., Louis, M., & Collet, C. (2012). Understanding the timing of motor imagery: Recent findings and future directions. *International Review of Sport and Exercise Psychology*, *5*(1), 3-22. <https://doi.org/10.1080/1750984X.2011.623787>
- Guleyupoglu, B., Schestatsky, P., Edwards, D., Fregni, F., & Bikson, M. (2013). Classification of methods in transcranial electrical stimulation (tES) and evolving strategy from historical approaches to contemporary innovations. *Journal of Neuroscience Methods*, *219*(2), 297-311. <https://doi.org/10.1016/j.jneumeth.2013.07.016>

- Haith, A. M., & Krakauer, J. W. (2013). Model-based and model-free mechanisms of human motor learning. *Advances in Experimental Medicine and Biology*, 782, 1-21. https://doi.org/10.1007/978-1-4614-5465-6_1
- Hall, C. R., & Martin, K. A. (1997). Measuring movement imagery abilities : A revision of the Movement Imagery Questionnaire. *Journal of Mental Imagery*, 21(1-2), 143-154.
- Hamilton, C. R. (1964). Intermanual Transfer of Adaptation to Prisms. *The American Journal of Psychology*, 77(3), 457-462. <https://doi.org/10.2307/1421017>
- Hanajima, R., Shadmehr, R., Ohminami, S., Tsutsumi, R., Shirota, Y., Shimizu, T., Tanaka, N., Terao, Y., Tsuji, S., Ugawa, Y., Uchimura, M., Inoue, M., & Kitazawa, S. (2015). Modulation of error-sensitivity during a prism adaptation task in people with cerebellar degeneration. *Journal of Neurophysiology*, 114(4), 2460-2471. <https://doi.org/10.1152/jn.00145.2015>
- Hanakawa, T., Dimyan, M. A., & Hallett, M. (2008). Motor planning, imagery, and execution in the distributed motor network : A time-course study with functional MRI. *Cerebral Cortex (New York, N.Y.: 1991)*, 18(12), 2775-2788. <https://doi.org/10.1093/cercor/bhn036>
- Hanakawa, T., Immisch, I., Toma, K., Dimyan, M. A., Van Gelderen, P., & Hallett, M. (2003). Functional properties of brain areas associated with motor execution and imagery. *Journal of Neurophysiology*, 89(2), 989-1002. <https://doi.org/10.1152/jn.00132.2002>
- Harris, C. S. (1963). Adaptation to Displaced Vision : Visual, Motor, or Proprioceptive Change? *Science*, 140(3568), 812-813. <https://doi.org/10.1126/science.140.3568.812>
- Harris, C.S., (1965). Perceptual adaptation to inverted, reversed, and displaced vision. *Psychol. Rev.* 72 (6), 419–444, <http://dx.doi.org/10.1037/h0022616>.
- Heams-Ogus, T. (2013). *Les mondes darwiniens : L'évolution de l'évolution*.
- Held, R., Freedman, S.J. (1963). Plasticity in human sensorimotor control. *Science* 142,455–462 <https://www.jstor.org/stable/1711937>.
- Held, R., & Gottlieb, N. (1958). Technique for Studying Adaptation to Disarranged Hand-Eye Coordination. *Perceptual and Motor Skills*, 8(3), 83-86. <https://doi.org/10.2466/pms.1958.8.3.83>
- Herculano-Houzel, S. (2009). The human brain in numbers : A linearly scaled-up primate brain. *Frontiers in Human Neuroscience*, 3, 31. <https://doi.org/10.3389/neuro.09.031.2009>
- Herzfeld, D. J., Pastor, D., Haith, A. M., Rossetti, Y., Shadmehr, R., & O'Shea, J. (2014). Contributions of the cerebellum and the motor cortex to acquisition and retention of motor memories. *NeuroImage*, 98, 147-158. <https://doi.org/10.1016/j.neuroimage.2014.04.076>
- Hétu, S., Grégoire, M., Saimpont, A., Coll, M.-P., Eugène, F., Michon, P.-E., & Jackson, P. L. (2013). The neural network of motor imagery : An ALE meta-analysis. *Neuroscience and Biobehavioral Reviews*, 37(5), 930-949. <https://doi.org/10.1016/j.neubiorev.2013.03.017>
- Huang, V. S., Haith, A., Mazzoni, P., & Krakauer, J. W. (2011). Rethinking motor learning and savings in adaptation paradigms : Model-free memory for successful actions combines with internal models. *Neuron*, 70(4), 787-801. <https://doi.org/10.1016/j.neuron.2011.04.012>
- Hwang, E. J., & Shadmehr, R. (2005). Internal models of limb dynamics and the encoding of limb state. *Journal of Neural Engineering*, 2(3), S266-278. <https://doi.org/10.1088/1741-2560/2/3/S09>
- Inoue, M., & Kitazawa, S. (2018). Motor Error in Parietal Area 5 and Target Error in Area 7 Drive Distinctive Adaptation in Reaching. *Current Biology: CB*, 28(14), 2250-2262.e3. <https://doi.org/10.1016/j.cub.2018.05.056>

- Inoue, M., Uchimura, M., Karibe, A., O'Shea, J., Rossetti, Y., & Kitazawa, S. (2015). Three timescales in prism adaptation. *Journal of Neurophysiology*, *113*(1), 328-338. <https://doi.org/10.1152/jn.00803.2013>
- Iseki, K., Hanakawa, T., Shinozaki, J., Nankaku, M., & Fukuyama, H. (2008). Neural mechanisms involved in mental imagery and observation of gait. *NeuroImage*, *41*(3), 1021-1031. <https://doi.org/10.1016/j.neuroimage.2008.03.010>
- Jackson, P. L., Meltzoff, A. N., & Decety, J. (2006). Neural circuits involved in imitation and perspective-taking. *NeuroImage*, *31*(1), 429-439. <https://doi.org/10.1016/j.neuroimage.2005.11.026>
- Jacquin-Courtois, S., O'Shea, J., Luauté, J., Pisella, L., Revol, P., Mizuno, K., Rode, G., & Rossetti, Y. (2013). Rehabilitation of spatial neglect by prism adaptation : A peculiar expansion of sensorimotor after-effects to spatial cognition. *Neuroscience & Biobehavioral Reviews*, *37*(4), 594-609. <https://doi.org/10.1016/j.neubiorev.2013.02.007>
- Jakobson, L. S., & Goodale, M. A. (1989). Trajectories of reaches to prismatically-displaced targets : Evidence for « automatic » visuomotor recalibration. *Experimental Brain Research*, *78*(3), 575-587. <https://doi.org/10.1007/BF00230245>
- Jayaram, G., Tang, B., Pallegadda, R., Vasudevan, E. V. L., Celnik, P., & Bastian, A. (2012). Modulating locomotor adaptation with cerebellar stimulation. *Journal of Neurophysiology*, *107*(11), 2950-2957. <https://doi.org/10.1152/jn.00645.2011>
- Jeannerod, M. (1984). The Timing of Natural Prehension Movements. *Journal of Motor Behavior*, *16*(3), 235-254. <https://doi.org/10.1080/00222895.1984.10735319>
- Jeannerod, M. (1994). The representing brain : Neural correlates of motor intention and imagery. *Behavioral and Brain Sciences*, *17*(2), 187-202. <https://doi.org/10.1017/S0140525X00034026>
- Jeannerod, Marc. (2001). Neural Simulation of Action : A Unifying Mechanism for Motor Cognition. *NeuroImage*, *14*(1), S103-S109. <https://doi.org/10.1006/nimg.2001.0832>
- Joiner, W. M., & Smith, M. A. (2008). Long-Term Retention Explained by a Model of Short-Term Learning in the Adaptive Control of Reaching. *Journal of Neurophysiology*, *100*(5), 2948-2955. <https://doi.org/10.1152/jn.90706.2008>
- Kalenscher, T., Kalveram, K.-T., & Konczak, J. (2003). Effects of two different dynamic environments on force adaptation : Exposure to a new force but not the preceding force experience accounts for transition- and after-effects. *Motor Control*, *7*(3), 242-263. <https://doi.org/10.1123/mcj.7.3.242>
- Kalil, R. E., & Freedman, S. J. (1966). Intermanual transfer of compensation for displaced vision. *Perceptual and Motor Skills*, *22*(1), 123-126. <https://doi.org/10.2466/pms.1966.22.1.123>
- Kawato, M. (1999). Internal models for motor control and trajectory planning. *Current Opinion in Neurobiology*, *9*(6), 718-727. [https://doi.org/10.1016/S0959-4388\(99\)00028-8](https://doi.org/10.1016/S0959-4388(99)00028-8)
- Kessler, S. K., Turkeltaub, P. E., Benson, J. G., & Hamilton, R. H. (2012). Differences in the experience of active and sham transcranial direct current stimulation. *Brain Stimulation*, *5*(2), 155-162. <https://doi.org/10.1016/j.brs.2011.02.007>
- Kitago, T., & Krakauer, J. W. (2013). Motor learning principles for neurorehabilitation. *Handbook of Clinical Neurology*, *110*, 93-103. <https://doi.org/10.1016/B978-0-444-52901-5.00008-3>
- Kitazawa, S., Kimura, T., & Uka, T. (1997). Prism Adaptation of Reaching Movements : Specificity for the Velocity of Reaching. *The Journal of Neuroscience*, *17*(4), 1481-1492. <https://doi.org/10.1523/JNEUROSCI.17-04-01481.1997>

- Kluzik, J., Diedrichsen, J., Shadmehr, R., & Bastian, A. J. (2008). Reach Adaptation : What Determines Whether We Learn an Internal Model of the Tool or Adapt the Model of Our Arm? *Journal of Neurophysiology*, *100*(3), 1455-1464. <https://doi.org/10.1152/jn.90334.2008>
- Köhlerl, (1951). Ueber aufbau und Wandlungen der wahrnehmungswelt. Ester. Akad.der Wissenschaften 227, 1–118
- Kojima, Y. (2004). Memory of Learning Facilitates Saccadic Adaptation in the Monkey. *Journal of Neuroscience*, *24*(34), 7531-7539. <https://doi.org/10.1523/JNEUROSCI.1741-04.2004>
- Kornheiser, A. S. (1976). Adaptation to laterally displaced vision : A review. *Psychological Bulletin*, *83*(5), 783-816. <https://doi.org/10.1037/0033-2909.83.5.783>
- Krakauer, J. W. (2005). Adaptation to Visuomotor Transformations : Consolidation, Interference, and Forgetting. *Journal of Neuroscience*, *25*(2), 473-478. <https://doi.org/10.1523/JNEUROSCI.4218-04.2005>
- Krakauer, J. W., Pine, Z. M., Ghilardi, M. F., & Ghez, C. (2000). Learning of visuomotor transformations for vectorial planning of reaching trajectories. *The Journal of Neuroscience: The Official Journal of the Society for Neuroscience*, *20*(23), 8916-8924.
- Krakauer, W. (2009). Motor learning and consolidation : The case of visuomotor rotation. *Advances in Experimental Medicine and Biology*, *629*, 405-421. https://doi.org/10.1007/978-0-387-77064-2_21
- Krakauer, W., Hadjiosif, A. M., Xu, J., Wong, A. L., & Haith, A. M. (2019). Motor Learning. *Comprehensive Physiology*, *9*(2), 613-663. <https://doi.org/10.1002/cphy.c170043>
- Krakauer, W., & Mazzoni, P. (2011). Human sensorimotor learning : Adaptation, skill, and beyond. *Current Opinion in Neurobiology*, *21*(4), 636-644. <https://doi.org/10.1016/j.conb.2011.06.012>
- Krueger, A. K., Hendriks, B., & Gauch, S. (2019). The multiple meanings of translational research in (bio)medical research. *History and Philosophy of the Life Sciences*, *41*(4), 57. <https://doi.org/10.1007/s40656-019-0293-7>
- Küper, M., Wünnemann, M. J. S., Thürling, M., Stefanescu, R. M., Maderwald, S., Elles, H. G., Göricke, S., Ladd, M. E., & Timmann, D. (2014). Activation of the cerebellar cortex and the dentate nucleus in a prism adaptation fMRI study. *Human Brain Mapping*, *35*(4), 1574-1586. <https://doi.org/10.1002/hbm.22274>
- Lackner, J. R., & Dizio, P. (1994). Rapid adaptation to Coriolis force perturbations of arm trajectory. *Journal of Neurophysiology*, *72*(1), 299-313. <https://doi.org/10.1152/jn.1994.72.1.299>
- Lackner, James R., & DiZio, P. (2002). Adaptation to Coriolis Force Perturbation of Movement Trajectory. In *Sensorimotor Control of Movement and Posture* (p. 69-78). Springer, Boston, MA. https://doi.org/10.1007/978-1-4615-0713-0_9
- Lackner, James R., & DiZio, P. (2005). Motor control and learning in altered dynamic environments. *Current Opinion in Neurobiology*, *15*(6), 653-659. <https://doi.org/10.1016/j.conb.2005.10.012>
- Lacourse, M. G., Orr, E. L. R., Cramer, S. C., & Cohen, M. J. (2005). Brain activation during execution and motor imagery of novel and skilled sequential hand movements. *NeuroImage*, *27*(3), 505-519. <https://doi.org/10.1016/j.neuroimage.2005.04.025>
- Làdavas, E., Bonifazi, S., Catena, L., & Serino, A. (2011). Neglect rehabilitation by prism adaptation : Different procedures have different impacts. *Neuropsychologia*, *49*(5), 1136-1145. <https://doi.org/10.1016/j.neuropsychologia.2011.01.044>

- Làdavvas, E., Giulietti, S., Avenanti, A., Bertini, C., Lorenzini, E., Quinquinio, C., & Serino, A. (2015). A-tDCS on the ipsilesional parietal cortex boosts the effects of prism adaptation treatment in neglect. *Restorative Neurology and Neuroscience*, *33*(5), 647-662. <https://doi.org/10.3233/RNN-140464>
- Lefumat, H. Z., Vercher, J.-L., Miall, R. C., Cole, J., Buloup, F., Bringoux, L., Bourdin, C., & Sarlegna, F. R. (2015). To transfer or not to transfer? Kinematics and laterality quotient predict interlimb transfer of motor learning. *Journal of Neurophysiology*, *114*(5), 2764-2774. <https://doi.org/10.1152/jn.00749.2015>
- Leow, L.-A., Marinovic, W., Riek, S., & Carroll, T. J. (2017). Cerebellar anodal tDCS increases implicit learning when strategic re-aiming is suppressed in sensorimotor adaptation. *PLoS One*, *12*(7), e0179977. <https://doi.org/10.1371/journal.pone.0179977>
- Lorey, B., Pilgramm, S., Bischoff, M., Stark, R., Vaitl, D., Kindermann, S., Munzert, J., & Zentgraf, K. (2011). Activation of the parieto-premotor network is associated with vivid motor imagery—A parametric fMRI study. *PLoS One*, *6*(5), e20368. <https://doi.org/10.1371/journal.pone.0020368>
- Lotze, M., Montoya, P., Erb, M., Hülsmann, E., Flor, H., Klose, U., Birbaumer, N., & Grodd, W. (1999). Activation of cortical and cerebellar motor areas during executed and imagined hand movements: An fMRI study. *Journal of Cognitive Neuroscience*, *11*(5), 491-501. <https://doi.org/10.1162/089892999563553>
- Lotze, Martin, & Halsband, U. (2006). Motor imagery. *Journal of Physiology, Paris*, *99*(4-6), 386-395. <https://doi.org/10.1016/j.jphysparis.2006.03.012>
- Luauté, J., Schwartz, S., Rossetti, Y., Spiridon, M., Rode, G., Boisson, D., & Vuilleumier, P. (2009). Dynamic Changes in Brain Activity during Prism Adaptation. *Journal of Neuroscience*, *29*(1), 169-178. <https://doi.org/10.1523/JNEUROSCI.3054-08.2009>
- MacIntyre, T. E., Madan, C. R., Moran, A. P., Collet, C., & Guillot, A. (2018). Motor imagery, performance and motor rehabilitation. *Progress in Brain Research*, *240*, 141-159. <https://doi.org/10.1016/bs.pbr.2018.09.010>
- Macuga, K. L., & Frey, S. H. (2012). Neural representations involved in observed, imagined, and imitated actions are dissociable and hierarchically organized. *NeuroImage*, *59*(3), 2798-2807. <https://doi.org/10.1016/j.neuroimage.2011.09.083>
- Makino, H., Hwang, E. J., Hedrick, N. G., & Komiyama, T. (2016). Circuit Mechanisms of Sensorimotor Learning. *Neuron*, *92*(4), 705-721. <https://doi.org/10.1016/j.neuron.2016.10.029>
- Malenka, R. C., & Bear, M. F. (2004). LTP and LTD: An embarrassment of riches. *Neuron*, *44*(1), 5-21. <https://doi.org/10.1016/j.neuron.2004.09.012>
- Malfait, N., & Ostry, D. J. (2004). Is interlimb transfer of force-field adaptation a cognitive response to the sudden introduction of load? *The Journal of Neuroscience: The Official Journal of the Society for Neuroscience*, *24*(37), 8084-8089. <https://doi.org/10.1523/JNEUROSCI.1742-04.2004>
- Malfait, N., Shiller, D. M., & Ostry, D. J. (2002). Transfer of motor learning across arm configurations. *The Journal of Neuroscience: The Official Journal of the Society for Neuroscience*, *22*(22), 9656-9660.
- Malouin, F., Richards, C. L., Jackson, P. L., Dumas, F., & Doyon, J. (2003). Brain activations during motor imagery of locomotor-related tasks: A PET study. *Human Brain Mapping*, *19*(1), 47-62. <https://doi.org/10.1002/hbm.10103>
- Malouin, F., Richards, C. L., Jackson, P. L., Lafleur, M. F., Durand, A., & Doyon, J. (2007). The Kinesthetic and Visual Imagery Questionnaire (KVIQ) for assessing motor imagery in persons with physical disabilities: A reliability and construct validity study. *Journal of Neurologic Physical Therapy: JNPT*, *31*(1), 20-29. <https://doi.org/10.1097/01.npt.0000260567.24122.64>

- Martin, T. A., Keating, J. G., Goodkin, H. P., Bastian, A. J., & Thach, W. T. (1996a). Throwing while looking through prisms. II. Specificity and storage of multiple gaze-throw calibrations. *Brain: A Journal of Neurology*, *119* (Pt 4), 1199-1211. <https://doi.org/10.1093/brain/119.4.1199>
- Martin, T. A., Keating, J. G., Goodkin, H. P., Bastian, A. J., & Thach, W. T. (1996b). Throwing while looking through prisms I. Focal olivocerebellar lesions impair adaptation. *Brain*, *119*(4), 1183-1198. <https://doi.org/10.1093/brain/119.4.1183>
- Maschke, M., Gomez, C. M., Ebner, T. J., & Konczak, J. (2004). Hereditary Cerebellar Ataxia Progressively Impairs Force Adaptation During Goal-Directed Arm Movements. *Journal of Neurophysiology*, *91*(1), 230-238. <https://doi.org/10.1152/jn.00557.2003>
- Mazzoni, P., & Krakauer, J. W. (2006). An Implicit Plan Overrides an Explicit Strategy during Visuomotor Adaptation. *Journal of Neuroscience*, *26*(14), 3642-3645. <https://doi.org/10.1523/JNEUROSCI.5317-05.2006>
- McDougale, S. D., Bond, K. M., & Taylor, J. A. (2015). Explicit and Implicit Processes Constitute the Fast and Slow Processes of Sensorimotor Learning. *The Journal of Neuroscience: The Official Journal of the Society for Neuroscience*, *35*(26), 9568-9579. <https://doi.org/10.1523/JNEUROSCI.5061-14.2015>
- McDougale, S. D., Ivry, R. B., & Taylor, J. A. (2016). Taking Aim at the Cognitive Side of Learning in Sensorimotor Adaptation Tasks. *Trends in Cognitive Sciences*, *20*(7), 535-544. <https://doi.org/10.1016/j.tics.2016.05.002>
- Merzenich, M. M., Nelson, R. J., Stryker, M. P., Cynader, M. S., Schoppmann, A., & Zook, J. M. (1984). Somatosensory cortical map changes following digit amputation in adult monkeys. *The Journal of Comparative Neurology*, *224*(4), 591-605. <https://doi.org/10.1002/cne.902240408>
- Miall, R. C., & Wolpert, D. M. (1996). Forward Models for Physiological Motor Control. *Neural Networks*, *9*(8), 1265-1279. [https://doi.org/10.1016/S0893-6080\(96\)00035-4](https://doi.org/10.1016/S0893-6080(96)00035-4)
- Micera, S., Caleo, M., Chisari, C., Hummel, F. C., & Pedrocchi, A. (2020). Advanced Neurotechnologies for the Restoration of Motor Function. *Neuron*, *105*(4), 604-620. <https://doi.org/10.1016/j.neuron.2020.01.039>
- Michel, C. (2006). Simulating unilateral neglect in normals : Myth or reality? *Restorative Neurology and Neuroscience*, *24*(4-6), 419-430.
- Michel, C. (2015). Beyond the Sensorimotor Plasticity : Cognitive Expansion of Prism Adaptation in Healthy Individuals. *Frontiers in Psychology*, *6*, 1979. <https://doi.org/10.3389/fpsyg.2015.01979>
- Michel, C., Gaveau, J., Pozzo, T., & Papaxanthis, C. (2013). Prism adaptation by mental practice. *Cortex*, *49*(8), 2249-2259. <https://doi.org/10.1016/j.cortex.2012.11.008>
- Michel, C., Pisella, L., Halligan, P. W., Luauté, J., Rode, G., Boisson, D., & Rossetti, Y. (2003). Simulating unilateral neglect in normals using prism adaptation: Implications for theory. *Neuropsychologia*, *41*(1), 25-39. [https://doi.org/10.1016/S0028-3932\(02\)00135-5](https://doi.org/10.1016/S0028-3932(02)00135-5)
- Michel, C., Pisella, L., Prablanc, C., Rode, G., & Rossetti, Y. (2007). Enhancing Visuomotor Adaptation by Reducing Error Signals : Single-step (Aware) versus Multiple-step (Unaware) Exposure to Wedge Prisms. *Journal of Cognitive Neuroscience*, *19*(2), 341-350. <https://doi.org/10.1162/jocn.2007.19.2.341>
- Michel, C., Rossetti, Y., Rode, G., & Tilikete, C. (2003). After-effects of visuo-manual adaptation to prisms on body posture in normal subjects. *Experimental Brain Research*, *148*(2), 219-226. <https://doi.org/10.1007/s00221-002-1294-3>

- Michel, C., Vernet, P., Courtine, G., Ballay, Y., & Pozzo, T. (2008). Asymmetrical after-effects of prism adaptation during goal oriented locomotion. *Experimental Brain Research*, *185*(2), 259-268. <https://doi.org/10.1007/s00221-007-1152-4>
- Morehead, J. R., Qasim, S. E., Crossley, M. J., & Ivry, R. (2015). Savings upon Re-Aiming in Visuomotor Adaptation. *Journal of Neuroscience*, *35*(42), 14386-14396. <https://doi.org/10.1523/JNEUROSCI.1046-15.2015>
- Morton, S. M., & Bastian, A. J. (2004). Prism Adaptation During Walking Generalizes to Reaching and Requires the Cerebellum. *Journal of Neurophysiology*, *92*(4), 2497-2509. <https://doi.org/10.1152/jn.00129.2004>
- Morton, S. M., & Bastian, A. J. (2006). Cerebellar Contributions to Locomotor Adaptations during Splitbelt Treadmill Walking. *The Journal of Neuroscience*, *26*(36), 9107-9116. <https://doi.org/10.1523/JNEUROSCI.2622-06.2006>
- Naito, E., Kochiyama, T., Kitada, R., Nakamura, S., Matsumura, M., Yonekura, Y., & Sadato, N. (2002). Internally simulated movement sensations during motor imagery activate cortical motor areas and the cerebellum. *The Journal of Neuroscience: The Official Journal of the Society for Neuroscience*, *22*(9), 3683-3691. <https://doi.org/20026282>
- Newport, R., & Jackson, S. R. (2006). Posterior parietal cortex and the dissociable components of prism adaptation. *Neuropsychologia*, *44*(13), 2757-2765. <https://doi.org/10.1016/j.neuropsychologia.2006.01.007>
- Newport, Roger, Brown, L., Husain, M., Mort, D., & Jackson, S. R. (2006). The Role of the Posterior Parietal Lobe in Prism Adaptation : Failure to Adapt to Optical Prisms in a Patient with Bilateral Damage to Posterior Parietal Cortex. *Cortex*, *42*(5), 720-729. [https://doi.org/10.1016/S0010-9452\(08\)70410-6](https://doi.org/10.1016/S0010-9452(08)70410-6)
- Newport, Roger, & Schenk, T. (2012). Prisms and neglect : What have we learned? *Neuropsychologia*, *50*(6), 1080-1091. <https://doi.org/10.1016/j.neuropsychologia.2012.01.023>
- Nijboer, T. C. W., Nys, G. M. S., van der Smagt, M. J., van der Stigchel, S., & Dijkerman, H. C. (2011). Repetitive long-term prism adaptation permanently improves the detection of contralesional visual stimuli in a patient with chronic neglect. *Cortex*, *47*(6), 734-740. <https://doi.org/10.1016/j.cortex.2010.07.003>
- Nijboer, T., Kitazawa, S., & Rossetti, Y. (2020). Prism adaptation : Reflections and future shifts for circular translational research? *Cortex*, *126*, 213-216. <https://doi.org/10.1016/j.cortex.2020.01.001>
- Nitsche, M. A., Fricke, K., Henschke, U., Schlitterlau, A., Liebetanz, D., Lang, N., Henning, S., Tergau, F., & Paulus, W. (2003). Pharmacological modulation of cortical excitability shifts induced by transcranial direct current stimulation in humans. *The Journal of Physiology*, *553*(Pt 1), 293-301. <https://doi.org/10.1113/jphysiol.2003.049916>
- Nitsche, M. A., & Paulus, W. (2000). Excitability changes induced in the human motor cortex by weak transcranial direct current stimulation. *The Journal of Physiology*, *527 Pt 3*, 633-639. <https://doi.org/10.1111/j.1469-7793.2000.t01-1-00633.x>
- Nitsche, M. A., & Paulus, W. (2001). Sustained excitability elevations induced by transcranial DC motor cortex stimulation in humans. *Neurology*, *57*(10), 1899-1901. <https://doi.org/10.1212/wnl.57.10.1899>
- Nitsche, Michael A., Jaussi, W., Liebetanz, D., Lang, N., Tergau, F., & Paulus, W. (2004). Consolidation of human motor cortical neuroplasticity by D-cycloserine. *Neuropsychopharmacology: Official Publication of the American College of Neuropsychopharmacology*, *29*(8), 1573-1578. <https://doi.org/10.1038/sj.npp.1300517>

- Nitsche, M. A., Liebetanz, D., Antal, A., Lang, N., Tergau, F., & Paulus, W. (2003). Modulation of cortical excitability by weak direct current stimulation—Technical, safety and functional aspects. *Supplements to Clinical Neurophysiology*, *56*, 255-276. [https://doi.org/10.1016/s1567-424x\(09\)70230-2](https://doi.org/10.1016/s1567-424x(09)70230-2)
- Nitsche, M. A., Nitsche, M. S., Klein, C. C., Tergau, F., Rothwell, J. C., & Paulus, W. (2003). Level of action of cathodal DC polarisation induced inhibition of the human motor cortex. *Clinical Neurophysiology: Official Journal of the International Federation of Clinical Neurophysiology*, *114*(4), 600-604. [https://doi.org/10.1016/s1388-2457\(02\)00412-1](https://doi.org/10.1016/s1388-2457(02)00412-1)
- Nitsche, M. A., Seeber, A., Frommann, K., Klein, C. C., Rochford, C., Nitsche, M. S., Fricke, K., Liebetanz, D., Lang, N., Antal, A., Paulus, W., & Tergau, F. (2005). Modulating parameters of excitability during and after transcranial direct current stimulation of the human motor cortex. *The Journal of Physiology*, *568*(Pt 1), 291-303. <https://doi.org/10.1113/jphysiol.2005.092429>
- Norris, S. A., Greger, B. E., Martin, T. A., & Thach, W. T. (2001). Prism adaptation of reaching is dependent on the type of visual feedback of hand and target position. *Brain Research*, *905*(1-2), 207-219. [https://doi.org/10.1016/s0006-8993\(01\)02552-5](https://doi.org/10.1016/s0006-8993(01)02552-5)
- Nudo, R. J., Milliken, G. W., Jenkins, W. M., & Merzenich, M. M. (1996). Use-dependent alterations of movement representations in primary motor cortex of adult squirrel monkeys. *The Journal of Neuroscience: The Official Journal of the Society for Neuroscience*, *16*(2), 785-807.
- Oldrati, V., & Schutter, D. J. L. G. (2018). Targeting the Human Cerebellum with Transcranial Direct Current Stimulation to Modulate Behavior: A Meta-Analysis. *The Cerebellum*, *17*(2), 228-236. <https://doi.org/10.1007/s12311-017-0877-2>
- O'Shea, J., Gaveau, V., Kandel, M., Koga, K., Susami, K., Prablanc, C., & Rossetti, Y. (2014). Kinematic markers dissociate error correction from sensorimotor realignment during prism adaptation. *Neuropsychologia*, *55*, 15-24. <https://doi.org/10.1016/j.neuropsychologia.2013.09.021>
- O'Shea, J., Revol, P., Cousijn, H., Near, J., Petitet, P., Jacquin-Courtois, S., Johansen-Berg, H., Rode, G., & Rossetti, Y. (2017). Induced sensorimotor cortex plasticity remediates chronic treatment-resistant visual neglect. *eLife*, *6*. <https://doi.org/10.7554/eLife.26602>
- Panico, F., Jacquin-Courtois, S., Di Marco, J., Perrin, C., Trojano, L., & Rossetti, Y. (2017). TDCS reactivation of dormant adaptation circuits. *Cortex*, *94*, 196-199. <https://doi.org/10.1016/j.cortex.2017.02.003>
- Panico, F., Rossetti, Y., & Trojano, L. (2020). On the mechanisms underlying Prism Adaptation: A review of neuro-imaging and neuro-stimulation studies. *Cortex*, *123*, 57-71. <https://doi.org/10.1016/j.cortex.2019.10.003>
- Panico, F., Sagliano, L., Grossi, D., & Trojano, L. (2016a). Cerebellar cathodal tDCS interferes with recalibration and spatial realignment during prism adaptation procedure in healthy subjects. *Brain and Cognition*, *105*, 1-8. <https://doi.org/10.1016/j.bandc.2016.03.002>
- Panico, F., Sagliano, L., Grossi, D., & Trojano, L. (2016b). Cerebellar cathodal tDCS interferes with recalibration and spatial realignment during prism adaptation procedure in healthy subjects. *Brain and Cognition*, *105*, 1-8. <https://doi.org/10.1016/j.bandc.2016.03.002>
- Panico, F., Sagliano, L., Grossi, D., & Trojano, L. (2018). Bi-cephalic parietal and cerebellar direct current stimulation interferes with early error correction in prism adaptation: Toward a complex view of the neural mechanisms underlying visuomotor control. *Cortex*, *109*, 226-233. <https://doi.org/10.1016/j.cortex.2018.09.020>

- Panico, F., Sagliano, L., Nozzolillo, C., Trojano, L., & Rossetti, Y. (2018). Cerebellar contribution to spatial realignment : A tDCS study during multiple-step prism adaptation. *Neuropsychologia*, *112*, 58-65. <https://doi.org/10.1016/j.neuropsychologia.2018.03.008>
- Parazzini, M., Rossi, E., Ferrucci, R., Liorni, I., Priori, A., & Ravazzani, P. (2014). Modelling the electric field and the current density generated by cerebellar transcranial DC stimulation in humans. *Clinical Neurophysiology: Official Journal of the International Federation of Clinical Neurophysiology*, *125*(3), 577-584. <https://doi.org/10.1016/j.clinph.2013.09.039>
- Pélisson, D., Alahyane, N., Panouillères, M., & Tilikete, C. (2010). Sensorimotor adaptation of saccadic eye movements. *Neuroscience & Biobehavioral Reviews*, *34*(8), 1103-1120. <https://doi.org/10.1016/j.neubiorev.2009.12.010>
- Person, A. L. (2019). Corollary Discharge Signals in the Cerebellum. *Biological Psychiatry: Cognitive Neuroscience and Neuroimaging*, *4*(9), 813-819. <https://doi.org/10.1016/j.bpsc.2019.04.010>
- Petitot, P., O'Reilly, J. X., & O'Shea, J. (2017). Towards a neuro-computational account of prism adaptation. *Neuropsychologia*. <https://doi.org/10.1016/j.neuropsychologia.2017.12.021>
- Pisella, L., Michel, C., Gréa, H., Tilikete, C., Vighetto, A., & Rossetti, Y. (2004). Preserved prism adaptation in bilateral optic ataxia : Strategic versus adaptive reaction to prisms. *Experimental Brain Research*, *156*(4), 399-408. <https://doi.org/10.1007/s00221-003-1746-4>
- Pisella, L., Rossetti, Y., Michel, C., Rode, G., Boisson, D., Pélisson, D., & Tilikete, C. (2005). Ipsidirectional impairment of prism adaptation after unilateral lesion of anterior cerebellum. *Neurology*, *65*(1), 150-152. <https://doi.org/10.1212/01.wnl.0000167945.34177.5e>
- Popa, L. S., & Ebner, T. J. (2018). Cerebellum, Predictions and Errors. *Frontiers in Cellular Neuroscience*, *12*, 524. <https://doi.org/10.3389/fncel.2018.00524>
- Pope, P. A., & Miall, R. C. (2012). Task-specific facilitation of cognition by cathodal transcranial direct current stimulation of the cerebellum. *Brain Stimulation*, *5*(2), 84-94. <https://doi.org/10.1016/j.brs.2012.03.006>
- Prablanc, C., Panico, F., Fleury, L., Pisella, L., Nijboer, T., Kitazawa, S., & Rossetti, Y. (2019). Adapting terminology : Clarifying prism adaptation vocabulary, concepts, and methods. *Neuroscience Research*. <https://doi.org/10.1016/j.neures.2019.03.003>
- Prablanc, C., Tzavaras, A., & Jeannerod, M. (1975). Adaptation of hand tracking to rotated visual coordinates. *Perception & Psychophysics*, *17*(3), 325-328. <https://doi.org/10.3758/BF03203218>
- Priori, A., Berardelli, A., Rona, S., Accornero, N., & Manfredi, M. (1998). Polarization of the human motor cortex through the scalp. *Neuroreport*, *9*(10), 2257-2260. <https://doi.org/10.1097/00001756-199807130-00020>
- Purves, D., & Coquery, J.-M. (2002). *Neurosciences*. De Boeck univ.
- Rampersad, S. M., Janssen, A. M., Lucka, F., Aydin, Ü., Lanfer, B., Lew, S., Wolters, C. H., Stegeman, D. F., & Oostendorp, T. F. (2014). Simulating transcranial direct current stimulation with a detailed anisotropic human head model. *IEEE Transactions on Neural Systems and Rehabilitation Engineering: A Publication of the IEEE Engineering in Medicine and Biology Society*, *22*(3), 441-452. <https://doi.org/10.1109/TNSRE.2014.2308997>
- Redding, G. M., & Wallace, B. (1985). Perceptual-motor coordination and adaptation during locomotion : Determinants of prism adaptation in hall exposure. *Perception & Psychophysics*, *38*(4), 320-330. <https://doi.org/10.3758/bf03207161>

- Redding, G. M., & Wallace, B. (1988). Head posture effects in prism adaptation during hallway exposure. *Perception & Psychophysics*, *44*(1), 69-75. <https://doi.org/10.3758/bf03207477>
- Redding, G. M., Rader, S. D., & Lucas, D. R. (1992). Cognitive Load and Prism Adaptation. *Journal of Motor Behavior*, *24*(3), 238-246. <https://doi.org/10.1080/00222895.1992.9941619>
- Redding, G. M., Rossetti, Y., & Wallace, B. (2005). Applications of prism adaptation : A tutorial in theory and method. *Neuroscience & Biobehavioral Reviews*, *29*(3), 431-444. <https://doi.org/10.1016/j.neubiorev.2004.12.004>
- Redding, G. M., & Wallace, B. (1988). Adaptive Mechanisms in Perceptual-Motor Coordination. *Journal of Motor Behavior*, *20*(3), 242-254. <https://doi.org/10.1080/00222895.1988.10735444>
- Redding, G. M., & Wallace, B. (1993). Adaptive Coordination and Alignment of Eye and Hand. *Journal of Motor Behavior*, *25*(2), 75-88. <https://doi.org/10.1080/00222895.1993.9941642>
- Redding, G. M., & Wallace, B. (1996). Adaptive spatial alignment and strategic perceptual-motor control. *Journal of Experimental Psychology: Human Perception and Performance*, *22*(2), 379-394. <https://doi.org/10.1037/0096-1523.22.2.379>
- Redding, G. M., & Wallace, B. (1997). Prism Adaptation During Target Pointing From Visible and Nonvisible Starting Locations. *Journal of Motor Behavior*, *29*(2), 119-130. <https://doi.org/10.1080/00222899709600827>
- Redding, G. M., & Wallace, B. (2001). Calibration and Alignment are Separable : Evidence From Prism Adaptation. *Journal of Motor Behavior*, *33*(4), 401-412. <https://doi.org/10.1080/00222890109601923>
- Redding, G. M., & Wallace, B. (2002). Strategie Calibration and Spatial Alignment : A Model From Prism Adaptation. *Journal of Motor Behavior*, *34*(2), 126-138. <https://doi.org/10.1080/00222890209601935>
- Redding, G. M., & Wallace, B. (2006). Generalization of prism adaptation. *Journal of Experimental Psychology. Human Perception and Performance*, *32*(4), 1006-1022. <https://doi.org/10.1037/0096-1523.32.4.1006>
- Reinkensmeyer, D. J., Burdet, E., Casadio, M., Krakauer, J. W., Kwakkel, G., Lang, C. E., Swinnen, S. P., Ward, N. S., & Schweighofer, N. (2016). Computational neurorehabilitation : Modeling plasticity and learning to predict recovery. *Journal of Neuroengineering and Rehabilitation*, *13*(1), 42. <https://doi.org/10.1186/s12984-016-0148-3>
- Reisman, D. S., Bastian, A. J., & Morton, S. M. (2010). Neurophysiologic and rehabilitation insights from the split-belt and other locomotor adaptation paradigms. *Physical Therapy*, *90*(2), 187-195. <https://doi.org/10.2522/ptj.20090073>
- Reisman, D. S., Wityk, R., Silver, K., & Bastian, A. J. (2007). Locomotor adaptation on a split-belt treadmill can improve walking symmetry post-stroke. *Brain: A Journal of Neurology*, *130*(Pt 7), 1861-1872. <https://doi.org/10.1093/brain/awm035>
- Renault, A. G., Lefumat, H., Miall, R. C., Bringoux, L., Bourdin, C., Vercher, J.-L., & Sarlegna, F. R. (2020). Individual movement features during prism adaptation correlate with after-effects and interlimb transfer. *Psychological Research*, *84*(4), 866-880. <https://doi.org/10.1007/s00426-018-1110-8>
- Robertson, E. M. (2007). The serial reaction time task : Implicit motor skill learning? *The Journal of Neuroscience: The Official Journal of the Society for Neuroscience*, *27*(38), 10073-10075. <https://doi.org/10.1523/JNEUROSCI.2747-07.2007>
- Rode, G., Lacour, S., Jacquin-Courtois, S., Pisella, L., Michel, C., Revol, P., Alahyane, N., Luauté, J., Gallagher, S., Halligan, P., Péliçon, D., & Rossetti, Y. (2015). Long-term sensorimotor and therapeutical effects of a mild regime of prism adaptation in spatial neglect. A double-blind RCT essay.

Annals of Physical and Rehabilitation Medicine, 58(2), 40-53.
<https://doi.org/10.1016/j.rehab.2014.10.004>

Roemmich, R. T., & Bastian, A. J. (2018). Closing the Loop: From Motor Neuroscience to Neurorehabilitation. *Annual Review of Neuroscience*, 41, 415-429. <https://doi.org/10.1146/annurev-neuro-080317-062245>

Rossetti, Y., Desmurget, M., & Prablanc, C. (1995). Vectorial coding of movement: Vision, proprioception, or both? *Journal of Neurophysiology*, 74(1), 457-463. <https://doi.org/10.1152/jn.1995.74.1.457>

Rossetti, Yves, Koga, K., & Mano, T. (1993). Prismatic displacement of vision induces transient changes in the timing of eye-hand coordination. *Perception & Psychophysics*, 54(3), 355-364. <https://doi.org/10.3758/BF03205270>

Rossetti, Yves, & Rode, G. (2016). Les dialogues sensori-moteurs : Une épreuve de réalité por nos représentations cognitives. Sensori-motricité et thérapeutiques cognitives ascendantes. In *La psychomotricité entre psychanalyse et neurosciences. Histoires, actualités et perspectives : Pour une pensée en mouvement*. (Editions In Press, p. 217-239).

Rossetti, Yves, Rode, G., Pisella, L., Farné, A., Li, L., Boisson, D., & Perenin, M.-T. (1998). Prism adaptation to a rightward optical deviation rehabilitates left hemispatial neglect. *Nature*, 395(6698), 166-169. <https://doi.org/10.1038/25988>

Roth, M., Decety, J., Raybaudi, M., Massarelli, R., Delon-Martin, C., Segebarth, C., Morand, S., Gemignani, A., Décorps, M., & Jeannerod, M. (1996). Possible involvement of primary motor cortex in mentally simulated movement: A functional magnetic resonance imaging study. *Neuroreport*, 7(7), 1280-1284. <https://doi.org/10.1097/00001756-199605170-00012>

Ruffino, C., Papaxanthis, C., & Lebon, F. (2017). Neural plasticity during motor learning with motor imagery practice: Review and perspectives. *Neuroscience*, 341, 61-78. <https://doi.org/10.1016/j.neuroscience.2016.11.023>

Santos Ferreira, I., Teixeira Costa, B., Lima Ramos, C., Lucena, P., Thibaut, A., & Fregni, F. (2019). Searching for the optimal tDCS target for motor rehabilitation. *Journal of Neuroengineering and Rehabilitation*, 16(1), 90. <https://doi.org/10.1186/s12984-019-0561-5>

Saruco, E., Di Rienzo, F., Nunez-Nagy, S., Rubio-Gonzalez, M. A., Debarnot, U., Collet, C., Guillot, A., & Saimpont, A. (2018). Optimal Combination of Anodal Transcranial Direct Current Stimulations and Motor Imagery Interventions. *Neural Plasticity*, 2018, 5351627. <https://doi.org/10.1155/2018/5351627>

Savin, D. N., & Morton, S. M. (2008). Asymmetric generalization between the arm and leg following prism-induced visuomotor adaptation. *Experimental Brain Research*, 186(1), 175-182. <https://doi.org/10.1007/s00221-007-1220-9>

Scheidt, R. A., Reinkensmeyer, D. J., Conditt, M. A., Rymer, W. Z., & Mussa-Ivaldi, F. A. (2000). Persistence of motor adaptation during constrained, multi-joint, arm movements. *Journal of Neurophysiology*, 84(2), 853-862. <https://doi.org/10.1152/jn.2000.84.2.853>

Schintu, S., Freedberg, M., Alam, Z. M., Shomstein, S., & Wassermann, E. M. (2018). Left-shifting prism adaptation boosts reward-based learning. *Cortex*, 109, 279-286. <https://doi.org/10.1016/j.cortex.2018.09.021>

Schintu, S., Freedberg, M., Gotts, S. J., Cunningham, C. A., Alam, Z. M., Shomstein, S., & Wassermann, E. M. (2020). Prism Adaptation Modulates Connectivity of the Intraparietal Sulcus with Multiple Brain Networks. *Cerebral Cortex (New York, N.Y.: 1991)*. <https://doi.org/10.1093/cercor/bhaa032>

- Schlerf, J. E., Galea, J. M., Spampinato, D., & Celnik, P. A. (2015). Laterality Differences in Cerebellar-Motor Cortex Connectivity. *Cerebral Cortex (New York, N.Y.: 1991)*, 25(7), 1827-1834. <https://doi.org/10.1093/cercor/bht422>
- Schmidt, R. A., Lee, T., Winstein, C., Wulf, G., & Zelaznik, H. N. (2018). *Motor Control and Learning : A Behavioral Emphasis* (Sixth). Human Kinetics Publishers.
- Sekiyama, K., Miyauchi, S., Imaruoka, T., Egusa, H., & Tashiro, T. (2000). Body image as a visuomotor transformation device revealed in adaptation to reversed vision. *Nature*, 407(6802), 374-377. <https://doi.org/10.1038/35030096>
- Sekiyama, Kaoru, Hashimoto, K., & Sugita, Y. (2012). Visuo-somatosensory reorganization in perceptual adaptation to reversed vision. *Acta Psychologica*, 141(2), 231-242. <https://doi.org/10.1016/j.actpsy.2012.05.011>
- Shadmehr, R., & Mussa-Ivaldi, F. A. (1994). Adaptive representation of dynamics during learning of a motor task. *The Journal of Neuroscience: The Official Journal of the Society for Neuroscience*, 14(5 Pt 2), 3208-3224.
- Shadmehr, R., Smith, M. A., & Krakauer, J. W. (2010). Error Correction, Sensory Prediction, and Adaptation in Motor Control. *Annual Review of Neuroscience*, 33(1), 89-108. <https://doi.org/10.1146/annurev-neuro-060909-153135>
- Simos, P. G., Kavroulakis, E., Maris, T., Papadaki, E., Boursianis, T., Kalaitzakis, G., & Savaki, H. E. (2017). Neural foundations of overt and covert actions. *NeuroImage*, 152, 482-496. <https://doi.org/10.1016/j.neuroimage.2017.03.036>
- Smith, L. (Éd.). (1996). *Critical readings on Piaget*. Routledge.
- Smith, M. A., Ghazizadeh, A., & Shadmehr, R. (2006). Interacting Adaptive Processes with Different Timescales Underlie Short-Term Motor Learning. *PLOS Biology*, 4(6), e179. <https://doi.org/10.1371/journal.pbio.0040179>
- Solodkin, A., Hlustik, P., Chen, E. E., & Small, S. L. (2004). Fine modulation in network activation during motor execution and motor imagery. *Cerebral Cortex (New York, N.Y.: 1991)*, 14(11), 1246-1255. <https://doi.org/10.1093/cercor/bhh086>
- Spampinato, D., & Celnik, P. (2020). Multiple Motor Learning Processes in Humans : Defining Their Neurophysiological Bases: *The Neuroscientist*. <https://doi.org/10.1177/1073858420939552>
- Stagg, C. J., Bestmann, S., Constantinescu, A. O., Moreno, L. M., Allman, C., Meckle, R., Woolrich, M., Near, J., Johansen-Berg, H., & Rothwell, J. C. (2011). Relationship between physiological measures of excitability and levels of glutamate and GABA in the human motor cortex. *The Journal of Physiology*, 589(Pt 23), 5845-5855. <https://doi.org/10.1113/jphysiol.2011.216978>
- Stagg, C. J., Antal, A., & Nitsche, M. A. (2018). Physiology of Transcranial Direct Current Stimulation. *The Journal of ECT*, 34(3), 144-152. <https://doi.org/10.1097/YCT.0000000000000510>
- Stagg, C. J., Best, J. G., Stephenson, M. C., O'Shea, J., Wylezinska, M., Kincses, Z. T., Morris, P. G., Matthews, P. M., & Johansen-Berg, H. (2009). Polarity-sensitive modulation of cortical neurotransmitters by transcranial stimulation. *The Journal of Neuroscience: The Official Journal of the Society for Neuroscience*, 29(16), 5202-5206. <https://doi.org/10.1523/JNEUROSCI.4432-08.2009>
- Statton, M. A., Vazquez, A., Morton, S. M., Vasudevan, E. V. L., & Bastian, A. J. (2018). Making Sense of Cerebellar Contributions to Perceptual and Motor Adaptation. *Cerebellum (London, England)*, 17(2), 111-121. <https://doi.org/10.1007/s12311-017-0879-0>

- Stern, Y., Mayeux, R., Hermann, A., & Rosen, J. (1988). Prism adaptation in Parkinson's disease. *Journal of Neurology, Neurosurgery & Psychiatry*, *51*(12), 1584-1587. <https://doi.org/10.1136/jnnp.51.12.1584>
- Stippich, C., Ochmann, H., & Sartor, K. (2002). Somatotopic mapping of the human primary sensorimotor cortex during motor imagery and motor execution by functional magnetic resonance imaging. *Neuroscience Letters*, *331*(1), 50-54. [https://doi.org/10.1016/s0304-3940\(02\)00826-1](https://doi.org/10.1016/s0304-3940(02)00826-1)
- Stratton, G. M. (1897). Vision without inversion of the retinal image. *Psychological Review*, *4*(4), 341-360. <https://doi.org/10.1037/h0075482>
- Striemer, C. L., & Danckert, J. (2010). Dissociating perceptual and motor effects of prism adaptation in neglect. *Neuroreport*, *21*(6), 436-441. <https://doi.org/10.1097/WNR.0b013e328338592f>
- Striemer, C. L., Enns, J. T., & Whitwell, R. L. (2019). Visuomotor adaptation in the absence of input from early visual cortex. *Cortex*, *115*, 201-215. <https://doi.org/10.1016/j.cortex.2019.01.022>
- Suica, Z., Platteau-Waldmeier, P., Koppel, S., Schmidt-Trucksäss, A., Ettlin, T., & Schuster-Amft, C. (2018). Motor imagery ability assessments in four disciplines : Protocol for a systematic review. *BMJ Open*, *8*(12), e023439. <https://doi.org/10.1136/bmjopen-2018-023439>
- Szameitat, A. J., Shen, S., & Sterr, A. (2007). Motor imagery of complex everyday movements. An fMRI study. *NeuroImage*, *34*(2), 702-713. <https://doi.org/10.1016/j.neuroimage.2006.09.033>
- Takeuchi, N., & Izumi, S.-I. (2012). Maladaptive plasticity for motor recovery after stroke : Mechanisms and approaches. *Neural Plasticity*, *2012*, 359728. <https://doi.org/10.1155/2012/359728>
- Tanaka, H., Krakauer, J. W., & Sejnowski, T. J. (2012). Generalization and multirate models of motor adaptation. *Neural Computation*, *24*(4), 939-966. https://doi.org/10.1162/NECO_a_00262
- Taub, E., & Goldberg, L. A. (1973). Prism adaptation : Control of intermanual transfer by distribution of practice. *Science (New York, N.Y.)*, *180*(4087), 755-757. <https://doi.org/10.1126/science.180.4087.755>
- Taylor, J. A., & Ivry, R. B. (2012). The role of strategies in motor learning. *Annals of the New York Academy of Sciences*, *1251*, 1-12. <https://doi.org/10.1111/j.1749-6632.2011.06430.x>
- Taylor, J. A., Krakauer, J. W., & Ivry, R. B. (2014a). Explicit and implicit contributions to learning in a sensorimotor adaptation task. *The Journal of Neuroscience: The Official Journal of the Society for Neuroscience*, *34*(8), 3023-3032. <https://doi.org/10.1523/JNEUROSCI.3619-13.2014>
- Taylor, J. A., Krakauer, J. W., & Ivry, R. B. (2014b). Explicit and implicit contributions to learning in a sensorimotor adaptation task. *The Journal of Neuroscience: The Official Journal of the Society for Neuroscience*, *34*(8), 3023-3032. <https://doi.org/10.1523/JNEUROSCI.3619-13.2014>
- Telgen, S., Parvin, D., & Diedrichsen, J. (2014). Mirror reversal and visual rotation are learned and consolidated via separate mechanisms : Recalibrating or learning de novo? *The Journal of Neuroscience: The Official Journal of the Society for Neuroscience*, *34*(41), 13768-13779. <https://doi.org/10.1523/JNEUROSCI.5306-13.2014>
- Templeton, W. B., Howard, I. P., & Wilkinson, D. A. (1974). Additivity of components of prismatic adaptation. *Perception & Psychophysics*, *15*(2), 249-257. <https://doi.org/10.3758/BF03213941>
- Therrien, A. S., & Bastian, A. J. (2019). The cerebellum as a movement sensor. *Neuroscience Letters*, *688*, 37-40. <https://doi.org/10.1016/j.neulet.2018.06.055>
- Tilikete, C., Rode, G., Rossetti, Y., Pichon, J., Li, L., & Boisson, D. (2001). Prism adaptation to rightward optical deviation improves postural imbalance in left-hemiparetic patients. *Current Biology*, *11*(7), 524-528. [https://doi.org/10.1016/S0960-9822\(01\)00151-8](https://doi.org/10.1016/S0960-9822(01)00151-8)

- Toriyama, H., Ushiba, J., & Ushiyama, J. (2018). Subjective Vividness of Kinesthetic Motor Imagery Is Associated With the Similarity in Magnitude of Sensorimotor Event-Related Desynchronization Between Motor Execution and Motor Imagery. *Frontiers in Human Neuroscience*, *12*, 295. <https://doi.org/10.3389/fnhum.2018.00295>
- Torres-Oviedo, G., & Bastian, A. J. (2010). Seeing is believing : Effects of visual contextual cues on learning and transfer of locomotor adaptation. *The Journal of Neuroscience: The Official Journal of the Society for Neuroscience*, *30*(50), 17015-17022. <https://doi.org/10.1523/JNEUROSCI.4205-10.2010>
- Toussaint, L., & Blandin, Y. (2010). On the role of imagery modalities on motor learning. *Journal of Sports Sciences*, *28*(5), 497-504. <https://doi.org/10.1080/02640410903555855>
- Tseng, Y.-W., Diedrichsen, J., Krakauer, J. W., Shadmehr, R., & Bastian, A. J. (2007). Sensory prediction errors drive cerebellum-dependent adaptation of reaching. *Journal of Neurophysiology*, *98*(1), 54-62. <https://doi.org/10.1152/jn.00266.2007>
- Tsujimoto, K., Mizuno, K., Nishida, D., Tahara, M., Yamada, E., Shindo, S., Kasuga, S., & Liu, M. (2019). Prism adaptation changes resting-state functional connectivity in the dorsal stream of visual attention networks in healthy adults: A fMRI study. *Cortex*, *119*, 594-605. <https://doi.org/10.1016/j.cortex.2018.10.018>
- van Beers, R. J., Sittig, A. C., & Denier van der Gon, J. J. (1996). How humans combine simultaneous proprioceptive and visual position information. *Experimental Brain Research*, *111*(2), 253-261.
- van Beers, R. J., Sittig, A. C., & Gon, J. J. D. van der. (1999). Integration of Proprioceptive and Visual Position-Information: An Experimentally Supported Model. *Journal of Neurophysiology*, *81*(3), 1355-1364. <https://doi.org/10.1152/jn.1999.81.3.1355>
- van Dun, K., Bodranghien, F., Manto, M., & Mariën, P. (2017). Targeting the Cerebellum by Noninvasive Neurostimulation : A Review. *The Cerebellum*, *16*(3), 695-741. <https://doi.org/10.1007/s12311-016-0840-7>
- von Helmholtz, H., (1962). In Helmholtz's treatise on physiological optics. In: Southall, J.P.C. (Ed.), Sect. 2. Translated from the Third German Ed, Vol. 3. Dover Press, New York, NY, pp. 242–270.
- Wang, J., & Sainburg, R. L. (2004). Limitations in interlimb transfer of visuomotor rotations. *Experimental Brain Research*, *155*(1), 1-8. <https://doi.org/10.1007/s00221-003-1691-2>
- Wei, K., & Körding, K. (2009). Relevance of error: What drives motor adaptation? *Journal of Neurophysiology*, *101*(2), 655-664. <https://doi.org/10.1152/jn.90545.2008>
- Weiner, M. J., Hallett, M., & Funkenstein, H. H. (1983). Adaptation to lateral displacement of vision in patients with lesions of the central nervous system. *Neurology*, *33*(6), 766-772.
- Welch, R.B., 1974. Speculations on a model of prism adaptation. *Perception* *3* (4),451–460, <http://dx.doi.org/10.1068/p030451>.
- Wessel, M. J., & Hummel, F. C. (2018). Non-invasive Cerebellar Stimulation : A Promising Approach for Stroke Recovery? *The Cerebellum*, *17*(3), 359-371. <https://doi.org/10.1007/s12311-017-0906-1>
- Wiestler, T., Waters-Metenier, S., & Diedrichsen, J. (2014). Effector-independent motor sequence representations exist in extrinsic and intrinsic reference frames. *The Journal of Neuroscience: The Official Journal of the Society for Neuroscience*, *34*(14), 5054-5064. <https://doi.org/10.1523/JNEUROSCI.5363-13.2014>
- Wiethoff, S., Hamada, M., & Rothwell, J. C. (2014). Variability in response to transcranial direct current stimulation of the motor cortex. *Brain Stimulation*, *7*(3), 468-475. <https://doi.org/10.1016/j.brs.2014.02.003>

- Wilf, M., Serino, A., Clarke, S., & Crotta-Herbette, S. (2019). Prism adaptation enhances decoupling between the default mode network and the attentional networks. *NeuroImage*, *200*, 210-220. <https://doi.org/10.1016/j.neuroimage.2019.06.050>
- Wilke, C., Synofzik, M., & Lindner, A. (2013). Sensorimotor Recalibration Depends on Attribution of Sensory Prediction Errors to Internal Causes. *PLoS ONE*, *8*(1). <https://doi.org/10.1371/journal.pone.0054925>
- Wilkinson, D. A. (1971). Visual-motor control loop: A linear system? *Journal of Experimental Psychology*, *89*(2), 250-257. <https://doi.org/10.1037/h0031162>
- Williams, J., Pearce, A. J., Loporto, M., Morris, T., & Holmes, P. S. (2012). The relationship between corticospinal excitability during motor imagery and motor imagery ability. *Behavioural Brain Research*, *226*(2), 369-375. <https://doi.org/10.1016/j.bbr.2011.09.014>
- Wolpert, D., Ghahramani, Z., & Jordan, M. (1995). An internal model for sensorimotor integration. *Science*, *269*(5232), 1880-1882. <https://doi.org/10.1126/science.7569931>
- Wolpert, D. M., Miall, R. C., & Kawato, M. (1998). Internal models in the cerebellum. *Trends in Cognitive Sciences*, *2*(9), 338-347. [https://doi.org/10.1016/s1364-6613\(98\)01221-2](https://doi.org/10.1016/s1364-6613(98)01221-2)
- Wolpert, Daniel M., Diedrichsen, J., & Flanagan, J. R. (2011). Principles of sensorimotor learning. *Nature Reviews Neuroscience*, *12*(12), 739-751. <https://doi.org/10.1038/nrn3112>
- Woods, A. J., Antal, A., Bikson, M., Boggio, P. S., Brunoni, A. R., Celnik, P., Cohen, L. G., Fregni, F., Herrmann, C. S., Kappenman, E. S., Knotkova, H., Liebetanz, D., Miniussi, C., Miranda, P. C., Paulus, W., Priori, A., Reato, D., Stagg, C., Wenderoth, N., & Nitsche, M. A. (2016). A technical guide to tDCS, and related non-invasive brain stimulation tools. *Clinical Neurophysiology*, *127*(2), 1031-1048. <https://doi.org/10.1016/j.clinph.2015.11.012>
- Woodworth, R. S. (1899). Accuracy of voluntary movement. *The Psychological Review: Monograph Supplements*, *3*(3), i-114. <https://doi.org/10.1037/h0092992>
- Yin, P. B., & Kitazawa, S. (2001). Long-lasting aftereffects of prism adaptation in the monkey. *Experimental Brain Research*, *141*(2), 250-253. <https://doi.org/10.1007/s002210100892>
- Zarahn, E., Weston, G. D., Liang, J., Mazzoni, P., & Krakauer, J. W. (2008). Explaining Savings for Visuomotor Adaptation: Linear Time-Invariant State-Space Models Are Not Sufficient. *Journal of Neurophysiology*, *100*(5), 2537-2548. <https://doi.org/10.1152/jn.90529.2008>
- Zilles, K. (1992). Neuronal plasticity as an adaptive property of the central nervous system. *Annals of Anatomy - Anatomischer Anzeiger*, *174*(5), 383-391. [https://doi.org/10.1016/S0940-9602\(11\)80255-4](https://doi.org/10.1016/S0940-9602(11)80255-4)