



HAL
open science

Integration of BIM and digital technologies for smart indoor hazards management

Rania Wehbi

► **To cite this version:**

Rania Wehbi. Integration of BIM and digital technologies for smart indoor hazards management. Civil Engineering. Université de Lille, 2021. English. NNT : 2021LILUN007 . tel-03526566

HAL Id: tel-03526566

<https://theses.hal.science/tel-03526566>

Submitted on 14 Jan 2022

HAL is a multi-disciplinary open access archive for the deposit and dissemination of scientific research documents, whether they are published or not. The documents may come from teaching and research institutions in France or abroad, or from public or private research centers.

L'archive ouverte pluridisciplinaire **HAL**, est destinée au dépôt et à la diffusion de documents scientifiques de niveau recherche, publiés ou non, émanant des établissements d'enseignement et de recherche français ou étrangers, des laboratoires publics ou privés.

University of Lille
Doctoral School of Engineering Sciences
Laboratory of Civil Engineering and Geo-Environment

THESIS

submitted to obtain the
Doctorate Degree
Speciality: **Civil Engineering**

By

Rania WEHBI

**Integration Of BIM And Digital Technologies For
Smart Indoor Hazards Management**

Defended on October 22nd, 2021, in front of the jury composed of

Isam SHAHROUR	Professor, Lille University, France	Director
Marwan SADEK	MCF - HDR, Lille University, France	Co-Director
Marwan ALHEIB	HDR, INERIS, France	Reporter
Yassin FAHJAN	Professor, Istanbul Technical University, Turkey	Reporter
Ola ALHAJ-HASAN	MCF, Artois University, France	Examiner
Elias FARAH	MCF, Holy Spirit University of Kaslik, Lebanon	Examiner
Hussein MROUEH	Professor, Lille University, France	President
Maria Pastora REVUELTA	Professor, Silvia University, Spain	Examiner

Université de Lille
École Doctorale Sciences Pour l'Ingénieur
Laboratoire Génie Civil et géo-Environnement

THÈSE

soumise pour l'obtention du

Grade de Docteur

Discipline : **Génie Civil**

Par

Rania WEHBI

Intégration Du BIM Et Des Technologies Numériques Pour La Gestion Intelligente Des Risques Intérieurs

Soutenue le 22 Octobre 2021 devant le jury composé de

Isam SHAHROUR	Professeur, Université de Lille, France	Directeur
Marwan SADEK	MCF - HDR, Université de Lille, France	Co-Directeur
Marwan ALHEIB	HDR, INERIS, France	Rapporteur
Yassin FAHJAN	Professeur, Université technique d'Istanbul, Turquie	Rapporteur
Ola ALHAJ-HASAN	MCF, Université d'Artois, France	Examinatrice
Elias FARAH	MCF, Université Saint-Esprit de Kaslik, Liban	Examineur
Hussein MROUEH	Professeur, Université de Lille, France	Président
Maria Pastora REVUELTA	Professeur, Université de Silvia, Espagne	Examinatrice

Acknowledgement

I would like to take this opportunity to acknowledge all the people that without whom this thesis might not have been written, and to whom I am greatly indebted. This work has been carried out at the Laboratory of Civil Engineering and geo-Environment (LGCgE), Lille University.

My sincere thanks go to my supervisor, Professor Isam SHAHROUR, for his patience, encouragement, guidance, kindness, support, and smart ideas. I am extremely grateful that he chosen me as one of his Ph.D. students and continued to have faith in me over the years. I have gained greatly from his wealth of knowledge and meticulous editing. Thank you for being a truly inspirational supervisor. I will always be grateful for all the hard work and dedication he has given to make me who I am today. Moreover, thanks to my co-director Dr. Marwan SADEK for his support.

I would like to thank my committee members for accepting to be part of this achievement by reviewing and examining my research work. Their encouraging words and thoughtful, detailed feedback have been very important to me. Their comments, and advice were highly appreciated and improved the quality of my work. Thanks to Prof. Marwan ALHEIB, Prof. Yassine FAHJAN, Dr. Ola ALHAJ-HASAN, Dr. Elias FARAH, Prof. Hussein MROUEH, and Prof. Maria Pastora REVUELTA. A special thanks to Dr. Elias FARAH for his continuous support and help during the thesis period.

I would also like to extend my deepest gratitude to the members of LGCgE; we spent together unforgettable moments. Thank you to my friends who always encourage me.

Last but not the least, I am grateful for my family, my parents and my two brothers, whose constant love and support keep me motivated and confident. My accomplishments and success are because they believed in me.

Abstract

The objective of this thesis is the development of a real-time comprehensive smart system for indoor hazards management based on the Internet of Things (IoT), Building Information Modeling (BIM), Artificial Intelligence (AI), and other digital technology. The system has the capacity to (i) identify the hazard, (ii) track occupants' location, (iii) illustrate the collected data in the BIM environment, (iv) take the necessary actions, (v) inform the key players and corresponding authorities, and (vi) store data for future incident management. This study's novelty consists of its capacity to manage indoor hazards in one platform and interact with users through a mobile application.

The thesis is composed of four chapters.

Chapter 1 presents a comprehensive review regarding indoor hazard management and the current smart building technologies used for this purpose, such as BIM, IoT, and AI.

Chapter 2 describes the methodology of the comprehensive indoor hazard management system. The indoor hazards included in this system are fire, electrical faults, indoor air pollution (IAP), gas leak, water leak, intrusion, and healthcare.

Chapter 3 presents the study related to the smart fire evacuation system that combines BIM and smart technologies. State of the art concerning fire evacuation management was presented. The materials and methods used are described in detail. This system was applied and validated in the research building - LGCgE laboratory of Lille University in France. Results showed the capacity of the system through simulation of fire events in the building.

Chapter 4 presents a comprehensive methodology for evaluating and improving the COVID-19 measures in higher education establishments. This study describes in detail the methods and materials used that are based on BIM and questionnaire approaches. The proposed methodology is applied at the engineering school Polytech' Lille in the North of France. Results show that the BIM model provides valuable services, and the questionnaire allows essential information to the administration.

Keywords: Building, Indoor, hazards, safety, smart building, BIM, Artificial Intelligence, fire, COVID-19, questionnaire.

Résumé

L'objectif de ce travail de thèse est le développement d'un système intelligent pour la gestion en temps réel des risques intérieurs. Le système est basé sur l'Internet des objets (IoT), l'intelligence artificielle (AI), les technologies de communication, la surveillance intelligente intérieure, la modélisation des informations du bâtiment (BIM), et d'autres technologies numériques. Le système a la capacité de (i) identifier le risque, (ii) localiser les occupants, (iii) illustrer les données dans l'environnement BIM, (iv) prendre les mesures nécessaires, (v) informer les acteurs clés et les autorités correspondantes, et (vi) stocker les données pour la gestion future des incidents. La nouveauté de cette recherche réside dans la capacité à gérer les risques intérieurs sur une seule plateforme, ainsi que l'interaction avec les utilisateurs. Ces derniers sont en mesure de fournir des informations pertinentes via une application mobile.

Le rapport de thèse est composé de quatre chapitres.

Le chapitre 1 présente l'état de l'art de la gestion des risques intérieurs et des technologies actuelles des bâtiments intelligentes utilisées à cette fin, telles que le BIM, l'IoT et l'AI.

Le chapitre 2 décrit la méthodologie du système complet de gestion des risques intérieurs. Les risques intérieurs inclus dans ce système sont le feu, les défauts électriques, la pollution de l'air intérieur (IAP), fuite de gaz, fuite d'eau, intrusion et problème de santé.

Le chapitre 3 présente l'étude du système intelligent d'évacuation de feu qui combine le BIM et les technologies intelligentes. Un état de l'art concernant la gestion de l'évacuation de feu a été présenté. Les matériaux et les méthodes utilisés sont décrits en détail. Ce système a été appliqué et validé dans le bâtiment de recherche - laboratoire LGCgE de l'Université de Lille en France. Les résultats ont montré la capacité du système à travers la simulation d'événements de feu dans le bâtiment.

Le chapitre 4 présente une méthodologie complète pour évaluer et améliorer les mesures COVID-19 dans les établissements d'enseignement supérieur. Cette étude décrit en détail les méthodes et les matériaux utilisés qui sont basés sur les approches BIM et questionnaire. La méthodologie proposée est appliquée à l'école d'ingénieur Polytech' Lille dans le Nord de la France. Les résultats montrent que le modèle BIM fournit des services précieux et le questionnaire fournit des informations importantes à l'administration.

Mots-clés : Bâtiment, Risques, intérieur, Bâtiment intelligent, BIM, intelligence artificielle, feu, COVID-19, questionnaire.

Table of Contents

Acknowledgement	IV
Abstract	V
Résumé.....	VI
Table of Contents	VII
Table of Figures	X
Table of Tables	XII
Chapter 0: General Introduction	1
Chapter 1: State of the Art – Literature Review	3
1.1. Introduction	3
1.2. Indoor Hazards	4
1.1. BIM for Risk Management	6
1.1.1. BIM Overview	7
1.1.2. Risk Management Overview.....	8
1.1.3. Risk Management Process	9
1.1.4. BIM Application for Risk Management	10
1.2. Smart Building for Indoor Safety.....	11
1.2.1. Smart Building Background	11
1.2.2. Internet of Things (IoT) Services for Smart Buildings.....	13
1.2.3. Artificial Intelligence (AI) for Smart Buildings	13
1.3. Use of Smart Building for Human Health.....	16
1.3.1. Indoor Air Pollution (IAP).....	17
1.3.2. Fall Detection.....	19
1.3.3. Real-Time Health Monitoring Systems	19
1.4. Use of Smart Building for Indoor Safety	20
1.4.1. Fire Hazard.....	20
1.4.2. Electrical faults	21
1.4.3. Gas Leak	25
1.4.4. Water Leak.....	28
1.5. Use of Smart Building for Security.....	30
1.5.1. Indoor Crime Prevention.....	31
1.6. Conclusion.....	33
Chapter 2: Research Methodology.....	35

2.1.	Introduction	35
2.2.	System General Architecture	35
2.2.1.	Data Collection Layer	37
2.2.2.	Data Transmission and processing.....	37
2.2.3.	Data Analysis	38
2.2.4.	Control Layer	38
2.2.5.	Smart Services	39
2.3.	System Operation Mechanism	39
2.4.	Role of BIM	39
2.5.	Use of Artificial Intelligence (AI).....	41
2.6.	Monitoring and Decision Making per Hazard.....	41
2.6.1.	Fire Hazard.....	41
2.6.2.	Electrical Faults	43
2.6.3.	Indoor Air Pollution (IAP).....	47
2.6.4.	Gas Leak	50
2.6.5.	Water Leak.....	53
2.6.6.	Intrusion and Crime	55
2.6.7.	Health Hazard	61
2.7.	Synthesis of System Monitor and Control	63
2.8.	Conclusion.....	66
Chapter 3: A BIM-based Smart System for Fire Evacuation		67
3.1.	Introduction	67
3.2.	Literature Review	67
3.2.1.	Space Management	67
3.2.2.	Early Detection	68
3.2.3.	Evacuation Management.....	68
3.2.4.	Simulations	69
3.2.5.	BIM for Fire Evacuation Management	70
3.3.	Materials and Methods	72
3.3.1.	Smart evacuation system framework	72
3.3.2.	Fire evacuation system operation mechanism	75
3.4.	Application to a research building of Lille University.....	78
3.4.1.	Presentation of the building	78
3.4.2.	Fire Simulation.....	79

3.4.3.	Agent-based Evacuation Simulation (ABS)	83
3.4.4.	Use of BIM for evacuation management	84
3.5.	Conclusion.....	88
Chapter 4:	Assessment and Improvement of Anti-COVID-19 Measures in Higher Education Establishments	89
4.1.	Introduction	89
4.2.	Literature Review	89
4.2.1.	Method of Transmission	89
4.2.2.	COVID-19 Risk Factors and Symptoms.....	90
4.2.3.	COVID-19 Prevention Measures	91
4.2.4.	Smart Building beyond COVID-19	92
4.2.5.	Digital technologies and AI Implementation for COVID-19	96
4.2.6.	BIM implementation for COVID-19	97
4.3.	Materials and Methods	98
4.3.1.	Methodology	98
4.3.2.	Application to the engineering school Polytech'Lille	101
4.3.3.	Anti-COVID-19 measures at Polytech'Lille	102
4.3.4.	Use of a questionnaire for the assessment of anti-COVID-19 measures.....	103
4.4.	Results and Discussion.....	105
4.4.1.	Students' Profile.....	105
4.4.2.	Students' evaluation of the anti-COVID-19 measures	106
4.4.3.	Students' commitment to anti-COVID-19 measures	108
4.4.4.	Students' opinion about additional anti-COVID-19 measures	111
4.5.	Improvement of anti-COVID-19 measures.....	114
4.6.	Recommendations for additional measures.....	118
4.6.1.	Thermal Camera (TC).....	118
4.6.2.	Surveillance Cameras (SVC)	119
4.6.3.	Social Network (SN).....	119
4.7.	Conclusion.....	119
General Conclusion and Perspectives		121
References.....		123

Table of Figures

Figure 1.1: Journal ISI-Web papers related to indoor hazard management	3
Figure 1.2: Indoor Hazard.....	4
Figure 1.3: Multi indoor hazard classification.....	6
Figure 1.4: BIM use for project life cycle (Azhar et al., 2012)	7
Figure 1.5: Risk management framework used in the UK AEC industry (Zou, 2017)	10
Figure 1.6: Software-intensive for sub systems (Pătrașcu & Drăgoicea, 2014)	12
Figure 1.7: IoT Basic Infrastructure (Kumar et al., 2018).....	13
Figure 1.8: General framework of ML solutions (Djenouri et al., 2019).	15
Figure 1.9: Rates based on 2004 resident population (Hall, 2013).....	16
Figure 1.10: Breakdown of the causes of carbon monoxide poisoning accidents in 2012-2017 (W. L. Hsu et al., 2019)	17
Figure 1.11: Intelligent system for IAQ assessment (Cociorva & Iftene, 2017).	18
Figure 1.12: Electrical fatalities from 2012 to 2016 in the U.S. (Zemaitis et al, 2019).	21
Figure 1.13: Embedded software control flow diagram (Machidon et al., 2018).....	22
Figure 1.14: Transmitter Section (Menon et al., 2019).....	24
Figure 1.15: Receiver Section (Menon et al., 2019)	24
Figure 1.16: Number of deaths caused by poisoning from gas leaks from 1980 to 2009 (Hall, 2013)	25
Figure 1.17: Block diagram of the system (Anandhakrishnan et al., 2017)	26
Figure 1.18: System flowchart (Vasantakumaar et al., 2018).....	27
Figure 1.19: The concept of the hazardous gas detection system (Cheung et al., 2018).....	28
Figure 1.20: Flow chart for water quality monitoring system (Saravanan et al., 2018).....	29
Figure 1.21: Summary diagram of the algorithm (Rojek & Studzinski, 2019)	30
Figure 1.22: Work Methodology (Gulve et al., 2017)	31
Figure 2.1: The system general architecture	35
Figure 2.2: System architectural design.....	36
Figure 2.3: System operation mechanism.....	39
Figure 2.4: AI methods	41
Figure 2.5: Line-to-Line fault	44
Figure 2.6: Single Line-to-Ground fault	44
Figure 2.7: Prototype for electrical fault detection	46
Figure 2.8: IAP monitoring system.....	49
Figure 2.9: Comparison of locating technologies (Rafiee et al., 2013)	57
Figure 2.10: Structure of the intrusion monitoring system	59
Figure 2.11: Position state in function with the thresholds(Jožef et al., 2011).....	62
Figure 2.12: Sensors used for indoor hazard management.....	64
Figure 3.1: Framework of BIM fire prediction and disaster relief system (M. Y. Cheng et al., 2017)	70
Figure 3.2: Framework of EvacuSafe platform (Mirahadi et al., 2019)	71
Figure 3.3: Architecture of the smart evacuation system	72
Figure 3.4: IoT smart sensors for fire detection.....	73
Figure 3.5: Dynamo script sample	75
Figure 3.6: Optimal evacuation path identification	76

Figure 3.7: LGCgE BIM Model.....	79
Figure 3.8: Fire information in the BIM model	79
Figure 3.9: LGCgE plan view – fire simulations input.....	79
Figure 3.10: Tenability variation for the first scenario (Kitchen fire scenario).....	81
Figure 3.11: The tenability variations with time for the second scenario (Electrical fire scenario).....	82
Figure 3.12: Impact of fire on the indoor occupants' flow rate (Kitchen fire scenario)	83
Figure 3.13: Impact of fire on occupants' exists (Kitchen fire scenario).....	84
Figure 3.14: Impact of fire on the indoor occupants' flow rate (Electrical fire scenario).....	84
Figure 3.15: Illustration of the temperature recorded values in the BIM Model.....	85
Figure 3.16: Heat map for temperature values generated by Dynamo	85
Figure 3.17: Temperature heat map (Kitchen fire scenario).....	86
Figure 3.18: CO emission by time in kitchen room (Kitchen fire scenario).....	86
Figure 3.19: BIM visualization for evacuation paths.....	87
Figure 3.20: Example of BIM optimal evacuation paths during a fire event	88
Figure 3.21: Occupants’ information.....	88
Figure 4.1: The frequencies of COVID-19 common symptoms’(Roser et al., 2020)	91
Figure 4.2: Social distancing (SD) importance (Armstrong, 2020).....	94
Figure 4.3: The relationships between environmental and human health (Megahed & Ghoneim, 2021)	95
Figure 4.4: Working diagram of smart device system (Nadikattu et al., 2020).....	96
Figure 4.5: General methodology for COVID-19 mitigation in buildings	99
Figure 4.6: Methodology to mitigate COVID-19	101
Figure 4.7: Polytech’Lille BIM Model	102
Figure 4.8: Illustration of the anti-COVID measures in the BIM model.....	103
Figure 4.9: Students’ opinion about anti-COVID-19 measures.....	106
Figure 4.10: Students' practice for Polytech'Lille safety measures	109
Figure 4.11: Students' opinion about additional safety measures	112
Figure 4.12: Influence of students’ profile on their opinion about additional safety measures	114
Figure 4.13: Methodology to improve anti-COVID-19 measures.....	115
Figure 4.14: Architectural rooms configuration before and after BIM implementation	116
Figure 4.15: Improvement in Anti-COVID measures	117
Figure 4.16: Entrance architecture safety layout after the optimal BIM-based design for COVID-19 spread mitigation.....	118

Table of Tables

Table 1.1: 5x5 Risk Matrix (Shuttleworth, 2017).....	9
Table 2.1: Task distribution between BIM and Platform	40
Table 2.2: Technology Combinations, Capabilities and Shortcoming (Rafiee et al., 2013) ...	58
Table 2.3: Monitor system and specific control per indoor hazard	64
Table 3.1: Monitor system and specific control per indoor hazard	77
Table 3.2: ASET computation for door exits in the first scenario (Kitchen fire scenario).....	81
Table 3.3: ASET computation for door exits in the second scenario (Electrical fire scenario)	82
Table 4.1: Composition of the questionnaire	104
Table 4.2: Students' Profile	105
Table 4.3: Students' evaluation of anti-COVID-19 measures	107
Table 4.4: Influence of students' profile on their commitment to respect anti-COVID-19 measures.....	110
Table 4.5: Influence of students' profile on acceptance of additional anti-Covid measures .	112
Table 4.6: Classroom capacity improvement using BIM (OBC-19) application	115

Chapter 0: General Introduction

Indoor hazard constitutes a major issue in buildings' design, construction, and management. Based on the American College of Occupational and Environmental Medicine (ACOEM), a great portion of our time is spent inside buildings. Hence, improving the fundamental human right to live in a healthy, safe, and comfortable environment became vital. While there are millions of indoor hazards, the six leading causes of these hazards are fire, IAP, water and gas leakage, domestic accidents, and domestic appliances faults.

According to the World Health Organization (WHO), (2016) approximately 12.6 million people died yearly as a result of working or living in an unhealthy environment (WHO, 2016). Moreover, around 3,500 people killed yearly due to home fires and 17 persons due to pipe gas leaks in the United States (Kawa, 2015). Regardless of the losses of human lives, indoor accidents yield to enormous economic losses, which amount to billions of dollars resulting from the cost of medical expenses, and property damages. For instance, home electrical fires account for \$ 1.3 billion in property damage that could be tremendously reduced by preventing or early detection of the fire (ESFI, 2015).

Focus on the last few years was centered on health and safety improvements in the construction phase using BIM. The European Commission adopted several strategic documents, recognizing key challenges and actions to improve health and safety in new buildings. Unfortunately, there is a lack of research work and implementation processes to prevent and monitor multi-indoor hazards in existing buildings to date. Many factors influence the risk management process of indoor hazards such as building components, hazard characteristics, its vulnerability and human exposure to hazard. The interdependence between the multi-indoor hazards and the interaction between technical and social systems are the main challenges in term of risk management. Therefore, the scientific question for this research is how to find an efficient and innovative solution for the complex interplay between technical and social systems for indoor hazard management? This complexity required multidisciplinary knowledge and skills to switch from a hazard centered system to an approach that recognizes the complexity of interaction.

To overcome this problematic this thesis aims to develop a comprehensive real-time system for multi-indoor hazard management system based on IoT, BIM, AI, and other digital technology. The novelty of this system is the integration of the social aspect into technical. The system is based on an integrated platform that could prevent, monitor, and detect multi-indoor hazards before they happen. The system relies on an information approach for each equipment asset and previous events from multiple connected sensors. In case of unpredictable hazards, the BIM system could detect the hazard, type, severity, and location in the BIM environment. Subsequently, the system will take the necessary actions in real-time. The system will not depend only on sensor networks; the occupants will interact with the platform through a mobile application. Briefly, this system is based on smart technologies inspired from smart building concept. IoT is used for data collection from several entities like sensors and crowdsourcing, AI for preventing future hazards based on previous events, the automation systems to take

actions regarding the equipment, and BIM technology which is the central platform of the system able to identify, control, manage, monitor, and optimize multi-indoor risks in existing buildings by real-time emergency response planning.

The target users of this research are primary the owners and occupants of private and public buildings. For example, emergency organizations have access to necessary information during a hazard scene. The higher educational establishment could manage the COVID-19 spread. Enterprises could increase their income by increasing the workers' productivity through indoor air quality (IAQ) management.

The thesis manuscript is composed of 4 chapters.

Chapter 1 presents a comprehensive review regarding indoor hazard management and the current smart building technologies used for this purpose, such as BIM, IoT, and AI. It presents the smart building technologies use for managing human health, indoor safety, and security. This chapter highlighted the limitation of previous research projects in order to highlight the importance of the proposed system.

Chapter 2 describes the methodology of the comprehensive indoor hazard management system. Firstly, the general architecture of the system is presented. Secondly, the monitoring system for each indoor hazard is defined, including the materials needed, the system decision-making, difficulties, and barriers. The indoor hazards include fire, electrical faults, IAP, gas leak, water leak, intrusion, and healthcare.

Chapter 3 presents the study related to the smart fire evacuation system that combines BIM and smart technologies. State of the art concerning fire evacuation management was presented. The materials and methods used are described in detail. This system was applied and validated in the research building - LGCgE laboratory of Lille University in France. The results of the system application are provided in the last section.

Chapter 4 presents a comprehensive methodology for evaluating and improving the COVID-19 measures in higher education establishments. The first section includes vital information regarding the COVID-19 virus, as well as the studies conducted for reducing its spread. This study describes in detail the methods and materials used that are based on BIM and questionnaire approaches. The proposed methodology is applied at the engineering school Polytech' Lille in the North of France. The results of the application are presented and discussed. Finally, improvements and recommendations are suggested to limit the COVID-19 spread.

Chapter 1: State of the Art – Literature Review

1.1. Introduction

This chapter presents the state of the art of indoor risk management. Management of indoor hazards constitutes an excellent challenge for buildings design, construction, and operation. The question is how to reduce both buildings' vulnerability to indoor hazards and the latter's impact on occupants and buildings' integrity. This chapter attempts to conduct a comprehensive review on the digital technology used for indoor hazard management such as BIM and IoT devices integrated with the AI, integration methods of current studies, an inspection of existing limitations, and prediction of future research directions.

To obtain up to date and high-quality research projects, the following steps are considered: (i) Journal papers from Web of Science; (ii) Set journal papers selection conditions and select great impact journals; (iii) Paper search in individual databases and libraries and (iv) Classification based on the results of content study and discussion on reviewed articles.

Keywords have been selected for the first stage to get the best keywords combinations for useful journals such as BIM, indoor hazard, building safety, smart building, risk management, digital technology, building monitoring, and operational phase. After using the matrix keywords methods, the three best keywords that summarize the important papers related to the topic were BIM, indoor hazard, and building safety. Using the Web of Science, we selected the last ten years' journal papers based on the three combinations. Referring to figure 1.1, “BIM and building safety” presented many journal papers about 282 papers. This high number is due to the building safety term that can be applicable to all construction phases, not only to the operational phase. The second combination, “indoor hazard and building safety,” gave around 47 articles, including more researchers about the IoT and smart building for indoor hazards. The last combination, “BIM and indoor hazards,” resulted in only four articles. Formerly, we can conclude the importance and the necessity of this research: integrating the BIM technology with other digital technologies to enhance indoor building safety by detecting and preventing indoor hazards.

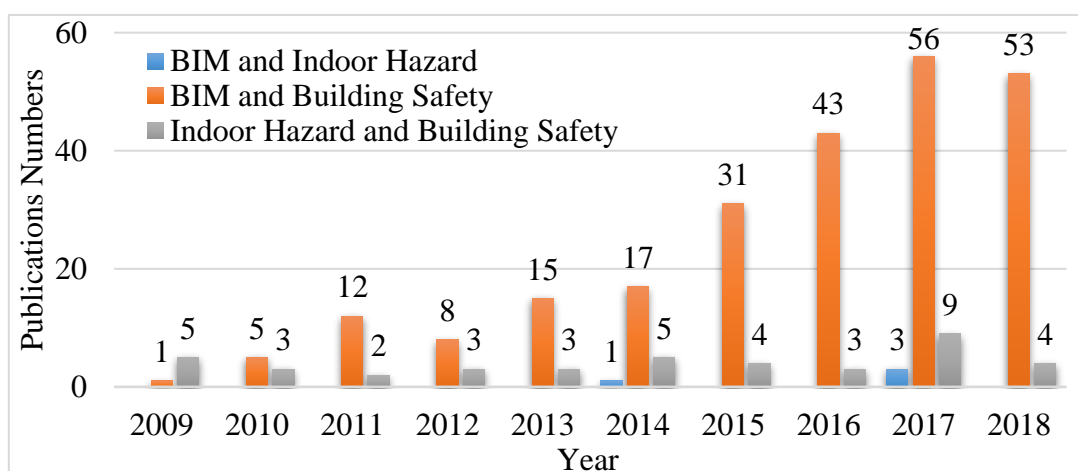

Figure 1.1: Journal ISI-Web papers related to indoor hazard management

This chapter is structured as follows: section 2 gives a quick view about the different types of indoor hazards with some recent statistics; section 3 explains the BIM concept, the traditional risk management process and gives some BIM applications for risk management. Section 4 presents the smart building concept and the integration of IoT and AI in smart buildings. Section 5 identifies the digital technologies used to enhance human health inside buildings by monitoring IAP, fall detection, and health problems. Section 6 explores the potential research related to smart building use for indoor safety, such as fire hazards, electrical faults, gas leaks, and water leaks. The last section discusses the use of smart buildings for security detection and prevention of intrusion and crimes. Those sub-sections explore the potential and recent research projects in this field with precise methodology, analysis, results, and comparison. Due to the reviewed papers, a sum-up is presented about the important innovation in indoor hazard management and a description of the current limitations, the future trends, and research and application need for a comprehensive BIM-based system for indoor safety.

1.2. Indoor Hazards

Hazard concerns any source of danger that has the potential to cause harm and damage to human beings, property, and the environment (Wehbe & Shahrour, 2019a). Some hazards are associated with natural phenomena such as floods, earthquakes, climate change, landslides, and storms, while others are related to human actions. This study concerns indoor hazards related to technical, environmental, and human factors such as fire, IAP, water and gas leak, domestic accidents, appliances hazards, intrusion, and breakout (figure 1.2).

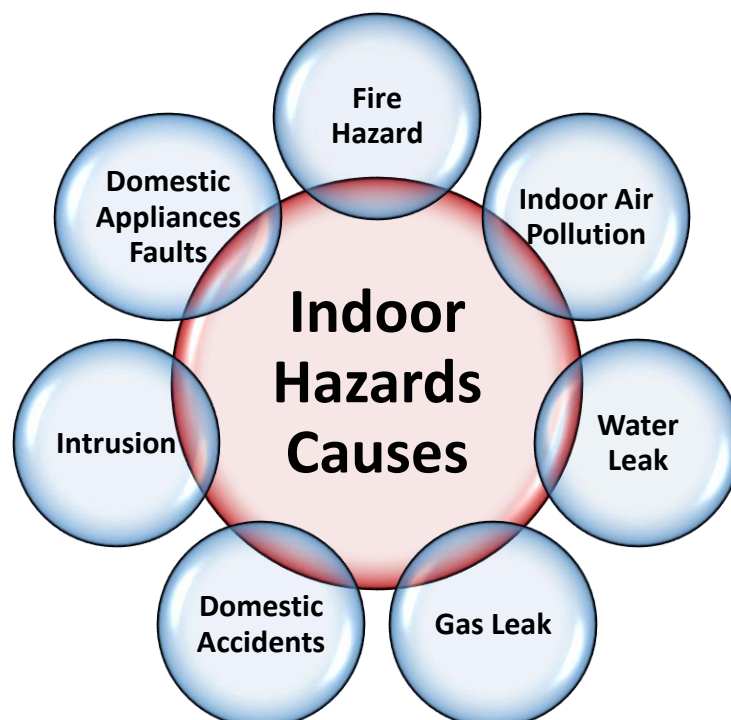

Figure 1.2: Indoor Hazard

In the United States, about 12 million accidental nonfatal residential injuries and no less than 18,000 fatal residential injuries occur in households every year (Runyan et al., 2004). The

foremost reasons for nonfatal residential injuries consist of falls, severe objects, intrusion, and poisonings, while the majority of fatal residential injuries are due to falls, poisonings, electrical faults, and fires.

Children and elderly persons are more exposed to the risk of unintentional residential injury, with estimated rates of fatal injuries ranging from 6.4% for children less than four years to 47.9% for elderly persons more than 80 years old (Runyan et al., 2004).

The following sections describe the main indoor hazards.

- **Fire hazard**

Fire constitutes a major threat that can affect constructions and cause tremendous losses in life and property damages. Fire in Stephen Court historic building in India caused more than 50 deaths (BusinessLine, 2017). It killed 72 people in an industrial building in the Philippines (Galvez, 2018). Electrical short circuits in Baldia garments factory killed more than 250 people (Tunio, 2012). According to the U.S. National Census of Fatal Occupational Injuries, around 2.5% of indoor injuries in 2017 were caused by fire and explosions (Bureau of Labor Statistics, 2018).

- **Indoor air pollution (IAP)**

IAP could cause serious disturbance to occupants' comfort, health, and productivity. It results from various factors such as combustion appliances, central heating, cooling system, tobacco, building materials, furnishers, household cleaning and maintenance products, excess moisture, and outdoor air pollution. Indoor pollutant concentrations could remain for long periods. In Kolkata, toxic fumes diffusion over the ducts of the central air conditioning system in the AMRI hospital killed around 90 persons (Dutta, 2011).

Studies conducted by the U.S. Environmental Protection Agency (EPA) stated that poor indoor air quality (IAQ) costs tens of billions of dollars each year in occupant's productivity and medical care (EPA, 1997).

- **Water and gas leak**

Water and gas leaks result from pipes or appliances deficiency. A water leak could be characterized by two types: slow leak caused by water that escapes due to poor maintenance, and the leak caused by freezing where the water flow may be slow or no flow at all. Water leak generally leads to severe damages for both the construction and furniture, while gas leak could result in fire or occupant intoxication. Ritz Barth, vice chairman of the European Water Partnership (EWP), stated that each year water leak costs Europe around €80 billion (Moriwaki, 2015).

- **Domestic accidents**

Domestic accidents could result from different factors such as falling objects, falls, cuts, burns, electrical chock, choking, drowning, poisoning by medicines, household, or cosmetics

products. These accidents concern different categories of occupants, in particular children, older people, and people with disabilities.

- **Domestic appliances faults**

Domestic appliances could present a high risk for occupants and constructions if they are improperly installed or maintained. The most common risks related to domestic appliances are fire, electric shock, and gas emissions. They could result from bad installation, poor maintenance, wrong usage, and children's inattention and curiosity.

- **Intrusion**

Burglary is defined as any offense concerning illegally entering a building to steal property. In 2017, 225,900 burglaries were recorded in Australia, which means one burglary every 3 minutes (SolarGard, 2018). In 2015, a study was conducted to present the state of burglary in Australia (Brown, 2015). As a significant result, 40 % of burglaries enter the residences or houses through unlocked doors and 28% through unlocked windows.

Based on this section, we can conclude that hazards could cause serious human and material damages. To qualify the danger of any hazard, we must measure its risk.

Multi indoor hazards could be classified into three categories: indoor safety, indoor security, and human health based on figure 1.3. Indoor safety comprises electrical faults, fire, gas leak and water leak; indoor security involves intrusion; and human health includes fall, IAP, and healthcare.

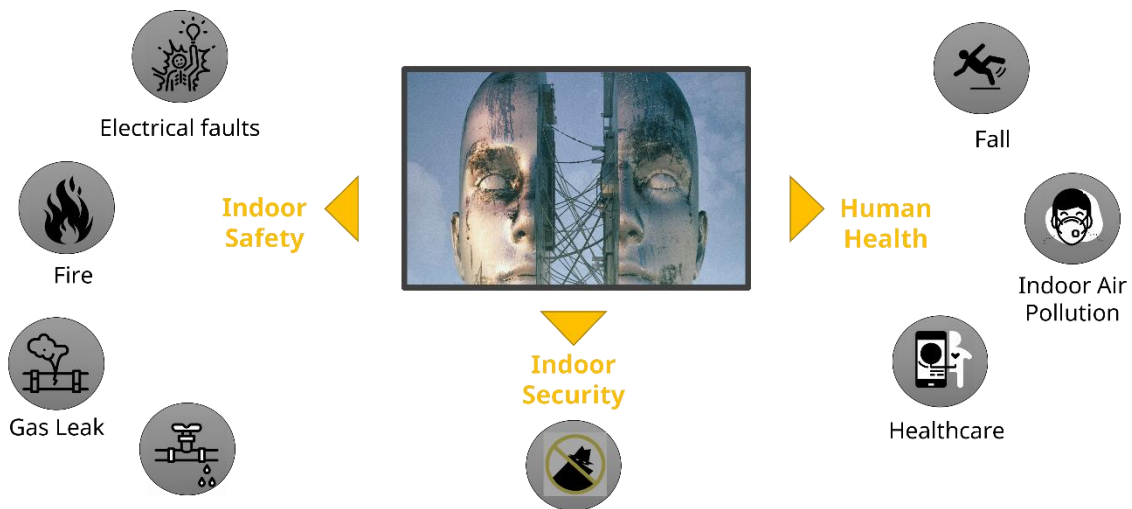

Figure 1.3: Multi indoor hazard classification

1.1. BIM for Risk Management

BIM's ability to connect project information in real-time monitoring reduces the risk probabilities because it minimizes the time lag between the occurring issues and the concerned authority. In the past years, BIM played a significant role in assessing risk management during the design and construction phase. However, at present, researchers are looking at BIM as a

handy tool in monitoring the project operational phase, enhancing building efficiency, indoor hazard monitoring, and increasing building performance.

1.1.1. BIM Overview

BIM is a system formed by several technologies and tools that lead to a digital representation of facilities' physical and valuable characteristics. BIM creates a database as a shared knowledge resource about the whole project, as illustrated in figure 1.4. This work-sharing technique produces a consistent base for any decision during the building life cycle, beginning with the concept idea to the demolition defined by Building Smart International. BIM, a visual platform, is transforming into an essential device for information management in Architecture, Engineering & Construction (AEC) industry as well for operation and maintenance (O&M) and facility management (FM) (Matějka et al., 2016). The 3D model presentation simplifies understanding how a completed project will look, how persons will move around, and how spaces will be mutually related, providing meaningful information for safety and security management.

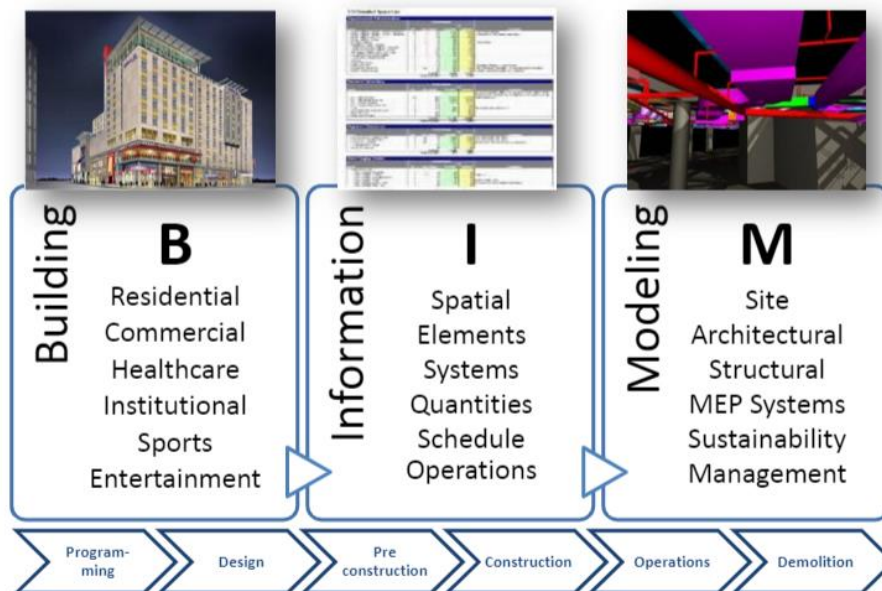

Figure 1.4: BIM use for project life cycle (Azhar et al., 2012)

BIM is used during the whole project life cycle:

- **Project Programming**

BIM offers for the team an opportunity to identify errors in early phases by analyzing the space and visualizing the ideas. It saves time and cost.

- **Project Design**

BIM generates at different stages of the project schematic design for analysis options and realistic illustrations, detailed design as structural analysis and 3D model and construction detailing as shop drawings and 5D model (3D model +time and cost management).

- **Preconstruction Phase**

Contractors can take advantage of BIM to estimate the quantities of the project. BIM is a considerable tool for safety management since it generates a 3D site coordination model that engineers can use to prepare site logistics and, therefore, a better site safety plan.

- **Construction Phase**

BIM allows the project team to monitor the project progress everywhere and anywhere using 5D model technology and a work-sharing module. These Add-ins help the working team (Engineers, Forman, Project managers, and others) coordinate their meetings and integrate all their paperwork and progress (RFIs, Variation order, punch list, working schedules) in the BIM model. Engineers also can access the BIM models at the jobsite for information extraction and coordination using their smartphones.

- **Post-construction Phase**

The facility manager can use the database generated by BIM to assess and monitor the building 24 hours. Thus, it increases the probability of preventing indoor hazards from happening and makes the maintenance of the facility more efficient in both dimensions: time and cost. Many studies showed that 85% of the lifecycle cost is related to the operational phase (Azhar et al., 2012).

BIM model changes the way infrastructure and building projects are visualized, constructed, and monitored. BIM users begin to focus on using BIM in asset management (AM), including Facilities Management (FM) tool contributing to a better efficiency facility monitoring.

1.1.2. Risk Management Overview

Most buildings are exposed to additional environmental and other safety requirements from the authorities, especially in the European Union, to achieve a better future in a sustainable way (Godager, 2011). It seems essential to understand the vital information for modeling and managing new and existing buildings during the operative life cycle to meet these challenges.

Various risks may occur in each project stage due to multi-hazards. There is a high demand for managing risks over a project's lifecycle to decrease the likelihood of these hazards.

Risk management is a decision-making process concerning the reflections of social, economic, and engineering issues with pertinent risk assessments to identify, evaluate, treat and monitor to choose the optimal controlling response for safety from that hazard. Risk is the probability that a hazard will happen. It could be obtained from the risk level that is the product of the hazard likelihood and the hazard severity using a probability/Impact matrix (Tomek & Matějka, 2014). Table 1.2 illustrates the 5x5 risk matrix that presents the risk level for all combinations after risks identifications. We can conclude from the risk matrix that the greater the chance of risk event occurrence, the greater the influence of the risk event, and the greater the risk response importance (Shuttleworth, 2017).

Table 1.1: 5x5 Risk Matrix (Shuttleworth, 2017).

Highly Probable	5 Moderate	10 Major	15 Major	20 Severe	25 Severe
Probable	4 Moderate	8 Moderate	12 Major	16 Major	20 Severe
Possible	3 Minor	6 Moderate	9 Moderate	12 Major	15 Major
Unlikely	2 Minor	4 Moderate	6 Moderate	8 Moderate	10 Major
Rare	1 Minor	2 Minor	3 Minor	4 Moderate	5 Moderate
Probability / Impact	Very low	Low	Medium	High	Very High

Three keywords should be defined in a risk management scenario: risk owner, risk source, and risk recipient (ISO, 2009). The risk owner is responsible for the risk management, knowing that the owner could be one or more. The risk source brings up the probable event cause; then, a no-risk scenario will be realized if there is no risk source. The risk recipient is the one who falls victim to the event in case the risk scenario happened.

1.1.3. Risk Management Process

Risk management includes the following:

- Establish the context: define and plan the framework for the risk identification and analysis.
- Risk Identification: start with identifying the potential risk and the risk source. This stage necessitates knowledge of the hazard vulnerability to unexpected losses. Any failure in the risk identification may cause major social and economic losses.
- Risk Assessment: Once hazards have been recognized, they must be assessed as to their occurrence probability and the potential severity of a loss. In this step, it is essential to make the best-educated guesses to prioritize the risk management strategy. The vital struggle in risk assessment is to determine the probability of risk occurrence.
- Risk treatment and control: Risk can be controlled by preventing or controlling losses.

- Create the risk management plan: precise the methods followed to control each kind of hazard. The risk management plan should include appropriate safety controls for risk management.
- Implementation: Follow the intentional methods for mitigating the risk effects.
- Plan review: the scenarios practice and experience will require modifications in the plan and new regulations to enhance the safety level.

1.1.4. BIM Application for Risk Management

The common risk management framework used in the UK AEC industry is described in figure 1.5 (Zou, 2017). It concerns a long-term risk management approach that allows stakeholders to work collaboratively to manage risks in all stages.

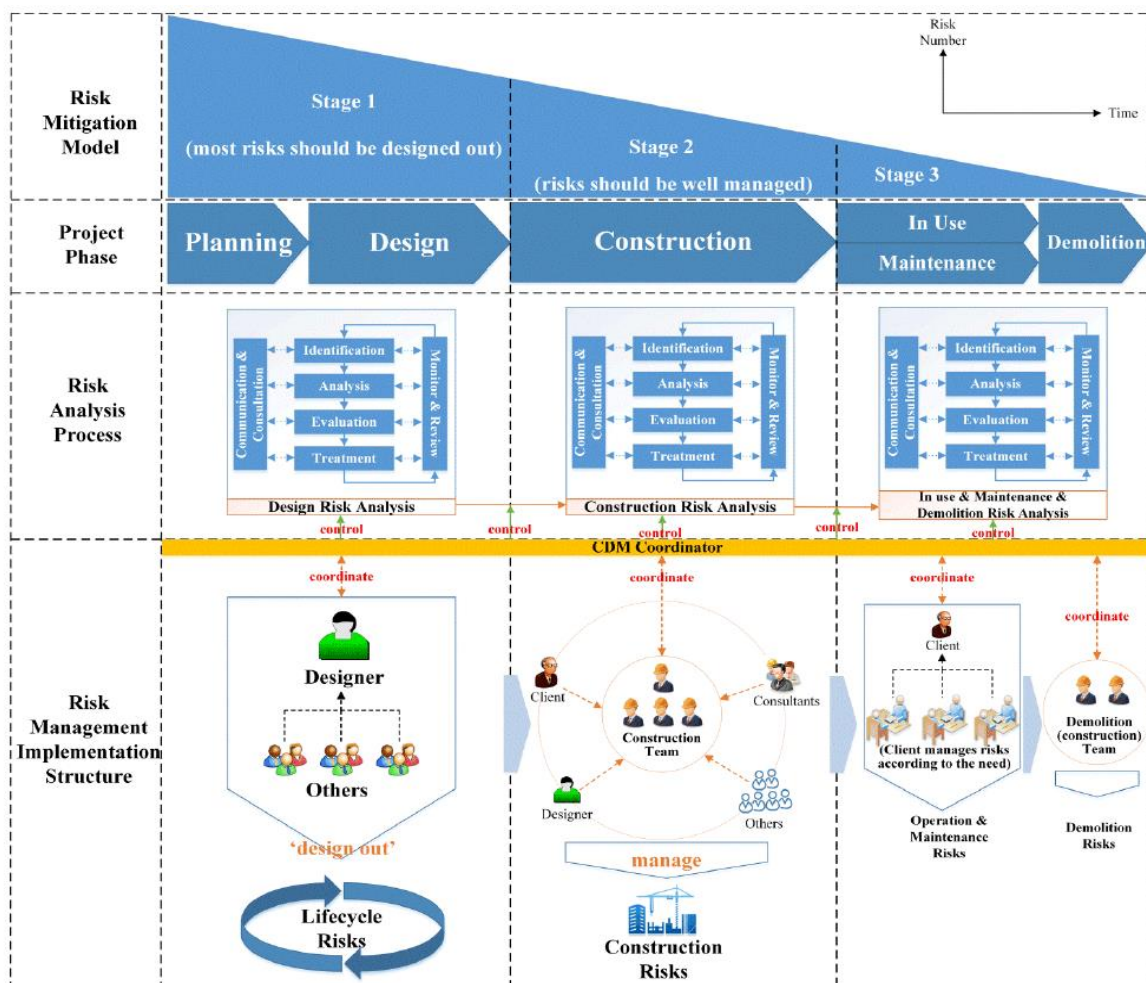

Figure 1.5: Risk management framework used in the UK AEC industry (Zou, 2017)

Initially, BIM was used to manage quantity and cost for the construction phase, improve data exchange and reduce data loss for the whole project. With the rapid improvement and use of BIM, some investigators tried to implement BIM for managing project risks in the last few years. For example, BIM was used to prevent any human safety accidents on site. It is essential to detect and mitigate these risks in design, review, monitoring, and construction safety (Bansal, 2011).

The process of applying BIM can be seen, to some extent, as a systematic way of managing risks. BIM is likewise used for other safety matters, reactive and proactive safety systems based on information technology. There is a necessity to distinguish between two safety systems: reactive and proactive for risk management. In 2014, Forsythe worked on a reactive system using information technologies such as IoT, VR, 4D CAD, and GIS. This system could collect real-time data but with additional effort to analyze collected data. In contrast, proactive technologies can collect data, analyze and provide real-time warnings and advice to concerned authorities about the hazard.

BIM is not always the way to solve safety issues. It is more about BIM-related technologies such as databases, sensors, VR, GIS, etc. BIM can be used as a systematic risk management tool. It can perform as a central data generator and platform to permit other BIM-related technologies for advanced risk analysis, where the majority of these tools can be used interactively in associated investigations (Zou, 2017). The visualization feature of BIM can commendably enhance risk detection, analysis, and information at an early stage. Today technologies are looking at BIM as a vital tool for security and safety management and preventing indoor hazards such as voluntary attacks, robbery, and other incidental events. Some researchers have already implemented BIM and BIM-related tools to manage some risks. For example, automatic examination of fall hazards in BIM over model checkers (S. Zhang et al., 2013) and evacuation simulation for fire accidents in buildings (B. Wang et al., 2014). The visualization feature of BIM can effectively improve risk identification and analysis.

Ding et al. (2016) presented a framework for risk knowledge management and developed a prototype with a user interface that links risk information to BIM objects. However, minimal research or tools exist in this field. Both theoretical developments and applied studies need to be explored. BIM is a flexible tool that can work in multidiscipline and is incorporated with the AI model for a self-learning system (Ding et al., 2016).

Researchers are working on developing new digital technologies to manage specific risks and take up precise scenarios. Consequently, there is a necessity for proper research on how we can integrate several technologies to improve the safety level. As a result, traditional risk management methods still have a significant role in building projects and stand in the way of the implementation of BIM and BIM-related tools for better risk management.

1.2. Smart Building for Indoor Safety

One of the most important conditions in a smart building concerns resiliency. A building must prepare, plan, withstand, recover, and learn to adapt to adverse hazards events to be considered resilient. Recently, technology is growing fast and opens doors to hi-tech inventions to prevent indoor hazards.

1.2.1. Smart Building Background

Smart buildings aim at reducing facilities expenses such as heating, ventilation, lighting, security, and numerous other services to the occupants without affecting the environment (Zafari et al., 2016). The fundamental reason behind the construction of smart buildings is to

provide people comfort, efficiency, and safety. In this context, smart buildings control temperature, humidity, ventilation, lighting, security, safety, and other building operations (Younus et al., 2019). However, the greatest tempting advantage of smart building technologies is the revolution in Building Management Systems (BMS). They are likewise expressively influencing other areas such as health care, safety, and security (Figure 1.6) (Djenouri et al., 2019).

Smart buildings use Information and Communication Technologies (ICTs) to interconnect building subsystems. Such interconnection provides information sharing that enhances building performances, interactions with occupants, and connections with other buildings (Zafari et al., 2016). The IoT solutions are the basics of ICTs for smart buildings, where there is a necessity to collect, store, filter, and analyze the information acquired from interacting entities (sensors, occupants, other buildings, etc.).

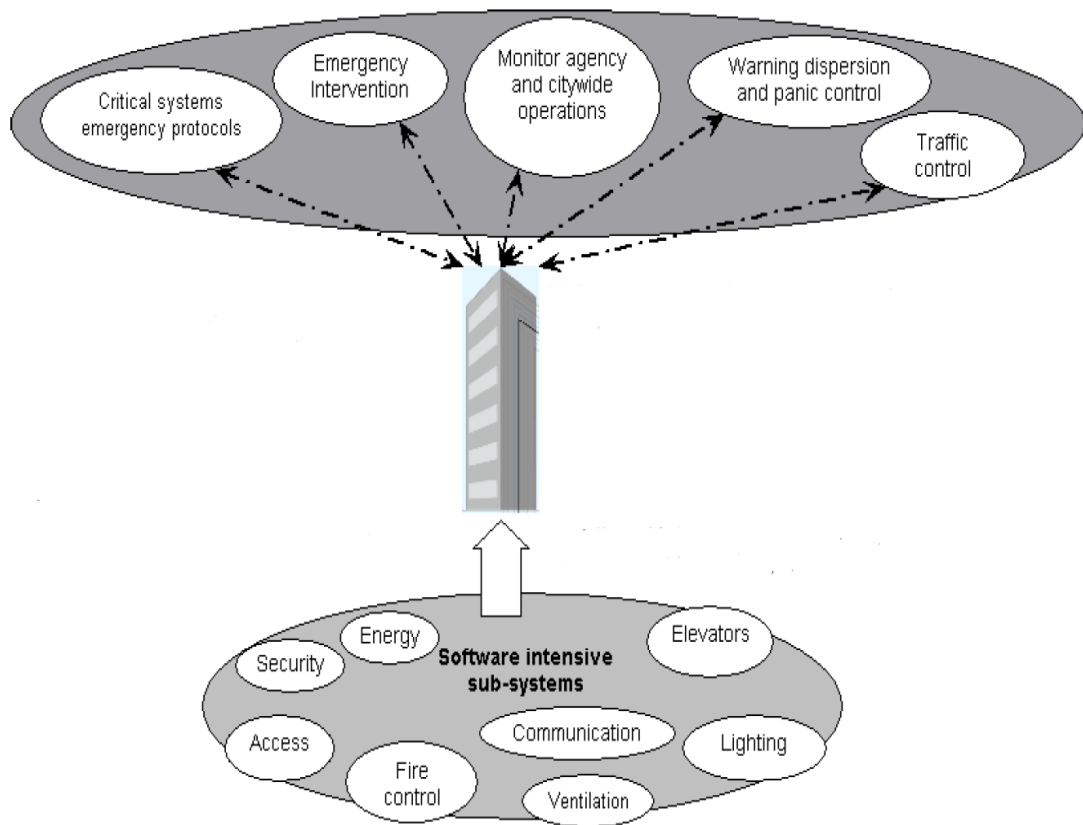

Figure 1.6: Software-intensive for sub systems (Pătrașcu & Drăgoicea, 2014)

Automation systems enhance disasters management. For example, in case of fire hazard, the fire sensors can alert the ventilation system to turn off the fans (Zafari et al., 2016). Likewise, the building security system and emergency response centers could be connected to interact in case of any incident (Pătrașcu & Drăgoicea, 2014).

Previous research about IoT for smart buildings focused on energy management, dynamic automation, and real-time information. The current trends in smart building concern the use of

machine learning (ML) for deducing the users’ profile, preferences, behavior, comfort, and optimization according to collected data (Djenouri et al., 2019).

1.2.2. Internet of Things (IoT) Services for Smart Buildings

IoT allows the interconnection of numerous “Things” like sensors, smart phones, buildings, actuators, and other objects. The collaboration between these devices forms the basic support for IoT to reach common goals (Giusto et al., 2014). The IoT is increasingly used since the public investigates its potentials to generate data with sensing, collecting, analyzing, and communication abilities. The European Commission started supporting IoT technologies in 2005 (Davies, 2017). The National Science Foundation (NSF) in the USA included the IoT as part of their cyber-physical systems (Miorandi et al., 2012).

IoT is used in various applications such as smart grids, smart transportation, smart manufacturing, smart environment, and smart healthcare. The future applications are envisioned to enhance the life quality of the tenants at the office, home, gym, library, hospital. The IoT infrastructure could be presented in seven layers, as illustrated in figure 1.7 (Kumar et al., 2018).

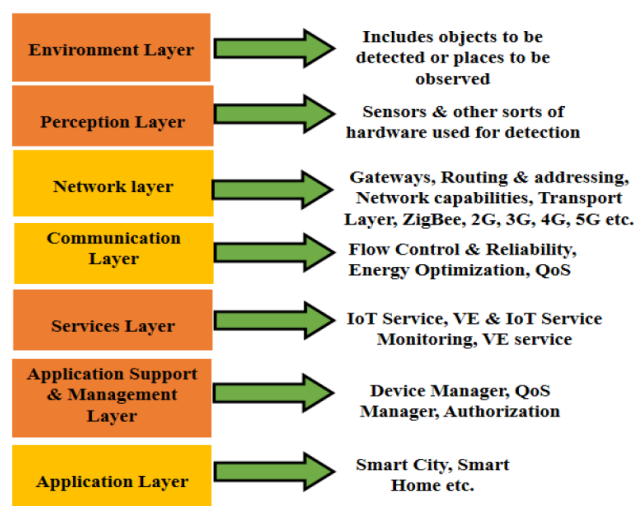

Figure 1.7: IoT Basic Infrastructure (Kumar et al., 2018).

The progress of sensing technology, control systems, and IoT infrastructure contributes to the development of smart buildings. Consequently, the innovation of smart buildings in the context of IoT is facing a great extent (Verma et al., 2019).

1.2.3. Artificial Intelligence (AI) for Smart Buildings

The use of Smart Buildings could concern five main areas: entertainment, caregiver, safety and security, health monitoring, behavior monitoring environment.

- **Artificial Neural Network (ANN) for Building Safety**

Many research projects use Artificial Neurol Network (ANN) for face recognition. Face detection could be helpful in the smart home environment for intruder detection. ANNs are

used in fire detection. Researchers developed a satellite-based remote sensing technique to identify smoke from the fire and interact with fire alarm systems.

ANN can help in recording medical and physiological data and diagnoses concerning human health. It is helpful for routine medication surveillance, heartbeat and blood pressure monitoring, and falls detection. In case of any abnormal record, notifications with the necessary information are automatically transmitted to health professionals.

Begg and Hassan (2006) presented how we can control devices used in home automation. First, the data bus is accountable for collecting the data for multi areas and send it to the middleware. The middleware extracts and selects the essential features from all the data collected and then pass these features on a relevant ANN. The middleware analyzes the data and decides whether there are any dependencies between the modules. Then, the central server will send the final decision based on associated data and their interdependencies (Begg & Hassan, 2006).

- **Use of Machine Learning (ML) in Smart Building**

ML is training computers to learn from data collected over previous experience, predictive modeling and applying the knowledge to expect future situations, and decision-making. Learning is the greatest suitable alternative when it is challenging to compose programs to solve problems directly. In this case, the solution is not a priori recognized but can only be established using past experiences (Djenouri et al., 2019).

Previously, ML has been fundamentally used in the domains related to speech and face-recognizing and language treating. In the context of buildings, important problems such as predicting occupants' behavior and preferences, predicting energy demand are challenging to be resolved with traditional software, but potential results can be well-educated from the stored data. Therefore, the use of ML in smart buildings is attracting researchers in several disciplines.

Figure 1.8 presents the general framework for the ML solution. It includes four steps: (1) Data collection from diverse sources, including environmental sources such as sensors, archive sources from event log databases like previous human experiences, or other data sources such as the internet. (2) Data preprocessing to (i) enhance the statistical data, (ii) data filtering, (iii) selection of the suitable features from all the data, (iv) normalization of the data, which is required for some ML operators. At the end of this phase, input data is generated for ML approaches. (3) Learning phase to learn functions and models. (4) Learning interpretation from the preceding step, which essentially is contingent upon the application used.

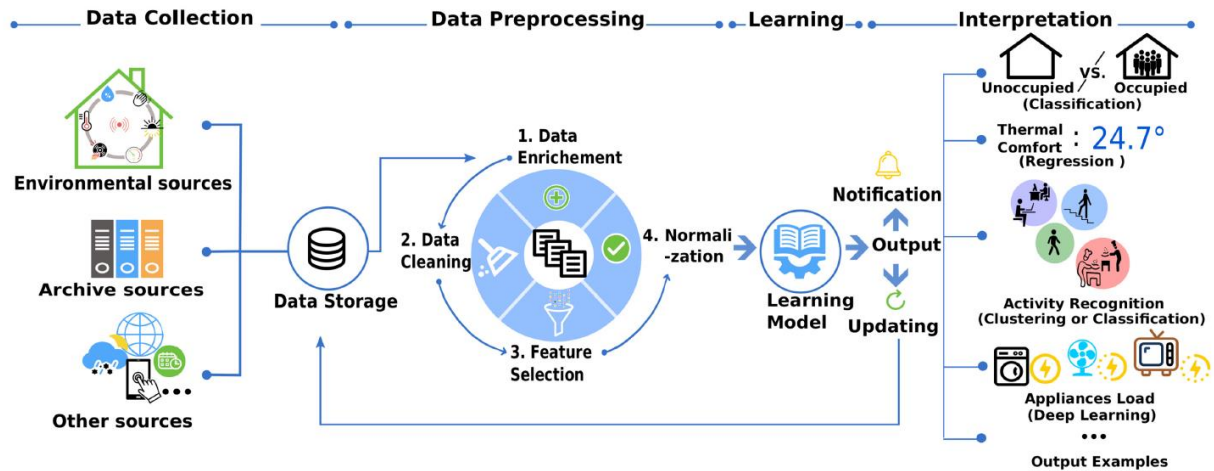

Figure 1.8: General framework of ML solutions (Djenouri et al., 2019).

The ML is used to deal with building residences to identify the occupants' presence, the number of occupants, and their characteristics. Previous works of buildings monitoring have concentrated on the use of wireless sensing tools to detect or track inhabitants. New innovative solutions are not restricted to real-time data but deliberate using sensors to assess future tenancy and features linked to tenancy via ML tools.

De Paola et al. (2014) presented the methodologies to detect occupancy and learning approaches for users' preferences (De Paola et al., 2014). Shih et al. (2016) divided the occupancy monitoring into two operating approaches: presence detection and estimation of the number of occupants. They used a system of active physical sensing called ultrasonic response estimation sensor, which is based on processing the superposition of the microphone-recorded reflections from a transmitted ultrasonic signal (Shih et al., 2016).

Soltanaghaei and Whitehouse (2016) suggested WalkSense, a solution that uses walkway sensors to sort states of the tenancy. In order to classify the occupant state, they presented three walkway zones: active (daily occupant activities), outside, and sleep. Two strategies were used for occupancy state: the offline and online WalkSense. The offline WalkSense uses stored data and defines a sleep or other state interval to be the period between a pair of two successive detections by the sensor at the state walkway. The online WalkSense can identify the diverse states in real-time. The results showed that the WalkSense approach reaches 96% accuracy in offline strategy and 95% in online strategy (Soltanaghaei & Whitehouse, 2016).

Bales et al. (2016) focused on occupant problems. They were not restricted to the occupant's detection or counting them but were more intent in defining their gender. Gender information has various potential applications, such as security in public buildings. They used accelerometer sensors placed on the walking floor surface for physical sensing. Supervised ML techniques were used for classification, including different methods. The authors reported high accuracy in detections, mainly when using Support Vector Machine (SVM) that provided less error than ANN: 88% precision for gender classification with SVM against 55% with ANN (Bales et al., 2016). However, the technique used necessitates many sensors under the floor, which confuses installation in existing buildings.

Khalil et al. (2016) went beyond gender classification and detected people by sensing their body shape and movement with ultrasonic sensors. The authors could extract seven features from the indicators sensed during walking actions: height, width (maximum and average values), girth, hand-waist distance, and bounce. The authors indicated that identification becomes possible by extracting features from their dissimilarities (Khalil et al., 2016).

Other researchers proposed a solution for occupants' detection over noninvasive sensor signals. This solution is helpful for security, safety, and advanced healthcare applications. The best solutions in this category are based on SVM and Decision Tress (DT) as the standard ML technique. Ota et al. (2017) described the use of Deep Neural Networks (DNNs) in (1) healthcare applications: assessing the number of calories from food through mobile pictures and appropriate information, human movement monitoring to avoid chronic diseases, and approximating the stress level by speech analysis; (2) security: detection of malware on smartphone devices; (3) ambient intelligence: recognizing spaces of concern and localizing garbage; and (4) translation and dialog recognition (Ota et al., 2017).

1.3. Use of Smart Building for Human Health

Quality healthcare services have become a major concern in today society. Indoor air pollutants consist of gas and air particles that could negatively affect users (Marques & Pitarma, 2019). Based on US Environmental Protection Agency (EPA), the indoor air pollutants could reach 100 times than outdoor air pollutants (EPA, 1997). Between 1999 and 2012, around 6,136 fatalities were caused by CO indoor pollution (Sircar et al., 2015). Furthermore, from December 2015 to January 2018, 54 cases of CO poisoning were identified in Taiwan, causing 11 deaths and 171 injuries (W. L. Hsu et al., 2019). Based on World Health Organization (WHO) report, 7 million people die each year from exposure to air pollution; more than half of them are victims of IAP. Gas poisoning results from different causes such as high levels of CO, isobutane cooking gas, methane gas, gas obtained from the chemical mixture, and in many times gas leaks. In 2009, around 784 persons died because of a gas leak, and in 2012, 33,600 injuries suffered from anoxia (deprived of oxygen) from which 16,800 weren't fire involved (Hall, 2013). Figure 1.9 describes statistical data of mortality rate caused by poisonous gas and vapors in 2004.

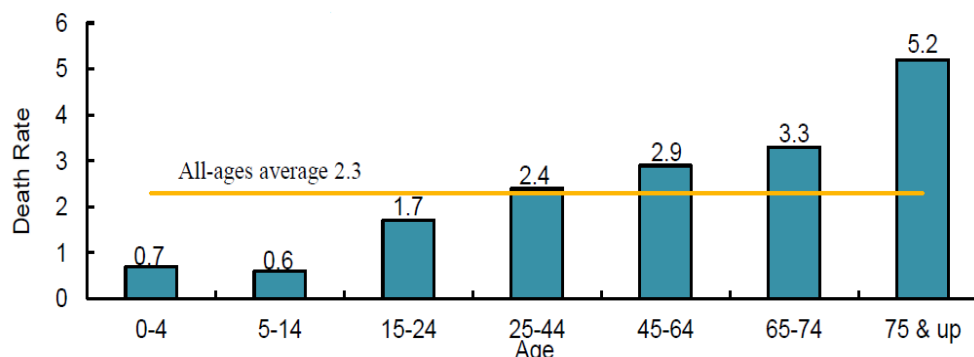

Figure 1.9: Rates based on 2004 resident population (Hall, 2013).

Since many people live alone and especially elderly persons, it is essential to provide basic services for them to live a safe and good life quality. According to WHO, falling presents the highest risk; approximately 646,000 fatal falls happen over the world yearly, making falling the second foremost cause of accidental injury death(WHO, 2021). In addition to the human health causes that will be presented in this section, a new health disease has appeared in late 2019 called Coronavirus (COVID-19) that is currently considered a dangerous indoor hazard. Chapter 4 will present all about COVID-19 with a detailed state of the art about the digital technology used to limit the virus spread.

1.3.1. Indoor Air Pollution (IAP)

Indoor air intoxication is, in general, the result of a gas leak or fire. In response to these hazards, governments are investing more and more in IoT and sensors technology for indoor air monitoring (W. L. Hsu et al., 2019). Marques & Pitarma (2019) developed an IoT system for air monitoring called IAir. This system is composed of an ES_p 8266 unit for communication and Mics-6814 air sensors. IAir was able to identify most toxic gases like Carbon Monoxide (CO), Nitric Oxide (NO), Ethanol, Methane, and Propane. In addition, the system can collect and store data in a ThingSpeak web platform. ThingSpeak offers the advantage of visualizing the archived and live data.

Furthermore, ThingSpeak using the internet can send a message alerting the users. However, this system does not take any actions other than alerting. In many times, gas like Methane and Isobutane are too fast in poisoning and thus need instantaneous actions (Marques & Pitarma, 2019).

In 2019, a study was made in Tokyo tackling the use of IoT to prevent CO poisoning. Since CO is a colorless and odorless gas, hence CO poisoning symptoms are challenging to be detected by humans (W. L. Hsu et al., 2019). Figure 1.10 presents the causes of CO poisoning accidents.

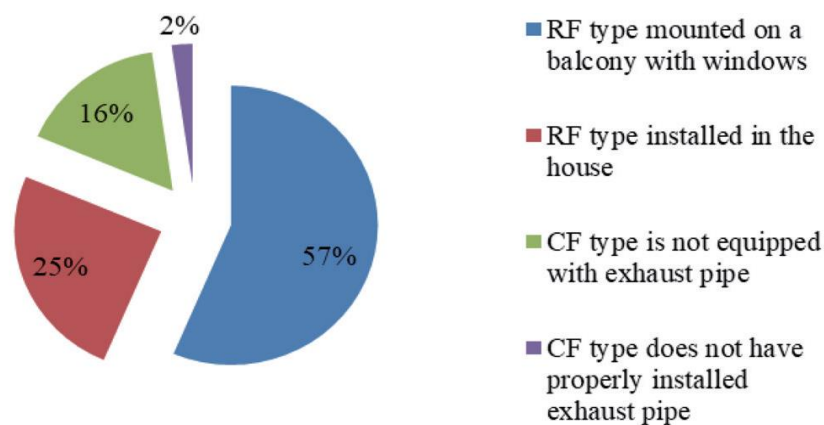

Figure 1.10: Breakdown of the causes of carbon monoxide poisoning accidents in 2012-2017 (W. L. Hsu et al., 2019)

The system was equipped with CO sensors and Arduino ship connected to electrical windows, fans, HVAC systems, and a device installed to stop the gas leak. The system can take decisions

depending on other platform conditions. Whenever the sensors detect an unusual rate of CO, it triggers an alarm and notifies the key players to conduct a rescue operation, plus ordering the windows to open and HVAC or fans to reduce the CO concentration.

Marques et al. (2018) created a system named Idust to monitor Particle Material (PM), which are considered the main reason for deteriorating the respiratory system of human beings, cardiovascular problems, and can cause mortality to young children (Marques et al., 2018). Idust is a software program on Arduino linked to PM sensors and SQL server for data collection and storage. The prototype is equipped with a platform connected on the web to real-time monitoring for IAQ.

Azizi et al. (2016) used IoT technology to track indoor methane gas used frequently in greenhouse buildings for its relatively clean combustion. They proposed dual monitoring for dangerous explosive gas and classified them into two stages: (1) stage where the gas density becomes poisonous and (2) stage where the gas density becomes very high and can trigger an explosion. If an explosion is triggered, the IoT system related to fire takes the necessary action (Azizi et al., 2016). Marzouk et al. (2015) proposed a BIM integrated module to track IAQ, temperature, humidity, and gas. The system was more related to comfort than hazard monitoring since it was responsible for adjusting comfort parameters to meet the standards (Marzouk et al., 2015).

Recently, AI provided an exceptional opportunity in monitoring IAP and making prior decisions. Cociorva & Iftene (2017) developed the assessment of IAQ and pollution using an electronic nose (E-nose). An E-nose is an electronic system based on AI, capable of meeting the olfactory functions of the human nose. The E-nose is an ML system that collects data from gas sensors and is transferred to an analytical vector V of size equal to the number of sensors installed (figure 1.11). On the other hand, the machine already has a predefined sensor vector classified to meet the users' needs. An IAP classified vector is characterized as dry air, hot, polluted with combustible gas, and fire hazard. During real-time monitoring and sensing, each collected vector V is transferred and compared with users' defined standards (Cociorva & Iftene, 2017).

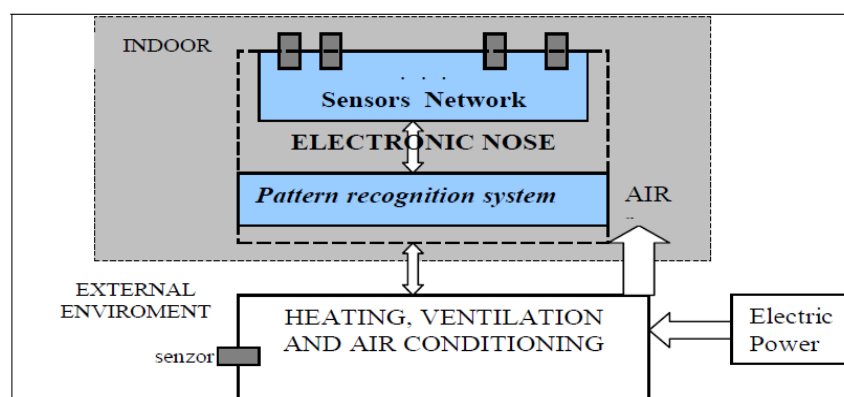

Figure 1.11: Intelligent system for IAQ assessment (Cociorva & Iftene, 2017).

1.3.2. Fall Detection

Before 2014, numerous scholars appraised the improvement of fall detection, existing issues, and challenges and directed the future of this topic (T. Xu et al., 2018). With the development of smart sensors and IoT technology, thousands of papers related to fall detection were published. Recently, researchers are looking at using BIM as a tool to link the IoT elements and create a comprehensive system that provides safety and healthcare for the entire unit.

The smart sensors used for fall detection could be classified into three categories (T. Xu et al., 2018):

- Vision-based: visual sensors are based on camera capture and kinetic sensors that are based on whole-body 3D motion capture with facial and voice recognition.
- Accelerometer-based: comprises specific accelerometer devices and accelerometers built-in smartphones.
- Radio Frequency sensor-based: includes Wi-Fi and radar system.

Mastorakis & Markis (2014) used kinetic sensors for real-time fall detection using the 3D bounding box method that requires no pre-knowledge of the scene (Mastorakis & Makris, 2014). In the same year, Gasparrini et al. (2014) inspected a privacy-preserving fall detection technique for the indoor environment. This method allows detecting fall hazards without using wearable sensors (Gasparrini et al., 2014). After one year, Kwolek & Kepski (2015) suggested a new algorithm for fall detection by combining the accelerometer and Kinect. The accelerometer was used to specify a potential fall, while Kinect authenticated the eventual fall alert (Kwolek & Kepski, 2015). Although accelerators are often used in fall detection systems, knowing that they can only get motion information of part of the body because of the ease of use in a specific position. Besides, the accelerometer is an extensively built-in smartphone nowadays.

The third category used wireless techniques to identify environment change and connect the wireless signal to human activities. Wang et al. (2017) presented the design and application of a real-time, low cost and accurate indoor fall detection system using WiFi devices called RT-Fall. RT-Fall deduces the phase and amplitude of the fine-grained channel state information (CSI) reachable in WiFi (H. Wang et al., 2017).

1.3.3. Real-Time Health Monitoring Systems

Kim et al. (2013) proposed a healthcare system with new services for elderly and less capable patients such as young children deprived of temporal and spatial limitations. U-Healthcare system can record health information about each patient (blood pressure, heart rate, pulse oximeter readings, etc.), alarm for medicals time, and alert medical staff in case of abnormal condition (S. C. Kim et al., 2013). The proposed system offers real-time monitoring of older people's whereabouts. This system used the Radio-Frequency Identification Technology (RFID) to perform indoor location sensing and tracking. The patient's movement wearing an RFID tag is sensed by the RFID readers placed inside the building. The sensed location, along with the timestamp, is sent to the home server for information stock and data analysis. The

collection of locations recorded in a predetermined interval of time permits identifying the elderly trajectories and movement, the duration of non-movement, and the emergency and abnormal situations. In addition, an external system is connected to the home server via external interfaces, which gives private access to the healthcare workers about the elderly health state (S. C. Kim et al., 2013).

Dziak et al. (2017) suggested an IoT-based healthcare information system for indoor and outdoor use. This system can monitor people's location, discriminate different activities and situations, behavior recognition, and classification (Dziak et al., 2017). People's posture is recorded through the Inertial Measurement Unit (IMU), with a built-in three-axis accelerometer, gyroscope, magnetometer, and altimeter. It is equipped with WiFi, GPS, and heart rate elements. The system seems to be very efficient since the accuracy is 98% for fall detection, 95% for other vital activities. In addition, the proposed behavior classification algorithm can distinguish normal, suspicious, and dangerous situations in almost 100% of cases.

Recently, Jeyaraj & Nadar (2019) proposed a smart monitoring system as a progressive electronics component by using an intelligent sensor. They used a national instrument, myRIO form, with a WiFi module of high-speed data transmission for smart data acquisition. Collected data are used for analysis and visualization through a deep learning algorithm (Jeyaraj & Nadar, 2019). The accuracy of the Electroencephalogram (EEG) system, electrocardiogram (ECG), temperature profile, and pulse rate is about 97.5%. This smart monitoring system is mainly used to predict abnormal situations for elderly persons. Durán-Vega et al. (2019) suggested an IoT health monitoring system, using a biometric bracelet linked to a mobile application, which permits real-time visualization of information generated by sensors (body temperature, heart rate, and blood oxygenation) (Durán-Vega et al., 2019). Users supposed the system to be easy to learn and use.

1.4. Use of Smart Building for Indoor Safety

1.4.1. Fire Hazard

In 2015, 2,635 died due to indoor fire hazards in the United States (National Fire Data Center, 2019). Yearly, 1,153 fire accidents happen in Taiwan, and around 100 firefighters died through fire rescue (X. S. Chen et al., 2018). Usually, the persons involved in a fire scene can be categorized into two groups with different motives and objectives: the evacuees and the firefighters. The goal of the evacuees is to escape and protect their own lives. However, that of the firefighters is to save the occupants' lives by performing rescue operations.

The fundamental causes of evacuees' death during a fire scene are the poor sense of escape, facing obstacles while evacuating, and exceed the required time to escape (M.-Y. Cheng et al., 2016). Conversely, firefighters frequently enter the building based on their previous experience, unaware of the fire causes and unfamiliar with the location's environment.

Then the riskiest situations in a fire scene for the evacuees and firefighters are:

- Lack of information about the fire scene and spatial configuration, which cause bad decision making when taking the escape route(N. Li et al., 2014).
- The obscurity of modifications in the fire scene, which can lead the occupants to pass too much time trying to escape (Lurz et al., 2017).

Several researchers proposed different models and ideas to achieve a resilient evacuation system. The research projects will be presented and discussed in chapter 3, highlighting the previous studies and suggesting a smart fire evacuation system.

1.4.2. Electrical faults

Electrical faults are defined as imperfections that happen in electrical wires, transmission lines, and electrical machines that can lead to network failure, fire burning, and a fatal effect on the human body (Mohd Hafizi et al., 2018). In the United States, each year, 1,000 deaths occur due to electrical faults and at least 30,000 shock incidents injuries (Zemaitis et al., 2019). Furthermore, 5% of all fires that occur in buildings are caused by electrical faults. Most importantly, 20% of these accidents concern children. Figure 1.12 describes the electrical fatalities from 2012 to 2016 in the US. (Zemaitis et al., 2019).

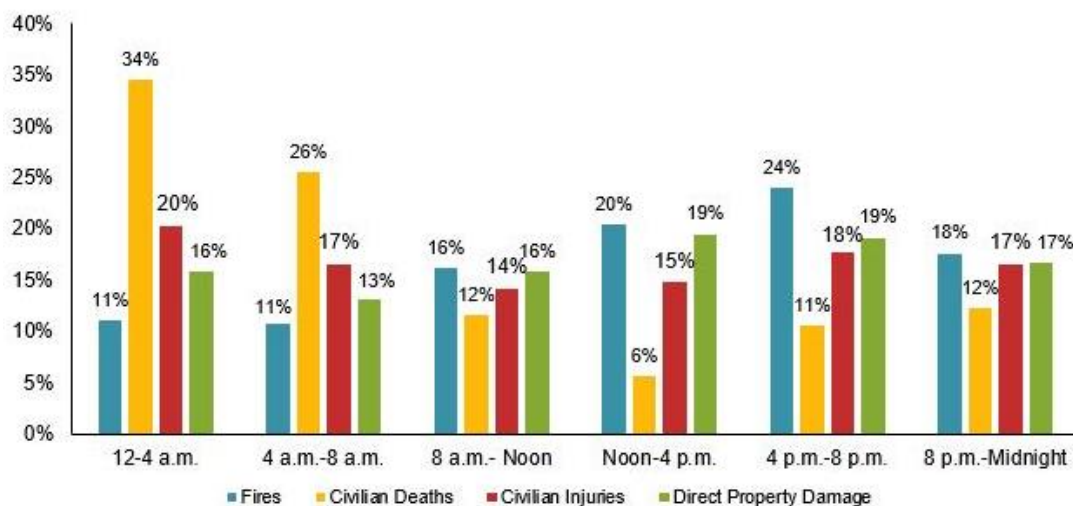

Figure 1.12: Electrical fatalities from 2012 to 2016 in the U.S. (Zemaitis et al, 2019).

The electricity in any infrastructure is highly vulnerable since it is subjected to many natural and malicious events (Suresh et al., 2017).

In the European Union, based on the Forum for European Electrical Domestic Safety, recently more than 280,000 domestic fires are caused by electrical faults, from which 50,000 of them happen in France, causing more than 300 fatalities and 15,000 injuries (Feeds, 2017). Based on the insurances companies in France, the total PDO cost and other damages resulting from electrical faults are worth €2 billion (Feeds, 2017).

The electricity in any infrastructure is highly vulnerable since it is subjected to many natural and malicious events (Suresh et al., 2017). Therefore, Suresh et al. (2017) proposed a system to monitor transmission electrical wires based on IoT technology. The system is equipped with

sensors placed in a critical location in the network system. These sensors record and transmit data related to electricity. The most used sensors are (i) power conductor surface temperature, (ii) sago meter, (iii) current sensor, and (iv) tension sensors.

Machidon et al. (2018) proposed the Electric Safety (ELSA) power system protection based on IoT technology. The system is characterized by a fast disconnection of the current in case of any fault detection. Octavian system is equipped with a PIC 16F1829 microcontroller able to operate in a standalone mode with sensors and can be integrated with other IoT modules (Machidon et al., 2018). ELSA is also connected to a real-time monitoring web server where users and supervisors can log in anytime to check if the electric network works well and look for errors. Figure 1.13 describes how ELSA detects faults.

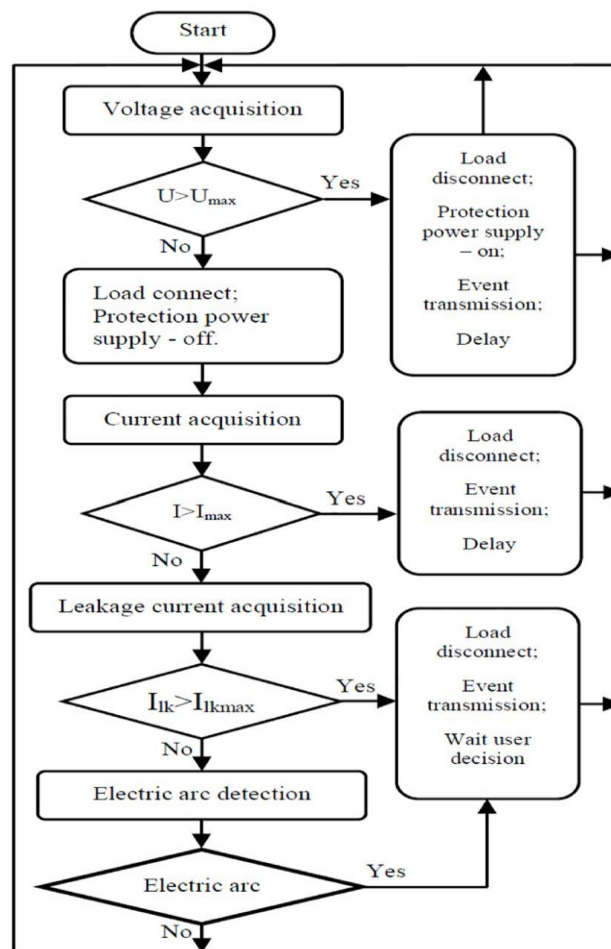

Figure 1.13: Embedded software control flow diagram (Machidon et al., 2018)

Mohd Hafizi et al. (2018) proposed a tripping fault monitoring and detection system using IoT. The framework introduces the ACS 712 microcontroller and VDR circuit to sense the current and the voltage in the transmission lines. Their system was built on the theory that “whenever a fault occurs, the current and voltage level change dramatically.” They also used a residual current device (RCD) for triggering an alarm and open the circuit whenever there is an unbalanced current in the transmission lines (Mohd Hafizi et al., 2018). The authors divided the system into two components: (i) sensor parameters and (ii) hardware functioning with the

microcontroller. In the first component, sensors are connected in series on the positive line to monitor the current. VDR sensor is placed on the inlet and outlet to measure the voltage. In the second component, Arduino and the installed microcontroller analyze sensors data and display them on the BLYNK server. If the readings obtained are different from the standard electric law and regulation, Arduino will alert the key players and cut the current.

Shreemaakanth et al. (2019) proposed another system to detect and monitor electrical faults based on IoT. The Prototype can locate the fault by interpreting the parameters such as fault resistance, fault types, incipient angle, and fault location. The algorithm is based on: (i) sensing the environmental data, (ii) current poles are monitored constantly, (iii) keep monitoring and comparing the electrical parameters to the threshold values and standards limits, (iv) Arduino microcontroller ship, (v) C language for Arduino programming and (vi) Zigbee for wireless data transmission from the controller to sensors and vice versa (Shreemaakanth et al., 2019).

The system is built on four modules:

- Module 1: Consist of the sensing part, responsible for sensing the network's main parameters like fire and current. The fire sensor can detect fire spark up to 100 cm of radius and send a signal to Arduino. The current sensor measures the current and can also detect flames up to 200 ft of range.
- Module 2: Sensors transmit the data to Arduino by sending an analog signal. Arduino generates the output data on led screens.
- Module 3: Arduino sends a signal to the relay to decide its status. Whenever the controller sounds the alarm, the relay cuts the current transmission line that caused the fault.
- Module 4: Arduino uses the Zigbee wireless ship and sends an alert signal to the concerned authority and the building inhabitants.

Menon et al. (2019) suggested a similar IoT device to monitor the network electricity in the buildings. The system is similar to that proposed in the literature (Menon et al., 2019). However, the device could make an emergency call, sending a voice message and a real-time clock (RTC) displaying the exact time the event happened. Figures 1.14 & 1.15 describe the system methodology.

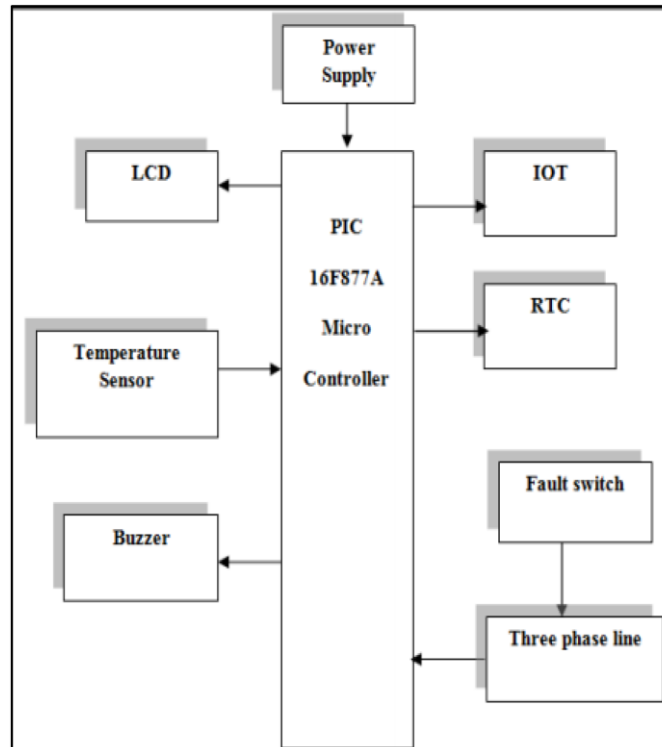

Figure 1.14: Transmitter Section (Menon et al., 2019)

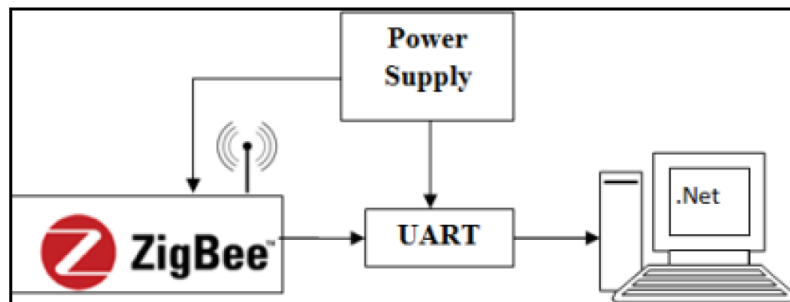

Figure 1.15: Receiver Section (Menon et al., 2019)

Wong et al. (1996) suggested a system based on AI. The device made tackle the early fault detection (EFD) and proposed an ANN technology. Since the electrical network is very complex, the system must provide an early detection based on early monitoring of the minor potential faults (Wong et al., 1996). EFD system is a hierarchical ANN structure based on ANN that can control main components in the networks such as switchgear and transformers. Each ANN is trained using the Back-Propagation Algorithm (BP). The BP train the ANN-based on enough electronics patterns that describe a faulty condition until the ML generalize all the problem condition in one equation. However, the BP method is a long-time process and cannot detect minor changes in the high voltage networks that are considered too small but may trigger a major faults hazard.

Nevertheless, the authors proposed another training algorithm to solve the problem using the Genetic Algorithm (GA). The GA training method consists of ANN and tests them under many

simulations that cause electrical faults. Finally, based on the survival of the fittest, the set that triggers the highest true positive alarm will be adapted by the software.

1.4.3. Gas Leak

Gas leakage is considered a major problem in our lives (Anandhakrishnan et al., 2017). A report published in 2013 by the high-pressure gas safety institute of Japan indicated that the yearly number of casualties and injuries in Japan due to indoor gas leaks exceeds 100 (KHK, 2016). In India, reports show that there are approximately 1,500 liquid petroleum gas (LPG) accidents each day, meaning at least 1,500 persons, including children, are threatened to die by these accidents (Vasantakumaar et al., 2018). The national fire protection association, fire analysis, and research division show that 784 persons died due to non-fire exposure to gases (U.S. Fire Administration, 2008). In 2012, 33,600 injuries were reported to the hospital, from 16,800 persons were gas intoxication (Hall, 2013). Figure 1.16 shows the number of deaths caused by gas leaks from 1980 to 2009.

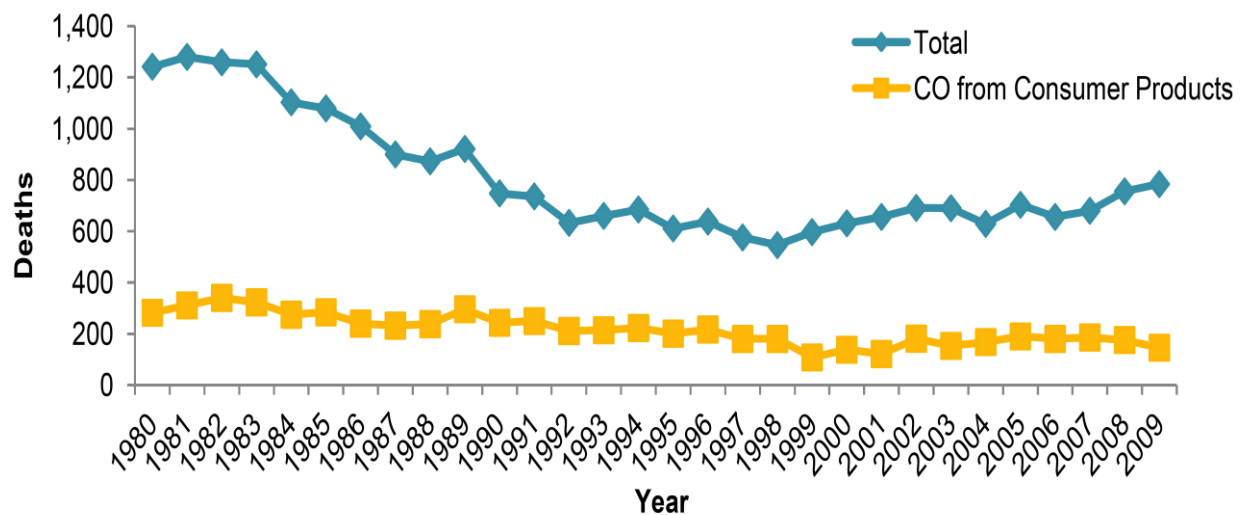

Figure 1.16: Number of deaths caused by poisoning from gas leaks from 1980 to 2009 (Hall, 2013)

A gas leak could lead to hazardous situations and fatalities (Bagwe et al., 2018). Furthermore, most fire breakouts in industries are caused by gas leaks, causing terrible damage to equipment, human life, death, and bad injuries (Kodali et al., 2018). Most of the gas leaks are considered dangerous, especially the LPG like Propane, Methane, Isobutane since they are colorless and at the same time poisonous and explosive. Gas leaks cause faulty gas appliances, bad pipes quality, corrosion, and human error.

Today's technology, including IoT, BIM, and AI, offers capacities to detect gas leak, take fast decisions, and prevent future events.

Pandey et al. (2018) proposed an IoT-based system for gas detection. The system consists of an MQ-6 LPG sensor, an ARM Cortex M4 processor, a Raspberry py, and an interface page to export the sensor readings. The authors divided the LPG sensor operation into three zones: (i)

heating zone, (ii) armed zone, and (iii) trigger and sensing zone (Pandey et al., 2018). The heating zone is considered the preparation stage of the system; the armed zone is the phase where the sensor is ready to sense the gas and the trigger zone whenever the sensor catches an LPG. The system alerts the users by flash blinking. In addition to that, the system has two potentiometers: one for adjusting the sensor sensitivity and the other for managing the voltage output whenever there is an LPG detection.

Anandhakrishnan et al. (2017) suggested a system with an Atmega320 micro ship Arduino core linked to an MQ2 gas sensor. The prototype includes a Buzzer alarm, a LED display to visualize the results, and an electrical Motor valve to stop the leak. For further air examination, the authors also used an infra-red GP2D120 sensor for measuring object temperature and a load cell to measure the air pressure (Anandhakrishnan et al., 2017). Figure 1.17 describes the model.

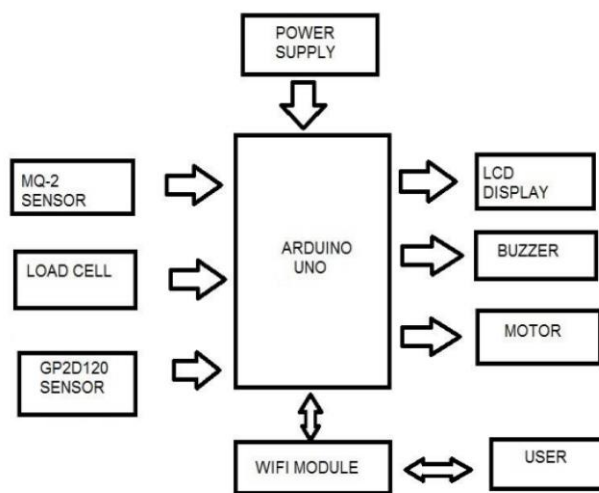

Figure 1.17: Block diagram of the system (Anandhakrishnan et al., 2017)

Bagwe et al. (2018) proposed a gas leak monitoring system that includes database logging, prediction, and smart alerting techniques in sending messages and emails to the concerned authorities. The system is equipped with a NodeMCU, Arduino core, an MQ5 gas sensor, a GSM module for communications, and a DHT22 temperature sensor. On the other hand, the software uses a XAMPP for web platform design and python language to interact between the components. Bagwe et al. (2018) system work according to the following chronology (Bagwe et al., 2018):

- MQ5 keeps sensing the gas concentration in the air, and the DHT22 measures the temperature.
- The NodeMCU ship collects the data and stores it using the XAMPP server. If the gas concentration is high, the ship sends an electric signal through the GSM module to a piezo electric buzzer.
- When the buzzer sounds the alarm, the system sends an SMS to the key players using the residence Wifi.
- During this period, data are stored using the XAMPP web platform.

- A professional supervisor analyzes archived data, and the stored info will be used for future event prediction based on the naïve Bayes algorithm.

Kodali et al. (2018) developed a similar system for industrial indoor use. Since industries are well exposed to a gas leak, there is a major need for a protective monitoring system. This system is like the previous model, but it has some additional aspects. The proposed system is equipped with an IFTTT module capable of sending mobile notifications to all users, in addition to Udibots cloud server for sharing the collected data (Kodali et al., 2018).

Vasantakumaar et al. (2018) suggested a framework based on the ESP8266 Arduino core as a micro controller ship. The system is responsible for sending a signal to the solenoid to shut the building gas valve (Figure 1.18). The system supports a mobile application called “thing tweet” similar to Tweeter and developed by Thingspeak to tweet the info and alert the neighbors living near the affected building (Vasantakumaar et al., 2018).

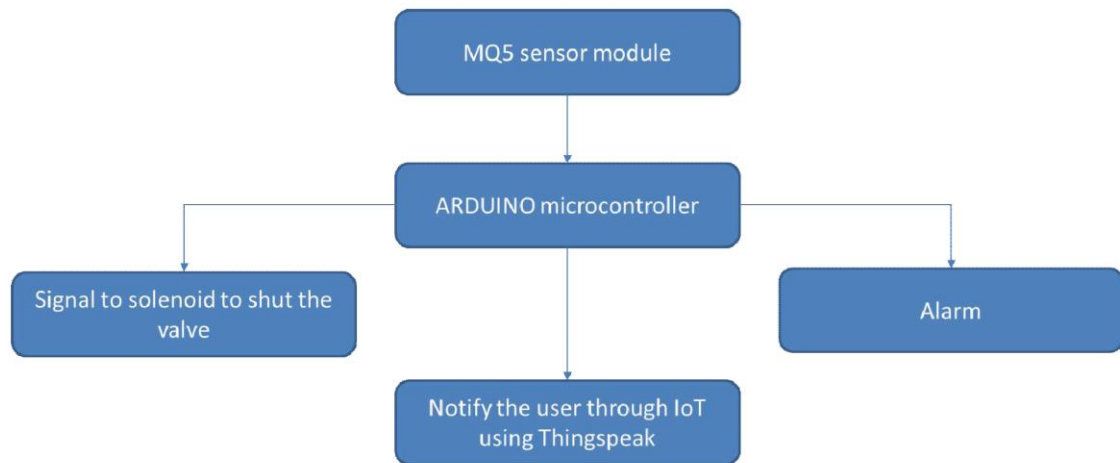

Figure 1.18: System flowchart (Vasantakumaar et al., 2018)

Cheung et al. (2018) suggested a gas leak system monitoring using WSN and BIM. BIM is considered as a potential component of IoT since BIM, and IoT integration can include: (i) spatial localization, (ii) environmental monitoring, (iii) better optimization, and (iv) better efficiency. The proposed system (Figure 1.19) was tested on an underground construction site. The model was linked to a flashing alarm and ventilators to reduce gas concentrations. WSN nodes were connected to BIM using Microsoft Visual Studio and the C# application (Cheung et al., 2018). BIM Revit model is transferred to Navisworks software for better and faster monitoring and 3D visualization. Navisworks provides the opportunity to observe the building and represent in colors variations of the gas concentration in each room.

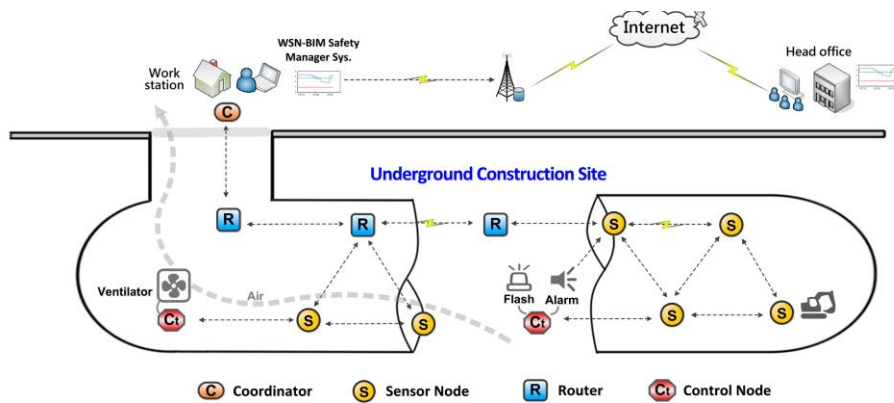

Figure 1.19: The concept of the hazardous gas detection system (Cheung et al., 2018)

Barradas et al. (2009) & Rahmati et al. (2017) used ANN and IoT for leak monitoring based on pressure, temperature, and flow. To control the gas flow, they used the WSN measures as an input for the ANN. To detect isolated leaks, they generated a mathematical equation that describes the gas flow during the normal and leak conditions (Barradas et al., 2009). The ANN uses only the inlet/outlet flow measurements. When there is a variation, the system divides the pipe into mini sections and restudies the flow distribution for each sub-section until finding the leak location (Rahmati et al., 2017).

1.4.4. Water Leak

Gupta & Pandey (2018) used the multi-sensor combination data and IoT for leak recognition in pipes for the water distribution network. Collected data are transferred to a data server through any digital communication network (3G/Wifi/Bluetooth) (Gupta & Pandey, 2018). Cloud information is accessible from smartphones. This system helps make decisions and control water leaks in pipes. Another mobile application (Smart2L) was developed. Smart2L is a mobile application capable of detecting the tank's water level and detecting water leaks at the valve or along the distribution pipes using specific sensors. In case of a leak, an Arduino sends emails to users or operators and automatically controls the pump (Hafiz Kadar et al., 2018).

Water pollution affects human health. A report in 2018 has shown that 14,000 people die each day around the world in which 580 people in India die due to water pollution and related illness (PressReader, 2016). The main reasons for water pollution are dumping water and untreated sewage. In several countries, contaminated water could cause many diseases such as diarrhea (Sun et al., 2017).

In 2017, a real-time water monitoring system was developed to monitor the water quality through three parameters: PH, dissolved oxygen, and temperature. This system uses wireless sensors and an Arduino board (Schindhya et al., 2017). Unfortunately, users are not connected to this system. A new supervisory control and data acquisition (SCADA) system integrated IoT technology was developed in 2018 to detect water contamination, water leak using the following parameters: Temperature, color, and water flow. Figure 1.20 shows the flow chart of water quality monitoring (Saravanan et al., 2018).

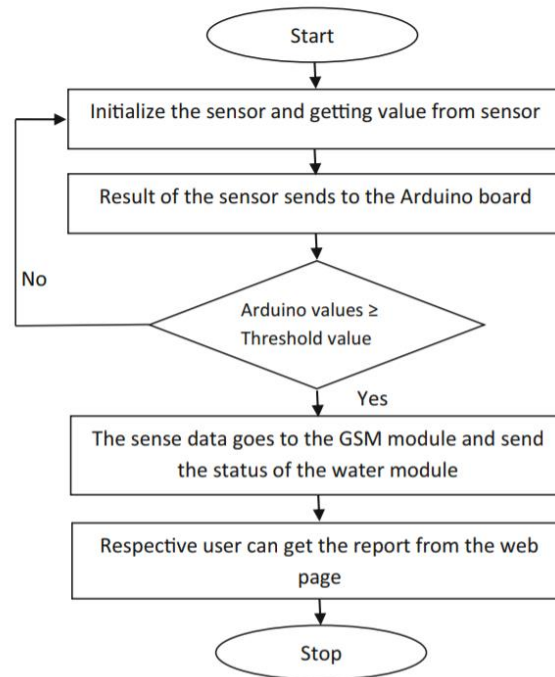

Figure 1.20: Flow chart for water quality monitoring system (Saravanan et al., 2018)

IoT technology and AI merged with BIM offer a great opportunity to create “Smart Cities” (Rojek & Studzinski, 2019). Use of AI permits to improve water management. Rojek & Studzinski (2019) suggested an algorithm based on AI and IoT to detect the leak. This algorithm consists of a hydraulic model of the water network and a neural classifier. The algorithm is based on six steps (Figure 1.21). The first step consists of applying a SCADA that monitors and tests the water network. Steps 2, 3, and 4 consists of calibrating the algorithm and making simulations and calculations in all nodes of the water network and pipes. Obtained data (pressure and flow) are stored in a database to be used later as a reference point for abnormal situations. In step 5, the software using the probes and neural classifier identifies leak locations based on stored data. The final step consists of detecting the pressure and flow distribution at the characteristics points and compare it with the stored standards distribution and pressure. If the difference exists, the probes will alert the key players and send the leak's location.

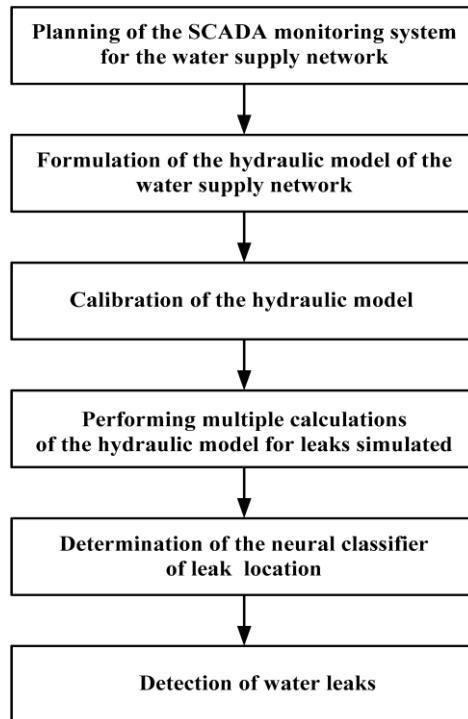

Figure 1.21: Summary diagram of the algorithm (Rojek & Studzinski, 2019)

Currently, the AEC industry is focusing on using BIM in water management (Z. Liu et al., 2019). BIM technology offers a big advantage in water monitoring. It allows collaboration between various parties; increases work efficiency, simulation, and analysis of sustainability performance.

1.5. Use of Smart Building for Security

According to Mawby (2007), residential intrusion and robbery have become more and more the most common and feared aspects of crime (Mawby, 2007). Safety and amenity are the major attributes that residents seek when looking for habitation and their cost became highly increasing in society (Moore & Shepherd, 2006). The average cost of residential robbery in Australia is around \$963 and around \$2199 in the US per residential (Smith et al., 2014). In the UK, the mean cost of burglary in buildings is approximately £3268 in 2003, and if adjusted with the inflammation, it is worth around £4500 in 2017 (Dubourg & Hamed, 2005). Besides the direct cost of material loss, victims, PDO, and others, burglary and crime have indirect costs that negatively affect the quality of life, depression, psychological and stress.

A study published in May 2019 shows that the Europe Market for detection and intrusion is expected to grow with a Compound Annual Growth Rate (CAGR) of over 12% by 2025 (BusinessWire, 2020). This high rise is due to governments' policies in partnership with the private sector to invest and deploy Intrusion Detection Systems (IDS) in private and public networks.

1.5.1. Indoor Crime Prevention

Indoor physical security and crime prevention are multi-layered, time-intensive, and labor-consuming tasks (Rafiee et al., 2013). Multiple technologies have been adopted for real-time monitoring, access control, and intrusion detection. Today, technology offers a high advantage in indoor security. The system is based on a collaboration among IoT sensors, BIM and ML to prepare, plan, withstand, recover and learn to adapt for future hostile events. In other words, recent technology can integrate crucial factors into the system; human intelligence (Jožef et al., 2011).

Closed-circuit television (CCTV) cameras are widely used for indoor security monitoring. However, CCTV systems are considered costly, and they keep recording and storing video even if there is no movement or suspicious act. Gulve et al. (2017) proposed an intelligent surveillance system that starts to record video after human motion is detected, resulting in cost efficiency and low storage use. This system is composed of IoT elements: Arduino board, Raspberry Pi, GSM module, cameras interconnected between each other through OpenCV language (Gulve et al., 2017). The proposed framework divides the system into Raspberry Pi for surveillance mode and Arduino for normal mode. During intrusion detection, Arduino allows the Raspberry Pi to start surveillance through the cameras. At the same time, Arduino will shut down all electrical appliances in the house for more protection and security. The Raspberry Pi will detect human motion and count them using OpenCV language. Once the activity is recorded, Raspberry Pi will send an SMS notifying the building owner or supervisors and an email containing the video footage. Figure 1.22 summarizes the work methodology.

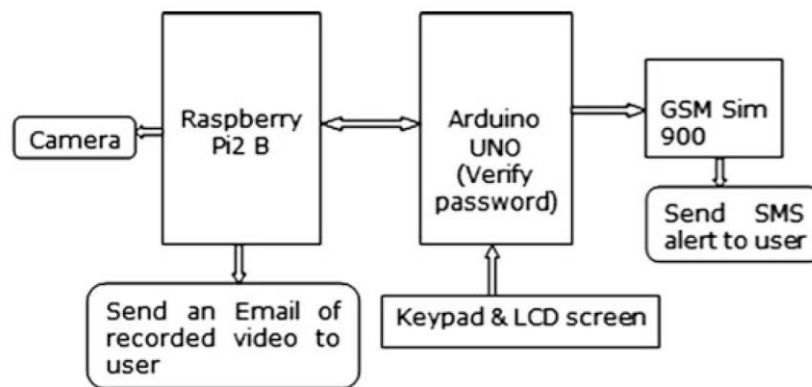

Figure 1.22: Work Methodology (Gulve et al., 2017)

- **Real-Time Location System (RTLS), Video & BIM**

The use of BIM in indoor surveillance allows real-time monitoring in residences, detects rapidly events related to safety, organizes emergencies, and establishes long-term safety and indoor hazards prevention (Crowe & Fennelly, 2013).

Rafiee et al. (2013) conducted research about integrating real-time location systems (RTLS), video surveillance, and BIM for indoor surveillance. The system uses three sources of environmental data:

- Ultra-wide band (UWB) module for RTLS.
- Pan-tilt-zoom (PTZ) cameras for video surveillance.
- BIM for sensor coverage and optimum deployment, and operation control.

The method is based on assuming two vectors for each person using the facility, suppose U and V. The U vector contains the coordinates obtained from a unique UWB tag given to each user and the V vector contains the coordinates of the same person wearing the tag obtained from video surveillance cameras. The authors then assume that if the coordinates are identical for the same user, therefore, the distance given between these vectors must tend to zero. Hence, they used K nearest neighbor (KNN) algorithm to identify the intruder by computing the distance between the U & V. If the distance δ_{uv} tend to be 0; thus, no intruder, else the system will sound the alarm. In addition, the system has the ability also to track the intruder using BIM or manual input using a graphical user interface (GUI) (Rafiee et al., 2013).

On the other hand, noises and other error sources such as instruments in the building can badly affect the UWB tag (Sato, 2011). For this reason, BIM will be responsible for filtering the noises, checking the coordinates before validating, and transmitting to the fusion module. The method achieved good results however at present scientist are seeking a dynamic technology where AI take part.

- **RTLS, Video & Artificial Intelligence (AI)**

Jozef et al. (2011) conducted research about using ML in indoor surveillance. They build up a prototype called “Poveljnikova Desna Roka” (PDR) for an intelligent security system. The prototype focused on internal threats by concentrating on unusual behaviors that occur each second (Jožef et al., 2011).

The PDR is equipped with an RTLS system, primitive’s routine, and AI modules. The RTLS system is also a UWB ID tag to locate the coordinates of the culprit. After identifying the intruder's coordinates, PDR uses kalman filtering and a six-dimensional vector to compute the speed of the invader. After that, PDR applies a three primitive’s routine. The first primitive is to detect which area a given tag is located when it has entered. The second primitive routine is to identify the position of the intruder; lying, sitting or standing. The third primitive routine is checking whether the tag is moving or not (Jožef et al., 2011).

PDR's most important specs are the AI modules for the security system. Five modules provide intelligence to the system:

- Expert System Module: user's ability to customize the system according to his/her needs by setting simple rules that must not be violated, including knowledge base and inference engine.
- Video Module: to determine the comparison between the locations of tagged personnel and the detected movement location
- Fuzzy Logic Module: differ between the idea of frequent and unusual behavior to detect any possible intrusion act.

- Macro and Statistic Modules: analyze persons' behavior and trigger alarms if it significantly deviates from the usual behavior.

Besides the difficulty of the PDR, the system achieved good results. PDR was able to become familiar with the normal behavior pre-installed by the user. Each time the system went wrong and sounds like a false negative alarm, PDR provides an alarm explanation report explaining the reason for the alert.

1.6. Conclusion

This chapter constitutes the basis of this Ph.D. research. Its main objective is to establish state of art concerning smart technology to improve indoor safety and security. The chapter focused on works conducted on indoor hazard monitoring. It showed a large development in the last ten years in the way of thinking and practicing in the field of indoor hazard management. The progress of technology provided new capacities in detecting the hazard, learning, and preventing future hazards. This technology moved from ordinary sensors linked to a control room to IoT integration, BIM managing, and AI uses for ML.

The chapter presented a synthesis of research projects conducted about indoor hazards categories: Indoor Health care, Indoor Safety, and Indoor Security.

Concerning smart buildings for human health, research projects focused on three types of indoor hazards: air pollution, fall, and health attack. For IAP, the Enose technology used for detecting and sensing the air gave the most promising results. The Enose main objective is to meet the olfactory function of human beings and, therefore, sense and detect any type of gas and pollutant (Cociorva & Iftene, 2017). Concerning indoor falling detection, Mastorakis & Markis (2014) proposed a new algorithm that combines kinetic and potential fall covering all the possible human fall causes. Health monitoring is mainly based on intelligent sensors. The IoT system of Jeyaraj & Nadar (2019) gave a 97.7% accuracy in managing the health of the inhabitant.

For indoor safety, Shreemaakanth et al. (2019) came out with a prototype based on the IoT and AI for electrical fault detection and prevention. Their system was equipped with an ML module able to compare the natural functioning of the electrical network with the odd behavior by focusing on the electrical parameters of the electricity at the inlet and outlet of the transmission line. Barradas et al. (2009) & Rahmati et al. (2017) worked on developing ML software for gas leak detection. The system combined the IoT technology and the ANN to generalize the flow's expected behavior and use it as an essential database for comparing all kinds of flows in the future. Consisting of the water leak monitoring, Saravanan et al. (2018) proposed a SCADA based on IoT technology to detect water using three parameters: Temperature, color, and water flow.

Regarding intrusion detection and prevention, Jozef et al. (2011) developed an ML software called PDR integrated with IoT. PDR system contained 4 AI modules that define the normal human being's behavior in the house during the day. Thus, PDR software detects the intrusion

by comparing the predefined behavior with the abnormal detected behavior. PDR also proved to be adaptable and become familiar with all types of unusual behavior events.

In the following chapters, we will present an approach to integrate the adequate technologies and systems proposed for indoor safety in a comprehensive BIM-based system and implement this system in actual cases to monitor and improve indoor hazards management.

Chapter 2: Research Methodology

2.1. Introduction

This chapter presents this research methodology, which aims to construct a platform to monitor, detect, act, and prevent in the best way indoor hazards. In the first part, the construction of the smart platform will be illustrated through the general architecture of the system by presenting all the necessary layers to succeed. The second section will define each indoor hazard by presenting successively its significance, the monitoring system including the sensor types and equipment, decision making, practical implementation, difficulties and barriers that could face the use of this system and highlighting critical case studies. This section will cover the following indoor hazards: fire, electrical faults, IAP, gas leak, water leak, intrusion, and healthcare.

2.2. System General Architecture

The main idea of the proposed framework is to enable and enhance the interaction between the system components: sensors, wireless-based data transferring, GSM module, BIM, platform, and users to have an intelligent monitoring system. The system general architecture is inspired from the smart general architecture. To achieve this objective, the system is designed in five layers: (1) data collection layer including physical and monitoring layers, (2) data transmission and processing, (3) data analysis, (4) control layer, and (5) smart services.

The figure 2.1 illustrates the architectural layers and figure 2.2 highlighted the system architecture design. The following section will describe each layer's role and function.

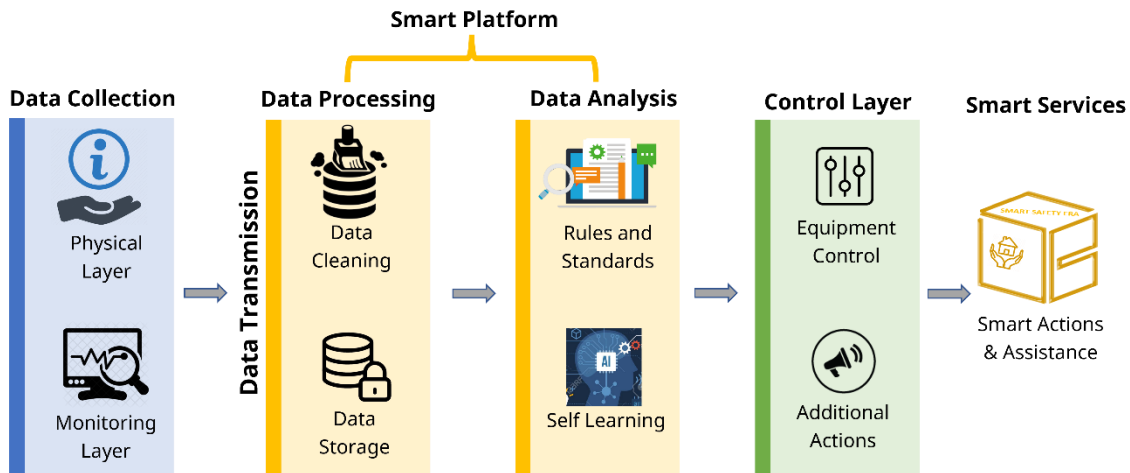

Figure 2.1: The system general architecture

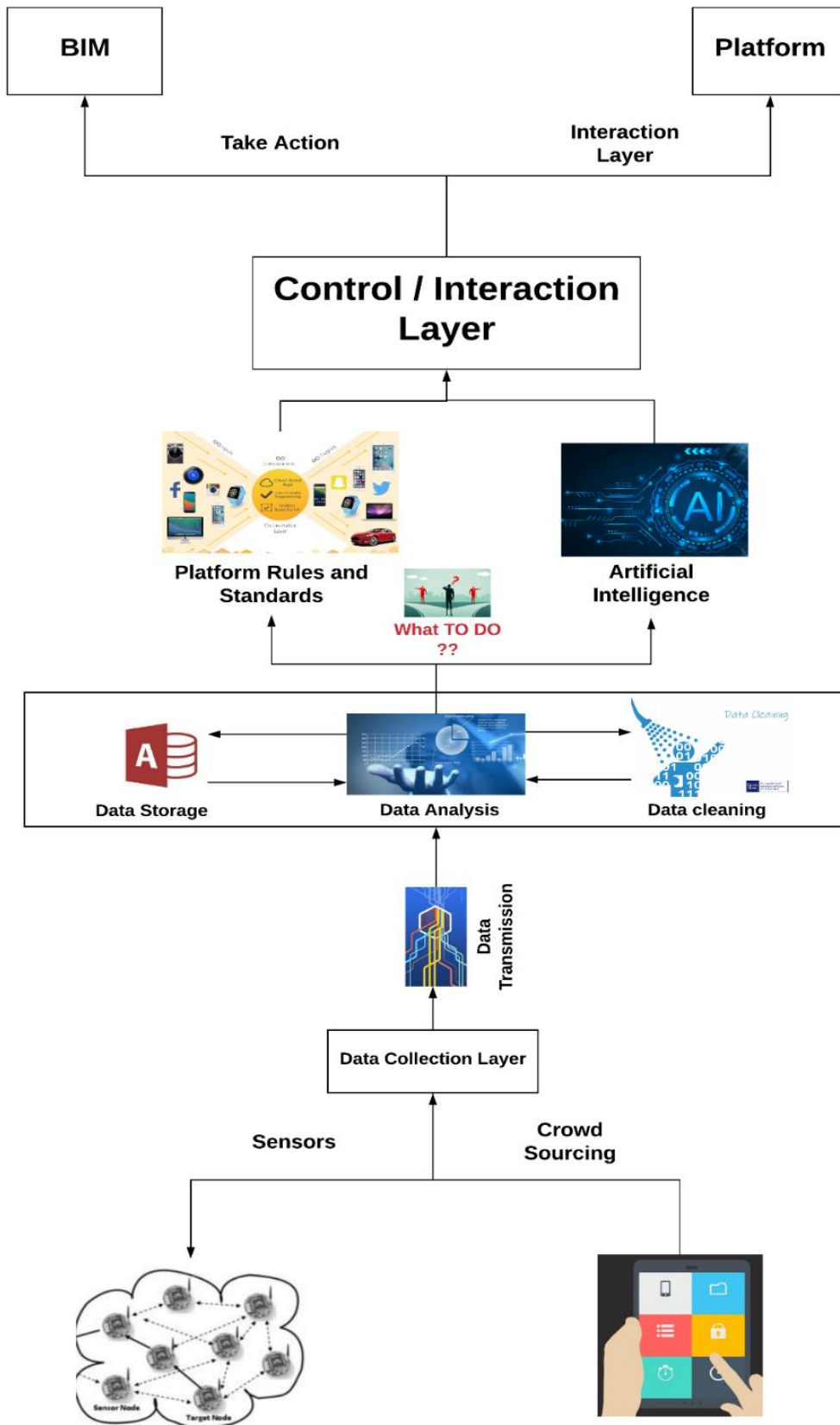

Figure 2.2: System architectural design

2.2.1. Data Collection Layer

The data collection comprises (a) the physical layer: building information, and hazard-related information and (b) the monitoring layer including IoT smart sensors and crowdsourcing, which are used to collect data and information from the users, key players, and the environment around.

a. Physical Layer

This layer includes information about the building such as the building geometry, spaces, configurations, equipment location, and material properties. In addition, it includes information related to each hazard. For example, in case of a fire hazard, the information related to the fire equipment and characteristics, evacuation components and emergency exit doors are required in the BIM model.

b. Monitoring Layer

A wide variety of sensors are available to deal with indoor hazards. Some of these sensors overlap depending on the hazard type. Indeed, temperature and smoke sensors are used for air pollution and fire hazards. Sensors must be placed in critical points; locations must be chosen wisely to avoid an over cost. Moreover, crowdsourcing involves users sharing data and experiences using smartphone applications. The utilization of crowdsourcing helps to enhance the quantity and quality of data.

2.2.2. Data Transmission and processing

a. Data Transmission

Data transfer is accomplished via wired or wireless technologies. Wireless networks transmit collected data to the server, where data are processed and analyzed. Routers should be installed inside the buildings to ensure the area transfer coverage of the data. Each router is considered a checkpoint that can take over the other router task and transfer it to the next one. In addition, the data transmitted from users is directly linked from the smartphone applications to the platform.

b. Data Processing

Data processing is generally conducted at the server level. It includes data cleaning and data storage. Data cleaning aims to detect inaccurate records to replace, modify, or delete the coarse data, also to fill missing data. This step is crucial since inaccurate or irrelevant data can reach a wrong act. For this reason, the data collected from the sensors and also the information from the stakeholders should be cleaned to avoid bad decision-making. Data storage is the process by which all the information is archived, organized in one database. In our case, the data will be stored in Microsoft Access.

Furthermore, the platform offers the ability to access the storage to search for a particular event. To realize this task, the platform must be accompanied by a XQuery that links the database

world with the Web world. XQuery provides the ability to access the database by granting the possibility to store, extract, and manipulate.

2.2.3. Data Analysis

Data analysis aims at the transformation of collected data into operational data that improves indoor security. It uses two modules: (1) Platform Specific rules and (2) AI.

a. Platform Specific rules

Like any other monitoring Platform, there is the ability to set norms, minor and upper limits for different types of sensors; whenever these boundaries are crossed, the platform alerts the concerned authorities and the inhabitants. These norms usually set for the temperature sensor, gas sensor, air quality sensor, current and voltage sensor, and many others with theoretical standards that state normal behavior.

b. Artificial Intelligence (AI)

The second part of the data analysis processing is based on introducing the missing and the innovative part in our system, which is human; in other words, providing intelligence to the system (Jožef et al., 2011). Adopting AI in our system makes it more secure, trustworthy, and resilient to other indoor hazards in the future.

The system is based on an ML algorithm implemented in Python; the machine automatically generates the model of usual behavior by analyzing the archived data and the normal daily behavior of the users, and thus whenever there is a non-familiar behavior, the system will recognize it as an odd event and alert the users.

The advantage of AI is its ability to self-learning, reasoning, and adapt. The integration of AI in the system is very important since it provides complete coverage on the building because it depends on various actions of known and unknown persons.

After the data analysis, the system will decide what to do depending on each situation. Thus, when an abnormal event occurs, the system takes action to limit the impact of this event.

2.2.4. Control Layer

The control layer concerns the execution of decisions and the interaction with users and other actors. The system will (a) illustrate the location, cause, and hazard type on the 3D model; (b) sound the alarm and declare the state of emergency in case of any abnormal situation; (c) notify the inhabitant of the corresponding situation and the necessary action that needs to be taken in the following situation in real-time; (d) notify the key players and corresponding authorities with all the necessary information including the location, number of inhabitant in this situation, hazard type and cause and keep them connected in real-time; (e) turn on the necessary equipment that enclose the danger and turn off the apparatus that might make the situation worth or more vulnerable through automation sensors; and (f) save all the related information and actions of the incident.

2.2.5. Smart Services

The proposed system will provide smart services including smart actions and assistance. The smart actions are related to its potential to control equipment and provide necessary actions in real-time. The smart assistance is presented by the system potential to communicate with users, key players and authorities and require them the vital information.

2.3. System Operation Mechanism

The system works through the following operation mechanism. As first step, the BIM model should be well prepared by modeling the building into Revit software. All the building and hazard information should be presented into the Revit model. The data coming from the sensors will be transferred through a script into Arduino and then send to the system via a panstamp. The sensors can provide information in real-time and update the CSV files. The information provided by users through platform is transformed in CSV files. All the CSV files are synchronized into Dynamo BIM which is a visual programming tools able to expand the Revit power via its API. The data analysis is conducted in Dynamo and all the required actions are performed also in Dynamo. All the data, results and actions will be visualized in Revit software. Finally, Revit model is synchronized with the platform, as well as the sensors data will be visualized in graphs, and the users will get all the necessary information through the platform. It should be noted that all the work completed into Dynamo could be performed in the platform since dynamo is used for coding purpose.

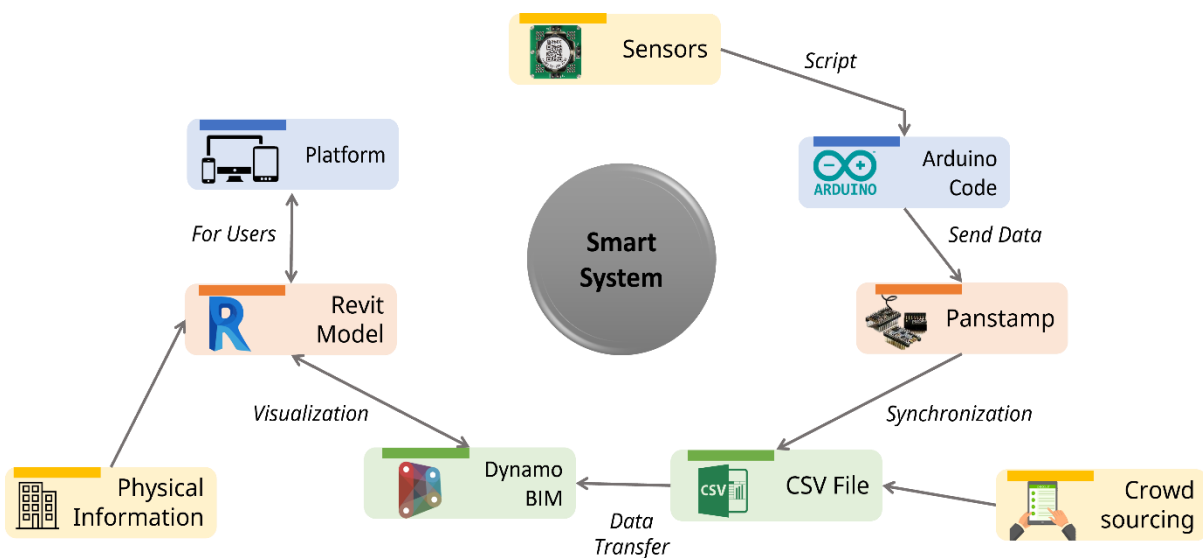

Figure 2.3: System operation mechanism

2.4. Role of BIM

Our system is designed not only to have the ability to explore the collected data but to integrate the data in BIM software. BIM has a massive advantage in detecting and acting in case of indoor hazards. BIM is used (1) to connect the data stored in Microsoft Access to the 3D visual

model, (2) to visualize the real-time data in color range for a better data illustration, (3) to detect any abnormal situation, (4) to locate the hazard inside the building, (4) to track the occupants and define their places, (5) to interact with the inhabitant during an emergency by guiding them to the nearest exit using RTLS, (6) to make the right decisions to limit the hazard such as shut the equipment off and (7) sound the alert.

The BIM is used to collect, analyze, detect, make decisions and alerts compared to the platform role. In the other hand, the platform visualizes graphs and 3D model per parameter and hazard, collect data from users and other actors, notify the stakeholders with all the necessary information in real-time, and provide the ability aftermath to control and reset the system on/off (Table 2.1).

Table 2.1:Task distribution between BIM and Platform

	BIM	Platform
Tasks	Connect the data stored in Microsoft Access to the 3D Visual model	Visualize graphs per index and hazard type
	Visualize the real-time data in color range for a better data illustration	3D module visualization
	Detect any abnormal situation	Collected Data from users
	Locate the hazard inside the building	Notification to users, Technician, and other concerned authorities
	Track the occupants and define their places.	Use control for the appliances
	Interact with inhabitants during emergency cases by guiding them to the nearest exit using RTLS	Information needed in case of any hazards occurring
	Take the right decision by switching ON/OFF the equipment's	Any data manipulation: storing, extracting, cleaning, filtering and refining
	Sound the alert	

2.5. Use of Artificial Intelligence (AI)

AI is used for data analysis. It includes three categories of methods (Figure 2.4)

- Supervised methods for regression and classification of labeled data (Logistic Regression, k-nearest neighbors, Decision Tree, Random Forest).
- Unsupervised methods for clustering unlabeled data such as K-mean and agglomerative hierarchical clustering (AHC) methods.
- Deep learning method for forecasting, classification, and clustering.

These methods require data for both training and testing. Then they can be used in forecasting.

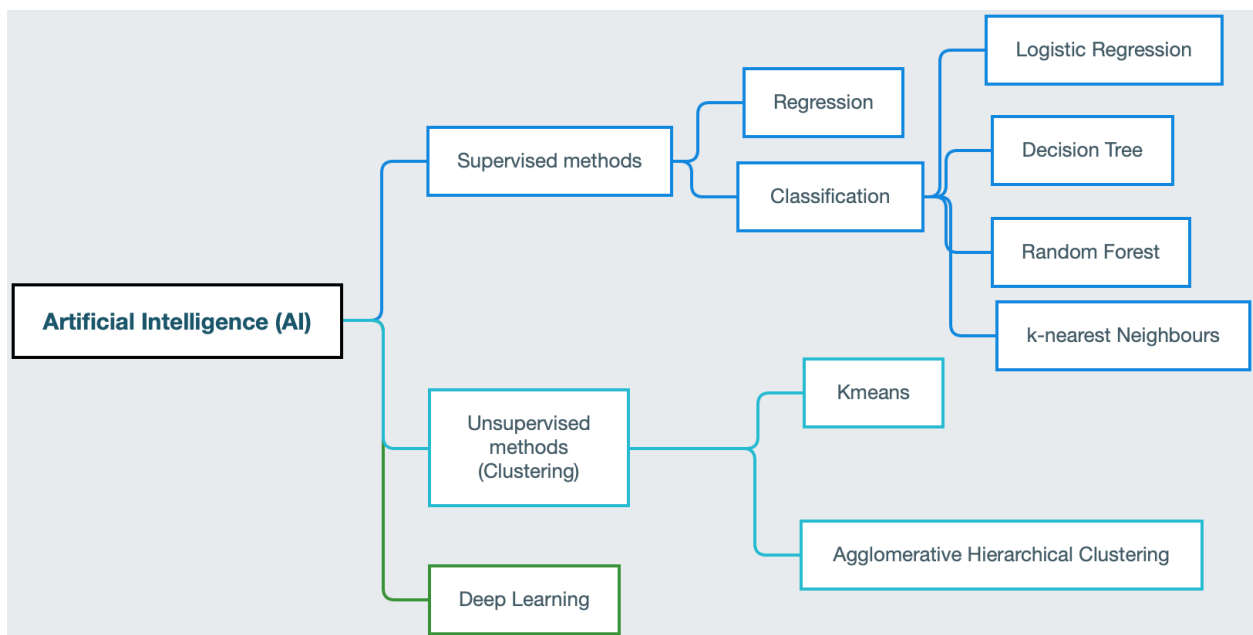

Figure 2.4: AI methods

Based on these methods, the system can learn from previous events including historical data to prevent and detect early the hazard. In addition, a huge database could reduce false detection due to the AI learning process.

2.6. Monitoring and Decision Making per Hazard

This section describes the application of the methodology presented in the previous section per hazard. Each hazard presents the significance, the monitoring system, the decision-making, the difficulties, and barriers facing the system implementation, and finally, a discussion about critical case studies.

2.6.1. Fire Hazard

a. Hazard Presentation and Significance

Mansions and other types of buildings are always exposed to indoor fire hazards due to several causes, and most importantly, even with the most advanced techniques adopted for

constructions recently, most of the buildings are vulnerable to fire and low resistance. A fire could occur instantly and spread uncontrollably within seconds, deteriorating home in minutes.

The causes that can lead to fire hazards are (Beaudrie, 2017) (Nowacki, 2019) the following:

- **Cooking Equipment:** Fire due to cooking is considered among the most common types of house fires. Sometimes human beings forgot the oven while cooking and get overheated; then it causes a fire. Moreover, grease is highly combustible and can lead to fire even without direct flame contact.
- **Heating:** Home space heaters can cause fire when combustibles objects are left too close to them, such as curtains, furniture, clothes, and others.
- **Electrical Equipment:** Extension cords can be dangerous if they are not used appropriately; as well as high draw equipment like heaters and toasters must not be plugged into a power strip and extension cord.
- **Smoking:** Cigarettes could burst into flames if they came near to flammable things like furniture.
- **Candles:** Candles can be a source to burst into flames in a room if they keep it unattended.
- **Faulty Wiring:** Inadequate wiring can cause electrical faults that may lead to fires hazards.
- **Combustible Liquids:** flammable liquids like Diesel, petrol, or alcohol can lead to a fire if they come close to heat sources.
- **Children's Curiosity:** Kids can lead to fire due to their curiosity.

House fires imperil every person inside the home and have many consequences such as property damage, triggering other hazards, health problems for the occupants or fatalities, indoor and outdoor pollution, and economic losses.

b. Hazard Monitoring

Fire hazard protection system should include:

- Smoke sensor
- Temperature sensor
- CO2 detector
- Human RTLS
- Windows and doors sensor

Fire hazard monitoring is somehow complex due to the numerous steps that should be followed to detect and take decisions in real-time. Due to its complexity and importance nowadays, the fire hazard has been selected for our study application. Therefore, the fire monitoring and evacuation system will be presented in detail in chapter 3.

c. Decision Making and Practical Implementation

When the system detects a fire hazard, it will take the essential decisions:

- Turn on the exit signs and alarm.
- Turn on the sprinklers and extinguishers.
- Identify the fire cause.
- Identify all the occupant's locations.
- Cut the electricity.
- Send notification to firefighters.
- Send alert to each occupant with the best map rescue on their mobile in real-time.

d. Difficulties and Barriers

The fire system could face implementation difficulties related to real-time monitoring; the occupants should be updated instantly to upload the information concerning the best rescue route for users. The most challenging part is transferring the BIM model to the fire simulation analysis and crowd simulation and resending the results quickly to the platform to inform the users. The solutions for those barriers are presented in chapter 3.

e. Case Studies

A detailed state of the art concerning fire hazards is presented in chapter 3. This section presents the important case study briefly. Chen et al. (2018) based their studies on Revit as a user interface for visualization and guidance in case of fire hazard, while Cheng et al. (2017) use a mobile app for user warning. Cheng et al. (2017) investigated the potential of a BIM-based intelligent fire prediction and disaster relief system that (i) detect and transmit environmental data, (ii) locate aided designs, (iii) select the best evacuation/rescue route, and (iv) a real-time mobile application for evacuation direction to help evacuees, firefighters during the early detection and interaction stages of a fire tragedy (M. Y. Cheng et al., 2017). Over and above, the FDS and evacuation routes were not considering the agent situations by implementing crowd simulation. Therefore, Mirahadi et al. (2019) created an EvacuSafe framework to assess the evacuation safety performance based on the risk indices considering the agent-based crowd simulation procedures with fire simulation techniques and BIM (Mirahadi et al., 2019). Zhang et al. (2019) also investigate an indoor real-time location system based on BIM and Bluetooth low energy through a mobile application that can automatically re-evaluate all paths every few seconds based on the greatest updated information, either in real-time (J. Zhang et al., 2019). Shiau et al. (2013) worked on a Web-based fire control surveillance and management system to detect the accuracy of a fire warning and identify the necessary information about the occupants near the fire area immediately (Shiau et al., 2013).

2.6.2. Electrical Faults

a. Hazard Presentation and Significance

The electrical system is vulnerable to events that affect its stability. Sometimes, these events could lead to disastrous hazards, such as fire, property damages, and many times, faults can lead to fatalities. The most common problems in the electrical system are faults, which could occur in electrical wires, and transmission lines.

The most common and frequent electrical faults include:

- Fault at the main power inlet.
- Fault inside the transmission line in buildings. These faults occur mostly because of corrosion in wires, water, or humidity.
- Faults in equipment and machines: These types of faults usually are the result of inadequate maintenance. However, recently, the equipment is equipped with a self-security system like a fuse to cut off the current.
- Faults in lighting transmission lines.

Indoor common electrical faults include line-to-line faults and line-to-ground faults. The former occurs when the transmission conductor line (phase) contacts another transmission line neutral. This type frequently occurs in buildings, and it is called a short circuit. Figure 2.5 describes this kind of fault. The single line-to-ground fault occurs when a transmission line falls into the ground and gets in contact with neutral. It is represented in figure 2.6.

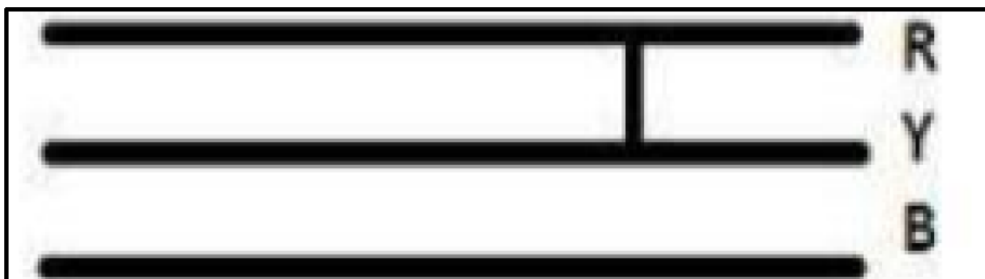

Figure 2.5: Line-to-Line fault

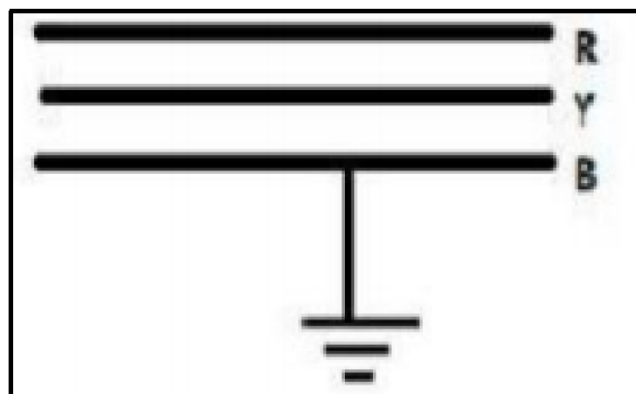

Figure 2.6: Single Line-to-Ground fault

An electrical fault is an abnormal situation caused by equipment failures like transformers and rotating machines, human mistakes, and environmental circumstances (ELProcus, 2014).

- **Weather Conditions:** including heavy rains and winds, snow accretion on transmission lines, etc. These environmental circumstances interrupt the power supply and also damage electrical installations.
- **Equipment Failures:** Several electrical equipment such as motors, generators, transformers, reactors, switching devices, etc., leads to short circuit faults because

of malfunctioning, aging, and cables insulation failure—these facts outcome in high current flow over the devices or equipment, which further damages it.

- **Human Faults:** Electrical faults are likewise caused due to human mistakes, for example, choosing inappropriate rating of apparatus or devices, switching the circuit though it is under servicing, etc.
- **Fire Smoke:** Air ionization, due to smoke particles neighboring the overhead lines, leads insulators to lose their insulating capacity because of high voltages.

Electrical faults cause equipment damages, interruption to electric flows, and humans' deaths.

- **Over Current Flow:** When a fault happens, it produces a shallow impedance path for the current flow. A heavy current is drawn from the supply, producing relays, insulation damage, and equipment components.
- **Humans' Danger:** Fault incidence can similarly cause person shocks. Shock severity depends on the voltage and current at fault location and even sometimes may cause deaths.
- **Equipment's Damage:** Short circuit faults increase the current high, resulting in the apparatuses being burnt totally, which leads to the inappropriate working of equipment or device and sometimes equipment burnout.
- **Interrupts Interconnected Dynamic Circuits:** Electrical faults could also disturb the active, interconnected circuits to the faulted line, not only the hazard location.
- **Electrical Fires:** Short circuit causes flashovers because of the air ionization among two conducting paths, leading to a fire.

It is possible to reduce causes like human errors by interrupting or breaking the circuit when fault occurs and providing an equipment maintenance schedule. In this research, our main concern is to build a smart system able to protect the electrical power and other equipment, moreover capable of predicting faults before they occur.

b. Hazard Monitoring

The electrical hazard defense system should include:

- **Fuse:** A thin wire bonded in a casing or glass that links two metal parts in equipment. This wire melts when excessive current flows in the circuit.
- **Circuit breaker/relays:** The circuit breaker or even relays make the circuit at normal and break at abnormal conditions. It causes automatic tripping of the circuit when a fault arises.
- **RTC** is displaying the exact time of the event.
- **Noise sensor:** To identify any abnormal equipment noise.
- **Temperature sensor.**
- **Fire sensor.**

Temperature and fire sensors are to be used since a short circuit lead to a massive increase in the current, and thus the temperature in the transmission line augments, risking the conductors to melt and cause a fire if no fast action is taken.

- Current sensor measurement.
- Voltage sensor measurement.

The most critical parameters to detect electrical faults are the current and the voltage. Whenever a fault occurs, these two parameters change drastically. Therefore, currents sensors must be placed at a critical transmission line to catch the current value.

The chart below summarizes the system prototype and illustrates how it will work. The chart in figure 2.7 illustrates the framework and how the sensors, hardware, software, and monitors are connected.

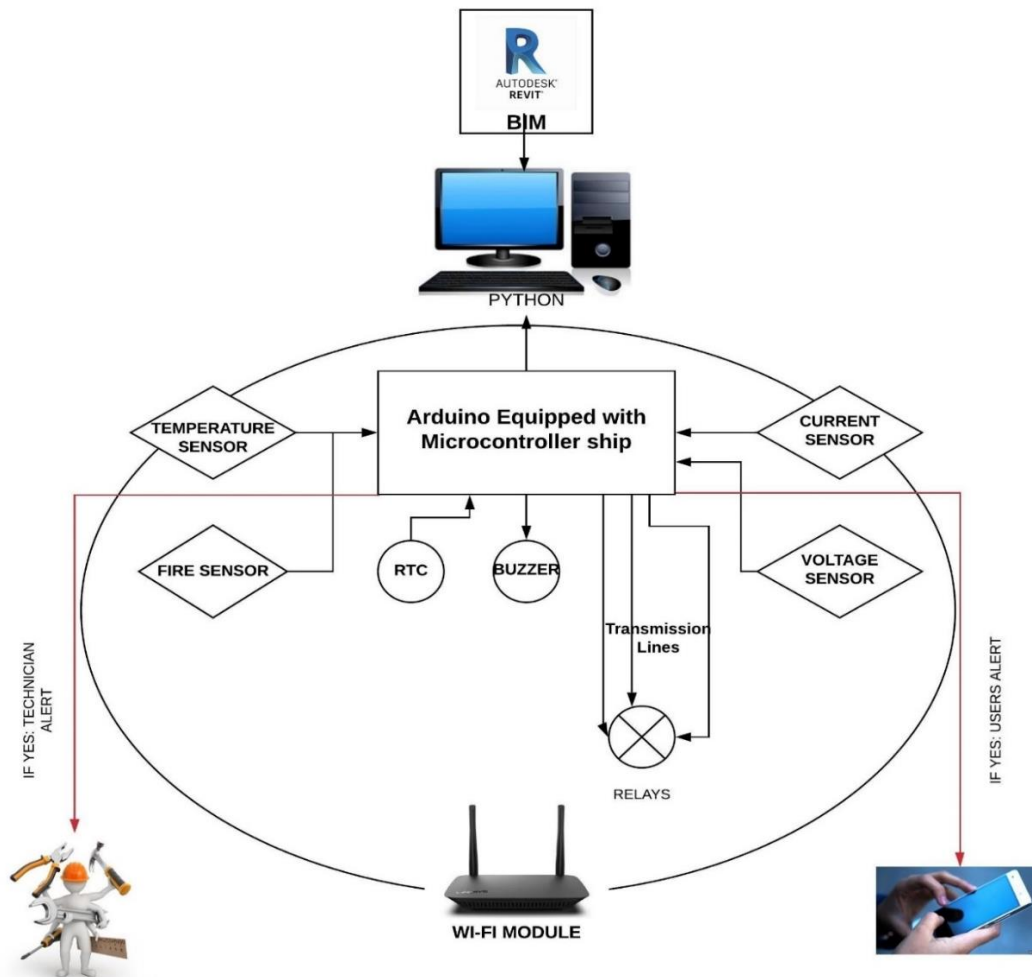

Figure 2.7:Prototype for electrical fault detection

c. Decision Making and Practical Implementation

The system should take the following decisions in case of electrical faults:

- Locate the network where the electrical faults occur.
- Precise the electrical fault cause.
- Cut the current on the conductor line.
- Switch relay off and provide power from a backup source.
- Turn off surrounding equipment and devices.
- Send a message to inhabitants and technicians with the necessary information for fixing the issue.

It is vital to link the system to other backup power sources in the facility, such as UPS or others, to provide safety for the inhabitants and exit during an emergency. For instance, in a hospital, if any fault occurs and there is a current cut-off, in case of link absence to the backup sources, it would be devastated for the working staff, equipment's apparatus, and the patients. Hence, we might face a similar issue inside any other type of buildings in case of the absence of the ability to control both sources of power: main and the backup power.

d. Difficulties and Barriers

The electrical faults system could face implementation difficulties related to real-time monitoring and control of extremely rapid events. Indeed, the time scale for these events could be some seconds.

e. Case Studies

Wong et al. (1996) suggested a system based on AI that operates early EFD by triggering true positive alarm. Suresh et al. (2017) proposed a system to monitor transmission electrical wires based on IoT technology without alerting and take necessary decisions. Machidon et al. (2018) proposed ELSA, a system characterized by a current disconnection in case of any fault detection with a web platform for users' follow-up. Mohd Hafizi et al. (2018) & Shreemaakanth et al. (2019) proposed a tripping fault monitoring and detection system using IoT. Whenever the controller sounds the alarm, the relay cuts the current transmission line that causes the fault, alerts concerned authorities and the building inhabitants. Menon et al. (2019) suggested a similar system that could make an emergency call, send a voice message, and an RTC displaying the exact time of the event.

2.6.3. Indoor Air Pollution (IAP)

a. Hazard Presentation and Significance

IAP is related to pollutants that occur from atmospheric PM and gases such as CO that contaminate and deteriorate IAQ. IAP results from outdoor air pollutants propagation and concentration inside the facility, indoor sources (ovens, fires, humidity, detergent, extra plantation, and other), building type and characteristics (Industrial, residence, restaurant), and the residents' habits. Common residential indoor pollutants contain excessive moisture, Volatile organic compounds (VOCs), combustion products, pesticides, radon, dust particles, bacteria, and viruses (Davis, 2017).

Air pollution is the result of interior and exterior factors (Yu, 2019).

Interior causes:

- Gas leaks that eject different types of gases.
- Indoor sources including combustion such as secondhand smoke, soot, gas stoves, fireplaces, many others.
- Household cleaning products and maintenance: Sometimes, wrong chemical mixing or the use of different detergent products eject poisonous gas inside the building.
- Building products and furniture such as formaldehyde fumes used in various household products such as wood furniture, plywood and laminate flooring.
- Central cooling and heating systems and humidification devices.

External causes:

- PM consists of solid and liquid particles in the air and are caused by the industries, automobiles, construction sites, unpaved roads, and others.
- CO and CO₂ resulting from industries, automobiles fires and other.

Air pollution conduces to different outcomes and tends to be dangerous, so humans begin to feel their side effects without acknowledging the cause of the problem. IAP could not be seen or smell, but it can cause a wide range of short-term or long-term health problems and kill quickly with no warning.

In the short term, exposure to high IAP concentrations can lead to headaches, eye irritation, nose and throat irritation, fatigue, and giddiness. Based on the IAP causes, the symptoms to differ, they might look like asthma, while others may be like cold symptoms. Unfortunately, in some cases, long-term health problems can be more serious, and after longtime exposure, a person can have respiratory sickness, heart problems, and even cancer (EWHAP, 2020).

Whatever the reason, and wherever it originates from, being able to identify and prevent IAP can aid in reducing the risk by easing severe short-term and long-term health problems and improving overall well-being and energy efficiency.

b. Hazard Monitoring

Each sensor and equipment related to sensing air pollutants or gases must abide by the European standards regulation. In this section, we will focus on the most important sensors related to explosive atmospheres, toxic gases, and air pollutants, and air quality, in particular:

- Flammable gases wireless sensors: Isobutane, ethane, propane, methane, CO, and hydrogen.
- VOC
- PMS 5003 for PM sensor detection
- CO₂ wireless sensors detectors
- Temperature sensor
- Humidity sensor

- Windows and doors sensor

uHoo IAQ Sensor offers a comprehensive analysis by gauging indoor temperature, humidity, dust, toxins, nitrogen dioxide, CO₂Ozone, air pressure, and more. uHoo tests the air, and the uHoo mobile app streamlines the data (Onghanseng & Lin, 2016). The uHoo system syncs with any IFTTT-compatible device, then we can record the data on a Google spreadsheet using IFTTT. The nine air quality parameters use safety thresholds indicated by the Environmental Protection Agency (EPA) and World Health Organization (WHO). This device can detect toxins and the exact air quality parameters that are unhealthy, all in real-time.

The data should be extracted from the device to spreadsheet in real-time to integrate the data in BIM for analysis and decision making. Figure 2.8 presents the monitoring system of the IAP by showing the necessary sensors and system components needed.

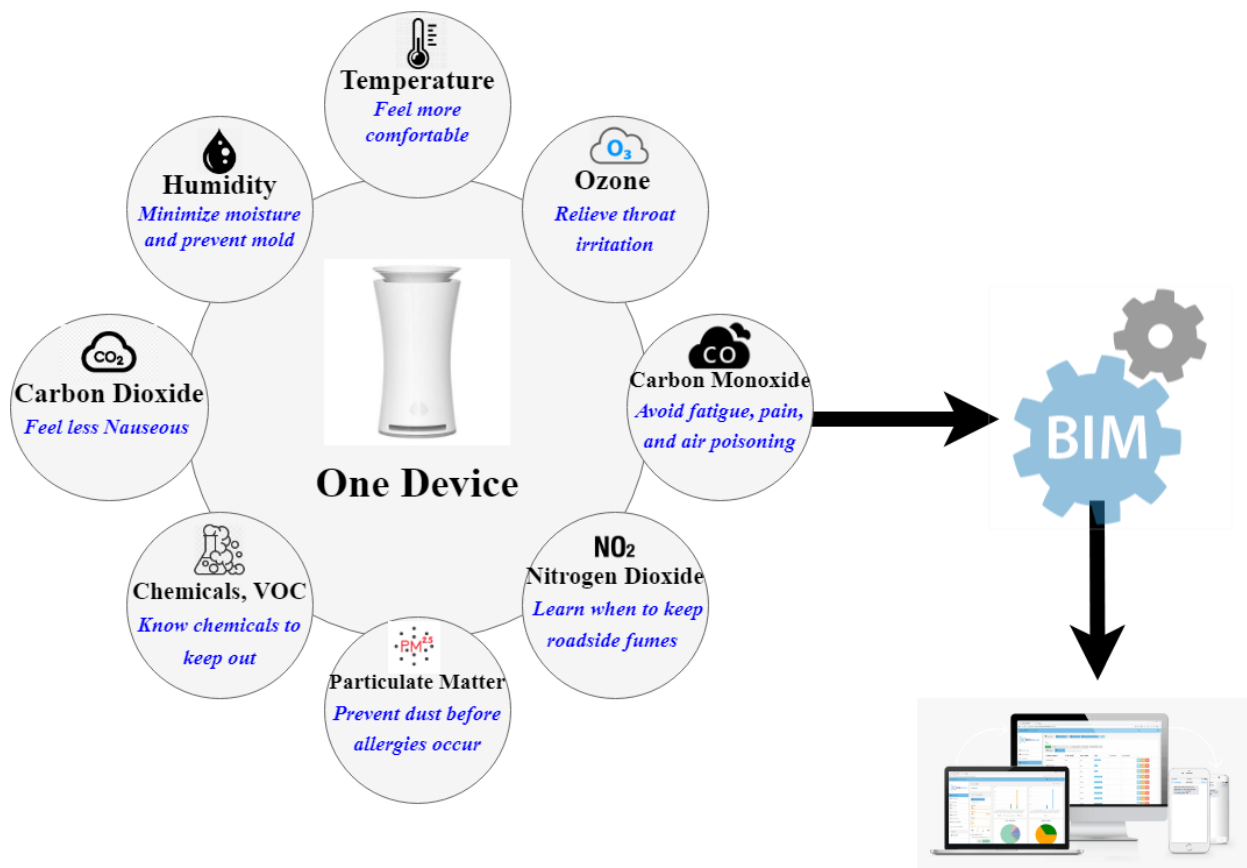

Figure 2.8: IAP monitoring system

c. Decision Making and Practical Implementation

For decision-making, the system should operate the following actions:

- Identify the air pollutant type, concentration, and location, and inform users and concerned groups.
- Present the IAP location visually in a 3D view.
- Take some mitigation actions, such as ventilation and the control of windows and doors opening.

The devices should be placed in sensitive places such as the bathroom, bedroom, and kitchen. We should take into consideration the radius that could be covered with such a device to be able to cover the whole house.

d. Difficulties and Barriers

The proposed system has some barriers and limitations, such as:

- The accuracy of the device's measurements.
- The distribution of the devices to cover the whole household.
- Many times, residences exist in an industrial area where air quality tends to be poor throughout the year. So even with a decision such as normal ventilation, sensors might get worse.
- Air quality that includes PM is challenging to get filtered, so an excellent ventilation and filtering system might come in handy to solve this situation.
- Sensors' location must be well placed in a conservative location, because sometimes if an IAP sensor is placed near a window or ventilation system, the readings will be inaccurate.

e. Case Studies

Marzouk et al. (2015) proposed a BIM integrated module to track IAQ, temperature, humidity, and carbon emissions. The system was more related to comfort healthcare than hazard monitoring since it was responsible for adjusting comfort parameters to meet the standards and taking the CO₂ as an IAP parameter. Azizi et al. (2016) used IoT technology to track indoor methane gas. If an explosion is triggered, the IoT system related to fire takes the necessary action. Hsu et al. (2019) created a system to monitor CO (1) by connecting the system to electrical windows, fans, HVAC systems, and a device installed to stop the gas leak and to take decisions, and (2) triggers an alarm and notifies the key players. In those two systems, the researchers worked on specific IAP sources. Marques & Pitarma (2019) developed an IoT system for air monitoring called IAir. The system aimed to (1) identify most toxic gases like ammonia, CO, nitrogen dioxide, ethanol, hydrogen, methane, isobutane, and Propane, (2) collect and store data in a ThingSpeak web platform, (3) visualize the archived and live data, and (4) send a message alerting the users (Marques & Pitarma, 2019). However, this system was not able to take any actions other than sounding the alarm. In many times, gas like Methane and Isobutane are too fast in poisoning and thus need instantaneous actions.

2.6.4. Gas Leak

a. Hazard Presentation and Significance

Gas leak contributes to several deaths per year and hundreds of hospitalizations. Therefore, gas safety is something each household must take seriously. Since this research is limited to indoor hazards, it will not consider the gas leak in external pipes.

An indoor gas leak could be due to many causes, such as faulty gas appliances, cooking, and indoor pipework. Be exposed to low levels of natural gas is not injurious, but long-term

exposure can contribute to dangerous consequences (Ginta, 2017). Gas leaks might lead to air poisoning due to inhaling combustion fumes, explosions, fast temperature variation, suffocation, property damage, and loss of human life. Indoor gas leaks are generally poorly fitted, inadequately maintained, or appliances such as cookers and boilers (Leonard, 2018). Indoor gas leak signs could be detected through unpleasant smells, hissing sounds, dead house plants, bubbles in water, a damaged gas pipe, pet symptoms, and human health symptoms such as faintness, breathing problems, or flu symptoms (Stickley, 2021).

To prevent gas leaks, all gas-burning appliances and gas pipelines should be inspected at least once per year; pipes must be well insulated to protect them from corrosion and ensure adequate ventilation. Therefore, our system is responsible for gas leak detection and prevention by taking the necessary decisions to reduce its effect.

b. Hazard Monitoring

It should be mentioned that some flammable gases listed in the IAP section could be caused by a gas leak from cooking and appliances. Therefore, the sensors needed for gas leak detection are:

- Flammable gases wireless sensors: Isobutane, propane, methane, and hydrogen.
- CO₂ wireless sensors detectors
- Temperature and humidity sensors
- Pressure wireless sensors
- Gaz meter sensor
- Windows and doors sensor

Therefore, for gas leak detection, we will use the same device as IAP, in addition to a pressure drop device. On the other hand, the gas meter is used to monitor the consumption and gas volume used by the occupants. A gas meter is considered a valuable tool for the database adopted by the AI; whenever the consumption tends to be high from the average of the user consumption, it is considered abnormal behavior. In that way, the system will be able to detect a gas leak situation.

Moreover, the AI will characterize an odd behavior by some variables such a pressure drops, fast variation of the temperature, abnormal sensor readings, fast drop in air quality, and most importantly, the conducting manner of the inhabitants in these situations; since human beings tend to be nervous, making disturbing noises, vibration due to running, loud sounds and many other.

The system will be able to monitor gas leaks by providing a maintenance schedule for the indoor appliances.

c. Decision Making and Practical Implementation

The system will be able to take the following actions to ensure indoor safety:

- Specify the gas leak source and location and alert the users and emergencies.

- Shut-off valve: Whenever the sensors detect a gas leak, the system output a signal to shut-off the valve of the main gas pipe or the appliance.
- Open windows and doors in this area.
- Interact with the ventilation system to reduce toxic air concentration.
- Main electrical switch: the system must not be linked to any major electrical switch in the residence since such actions lead to further hazards.

Concerning the practical work, gas leaks might show some difficulties and need special implementation. One of the most challenging tasks is to confirm a leak using a pressure drop sensor for many reasons. Pressure drop in pipes happens whenever there is gas consumption; for example, whenever an inhabitant is using the oven, there will be a pressure drop in the pipe. Therefore, a pressure drop sensor alone cannot be taken as proof of gas leak existence. Other solutions can be adopted, like implementing several pressures drops and at least two gas meter sensors, one on the inlet and one at the outlet. Using the difference between the measurements acquired from the two gas meters and pressure sensors, one can confirm if a hazard leak is occurring or not. For example, a pipe section with pressure sensors and two gas meter sensors; in case of normal usage, there will be a drop of pressure, and the difference between a couple of gas meters is zero, however in case of abnormal behavior, there will be no volume reading but drop in the pressure sensor. These readings are considered a very important source of data that is vital for ML's future training.

d. Difficulties and Barriers

The real implementation of the gas hazard defense system faces difficulties related to real-time data collection, decision-making, and actions conduction because this system requires rapid actions to prevent gas leak impact on both users and buildings.

e. Case Studies

Anandhakrishnan et al. (2017) suggested a system linked to the MQ2 gas sensor, includes a buzzer alarm, a LED display to visualize the results, and an electrical motor valve to stop the leak. The authors also used an IR GP2D120 sensor to measure object temperature and a load cell to measure air pressure. Bagwe et al. (2018) proposed a gas leak monitoring system connected to MQ5 gas sensor and temperature sensor that includes database logging, prediction, and smart alerting techniques in sending messages and emails to the concerned authorities. Kodali et al. (2018) developed a similar system for industrial indoor use but sent mobile notifications, Udibots cloud server for sharing the collected data and shutting the building gas valve. Cheung et al. (2018) suggested a gas leak system monitoring using WSN and BIM. The proposed system was tested on an underground construction site. The model was linked to a flashing alarm and ventilators to reduce gas concentrations.

The previous studies are related to pipe underground gas leaks. Specific developments are required for indoor gas hazards.

2.6.5. Water Leak

a. Hazard Presentation and Significance

Minor issues such as small leaks have been diagnosed to cause much influential damage than natural disasters since they occur more often and generally persist unnoticed for a permanent time. Unfortunately, since most of the pipework in buildings is not under eye contact and could not be seen, the leak could not be easily detected until visual damage appears, such as humidity spots, greenish color on walls, and others. Furthermore, if the leak is unnoticed and neglected, it might cause substantial long-term water loss, increase water bills, and damaged equipment (ServiceMaster, 2019).

The most common water leak types found in buildings are (T&S Roofing Systems, 2018)

- **Toilet Leaks:** This leak could happen from the water tank or supply, flange, and wax ring, and it is not considered a big problem since it is visible. In this case, the malfunctioning parts could be replaced. The more dangerous cases are when the leak occurs in pipes behind walls, giving signs of mold and wet spots.
- **Faucet Leaks:** The results of a damaged component in the faucet. For example, if the rubber washers are used to produce a waterproof seal exhaust, the seal will fail, and the faucet will leak.
- **Washing Machine and Refrigerators:** Usually, the washing machine leak occurs due to a ruptured hot or cold-water supply tube that becomes failure-prone with time. Moreover, due to the automatic ice maker in the refrigerator, a leak chance is always possible.
- **Showers and Sinks:** This leak type is challenging since they are often buried in the wall surrounded by tiles. Gaps in the water supply lines can lead to grave water damage.
- **HVAC Equipment:** Moisture around the HVAC equipment is persistent, knowing that moisture on drywalls can cause a water leak.
- **High Water Pressure:** If the water pressure is too high, it could stress the pipes, equipment, and fittings; this can lead to slight pinhole ruptures that can cause major ruptures and flooding in the house.
- **Ceiling and Roof Leakage:** One of the main causes to have ceiling and roof leaks is due to the damage of waterproofing membrane. This damage will lead directly to dampness and water seepage inside buildings.

A water leak could be a short-term and long-term hazard that can sometimes contribute to minor effects such as wastewater, equipment damage, and major leak like flooding. In both cases, water leak poses risks to the home and humans health.

The consequences of a water leak are the following (Jennifer, 2017):

- **Health Problems:** Mold due to water leak spores in the air and affect human health with many symptoms such as nasal congestion, coughing, difficulty breathing, and

sneezing fits. Sometimes the impact could be more severe, creating greater health complications.

- **Economic Effects:** Water leak will lead to high water consumption, in consequence to high water bills. In addition, water damage drives down property values since even after fixing the water damage, lingering effects may persist.
- **Structure Damage:** The most noticeable and direct effects of a water leak are visual as discoloration and streaks along the walls. Moreover, when a wall absorbs water from a holey pipe or other water damage forms, it starts to swell and warp. If left untreated for a long-time, this could attack the structural integrity of the home.

Then to prevent water leaks, routine inspections and monthly maintenance should be conducted for the water heater and all other equipment.

b. Hazard Monitoring

The water leak hazard defense system should include:

- Temperature and humidity sensors
- Water Leak Detector: This device could be placed next to basements, bathrooms, and kitchen to detect water leaks from a water heater, washing machine, refrigerator, sink cabinet, sump pump, radiators, and more. When the water leak alarm senses even a small leak, it sounds like a very loud alarm.
- Running Toilet Detector: Since the toilet's leak is more critical and could not be detected with the same device of water leak detector, the leak alert device is used. This smart device electronically monitors the toilet for leaks, stuck open flappers, imminent overflows, and other water-wasting problems. The device recognizes the faulty part and alerts the user to the problem.
- Water meter: The water meter is used to monitor the consumption and water volume used by the occupants. Then if the volume used is very high and unusual, in this case, there is a water leak somewhere.
- Window status sensor: This sensor is used to identify if the window is open when nobody is inside the room. Since an open window in a rainy situation could lead to flood hazards.

Due to those sensors' combination, the system will recognize water leaks in all the household appliances. The water meter is very useful for AI work since the system will be able to detect any abnormal water bill or water volume consumption per household. Nevertheless, the challenging part is the detection of an indoor pipe water leak. To overcome this issue, AI will get a vast number of photos for different rooms, corners, walls, and floors, and the ML will learn the normal components and situations of each photos package related to one part. For example, if discoloration or streaks along the walls occur, AI will detect them from the photos. Moreover, the system will be able to monitor water leaks by providing a maintenance schedule for the necessary appliances.

c. Decision Making and Practical Implementation

When the system detects a water leak, it will take the essential decisions:

- If the water leak is due to an appliance, the system will turn off the equipment.
- If the windows are open and nobody is inside the room, the system will close the automatic window or inform the user to take action.
- Specify the water leak source and location and alert the occupants and technicians.
- Turn off the electrical equipment near the water leak to avoid an electrical fault hazard.
- Stop the water supply if a flood occurs.

d. Difficulties and Barriers

The difficulties that can face the system for water leak detection are:

- To cover all the appliances and areas that can lead to water leak
- To detect the hazard in real-time before a flood occur
- The recognition of a humidity trace appearance on walls and floors due to AI technology
- Difficulties of system application in old residence.

e. Case Studies

Gupta & Pandey (2018) used the multi-sensor combination data and IoT for leak detection in pipes for WDN; the system can take decisions and control water leaks in pipes. Smart2L, a mobile application, was developed to detect the water level in the tank and water leak at the valve or along the distribution pipes. This system could also inform users and automatically control the pump (Hafiz Kadar et al., 2018). Moreover, a SCADA system integrated IoT technology to detect water contamination and water leak using the following parameters: Temperature, color, and water flow without taking any action (Saravanan et al., 2018). Rojek & Studzinski (2019) suggested an algorithm based on AI and IoT to detect a leak. The system using the probes and neural classifier identifies leak locations based on stored data. The probes could alert the key players and send the location of the leak (Rojek & Studzinski, 2019).

The previous studies are related to pipe underground water leaks. Precise advances are required for indoor water hazards.

2.6.6. Intrusion and Crime

a. Hazard Presentation and Significance

The intrusion and crime effects could be characterized as short-term or long-term. Some effects may only be short-term such as financial losses. However, psychological and social effects can be very long-lasting. Moreover, the effects of a crime can be felt not only by the victim but also by their family member, those close to them, or living in the same building. Moreover,

crime against businesses is not a direct effect on managers, but also the staff is prospective to be affected.

The consequences of crimes are the followings (Shapland & Hall, 2007):

- Property damage cost, in addition to the loss of production in work.
- Emotionally, the victims might suffer for a while by blaming themselves as the cause of crime, especially if there was a possibility to prevent it.
- Victims are hunted by depression, fear, unusual anger, and in a serious situation, it can cause post-traumatic stress disorder and may lead to suicide.
- In high crime rate areas, many times, people who faced a crime lose trust in their community and move to another.
- Fear of crime (FoC) always affects one's social life, production at work and causes a drastic change in the whole family's lifestyle.
- FoC leads some persons to obsessions by forcing them to take extraneous and unnecessary measures.

There is a strong relationship between crimes, intrusion detection systems, and the community's well-being that should confer that a good intrusion detection system is of greatest utility. It is known that FoC affects the living community greatly; having a resilient system provides great advantages:

- Having a low FoC increases people working efficiency and production in society.
- People tend to choose secure areas and buildings to live in, so providing them the sensation of being safe and well-secured attracts more people to seek habitations with such offering qualities.
- Living in a safe environment affects psychologically on humans especially the young one, violence, delinquency, and crimes progressively.
- Economically and business-wise, attracting people more and more to these types of buildings incite other landlords to apply such measurement and offer these types of security systems in their buildings.

For this reason, security design and access control are more than architectural barriers, security guards, and cameras. Crime anticipation includes the systematic integration of design, technology, and operation to the safety of three serious assets: people, information, and property (Atlas, 2018). Protection of these assets is the concern of our smart system.

b. Hazard Monitoring

The monitoring system includes:

- Noise sensors or decibel meter - Noise detector application. This application presents the environmental noise information anytime. The characteristics of this mobile application are the positioning measurement, standard decibel comparison table, high precision measurement, multi-device adaptation, simple design, and historical data storage.

- Windows and doors sensors like glass break detectors or magnetic fields.
- UWB for RTLS

The UWB technology is used to track and position an individual's movements in real-time (Sato, 2011). Since other RF technologies do not provide accurate results and coverage simultaneously, UWB has gained widespread use (Rafiee et al., 2013). Figure 2.8 below illustrates and compares all the RFID to the ideal system for tracking, positioning, and coverage. As shown in figure 2.9, UWB tends to merge the accuracy of locating and the coverage area.

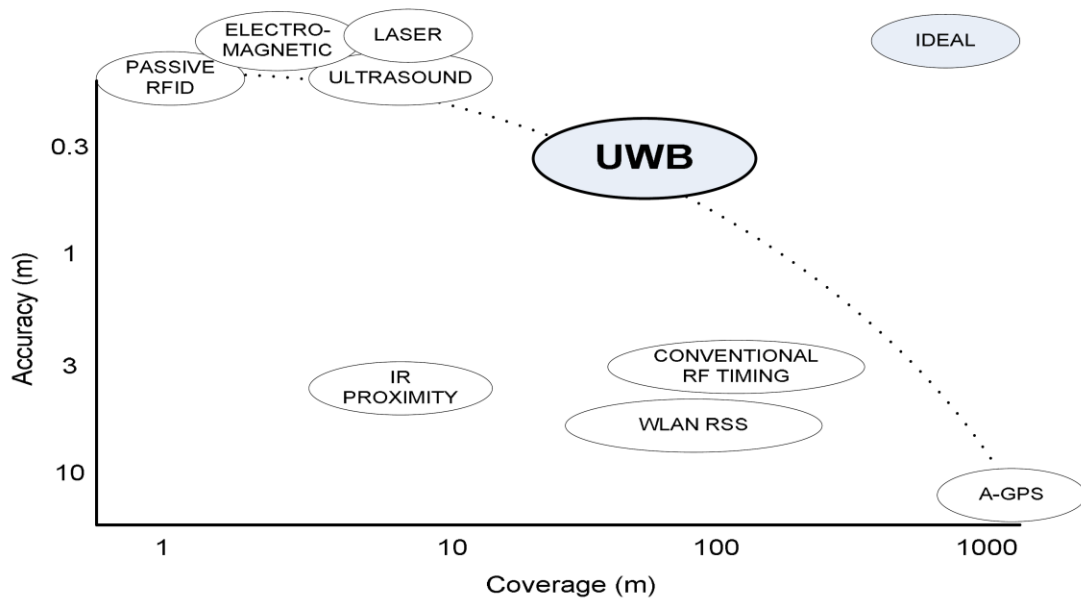

Figure 2.9: Comparison of locating technologies (Rafiee et al., 2013)

- PTZ cameras/fixed Cameras

PTZ camera is an instrument able to rotate in all directions and zoom control. PTZ is used in television programs, studios, cinema, and the most important thing in indoor surveillance. A handover algorithm can also monitor PTZ cameras to follow a certain target. PTZ cameras can also be used to monitor entrances for counting people, intruder detection, and identification (Rafiee et al., 2013). However, due to the continuous movements and changing positions of residents, lighting conditions, and various behaviors, PTZ cameras can risk losing count and miscalculate intrusion due to losing a certain angle of the picture while rotating. Therefore, it is more efficient to set up Fixed Field of View (FoV) cameras in certain critical regions like entrances, gates, safe money boxes, and other important locations to have a reliable result.

On the other hand, since our objective is to have a high automated indoor level of security, the system must reach the following goals: Intrusion detection, intrusion identification, and visual tracking. Therefore, to achieve these main objectives, we must correctly combine the sensors and hardware depending on specific parameters like degree of importance, location, angle of view, and human movements. Table 2.2 below summarizes the sensor collaboration to achieve

better results. It is noticeable that using UWB, FoV, and PTZ cameras reach the best results by covering all types of locations.

Table 2.2: Technology Combinations, Capabilities and Shortcoming (Rafiee et al., 2013)

			Camera Types		
			Fixed Camera	PTZ Camera	Fixed + PTZ Cameras
			Continuous observance over a limited FoV (Suitable for lossless-data applications)	Wider FoV achievable in exchange of loss of continuity during camera rotations (Suitable for target tracking & behavior analysis)	Continuous observance over critical & confined areas (e.g. entrance) with fixed cameras + wide-area on-demand surveillance with PTZ cameras
RF-based Technologies For RTLS	Traditional RFIDs	Tag detection & identification + chokepoint locating	Step 1, 2 and 3 are infeasible across wide areas	Although PTZ camera is available for performing step 3, steps 1 and 2 are infeasible across wide areas	Although PTZ camera is available for performing step 3, steps 1 and 2 are infeasible across wide areas
	UWB	RFID capabilities + precise wider range locating	Step 3 is doable only within a very limited area	Step 1, 2 and 3 are feasible	Fixed camera is assigned to collaborate with UWB in steps 1 and 2. PTZ camera is assigned to step 3

Indoor physical security is a very important step toward indoor hazard management. The methodology developed the indoor surveillance as a 4-layer process: (i) environmental design to prevent threats, (ii) real-time monitoring and 24 hours access control to protect authorized users from intruders, (iii) indoor intrusion detection and prevention system, (iv) intruder identification for prosecution and incidents verification.

To accomplish these four points and achieve good results, the system must follow the monitoring steps:

- Mapping location into real world coordinates and filtering the noise from the building to prevent false alert intrusion, in addition, to specify any abnormal situation as intrusion, windows and doors situations.
- Use unique registered ID tag connected to UWB system for RTLS. Users are requested to wear it before entering the building.
- Using video surveillance and PTZ camera for expanding the ability to detect and auto-track a non-registered user into the building.
- Merge the data by comparing UWB, and PTZ counts in the overlapped area to distinguish the users from intruders and their coordinates on the real map. The fusing data will be stored and can be used for further inspection of evidence of intruders.

Figure 2.10 below describes the steps needed to achieve our intrusion methodology.

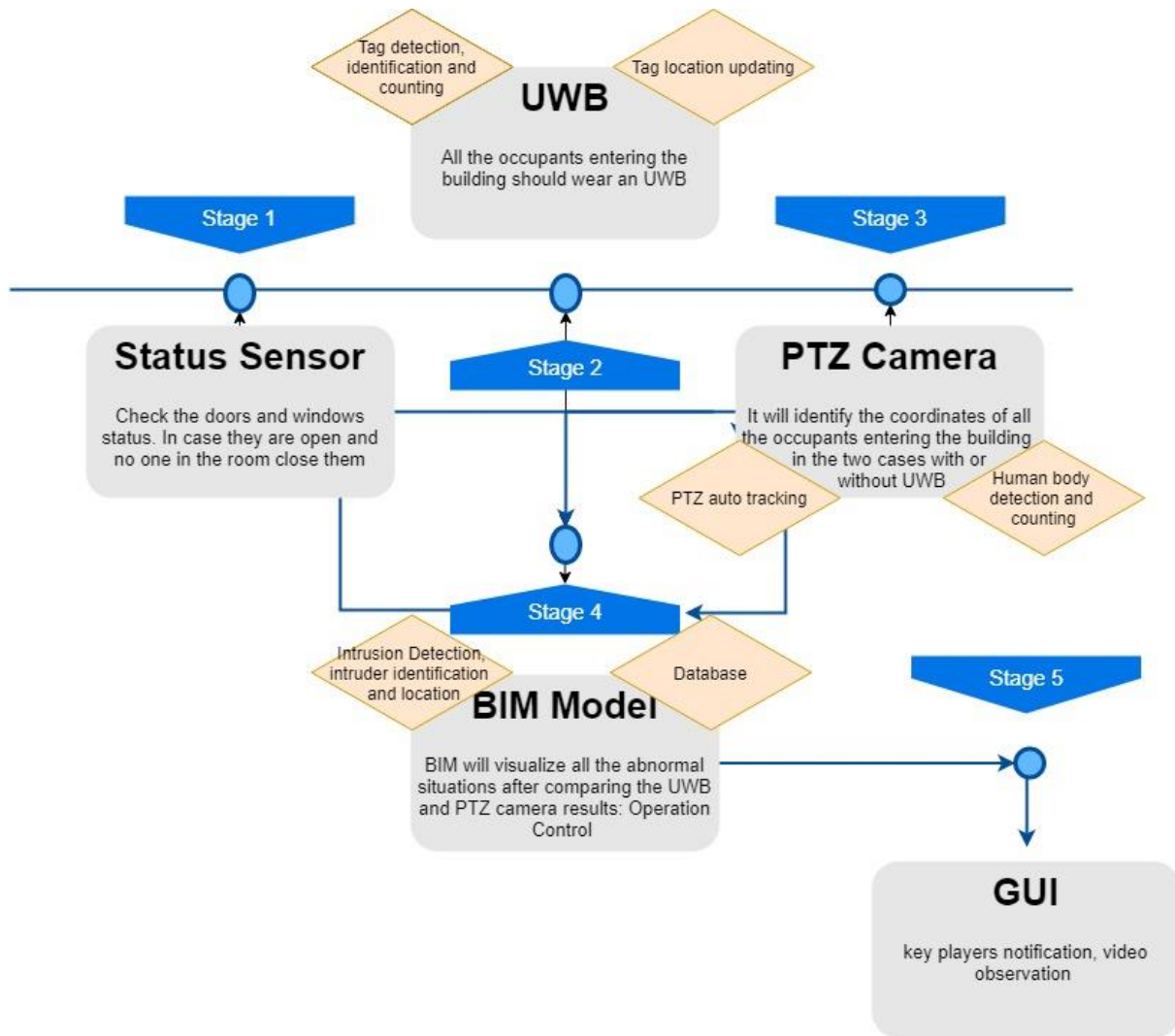

Figure 2.10: Structure of the intrusion monitoring system

c. Decision Making and Practical Implementation

When the system recognizes an abnormal event, it takes actions such as closing the doors and windows related to the room where the intruder is located and contacting the key players as the homeowner and the police, sharing the intruder location. In addition, the system converts all the data from UWB and PLZ cameras as CSV files to transfer them in BIM and conserve them as a database for analysis tools.

d. Difficulties and Barriers

The proposed system has some barriers and limitations, such as:

- Long signal acquisition: sometimes UWB has late signal acquisition depending on the distance and area of coverage.
- UWB is a very sensitive wave that sometimes may face issues with other co-existence RF and affect the precision of the data.

- Storage: like any other surveillance system, camera footage, and video recording consume large storage, especially in our case since the data storage is achieved to be later used for ML training along with the operation phase of the building. Hence, data cleaning does not happen frequently, and large storage is needed.
- Noise filtering: Considered one of the most challenging issues in the system because noises tend to be loud during hazard occurrence and are registered as odd parameters for ML. However, many times loud noises are the result of other sources that happen to be not dangerous. To overcome this issue, the system must filter the data and seek a combination of other parameters before confirming the hazards.
- Internet speed for data uploading, especially in case of an emergency since, as mentioned before, the system will inform all key players, users, and concerned authorities about the incident and sending video footage for escape plan depending on internet speed and services.
- Our system provides users the ability to interact with the platform to increase its reliability and resiliency. However, the collection of such data and their analysis must be well filtered to refine the definitions of the events.

e. Case Studies

Gulve et al. (2017) proposed an intelligent surveillance system able to record video, shut down all electrical appliances in the house for more protection and security, and send an SMS notifying the building owner and an email containing the video footage. This system could contribute to high false detection events since it is only based on video and camera records. Rafiee et al. (2013) conducted research about integrating RTLS, video surveillance, and BIM for indoor surveillance. The system uses three sources of environmental data: UWB module for RTLS, PTZ cameras for video surveillance, and BIM for sensor coverage and operation control. In addition, the system has the ability also to (i) track the intruder using BIM or manual input using GUI, (ii) filter the noises, (iii) check the coordinates before validating, and (iv) transmit to the fusion module. Unfortunately, there is no real interaction between the system and the user, and the system cannot upgrade itself through users' experiences and previous events.

Moreover, Jozef et al. (2011) conducted research about using ML in indoor surveillance. They build up a prototype called PDR for an intelligent security system based on a UWB ID tag to locate the coordinates of the culprit. After identifying the coordinates of the intruder, PDR could compute the speed of the invader, detect which area a given tag is located when it has entered, identify the position, and keep checking whether the tag is moving or not. Besides the difficulty of the PDR, the system achieved good results because it was able to recognize the normal behavior predefined by the user. However, since the system is based only on the UWB tag, thus will not be able to detect an intruder from outside the building.

Therefore, our smart system will present a system that combines UWB, PTZ, BIM, and AI to detect intruders living inside the building or coming from outside and learn from previous events and human experiences to take the necessary actions.

2.6.7. Health Hazard

a. Hazard Presentation and Significance

Health problems are many and could lead to severe consequences. When a disease is detected earlier, it could prevent or delay problems from the disease. Therefore, some medical problems could be prevented through vital signs like blood pressure, heart rate, body temperature, breathing rate, and pulse oximeter readings (Hopkins, 2020). Vital signs referred to a patient's normal health situation, which is helpful to be compared to an abnormal patient's condition.

The vital signs are (Median College, 2018)

- **Body Temperature:** The key cause for checking body temperature is to solicit any signs of systemic contamination or inflammation in the presence of a fever. The factors that influence body temperature are age, emotional conditions, environment, exercise, and others.
- **Heartbeat:** Heart abnormalities are detected by analyzing the heartbeat. The rhythm, rate, and beat regularity are measured, also the beat tension and strength of the beat against the arterial wall.
- **Blood Pressure:** High blood pressure is one of the most common and frequently occurring diseases; heredity, unbalanced diet, fat, lack of exercise, and drink may cause high blood pressure.
- **Respiration Rate:** Respiration rhythm should be uniform and regular, with identical pauses between breath in and breathe out. Several aspects can disturb the normal respiration rate, such as age, emotional situation, physical activity, fever, and medications are taken.

By managing the vital health signs, an individual's health situation will always be followed and tracked. In addition, elderly persons are always exposed to fall hazards, and the vital signs will not detect such a state. Therefore, the combination of vital signs and fall detection is an essential step to cover individual health monitoring. Furthermore, viruses are considered the main cause of health problems. Therefore, buildings monitoring to reduce the virus spread is essential. The section below will define the humans' health monitoring system. In particular, chapter 4 will describe a comprehensive methodology for evaluating and improving the COVID-19 measures in higher education establishments.

b. Hazard Monitoring

The sensors needed for health monitoring are:

- Human fall: UWB system and vibration sensor
- Heartbeat
- Blood Pressure
- Respiration rate
- Body temperature

It could be found one wearable device that collects the four vital signs: heartbeat, respiration rate, body pressure, and blood pressure.

Fall hazards could be detected through vibration sensors, UWB wearable devices, or even non-wearable devices. The UWB device used for intrusion could also be used for fall detection since it could define the user's location, position, and speed. If the UWB system detects a horizontal fixed position, in addition, a vibration happens; in this case, we have a fall hazard.

To find the intruder speed and the body position Kalman vector method is used. Kalman vector define the next position by the addition of the previous location and the product of velocity $V_{x,y,z}$ and a time Δ_t . The matrix below describes the six equations that compute the 3D coordinates and the speed of the intruder (Equation 2.1). In addition, from the UWB tag and BIM model, the system now can determine in which room the intruder is placed.

$$\begin{bmatrix} x_{n+1} \\ y_{n+1} \\ z_{n+1} \\ v_{x,n+1} \\ v_{y,n+1} \\ v_{z,n+1} \end{bmatrix} = \begin{bmatrix} 1 & 0 & 0 & \Delta_t & 0 & 0 \\ 0 & 1 & 0 & 0 & \Delta_t & 0 \\ 0 & 0 & 1 & 0 & 0 & \Delta_t \\ 0 & 0 & 0 & 1 & 0 & 0 \\ 0 & 0 & 0 & 0 & 1 & 0 \\ 0 & 0 & 0 & 0 & 0 & 1 \end{bmatrix} \begin{bmatrix} x_n \\ y_n \\ z_n \\ v_{x,n} \\ v_{y,n} \\ v_{z,n} \end{bmatrix} \quad (2.1)$$

The system will also provide the body position of the users by classifying a person wearing a tag into standing, sitting, and lying. A pre-recorded data stored in the system classify the tag position into three intervals separated by two thresholds t_{lo} and t_{hi} where (Jožef et al., 2011):

- t_{lo} represent the limits between lying and sitting
- t_{hi} represent the limits between sitting and standing

However, since human beings differentiate a lot in the physical length and body proportions, a tolerance d is added or decreased to adjust the boundaries limit. For instance, if a person in a standing state is below the limit t_{hi} , the system will increase the tag height by d ; otherwise, it is decreased by d . Figure 2.11 describes the limits of each state:

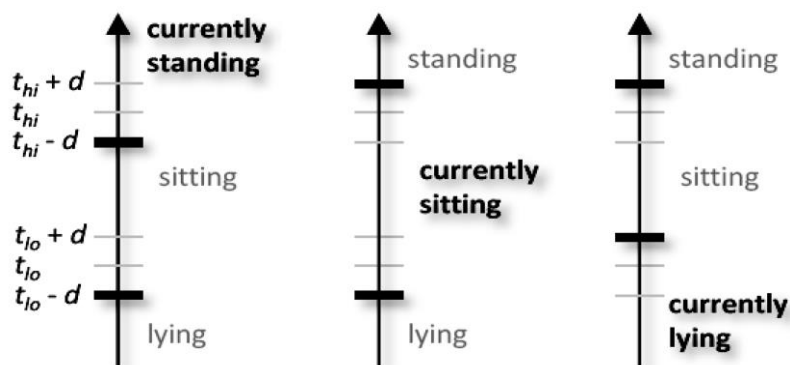

Figure 2.11: Position state in function with the thresholds(Jožef et al., 2011).

The system will always record the health data to analyze them and detect any abnormal situation. In addition, AI will be beneficial to prevent any health problem before it happens due to the profile of each occupant, their previous health record, and disease report.

c. Decision Making and Practical Implementation

In case of health problem detection, the system will inform the user and ask him to contact the doctor for further instructions. When a fall hazard is detected, the system should inform any nearby user to act and assist the victim with some instructions depending on the health situation (high fever, slow or high heartbeat, etc.); moreover, the system will alert the emergency by calling the caregiver.

As a practical implementation, all the occupants will be asked to wear a device to manage their health and ensure the wellbeing of the inhabitants. To detect the users' position to know the posture of a person wearing the tag (standing, sitting, or lying), UWB anchors should be placed on walls in each room with a maximum distance limit of 25 meters between each other.

d. Difficulties and Barriers

The system should be real-time since a fall hazard could lead to drastic consequences, and fast actions must be taken. Moreover, sometimes children sleep on the floors for a long time, hence, to overcome a false detecting alarm, the system needs to check the vibrating sensor to differentiate between two situations: sleeping on the floor or falling.

e. Case Studies

Mastorakis & Markis (2014) used kinetic sensors for real-time fall recognition with a 3D bounding box that needs no pre-knowledge of the scene. In the same year, Gasparrini et al. (2014) studied a privacy-preserving fall detection method for the indoor environment that allows detecting fall without using wearable sensors. After one year, Kwolek & Kępski (2015) proposed a new algorithm for fall detection by combining the accelerometer and Kinect. Wang et al. (2017) presented the design and application of a real-time, low-cost, and accurate indoor fall detection system using WiFi devices. In addition, Kim et al. (2012) proposed a U-Healthcare system that can record health information about each patient, provide an alarm for medicals time, and alert medical staff in case of an abnormal condition. Dziak et al. (2017) suggested an IoT-based healthcare information system for indoor and outdoor use that can monitor people's location, discriminate different activities and situations, behavior recognition, and classification. Recently, Jeyaraj & Nadar (2019) projected a smart monitoring system as an advanced electronics component using an intelligent sensor for EEG, ECG, temperature profile, and pulse rate. Collected data are used for analysis and visualization through a deep learning algorithm. Durán-Vega et al. (2019) suggested an IoT health monitoring system, using a biometric bracelet linked to a mobile application, which permits real-time visualization of information generated by sensors (body temperature, heart rate, and blood oxygenation).

2.7. Synthesis of System Monitor and Control

Indoor hazards overlap in some monitoring steps and actions since many hazards are related to each other. The sensors used for indoor hazard management are illustrated in figure 2.12. It was evident that many sensors are used for different indoor hazard identification and monitoring. Many sensors are combined in one device, such as IAP sensors.



Figure 2.12: Sensors used for indoor hazard management

Table 2.3 sums up the monitor equipment system for each type of hazard and what are specific decisions need to be taken to restrain it and minimize the damages as much as possible.

Table 2.3: Monitor system and specific control per indoor hazard

Indoor Hazard	Monitor System	Specific Control
Fire	<ul style="list-style-type: none"> • Smoke sensor • Temperature sensor 	<ul style="list-style-type: none"> • Turn on the exit signs

	<ul style="list-style-type: none"> • CO2 detector • Human RTLS • Windows and doors sensor 	<ul style="list-style-type: none"> • Turn on the sprinklers and extinguishers. • Cut the electricity. • Provide occupants and firefighters with the map rescue on their mobile in real-time.
Electrical Faults	<ul style="list-style-type: none"> • Fuse • RTC • Circuit breaker/relays • Noise sensor • Temperature • Fire sensors • Current sensor • Voltage sensor 	<ul style="list-style-type: none"> • Cut the current on the conductor line. • Switch relay off and provide power from a backup source • Turn off surrounding equipment and devices.
Indoor Air Pollution (IAP)	<ul style="list-style-type: none"> • Flammable gases sensors • VOC • PM sensor • CO₂ sensor • Temperature sensor • Humidity sensor • Windows and doors sensor 	<ul style="list-style-type: none"> • Turn on the ventilation system • Open windows and doors in this area.
Gas Leak	<ul style="list-style-type: none"> • Flammable gases sensors • CO₂ sensor • Temperature sensor • Humidity sensor • Pressure sensors • Gaz meter sensor • Windows and doors sensor 	<ul style="list-style-type: none"> • Shut-off valve of the main gas pipe or the appliance. • Open windows and doors in this area. • Turn on the ventilation system • Main electrical switch.
Water Leak	<ul style="list-style-type: none"> • Temperature sensor • Humidity sensor • Water leak detector • Running toilet detector • Water meter • Window status sensor 	<ul style="list-style-type: none"> • Turn off the equipment. • Open windows and doors in this area. • Turn off the electrical equipment near the water leak. • Stop the water supply if a flood occurs.
Intrusion	<ul style="list-style-type: none"> • Noise sensors • Windows and doors sensor • UWB for RTLS • PTZ cameras 	<ul style="list-style-type: none"> • Close windows and doors in this area.

Health	<ul style="list-style-type: none"> • UWB for RTLS • Vibration sensor • Heartbeat • Blood Pressure • Respiration rate • Body temperature 	<ul style="list-style-type: none"> • Ask the user to contact the doctor. • Assist a neighbor with some instructions to help the victim.
--------	-----------------------------------------------------------------------------------------------------------------------------------------------------------------------------------------------------	-----------------------------------------------------------------------------------------------------------------------------------------------------------------

In addition to the control actions listed in table 2.3, other overlapping decisions will be taken by the system in all indoor hazards. The system will always be responsible to:

- Identify the indoor hazard type, location, and cause.
- Sound the alarm and alert the inhabitants that are close to danger.
- Call the emergency services and responsible authorities: police, firefighters, technicians, doctors, etc., and provide them with all the necessary information in real-time.
- Ease the evacuation process for all the inhabitants and follow them in real-time.

2.8. Conclusion

The proposed smart platform is innovative since it combines major indoor hazards in one framework. This framework can alert users in real-time and identify the location of hazards, their causes, and provide instructions. BIM is an added value for the system because it provides a high capacity to (i) visualize hazard location, propagation, and causes, (ii) identify the occupant's situation and, (iii) take mandatory actions to limit the hazard. The system allows users to interact with the platform via cell phones: whenever users detect abnormal or suspicious events. They can share and upload their suggestions concerning the event. Historical data are used to construct AI algorithms, which are then used with real-time data for the detection of anomalies, and the determination of the best actions to make to cope with these anomalies. Two indoor hazards have been selected to validate the described system; fire hazards and Health hazards (COVID-19). Chapter 3 will present the fire system functionality, while chapter 4 will present the COVID-19 system functionality based on BIM and digital technologies integration.

Chapter 3: A BIM-based Smart System for Fire Evacuation

3.1. Introduction

This chapter proposes a system for a comprehensive fire evacuation system. The fire evacuation system is a sub-system of the indoor hazard management system presented in chapter 2. According to Brushlinsky et al. (2017), fire in buildings causes 44,300 deaths per year (Brushlinsky et al., 2017). In addition to standards and regulations about building fire safety, significant work was conducted to improve occupants' evacuation safety during fire events. The National Fire Data Center (2017) reported that in the United States, between 2013-2015, around 20% of fire fatalities in residential buildings were caused by egress problems, and 17% were caused by escape difficulties (National Fire Data Center, 2017). Scholars attributed fatalities during fire evacuation to poor sense of escape, obstacles, and exceeding the required time to escape (M.-Y. Cheng et al., 2016; N. Li et al., 2014; Lurz et al., 2017). Research on improving occupants' safety during fire evacuation focused on (i) use of BIM in the fire evacuation management, (ii) development of early fire detection systems, and (iii) use of the Fire Dynamic Simulation (FDS) and Agent-based Simulation (ABS) to optimize the evacuation routes.

Particularly in European Union (EU), each day 5000 fire incidents occur, and 70,000 fire-related injuries required hospitalization yearly. Moreover, the economic losses due to fire incidents in Europe countries are estimated about 1% of GDP. Therefore, the Fire Safe Europe called the EU to work on a fire safety strategy for buildings, since until now there is no comprehensive approach to fire safety.

This chapter will cover the following sections: section 2 includes a literature review concerning fire evacuation management. Section 3 presents the materials and methods used for the system. Finally, the last section illustrates an application to research building to validating the smart fire evacuation system proposed in this study.

3.2. Literature Review

Several researchers proposed different models and ideas to achieve a resilient evacuation system. This passage gives a brief illustration of the previous works achieved regarding smart evacuation, and its following parameters: (1) space management, (2) early detection, (3) evacuation management, (4) simulation, and (5) BIM for fire evacuation management.

3.2.1. Space Management

Since building geometry and space distribution play a significant role in fire propagation and occupants' evacuation, they should be adequately considered in buildings' fire management (Onyenobi et al., 2006). Richardson (2019) demonstrated the effect of geometry on evacuation time. The author proved that whenever occupants start to be familiar with geometry, they head toward the exits faster and smoother than non-familiar habitants (Richardson, 2019); this proves the importance of space management during the evacuation process.

3.2.2. Early Detection

Research on early fire detection focused on using the IoT and AI to improve the occupants' evacuation and the buildings' safety. IoT was used to monitor indoor temperature, smoke, and CO (Mehra & Tanmay, 2017; Singh et al., 2017). Mehra & Tanmay (2017) suggested a hazard detection system based on an Arduino microcontroller capable of detecting and alert the tenants and the concerned authorities. Singh et al. (2017) designed a fire detection system based on Arduino UNO capable of projecting a live video feed on the fire location and where it was first detected. The system also was equipped with a GSM module to alert via messages all the concerned parties.

Some scholars used AI to identify the fire source (Wu et al., 2021) (S. H. Wang et al., 2015). Hsu et al. (2017) suggested a fire monitoring system based on IoT and a feed-forward neural network approach (Y. L. Hsu et al., 2017). Despite the success of the system in early fire detection, it suffered from a high-power consumption demand and a large data processing reducing the life span for each node sensor.

IoT was also used to shut down critical equipment such as power supply and turning on sprinklers (Al Shereiqli & Sohail, 2020; Sowah et al., 2017). Al Shereiqli & Sohail (2020) proposed a system that uses an IoT wireless network controlled by Arduino to monitor and detect any unusual behavior in the building. The systems monitor the building and store the data for future investigation. In case of fire, the system sounds the alarm, turns on the sprinklers, and cuts the main power to restrain the fire. Sowah et al. (2017) present a similar system composed of a wireless sensor fire detection network with an original idea of a Web-based notification system.

3.2.3. Evacuation Management

IoT sensors were widely used to determine the indoor occupants' localization (Atila et al., 2018) and evacuation path for the habitants (T. Y. Wang et al., 2011; Y. Xu et al., 2012). Xu et al. (2012) algorithm find the shortest distance between occupants and exit doors. Once the system detects a fire, it controls the lighting system to guide tenants to exits. Wang et al. (2011) used the same algorithm with an IoT system; however, they improved their prototype by adding coefficients depending on the FDS parameters of their model to have a real estimation of the egress time. Despite the accuracy of both systems, both studies used Dijkstra's algorithm that considers only the shortest path and not the safest. Atila et al. (2018) developed a smart fire evacuation system based on a 3D spatial model using RFID technology for occupant tracking. This system can provide the evacuation path using vocal and visual instructions to each person.

Khan et al. (2018) used IoT technology by implementing a wireless sensor that includes smoke, heat, temperature, and CO₂ controlled by the A* algorithm. The system computes the shortest and safest evacuation and notifies each habitant. Additionally, the system provides the second-best evacuation path if the first one starts to be congested (Khan et al., 2018). Zualkernan et al. (2019) presented a system that uses IoT to track fire and occupant's location. The system tracks the danger degree via sensors, and for more resiliency, researchers implemented message queuing telemetry transport (MQTT) to provide line maps for the occupants (Zualkernan et al.,

2019). However, the system depends on Bluetooth low energy, meaning that all the habitants need to have Bluetooth on their smartphones when the incident occurs. Lujak et al. (2017) used IoT for real-time evacuation guidance in large smart buildings. The system depends on smart sensors and occupant's smartphones' location to recommend the optimum evacuation routes (Lujak et al., 2017). This system was robust since it includes a network of smart building agents that each one is responsible for guiding occupants and updates the evacuation instructions in case the occupant did not proceed with the recommended path at first. Nevertheless, the system only uses vocal instruction guidance and does not have 3D visualization.

Several years after the IoT immerge, AI was adopted in the evacuation field. Wu et al. (2021) proposed an AI model that can forecast fire and quickly identify the critical temperature area for a safe and quick evacuation in case of emergency. The system proved successful and achieved a real-time fire prediction of the spatial-temporal temperature distribution along the tunnel (Wu et al., 2021). The system was developed using transpose convolutional neural networking (TCNN). However, the system needs a huge amount of memory and a database to start predicting. Li et al. (2019) used a deep learning algorithm to simulate and evacuate the large crowded area during emergencies. The proposed model combines a deep learning method with social force model simulation (X. Li et al., 2019). The system detects the pedestrian coordinates and provides them with instructions toward the evacuation exit that is safe and not crowded. However, when the area is very crowded, the region-based convolutional neural network (R-CNN) selected suffered from low accuracy.

3.2.4. Simulations

Fire detection and evacuation modeling to determine the egress time are crucially related to FDS data. The FDS tool was used to visualize the fire growth and simulate the substances spread for a time interval. FDS has aided in accomplishing various fire simulation studies in diverse construction projects such as tunnels, bridges, and buildings (C. H. Cheng et al., 2021; Choi et al., 2012; Shen et al., 2008; G. Zhao et al., 2017). Many computers software are available for FDS. However, PyroSim is the leading software used for simulating FDS models (Rajendram et al., 2015). Jevtic (2016) (Jevtić, 2016) highlighted the FDS potential in (1) planning for fire detectors location; (2) illustrating the fire spreading; (3) predicting the fire; and (4) determining the evacuation routes. The ability of PyroSim to draw slices in the building provides a strong idea of how the fire consequences (CO₂, Temperature, visibility, smoke density) are progressing during the time. Moreover, PyroSim can study the effect of windows and doors opening on the fire (H. Zhang, 2020).

However, an effective evacuation plan should be based on building knowledge, fire growth, and evacuation management. Pathfinder software is an innovative movement simulation widely used in ABS (Thunderhead, 2019). Many researchers presented a numerical fire and evacuation simulation based on PyroSim and Pathfinder for buildings (Long et al., 2017; M. Xu & Peng, 2020). They showed that coupling FDS and ABS provides a reasonable estimation of the evacuation time (Q. Sun, 2018; Q. Sun & Turkan, 2020).

3.2.5. BIM for Fire Evacuation Management

BIM stepped forward to extend the technology boundaries and provide great potential in the evacuation process domain. BIM turns up a powerful tool for risk management (Wehbe & Shahrour, 2021). Therefore, many studies have worked on using BIM for fire safety management. Shiau et al. (2013) proposed a BIM web-based fire management system to detect fire events and collect information about the occupants (Shiau et al., 2013). This system enables firefighters to access online information about the fire conditions and existing fire frightening equipment. Wang et al. (2014) established a BIM-based virtual environment to improve building emergency management. They focused on two issues: real-time two-way information flow and occupants' evacuation (B. Wang et al., 2014). The implementation of this system suffered from weakness in data transmission and indoor localization. Later, Cheng et al. (2017) proposed an intelligent system for indoor fire prediction and disaster relief. The system included BIM and Bluetooth sensors to collect environmental data and determine the best evacuation route (M. Y. Cheng et al., 2017). A mobile application was integrated to help evacuees and firefighters during fire tragedies. The framework of this system is illustrated in figure 3.1.

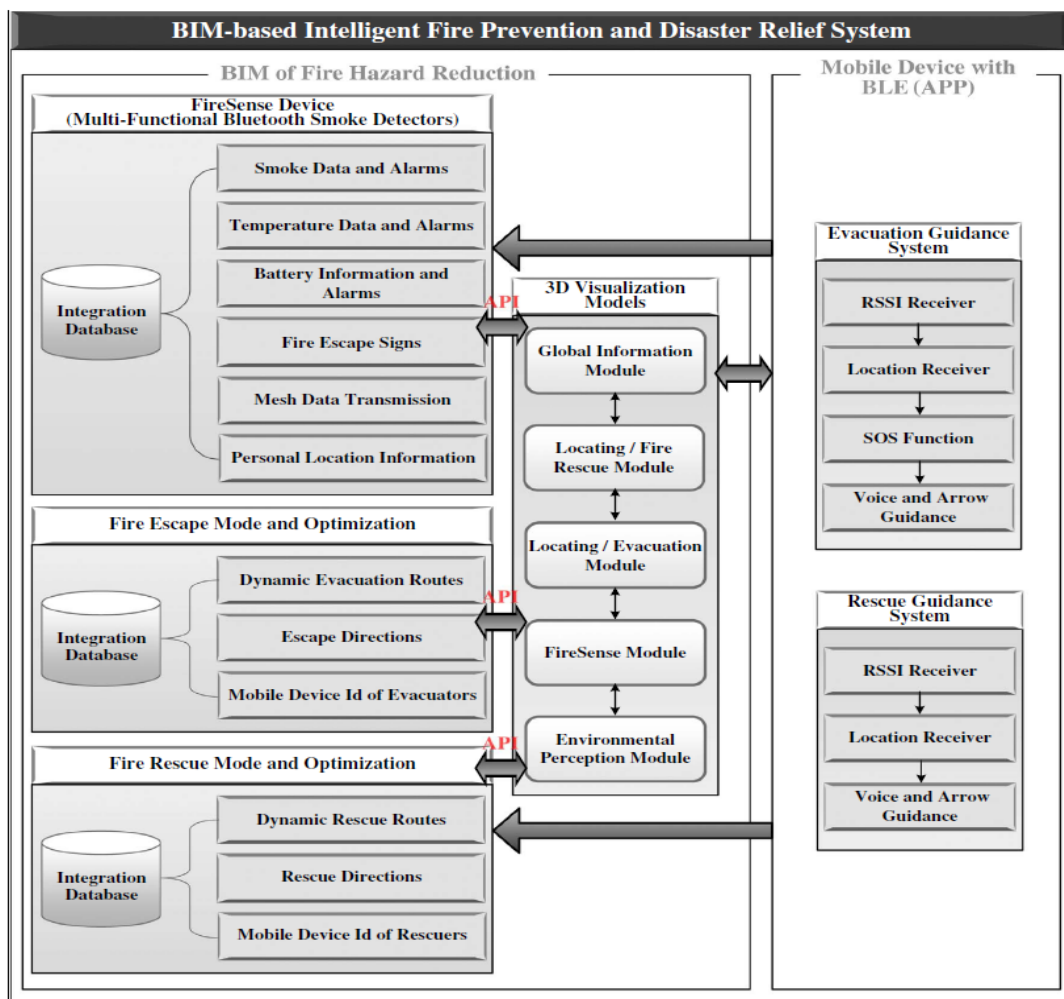

Figure 3.1: Framework of BIM fire prediction and disaster relief system (M. Y. Cheng et al., 2017)

Recently, Fu & Lui (2020) proposed a BIM-based approach to automatically determine the directions of building exit signs automatically by generating real-time the shortest route (Fu & Liu, 2020). Ma & Wu (2020) considered the behavior decisions of users in fire emergency management. They proposed a BIM-based platform model, which is connected to numerous sensors networks and video surveillance. This platform could (i) avoid false alarms; (ii) determine whether the fire is manageable or not; (iii) locate the position of the diverse behavior's crowds; and (iv) identify the optimal path for different behavior decision-making (Ma & Wu, 2020). These studies were limited to data transferred from sensors without considering the FDS and ABS to check the available safe egress time (ASET). A BIM-based simulation framework was conducted using FDS and ABS to simulate fire spread and evacuation performance for several building layout scenarios (Q. Sun, 2018; Q. Sun & Turkan, 2020). In addition, Mirahadi et al. (2019) developed a BIM-based simulation framework by combining FDS and ABS. The framework of EvacuSafe is presented in figure 3.2.

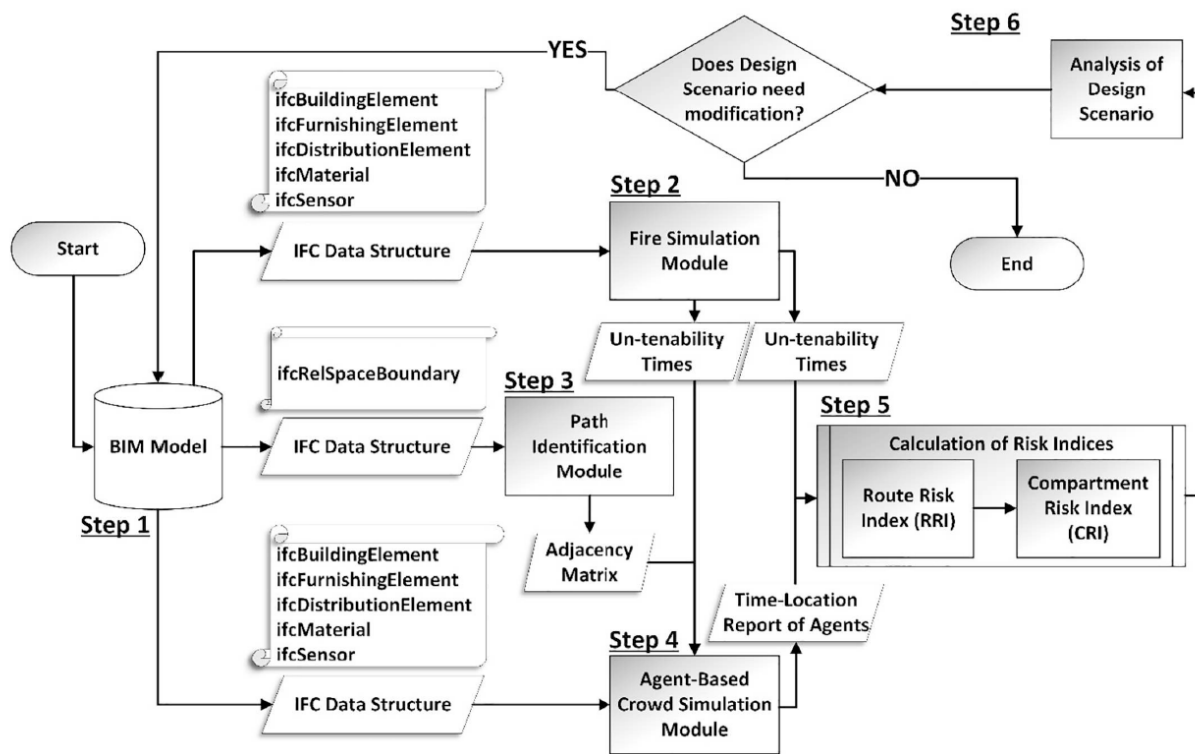

Figure 3.2: Framework of EvacuSafe platform (Mirahadi et al., 2019)

Previous research did not develop a comprehensive solution for occupants' evacuation during buildings fires. To fill this gap, this chapter presents a smart system for fire evacuation management. This system is inspired by the smart building concept. It uses the BIM model for the spatial modeling of the building and the fire evacuation system. The system uses the basic layers of the smart systems, such as the monitoring layer, data processing and analysis layer, control layer, and smart services layer. The system is coupled with FDS and ABS to check the ASET.

3.3. Materials and Methods

This research aims at developing a smart fire evacuation system, which is inspired by the smart buildings concept. It aims to create a smart system to ensure early detection of fire in buildings, interact with users, identify the optimal evacuation paths, and share information with occupants, building managers, and emergency services. BIM is used for (i) building and fire system modeling, (ii) real-time visualization of events and parameters related to the fire evacuation, and (iii) identification of the optimal evacuation paths. The latter is based on software for fire evacuation paths and ML. In addition, IoT and mobile applications are used for data collection and control of critical equipment. The following sections present the architecture of this system and its main layers.

3.3.1. Smart evacuation system framework

The smart evacuation system is composed of five layers (Figure 3.3): (a) Physical layer, (b) monitoring layer, (c) smart platform, (d) control and alert layer, and (e) smart services. The following sections present the layers of this system. The layers are more detailed and concentrated to fire hazard in this section comparing to the general architecture in chapter 2.

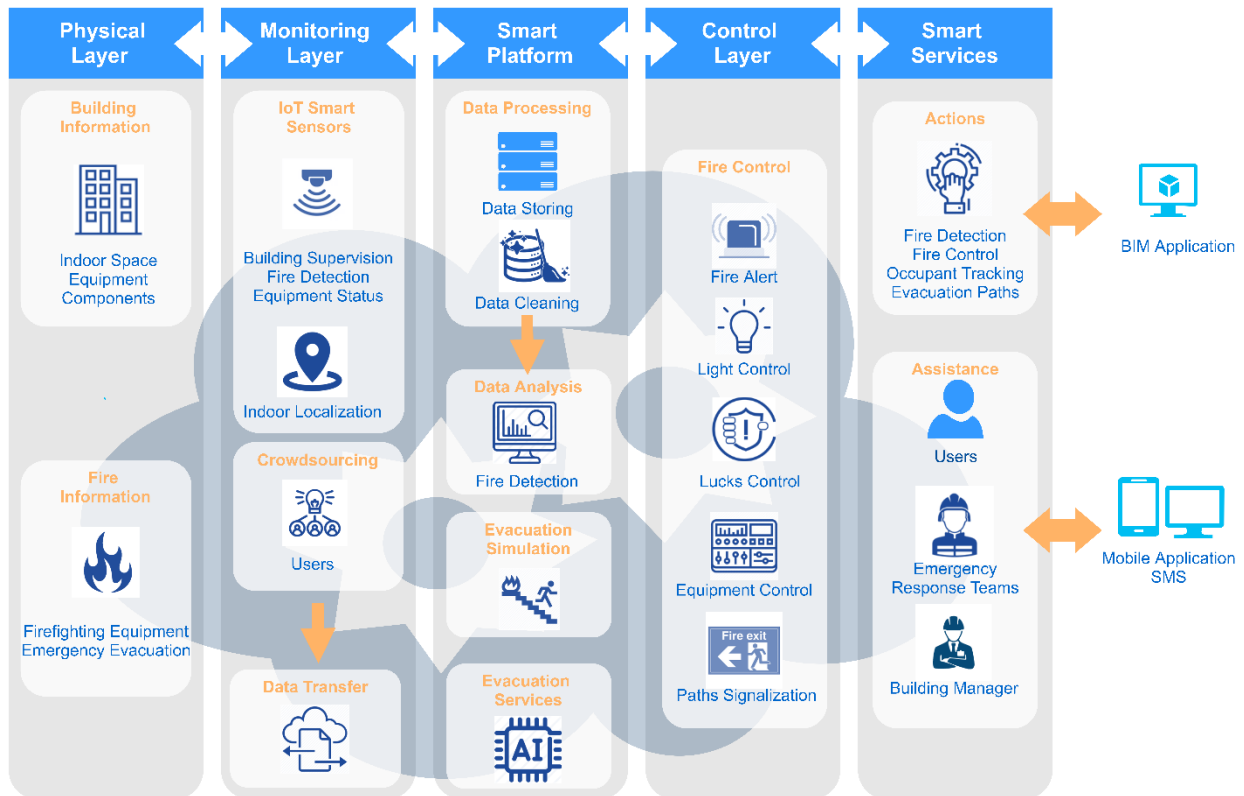

Figure 3.3: Architecture of the smart evacuation system

a. Physical Layer

Fire propagation and people evacuation are affected by building geometry and space distribution (Onyenobi et al., 2006). Consequently, the fire evacuation system should include data concerning the spatial organization of the building, materials used in the construction, building equipment, and the fire components. The building geometry information is required

for indoor navigation by considering the obstacles (walls, columns, furniture) and doors. The building materials characteristics, including their thermal properties, are necessary for simulating fire scenarios, understanding spaces' function, and equipment location help to recognize the fire source and severity. Moreover, data related to the firefighting equipment such as fire detectors, extinguishers, alarms, and emergency evacuation should be integrated into the model for optimal evacuation management. Finally, data concerning the physical layer are integrated into the BIM model and shared with users, the management team, and emergency services.

b. Monitoring Layer

Smart sensors are used for building supervision and fire evacuation management. Detectors are used to monitor flame, heat, smoke, and other combustion products. The most used sensors to deal with fire hazards are temperature, smoke, CO, and CO₂ (figure 3.4). Sensors collect and transmit data to the system in real-time. They are placed in critical locations to collect and share data with the smart platform.

Real-time humans' location in the building constitutes a vital issue in evacuation management, as well as door status and video surveillance (figure 3.4). Therefore, UWB is used for comprehensive fire risk management (Rafiee et al., 2013; Sato, 2011). As mentioned in chapter 2, data transfer is accomplished via wired or wireless technologies. Wireless networks transmit collected data to the server, where data are processed and analyzed. Routers are installed inside the buildings to ensure good communication coverage. Each router operates as a checkpoint to take over the other router task and transfer it to the next one.

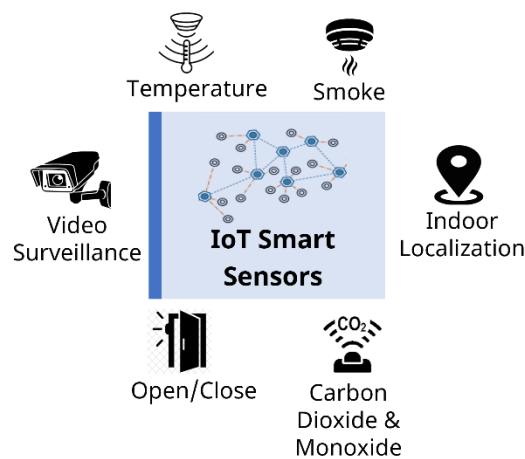

Figure 3.4: IoT smart sensors for fire detection

Users effectively participate in the fire evacuation management by using mobile applications to share real-time information about the fire event.

c. Smart Platform

This layer comprises both data processing and analysis.

- **Data Processing:** Data processing includes data cleaning and storage, as described in chapter 2. Data cleaning aims to detect inexact records that can contribute to a wrong action. For this reason, data collected from sensors and stakeholders should be cleaned to avoid bad decisions. Data storage concerns the integration of collected data in one database. Furthermore, the platform offers the ability to access the storage to search for a particular event. The platform is accompanied by a XQuery that links the database with the Web world. XQuery provides the ability to access the database by granting the possibility to store, extract, and manipulate.
- **Data Analysis:** Data analysis aims to transform the collected data into operational data that improves fire evacuation operations. The BIM environment offers the capacity to set up norms, minor and upper limits for sensors; whenever these boundaries are reached, BIM could identify the fire source and type. These norms concern temperature, CO₂, and smoke.
- **Evacuation Simulation:** FDS generates several fire scenarios based on different fire locations, types, and severity. The fire reaction should be created, and smoke devices should be placed at critical points. Over the FDS, the fire extension and the environmental data such as temperature, smoke, and air intoxication are estimated. According to the tenability boundaries, the ASET is computed for proposed scenarios, including visibility, temperature, smoke, and air intoxication (Arthur & Passini, 1992). ABS should be conducted for fire scenarios to determine the appropriate evacuation paths. FDS should be integrated with ABS to investigate the impact of fire on occupants' movement and evacuation paths. Steering mode is used to deviate occupants from risky paths that could include obstacles, high smoke density, low visibility, and high CO concentration. Accordingly, the model selects the evacuation path depending on (1) FDS parameters, (2) queue time to evacuation exits, (3) estimated time from each door to exit, and (4) the total travel distance to stay safe (Gerges et al., 2021).
- **Evacuation services:** AI is used to determine the optimal solution by analyzing historical and real-time data. AI proved to be effective in resilient fire hazard management (Jožef et al., 2011). The system is based on an ML algorithm implemented in Dynamo. When BIM detects a fire source through sensors and identifies its cause and location, the system automatically generates the optimal evacuation solution by analyzing the historical data. The advantage of AI lies in self-learning, reasoning, and adaptation of the best fire evacuation scenario from the previous scenarios generated and incorporated in the database.

d. Control and alert Layer

Based on the IoT smart sensors and data analysis, the system provides fire alerts. Detection and alarm services help to sound an alarm or other signals to alert the fire emergency service. In addition, it conducts actions for fire defenses like closing doors, turning off equipment, automatic fire suppression, or smoke control systems. In other words, the system takes adequate measures concerning lucks, light, and critical equipment control to limit the fire spread and related damages. It also provides light and voice path signalization. The proposed

system could be directly connected to the existing fire security system, including sensors and alarms. Dynamo tool can connect existing systems with the proposed one to provide additional services for users.

e. Smart Services

The system offers via BIM valuables services such as (1) detect the fire location, cause, and type, (2) track the occupants and define their locations, (3) display the environmental data, (4) sound the alert, (5) identify the optimal evacuation paths, (6) take decisions to limit the fire spread such as shutting off equipment, and (7) sound alerts.

3.3.2. Fire evacuation system operation mechanism

The building's spatial layout and information are vital for a fire evacuation system. The minimum Level of Development (LOD) provided for the BIM Model is LOD 300, which presents the building components' geometry, material properties, and equipment (Grytting et al., 2017; Q. Sun & Turkan, 2020).

As a first step, the data will be collected through sensors to the system. This is due to an Arduino script that can generate a CSV file through a pan stamp. The CSV file is linked in real-time to Revit through Dynamo coding.

The smart sensors will be integrated into the BIM model. Data will be stored in the database connected to Dynamo, so data could be visualized and analyzed in real-time using the BIM model. Dynamo is a visual programming tool that spreads the Revit power by providing access to the Revit API (J. Li et al., 2019). The system is based on dynamo scripts to generate new tools for BIM environment. As an example, through python coding in dynamo, BIM will be able to (i) visualize the environmental data, (ii) provide messages for users, (iii) create evacuation paths, and many others. Figure 3.5 illustrates a part of the dynamo script for this study related to heat map generation for sensors data.

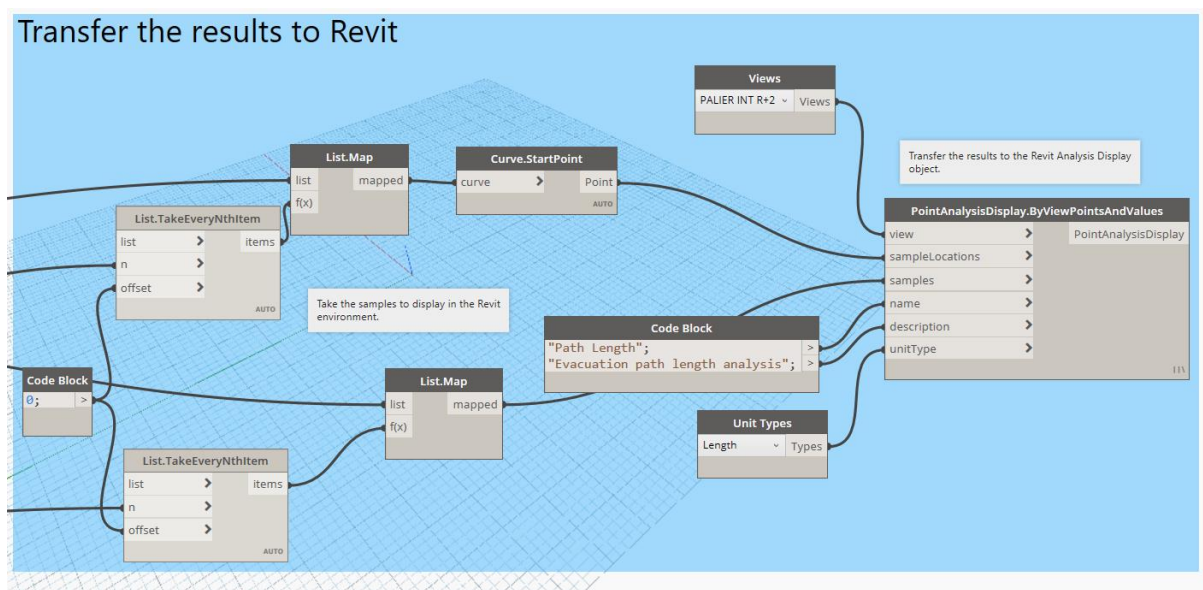

Figure 3.5: Dynamo script sample

Through dynamo the system will be able to identify early the fire based on sensors data and AI algorithm in dynamo considering real-time environmental and historical data. After the data analysis, the system will identify the fire location, category, and severity and prevent false detection. Whenever the system scans and extrapolates the fire characteristics, evacuation paths will be generated using the fire simulation and evacuation Modules' history.

For the selection of the optimal evacuation paths, the system should be integrating a huge data base for self-learning. The database includes information regarding the two simulations FDS and ABS. They should be integrated into Dynamo which has a ML package for self-learning and is used to select the optimal evacuation path (figure 3.6).

The FDS simulations are generated via Pyrosim software. The FDS data are exported to Pathfinder to simulate the evacuation paths. According to Thornton et al. (2014), Pathfinder is considered a reliable ABS tool to simulate evacuation. Pathfinder takes into consideration the building complexity, geometry, obstacles, and human parameters (Thornton et al., 2014). However, it does not simulate fire, smoke density, visibility, and temperature during evacuation. The program allows users to take FDS results and plug these data during simulation, allowing designers to examine the influence of each parameter on occupants' movement and evacuation path.

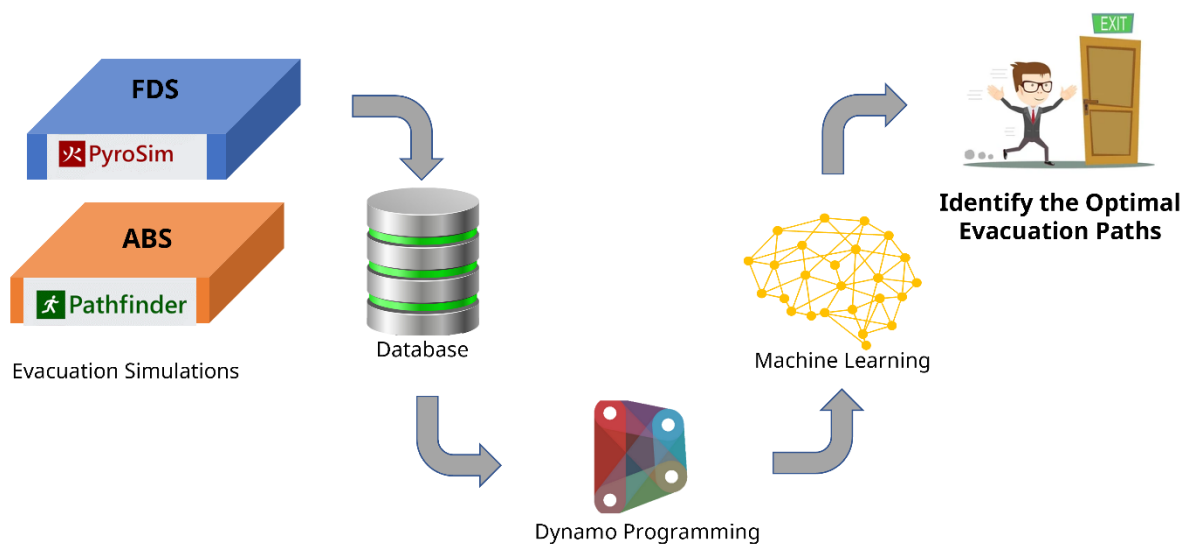

Figure 3.6: Optimal evacuation path identification

a. Fire Dynamic Simulation (FDS)

Several fire sources, locations, and intensities should be generated in Pyrosim software to create an FDS database. The FDS is used to compute the ASET for each emergency exit based on tenability boundaries. The tenability boundaries, including visibility, temperature, CO concentration, and smoke density, should be checked to validate the scenarios, as shown in table 3.1.

- **Visibility**

Visibility is considered a significant cause of human injuries and fatalities during buildings fires. In the initial fire phase, smoke is released due to blazing. Smoke comprises a high quantity of toxic gases and small particles, which could smother or poison the stuck personnel. Particles in the smoke decrease humans' visibility that leads to difficulty in escaping from the building. Smoke will become thicker with time and the fire growth. Therefore, the visibility limit should be considered because the evacuation route could no longer be visible. The critical smoke height (H_c) is calculated based on equation 3.1 (M. Xu & Peng, 2020).

$$H_c = H_p + 0.1 H_b \quad (3.1)$$

H_p is the typical height of individual eyes taken equal to 0.8 of human height, and H_b corresponds to the floor height.

FRI research institute states that the relation between visibility and smoke density could be computed using equation 3.2 (Klote et al., 2012):

$$S = \frac{K}{e} \quad (3.2)$$

S is the visibility in meter, K is the proportionality constant that depends on the illumination of the evacuation sign, and e is the extinction coefficient (1/m).

To start being emotionally affected by smoke, a value of $e = 0.1(1/m)$ is enough, and to start showing strong emotional fluctuation, a range of $e [0.35-0.55]$ is considered (Arthur & Passini, 1992). However, it should be noted that during fire hazards, occupants are affected psychologically by fear. Therefore, a value of $e = 0.15 (1/m)$ is considered as the maximum allowable density during evacuation. On the other hand, this value considers the tenants who are unfamiliar with the building architecture, which constitutes the worst-case scenario. For $e = 0.15$, the visibility limit S for the unfamiliar occupant is 13 m. For a familiar resident, e can be taken 0.5, which gives a visibility limit $S = 4$ (Yamada & Akizuki, 2016). Humans will have visibility and mobility difficulties when the smoke density exceeds 85% (Fridolf et al., 2013).

- **Temperature**

High temperatures can cause heatstroke, burns, and respiratory issues. The heat produced will start to impact the human body once (1) its upper layer radiation strength exceeds 180 °C and (2) the smoke layer of direct contact with the human body exceeds 60 °C (Zhong et al., 2008).

- **Gas intoxication**

Gases that affect the occupants are CO, CO₂, and hydrogen cyanide (HCN). CO is considered the primary toxic gas during a fire (Purser & McAllister, 2016). The CO toxicity concentration harms humans when it exceeds 2500 ppm (R. Liu et al., 2017).

Table 3.1: Monitor system and specific control per indoor hazard

Tenability	Tenability boundaries
Smoke Density	> 85%

Visibility	13 m
Temperature	60 °C
Air intoxication: CO	2500 ppm

b. Agent-based Simulation (ABS)

Several scenarios should be generated in Pathfinder software to create a huge ABS database by changing the following parameters: occupants' number, densities, location, and characteristics. The ABS is used to identify the occupants' movement and evacuation paths, as well as the RSET which should be less than ASET for a safe evacuation.

Peacock et al. (2011) analyzed different buildings with various stories and geometry the occupants' movement while evacuating. An overall speed of 0.78 m/s was recommended (Peacock et al., 2011). Moreover, Pathfinder changes the speed dynamically in response to obstacles, geometry (flat terrain, stairs, ramp), and fire impact, making the simulation more realistic.

3.4. Application to a research building of Lille University

3.4.1. Presentation of the building

The smart evacuation system was applied to the 4th floor of the research building ESPRIT of Lille University, which hosts the Civil Engineering and Geo-Environment Laboratory (LGCgE). The total area of this space is equal to 1256 m². It includes offices, technical rooms, kitchen, and WCs. This space hosts about 50 users, including faculty members, Ph.D. students, and technical staff. Figure 3.7 shows the BIM model of ESPRIT building by providing a 3D section in the LGCgE laboratory, including the building geometry, compartments, and components. The BIM model provides data and information to the fire simulation module to (i) estimate the fire expansion configuration, (ii) identify the suitable egress routes for each partition, and (iii) assist as a basis for the agent simulation module.

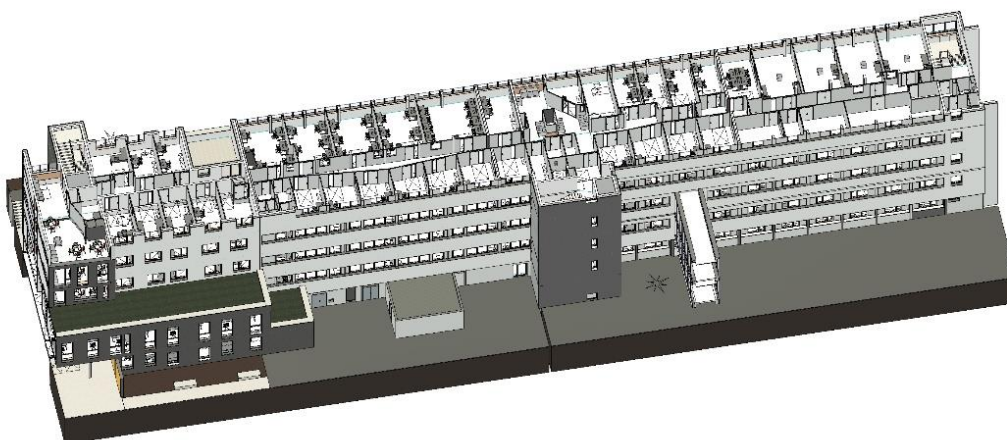

Figure 3.7: LGCgE BIM Model

Figure 3.8 illustrates the LGCgE main entrance with the fire equipment, emergency evacuation, and sensors. The fire equipment includes fire detectors, extinguishers, and alarms. In addition, the space is equipped with multi-sensors, including environmental sensors such as temperature, humidity, IAQ, and open/close sensors for windows and doors. Through these sensors, the system can monitor and interact in real-time during the fire.

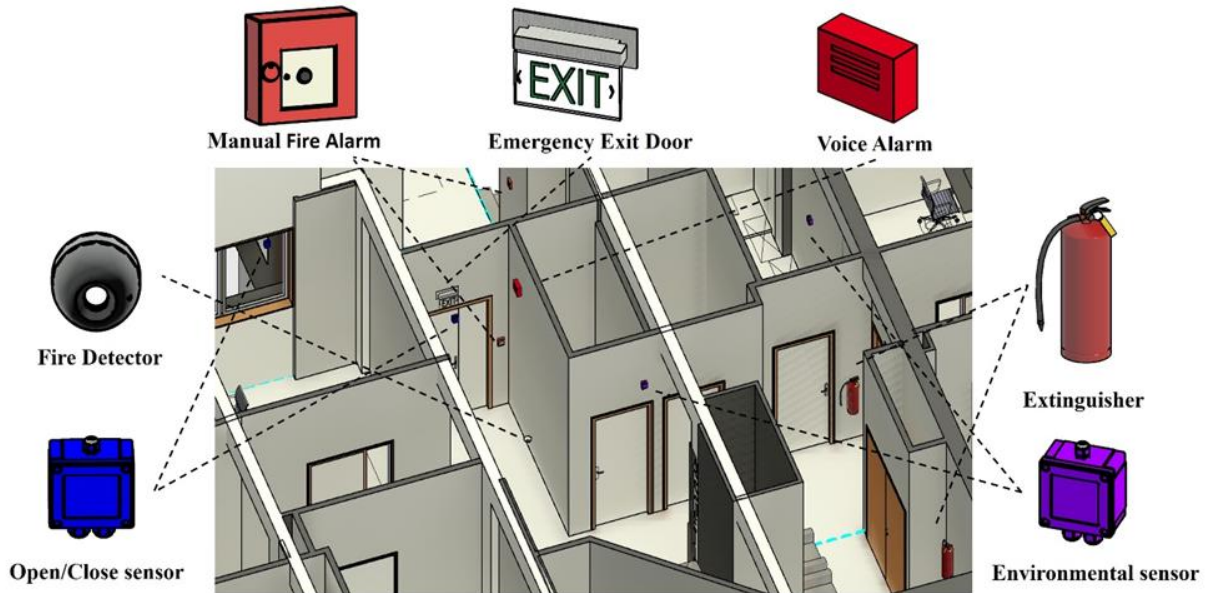

Figure 3.8: Fire information in the BIM model

3.4.2. Fire Simulation

Fire scenarios were simulated with two fire sources to highlight critical areas. Figure 3.9 shows the fire's location and the emergency exit doors. The first scenario corresponds to a fire event in the kitchen due to a gas burner, while the second is related to an electrical fault in an electrical room.

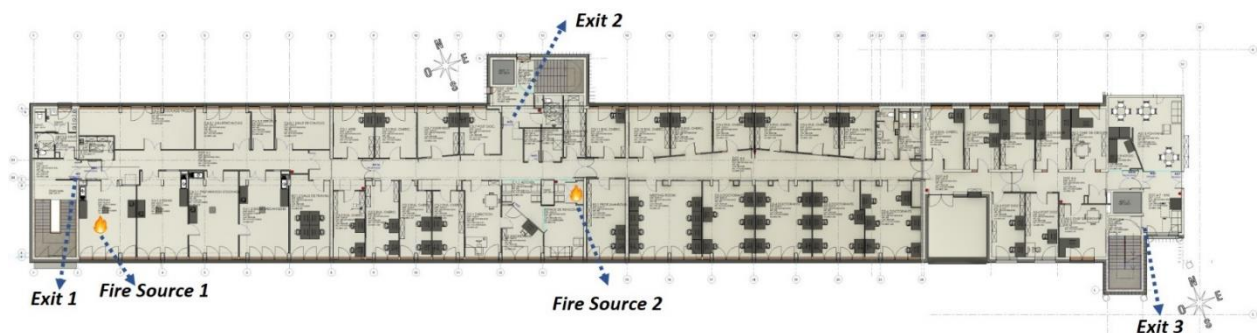

Figure 3.9: LGCgE plan view – fire simulations input

The reactions differed between the two scenarios since the fire sources are dissimilar. The fuel for the first scenario based on natural gas burning is a methane. For the second scenario caused by electrical fault, the fuels considered are polyethylene and nylon. Usually, electrical fault causes the insulation material to melt and burn due to overheating of the wires. The insulated

material used in wire is mostly composed of polyethylene and Nylon. Each fire scenario was modeled by itself, and the reaction input data were based on the Europeans guidelines and previous published work. The simulation time for both scenarios was set at 900 seconds.

The fire reaction is created by a burner surface with specific parameters. For both scenarios the heat of combustion per unit mass of the consumed oxygen at 25 degrees is approximately equal to 419.2 MJ/Kmol of O₂ or 13.1 MJ/kg of O₂. Methane flammability and explosion limits were also included. For the Methane, based on ISO10156, the lower flammability limit (LFL) and upper flammability limit (UFL) are 4.3 (% Vol) and 16.8 (% Vol), respectively (NSAI, 2017). The heat release rate per unit area (HRRPUA), known as the fire power, is originally calculated from experience simulation. Nonetheless, for natural gas fuels it is ranged from 86 kw/m² to 650 kw/m² (Hopkin et al., 2019). In our model we chose the upper HRRPUA limit of 650 kw/m² since it represents a higher safety factor while analyzing the evacuation path process and determining the egress time. In addition, the rate of heat energy transferred per surface unit area is also an essential parameter for fire reaction which is known as net heat flux (NHF). According to experimental investigations carried out for a pressure range from 0.3 Mpa to 0.6 Mpa, the NHF range is considered from 5 to 63 kw/m². A 63 kw/m² is selected to increase the safety level.

Electrical wires are insulated with a combination of polyethylene, PVC, Teflon, Nylon, and other substances. The HRRPUA for polyethylene, nylon and PVC are 1408 kw/m², 1313 kw/m², and 234 kw/m², respectively. Therefore, for the second scenario, a 1000 kw/m² of HRRPUA can be taken as an average value.

Measurement slices plan, and critical points should be in the model to measure the CO concentration, visibility, and temperature at the critical height based on equation 1. The average human height in this study is considered 1.7m; accordingly, H_p is equal to 1.36. H_b corresponds to a floor height of 3.3 m. Therefore, the critical height is equal to 1.69 m.

The CO concentration was under 2500 ppm for both scenarios; therefore, the CO data were not used for ASET computation. For the first scenario, the smoke density, visibility, and temperature variation during the fire simulation are illustrated in figure 3.10. Exit 1 is the most affected because it is closest to the fire source. The smoke reaches its limit at exit 1 within 27s (figure 3.10a), the visibility attains 13 m at 52 s (figure 3.10c), and the temperature reaches 60°C (figure 3.10b) at 91s. The smoke continues to grow and reaches exit 2 (265s), then exit 3 (337s) before starting by impacting the floor below after around 340 s. The occupants near exit 2 (203s) have visibility difficulty before exit 3 (546s). According to table 3.2, exit 1 is impassable after 27s (first ASET stage), exit 2 is blocked at 203s (second ASET stage), and exit 3 at 334s (third ASET stage).

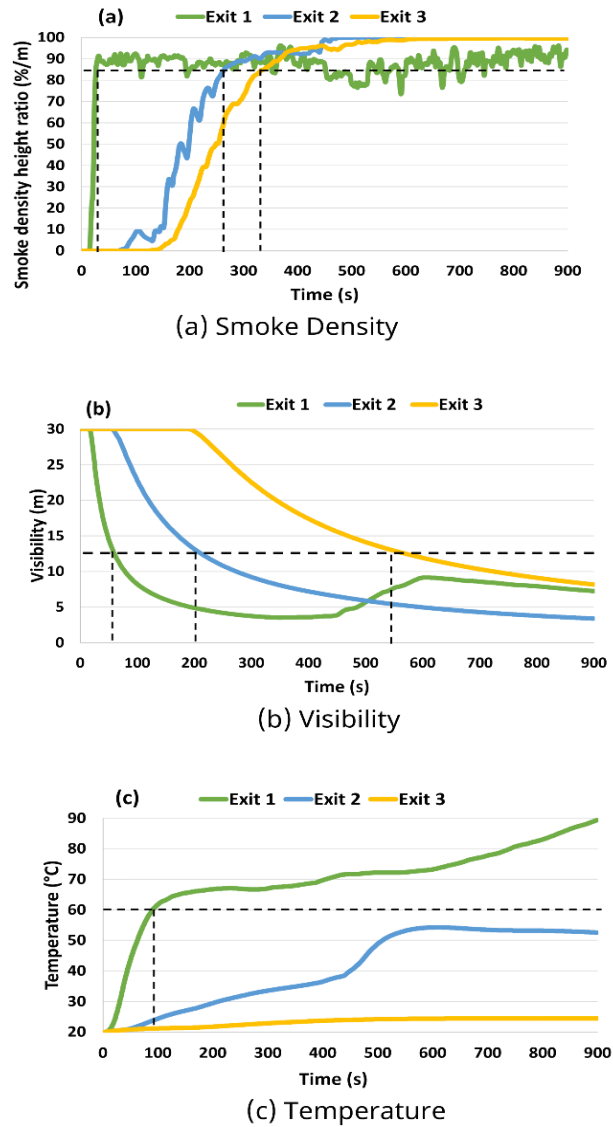

Figure 3.10: Tenability variation for the first scenario (Kitchen fire scenario)

Table 3.2: ASET computation for door exits in the first scenario (Kitchen fire scenario)

Limits	Exit 1	Exit 2	Exit 3
Smoke Density	27s	265s	337s
Visibility	58s	203s	546s
Temperature	91s	NA	NA
ASET	27s	203s	337s

The electrical fault is close to exit 2. Thus, the occupants' visibility is first impacted at this exit (83s) (figure 3.11b). The smoke density boundary reaches exit 3 (254s) before exit 1 (441s) (figure 3.11a). In this scenario, the maximum temperature (50 °C) occurs at exit 2 (figure

3.11c). Based on Table 3.3, exits are blocked as follows: exit 2 at 83s (first ASET stage), exit 3 at 254s (second ASET stage), and exit 1 at 441s (third ASET stage).

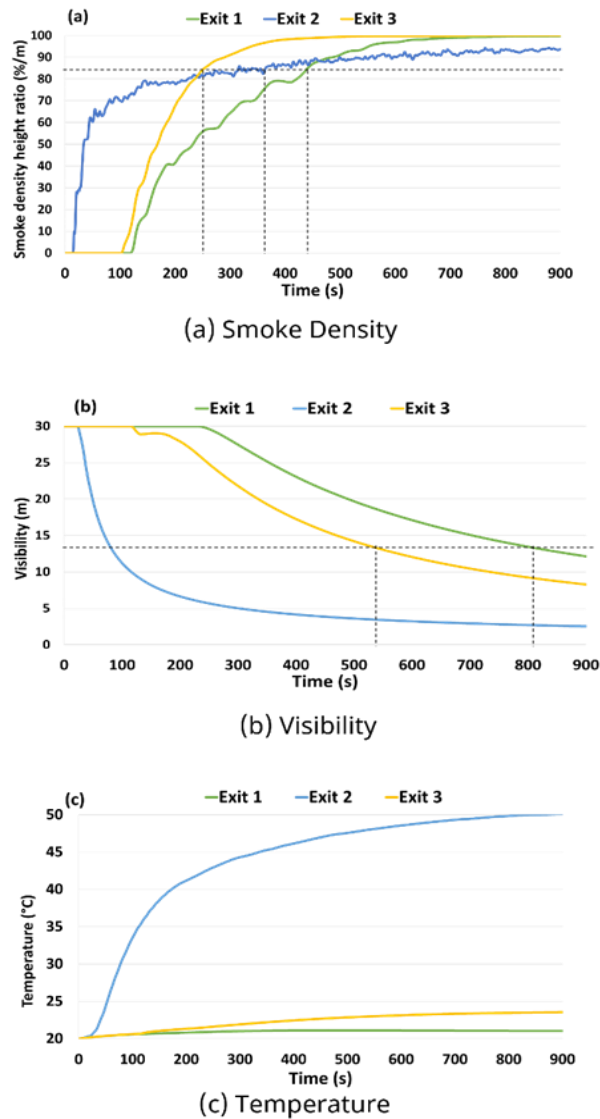

Figure 3.11: The tenability variations with time for the second scenario (Electrical fire scenario)

Table 3.3: ASET computation for door exits in the second scenario (Electrical fire scenario)

Limits	Exit 1	Exit 2	Exit 3
Smoke Density	441s	316s	254s
Visibility	829s	83s	549s
Temperature	NA	NA	NA
ASET	441s	83s	254s

3.4.3. Agent-based Evacuation Simulation (ABS)

According to Khandoker et al. (2018), the generated heat, smoke density, and toxicity concentration constitute the main features that affect the occupants' movement (Khandoker et al., 2018). Therefore, the FDS simulations are integrated into Pathfinder to consider humans' movement during the fire. 50 occupants are distributed randomly in the laboratory, where at least one occupant is placed in each room. The required safe egress time (RSET) was needed, and the exit door used by each occupant was computed. The simulations validation was conducted by checking that the RSET is less than the ASET for all occupants. Several evacuation simulations need to be done to achieve the optimum goal while using a pathfinder to derive the optimum set of instructions for each tenant considering the real-time location.

Figure 3.12 shows the difference in flow rates between the evacuation under normal conditions and fire circumstances for the kitchen fire scenario. It indicates that under normal situations, the flow rates on each exit are smooth compared to fire incidents. However, the latter fluctuates all along the evacuation process. Moreover, the total evacuation time in normal conditions is 54.5s compared to 251.5s during the fire. This important change in the evacuation time is due to visibility losses and smoke.

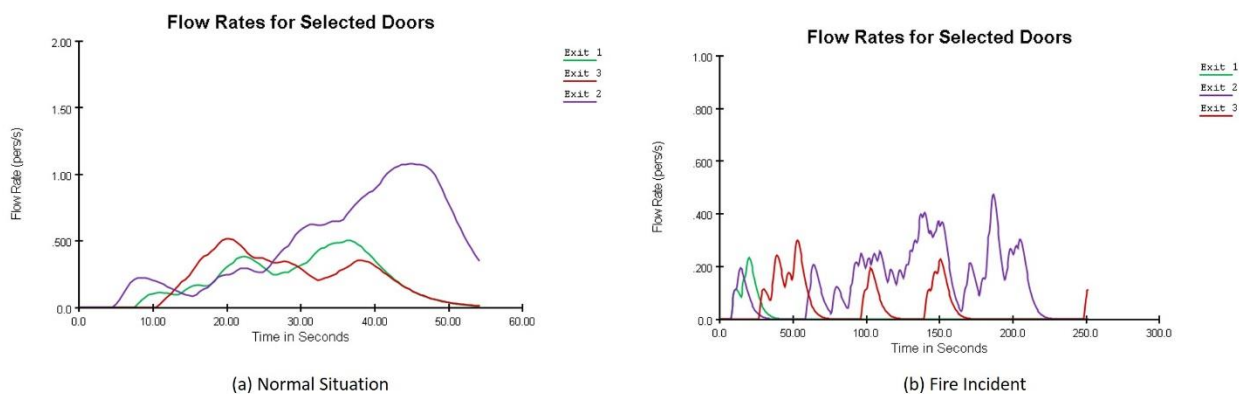

Figure 3.12: Impact of fire on the indoor occupants' flow rate (Kitchen fire scenario)

Figure 3.13 shows that only 3 occupants used exit 1 during the fire event, to be compared to 11 occupants in normal condition. This means that most occupants near exit 1 changed their direction to exit 2 because the fire location is very close to exit 1. This result indicates that the model guides occupants according to the safest path more than the quickest ones. It should be noted that occupants reached the exit doors in less time than the ASET derived from PyroSim.

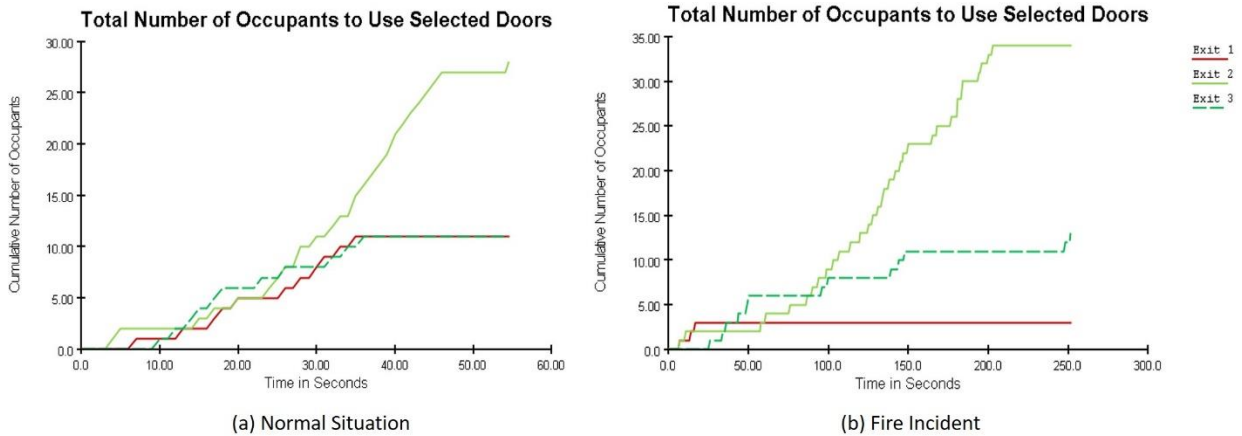

Figure 3.13: Impact of fire on occupants' exits (Kitchen fire scenario)

For the electrical fire scenario, the total time for evacuation under FDS conditions is equal to 209.5s. The flow rates illustrated in figure 3.14 indicate a significant change in the occupants' behavior. For example, 14 occupants out of 28 changed exit 2 to exit 1 or exit 3 under fire circumstances. Moreover, the model respects the 83 seconds ASET for exit 2, confirming that the model privileges the safest evacuation paths.

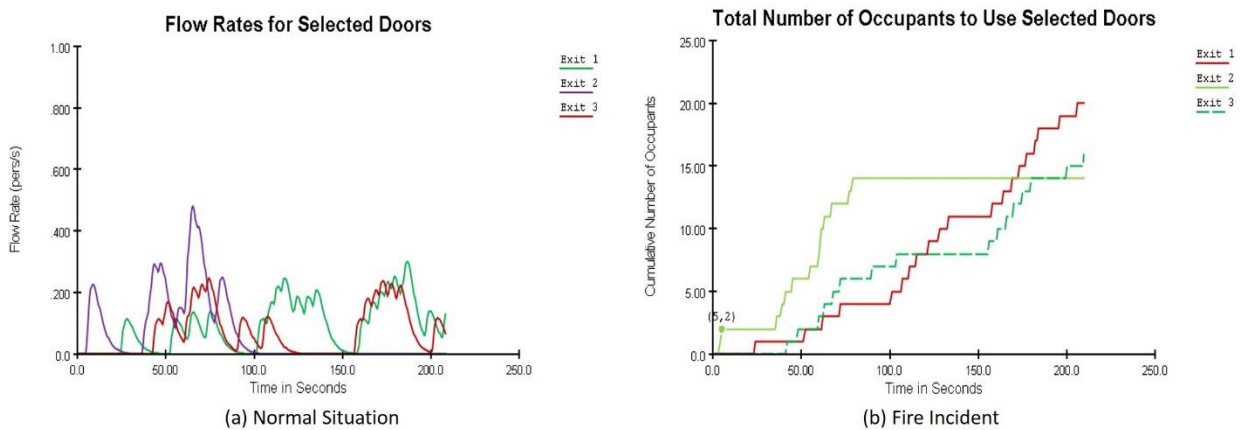
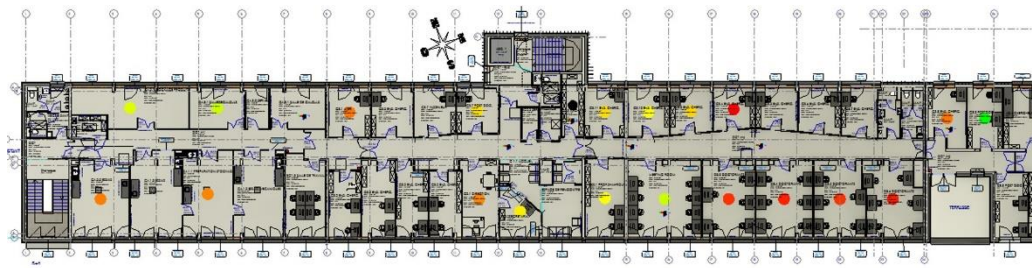

Figure 3.14: Impact of fire on the indoor occupants' flow rate (Electrical fire scenario)

3.4.4. Use of BIM for evacuation management

The BIM model provides real-time visualization of sensors data through the visual programming code conducted in dynamo. Sensors provide real-time data concerning temperature, humidity, and CO₂. Figure 15a illustrates an example of the visualization of temperature data. In total, 20 sensors were installed in rooms with high occupancy to track the temperature variation. A color range was used to present the temperature levels: green (lowest temperature) to red (highest temperature). As shown in the legend, the temperature varies between 18.8 °C and 21.8 °C. The highest temperatures are located in the Ph.D. students' offices, where the number of occupants is higher than in other rooms. For each room, the users can check the sensors' recorded data in the room properties (figure 15b). In addition, via dynamo script, the system can interpolate the sensors' values to generate a heat map for the entire floor in 2D and 3D view, as shown in figure 3.16.



(a) Temperature Data

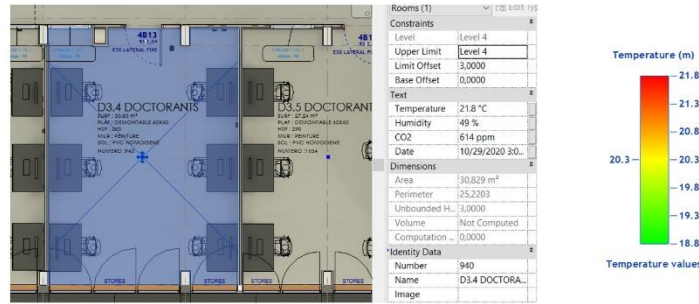

(b) Room Properties

Figure 3.15: Illustration of the temperature recorded values in the BIM Model

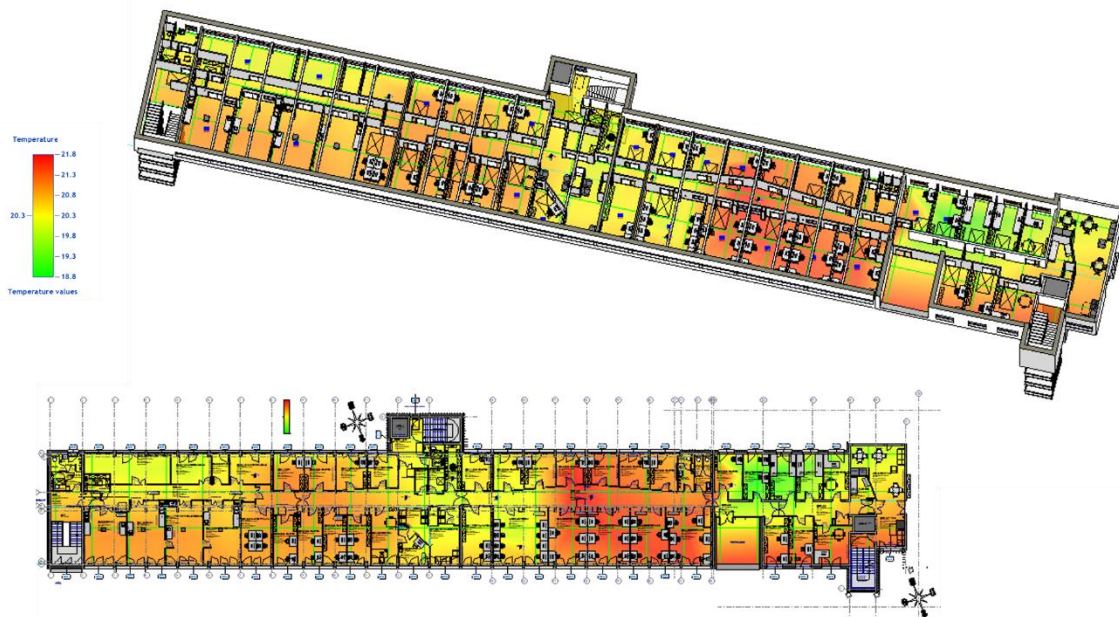

Figure 3.16: Heat map for temperature values generated by Dynamo

The results presented in the FDS and ABS are visualized and recorded in a BIM environment. The environmental data at several points will be exported to dynamo, which will be responsible for generating interpolations to provide heat map values for each environmental parameter during the simulation interval. For example, the temperature values recorded during the fire simulations are exported and visualized in the BIM Model. Figure 3.17 illustrates the temperature values, where the fire is located in the kitchen at 250s of the simulation time. Based

on the figure legend, the color range varies from blue presenting the lowest temperature (20°C) to red presenting the highest temperature value (420 °C). The red zone shows the fire location while surrounding high temperatures precise the fire severity and spread. The temperature at the fire source reaches 420 °C; it impacts the surrounding areas with a temperature higher than 100 °C. In rooms far from the fire source, the temperature remains less than 60 °C. The electrical fire reaches lower temperature values comparing to the kitchen scenario. The temperature at the fire source reaches 120 °C.

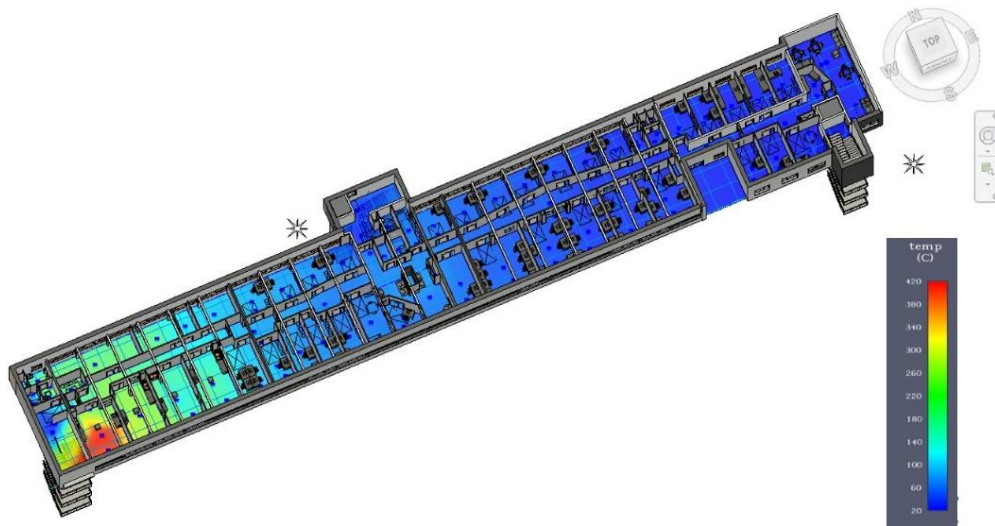

Figure 3.17: Temperature heat map (Kitchen fire scenario)

The system illustrates the parameter values in graph view. Figure 3.18 presents the CO variation for the kitchen room during a fire. It shows that the CO emission increases rapidly after the fire ignition, then remains constant.

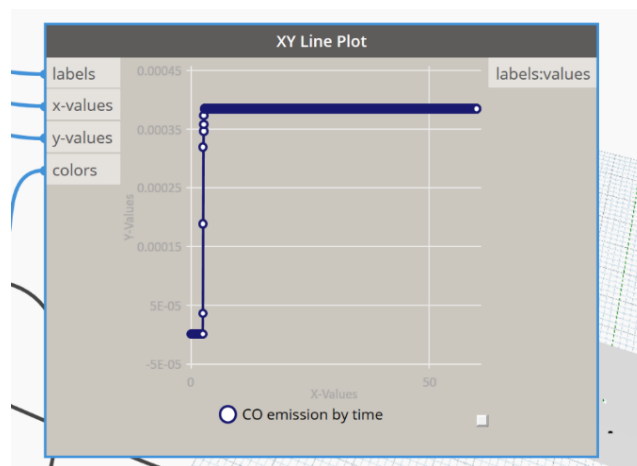

Figure 3.18: CO emission by time in kitchen room (Kitchen fire scenario)

The system offers the capacity to visualize fire and evacuation simulation outputs simultaneously in the BIM environment. It illustrates the optimal evacuation paths for occupants based on their locations and provides the necessary information such as the RSET, the distance needed, and the exit door. Figure 3.19 presents the evacuation paths for occupants from each room to the nearest exit in a normal situation. The legend color range gives the path

length already achieved from each room to reach the closest exit during evacuation. It was noticed that during a normal situation, the longest evacuation path is 34.4 m. In case of a fire, the system can change the occupants' directions according to the shortest and safest route (Figure 3.20); in other words, they will take a longest route, but it is safer than the shortest one. In addition, the system displays occupants' information and sends them notification messages (Figure 3.21).

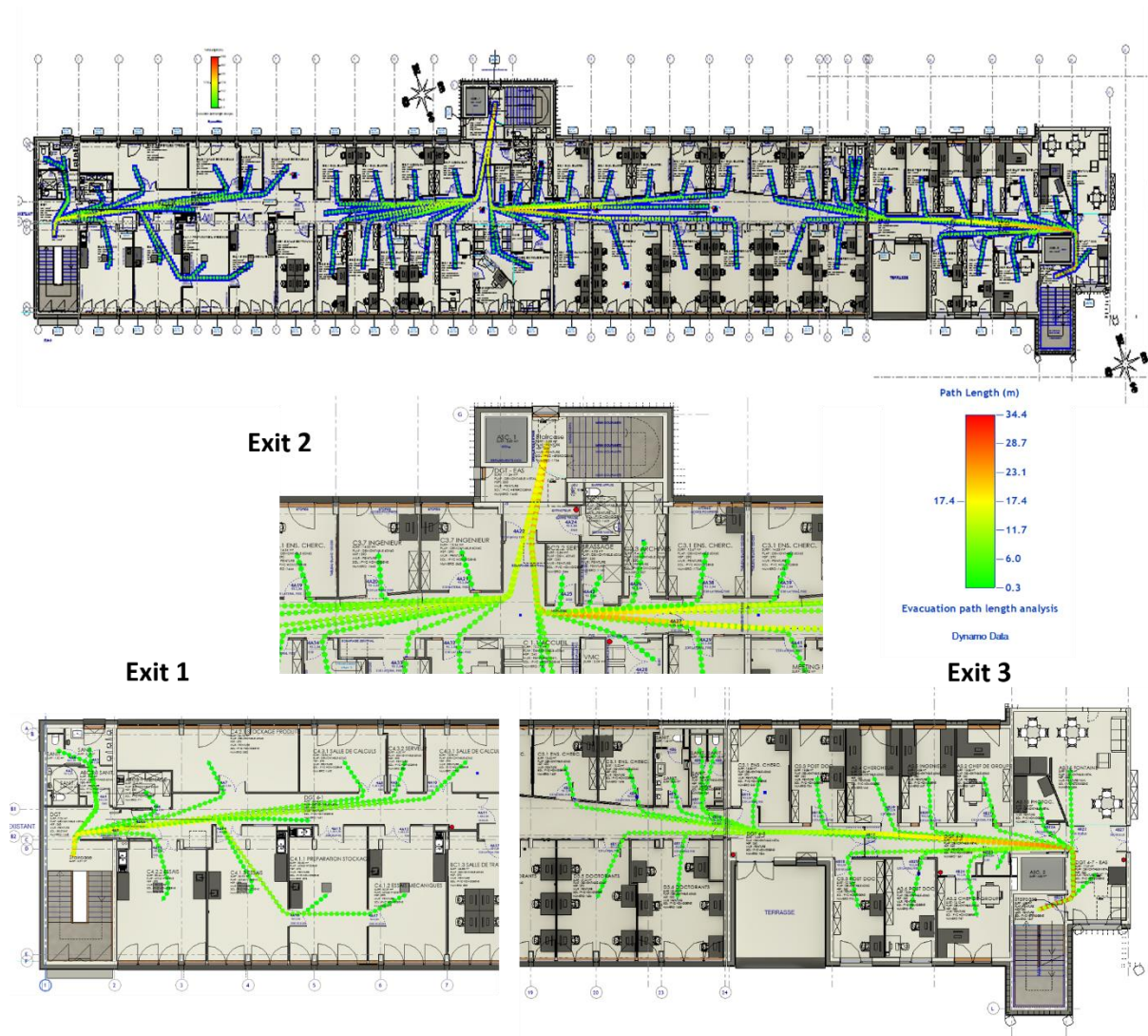

Figure 3.19: BIM visualization for evacuation paths

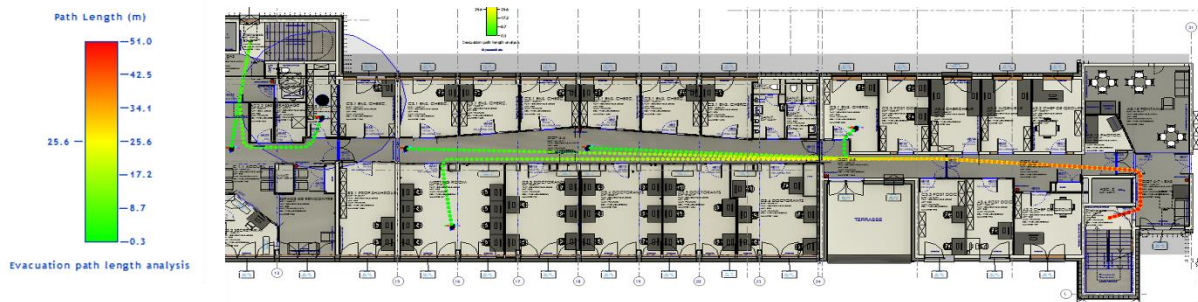

Figure 3.20: Example of BIM optimal evacuation paths during a fire event

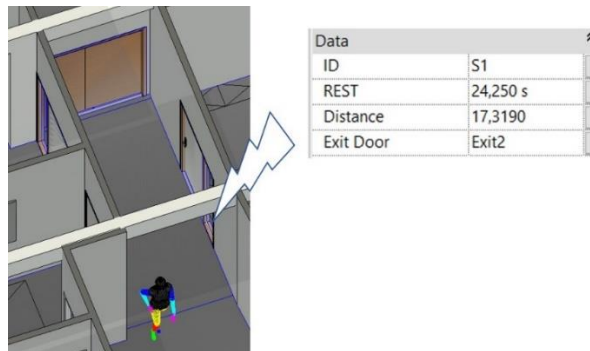

Figure 3.21: Occupants' information

3.5. Conclusion

This chapter presented a comprehensive management system for fire evacuation. The system can (i) detect fire early, (ii) collect and analyze the environmental data provided by sensors, (iii) locate occupants, and (iv) provide users with the optimal evacuation paths. This system is based on the combination of several technologies and simulation tools. IoT and smart technology are used to detect a fire early and reduce false detection. FDS is used to simulate fire scenarios and ABS for crowd simulation and evacuation paths generation. Both FDS and ABS provide a database that is used for the smart selection of evacuation paths in real-time using AI. Moreover, this study highlighted the importance of BIM tools for (i) visualizing environmental data in a 3D model, (ii) tracking occupants in real-time, and (iii) alerting occupants and providing them with the optimal evacuation paths.

The novelties of this study are

- Using AI and previous simulations to learn and predict the better evacuation routes for occupants during fire via BIM environment.
- The system power in visualizing fire and evacuation simulation outputs simultaneously in the BIM environment. It provides the evacuation route with accurate information regarding the distance needed to evacuate safely and the emergency exit to be taken.
- The capacity of occupants to interact with the system using a mobile application.

The capacity of the system was illustrated through its application to a research building-LGCgE laboratory of Lille University. Two fire scenarios were presented to demonstrate the evacuation simulation layer preparation. They show how the fire location, type, and severity impact the occupants' selection for the evacuation routes. Moreover, the results of the system output were well presented through the application.

The future work is to establish a dataset about the best evacuation paths during fire events in critical locations of the building. This dataset will be used with the ML technics for a real-time determination of the best evacuation paths in complex buildings.

Chapter 4: Assessment and Improvement of Anti-COVID-19 Measures in Higher Education Establishments

4.1. Introduction

From beginning 2020, we are facing a severe hazard known by COVID-19. Due to COVID-19 severity and fast rate transmission, the mitigation of its spread constitutes an urgent necessity. COVID-19 is considered an indoor hazard that should be carefully monitored to reduce its spread.

This chapter presents a comprehensive methodology for evaluating and improving the anti-COVID-19 measures in higher education establishments. The first section describes the COVID-19 virus, its transmission mode, risk factors and symptoms, and prevention measures. Moreover, this section presents the state of art related to BIM and digital technology to limit the virus spread. Section 2 provides the methods and methodology used for this study. The methodology combines the use of (1) Building BIM for the integration and control in a 3D graphic environment the anti-COVID-19 safety measures; (2) a questionnaire to collect the students' commitment to safety measures and their suggestions to improve these measures; (3) data analysis to explore the impact of the students' profile on their commitment to safety measures. The proposed methodology is applied at the engineering school Polytech' Lille in the North of France. Section 3 illustrated the results regarding the questionnaire distributed to Polytech'Lille students. Section 4 presents the improvements and recommendations in order to reduce the virus spread.

4.2. Literature Review

Beginning 2020, a new hazard known by Coronavirus has been considered a serious hazard to human lives (Mahase, 2020). Given its high infection and mortality rates, COVID-19 is classified as a global epidemic (J. Chen, 2020). Till April 2021, around 136 million people have been infected, and 2.54 million people passed away (CSSE, 2021). In addition, The virus has been recognized as the most critical economic crisis in recent years (McKee & Stuckler, 2020). Consequently, the food systems, the world of work, and education faced an unprecedented challenge. Tens of millions of people risk falling into life-threatening poverty, and millions of enterprises face an existential risk (ILO et al., 2020).

4.2.1. Method of Transmission

The main way of COVID-19 transmission is from one individual to another through direct personal and physical contact (Huang et al., 2020). The direct person transmission can be via respiratory droplets, which can be improved by physical body contact over a handshake, kissing, and hugging due to close physical contact. Correspondingly, the virus can be released in respiratory droplets over coughing and sneezing. Moreover, in case the respiratory droplets dropped in contact with the lubricated membrane of the eyes, nose, or mouth of a person directly or indirectly from infected persons and surfaces such as machines, electronic devices,

door handles and handrails, lift or elevator buttons, products, and furniture), the infection can highly occur (Lu et al., 2020; Ong et al., 2020).

Moreover, researchers have concluded that respiratory droplets of small size can persist in the air for about three hours. Accordingly, the virus transmission can similarly be airborne (Doremalen et al., 2020). Also, other researchers showed that the infection could be transmitted in aerosol, especially in an environment with poor air quality (Guan et al., 2021).

4.2.2. COVID-19 Risk Factors and Symptoms

All ages, including children, adults, and the elderly, are exposed to COVID-19 infection. Most infected persons showed mild to moderate illness and recovered without special treatment and hospitalization.

Nonetheless, infection severity depends on two main factors: (a) human factors like patient age, sex, immune system, blood group, personal hygiene, underline diseases, and health problems, and (b) environmental factors such as humidity, temperature, and CO₂ (Huang et al., 2020; Q. Li et al., 2020; T. Liu et al., 2020).

Therefore, vulnerable persons such as the elderly or persons with health problems like lung or heart disease, diabetes, cancer, or circumstances that disturb their immune system are more prone to high risk that might cause fatality (Huang et al., 2020; Q. Li et al., 2020). Only rare cases have been detected for infants and children's infections and have shown that children are very rarely exposed to a high risk of COVID-19 infection (Jiehao et al., 2020). Also, statistics have shown that male is more exposed to the virus compared to females (Q. Li et al., 2020). Additionally, studies have been determined that individuals with blood group O may be protected from severe COVID-19 due to low ACE present in this blood group that the virus can use as a receptor for entry. In contrast, persons with blood group A are more disposed to severe COVID-19 infection (J. Zhao et al., 2020).

Symptoms could be classified into three main types regarding their severity : (a) mild symptoms at onset of COVID-19 illness are fever, dry cough, and tiredness, (b) moderate symptoms are sore throat, aches and pains, headache, diarrhea, loss of taste and smell, rash on skin and conjunctivitis, and (c) serious symptoms such trouble in breathing, chest pain or pressure, loss of speech or movement that can face vulnerable persons (Huang et al., 2020; Q. Li et al., 2020).

WHO reported a study showing the frequencies of the three symptoms types in China. This study was adopted considering 55,924 laboratories and using records from the beginning of the outbreak up to February 2020 (Figure 4.1). Accordingly, it was noticed that the mild symptoms are the most frequent comparing to the moderate and serious symptoms.

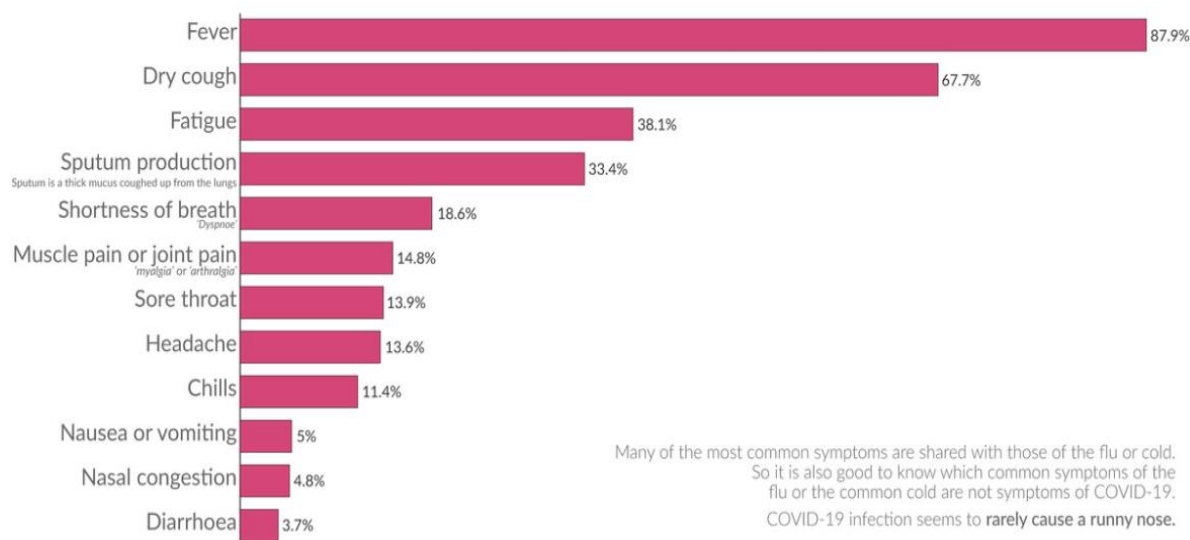

Figure 4.1: The frequencies of COVID-19 common symptoms' (Roser et al., 2020)

The symptoms of COVID-19 infection appear after 5–6 days from the day of infection; however, it can take up to 14 days (WHO, 2020). Nevertheless, some patients can stay positive even after symptoms have gone for up to 8 days (Rothe et al., 2020). Therefore, those who may have recovered should isolate themselves for further two weeks to reduce the percentage to transmit the virus to others.

4.2.3. COVID-19 Prevention Measures

Due to the slow vaccination rate and the absence of efficient medication for COVID-19, countries, and organizations imposed protective measures to limit the virus spread. The WHO recommended commitments to personal protection measures (e.g., use of hand sanitizing, surfaces disinfection, face mask) and physical distancing measures (WHO, 2020). On the other hand, governments organized awareness campaigns concerning the risk of COVID-19, its symptoms, transmission modes, and prevention methods, and they encouraged online learning (Oluwaseun & Oluwole, 2020).

Safety measures were imposed worldwide and suggested by the WHO:

- Wash hands for 20 seconds frequently.
- Use hand sanitizer in case of the unavailability of soap and water with at least 60% alcohol.
- Cover coughs and sneezes with a tissue and throw it away directly.
- Avoid touching the face, especially the eyes, nose, and mouth, with uncleaned hands.
- Disinfect surfaces such as buttons, tables, handles, and others before touching them.
- Keep at least one meter as social distancing with others.
- Wear a face mask.

Many governments took other measures:

- Self-quarantine up to 14 days after travel or do the COVID-19 test before the travel.
- Airports and border closure between regions and countries.

- Stop the planned events and closure of crowding places like restaurants, malls, museums.
- Boosts telework and online learning.
- Impose curfew and limit the shifting only for necessary purposes.

Additionally, COVID-19 high transmission persuades most countries to force people to stay home by doing a lockdown. In the lockdown period, the government policy was responsible for following and control the human practice for government rules by imposing penalties.

Concerning the safety measures for educational establishments, in some countries, such as France, the Ministry of Education allowed higher education establishments to open with a maximum of 50% occupancy in classrooms with the necessary safety measures (APUAF, 2020). The universities face unique challenges in providing in-person instruction during the COVID-19 pandemic (Smalley, 2021). They have to figure out a set of modifications and improvements to regular operations to protect students and staff (Gressman & Peck, 2020). Researchers in Taiwan suggested that higher education establishments could reopen safely with a combination of approaches that comprise containment (access control) and mitigation (sanitation, ventilation, and physical distancing) practices (S. Y. Cheng et al., 2020).

The virus spread has pushed the world to change and introduce new concepts and rules to their daily habits, especially in common spaces, such as sanitizers and social distancing (SD) requirements. Several national and international groups of expertise proposed guidelines to implement anti-COVID-19 measures. For example, the MASS group, which specialized in designing a living environment, established a guideline for redesigning restaurant spaces (Klein, 2020). In addition, Working Groups (WGs) suggested a document helping school managers to redesign schools through sustainable actions (Robiglio, 2020). Higher education establishments are concerned by the evaluation and improvement of anti-COVID-19 measures. Recently, Vozzoli (2020) proposed tools to improve the anti-COVID-19 measures in schools, universities, and workplaces (Vozzola, 2020).

4.2.4. Smart Building beyond COVID-19

Hazard mitigation required a focus continuously on applying measures to decrease the risk. According to Megahed & Ghoneim (2021), COVID-19 hazard control should involve the following layers of defense inside buildings (Megahed & Ghoneim, 2021):

- **Hazard elimination:** understand the COVID-19 symptoms and mode of transmission.
- **Engineering and construction control:** re-design or adjust building configuration, functions, and systems to incorporate healthier building strategies.
- **Administrative and technical controls:** instructing individuals on what to do based on the updates and new measures.
- **Personal protective equipment:** related to the people protection from the virus because people are the key source of the virus transmission.
- **Measures Implementation:** provide the necessary safety measures inside the building.

Researchers and enterprises are altering in response to the COVID-19 challenge by providing new innovative solutions. Technology has a significant role in keeping people safe, especially over smart building technologies in private and public buildings (Hatcher, 2020).

Smart Buildings will permit the employees to return to work and public buildings to reopen their doors again. Smart buildings are generally more related to environmental management and security; now, the integration of IoT sensors and smart buildings can also support applications useful for safely monitoring and managing coronavirus risk (Hatcher, 2020).

The owners can get real-time data regarding building safety against COVID-19 transmission using the smart building, exclusively for tasks such as building access control, monitoring HVAC systems, and tracking density within spaces, and surface cleaning.

a. Building access (BA) control

Cameras already contribute to site security by automatically monitoring entrances and traffic in buildings. They can also become a means of reducing the transmission from the building access (BA) control, typically:

- At the building entrance, a camera can detect whether or not the mask is worn. If this measure is made mandatory by company policy or the public authorities, access to the site may be blocked automatically by access control gates. This measure is particularly effective for large sites with many entrances that cannot all be controlled by a human.
- The use of a thermal camera (TC) makes it possible to assess body temperature and, for example, inform building managers of suspected cases. This device can be installed at the entrance to filter access and in other areas to alert on cases of developing fever symptoms on users already present in the building.

Some of this equipment blurs the stored images or does not store them, anonymizing the people filmed. However, it must be ensured that the thermal sensitivity meets the desired need.

The smart cameras could help monitor the building occupancy, SD, and ensure the face masks use. In addition, with the AI technology integration, the owners could detect the crowded zones to take the necessary actions. Similarly, Hatcher (2020) highlighted that thermal imaging cameras and occupancy monitoring systems are some of the strongest solutions to fight against COVID-19 (Hatcher, 2020). For example, Narita Airport in Japan uses thermal cameras to identify the passenger's temperature (Verdentix, 2020).

b. Occupation of building spaces

Counting people is possible thanks to many technologies. For example, through cameras or count sensors installed at the entrance or other spaces.

- After access control, the smart building use can quickly identify the current occupation in the different areas of the building.

- In a room, if the number of people present is greater than the health rule established, a signal may invite the occupants to return to the authorized threshold.
- The manager has a real-time monitoring tool that allows him to configure alerts such as sending an email if the occupancy threshold defined for a zone is exceeded. It can also perform more in-depth analyzes over the desired period.

c. Physical distancing

The physical distancing also could limit the risk of virus propagation, especially by an early and immediate practice of SD (Prem et al., 2020). Referring to Figure 4.2, it is clear that SD can reduce the number of infected patients and decrease the load on healthcare organizations (Armstrong, 2020).

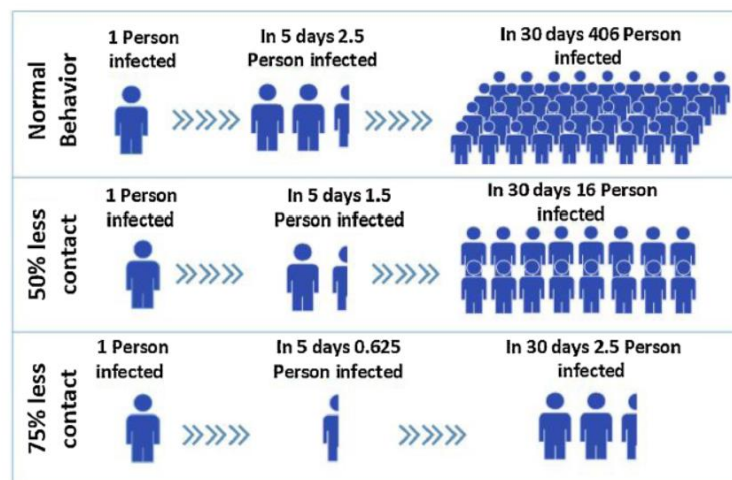

Figure 4.2: Social distancing (SD) importance (Armstrong, 2020)

Some technologies suggestions based on the smart city were released. They can be used by the building user and the organizations at the same time (Desvaux de Marigny & Keli, 2020):

- Users equipped with a connected device can be alerted when the recommended physical distance limit is not respected. In addition, if a user declares to have been infected by the virus, this information makes it possible to identify and alert individuals having been in close contact with him.
- Without investing in individual devices, the use of video analytics solutions makes it possible to identify behavior that does not comply with the physical distancing requirements.

d. Surfaces Cleaning

The interventions of cleaners can be triggered from events reported from the field:

- Sensors integrated into the soap/gel distributors collect data relating to the quantity available. These sensors can trigger the intervention of technicians and thus minimize the missing of soap or gel.

- In some cases, it may be relevant for users by indicating on their application that they are permanently leaving the space they were using (office, meeting room, etc.), automatically initiating a disinfection request. The application could be completed by the deployment of IoT sensors in these spaces.
- The planning of cleaning actions is automated so that each cleaning agent receives a service request on his application.

Detect real-time desk occupancy and availability, help to understand which areas have been used by occupants, and then facilitate robust cleaning. With these devices, the owners can remotely monitor and manage the soap/gel replenishment needs of a space and, more generally, the level of disinfection plan execution of the different spaces. These solutions provide continuous access to soap/gel and the assurance of regularly disinfected spaces for users.

e. Air Quality

Environmental health has a direct impact on human health, as illustrated in figure 4.3. Therefore, the impact of indoor environment quality on human health has long been one of the main topics for researchers in engineering and public health. Current studies proved that airborne virus transmission is very high, principally in crowded spaces and poorly ventilated environments. Accordingly, air quality seems to be a serious environmental feature in the COVID-19 pandemic (Megahed & Ghoneim, 2021).

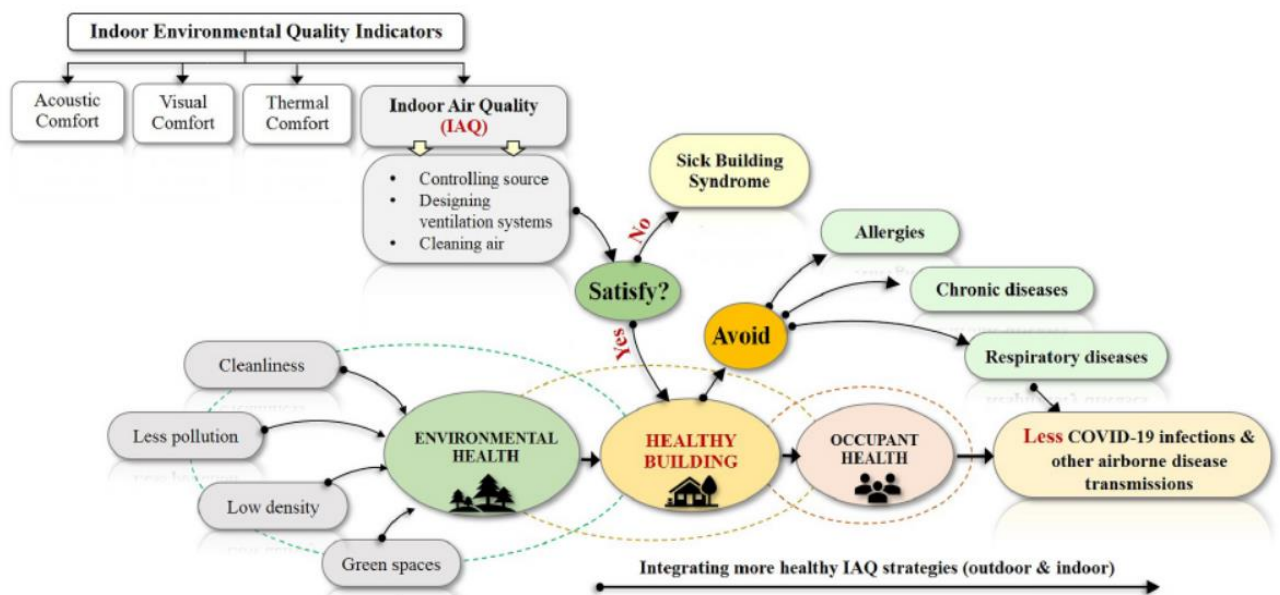

Figure 4.3: The relationships between environmental and human health (Megahed & Ghoneim, 2021)

One of the smart solutions to monitor and enhance the IAQ is the use of connected controlled mechanical ventilation coupled with presence sensors in the spaces. In addition, the doors and windows status monitoring could be also a great tool to ventilate rooms.

4.2.5. Digital technologies and AI Implementation for COVID-19

Considering the vital role of buildings management in addressing pandemic challenges, both researchers and professionals proposed using digital technology to improve the implementation of anti-COVID safety measures in buildings.

For example, Nguyen et al. (2020) provide a study of diverse developing technologies, including GPS, Bluetooth, WIFI, smartphones, computer vision, and ML, that can be very important tools for SD scenarios (Nguyen et al., 2020a). Research suggested a framework using the YOLOv3 model to detect persons and the Deepsort method to follow their movements through bounding boxes and allocated IDs information (Punn et al., 2020). In this study, they used an open image and a frontal view data set. Therefore, another study has been conducted by Ahmed et al. (2021) with a tracking accuracy of 95%. This model has been done with an overhead view that proposed a better field of view and disables obstruction issues (Ahmed et al., 2021).

Another smart device with AI integration has been improved to maintain an SD as well as detecting COVID-19 symptoms. The projected belt was created on the principle of a PIR sensor by getting infrared radiation from the human body to send a message alert on the mobile. The functional diagram is illustrated in figure 4.4. Using a deep learning algorithm, the device can identify if the user has COVID-19 symptoms or not (Nadikattu et al., 2020).

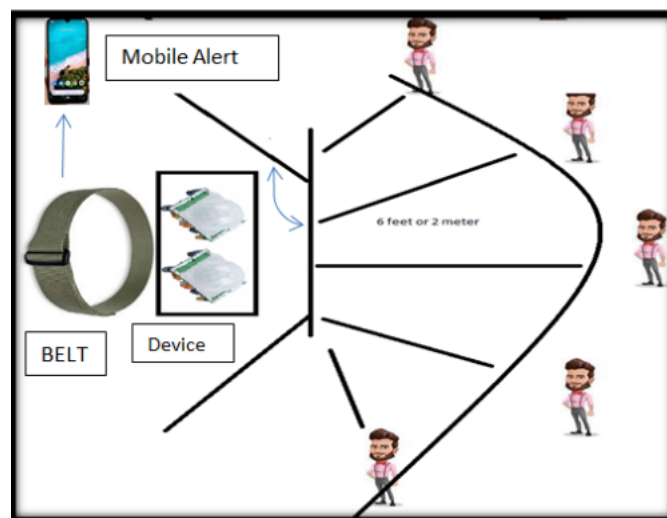

Figure 4.4: Working diagram of smart device system (Nadikattu et al., 2020)

Neelavathy et al. (2020) created a smart SD mobile application-based monitoring, aided by mobile Bluetooth and mobile camera. This system depends on two main steps to expect the social distancing: (a) persons are identified in the video frames due to deep learning, and (b) the distance between them is assessed over image processing techniques. The mobile application proves 85% accuracy and alerts the user through a beep sound or message (Neelavathy et al., 2020).

In addition, some researchers use drones and other surveillance cameras (SVC) to sense crowd spaces. Ramadass et al. (2020) suggested using video surveillance to identify individuals' behavior that does not comply with physical distancing requirements. They accomplished the

YOLOv3 model with the custom data set (frontal and side view images of limited people). This research is similarly extended for facial mask monitoring (Ramadass et al., 2020). Another study based on a mobile robot with an RGB-D camera and a 2D lidar was used to make collision-free navigation in a crowded situation. This model is planned for persons who do not follow the SD restriction, i.e., 6 feet of space among them (Sathyamoorthy et al., 2020).

Concerning the researchers more related to COVID-19 symptoms check, many studies related to thermal image technology using machine learning were conducted. For example, the previous study can also monitor if any occupant shows a higher than normal temperature. Since the robot is equipped with a TC that wirelessly diffuses thermal images to the responsible without people face recognition to protect their privacy. Sathyamoorthy et al. (2020) highlighted the importance of Thermal Imaging Cameras (TC) in fighting against COVID-19. Otaam et al. (2020) suggest a real-time COVID-19 detection and monitoring system. The system, through IoT framework, is responsible for (a) record the users' real-time symptom data to early identify supposed COVID-19 cases using wearable sensors, (b) monitor the treatment response of the recovered persons from the virus, and (c) to recognize the virus nature by collecting and studying pertinent data (Otoom et al., 2020). The authors used eight machine learning algorithms: Support Vector Machine, Naïve Bayes, Neural Network, K-Nearest Neighbor, Decision Table, Decision Stump, ZeroR, and OneR. The machine learning algorithms are used to identify the potential COVID-19 cases by the real-time symptom dataset collected. Accordingly, the system would be able to indicate the necessary treatment for each COVID-19 patient. The results presented that five out of eight algorithms reached an accuracy of more than 90 % (Otoom et al., 2020).

For face mask detection, a hybrid model via classic and deep ML was conducted by Loey et al. (2021). The model is comprised of two sections: (a) The feature extraction using the Resnet50 model accessible from deep transfer learning models, and (b) the face masks detection process using classic ML algorithms. Three traditional ML methods were used for the hybrid model investigation: support vector machine, decision trees, and ensemble algorithms. It was deduced that the support vector machine method attained the highest accuracy (Loey et al., 2021).

4.2.6. BIM implementation for COVID-19

BIM technology use for limiting the spread of COVID-19 is still a challenging topic for researchers, which gives high importance to our study. Some scholars and professionals focused on the use of BIM in implementing anti-COVID-19 safety measures for its high capacity in (1) effective lifecycle management of buildings (Azhar et al., 2012; Matějka et al., 2016; Zou, 2017), (2) indoor risk management (Wehbe & Shahrour, 2019a) and (3) spatial health risk evaluation (Akin et al., 2018). (L.-K. Chen et al., 2021; Luo et al., 2020) reported that China used BIM to construct two emergency hospitals in the first period of COVID-19. BIM proved to be effective in the rapid design and construction and the organization of emergency operations. Li et al. (2021) developed a BIM model to evaluate the indoor infection risk using data concerning the built environment, occupancy, and pathogen transmission (S. Li et al., 2021). Pavon et al. (2020) used BIM for real-time identification of individual paths and facilities occupancy ratio to limit individuals' crossing (Pavón et al., 2020). Considering the

vital role of ventilation in reducing the COVID-19 Spread (Buonanno et al., 2020; Dai & Zhao, 2020), some scholars proposed to use BIM to monitor the IAQ (Gan et al., 2019; Sporr et al., 2019; Wehbe & Shahrour, 2019b). In a recent paper, Delval et al. (2021) presented the use of BIM to assess COVID-19 risk management concerning indoor air ventilation. They used the BIM model to analyze risks related to schools' space configuration and ventilation systems (Delval et al., 2021). Leon et al. (2021) developed a BIM-based approach to improve the implementation of anti-COVID-19 safety measures, including (1) optimization of classroom occupancy, (2) respecting the safety distances, (3) improving disinfection and waste management, and (4) assessment of a natural ventilation system (Leon et al., 2021).

Previous works on implementing the anti-COVID-19 safety measures focused on digital technology, including smart monitoring and BIM. The users' feedback and experience were not considered to assess and improve the efficiency of the implemented solutions. Since users' experience is vital in improving services, including digital services, this paper proposes combining BIM and users' feedback to assess and enhance the anti-COVID-19 system. The research is based on data collected in the school of engineering Polytech'Lille in the North of France. A questionnaire is used to collect the students' evaluation of the anti-COVID-19 safety measures as well as their opinion and suggestions about the extension of these measures. A COVID-19 layer is created in the BIM model of the school of engineering to integrate the COVID-19 safety measures in the building management system. This layer aims to create a shared digital space to integrate and illustrate safety measures, optimize classroom capacity and indoor circulation paths, data, and information updates, and improve students' awareness.

4.3. Materials and Methods

4.3.1. Methodology

The general methodology described in chapter 2 should be as well used for COVID-19 study (Figure 4.). The data collection includes physical and monitoring layers. Many IoT monitoring sensors are required:

- Temperature, CO₂, doors, and windows status used to monitor IAQ.
- Thermal camera used to check humans' body temperature
- Video surveillance and indoor localization used to check students' commitment to safety measures.
- Level sensor used to verify the quantity of hand sanitizers and disinfection products.
- The motion sensor to verify rooms capacity.

After the data transmission and processing, the data analysis is done. The governments protection requirements such as respect social distancing, wear facial masks, and regularly disinfect hands, as well as the building protection requirements like check body temperature, monitor IAQ, and check room capacities are integrated into BIM. BIM will be able to check these requirements also by the integration of AI. As an example, the system could detect when the disinfection products and hand sanitizers will be empty, and it can inform the responsible in advance. The system can control the equipment, for example in case the IAQ is poor, the system will turn on the ventilation system and open the doors and windows. The system will

provide smart actions such as improving space configuration, users' awareness, path directions, and provide sanitizers and disinfection products, as well as the assistance services.

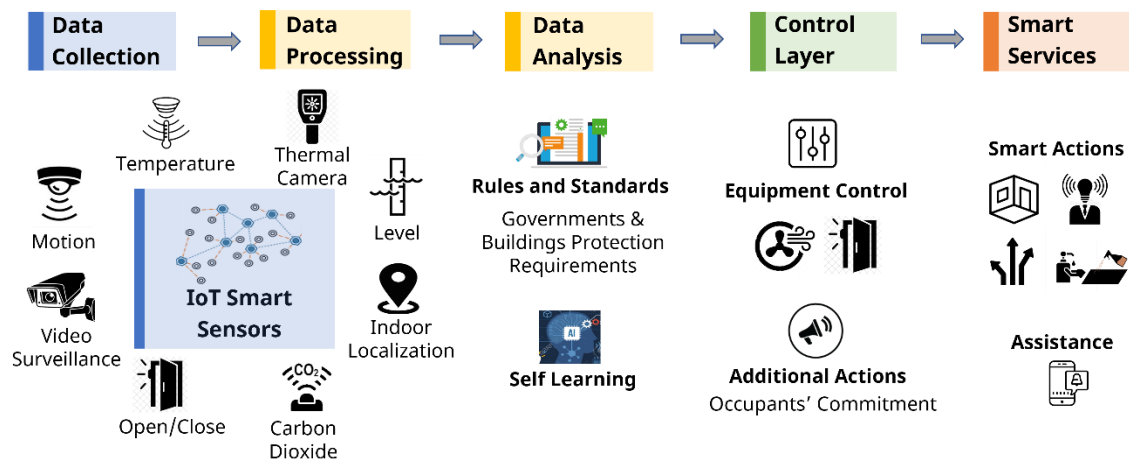

Figure 4.5: General methodology for COVID-19 mitigation in buildings

The system novelty is the integration of users' feedback and experience via questionnaire to enhance decisions. Users' feedback and intelligence are very vital to enhance a system.

Figure 4.6 shows the methodology used in this research to evaluate and improve measures taken by higher education establishments to prevent COVID-19 spread. It includes 3 phases: (1) use of BIM for the spatial modeling of the anti-COVID-19 measures through the creation of COVID-19 Layer in the BIM model that integrates and shares in 3D environment data and information about the anti-COVID-19 safety measures (2) use of a questionnaire to collect students' evaluation of the COVID-19 measures efficiency as well as their suggestions to enhance these measures; (3) data analysis and recommendations.

The use of BIM allows the building managers to integrate into a friendly environment the buildings' components and information (Pavón et al., 2020)]. In addition, BIM could represent and check the compatibility of safety measures with guidelines comprehensively. This methodology could be easily extended to other educational establishments. The BIM model could integrate real-time data from sensors to enhance safety measures. The questionnaire could be conducted regularly to improve both the safety measures and the students' awareness.

The anti-COVID-19 layer in the BIM model includes access restrictions in the building, localization of hand gel and disinfection products (DP), classroom capacity and desks' localization, circulation indications, and any additional measure. The BIM model could also include SVC to control the anti-COVID-19 measures (Punn et al., 2020). Access to these cameras is limited to the administration in charge of the building's safety and security (ECB, 2020). The BIM model could be accessed via the administration, faculty members, and students via the online application. The administration is responsible for data and information updates. Users could use the model to notify any deficiency in the anti-COVID-19 system.

The questionnaire is used to evaluate safety measures taken by the administration and involve students in improving the efficiency of these measures. This approach has been used to analyze

the COVID-19 situation from different perspectives. University students were considered a target population in many studies, especially in researches related to the mental health and psychological impact of COVID-19 (Akhtarul Islam et al., 2020; Liang et al., 2020; Meo et al., 2020; Salman et al., 2020). Other studies evaluate students' knowledge, perceptions, and practice to COVID-19 measures (Alzoubi et al., 2020; Nguyen et al., 2020b; Salameh et al., 2021; Taghrir et al., 2020). However, questionnaires were used to assess the effect of COVID-19 on students' life without development goals.

The questionnaire includes closed-ended questions, which are better for gathering quantitative data (Guo et al., 2009). The questionnaire aims to collect the students' evaluation and respect of the anti-COVID-19 measures and their recommendations to improve them. The students' feedback is helpful for the administration to understand the acceptability of the restriction and precaution measures as well as their efficiency.

Data analysis is conducted with emphasis on (1) analysis of the students' perception of the anti-COVID-19 measures and their suggestions to improve these measures; and (2) the correlation between the students' profile and their feedback about the anti-COVID-19 measures. Analysis was conducted with SPSS Statistics 20 software, which is largely used to analyze quantitative data, especially in social and health science researches (Gogoi, 2020; Masuadi et al., 2021). The descriptive analysis is presented as frequencies, percentages, and medians. Whereas categorical measures are described as means with standard deviation. Two independent samples t-tests or one-way analysis of variance (ANOVA-test) could be used to explore the impact of the students' profile on their perception of the anti-COVID-19 measures. These tests are the keystone of data analysis in several fields such as economics, biology, sociology, and psychology (Wetzels et al., 2012). They are used to determine if there are any statistically significant differences among the means of two or more groups (H.-Y. Kim, 2014). When comparing only two groups, both tests could be used since they use identical P-values, knowing that F values are equal to the square of t values (Green et al., 2012). However, ANOVA-test has some advantages. Several reports indicate that ANOVA-test is among the most popular inferential data analysis techniques employed in educational research (Elmore & Woehlke, 1998; Erceg-Hurn & Mirosevich, 2008; Rojewski et al., 2012).

In this research, data analysis was carried out using ANOVA-test with a 95% confidence level. Consequently, a difference of P-value < 0.05 is considered statistically significant. Assumption of ANOVA-test regarding the normal data distribution, the homogeneity of variance, and sample independence are well checked before using the test.

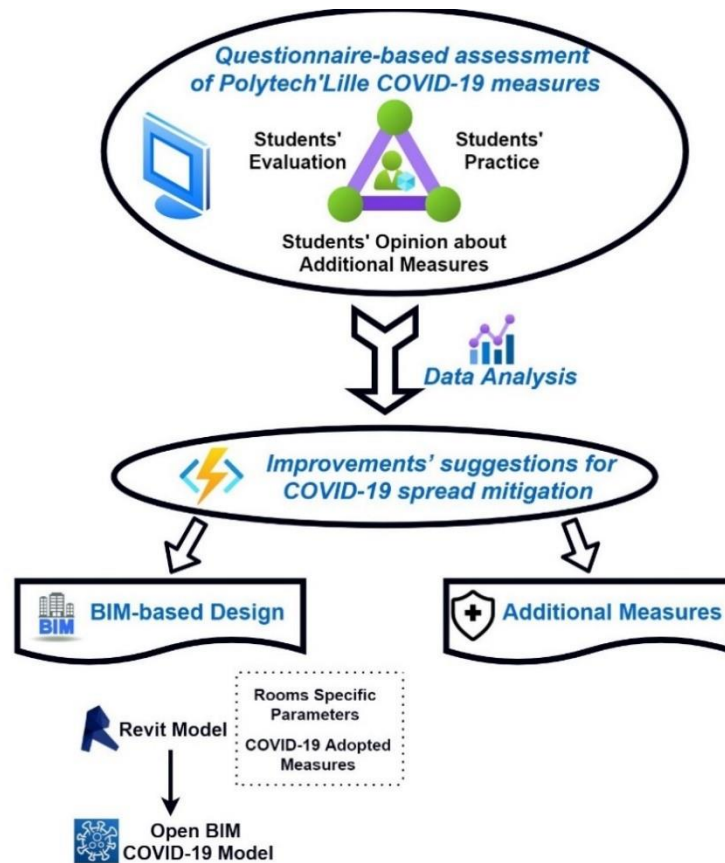

Figure 4.6: Methodology to mitigate COVID-19

4.3.2. Application to the engineering school Polytech'Lille

The proposed methodology was applied to the public engineering school Polytech'Lille, situated near the city of Lille in the North of France. Polytech'Lille provides engineering education to about 2000 students. The total area of the school buildings is around 20,000 m². Figure 4.7 shows the architecture of the school, including three 4-floor buildings and a common ground floor. The ground floor comprises a hall, amphitheatres, WCs, cafeteria, and offices. Other floors have mainly classrooms and offices.

A BIM model was established for Polytech'Lille to implement the COVID-19 measures. This model provides a 3D representation of the building, including rooms, facility areas, architectural components (doors, windows, walls), furniture, and occupancy number.

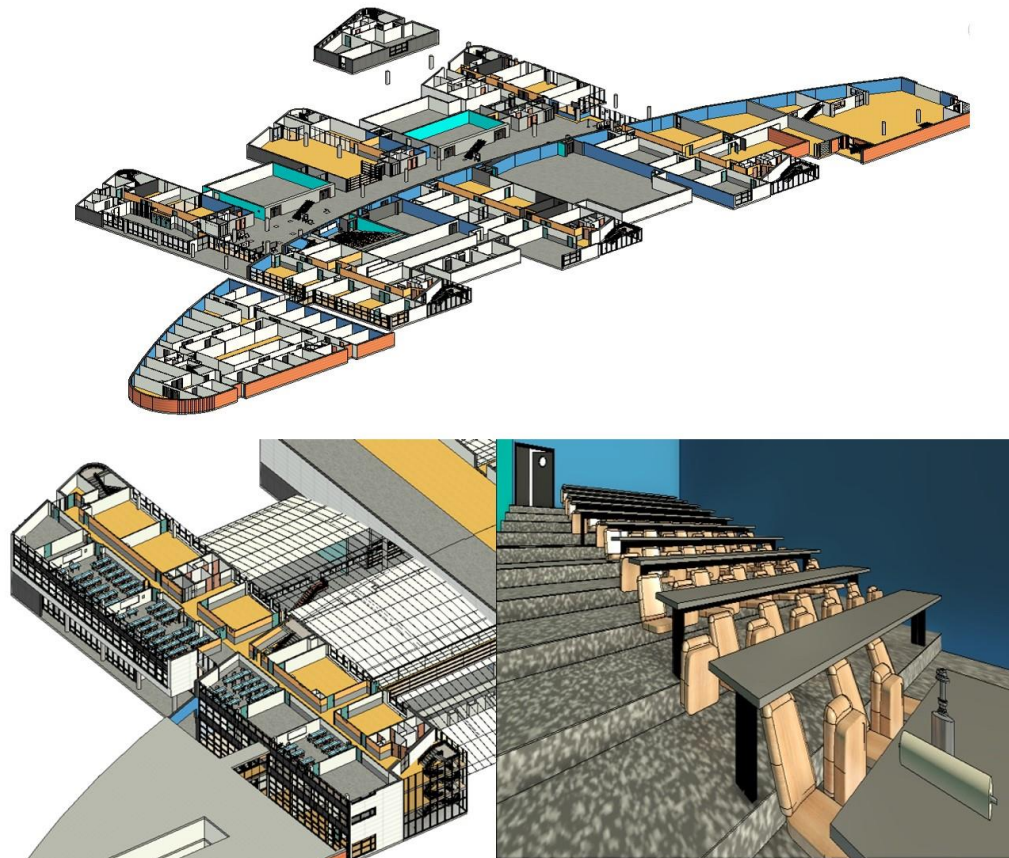

Figure 4.7: Polytech'Lille BIM Model

4.3.3. Anti-COVID-19 measures at Polytech'Lille

In May 2020, Polytech'Lille implemented the government safety regulations associated with the COVID-19 epidemic. These measures concerned awareness instructions, BA restriction, indoor circulation paths, Closure of Common Spaces (CCS), surfaces disinfection, hand sanitizer services at the entrance, hall, and classrooms. The safety measures were added as a COVID-19 layer in the BIM Model. Figure 4.8 shows the safety measures at the school entrance and classrooms as integrated into the BIM model.

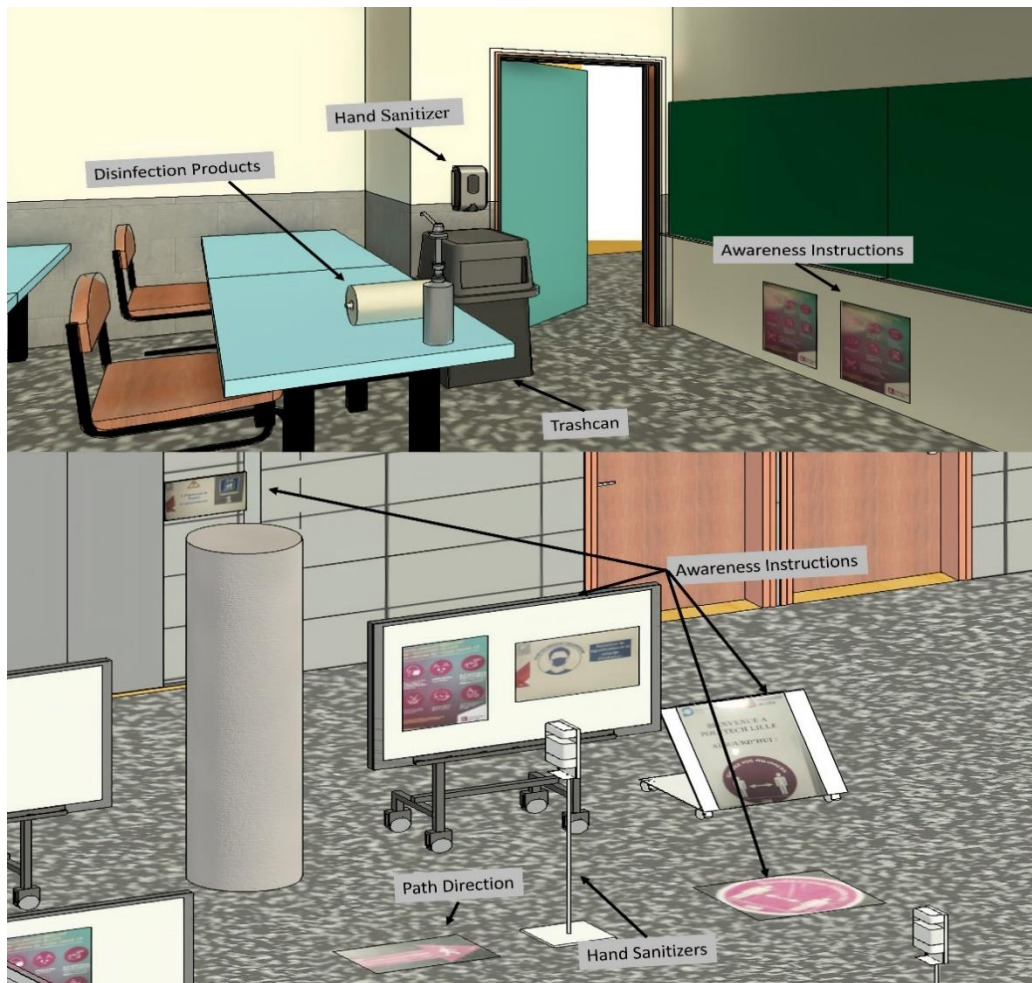

Figure 4.8: Illustration of the anti-COVID measures in the BIM model

4.3.4. Use of a questionnaire for the assessment of anti-COVID-19 measures

A web-based questionnaire was used to assess the COVID-19 safety measures in the school and the students' commitment to these measures. The questions are based on Likert-scale 5 points questions. The questionnaire consists of four parts (Table 4.1).

The first part includes general information about the students' profiles. It consists of questions about gender, level of education, and the national anti-COVID-19 mobile application "TousAntiCovid". This application includes general information about COVID-19, services to track users' contact with alerts to users who had contact with positive COVID-19 people. Up to November 3, 2020, around 7.2 million users downloaded this application in France. The use of this application by students constitutes an indicator of their awareness and commitment to anti-COVID-19 measures.

The second part of the questionnaire concerned the students' evaluation of the school anti-COVID-19 measures. These measures cover the BA restriction, Path Direction (PD) organization, CCS, DP, and hand sanitizers.

The third part aimed to explore the students' commitment to anti-COVID-19 measures. Students were asked about their commitment to the following measures: hand sanitizer, disinfection of tables upon arrival and after the course, PD, and SD inside the building.

The fourth part of the questionnaire concerned the students' opinion about additional measures such as (1) implementation of SVC to check the students' respect of safety measures (e.g., physical distancing and mask-wearing); (2) use of TC at the building entrance to measure students' body temperature; (3) creation of a Social Network (SN) to share COVID-19 information; and (4) access to Common Spaces (CS).

The questionnaire was targeted to the bachelor's and master's students in Polytech'Lille (Population (Pop) equal to 190). Accordingly, the sample size for infinite population (SSIP) and the required sample size (SS) was calculated based on the Cochran formula (Heinisch, 1965).

$$SSIP = \frac{Z^2 p(1-p)}{e^2} \quad (4.1)$$

$$SS = \frac{SSIP}{1 + \left(\frac{SSIP-1}{Pop}\right)} \quad (4.2)$$

Z value corresponding to the 95% confidence interval, the margin of error (e), and the population proportion (p) were taken equal to 1.96, 0.1, and 0.5, respectively. Accordingly, the required SS is 65.

Table 4.1: Composition of the questionnaire

Questionnaire Parts	Questions
Part 1: general information	<ul style="list-style-type: none"> • Gender • Education degree (bachelor or master) • Use of the mobile application "TousAntiCovid"
Part 2: assessing COVID-19 safety measures taken by Polytech'Lille	<ul style="list-style-type: none"> • To what extent do the following measures are efficiently performed in Polytech Lille? • Hand sanitizer at the entrance • Hand sanitizer in the hall • Hand sanitizer in classrooms • Disinfection Products • Access restrictions • Path direction organization • Closure of common areas
Part 3: assessing students' commitment to the COVID-19 safety measures	<ul style="list-style-type: none"> • To what extent are you committed to the following measures? • Hand sanitizer at the entrance • Hand sanitizer in the hall

	<ul style="list-style-type: none"> • Hand sanitizer in classrooms • Path direction • Surfaces Disinfection upon arrival • Surfaces Disinfection at the end of the course • Social distancing
Part 4: Students' suggestions about additional measures	<ul style="list-style-type: none"> • What is your opinion concerning the implementation of the following additional measures? • Thermal camera (without facial recognition) • Surveillance cameras (without facial recognition) to verify compliance with measures • A social network of information about COVID-19 • Common spaces available to students while respecting social distancing

4.4. Results and Discussion

4.4.1. Students' Profile

A total of 65 students participated in this survey. Table 4.2 summarizes the students' profiles. It shows that males (65%) were more than females (35%), and bachelor students (60%) were more than master ones (40%). 29% of the participants were using the TousAntiCovid application. ANOVA-test results indicate no significant difference between genders regarding using the TousAntiCovid application ($F=0.024$, $P>0.1$). Approximately both genders have the same level of commitment in using the TousAntiCovid application (30%). On the other hand, the education degree impacted the use of the TousAntiCovid application ($F=3.674$, $P=0.05$). The application adoption ratio amongst the master's degree students (42 %) is twice that of the bachelor's degree students (21%).

Table 4.2: Students' Profile

Characteristic	Total (N=65), n%	With AntiCovid Application (N=19, 29%)	Without AntiCovid Application (N=46, 71%)	F	P-value
Gender				0.024	0.877
Female	23 (35)	7 (30)	16 (70)		
Male	42 (65)	12 (29)	30 (71)		
Education				3.674	0.05
Degree					
Bachelor	39 (60)	8 (21)	31 (79)		
Master	26 (40)	11 (42)	15 (58)		

4.4.2. Students' evaluation of the anti-COVID-19 measures

Figure 4.9 shows the evaluation by the students of the anti-COVID-19 measures, which concern both disinfection and access restrictions. The disinfection measures include the availability of DP, Gel at the Entrance (GE), Gel at the Hall (GH), and Gel in Classrooms (GC). The access measures contain restrictions of the BA, PD, and CCS.

Disinfection measures reported a higher satisfaction score (satisfied to very satisfied) than access measures. The satisfaction score for disinfection measures ranged between 66% and 89%, while the score for access measures ranged between 49% to 65%.

The overall average score for disinfection measures was 4.23 ± 1.04 . The DP had the lowest "very satisfied" record (46%), while GE had the highest "very satisfied" score (72%). More than 75% of the students gave a satisfaction score concerning the gel measures (GE, GH, GC). Amongst the 75%, more than 50% were "very satisfied". This result indicates the necessity to provide hand sanitizers in all spaces.

The overall average score for access measures was 3.5 ± 1.21 . The highest satisfaction score was recorded in the CCS (65%). 60% of the students gave a satisfaction score for the BA restriction. The lowest satisfaction score (49%) was recorded for the PD. This low score suggests rethinking this measure by the school.

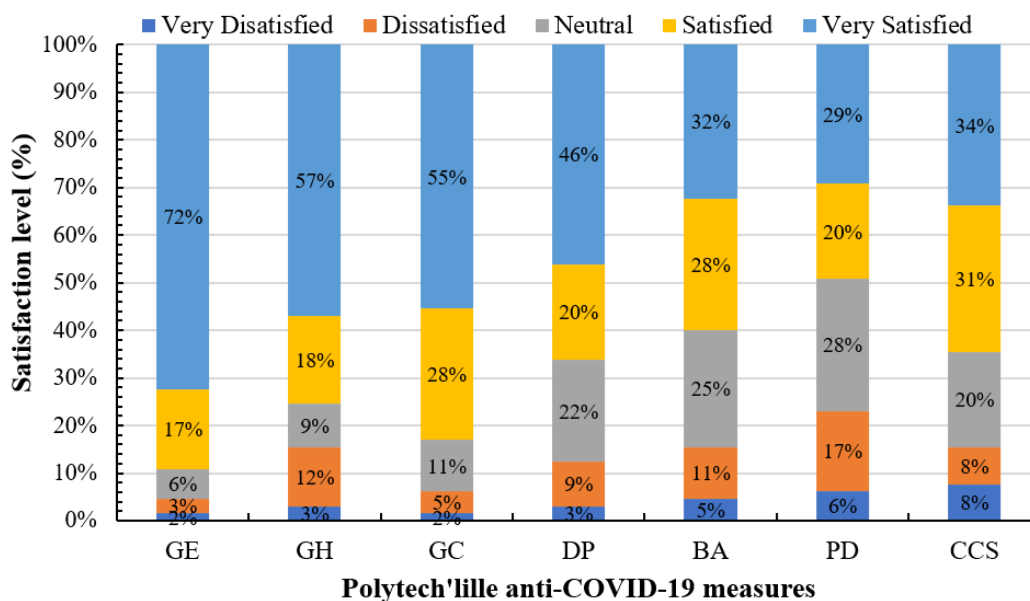

Figure 4.9: Students' opinion about anti-COVID-19 measures

Influence of the students' profile: Table 4.3 summarizes the relationship between the students' profile (gender, education degree, and use of the TousAntiCovid mobile application) and evaluating the anti-COVID-19 measures. Statistically, significant difference was found based on genders regarding students' assessment of the disinfection measures ($F=4.68$, $P=0.03$), while no significant difference was observed concerning the access measures ($F=1.58$, $P>0.05$). A high satisfaction score was reported by both genders for disinfection measures (74-

95% in females, 61-88% in males), compared to access measures (53-69% in females, 45-60% in males).

Generally, females gave higher satisfaction scores compared to males. On the other hand, females and males disagree on the access measures ranking. Females considered the CCS as the most satisfying measure and the PD as the less satisfying one. At the same time, males declared the BA as the highest satisfied measure and PD as the lowest. Furthermore, males were “very satisfied” equally between access measures (23%).

Results did not reveal a statistically significant difference between the evaluation of bachelor’s and master’s degree students concerning their evaluation of anti-COVID-19 measures. However, the satisfaction score for disinfection measures was higher than the access measures. In disinfection measures, master’s degree students have a higher satisfaction score than bachelor’s degree students, except for DP.

On the other hand, concerning the students’ evaluation for disinfection measures, a statistically significant difference was found based on using the TousAntiCovid mobile application (F=5.11, P=0.02). Nevertheless, no statistically significant differences were observed based on using the TousAntiCovid mobile application for access measures (F=0.03, P>0.05). Students who use the TousAntiCovid mobile application gave a higher satisfaction score than other students for disinfection measures. In both PD and CCS, students who do not use the TousAntiCovid mobile application gave higher satisfaction scores.

Table 4.3: Students’ evaluation of anti-COVID-19 measures

Category	Measure ^s	Satisfaction Level (%)										F	P-value
		1	2	3	4	5	1	2	3	4	5		
Gender													
		Female					Male						
Disinfection Measures	GE	0	4	4	13	78	2	2	7	19	69	4.68	0.03*
	GH	4	9	4	13	70	2	14	12	21	50		
	GC	0	0	4	30	65	2	7	14	26	50		
	DP	4	9	13	17	57	2	10	26	21	40		
Access Measures	BA	9	9	22	22	39	2	12	26	31	29	1.58	0.21
	PD	4	9	30	13	43	7	21	26	24	21		
	CCS	9	9	13	17	52	7	7	26	33	26		
Education Degree													
		Bachelor					Master						

	GE	3	5	8	15	69	0	0	4	19	77		
Disinfection Measures	GH	5	13	15	18	49	0	12	0	19	69		
	GC	3	5	13	33	46	0	4	8	19	69	1.19	0.27
	DP	5	10	18	21	46	0	8	27	19	46		
Access Measures	BA	5	10	21	26	38	4	12	31	31	23		
	PD	5	18	28	15	33	8	15	27	27	23	0.36	0.55
	CCS	8	10	13	28	41	8	4	31	35	23		
Use of the TousAntiCovid mobile application													
		No					Yes						
Disinfection Measures	GE	2	4	7	20	67	0	0	5	11	84		
	GH	4	11	11	22	52	0	16	5	11	68	5.11	0.02*
	GC	2	2	13	33	50	0	11	5	16	68		
	DP	4	9	24	17	46	0	11	16	26	47		
Access Measures	BA	4	11	26	33	26	5	11	21	16	47		
	PD	4	15	28	24	28	11	21	26	11	32	0.03	0.85
	CCS	7	11	13	35	35	11	0	37	21	32		

*P<0.05; 1: Very Dissatisfied, 2: Dissatisfied, 3: Neutral, 4: Satisfied, 5: Very Satisfied

4.4.3. Students' commitment to anti-COVID-19 measures

Students were asked about their degree of practicing hand sanitizers, surfaces disinfection, and distancing measures. The hand sanitizers include GE, GH, and GC. Surfaces Disinfection consists of cleaning when Arriving (SDA) and before Leaving (SDL) the room. Distancing measures comprise SD and PD.

Figure 4.10 presents a synthesis of the students' responses. It shows that the highest students' commitment concerned hand sanitizers (4.29 ± 1.02) followed by distancing measures (3.54 ± 1.16), then surface disinfection (3.14 ± 1.43). The strong commitment (high to very high practice) ranged from 68% to 92%, 28% to 58%, 42% to 53% for hand sanitizers, surfaces disinfection, and distancing measures. Distancing measures presented the highest number of students with "moderate practice". On the other hand, surface disinfection has the highest number of students with "no practice".

The highest use of hand sanitizers was at the school entrance. 92% of students claimed a strong commitment to using hand sanitizers at the gate. No students presented a "weak practice" of

GE; only 2% did not use GE at all. GC has a higher strong commitment (84%) than GH (68%). This result could be related to the higher possibility of touching surfaces in the classrooms than in the hall.

The students' responses revealed a remarkable difference in practice degree between SDA and SDL. SDA (58%) recorded a strong commitment as double as SDL (28%). Amongst all measures, the highest number of students with no practice was reported at the SDL (38%). Such results indicate that students care more about protecting themselves than protecting others.

In both SD and PD, students with “no practice” to “weak practice” represented approximately 15%. SD reported the highest “moderate practice” (42%), followed by PD (31%). Students with a strong commitment are higher for PD (53%) than SD (42%). Therefore, the school should improve PD and students' respect for SD.

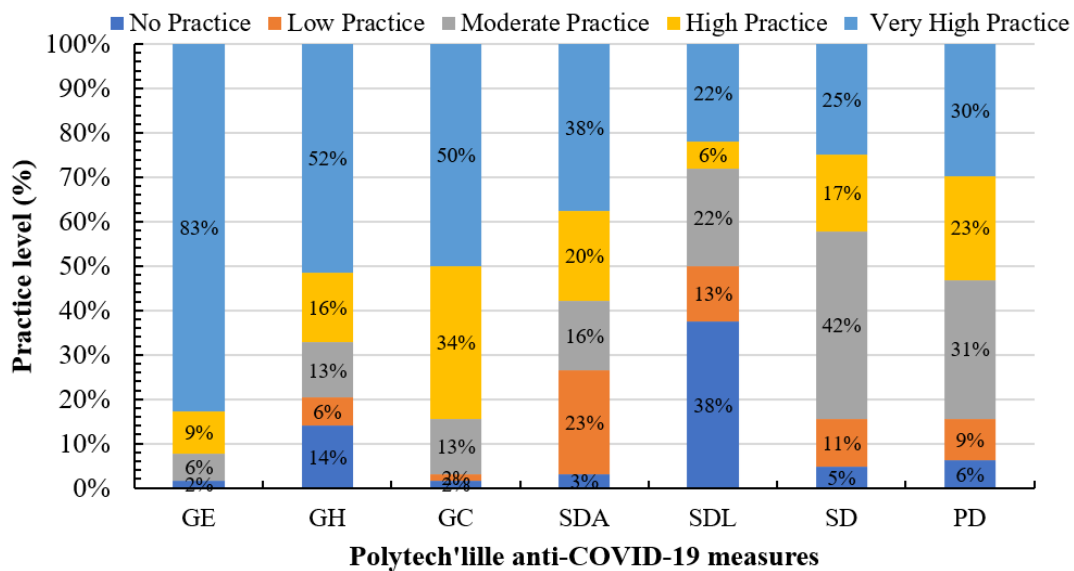

Figure 4.10: Students' practice for Polytech'Lille safety measures

Influence of students' profiles: Table 4.4 shows the impact of students' profiles on their commitment to respect the anti-COVID-19 measures. For both genders, GE has the highest strong commitment, followed by GC and GH. Nonetheless, females have a “very high practice” for hand sanitizers (52-83%) compared to males (43-83%). Females were more committed to using hand gels (4.38 ± 0.95) than males (4.15 ± 1.25). In surface disinfection, a slight difference was recorded between genders with a strong commitment (males: 28-59%, females: 26-57%). Males have a higher commitment to follow the instructions related to SD and PD (45%, 55%) than females (39%, 48%). However, on average, females (3.52 ± 1.34) were more committed to respecting distancing measures than males (3.43 ± 1.23).

A statistically significant difference was found based on the education degree concerning students' use of hand sanitizers ($F=9.12, P=0.003$). No statistically significant difference was detected regarding students' practice for surfaces disinfection and distancing measures based on the academic degree. Master's degree students were more committed to respecting the anti-

COVID-19 measures (3.92 ± 1.08) than bachelor's degree students (3.52 ± 1.35). The strong commitment concerned GE (bachelor: 92%, master: 96%), while the lowest one concerned SDL (bachelor: 26%, master: 28%).

Concerning the students' commitment to using hand sanitizers and distancing measures, a statistically significant difference was observed based on using the TousAntiCovid mobile application ($F=4.96$, $P=0.02$; $F=3.83$, $P=0.05$). The mean value for students' commitment to using the mobile application (4.02 ± 1.11) is higher than other students (3.54 ± 1.31). This result indicates that students who use the TousAntiCovid mobile application have a higher commitment to respect the anti-COVID-19 measures than other students.

Table 4.4: Influence of students' profile on their commitment to respect anti-COVID-19 measures

Category	Measures	Practice Level (%)										F	P-value
		1	2	3	4	5	1	2	3	4	5		
		Gender											
		Female					Male						
Hand Sanitizers	GE	0	0	9	9	83	2	0	5	10	83	0.31	0.58
	GH	9	9	22	9	52	17	5	7	21	50		
	GC	0	4	9	26	61	2	0	14	40	43		
Surfaces Disinfection	SDA	9	30	4	22	35	0	19	21	21	38	0.88	0.35
	SDL	43	9	22	4	22	33	14	24	7	21		
Distancing Measures	PD	13	4	35	13	35	2	12	31	29	26	0.13	0.72
	SD	0	9	52	4	35	7	12	36	26	19		
		Education Degree											
		Bachelor					Master						
Hand Sanitizers	GE	3	0	8	10	79	0	0	4	8	88	9.12	0.003**
	GH	21	10	8	18	44	4	0	19	15	62		
	GC	3	3	15	41	38	0	0	8	27	65		
Surfaces Disinfection	SDA	3	26	18	18	36	4	19	12	27	38	3.39	0.07
	SDL	46	18	13	5	18	23	4	38	8	27		
	PD	5	5	31	26	33	8	15	35	19	23	0.22	0.64

Distancing Measures	SD												
		5	10	44	23	18	4	12	38	12	35		
Use of the TousAntiCovid mobile application													
		No					Yes						
Hand Sanitizers	GE	2	0	4	11	83	0	0	11	5	84		
	GH	17	9	11	22	41	5	0	16	5	74	4.96	0.02*
	GC	2	2	13	39	43	0	0	11	26	63		
Surfaces Disinfection	SDA	4	26	15	24	30	0	16	16	16	53		
	SDL	35	13	28	7	17	42	11	11	5	32	1.46	0.23
Distancing Measures	PD	7	9	35	24	26	5	11	26	21	37		
	SD	7	13	41	24	15	0	5	42	5	47	3.83	0.05*

*P<0.05, **P<0.01; 1: No Practice, 2: Low Practice, 3: Moderate Practice, 4: High Practice, 5: Very High Practice.

4.4.4. Students' opinion about additional anti-COVID-19 measures

Students were asked about their opinion concerning additional safety measures such as implementing TC at the school entrance and SVC, creating an SN, and reopening the CS.

Figure 4.11 provides a synthesis of the student's opinions about the suggested additional safety measures. It could be observed that students were more favorable to the CS reopening (4.37 ± 0.96) and less favorable to the SVC implementation (3.29 ± 1.57). More than 50% of students "strongly agree" with additional measures (CS: 87%, TC: 73%, SN: 68%) except for SVC (50%). Neutral responses were higher for SVC application (20%), same to "disagree" and "strongly disagree" responses (30%). This opinion is related to privacy concerns. The high approval of the CS reopening illustrated the difficulty of group work in the current situation. Only 6% of respondents "disagree" to "strongly disagree" with CS reopening.

A high mean value for TC acceptance is observed (4.05 ± 1.15). Students feel the importance of controlling body temperature at the building entrance. Furthermore, only 17% of students "disagree" to "strongly disagree" with the SN creation. The mean value was 3.88 ± 1.22 . This result reflects student's enthusiasm for SN creation. Such a network will help to share COVID-19 updates and to allocate the surrounding positive COVID-19 cases.

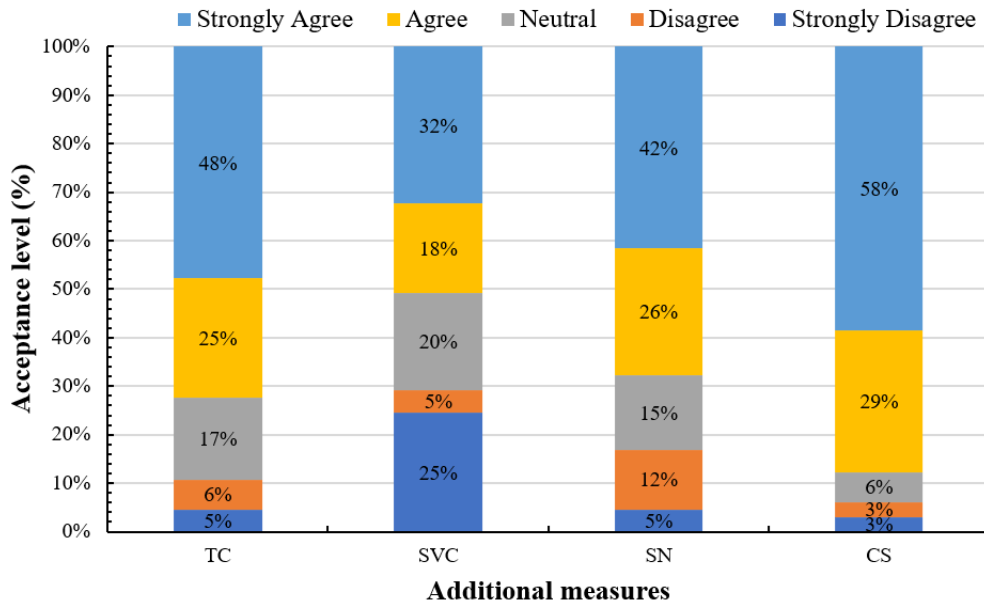

Figure 4.11: Students' opinion about additional safety measures

Influence of students' profile: Table 4.5 and figure 4.12 show that the students' opinions about additional anti-COVID-19 measures depend on their profile. A statistically significant difference is observed based on gender concerning student's opinions for the suggested measures ($F=4.27$, $P=0.04$). The highest difference between males and females concerns SVC (males: 3, females: 5). 33% of males and 22% of females did not approve of the idea of installing SVC. More than 64% of males and 70% of females "agree" to "strongly agree" with the TC, SN, and CS implementation. The lowest variance was recorded for both genders for CS (females: 0.61, males: 1.11). This result indicates that both genders have almost the same favorable judgment about CS reopening.

The level of education grouped box plot shows that master's degree students care more than bachelor's degree students about additional measures. The median seems similar for SN (4) and CS (5) in both degrees, but it differs for SVC and TC. The median weight is more pronounced for SVC (bachelor: 3, master: 4) than TC (bachelor: 4, master: 4.5). This result shows that master's and bachelor's degree students have approximately the same judgment about SN and CS. The assessment differs between them for TC and SVC. Especially in SVC, where the responses are highly scattered among different scales.

Students using the TousAntiCovid application were more favorable for applying TC and SN than other students. 5% of students using the mobile application "disagree" with the SN implementation, while 21% of other students "disagree" with this measure. For CS, respondents' concentration is around the median (5) for both groups.

Table 4.5: Influence of students' profile on acceptance of additional anti-Covid measures

Measures	Acceptance Level (%)					F	P-value
	1	2	3	4	5		

Gender										
	Female					Male				
TC	4	9	17	13	57	5	5	16	31	43
SVC	22	0	9	17	52	26	7	26	19	22
SN	0	4	22	22	52	7	17	12	28	36
CS	0	4	4	40	52	5	2	7	24	62
Education Degree										
	Bachelor					Master				
TC	5	7	21	21	46	4	4	11	31	50
SVC	23	5	26	15	31	27	4	11	23	35
SN	8	13	13	25	41	0	11	19	27	43
CS	5	5	5	26	59	0	0	7	35	58
Use of the TousAntiCovid mobile application										
	No					Yes				
TC	6	9	13	26	46	0	0	26	21	53
SVC	20	6	24	20	30	37	0	10	16	37
SN	6	15	11	31	37	0	5	26	16	53
CS	4	2	4	29	61	0	5	11	31	53

4.27 0.04*

1.32 0.25

0.38 0.54

*P<0.05; 1: Strongly Disagree, 2: Disagree, 3: Neutral, 4: Agree, 5: Strongly Agree.

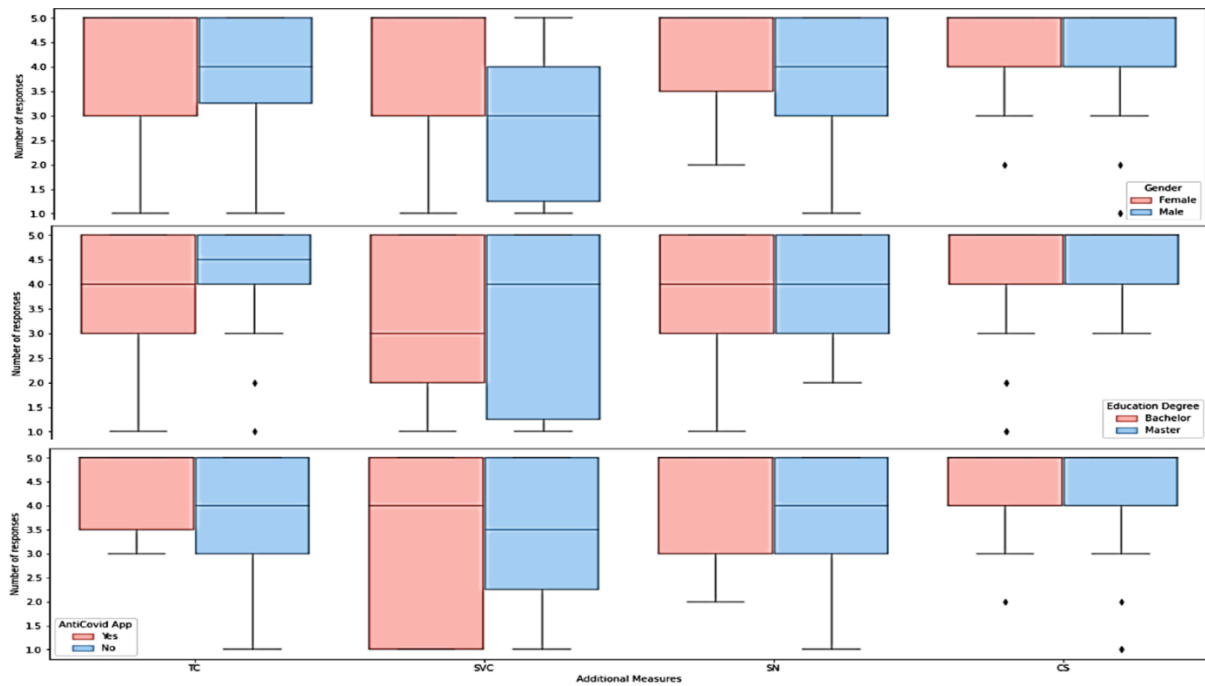

Figure 4.12: Influence of students' profile on their opinion about additional safety measures

4.5. Improvement of anti-COVID-19 measures

The improvement of anti-COVID-19 measures is based on the analysis of students' evaluation and suggestions. The improvement concerns measure with low rating scores, additional measures with high scores, and extensive BIM and smart technology use. Figure 4.13 summarizes the methodology followed to improve the anti-COVID-19 measures. The BIM model is used to (1) assess the physical distancing in CS; (2) check the spaces' capacities; (3) evaluate the anti-COVID-19 measures; (4) design new spaces configuration with enhanced safety measures.

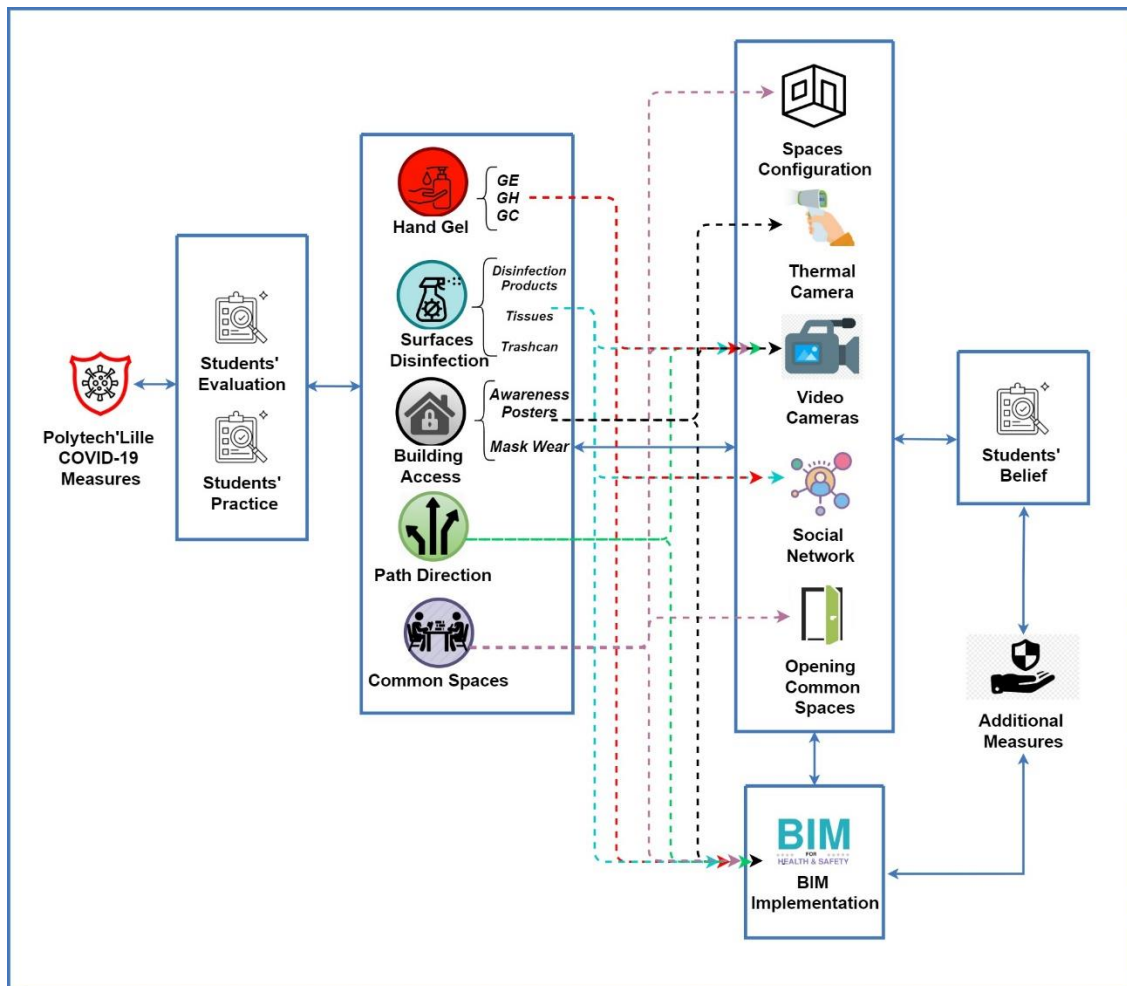

Figure 4.13: Methodology to improve anti-COVID-19 measures.

The optimization of the classroom capacity was conducted using the Open BIM COVID-19 (OBC-19) application, which complies with safety COVID-19 regulations stated by governments worldwide (Cype, 2020). Table 4.6 summarizes the results of the use of this application in some classrooms. It could be observed that the capacity of some classrooms could be increased by 30%. Figure 4.14 illustrates the change in the desk configuration according to the OBC-19 application. The desks are redistributed in a way to respect the SD.

Table 4.6: Classroom capacity improvement using BIM (OBC-19) application

Rooms	Initial capacity	Capacity according to anti-COVID measures	Optimized capacity using BIM (OBC-19)	Increase in the capacity (%)
Amphi LeBon	120	60	60	0
A 203	32	15	20	33
A 207	42	18	21	17
A 209	60	32	32	0

A 211	59	26	28	7
A 306	22	13	15	15
A 319	68	49	24	29

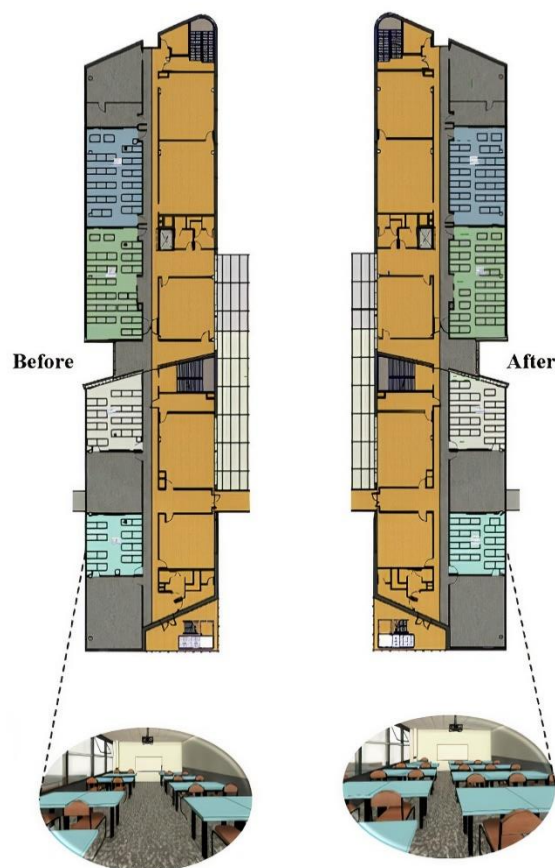

Figure 4.14: Architectural rooms configuration before and after BIM implementation

Figure 4.15 shows the improvement in measures related to hand sanitizers, DP, tissues, and trashcans. Hand gel dispensers should be available at the school entrance, in the hall, and in classrooms. Some students suggested providing masks and gloves. The three safety components are placed at the gate in the new BIM design. GH was improved by placing the hand gel dispensers at specific locations (e.g., next to the elevators, coffee machines, and vending machines). The measures are placed on each door for rooms with two doors to remind students to disinfect surfaces before and after the class and use hand gels frequently.

The school postured some anti-COVID-19 instructions. Unfortunately, awareness posters were not well distributed in the hall. Consequently, we smartly placed the boards (at the entrance and next to the stairs) to remind students about anti-COVID-19 measures. The general awareness advice includes the interpersonal safety distance, how they should wash their hands, avoid touching their faces, recommendations when coughing and sneezing, and the obligation to wear masks. In addition, some indications were located to inform the students about the

facilities' capacity and guide students in their directions. The awareness instructions were also placed in corridors and postured on classroom walls to remind the students about safety measures even during classes.



Figure 4.15: Improvement in Anti-COVID measures

A new indoor circulation plan was proposed because about 50% of the students were unsatisfied with the PD organization. Polytech'Lille hall signs were limited to specify the entrance and exit doors, stairs way, and physical distancing signs for the vending machines' area. The improvement includes path planning for hall circulation (two-way directions) to reduce students' crossing and gathering. Queue distance marks were used to provide a physical distancing of 1 m at crowding places such as WCs and vending machines. Figure 4.16 illustrates the hall architecture layout after the optimal BIM-based design for COVID-19 spread mitigation.

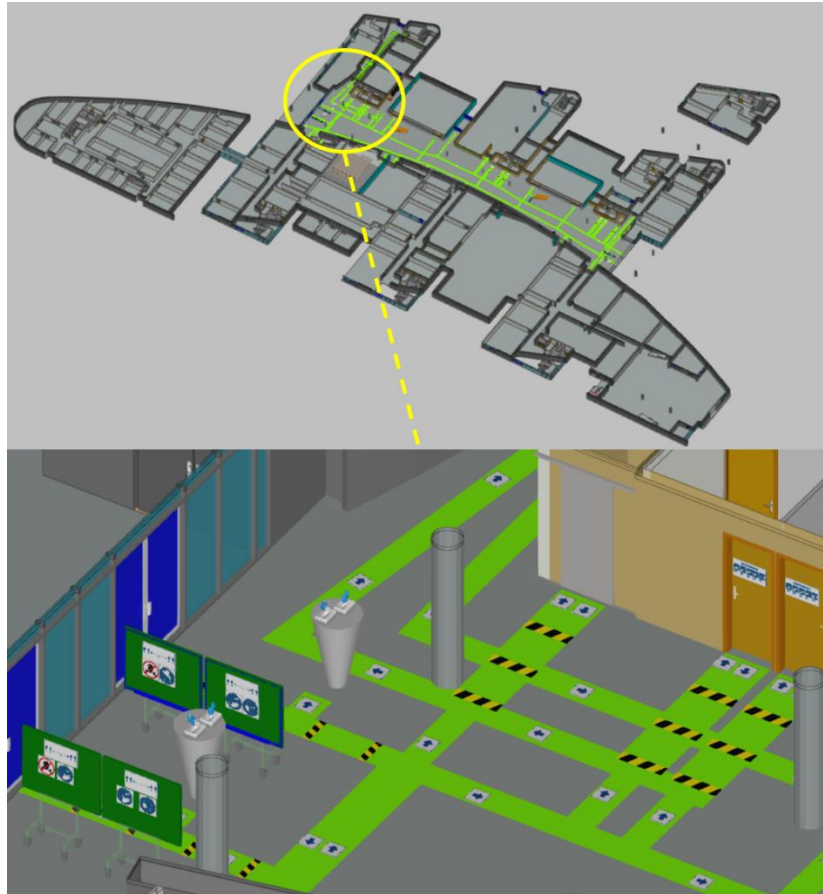

Figure 4.16: Entrance architecture safety layout after the optimal BIM-based design for COVID-19 spread mitigation

4.6. Recommendations for additional measures

This section presents an analysis of the student's opinion about the digital extension of anti-COVID measures, including the use of TC at the school entrance and SVC in the shared space, as well as the creation of a students' SN to share information, awareness, and suggestions to improve both the safety and a collective life in the COVID period.

4.6.1. Thermal Camera (TC)

Fever is one of the initial and most common symptoms of the COVID-19 virus. Temperature screening has become a powerful COVID-19 detection tool (Wright & MacKowiak, 2021). 73% of students “agree” to “strongly agree” with the use of TC at the building entrance. However, this use is insufficient to detect COVID-19 positive cases, especially for individuals between 18 and 25 years. In addition, around half of infected persons are asymptomatic (Oran & Topol, 2020). A survey of 84 COVID-19 patients with a median age of 21 showed that 83% of patients did not exhibit fever, and 11% exhibited fever during one day (Bielecki et al., 2020). Other limitations are related to TC devices that contribute to false values, in particular (1) the necessity of a calibration process; (2) the correlation between facial skin and core temperature; and (3) the influence of the site environment (Buoite Stella et al., 2020).

4.6.2. Surveillance Cameras (SVC)

SVC is helpful to check in real-time students' respect of safety measures. CCTV can monitor the following safety measures: wearing masks, physical distancing, hand gels and DP use, indoor circulation paths, and room occupancy number. CCTV should be installed in different spaces: building entrance shared spaces and circulation areas. Besides, CCTV could be oriented to hand gels and DP to identify the refill need. Only half of the students "agree" to "strongly agreed" with SVC use, even without facial recognition.

According to French regulation, cameras in an educational institution are limited to the building entrance and circulation areas. The law protects individual privacy (Abas et al., 2014). Access to videos is allowed to authorized people only in case of an incident check. Authorized people must be trained about using video surveillance systems (EDPB, 2019; Socha & Kogut, 2020). Therefore, the SVC access to check students' practice for safety measures is still unauthorized.

4.6.3. Social Network (SN)

68% of students "agree" to "strongly agree" to implement an anti-COVID-19 SN. This network will enable students to (1) interact between them; (2) identify COVID-19 positive cases; (3) share news about the COVID-19 situation; (4) optimize the use of the school facilities; and (5) share suggestions about improving anti-COVID-19 measures.

4.7. Conclusion

This thesis presented a comprehensive methodology for evaluating and improving the anti-COVID-19 measures in higher education establishments. This methodology combines BIM and questionnaires to collect the students' feedback about the safety measures and suggest improvements. This methodology was applied at the engineering school Polytech'Lille in the North of France. It should be noted that this system could be generalized for other viruses that have the same mode of transmission.

The main results of this research could be summarized as follows:

- The integration of the anti-COVID-19 measures in the BIM model allowed the school administration to access a 3D graphical environment the totality of the safety measures to check their compatibility. The use of BIM allowed an extension of the capacity of some classrooms while respecting safety measures. The capacity of some classrooms was increased by about 30 %. The indoor circulations paths were improved using both the students' evaluation and the BIM model.
- The use of the questionnaire proved to be efficient in collecting students' feedback about the safety measures and their commitment to these measures. It also allowed collecting data about the students' suggestions to improve the safety measures. The questionnaire provided information about the students' commitment to implemented safety measures and their opinion about additional digital safety measures.
- Data analysis showed a higher commitment of students to disinfection measures than to access safety measures. The highest students' commitment concerned hand sanitizers, while the lowest commitment concerned the respect of imposed PD.

- Concerning the additional safety measures, students were favorable for common spaces reopening, using TC at the school entrance, and creating an anti-COVID-19 SN. Still, they did not support the use of SVC.

As limitations, the study and the questionnaire distribution were done during the lockdown. Therefore, the number of participants in the project were limited. In future studies, the number of students participating in the survey should be increased to refine their assessment of anti-COVID safety measures and their suggestions to improve these measures. Moreover, the IoT smart sensors should be placed in the building to enhance the monitoring system.

General Conclusion and Perspectives

Multi indoor hazard are really a source of danger for buildings. The management of these hazard is a complex issue due to the interdependence between the social and the technical aspects. To overcome this complexity, this thesis presented a smart indoor hazards management platform based on smart technologies, including IoT, BIM, and AI. This system's originality consists of its ability to interact with users via a mobile application to provide relevant information regarding suspicious incidents. This system can manage several hazards through an integrated smart framework by detecting, preventing, and monitoring hazard events based on a smart system architecture layer: data collection, data processing, data analysis, control layer, and smart services. BIM is an added value for the system as it offers the great capacity to (i) identify hazard location and type, (ii) visualize environmental data and occupant's localization, and (iii) take required actions. On the other hand, it highlighted the AI's power to detect early and prevent abnormal situations based on historical data. The system was applied for the management of fire hazards and health hazards (COVID-19).

A comprehensive fire evacuation system was developed in this research. The system can (i) detect a fire early, (ii) collect and analyze the environmental data provided by sensors, (iii) locate occupants, and (iv) provide users with the optimal evacuation paths. This system is based on the combination of several technologies and simulation tools. IoT and smart technology are used to detect fire and reduce false detection early. FDS is used to simulate fire scenarios and ABS for crowd simulation and evacuation paths generation. Both FDS and ABS provide a database that is used for the smart selection of evacuation paths in real-time using AI.

Moreover, this study highlighted the importance of BIM tools for (i) visualizing environmental data in a 3D model, (ii) tracking occupants in real-time, and (iii) alerting occupants and providing them with the optimal evacuation paths. The capacity of the system was illustrated through its application to a research building-LGCgE laboratory of Lille University. Two fire scenarios were presented to demonstrate the evacuation simulation layer preparation. They show how the fire location, type, and severity impact the occupants' selection for the evacuation routes. Moreover, the results of the system output were well presented through the application.

The system was adapted for the management of COVID-19 hazards in higher education establishments. The adaptation combined both the use of BIM and a questionnaire to collect the students' opinions and suggestions about the anti-COVID-19 measurements. The application of this system to Polytech'Lille showed (i) The integration of the anti-COVID-19 measures in the BIM model allowed the school administration to access in a 3D graphical environment the totality of the safety measures to check their compatibility. BIM allowed an extension of the capacity of some classrooms while respecting safety measures. The capacity of some classrooms was increased by about 30 %. The indoor circulations paths were improved using both the students' evaluation and the BIM Model. (ii) The use of the questionnaire proved to be efficient in collecting students' feedback about the safety measures and their commitment to these measures. It also allowed collecting data about the students' suggestions to improve the safety measures. The questionnaire provided information about the students' commitment to implemented safety measures and their opinion about additional digital safety

measures. (iii) Data analysis showed a higher commitment of students to disinfection measures than to access safety measures

Future work on fire evacuation systems could focus on establishing a dataset about the best evacuation paths during fire events in critical locations of the building. This dataset will be used with the ML technics for a real-time determination of the best evacuation paths in complex buildings. Finally, the COVID-19 study could be applied to other building types such as business buildings as well as hospitals.

References

1. Abas, K., Porto, C., & Obraczka, K. (2014). Wireless smart camera networks for the surveillance of public spaces. *Computer*, 47(5), 37–44. <https://doi.org/10.1109/MC.2014.140>
2. Ahmed, I., Ahmad, M., Rodrigues, J. J. P. C., Jeon, G., & Din, S. (2021). A deep learning-based social distance monitoring framework for COVID-19. *Sustainable Cities and Society*, 65(September). <https://doi.org/10.1016/j.scs.2020.102571>
3. Akhtarul Islam, M., Barna, S. D., Raihan, H., Nafiul Alam Khan, M., & Tanvir Hossain, M. (2020). Depression and anxiety among university students during the COVID-19 pandemic in Bangladesh: A web-based cross-sectional survey. *PLoS ONE*, 15(8), 1–12. <https://doi.org/10.1371/journal.pone.0238162>
4. Akin, Ö., Mert, B., Eroglu, Ö., Arslan, M., Şeker, D. Z., & Demirel, H. (2018). The Role of Spatial Data in Building Information Modelling. *Journal of the Institute of Science and Technology*, 8(3), 137–143. <https://doi.org/10.21597/jist.458612>
5. Al Shereiqli, I., & Sohail, M. (2020). Smart Fire Alarm System Using IoT. *Journal of Student Research*, 1–9. <https://doi.org/10.47611/jsr.vi.882>
6. Alzoubi, H., Alnawaiseh, N., Al-Mnayyis, A., Abu-Lubad, M., Aqel, A., & Al-Shagahin, H. (2020). Covid-19 - Knowledge, attitude and practice among medical and non-medical university students in Jordan. *Journal of Pure and Applied Microbiology*, 14(1), 17–24. <https://doi.org/10.22207/JPAM.14.1.04>
7. Anandhakrishnan, S., Deepesh, N., Rakesh, S., & Gayathri, N. (2017). IOT Based Smart Gas Monitoring System. *Emerging Research Trends in Electrical, Electronics & Instrumentation*, 82–87. www.iosrjournals.org
8. APUAF. (2020, October 5). French University Update – October 5, 2020. *Association Des Programmes Universitaires Americains En France*. <https://www.apuaf.org/french-university-update-october-5-2020/>
9. Armstrong, M. (2020). *The Vital Importance of Social Distancing*. Statista. <https://www.statista.com/chart/21198/effect-of-social-distancing-signer-lab/>
10. Arthur, P., & Passini, R. (1992). *Wayfinding: People, Signs, and Architecture*.
11. Atila, U., Ortakci, Y., Ozacar, K., Demiral, E., & Rakip Karas, I. (2018). SmartEscape: A mobile smart individual fire evacuation system based on 3D spatial model. *ISPRS International Journal of Geo-Information*, 7(223), 1–19. <https://doi.org/10.3390/ijgi7060223>
12. Atlas, R. I. (2018). *Building Resilience: Crime Prevention Through Environmental Design*. Whole Building Design Guide. <https://www.wbdg.org/resources/crime-prevention-environmental-design>
13. Azhar, S., Khalfan, M., & Maqsood, T. (2012). Building Information Modeling (BIM): Now and Beyond. *Construction Economics and Building*, 12(4), 15–28. <https://doi.org/10.5130/AJCEB.v12i4.3032>
14. Azizi, N., Copeland, A., Chun, J., Ell, M., Kanani, K., & Khoury, Z. (2016). A Study of Methane Sensors in Internet-of-Things Technology. *National Fire Protection Association*, 1–9.
15. Bagwe, C., Ghadi, V., Naik, V., & Kunte, N. (2018). IOT Based Gas Leakage Detection System With Database Logging, Prediction And Smart Alerting. In *IOSR Journal of Engineering (IOSRJEN)* www.iosrjen.org ISSN (Vol. 13). www.iosrjen.org
16. Bales, D., Tarazaga, P. A., Kasarda, M., Batra, D., Woolard, A. G., Poston, J. D., & Malladi, V. V. N. S. (2016). Gender Classification of Walkers via Underfloor

- Accelerometer Measurements. *IEEE Internet of Things Journal*, 3(6), 1259–1266. <https://doi.org/10.1109/JIOT.2016.2582723>
17. Bansal, V. K. (2011). Application of geographic information systems in construction safety planning. *International Journal of Project Management*, 29(1), 66–77. <https://doi.org/10.1016/j.ijproman.2010.01.007>
 18. Barradas, I., Garza, L. E., Morales-Menendez, R., & Vargas-Martínez, A. (2009). *Leaks Detection in a Pipeline Using Artificial Neural Networks*.
 19. Beaudrie, D. (2017). *7 Common Causes of House Fires and How to Prevent Them*. The Spruce. <https://www.thespruce.com/causes-of-house-fires-1835107>
 20. Begg, R., & Hassan, R. (2006). Artificial neural networks in Smart Homes. *Lecture Notes in Computer Science (Including Subseries Lecture Notes in Artificial Intelligence and Lecture Notes in Bioinformatics)*, 4008 LNAI, 146–164.
 21. Bielecki, M., Cramer, G. A. G., Schlagenhaut, P., Buehrer, T. W., & Deuel, J. W. (2020). Body temperature screening to identify SARS-CoV-2 infected young adult travellers is ineffective. *Travel Medicine and Infectious Disease*, 37(101832). <https://doi.org/10.1016/j.tmaid.2020.101832>
 22. Brown, R. (2015). Explaining the property crime drop: The offender perspective. In *Trends & issues in crime and criminal justice* (pp. 1–7). Australian Government.
 23. Brushlinsky, N., Ahrens, M., Sokolov, S., & Wagner, P. (2017). *World Fire Statistics*.
 24. Buoite Stella, A., Manganotti, P., Furlanis, G., Accardo, A., & Ajčević, M. (2020). Return to school in the COVID-19 era: considerations for temperature measurement. *Journal of Medical Engineering and Technology*, 44(8), 468–471. <https://doi.org/10.1080/03091902.2020.1822941>
 25. Buonanno, G., Stabile, L., & Morawska, L. (2020). Estimation of airborne viral emission: Quanta emission rate of SARS-CoV-2 for infection risk assessment. *Environment International*, 141, 105794. <https://doi.org/https://doi.org/10.1016/j.envint.2020.105794>
 26. Bureau of Labor Statistics. (2018). *National Census of Fatal Occupational Injuries in 2017*. www.bls.gov/iif/oshcfoi1.htm
 27. BusinessLine. (2017). *Fire breaks out in Stephen Court building*. BusinessLine. <https://www.thehindubusinessline.com/economy/Fire-breaks-out-in-Stephen-Court-building/article20424284.ece>
 28. BusinessWire. (2020). *Global Intrusion Detection System/Intrusion Prevention System Industry to 2027 - Market Trajectory & Analytics - ResearchAndMarkets.com*. BusinessWire. <https://www.businesswire.com/news/home/20200610005563/en/Global-Intrusion-Detection-SystemIntrusion-Prevention-System-Industry-to-2027---Market-Trajectory-Analytics---ResearchAndMarkets.com>
 29. Chen, J. (2020). Pathogenicity and transmissibility of 2019-nCoV—A quick overview and comparison with other emerging viruses. *Microbes and Infection*, 22(2), 69–71. <https://doi.org/10.1016/j.micinf.2020.01.004>
 30. Chen, L.-K., Yuan, R.-P., Ji, X.-J., Lu, X.-Y., Xiao, J., Tao, J.-B., Kang, X., Li, X., He, Z.-H., Quan, S., & Jiang, L.-Z. (2021). Modular composite building in urgent emergency engineering projects: A case study of accelerated design and construction of Wuhan Thunder God Mountain/Leishenshan hospital to COVID-19 pandemic. *Automation in Construction*, 124(2021), 103555. <https://doi.org/https://doi.org/10.1016/j.autcon.2021.103555>
 31. Chen, X. S., Liu, C. C., & Wu, I. C. (2018). A BIM-based visualization and warning system for fire rescue. *Advanced Engineering Informatics*, 37, 42–53.

- <https://doi.org/10.1016/j.aei.2018.04.015>
32. Cheng, C. H., Chow, C. L., & Chow, W. K. (2021). A simulation study of tenability for passengers in a railway tunnel with arson fire. *Tunnelling and Underground Space Technology*, 108(October 2020), 103679. <https://doi.org/10.1016/j.tust.2020.103679>
 33. Cheng, M.-Y., Chiu, K.-C., Hsieh, Y.-M., Yang, I.-T., & Chou, J.-S. (2016, October 2). Development of BIM-Based Real-time Evacuation and Rescue System for Complex Buildings. *Proceedings of the 33rd International Symposium on Automation and Robotics in Construction (ISARC)*. <https://doi.org/10.22260/isarc2016/0120>
 34. Cheng, M. Y., Chiu, K. C., Hsieh, Y. M., Yang, I. T., Chou, J. S., & Wu, Y. W. (2017). BIM integrated smart monitoring technique for building fire prevention and disaster relief. *Automation in Construction*, 84, 14–30. <https://doi.org/10.1016/j.autcon.2017.08.027>
 35. Cheng, S. Y., Wang, C. J., Shen, A. C. T., & Chang, S. C. (2020). How to Safely Reopen Colleges and Universities During COVID-19: Experiences From Taiwan. *Annals of Internal Medicine*, 173(8), 638–641. <https://doi.org/10.7326/M20-2927>
 36. Cheung, W. F., Lin, T. H., & Lin, Y. C. (2018). A real-time construction safety monitoring system for hazardous gas integrating wireless sensor network and building information modeling technologies. *Sensors (Switzerland)*, 18(2). <https://doi.org/10.3390/s18020436>
 37. Choi, J., Haj-Ali, R., & Kim, H. S. (2012). Integrated fire dynamic and thermomechanical modeling of a bridge under fire. *Structural Engineering and Mechanics*, 42(6), 815–829. <https://doi.org/10.12989/sem.2012.42.6.815>
 38. Cociorva, S., & Iftene, A. (2017). Indoor Air Quality Evaluation in Intelligent Building. *Energy Procedia*, 112, 261–268. <https://doi.org/10.1016/j.egypro.2017.03.1095>
 39. Crowe, T., & Fennelly, L. (2013). *Crime Prevention Through Environmental Design* (3rd ed.). Elsevier.
 40. CSSE. (2021). *COVID-19 Dashboard by the Center for Systems Science and Engineering (CSSE)*. Center for Systems Science and Engineering (CSSE). <https://coronavirus.jhu.edu/map.html>
 41. Cype. (2020). *Open BIM COVID-19*. http://www.cype.net/manuales/open_bim_covid_19/open_bim_covid-19_en.pdf
 42. Dai, H., & Zhao, B. (2020). Association of the infection probability of COVID-19 with ventilation rates in confined spaces. *Building Simulation*, 13(6), 1321–1327. <https://doi.org/10.1007/s12273-020-0703-5>
 43. Davies, R. (2017). The internet of things Opportunities and challenges. In *European Parliament* (Vol. 15, Issue 1). <https://doi.org/10.1002/9781119561477.ch11>
 44. Davis, C. P. (2017). *What's Causing Your Indoor Air Pollution?* OnHealth. https://www.onhealth.com/content/1/indoor_air_pollution
 45. De Paola, A., Ortolani, M., Lo Re, G., Anastasi, G., & Das, S. K. (2014). Intelligent management systems for energy efficiency in buildings: A survey. In *ACM Computing Surveys* (Vol. 47, Issue 1). Association for Computing Machinery. <https://doi.org/10.1145/2611779>
 46. Delval, T., Sauvage, C., Jullien, Q., Viano, R., Diallo, T., Collignan, B., & Picinbono, G. (2021). A BIM-Based Approach to Assess COVID-19 Risk Management Regarding Indoor Air Ventilation and Pedestrian Dynamics. *International Journal of Civil and Environmental Engineering*, 15(4), 187–196.
 47. Desvaux de Marigny, V., & Keli, S. (2020). *Smart Building : comment l'IoT contribue au confort, à la sécurité et à l'hygiène sur le lieu de travail ?* Le Blog Des Octos. <https://blog.octo.com/tag/covid-19/>

48. Ding, L. Y., Zhong, B. T., Wu, S., & Luo, H. B. (2016). Construction risk knowledge management in BIM using ontology and semantic web technology. *Safety Science*, 87, 202–213. <https://doi.org/10.1016/j.ssci.2016.04.008>
49. Djenouri, D., Laidi, R., Djenouri, Y., & Balasingham, I. (2019). Machine learning for smart building applications: Review and taxonomy. *ACM Computing Surveys*, 52(2). <https://doi.org/10.1145/3311950>
50. Doremalen, N., Bushmaker, T., & Morris, D. (2020). Aerosol and Surface Stability of SARS-CoV-2 as Compared with SARS-CoV-1. *New England Journal of Medicine*, 382(12), 1177–1179. <https://pubmed.ncbi.nlm.nih.gov/32182409/>
51. Dubourg, R., & Hamed, J. (2005). *The economic and social costs of crime against individuals and households 2003/04*.
52. Durán-Vega, L. A., Santana-Mancilla, P. C., Buenrostro-Mariscal, R., Contreras-Castillo, J., Anido-Rifón, L. E., García-Ruiz, M. A., Montesinos-López, O. A., & Estrada-González, F. (2019). An IoT System for Remote Health Monitoring in Elderly Adults through a Wearable Device and Mobile Application. *Geriatrics*, 4(2), 34. <https://doi.org/10.3390/geriatrics4020034>
53. Dutta, A. (2011). *At least 89 killed in Kolkata hospital fire*. Mint. <https://www.livemint.com/Politics/tZcRjGyGk5F5HH2eVMKcqN/At-least-89-killed-in-Kolkata-hospital-fire.html>
54. Dziak, D., Jachimczyk, B., & Kulesza, W. J. (2017). IoT-based information system for healthcare application: Design methodology approach. *Applied Sciences (Switzerland)*, 7(6). <https://doi.org/10.3390/app7060596>
55. ECB. (2020). *ECB Video Surveillance Policy 15* (Issue September).
56. EDPB. (2019). *Guidelines 2/2019 on the processing of personal data under Article 6(1)(b) GDPR in the context of the provision of online services to data subjects* (Vol. 6, Issue April). https://edpb.europa.eu/sites/edpb/files/consultation/edpb_draft_guidelines-art_6-1-b-final_public_consultation_version_en.pdf
57. Elmore, P. B., & Woehlke, P. L. (1998). Twenty Years of Research Methods Employed in “American Educational Research Journal,” “Educational Researcher,” and “Review of Educational Research. In *American Educational Research Journal*.
58. ELProcus. (2014). *Types of Faults and Effects in Electrical Power Systems*. ELprocus. <https://www.elprocus.com/what-are-the-different-types-of-faults-in-electrical-power-systems/>
59. EPA. (1997). *An Office Building Occupant’s Guide to Indoor Air Quality* www “An Office Building Occupant’s Guide to Indoor Air Quality. Office of Air Radiation.
60. Erceg-Hurn, D. M., & Mirosevich, V. M. (2008). Modern Robust Statistical Methods: An Easy Way to Maximize the Accuracy and Power of Your Research. *American Psychologist*, 63(7), 591–601. <https://doi.org/10.1037/0003-066X.63.7.591>
61. ESFI. (2015). *Home Electrical Fires*. ESFI. <https://www.esfi.org/resource/home-electrical-fires-184>
62. EWHAP. (2020). *Immediate Effects of Indoor Air Pollution*. Econo West Heating, Air & Plumbing. <https://www.econowestair.com/indoor-air-pollution-has-both-short-and-long-term-effects-on-your-health/>
63. Feeds. (2017). *Residential Electrical Safety How to ensure progress?* Fisuel. https://www.europeanfiresafetyalliance.org/wp-content/uploads/2017/06/FEEDS_rev-OT.pdf
64. Fridolf, K., Andree, K., Nilsson, D., & Frantzich, H. (2013). The impact of smoke on walking speed. *Fire and Materials*, 38(7), 744–759. <https://doi.org/10.1002/fam.2217>

65. Fu, M., & Liu, R. (2020). BIM-based automated determination of exit sign direction for intelligent building sign systems. *Automation in Construction*, 120(February). <https://doi.org/10.1016/j.autcon.2020.103353>
66. Galvez, D. (2018). *Fire hits industrial building in Valenzuela City*. Sections. <https://newsinfo.inquirer.net/1061938/fire-hits-industrial-building-in-valenzuela-city>
67. Gan, V. J. L., Deng, M., Tan, Y., Chen, W., & Cheng, J. C. P. (2019). BIM-based framework to analyze the effect of natural ventilation on thermal comfort and energy performance in buildings. *Energy Procedia*, 158, 3319–3324. <https://doi.org/10.1016/j.egypro.2019.01.971>
68. Gasparri, S., Cippitelli, E., Spinsante, S., & Gambi, E. (2014). A depth-based fall detection system using a Kinect® sensor. *Sensors (Switzerland)*, 14(2), 2756–2775. <https://doi.org/10.3390/s140202756>
69. Gerges, M., Demian, P., & Adamu, Z. (2021). Customising evacuation instructions for high-rise residential occupants to expedite fire egress: Results from agent-based simulation. *Fire*, 4(2), 1–18. <https://doi.org/10.3390/fire4020021>
70. Ginta, D. (2017). *What Symptoms Can a Gas Leak Cause?* Healthline. <https://www.healthline.com/health/gas-leak-symptoms>
71. Giusto, D., Iera, A., Morabito, G., & Atzori, L. (2014). *The Internet of Things: 20th Tyrrhenian Workshop on Digital Communications* (Daniel Giusto, A. Iera, G. Morabito, & L. Atzori (eds.); 1st ed.). Springer-Verlag.
72. Godager, B. (2011). Analysis of the Information Needs for Existing Buildings for Integration in Modern Bim-Based Building Information Management. *The 8th International Conference "Environmental Engineering,"* 886–892. <http://old.vgtu.lt/leidiniai/leidykla/Enviro2011/Abstracts/4/153.html%5Cnhttp://enviro.vgtu.lt>
73. Gogoi, P. (2020). Application of SPSS Programme in the Field of Social Science Research. *International Journal of Recent Technology and Engineering*, 8(5), 2424–2427. <https://doi.org/10.35940/ijrte.d9260.018520>
74. Green, J. L., Camilli, G., & Elmore, P. B. (2012). Handbook of complementary methods in education research. *Handbook of Complementary Methods in Education Research*, May, 1–865. <https://doi.org/10.4324/9780203874769>
75. Gressman, P. T., & Peck, J. R. (2020). Simulating COVID-19 in a university environment. *Mathematical Biosciences*, 328(108436). <https://doi.org/10.1016/j.mbs.2020.108436>
76. Grytting, I., Svalestuen, F., Lohne, J., Sommerseth, H., Augdal, S., & Laedre, O. (2017). Use of LoD decision plan in BIM-projects. *Science Direct*, 196(2017), 407–414.
77. Guan, W., Ni, Z., Hu, Y., Liang, W., Ou, C., He, J., Liu, L., Shan, H., Lei, C., Hui, D. S. C., Du, B., Li, L., Zeng, G., Yuen, K.-Y., Chen, R., Tang, C., Wang, T., Chen, P., Xiang, J., ... Zhon, N. (2021). Clinical characteristics of 2019 novel coronavirus infection in China. *New England Journal of Medicine*, 58(March), 134–142. <https://doi.org/10.1101/2020.02.06.20020974>
78. Gulve, S. P., Khoje, S. A., & Pardeshi, P. (2017). Implementation of IoT-based smart video surveillance system. *Advances in Intelligent Systems and Computing*, 556, 771–780. https://doi.org/10.1007/978-981-10-3874-7_73
79. Guo, Y., Proctor, R., & Salvendy, G. (2009). What Do Users Want to See? A Content Preparation Study for Consumer Electronics. In *Human-Computer Interaction (HCI Intern*, pp. 1–909). Springer.
80. Gupta, S. P., & Pandey, U. K. (2018). Automatic and intelligent integrated system for

- leakage detection in pipes for water distribution network using internet of things. *Smart Innovation, Systems and Technologies*, 83, 516–523. https://doi.org/10.1007/978-3-319-63673-3_62
81. Hafiz Kadar, H., Syarmila Sameon, S., & Rusli, M. E. (2018). SMART2L: Smart Water Level and Leakage Detection. In *International Journal of Engineering & Technology*. www.sciencepubco.com/index.php/IJET
 82. Hall, J. R. (2013). *Deaths and Injuries Due To Non-Fire Exposure to Gases*. www.cpsc.gov.
 83. Hatcher, J. (2020). *COVID-19: Why the smart building market is in a unique position to help*. Smart Buildings Magazine. <https://smartbuildingsmagazine.com/features/covid-19-why-the-smart-building-market-is-in-a-unique-position-to-help>
 84. Heinisch, O. (1965). Cochran, W. G.: Sampling Techniques, 2. Aufl. John Wiley and Sons, New York, London 1963. Preis s. *Biometrische Zeitschrift*, 7(3), 203. <https://doi.org/https://doi.org/10.1002/bimj.19650070312>
 85. Hopkin, C., Spearpoint, M. & Hopkin, D. (2019). A Review of Design Values Adopted for Heat Release Rate Per Unit Area. *Fire Technology*, 55, 1599–1618. <https://doi.org/10.1007/s10694-019-00834-8>
 86. Hopkins, J. (2020). *Vital Signs (Body Temperature, Pulse Rate, Respiration Rate, Blood Pressure)*. Johns Hopkins Medicine. <https://www.hopkinsmedicine.org/health/conditions-and-diseases/vital-signs-body-temperature-pulse-rate-respiration-rate-blood-pressure>
 87. Hsu, W. L., Ho, C. Y., Liang, C. K., Shiau, Y. C., Hsieh, H. N., & Lai, S. C. (2019). Application of IoT in the prevention of carbon monoxide poisoning. *Sensors and Materials*, 31(11), 3465–3482. <https://doi.org/10.18494/SAM.2019.2482>
 88. Hsu, Y. L., Chou, P. H., Chang, H. C., Lin, S. L., Yang, S. C., Su, H. Y., Chang, C. C., Cheng, Y. S., & Kuo, Y. C. (2017). Design and implementation of a smart home system using multisensor data fusion technology. *Sensors (Switzerland)*, 17(7). <https://doi.org/10.3390/s17071631>
 89. Huang, C., Wang, Y., Li, X., Ren, L., Zhao, J., Hu, Y., Zhang, L., Fan, G., Xu, J., Gu, X., Cheng, Z., Yu, T., Xia, J., Wei, Y., Wu, W., Xie, X., Yin, W., Li, H., Liu, M., ... Cao, B. (2020). Clinical features of patients infected with 2019 novel coronavirus in Wuhan, China. *The Lancet*, 395(10223), 497–506. [https://doi.org/10.1016/S0140-6736\(20\)30183-5](https://doi.org/10.1016/S0140-6736(20)30183-5)
 90. ILO, FAO, IFAD, & WHO. (2020). *Impact of COVID-19 on people's livelihoods, their health and our food systems*. World Health Organization; World Health Organization. <https://www.who.int/news/item/13-10-2020-impact-of-covid-19-on-people%27s-livelihoods-their-health-and-our-food-systems>
 91. ISO. (2009). *ISO 31000:2009 Risk management — Principles and guidelines* (1st ed.). ISO.
 92. Jennifer. (2017). *Water Leak Consequences on Home and Health*. The Plumbing Company of the Treasure Coast. <https://www.theplumbingco.net/water-leak-consequences-on-home-and-health/>
 93. Jevtić, R. B. (2016). Fire simulation in house conditions. *Tehnika*, 71(1), 160–166. <https://doi.org/10.5937/tehnika1601160j>
 94. Jeyaraj, P. R., & Nadar, E. R. S. (2019). Smart-Monitor: Patient Monitoring System for IoT-Based Healthcare System Using Deep Learning. *IETE Journal of Research*, 1–8. <https://doi.org/10.1080/03772063.2019.1649215>
 95. Jiehao, C., Jin, X., Daojiong, L., Zhi, Y., Lei, X., Zhenghai, Q., Yuehua, Z., Hua, Z.,

- Ran, J., Pengcheng, L., Xiangshi, W., Yanling, G., Aimei, X., He, T., Hailing, C., Chuning, W., Jingjing, L., Jianshe, W., & Mei, Z. (2020). A case series of children with 2019 novel coronavirus infection: Clinical and epidemiological features. *Clinical Infectious Diseases*, 71(6), 1547–1551. <https://doi.org/10.1093/cid/ciaa198>
96. Jožef, R. P., Institute, S., Dovgan, E., & Institute, J. S. (2011). *An Intelligent Indoor Surveillance System Fit4Work View project IN LIFE View project*. <http://www.ati.es/novatica/>
97. Kawa, N. (2015). *Gas Leaks Can't Be Tamed*. The Atlantic. <https://www.theatlantic.com/technology/archive/2015/09/gas-leaks-are-everywhere/405820/>
98. Khalil, N., Benhaddou, D., Gnawali, O., & Subhlok, J. (2016). Nonintrusive occupant identification by sensing body shape and movement. *Proceedings of the 3rd ACM Conference on Systems for Energy-Efficient Built Environments, BuildSys 2016*, 1–10. <https://doi.org/10.1145/2993422.2993429>
99. Khan, A., Aesha, A. A., Aka, J. S., Rahman, S. M. F., & Rahman, M. J. U. (2018). An IoT Based Intelligent Fire Evacuation System. *2018 21st International Conference of Computer and Information Technology, ICCIT 2018*, 1–6. <https://doi.org/10.1109/ICCITECHN.2018.8631945>
100. Khandoker, M. A. R., Mou, R. J., Muntaha, M. A., & Rahman, M. A. (2018). Numerical simulation of fire in a multistoried ready-made garments factory using PyroSim. *AIP Conference Proceedings*, 1980(050026), 1–8. <https://doi.org/10.1063/1.5044362>
101. KHK. (2016). Annual Report on Liquefied Petroleum Gas (LPG) Related Accidents. In *Information and International Affairs Department*. <http://www.khk.or.jp/english/index.html>
102. Kim, H.-Y. (2014). Analysis of variance (ANOVA) comparing means of more than two groups. *Restorative Dentistry & Endodontics*, 39(1), 74. <https://doi.org/10.5395/rde.2014.39.1.74>
103. Kim, S. C., Jeong, Y. S., & Park, S. O. (2013). RFID-based indoor location tracking to ensure the safety of the elderly in smart home environments. *Personal and Ubiquitous Computing*, 17(8), 1699–1707. <https://doi.org/10.1007/s00779-012-0604-4>
104. Klein, K. (2020). MASS Design Group outlines redesign strategies for restaurants following coronavirus. *Dezeen*. <https://www.dezeen.com/2020/05/29/mass-design-strategies-restaurants-in-response-to-coronavirus/>
105. Klote, J., Milke, J., Tumbull, P., Kashe, A., & Ferreira, M. (2012). Human Exposure to Smoke. In *Handbook of Smoke Control Engineering*. ICC, NFPA, and SFPE.
106. Kodali, R. K., Greeshma, R. N. V., Nimmanapalli, K. P., & Borra, Y. K. Y. (2018). IOT Based Industrial Plant Safety Gas Leakage Detection System. *2018 4th International Conference on Computing Communication and Automation (ICCCA)*, 1–5.
107. Kumar, A., Singh, A., Kumar, A., Singh, M. K., Mahanta, P., & Mukhopadhyay, S. C. (2018). Sensing Technologies for Monitoring Intelligent Buildings: A Review. In *IEEE Sensors Journal* (Vol. 18, Issue 12, pp. 4847–4860). Institute of Electrical and Electronics Engineers Inc. <https://doi.org/10.1109/JSEN.2018.2829268>
108. Kwolek, B., & Kepski, M. (2015). Improving fall detection by the use of depth sensor and accelerometer. *Neurocomputing*, 168, 637–645. <https://doi.org/10.1016/j.neucom.2015.05.061>
109. Leon, I., Sagarna, M., Mora, F., & Otaduy, J. P. (2021). BIM Application for

- Sustainable Teaching Environment and Solutions in the Context of COVID-19. *Sustainability*, 13(9), 4746. <https://doi.org/10.3390/su13094746>
110. Leonard, J. (2018). *How to recognize a gas leak*. Medical News Today. <https://www.medicalnewstoday.com/articles/321277>
 111. Li, J., Li, N., Afsari, K., Peng, J., Wu, Z., & Cui, H. (2019). Integration of Building Information Modeling and Web Service Application Programming Interface for assessing building surroundings in early design stages. *Building and Environment*, 153(February), 91–100. <https://doi.org/10.1016/j.buildenv.2019.02.024>
 112. Li, N., Yang, Z., Ghahramani, A., Becerik-Gerber, B., & Soibelman, L. (2014). Situational awareness for supporting building fire emergency response: Information needs, information sources, and implementation requirements. *Fire Safety Journal*, 63, 17–28. <https://doi.org/10.1016/j.firesaf.2013.11.010>
 113. Li, Q., Guan, X., Wu, P., Wang, X., Zhou, L., Tong, Y., Ren, R., Leung, K. S. M., Lau, E. H. Y., Wong, J. Y., Xing, X., Xiang, N., Wu, Y., Li, C., Chen, Q., Li, D., Liu, T., Zhao, J., Liu, M., ... Feng, Z. (2020). Early Transmission Dynamics in Wuhan, China, of Novel Coronavirus–Infected Pneumonia. *New England Journal of Medicine*, 382(13), 1199–1207. <https://doi.org/10.1056/nejmoa2001316>
 114. Li, S., Xu, Y., Cai, J., Hu, D., & He, Q. (2021). Integrated environment-occupant-pathogen information modeling to assess and communicate room-level outbreak risks of infectious diseases. *Building and Environment*, 187, 107394. <https://doi.org/10.1016/j.buildenv.2020.107394>
 115. Li, X., Liang, Y., Zhao, M., Wang, C., Bai, H., & Jiang, Y. (2019). Simulation of evacuating crowd based on deep learning and social force model. *IEEE Access*, 7, 155361–155371. <https://doi.org/10.1109/ACCESS.2019.2949106>
 116. Liang, L., Ren, H., Cao, R., Hu, Y., Qin, Z., Li, C., Mei, S., Kong, H., Government, C., & Ministry, T. (2020). The Effect of COVID-19 on Youth Mental Health. *Psychiatric Quarterly*, 91(1163), 841–852. <https://doi.org/10.1007/s11126-020-09744-3>
 117. Liu, R., Jiang, D., & Shi, L. (2017). Agent-based simulation of alternative classroom evacuation scenarios. *Frontiers of Architectural Research*, 5, 111–125.
 118. Liu, T., Hu, J., Kang, M., Lin, L., Zhong, H., Xiao, J., He, G., Song, T., Huang, Q., Rong, Z., Deng, A., Zeng, W., Tan, X., Zeng, S., Zhu, Z., Li, J., Wan, D., Lu, J., Deng, H., ... Ma, W. (2020). *Transmission dynamics of 2019 novel coronavirus (2019-nCoV) Tao*. 2017(1), 1–9.
 119. Liu, Z., Zhang, C., Guo, Y., Osmani, M., & Demian, P. (2019). A building information modelling (BIM) based water efficiency (BWe) framework for sustainable building design and construction management. *Electronics (Switzerland)*, 8(6). <https://doi.org/10.3390/electronics8060599>
 120. Loey, M., Manogaran, G., Taha, M. H., & Khalifa, N. E. (2021). A hybrid deep transfer learning model with machine learning methods for face mask detection in the era of the COVID-19 pandemic. *Science Direct - Measurement*, 167(108288).
 121. Long, X., Zhang, X., & Lou, B. (2017). Numerical simulation of dormitory building fire and personnel escape based on Pyrosim and Pathfinder. *Journal of the Chinese Institute of Engineers*, 40(3), 257–266. <https://doi.org/10.1080/02533839.2017.1300072>
 122. Lu, C. wei, Liu, X. fen, & Jia, Z. fang. (2020). 2019-nCoV transmission through the ocular surface must not be ignored. *The Lancet*, 395(10224). [https://doi.org/10.1016/S0140-6736\(20\)30313-5](https://doi.org/10.1016/S0140-6736(20)30313-5)
 123. Lujak, M., Billhardt, H., Dunkel, J., Fernández, A., Hermoso, R., & Ossowski,

- S. (2017). A distributed architecture for real-time evacuation guidance in large smart buildings. *Computer Science and Information Systems*, 14(1), 257–282. <https://doi.org/10.2298/CSIS161014002L>
124. Luo, H., Liu, J., Li, C., Chen, K., & Zhang, M. (2020). Ultra-rapid delivery of specialty field hospitals to combat COVID-19: Lessons learned from the Leishenshan Hospital project in Wuhan. *Automation in Construction*, 119, 103345. <https://doi.org/10.1016/j.autcon.2020.103345>
125. Lurz, F., Mueller, S., Lindner, S., & Linz, S. (2017). *Smart Communication and Relative Localization System for Firefighters and Rescuers*. IEEE.
126. Ma, G., & Wu, Z. (2020). BIM-based building fire emergency management: Combining building users' behavior decisions. *Automation in Construction*, 109. <https://doi.org/10.1016/j.autcon.2019.102975>
127. Machidon, O. M., Stanca, C., Ogrutan, P., Gerigan, C., & Aciu, L. (2018). Power-system protection device with IoT-based support for integration in smart environments. *PLoS ONE*, 13(12). <https://doi.org/10.1371/journal.pone.0208168>
128. Mahase, E. (2020). Coronavirus covid-19 has killed more people than SARS and MERS combined, despite lower case fatality rate. *BMJ (Clinical Research Ed.)*, 368. <https://doi.org/10.1136/bmj.m641>
129. Marques, G., & Pitarma, R. (2019). A cost-effective air quality supervision solution for enhanced living environments through the internet of things. *Electronics (Switzerland)*, 8(2). <https://doi.org/10.3390/electronics8020170>
130. Marques, G., Roque Ferreira, C., & Pitarma, R. (2018). A system based on the internet of things for real-time particle monitoring in buildings. *International Journal of Environmental Research and Public Health*, 15(4). <https://doi.org/10.3390/ijerph15040821>
131. Marzouk, M. M., Abdelbasset, I. G., & Al-Gahtani, K. (2015). Tracking Indoor Air Quality of Buildings Using BIM. *5th International/11th Construction Specialty Conference*, 1–10.
132. Mastorakis, G., & Makris, D. (2014). Fall detection system using Kinect's infrared sensor. *Journal of Real-Time Image Processing*, 9(4), 635–646. <https://doi.org/10.1007/s11554-012-0246-9>
133. Masuadi, E., Mohamud, M., Almutairi, M., Alsunaidi, A., Alswayed, A. K., & Aldhafeeri, O. F. (2021). Trends in the Usage of Statistical Software and Their Associated Study Designs in Health Sciences Research: A Bibliometric Analysis. *Cureus*, 13(1), 1–7. <https://doi.org/10.7759/cureus.12639>
134. Matějka, P., Kosina, V., Tomek, A., Tomek, R., Berka, V., & Šulc, D. (2016). The Integration of BIM in Later Project Life Cycle Phases in Unprepared Environment from FM Perspective. *Procedia Engineering*, 164, 550–557. <https://doi.org/10.1016/j.proeng.2016.11.657>
135. Mawby, R. I. (2007). Crime, place and explaining rural hotspots. *International Journal of Rural Crime*, 1, 21–43. www.amethyst.gov.uk/strataudit.htm
136. McKee, M., & Stuckler, D. (2020). If the world fails to protect the economy, COVID-19 will damage health not just now but also in the future. *Nature Medicine*, 26(5), 640–642. <https://doi.org/10.1038/s41591-020-0863-y>
137. Median College. (2018). *Why Do We Check Patient Vital Signs*. Median College. <https://www.meridian.edu/importance-taking-vital-signs-medical-assisting-guide/>
138. Megahed, N. A., & Ghoneim, E. M. (2021). Indoor Air Quality: Rethinking rules of building design strategies in post-pandemic architecture. *Environmental*

- Research*, 193, 110471. <https://doi.org/10.1016/j.envres.2020.110471>
139. Mehra, S., & Tanmay. (2017). Disaster Detection System Using Arduino. *2017 International Conference on Information Communication and Embedded Systems (ICICES)*, 1–6. <https://doi.org/10.1109/ICICES.2017.8070777>
 140. Menon, S., Tommey, D., Thomas Paul, R., Vinod, K., Menon, R., Student, Bt., & Scholar, P. (2019). *Automatic Fault Detection and Location of Transmission Lines using IoT*. www.grdjournals.com
 141. Meo, S. A., Abukhalaf, A. A., Alomar, A. A., Sattar, K., & Klonoff, D. C. (2020). COVID-19 Pandemic: Impact of Quarantine on Medical Students' Mental Wellbeing and Learning Behaviors. *Pakistan Journal of Medical Sciences*, 36(COVID19-S4), S43–S48. <https://doi.org/10.12669/pjms.36.COVID19-S4.2809>
 142. Miorandi, D., Sicari, S., De Pellegrini, F., & Chlamtac, I. (2012). Internet of things: Vision, applications and research challenges. In *Ad Hoc Networks* (Vol. 10, Issue 7, pp. 1497–1516). Elsevier B.V. <https://doi.org/10.1016/j.adhoc.2012.02.016>
 143. Mirahadi, F., McCabe, B., & Shahi, A. (2019). IFC-centric performance-based evaluation of building evacuations using fire dynamics simulation and agent-based modeling. *Automation in Construction*, 101, 1–16. <https://doi.org/10.1016/j.autcon.2019.01.007>
 144. Mohd Hafizi, M. S., Mat Leh, N. A., Kamarzaman, N. A., & Ishak, N. H. (2018). Developing a Monitoring System for Tripping Fault Detection via IoT. *2018 9th IEEE Control and System Graduate Research Colloquium (ICSGRC2018)*, 110–115.
 145. Moore, S., & Shepherd, J. P. (2006). The cost of fear: Shadow pricing the intangible costs of crime. *Applied Economics*, 38(3), 293–300. <https://doi.org/10.1080/00036840500367781>
 146. Moriwaki, A. (2015). *Realistic Simulation Supports Expansion of the London Underground*. AECC. <https://www10.aeccafe.com/blogs/3dexperienceconstruction/2015/06/24/realistic-simulation-supports-expansion-of-the-london-underground/>
 147. Nadikattu, R. R., Mohammad, S. M., & Whig, P. (2020). Novel economical social distancing smart device for covid19. *International Journal of Electrical Engineering and Technology*, 11(4), 204–217. <https://doi.org/10.34218/IJEET.11.4.2020.023>
 148. National Fire Data Center. (2017). *Topical Fire Report Series Civilian Fire Fatalities in Residential Buildings (2013-2015)*. <https://www.usfa.fema.gov/data/statistics/>
 149. National Fire Data Center. (2019). Nonresidential Building Fire Trends (2008-2017). In *Fire Estimate Summary - Nonresidential Building Fire Trends* (1st ed., pp. 1–9). FEMA.
 150. Neelavathy, P., Balaji, V., Geetha, A., & Jeevitha, V. (2020). Monitoring Social Distancing by Smart Phone App in the Effect of COVID-19. *International Journal of Engineering Research & Technology*, 9(09), 946–953.
 151. Nguyen, D. Van, Pham, G. H., & Nguyen, D. N. (2020a). Impact of the Covid-19 pandemic on perceptions and behaviors of university students in Vietnam. *Data in Brief*, 31, 105880. <https://doi.org/10.1016/j.dib.2020.105880>
 152. Nguyen, D. Van, Pham, G. H., & Nguyen, D. N. (2020b). Impact of the Covid-19 pandemic on perceptions and behaviors of university students in Vietnam. *Data in Brief*, 31, 105880. <https://doi.org/https://doi.org/10.1016/j.dib.2020.105880>
 153. Nowacki, L. (2019). *Fire Safety 101: Common Causes Of House Fires And How To Prevent Them*. RocketHomes. <https://www.rockethomes.com/blog/homeowner->

- tips/fire-safety-101-common-causes-of-house-fires-and-how-to-prevent-them
154. NSAI. (2017). *Determination of the Explosion Limits and the Limiting Oxygen Concentration (LOC) for Flammable Gases and Vapours*; CEN: Brussels, Belgium, 1-48.
 155. Oluwaseun, A., & Oluwole, O. (2020). Coronavirus Disease 2019 (COVID-19) Transmission, Risk Factors, Prevention and Control: A Minireview. *Journal of Infectious Diseases and Epidemiology*, 6(4), 1–5. <https://doi.org/10.23937/2474-3658/1510145>
 156. Ong, S. W. X., Tan, Y. K., Chia, P. Y., Lee, T. H., Ng, O. T., Wong, M. S. Y., & Marimuthu, K. (2020). Air, Surface Environmental, and Personal Protective Equipment Contamination by Severe Acute Respiratory Syndrome Coronavirus 2 (SARS-CoV-2) from a Symptomatic Patient. *JAMA - Journal of the American Medical Association*, 323(16), 1610–1612. <https://doi.org/10.1001/jama.2020.3227>
 157. Onghanseng, D., & Lin, B. (2016). *How it Works*. UHoo. <https://uhooair.com/how-it-works/>
 158. Onyenobi, T., Hudson, J., & Ormerod, M. (2006). Impact of building geometry on fire spread rate. *Association of Researchers in Construction Management, ARCOM 2006 - Procs 22nd Annual ARCOM Conference*, 2(September), 739–748.
 159. Oran, D. P., & Topol, E. J. (2020). Prevalence of Asymptomatic SARS-CoV-2 Infection : A Narrative Review. *Annals of Internal Medicine*, 173(5), 362–367. <https://doi.org/10.7326/M20-3012>
 160. Ota, K., Dao, M. S., Mezaris, V., & De Natale, F. (2017). Deep Learning for Mobile Multimedia: A Survey. *ACM Transactions on Multimedia Computing Communications and Applications (TOMM)*, 13(3), 1–21. <https://doi.org/10.1145/nnnnnnn.nnnnnnn>
 161. Otoom, M., Otoum, N., Alzubaidi, M. A., Etoom, Y., & Banihani, R. (2020). An IoT-based framework for early identification and monitoring of COVID-19 cases. *Biomedical Signal Processing and Control*, 62(April), 102149. <https://doi.org/10.1016/j.bspc.2020.102149>
 162. Pandey, R. C., Verma, M., Kumar Sahu, L., & Deshmukh, S. (2018). Internet of Things (IoT) Based Gas Leakage Monitoring and Alerting System with MQ-6 Sensor. *International Journal of Creative Research Thoughts*, 6(1), 2320–2882. www.ijcrt.org
 163. Pătrașcu, M., & Drăgoicea, M. (2014). Integrating agents and services for control and monitoring: Managing emergencies in smart buildings. *Studies in Computational Intelligence*, 544, 209–224. https://doi.org/10.1007/978-3-319-04735-5_14
 164. Pavón, R. M., Arcos Alvarez, A. A., & Alberti, M. G. (2020). BIM-based educational and facility management of large university venues. *Applied Sciences (Switzerland)*, 10(22), 1–28. <https://doi.org/10.3390/app10227976>
 165. Peacock, R. D., Hoskins, B. L., & Kuligowski, E. D. (2011). Overall and Local Movement Speeds During Fire Drill Evacuations in Buildings up to 31 Stories. *Safety Science*, 50(8), 1655–1664. <https://doi.org/10.1016/j.ssci.2012.01.003>
 166. Prem, K., Liu, Y., Russell, T. W., Kucharsld, A., Eggo, R. M., & Davies, N. (2020). The effect of control strategies to reduce social mixing on outcomes of the COVID-19 epidemic in Wuhan, China: a modelling study. *Lancet Public Health*, 5, 261–270.
 167. PressReader. (2016). *Water: Freely we receive, freely we abuse*. PressReader. <https://www.pressreader.com/sri-lanka/daily-mirror-sri-lanka/20160608/282432758422013>

168. Punn, N. S., Sonbhadra, S. K., & Agarwal, S. (2020). Monitoring COVID-19 social distancing with person detection and tracking via fine-tuned YOLO v3 and Deepsort techniques. *ArXiv*, 1(4), 1–10.
169. Purser, D., & McAllister, J. (2016). Assessment of Hazards to Occupants from Smoke, Toxic Gases, and Heat. In *SFPE Handbook of Fire Protection Engineering, Fifth Edition* (pp. 2308–2428). Springer. <https://doi.org/10.1007/978-1-4939-2565-0>
170. Rafiee, M., Siddiqui, H., & Hammad, A. (2013). Improving Indoor Security Surveillance by Fusing Data from BIM, UWB and Video. *The 30th ISARC*, 742–752.
171. Rahmati, M., Yazdizadeh, H., & Yazdizadeh, A. (2017). Leakage detection in a gas pipeline using artificial neural networks based on wireless sensor network and Internet of Things. *Proceedings - 2017 IEEE 15th International Conference on Industrial Informatics, INDIN 2017*, 659–664. <https://doi.org/10.1109/INDIN.2017.8104850>
172. Rajendram, A., Khan, F., & Garaniya, V. (2015). Modelling of fire risks in an offshore facility. *Fire Safety Journal*, 71, 79–85. <https://doi.org/10.1016/j.firesaf.2014.11.019>
173. Richardson, O. T. (2019). Effects of Environment Knowledge in Evacuation Scenarios Involving Fire and smoke: A Multiscale Modelling and Simulation Approach. *Fire Technology*, 55, 415–436. <https://doi.org/10.1007/s10694-018-0743-x>
174. Robiglio, M. (2020). *Fare spazio Fare spazio Idee progettuali*.
175. Rojek, I., & Studzinski, J. (2019). Detection and localization of water leaks in water nets supported by an ICT system with artificial intelligence methods as away forward for smart cities. *Sustainability (Switzerland)*, 11(2). <https://doi.org/10.3390/su11020518>
176. Rojewski, J. W., Lee, I. H., & Gemici, S. (2012). Use of *t*-test and ANOVA in Career-Technical Education Research. *Career and Technical Education Research*, 37(3), 263–275. <https://doi.org/10.5328/cter37.3.263>
177. Roser, M., Ritchie, H., Ortiz-Ospina, E., & Hansell, J. (2020). Mortality Risk of COVID-19 - Statistics and Research - Our World in Data. *Mortality Risk of COVID-19, 2020*, 1. <https://ourworldindata.org/mortality-risk-covid#case-fatality-rate-of-covid-19-compared-to-other-diseases%0Ahttps://ourworldindata.org/mortality-risk-covid?country=DOM>
178. Rothe, C., Schunk, M., Sothmann, P., Bretzel, G., Froeschl, G., Wallrauch, C., Zimmer, T., Thiel, V., Janke, C., Guggemos, W., Seilmaier, M., Drost, C., Vollmar, P., Zwirgmaier, K., Zange, S., Wölfel, R., & Hoelscher, M. (2020). Transmission of 2019-nCoV Infection from an Asymptomatic Contact in Germany. *New England Journal of Medicine*, 382(10), 970–971. <https://doi.org/10.1056/nejmc2001468>
179. Runyan, C. W., Casteel, C., Home Safety Council., University of North Carolina at Chapel Hill. Injury Prevention Research Center., Pacific Institute for Research and Evaluation., & University of North Carolina (System). Survey Research Unit. (2004). *The state of home safety in America : facts about unintentional injuries in the home : executive summary*. Home Safety Council.
180. Salameh, B., Basha, S., Basha, W., & Abdallah, J. (2021). Knowledge, Perceptions, and Prevention Practices among Palestinian University Students during the COVID-19 Pandemic: A Questionnaire-Based Survey. *Inquiry (United States): The Journal of Health Care Organization, Provision, and Financing*, 58, 1–11. <https://doi.org/10.1177/0046958021993944>
181. Salman, M., Asif, N., Ul Mustafa, Z., Khan, T. M., Shehzadi, N., Hussain, K., Tahir, H., Raza, M. H., & Khan, M. T. (2020). Psychological Impact of COVID-19 on

- Pakistani University Students and How They Are Coping. *MedRxiv*, 2020.05.21.20108647. <https://doi.org/10.1101/2020.05.21.20108647>
182. Saravanan, K., Anusuya, E., Kumar, R., & Son, L. H. (2018). Real-time water quality monitoring using Internet of Things in SCADA. *Environmental Monitoring and Assessment*, 190(9). <https://doi.org/10.1007/s10661-018-6914-x>
 183. Sathyamoorthy, A. J., Patel, U., Savle, Y. A., Paul, M., & Manocha, D. (2020). COVID-Robot: Monitoring social distancing constraints in crowded scenarios. *ArXiv*, 1–11.
 184. Sato, Y. (2011). *Location-based Responsive Space for Multimedia Environment Using Ultra-wideband Technology*.
 185. Schindhya, R., Simi, V. ., Sathya, E., & Janani, B. (2017). Real Time Water Monitoring System using IoT. *International Journal of Advanced Research in Computer and Communication Engineering*, 6(3), 378–380. <https://doi.org/10.17148/ijarcce.2017.6386>
 186. ServiceMaster. (2019). *Common Leaks Detected in Commercial Buildings – What to Do to Prevent Water Damage*. ServiceMaster NCR. <https://www.servicemaster-ncr.com/leaks-commercial-buildings-prevent-water-damage/>
 187. Shapland, J., & Hall, M. (2007). What Do We Know About the Effects of Crime on Victims? *SAGE*, 14(2), 175–217. <https://doi.org/10.1177/026975800701400202>
 188. Shen, T. S., Huang, Y. H., & Chien, S. W. (2008). Using fire dynamic simulation (FDS) to reconstruct an arson fire scene. *Building and Environment*, 43(6), 1036–1045. <https://doi.org/10.1016/j.buildenv.2006.11.001>
 189. Shiau, Y.-C., Tsai, Y.-Y., Hsiao, J.-Y., & Chang, C.-T. (2013). Development of Building Fire Control and Management System in BIM Environment. *Studies in Informatics and Control*, 22(1), 15–24. <http://www.sic.ici.ro>
 190. Shih, O., Lazik, P., & Rowe, A. (2016). AURES: A wide-band ultrasonic occupancy sensing platform. *Proceedings of the 3rd ACM Conference on Systems for Energy-Efficient Built Environments, BuildSys 2016*, 157–166. <https://doi.org/10.1145/2993422.2993580>
 191. Shreemaakanth, Preethi, Muralidharan, S., & Lalitha. (2019). IOT Based Fault Detection and Automation In Electricity Board. *International Journal of Innovative Research in Computer and Communication Engineering*, 7(2), 659–666. <https://doi.org/10.15680/IJIRCCE.2019>
 192. Shuttleworth, M. (2017). *5 Tips in Project Risk Management*. Project Risk Manager. <https://www.project-risk-manager.com/blog/project-risk-management-tips/>
 193. Singh, D., Sharma, N., Gupta, M., & Sharma, S. (2017). Development of System for Early Fire Detection using Arduino UNO. *International Journal of Engineering Science and Computing*, 7(5), 10857–10860. <http://ijesc.org/>
 194. Sircar, K., Clower, J., Shin, M. K., Bailey, C., King, M., & Yip, F. (2015). Carbon monoxide poisoning deaths in the United States, 1999 to 2012. *American Journal of Emergency Medicine*, 33(9), 1140–1145. <https://doi.org/10.1016/j.ajem.2015.05.002>
 195. Smalley, A. (2021, March). Higher Education Responses to Coronavirus (COVID-19). *National Conference of State Legislatures*.
 196. Smith, R. G., Jorna, P., Sweeney, J., & Fuller, G. (2014). *Counting the costs of crime in Australia: A 2011 estimate*.
 197. Socha, R., & Kogut, B. (2020). Urban video surveillance as a tool to improve security in public spaces. *Sustainability (Switzerland)*, 12(15).

- <https://doi.org/10.3390/su12156210>
198. SolarGard. (2018). *Breaking a Door or Window is the Second Most Common Method of Illegal Entry into a Building*. SolarGard. <https://www.solargard.com/au/blog/safety/breaking-a-door-or-window-is-the-second-most-common-method-of-illegal-entry-into-a-building/>
 199. Soltanaghaei, E., & Whitehouse, K. (2016). WalkSense: Classifying home occupancy states using walkway sensing. *Proceedings of the 3rd ACM Conference on Systems for Energy-Efficient Built Environments, BuildSys 2016*, 167–176. <https://doi.org/10.1145/2993422.2993576>
 200. Sowah, R. A., Ofoli, A. R., Krakani, S. N., & Fiawoo, S. Y. (2017). Hardware design and web-based communication modules of a real-time multisensor fire detection and notification system using fuzzy logic. *IEEE Transactions on Industry Applications*, 53(1), 559–566. <https://doi.org/10.1109/TIA.2016.2613075>
 201. Sporr, A., Zucker, G., & Hofmann, R. (2019). Automated HVAC Control Creation Based on Building Information Modeling (BIM): Ventilation System. *IEEE Access*, 7, 74747–74758. <https://doi.org/10.1109/ACCESS.2019.2919262>
 202. Stickley, A. (2021). *Common Signs of a Natural Gas Leak*. The Spruce. <https://www.thespruce.com/how-to-spot-signs-of-a-gas-leak-2718710>
 203. Sun, H., Shi, B., Yang, F., & Wang, D. (2017). Effects of sulfate on heavy metal release from iron corrosion scales in drinking water distribution system. *Water Research*, 114, 69–77. <https://doi.org/10.1016/j.watres.2017.02.021>
 204. Sun, Q. (2018). *A BIM-based Simulation Framework for Fire Evacuation Planning*. Oregon State University in.
 205. Sun, Q., & Turkan, Y. (2020). A BIM-based simulation framework for fire safety management and investigation of the critical factors affecting human evacuation performance. *Advanced Engineering Informatics*, 44(October 2019), 1–13. <https://doi.org/10.1016/j.aei.2020.101093>
 206. Suresh, S., Nagarajan, R., Sakthivel, L., Logesh, V., Mohandass, C., & Tamilselvan, G. (2017). Transmission Line Fault Monitoring and Identification System by Using Internet of Things. *International Journal of Advanced Engineering Research and Science*, 4(4), 9–14. <https://doi.org/10.22161/ijaers.4.4.2>
 207. T&S Roofing Systems. (2018). *Top 10 Causes for a Household Water Leak*. T&S Roofing Systems. <https://www.tsroofingsystems.com/top-10-causes-water-leaks/>
 208. Taghrir, M. H., Borazjani, R., & Shiraly, R. (2020). COVID-19 and iranian medical students; A survey on their related-knowledge, preventive behaviors and risk perception. *Archives of Iranian Medicine*, 23(4), 249–254. <https://doi.org/10.34172/aim.2020.06>
 209. Thornton, C., Konski, R. O., Klein, B., Hardeman, B., & Swenson, D. (2014). New Wayfinding Techniques in Pathfinder and Supporting Research. *Pedestrian and Evacuation Dynamics 2012, May 2017*. <https://doi.org/10.1007/978-3-319-02447-9>
 210. Thunderhead. (2019). *Agent Based Evacuation Simulation*. Pathfinder. https://www.thunderheadeng.com/pathfinder/?gclid=CjwKCAjwlrqHBhByEiwAnLmYUB2QaOQ5okCYwnu4uCmP3_sN_SQ8MC81R4MpC684rnaS8FNrMX3uHhoCgzUQAvD_BwE
 211. Tomek, A., & Matějka, P. (2014). The impact of BIM on risk management As an argument for its implementation in a construction company. *Procedia Engineering*, 85, 501–509. <https://doi.org/10.1016/j.proeng.2014.10.577>
 212. Tunio, H. (2012). *Baldia factory fire: Short circuit, all of Karachi to blame for tragedy, says tribunal*. The Express Tribune.

- <https://tribune.com.pk/story/474798/baldia-factory-fire-short-circuit-all-of-karachi-to-blame-for-tragedy-says-tribunal>
213. U.S. Fire Administration. (2008). *Fire-Related Firefighter Injuries in 2004*. FEMA.
 214. Vasantakumaar, N., Naren, V., Indrajith², P., Prabhu³, R. A., & Ganesh, S. (2018). *Intelligent Gas Leakage Detection System with IoT Using ESP 8266 Module* *International Journal of Advanced Research in Electrical, Electronics and Instrumentation Engineering* *Intelligent Gas Leakage Detection System with IoT Using ESP 8266 Module*. <https://doi.org/10.15662/IJAREEIE.2018.0712003>
 215. Verdantix. (2020). *Can Smart Building Technology Help Firms Fight Covid-19?* Verdantix. <https://www.verdantix.com/blog/can-smart-building-technology-help-firms-fight-covid-19>
 216. Verma, A., Prakash, S., Srivastava, V., Kumar, A., & Mukhopadhyay, S. C. (2019). Sensing, Controlling, and IoT Infrastructure in Smart Building: A Review. In *IEEE Sensors Journal* (Vol. 19, Issue 20, pp. 9036–9046). Institute of Electrical and Electronics Engineers Inc. <https://doi.org/10.1109/JSEN.2019.2922409>
 217. Vozzola, M. (2020). #NEWNORMAL: The support of graphic representation for the analysis of the distribution and the preparation of temporary works in the post pandemic period. *Vitruvio*, 5(2), 39–54. <https://doi.org/10.4995/vitruvio-ijats.2020.14480>
 218. Wang, B., Li, H., Rezgui, Y., Bradley, A., & Ong, H. N. (2014). BIM based virtual environment for fire emergency evacuation. *Scientific World Journal*, 2014. <https://doi.org/10.1155/2014/589016>
 219. Wang, H., Zhang, D., Wang, Y., Ma, J., Wang, Y., & Li, S. (2017). RT-Fall: A Real-Time and Contactless Fall Detection System with Commodity WiFi Devices. *IEEE Transactions on Mobile Computing*, 16(2), 511–526. <https://doi.org/10.1109/TMC.2016.2557795>
 220. Wang, S. H., Wang, W. C., Wang, K. C., & Shih, S. Y. (2015). Applying building information modeling to support fire safety management. *Automation in Construction*, 59, 158–167. <https://doi.org/10.1016/j.autcon.2015.02.001>
 221. Wang, T. Y., Huang, R., Li, L., Xu, W. G., & Nie, J. G. (2011). The application of the shortest path algorithm in the evacuation system. *Proceedings - 2011 International Conference of Information Technology, Computer Engineering and Management Sciences, ICM 2011*, 2, 250–253. <https://doi.org/10.1109/ICM.2011.119>
 222. Wehbe, R., & Shahrour, I. (2019a). Indoor hazards management using digital technology. *MATEC Web of Conferences*, 281, 01013. <https://doi.org/10.1051/mateconf/201928101013>
 223. Wehbe, R., & Shahrour, I. (2019b). Use of BIM and Smart Monitoring for buildings' Indoor Comfort Control. *MATEC Web of Conferences*, 295, 02010. <https://doi.org/10.1051/mateconf/201929502010>
 224. Wehbe, R., & Shahrour, I. (2021). Assessment and improvement of anti-COVID-19 measures in higher education establishments. In *Sustainability (Switzerland)* (Vol. 13, Issue 11). <https://doi.org/10.3390/su13115989>
 225. Wetzels, R., Grasman, R. P. P. P., & Wagenmakers, E. J. (2012). A default Bayesian hypothesis test for ANOVA designs. *American Statistician*, 66(2), 104–111. <https://doi.org/10.1080/00031305.2012.695956>
 226. WHO. (2016). *to unhealthy environments sustainable development and well-being of women and World Water Day World Day for Health and Safety Health Assembly Better water , better jobs – World Water Day 2016 Facts and Figures :*

Preventing disease Health in All Policies (Issue 82).

227. WHO. (2020). Considerations in adjusting public health and social measures in the context of COVID-19. In *World Health Organisation Interim Guidance*. <https://www.who.int/publications-detail/risk->
228. WHO. (2021). *Falls*. World Health Organization. <https://www.who.int/en/news-room/fact-sheets/detail/falls>
229. Wong, K. C. P., Ryan, H. M., & Tindle, J. (1996). *Early Warning Fault Detection Using Artificial Intelligent Methods*. <http://www.sunderland.ac.uk/~ts0pwo/index.htm>
230. Wright, W. F., & MacKowiak, P. A. (2021). Why Temperature Screening for Coronavirus Disease 2019 with Noncontact Infrared Thermometers Does Not Work. *Open Forum Infectious Diseases*, 8(1), 4–6. <https://doi.org/10.1093/ofid/ofaa603>
231. Wu, X., Zhang, X., Huang, X., Xiao, F., & Usmani, A. (2021). A real-time forecast of tunnel fire based on numerical database and artificial intelligence. *Building Simulation*, 2019. <https://doi.org/10.1007/s12273-021-0775-x>
232. Xu, M., & Peng, D. (2020). International journal of safety and security in tourism/hospitality. *International Journal of Safety and Security in Tourism/Hospitality*, 10(2), 293–299. <https://doi.org/10.18280/ijss.100218>
233. Xu, T., Zhou, Y., & Zhu, J. (2018). New advances and challenges of fall detection systems: A survey. In *Applied Sciences (Switzerland)* (Vol. 8, Issue 3). MDPI AG. <https://doi.org/10.3390/app8030418>
234. Xu, Y., Wang, Z., Zheng, Q., & Han, Z. (2012). The application of Dijkstra’s algorithm in the intelligent fire evacuation system. *Proceedings of the 2012 4th International Conference on Intelligent Human-Machine Systems and Cybernetics, IHMSC 2012, 1*, 3–6. <https://doi.org/10.1109/IHMSC.2012.7>
235. Yamada, T., & Akizuki, Y. (2016). Visibility and Human Behavior in Fire Smoke. In *SFPE Handbook of Fire Protection Engineering, Fifth Edition* (pp. 2181–2206). <https://doi.org/10.1007/978-1-4939-2565-0>
236. Younus, M. U., Islam, S. ul, Ali, I., Khan, S., & Khan, M. K. (2019). A survey on software defined networking enabled smart buildings: Architecture, challenges and use cases. In *Journal of Network and Computer Applications* (Vol. 137, pp. 62–77). Academic Press. <https://doi.org/10.1016/j.jnca.2019.04.002>
237. Yu, D. (2019). *ATSDR Case Studies in Environmental Medicine Taking an Exposure History*.
238. Zafari, F., Papapanagiotou, I., & Christidis, K. (2016). Microlocation for internet-of-things-equipped smart buildings. *IEEE Internet of Things Journal*, 3(1), 96–112. <https://doi.org/10.1109/JIOT.2015.2442956>
239. Zemaitis, M. R., Foris, L. A., Lopez, R. A., & Martin, H. R. (2019). *Electrical Injuries*. StatPearls. <https://www.ncbi.nlm.nih.gov/books/NBK448087/>
240. Zhang, H. (2020). Research on Building Fire Risk Management Based on BIM. *IOP Conference Series: Earth and Environmental Science*, 571(1). <https://doi.org/10.1088/1755-1315/571/1/012067>
241. Zhang, J., Guo, J., Liu, X., Xiong, H., & Zhang, D. (2019). A framework for an intelligent and personalized fire evacuation management system. *Sensors (Switzerland)*, 19(14). <https://doi.org/10.3390/s19143128>
242. Zhang, S., Teizer, J., Lee, J. K., Eastman, C. M., & Venugopal, M. (2013). Building Information Modeling (BIM) and Safety: Automatic Safety Checking of Construction Models and Schedules. *Automation in Construction*, 29, 183–195. <https://doi.org/10.1016/j.autcon.2012.05.006>

243. Zhao, G., Beji, T., & Merci, B. (2017). Study of FDS simulations of buoyant fire-induced smoke movement in a high-rise building stairwell. *Fire Safety Journal*, 91(March), 276–283. <https://doi.org/10.1016/j.firesaf.2017.04.005>
244. Zhao, J., Yuan, Q., Wang, H., Liu, W., Liao, X., Su, Y., Wang, X., Yuan, J., Li, T., Li, J., Qian, S., Hong, C., Wang, F., Liu, Y., Wang, Z., He, Q., Li, Z., He, B., Zhang, T., ... Zhang, Z. (2020). Antibody Responses to SARS-CoV-2 in Patients with Novel Coronavirus Disease 2019. *Clinical Infectious Diseases*, 71(16), 2027–2034. <https://doi.org/10.1093/cid/ciaa344>
245. Zhong, M., Shi, C., Tu, X., Fu, T., & He, L. (2008). Study of the human evacuation simulation of metro fire safety analysis in China. *Journal of Loss Prevention in the Process Industries*, 21(3), 287–298. <https://doi.org/10.1016/j.jlp.2007.08.001>
246. Zou, Y. (2017). *BIM and Knowledge based Risk Management System*. University of Liverpool.
247. Zualkernan, I. A., Aloul, F. A., Sakkia, V., Noman, H. Al, Sowdagar, S., & Hammadi, O. Al. (2019). An IoT-based emergency evacuation system. *Proceedings - 2019 IEEE International Conference on Internet of Things and Intelligence System, IoTaIS 2019*, 62–66. <https://doi.org/10.1109/IoTaIS47347.2019.8980381>