



**HAL**  
open science

# Gallai's path decomposition in planar graphs

Alexandre Blanche

► **To cite this version:**

Alexandre Blanche. Gallai's path decomposition in planar graphs. Data Structures and Algorithms [cs.DS]. Université de Bordeaux, 2021. English. NNT : 2021BORD0354 . tel-03539539

**HAL Id: tel-03539539**

**<https://theses.hal.science/tel-03539539v1>**

Submitted on 21 Jan 2022

**HAL** is a multi-disciplinary open access archive for the deposit and dissemination of scientific research documents, whether they are published or not. The documents may come from teaching and research institutions in France or abroad, or from public or private research centers.

L'archive ouverte pluridisciplinaire **HAL**, est destinée au dépôt et à la diffusion de documents scientifiques de niveau recherche, publiés ou non, émanant des établissements d'enseignement et de recherche français ou étrangers, des laboratoires publics ou privés.



THÈSE PRÉSENTÉE  
POUR OBTENIR LE GRADE DE  
**DOCTEUR**  
**DE L'UNIVERSITÉ DE BORDEAUX**

ÉCOLE DOCTORALE DE MATHÉMATIQUES ET INFORMATIQUE

Spécialité : INFORMATIQUE

Par **Alexandre BLANCHÉ**

---

**GALLAI'S PATH DECOMPOSITION  
IN PLANAR GRAPHS**

---

Sous la direction de : **Marthe BONAMY** et **Nicolas BONICHON**

Soutenue le 13 décembre 2021

**Devant la commission d'examen composée de :**

M. Stéphane BESSY	Maître de Conférences, Université de Montpellier	Rapporteur
Mme. Marthe BONAMY	Chargée de Recherche, Université de Bordeaux	Directrice
M. Nicolas BONICHON	Maître de Conférences, Université de Bordeaux	Directeur
M. Fábio BOTLER	Docteur, Université fédérale de Rio de Janeiro	Invité
Mme. Nadia BRAUNER	Professeur, Université Grenoble Alpes	Examinatrice
M. Paul DORBEC	Professeur, Université de Caen Normandie	Rapporteur
M. Arnaud PÉCHER	Professeur, Université de Bordeaux	Président



---

## Résumé

Ce manuscrit s'inscrit dans le domaine informatique de la théorie des graphes, et traite d'une question posée en 1968 par Tibor Gallai, toujours sans réponse aujourd'hui. Gallai conjectura que les arêtes de tout graphe connexe à  $n$  sommets pouvaient être partitionnées en  $\lceil \frac{n}{2} \rceil$  chemins. Bien que cette conjecture fut attaquée et partiellement résolue au fil des ans, la propriété n'a été prouvée que pour des classes de graphes très spécifiques, comme les graphes dont les sommets de degré pair forment une forêt (Pyber, 1996), les graphes de degré maximum 5 (Bonamy, Perrett, 2016) ou les graphes de largeur arborescente au plus 3 (Botler, Sambinelli, Coelho, Lee, 2017). Les graphes planaires sont les graphes qui peuvent être plongés dans le plan, c'est-à-dire dessinés sans croisements d'arêtes. C'est une classe bien connue dans la théorie des graphes, et largement étudiée. Botler, Jiménez et Sambinelli ont récemment confirmé la conjecture dans le cas des graphes planaires sans triangles. Notre résultat consiste en une preuve de la conjecture sur la classe générale des graphes planaires. Cette classe est notablement plus générale que celles des précédents résultats, et de notre point de vue constitue une importante contribution à l'étude de la conjecture de Gallai. Plus précisément, nous travaillons sur une version plus forte de la conjecture, proposée par Bonamy et Perrett en 2016, et qui énonce que les graphes connexes à  $n$  sommets peuvent être décomposés en  $\lfloor \frac{n}{2} \rfloor$  chemins, à l'exception d'une famille de graphes denses. Nous confirmons cette conjecture dans le cas des graphes planaires, en démontrant que tout graphe planaire connexe à  $n$  sommets, à l'exception de  $K_3$  et de  $K_5^-$  ( $K_5$  moins une arête), peut être décomposé en  $\lfloor \frac{n}{2} \rfloor$  chemins. La preuve est divisée en trois parties : les deux premières montrent le lemme principal de la preuve, qui restreint la structure d'un contre-exemple hypothétique ayant un minimum de sommets, et la troisième partie utilise ce lemme pour montrer qu'un tel contre-exemple n'existe pas.

**Mots-clés :** Décomposition de graphe, Chemin, Conjecture de Gallai, Graphe planaire

---

## Abstract

This thesis falls within the theoretical computer science field of graph theory, and deals with a question asked in 1968 by Tibor Gallai, still unanswered as of today. Gallai conjectured that the edges of any connected graph with  $n$  vertices can be partitioned into  $\lceil \frac{n}{2} \rceil$  paths. Although this conjecture has been tackled and partially solved over the years, the property has only been proven on very specific graph classes, which include graphs in which the vertices of even degree form a forest (Pyber, 1996), graphs of maximum degree 5 (Bonamy, Perrett, 2016) or graphs of treewidth at most 3 (Botler, Sambinelli, Coelho, Lee, 2017). The planar graphs are the graphs that can be embedded in the plane, or drawn without edges crossing. The class of planar graphs is well-known in graph theory and has been thoroughly studied. Botler, Jiménez and Sambinelli recently confirmed the conjecture on triangle-free planar graphs. Our result consists in a proof of the conjecture on the whole class of planar graphs. This class is significantly broader and more general than those of previous results, and in our opinion constitutes an important contribution to the study of Gallai's conjecture. More precisely, we work on a stronger variant of the conjecture, proposed by Bonamy and Perrett in 2016, which states that all connected graphs on  $n$  vertices could be decomposed into  $\lfloor \frac{n}{2} \rfloor$  paths, with the exception of a family of dense graphs. We confirm this conjecture in the case of planar graphs, by showing that every connected planar graph on  $n$  vertices except  $K_3$  and  $K_5^-$  ( $K_5$  minus one edge) can be decomposed into  $\lfloor \frac{n}{2} \rfloor$  paths. The proof is divided into three parts: the first two show the main lemma of the proof, which restricts the structure of a hypothetical vertex-minimum counterexample to the statement, while the third part uses the main lemma to show that such a counterexample does not exist.

**Keywords:** Graph decomposition, Path, Gallai's conjecture, Planar graph.

---

Unité de recherche

LaBRI, UMR 5800, 351, cours de la Libération, 33405 Talence

# Contents

<b>Introduction (en français)</b>	<b>6</b>
<b>Introduction</b>	<b>12</b>
<b>1 Preliminaries</b>	<b>17</b>
1.1 Basic definitions on graphs . . . . .	17
1.2 Paths and cycles . . . . .	18
1.3 Decompositions . . . . .	20
1.4 Connectivity . . . . .	20
1.5 Definitions around planar graphs . . . . .	21
1.6 Some graph classes . . . . .	22
<b>2 History of Gallai's conjecture</b>	<b>24</b>
2.1 Decomposition problems . . . . .	24
2.2 Gallai's conjecture . . . . .	28
2.2.1 Origins of the conjecture . . . . .	28
2.2.2 Hajós' conjecture . . . . .	29
2.2.3 Related problems . . . . .	30
2.2.4 Lovász's theorem . . . . .	32
2.3 A first approach: improving a general bound . . . . .	32
2.4 A second approach: partial resolution . . . . .	33
2.4.1 Example: the trees . . . . .	33
2.4.2 Initial results . . . . .	34
2.4.3 Even degrees . . . . .	35
2.4.4 Maximum degree . . . . .	36
2.4.5 Planar graphs . . . . .	37
2.5 The strong conjecture . . . . .	38
2.6 Our contribution: planar graphs . . . . .	39
2.6.1 Main lemma . . . . .	39
<b>3 Elimination of vertices of degree at most 4</b>	<b>41</b>
3.1 Reduction rules for $(C_I)$ configurations . . . . .	42
3.2 Sufficiency of the $(C_I)$ rules . . . . .	61
3.3 The rules cover all cases . . . . .	63
<b>4 Elimination of vertices of degree 5</b>	<b>72</b>
4.1 $K_4, C_{4+}$ -subdivisions . . . . .	74
4.2 Patterns . . . . .	78
4.3 Redirection procedure . . . . .	90

4.4	Sufficiency of the ( $C_{II}$ ) rules . . . . .	96
4.5	Distant problems . . . . .	98
4.6	Semi-distant configurations . . . . .	107
4.7	Close configurations . . . . .	115
<b>5</b>	<b>The structure of minimum counterexample is contradictory</b>	<b>130</b>
	<b>Conclusion</b>	<b>133</b>
	<b>Bibliography</b>	<b>135</b>

# Introduction (en français)

Cette thèse s'inscrit dans le domaine de la théorie des graphes. Un *graphe* est défini par son ensemble de *sommets*, ou nœuds, et *d'arêtes*, ou liens entre ces nœuds. La première mention d'un graphe date de 1736, lorsque le mathématicien suisse Leonhard Euler s'intéressa au problème des ponts de Königsberg. La Pregolia est un fleuve qui coule à travers la ville de Königsberg en Prusse (aujourd'hui Kaliningrad en Russie), et la sépare en quatre régions connectées à l'époque par sept ponts, comme illustré en Figure 1. Nombreux observateurs se demandaient alors s'il était possible de concevoir un parcours de la ville qui empruntait chaque pont exactement une fois.

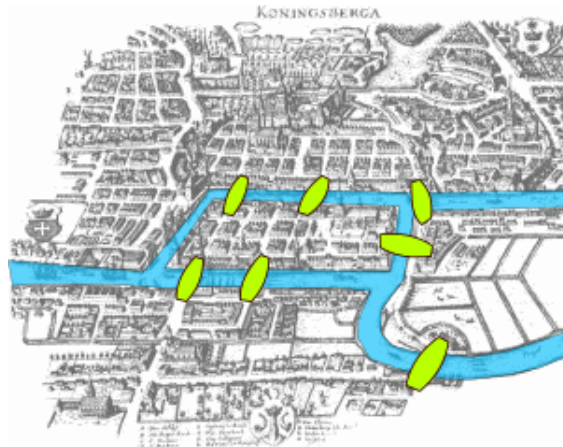

Figure 1: Les sept ponts de Königsberg

Euler eut l'intuition que la position exacte de chaque pont n'était pas importante au problème, et il se concentra uniquement sur la structure sous-jacente du réseau. Appelons *tour* une suite d'arêtes dans laquelle deux arêtes successives touchent un même sommet. Euler déduit alors que le problème consistait uniquement à trouver un tour qui contient toutes les arêtes du graphe de la Figure 2.

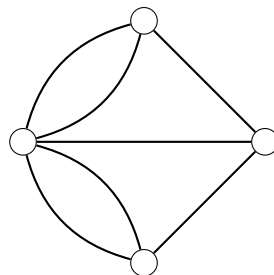

Figure 2: Le graphe représentant la structure de l'instance. Chaque sommet représente une région, et chaque arête un pont.



Un sommet est *pair* s'il touche un nombre pair d'arêtes, et *impair* sinon. Euler observa qu'à chaque fois qu'un tour entre dans un sommet par une arête, il doit en sortir par une autre, à l'exception du premier et du dernier sommet du tour. Ainsi, pour qu'un tel tour existe, chaque sommet à l'exception des extrémités doit être pair. Puisque notre graphe possède quatre sommets impairs, Euler avait prouvé que le problème ne possédait pas de solution [28].

Ce raisonnement s'avéra d'une importance considérable dans l'histoire des mathématiques, puisqu'il introduit le domaine de la théorie des graphes, et anticipa le développement de la topologie. Un tour qui contient toutes les arêtes du graphe est aujourd'hui appelé *chemin eulérien* (ou *cycle eulérien* si les deux extrémités sont un même point) [4].

Les graphes sont très utiles pour extraire les propriétés intrinsèques d'une instance d'un problème concret, afin de les abstraire et de les modéliser. Considérons le "problème jouet" suivant en guise de première exemple. Nous organisons un mariage, et nous devons assigner chaque invité à une table. Pour éviter les incidents, si deux invités ne s'apprécient pas, nous souhaiterions les placer à deux tables différentes. Nous pouvons observer que cette condition est satisfaite si nous n'avons qu'une personne par table. De plus, dès lors que deux personnes ne s'apprécient pas, une seule table ne suffit pas à satisfaire la contrainte. Quel est donc le nombre minimum de tables requises pour notre ensemble d'invités ?

Ici, la seule information pertinente est le statut de la relation entre toutes les paires d'invités, et nous pouvons donc modéliser le problème par un graphe dont les sommets représentent les invités, et où une arête entre deux sommets signifie que les invités correspondants ne s'apprécient pas. Pour trouver le nombre minimum de tables, il nous faut résoudre le problème appelé *problème de coloration de sommets* [35] : assigner à chaque sommet d'un graphe une couleur, de telle sorte que deux sommets reliés par une arête n'aient pas la même couleur, et cela en utilisant le moins de couleurs possibles. La Figure 3 montre un exemple d'instance du problème de répartition des invités, encodé en tant qu'instance du problème de coloration de sommets, avec une solution à 3 tables (représentées par 3 couleurs). C'est une solution optimale, car on peut observer qu'avec seulement 2 tables, deux personnes parmi Jacques, Jean et Sylvie se seraient retrouvés à la même table, alors qu'aucun d'entre eux n'apprécie les deux autres.

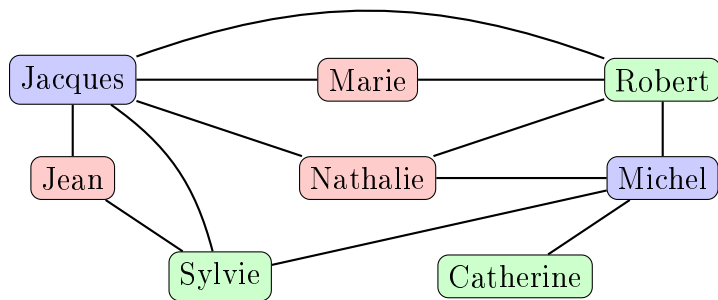

Figure 3: Le graphe représentant les relations entre les invités : une arête indique que deux invités ne s'apprécient pas, et les couleurs représentent les tables.

Les graphes peuvent donc être utilisés pour modéliser la structure d'un réseau réel, comme dans le cas du problème des ponts de Königsberg, ou pour modéliser les interactions et relations entre objets, comme pour le problème des invités. Les graphes sont aujourd'hui utilisés dans la plupart des domaines scientifiques, comme l'explique

le mathématicien hongrois László Lovász, lauréat du Prix Abel 2021, dans son discours d'acceptation :

*“Nous réalisons à présent que la plupart des structures et systèmes que nous cherchons à comprendre ont un réseau ou graphe sous-jacent, des ordinateurs à internet, des communautés écologiques au cerveau, des réseaux sociaux aux épidémies, la théorie des graphes est en train de devenir le modèle mathématique pour ce nouveau paradigme.”*

Les graphes sont en effet utilisés pour modéliser une variété de réseaux, tels les réseaux routiers, ou des ensembles d'ordinateurs interconnectés, ainsi que pour résoudre des problèmes associés, comme trouver le plus court chemin entre deux nœuds [36]. En physique, les molécules possèdent une structure de graphe, avec des atomes reliés par des liaisons covalentes, et leurs propriétés peuvent être étudiées grâce à la théorie des graphes [15]. Les graphes sont utilisés dans des domaines aussi variés que la modélisation 3D, avec l'utilisation de maillages [3]; en biologie, où ils permettent de modéliser les interactions entre protéines [50]; en linguistique, par le biais des arbres syntaxiques [17]; en sciences sociales, où les graphes sont utilisés pour mesurer l'influence d'un individu dans un groupe [63]; ou en science des données, grâce aux bases de données orientées graphes [81]. L'avènement des réseaux sociaux au cours des dernières décennies a encore renforcé l'importance de la théorie des graphes, avec des applications dans les algorithmes de recommandation [62].

La théorie des graphes est fortement reliée à d'autres domaines de l'informatique, comme l'algorithmique et la théorie de la complexité. Nombre de problèmes théoriques de graphes ont été étudiés en profondeur, comme le problème du *voyageur de commerce*, où l'on cherche le tour le plus court qui visite tous les sommets d'un graphe et retourne au sommet de départ, ou le *problème de l'ensemble indépendant*, où l'on cherche dans un graphe le plus grand ensemble de sommets qui ne possède aucune arête interne. Ces deux problèmes, ainsi que le problème de coloration de sommets cité précédemment, ont la particularité d'être *NP-difficiles* [39], ce qui signifie grossièrement que le calcul par un ordinateur d'une solution exacte à l'un de ces problèmes représente un défi, y compris pour des instances de petite taille.

En plus du problème de coloration de sommets, de nombreuses variantes de problèmes de coloration ont été étudiées au cours des deux derniers siècles. Par exemple, le *problème de coloration par liste*, qui est similaire au problème de coloration de sommets, où cette fois les couleurs des sommets sont choisies parmi une liste de candidats assignée à chaque sommet. Le but est ici de trouver la plus petite taille commune des listes qui garantit que le graphe possède une bonne affectation de couleurs (avec des couleurs différentes pour des sommets reliés par une arête) quelque soit le contenu des listes. Avec le *problème de coloration d'arêtes* (voir la Figure 4a), les couleurs sont cette fois attribuées aux arêtes du graphe, de manière à ce que deux arêtes ayant une extrémité en commun soient assignées à deux couleurs différentes, et le but est encore une fois de minimiser le nombre de couleurs utilisées pour colorer toutes les arêtes. Un autre exemple de problème de coloration est le *problème de coloration totale* (voir la Figure 4b), où nous colorons à la fois les sommets et les arêtes, de telle manière à ce qu'une même couleur n'est pas attribuée à deux sommets reliés par une arête, ou à deux arêtes ayant une extrémité en commun, ou à une arête et l'une de ses extrémités [35].

Les problèmes de coloration appartiennent à une famille plus large de *problèmes de décomposition*, qui visent à partitionner un graphe en structures plus petites et plus simples. Le problème de coloration de sommets est équivalent à partitionner les sommets du

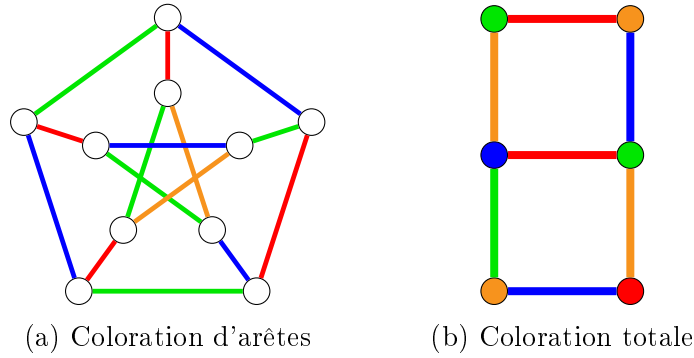

Figure 4: Instances de coloration d'arêtes et de coloration totale en 4 couleurs

graphe en ensembles indépendants, et le problème de coloration d'arêtes consiste à partitionner les arêtes du graphe en *couplages*, c'est-à-dire en ensembles d'arêtes disjointes. De nombreux problèmes de ce type ont été étudiés, tels le problème consistant à décomposer un graphe en *cliques*, i.e. en sous-graphes dont tous les sommets sont reliés deux-à-deux par une arête; ou en *étoiles*, c'est-à-dire en sous-ensembles d'arêtes ayant exactement une extrémité en commun. Un *chemin* dans un graphe est un tour, donc une séquence d'arêtes consécutives, tel que chaque sommet du tour n'est touché qu'une seule fois, comme en Figure 5a. On dit qu'un graphe est *connexe* si pour toute paire de sommets du graphe il existe un chemin ayant ces deux sommets pour extrémités. Dans le problème de décomposition que l'on étudie dans ce manuscrit, nous cherchons une partition des arêtes du graphe en chemins, que nous appelons une *décomposition en chemins*. De manière équivalente, une décomposition en chemins est une coloration des arêtes d'un graphe, de telle manière à ce que les arêtes ayant la même couleur forment un chemin. La Figure 5b propose une décomposition du graphe en 4 chemins. Le même graphe peut également être décomposé en 3 chemins, comme dans la Figure 5c, mais pas moins. En effet, le *degré* (le nombre d'arêtes incidentes) du sommet central est de 6, et ses arêtes incidentes requièrent donc au moins 3 chemins pour être couvertes. Nous pouvons également observer que dans une décomposition en chemin, chaque sommet impair du graphe doit être l'extrémité d'au moins un chemin. Le graphe en Figure 5 contient 6 sommets impairs, et ne peut donc pas être décomposé en moins de 3 chemins.

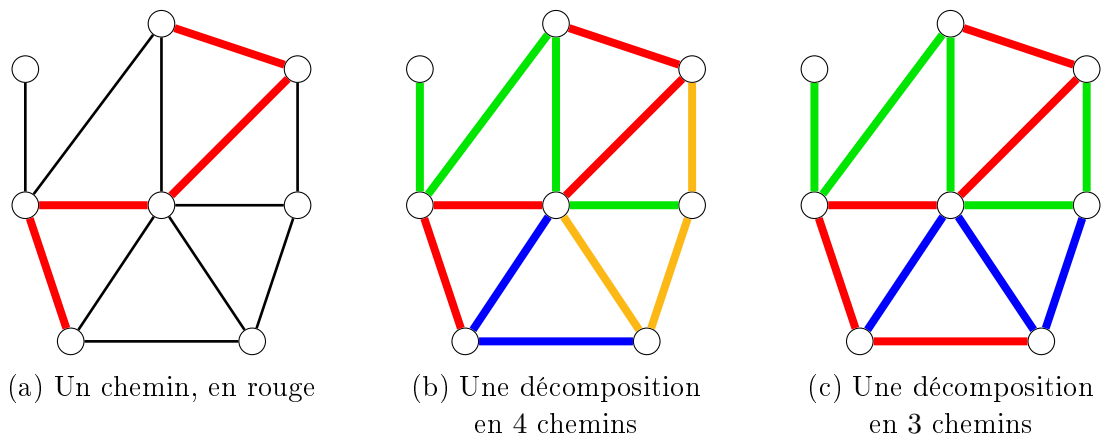

Figure 5: Un chemin et deux décompositions en chemins

En 1968, le mathématicien hongrois Tibor Gallai posa la question suivante [58] : étant donné un graphe connexe à  $n$  sommets, est-il possible de trouver une décomposition en chemins de ce graphe en au plus  $\lceil \frac{n}{2} \rceil$  chemins ? Par exemple, c'est le cas du graphe en Figure 5, puisqu'il contient 8 sommets et peut être décomposé en 3 chemins. Cependant, malgré la simplicité apparente de l'énoncé, sa preuve n'a toujours pas été trouvée après un demi-siècle. La question est connue comme la *conjecture de Gallai de décomposition en chemins*, et l'objet de la contribution présentée dans ce manuscrit.

Bien que la résolution du problème pour tous les graphes semble difficile, nous pouvons observer que restreindre le problème à des familles de graphes plus spécifiques peut dans certains cas le rendre plus facile. La propriété est évidemment satisfaite pour les graphes constitués d'un seul chemin, ou d'un seul cycle (un tour dans lequel les deux extrémités sont le même sommet). Depuis son énoncé, la conjecture a été résolue pour de nombreuses familles de graphes, telles les graphes ayant au plus un sommet pair [58], ou récemment les graphes dont tous les sommets ont un degré d'au plus 5 [6]. Nous avons prouvé un résultat similaire, en restreignant le problème à une famille de graphe ayant des propriétés utiles, de sorte à apporter une nouvelle solution partielle à la conjecture.

Une preuve nous semblait réalisable pour les graphes planaires, une famille bien connue de graphes ayant une grande variété d'applications. Un graphe est *planair* s'il peut être plongé dans le plan, c'est-à-dire s'il peut être dessiné dans le plan de sorte que ses arêtes ne se croisent pas. Les graphes des Figures 3, 4b et 5 constituent des exemples de graphes planaires, mais ce n'est pas le cas du graphe de la Figure 4a (connu comme le *graphe de Petersen*) pour lequel il est impossible de déplacer les sommets ou de courber les arêtes pour plonger le graphe dans le plan.

Il est naturel de considérer la famille des graphes planaires, en premier lieu car un graphe plongé dans le plan est bien plus facile à appréhender pour un humain qu'un graphe dessiné avec des arêtes se recouvrant. Les applications pratiques des graphes planaires incluent la conception de circuits imprimés [14], pour empêcher des recouvrements de pistes conductrices, ou celle des routes aériennes [32]. La classe est surtout connue pour le *théorème des quatre couleurs*, qui établit que seules 4 couleurs sont nécessaires pour colorier les régions d'une carte de manière à ce que deux régions adjacentes ne partagent pas une même couleur; ou, de manière équivalente, qu'il y a toujours une solution à 4 couleurs au problème de coloration de sommets sur les graphes planaires. Conjecturé en 1852, sa preuve [1, 2] en 1976 était unique en son genre, nécessitant un ordinateur pour résoudre un grand nombre de sous-cas techniques.

Nous contribuons à la recherche sur la conjecture de Gallai en prouvant que celle-ci est vraie sur la famille des graphes planaires.

**Theorem** (Blanché, Bonamy, Bonichon [5], 2021+). *Tout graphe planaire connexe à  $n$  sommets possède une décomposition en au plus  $\lceil \frac{n}{2} \rceil$  chemins.*

La classe des graphe planaires est l'une des plus naturelles et générales sur lesquelles la conjecture a été confirmée, et représente une étape importante sur la route d'une complète résolution. De plus, nous expliquons dans le Chapitre 2 que nous prouvons en réalité une version légèrement plus forte de la conjecture, dans les cas des graphes planaires, en montrant que nous pouvons atteindre la borne plus fine de  $\lfloor \frac{n}{2} \rfloor$ , à l'exception de deux graphes de petite taille.

La méthode que nous avons utilisée pour démontrer ce théorème est courante ([6, 9, 72, 82]) : nous commençons par supposer que le théorème est faux, ce qui implique qu'il doit

exister des graphes planaires qui ne satisfont pas la propriété. Parmi ces contre-exemples, nous en considérons un qui contient un nombre minimum de sommets. Pour prouver notre théorème, il suffit de montrer que ce contre-exemple minimum n'existe pas, ce que nous réalisons en démontrant que son existence mène à une contradiction. L'essentiel de la preuve consiste à prouver que certaines structures ne peuvent pas apparaître dans notre graphe, en raison de sa nature de contre-exemple minimum. Enfin, une preuve plus succincte montre que le graphe doit en réalité contenir l'une de ces structures. Les deux résultats étant en contradiction, nous pouvons en déduire que le contre-exemple minimum que nous avons considéré n'existe pas.

Le manuscrit présente la preuve du théorème. Les notions et définitions importantes sont présentées dans le Chapitre 1, tandis que le Chapitre 2 résume l'histoire de la conjecture ainsi que les nombreux résultats partiels obtenus depuis les cinquante dernières années. Le Chapitre 3 consiste en une preuve du premier lemme, qui limite le nombre de sommets de degré au plus 4 dans notre contre-exemple à au plus un. La preuve de ce lemme suppose l'existence de deux tels sommets, et montre pour chaque cas qu'une telle structure contredit la propriété que possède le graphe d'être un contre-exemple minimum à la conjecture de Gallai. Le Chapitre 4 propose un deuxième lemme, qui généralise les idées du premier, et qui limite le nombre de sommets de degré 5. Finalement, nous concluons notre preuve du théorème en montrant dans le Chapitre 5 que l'existence d'un contre-exemple minimum avec une telle structure produit une contradiction.

# Introduction

This thesis falls within the domain of graph theory. A *graph* is defined by its set of *vertices*, or nodes, and *edges*, or links between these nodes. The first mention of a graph dates back to 1736, when Swiss mathematician Leonhard Euler took interest in the Königsberg bridge problem. The city of Königsberg in Prussia (now Kaliningrad, Russia) contained four land masses connected at the time by seven bridges across the Pregel River, as depicted in Figure 6, and many had started asking whether one could design a walk through the city that crossed each bridge exactly once.

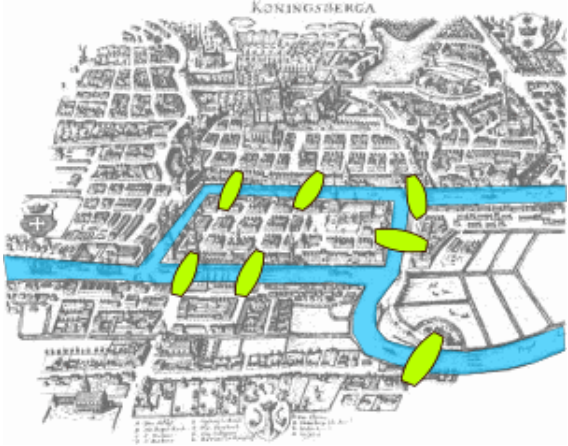

Figure 6: The seven bridges of Königsberg

Euler had the intuition that the exact position of each bridge was irrelevant to the problem, and he only focused on the underlying structure of the network. We call *walk* a sequence of edges in which two consecutive edges touch a common vertex. Euler deduced that the problem only consisted in finding a walk that contains all the edges from the graph of Figure 7.

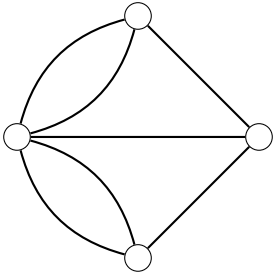

Figure 7: The graph representing the structure of the instance. Each vertex represents a land mass, and each edge a bridge.

A vertex is *even* if it touches an even number of edges, and *odd* otherwise. Euler observed that each time the walk enters a vertex through an edge, it has to go out

through another edge, except for the last vertex of the walk. Hence, for such a walk to exist, each vertex except the two endpoints have to be even. Since the graph in question has four odd vertices, Euler had proven that the problem had no solution [28].

This reasoning would prove to be of great significance in the history of mathematics, by introducing the field of graph theory and foreseeing topology. A walk going through all the edges of a graph is now called an *Eulerian path* (or *Eulerian cycle* if the two endpoints are the same vertex) [4].

Graphs are helpful to extract the intrinsic properties of an instance of a practical problem, and are thus often used to abstract and model such problems. As a first example, let us consider the following “toy problem”. We are organizing a wedding, and would like to assign each guest to a table. To prevent incidents, if two guests dislike each other, we would like to assign them to different tables. We can observe that the condition is satisfied if we only have a single guest per table, and as long as two guests dislike each other, one table is not sufficient. Then what is the minimum number of tables required to satisfy the condition for a given set of guests?

The only relevant information here is the status of the relationship between each pair of guests, hence we can model this problem with a graph in which each vertex represents a guest, and there is an edge between two vertices if the associated guests dislike each other. The problem of finding the minimum number of tables thus consists in solving the so-called *vertex coloring problem* [35]: assigning to each vertex of a graph a color, in such a way that two vertices linked by an edge are assigned different colors, all while using the smallest number of colors. Figure 8 shows an example of an instance of the guest problem encoded as an instance of the vertex coloring problem, and a solution with 3 tables (represented by 3 colors). This is an optimal solution, as we can observe that with only 2 tables, two of James, John and Jennifer would end up at the same table, despite disliking each other.

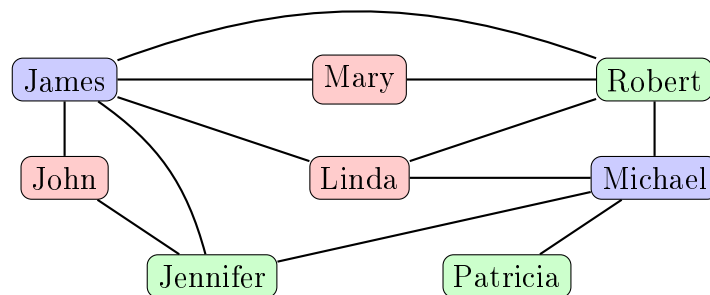

Figure 8: The graph representing the relationships between the guests: an edge indicates that the two associated guests hate each other. The colors represent the tables.

Graphs can thus be used to model the structure of a concrete network, like for the Königsberg bridge problem, or to model the interactions and relations between objects, such as for the guest problem. They are in fact used in most scientific domains nowadays, as explained by 2021 Abel Prize recipient László Lovász in his acceptance speech:

*“We now realize that most of the structures and systems we want to understand have an underlying network or graph, from computer to the internet, from ecological communities to the brain, from social networks to epidemics, graph theory is becoming the mathematical background for this new paradigm.”*

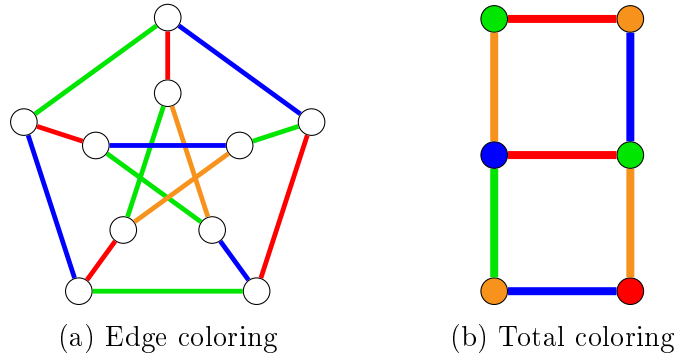

Figure 9: Instances of edge coloring and total coloring with 4 colors

Graphs are indeed used to model a variety of networks, like road networks or sets of interconnected computers, and to solve related problems like finding a shortest route between two nodes [36]. Molecules in physics have a graph structure, with atoms linked by covalent bonds, and their properties can be studied with the use of graph theory [15]. Graphs are used in fields as varied as 3D modelling, through the use of meshes [3]; biology, where they help model the interactions between proteins [50]; linguistics, through parse trees [17]; social sciences, with graphs being used to measure the influence of an individual within a group of people [63]; or data science, with graph databases [81]. The advent of social networks in the last decades only reinforced the need for graph theory, with applications in recommendation algorithms [62].

Graph theory is closely related to other domains of computer science, such as algorithmics and complexity theory. Many theoretical graph problems have been thoroughly studied, like the *travelling salesman problem*, which asks for the shortest walk that visits all the vertices of the graph and goes back to the first one, or the *independent set problem*, which asks for the biggest subset of vertices that does not contain any edge in a given graph. These two problems, as well as the aforementioned vertex coloring problem, have the particularity of being *NP-hard* [39], which roughly means that the computation of an exact solution by a computer is challenging, even on relatively small instances.

Although the vertex coloring problem is the most famous, many variants of coloring problems have been studied in the last centuries. For instance the *list coloring problem*, which is similar to the vertex coloring problem, except that the color of each vertex must be chosen among a list of candidates assigned to each vertex. The goal is here to find the smallest common size of the lists, in order for the graph to have a correct assignment (with different colors for vertices linked by an edge) no matter the content of the lists. The *edge coloring problem* (see Figure 9a) features a different kind of graph coloring, where the colors are assigned to the edges, and the goal is to find the minimum number of colors needed to color all the edges in such a way that two edges incident with the same vertex are not assigned the same color. Another example is *total coloring* (see Figure 9b), in which both the vertices and the edges are colored, in such a way that the same color is not assigned to two vertices linked by an edge, to two edges incident with the same vertex, or to a vertex and one of its incident edges [35].

Coloring problems belong to a larger family of *decomposition problems*, which aim at partitioning a graph into smaller, simpler structures. The vertex coloring problem is equivalent to partitioning the vertices of a graph into independent sets, and the edge coloring consists in partitioning the edges of a graph into *matchings*, i.e. subsets of



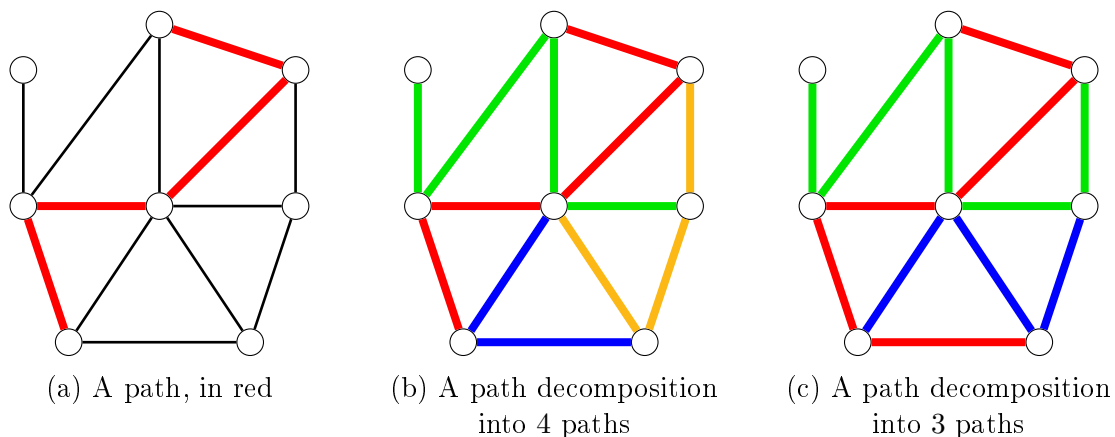

Figure 10: A path, and two path decompositions

pairwise non-incident edges. Many graph decomposition problems have been studied: decomposing a graph into *cliques*, i.e. subgraphs containing all possible inner edges, or into *stars*, subsets of edges having exactly one end in common, for example. A *path* in a graph is a walk, so a consecutive sequence of edges, such that each vertex of the walk is touched exactly once, as in Figure 10a. We say that a graph is *connected* if any two vertices are the endpoints of a path in the graph. The decomposition problem we study in this thesis asks for a partition of the edges into paths, or *path decomposition*. Equivalently, a path decomposition of a graph is a coloring of its edges in such a way that edges with the same color form a path. Figure 10b features a graph decomposed into 4 paths. The same graph can also be decomposed into only 3 paths, as in Figure 10c, but not less. Indeed, the central vertex has a *degree* (a number of incident edges) of 6, so its incident edges require at least three paths to be covered. Let us also observe that each odd vertex must be the end of at least one path. The graph of Figure 10 contains 6 odd vertices, hence cannot be decomposed into less than 3 paths.

In 1968, Hungarian mathematician Tibor Gallai asked the following question [58]: given a connected graph with  $n$  vertices, is it always possible to find a path decomposition of the graph into  $\lceil \frac{n}{2} \rceil$  paths? For example, this is the case with the graph on Figure 10, since it contains 8 vertices and can be decomposed into 3 paths. However, despite the apparent simplicity of the statement, its proof is yet to be found half a century later. This question is known as *Gallai's path decomposition conjecture*, and is the subject of the contribution presented along this thesis.

Even though solving the problem on all graphs seems difficult, we can observe that restricting it to specific families of graphs can in certain cases make it easier. The property is clearly satisfied by graphs made up of one path, or one cycle (a walk in which the two endpoints are the same vertex). Since its first mention, the conjecture has been solved on many graph families, like graphs with at most one even vertex [58], or recently graphs where each vertex has a degree of at most 5 [6]. We proved a result of the same kind, by restricting the problem to a family of graphs with helpful properties, in order to bring another partial solution to the conjecture.

The graphs which emboldened us were planar graphs, a well-known graph family with a wide range of applications. A graph is *planar* if it can be *embedded* in the plane, i.e. if it can be drawn in the plane in such a way that no two edges cross each other. Examples of planar graphs include the graphs in Figures 8, 9b and 10, but it is not the case for the

graph in Figure 9a (known as the *Petersen graph*) for which there is no way of moving the vertices or bending the edges to embed it in the plane.

The family of planar graphs is natural to consider, firstly because a graph embedded in the plane is much easier for a human to apprehend than a graph drawn with multiple overlapping edges. Applications of planar graphs include the design of printed circuit boards [14], to prevent conductive tracks from overlapping, or the design of flight paths [32]. The class is most notably known for the *four-color theorem*, which states that only 4 colors are needed to color the regions of a map in a way that no two adjacent regions share the same color, or equivalently that there is always a solution with 4 colors to the vertex coloring problem on planar graphs. Conjectured in 1852, its proof [1, 2] in 1976 was the first of its kind, requiring a computer to solve a vast number of technical cases.

We contribute to the research on Gallai’s conjecture by proving that it holds on the family of planar graphs.

**Theorem** (Blanché, Bonamy, Bonichon [5], 2021+). *Any connected planar graph with  $n$  vertices has a path decomposition into at most  $\lceil \frac{n}{2} \rceil$  paths.*

The class of planar graphs is one of the most natural and wide classes on which the conjecture was confirmed, and represents a significant milestone on the path toward its full resolution. In addition, we explain in Chapter 2 that we actually prove a slightly stronger version of the conjecture in the case of planar graphs, by showing that we can reach the sharper bound of  $\lfloor \frac{n}{2} \rfloor$ , with the exception of two small graphs.

The method we used to prove this theorem is a fairly common one ([6, 9, 72, 82]): we start by assuming that our theorem is false, which implies that there must exist some planar graphs that do not satisfy the property. Among these counterexamples, we consider one that contains the smallest number of vertices. To prove our theorem, it suffices to show that this minimum counterexample does not exist, which we do by demonstrating that its existence leads to a contradiction. The bulk of the proof consists in proving that certain structures cannot appear in our minimum counterexample due to its properties. Finally, a quick proof shows that the graph must in fact contain one of these forbidden structures. The two results being contradictory, we are able to deduce that the counterexample does not exist.

This thesis lays out our proof of the theorem. The important notions and definitions are presented in Chapter 1, while Chapter 2 summarizes the history of the conjecture and the multiple partial results that were proven in the past 50 years. Chapter 3 consists in the proof of a first lemma, that limits the number of vertices of degree at most 4 in our counterexample to at most one. The proof of this lemma assumes the existence of two such vertices, and shows in each case that such a structure contradicts the property of the graph being a minimum counterexample to Gallai’s conjecture. Chapter 4 features a second lemma, that generalizes the ideas of the first one, and which limits the number of vertices of degree 5. Finally, we conclude our proof of the theorem by showing in Chapter 5 that the existence of a minimum counterexample with such a structure yields a contradiction.



# Chapter 1

## Preliminaries

The following chapter introduces the basic definitions around graphs, path and cycle decompositions, as well as connectivity and planarity-related notions. We finally define some classical graph classes, which are mentioned throughout this thesis and especially in the state of the art of Chapter 2.

### 1.1 Basic definitions on graphs

**Graphs.** A *graph* is an abstract object made up of a set of *vertices*, corresponding to points in space or nodes in a network, and a set of *edges*, or links between pairs of vertices. We denote a graph  $G$  with vertex set  $V$  and edge set  $E$  by  $G = (V, E)$ . An edge between two vertices  $u, v$  is denoted by  $uv$ , and we say that  $u, v$  are the *ends* of  $uv$ . The graphs that we consider throughout this thesis are *finite*, i.e. contain a finite number of vertices, and *simple*, i.e. each edge of the graph connects two distinct vertices, and there is at most one edge between any two vertices. Hence, the number of edges in a graph with  $n$  vertices is at most  $\binom{n}{2} = \frac{n(n-1)}{2}$ . We may denote  $V, E$  as  $V(G), E(G)$  respectively.

These graphs are called *undirected*. In a *directed* graph, the edges are called *arcs*, and the two ends of each arc are ordered. This thesis deals almost exclusively with undirected graphs, and directed graphs are only mentioned in the state of the art of Chapter 2.

For the rest of the definitions, let us fix a graph  $G = (V, E)$ .

**Adjacency.** In a given graph, we say that two vertices  $u, v$  are *adjacent* (or that  $u$  is adjacent to  $v$ , or vice-versa) if the graph contains the edge  $uv$ , and in this case we say that the edge  $uv$  is *incident* with  $u$  and  $v$ . In this case, we say that  $v$  is a *neighbor* of  $u$ , and vice-versa. Given a subset  $X \subseteq V$  of vertices, we denote by  $N(X) = \{v \in V \mid \exists u \in X, uv \in E\}$  the *neighborhood* of  $X$ , i.e. the set of vertices that are adjacent to  $u$ .

**Incident edges.** We say that two edges  $uv, uw$  sharing an end  $u$  are *incident*. A *matching* is a subset of pairwise non-incident edges in a graph.

**Complement.** The *complement* of  $G$  is the graph  $\overline{G} = (V', E')$  defined by  $V' = V$  and  $E' = \{uv \mid u, v \in V, u \neq v, uv \notin E\}$ .

**Subgraphs.** The *subgraph* of  $G$  induced by a subset  $X \subseteq V$  is the graph with vertices  $X$  and edges  $\{uv \in E \mid u, v \in X\}$ , and is denoted by  $G[X]$ . Equivalently, it is the graph

formed by removing all the vertices in  $V \setminus X$  and their incident edges, but keeping all edges with both ends in  $X$ . We say that  $G[X]$  is an *induced subgraph* of  $G$ .

More generally, a graph  $G' = (V', E')$  is a *subgraph* of  $G$  if  $V' \subseteq V$  and  $E' \subseteq (V' \times V') \cap E$ ; equivalently,  $G'$  is obtained from  $G[V']$  by possibly deleting some edges.

Given a graph  $H$ , we say that  $G$  is *H-free* if  $H$  is not an induced subgraph of  $G$ .

**Edge contractions, minors.** The graph  $G_e = (V_e, E_e)$  is obtained by *contracting* an edge  $e = uv$  of  $G$  if  $V_e = V \setminus \{u, v\} \cup \{w\}$ , with  $w$  being a new vertex not present in  $V$ , and  $E_e = (E \cap (V' \times V')) \cup \{wx \mid ux \in E \text{ or } vx \in E\}$ . In other words, the graph  $G_e$  is obtained by merging the vertices  $u$  and  $v$  into a new one  $w$ , and linking  $w$  to the neighbors of  $u$  and to the neighbors of  $v$ . The graph  $G_e$  thus has fewer vertices than  $G$ , but is not a subgraph of  $G$ .

A graph is a *minor* of  $G$  if it is obtained from  $G$  by deleting vertices and edges, and contracting edges. Similarly to induced subgraphs, given a graph  $H$ , we say that  $G$  is *H-minor-free* if  $H$  is not a minor of  $G$ .

**Cliques, independent sets.** A *complete graph* is a graph on  $n$  vertices that contains the  $\frac{n(n-1)}{2}$  possible edges between these vertices. Figure 1.2a represents a complete graph on 5 vertices. A *clique* of a graph  $G$  is a complete subgraph of  $G$ .

A subset  $V' \subseteq V$  of vertices of a graph  $G$  is an *independent set* of  $G$  if  $G[V']$  has no edge.

**Degree.** The *degree* of a vertex  $u$  is its number of incident edges in  $G$ , and is denoted  $d_G(u)$ . A vertex with degree  $i$  in  $G$  is called an *i-vertex* of  $G$ . In particular, the proofs in Chapters 3 and 4 heavily use the parity of the degree of the vertices.

A graph is (*i*-) *regular* if all its vertices have the same degree (*i*).

## 1.2 Paths and cycles

**Walks.** A *walk* in  $G$  is a finite sequence of distinct edges of  $G$ , in which each pair of consecutive edges shares one end. Let  $W$  be the walk  $(v_1v_2, v_2v_3, \dots, v_{k-1}v_k)$ , that we denote by  $W = (v_1, v_2, \dots, v_k)$ . In this case, we say that the vertices  $v_1, v_2, \dots, v_k$  *belong* to  $W$ , and they are not necessarily distinct. We write  $V(W) = \{v_1, v_2, \dots, v_k\}$  and  $E(W) = \{v_1v_2, v_2v_3, \dots, v_{k-1}v_k\}$ . The *length* of a walk is its number of edges, in this case  $k - 1$ . The two *ends* of the walk are  $v_1$  and  $v_k$  (which may be the same vertex).

Let us now consider two specifications of the notion of walk.

**Paths.** A *path*  $P = (v_1, v_2, \dots, v_k)$  is a walk in which all vertices are distinct. The vertices  $v_2, \dots, v_{k-1}$  are the *internal vertices* of  $P$ . We say that two paths are *internally disjoint* if they have no internal vertex in common. We also call  $P$  a  $(v_1, v_k)$ -*path*. We say that two vertices  $u, v$  are *at distance*  $k$  if the minimum length of a  $(u, v)$ -path is  $k$ .

A *section*  $Q = (v_i, \dots, v_j)$  of a path  $P = (v_1, \dots, v_k)$ , for  $1 \leq i < j \leq k$ , is a subsequence of consecutive edges of  $P$ . For simplicity, we denote some paths by a sequence of subpaths: if  $(Q_i)_{i=1..k}$  is a family of edge-disjoint paths, we may denote the path  $P = (Q_1, Q_2, \dots, Q_k)$ ; we may also denote it by an alternation of vertices and subpaths:  $P = (v_1, Q_1, v_2, \dots, v_{k-1}, Q_k, v_k)$ .

A path  $P = (v_1, \dots, v_k)$  of a graph  $G$  has a *chord* if there is an edge  $v_iv_j \in E(G)$  such that  $v_i$  and  $v_j$  belong to  $V(P)$  but are not consecutive in  $P$ . We say that  $P$  is *chordless* if it has no chord.

**Cycles.** A *cycle* is a walk where the two ends are the same vertex, and all other vertices are distinct from the ends and from one another. We denote a cycle  $C = (v_1v_2, \dots, v_kv_1)$  by its sequence of vertices:  $C = (v_1, v_2, \dots, v_k)$ . This notation is not unique, as any vertex from  $C$  could be considered the merged ends of the underlying walk.

The notion of length for paths and cycles is inherited from walks.

**Hamiltonian path, cycle.** A path (resp. a cycle) in a graph  $G$  is *Hamiltonian* if its vertex set is  $V(G)$ .

**Girth.** The *girth*  $g$  of a graph is the length of its shortest cycle ( $g \geq 3$ ).

**Subdivisions.** A graph is obtained from a *subdivision* of an edge  $uv$ , by replacing the edge  $uv$  with a  $(u, v)$ -path of length 2, i.e. by adding an intermediate vertex of degree 2. A graph  $K$  is a *subdivision* of a graph  $H$  if  $K$  can be obtained from  $H$  by successive subdivisions of edges.

Given a graph  $K$ , a  $K$ -*subdivision* in  $G$  is a subgraph of  $G$  that is a subdivision of  $K$ . The *roots* of the  $K$ -subdivision are the images in  $G$  of the vertices of  $K$ , and the *paths* of the  $K$ -subdivision are the images in  $G$  of the edges of  $K$ . Given a set  $U$  of vertices of a graph  $G$ , we say that a  $K$ -subdivision of  $G$  is *rooted on*  $U$  if its roots are exactly the vertices of  $U$ . We say that a  $K$ -subdivision is *chordless* if its paths are chordless.

**$K_4$ -,  $C_{4+}$ -subdivisions.** The subdivisions we use in Chapter 4 are  $K_4$ -subdivisions and  $C_{4+}$ -subdivisions (see Figure 1.1 below), where  $K_4$  is the complete graph on 4 vertices and  $C_{4+}$  is the graph made up of a cycle on 4 vertices  $U = \{x_1, x_2, x_3, x_4\}$  and two additional parallel edges  $x_1x_3, x_2x_4$ . We say that two subdivisions  $S, S'$  have the same *type* if  $S, S'$  are both  $K_4$ -subdivisions or both  $C_{4+}$ -subdivision. For  $u_i, u_j \in U$ , we denote  $u_i \sim u_j$  the  $(u_i, u_j)$ -path of a  $K_4$ - or  $C_{4+}$ -subdivision when there is no ambiguity.

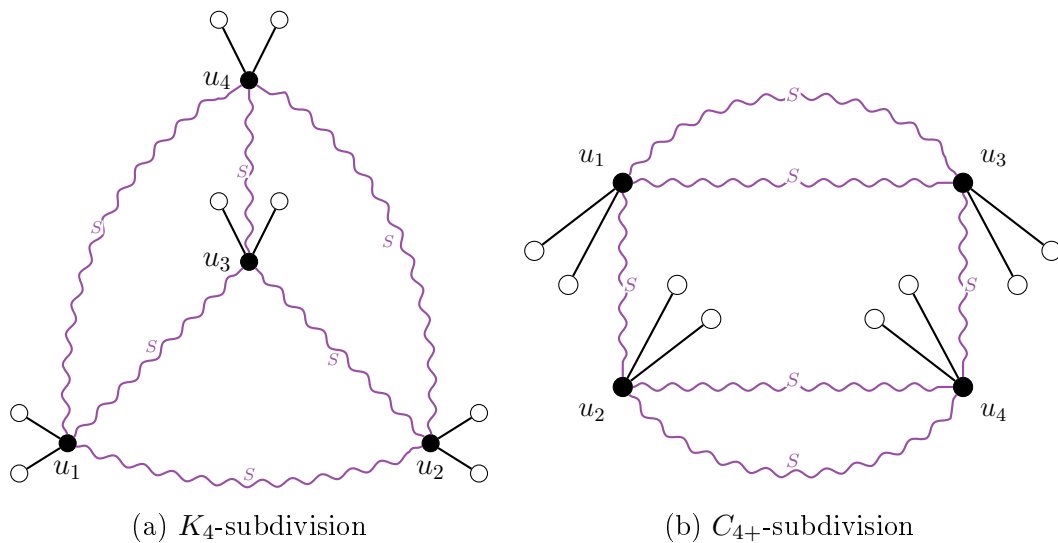

Figure 1.1: The two subdivisions considered in Chapter 4

## 1.3 Decompositions

The main result of this thesis deals with a decomposition problem. We present in Chapter 2 several examples of such problems, divided into two main categories, *vertex-* and *edge-*decompositions.

**Decompositions.** A *vertex*-decomposition (resp. *edge*-decomposition) is a partition of the vertices (resp. edges) of a graph. Given a graph class  $\mathcal{G}$ , a  $\mathcal{G}$ -vertex-decomposition of a graph  $G$  is a vertex-decomposition of  $G$  into subsets  $V_1, \dots, V_k$  of vertices, such that  $G[V_i] \in \mathcal{G}$  for each  $i \in \{1, \dots, k\}$ . Similarly, a  $\mathcal{G}$ -edge-decomposition of a graph  $G$  is an edge-decomposition of  $G$  into subsets  $E_1, \dots, E_k$  of edges, such that the subgraph of  $G$  containing exactly the edges in  $E_i$  and their ends is a graph of  $\mathcal{G}$ , for each  $i \in \{1, \dots, k\}$ .

The conjecture studied in this thesis deals with edge-decompositions into paths, which we call *path decompositions* for conciseness. The framework we adopt to talk about such decompositions represents paths as colors.

**Coloring, path decompositions.** We say that a  $(k)$ -*path-coloring* (or just *coloring* in Chapters 3 and 4) of a graph  $G = (V, E)$  is a function  $c : E \rightarrow \llbracket 1, k \rrbracket$ , with  $k \in \mathbb{N} \setminus \{0\}$ , such that the edges with the same color form a path. We denote  $|c| = k$  the number of colors used in the coloring. We say that a color  $x$  *induces* a path  $P$  if  $E(P) = c^{-1}(\{x\})$ . A *good coloring* of a connected graph  $G$  with  $n$  vertices is a  $\lfloor \frac{n}{2} \rfloor$ -path-coloring. A color  $x$  *ends* on a vertex  $v$  if the path induced by the color  $x$  ends on  $v$ .

**2-colorings of  $K_4$ -,  $C_{4+}$ -subdivisions.** To describe the 2-path-coloring of a  $K_4$ -subdivision or a  $C_{4+}$ -subdivision  $S$  rooted on  $\{u_1, u_2, u_3, u_4\}$ , we use the notation  $\{red = (u_{i_1} \rightarrow u_{i_2} \rightarrow u_{i_3} \rightarrow u_{i_4}), blue = (u_{j_1} \rightarrow u_{j_2} \rightarrow u_{j_3} \rightarrow u_{j_4})\}$  for  $i_1, i_2, i_3, i_4$  and  $j_1, j_2, j_3, j_4$  two permutations of  $1, 2, 3, 4$ . This notation means that we decompose  $S$  into two paths  $P_{red} = (u_{i_1} \sim u_{i_2}, u_{i_2} \sim u_{i_3}, u_{i_3} \sim u_{i_4})$  and  $P_{blue} = (u_{j_1} \sim u_{j_2}, u_{j_2} \sim u_{j_3}, u_{j_3} \sim u_{j_4})$ . The decompositions of this kind that we consider throughout Chapter 4 feature each edge of  $S$  exactly once. We sometimes insert non-special vertices in between the vertices from  $U$  to describe the paths we take more precisely: the notation  $(\dots \rightarrow u_i \rightarrow v \rightarrow u_j \rightarrow \dots)$  means that the path  $u_i \sim u_j$  considered is the  $(u_i, u_j)$ -path of the subdivision that contains the vertex  $v$ .

## 1.4 Connectivity

**Connected graphs.** A graph is *connected* if there is a  $(u, v)$ -path in the graph between any pair of vertices  $u, v$ . We say that the graph is *disconnected* otherwise. A disconnected graph can be decomposed into *connected components* (or simply *components*), subsets of vertices such that the vertices from each set form a connected graph.

**Cuts.** A  $k$ -*cut* of a connected graph  $G = (V, E)$  is a set  $X$  of  $k$  vertices of  $G$ , such that  $G[V \setminus X]$  is disconnected.

**Connectivity.** A graph is  $k$ -*connected* if it has more than  $k$  vertices and does not have a  $(k - 1)$ -cut.

Alternatively, Menger proved that a graph without a  $k$ -cut has  $k$  internally disjoint  $(u, v)$ -paths between any pair  $(u, v)$  of vertices [61].

## 1.5 Definitions around planar graphs

We now define the graph class that is the object of the main theorem of this thesis. The class of planar graphs has been well-studied over the years, as detailed in Chapter 2.

**Planar graphs.** A *planar embedding* of a graph in the plane is a placement of the vertices and edges of the graph in the plane  $\mathbb{R}^2$ , assigning a position  $(x, y) \in \mathbb{R}^2$  to each vertex and a curve to each edge of the graph in such a way that the edges intersect only at their endpoints. A graph is *planar* if it admits a planar embedding.

**Faces.** A planar embedding of a planar graph  $G$  partitions the plane  $\mathbb{R}^2$  into *regions*. The edges of  $G$  delimiting a region form a *face*. The *degree* of a face  $F$  is its number of edges. Notably, the number of faces of a planar graph does not depend on the planar embedding.

**Outerplanar graphs.** A graph is *outerplanar* if it is planar and has an embedding in which all its vertices belong to the same face.

The following formula links the numbers of vertices, edges and faces of a planar graph. Given a planar graph  $G = (V, E)$ , with a set  $F$  of faces, we denote  $|V|, |E|, |F|$  the number of vertices, edges and faces respectively.

**Theorem** (Euler's formula). *If  $G = (V, E)$  is a connected planar graph embedded in the plane, with at least 1 vertex and a set  $F$  of faces, then  $|V| - |E| + |F| = 2$ .*

Note that despite the folklore attributing this formula to René Descartes in 1630, it was indeed discovered by Euler [27] in 1752 and first proved by Adrien-Marie Legendre [57] in 1794 [60].

Given a planar graph  $G = (V, E)$ , with a set  $F$  of faces, we denote  $d(v), d(f)$  the degree of a vertex  $v$  and a face  $f$  respectively. Observe that  $\sum_{v \in V} (d(v) - 6) = 2 \cdot |E| - 6 \cdot |V|$  and  $\sum_{f \in F} (2 \cdot d(f) - 6) = 4 \cdot |E| - 6 \cdot |F|$ . Then we can deduce from Euler's formula that:

$$\sum_{v \in V} (d(v) - 6) + 2 \cdot \sum_{f \in F} (d(f) - 3) = -12$$

**Kuratowski's and Wagner's theorems.** Planar graphs are usually characterized by two results from the 1930s. The first one is *Kuratowski's theorem*, from 1930, and it defines planar graphs over forbidden subdivisions.

$K_5$  is the complete graph on 5 vertices (see Figure 1.2a), while  $K_{3,3}$  is the complete bipartite graph on two sets of 3 vertices (see Figure 1.2b), i.e. the graph with vertices  $\{a_1, a_2, a_3, b_1, b_2, b_3\}$  and edges  $a_i b_j, i, j \in \{1, 2, 3\}$ .

**Theorem** (Kuratowski, [56]). *A graph is planar if and only if it does not contain a  $K_5$ -subdivision or a  $K_{3,3}$ -subdivision.*



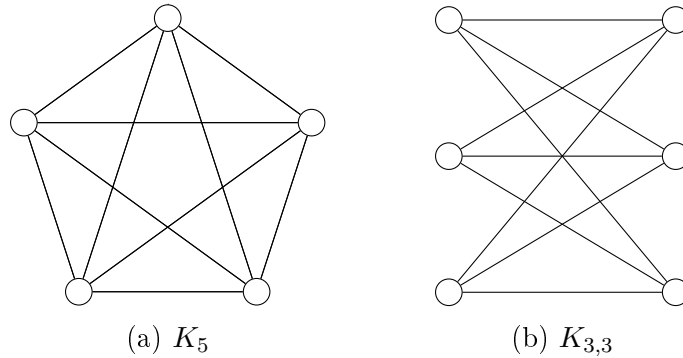

Figure 1.2: The forbidden subdivisions and minors of Kuratowski's and Wagner's theorems

The second result is from 1937 and is the one we use in the proof of Chapter 4.

**Theorem** (Wagner, [78]). *A graph is planar if and only if it does not contain a  $K_5$ -minor or a  $K_{3,3}$ -minor.*

## 1.6 Some graph classes

Let us now define some classical graph classes, mentioned in the proof and in the state of the art of Chapter 2.

**Trees.** A graph is *acyclic* if none of it does not have a cycle as a subgraph. A *tree* is a connected acyclic graph. A *forest* is a graph whose connected components are trees.

**Bipartite graphs.** A graph is *bipartite* if its vertex set  $V$  can be partitioned into two independent sets. A *complete bipartite graph*  $K_{m,n}$  is the graph on  $m+n$  vertices, whose vertex set can be partitioned into two independent sets  $V_m, V_n$ , such that there is an edge between each vertex of  $V_m$  and each vertex of  $V_n$ .

**Triangle-free graphs.** We call *triangle* the complete graph  $K_3$  on 3 vertices. A graph is *triangle-free* if it does not have a triangle as an induced subgraph.

**Treewidth.** A *junction tree* of a graph  $G = (V, E)$  is a tree  $T$  whose vertex set is made up of  $n$  sets  $X_1, \dots, X_n \subseteq V$ , such that the union of these sets cover  $V$ . For every edge  $uv \in E$ , there is a set  $X_i$  that contains both  $u$  and  $v$ ; and if  $X_i$  and  $X_j$  both contain a vertex  $v$ , then  $v$  belongs to all the sets that form the unique  $(X_i, X_j)$ -path in  $T$ .

The *treewidth* of a graph  $G$  is the minimum size of the largest set  $X_i$  minus 1, among all junction trees of  $G$ .

The *pathwidth* parameter has the same definition, as the minimum size of the largest set  $X_i$  minus one, among all junction paths of  $G$ .

**Series-parallel graphs.** An  $(s, t)$ -*series-parallel graph* is a graph with two distinguished vertices  $s, t$ , recursively defined as follows. An edge  $st$  is an  $(s, t)$ -series-parallel graph. Given an  $(s, t_1)$ - and an  $(s_2, t)$ -series-parallel graphs, the *series-composition* of these two

graphs obtained by identifying  $t_1$  and  $s_2$  is an  $(s, t)$ -series-parallel graph; and the *parallel-composition* obtained by identifying the pair of vertices  $s, s_2$  and the pair  $t, t_1$  is an  $(s, t)$ -series-parallel graph. A *series-parallel graph* is an  $(s, t)$ -series-parallel graph w.r.t. two of its vertices  $s, t$ .

**Planar 3-trees.** A *planar 3-tree* is a planar graph that can be constructed from the triangle  $K_3$  by a sequence of *stacking operations*, which consist in adding a vertex  $v$  to the graph, and 3 edges  $vw_1, vw_2, vw_3$  to vertices  $w_1, w_2, w_3$  forming a (triangular) face.



# Chapter 2

## History of Gallai's conjecture

In this chapter, we first give an overview of some classical decomposition and coloring problems in graph theory. We then present the different results of László Lovász's paper from 1968, *On covering of graphs* [58], including the titular conjecture by Tibor Gallai, a similar conjecture posed by György Hajós, and a seminal theorem by Lovász, before discussing its corollaries. We mention problems related to Gallai's and Hajós' conjectures, and give a quick summary of the main results around Hajós' conjecture. We then dive into the literature and the many partial results around Gallai's conjecture, and we conclude the chapter by stating our contribution.

### 2.1 Decomposition problems

Many graph problems are studied under frameworks of graph coloring, as the use of colors is a convenient way of representing partitions of vertices, edges or faces in a graph. Decomposition problems involving such partitions have been extensively studied in the last century and form a major part of graph theory. The origin of such a framework can be traced back to the mid-19th century. Francis Guthrie was trying to color the map of counties of England in such a way that two counties sharing a border would receive different colors, and noticed that he could do it with only four colors. The conjecture that four colors suffice for any map was first mentioned in a letter of Augustus De Morgan to William Rowan Hamilton on October 23, 1852, and became one of the most famous problems in discrete mathematics in the century that followed, until it was finally proved in 1977 by Kenneth Appel, Wolfgang Haken and John Koch [1, 2], and became the *Four-color theorem*. The proof itself was revolutionary, as it had required 1200 hours of computer time and was the first proof to necessitate extensive use of computers to solve a large number of subcases. The final proof consists in getting the problem down to a set of *unavoidable configurations*, then proving that each of these configurations is *reducible* and can be solved individually; the same structure as in the main proof of the present thesis, in Chapters 3 and 4.

The most well-studied graph coloring problem is the so-called *vertex coloring problem* [35]. It uses colors to translate an incompatibility between two actors: the vertices each receive a color, and two vertices that are adjacent must receive different colors (see Figure 2.1).

**Vertex coloring problem**

- *Instance:* A graph  $G$ , an integer  $k$
- *Question:* Can  $V(G)$  be colored with at most  $k$  colors in such a way that adjacent vertices receive different colors?

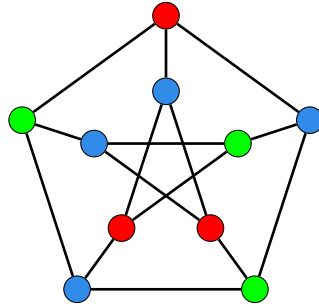

Figure 2.1: The Petersen graph vertex-colored with 3 colors

Such a coloring is often called a *proper coloring*, and the smallest number  $k$  of colors for which the graph  $G$  admits a proper coloring is called the *chromatic number* of  $G$ . The vertex coloring problem is a well-known NP-complete problem, as proven by Richard Karp in his seminal list of 21 NP-complete problems from 1972 [53], and as such is integral to computational complexity theory and the *P versus NP* problem (for definitions around complexity theory, see [39]). As a decomposition problem, the vertex coloring problem consists in partitioning the vertices of a graph into independent sets.

One significant result related to vertex coloring is *Brooks' theorem*, stated by R. Leonard Brooks in 1941.

**Theorem** (Brooks [13], 1941). *Let  $G$  be a connected graph with maximum degree  $\Delta$ . Then the chromatic number of  $G$  is at most  $\Delta$ , unless  $G$  is a clique or an odd cycle, in which case its chromatic number is  $\Delta + 1$ .*

One major application of the vertex coloring problem is register allocation in compilers. Introduced by Gregory J. Chaitlin, Marc A. Auslander, Ashok K. Chandra, John Cocke, Martin E. Hopkins and Peter W. Markstein [16] in 1981, the coloring approach to this problem is still current [24].

Many variants of graph coloring problems have been studied, a famous one being the *edge coloring problem* [35] (see Figure 2.2).

**Edge coloring problem**

- *Instance:* A graph  $G$ , an integer  $k$
- *Question:* Can  $E(G)$  be colored with at most  $k$  colors in such a way that incident edges receive different colors?

The minimum  $k$  for which  $G$  admits such a coloring is called the *chromatic index* of  $G$ . The chromatic index is always greater than the maximum degree  $\Delta$  of the graph. Similarly to its vertex coloring counterpart, this problem can be seen as a decomposition problem and consists in partitioning the edges of a graph into matchings.

A fundamental result for edge coloring is *Vizing's theorem*, proved in 1964 by Vadim G. Vizing. It is analogous to Brooks' theorem mentioned above.

**Theorem** (Vizing [77], 1964). *Let  $G$  be a connected graph with maximum degree  $\Delta$ . Then the chromatic index of  $G$  is at most  $\Delta + 1$ .*

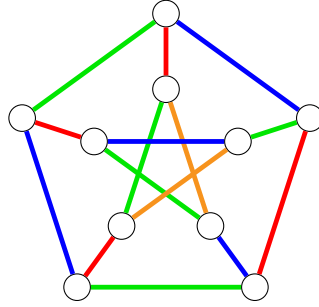

Figure 2.2: The Petersen graph edge-colored with 4 colors

Other variants of graph coloring problems include *total coloring* [35], which combines the constraints of vertex and edge coloring: can we color the vertices and edges of a graph with at most  $k$  colors in such a way that no two adjacent vertices, no two incident edges, and a vertex and an edge that are incident have the same color?

Finally, let us cite the variant of *list coloring* [35], which consists in coloring each vertex  $v$  with a color taken from a list  $L(v)$  to obtain a proper coloring. A graph is *k-choosable* if it has such a coloring for any assignment of lists  $L(v)$  of same capacity  $k$  to the vertices.

Graph coloring is the subject of many open problems in graph theory, like the *1-2-3 conjecture*, stated in 2004 by Michał Karoński, Tomasz Łuczak and Andrew Thomason [52]. The edges of the graph are “colored” with weights 1, 2 or 3, and the weight of a vertex is the sum of the weights of its incident edges. The conjecture states that any connected graph on at least three vertices should have such a coloring in a way that the weights of the vertices form a proper coloring. It is still open and an active research topic.

The four-color problem was graph theory’s earliest and most famous conjecture, and its generalization, *Hadwiger’s conjecture* [45], is now considered one of the most important problems in graph theory. It states that if a graph does not have the clique  $K_k$  as a minor, its chromatic number is at most  $k - 1$ . Hadwiger proved the cases  $k \leq 4$  in 1943 [45], and the four-color theorem of 1976 gives a solution for  $k = 5$ . Finally, Neil Robertson, Paul Seymour and Robin Thomas [71] proved the case  $k = 6$  in 1993, but the conjecture remains open for  $k > 6$ .

As mentioned above, graph coloring problems belong to a larger family of decomposition problems. The vertex coloring problem asks to partition, or decompose, the graph into independent sets, while the edge coloring problem partitions the edges into matchings, and many other decompositions have been studied.

Some of these problems ask for a *bipartition*, or a partition into 2 sets. For instance, the problems of *maximum cut* [44] and *minimum cut* [20] are examples of such decomposition problems: they ask to split the vertex set of a graph into two disjoint subsets, such that the edges between these sets respectively maximize and minimize some metric, like the total weight for a weighted graph. A significant result about bipartitions that we can mention was obtained by Daniel Gonçalves in 2005 [42], when he proved that the edges of any planar graph can be partitioned into two outerplanar graphs.

The treewidth parameter can be seen as a *covering* problem, since it does not involve a partition of the vertex set but rather a collection of non-disjoint sets that cover all vertices. The same applies to some variants of treewidth, such as *pathwidth* (the definitions of these two parameters are given in Chapter 1 on page 22). For these parameters, only the size of the sets that cover all vertices is minimized (and not their number).

Other types of decompositions, including the ones involved in the conjectures we present in the next section, ask for a partition of the vertex or edge set into a minimum number of particular subsets. For example, the *arboricity* of a graph is the minimum number of forests into which its edges can be partitioned. This parameter can be computed in polynomial time [38]. This is not necessarily the case however for *linear arboricity*, the minimum number of linear forests (forests made up of disjoint paths) into which the edges may be partitioned. This problem is indeed NP-complete, since recognizing the graphs of linear arboricity 2 is NP-complete as well [65].

The decomposition we study in this thesis is close to the definition of linear arboricity, but involves edge-disjoint paths instead of linear forests. A *path decomposition* of a graph is a partition of its edges into paths, and can be viewed as an edge coloring where each color induces a path. This notion appears to have originated in the 1960s; it is mentioned by Øystein Ore in 1962 [64] and Erdős in 1966 [58]. A similar variant we will mention is the *cycle decomposition*, a partition of the edges of a graph into cycles.

The problem of finding the minimum number of paths in which a given graph can be decomposed is NP-hard. Indeed, its decisional version, the problem consisting given a graph  $G$  and an integer  $k$  of deciding whether the edges of  $G$  can be decomposed into at most  $k$  of paths, was proven to be NP-complete by Péroche [66] in 1984. Péroche actually showed that deciding whether a given graph can be decomposed into 2 paths is NP-complete, even when the maximum degree of the graph is 4, with a reduction from the problem of deciding whether the arcs of a given directed graph, with in-degree and out-degree 2 for each vertex, can be partitioned into 2 Hamiltonian circuits, which he also proved to be NP-complete.

We will see in the next section that path and cycle decompositions are closely linked, by two similar conjectures that remain open as of today.

## 2.2 Gallai's conjecture

### 2.2.1 Origins of the conjecture

The story of the conjecture we are interested in starts in Hungary in the 1960s, with a discussion between Paul Erdős (1913-1996) and Tibor Gallai (1912-1992). The two childhood friends are well-known names in graph theory, and Erdős is often considered one of the most prolific mathematicians of the 20th century.

According to László Lovász [58], at the time Ph.D. student of Gallai, the following question can be attributed to Erdős: what is the minimum number of paths needed in a path decomposition of any connected graph on  $n$  vertices. The bound of  $\lceil \frac{n}{2} \rceil$  was suggested by Gallai, and seems to have been first mentioned by Lovász in a colloquium held in Tihany, Hungary in September 1966, before being published in 1968:

**Conjecture 2.2.1** (Gallai [58], 1968). *A connected graph with  $n$  vertices can be decomposed into at most  $\lceil \frac{n}{2} \rceil$  paths.*

This conjecture would go on to be known as *Gallai's path decomposition conjecture* in the literature, and is still open to this day. This is the problem we study in this thesis, and the rest of this section is dedicated to laying out the many partial results established over the past half-century.

We can first observe that connectivity is necessary for Gallai's bound to hold. Indeed, the disjoint union of  $k$  triangles has  $3k$  vertices, and at least  $2k$  paths are required in any path decomposition of this graph, contradicting the bound of  $\frac{3k}{2}$  postulated by the conjecture.

To prove that the conjecture's bound of  $\lceil \frac{n}{2} \rceil$  is tight, we consider the class of complete graphs. In a graph with an odd number  $2k + 1$  of vertices, a single path covers at most  $2k$  edges (if it is Hamiltonian), hence at least  $k + 1$  paths are required to decompose the  $(2k + 1)k$  edges of the complete graph  $K_{2k+1}$  on  $2k + 1$  vertices. This provides an infinite family of graphs on which Gallai's  $\lceil \frac{n}{2} \rceil$  bound is tight. The graphs requiring at least  $\lceil \frac{n}{2} \rceil$  paths to be decomposed are discussed in Section 2.5.

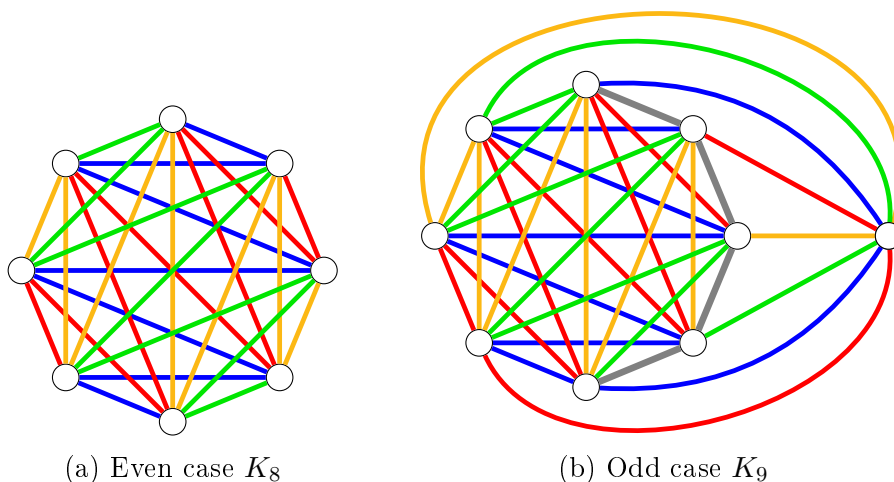

Figure 2.3: Walecki's construction for an even and an odd complete graph

Let us take the opportunity to confirm Gallai's conjecture on the class of complete graphs, by using a construction attributed to Walecki by Édouard Lucas [59] in the second volume of his *Récréations mathématiques* (1883). A complete graph  $K_{2p}$  on an



even number  $2p$  of vertices  $\{v_0, \dots, v_{2p-1}\}$  can be decomposed into  $p$  paths defined as  $P_k = (v_k, v_{k+1}, v_{k-1}, v_{k+2}, v_{k-2}, v_{k+3}, \dots, v_{k+p+1}, v_{k+p})$ , for  $k \in \{0, \dots, p-1\}$  and with each index taken modulo  $2p$  (see Figure 2.3a). A complete graph  $K_{2p+1}$  on an odd number  $2p+1$  of vertices  $\{v_0, \dots, v_{2p}\}$  can be decomposed in a similar way: we apply the previous decomposition to a clique made up of the first  $2p$  vertices  $\{v_0, \dots, v_{2p-1}\}$ , and turn each path  $P_k$  into a cycle  $C_k$  by adding the edges  $v_k v_{2p}$  and  $v_{k+p} v_{2p}$ . Then we remove the edges  $v_k v_{k+1}$  for  $k \in \{0, \dots, p-1\}$ , to turn the  $p$  cycles  $C_k$  into paths  $P'_k$ , and we add the path  $P_p = (v_0, v_1, \dots, v_p)$  to the decomposition. This defines a path decomposition of  $K_{2p+1}$  into  $p+1$  paths (see Figure 2.3b).

## 2.2.2 Hajós' conjecture

A similar conjecture was stated the same year by György Hajós (1912-1972), another Hungarian mathematician, at the time professor at Eötvös Loránd University of Budapest, at which Lovász was also studying. Hajós' conjecture is analogous to Gallai's and adapts it to cycle decompositions (see Figure 2.4). An *even* (resp. *odd*) graph is a graph whose vertices all have an even (resp. odd) degree.

**Conjecture 2.2.2** (Hajós [58], 1968). *An even graph with  $n$  vertices can be decomposed into at most  $\lfloor \frac{n}{2} \rfloor$  cycles.*

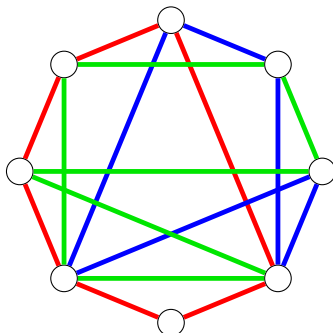

Figure 2.4: An even graph decomposed into 3 cycles

The graphs in question are necessarily even in order to have a cycle decomposition, and contrary to Gallai's conjecture they do not need to be connected. This is due to the arithmetical perks of using a *floor* function instead of a *ceiling* like in Gallai's conjecture (this point is detailed in Section 2.5).

Like Gallai's conjecture, Hajós' remains open as of today, and both were included in John Adrian Bondy's *Beautiful conjectures in graph theory* [7] in 2014. In 1986, Nathaniel Dean observed that the conjecture's bound could be easily strengthened.

**Theorem** (Dean [21], 1986). *Hajós' conjecture is equivalent to the statement: an even graph with  $n$  vertices can be decomposed into  $\lfloor \frac{n-1}{2} \rfloor$  cycles.*

Hajós' conjecture can be easily proven on complete graphs, with the construction of Figure 2.3. It was then confirmed for graphs of maximum degree 4, independently by Andrew Granville and Alexandros Moisiadis [43] in 1987 and by Odile Favaron and Mekhia Kouider [33] in 1988. Favaron and Kouider's result simultaneously proves Gallai's conjecture on the same class (see Section 2.4).

**Theorem** (Granville, Moisiadis [43], 1987, Favaron, Kouider [33], 1988). *Hajós’ conjecture is true for graphs of maximum degree at most 4.*

Our contribution to Gallai’s conjecture concerns planar graphs (see Section 2.6), and follows a series of recent results on this class ([9, 40, 51, 55]). Hajós’ conjecture has however been confirmed on planar graphs for decades, which is remarkable considering the similarity of the two conjectures’ statements. Jiang Tao [75] claimed the result in 1984, but his proof was apparently incomplete. Karen Seyffarth [72] confirmed it in 1992, with a proof based on Granville and Moisiadis’.

**Theorem** (Tao [75], 1984, Seyffarth [72], 1992). *Hajós’ conjecture is true for planar graphs.*

Seyffarth’s strategy is somewhat similar to ours. It operates by contradiction, considers a minimum counterexample to Hajós’ conjecture and uses it to show that it cannot contain some simple structures (a 1-cut, two vertices of degree 2, some particular vertices of degree 4...). Finally, a technical lemma yields a contradiction and is proved by diving into an intricate case analysis.

Other results on Hajós’ conjecture include the case of  $K_6^-$ -minor-free graphs, by Genghua Fan and Baogang Xu [31] in 2002 ( $K_6^-$  is the complete graph on 6 vertices minus one edge). The conjecture was confirmed for graphs of size up to 12 by Irene Heinrich, Marco V. Natale and Manuel Streicher [49] in 2017, and on graphs of pathwidth at most 6 by Elke Fuchs, Laura Gellert and Irene Heinrich [37] in 2020.

The next subsection addresses conjectures and results that are related to Gallai’s and Hajós’ conjectures. The sections that come after and the next chapters focus solely on Gallai’s conjecture, which constitutes the most active research topic out of all the conjectures presented in this chapter.

### 2.2.3 Related problems

We mention two problems related to Gallai’s and Hajós’ conjectures: one involves hybrid decompositions into cycles and edges, the other deals with the covering variant of Gallai’s conjecture.

**Erdős-Gallai conjecture.** Paul Erdős and Tibor Gallai conjectured [26] in 1966 that the edges of a graph with  $n$  vertices could be covered with at most  $n - 1$  cycles and edges. This conjecture was proved [68] in 1985 by another Hungarian mathematician, László Pyber, at the time Ph.D. student of László Lovász and Gyula O. H. Katona.

The more general problem of decomposing an even graph into  $O(n)$  cycles is closely related to Hajós’ conjecture and is also still open [34]. This problem is equivalent [34] to a problem posed in 1966 by Paul Erdős and Tibor Gallai [26], which is known as the Erdős-Gallai conjecture [25]:

**Conjecture 2.2.3** (Erdős, Gallai [26], 1966). *A graph with  $n$  vertices can be decomposed into  $O(n)$  cycles and edges.*

Girão, Granet, Kühn and Osthus [34] noted that Hajós’ conjecture would imply the existence of a decomposition of any graph with  $n$  vertices into  $\frac{3(n-1)}{2}$  cycles and edges, hence the Erdős-Gallai conjecture holds on all classes on which Hajós’ conjecture was proved.

**Chung’s conjecture.** Decomposition problems ask for a partition of the vertex or edge set of some graph. The *covering* variant of these problems asks for a collection of subsets of vertices or edges such that each vertex or edge is covered by at least one subset. The covering variant of Gallai’s conjecture was stated in 1980 by Fan Chung, which was a close friend and frequent collaborator of Paul Erdős.

**Conjecture 2.2.4** (Chung [19], 1980). *Any connected graph with  $n$  vertices can be covered by  $\lceil \frac{n}{2} \rceil$  paths.*

Toward a proof of this conjecture, László Pyber proved [69] in 1996 the following asymptotic result:

**Theorem** (Pyber [69], 1996). *Any connected graph on  $n$  vertices can be covered by at most  $\lceil \frac{n}{2} \rceil + O(n^{3/4})$  paths.*

Chung’s conjecture was then confirmed by Genghua Fan [30] in 1998.

Regarding the asymptotic version of Gallai’s conjecture, i.e. asking for a decomposition of any graph with  $n$  vertices into  $\frac{n}{2} + o(n)$  paths, Pyber observes in the same paper [69] that it cannot be proved without proving the conjecture itself.

Recently, António Girão, Bertille Granet, Daniela Kühn and Deryk Osthus [34] also studied Gallai’s, Hajós’ and Erdős-Gallai conjectures under an asymptotic framework, and proved all three asymptotically for sufficiently large graphs with linear minimum degree.

**Theorem** (Girão, Granet, Kühn, Osthus [34], 2021). *For any  $\alpha, \delta > 0$ , there exists  $n_0$  such that if  $G$  is a graph on  $n \geq n_0$  vertices with minimum degree at least  $\alpha n$ , then the following hold.*

- $G$  can be decomposed into at most  $\frac{n}{2} + \delta n$  paths;
- If  $G$  is even, then it can be decomposed into at most  $\frac{n}{2} + \delta n$  cycles;
- $G$  can be decomposed into at most  $\frac{3n}{2} + \delta n$  cycles and edges.

Apart from complete graphs (see Figure 2.3 above) and complete bipartite graphs (discussed in Section 2.4 below), this is one of the only results dealing specifically with *dense* graphs, i.e. graphs with a supralinear number of edges. Most other results in Section 2.4 feature graph classes that are under some condition of small degree, large girth or planarity. Density seems to be the most significant barrier to a complete proof of one of the aforementioned conjectures.

**Random graphs.** A remarkable result from the last few years comes from Stefan Glock, Daniela Kühn and Deryk Osthus, who proved [41] that Gallai’s conjecture holds for almost all graphs, by studying it on random graphs. An *Erdős-Rényi random graph*  $G_{n,p}$  is a graph on  $n$  vertices, such that each edge has the same probability  $p \in [0, 1]$  to be added to the graph. We denote  $G \sim G_{n,p}$  when a graph  $G$  is an Erdős-Rényi random graph. We denote  $odd(G)$  the number of vertices of odd degree of  $G$  and  $\Delta(G)$  the maximum degree of  $G$ . The result is the following:

**Theorem 2.2.5** (Glock, Kühn, Osthus [41], 2016). *Let  $p \in ]0, 1[$  be a constant and  $G \sim G_{n,p}$ . The probability that  $G$  can be decomposed into  $\max\left\{\frac{odd(G)}{2}, \left\lceil \frac{\Delta(G)}{2} \right\rceil\right\}$  paths converges to 1.*

This implies that almost all graphs satisfy Gallai’s conjecture, with room to spare, which makes us fairly optimistic about the chances of the conjecture being true.

## 2.2.4 Lovász's theorem

In 1968, in the same paper he introduced Gallai's conjecture, László Lovász considered hybrid decompositions allowing paths and cycles, and proved the following theorem:

**Theorem 2.2.6** (Lovász [58], 1968). *A graph with  $n$  vertices can be decomposed into at most  $\lfloor \frac{n}{2} \rfloor$  paths and cycles.*

His proof only takes 2 pages and consists in a quite straightforward induction on  $2|E| + |V|$ , yet his result settles the same  $\frac{n}{2}$  bound as in Gallai's and Hajós' conjectures. It is interesting and rather counterintuitive that this bound was proved so early, and arguably so easily, with a mix of paths and cycles allowed, while the same bound for paths only or cycles only keeps resisting more than 50 years and many proof attempts later.

This seminal paper was Lovász's first at age 20, and marked the beginning of a successful career, which culminated in 2021 when he was awarded the Abel Prize, often regarded as the Nobel Prize of mathematics, jointly with Avi Wigderson.

## 2.3 A first approach: improving a general bound

A solution to Gallai's conjecture is still to be found after half a century, but many partial results have been obtained since then. Most of them may be split in two categories: those that consider all connected graphs and prove a general bound on the number of paths needed in a decomposition, and those that restrict the considered graphs to a certain family, and settle the conjecture for this family. We present some results from the former approach in this section, and from the latter in Section 2.4.

This section is thus dedicated to laying out general bounds in the minimum number  $\mathcal{P}(G)$  of paths needed to decompose any connected graph  $G$ . In the following theorems, the graph  $G$  is not necessarily connected, and we denote  $odd(G)$  and  $even(G)$  the numbers of vertices of odd and even non-zero degree in  $G$  respectively.

The first result of this kind comes once again from Lovász's paper from 1968, and is a consequence from his Theorem 2.2.6.

**Theorem 2.3.1** (Lovász [58], 1968). *If  $G$  is a graph such that  $even(G) \geq 1$ , then*

$$\mathcal{P}(G) \leq \frac{odd(G)}{2} + even(G) - 1$$

The proof of this theorem makes good use of the fundamental observation that in any path decomposition, a vertex of odd degree is an end of a path from the decomposition. Lovász first observes that if  $G$  has at most one vertex of even degree, the theorem yields a path decomposition that satisfies Gallai's conjecture. He then adds  $even(G) - 1$  new vertices to  $G$  and connects them one-to-one to the vertices of  $G$  of even degree: the graph created has at most one vertex of even degree, and by applying Theorem 2.2.6, Lovász obtains the above bound.

In 1980, Alan Donald notes an error in the proof of Theorem 2.2.6, corrects it and substantially improves Lovász's bound by refining his construction:

**Theorem** (Donald [23], 1980).

$$\mathcal{P}(G) \leq \frac{odd(G)}{2} + \left\lfloor \frac{3 \cdot even(G)}{4} \right\rfloor$$

The general bound was improved twice, each time by further refining Lovász’s construction. The bound was first brought down to  $\frac{2}{3}$ , independently in 1998 by Lirong Yan [80] in his Ph.D. thesis and in 2000 by Nathaniel Dean and Mekkia Kouider [22]:

**Theorem 2.3.2** (Yan [80], 1998, Dean, Kouider [22], 2000).

$$\mathcal{P}(G) \leq \frac{\text{odd}(G)}{2} + \left\lfloor \frac{2 \text{ even}(G)}{3} \right\rfloor$$

This bound is the best possible for graphs that are not necessarily connected, as can be seen by once again considering a disjoint union triangles.

The bound was then somewhat lowered in 2013 by Peter Harding and Sean McGuinness, with the additional requirement of having girth at least 4.

**Theorem** (Harding, McGuinness [48], 2013). *If  $G$  is a graph with girth  $g \geq 4$ , then*

$$\mathcal{P}(G) \leq \frac{\text{odd}(G)}{2} + \left\lfloor \frac{(g+1) \text{ even}(G)}{2g} \right\rfloor$$

Note that for graphs with arbitrarily large girth, the bound  $\frac{g+1}{2g}$  gets arbitrarily close to Gallai’s bound of  $\frac{1}{2}$ .

It does not seem that progress was made since 2000 on the general bound, which incited us to favor a different approach: restricting the problem to some graph class and proving that the conjecture holds on it. The next section lays out some of the results of this branch, and Section 2.6 presents our contribution.

## 2.4 A second approach: partial resolution

When confronted to a statement difficult or impossible to prove in the general case, a classical approach in graph theory is to restrict the set of considered graphs to some specific class and prove that all its graphs satisfy the statement.

### 2.4.1 Example: the trees

We proved in Section 2.2.1 that the class of complete graphs satisfied Gallai’s conjecture. As a second introductory example, we prove that the class of trees satisfies the conjecture as well, by using a simplified version of the method we use to prove our main theorem.

This technique is widely used in the literature and in graph theory as a whole. We operate by contradiction and assume that the result does not hold on trees. We can then consider a counterexample to the conjecture on trees, i.e. a connected tree on  $n$  vertices that cannot be decomposed into at most  $\lceil \frac{n}{2} \rceil$  paths, and we take this graph minimal w.r.t. its number of vertices  $n$ . We then prove that the existence of such a *minimum counterexample*  $G$  yields a contradiction, by considering the two *configurations* depicted on Figure 2.5:

- $G$  contains two vertices  $u_1, u_2$  of degree 1 with a common neighbor  $v$ . In this case, we consider the *reduced graph*  $G'$  obtained from  $G$  by removing  $u_1$  and  $u_2$ . The graph  $G'$  is a connected tree with less vertices than  $G$ , hence is not a counterexample, by the minimality assumption on  $G$ . We consider a decomposition of  $G'$  with  $\lceil \frac{n-2}{2} \rceil =$

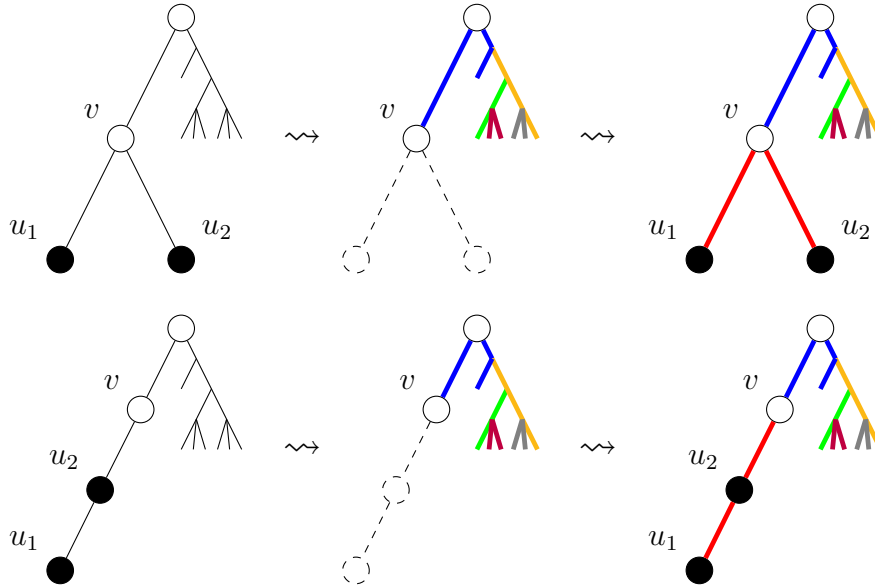

Figure 2.5: Reductions for trees

$\lceil \frac{n}{2} \rceil - 1$  paths. We keep this decomposition in  $G$  and complete it with the path  $(u_1, v, u_2)$ . We thus built a decomposition of  $G$  into  $\lceil \frac{n}{2} \rceil$  paths, which contradicts the nature of counterexample of  $G$ . Hence this configuration cannot appear in a minimum counterexample.

- $G$  contains a vertex  $u_1$  of degree 1 whose unique neighbor  $u_2$  has degree 2, having a vertex  $v$  as a second neighbor. In this case as well, we consider the reduced graph  $G'$  obtained from  $G$  by removing  $u_1$  and  $u_2$ . We consider a decomposition of  $G'$  into  $\lceil \frac{n-2}{2} \rceil = \lceil \frac{n}{2} \rceil - 1$  paths, and extend it with the path  $(u_1, u_2, v)$  in  $G$ . Once again, we produced a decomposition of  $G$  that yields a contradiction.

Since these two configurations cover all cases, we deduce that no minimum counterexample of the conjecture on trees can exist, hence the conjecture holds on trees.

In the main proof of this thesis, we proceed in the same way: we consider a minimum counterexample of the conjecture on planar graphs, then consider similar *reducible configurations* with 2 vertices to remove in Chapter 3, and more complex configurations with 4 vertices to remove in Chapter 4. For each we provide a method to extend a good decomposition of the reduced graph to a good decomposition of the whole graph. We prove in Chapter 5 that a minimum counterexample without these configurations cannot exist, which concludes the proof.

## 2.4.2 Initial results

American mathematician Frank Harary (1921-2005) is widely recognized as one of the “fathers” of modern graph theory, and contributed to bring the usefulness of this field to other scientific domains as diverse as physics, psychology, sociology or anthropology [73].

He took interest in the concept of path decompositions of directed and undirected graphs (he coined the often-used term *path number*) when he met David Hsiao at the FILE 68 conference, in Helsingør, Denmark, in November 1968. Their exchange led to an application of these concepts, in the development of a formal system for information retrieval from files [46] in 1970. In their formalism, the vertices of a directed graph represent records in a file structure, and there is an arc from  $u$  to  $v$  whenever the record

$u$  points to the address of record  $v$ . The minimum number of record addresses needed to trace through the entire file structure is therefore the minimum number of paths needed to decompose the graph.

After Harary presented this work at the 1st Caribbean Combinatorial Conference in Kingston, Jamaica, in 1970, Ralph G. Stanton teamed up with Donald D. Cowan and L. O. James to start calculating the minimum number of paths to decompose some classical graph classes [74]. His findings were summed up and simplified [47] by Frank Harary and his Ph.D. student at the time, Allen J. Schwenk, in 1972.

**Theorem** (Stanton, Cowan, James [74], 1970, Harary, Schwenk [47], 1972).

*Gallai's conjecture holds on:*

- *trees;*
- *3-regular ("cubic") graphs;*
- *complete graphs;*
- *complete bipartite graphs.*

### 2.4.3 Even degrees

Given the importance of the parity of the degrees for path decompositions, a lot of results focus on classes defined by the degree of their vertices. The earliest class on which Gallai's conjecture was proved is the class of graphs with at most one vertex of even degree, as a corollary to Lovász's bound of Theorem 2.3.1.

**Theorem 2.4.1** (Lovász [58], 1968). *Gallai's conjecture holds on graphs  $G$  with at most one vertex of even degree.*

This solves the case of odd graphs. Many results from the following decades concern even graphs or the *even subgraph*  $G_{\text{even}}$ , the subgraph of a graph  $G$  induced by the vertices of even degree of  $G$ .

Odile Favaron and Mekkia Kouider [33] confirmed both Gallai's and Hajós' conjectures on even graphs of maximum degree 4 in 1988:

**Theorem** (Favaron, Kouider [33], 1988). *Let  $G$  be a graph with  $n$  vertices, such that each vertex has degree 2 or 4. Then  $G$  can be decomposed into at most  $\lceil \frac{n}{2} \rceil$  paths or at most  $\lfloor \frac{n-1}{2} \rfloor$  cycles.*

László Pyber proved that Gallai's conjecture holds on graphs in which each cycle contains a vertex of odd degree:

**Theorem 2.4.2** (Pyber [69], 1996). *Gallai's conjecture holds on graphs  $G$  such that  $G_{\text{even}}$  is a forest.*

Pyber's proof is based on Lovász's method for Theorem 2.2.6 [58], just like Donald [23] did in 1980 and himself [68] in 1985.

A *block* of a graph is a maximal 2-connected subgraph. A forest is a graph in which each block is a single edge, thus each block of a forest has maximum degree at most 1. In 2005, Genghua Fan extended Pyber's result with the following result:

**Theorem 2.4.3** (Fan [29], 2005). *Gallai's conjecture holds on graphs  $G$  for which each block of  $G_{\text{even}}$  is a triangle-free graph of maximum degree at most 3.*

The next result we present on even graphs was proved in 2017 by Fábio Botler and Andrea Jiménez. A *perfect matching* of a graph  $G$  is a subset of disjoint edges of  $G$ , such that each vertex is the end of an edge.

**Theorem** (Botler, Jiménez [8], 2017). *Gallai’s conjecture holds on  $2k$ -graphs ( $k \geq 3$ ) of girth at least  $2k - 2$  and which admit a pair of disjoint perfect matchings.*

To prove the theorem, Botler and Jiménez consider an intermediate decomposition into paths and cycles. They then show how some pair of cycles from the decomposition can be alternatively decomposed into two paths, and how some path and cycle from the decomposition can be decomposed into two paths. They apply these operations successively to each cycle to obtain the desired decomposition of the graph into paths. This idea was also used the same year by Fábio Botler, Maycon Sambinelli, Rafael S. Coelho and Orlando Lee [12], and in 2020 by Yanan Chu, Genghua Fan and Qinghai Liu [18]. Parts of our proof are based on this method (Lemmas 3.2.2 and 4.4.1 in Chapters 3 and 4 use a lemma by Chu, Fan and Liu from [18]).

Finally and fairly recently, Fábio Botler and Maycon Sambinelli extended Fan’s result of 2005, by allowing the even subgraph’s blocks to contain some triangles, as long as these blocks are subgraphs of a specified family of graphs. They define the family  $\mathcal{G}$  as the family of graphs for which each block has maximum degree 3 and each component either has maximum degree at most 3 or has at most one block that contains triangles.

**Theorem** (Botler, Sambinelli [10], 2021). *Gallai’s conjecture holds on graphs  $G$  for which  $G_{\text{even}}$  is a subgraph of a graph in  $\mathcal{G}$ .*

#### 2.4.4 Maximum degree

In 2016, Marthe Bonamy and Thomas J. Perrett proved that the conjecture holds when restricted to graphs of maximum degree at most 5 [6].

**Theorem** (Bonamy, Perrett [6], 2016). *Gallai’s conjecture holds on graphs of maximum degree at most 5.*

A year later, I asked Marthe Bonamy to be a supervisor of my Master’s degree research internship, and she introduced me to Gallai’s conjecture and offered me to work on some planar classes. I then went on to dedicate the three years of my Ph.D. to prove the conjecture on the class of planar graphs. The proof makes up the next three chapters of this thesis, and uses the same techniques as Bonamy and Perrett’s proof. In [6], they consider a minimum counterexample and prove that it cannot contain five specified configurations. Then they show that the even subgraph of such a graph must be a forest and conclude with Pyber’s Theorem 2.4.2.

In 2021, Yanan Chu, Genghua Fan and Qinghai Liu [18] extended this result by making a first step toward graphs with maximum degree 6. The graphs  $K_3$ ,  $K_5$  and  $K_5^-$  are respectively the complete graphs on 3 and 5 vertices, and  $K_5$  minus one edge.

**Theorem 2.4.4** (Chu, Fan, Liu [18], 2021). *Gallai’s conjecture holds on graphs  $G$  of maximum degree at most 6, such that the vertices of degree 6 of  $G$  induce an independent set, and such that  $G$  is not  $K_3$ ,  $K_5$  or  $K_5^-$ .*

Their proof is more complex than Bonamy and Perrett’s, and involves successively replacing some path and cycle with two paths, or two cycles with two paths, in a decomposition, with the method discussed in the last subsection. Chu, Fan and Liu justify their



condition of independence of the vertices of degree 6 by noting the existence of many counterexamples to the general case, which substantially complexify the proof. These counterexamples include graphs with 7 vertices and between 19 and 21 edges (i.e. the complete graph  $K_7$  minus one or two edges), and are discussed in Section 2.5 below.

### 2.4.5 Planar graphs

Planar graphs are sparse, and make ideal candidates for case analyses. Many results are centered on this class, including the main theorem of this thesis.

In 2015, Xianya Geng, Minglei Fang and Dequan Li [40] focused on the class of outerplanar graphs, and confirmed the conjecture on its maximal and 2-connected elements. A *maximal* outerplanar graph is an outerplanar graph that loses this property if one edge were to be added to it.

**Theorem** (Geng, Fang, Li [40], 2015). *Gallai’s conjecture holds on maximal outerplanar graphs and 2-connected outerplanar graphs.*

Their proof is rather straightforward: they decompose a maximal outerplanar graph  $G$  into a Hamiltonian path and paths of length 2 (shown in Figure 2.6), then adapt this decomposition for any 2-connected subgraph of  $G$ .

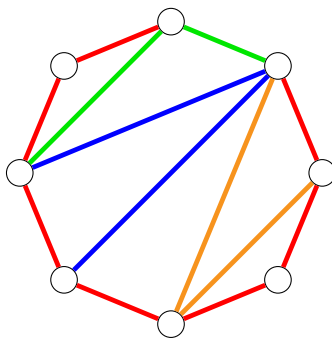

Figure 2.6: A maximal outerplanar graph decomposed into a Hamiltonian path and paths of length 2

Two years later, Philipp Kindermann, Lena Schlipf and André Schulz [55] took a look at the class of series-parallel graphs, which is a subclass of planar graphs. They confirmed Gallai’s conjecture on it with a proof that takes advantage of the inductive definition of series-parallel graphs.

**Theorem** (Kindermann, Schlipf, Schulz [55], 2017). *Gallai’s conjecture holds on series-parallel graphs.*

By combining their result and Dean and Kouider’s Theorem 2.3.2, they were able to obtain a bound of  $\lfloor \frac{5n}{8} \rfloor$  for planar 3-trees.

The same year, Fábio Botler, Maycon Sambinelli, Rafael S. Coelho and Orlando Lee [11] generalized this result by confirming Gallai’s conjecture on the whole class of graphs of treewidth at most 3. Their method allows them to solve Hajós’ conjecture on this class as well [12].

**Theorem 2.4.5** (Botler, Sambinelli, Coelho, Lee [11, 12], 2017). *Gallai’s and Hajós’ conjectures hold on graphs of treewidth at most 3.*

They then used the methods developed for this proof to prove Gallai's and Hajós' conjectures on graphs of maximum degree 4 [12] (independently of Bonamy and Perrett's proof for degree 5) and Gallai's conjecture on planar graphs of girth at least 6 [11].

In 2017, Andrea Jiménez and Yoshiko Wakabayashi [51] confirmed Gallai's conjecture on some family of triangle-free planar graphs. The *odd distance* of a graph  $G$  is the minimum distance between any pair of vertices of  $G$  of odd degree.

**Theorem** (Jiménez, Wakabayashi [51], 2017). *Gallai's conjecture holds on triangle-free planar graphs with odd distance at least 3.*

Finally, Fábio Botler, Andrea Jiménez and Maycon Sambinelli [9] confirmed the conjecture on the whole class of triangle-free planar graphs in 2018.

**Theorem 2.4.6** (Botler, Jiménez, Sambinelli [9], 2018). *Gallai's conjecture holds on triangle-free planar graphs.*

## 2.5 The strong conjecture

Some of the results presented in the previous section actually obtain a slightly stronger bound than the one of  $\lceil \frac{n}{2} \rceil$  required by Gallai's conjecture, which we call the *ceiling* bound. Theorems 2.4.1, 2.4.2, 2.4.3, 2.4.5 and 2.4.6 reach a bound of  $\lfloor \frac{n}{2} \rfloor$ , which we call the *floor* bound, that saves one path from the original bound when the number  $n$  of vertices is odd.

Working with such a bound is useful, as underscored by the following observation.

**Observation.** *Given  $k > 0$  integers  $n_1, \dots, n_k$ ,*

$$\sum_{i=1}^k \left\lfloor \frac{n_i}{2} \right\rfloor \leq \left\lfloor \frac{\sum_{i=1}^k n_i}{2} \right\rfloor$$

Let us consider a disconnected graph  $G$  with  $n$  vertices and  $k$  connected components  $G_i, i = 1..k$ , such that each  $G_i$  has  $n_i$  vertices. Let us assume that each component  $G_i$  can be decomposed into  $\lfloor \frac{n_i}{2} \rfloor$  paths. The observations tells us that  $G$  has a decomposition into  $\lfloor \frac{n}{2} \rfloor$  paths, which is not the case with the *ceiling* bound.

We call *odd semi-clique* a graph obtained from the complete graph  $K_{2k+1}$  on an odd number  $2k + 1$  of vertices, for  $k \geq 1$ , by removing at most  $k - 1$  edges. These graphs are exactly the graphs with  $n \geq 1$  vertices and at least  $\lfloor \frac{n}{2} \rfloor (n - 1) + 1$  edges. The next observation states the impossibility of reaching the *floor* bound on odd semi-cliques.

**Observation.** *Since  $\lfloor \frac{n}{2} \rfloor$  paths can cover at most  $\lfloor \frac{n}{2} \rfloor (n - 1)$  edges, odd semi-cliques cannot be decomposed into  $\lfloor \frac{n}{2} \rfloor$  paths.*

The aforementioned exceptions of Theorem 2.4.4,  $K_3$ ,  $K_5$  and  $K_5^-$ , as well as the graphs obtained from  $K_7$  by removing at most 2 edges, are examples of odd semi-cliques.

In 2016, Marthe Bonamy and Thomas J. Perrett conjectured [6] that the odd semi-cliques are the only exception to the floor bound on connected graphs. We call this conjecture the *strong Gallai's conjecture*, motivated by the obvious fact that it implies the traditional conjecture.

**Conjecture 2.5.1** (*Strong Gallai’s conjecture*, Bonamy, Perrett [6], 2016).  
*Any connected graph with  $n$  vertices can be decomposed into  $\lfloor \frac{n}{2} \rfloor$  paths or is an odd semi-clique which can be decomposed into  $\lceil \frac{n}{2} \rceil$  paths.*

Odd semi-cliques correspond to the most dense graphs, and as noted above, seem to be the ones on which Gallai’s conjecture is the hardest to prove.

## 2.6 Our contribution: planar graphs

We can now state the main result of this thesis, which concerns planar graphs. As mentioned in the introduction and in Chapter 1, the class of planar graphs is a natural one to consider, it has been studied ever since the 18th century [27, 57] and leads to practical applications still in use [14, 32]. The following theorem is a joint work with Marthe Bonamy and Nicolas Bonichon [5], and confirms the strong Gallai’s conjecture on planar graphs.

Only two odd semi-cliques are planar: the triangle  $K_3$  and  $K_5$  minus one edge, which we denote by  $K_5^-$  (see Figure 2.7 below).

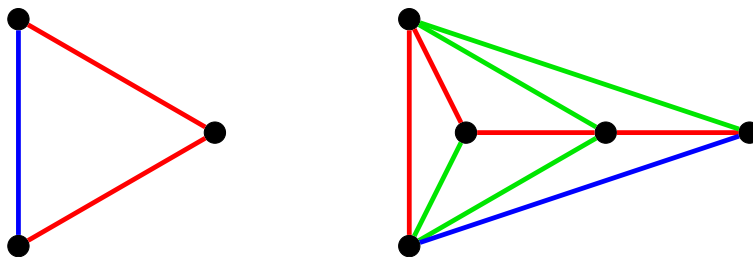

Figure 2.7: A 2-path decomposition of  $K_3$  (left) and a 3-path decomposition of  $K_5^-$  (right)

**Theorem 2.6.1** (Blanché, Bonamy, Bonichon [5], 2021+). *Every connected planar graph on  $n$  vertices, except  $K_3$  and  $K_5^-$ , can be decomposed into  $\lfloor \frac{n}{2} \rfloor$  paths.*

To prove the result, we proceed with the approach formulated in Section 2.4, by considering a planar graph that is a counterexample to our theorem and is vertex-minimum with respect to this property. We prove that such a *minimum counterexample* (MCE) does not contain a certain set of configurations, by providing for each of these configurations a reduction rule that takes advantage of the properties of the MCE and yields a contradiction. This technique is widely used in the literature on graph coloring and on Gallai’s conjecture ([6, 8, 9, 18]). More precisely, these reducible configurations deal with vertices of small degree (at most 5), and after showing that our MCE cannot contain any of these configurations (Lemma 2.6.2 below), we know that all of its vertices except four have degree at least 6. We finally use Euler’s formula and structural arguments to prove that there is no such graph (Lemma 5.0.1, p. 130, in Chapter 5).

### 2.6.1 Main lemma

We present in this subsection the main lemma, whose proof spans Chapters 3 and 4.

We call *minimum counterexample* (MCE) a planar graph that is distinct from  $K_3$  or  $K_5^-$ , that does not admit a good coloring (a path decomposition into  $\lfloor \frac{n}{2} \rfloor$  paths in our color framework) and is vertex minimum with respect to this property.

Given a planar graph  $G$ , a *2-family* is a set  $U$  of two vertices of  $G$  of degree at most 4. A *4-family* is a set of four 5-vertices. We say that a graph  $G$  with a 4-family  $U$  is *almost 4-connected* w.r.t.  $U$  if it does not contain a 3-cut  $A = \{a_1, a_2, a_3\} \subseteq V(G)$  that separates two vertices  $u, u' \in U$  or two neighbors of some vertex  $u \in U \cap A$ .

A *configuration*  $C$  is a property satisfied by a graph. The configurations we consider are usually defined locally as specifications on the neighborhoods of some vertices in the graph, and the possible presence (or absence) of some paths between them. By abuse of language, we say that a graph  $G$  *contains* a configuration  $C$  when  $G$  satisfies the properties of  $C$ .

The following lemma is the main result of this chapter and the next, and helps us prove the main theorem in Chapter 5. We prove the first property as Lemma 3.1.1 (p. 43) in Chapter 3 and the second property as Lemma 4.0.1 (p. 72) in Chapter 4.

**Lemma 2.6.2.** *An MCE does not contain any of the following configurations:*

- $(C_I)$ : a 2-family;
- $(C_{II})$ : a 4-family with respect to which the MCE is almost 4-connected.



# Chapter 3

## Elimination of vertices of degree at most 4

In this chapter, we prove Lemma 3.1.1 (p. 43), which constitutes the first property of the main lemma of our proof, Lemma 2.6.2 in the previous chapter.

To prove that an MCE  $G$  does not contain a configuration  $\mathcal{C}$ , we proceed by contradiction: we assume that  $G$  does contain the configuration, then use its nature of MCE to build a good coloring of  $G$ . The only configurations  $\mathcal{C}$  we consider are specifications of  $(C_I)$  and  $(C_{II})$ . To build a good coloring of  $G$ , we start by removing the two or four *special vertices* forming the 2- or 4-family of  $\mathcal{C}$ , along with their incident edges. Depending on the case, we add or remove some edges from the obtained graph, and define the resulting graph as the *reduced graph*  $G'$ . Ideally, this graph is connected and not a  $K_3$  or  $K_5^-$ : in this case, since it is smaller than the minimum counterexample  $G$ , it admits a good coloring, that we call *pre-coloring*. We then adapt this pre-coloring to the original graph  $G$ , and since  $G$  has two or four more vertices than  $G'$ , we may use 1 additional color (for  $(C_I)$ ) or 2 (for  $(C_{II})$ ) to color  $G$ . The cases where  $G'$  is disconnected are equally easy, unless  $G'$  has some  $K_3$  or  $K_5^-$  connected components, in which case a complementary method is used to combine a “bad” coloring of these components with the rest of the coloring.

In the present chapter, we split the configuration  $(C_I)$  into simpler, specified cases, and for each of them provide a *reduction rule* describing the adaptation of the pre-coloring to a good coloring of  $G$ . The general method consists in fixing a shortest path  $P$  between the two special vertices. The edges of  $P$  are removed alongside the special vertices and possibly some additional edges, in order to obtain the reduced graph  $G'$ . In  $G$ , the edges of  $P$  are then colored with the extra color. This has the advantage of having an end of this extra color on each of the two special vertices, and the path induced by the extra color can be conveniently extended to help cover all the edges of  $G$  that were missing in  $G'$ .

This is the method used when the two special vertices are sufficiently distant from each other, and in this case the adapting methods for each are independent and can be defined separately. Figure 3.1 depicts a  $(C_I)$  configuration where the two special vertices  $u_1, u_2$  are at distance at least 3, and their neighborhoods are taken care of with two independent *elementary partial rules* that when combined form a complete reduction rule. The extra color induces the path  $P$  in red. These rules are defined in Section 3.1 on page 57.

When instead the special vertices are too close to each other and share some neighbors, two elementary partial rules would interfere with each other and possibly create some cycles in the decomposition. In these cases, we discard the shortest path and instead use

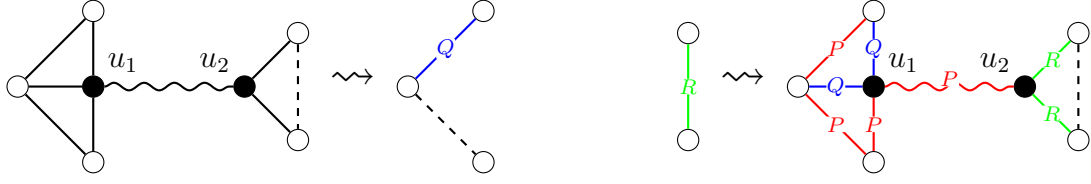

Figure 3.1: A  $(C_I)$  reduction rule made up of two elementary partial rules

a custom reduction rule to treat the neighborhoods of both special vertices at once. These rules correspond to rules (a), (b), ..., (u) in Section 3.1 on page 45. Figure 3.2 features an example of such a rule, and the extra color is again represented in red as the path  $P$ .

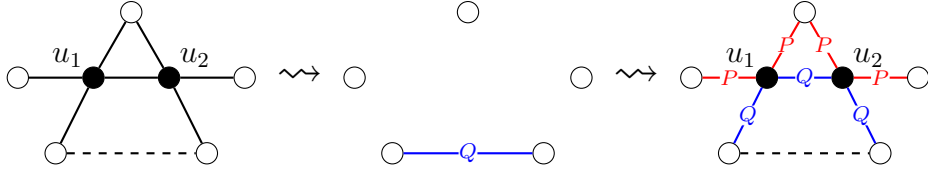

Figure 3.2: A  $(C_I)$  reduction rule treating close special vertices

The next section introduces the reduction rules we need to treat the  $(C_I)$  configurations. The generalization to this method for  $(C_{II})$  configurations is presented at the beginning of Chapter 4, on page 72.

### 3.1 Reduction rules for $(C_I)$ configurations

This notion of reducible subgraph has been used in previous works [6, 8, 9, 10, 11]. We present here a formalism appropriate for our subgraphs.

A *reduction rule*  $\mathcal{R} = (\mathcal{C}, f^r, f^c)$  is composed of a configuration  $\mathcal{C}$ , a *reduction function*  $f^r$  and a *recoloring function*  $f^c$ . The configuration distinguishes a 2-family or 4-family  $U$ , that we call **special vertices**. Given a planar graph  $G$  that contains the configuration  $\mathcal{C}$ , we call  $f^r(G)$  the *reduced graph*  $G'$ , whose vertex set is  $V(G') = V(G) \setminus U$  and some of its edges were added or removed from  $G$ .

Given  $G$  and a coloring  $pc$  (called *pre-coloring*) of the reduced graph  $G' = f^r(G)$ , the recoloring function  $f^c(G, pc)$  gives a coloring of  $G$ .

For instance, let us consider the rule shown in Figure 3.3, whose formalism will be fully described in the next section. The configuration of the rule is the following: the graph contains at least 5 vertices  $u_1, u_2, v, v_1, v_2$  and potentially a vertex  $v_3$  such that  $u_1$  is a 3-vertex adjacent to  $v_1, v$  and  $u_2$ ; the vertex  $u_2$  is adjacent to  $u_1, v, v_2$  and potentially  $v_3$ , but not to other vertices; and  $v_2$  is a vertex of even degree. The reduction function consists in removing every edge incident to  $u_1$  and  $u_2$ . As  $v_2$  has an even degree in  $G$ , it has an odd degree in the reduced graph  $G'$ . Hence it is the end of a path  $Q$ . The recoloring function is the following: color the edges  $(v_2, u_2)$  and  $(u_2, u_1)$  with the color of  $Q$ , use a new color to color the edges  $(v_1, u_1), (u_1, v), (v, u_2)$  and  $(u_2, v_3)$  if  $u_2$  is a 4-vertex, to form a new path  $P$ . For all other edges, use colors of  $pc$ .

A reduction rule  $\mathcal{R} = (\mathcal{C}, f^r, f^c)$  is *valid* if for any planar graph  $G$  that contains the configuration  $\mathcal{C}$ , then the reduced graph  $G' = f^r(G)$  is planar; for any path coloring  $pc$  of  $G'$ ,  $f^c(G, pc)$  is a path coloring; and for any coloring  $pc$  of  $G'$ ,  $|f^c(G, pc)| - |pc| \leq \lfloor \frac{|V(G)| - |V(G')|}{2} \rfloor$ .

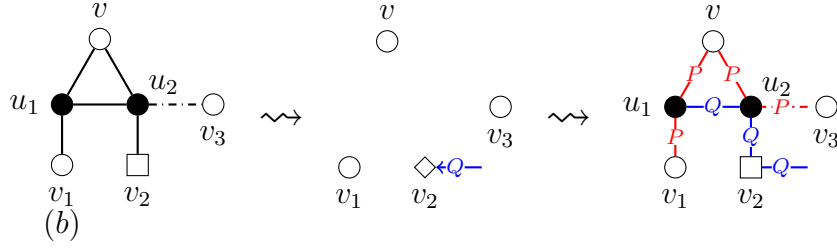

Figure 3.3: Example of a reduction rule. The formalism used to describe reduction rules is given in Section 3.1.

One can easily check that the rule of Figure 3.3 is valid.

The rest of this chapter and the entirety of Chapter 4 are dedicated to describing a set of configurations that cover all the cases of Lemma 2.6.2, and providing a resolution rule for each of these configurations. For each rule we provide, we justify that it is valid. The existence of a valid rule  $\mathcal{R} = (\mathcal{C}, f^r, f^c)$  is in itself not enough to guarantee that an MCE cannot contain the configuration  $\mathcal{C}$ . Indeed, the reduced graph could contain a  $K_3$  or  $K_5^-$  connected component, and therefore not admit a good coloring. However, we argue in Lemma 3.2.2 (on page 62, for rules associated with  $(C_I)$  configurations) and Lemma 4.4.1 (on page 96, for rules associated with  $(C_{II})$  configurations) that our rules are sufficient to build a good coloring of the MCE regardless of the presence of  $K_3$  or  $K_5^-$  components in the reduced graph.

The rest of this chapter is dedicated to proving the first part of Lemma 2.6.2 (p. 40), which we reformulate as the following lemma.

**Lemma 3.1.1.** *An MCE does not contain a configuration  $(C_I)$ .*

To prove this result let us introduce a first set of reduction rules, defined over local conditions. We show that each reduction rule is valid in Lemmas 3.1.2, p. 55, and 3.1.3, p. 60. We then prove that the application of each of these rules on an MCE  $G$  is sufficient to provide a good coloring of  $G$  (Lemma 3.2.2, p. 62). Finally, we show (Lemma 3.3.1, p. 63) that the configuration  $(C_I)$  is of the form of at least one of the reducible configurations that we list below.

We define the rules with both a graphical and a textual formalism, each of them being self-sufficient.

**Graphical formalism** Each rule  $(\mathcal{C}, f^r, f^c)$  is formally defined by a triplet of drawings (see for instance Figure 3.3). The first drawing defines the configuration  $\mathcal{C}$  of the rule, the reduction function  $f^r$  of defined by the difference between the first two drawings, and finally the third drawing defines the recoloring function  $f^c$ . Let us first describe the graphical formalism used to define the configuration of a rule.

The vertices involved in a configuration are represented by circles ( $\circ$  or  $\bullet$ ), diamond ( $\diamond$ ) or squares ( $\square$ ). The existence of an edge is materialized by a solid line ( $\bullet\text{---}\bullet$ ) between the vertices. The absence of an edge is materialized by a dashed line ( $\bullet\text{---}\bullet$ ). A waved line ( $\bullet\text{~}\bullet$ ) represents a path between two vertices that avoids other represented vertices (unless specified). When an edge is represented by a dash-dotted edge ( $\bullet\text{---}\bullet$ ), this means that we consider the cases when this edge is present and when it is absent. A solid line



with a gray vertex in the middle ( $\bullet\text{---}\bullet\text{---}\bullet$ ) represents a path of length 1 or 2. If it is of length 2, the middle vertex is distinct from the other vertices on the figure.

When all the incident edges of a vertex are explicitly drawn (with solid or dash-dotted edges), the vertex is represented by a black circle ( $\bullet$ ). Vertices of odd (resp. even) degree are represented by diamonds ( $\diamond$ ) (resp. squares ( $\square$ )). A dashed wavy line ( $\bullet\text{---}\cdot\text{---}\bullet$ ) means that the graph does not contain a path between its endpoints that avoids every vertex represented.

For the second drawing of the triplet, we need a few other conventions, because it also encodes information on the pre-coloring. Letters  $Q, R$  denote paths from the pre-coloring, and the two letters may represent the same path. If an edge is colored  $Q$  and another is colored  $\overline{Q}$ , this means that they have different colors. If an edge stays black in the second drawing, it means that the edge keeps its color in the recoloring of  $G$ . An incoming arrow colored  $Q$  at a vertex means that this vertex is the end of a path colored  $Q$ . If this arrow is on a half-edge, this means that the last edge of the path is not determined by the figure, and one of the drawn vertices could be the other end of the edge.

A black solid (resp. dashed) arrow between a vertex and a path means that the vertex is (resp. is not) on the path (see for example the cases  $(h_5)$  and  $(h_6)$  of rule  $(h)$ ).

The definition of the reduction function is quite straightforward. Every edge that is in the first (resp. second) drawing but not in the second (resp. first) is deleted (resp. added) by the reduction function and both vertices  $u_1, u_2$  are deleted (together with their incident edges).

For rules  $(h)$  and  $(r)$ , a case analysis is needed to define the recoloring function: the second drawing is split into several copies of the same graph, depicting the different possible properties of the pre-coloring of the reduced graph.

The third graph encodes directly the recoloring function by giving colors explicitly to the edges of  $G \setminus G'$  from the pre-coloring of the reduced graph  $G'$ .

**Textual formalism** For each rule  $(\mathcal{C}, f^r, f^c)$ , we first define textually the configuration  $\mathcal{C}$ , over local conditions around the special vertices. We then define the reduction function  $f^r$  by specifying the edges that are added or removed to form the reduced graph  $G'$ . The special vertices  $u_1, u_2$  and their incident edges are removed in each rule and omitted in the descriptions. Finally, we define the recoloring function  $f^c$  by describing the operations applied to a coloring of  $G'$  to color all the edges of  $G$ .

We call *deviation* the recoloring operation that consists in replacing a color inducing a path  $P'$  in  $G'$  by a color inducing a path  $P$  in  $G$ , such that  $P$  is obtained from  $P'$  by replacing an edge  $vv'$  with a section  $(v, u, v')$  of length 2 or  $(v, u, u', v')$  of length 3, using only special vertices  $u, u'$  as internal vertices. An example of deviation is the path  $Q$  in rule  $(a)$ .

We call *extension* the recoloring operation that extends a path  $Q$  induced by a color of  $G'$  on several additional edges in the coloring of  $G$ , those edges having only the endpoints of  $Q$  and special vertices as ends. In particular, when a non-special vertex has an odd degree in  $G'$ , a color must end on it and we may extend this color in  $G$ . The rules are frequently defined so as to “force” some vertices to have an odd degree in the reduced graph.

When the rule involves 2 special vertices (which is the case for all of them except  $(a)$ ), we may use an *extra color* (inducing the red path  $P$  on the drawings) to color the graph  $G$ , as by definition of valid rule, one  $\left(\lfloor \frac{|V(G)| - |V(G')|}{2} \rfloor\right)$  additional color is allowed when adapting the pre-coloring of  $G'$  to a coloring of  $G$ .

With all this formalism in mind, we can introduce our first set of rules: (a), (b), ..., (u). Note that we justify the planarity of the reduced graph and the validity of all the rules in Lemma 3.1.2 after the definitions.

**List of the rules** (a), (b), ..., (u):

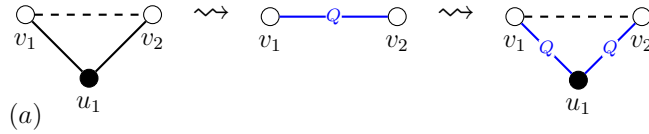

- (a): The special vertex  $u_1$  has degree 2: it has two non-adjacent neighbors  $v_1, v_2$ .  
**Reduction:** In the reduced graph, we add the edge  $v_1v_2$ .  
**Recoloring:** In  $G$ , we deviate the color of  $v_1v_2$  on  $u_1$ .

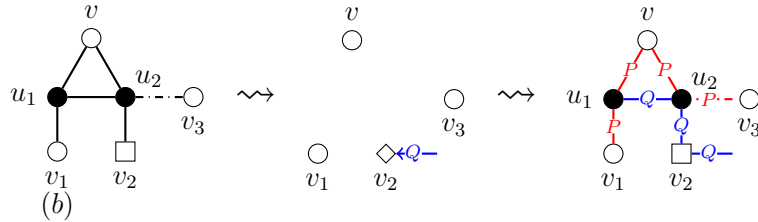

- (b): The two special vertices  $u_1, u_2$  are adjacent and they have one common neighbor  $v$ . The special vertex  $u_1$  has degree 3: it has another neighbor  $v_1$ , and  $u_2$  has degree 3 or 4, with a neighbor  $v_2$  and maybe another  $v_3$ . The vertex  $v_2$  has an even degree in  $G$ .  
**Reduction:** In the reduced graph,  $v_2$  has an odd degree: let  $Q$  be a path of the coloring of  $G'$  that ends on  $v_2$ .  
**Recoloring:** In  $G$ , we extend  $Q$  to the edges  $v_2u_2, u_2u_1$ . We use the extra color on the path  $P = (v_1, u_1, v, u_2)$  and maybe the edge  $u_2v_3$  if it is in  $G$ .

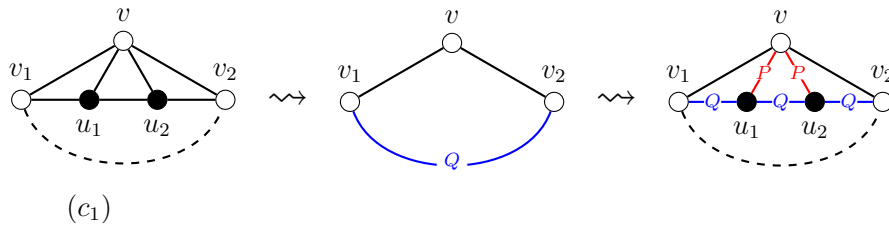

- (c<sub>1</sub>): The two special vertices  $u_1, u_2$  have degree 3. They are adjacent, they have one common neighbor  $v$  and each of  $u_1, u_2$  has another neighbor,  $v_1, v_2$  respectively, which is adjacent to  $v$ . The vertices  $v_1, v_2$  are non-adjacent.  
**Reduction:** In the reduced graph, we add the edge  $v_1v_2$ .  
**Recoloring:** In  $G$ , we deviate the color of  $v_1v_2$  on  $u_1, u_2$ . We use the extra color on the path  $P = (u_1, v, u_2)$ .

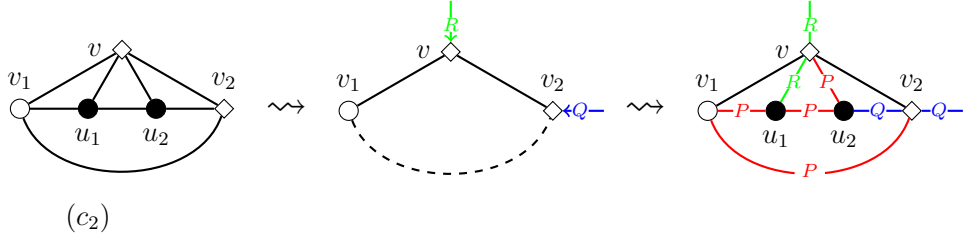

- (c<sub>2</sub>): The two special vertices  $u_1, u_2$  have degree 3. They are adjacent, they have one common neighbor  $v$  and each of  $u_1, u_2$  has another neighbor,  $v_1, v_2$  respectively, which is adjacent to  $v$ . The vertices  $v_1, v_2$  are adjacent, and  $v, v_2$  have an odd degree in  $G$ .

**Reduction:** In the reduced graph, we remove the edge  $v_1v_2$ . The vertices  $v, v_2$  keep an odd degree: let  $Q, R$  be paths of the coloring of  $G'$  that end on  $v_2, v$  respectively.  
**Recoloring:** In  $G$ , we extend  $Q$  on the edge  $v_2u_2$ , and  $R$  on the edge  $vu_1$ . We use the extra color on the path  $(v, u_2, u_1, v_1, v_2)$ .

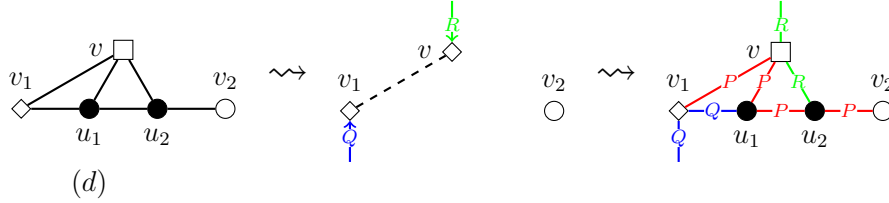

- (d): The two special vertices  $u_1, u_2$  have degree 3. They are adjacent, they have one common neighbor  $v$  and each of  $u_1, u_2$  has another neighbor,  $v_1, v_2$  respectively. The vertex  $v_1$  is adjacent to  $v$ . The vertex  $v$  has an even degree in  $G$ , and  $v_1$  an odd degree in  $G$ .

**Reduction:** In the reduced graph, we remove the edge  $vv_1$ . Let  $Q, R$  be paths of the coloring of  $G'$  that end on  $v_1, v$  respectively.  
**Recoloring:** In  $G$ , we extend  $Q$  on the edge  $v_1u_1$  and  $R$  on the edge  $vv_2$ . We use the extra color on the path  $P = (v_1, v, u_1, u_2, v_2)$ .

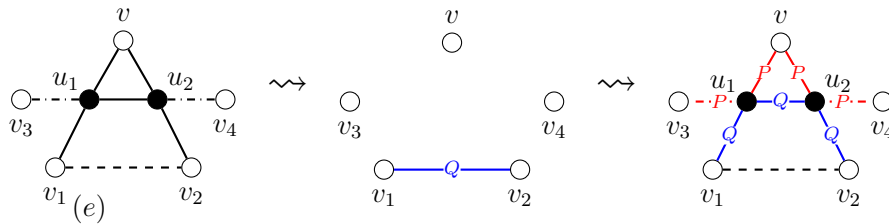

- (e): Each of the two special vertices  $u_1, u_2$  has degree 3 or 4. They are adjacent, they have one common neighbor  $v$  and each of  $u_1, u_2$  has another neighbor,  $v_1, v_2$  respectively. Each of  $u_1, u_2$  may have a third neighbor  $v_3, v_4$  respectively. The vertices  $v_1, v_2$  are non-adjacent.

**Reduction:** In the reduced graph, we add the edge  $v_1v_2$ .  
**Recoloring:** In  $G$ , we deviate the color of  $v_1v_2$  on  $u_1, u_2$ . We use the extra color on the path  $P = (u_1, v, u_2)$ , and maybe on the edges  $v_3u_1$  and  $u_2v_4$  if they belong to  $G$ .

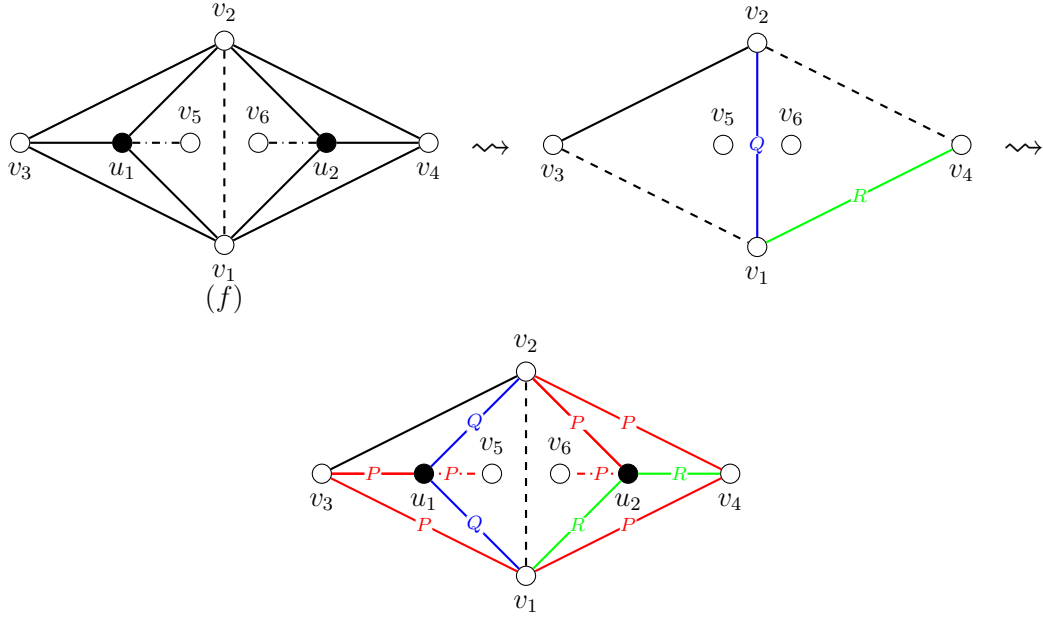

- (f): Each of the two special vertices  $u_1, u_2$  has degree 3 or 4. They are non-adjacent, they have two common neighbors  $v_1, v_2$  and each of  $u_1, u_2$  has another neighbor  $v_3, v_4$  respectively. Both  $v_3, v_4$  are adjacent to both  $v_1, v_2$ . The vertices  $v_1, v_2$  are non-adjacent. Each of  $u_1, u_2$  may have another neighbor,  $v_5, v_6$  respectively.

**Reduction:** In the reduced graph, we add the edge  $v_1v_2$  and remove the edges  $v_1v_3$  and  $v_2v_4$ .

**Recoloring:** In  $G$ , we deviate the color of  $v_1v_2$  on  $u_1$ , and the color of  $v_1v_4$  on  $u_2$ . We use the extra color on the path  $P = (u_1, v_3, v_1, v_4, v_2, u_2)$ , and maybe on the edges  $v_5u_1$  and  $u_2v_6$  if they belong to  $G$ .

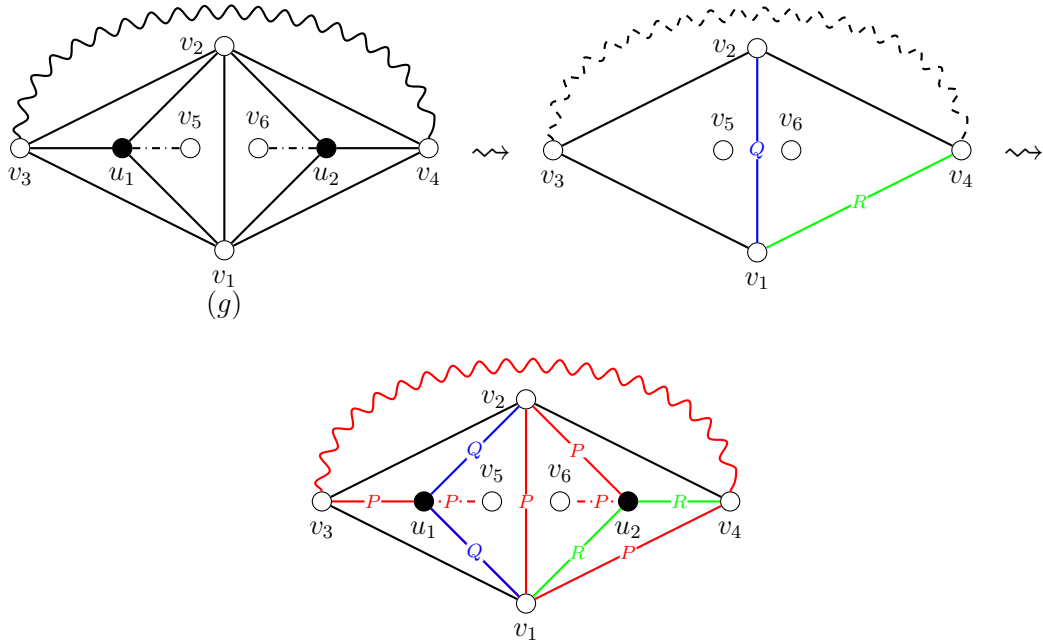

- (g): Each of the two special vertices  $u_1, u_2$  has degree 3 or 4. They are non-adjacent, they have two common neighbors  $v_1, v_2$  and each of  $u_1, u_2$  has another neighbor  $v_3, v_4$  respectively. Both  $v_3, v_4$  are adjacent to both  $v_1, v_2$ . The vertices  $v_1, v_2$  are adjacent. Each of  $u_1, u_2$  may have another neighbor,  $v_5, v_6$  respectively. There is a path  $P_{34}$

between  $v_3$  and  $v_4$  in  $G$  that is vertex-disjoint from the other 6 vertices.

**Reduction:** In the reduced graph, we remove the edges of the path  $P_{34}$ .

**Recoloring:** In  $G$ , we deviate the color of  $v_1v_2$  on  $u_1$ , and the color of  $v_1v_4$  on  $u_2$ . We use the extra color on the path  $P = (u_1, v_3, P_{34}, v_4, v_1, v_2, u_2)$ , and maybe on the edges  $v_5u_1$  and  $u_2v_6$  if they belong to  $G$ .

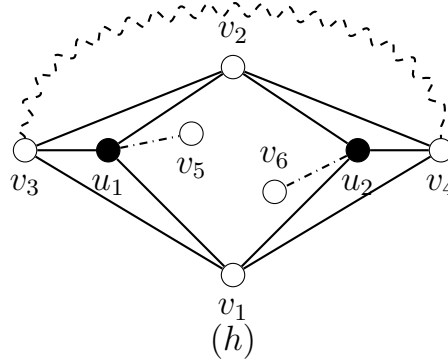

- (h): Each of the two special vertices  $u_1, u_2$  has degree 3 or 4. They are non-adjacent and have two common neighbors  $v_1, v_2$ . Each of  $u_1, u_2$  has another neighbor  $v_3, v_4$  respectively, both adjacent to both  $v_1, v_2$ . The set  $\{v_1, v_2\}$  is a 2-cut that separates  $u_1, u_2$ . Each of  $u_1, u_2$  may have another neighbor  $v_5, v_6$  respectively.

**Reduction:** In the reduced graph, we add the edge  $v_3v_4$ . Let  $Q$  be the path of the coloring of  $G'$  induced by the color of  $v_3v_4$ . We denote it  $Q = (Q_1, v_3, v_4, Q_2)$ .

**Recoloring:** We distinguish between six cases, depending on the properties of the path  $Q$ . Rule  $(h_1)$  covers the case where the path  $Q$  avoids the vertex  $v_2$ . In rules  $(h_2)$  and  $(h_3)$ , the vertices  $v_2, v_3, v_4$  and  $v_1$  appear in that order on the path  $Q$ . Rule  $(h_2)$  covers the case where  $v_5$  is on the subpath between  $v_2$  and  $v_3$ , and  $v_6$  is on the subpath between  $v_4$  and  $v_1$  (the rules are a bit more general and only require  $v_5$  and  $v_6$  to avoid some subpaths of  $Q$ ). Rule  $(h_3)$  covers the case where the vertex  $v_5$  (if it exists) avoids the subpath of  $Q$  between  $v_2$  and  $v_3$ . By symmetry, this also covers the case where  $v_6$  (if it exists) avoids the subpath of  $Q$  between  $v_4$  and  $v_1$ . In rules  $(h_4), (h_5)$  and  $(h_6)$ , the vertices  $v_1, v_2, v_3$  and  $v_4$  appear in this order on the path  $Q$ . Rule  $(h_4)$  covers the case where the vertex  $v_5$  avoids the subpath of  $Q$  between  $v_2$  and  $v_3$ , while in rules  $(h_5)$  and  $(h_6)$  the vertex  $v_5$  avoids the subpath of  $Q$  between  $v_1$  and  $v_2$ . In rule  $(h_5)$ , the vertex  $v_6$  avoids the subpath of  $Q$  after  $v_1$ , and in rule  $(h_6)$  it avoids the subpath between  $v_1$  and  $v_2$ . Since each of  $v_5, v_6$  avoids at least one subpath of  $Q$ , this covers all possible cases.

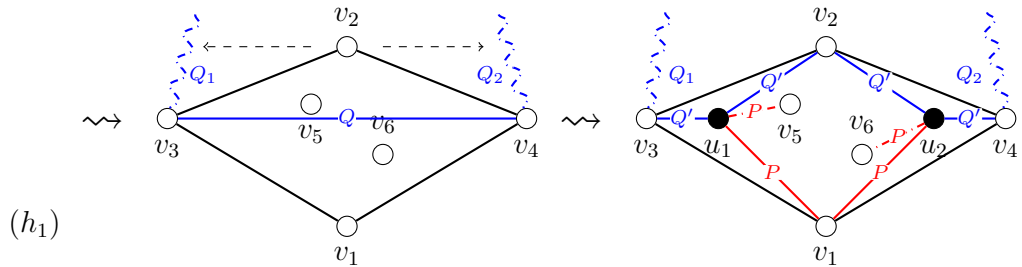

1.  $Q$  does not touch  $v_2$  in  $G'$ .

In  $G$ , we replace the path  $Q$  with the path  $Q' = (Q_1, v_3, u_1, v_2, u_2, v_4, Q_2)$ . We use the extra color on the path  $P = (u_1, v_1, u_2)$  and maybe on the edges  $v_5u_1$  and  $u_2v_6$  if they belong to  $G$ .

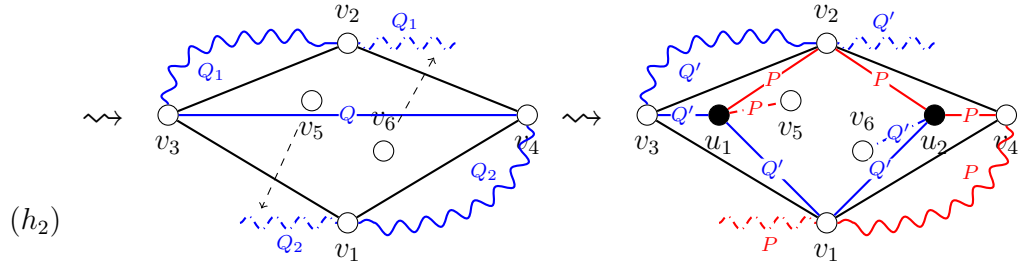

2.  $Q_1$  touches  $v_2$  and  $Q_2$  touches  $v_1$ . The vertex  $v_5$  does not touch  $Q_2$ , and  $v_6$  does not touch  $Q_1$ .  
 In  $G$ , we replace  $Q$  with a path  $Q' = (Q_1, v_3, u_1, v_1, u_2)$  and maybe extend  $Q'$  on  $u_2v_6$ . We use the extra color on the path  $P = (Q_2, v_4, u_2, v_2, u_1)$  and maybe on the edge  $u_1v_5$ .

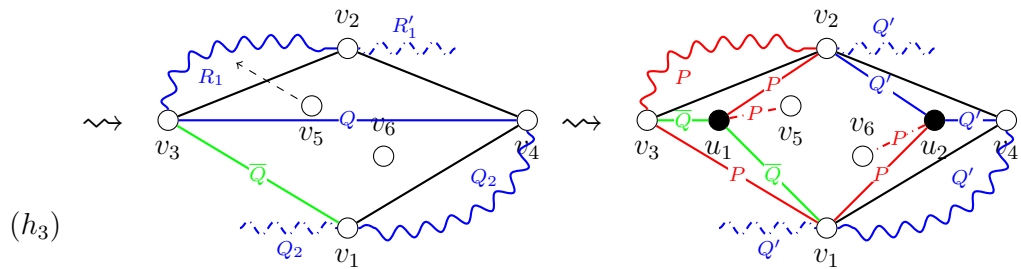

3.  $Q_1$  touches  $v_2$  and  $Q_2$  touches  $v_1$ . We denote  $Q_1 = (v_3, R_1, v_2, R'_1)$ . The vertex  $v_5$  does not touch  $R_1$ .  
 In  $G$ , we replace  $Q$  with a path  $Q' = (R'_1, v_2, u_2, v_4, Q_2)$  and we deviate the color of  $v_3v_1$  in  $G'$  on  $u_1$ . We use the extra color on the path  $P = (v_5, u_1, v_2, R_1, v_3, v_1, u_2)$  and maybe on the edge  $u_2v_6$ .

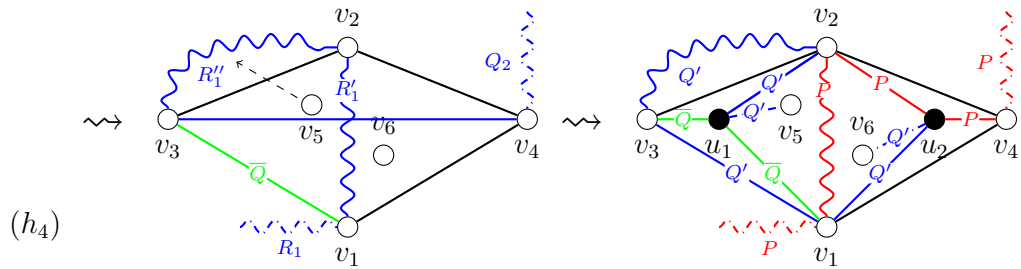

4.  $Q_1$  touches both  $v_1, v_2$ : we denote it  $Q_1 = (R_1, v_1, R'_1, v_2, R''_1, v_3)$ . The vertex  $v_5$  does not touch  $R''_1$ .  
 In  $G$ , we replace  $Q$  with a path  $Q' = (u_1, v_2, R''_1, v_3, v_1, u_2)$  and maybe extend  $Q'$  on the edges  $v_5u_1$  and  $u_2v_6$ . We deviate the color of  $v_3v_1$  on  $u_1$  and we use the extra color on the path  $P = (Q_2, v_4, u_2, v_2, R'_1, v_1, R_1)$ .

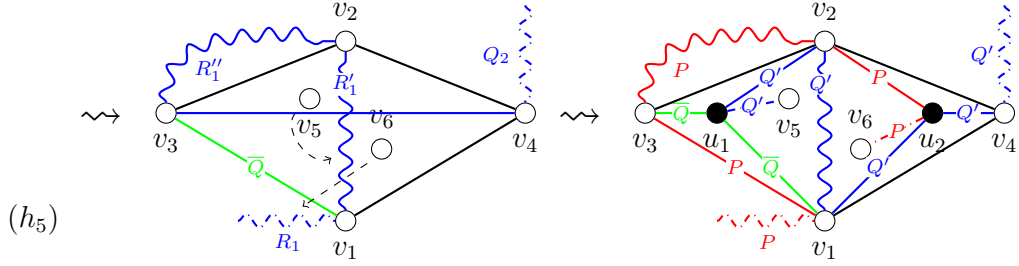

5.  $Q_1$  touches both  $v_1, v_2$ : we denote it  $Q_1 = (R_1, v_1, R'_1, v_2, R''_1, v_3)$ . The vertex  $v_5$  does not touch  $R'_1$ , and  $v_6$  does not touch  $R_1$ .  
 In  $G$ , we replace  $Q$  with a path  $Q' = (u_1, v_2, R'_1, v_1, u_2, v_4, Q_2)$  and maybe extend  $Q'$  on the edge  $v_5u_1$ . We deviate the color of  $v_3v_1$  on  $u_1$  and we use the extra color on the path  $P = (R_1, v_1, v_3, R''_1, v_2, u_2)$  and maybe on the edge  $u_2v_6$ .

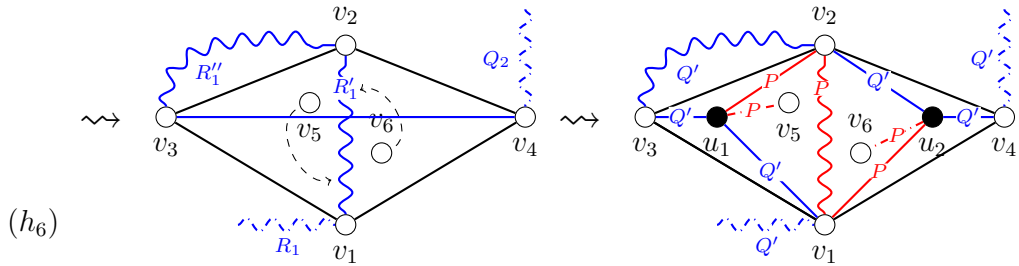

6.  $Q_1$  touches both  $v_1, v_2$ : we denote it  $Q_1 = (R_1, v_1, R'_1, v_2, R''_1, v_3)$ . None of  $v_5, v_6$  touch  $R'_1$ .  
 In  $G$ , we replace  $Q$  with a path  $Q' = (R_1, v_1, u_1, v_3, R''_1, v_2, u_2, v_4, Q_2)$ . We use the extra color on the path  $P = (u_1, v_2, R'_1, v_1, u_2)$  and maybe on the edges  $v_5u_1$  and  $u_2v_6$ .

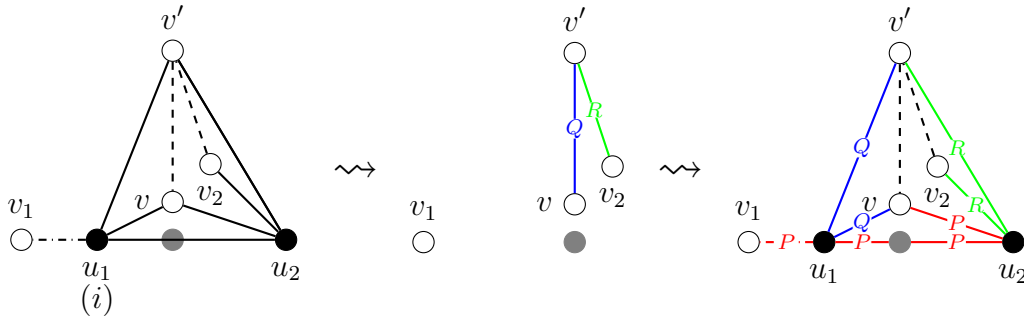

- (i): The special vertex  $u_1$  has degree 3 or 4, and  $u_2$  has degree 4. The special vertices  $u_1, u_2$  have two common neighbors  $v, v'$  that are non-adjacent. The special vertex  $u_2$  has another neighbor  $v_2$ , non-adjacent to  $v'$ , and  $u_1$  may have another neighbor  $v_1$ . If  $u_1, u_2$  are non-adjacent, they have another common neighbor  $w$ ; let us denote  $P_{12}$  the path  $(u_1, u_2)$  if  $u_1, u_2$  are adjacent, and  $(u_1, w, u_2)$  otherwise.

**Reduction:** In the reduced graph, we add the edges  $vv'$  and  $v_2v'$ .

**Recoloring:** In  $G$ , we deviate the color of  $vv'$  on  $u_1$  and the color of  $v_2v'$  on  $u_2$ . We use the extra color on the path  $P = (v, u_2, P_{12}, u_1)$  and maybe on the edge  $u_1v_1$  if it belongs to  $G$ .

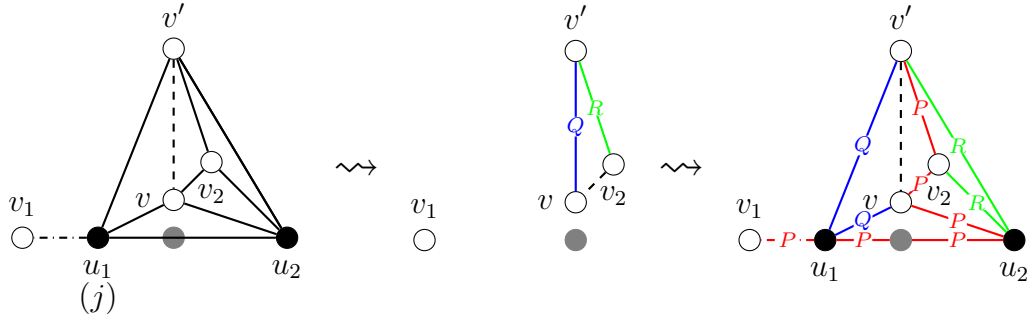

- (j): The special vertex  $u_1$  has degree 3 or 4, and  $u_2$  has degree 4. The special vertices  $u_1, u_2$  have two common neighbors  $v, v'$  that are non-adjacent. The special vertex  $u_2$  has another neighbor  $v_2$ , adjacent to  $v, v'$ , and  $u_1$  may have another neighbor  $v_1$ . If  $u_1, u_2$  are non-adjacent, they have another common neighbor  $w$ ; let us denote  $P_{12}$  the path  $(u_1, u_2)$  if  $u_1, u_2$  are adjacent, and  $(u_1, w, u_2)$  otherwise.

**Reduction:** In the reduced graph, we add the edge  $vv'$  and remove the edge  $vv_2$ .

**Recoloring:** In  $G$ , we deviate the color of  $vv'$  on  $u_1$  and the color of  $v_2v'$  on  $u_2$ . We use the extra color on the path  $P = (v', v_2, v, u_2, P_{12}, u_1)$  and maybe on the edge  $u_1v_1$ .

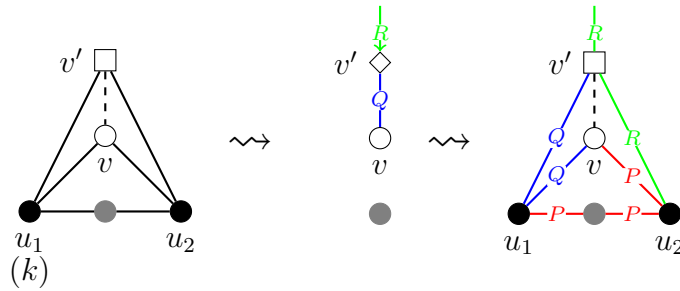

- (k): The special vertices  $u_1, u_2$  have degree 3, with two common neighbors  $v, v'$  that are non-adjacent. If  $u_1, u_2$  are non-adjacent, they have another common neighbor  $w$ ; let us denote  $P_{12}$  the path  $(u_1, u_2)$  if  $u_1, u_2$  are adjacent, and  $(u_1, w, u_2)$  otherwise. The vertex  $v'$  has an even degree in  $G$ .

**Reduction:** In the reduced graph, we add the edge  $vv'$ . The vertex  $v'$  now has an odd degree, so let  $R$  be a path of the coloring of  $G'$  that ends on  $v'$ .

**Recoloring:** In  $G$ , we deviate the color of  $vv'$  on  $u_1$ , and extend  $R$  on the edge  $v'u_2$ . We use the extra color on the path  $P = (u_1, P_{12}, u_2, v)$ .

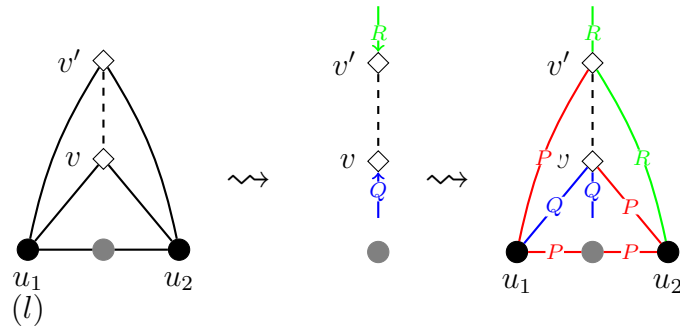

- (l): The special vertices  $u_1, u_2$  have degree 3, with two common neighbors  $v, v'$  that are non-adjacent and both have an odd degree in  $G$ . If  $u_1, u_2$  are non-adjacent, they have another common neighbor  $w$ ; let us denote  $P_{12}$  the path  $(u_1, u_2)$  if  $u_1, u_2$  are adjacent, and  $(u_1, w, u_2)$  otherwise.

**Reduction:** In the reduced graph,  $v, v'$  now have an odd degree, so let  $Q, R$  be paths of the coloring of  $G'$  that end on  $v, v'$  respectively.



**Recoloring:** In  $G$ , we extend  $Q$  on the edge  $vu_1$  and  $R$  on  $v'u_2$ . We use the extra color on the path  $P = (v', u_1, P_{12}, u_2, v)$ .

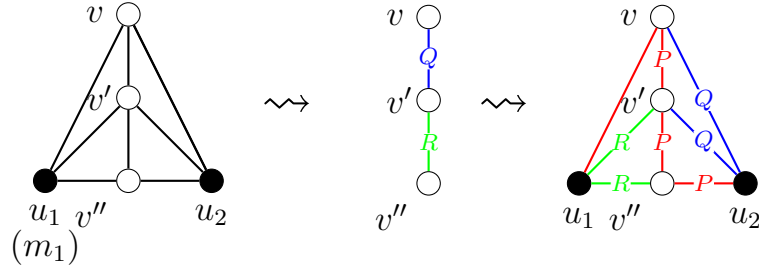

- $(m_1)$ : The two special vertices  $u_1, u_2$  have degree 3, they are non-adjacent and have three common neighbors  $v, v', v''$ , such that  $v'$  is adjacent to  $v$  and  $v''$ .

**Recoloring:** In  $G$ , we deviate the color of  $vv'$  in  $G'$  on  $u_2$  and the color of  $v'v''$  on  $u_1$ . We use the extra color on the path  $P = (u_1, v, v', v'', u_2)$ .

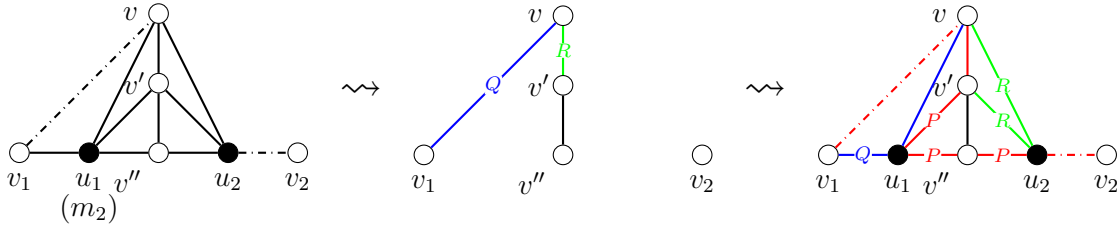

- $(m_2)$ : The special vertex  $u_1$  has degree 4, and  $u_2$  has degree 3 or 4: they are non-adjacent and have three common neighbors  $v, v', v''$ , such that  $v'$  is adjacent to  $v$  and  $v''$ . The special vertex  $u_1$  has another neighbor  $v_1$ , and  $u_2$  may have another neighbor  $v_2$ , such that  $v_1 \neq v_2$ .

**Reduction:** In the reduced graph, we add the edge  $vv_1$  if it does not already belong to  $G$ .

**Recoloring:** In  $G$ , we deviate the color of  $vv_1$  in  $G'$  on  $u_1$ , and the color of  $vv'$  on  $u_2$ . We use the extra color on the path  $P = (v, v', u_1, v'', u_2)$  and maybe on the edges  $vv_1$  and  $u_2v_2$  if they belong to  $G$ .

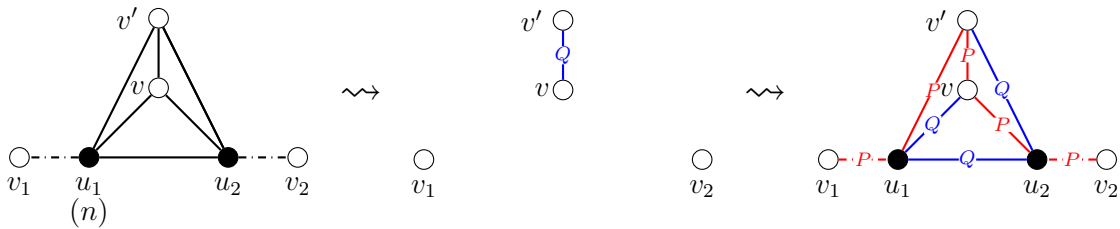

- $(n)$ : Each of the two special vertices  $u_1, u_2$  has degree 3 or 4. They are adjacent and have two common neighbors  $v, v'$  that are adjacent. Each of  $u_1, u_2$  may have another neighbor,  $v_1, v_2$  respectively.

**Recoloring:** In  $G$ , we deviate the color of  $vv'$  in  $G'$  on  $u_1, u_2$ . We use the extra color on the path  $P = (u_1, v', v, u_2)$  and maybe on the edges  $v_1u_1$  and  $u_2v_2$  if they belong to  $G$ .

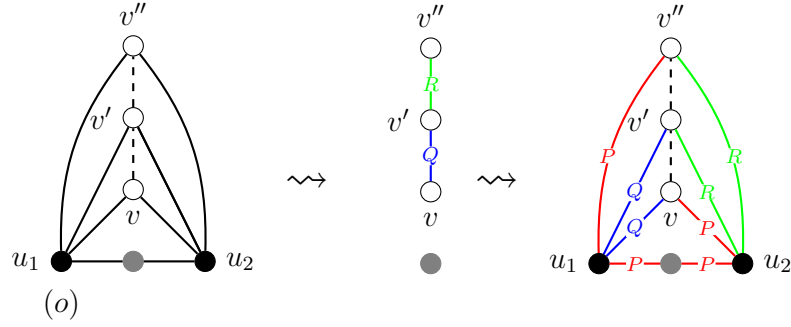

- (o): The special vertices  $u_1, u_2$  have degree 4, with three common neighbors  $v, v', v''$  such that  $v'$  is non-adjacent to  $v$  and  $v''$ . If  $u_1, u_2$  are non-adjacent, they have another common neighbor  $w$ ; let us denote  $P_{12}$  the path  $(u_1, u_2)$  if  $u_1, u_2$  are adjacent, and  $(u_1, w, u_2)$  otherwise.

**Reduction:** In the reduced graph, we add the edges  $vv'$  and  $v'v''$ .

**Recoloring:** In  $G$ , we deviate the color of  $vv'$  on  $u_1$  and the color of  $v'v''$  on  $u_2$ . We use the extra color on the path  $P = (v'', u_1, P_{12}, u_2, v)$ .

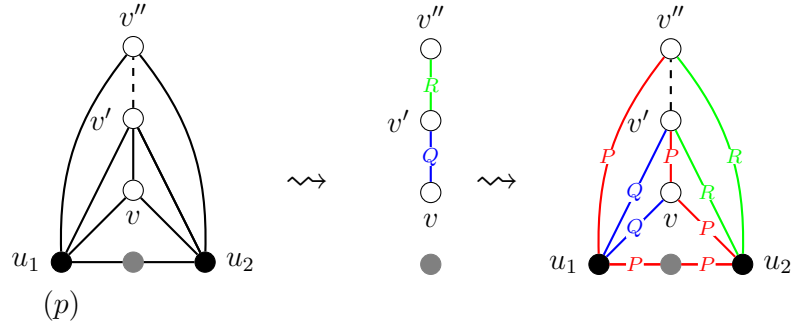

- (p): The special vertices  $u_1, u_2$  have degree 4, with three common neighbors  $v, v', v''$  such that  $v'$  is adjacent to  $v$  and non-adjacent to  $v''$ . If  $u_1, u_2$  are non-adjacent, they have another common neighbor  $w$ ; let us denote  $P_{12}$  the path  $(u_1, u_2)$  if  $u_1, u_2$  are adjacent, and  $(u_1, w, u_2)$  otherwise.

**Reduction:** In the reduced graph, we add the edge  $v'v''$ .

**Recoloring:** In  $G$ , we deviate the color of  $vv'$  on  $u_1$  and the color of  $v'v''$  on  $u_2$ . We use the extra color on the path  $P = (v'', u_1, P_{12}, u_2, v, v')$ .

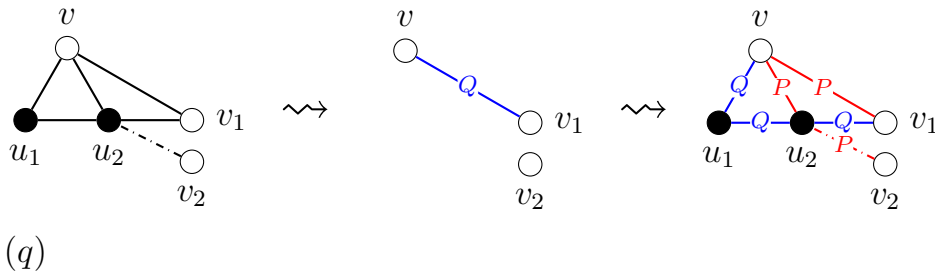

- (q): The special vertex  $u_1$  has degree 2, and  $u_2$  has degree 3 or 4. The special vertices  $u_1, u_2$  are adjacent and have one common neighbor  $v$ . The special vertex  $u_2$  has another neighbor  $v_1$  adjacent to  $v$ , and maybe another neighbor  $v_2$ .

**Recoloring:** In  $G$ , we deviate the color of the edge  $vv_1$  in  $G'$  on  $u_1, u_2$ . We use the extra color on the path  $P = (u_2, v, v_1)$ , and maybe on the edge  $v_2u_2$  if it belongs to  $G$ .

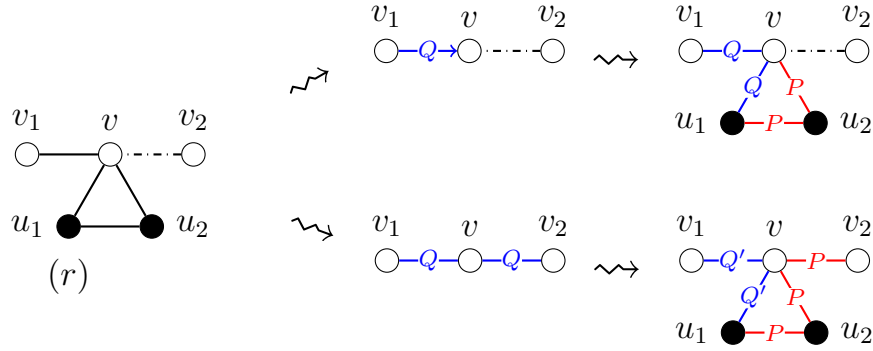

- (r): The two special vertices  $u_1, u_2$  have degree 2: they are adjacent and have one common neighbor  $v$ . The vertex  $v$  has at least one other neighbor  $v_1$ .

In the reduced graph, we examine two cases.

- In the first case, a path  $Q$  of the coloring of  $G'$  ends on  $v$  (through the edge  $v_1v$ ).

**Recoloring:** In  $G$ , we extend  $Q$  on the edge  $vu_1$ . We use the extra color on the path  $P = (u_1, u_2, v)$ .

- In the second case, no path of the coloring of  $G'$  ends on  $v$ . Let  $Q$  be a path of the coloring such that  $Q = (Q_1, v_1, v, v_2, Q_2)$ , with  $v_2$  another neighbor of  $v$ .

**Recoloring:** In  $G$ , we replace  $Q$  with a path  $Q' = (Q_1, v_1, v, u_1)$  and we use the extra color on the path  $P = (u_1, u_2, v, v_2, Q_2)$ .

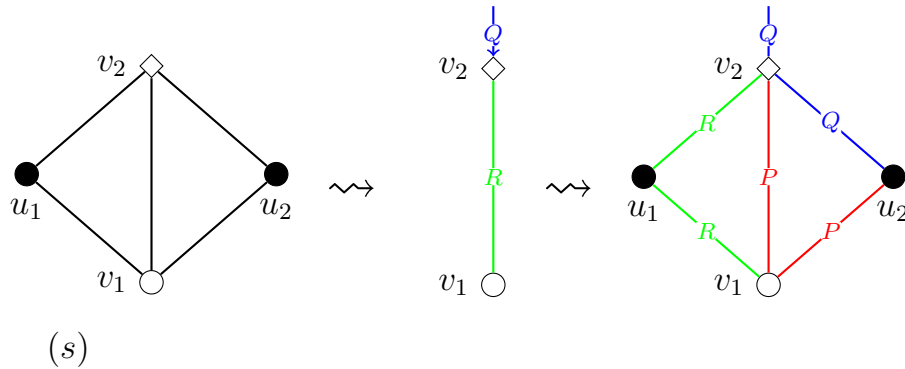

- (s): The two special vertices  $u_1, u_2$  have degree 2: they are non-adjacent and have two common neighbors  $v_1, v_2$  that are adjacent. The vertex  $v_2$  has an odd degree in  $G$ .

**Reduction:** In the reduced graph,  $v_2$  keeps an odd degree: let  $Q$  be a path of the coloring that ends on  $v_2$ .

**Recoloring:** In  $G$ , we deviate the color of  $v_1v_2$  in  $G'$  on  $u_1$ , and we extend the path  $Q$  on the edge  $v_2u_2$ .

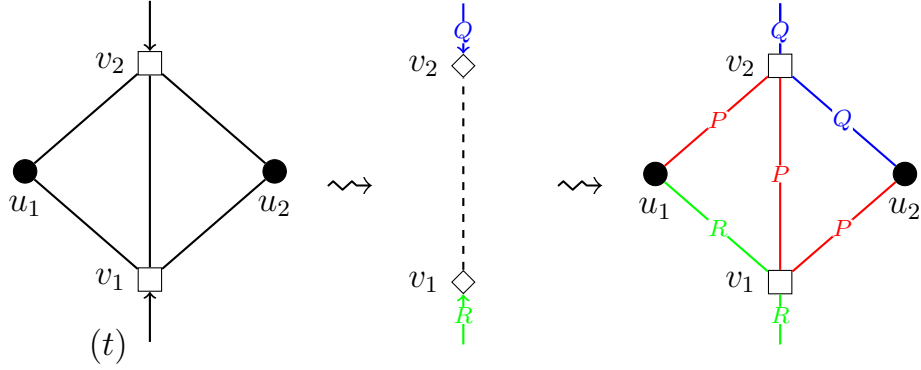

- (t): The two special vertices  $u_1, u_2$  have degree 2: they are non-adjacent and have two common neighbors  $v_1, v_2$  that are adjacent and have an even degree in  $G$ .  
**Reduction:** In the reduced graph, we remove the edge  $v_1v_2$ . The vertices  $v_1, v_2$  have odd degrees in  $G'$ : let  $Q, R$  be two paths of the coloring that end on  $v_2, v_1$  respectively.

**Recoloring:** In  $G$ , we extend the path  $Q$  on the edge  $v_2u_2$  and the path  $R$  on  $v_1u_1$ . We use the extra color on the path  $P = (u_1, v_2, v_1, u_2)$ .

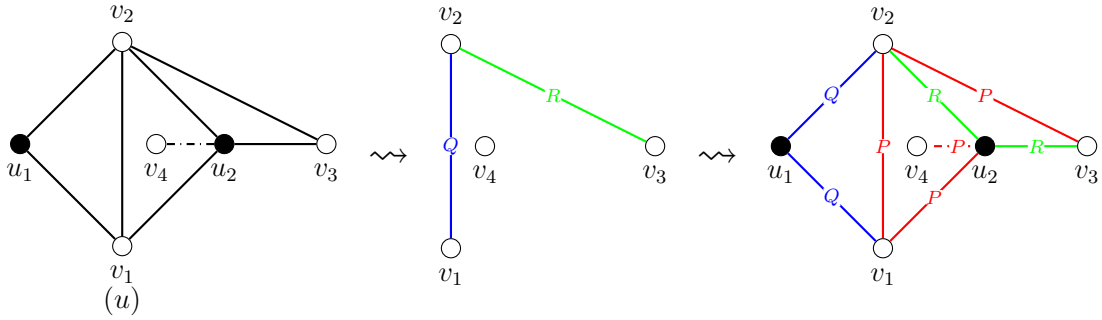

- (u): The special vertex  $u_1$  has degree 2, and  $u_2$  has degree 3 or 4. The special vertices  $u_1, u_2$  are non-adjacent and have two common neighbors  $v_1, v_2$  that are adjacent. The vertex  $u_2$  has another neighbor  $v_3$  adjacent to  $v_2$ . The vertex  $u_2$  may have another neighbor  $v_4$ .

**Reduction:** In  $G$ , we deviate the color of the edge  $v_1v_2$  in  $G'$  on  $u_1$  and the color of  $v_2v_3$  on  $u_2$ . We use the extra color on the path  $P = (v_3, v_2, v_1, u_2)$  and maybe on the edge  $u_2v_4$  if it belongs to  $G$ .

**Lemma 3.1.2.** *The reduction rules of configurations (a), (b),  $\dots$ , (u) are valid.*

*Proof.* For each rule, we need to check three properties: when the rule applied to a planar graph  $G$ , the reduced graph  $G'$  produced is planar; the recoloring function yields a path coloring (i.e. does not introduce cycles); and the number of additional colors used in the recoloring function is at most  $\left\lfloor \frac{|V(G)| - |V(G')|}{2} \right\rfloor$ .

For the first property, observe that in all considered rules except rule (h), an edge  $ab$  added by the reduction function replaces a deleted path of length 2 or 3 between  $a$  and  $b$  that goes through 1 or 2 special vertices. Hence the planarity is preserved. Now, let us consider rule (h). Let  $G''$  be the graph obtained from  $G$  by removing the vertices  $u_1$  and  $u_2$  and their incident edges. When removing  $u_1$  and its incident edges, we obtain a face  $f_1$  incident with  $v_3, v_1$  and  $v_2$ . For the same reason,  $v_4, v_1$  and  $v_2$  have a common face  $f_2$ . If  $f_1 \neq f_2$ , since  $v_1, v_2$  is a separating pair that separates  $v_3$  from  $v_4$ , there exists a planar embedding of  $G''$  such that  $v_3$  and  $v_4$  are on the same face. Hence in both cases there is

an embedding of  $G''$  such that  $v_3$  and  $v_4$  are incident with a common face. Hence we can add the edge  $v_3v_4$  to obtain  $G'$  while preserving the planarity.

The third property is easy to check, since the rule (a) does not introduce any new color, and all other rules have 2 special vertices and introduce exactly 1 new color (the color red on the figures, inducing the new path  $P$ ).

Finally, let us check the second property. We can easily check on each rule that when the recoloring function  $f^c$  is applied on a planar graph  $G$  and a coloring  $pc$  of the reduced graph  $G'$ , the coloring  $f^c(G, pc)$  provides a color for each edge of  $G$  (as a reminder, the edges drawn in black in the second and third drawings of a rule keep their color from the pre-coloring  $pc$  in  $G$ ).

In  $G$ , the only edges of the new path  $P$  are the ones represented in the third drawing of each rule. One can easily check for each rule that these edges form a path. For colors used in the pre-coloring  $pc$ , except in rules (h) and (r), we only perform two types of modification, deviations and extensions. Since each special vertex is only involved in one such modification, each color of  $pc$  induces a path in  $G$ .

In the first case of rule (r), we do a simple path extension as before. In the second case, we first split an existing path into two paths, using the new color (the path  $P$  in red). Then we extend these two subpaths toward special vertices, hence we obtain a path coloring.

For rule (h), heavier modifications are made on the path  $Q$  in  $G'$ . In rule ( $h_1$ ), the edge  $v_3v_4$  is replaced by the path  $(v_3, u_1, v_2, u_2, v_4)$ . Since the vertex  $v_2$  explicitly avoids the path  $Q$ , the resulting coloring does not introduce cycles. In rule ( $h_2$ ), the vertex  $v_5$  avoids the subpath  $Q_2$  of  $Q$ , i.e. the section after  $v_4$ , and  $v_6$  avoids  $Q_1$ , i.e. the section before  $v_2$ . Hence in the final coloring,  $P$  and  $Q'$  are paths. In rule ( $h_3$ ), we can easily check that  $Q'$  is a path. Moreover,  $v_5$  avoids the section  $R_1$  of  $Q$ , i.e. the section between  $v_2$  and  $v_3$ . Since by planarity  $v_6$  cannot touch  $R_1$ , then  $P$  is a path. The same argument applies to rule ( $h_4$ ) with both  $v_5$  and  $v_6$  avoiding the section  $R_1''$ , the former by hypothesis and the latter by planarity. In rule ( $h_5$ ),  $Q'$  is a path since  $v_5$  cannot touch the section  $R_1'$  of  $Q$  by hypothesis, and the section  $Q_2$  by planarity. Similarly,  $P$  is a path since  $v_6$  cannot touch the section  $R_1$  of  $Q$  by hypothesis, and the section  $R_1''$  by planarity. In rule ( $h_6$ ), we can easily check that  $Q'$  is a path. Since both  $v_5$  and  $v_6$  avoid the section  $R_1'$  of  $Q$ , then  $P$  is a path. This completes the examination of all cases.  $\square$

The second group of rules we consider are given by the neighborhood of two vertices  $u_1$  and  $u_2$  of degree at most 4 together with a shortest path  $S$  joining them, such that  $|N(u_1) \cap N(u_2)| \leq 1$ . Note that this includes the case where  $u_1$  and  $u_2$  are adjacent, with no common neighbors. These rules can be described as the product of two so-called *elementary partial rules*, that specifies the behavior of the rule around each endpoint of the path. In Chapter 4, we will introduce more general rules and partial rules to deal with ( $C_{II}$ ) configurations.

More formally, an *elementary partial configuration*  $\mathcal{C}_i$  is a configuration defined over the neighborhood of one *special vertex*  $u_i$ , with one identified incident edge, called *subdivision edge*. We say that a neighbor  $v$  of  $u_i$  is a *remaining neighbor* of  $u_i$  if  $u_iv$  is not the subdivision edge.

Given a graph  $G$ , two vertices  $u_1, u_2$  of  $G$ , a shortest  $(u_1, u_2)$ -path  $S$ , and two elementary partial configurations  $\mathcal{C}_1$  and  $\mathcal{C}_2$ , the *path composite configuration*  $(\{\mathcal{C}_1(u_1), \mathcal{C}_2(u_2)\}, S)$  is defined as the following configuration:  $u_1$  (resp.  $u_2$ ) satisfies the partial configuration  $\mathcal{C}_1$  (resp.  $\mathcal{C}_2$ ), the path  $S$  contains the subdivision edges of  $\mathcal{C}_1$  and  $\mathcal{C}_2$  and does not touch the other neighbors of  $u_1$  and  $u_2$ . For ease of notation, we may simply write  $\mathcal{C}_1 \oplus \mathcal{C}_2$ .

An *elementary partial rule* is a rule  $\mathcal{R}_i = (\mathcal{C}_i, f_i^r, f_i^c)$  associated with an elementary partial configuration  $\mathcal{C}_i$ , a partial reduction function  $f_i^r$  and a partial recoloring function  $f_i^c$ . The partial reduction function  $f_i^r$  of the rule is encoded by a set  $\mathcal{O}_i \subseteq \{add, remove\} \times E(\mathcal{C}_i)$  with straightforward semantics. In particular, we can identify all the vertices of  $V(G) \setminus N(u_i)$  between  $G$  and  $f_i^r(G)$ . The partial recoloring function defines the coloring of the edges, based on existing colors plus an extra color (represented as red on the figures) used in part for the edges of  $S$ .

If  $\mathcal{R}_1 = (\mathcal{C}_1, f_1^r, f_1^c)$  and  $\mathcal{R}_2 = (\mathcal{C}_2, f_2^r, f_2^c)$  are two elementary partial rules,  $u_1, u_2$  two vertices and  $S$  a shortest  $(u_1, u_2)$ -path, the *path composite rule*  $(\{\mathcal{R}_1(u_1), \mathcal{R}_2(u_2)\}, S)$  is the reduction rule  $(\mathcal{C}_c, f_c^r, f_c^c)$  associated with the path composite configuration  $(\{\mathcal{C}_1(u_1), \mathcal{C}_2(u_2)\}, S)$ , and is defined as follows. Let  $U = \{u_1, u_2\}$ . The reduction function  $f_c^r$  is defined by  $f_c^r(G) = (f_1^r \circ f_2^r(G)) \setminus (U \cup E(S))$ , i.e. the successive application of the operations in  $\mathcal{O}_2$  and  $\mathcal{O}_1$  and the removal of the special vertices and the edges of  $S$  to form the reduced graph  $G'$ .

Let  $pc$  be a coloring of  $G' = f_c^r(G)$ , and  $c_S$  a 1-coloring of the path  $S$ . The recoloring function  $f_c^c$  is defined by  $f_c^c(G, pc) = f_2^c(G, f_1^c(f_2^r(G), pc \cup c_S))$ ; in other words, the path  $S$  is added to  $G'$  and colored with  $c_S$ , then the reduction of  $\mathcal{C}_1$  is undone, the edges in the neighborhood of  $u_1$  are colored according to the partial recoloring function  $f_1^c$ , and finally the reduction of  $\mathcal{C}_2$  is undone (to obtain  $G$ ) and the edges in the neighborhood of  $u_2$  are colored according to the partial recoloring function  $f_2^c$ .

Let us present the list of elementary partial rules that we consider in this chapter. We extend our graphical formalism by representing the subdivision edge as a red edge with a double arrow ( $\bullet \leftarrow \leftarrow$ ).

Note again that we justify the planarity of the reduced graph and the validity of the rules formed by two elementary partial rules in Lemma 3.1.3 after the definitions.

### List of the elementary partial configurations:



( $\mathcal{C}_{EXT}$ )

- ( $\mathcal{C}_{EXT}$ ): The special vertex  $u_1$  has exactly one remaining neighbor  $v_1$ .

**Recoloring:** In  $G$ , we extend the extra color on the edge  $u_1v_1$ .

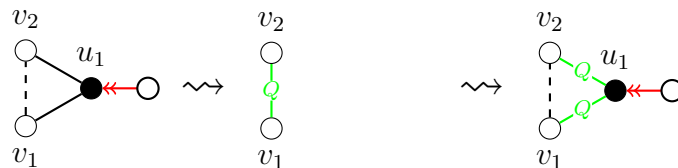

( $\mathcal{C}_V$ )

- ( $\mathcal{C}_V$ ): The special vertex  $u_1$  has exactly two remaining neighbors  $v_1, v_2$  that are non-adjacent.

**Reduction:** In the reduced graph, we add the edge  $v_1v_2$ .

**Recoloring:** In  $G$ , we deviate the color of  $v_1v_2$  on  $u_1$ .

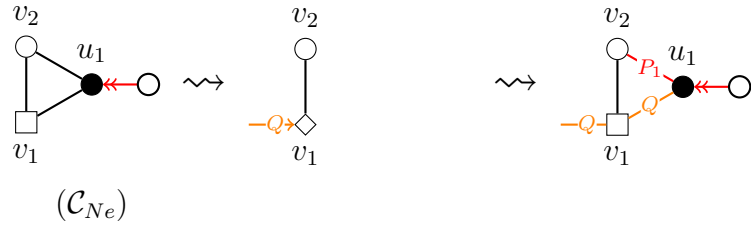

- $(\mathcal{C}_{Ne})$ : The special vertex  $u_1$  has exactly two remaining neighbors  $v_1, v_2$  that are adjacent. The vertex  $v_1$  has an even degree in  $G$ .

**Reduction:** In the reduced graph,  $v_1$  has an odd degree: let  $R$  be a path of the coloring of  $G'$  that ends on  $v_1$ .

**Recoloring:** In  $G$ , we extend the path  $R$  on the edge  $v_1u_1$ .

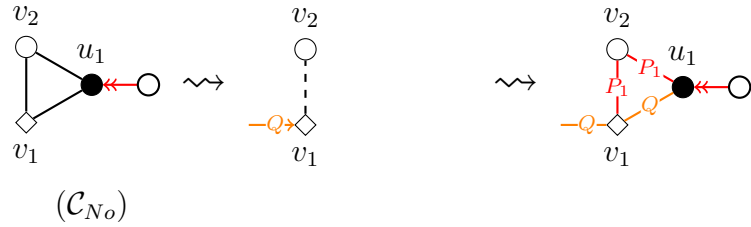

- $(\mathcal{C}_{No})$ : The special vertex  $u_1$  has exactly two remaining neighbors  $v_1, v_2$  that are adjacent. The vertex  $v_1$  has an odd degree in  $G$ .

**Reduction:** In the reduced graph, we remove the edge  $v_1v_2$ . The vertex  $v_1$  keeps an odd degree in  $G'$ : let  $R$  be a path of the coloring of  $G'$  that ends on  $v_1$ .

**Recoloring:** In  $G$ , we extend the path  $R$  on the edge  $v_1u_1$ , and we extend the extra color on the edges  $u_1v_2$  and  $v_2v_1$ .

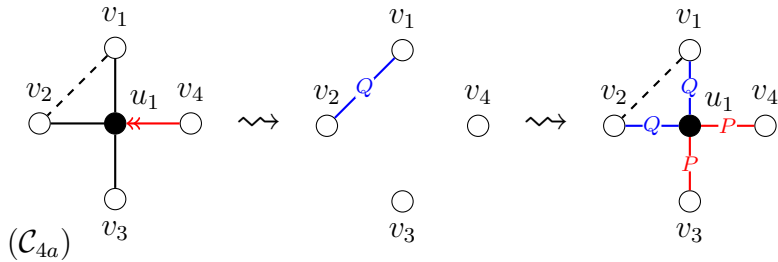

- $(\mathcal{C}_{4a})$ : The special vertex  $u_1$  has exactly three remaining neighbors  $v_1, v_2, v_3$ , such that  $v_1, v_2$  are non-adjacent.

**Reduction:** In the reduced graph, we add the edge  $v_1v_2$ .

**Recoloring:** In  $G$ , we deviate the color of  $v_1v_2$  on  $u_1$  and extend the extra color on the edge  $u_1v_3$ .

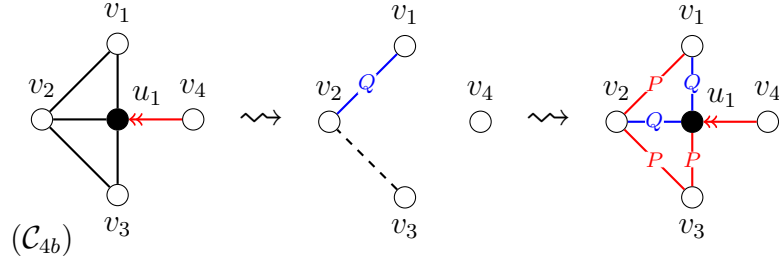

- $(\mathcal{C}_{4b})$ : The special vertex  $u_1$  has exactly three remaining neighbors  $v_1, v_2, v_3$ , such that the edges  $v_1v_2$  and  $v_2v_3$  belong to  $G$ .

**Reduction:** In the reduced graph, we remove the edge  $v_2v_3$ .

**Recoloring:** In  $G$ , we deviate the color of  $v_1v_2$  on  $u_1$  and extend the extra color on the edges  $u_1v_3, v_3v_2, v_2v_1$ .

For convenience, we define some aliases which group several elementary partial configurations together. Note that these aliases are not disjoint: the configuration  $(\mathcal{C}_V)$  appears in both  $(\mathcal{C}_V^+)$  and  $(\mathcal{C}_N)$ , and these two aliases are particular cases of  $(\mathcal{C}_N^+)$ .

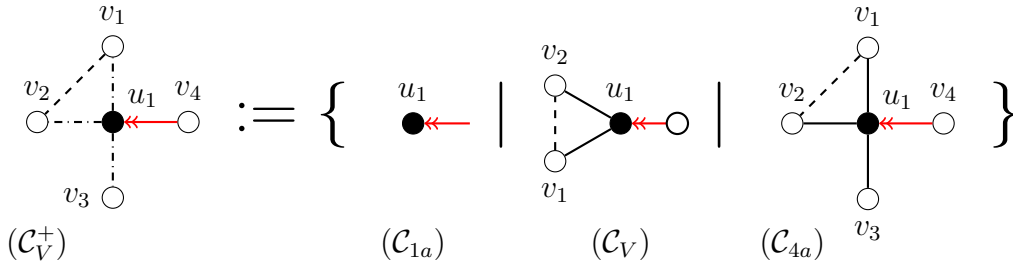

- $(\mathcal{C}_V^+)$ : The special vertex  $u_1$  has either 0, 2 or 3 remaining neighbors  $v_1, v_2, v_3$ , such that at least two of them are non-adjacent. If it has 0, this is configuration  $(\mathcal{C}_{1a})$ ; if it has exactly 2 and they are non-adjacent this is configuration  $(\mathcal{C}_V)$ ; and if it has three remaining neighbors, and at least two of them are non-adjacent, this is configuration  $(\mathcal{C}_{4a})$ .

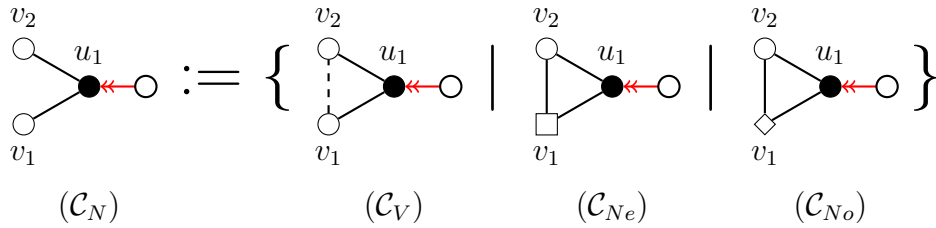

- $(\mathcal{C}_N)$ : The special vertex  $u_1$  has 2 remaining neighbors  $v_1, v_2$ . If  $v_1, v_2$  are non-adjacent, this is configuration  $(\mathcal{C}_V)$ . Otherwise, if one of  $v_1, v_2$  has an even degree in  $G$ , this is configuration  $(\mathcal{C}_{Ne})$ , and if both have an odd degree in  $G$ , this is configuration  $(\mathcal{C}_{No})$ .



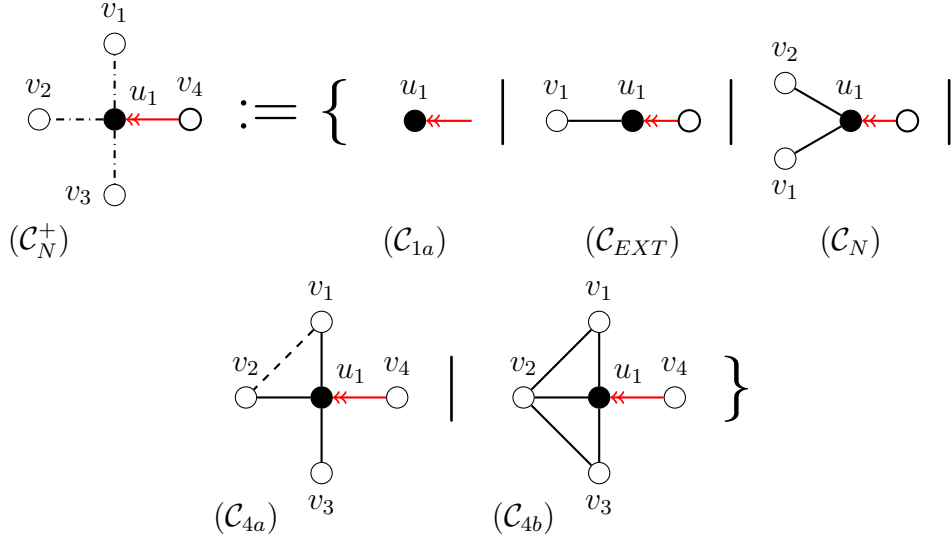

- $(\mathcal{C}_N^+)$ : The special vertex  $u_1$  has between 0 and 3 remaining neighbors  $v_1, v_2, v_3$ . If it has 0, 1 or 2, this is configuration  $(\mathcal{C}_{1a})$ ,  $(\mathcal{C}_{EXT})$  and  $(\mathcal{C}_N)$  respectively. If it has 3 remaining neighbors, then if two of them are non-adjacent this is configuration  $(\mathcal{C}_{4a})$  and otherwise  $(\mathcal{C}_{4b})$ .

**Lemma 3.1.3.** *Let  $u_1, u_2$  be two special vertices, and  $S$  a shortest  $(u_1, u_2)$ -path, let  $\mathcal{C}_a \in (\mathcal{C}_N^+)$  and  $\mathcal{C}_b \in (\mathcal{C}_N^+)$ , and let  $\mathcal{R}_a, \mathcal{R}_b$  be the elementary partial rules associated with  $\mathcal{C}_a, \mathcal{C}_b$  respectively. Then the path composite rule  $(\{\mathcal{R}_a(u_1), \mathcal{R}_b(u_2)\}, S)$  is valid if the following conditions are satisfied:*

- *If none of  $\mathcal{C}_a, \mathcal{C}_b$  are  $(\mathcal{C}_V)$  or  $(\mathcal{C}_{4a})$  configurations, then  $u_1, u_2$  share no remaining neighbors;*
- *If  $\mathcal{C}_a$  is a configuration  $(\mathcal{C}_V)$  or  $(\mathcal{C}_{4a})$ , then  $u_1$  shares at most one remaining neighbor  $v$  with  $u_2$ , and  $v$  is non-adjacent to at least one other remaining neighbor of  $u_1$  (i.e.  $v$  is not  $v_3$  in the definition of  $(\mathcal{C}_{4a})$ ).*

*Proof.* We need to check three properties: when the path composite rule is applied on a planar graph  $G$ , the reduced graph  $G'$  produced is planar; the recoloring function does not introduce cycles; and the number of additional colors used in the recoloring function is at most  $\lfloor \frac{|V(G)| - |V(G')|}{2} \rfloor$ .

The first property is easy to check, as in all considered elementary partial rules, an edge  $v_1v_2$  added by the reduction function replaces a deleted path of length 2 between  $v_1$  and  $v_2$  that goes through a special vertex, and each special vertex is involved in at most one such operation.

For the the third property, observe that the rule  $(\{\mathcal{R}_a(u_1), \mathcal{R}_b(u_2)\}, S)$  involves two special vertices. The recoloring function only uses colors from the pre-coloring, plus 1 new color ( $c_S$  in the definition, the path  $P$  drawn in red on the figures) which is exactly  $\lfloor \frac{|V(G)| - |V(G')|}{2} \rfloor$ .

For colors used in the pre-coloring, we only perform two types of modification: deviations and extensions. Since each special vertex is involved in at most one such modification, the recoloring function does not introduce cycles involving these colors.

It remains to check that the set  $P$  of edges colored with the new color in  $c_S$  is indeed a path. It is made up of a shortest path  $S$  between the two special vertices, and maybe some edges incident with only remaining neighbors and special vertices. Let  $P_a$  (resp.  $P_b$ ) be the edges of  $P$  in the recoloring of  $\mathcal{R}_a$  (resp.  $\mathcal{R}_b$ ). So  $P = S \cup P_a \cup P_b$ . We can check that each elementary partial rule does not introduce cycles within the elementary partial

configuration, i.e.  $S \cup P_a$  and  $S \cup P_b$  are paths. If  $\mathcal{C}_a$  and  $\mathcal{C}_b$  do not share remaining neighbors, then  $P_a$  and  $P_b$  are vertex-disjoint, and thus  $P$  induces a path. Now assume that  $\mathcal{C}_a$  is a configuration  $(\mathcal{C}_V)$  or  $(\mathcal{C}_{4a})$ , that (w.l.o.g.) the vertex  $v_1$  of  $\mathcal{C}_a$  (w.r.t. the notations in the definition of  $(\mathcal{C}_V)$  and  $(\mathcal{C}_{4a})$ ) also belongs to  $\mathcal{C}_b$ , and that the other remaining neighbors of  $\mathcal{C}_a$  and  $\mathcal{C}_b$  are disjoint. Since  $v_1$  does not touch the edges of  $P_a$ , then  $P_a$  and  $P_b$  are vertex-disjoint and  $P$  is a path. This concludes the proof.  $\square$

### 3.2 Sufficiency of the $(C_I)$ rules

We prove with Lemma 3.2.2 that, because of the reduction rules associated with configurations (a), (b),  $\dots$ , (u),  $(\mathcal{C}_N^+) \oplus (\mathcal{C}_N^+)$ , an MCE  $G$  cannot contain any of them. We first show that it is easy to derive a contradiction if the reduced graph  $G'$  does not contain  $K_3$  or  $K_5^-$  components, by building a good coloring of  $G$ . Then, we assume that  $G'$  contains some  $K_3$  or  $K_5^-$  connected components, and we build once again a good (path-)coloring of  $G$ , with the help of an intermediate coloring of  $G'$  with paths and cycles. The proof then combines cycles and paths together to save colors. Let us introduce a relevant lemma from [18]. The *exceptional graph* is a graph consisting of a cycle  $C$  of length 5 and a path  $P$ , such that  $V(C) \subseteq V(P)$  and  $V(C)$  induces a  $K_5^-$ . We restate here Lemma 2.1. from [18].

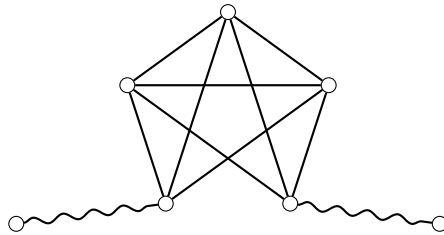

Figure 3.4: The exceptional graph

**Lemma 3.2.1** ([18]). *Let  $C$  be a cycle and  $P$  a path, such that  $C$  and  $P$  are edge-disjoint. If  $1 \leq |V(C) \cap V(P)| \leq 5$ , then  $E(C) \cup E(P)$  can be decomposed into 2 paths, unless  $C \cup P$  is the exceptional graph.*

Remark that Lemma 3.2.1 cannot be applied to  $K_5^-$ , as in any decomposition of  $K_5^-$  into a cycle of length 5 and a path of length 4, the path and the cycle form the exceptional graph.

There are several possible decompositions of the exceptional graph into a path and a cycle. The following observation states that in any such decomposition, the path and the cycle satisfy the properties of the definition.

**Observation 1.** *Let  $C$  be a cycle and  $P$  a path, such that  $C \cup P$  forms the exceptional graph. Then  $C$  has length 5,  $V(C) \subseteq V(P)$  and  $(C \cup P)[V(C)]$  (the subgraph of  $C \cup P$  induced by the vertices of  $C$ ) is a  $K_5^-$ .*

*Proof.* There are exactly 5 vertices of degree at least 3 in  $C \cup P$ . Since the vertices of  $(C \setminus P) \cup (P \setminus C)$  have degree 1 or 2, we deduce that  $|C \cap P| = 5$ .

$(C \cup P)[V(C \cap P)]$  is a  $K_5^-$ , so if there is an edge  $e \in C$  that does not belong to  $E(C \cap P)$ , then there is a 2-path decomposition of  $K_5^-$ , a contradiction. So  $E(C) \subseteq E(C \cap P)$ , hence  $V(C) = V(C \cap P)$ . We deduce that  $V(C) \subseteq V(P)$ ,  $C$  has length 5 and  $(C \cup P)[V(C)]$  is a  $K_5^-$ .  $\square$

**Lemma 3.2.2.** *An MCE does not contain any of the configurations (a), (b), ..., (u), and does not contain a path composite configuration  $(\mathcal{C}_N^+) \oplus (\mathcal{C}_N^+)$  that satisfies the conditions of Lemma 3.1.3 (p. 60).*

*Proof.* Let us consider such a configuration  $X$  and let  $\mathcal{R}_X = (X, f_X^r, f_X^c)$  be its associated reduction rule. By Lemmas 3.1.2 (p. 55) and 3.1.3 (p. 60),  $\mathcal{R}_X$  is valid. Let  $G$  be an MCE containing the configuration  $X$ , and  $G' = f^r(G)$  its reduced graph.

Let  $n'_1, \dots, n'_p$  be the sizes of the connected components  $G'_1, \dots, G'_p$  of  $G'$ . Observe that  $\sum_{j \leq k} n'_j = |V(G')|$ . Observe that each  $G'_i$  that is not a  $K_3$  nor a  $K_5^-$  component is a connected planar graph that is smaller than the minimum counterexample  $G$ , hence these  $G'_i$  each admit a good coloring, using  $\lfloor \frac{n'_i}{2} \rfloor$  colors. Each  $K_3$  component can be decomposed into 1 cycle and each  $K_5^-$  component into 1 path and 1 cycle. Then  $G'$  admits a coloring  $pc$  into paths and cycles with  $\sum_{i=1..p} \lfloor \frac{n'_i}{2} \rfloor \leq \lfloor \frac{|V(G')|}{2} \rfloor$  colors. Since the reduction rule is valid,  $G$  admits a coloring  $c_0$  into paths and cycles with at most  $\lfloor \frac{|V(G')|}{2} \rfloor + \lfloor \frac{|V(G)| - |V(G')|}{2} \rfloor \leq \lfloor \frac{|V(G)|}{2} \rfloor$  colors, such that no new cycles are created.

Observe that all the cycles in  $c_0$  are vertex-disjoint. Indeed, the cycles in  $pc$  are vertex-disjoint because they belong to different connected components of  $G'$ ; the cycles may have been deviated into longer cycles in  $G$ , but since the internal vertices of the deviated sections are all special vertices, and since each special vertex is involved in at most one deviation, then no vertex of  $G$  can belong to the intersection of two cycles of  $c_0$ .

We build iteratively a good coloring  $c$  of  $G$ , by starting from  $c_0$  and using Lemma 3.2.1 (p. 61) at each iteration to replace a cycle and a path of  $c$  by two new paths that decompose the same set of edges. We first consider the case where  $X \neq (a)$  and  $X \neq (h)$ .

We successively treat the  $K_5^-$  and  $K_3$  components in  $G'$ . First, let us consider a component  $K$  in  $G'$  that is a  $K_5^-$ , colored with a cycle  $C'$  of length 5 and a path  $P'$  of length 4 in  $pc$ .  $C'$  is turned into a cycle  $C_0$  from  $c_0$  after possibly some deviations, and Lemma 3.2.1 has not been applied to it yet, so  $C_0$  is also induced by a color of  $c$ .  $P'$  may have been extended (such as with path  $Q$  in rule  $(\mathcal{C}_{N_e})$ ) and deviated to special vertices, into a path  $P_0$  of  $G$  induced by a color of  $c_0$ . So  $V(P_0) \subseteq V(P') \cup U$ , and since each special vertex is involved in at most one deviation or one extension, then  $P_0$  is disjoint from the cycles of  $c_0$  different from  $C_0$ , so Lemma 3.2.1 has not been applied to it in previous iterations, and thus  $P_0$  is also induced by a color of  $c$ . Finally, let  $\hat{P}$  be a path induced by a color of  $c$  such that  $V(\hat{P}) \cap V(C_0) \neq \emptyset$  and  $\hat{P} \neq P_0$ . Such a path  $\hat{P}$  exists because  $G$  is connected and the cycles in  $c$  are disjoint.

Observe that  $V(P_0) \cap V(C_0) = V(K)$ , so  $|V(P_0) \cap V(C_0)| = 5$ . If there is at least one deviation on  $C'$ , then by Observation 1 (p. 61),  $C \cup P$  does not form the exceptional graph. We may then apply Lemma 3.2.1 (p. 61) on  $C$  and  $P$ . Otherwise there is no deviation on  $C'$ , so  $C_0 = C'$  (of length 5). At least 2 edges of  $G[V(C_0)]$  belong to  $P_0$ , and thus by Observation 1 (p. 61),  $C_0 \cup \hat{P}$  does not form the exceptional graph. We can apply Lemma 3.2.1 (p. 61) on  $C_0$  and  $\hat{P}$ , as  $|V(C_0) \cap V(\hat{P})| \leq |V(C_0)| = 5$ .

Now consider the case where  $K$  is a  $K_3$ , colored by a cycle  $C'$  of length 3 in  $G'$ . Again let  $C$  be the cycle in  $G$  that is induced by the same color in  $c$  as  $C'$  in  $pc$ , after possibly some deviations, and let  $\hat{P}$  be a path induced by a color of  $c$  such that  $V(\hat{P}) \cap V(C) \neq \emptyset$ . At most two deviations were performed on  $C'$ , so  $|V(C)| \leq 5$ . We apply Lemma 3.2.1 (p. 61) on  $C$  and  $\hat{P}$ , unless they form the exceptional graph. Assume it is the case and  $C$  is disjoint from any other path in the coloring of  $G$ . By Observation 1 (p. 61),  $C$  has length 5 and thus contains both special vertices. Since  $G$  is not a  $K_5^-$ ,  $\hat{P}$  has at least one other edge, necessarily from one special vertex to a vertex outside  $V(C)$ .  $G$  fits the description of the configuration  $(m_2)$ . In the rule associated with  $(m_2)$ , if the reduced

graph contains a  $K_3$  component, it contains only the vertex  $v_2$  (in the definition of the rule), and its cycle is not deviated to the special vertices, a contradiction.

In all cases, we were able to find a cycle and a path that do not form the exceptional graph. We apply to them Lemma 3.2.1 (p. 61) and obtain two new paths that decompose them. We replace the cycle and the path in  $c$  by the two new paths, to obtain a coloring of  $G$  that uses the same number of colors and contains one less cycle. After this method has been successively applied to all  $K_3$  and  $K_5^-$  appearing in  $G'$ ,  $c$  that has the right number of colors and contains only paths, a contradiction with  $G$  being a counterexample.

We are left with rules (a) and (h). If  $X = (a)$ , observe that the reduced graph  $G'$  is connected. If  $G' = K_3$  or  $G' = K_5^-$ , then  $G$  is the same graph with one subdivided edge, so we can easily find a good coloring of  $G$ . Finally, let us consider the case  $X = (h)$ . First note that if a  $K_3$  appears in  $G'$ , it contains only  $v_5$  or only  $v_6$  among the vertices represented in the figures. It cannot contain both as there would be a path from  $v_3$  to  $v_4$  in  $G$ , a contradiction with the definition of (h). A  $K_5^-$  in  $G'$  contains only  $v_5$ , only  $v_6$ , or only  $v_1, v_2, v_3, v_4$  among the vertices represented. In the latter case, the  $K_5^-$  must be on vertices  $v_1, v_2, v_3, v_4$  and another vertex  $v_7$ . If there is a non-edge between  $v_1$  and  $v_2$ , then  $v_7$  is adjacent to  $v_1, v_2, v_3, v_4$ . Then the path  $v_3, v_7, v_4$  contradicts the definition of (h). Thus, there is an edge  $v_1v_2$ , and we may assume w.l.o.g. that  $v_7$  is adjacent to  $v_1, v_2, v_3$ .

If a  $K_3$  (resp.  $K_5^-$ ) component appears in  $G'$  and contains (only)  $v_5$  or  $v_6$ , then the red path  $P$  or the blue path  $Q$  in  $f_X^c(G, pc)$  can easily be extended to color both the path and the  $K_3$  (resp.  $K_5^-$ ) with 2 colors (resp. 3 colors) (which is equivalent to applying Lemma 3.2.1, p. 61). Now assume that  $v_1, v_2, v_3, v_4, v_7$  form a  $K_5^-$  in  $G'$ . We color it in  $G'$  with the path  $R = (v_7, v_3, v_1, v_2, v_4)$  and a cycle  $Q = (v_7, v_1, v_4, v_3, v_2)$ . We thus place ourselves in case 3 of (h), treated with rule (h<sub>3</sub>). When applying the recoloring function, we change the color of the edge  $u_2v_4$  from  $Q$  (blue) to  $R$  (green), to turn  $Q$  into a path. We thus built a good coloring of  $G$  in all cases, a contradiction.  $\square$

### 3.3 The rules cover all cases

**Lemma 3.3.1.** *If a graph contains a configuration  $(C_I)$ , then it contains at least one configuration among (a), (b), ..., (u),  $(\mathcal{C}_N^+) \oplus (\mathcal{C}_N^+)$ ,  $(\mathcal{C}_V^+) \oplus (\mathcal{C}_N^+)$ , in which case the conditions of Lemma 3.1.3 (p. 60) are satisfied.*

*Proof.* We make a case analysis, described by the tree of Figure 3.5. We will now go through the tree, and for each inner node we are going to define the configurations of the children and show that if a graph contains a node configuration, then it contains (at least) one of its children configurations.

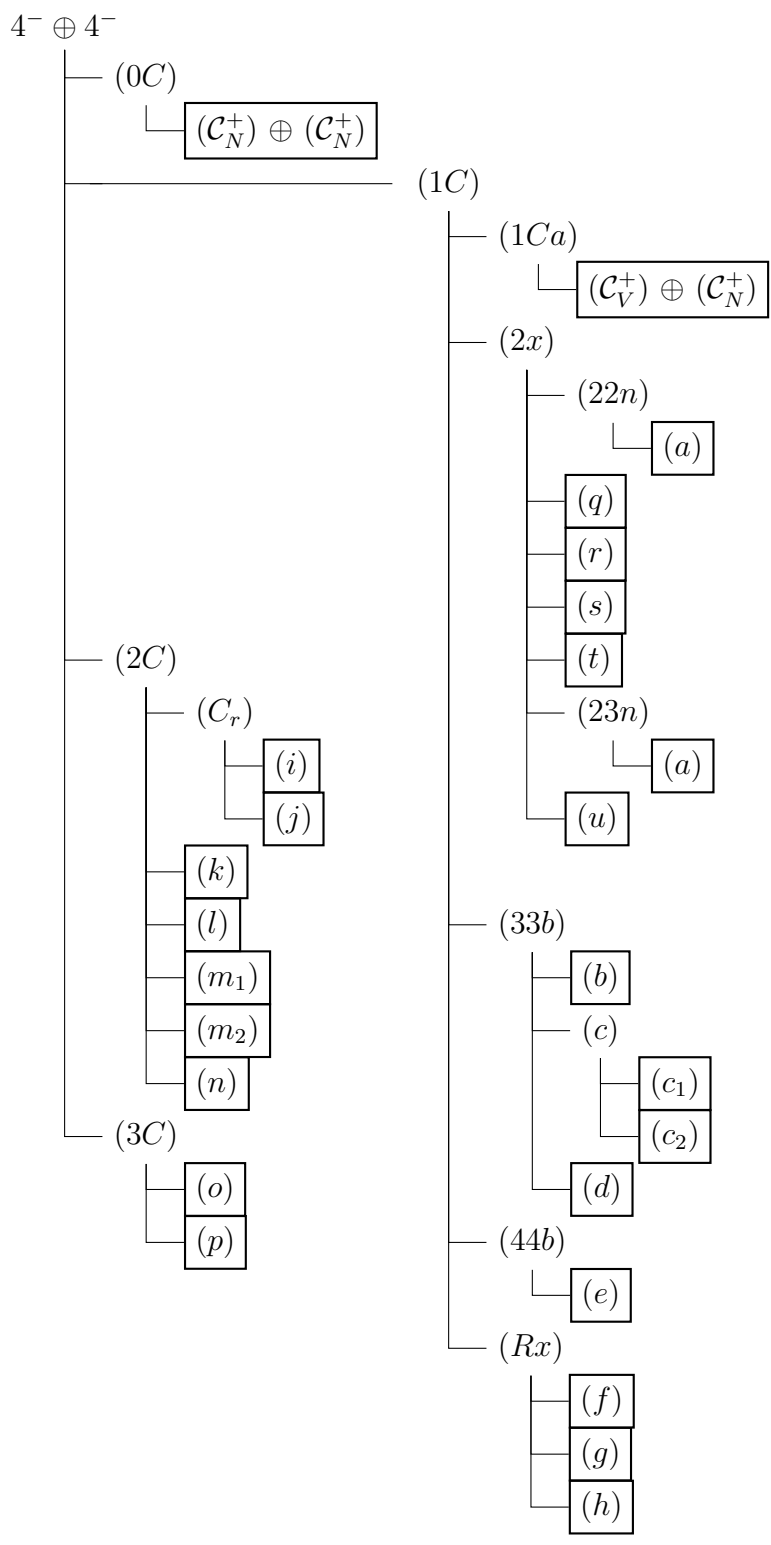
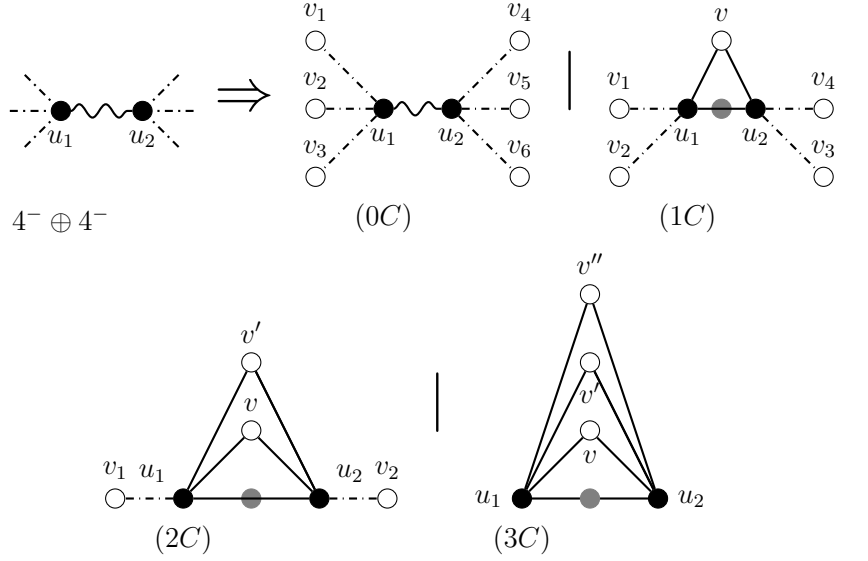

Figure 3.5: Tree of implications between configurations.



- $4^- \oplus 4^-$ : In the following configurations, let  $u_1, u_2$  be two special vertices that form a configuration  $(C_I)$  and let  $P$  be a shortest path between  $u_1$  and  $u_2$ .
  - $(0C)$  (0 common remaining neighbor): the vertices  $u_1$  and  $u_2$  have degree 1, 2, 3 or 4; the vertices  $u_1$  and  $u_2$  have no common remaining neighbor.
  - $(1C)$  (1 common remaining neighbor): the special vertices have degree 2, 3 or 4; the path  $P$  has length 1 or 2; the special vertices have exactly one common remaining neighbor  $v$ .
  - $(2C)$  (2 common remaining neighbors): the special vertices have degree 3 or 4; the path  $P$  has length 1 or 2; the special vertices have exactly two common remaining neighbors  $v$  and  $v'$ .
  - $(3C)$  (3 common remaining neighbors): the special vertices have degree 4; the path  $P$  has length 1 or 2; the special vertices have exactly three common remaining neighbors  $v, v'$  and  $v''$ .

Depending on the number of common remaining neighbors between  $u_1$  and  $u_2$ , we have one of the configurations  $(0C)$ ,  $(1C)$ ,  $(2C)$  or  $(3C)$ .

Since  $P$  is a shortest path between  $u_1$  and  $u_2$ , when  $u_1$  and  $u_2$  have a common neighbor,  $P$  has length at most 2, hence all cases are covered.

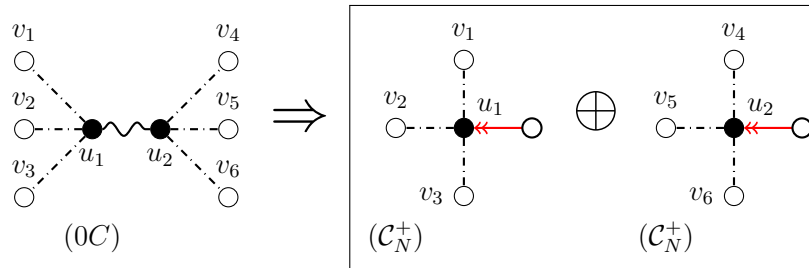

- $(0C)$ : The neighborhoods of both special vertices match the elementary partial configuration  $(\mathcal{C}_N^+)$ . Since  $u_1$  and  $u_2$  have no common remaining neighbors, we have a path composite configuration  $(\mathcal{C}_N^+) \oplus (\mathcal{C}_N^+)$  that satisfies the conditions of Lemma 3.1.3 (p. 60).

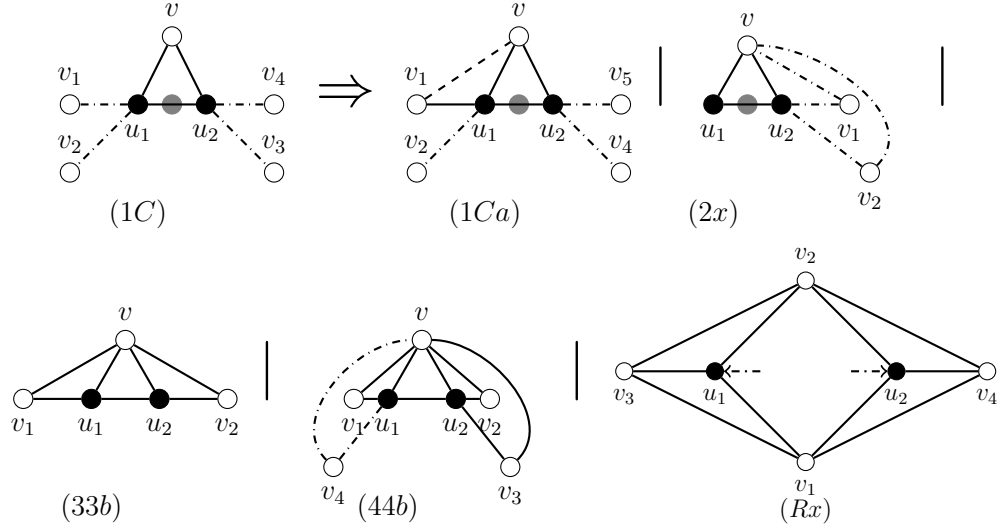

• (1C):

- (1Ca): The special vertex  $u_1$  has degree 3 or 4 and the special vertex  $u_2$  has degree 2, 3 or 4; the special vertices have one common remaining neighbor  $v$  and  $u_1$  and  $u_2$  are linked by a path  $P$  of length 1 or 2; moreover  $u_1$  has a remaining neighbor  $v_1$  that is not adjacent to  $v$ .
- (2x): The special vertex  $u_1$  has degree 2 and the special vertex  $u_2$  has degree 2, 3 or 4; the special vertices have one common remaining neighbor  $v$  and  $u_1$  and  $u_2$  are linked by a path  $P$  of length 1 or 2; if the degree of  $u_2$  is greater than 2, let  $v_1$  and possibly  $v_2$  be its other remaining neighbors and these neighbors are adjacent to  $v$ .
- (Rx): The special vertices  $u_1$  and  $u_2$  have degree 3 or 4;  $u_1$  and  $u_2$  have 2 common neighbors  $v_1$  and  $v_2$ ; each special vertex has a remaining neighbor ( $v_3$  and  $v_4$  respectively) that is adjacent to  $v_1$  and  $v_2$ .
- (33b): The special vertices  $u_1$  and  $u_2$  have degree 3;  $u_1$  is adjacent to  $u_2$  and they have a common neighbor  $v$ .
- (44b): The special vertex  $u_1$  has degree 3 or 4 and the special vertex  $u_2$  has degree 4;  $u_1$  is adjacent to  $u_2$  and they have a common neighbor  $v$ ; the remaining neighbors of  $u_1$  are adjacent to  $v$ .

If there is a remaining neighbor of a special vertex that is not adjacent with the common remaining neighbor, then we have the configuration (1Ca). Otherwise, every remaining neighbor is adjacent to the common neighbor  $v$ . If at least one of the special vertices has degree 2, then we have the configuration (2x). Otherwise, every special vertex has degree 3 or 4. If the distance between the special vertices is 2, then  $u_1$  and  $u_2$  have 2 common neighbors (let us call them  $v$  and  $v'$ ). In this case, all the other neighbors are adjacent to both of them (otherwise we are back in case (1Ca), possibly changing the role of  $v$  and  $v'$ ). In this case, we have the configuration (Rx). Otherwise, the special vertices are adjacent. If both vertices have degree 2, we have the configuration (33b), otherwise we have the configuration (44b).

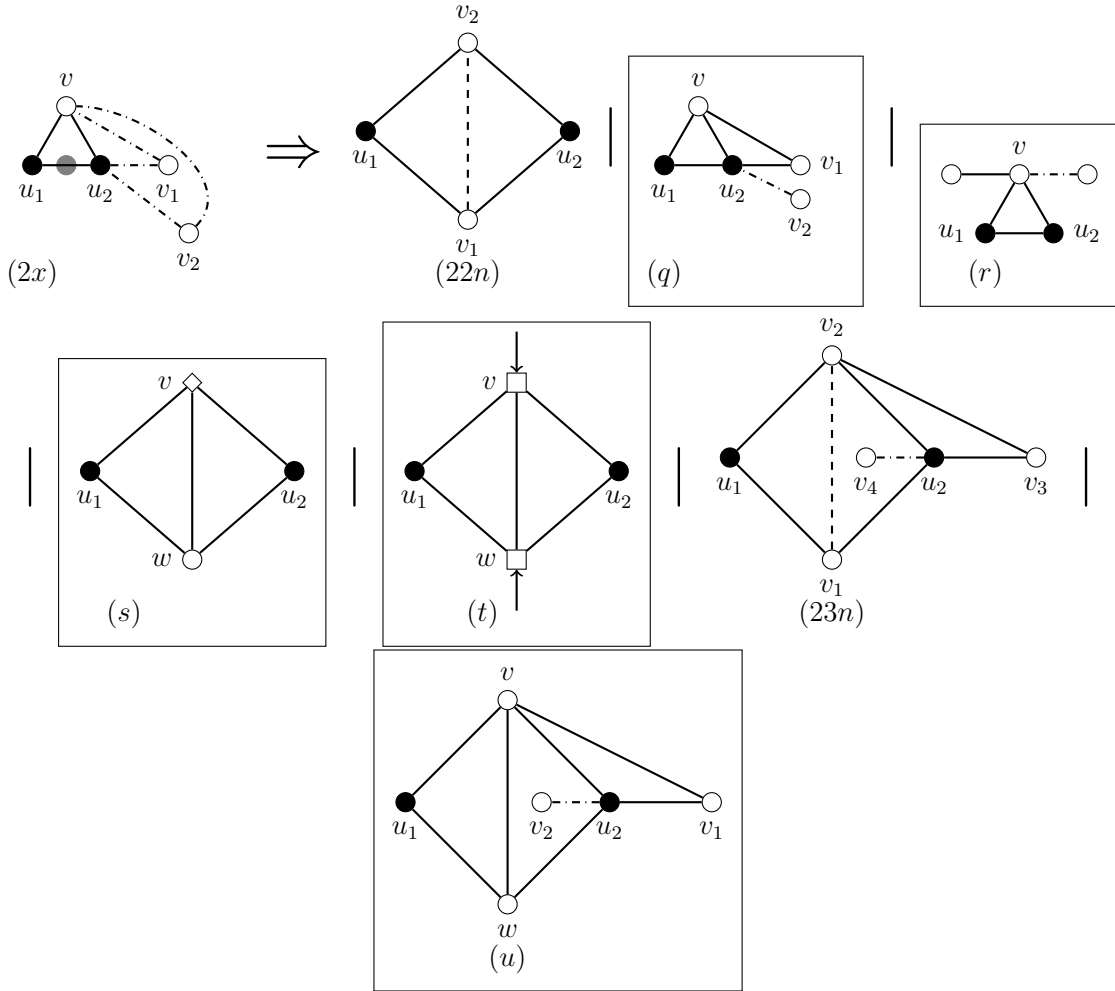

- (2x):
  - (22n): The two special vertices  $u_1$  and  $u_2$  have degree 2; they have two common neighbors  $v_1$  and  $v_2$ ; moreover  $v_1$  and  $v_2$  are not adjacent.
  - (23n): The special vertex  $u_1$  has degree 2 and  $u_2$  has degree 3 or 4;  $u_1$  and  $u_2$  have two common neighbors  $v_1$  and  $v_2$ ;  $v_1$  and  $v_2$  are not adjacent;  $u_2$  has a neighbor  $v_3$  that is adjacent to  $v_2$ .

In this case,  $u_1$  has degree 2, and  $u_1, u_2$  are either adjacent or share a neighbor  $w$  in addition to their common remaining neighbor  $v$ . First let us assume that  $u_2$  has degree 2. If  $u_1, u_2$  are adjacent, then this is configuration (r). Otherwise,  $u_1, u_2$  are non-adjacent. If  $v, w$  are non-adjacent, this is configuration (22n), and otherwise this is configuration (s) if one among  $v, w$  has an odd degree, and configuration (t) if both have an even degree.

Now assume  $u_2$  has degree at least 3. If  $u_1, u_2$  are adjacent this is configuration (q), and otherwise this is configuration (23n) if  $v, w$  are non-adjacent, or (u) otherwise.



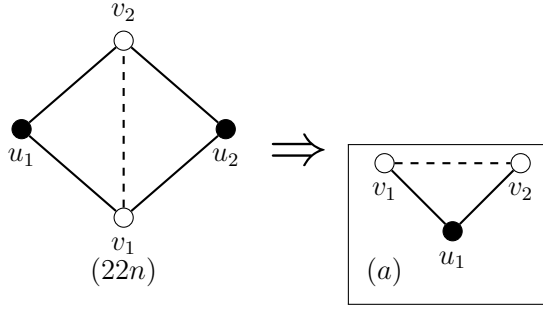

- (22n): In this case have the configuration (a) around special vertex  $u_1$ .

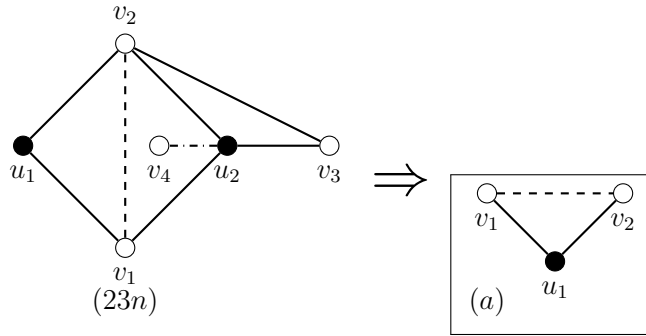

- (23n): In this case have the configuration (a) around special vertex  $u_1$ .

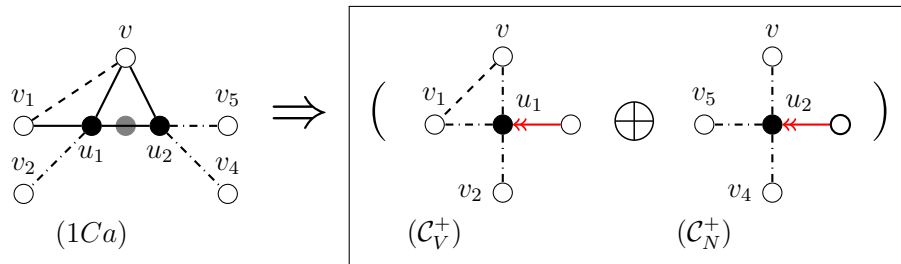

- (1Ca): The neighborhood of the first special vertex matches with the elementary partial configuration  $(\mathcal{C}_V^+)$  and the neighborhood of the second one with the elementary partial configuration  $(\mathcal{C}_N^+)$ . Moreover both special vertices have only one remaining neighbor in common,  $v$ , which is non-adjacent to  $v_1$ . Hence the conditions of Lemma 3.1.3 (p. 60) are satisfied.

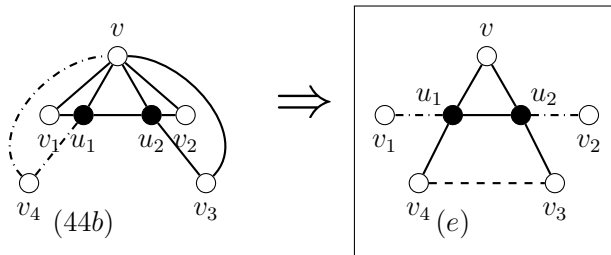

- (44b): Since the graph is planar, at least one of the remaining neighbors of  $u_2$  is not adjacent to the remaining neighbor of  $u_1$ . Hence we have the configuration (e).

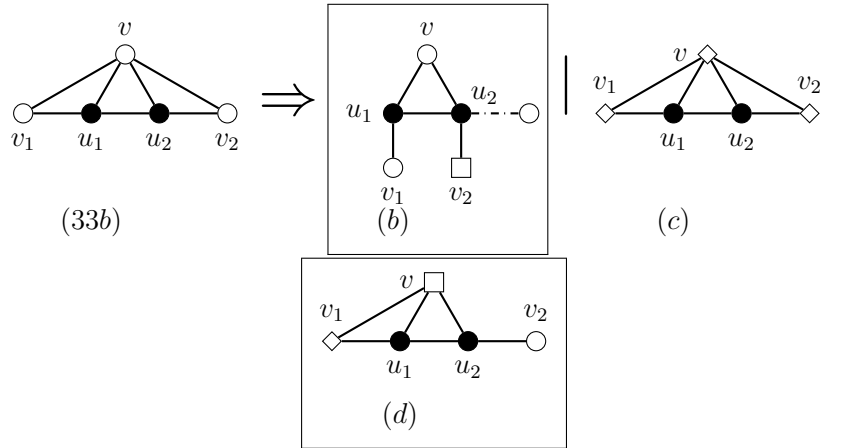

• (33b):

- (c): The special vertices  $u_1$  and  $u_2$  have degree 3; they are adjacent and they have a common neighbor  $v$  of odd degree; each special vertex has another neighbor of odd degree ( $v_1$  and  $v_2$  respectively) that is adjacent to  $v$ .

If there is a special vertex with an even non-common remaining neighbor, we are in the configuration (b). Otherwise, depending of the parity of the common neighbor we are in configuration (c) (odd) or in configuration (d) (even).

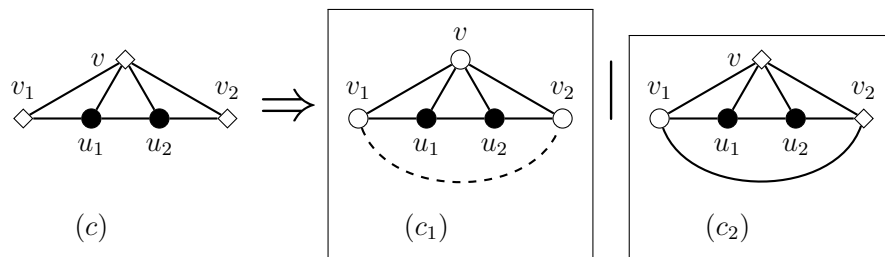

- (c): We split the case depending on whether there is an edge between  $v_1$  and  $v_2$ , the associated rules are (c<sub>1</sub>) if there is not and (c<sub>2</sub>) otherwise.

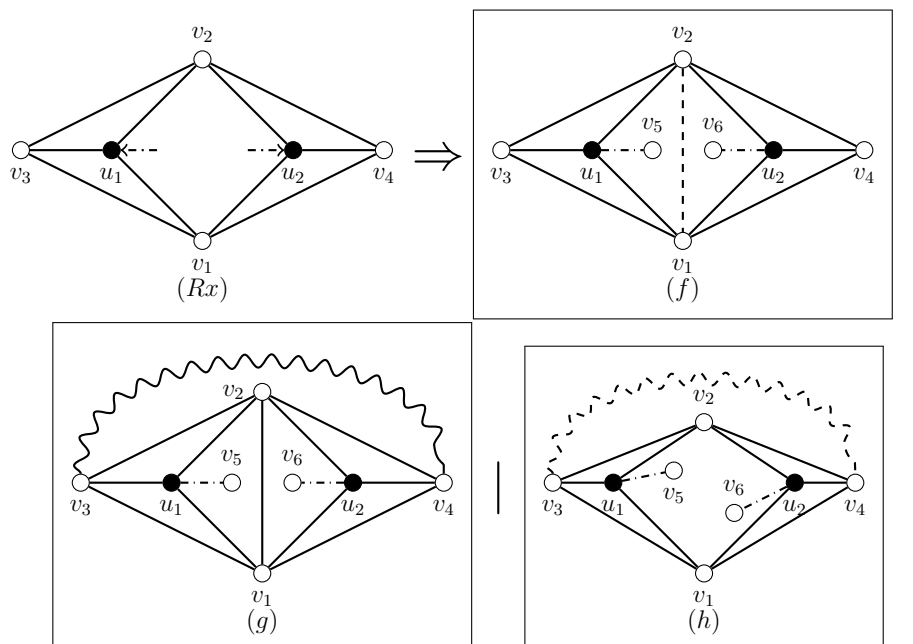

- $(Rx)$ : If the two common neighbors are non-adjacent we are in configuration  $(f)$ , Otherwise, if the two common neighbors form a separating pair, then we are in configuration  $(h)$ , otherwise we are in configuration  $(g)$ .

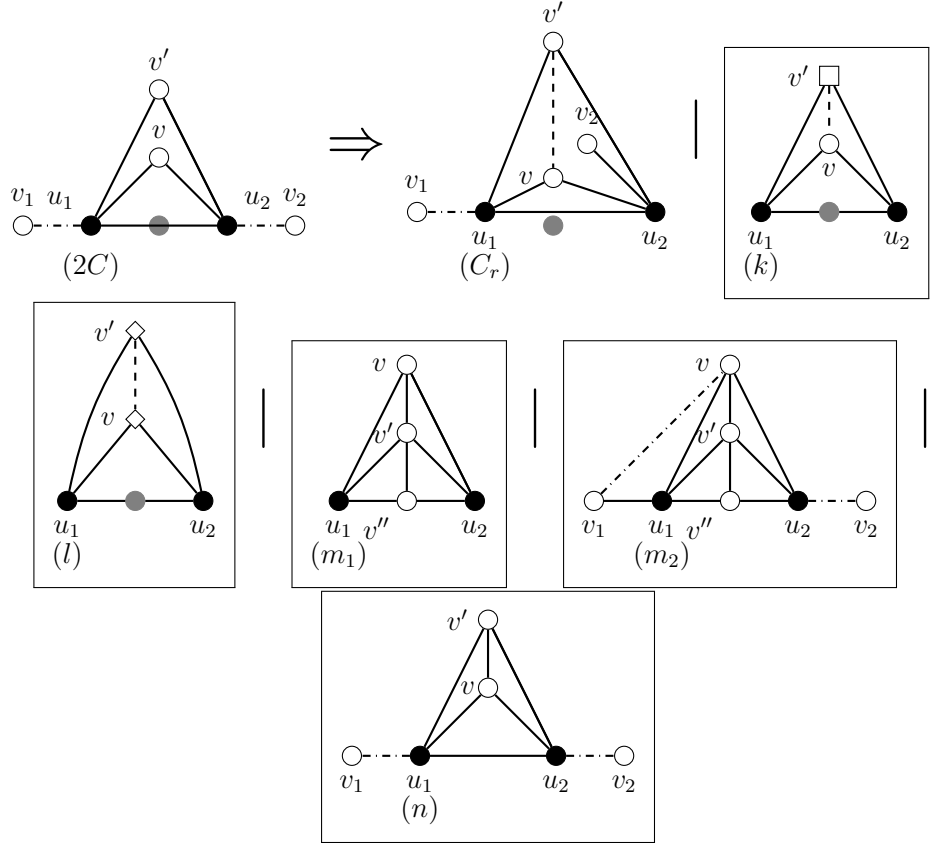

- $(2C)$ :
  - $(C_r)$ : the special vertex  $u_1$  has degree 3 or 4 and the special vertex  $u_2$  has degree 4;  $u_1$  and  $u_2$  are linked by a path  $P$  of length 1 or 2; they have two common remaining neighbors  $v$  and  $v'$ ; moreover,  $v$  and  $v'$  are not adjacent. If there are two common neighbors that are non-adjacent, then we are in configuration  $(C_r)$  if at least one special vertex has degree 4, and otherwise in configuration  $(k)$  or  $(l)$  depending on whether one of these neighbors has an even degree. Otherwise all common neighbors are adjacent. If the special vertices are adjacent, then we are in configuration  $(n)$ . Otherwise, the path  $P$  has length 2 and a middle-vertex  $v''$ . If both special vertices have degree 3, then we are in configuration  $(m_1)$ , and if at least one has degree 4, we are in configuration  $(m_2)$ .

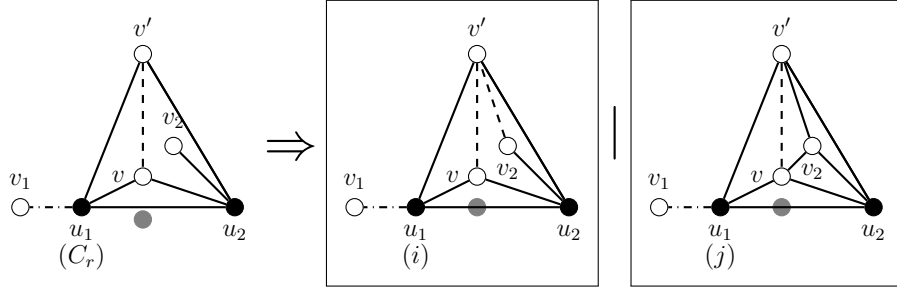

- $(C_r)$ : If there is a non-common remaining neighbor that is not adjacent to a common remaining neighbor we are in configuration  $(i)$ , otherwise at least one remaining neighbor is adjacent to both common remaining neighbors and we are in configuration  $(j)$ .

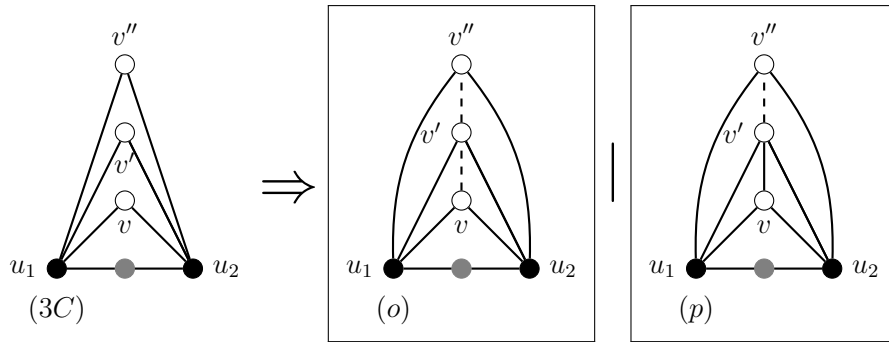

- $(3C)$ : Since the graph is planar, there are at least two non-adjacent common remaining neighbors. If none of them are adjacent we are in configuration  $(o)$ , otherwise we are in configuration  $(p)$ .

□

The proof of the main lemma of this chapter is now straightforward.

*Proof of Lemma 3.1.1 (p. 43).* Let  $G$  be an MCE, and assume it contains a configuration  $(C_I)$ . By Lemma 3.3.1,  $G$  contains a configuration among  $(a)$ ,  $(b)$ ,  $\dots$ ,  $(u)$ , or a path composite configuration  $(C_V^+) \oplus (C_N^+)$  or  $(C_N^+) \oplus (C_N^+)$ . Lemma 3.2.2 (p. 62) provides a contradiction.

□



# Chapter 4

## Elimination of vertices of degree 5

In this chapter, we prove the following lemma, which constitutes the second property of Lemma 2.6.2.

**Lemma 4.0.1.** *An MCE does not contain a configuration  $(C_{II})$ .*

As a reminder, a planar graph  $G$  has a configuration  $(C_{II})$  if it is almost 4-connected w.r.t. a 4-family  $U$ , i.e. a set of four vertices of degree 5; we say that  $G$  has a  $(C_{II})$  configuration w.r.t.  $U$ . The proof of Lemma 4.0.1 is given at the end of this chapter, and uses a method similar to the proof of Lemma 3.1.1 (p. 43) in the previous chapter.

In this chapter, we take care of our four special vertices by generalizing the tools of the previous chapter. Instead of considering a shortest path like in  $(C_I)$  rules, we use a *subdivision*, either a  $K_4$  or a  $C_{4+}$ -subdivision (see Figure 4.3), and again remove it in the reduction, then color it with our extra colors. These structures have the same convenient properties as the shortest path of the  $(C_I)$  rules: they can be colored with 2 extra colors, and there is an end of an extra color on each of the four special vertices, which is again helpful to take care of all the missing edges. We generalize the concept of elementary partial rule and consider *patterns* that recolor the neighborhoods of one or two special vertices at once. Similarly to the distant special vertices in the  $(C_I)$  rules, when the remaining neighbors of the special vertices are disjoint, we combine four “normal” patterns (called  $\mathcal{C}_N$  like in Chapter 3) to form a complete reduction rule. Figure 4.1 shows four special vertices  $u_1, u_2, u_3, u_4$  linked by a  $K_4$ -subdivision  $S$ , with disjoint remaining neighbors and thus treated with the pattern  $\mathcal{C}_N$ .

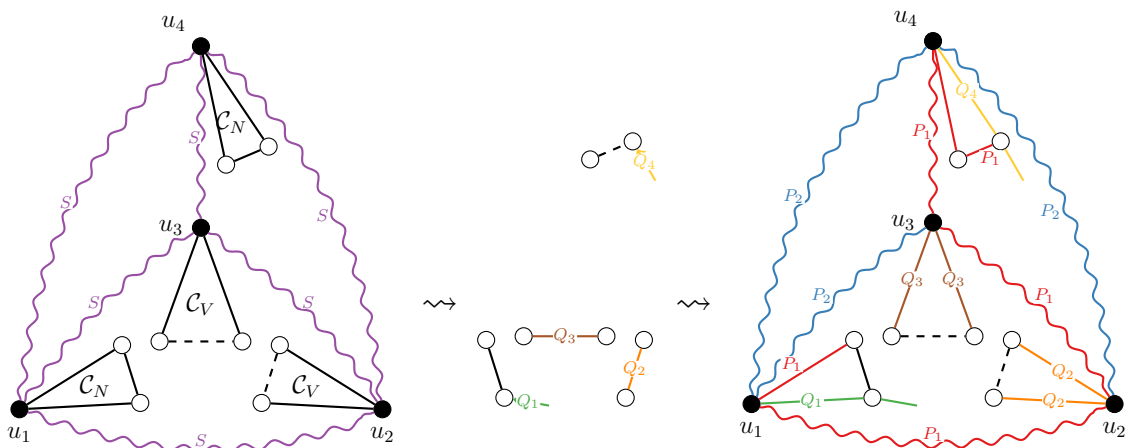

Figure 4.1: A  $(C_{II})$  reducible configuration featuring  $\mathcal{C}_N$  patterns

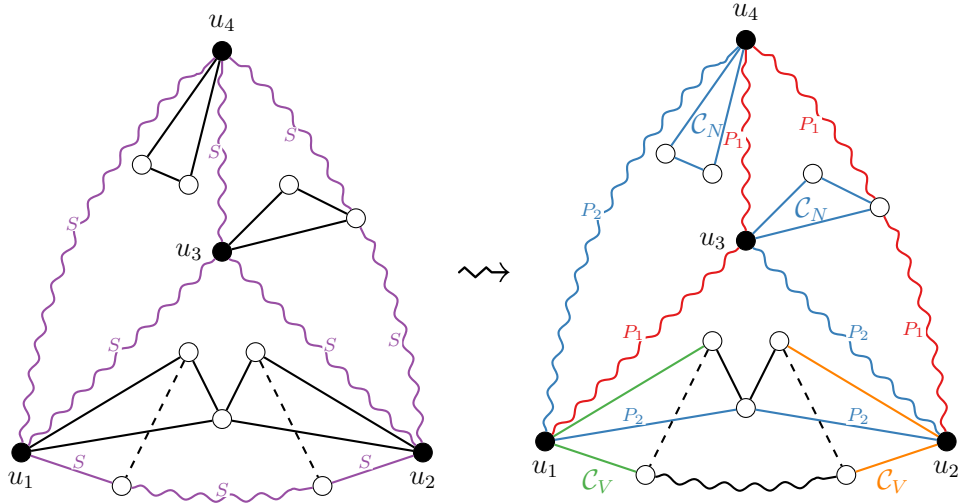

Figure 4.2: A  $(C_{II})$  configuration where  $u_1, u_2$  form a close problem and  $u_3$  a distant problem. The close problem is eliminated by redirection of the subdivision  $S$ , and the distant problem is inactivated by the 2-coloring of  $S$ .

Several problems can occur however, which we classify in two types, *distant* and *close* problems. A special vertex forms a distant problem when its remaining neighbors are adjacent and touch the subdivision. If left untreated, a distant problem may cause a  $C_N$  pattern to create a cycle in the final coloring. The distant problems are eliminated in two ways: either by modifying the subdivision to assign new remaining neighbors to the problematic special vertices, or by **inactivating** them by finding a 2-coloring of the subdivision that is compatible with the  $C_N$  patterns treating the remaining distant problems. Figure 4.2 features a  $(C_{II})$  configuration with a  $K_4$ -subdivision  $S$ , where the special vertex  $u_3$  causes a distant problem on a  $(u_2, u_4)$ -path of  $S$ . This problem is inactivated by a carefully chosen 2-coloring of  $S$ .

The close problems occur when two special vertices share some remaining neighbors, with these remaining neighbors possibly touching the subdivision as well. These problems are treated in a custom manner, by redirecting the subdivision to assign new remaining neighbors to the special vertices and finding a compatible set of patterns to treat all four special vertices. In Figure 4.2,  $u_1$  and  $u_2$  initially form a close problem, which is eliminated by a redirection of the subdivision. The special vertices  $u_1, u_2$  are then both treated with the  $C_V$  pattern.

More precisely, we first treat the cases with at least 3 distant problems (and no close ones), in the *distant lemma* (Lemma 4.5.5, p. 105), then the cases with at most 2 distant problems and no close ones in the *semi-distant lemma* (Lemma 4.6.2, p. 114), and finally the cases with at most 2 distant problems and some close problems in the *close lemma* (Lemma 4.7.2, p. 124).

The following claim is a corollary of the properties of almost 4-connectivity, and is useful in various proofs of this chapter.

**Claim 4.0.2.** *Let  $G$  be a planar graph that is almost 4-connected w.r.t. a 4-family  $U$ . Then  $G$  does not have a special vertex  $u \in U$  that forms a  $K_4$  with three of its neighbors.*

*Proof.* Let  $v_1, v_2, v_3 \in N(u)$ , such that  $\{u, v_1, v_2, v_3\}$  form an induced  $K_4$  in  $G$ . Since  $d(u) = 5$ ,  $u$  has a neighbor  $v_4$  distinct from  $v_1, v_2, v_3$ . W.l.o.g.,  $v_4$  belongs to the face de-

limited by  $\{u, v_1, v_2\}$ . Then  $\{u, v_1, v_2\}$  is a 3-cut that separates  $v_3$  from  $v_4$ , a contradiction to the definition of almost 4-connectivity.  $\square$

## 4.1 $K_4, C_{4+}$ -subdivisions

In Chapter 3, the composite rules that we considered were associated with a path between the two special vertices. In order to apply a similar method to the  $(C_{II})$  configurations made up of 4 special vertices, we consider more complex structures:  $K_4$ -subdivisions and  $C_{4+}$ -subdivisions (defined in the preliminaries chapter).

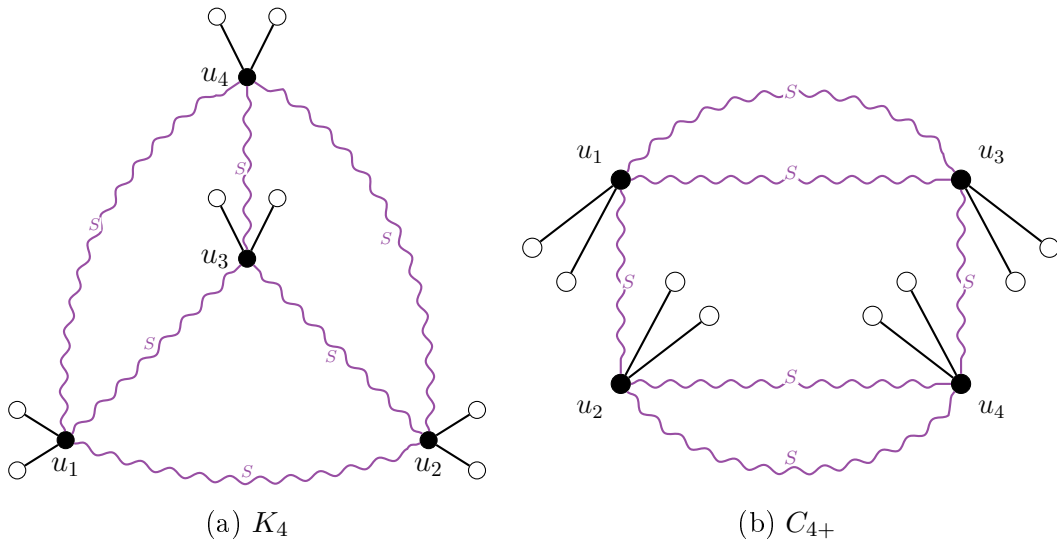

Figure 4.3: The two subdivisions considered in the proof of Lemma 4.1.2:  $K_4$ -subdivision and  $C_{4+}$ -subdivision

The general idea is to color the edges of the subdivision with 2 new “extra” colors such that each special vertex is the endpoint of one path. We can then proceed as in the case of the configuration  $(C_I)$  to color the neighborhood of the special vertices. However, not only are the remaining neighbors of the special vertices still not necessarily disjoint, but they can now be touched by paths of the subdivision, which forces us to consider a large number of subcases.

A result by Yu [82] gives us a  $K_4$ -subdivision (see Figure 4.3a) under the condition of almost 4-connectivity, with two exceptions. We show in Lemma 4.1.2 below that we are able to extract from these two exceptions a  $C_{4+}$ -subdivisions (see Figure 4.3b) with some additional properties, which we call  $C_{4+}^*$ -subdivision.

In a subdivision  $S$  rooted on a 4-family  $U$ , let us say that two special vertices  $u_i, u_j$  are  $k$ -linked,  $k \in \{0, 1, 2\}$ , if there are  $k$   $(u_i, u_j)$ -paths in  $S$  with no special vertex as an internal vertex. In a  $K_4$ -subdivision, all special vertices  $u_i, u_j$  are pairwise 1-linked, while in a  $C_{4+}$ -subdivision there are two pairs of 0-linked, two pairs of 1-linked, and two pairs of 2-linked special vertices. Note that it is sufficient to specify one pair of 1-linked and one pair of 2-linked special vertices to deduce the link of all pairs. If  $u_i, u_j$  are 1-linked, we call the  $(u_i, u_j)$ -path a *solo* path of  $S$ . If  $u_i, u_j$  are 2-linked, we call the two  $(u_i, u_j)$ -paths *parallel paths* of  $S$ .

Just like in the previous chapter, if  $u_i \in U$  is a special vertex and  $v$  one of its neighbors, we say that  $v$  is a *remaining neighbor* of  $u_i$  if the edge  $u_i v$  does not belong to  $S$ .



**Definition 4.1.1** ( $C_{4+}^*$ -subdivision). Let  $G$  be a planar graph with a  $C_{4+}$ -subdivision  $S$  rooted on  $U$ .

$S$  is a  $C_{4+}^*$  if its satisfies the following three conditions:

- Property “0-linked”: Two 0-linked special vertices have no common remaining neighbor;
- Property “1-linked”: No internal vertex of a solo  $(u_i, u_j)$ -path of  $S$  is a remaining neighbor of some  $u_k \in U \setminus \{u_i, u_j\}$ ;
- Property “2-linked”: If  $u_i, u_j \in U$  are 2-linked, then  $u_i, u_j$  have at most one common remaining neighbor, and it belongs to a parallel path of  $S$  that is not incident with  $u_i, u_j$ .

We say that  $S$  is a  $\mathcal{K}$ -subdivision if it is a  $K_4$ -subdivision or a  $C_{4+}^*$ -subdivision. In the next lemma, we show how we find such a subdivision in a planar graph  $G$  with a  $(C_{II})$  configuration  $U$ .

In order to reduce the number of cases in the rest of the proof, we want to guarantee the additional property of chordlessness of the subdivision.

**Lemma 4.1.2.** Let  $H$  be a planar graph that is almost 4-connected w.r.t. a 4-family  $U = \{u_1, u_2, u_3, u_4\}$ . Then  $H$  contains a chordless  $K_4$ - or  $C_{4+}^*$ -subdivision rooted on  $U$ .

In order to prove this lemma, we use a result by Yu [82], which deals with graphs with two types of structure constraints. Let us introduce them, as  $N_1$ -graphs and  $N_2$ -graphs. The following definitions are taken straight from the beginning of Section 4 of [82], as the two *obstructions*, pictured in Figure 7 of [82] on page 36.

An  $N_1$ -graph (Figure 4.4) is a planar graph  $H$  that has a 4-family  $U = \{u_1, u_2, u_3, u_4\}$  and a facial cycle  $C$  (that we assume is the outer cycle), such that for each  $i \in \{1, 2, 3, 4\}$  either  $u_i \in C$  or  $H$  has a 4-cut  $X_i$  separating  $u_i$  from  $U \setminus \{u_i\}$  (so  $u_j \notin X_j$  for  $j \neq i$ ), and  $|X_i \cap C| = 2$ . Moreover, if  $H_i$  is the component of  $H \setminus X_i$  containing  $u_i$ , then the components  $H_i$  for  $i = 1..4$  are disjoint.

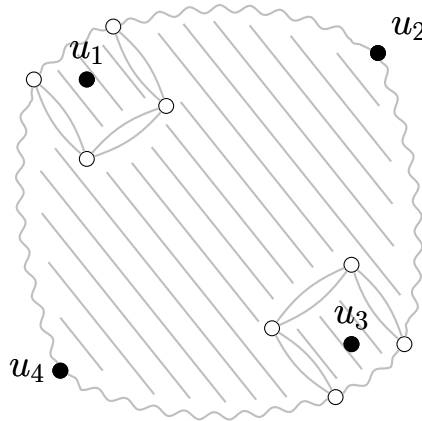

Figure 4.4: An  $N_1$ -graph, with  $u_2, u_4$  on the outer cycle, and  $u_1, u_3$  surrounded by 4-cuts

An  $N_2$ -graph (Figure 4.5) is a planar graph  $H$  with a 4-family  $U = \{u_1, u_2, u_3, u_4\}$  and distinct (but not necessarily disjoint) 4-cuts  $T_i$ ,  $i = 1..m$ . The 4-cuts are such that each  $T_i$  separates two vertices of  $U$ , say  $\{u_1, u_2\}$ , from  $T_{i+1} - T_i \neq \emptyset$ ;  $T_1 = \{a_1, a_2, a_3, a_4\}$ ,  $T_m = \{b_1, b_2, b_3, b_4\}$  and  $H$  contains 4 disjoint paths  $S_i$  from  $a_i$  to  $b_i$  for  $i = 1..4$  respectively. Additionally,  $H$  has no 4-cut  $T$  separating  $T_i \setminus T \neq \emptyset$  from  $T_{i+1} \setminus T \neq \emptyset$ , or separating  $\{u_1, u_2\}$  from  $T_1 \setminus T \neq \emptyset$ , or separating  $\{u_3, u_4\}$  from  $T_m \setminus T \neq \emptyset$ ; and either  $T_i \cap T_{i+1} \neq \emptyset$

or two vertices of  $T_i$  and two vertices of  $T_{i+1}$  are cofacial in  $H$ . Finally, the ten following paths exist and are internally disjoint: a  $(u_1, u_2)$ -path  $P_{12}$ , a  $(u_1, a_1)$ -path  $Q_1$ , a  $(u_1, a_2)$ -path  $Q_2$ , a  $(u_2, a_3)$ -path  $Q_3$ , a  $(u_2, a_4)$ -path  $Q_4$ , a  $(u_3, u_4)$ -path  $P_{34}$ , a  $(u_3, b_1)$ -path  $Q'_1$ , a  $(u_3, b_2)$ -path  $Q'_2$ , a  $(u_4, b_3)$ -path  $Q'_3$ , and a  $(u_4, b_4)$ -path  $Q'_4$ . This last property is not part of the exact definition from [82], but deduced from the first remark in Section 3 on page 20 of [82].

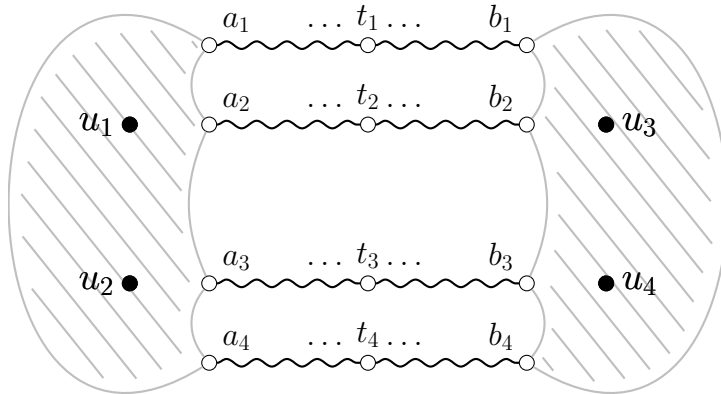

Figure 4.5: An  $N_2$ -graph, with three 4-cuts represented:  $\{a_1, a_2, a_3, a_4\}$ ,  $\{t_1, t_2, t_3, t_4\}$ ,  $\{b_1, b_2, b_3, b_4\}$

Let us restate Theorem 4.2 from [82] in the new formalism. The definitions in Yu's paper have stronger constraints and the theorem is an equivalence, but in the present paper we only need one implication. Our definitions of  $N_1$ -graph and  $N_2$ -graph are slightly simplified and the theorem is restated as an implication.

**Theorem 4.1.3** (Theorem 4.2 of [82]). *Let  $G$  be a 3-connected planar graph and  $U = \{u_1, u_2, u_3, u_4\} \subseteq V(G)$  be such that  $G$  has no 3-cut separating two vertices in  $U$ . Then  $G$  has a  $K_4$ -subdivision rooted on  $U$ , or  $G$  is an  $N_1$ -graph or an  $N_2$ -graph.*

We argue that Theorem 4.1.3 does not in fact require the 3-connectivity assumption.

**Theorem 4.1.4.** *Let  $G$  be a planar graph and  $U = \{u_1, u_2, u_3, u_4\} \subseteq V(G)$  be such that  $G$  has no 3-cut separating two vertices in  $U$ . Then  $G$  has a  $K_4$ -subdivision rooted on  $U$ , or  $G$  is an  $N_1$ -graph or an  $N_2$ -graph.*

*Proof of Theorem 4.1.4.* We proceed by induction on the size of  $G$ . Assume that  $G$  is not 3-connected. Then there is a cut  $X$  of size at most 2. We may assume that  $X$  is a minimal cut. We consider the connected components  $C_1, \dots, C_p$  of  $G \setminus X$ , and observe that all special vertices in  $U$  belong to the same one, say  $C_1$ . If  $|X| = 1$ , we consider  $G' = G \setminus \{C_2 \cup \dots \cup C_p\}$ . If  $|X| = 2$ , we consider  $G' = G \setminus \{C_2 \cup \dots \cup C_p\} + xy$ , where  $x$  and  $y$  are the two vertices in  $X$ . If  $xy \in E(G)$  then adding the edge  $xy$  does not create a double edge.

In both cases,  $G'$  has fewer vertices than  $G$ , and is almost 4-connected with respect to  $U$ . By Theorem 4.1.3,  $G'$  has a  $K_4$ -subdivision rooted on  $U$ , or  $G$  is an  $N_1$ -graph or an  $N_2$ -graph. Note that each of those three properties extend to all of  $G$  (up to modifying the embedding, in the case of an  $N_1$ -graph with  $|X| = 1$  so as to maintain that the cycle is facial).  $\square$

We can now tackle the proof of Lemma 4.1.2 (p. 75).

*Proof of Lemma 4.1.2.* First, let us define the operation that turns a subdivision into a chordless one. Given a  $K_4$ - or  $C_{4+}$ -subdivision  $S$  rooted on a 4-family  $U$ , we say that we *eliminate the chords* of  $S$  if we apply the following operation exhaustively: if a path  $P = (v_1, \dots, v_k)$  of  $S$  has a chord  $v_i v_j$ , we replace  $P$  in  $S$  with the path  $P' = (v_1, \dots, v_i, v_j, \dots, v_k)$ , except if  $v_i, v_j \in U$  and the edge  $v_i v_j$  already constitutes a path of  $S$ . Since each elimination decreases the number of edges in  $S$ , the process terminates, and the obtained subdivision  $S'$  is well-defined and chordless. Since the vertices of  $S'$  are a subset of the vertices of  $S$  and the ends of the paths are preserved,  $S'$  has the same type ( $K_4$  or  $C_{4+}$ ) as  $S$ .

If  $G$  has a  $K_4$ -subdivision, eliminating its chords gives us the result. Using Theorem 4.1.4 (p. 76), it now suffices to show that any  $N_1$ -graph and any  $N_2$ -graph contain a chordless  $C_{4+}^*$ -subdivision to prove our lemma.

Let us first take care of the case where  $H$  is an  $N_2$ -graph, defined as in the definition above. Let  $S$  be the union of the paths  $P_{12}, Q_1, Q_2, Q_3, Q_4, P_{34}, Q'_1, Q'_2, Q'_3, Q'_4, S_1, S_2, S_3, S_4$ .  $S$  is a  $C_{4+}$ -subdivision rooted on  $U$ , so let  $S'$  be the chordless  $C_{4+}$ -subdivision obtained by eliminating the chords of  $S$ . Let us prove that  $S'$  is a  $C_{4+}^*$ -subdivision.

By definition, the 4-cut  $T_1$  is a subset of  $V(S)$ , and we show that  $T_1 \subseteq V(S')$ . Let us assume for contradiction that there is a vertex  $t \in T_1$  which belongs to a path  $P$  of  $S$  on which a chord elimination was performed: there are two vertices  $v, v'$  on  $P$ , such that the edge  $vv' \in E(H)$  is not in  $P$  and  $t$  is on the  $(v, v')$ -section  $P'$  of  $P$ . But then the path  $(P \setminus P') \cup \{vv'\}$  is a path between two 1-linked special vertices in  $H \setminus T_1$ , which is a contradiction; so  $T_1 \subseteq V(S')$ .

Assume for contradiction that two 0-linked special vertices  $u_i, u_j$  have a common remaining neighbor  $v$  w.r.t.  $S'$ . If  $v$  belongs to  $V(S')$ , then the edge  $u_i v$  or  $u_j v$  forms a chord of  $S'$  since all paths of  $S'$  are incident with  $u_i$  or  $u_j$ . It is a contradiction, so  $v$  does not belong to  $V(S')$ . However, since  $u_i$  and  $u_j$  are 0-linked, they are separated by the 4-cut  $T_1$ , and so  $v$  is a vertex of  $T_1$ , hence in  $S$ . This is a contradiction, which gives us the property “0-linked” of  $S'$ .

To obtain property “1-linked”, observe that no internal vertex of a solo  $(u_i, u_j)$ -path is a remaining neighbor of a  $u_k \in U \setminus \{u_i, u_j\}$ , since this would create a path between 0-linked special vertices that would be disjoint from the 4-cut  $T_1$ , a contradiction.

Let us now prove the property “2-linked”. By definition of the cut  $T_1$ , the common remaining neighbors of two 2-linked special vertices  $u_i, u_j$  belong to parallel paths of  $S'$ . If a common remaining neighbor  $v$  of  $u_i, u_j$  belongs to a  $(u_i, u_j)$ -path of  $S'$ , the two edges  $u_i v, u_j v$  form chords in  $S'$ , a contradiction, so the common remaining neighbors of  $u_i, u_j$  belong to parallel  $(u_k, u_l)$ -paths that are not incident with  $u_i, u_j$ . If  $u_1, u_3$  (2-linked) have two common remaining neighbors  $v, v'$ , they belong to different parallel  $(u_2, u_4)$ -paths by planarity (otherwise  $\{u_1, u_4, v\}$  and  $\{u_2, u_3, v'\}$  form a  $K_{3,3}$ -minor in  $H$  if  $v, v'$  belong to a path  $P = (u_2, \dots, v, \dots, v', \dots, u_4)$ ). Then we claim that  $\{u_1, v, v'\}$  is a 3-cut of  $H$  that separates  $u_2$  from  $u_3$ . If not, there is a  $(u_2, u_3)$ -path  $P_{23}$  in  $H$  that is vertex-disjoint from  $u_1, v, v'$ , and by definition of  $T_1$ ,  $P_{23}$  contains a vertex  $t \in T_1$  that is on a  $(u_1, u_3)$ -path of  $S'$ , and the  $(u_2, t)$ -section of  $P_{23}$  does not contain  $u_4$ . Then  $\{u_1, u_2, v, t, u_4 = v'\}$  induce a  $K_5$ -minor in  $H$  by contracting the  $(u_4, v')$ -path of  $S'$  into a vertex. Hence  $\{u_1, v, v'\}$  is a 3-cut of  $H$  that separates  $u_2$  from  $u_3$ , which is a contradiction with the almost 4-connectivity of  $H$  w.r.t.  $U$ . Property “2-linked” follows.

Now let us consider the case where  $H$  is an  $N_1$ -graph with outer cycle  $C$ . We build a  $C_{4+}$ -subdivision  $S$  rooted on  $U$  as follows. First, for each  $u_i \notin C$ , we find four internally-disjoint paths  $p_1^i, p_2^i, p_3^i, p_4^i$  from  $u_i$  to the four vertices of its associated 4-cut  $X_i$ . Such paths exist since there is no 3-cut separating  $u_i$  from  $U \setminus \{u_i\}$  in  $H$ . We assume  $p_1^i$  and  $p_2^i$  each have an end on the outer cycle  $C$ . We add  $(E(C) \setminus \bigcup_{u_i \notin C} E(H_i)) \cup \bigcup_{u_i \notin C} (E(p_1^i) \cup E(p_2^i))$  to  $S$ , where  $H_i$  is the component of  $H \setminus X_i$  containing  $u_i$ . To obtain the two remaining paths of  $S$ , we consider the graph  $H'$  formed by removing  $(V(C) \cup \bigcup_{u_i \notin C} V(H_i)) \setminus U$  from  $H$ , and add back  $p_3^i$  and  $p_4^i$  to  $H'$ . We look at the outer face of  $H'$ . Let  $P_{13}$  be the outer  $(u_1, u_3)$ -path and  $P_{24}$  the outer  $(u_2, u_4)$ -path of  $H'$ . We claim that these paths are vertex-disjoint. To see it, observe that in  $H$  there are at least 4 internally-disjoint paths from  $u_1$  to  $u_3$ . At least two of them are disjoint from  $C$ , hence belong to  $H'$ . Therefore,  $H'$  cannot contain a 1-cut separating  $\{u_1, u_2\}$  from  $\{u_3, u_4\}$ . Therefore, let us add  $P_{13}$  and  $P_{24}$  to  $S$  to form our  $C_{4+}$ -subdivision  $S$ .

Let  $S'$  be the chordless  $C_{4+}$ -subdivision obtained by eliminating the chords of  $S$ . Let us now prove that  $S'$  is a  $C_{4+}^*$ -subdivision.

We first check property “1-linked”. Let  $u_i, u_j$  be 1-linked special vertices with a path  $P_{ij}$  of  $S'$ , and  $u_k \in U \setminus \{u_i, u_j\}$ . If there is an internal vertex  $v$  of  $P_{ij}$  that is a remaining neighbor of  $u_k$ , then  $\{u_k, v\}$  is a 2-cut of  $H$  if  $u_k$  is on  $C$ , otherwise there is a vertex  $x$  in the 4-cut  $X_k$  of  $u_k$  such that  $\{x, v\}$  is a 2-cut of  $H$ , contradicting its 3-connectivity.

To check properties “0-linked” and “2-linked”, we show that there is no remaining neighbor in common between  $u_1$  and  $\{u_3, u_4\}$  (respectively 2-linked and 0-linked to  $u_1$ ), because of the properties of almost 4-connectivity of  $H$ . Each special vertex  $u_i$  either belongs to  $C$  or there is a 4-cut  $X_i = \{x_1, x_2, x_3, x_4\}$  separating  $H$  into a component  $H_i$  containing  $u_i$  and a  $H \setminus (X_i \cup H_i)$  containing  $U \setminus \{u_i\}$ . If  $u_1, u_k, k \in \{3, 4\}$ , belong to  $C$  and share a remaining neighbor  $v$ , then  $\{u_1, u_k, v\}$  is a 3-cut that separates two neighbors of  $u_1$  (if  $k = 3$ ) or separates  $u_2$  from  $u_3$  (if  $k = 4$ ). If  $u_1$  belongs to  $C$  and  $u_k$  has a 4-cut  $X_k$ , then their common remaining neighbor is the only vertex  $x \in X_k$  that does not belong to  $S'$ . Then there is a vertex  $x' \in X_k \cap C$ , such that  $\{u_1, x, x'\}$  is a 3-cut that separates  $u_2$  from  $u_3$  (whether  $k = 3$  or 4). If both  $u_1, u_k$  have 4-cuts  $X_1, X_k$ , then their common remaining neighbor is again the only  $x \in X_1 \cap X_k$  that does not belong to  $S'$ , and there are  $x'_1 \in X_1 \cap C$  and  $x'_k \in X_k \cap C$  such that  $\{x'_1, x'_k, x\}$  is a 3-cut that separates  $u_2$  from  $u_3$ .

In all cases, we obtain a contradiction with the almost 4-connectivity of  $H$ . Properties “0-linked” and “2-linked” follow, which completes the proof.  $\square$

## 4.2 Patterns

Although almost all the subdivisions that we consider throughout the paper are regular  $K_4$ -subdivisions or  $C_{4+}$ -subdivisions, we introduce another type of subdivision that relaxes some of the properties of subdivisions, and that are convenient to use in some cases.

**Definition 4.2.1** (Semi-subdivision). *A semi-subdivision  $S$  in a graph  $G$  is a  $K_4$ -subdivision or a  $C_{4+}$ -subdivision rooted on a 4-family  $U$ , in which we lift the constraint that the paths of  $S$  must be internally disjoint, and such that there is at most one pair of paths  $u_1 \sim u_2, u_3 \sim u_4$  of  $S$  between two disjoint sets of special vertices, that share exactly one internal vertex; the other paths are internally disjoint.*

To summarize, we sometimes allow a contact between two paths of a subdivision, if

it makes it easier to find a solution to some cases of the proof. Observe that a semi-subdivision is always 2-colorable, as there is a 2-coloring of any  $K_4$ - or  $C_{4+}$ -subdivision that gives different colors to any pair of paths.

Our overall goal is to find an individual reduction rule for each of the four special vertices, and combine them into a general rule for the whole configuration. We define these rules by extending the formalism of Chapter 3.

A *subdivision partial configuration* (or **pattern**)  $\mathcal{C}_i$  is a configuration defined over the neighborhood of one special vertex  $u_j$  or two special vertices  $u_j, u_l$ , with three identified incident edges per special vertex, called *subdivision edges*. We denote it  $\mathcal{C}_i(u_j)$  if it involves one special vertex, and  $\mathcal{C}_i(u_j, u_k)$  otherwise.

Observe that an elementary partial configuration can be turned into a subdivision partial configuration by adding two subdivision edges. The subdivision partial configuration ( $\mathcal{C}_U$ ) defined below is an example of partial configuration that involves two special vertices.

We say that a set of patterns  $\mathcal{M} = \{\mathcal{C}_1, \dots, \mathcal{C}_k\}$ ,  $k \in \{2, 3, 4\}$ , is a *mapping* of a 4-family  $U$ , w.r.t. a semi-subdivision  $S$  rooted on  $U$ , if in this semi-subdivision there is a bijection between the special vertices of  $\mathcal{C}_1, \dots, \mathcal{C}_k$  and the special vertices of  $U$ ; i.e. each special vertex  $u$  of  $\mathcal{C}_1, \dots, \mathcal{C}_k$  can be associated with a special vertex  $u' \in U$ , and the neighborhoods of  $u$  and  $u'$  are isomorphic. If  $u' \in U$  is associated to the special vertex  $u$  of a pattern  $\mathcal{C}_i$ , we say that  $u'$  *forms* a pattern  $\mathcal{C}_i$  w.r.t.  $S$ .

Given a mapping  $\mathcal{M} = \{\mathcal{C}_1, \dots, \mathcal{C}_k\}$  and  $\mathcal{C}_i \in \mathcal{M}$ , we denote  $V(\mathcal{C}_i)$  the set containing the special vertices associated with  $\mathcal{C}_i$  in  $\mathcal{M}$  and their remaining neighbors. We say that a pattern  $\mathcal{C}_i$  *touches* another pattern  $\mathcal{C}_j$  if  $V(\mathcal{C}_i) \cap V(\mathcal{C}_j) \neq \emptyset$ . We say that  $\mathcal{C}_i$  touches  $S$  if at least one non-special vertex of  $V(\mathcal{C}_i)$  belongs to a path of  $S$ .

A *subdivision composite configuration*  $(\mathcal{M}, S)$  is the following configuration: the graph contains a 4-family  $U$  and a semi-subdivision  $S$  rooted on  $U$ , while  $\mathcal{M}$  is a mapping of  $U$  w.r.t.  $S$ .

In the previous chapter, we defined elementary partial rules over elementary partial configurations. This definition can be directly extended to define *subdivision partial rules* over subdivision partial configurations, i.e. as a rule  $\mathcal{R}_i = (\mathcal{C}_i, f_i^r, f_i^c)$  associated with a pattern  $\mathcal{C}_i$ , a partial reduction function encoded by a set  $\mathcal{O}_i \subseteq \{\text{add}, \text{remove}\} \times E(\mathcal{C}_i)$  and the partial recoloring function  $f_i^c$ .



Let  $\mathcal{M} = \{\mathcal{C}_1, \dots, \mathcal{C}_k\}$ ,  $k \in \{2, 3, 4\}$ , be a mapping of a 4-family  $U = \{u_1, u_2, u_3, u_4\}$ , w.r.t. a semi-subdivision  $S$  rooted on  $U$ . For each  $i \in \{1, \dots, k\}$ , let  $\mathcal{R}_i = (\mathcal{C}_i, f_i^r, f_i^c)$  be a subdivision partial rule associated with the pattern  $\mathcal{C}_i$ . Let  $c_S$  be a 2-coloring of  $S$ . The *subdivision composite rule*  $\mathcal{R}_c = (\mathcal{C}_c, f_c^r, f_c^c)$ , denoted by  $(\{\mathcal{R}_1, \dots, \mathcal{R}_k\}, S, c_S)$ , is the reduction rule associated with the subdivision composite configuration  $\mathcal{C}_c = (\mathcal{M}, S)$  and is defined as follows. The reduction function  $f_c^r$  is defined by  $f_c^r(G) = (f_1^r \circ \dots \circ f_k^r(G)) \setminus (U \cup E(S))$ , i.e. the successive application of the operations in  $\mathcal{O}_i$  in reverse order and the removal of the special vertices  $U$  and the edges of the semi-subdivision  $S$ , to form the reduced graph  $G'$ .

In order to provide a semantics of  $f_c^c$ , we define the *intermediate graphs*  $G_{\text{int}}^i = f_{i+1}^r \circ \dots \circ f_k^r(G)$ , for  $0 \leq i \leq k$ . We use these graphs to define a sequence of colorings  $c_{\text{int}}^i$  that lead to a coloring  $c$  of  $G$ . Let  $pc$  be a coloring of  $G'$ . Let  $c_{\text{int}}^0 = pc \cup c_S$  be a coloring of  $G_{\text{int}}^0 = G' \cup (U \cup E(S))$ . We define  $c_{\text{int}}^i = f_i^c(G_{\text{int}}^i, c_{\text{int}}^{i-1})$  for  $i = 1..k$ . We finally define  $f_c^c(G, pc, c_S) = c_{\text{int}}^k$  for any planar graph  $G$ , coloring  $pc$  of  $f_c^r(G)$  and good coloring  $c_S$  of  $S$ . In other words, the semi-subdivision  $S$  is added to  $G'$  and colored with  $c_S$ , then for each pattern  $\mathcal{C}_i$  considered in ascending order, the reduction of  $\mathcal{C}_i$  is undone and the

edges in the neighborhood of  $\mathcal{C}_i$  are colored according to the partial recoloring function  $f_i^c$ . This definition is motivated by the fact that whenever  $pc$  is a good coloring of the reduced graph  $G'$ , and the partial rules  $\mathcal{R}_i$  are valid and do not interfere with each other, each intermediate coloring  $c_{\text{int}}^i$  is a good coloring of the intermediate graph  $G_{\text{int}}^i$ , which allows to build step by step a good coloring of  $G$ .

The 2-coloring  $c_S$  of  $S$  is specified only when necessary.

In the figures, the two paths  $P_1, P_2$  induced by the 2-coloring of  $S$  are represented in red and blue. The purple color is used to color the whole subdivision when its 2-coloring is not specified. An edge represented in black does not belong to the subdivision. A red vertex ( $\ominus$ ) (resp. blue  $\oplus$ ) represents a vertex that may be touched by a red (resp. blue) subdivision path. A purple vertex ( $\oplus$ ) may be touched by either a red or a blue subdivision path. When a path of the subdivision ends on a special vertex, it is represented by this

symbol  if it is the red path, and by this symbol  if it is the blue path. When the color is not specified, we represent the special vertex with three incoming purple edges .

Let us now introduce the patterns we use in the rest of the proof. For each pattern, we describe the associated partial configuration, as well as the conditions on the colors of a 2-coloring of the associated subdivision  $S$ . We then provide a definition of the partial reduction and recoloring functions. The patterns  $(\mathcal{C}_V)$ ,  $(\mathcal{C}_{Ne})$ ,  $(\mathcal{C}_{No})$  are taken from Chapter 3 and their definitions are omitted.

### List of the patterns:

The following patterns involve one special vertex.

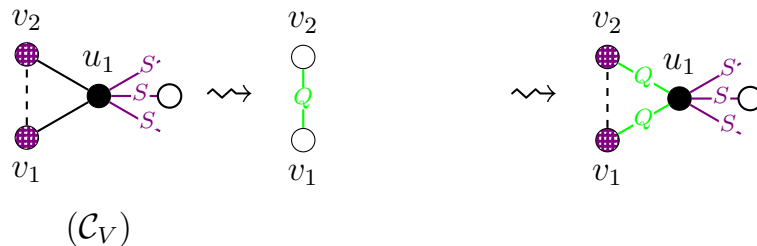

- $(\mathcal{C}_V)$ : Identical to the elementary partial configuration  $(\mathcal{C}_V)$  from Section ??.

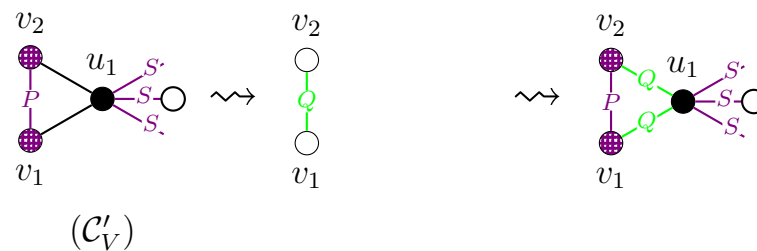

- $(\mathcal{C}'_V)$ : The special vertex  $u_1$  has two adjacent remaining neighbors  $v_1, v_2$ , and the edge  $v_1v_2$  belongs to  $S$ .

**Reduction:** In the reduced graph, we add the edge  $v_1v_2$ .

**Recoloring:** In  $G$ , we deviate the color of  $v_1v_2$  on  $u_1$ . The color of  $v_1v_2$  in the recoloring of  $G$  is given by the subdivision.

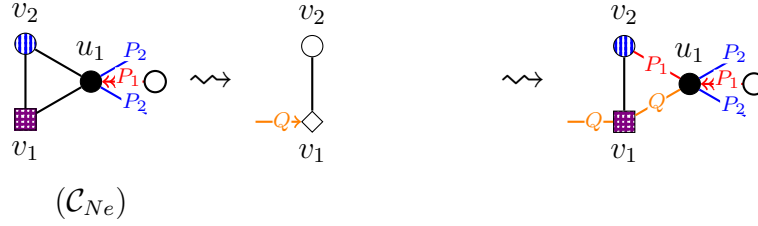

- (C<sub>Ne</sub>): Identical to the elementary partial configuration (C<sub>Ne</sub>) from Section ??.  
**Color requirements:** If the remaining neighbor  $v_1$  is even, then the other remaining neighbor  $v_2$  of  $u_1$  cannot touch the color of  $S$  that ends on  $u_1$ .

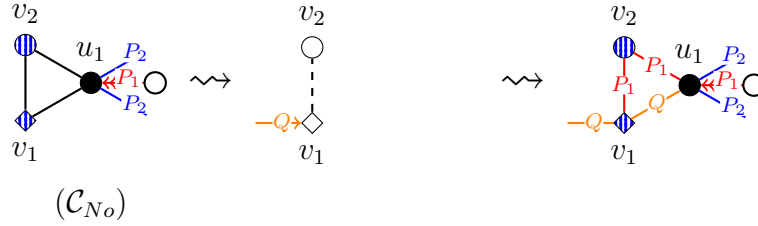

- (C<sub>No</sub>): Identical to the elementary partial configuration (C<sub>No</sub>) from Section ??.  
**Color requirements:** None of the remaining neighbors  $v_1, v_2$  of  $u_1$  can touch the color of  $S$  that ends on  $u_1$ .

The following patterns involve two special vertices.

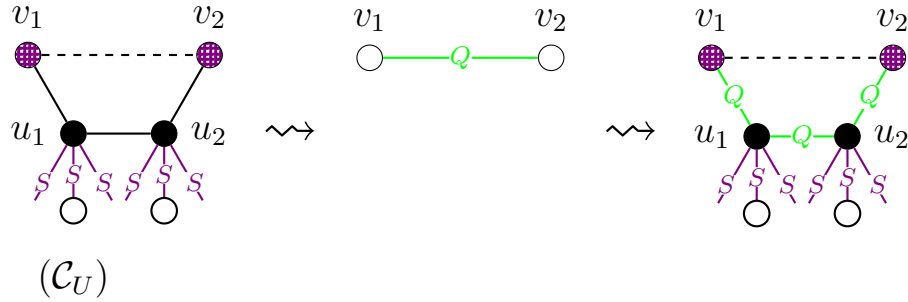

- (C<sub>U</sub>): The two special vertices  $u_1, u_2$  are adjacent but the edge  $u_1u_2$  does not belong to  $S$ . Let  $v_1$  (resp.  $v_2$ ) be the remaining neighbor of  $u_1$  (resp.  $u_2$ ) distinct from  $u_2$  (resp.  $u_1$ ). The vertices  $v_1, v_2$  are distinct, non-adjacent and disjoint from  $U$ .  
**Reduction:** In the reduced graph, we add the edge  $v_1v_2$ .  
**Recoloring:** In  $G$ , we deviate the color of  $v_1v_2$  on  $u_1, u_2$ .

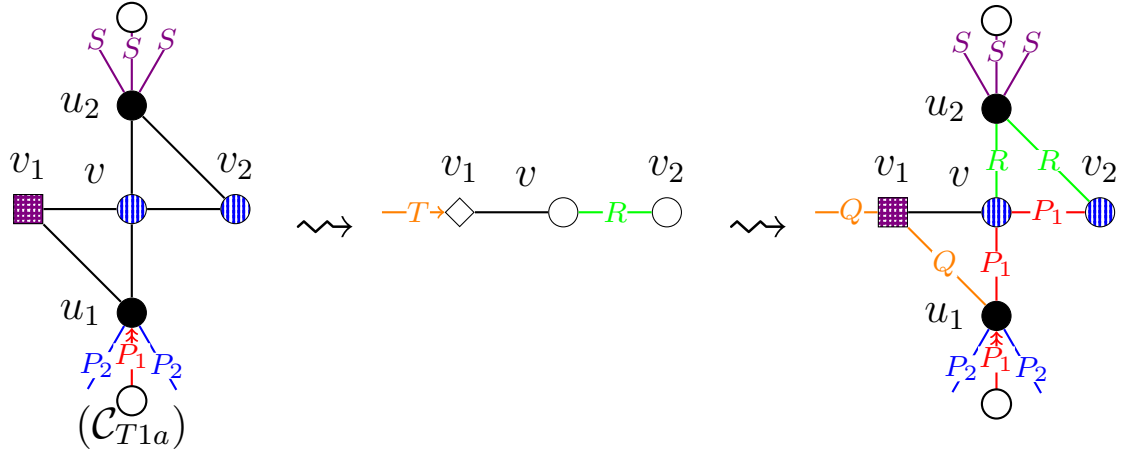

- $(\mathcal{C}_{T1a})$ : The two special vertices  $u_1, u_2$  have one remaining neighbor  $v$  in common. We denote  $v_1, v_2$  the other remaining neighbor of  $u_1, u_2$  respectively. Both  $v_1$  and  $v_2$  are adjacent to  $v$ . The vertices  $v, v_1, v_2$  are disjoint from  $U$ . The vertex  $v_1$  has an even degree.

**Color requirements:** The vertices  $v, v_2$  cannot touch the color of  $S$  that ends on  $u_1$ .

**Reduction:** In the reduced graph,  $v_1$  has an odd degree: let  $Q$  be a path of the coloring of  $G'$  that ends on  $v_1$ .

**Recoloring:** In  $G$ , we deviate the color of  $vv_2$  on  $u_2$ , we extend the path  $Q$  on the edge  $v_1u_1$ , and we extend the extra color that ends on  $u_1$  on the edges  $u_1v$  and  $vv_2$ .

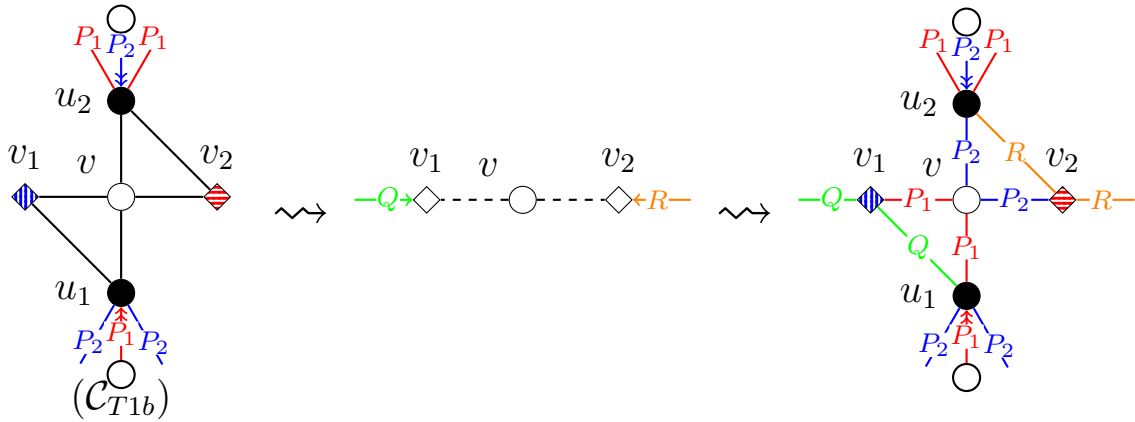

- $(\mathcal{C}_{T1b})$ : The two special vertices  $u_1, u_2$  have one remaining neighbor  $v$  in common. We denote  $v_1, v_2$  the other remaining neighbor of  $u_1, u_2$  respectively. Both  $v_1$  and  $v_2$  are adjacent to  $v$ . The vertices  $v, v_1, v_2$  are disjoint from  $U$ . The vertices  $v_1, v_2$  both have an odd degree in  $G$ .

**Color requirements:** The colors ending on  $u_1, u_2$  in a 2-coloring of  $S$  must be different. The vertex  $v_1$  (resp.  $v_2$ ) cannot touch the color that ends on  $u_1$  (resp.  $u_2$ ).

**Reduction:** In the reduced graph, we remove the edges  $vv_1$  and  $vv_2$ . The vertices  $v_1, v_2$  keep an odd degree in  $G'$ : let  $Q, R$  be paths of the coloring of  $G'$  that end on  $v_1, v_2$  respectively.

**Recoloring:** In  $G$ , we extend the paths  $Q, R$  on the edges  $v_1u_1$  and  $v_2, u_2$  respectively. We extend the extra color ending on  $u_1$  on the edges  $u_1v$  and  $vv_1$ , and we extend the extra color ending on  $u_2$  on the edges  $u_2v$  and  $vv_2$ .



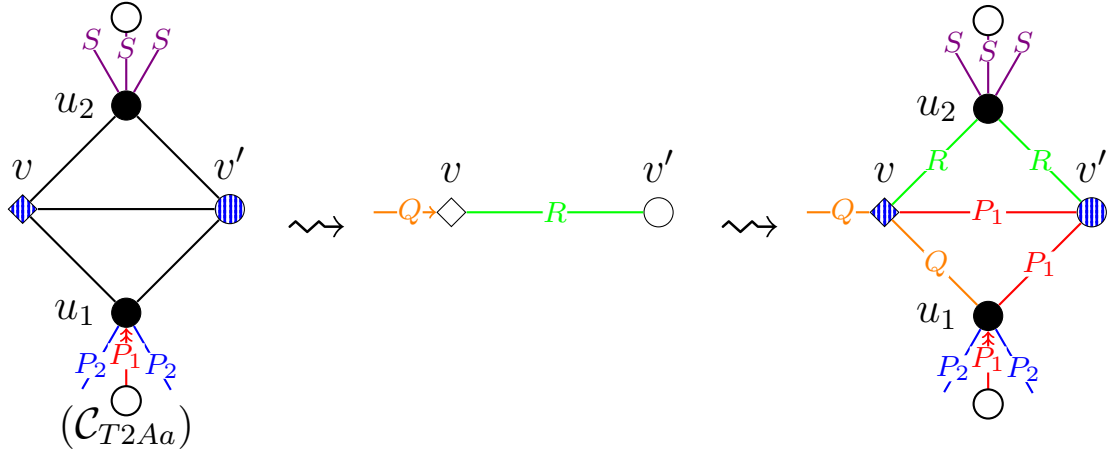

- $(\mathcal{C}_{T2Aa})$ : The two special vertices  $u_1, u_2$  have both their remaining neighbors  $v, v'$  in common, which are adjacent and disjoint from  $U$ . The vertex  $v$  has an odd degree in  $G$ .

**Color requirements:** There is a color of  $S$  ending on  $u_1$  or  $u_2$  (let us say  $u_1$ ) that does not touch  $v$  nor  $v'$ .

**Reduction:** In the reduced graph,  $v$  keeps an odd degree: let  $Q$  be a path of the coloring of  $G'$  that ends on  $v$ .

**Recoloring:** In  $G$ , we extend the path  $Q$  on the edge  $vu_1$ , we deviate the color of  $vv'$  on  $u_2$ , and we extend the extra color ending on  $u_1$  on the edges  $u_1v'$  and  $v'v$ .

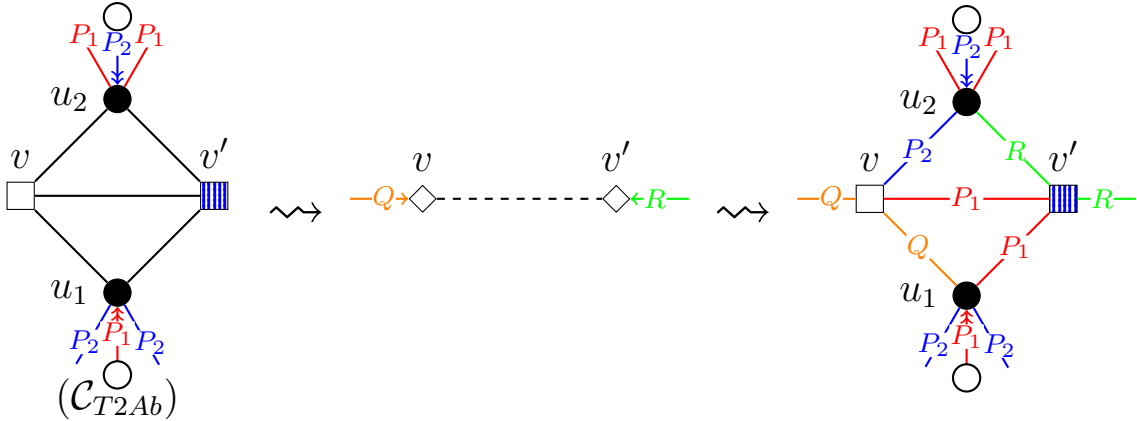

- $(\mathcal{C}_{T2Ab})$ : The two special vertices  $u_1, u_2$  have both their remaining neighbors  $v, v'$  in common, which are adjacent and disjoint from  $U$ . Both  $v$  and  $v'$  have an even degree in  $G$ .

**Color requirements:** The colors of  $S$  that end on  $u_1$  and  $u_2$  must be different. At least one of  $v, v'$  (let us say  $v'$ ) does not touch at least one of the two colors of  $S$  (let us say the one ending on  $u_1$ ).

**Reduction:** In the reduced graph, we remove the edge  $vv'$ . The vertices  $v, v'$  have an odd degree in  $G'$ : let  $T, R$  be paths of the coloring of  $G'$  that end on  $v, v'$  respectively.

**Recoloring:** In  $G$ , we extend the paths  $T, R$  on the edges  $vu_1$  and  $v'u_2$  respectively. We extend the extra color ending on  $u_1$  on the edges  $u_1v'$  and  $v'v$ , and we extend the extra color ending on  $u_2$  on the edge  $u_2v$ .

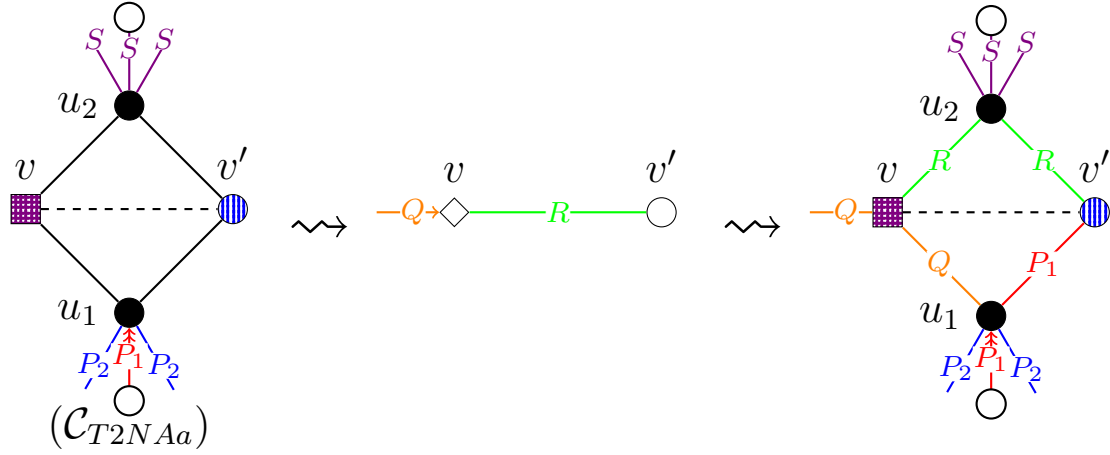

- $(\mathcal{C}_{T2NAa})$ : The two special vertices  $u_1, u_2$  have both their remaining neighbors  $v, v'$  in common, which are not adjacent and are disjoint from  $U$ . The vertex  $v$  has an even degree in the  $G$ .

**Color requirements:** One of  $v, v'$  (let us say  $v'$ ) does not touch a color of  $S$  that ends on  $u_1$  or  $u_2$  (let us say  $u_1$ ).

**Reduction:** In the reduced graph, we add the edge  $vv'$ . The vertex  $v$  has an odd degree in  $G'$ : let  $Q$  be a path of the coloring of  $G'$  that ends on  $v$ .

**Recoloring:** In  $G$ , we extend the path  $Q$  on the edge  $vu_1$ , we deviate the color of  $vv'$  on  $u_2$ , and we extend the extra color ending on  $u_1$  on the edge  $u_1v'$ .

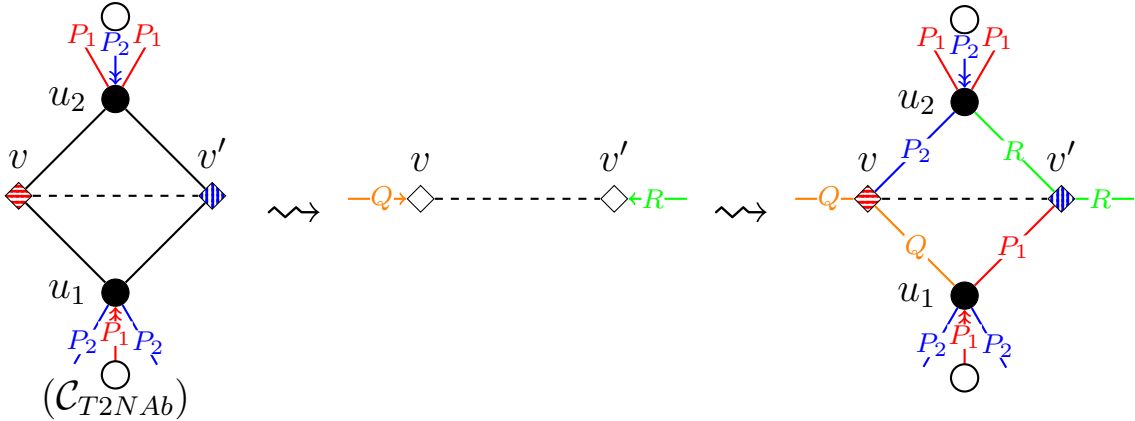

- $(\mathcal{C}_{T2NAb})$ : The two special vertices  $u_1, u_2$  have both their remaining neighbors  $v, v'$  in common, which are not adjacent and are disjoint from  $U$ . Both  $v$  and  $v'$  have an odd degree in  $G$ .

**Color requirements:** One of  $v, v'$  (let us say  $v'$ ) does not touch the color ending on  $u_1$ , the other ( $v$ ) does not touch the one ending on  $u_2$ .

**Reduction:** In the reduced graph,  $v, v'$  keep an odd degree: let  $T, R$  be paths of the coloring of  $G'$  that end on  $v, v'$  respectively.

**Recoloring:** In  $G$ , we extend the paths  $T, R$  on the edges  $vu_1$  and  $v'u_2$  respectively. We extend the extra colors ending on  $u_1, u_2$  on the edges  $u_1v'$  and  $u_2v$  respectively.

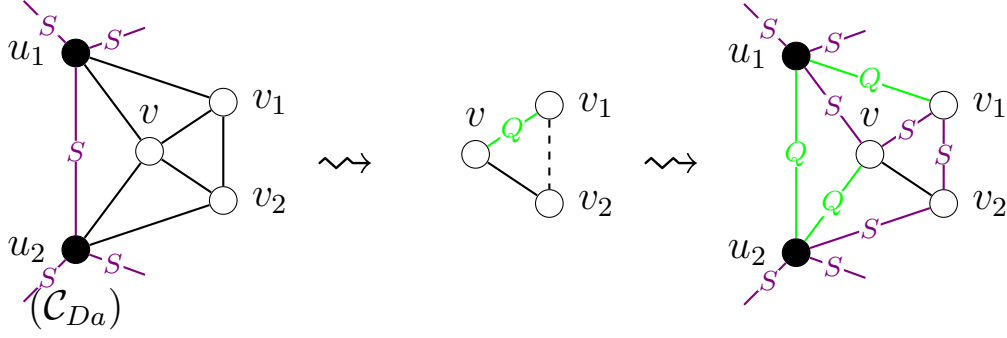

- $(\mathcal{C}_{Da})$ : The two special vertices  $u_1, u_2$  are adjacent and the edge  $u_1, u_2$  belongs to  $S$ . The special vertices  $u_1, u_2$  have a common remaining neighbor  $v$ , and  $u_1, u_2$  have  $v_1, v_2$  respectively as their other remaining neighbor. The vertices  $v_1, v_2$  are adjacent and both are adjacent to  $v$ . The vertices  $v, v_1, v_2$  are disjoint from  $S$ .

**Reduction:** In the reduced graph, we remove the edge  $v_1v_2$ .

**Recoloring:** In  $G$ , we deviate the color of  $vv_1$  on the edges  $vu_2, u_2u_1$  and  $u_1v_1$ . We redirect the path  $u_1 \sim u_2$  of  $S$  to make it go through the edges  $u_1v, vv_1, v_1v_2$  and  $v_2u_2$ .

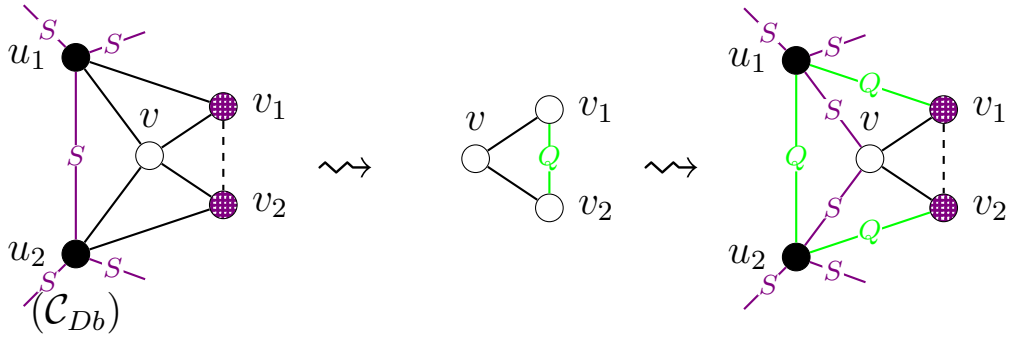

- $(\mathcal{C}_{Db})$ : The two special vertices  $u_1, u_2$  are adjacent and the edge  $u_1, u_2$  belongs to  $S$ . The special vertices  $u_1, u_2$  have a common remaining neighbor  $v$ , and  $u_1, u_2$  have  $v_1, v_2$  respectively as their other remaining neighbor. The vertices  $v_1, v_2$  are not adjacent and both are adjacent to  $v$ . The vertex  $v$  does not belong to  $S$ .

**Reduction:** In the reduced graph, we add the edge  $v_1v_2$ .

**Recoloring:** In  $G$ , we deviate the color of  $v_1v_2$  on the edges  $v_1u_1, u_1u_2$  and  $u_2v_2$ . We redirect the path  $u_1 \sim u_2$  of  $S$  to make it go through the edges  $u_1v$  and  $vv_2$ .

For convenience, we define some aliases which group several patterns together.

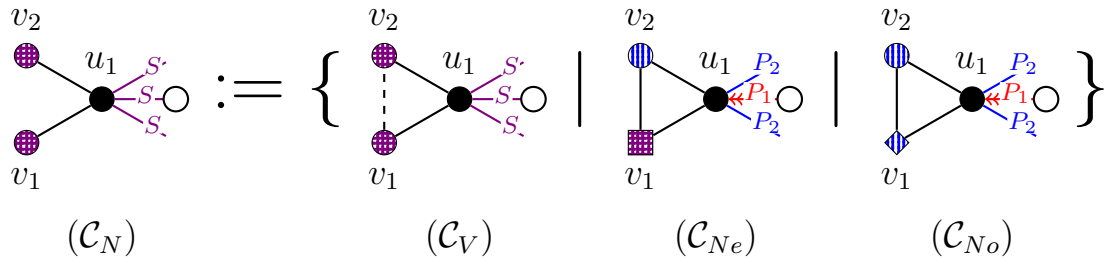

- $(\mathcal{C}_N)$ : The special vertex  $u_1$  has 2 remaining neighbors  $v_1, v_2$ . If  $v_1, v_2$  are non-adjacent, this is configuration  $(\mathcal{C}_V)$ . Otherwise, if one of  $v_1, v_2$  has an even degree in  $G$ , this is configuration  $(\mathcal{C}_{Ne})$ , and if both have an odd degree in  $G$ , this is configuration  $(\mathcal{C}_{No})$ .

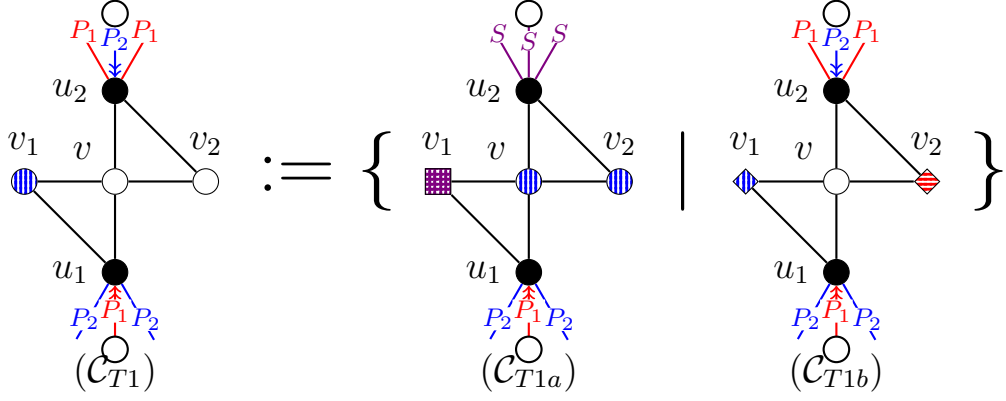

- $(\mathcal{C}_{T1})$ : The two special vertices  $u_1, u_2$  have one remaining neighbor  $v$  in common. We denote  $v_1, v_2$  the other remaining neighbor of  $u_1, u_2$  respectively. Both  $v_1$  and  $v_2$  are adjacent to  $v$ . The vertices  $v, v_1, v_2$  and  $U$  are disjoint.

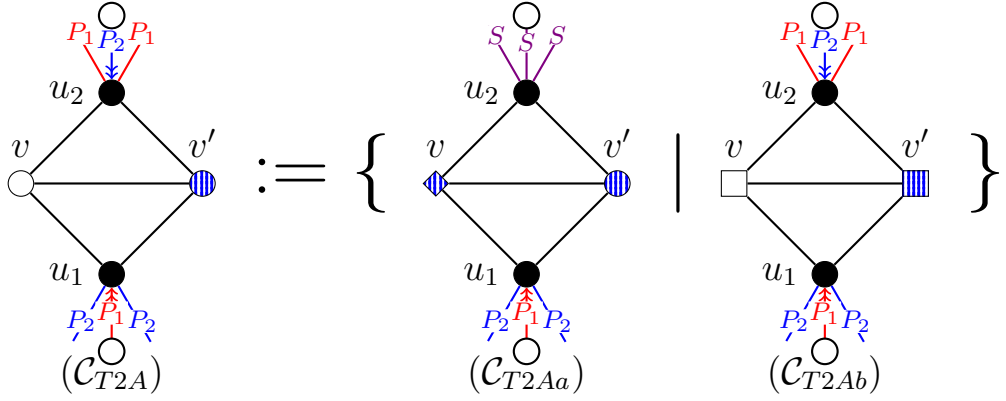

- $(\mathcal{C}_{T2A})$ : The two special vertices  $u_1, u_2$  have both their remaining neighbors  $v, v'$  in common, which are adjacent and disjoint from  $U$ .

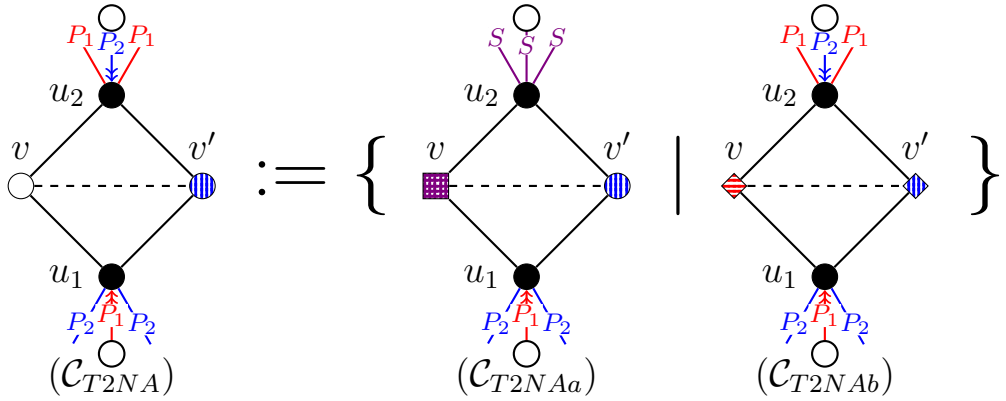

- $(\mathcal{C}_{T2NA})$ : The two special vertices  $u_1, u_2$  have both their remaining neighbors  $v, v'$  in common, which are not adjacent and are disjoint from  $U$ .

From now on, when we talk about patterns, we refer exclusively to patterns from this list.

Obviously the partial rules associated with the patterns of the considered mapping may conflict with each other. We now address the conditions of compatibility between patterns.

**Definition 4.2.2** (Compatible patterns). *Let  $G$  be a planar graph with a semi-subdivision  $S$  rooted on a 4-family  $U$ .*

*Let  $\mathcal{C}_i, \mathcal{C}_j$  be two patterns on  $U$  w.r.t.  $S$ .  $\mathcal{C}_i, \mathcal{C}_j$  are compatible if:*

- $\mathcal{C}_i$  or  $\mathcal{C}_j$  is a  $\mathcal{C}_V, \mathcal{C}'_V$  or  $\mathcal{C}_U$ , and  $|V(\mathcal{C}_i) \cap V(\mathcal{C}_j)| \leq 1$ ; or
- $\mathcal{C}_i, \mathcal{C}_j$  are among  $\mathcal{C}_N, \mathcal{C}_{T1}, \mathcal{C}_{T2A}, \mathcal{C}_{T2NA}, \mathcal{C}_{Da}, \mathcal{C}_{Db}$ , and  $V(\mathcal{C}_i) \cap V(\mathcal{C}_j) = \emptyset$ .

*Let  $\mathcal{M} = \{\mathcal{C}_1, \dots, \mathcal{C}_k\}$  be a mapping of  $U$  w.r.t. a semi-subdivision  $S$ , with  $2 \leq k \leq 4$ . We say that  $\mathcal{M}$  is a compatible mapping w.r.t.  $S$  if it satisfies the following two conditions:*

- *The  $\mathcal{C}_i$  patterns in  $\mathcal{M}$  are pairwise compatible;*
- *There exists a 2-coloring  $c_S$  of  $S$  that fits the color requirements in the definition of each  $\mathcal{C}_i \in \mathcal{M}$ .*

We justify this notion of compatible patterns and compatible mapping with the following claim.

**Claim 4.2.3.** *Let  $G$  be a planar graph with a  $(C_{II})$  configuration w.r.t. a 4-family  $U$ . Let  $\mathcal{M} = \{\mathcal{C}_1, \dots, \mathcal{C}_k\}$  be a mapping of  $U$  w.r.t. a semi-subdivision  $S$ , with  $2 \leq k \leq 4$ , and let  $\mathcal{R}_i$  be a subdivision partial rule associated with  $\mathcal{C}_i$  for  $i \in \{1, \dots, k\}$ .*

*If  $\mathcal{M}$  is a compatible mapping w.r.t.  $S$ , then the 2-coloring  $c_S$  of  $S$  associated with  $\mathcal{M}$  is such that the subdivision composite rule  $(\{\mathcal{R}_1, \dots, \mathcal{R}_k\}, S, c_S)$  associated with  $(\mathcal{M}, S)$  is valid.*

*Proof.* Each pattern  $\mathcal{C}_i \in \{\mathcal{C}_V, \mathcal{C}'_V, \mathcal{C}_U\}$  has a deviated edge,  $v_1v_2$  in the previous definitions. Since  $\mathcal{C}_i$  is compatible with all other patterns, it shares at most one vertex with each of them, thus the edge  $v_1v_2$  cannot be used as a deviated edge by another pattern. Hence the resolution rules of the  $\mathcal{C}_V, \mathcal{C}'_V, \mathcal{C}_U$  patterns can be applied independently.

A pattern  $\mathcal{C}_i$  in  $\{\mathcal{C}_N, \mathcal{C}_{T1}, \mathcal{C}_{T2A}, \mathcal{C}_{T2NA}, \mathcal{C}_{Da}, \mathcal{C}_{Db}\}$  can only share at most one vertex with each  $\mathcal{C}_V, \mathcal{C}'_V$  or  $\mathcal{C}_U$  patterns, which do not prevent the resolution rule of  $\mathcal{C}_i$  from being applied.

We emphasize that the parities involved in the resolution rules of  $\mathcal{C}_N, \mathcal{C}_{T1}, \mathcal{C}_{T2A}, \mathcal{C}_{T2NA}$  are preserved no matter how many  $\mathcal{C}_V, \mathcal{C}'_V$  or  $\mathcal{C}_U$  patterns touch them. Say we have a pattern  $\mathcal{C}_i$  in  $\{\mathcal{C}_N, \mathcal{C}_{T1}, \mathcal{C}_{T2A}, \mathcal{C}_{T2NA}\}$ , and a non-special vertex  $v$  of  $\mathcal{C}_i$ . In the descriptions of the patterns and their resolution rules, we may specify the parity of  $v$  in the graph  $G$ , then which edges we add or remove to obtain that  $v$  has an odd degree in the reduced graph  $G'$ . These definitions do not take into account the  $\mathcal{C}_V, \mathcal{C}'_V, \mathcal{C}_U$  patterns or a path from  $S$  that may touch  $v$ , but we argue that they do not interfere with the parity of  $v$  in the reduced graph  $G'$ .

If a path from  $S$  touches  $v$  in  $G$  and does not form a  $\mathcal{C}'_V$  pattern, then the reduction from  $G$  to  $G'$  removes 2 edges incident with  $v$ , which preserves the parity of  $v$ . If a  $\mathcal{C}_V$  or  $\mathcal{C}_U$  pattern touches  $v$  in  $G$ , then 1 edge  $vu'$  ( $u' \in U$ ) is removed and 1 edge  $vv'$  ( $v' \notin U$ ) is added, which preserves the parity of  $v$ . Finally if a  $\mathcal{C}'_V$  pattern  $\{u', v, v'\}$  touches  $v$ , then the edge  $vu'$  is removed, as well as an edge  $vw$  from the path of  $S$  that contains the edge  $vv'$ . The edge  $vv'$  is kept in the reduced graph. Thus,  $v$  has lost 2 incident edges, and so its degree is preserved.

In conclusion, we may apply the resolution rules of compatible patterns in any order.

Since the definitions of patterns do not create cycles, do not use additional colors, and since the 2-coloring  $c_S$  of  $S$  fits the color requirements of all patterns in  $\mathcal{M}$ , the subdivision composite rule  $(\{\mathcal{R}_1, \dots, \mathcal{R}_k\}, S, c_S)$  associated with  $(\mathcal{M}, S)$  is valid.  $\square$

Let us introduce the notion of *settled* special vertex, to characterize the special vertices that are already compatible with the rest of the configuration and whose remaining neighbors do not need to be further altered.

**Definition 4.2.4** (Settled vertices). *Let  $G$  be a planar graph with a  $(C_{II})$  configuration w.r.t. a 4-family  $U$ . Let  $S$  be a semi-subdivision rooted on  $U$ .*

*We say that a special vertex  $u$  is lone-settled w.r.t.  $S$  if:*

- *$u$  forms a  $\mathcal{C}_V$  or  $\mathcal{C}'_V$  pattern and shares at most one remaining neighbor with each of the other special vertices, and the two remaining neighbors of  $u$  are not the two remaining neighbors of a  $\mathcal{C}_U$  pattern; or*
- *$u$  forms a  $\mathcal{C}_N$  pattern and its remaining neighbors are disjoint from  $S$  and from the remaining neighbors of other special vertices.*

*A special vertex is settled if it is lone-settled or forms a  $\mathcal{C}_{T2NA}$  pattern  $\{u, u', v, v'\}$  with another special vertex  $u'$ , such that  $v, v'$  are disjoint from  $S$  and from the remaining neighbors of other special vertices.*

Note that in this definition, the  $\mathcal{C}_V$  pattern formed by lone-settled special vertex can touch the subdivision  $S$ .

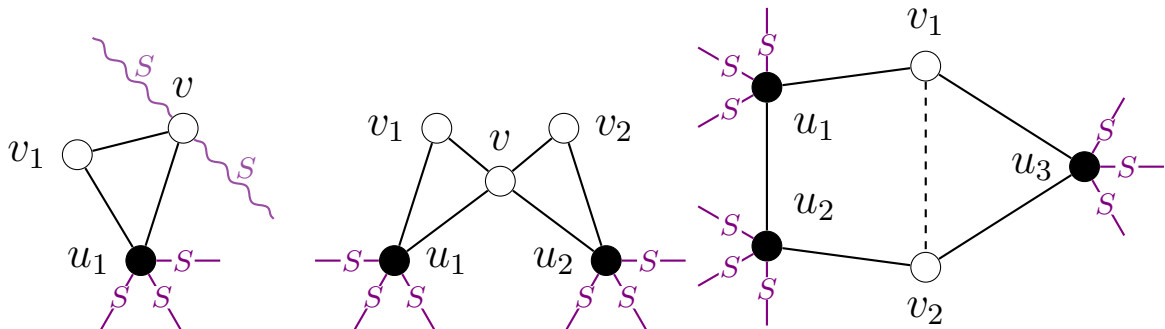

Figure 4.6: Examples of **unsettled** vertices

Figure 4.6 provides a few examples of unsettled special vertices: on the left a  $\mathcal{C}_N$  pattern touching the subdivision, in the middle two  $\mathcal{C}_N$  patterns sharing a remaining neighbor, and on the right a  $\mathcal{C}_U$  and a  $\mathcal{C}_V$  pattern sharing both remaining neighbors. None of the depicted special vertices are settled.

By Claim 4.2.3 (p. 88), we deduce immediately that if all four vertices of  $U$  are settled w.r.t.  $S$ , then there exists a mapping  $\mathcal{M}$  of  $U$  that is compatible w.r.t.  $S$ .

### 4.3 Redirection procedure

To further decrease the number of problematic cases to consider in the rest of the proof, we consider a set of local transformations that, when applied exhaustively to a  $\mathcal{K}$ -subdivision  $S$  rooted on a 4-family  $U$ , return another  $\mathcal{K}$ -subdivision  $S'$  rooted on  $U$ , of the same type and which does not contain some inconvenient configurations. The special vertices of  $U$  can be more easily mapped to patterns in  $S'$  than in  $S$ .

This procedure does not preserve the chordlessness of a subdivision it is applied to, so let us consider the following weaker properties that are preserved by the procedure (as is proven in Claim 4.3.2, p. 93).

Given a  $\mathcal{K}$ -subdivision  $S$  rooted on  $U$ , an *A-chord* of  $S$  is a chord on a path of  $S$  incident with a special vertex  $u \in U$  that is unsettled or forms a  $\mathcal{C}_V$  pattern w.r.t.  $S$  (see Figure 4.7a); and a *B-chord* is a chord between two remaining neighbors of  $u \in U$  on a path of  $S$  that is **not** incident with  $u$  (see Figure 4.7b). We say respectively that  $u$  has an A-chord, a B-chord.

A  $\mathcal{K}$ -subdivision satisfies *property A* (resp. *property B*) if it does not have an A-chord (resp. a B-chord). A chordless  $\mathcal{K}$ -subdivision obviously satisfies properties A and B.

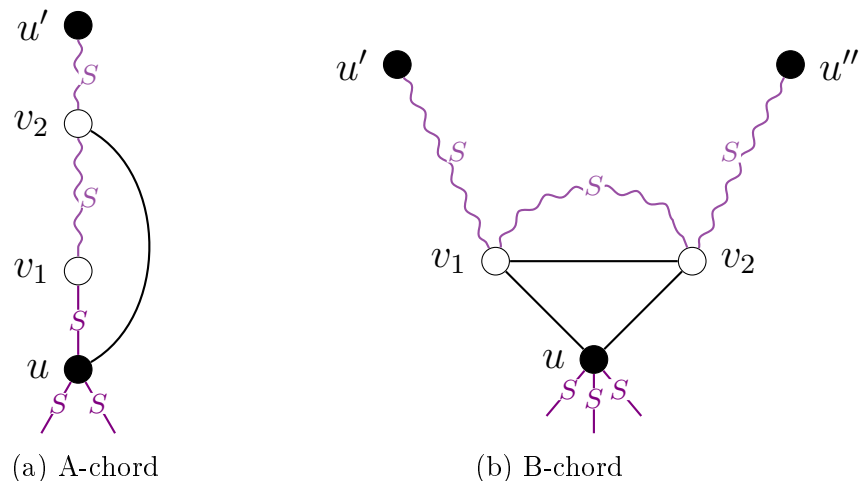

Figure 4.7: The configurations that are avoided by properties A and B.

Let us now define the procedure that helps take care of problematic cases in a  $\mathcal{K}$ -subdivision.

**Definition 4.3.1** (Redirection procedure). *Let  $G$  be a planar graph with a  $(C_{II})$  configuration w.r.t. a 4-family  $U$ , and  $S$  be a  $\mathcal{K}$ -subdivision rooted on  $U$ , such that  $S$  satisfies properties A and B. The redirection procedure consists in applying as many times as possible the redirection operations  $\mathcal{C}_{X1}$ ,  $\mathcal{C}_{X2}$ ,  $\mathcal{C}_{X3}$  and  $\mathcal{C}_{X4}$  to  $S$ .*

Note that these configurations are defined on  $u_1, u_2$  but may be in contact with unspecified remaining neighbors of  $u_3, u_4$ , in which case we apply the redirections anyway. The contacts with paths from  $S$  that would prevent us from applying the redirections are specified.

**Remark:** the  $\mathcal{C}_V$  patterns on the drawings illustrating the redirections could turn out to be  $\mathcal{C}_{T2NA}$  patterns, and are only featured as an indication.

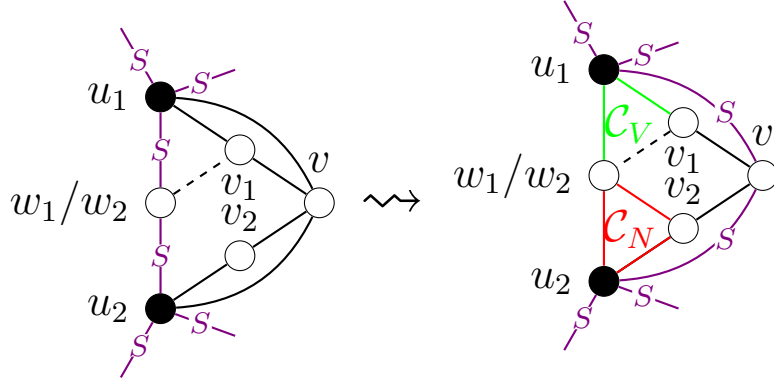

Redirection  $\mathcal{C}_{X1}$ , when  $w_1 = w_2$

- $\mathcal{C}_{X1}$ : The vertices  $u_1, u_2$  are linked by a path  $u_1 \sim u_2$  of  $S$  of the form  $(u_1, w_1, Q, w_2, u_2)$ , with  $w_1 = w_2$  if  $l(Q) = 0$ . The vertices  $u_1, u_2$  have a common remaining neighbor  $v$  and have another remaining neighbor  $v_1, v_2$  respectively, both adjacent to  $v$ . The vertices  $v_1$  and  $w_1$  are non-adjacent. No path from  $S$  touches  $v, v_1$  or  $v_2$ .

**Redirection protocol:** We replace the path  $u_1 \sim u_2$  in  $S$  with the path  $(u_1, v, u_2)$ .

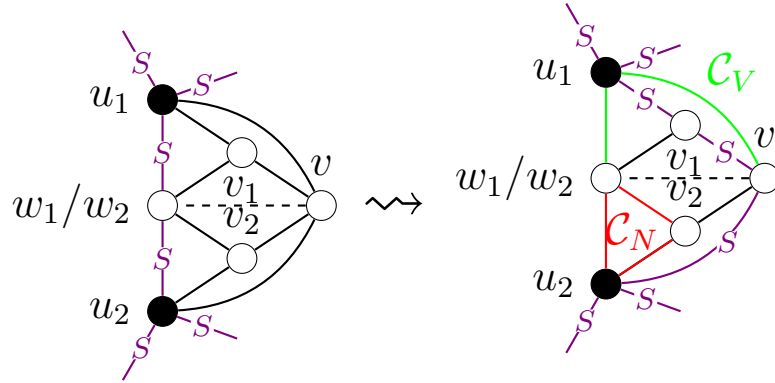

Redirection  $\mathcal{C}_{X2}$ , when  $w_1 = w_2$

- $\mathcal{C}_{X2}$ : The vertices  $u_1, u_2$  are linked by a path  $u_1 \sim u_2$  of  $S$  of the form  $(u_1, w_1, Q, w_2, u_2)$ , with  $w_1 = w_2$  if  $l(Q) = 0$ . The vertices  $u_1, u_2$  have a common remaining neighbor  $v$  and have another remaining neighbor  $v_1, v_2$  respectively, both adjacent to  $v$ . The vertices  $v_1$  and  $w_1$  (resp.  $v_2$  and  $w_2$ ) are adjacent. No path from  $S$  touches  $v, v_1$  or  $v_2$ .

**Redirection protocol:** We replace the path  $u_1 \sim u_2$  in  $S$  with the path  $(u_1, v_1, v, u_2)$ . The vertices  $v, w_1$  are the new remaining neighbors of  $u_1$  and are not adjacent, otherwise  $\{u_1, v, v_1, w_1\}$  would form a  $K_4$ , contradicting Claim 4.0.2 (p. 73).



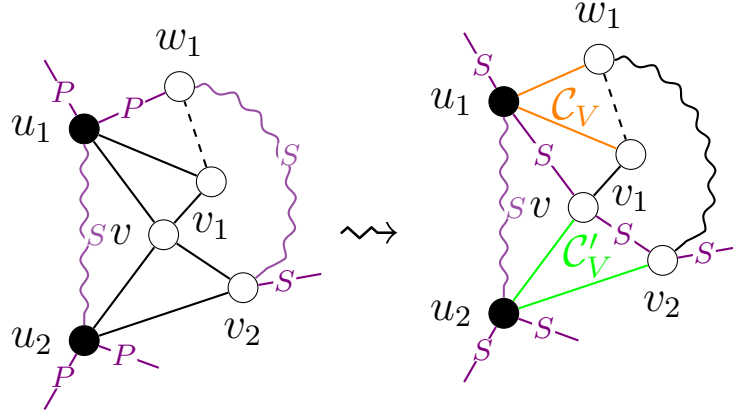

Redirection  $\mathcal{C}_{X3}$ , when  $w_1, v_1$  are not adjacent

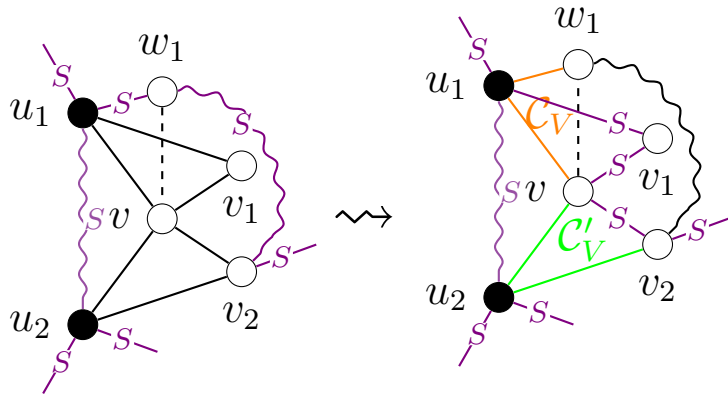

Redirection  $\mathcal{C}_{X3}$  when  $w_1, v$  are not adjacent

- $\mathcal{C}_{X3}$ : The vertices  $u_1, u_2$  are linked by a path  $u_1 \sim u_2$  of  $S$ , they have a remaining neighbor  $v$  in common, and  $u_1, u_2$  have another remaining neighbor  $v_1, v_2$  respectively.  $v_1, v_2$  are both adjacent to  $v$ . There is another special vertex  $u_3$  such that there is a path  $u_1 \sim u_3$  in  $S$  of the form  $P = (u_1, w_1, Q, v_2, Q', u_3)$ , with  $l(Q) \geq 0$  (so  $w_1$  may be equal to  $v_2$ ) and  $l(Q') \geq 1$ . No path from  $S$  touches  $v$  nor  $v_1$ .

**Redirection protocol:** The vertex  $w_1$  cannot be adjacent to both  $v$  and  $v_1$ , otherwise  $\{u_1, v, v_1, w_1\}$  would induce a  $K_4$  in the graph, a contradiction by Claim 4.0.2 (p. 73). We distinguish between two cases:

- If  $w_1, v_1$  are **not adjacent**: we replace the path  $P$  in  $S$  with the path  $P' = (u_1, v, v_2, Q', u_3)$ ;
- If  $w_1, v_1$  are **adjacent**: then necessarily  $w_1, v$  are not, and in this case we replace  $P$  in  $S$  with the path  $P' = (u_1, v_1, v, v_2, Q', u_3)$ .

In both cases, the two new remaining neighbors of  $u_1$  are not adjacent.

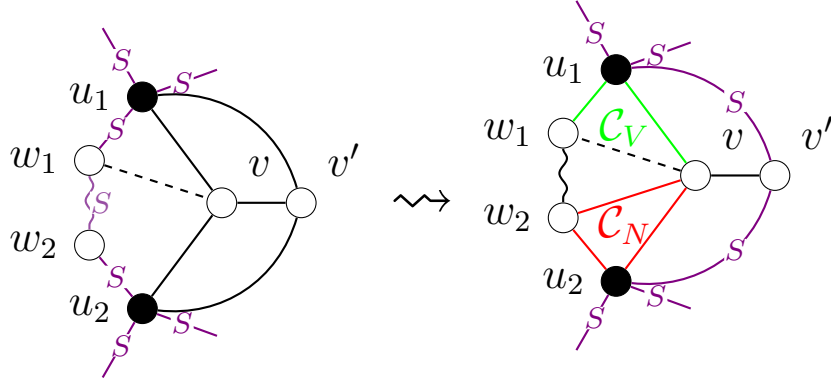

Redirection  $\mathcal{C}_{X4}$

- $\mathcal{C}_{X4}$ : The vertices  $u_1, u_2$  are linked by a path  $u_1 \sim u_2$  of the form  $(u_1, w_1, Q, w_2, u_2)$ , with  $l(Q) \geq 0$  (with  $w_1 = w_2$  if  $l(Q) = 0$ ). The vertices  $u_1, u_2$  have two adjacent remaining neighbors  $v, v'$  in common. No path from  $S$  touches  $v$  nor  $v'$ .

**Redirection protocol:** There must be a non-edge  $e$  among  $vw_1, v'w_1$ , otherwise  $\{u_1, v, v', w_1\}$  form an induced  $K_4$ , which contradicts the fact that  $G$  has a  $(C_{II})$  configuration by Claim 4.0.2 (p. 73). Let us say that  $e = vw_1$ . We replace the path  $u_1 \sim u_2$  in  $S$  with the path  $(u_1, v', u_2)$ .

In all cases, the special vertex  $u_1$  is given a new set of remaining neighbors that are not adjacent. The procedure terminates, as each redirection requires two special vertices that have adjacent remaining neighbors to be applied, and increases the number of special vertices with non-adjacent remaining neighbors.

We define the associated property: a subdivision satisfies **Property C** if no redirection can be applied. We say that a subdivision is **strong** when it satisfies properties A, B and C.

To justify the choice of this procedure and the notion of strong subdivision, we prove that it preserves properties A and B and the structure of  $\mathcal{K}$ -subdivision.

**Claim 4.3.2.** *The redirection procedure preserves properties A and B.*

*Proof.* Let  $G$  be a planar graph with a 4-family  $U$  and a  $\mathcal{K}$ -subdivision  $S$  rooted on  $U$ , such that  $S$  satisfies properties A and B. Let  $S'$  be the subdivision obtained by applying the redirection procedure to  $S$ . Let us prove that  $S'$  satisfies properties A and B as well.

- $\mathcal{C}_{X1}, \mathcal{C}_{X4}$ : Redirection configurations  $\mathcal{C}_{X1}$  and  $\mathcal{C}_{X4}$  feature two special vertices  $u_1, u_2$  and only modify one  $(u_1, u_2)$ -path in the subdivision, by replacing it with another of length 2. No path of length 2 has a B-chord, and since an edge  $u_1u_2 \in E(G)$  already constitutes a path of  $S$ , there is no A-chord either.
- $\mathcal{C}_{X2}$ : In redirection configuration  $\mathcal{C}_{X2}$ , the new  $(u_1, u_2)$ -path  $P'$  has length 3, hence does not contain B-chords. Since the remaining neighbors of  $u_1, u_2$  w.r.t.  $S'$  do not belong to  $S'$  except one ( $v$ ), the other paths of  $S'$  do not contain B-chords either. The remaining neighbors of  $u_2$  are disjoint from  $P'$ , hence  $u_2$  does not have an A-chord, but  $u_1$  does however. We claim that property A is still satisfied because  $u_1$  is (lone-)settled w.r.t.  $S'$ . The remaining neighbors of  $u_1$  are not adjacent, hence  $u_1$  is unsettled only if it forms a  $\mathcal{C}_{T2NA}$  pattern with  $u_3$  or  $u_4$  (this pattern would then touch  $S'$ ), since  $u_3, u_4$  do not form a  $\mathcal{C}_U$  pattern as  $S$  satisfies property A.

Let us first consider the case where  $S$  is a  $K_4$ -subdivision, and assume  $u_3$  has  $w_1, v$  as its remaining neighbors w.r.t.  $S'$  (it has the same remaining neighbors w.r.t.  $S$ ,

since only the remaining neighbors of  $u_1, u_2$  were modified). Then  $\{u_1, w_1, v\}$  and  $\{v_1, u_2 = u_4, u_3\}$  induce a  $K_{3,3}$ -minor of  $G$  (by contracting the path  $u_2 \sim u_4$  to a vertex), contradicting the planarity of  $G$ .

Now let us take a look at the case where  $S$  is a  $C_{4+}$ -subdivision and assume that  $u_3$  or  $u_4$  has  $w_1, v$  as its remaining neighbors w.r.t.  $S'$  (thus w.r.t.  $S$ ). If  $u_1, u_2$  are 1-linked,  $u_3$  or  $u_4$  has a remaining neighbor in the solo  $(u_1, u_2)$ -path  $P$ , contradicting the property “1-linked” of  $S$ . If  $u_1, u_2$  are 2-linked, then  $\{u_1, w_1, v\}$  and  $\{v_1, u_2, u_3 = u_4\}$  induce a  $K_{3,3}$ -minor by contracting a  $(u_3, u_4)$ -path to a vertex, again a contradiction. Thus,  $u_1$  cannot form a  $\mathcal{C}_{T2NA}$  pattern, so forms a  $\mathcal{C}_V$  pattern and is lone-settled.

- $\mathcal{C}_{X3}$ : The remaining neighbors  $v, v_2$  of  $u_2$  w.r.t.  $S'$  belong to the new  $(u_1, u_3)$ -path  $P'$  of  $S'$  and the edge  $vv_2$  belongs to  $P'$ , so  $u_2$  does not have an A-chord nor a B-chord.

The remaining neighbors of  $u_3, u_4$  are not modified by the redirection. The paths of  $S$  incident with  $u_4$  are not modified, so  $u_4$  does not have an A-chord, and a B-chord of  $u_4$  could only belong to the new path  $P'$  of  $S'$ . An A-chord of  $u_3$  could only belong to  $P'$ , as its other incident paths of  $S$  were not modified, and  $u_3$  does not have a B-chord, as its non-incident paths of  $S$  were not modified. We claim that none of  $u_3$  and  $u_4$  have an A-chord or B-chord on  $P'$  in  $S'$  if they did not in  $S$ .

We examine the case of  $u_1$  at the end of this proof. Let us make several observations that will help us prove our claims.

Whether  $S$  is a  $K_4$ - or a  $C_{4+}$ -subdivision, it contains a  $(u_1, u_2)$ -path  $P_{12}$ , a  $(u_2, u_4)$ -path  $P_{24}$ , a  $(u_3, u_4)$ -path  $P_{34}$ , as well as the path  $P = P_{13}$ , split into a  $(u_1, v_2)$ -section  $Q_{13}$  and a  $(v_2, u_3)$ -section  $T_{13}$ , all these paths having no special vertex as internal vertex.

**Observation 2.** *The special vertex  $u_3$  does not have  $v_1$  as a remaining neighbor w.r.t.  $S$ .*

*Proof.* If it were the case, then  $G$  would contain a  $K_{3,3}$ -minor induced by  $\{u_1, u_3, v\}$  and  $\{u_2, v_1, v_2\}$ , obtained by contracting  $P_{12}, P_{34}, Q_{13}$  and  $T_{13}$  to one edge, and  $P_{24}$  to one vertex. This would contradict the planarity of  $G$ .  $\square$

**Observation 3.** *The special vertex  $u_3$  does not have  $v$  as a remaining neighbor w.r.t.  $S$ .*

*Proof.* Because the paths  $P_{24}$  and  $P_{34}$  are disjoint from  $v, v_1, v_2$ , the vertices  $u_1, u_3$  would then belong to two different regions of the plane delimited by the three edges  $u_2v, u_2v_2, vv_2$ . This is a contradiction with the almost 4-connectivity of  $G$ .  $\square$

**Observation 4.** *The special vertex  $u_4$  does not have two remaining neighbors (w.r.t.  $S$ )  $v_4$  in  $T_{13}$ , and  $v'_4 \in \{v, v_1\}$ .*

*Proof.* If  $v'_4 = v_1$ , contracting the  $(v_2, v_4)$ -section of  $T_{13}$  gives us a  $K_{3,3}$ -minor of  $G$  induced by  $\{u_1, v, u_4\}$  and  $\{u_2, v_1, v_2\}$ , a contradiction. If  $v'_4 = v$ , then by planarity  $u_1, u_4$  must belong to two different regions of the plane delimited by the three edges  $u_2v, vv_2$  and  $u_2v_2$ , again a contradiction to the almost 4-connectivity of  $G$ .  $\square$

**Observation 5.** *The special vertex  $u_4$  does not have  $w_1, v$  as its remaining neighbors w.r.t.  $S$  if  $w_1, v$  are non-adjacent.*

*Proof.* If it were the case, there would be a  $K_{3,3}$ -minor in  $G$  induced by  $\{u_1, u_4, v_2\}$  and  $\{u_2, w_1, v\}$ , a contradiction with the planarity of  $G$  (note that by assumption  $w_1, v$  are non-adjacent, hence  $w_1 \neq v_2$ ).  $\square$

Since only the  $(u_1, u_3)$ -path  $P$  changes into the path  $P'$ , and the remaining neighbors of  $u_3, u_4$  are not changed by the redirection,  $u_3$  (resp.  $u_4$ ) may only have an A-chord (resp. B-chord) on the new path  $P'$ . This  $(u_1, u_3)$ -path is incident with  $u_3$  so  $u_3$  does not have a B-chord on it, and no A-chord either by Observations 2 and 3. Note that if  $u_3$  has an A-chord in  $S$ , then  $u_3$  forms a  $\mathcal{C}_V$  pattern w.r.t.  $S$ , and the same pattern w.r.t.  $S'$ .

$P'$  is not incident with  $u_4$ , so  $u_4$  does not have an A-chord on it, and Observation 4 tells us that it does not have a B-chord either.

As for  $u_1$ , note that in the version with  $w_1, v_1$  non-adjacent, the new remaining neighbors of  $u_1$  are disjoint from  $S$ , thus  $u_1$  forms a  $\mathcal{C}_V$  or  $\mathcal{C}_{T2NA}$  pattern disjoint from  $S$  (since no pair of special vertices form a  $\mathcal{C}_U$  pattern by property A), hence is settled. In the version with  $w_1, v$  non-adjacent, the edge  $u_1v$  is an A-chord of  $u_1$ , but Observations 3 and 5 tell us that neither  $u_3$  nor  $u_4$  can form a  $\mathcal{C}_{T2NA}$  pattern with  $u_1$ . Again, since no pair of special vertices form a  $\mathcal{C}_U$  pattern by property A of  $S$ ,  $u_1$  is left lone-settled by the redirection, and property A is satisfied by  $S'$ . □

**Claim 4.3.3.** *Let  $G$  be a planar graph with a  $(C_{II})$  configuration w.r.t. a 4-family  $U$ . Then  $G$  contains a strong  $\mathcal{K}$ -subdivision rooted on  $U$ .*

*Proof.* By Lemma 4.1.2 (p. 75),  $G$  contains a  $\mathcal{K}$ -subdivision  $S$  rooted on  $U$ , on which neither operations A nor B can be applied. In particular,  $S$  satisfies properties A and B.

Since by Claim 4.3.2 (p. 93) the redirection procedure preserves properties A and B, and since the type of subdivision ( $K_4$  or  $C_{4+}$ ) is preserved by each redirection operation, then result follows if  $S$  is a  $K_4$ -subdivision.

Now assume that  $S$  is a  $C_{4+}^*$ -subdivision. We prove that after application of any redirection operation to  $S$ , the obtained subdivision  $S'$  is a  $C_{4+}^*$ -subdivision, and the result follows by induction.

By Claim 4.3.2 (p. 93),  $S'$  satisfies properties A and B. Observe that the redirection operations preserve the ends of the paths of  $S$ ; in particular, vertices that are  $k$ -linked stay  $k$ -linked after application of an operation.

Observe that in each redirection configuration, the two special vertices  $u_1, u_2$  involved have a common remaining neighbor that is disjoint from  $S$ . Therefore, by property “2-linked”, the two special vertices  $u_1, u_2$  involved in the configuration cannot be 2-linked: they are necessarily 1-linked.

Let us prove the three properties of  $C_{4+}^*$  of  $S'$  in order.

- *Property “0-linked”:* The only special vertices whose remaining neighbors are modified by a redirection operation are the special vertices  $u_1$  and  $u_2$  involved in the redirection configuration. Therefore, if  $u_j, u_k$  are 0-linked special vertices, then their remaining neighbors w.r.t.  $S'$  are the same as w.r.t.  $S$ , and property “0-linked” of  $S'$  is implied by the same property of  $S$ .
- *Property “1-linked”:* Let  $u_i, u_j$  be 1-linked special vertices associated with a path  $P_{ij}$  of  $S$ , and  $u_k \in U \setminus \{u_i, u_j\}$ . Assume for contradiction that  $u_k$  has a remaining neighbor  $v_k$  w.r.t.  $S'$  that is an internal vertex of the  $(u_i, u_j)$ -path  $P'_{ij}$  of  $S'$ . If  $v_k$  is not a remaining neighbor of  $u_k$  w.r.t.  $S$ , then the operation applied to  $S$  involves  $u_k$ , and the edge  $u_kv_k$  belongs to  $S$ . However, we can check in all redirection operations that when an edge  $uv$  incident with a special vertex  $u$  is removed from the subdivision, then  $v$  does not belong to the subdivision after the operation is applied. This is a contradiction with the definition of  $v_k$ , therefore  $v_k$  is indeed a remaining neighbor of  $u_k$  w.r.t.  $S$ . Thus,  $P'_{ij} \neq P_{ij}$ .

Since  $u_k$  is 0-linked with one of  $u_i, u_j$ , the vertex  $v_k$  cannot be a remaining neighbor of both w.r.t.  $S$ , by “0-linked” property of  $S$ . So the operation applied to  $S$  cannot be  $\mathcal{C}_{X1}$  or  $\mathcal{C}_{X4}$ , as their new path has length 2.

The operation cannot be  $\mathcal{C}_{X3}$  either, since in this case  $u_i, u_j$  must be the vertices  $u_1, u_3$  in the definition of this configuration (so that  $P'_{ij}$  is the new path);  $u_i, u_j$  are 1-linked, and the operation is applied on the vertices  $u_1, u_2$ , which are also 1-linked as mentioned above. Thus,  $u_i$  or  $u_j$  is 1-linked to two different special vertices, a contradiction.

If the operation is  $\mathcal{C}_{X2}$ , then  $v_k$  cannot be the common remaining neighbor  $v$  of  $u_1, u_2$  in the definition, since  $u_k$  is 0-linked to one of them. If  $v_k$  is the  $v_1$  of  $\mathcal{C}_{X2}$ , then  $\{u_k, v, w_1\}$  and  $\{u_1, u_2, v_1\}$  induce a  $K_{3,3}$ -minor in  $G$  (by contracting the  $(w_1, u_2)$ -section of  $u_1 \sim u_2$  to an edge, and contracting a  $(u_k, u_2)$ -path of  $S$  or a  $(u_k, u_m)$ -path and a  $(u_m, u_2)$ -path of  $S$  to an edge, for  $u_m \in U \setminus \{u_1, u_2, u_k\}$ ), a contradiction to the planarity of  $G$ .

- *Property “2-linked”*: Let  $u_i, u_j$  be two 2-linked special vertices. Since the operations are applied on 1-linked special vertices, exactly one of these two special vertices, say  $u_i$ , is involved in the operation (as  $u_1$  or  $u_2$  in the definitions) applied to  $S$ . Let  $v$  be a common remaining neighbor of  $u_i, u_j$  w.r.t.  $S'$ . If  $v$  was not a common remaining neighbor of  $u_i, u_j$  w.r.t.  $S$ , then it was a remaining neighbor of  $u_j$  and not  $u_i$ , as  $u_j$  is not involved in the operation: the edge  $u_i v$  belongs to  $S$ , and more precisely belongs to a solo  $(u_i, u_k)$ -path  $P_{ik}$  of  $S$  between the two 1-linked special vertices  $u_i$  and  $u_k \in U \setminus \{u_i, u_j\}$ . Thus,  $u_j$  has a remaining neighbor (w.r.t.  $S$ ) that is an internal vertex of a solo path of  $S$ , a contradiction with the “1-linked” property of  $S$ .

Therefore, the potential common remaining neighbors  $v, v'$  of  $u_i, u_j$  w.r.t.  $S'$  are also their common remaining neighbors w.r.t.  $S$ . So by property “2-linked” of  $S$ ,  $u_i, u_j$  have at most one remaining neighbor  $v$ , and it belongs to a parallel  $(u_k, u_l)$ -path  $P_{kl}$  of  $S$  that is not incident with  $u_i, u_j$ . If the path  $P_{kl}$  was not modified by the operation, the result follows. If  $P_{kl}$  was modified into a path  $P'_{kl}$  of  $S'$ , then the operation is necessarily  $\mathcal{C}_{X3}$  (as in the others, only a solo path is modified). The special vertex  $u_i$  is the  $u_2$  in the definition, as it keeps the same special neighbor  $v_2$  in  $S$  and  $S'$ . This vertex belongs to both  $P_{kl}$  and  $P'_{kl}$ , and the result follows.

This proves that  $S'$  is a  $C_{4+}^*$ -subdivision, and the result follows by induction.  $\square$

## 4.4 Sufficiency of the $(C_{II})$ rules

As with the  $(C_I)$  configurations, we need to make sure the composite rules we define in this chapter can indeed be applied, and yield a contradiction with the existence of their associated configuration in an MCE. Let us first prove that the rules we will define throughout this chapter allow us to find a good coloring of an MCE, thus a contradiction, similarly to Lemma 3.2.2 (p. 62).

**Lemma 4.4.1.** *An MCE with a 4-family  $U$  does not contain a subdivision composite configuration made up of a semi-subdivision  $S$  rooted on  $U$  and a mapping  $\mathcal{M}$  of  $U$  compatible w.r.t.  $S$ .*

*Proof.* Let  $G$  be such an MCE, and assume it contains the composite configuration  $X = (\{\mathcal{C}_1, \dots, \mathcal{C}_k\}, S)$  where  $\{\mathcal{C}_1, \dots, \mathcal{C}_k\}$  is a compatible mapping of  $U$ . The associated composite rule  $\mathcal{R}_X = (X, f_X^r, f_X^c)$  is thus valid. We build a good coloring  $c$  of  $G$  to

show a contradiction.

Let us first build a coloring  $pc$  of  $G'$  using the right number of colors. Similarly to the proof of Lemma 3.2.2 (p. 62), let us color each  $K_3$  component of  $G'$  with a cycle of length 3 and each  $K_5^-$  component with a cycle of length 5 and a path of length 4. We color each other components with a good coloring. Thus,  $pc$  uses the right number of colors ( $\lfloor \frac{|V(G')|}{2} \rfloor$ ), with a mix of cycles and paths. Let  $c_0 = f_X^c(G, pc)$  be the coloring of  $G$  obtained from  $pc$  by  $\mathcal{R}_X$ . Since  $\mathcal{R}_X$  is valid,  $c_0$  has the right number of colors ( $\lfloor \frac{|V(G)|}{2} \rfloor$ ) again with some cycles instead of paths. We build iteratively a good coloring  $c$  of  $G$ , by starting from  $c_0$  and using Lemma 3.2.1 (p. 61) to successively replace a pair of colors, inducing a path and a cycle, by another pair of colors inducing two paths.

Observe that the cycles induced by colors of  $c_0$  are disjoint in  $G$ . Indeed, the cycles in  $pc$  are disjoint because they belong to different connected components; the cycles of  $pc$  may have been deviated into longer cycles in  $c_0$ , but since the internal vertices of the deviated sections are all special vertices, and since each special vertex is involved in at most one deviation, then no vertex of  $G$  can belong to the intersection of two cycles in  $c_0$ .

First let us prove that no  $K_3$  connected component can appear in  $G'$ . Let  $K$  be such a component, colored with a cycle in  $pc$ , and let  $C$  be the cycle of  $G$  induced by the same color in  $c$ , after some deviations. Observe that if one pattern involved in the deviations is  $\mathcal{C}_{T1}$ ,  $\mathcal{C}_{T2A}$  or  $\mathcal{C}_{T2NA}$ , one vertex of  $K$  is supposed to have odd degree in  $G'$ , which is impossible since  $K$  is a  $K_3$ . Since  $K$  is a connected component of  $G'$ , the vertices of  $C$  on  $V(K)$  are only incident with edges of  $G[V(K)]$ , edges between special vertices and their remaining neighbors, and edges from the subdivision  $S$ . A semi-subdivision has at most one pair of intersecting paths, sharing exactly one vertex. Hence, there are at least two vertices in  $V(K)$  which are incident with 2 edges of  $C$  and 0 or 2 edges of  $S$ , and so these two vertices have a degree of at most 4 in  $G$ . This contradicts Lemma 3.1.1, so no  $K_3$  component can be created in  $G'$ .

Now let  $K$  be a  $K_5^-$  component of  $G'$ , and let  $C', P'$  be the cycle and path coloring it in  $G'$ . Let  $C, P$  be the cycle and path induced in  $c_0$  by the same colors as  $C', P'$ .  $C$  has not been treated yet and is thus induced by the same color in  $c$  as in  $c_0$ . If  $P = P'$ , then it is disjoint from the cycles treated in previous iterations of  $c$ , and thus has not been involved in a replacement of a pair of colors. Otherwise,  $P$  results from deviations of  $P'$  on special vertices, or an extension of  $P'$  by at most two edges (one for each of its endpoints) to special vertices. If  $u$  is a special vertex touching  $P$ , since  $u$  belongs to exactly one pattern of the mapping of  $X$ , then  $u$  does not touch a cycle treated in any previous iteration of  $c$ . Thus  $P$  is again disjoint from the cycles treated in the previous iterations. In both cases,  $P$  is induced by the same color in  $c$  as in  $c_0$ .

Observe that  $V(C) \cap V(P) \subseteq V(K)$ , so  $|V(C) \cap V(P)| \leq 5$ . We distinguish between three cases:

- **$C$  results from a deviation of  $C'$ :** then its length is different from 5. By Observation 1 (p. 61),  $C \cup P$  does not form the exceptional graph.
- **$C'$  has not been deviated, but  $P'$  has:** then  $V(C) = V(K)$ , and there is an edge of  $K$  that does not belong to  $(C \cup P)[V(C)]$ . Thus  $(C \cup P)[V(C)] \subsetneq (C' \cup P')[V(C')] = K$ , and so  $(C \cup P)[V(C)]$  does not form a  $K_5^-$ , and by Observation 1 (p. 61),  $C \cup P$  does not form the exceptional graph.
- **Neither  $C'$  nor  $P'$  have been deviated:** then  $(C \cup P)[V(C)] = K$ , which is a  $K_5^-$ , and so  $E(K) \subseteq E(G)$ . The edges of  $K$  split  $G$  into 6 regions bounded

by triangles. Since the graph is almost 4-connected w.r.t. all the special vertices, they belong to the same region of the graph. Hence at most 3 vertices from  $K$  are neighbors of special vertices. Since there is at most one vertex of degree at most 4 in  $G$ , all vertices from  $K$ , except maybe one, have their degree changed between  $G$  and  $G'$ . Only 3 of them can belong in patterns, thus at least one of them is touched by a path  $Q$  induced by a color of  $c$  and different from  $P$ . Since  $C \cup P$  forms the exceptional graph, by Observation 1 (p. 61)  $C \cup Q$  does not, and since  $C'$  has not been deviated,  $|C| = 5$ , and so  $vertV(C) \cap V(Q) \leq 5$ .

In all three cases, Lemma 3.2.1 (p. 61) gives us a decomposition of  $C \cup P$  or  $C \cup Q$  into two new paths  $Q', Q''$ . We replace  $C, P$  or  $C, Q$  in  $c$ , depending on the case, with  $Q', Q''$ .

The coloring  $c$  contains the same number of colors as  $c_0$  in all iterations, with one less cycle at each iteration. When all  $K_3$  and  $K_5^-$  components have been treated, the resulting coloring  $c$  is a good path decomposition of  $G$ , a contradiction.  $\square$

In order to show a contradiction, we now need to prove that an MCE containing a configuration  $(C_{II})$  indeed contains a subdivision composite configuration made up of a semi-subdivision rooted on its 4-family and a compatible mapping.

**Lemma 4.4.2.** *Let  $G$  be a planar graph with a  $(C_{II})$  configuration w.r.t. a 4-family  $U$ , that admits a strong  $\mathcal{K}$ -subdivision rooted on  $U$ . Then  $G$  contains a subdivision composite configuration made up of a semi-subdivision  $S$  rooted on  $U$  and a compatible mapping w.r.t.  $S$ .*

Note that the subdivision is a semi-subdivision and so it may have missing edges or having two paths crossing, but it is 2-colorable, and therefore sufficient to produce a good coloring of  $G$  if  $G$  is an MCE, and therefore show a contradiction.

The rest of this chapter constitutes a proof of this lemma, before the conclusion in which we show that Lemma 4.0.1 (p. 72) ensues.

## 4.5 Distant problems

In the following, we prove that the graph admits a composite configuration made up of a subdivision and a set of compatible patterns. We will distinguish two types of “problems” that could occur and prevent us from applying directly a reduction  $(\mathcal{C}_N)^4$ . First, a  $\mathcal{C}_N$  pattern could cause a “distant problem” by touching a path of the subdivision, and the associated reduction rule could create a cycle in the coloring. Then, some special vertices from  $U$  could cause a “close problem” by sharing some of their remaining neighbors and the  $\mathcal{C}_N$  patterns would not be compatible. We first treat the cases with at least 3 distant problems (Lemma 4.5.5, p. 105), then the cases with at most 2 distant problems and no close problems (Lemma 4.6.2, p. 114) and finally the cases with at most 2 distant problems and some close problems (Lemma 4.7.2, p. 124).

**Definition 4.5.1** (Distant problem). *Let  $G$  be a planar graph with a 4-family  $U$  and let  $S$  be a strong  $\mathcal{K}$ -subdivision rooted on  $U$ . Let  $u \in U$  be a special vertex and  $P$  be a path of  $S$  that is not incident with  $u$ . We say that  $u$  causes a distant problem on  $P$  if the three conditions are satisfied:*

- $u$  has two adjacent remaining neighbors  $v, v'$  that are disjoint from  $U$ ;
- exactly one of its remaining neighbors belongs to  $P$ ;

- if some other special vertex  $u'$  has one of  $v, v'$  as a remaining neighbor, then  $u'$  is settled.

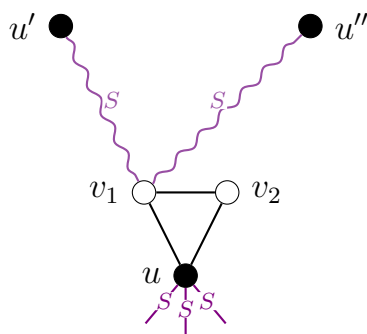

Figure 4.8: Distant problem caused by a special vertex  $u$

Figure 4.8 provides an example of distant problem. Only the path  $P$  from the definition is represented.

This definition is motivated by the fact that because of property B, an unsettled special vertex  $u$  cannot have both its remaining neighbors belong to a path  $P$  not incident with  $u$ .

Note that if three special vertices cause distant problems, the fourth one is lone-settled, because of the last condition in the definition of distant problem and by properties A and B.

Once we 2-color the subdivision  $S$  such that each vertex of  $U$  is at the end of a color, a distant problem is *active* if the color that ends on  $u$  is the same as the color of the path  $P$ . A distant problem is otherwise *inactive*. We can treat inactive distant problems as  $\mathcal{C}_N$  patterns, as the coloring fits the color requirements of the pattern (i.e. the color requirements of the two patterns  $(\mathcal{C}_{Ne})$  and  $(\mathcal{C}_{No})$ ). Since the distant problems are caused by special vertices  $u$  which have their remaining neighbors  $v, v'$  adjacent, we refer to  $\{u, v, v'\}$  as the *triangle of  $u$* .

We prove here two results that is convenient for the rest of the proof.

**Claim 4.5.2.** *A  $K_4$ -subdivision can be 2-colored so as to inactivate up to 2 distant problems that are on different paths of  $S$ .*

*Proof.* Let  $S$  be a  $K_4$ -subdivision rooted on  $\{u_1, u_2, u_3, u_4\}$ . Let us assume w.l.o.g. that  $u_1$  causes a distant problem on the path  $u_2 \sim u_3$ . The following 2-coloring of  $S$  inactivates the distant problem of  $u_1$ :  $\{(u_3 \rightarrow u_2 \rightarrow u_1 \rightarrow u_4), (u_1 \rightarrow u_3 \rightarrow u_4 \rightarrow u_2)\}$ .

If  $S$  has a second distant problem on a different path, then there are several possible cases. Either  $u_3$  causes a distant problem on  $u_2 \sim u_4$  (case A) or on  $u_1 \sim u_4$  (case B). These cases are symmetric with the ones where  $u_2$  causes a distant problem on  $u_3 \sim u_4$  and  $u_1 \sim u_4$  respectively. If instead the second distant problem is caused by  $u_4$  on (w.l.o.g.)  $u_1 \sim u_3$ , then this is equivalent to case A: just replace  $(1, 2, 3, 4)$  with  $(3, 4, 2, 1)$  to obtain case A. The coloring of the previous case inactivates the two distant problems of case A, and the coloring  $\{(u_4 \rightarrow u_1 \rightarrow u_3 \rightarrow u_2), (u_1 \rightarrow u_2 \rightarrow u_4 \rightarrow u_3)\}$  of  $S$  inactivates those of case B.  $\square$

**Claim 4.5.3.** *Let  $G$  be a planar graph with a  $(C_{II})$  configuration w.r.t. a 4-family  $U$  and a strong  $C_{4+}^*$ -subdivision rooted on  $U$ , such that  $G$  does not have a  $K_4$ -subdivision rooted on  $U$ . If  $u_i, u_j \in U$  are 1-linked, then at most one of them has a remaining neighbor belonging to  $S$ .*



*Proof.* By property “1-linked” of  $S$  and property A, the remaining neighbors of  $u_i, u_j$  are on parallel paths of  $S$ . Let us assume for contradiction that the 1-linked special vertices  $u_1, u_2$  are such that  $u_1$  has a remaining neighbor  $v_1$  on a  $(u_2, u_4)$ -path  $P_2$  of  $S$  and  $u_2$  has a remaining neighbor  $v_2$  on a  $(u_1, u_3)$ -path  $P_1$  of  $S$ : let  $P_1 = (u_1, Q_1, v_2, Q_3, u_3)$  and  $P_2 = (u_2, Q_2, v_1, Q_4, u_4)$ .

Let  $S'$  be the set of paths of  $S$  different from  $P_1, P_2$ , and let  $P'_1 = (u_1, v_1, Q_4, u_4)$  and  $P'_2 = (u_2, v_2, Q_3, u_3)$ , as depicted on Figure 4.9. These  $(u_1, u_4)$ -path and  $(u_2, u_3)$ -path are internally disjoint from the paths of  $S'$ , hence  $S' \cup \{P'_1, P'_2\}$  forms a  $K_4$ -subdivision of  $G$  rooted on  $U$ , a contradiction. Hence, two 1-linked special vertices cannot both have a remaining neighbor in  $S$ .

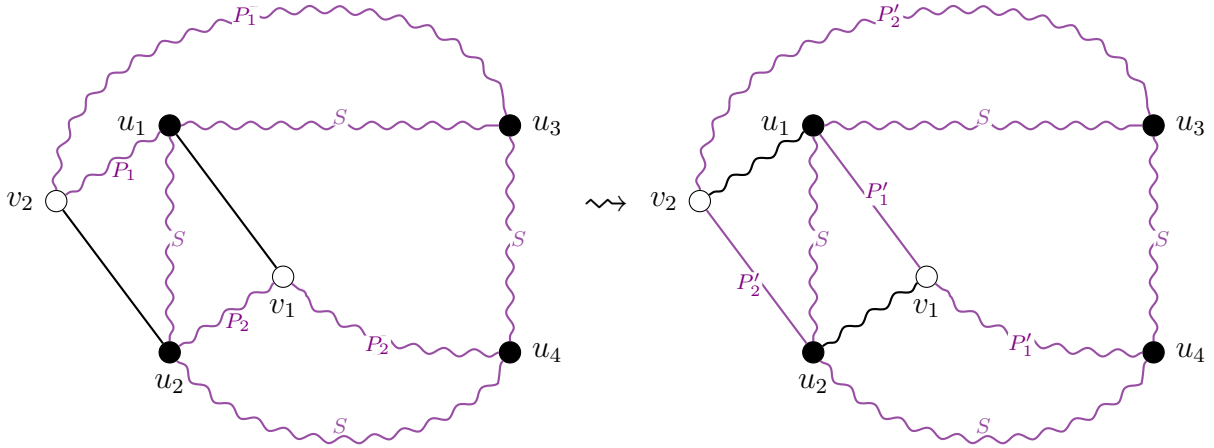

Figure 4.9: Display of the underlying  $K_4$ -subdivision of  $G$  rooted on  $U$

Finally,  $S$  cannot have three distant problems or more, as two of them would be caused by a pair of 1-linked special vertices.  $\square$

We define below the “distant configurations” that correspond to subdivisions with at least 3 distant problems. We first introduce a *routing operation* that helps us take care of these distant problems. For each distant configuration, we perform a redirection of the subdivision  $S$  into a subdivision  $S'$ , to turn each special vertex causing a distant problem into a settled one. When  $S$  has a distant problem caused by  $u_i$  and  $S'$  has a new path of the form  $u_i, v_i, Q, u_j$ , the goal is to turn the distant problem on  $u_i$  into a  $\mathcal{C}_V$  pattern. To do so, we use the following operation.

**Definition 4.5.4** (Routing operation). *Let  $G$  be a planar graph with a 4-family  $U$  and a strong  $\mathcal{K}$ -subdivision  $S$  rooted on  $U$ . Let  $u \in U$  have two adjacent remaining neighbors  $v_1, v_2$  w.r.t.  $S$ , and let  $w$  be a neighbor of  $u$  that belongs to  $S$ . Assume that  $u$  causes a distant problem, with  $v_1$  touching a path of  $S$ . One of  $v_1, v_2$ , say  $v'$ , is not adjacent to  $w$ , otherwise  $\{u, v_1, v_2, w\}$  would form an induced  $K_4$  in the graph, which contradicts the fact that  $G$  has a  $(C_{II})$  configuration by Claim 4.0.2 (p. 73).*

*The paths of  $S$  are redirected to create a new subdivision  $S'$ , containing a path  $P' = u, v_1, Q, u'$ , and such that  $w$  does not belong to  $S'$ . Applying the routing operation on  $u$  consists in replacing the edge  $uv_1$  in  $P'$  by the edges  $uv_2, v_2v_1$  if  $v' = v_1$ , and leaving  $P'$  as it is otherwise.*

This routing operation ensures that the two remaining neighbors of  $u$  in  $S'$  are  $w, v'$  and are thus non-adjacent. The vertex  $u$  now forms a  $\mathcal{C}_V$  pattern w.r.t.  $S'$  and we justify

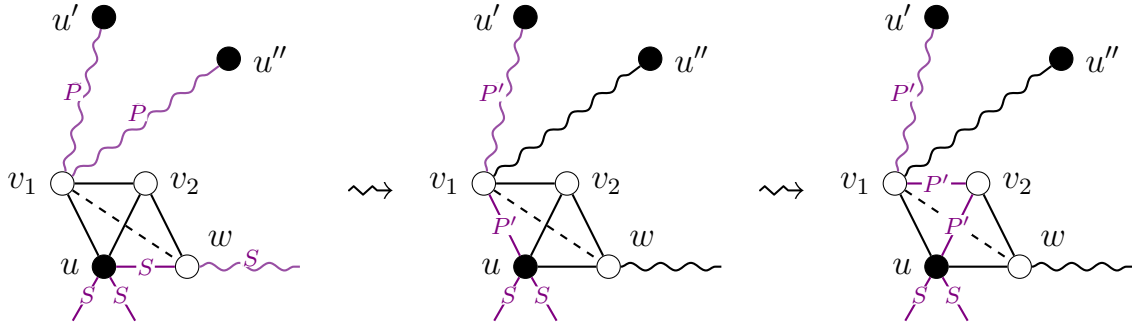

Figure 4.10: On the left:  $u$  causes a distant problem on a path  $P = u' \sim u''$  of the subdivision. In the middle: a new subdivision is considered for some reduction rule, with a new path  $P' = u' \sim u$ . On the right: the routing operation modifies the path  $P' = u' \sim u$  in order to choose two non-adjacent vertices  $(v_1, w)$  as remaining neighbors for  $u$ .

for each application of the routing operation that  $u$  is left settled. For all cases, we provide a subdivision  $S$  and describe a mapping of compatible patterns that settles all vertices.

**List of the distant configurations:**

*The distant configurations are the configurations  $D_1, D_2, D_3, D_4$  listed below.*

*Each configuration describes a 4-family  $U$  and a strong  $\mathcal{K}$ -subdivision  $S$ , such that at least 3 special vertices of  $U$  cause a distant problem on  $S$ . For each configuration, we describe a new semi-subdivision  $S'$ . The routing operation is applied to  $S'$  for all unsettled special vertices.*

*We provide for each configuration a subdivision composite rule made up of  $\mathcal{C}_V$  and  $\mathcal{C}_N$  patterns. We justify for each rule that the mapping is compatible w.r.t.  $S'$ .*

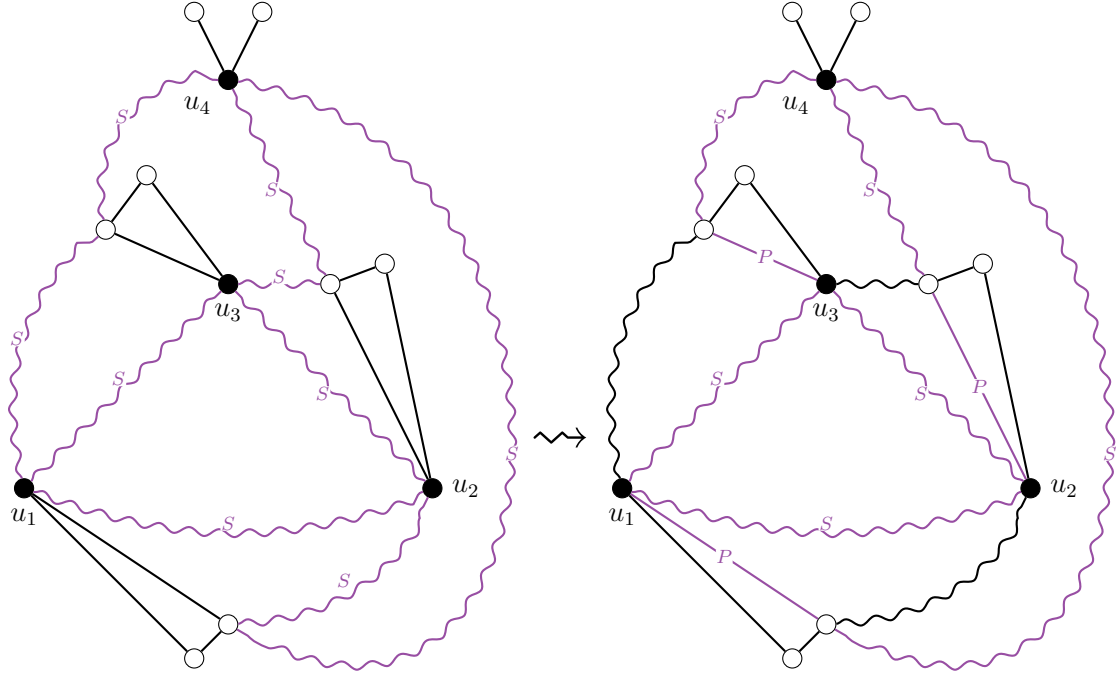

Figure 4.11: Semi-subdivision of  $D_1$

### Configuration $D_1$

Properties:

- The graph has a strong  $K_4$ -subdivision  $S$  rooted on  $u_1, u_2, u_3, u_4$
- $u_1$  causes a distant problem on the path  $u_2 \sim u_4$ : it has a remaining neighbor  $v_1$  such that  $u_2 \sim u_4 = (P_2^1, v_1, P_4^1)$
- $u_2$  causes a distant problem on the path  $u_3 \sim u_4$ : it has a remaining neighbor  $v_2$  such that  $u_3 \sim u_4 = (P_3^2, v_2, P_4^2)$
- $u_3$  causes a distant problem on the path  $u_1 \sim u_4$ : it has a remaining neighbor  $v_3$  such that  $u_1 \sim u_4 = (P_1^3, v_3, P_4^3)$

We transform the  $K_4$ -subdivision  $S$  into another  $K_4$ -subdivision  $S'$ , by removing the paths  $u_1 \sim u_4$ ,  $u_2 \sim u_4$ ,  $u_3 \sim u_4$ , and adding the paths  $(u_1, v_1, P_4^1)$ ,  $(u_2, v_2, P_4^2)$ ,  $(u_3, v_3, P_4^3)$ .

After the routing operation is applied, all unsettled special vertices are turned into  $\mathcal{C}_V$  patterns.

Note that  $u_4$  could not form a  $\mathcal{C}'_V$  pattern in  $S$  by property A and planarity, hence stays lone-settled in  $S'$ .

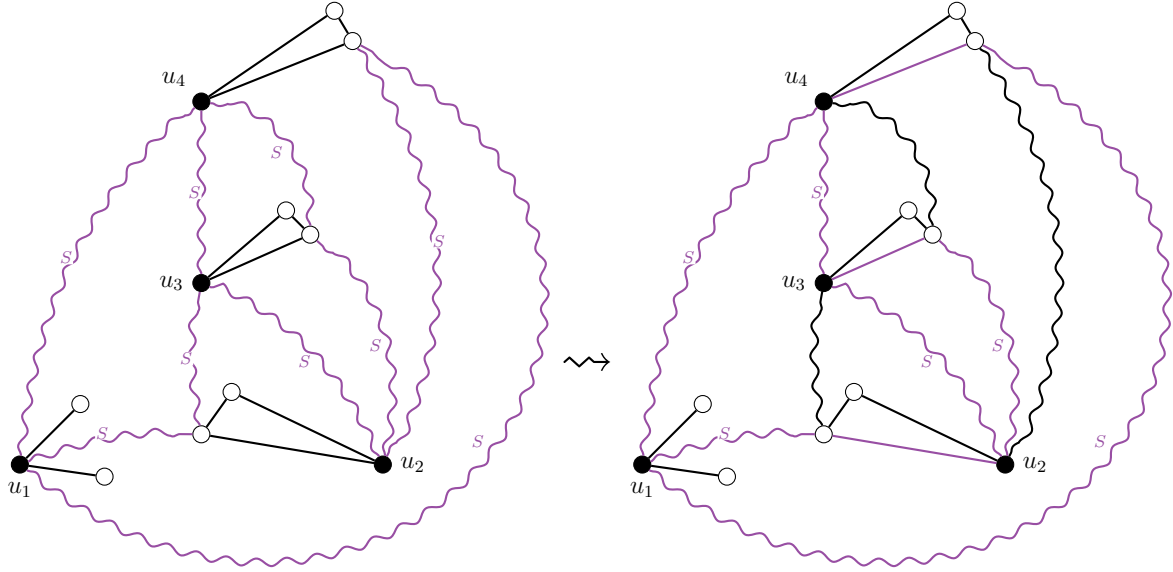

Figure 4.12: Semi-subdivision of  $D_2$

### Configuration $D_2$

Properties:

- The graph has a strong  $K_4$ -subdivision  $S$  rooted on  $u_1, u_2, u_3, u_4$
- $u_2$  causes a distant problem on the path  $u_1 \sim u_3$ : it has a remaining neighbor  $v_2$  such that  $u_1 \sim u_3 = (P_1^2, v_2, P_3^2)$
- $u_3$  causes a distant problem on the path  $u_2 \sim u_4$ : it has a remaining neighbor  $v_3$  such that  $u_2 \sim u_4 = (P_2^3, v_3, P_4^3)$
- $u_4$  causes a distant problem on the path  $u_1 \sim u_2$ : it has a remaining neighbor  $v_4$  such that  $u_1 \sim u_2 = (P_1^4, v_4, P_2^4)$

We transform the  $K_4$ -subdivision  $S$  into a  $C_{4+}$ -subdivision  $S'$ , by removing the paths  $u_1 \sim u_2$ ,  $u_1 \sim u_3$  and  $u_2 \sim u_4$ , and adding the paths  $(u_2, v_2, P_1^2, u_1)$ ,  $(u_3, v_3, P_2^3, u_2)$ ,  $(u_4, v_4, P_1^4, u_1)$ .

After the routing operation is applied, all unsettled special vertices are turned into  $\mathcal{C}_V$  patterns.

Note that  $u_1$  could only form a  $\mathcal{C}'_V$  pattern in  $S$  on the path  $u_3 \sim u_4$  by property A and planarity, and this path was not modified in  $S'$ . Hence,  $u_1$  remains lone-settled in  $S'$ .

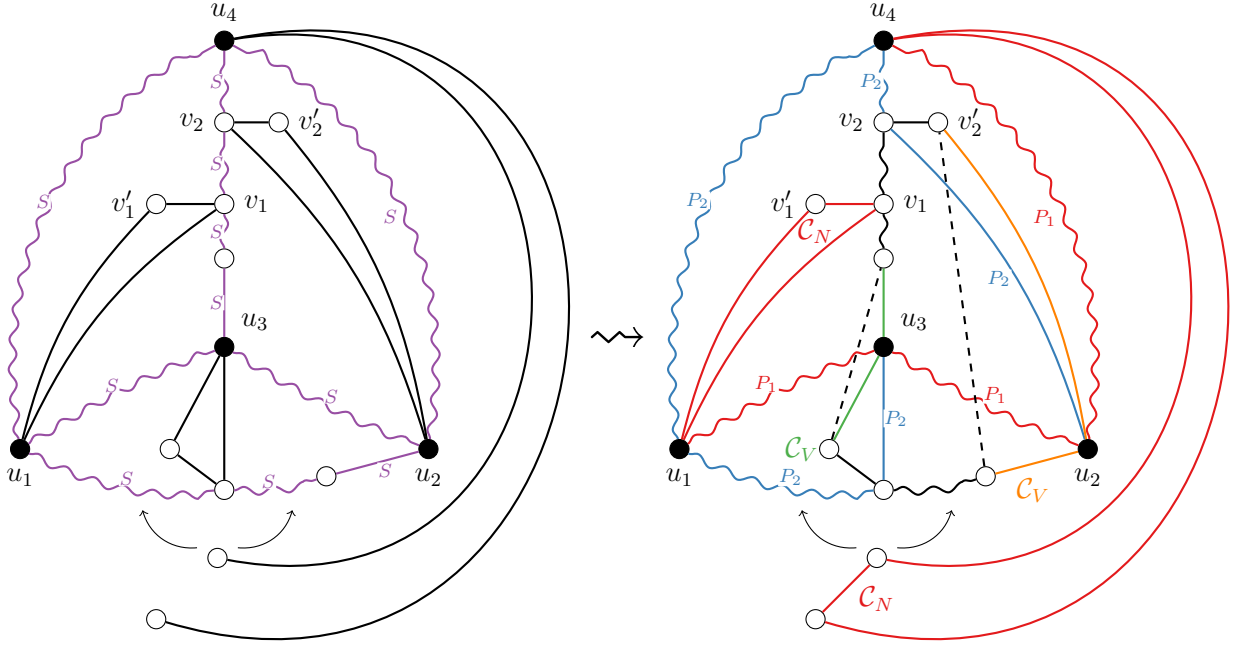

Figure 4.13: Reduction of configuration  $D_3$

### Configuration $D_3$

Properties:

- The graph has a strong  $K_4$ -subdivision  $S$  rooted on  $u_1, u_2, u_3, u_4$
- $u_1$  and  $u_2$  cause distant problems on the path  $u_3 \sim u_4$ : they have remaining neighbors  $v_1, v_2$  respectively, such that  $u_3 \sim u_4 = (P_3^{12}, v_1, P_4^{12}, v_2, P_4^{12})$
- $u_3$  causes a distant problem on the path  $u_1 \sim u_2$ : it has a remaining neighbor  $v_3$  such that  $u_1 \sim u_2 = (P_1^3, v_3, P_2^3)$
- Remark:  $u_4$  may cause a distant problem on  $u_1 \sim u_2$ ; it has a remaining neighbor  $v_4$  that may belong to  $P_1^3$  or  $P_2^3$

We transform the  $K_4$ -subdivision  $S$  into a  $C_{4+}$ -subdivision  $S'$  by removing the paths  $u_1 \sim u_2$  and  $u_3 \sim u_4$ , and adding the paths  $(u_1, P_1^3, v_3, u_3)$  and  $(u_2, v_2, P_4^{12}, u_4)$ . We consider the following 2-coloring of  $S'$ :  $\{red = (u_1 \rightarrow u_3 \rightarrow u_2 \rightarrow u_4), blue = (u_2 \rightarrow v_2 \rightarrow u_4 \rightarrow u_1 \rightarrow v_3 \rightarrow u_3)\}$ . There is no need to apply the routing operation.

The special vertex  $u_3$  is turned into a  $C_V$  pattern.

The special vertices  $u_1, u_4$  are treated as  $C_N$  patterns. The  $C_N$  pattern of  $u_4$  may cause a distant problem on the new path  $(u_1, P_1^3, v_3, u_3)$ , but this path is colored blue and  $u_4$  uses the color red, hence the distant problem is inactive.

The patterns used are  $C_N(u_1), C_V(u_2), C_N(u_3), C_N(u_4)$ .

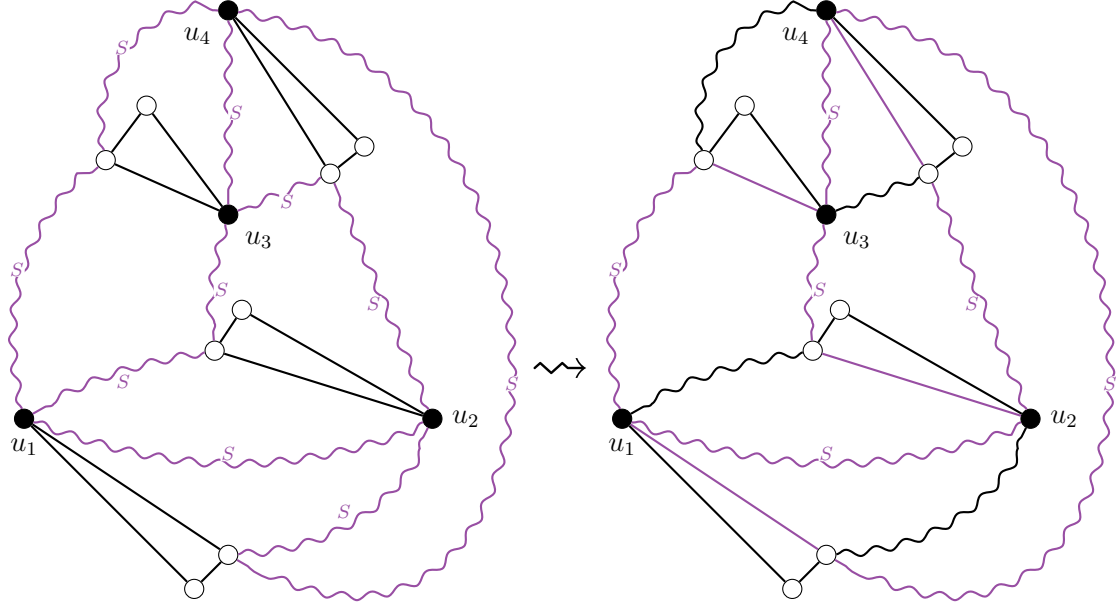

Figure 4.14: Semi-subdivision of  $D_4$

### Configuration $D_4$

Properties:

- The graph has a strong  $K_4$ -subdivision  $S$  rooted on  $u_1, u_2, u_3, u_4$
- $u_1$  causes a distant problem on the path  $u_2 \sim u_4$ : it has a remaining neighbor  $v_1$  such that  $u_2 \sim u_4 = (P_2^1, v_1, P_4^1)$
- $u_2$  causes a distant problem on the path  $u_1 \sim u_3$ : it has a remaining neighbor  $v_2$  such that  $u_1 \sim u_3 = (P_1^2, v_2, P_3^2)$
- $u_3$  causes a distant problem on the path  $u_1 \sim u_4$ : it has a remaining neighbor  $v_3$  such that  $u_1 \sim u_4 = (P_1^3, v_3, P_4^3)$
- $u_4$  causes a distant problem on the path  $u_2 \sim u_3$ : it has a remaining neighbor  $v_4$  such that  $u_2 \sim u_3 = (P_2^4, v_4, P_3^4)$

We transform the  $K_4$ -subdivision  $S$  into another  $K_4$ -subdivision  $S'$  by keeping the paths  $u_1 \sim u_2$  and  $u_3 \sim u_4$  from  $S$  and adding the paths  $(u_1, v_1, P_4^1, u_4)$ ,  $(u_2, v_2, P_3^2, u_3)$ ,  $(u_3, v_3, P_1^3, u_1)$ ,  $(u_4, v_4, P_2^4, u_2)$ .

By planarity and definition of distant problem, the routing operation does not need to be applied for all the special vertices to be turned into  $\mathcal{C}_V$  patterns.

The following lemma shows how a planar graph with  $(C_{II})$  configuration can be treated with one of the distant configurations if the associated subdivision has at least three distant problems.

**Lemma 4.5.5** (Distant lemma). *Let  $G$  be a planar graph with a  $(C_{II})$  configuration w.r.t. a 4-family  $U$ , with a strong  $\mathcal{K}$ -subdivision  $S$  rooted on  $U$ . If  $G$  has at least 3 distant problems w.r.t.  $S$ , then  $G$  contains a configuration among  $\{D_1, D_2, D_3, D_4\}$ .*

*Proof.* If  $S$  is a  $C_{4+}$ -subdivision, we may assume that  $G$  does not have a  $K_4$ -subdivision rooted on  $U$ . Then Claim 4.5.3 (p. 99) tells us that  $S$  cannot have 3 distant problems or more, which contradicts our hypothesis. Hence  $S$  is a  $K_4$ -subdivision.

Let us call  $i$ -path a path of  $S$  that touches exactly  $i$  triangles of special vertices. We consider the three quantities, for  $i \in \{0, 1, 2\}$ ,  $p_i := |\{i\text{-paths}\}|$ . By property A, a special

vertex  $u$  can only cause a distant problem on one of the three paths of  $S$  that are not incident with it: we call these paths the *potential paths* of  $u$ . For the same reasons, a path of  $S$  can touch at most 2 triangles of special vertices.

We have  $p_0 + p_1 + p_2 = 6$  and  $p_1 + 2p_2 = \text{number of distant problems} = 3$  or  $4$ . Hence we need to consider five cases, depending on whether there are 3 or 4 distant problems and on the values the  $p_i$  parameters.

- **3 distant problems**,  $p_1 = 3$ ,  $p_2 = 0$ . We have  $p_0 = 3$ . If all three 0-paths are incident with say  $u_4$ , then there cannot be three 1-paths. Indeed,  $u_3$  would have to cause a distant problem on  $u_1 \sim u_2$ , then by planarity none of  $u_1, u_2$  could cause a distant problem on  $u_2 \sim u_3, u_1 \sim u_3$  respectively.

Now let us assume that the three 0-paths form a subdivision of a triangle rooted on  $\{u_1, u_2, u_3\}$ . Thus  $u_4$  cannot cause any distant problem. The three 1-paths are  $u_1 \sim u_4, u_2 \sim u_4, u_3 \sim u_4$ . Let us say w.l.o.g. that  $u_3$  causes a distant problem on  $u_1 \sim u_4$ . Thus by planarity  $u_2$  causes a distant problem on  $u_3 \sim u_4$ , and  $u_1$  causes a distant problem on  $u_2 \sim u_4$ . This is the configuration  $D_1$ .

Let us finally assume that the three 0-paths form a subdivision of a path on three edges, rooted on  $U$ . Let us say that the 0-paths are  $u_1 \sim u_4, u_3 \sim u_4, u_2 \sim u_3$ . The path  $u_2 \sim u_4$  touches the triangle of either  $u_1$  or  $u_3$ . If it touches the triangle of  $u_3$ , then  $u_1$  cannot cause any distant problem (as its two other potential paths are 0-paths), thus in this case both  $u_2$  and  $u_4$  cause a distant problem. There is only one possibility for  $u_2$ : it causes a distant problem on  $u_1 \sim u_3$ ; then there is only one possibility for  $u_4$ , the path  $u_1 \sim u_2$ . This is the configuration  $D_2$ . Now assume that instead,  $u_2 \sim u_4$  touches the triangle of  $u_1$ . By planarity and property A, only  $u_3$  can touch the 1-path  $u_1 \sim u_2$ . Again by planarity, only  $u_4$  can touch the 1-path  $u_1 \sim u_3$ . This case is equivalent to  $D_2$ :  $(u_1, u_2, u_3, u_4)$  in  $D_2$  correspond to  $(u_2, u_1, u_4, u_3)$  in this case, in this order.

- **3 distant problems**,  $p_1 = 1$ ,  $p_2 = 1$ . We have  $p_0 = 4$ : the four 0-paths can only either form a subdivision of the “paw” graph (a triangle with an additional edge attached to one vertex) or a subdivision of the cycle on four vertices. We can easily see that the first case is impossible: let us say the non-0-paths are  $u_1 \sim u_2, u_1 \sim u_3$ ; there must be a path that touches two triangles of  $U$ , say it is  $u_1 \sim u_2$ , that necessarily touches the triangles of  $u_3$  and  $u_4$ . Then by planarity, the path  $u_1 \sim u_3$  cannot touch the triangle of  $u_2$  and thus cannot be a 1-path. Hence the 0-paths cannot form a paw.

Now let us assume that the 0-paths are  $u_1 \sim u_3, u_2 \sim u_3, u_1 \sim u_4, u_2 \sim u_4$ . Let us assume w.l.o.g. that each of  $u_1, u_2$  causes a distant problem on  $u_3 \sim u_4$ , and  $u_3$  causes a distant problem on  $u_1 \sim u_2$ . This case can be treated as configuration  $D_3$ .

- **4 distant problems**,  $p_1 = 4$ ,  $p_2 = 0$ . We have  $p_0 = 2$ , so the two 0-paths can either be incident on one vertex or disjoint. Let us consider the first case. Assume that  $u_1 \sim u_4, u_2 \sim u_4$  are the 0-paths; the other four paths are 1-paths and must each touch one triangle of  $U$ , so all of  $u_1, u_2, u_3, u_4$  cause a distant problem. The vertex  $u_3$  causes a distant problem on  $u_1 \sim u_2$ , as it is its only potential path. Then w.l.o.g.  $u_4$  causes a distant problem on  $u_2 \sim u_3$ , and  $u_1$  can only cause a distant problem on  $u_3 \sim u_4$ . Finally, by planarity the triangle of  $u_2$  cannot touch the path  $u_1 \sim u_3$ , its only potential path left. Hence, the 0-paths cannot be incident.

Now let us assume that the two 0-paths are  $u_1 \sim u_2, u_3 \sim u_4$ . Assume w.l.o.g. that  $u_1$  causes a distant problem on  $u_2 \sim u_4$ . Then  $u_3$  causes a distant problem on  $u_1 \sim u_4$  as it is its last potential path. In the same way,  $u_2$  causes a distant problem on  $u_1 \sim u_3$  and  $u_4$  on  $u_2 \sim u_3$ . This is the configuration  $D_4$ .

- **4 distant problems**,  $p_1 = 2$ ,  $p_2 = 1$ . Let us assume that  $u_1$  and  $u_2$  cause distant problems on the same 2-path  $u_3 \sim u_4$ . By planarity, the triangle of  $u_3$  can only reach the path  $u_1 \sim u_2$ , and so does the triangle of  $u_4$ . Therefore, there cannot be two distinct 1-paths. Hence, this case is impossible.
- **4 distant problems**,  $p_1 = 0$ ,  $p_2 = 2$ . If we assume that the path  $u_3 \sim u_4$  touches the triangles of  $u_1$  and  $u_2$ , then necessarily the path  $u_1 \sim u_2$  touches the triangles of  $u_3$  and  $u_4$ . This is again configuration  $D_3$ .

This concludes the proof. □

## 4.6 Semi-distant configurations

We can now focus on the cases where the subdivision has up to 2 distant problems. Let us define another type of problem that we have to deal with in order to finish the proof of Lemma 4.4.2 (p. 98).

**Definition 4.6.1** (Close problem). *Let  $G$  be a planar graph with a 4-family  $U$  and let  $S$  be a  $\mathcal{K}$ -subdivision rooted on  $U$ . A special vertex  $u \in U$  causes a close problem if it is unsettled w.r.t.  $S$  and shares at least one of its remaining neighbors with at least one other unsettled special vertex.*

Note that by definition there are either zero or at least two special vertices causing a close problem; there cannot be a single special vertex causing a close problem on its own. Also, note that by definition, an unsettled special vertex that does not cause a distant nor a close problem forms a  $\mathcal{C}_N$  pattern that is disjoint from  $S$  and that touches only  $\mathcal{C}_V$  patterns, hence its reduction rule can be applied safely.

Let us first deal with subdivisions that have at most 2 distant problems and no close problem, with the following *semi-distant configurations* and their associated subdivision composite rules. We will then deal with subdivisions with close problems in Section 4.7.

### List of the semi-distant configurations:

*The semi-distant configurations are the configurations  $J_1, J_2, J_3, J_4, J_5, J_6$  listed below.*

*Each configuration describes a 4-family  $U$  and a strong  $\mathcal{K}$ -subdivision  $S$ , such that at most 2 special vertices of  $U$  cause a distant problem on  $S$ , and none cause close problems. For each configuration, we describe a new semi-subdivision  $S'$ . The routing operation is not applied to  $S'$  unless stated otherwise.*

*We provide for each configuration a subdivision composite rule. We justify for each rule that the mapping is compatible w.r.t.  $S'$ .*



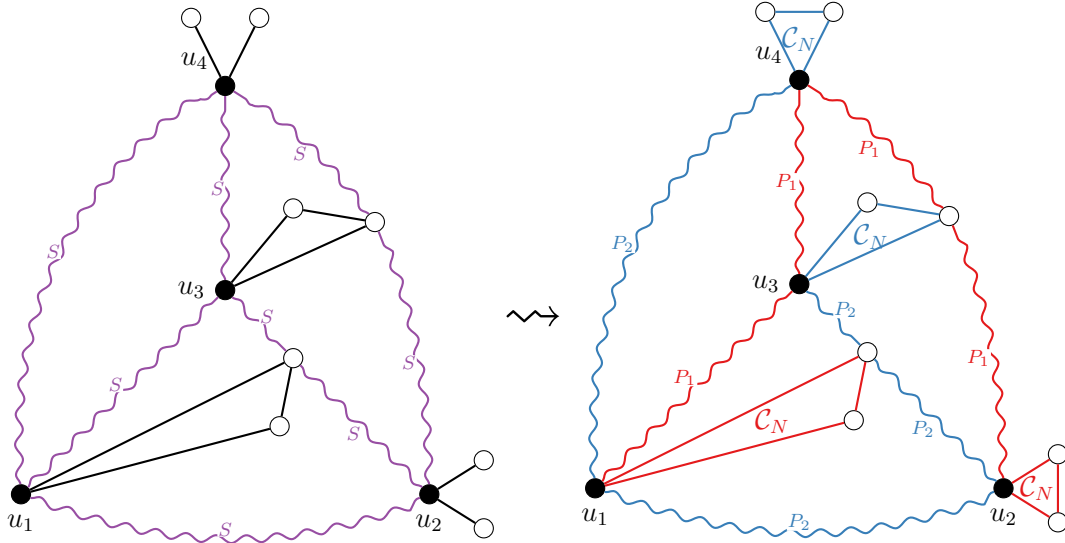

Figure 4.15:  $J_1$  in a case where  $u_1$  and  $u_3$  cause distant problems

### Configuration $J_1$

Properties:

- The graph has a strong  $K_4$ -subdivision  $S$  rooted on  $u_1, u_2, u_3, u_4$
- At most 2 special vertices cause distant problems
- If there are two distant problems, they are not on the same path of  $S$
- The special vertices that do not cause distant problems are settled

We consider a 2-coloring of  $S$  given by Claim 4.5.2 (p. 99) to inactivate the two potential distant problems.

The patterns used are  $\mathcal{C}_N$  for all special vertices.

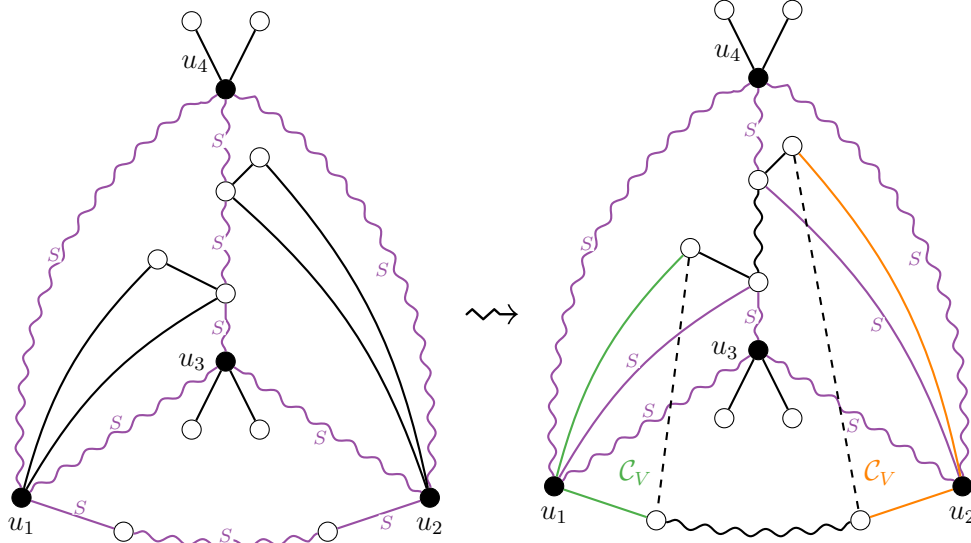

Figure 4.16:  $J_2$  in a case where the length of  $u_1 \sim u_2$  is at least 2

### Configuration $J_2$

Properties:

- The graph has a strong  $K_4$ -subdivision  $S$  rooted on  $u_1, u_2, u_3, u_4$
- $u_1$  and  $u_2$  cause distant problems on the path  $u_3 \sim u_4$ : the path  $u_3 \sim u_4 = (u_3, P_1, v_1, P_2, v_2, P_3, u_4)$ , with  $v_1, v_2$  being remaining neighbors of  $u_1, u_2$  respectively, and  $l(P_1), l(P_2), l(P_3) \geq 1$ ; we denote  $v'_1, v'_2$  the other remaining neighbor of  $u_1, u_2$  respectively
- $u_3, u_4$  are settled
- Either  $l(u_1 \sim u_2) \geq 2$  or neither  $u_3$  nor  $u_4$  has  $v'_1, v'_2$  as remaining neighbors
- If  $u_1 \sim u_2$  has length 2 ( $u_1, w, u_2$ ), then  $w$  has at most 1 neighbor among  $u_3, u_4$ , or at least one of  $v'_1, v'_2$  does not have a neighbor in  $\{u_3, u_4\}$

We transform the  $K_4$ -subdivision  $S$  into a  $C_{4+}$ -subdivision  $S'$ , by removing the paths  $u_1 \sim u_2$  and  $u_3 \sim u_4$  from  $S$ , and adding the paths  $(u_1, v_1, P_1, u_3)$  and  $(u_2, v_2, P_3, u_4)$ .

The special vertices  $u_1, u_2$  are thus turned into  $\mathcal{C}_V$  patterns, unless the path  $u_1 \sim u_2$  from  $S$  has length 1, in which case  $u_1, u_2$  form a  $\mathcal{C}_U$  pattern. By the fourth condition of this configuration, neither  $u_3$  nor  $u_4$  has  $v'_1, v'_2$  as remaining neighbors, thus they remain settled (the case where one has  $v'_1, v'_2$  as remaining neighbors is treated as  $J_3$ ).

Instead of  $\mathcal{C}_V$  patterns,  $u_1$  or  $u_2$  may form  $\mathcal{C}_{T2NA}$  patterns with  $u_3$  or  $u_4$ . If there are two such patterns, for instance  $\mathcal{C}_{T2NA}(u_1, u_3)$  and  $\mathcal{C}_{T2NA}(u_2, u_4)$ , they may only intersect if they have a common vertex in the path  $u_1 \sim u_2$  of  $S$ . By the last condition of the configuration, this is not the case (this case is treated as  $J_4$ ).

The patterns used are  $\mathcal{C}_V(u_1)$ ,  $\mathcal{C}_V(u_2)$ , or  $\mathcal{C}_{T2NA}(u_i, u_j)$  for  $i \in \{1, 2\}$  and  $j \in \{3, 4\}$ , or  $\mathcal{C}_U(u_1, u_2)$ ,  $\mathcal{C}_N(u_3)$ ,  $\mathcal{C}_N(u_4)$ .

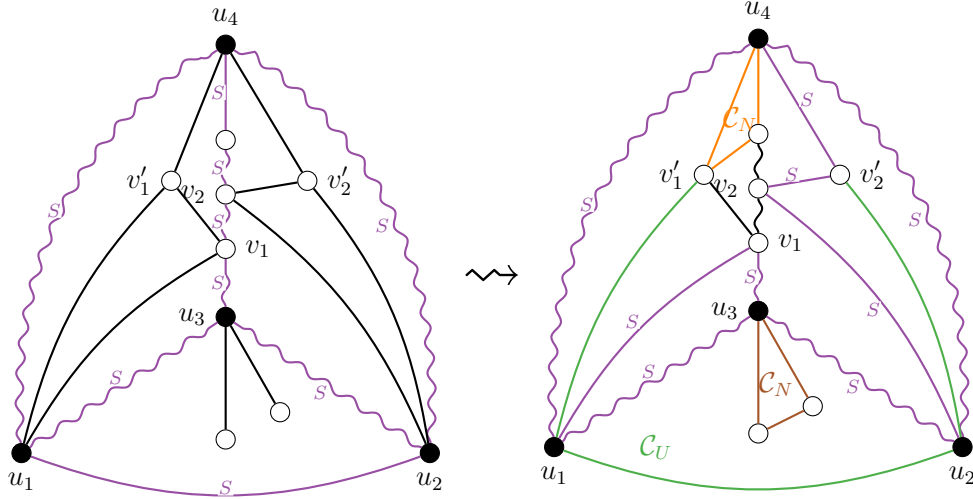

Figure 4.17: Reduction of configuration  $J_3$

### Configuration $J_3$

Properties:

- The graph has a strong  $K_4$ -subdivision  $S$  rooted on  $u_1, u_2, u_3, u_4$
- $u_1$  and  $u_2$  cause distant problems on the path  $u_3 \sim u_4$ : the path  $u_3 \sim u_4 = (u_3, P_1, v_1, P_2, v_2, P_3, u_4)$ , with  $v_1, v_2$  being remaining neighbors of  $u_1, u_2$  respectively, and  $l(P_1), l(P_2), l(P_3) \geq 1$ ; we denote  $v'_1, v'_2$  the other remaining neighbor of  $u_1, u_2$  respectively
- $l(u_1 \sim u_2) = 1$
- $u_4$  has  $v'_1, v'_2$  as remaining neighbors
- $u_3$  is settled

Note that  $u_4$  is initially settled, but the rule that follows changes its  $\mathcal{C}_V$  nature into a  $\mathcal{C}_N$  one.

We transform the  $K_4$ -subdivision  $S$  into a  $\mathcal{C}_{4+}$ -subdivision  $S'$ , by removing the paths  $u_1 \sim u_2$  and  $u_3 \sim u_4$  from  $S$ , and adding the paths  $(u_1, v_1, P_1, u_3)$  and  $(u_2, v_2, v'_2, u_4)$ .

The special vertices  $u_1, u_2$  are thus turned into a  $\mathcal{C}_U$  pattern, while  $u_4$  is turned into a  $\mathcal{C}_N$ . If  $v_2$  is adjacent to  $u_4$ , it becomes one of its remaining neighbors in  $S'$ , and in this case  $u_4$  causes a distant problem. We inactivate this problem by maybe swapping the colors of the paths  $u_2 \sim u_4$  and  $(u_2, v_2, v'_2, u_4)$  in a 2-coloring of  $S'$ .

The patterns used are  $\mathcal{C}_U(u_1, u_2)$ ,  $\mathcal{C}_N(u_3)$ ,  $\mathcal{C}_N(u_4)$ .

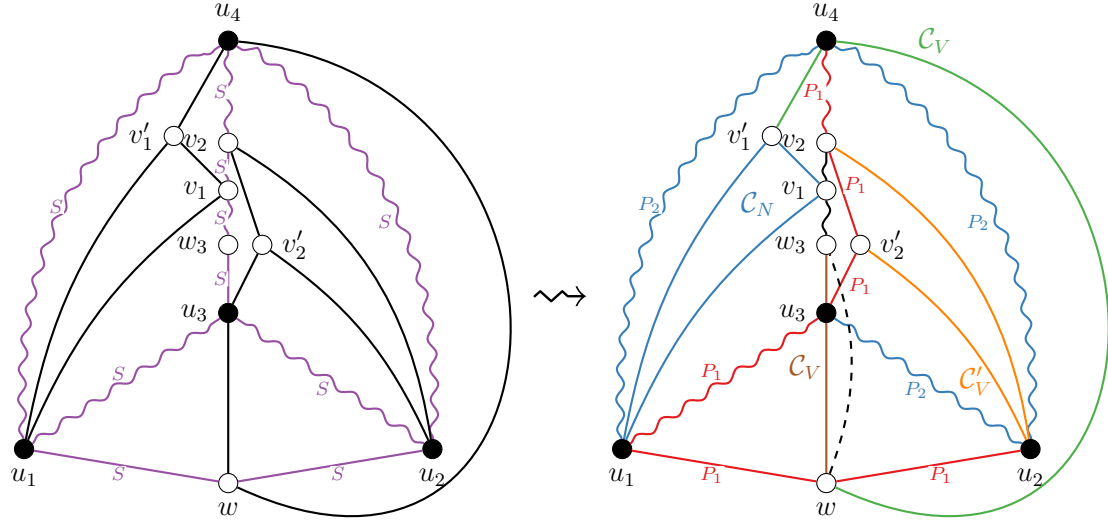

Figure 4.18: Reduction of configuration  $J_4$ . Example of a 2-coloring of  $S'$

### Configuration $J_4$

Properties:

- The graph has a strong  $K_4$ -subdivision  $S$  rooted on  $u_1, u_2, u_3, u_4$
- $u_1$  has two adjacent remaining neighbors  $v_1, v_1'$ , with  $v_1 \in u_3 \sim u_4$
- $u_2$  has two adjacent remaining neighbors  $v_2, v_2'$  with  $v_2 \in u_3 \sim u_4$
- $v_1, v_2$  may be equal, or come in any order on  $u_3 \sim u_4$
- $u_1 \sim u_2$  has length 2: call the third vertex  $w$
- $u_3$  has  $v_2', w$  as remaining neighbors
- $u_4$  has  $v_1', w$  as remaining neighbors

We transform the  $K_4$ -subdivision  $S$  into another  $K_4$ -subdivision  $S'$  by replacing the path  $u_3 \sim u_4$  by the path  $(u_3, v_2', v_2, \dots, u_4)$ . The vertices  $u_3, u_4$  are turned into  $\mathcal{C}_V$  patterns and  $u_2$  into a  $\mathcal{C}'_V$  pattern. Depending on the order of  $v_1, v_2$  on the path  $u_3 \sim u_4$  of  $S$ ,  $u_1$  forms a  $\mathcal{C}_N$  that may cause a distant problem on the new path  $(u_3, v_2', v_2, \dots, u_4)$ . We consider a coloring of  $S'$  given by Claim 4.5.2 (p. 99) to inactivate it.

The patterns used are  $\mathcal{C}_N(u_1), \mathcal{C}'_V(u_2), \mathcal{C}_V(u_3), \mathcal{C}_V(u_4)$ .

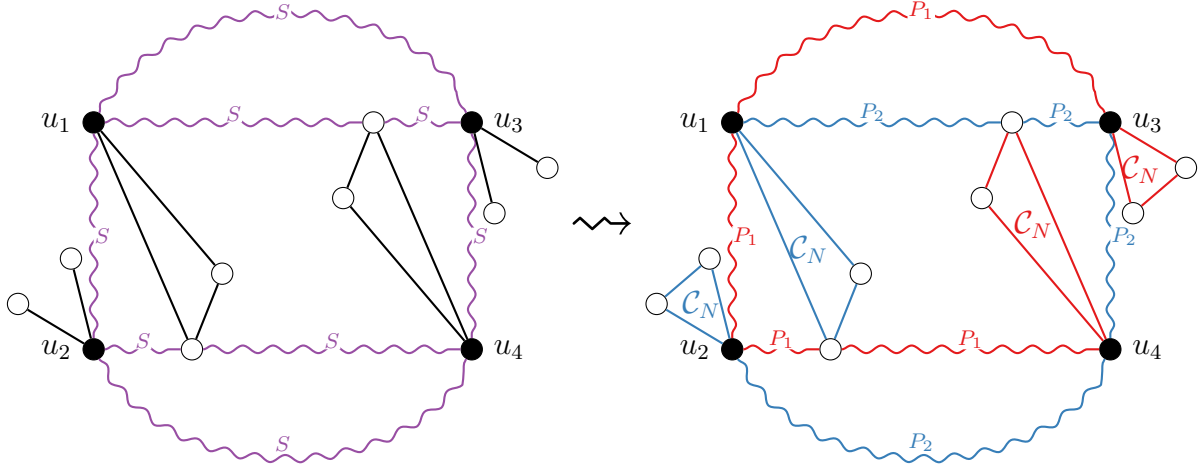

Figure 4.19:  $J_5$  when  $u_1$  and  $u_4$  cause distant problems

### Configuration $J_5$

Properties:

- The graph has a strong  $\mathcal{C}_{4+}^*$ -subdivision  $S$  rooted on  $u_1, u_2, u_3, u_4$ , such that  $u_1, u_2$  are 1-linked and  $u_1, u_3$  are 2-linked
- There are at most 2 distant problems: if there is at least one, we may assume w.l.o.g. that  $u_1$  causes a distant problem on a  $(u_2, u_4)$ -path  $P_{24}$
- $u_2$  is settled
- $u_3$  is settled or causes a distant problem on the  $(u_2, u_4)$ -path  $P'_{24}$  of  $S$  different from  $P_{24}$

We consider a 2-coloring of  $S$  that inactivates the distant problems:  $\{red = (u_3 \rightarrow u_1 \rightarrow u_2 \rightarrow u_4), blue = (u_1 \rightarrow u_3 \rightarrow u_4 \rightarrow u_2)\}$  in such a way that  $P_{24}$  receives the color red. The distant problem of  $u_1$  is thus inactivated. Since the colors ending on  $u_1$  and  $u_3$  are different, and since the colors of  $P_{24}$  and  $P'_{24}$  are different, the potential distant problem of  $u_3$  is inactivated. If  $u_4$  causes a distant problem instead, we inactivate it by maybe swapping the colors of the two paths between  $u_1$  and  $u_3$ .

The patterns used are  $\mathcal{C}_N$  for all the special vertices, or possibly  $\mathcal{C}_{T2NA}(u_1, u_2)$  and  $\mathcal{C}_{T2NA}(u_3, u_4)$ .

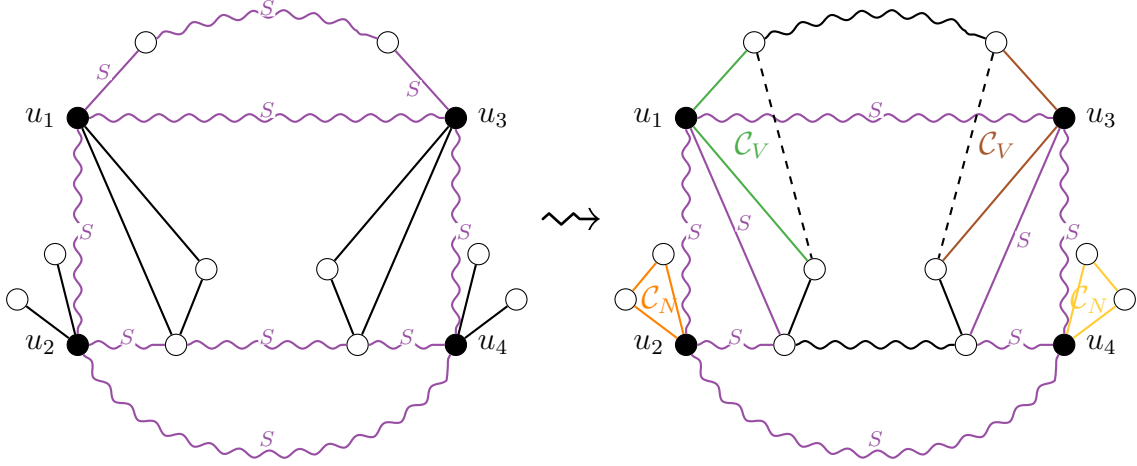

Figure 4.20: Reduction of configuration  $J_6$

### Configuration $J_6$

Properties:

- The graph has a strong  $C_{4+}^*$ -subdivision  $S$  rooted on  $u_1, u_2, u_3, u_4$ , such that  $u_1, u_2$  are 1-linked and  $u_1, u_3$  are 2-linked
- $u_1$  and  $u_3$  cause distant problems on a path  $P_{24}$  between  $u_2$  and  $u_4$
- $u_2$  and  $u_4$  are settled and their remaining neighbors are disjoint from  $S$

Assume w.l.o.g. that the path  $P_{24} = (u_2, Q_1, v_1, Q_2, v_3, Q_3, u_4)$ , where  $v_1, v_3$  are remaining neighbors of  $u_1, u_3$  respectively, and  $l(Q_1), l(Q_2), l(Q_3) \geq 1$ . Each of  $u_1, u_3$  has another remaining neighbor  $v'_1, v'_3$  respectively, adjacent to  $v_1, v_3$  respectively. The vertices  $v'_1, v'_3$  belong to a region of the graph delimited by the four paths  $P_{24}$ ,  $u_1 \sim u_2$ ,  $u_3 \sim u_4$  and a path  $P_{13}$  of  $S$  between  $u_1$  and  $u_3$ . Let  $P'_{13}$  be the other path of  $S$  between  $u_1$  and  $u_3$ . We transform the  $C_{4+}$ -subdivision  $S$  into another  $C_{4+}$ -subdivision  $S'$ , by removing the paths  $P'_{13}$  and  $P_{24}$ , and adding the paths  $(u_1, v_1, Q_1, u_2)$  and  $(u_3, v_3, Q_3, u_4)$ .

The remaining neighbors of  $u_1$  (resp.  $u_3$ ) w.r.t.  $S'$  are non-adjacent, and since the remaining neighbors of  $u_2$  (resp.  $u_4$ ) are disjoint from  $S$ ,  $(u_1, u_2)$  (resp.  $(u_3, u_4)$ ) cannot form a  $C_{T2NA}$  pattern.

The special vertices  $u_1, u_3$  are thus turned into  $C_V$  patterns, unless the path  $P'_{13}$  has length 1, in which case they form a  $C_U$  pattern. In the latter case, by property “0-linked”, none of  $u_2, u_4$  can have both  $v'_1, v'_3$  as remaining neighbors, and by property “2-linked”, the remaining neighbors of  $u_2, u_4$  are disjoint, so  $u_2$  and  $u_4$  remain settled w.r.t.  $S'$ .

The patterns used are  $C_V(u_1)$ ,  $C_N(u_2)$ ,  $C_V(u_3)$ ,  $C_N(u_4)$ , or  $C_U(u_1, u_3)$ .

The following lemma shows that we can treat any subdivision that has at most 2 distant problems and no close problem with one of the semi-distant configurations.

**Lemma 4.6.2** (Semi-distant lemma). *Let  $G$  be a planar graph with a  $(C_{II})$  configuration w.r.t. a 4-family  $U$ , with a strong  $\mathcal{K}$ -subdivision  $S$  rooted on  $U$ . If  $G$  has at most 2 distant problems and no close problem w.r.t.  $S$ , then  $G$  contains a configuration among  $\{J_1, J_2, J_3, J_4, J_5, J_6\}$ .*

*Proof.* Let us consider the case where  $S$  is a  $K_4$ -subdivision. If it has at most one distant problem, or two distant problems on different paths of  $S$ , then this is configuration  $J_1$ . If  $u_1, u_2 \in U$  both cause distant problems on the same path  $u_3 \sim u_4$  of  $S$ , then we distinguish between 3 cases. Let  $v_1, v_2$  be the remaining neighbors of  $u_1, u_2$  respectively that are on the path  $u_3 \sim u_4$ , and let  $v'_1, v'_2$  be their other remaining neighbors. If  $l(u_1 \sim u_2) = 1$  and  $u_3$  or  $u_4$  has both  $v'_1, v'_2$  as remaining neighbors, then this is configuration  $J_3$ . If  $l(u_1 \sim u_2) = 2$ , with  $w$  as the middle vertex,  $w$  is adjacent to  $u_3$  and  $u_4$ , and  $v'_1, v'_2$  are remaining neighbors of  $u_3$  or  $u_4$ , then this is configuration  $J_4$ . Otherwise, this is configuration  $J_2$ .

Now let us consider the case where  $S$  is a  $C_{4+}$ -subdivision. By property “1-linked” and property A of  $S$ , the distant problems occur on parallel paths of  $S$ . Thus, if there is at most one distant problem, this is configuration  $J_5$ . By Claim 4.5.3 (p. 99), two distant problems cannot be caused by 1-linked special vertices. Therefore, if there are two distant problems on different paths of  $S$ , then this is configuration  $J_5$ . If there are two distant problems caused by (w.l.o.g.)  $u_1, u_3$  on the same parallel  $(u_2, u_4)$ -path of  $S$ , by Claim 4.5.3 (p. 99) the remaining neighbors of  $u_2, u_4$  are disjoint from  $S$ , and this is configuration  $J_6$ . This concludes the proof.  $\square$

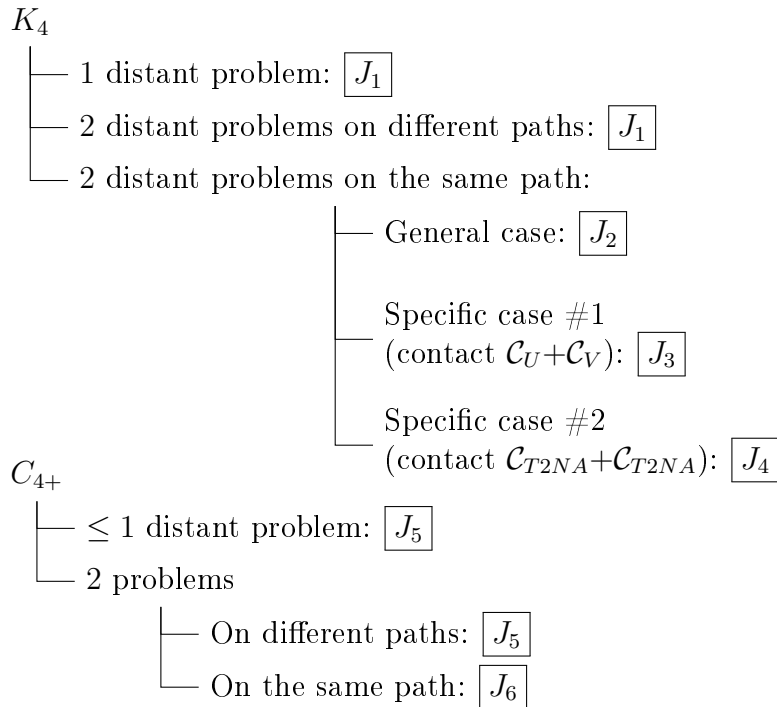

Figure 4.21: Semi-distant lemma trees of cases

## 4.7 Close configurations

For simplicity, we define some macros that encapsulate several patterns and configurations from the redirection procedure.

- $\mathcal{C}_{D1}$ : In this configuration,  $u_1, u_2 \in U$  are linked by a path  $u_1 \sim u_2$  in  $S$ . The vertices  $u_1, u_2$  have a common remaining neighbor  $v$  and have another remaining neighbor  $v_1, v_2$  respectively, both adjacent to  $v$ . The vertices  $v$  and  $v_1$  are disjoint from  $S$ , and if  $v_2$  is in  $S$ , it belongs to a path of  $S$  incident with  $u_1$  and not  $u_2$ .  
First let us assume that  $v_2$  is not in  $S$ . If the path  $u_1 \sim u_2$  has length 1, then it is a  $\mathcal{C}_{Da}$  pattern if  $v_1, v_2$  are not adjacent, or a  $\mathcal{C}_{Db}$  pattern if they are. If  $u_1 \sim u_2$  has length at least two, then this is forbidden by the redirection procedure, as this is a  $\mathcal{C}_{X1}$  or  $\mathcal{C}_{X2}$  configuration depending on whether  $v_1$  is adjacent to the neighbor  $w_1$  of  $u_1$  on  $u_1 \sim u_2$ .  
Now if there is a path  $u_1 \sim u'$  in  $S$  that touches  $v_2$ , with  $u' \neq u_2$ , then it is a  $\mathcal{C}_{X3}$  configuration, forbidden by property C.
- $\mathcal{C}_{D2}$ : The vertices  $u_1, u_2$  are linked by a path  $u_1 \sim u_2$  in  $S$ . The vertices  $u_1, u_2$  have two remaining neighbors  $v, v'$  in common. No path of  $S$  touches  $v, v'$ .  
If  $v, v'$  are not adjacent, then this is  $(\mathcal{C}_{T2NAa})$  or  $(\mathcal{C}_{T2NAb})$  depending on the parity of  $v, v'$ . Now assume  $v, v'$  are adjacent, and let  $l$  be the length of  $u_1 \sim u_2$ . If  $l = 1$ , then  $\{u_1, u_2, v, v'\}$  form an induced  $K_4$ , contradicting the fact that  $G$  has a  $(C_{II})$  configuration by Claim 4.0.2 (p. 73). Then  $l \geq 2$  and this is configuration  $\mathcal{C}_{X4}$  from the redirection procedure, hence forbidden by property C.

To summarize, apart from forbidden configurations removed by the redirection procedure, a  $\mathcal{C}_{D1}$  macro is a  $\mathcal{C}_{Da}$  or  $\mathcal{C}_{Db}$  pattern. A  $\mathcal{C}_{D2}$  is a  $\mathcal{C}_{T2NA}$  pattern and in this case  $u_1, u_2$  are therefore settled if no unsettled special vertex shares remaining neighbors with them. See Figure 4.22.

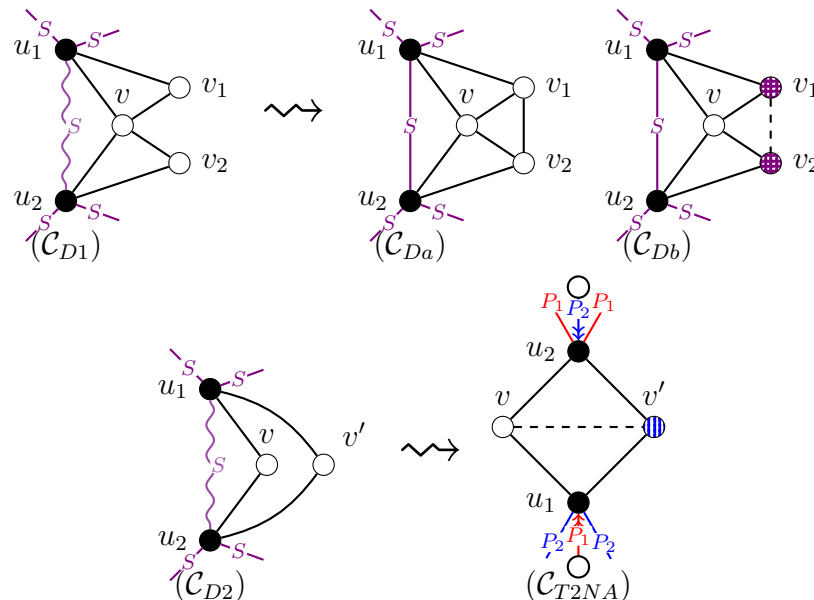

Figure 4.22: Possible patterns for each macro

Let us now introduce the remaining configurations, with which we treat all the cases of  $\mathcal{K}$ -subdivisions with close problems.



**List of the close configurations:**

The close configurations are the configurations  $R_1, \dots, R_9$  listed below.

Each configuration describes a strong  $K$ -subdivision  $S$  rooted on a 4-family  $U = \{u_1, u_2, u_3, u_4\}$ , such that at most two special vertices cause distant problems, and some special vertices cause close problems. We describe for each a subdivision composite rule made up of a semi-subdivision  $S'$  (if not specified,  $S' = S$ ) and a compatible mapping w.r.t.  $S'$ .

**Remark:** When two remaining neighbors of a special vertex form a  $\mathcal{C}_N$  pattern or a  $\mathcal{C}'_V$  pattern, we denote it  $\mathcal{C}_N$  for simplicity. This does not change the case analysis.

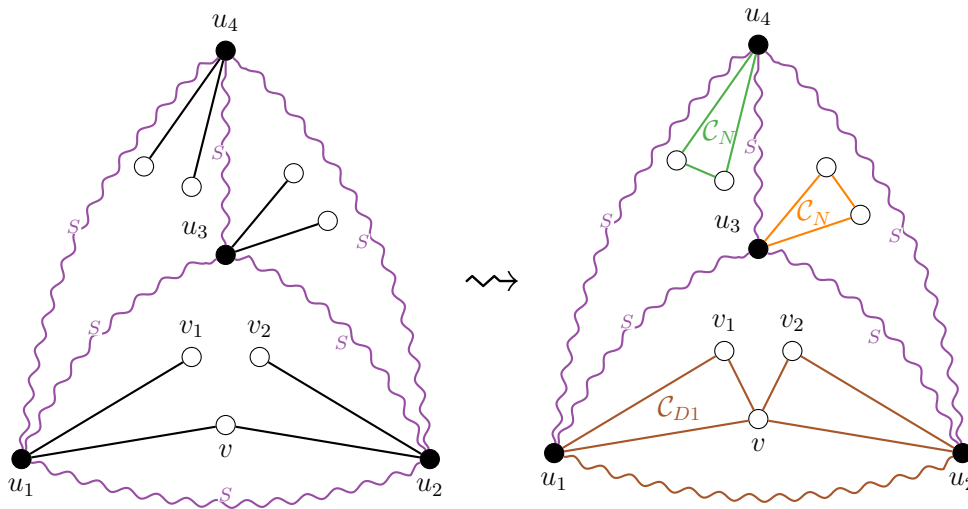

Figure 4.23: Reduction of configuration  $R_1$ .  $u_3, u_4$  may cause distant problems

**Configuration  $R_1$**

Properties:

- The graph has a strong  $K_4$ -subdivision  $S$  rooted on  $u_1, u_2, u_3, u_4$ , with 2 special vertices involved in a close problem:  $u_1, u_2$  share a remaining neighbor  $v$
- $v \notin S$
- $u_1, u_2$  each have another remaining neighbor  $v_1, v_2$  respectively, and  $v_1 \neq v_2$
- Remark: each of  $u_3, u_4$  is either settled or causes a distant problem

We consider a 2-coloring of  $S$  given by Claim 4.5.2 (p. 99) to inactivate the two potential distant problems on  $u_3$  and  $u_4$ . If one of  $v_1, v_2$  is not adjacent to  $v$ , then its associated special vertex forms a  $\mathcal{C}_V$  pattern and is thus settled: a contradiction, as  $u_1$  and  $u_2$  are the ones causing a close problem. Hence  $v_1, v_2$  are both adjacent to  $v$ . The vertices  $u_1$  and  $u_2$  form a  $\mathcal{C}_{D1}$  configuration, hence a  $\mathcal{C}_{Da}$  or  $\mathcal{C}_{Db}$  pattern. Note that  $v_2$  cannot belong to the path  $u_1 \sim u_3$  and  $v_1$  cannot belong to  $u_2 \sim u_3$ , as this would form a  $\mathcal{C}_{X3}$  configuration, forbidden by the redirection procedure.

The patterns used are  $\mathcal{C}_{Da}$  or  $\mathcal{C}_{Db}(u_1, u_2)$ ,  $\mathcal{C}_N(u_3)$ ,  $\mathcal{C}_N(u_4)$ .

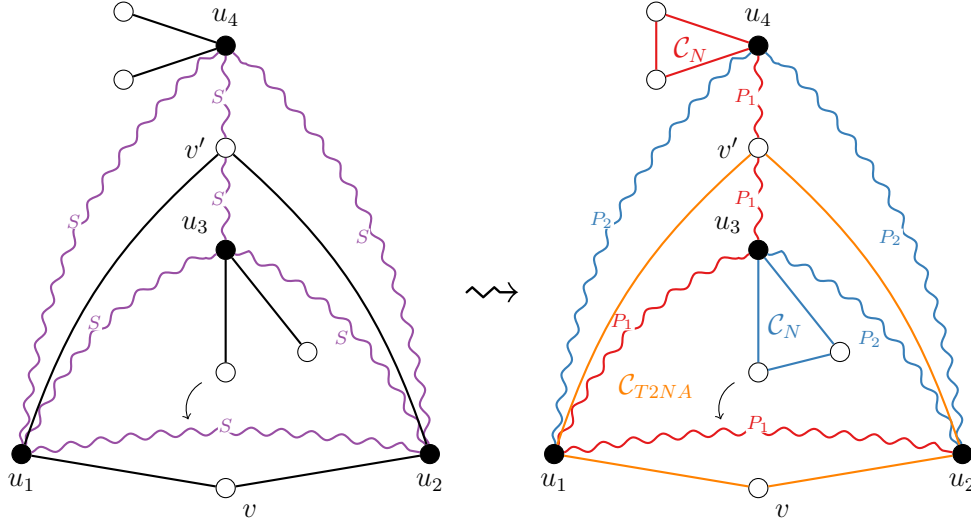

Figure 4.24: Reduction of configuration  $R_2$

### Configuration $R_2$

Properties:

- The graph has a strong  $K_4$ -subdivision  $S$  rooted on  $u_1, u_2, u_3, u_4$ , without distant problems and such that 2 special vertices are involved in a close problem:  $u_1, u_2$  share two remaining neighbors  $v, v'$
- $v \notin S$  and  $v' \in S$
- Remark: each of  $u_3, u_4$  is either settled or causes a distant problem

By planarity and property A, there is at most one distant problem, caused by  $u_3$  or  $u_4$  on the path  $u_1 \sim u_2$ . If it is the case, we assume w.l.o.g. that this is  $u_3$ .

Let us color  $S$  with this 2-coloring:  $\{red = (u_2 \rightarrow u_1 \rightarrow u_3 \rightarrow u_4), blue = (u_1 \rightarrow u_4 \rightarrow u_2 \rightarrow u_3)\}$ . The colors ending on  $u_1, u_2$  are different, so  $u_1, u_2$  form a  $\mathcal{C}_{T2NA}$  pattern that crosses the red path  $u_3 \sim u_4$ . This is authorized by the definition of  $\mathcal{C}_{T2NA}$ . The potential distant problem of  $u_3$  is inactive in this coloring of  $S$ .

The patterns used are  $\mathcal{C}_{T2NA}(u_1, u_2)$ ,  $\mathcal{C}_N(u_3)$  (or  $\mathcal{C}'_V$ ),  $\mathcal{C}_N(u_4)$ .

### Configuration $R_3$

Properties:

- The graph has a strong  $K_4$ -subdivision  $S$
- $u_1, u_2$  each have two remaining neighbors  $v_1, v'_1$  and  $v_2, v'_2$  respectively
- $v_1, v_2$  belong to  $u_3 \sim u_4$ ; by convention  $u_3 \sim u_4 = (u_3, P_1, v_1, P_2, v_2, P_3, u_4)$ , with  $l(P_1), l(P_3) \geq 1$  and  $l(P_2) \geq 0$  (so  $v_1$  may equal  $v_2$ )
- If  $v_1 \neq v_2$ ,  $v'_1, v'_2$  are disjoint from  $S$
- Remark: if  $v_1 = v_2$ , then  $v'_1, v'_2$  may belong to  $u_3 \sim u_4$  and  $v'_1$  may equal  $v'_2$
- If  $v'_1$  (resp.  $v'_2$ ) does not belong to  $S$ , then it is adjacent to  $v_1$  (resp.  $v_2$ )
- $u_3, u_4$  each have two remaining neighbors  $v_3, v'_3$  and  $v_4, v'_4$  respectively
- The path  $u_1 \sim u_2$  does not have length 1
- If  $u_1 \sim u_2$  has length 2, let  $w$  be its middle vertex. Then  $w$  has at most 1 neighbor among  $u_3, u_4$ , or at least one of  $v'_1, v'_2$  does not have a neighbor in  $\{u_3, u_4\}$

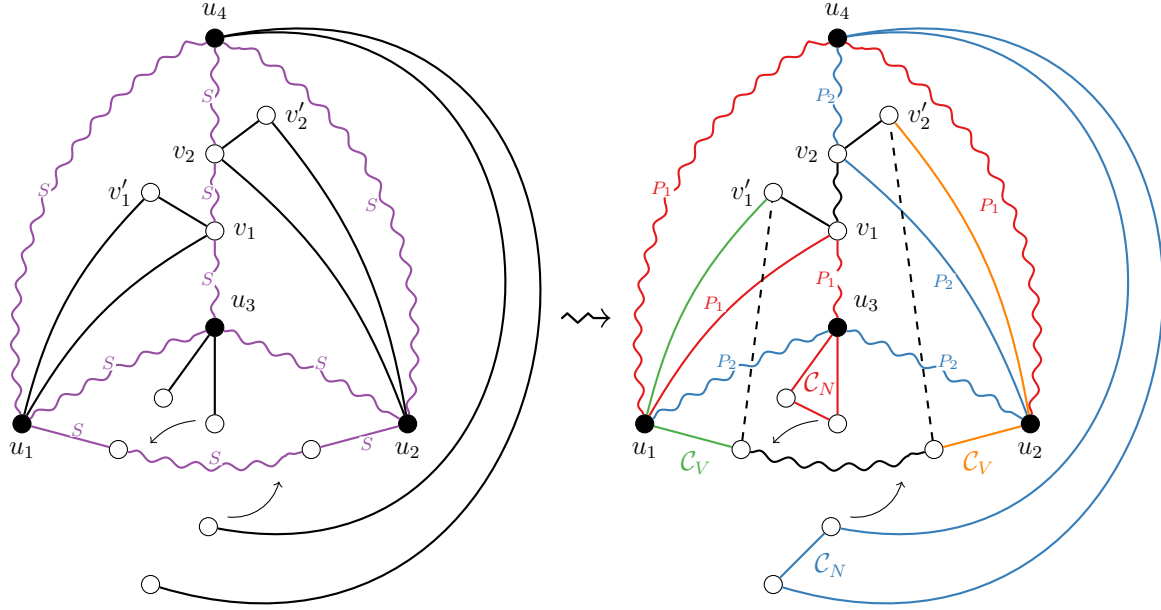

Figure 4.25:  $R_3$  when  $v_1 \neq v_2, v'_1 \neq v'_2$

We transform the  $K_4$ -subdivision  $S$  into a  $C_{4+}$ -semi-subdivision  $S'$  by removing the paths  $u_1 \sim u_2$  and  $u_3 \sim u_4$ , and adding the paths  $(u_1, v_1, P_1, u_3)$  and  $(u_2, v_2, P_2, u_4)$  if  $v_1 \neq v_2$  or if  $v_1 = v_2$  and  $v'_1 \neq v'_2$ . Otherwise, we have  $v_1 = v_2$  and  $v'_1 = v'_2$ , and we assume  $u_3 \sim u_4 = (u_3, Q_1, v'_1, Q_2, v_1, Q_3, u_4)$ . In this case, we add the paths  $(u_1, v'_1, Q_1, u_3)$  and  $(u_2, v_1, Q_3, u_4)$  to  $S'$  instead. This semi-subdivision has two paths that intersect if  $v_1 = v_2$  and  $v'_1 \neq v'_2$  ( $l(P_2) = 0$ ), but it is 2-colorable with the coloring  $\{red = (u_2 \rightarrow u_4 \rightarrow u_1 \rightarrow v_1 \rightarrow u_3), blue = (u_1 \rightarrow u_3 \rightarrow u_2 \rightarrow v_2 \rightarrow u_4)\}$ .

Since the path  $u_1 \sim u_2$  of  $S$  does not have length 1, the special vertices  $u_1, u_2$  form  $C_V$  patterns in  $S'$ .

The special vertices  $u_3, u_4$  may form  $C_{T2NA}$  patterns in  $S'$  with each of  $u_1, u_2$ . These patterns may only touch each other on the path  $u_1 \sim u_2$  from  $S$ , but the last condition of the configuration ensures that this is not the case (this case is treated as configuration  $J_4$ ).

Otherwise, the vertices  $u_3, u_4$  form  $C_N$  patterns if they do not have common remaining neighbors. These  $C_N$  patterns are compatible with the  $C_V$  patterns of  $u_1, u_2$ . Note that if  $v'_1 \neq v'_2$  and  $u_4$  has both as its remaining neighbors, then  $u_4$  forms a  $C_V$  pattern which touches the  $C_V$  patterns of  $u_1$  and  $u_2$ . The precise case where  $u_4$  has  $v_1, v_2$  as remaining neighbors and  $u_1 \sim u_2$  has length 1 in  $S$  is treated as configuration  $J_3$ .

The special vertices  $u_3, u_4$  may also form a  $C_{T1}$ ,  $C_{T2A}$  or  $C_{T2NA}$  pattern, since the colors ending on each vertex are different in any 2-coloring of  $S'$ .

The patterns used are  $C_V(u_1)$ ,  $C_V(u_2)$  and  $C_{T1}$ ,  $C_{T2A}$  or  $C_{T2NA}(u_3, u_4)$ , or  $C_N$  for  $u_3, u_4$ .

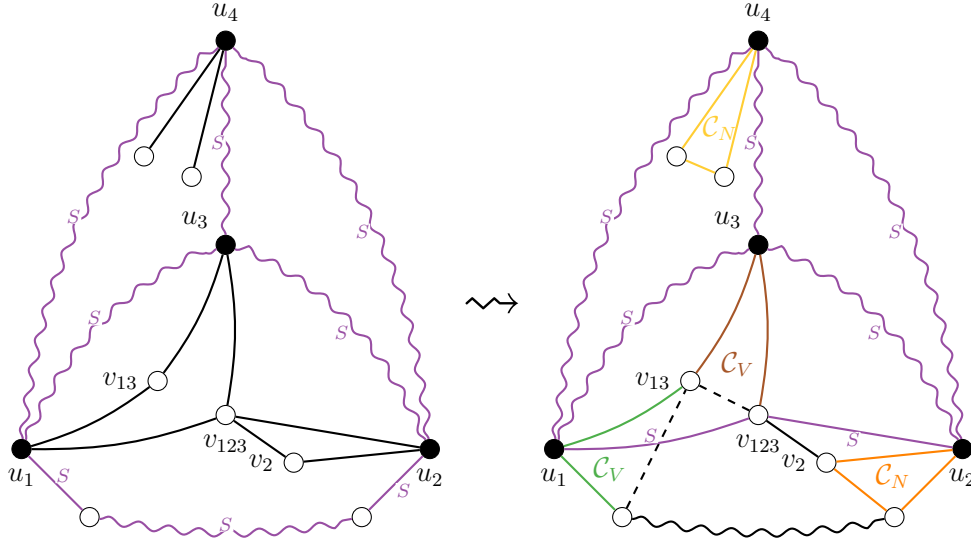

Figure 4.26:  $R_4$  when  $l(u_1 \sim u_2) \geq 2$  in  $S$

### Configuration $R_4$

Properties:

- The graph has a strong  $K_4$ -subdivision  $S$  rooted on  $u_1, u_2, u_3, u_4$ , with 3 special vertices involved in a close problem:  $u_1, u_2, u_3$ .
- The vertices  $u_1, u_3$  share a remaining neighbor  $v_{13} \notin S$
- $u_1, u_2, u_3$  share a remaining neighbor  $v_{123}$  (different from  $v_{13}$ )
- $u_2$  has another remaining neighbor  $v_2$  adjacent to  $v_{123}$
- Remark:  $u_4$  is either settled or causes a distant problem

By planarity and property A,  $v_{13}$  and  $v_{123}$  do not belong to  $S$ . The special vertices  $u_1, u_3$  thus form a  $\mathcal{C}_{D2}$  configuration, which is therefore a  $\mathcal{C}_{T2NA}$  pattern: the vertices  $v_{13}$  and  $v_{123}$  are non-adjacent. However, this pattern is not compatible with a  $\mathcal{C}_N$  pattern applied to  $u_2$ .

The vertex  $u_4$  may cause a distant problem or cause a  $\mathcal{C}'_V$  pattern on the path  $u_1 \sim u_3$  or (w.l.o.g.)  $u_2 \sim u_3$ . We replace the  $K_4$ -subdivision  $S$  with another  $K_4$ -subdivision  $S'$  by replacing the path  $u_1 \sim u_2$  with the path  $(u_1, v_{123}, u_2)$ . If  $u_4$  causes a distant problem on  $u_1 \sim u_3$  or  $u_2 \sim u_3$ , we use Claim 4.5.2 (p. 99) and consider a 2-coloring of  $S'$  that inactivates it.

By planarity and property A,  $v_2$  does not belong to  $S$ . The vertices  $u_1$  and  $u_2$  form either a  $\mathcal{C}_V$  and a  $\mathcal{C}_N$  in  $S'$ , or a  $\mathcal{C}_U$  pattern depending on the length of the original  $u_1 \sim u_2$  in  $S$ .

The pattern used are  $\mathcal{C}_V(u_1)$ ,  $\mathcal{C}_N(u_2)$ , or  $\mathcal{C}_U(u_1, u_2)$ ,  $\mathcal{C}_V(u_3)$ ,  $\mathcal{C}_N(u_4)$  (or  $\mathcal{C}'_V$ ).

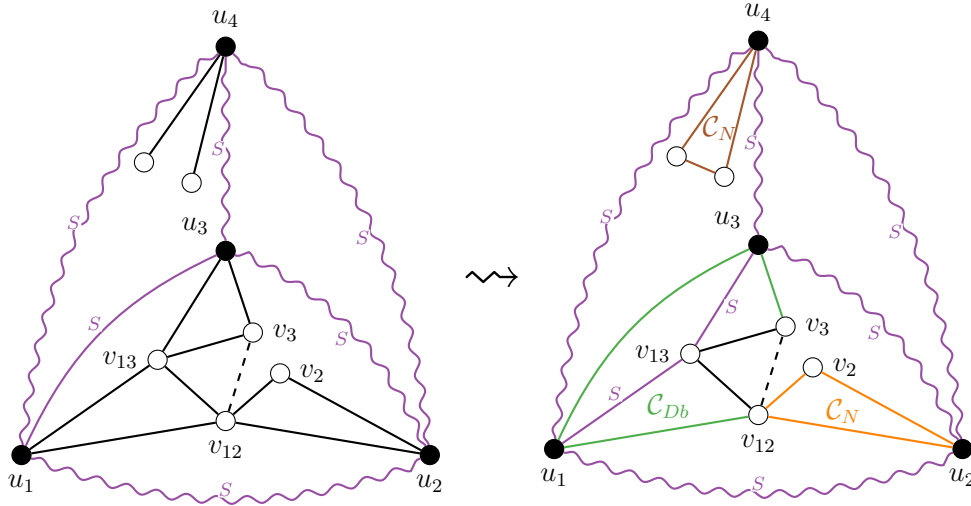

Figure 4.27: Reduction of configuration  $R_5$ . The special vertex  $u_4$  may cause a distant problem on  $u_1 \sim u_2$  or  $u_2 \sim u_3$

### Configuration $R_5$

Properties:

- The graph has a strong  $K_4$ -subdivision  $S$  rooted on  $u_1, u_2, u_3, u_4$ , with 3 vertices involved in a close problem:  $u_1, u_2, u_3$ .
- $u_1, u_3$  share a remaining neighbor  $v_{13}$  (which is not a neighbor of  $u_2$ )
- $u_1, u_2$  share a remaining neighbor  $v_{12}$  (which is not a neighbor of  $u_3$ )
- $u_2, u_3$  each have another remaining neighbor  $v_2, v_3$  respectively, and  $v_2 \neq v_3$
- $v_3, v_{12}$  are not adjacent
- None of  $v_{13}, v_{12}, v_2, v_3$  belong to  $S$
- The graph contains the edges  $v_{13}v_3, v_{13}v_{12}, v_{12}v_2$
- Remark:  $u_4$  is either settled or causes a distant problem

At least one edge among  $v_2v_{13}, v_3v_{12}$  does not exist by planarity (otherwise  $\{(u_1, v_2, v_3), (u_2 = u_3, v_{12}, v_{13})\}$  form a  $K_{3,3}$  minor by contracting the path  $u_2 \sim u_3$ ). Assume w.l.o.g. that the edge  $v_3v_{12}$  is absent from the graph.

The vertices  $u_1, u_3$  form a  $\mathcal{C}_{D1}$  configuration, and since  $v_3v_{12}$  does not exist, they form a  $\mathcal{C}_{Db}$  pattern. By planarity and property A,  $v_2$  does not belong to  $S$ . Hence,  $u_2$  can be treated as a  $\mathcal{C}_N$  pattern that is compatible with the  $\mathcal{C}_{Db}$  pattern, since it touches only  $v_{12}$ . We use Claim 4.5.2 (p. 99) and consider a 2-coloring of  $G$  that inactivates the potential distant problem caused by  $u_4$ .

The patterns used are  $\mathcal{C}_{Db}(u_1, u_3), \mathcal{C}_N(u_2), \mathcal{C}_N(u_4)$ .

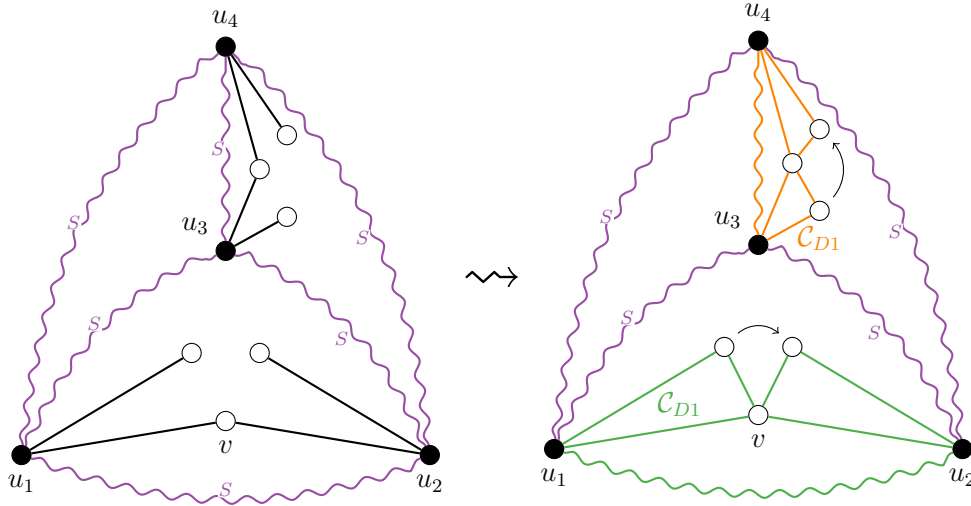

Figure 4.28:  $R_6$  when  $u_1, u_2$  and  $u_3, u_4$  form  $\mathcal{C}_{D1}$  configurations

### Configuration $R_6$

Properties:

- The graph has a strong  $K_4$ -subdivision  $S$  rooted on  $u_1, u_2, u_3, u_4$ , with all 4 special vertices involved in close problems
- $u_1, u_2$  share a remaining neighbor  $v_{12} \notin S$
- $u_3, u_4$  share a remaining neighbor  $v_{34} \notin S$
- $u_1, u_2, u_3, u_4$  each have another remaining neighbor  $v_1, v_2, v_3, v_4$  respectively
- $v_1, v_2$  are disjoint from  $v_3, v_4$
- Remark: it may be that  $v_1 = v_2$  or  $v_3 = v_4$
- $v_1, v_2, v_3, v_4$  are disjoint from  $S$

This case is straightforward: each of  $(u_1, u_2)$  and  $(u_3, u_4)$  forms a  $\mathcal{C}_{D1}$  or  $\mathcal{C}_{D2}$  configuration, which can be a  $\mathcal{C}_{Da}$ ,  $\mathcal{C}_{Db}$  or  $\mathcal{C}_{T2NA}$  pattern. By definition, these two patterns are disjoint.

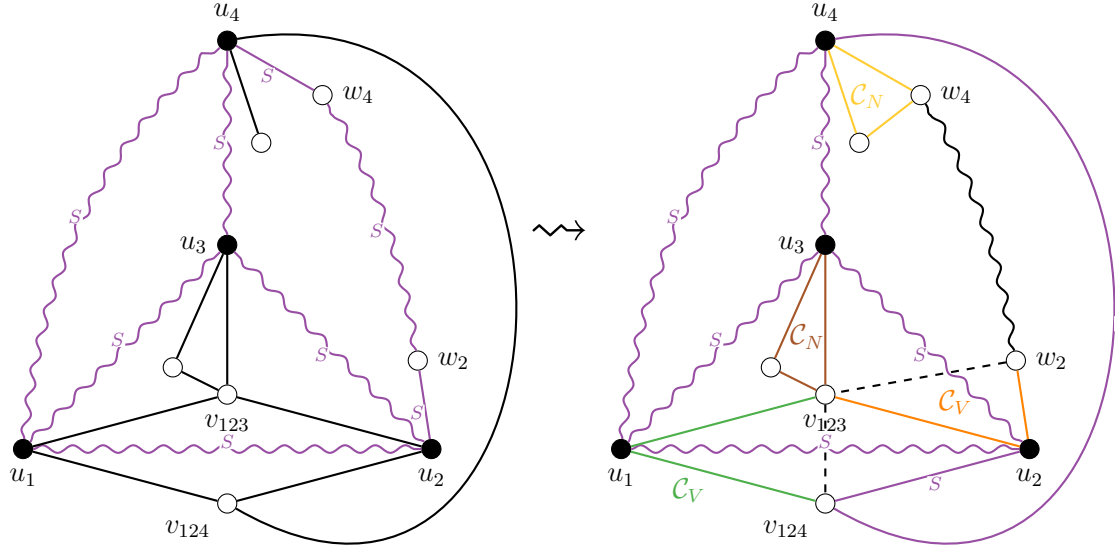

Figure 4.29:  $R_7$  when  $l(u_2 \sim u_4) \geq 2$  in  $S$

### Configuration $R_7$

Properties:

- The graph has a strong  $K_4$ -subdivision  $S$  rooted on  $u_1, u_2, u_3, u_4$ , with all 4 special vertices involved in one close problem
- $u_1, u_2, u_3$  share a remaining neighbor  $v_{123} \notin S$
- $u_1, u_2, u_4$  share a remaining neighbor  $v_{124} \notin S$
- $u_3, u_4$  do not share a remaining neighbor
- $u_3, u_4$  each have another remaining neighbor  $v_3, v_4$  respectively, adjacent to  $v_{123}, v_{124}$  respectively

We first claim that  $v_4$  cannot be adjacent to  $v_{123}$ . If it is the case, then  $\{(u_1, u_2, v_4), (u_4, v_{123}, v_{124})\}$  form a  $K_{3,3}$ -minor, a contradiction with the planarity of  $G$ .

We replace the  $K_4$ -subdivision  $S$  with another  $K_4$ -subdivision  $S'$  by removing the path  $u_2 \sim u_4$  and adding the path  $(u_2, v_{124}, u_4)$ .

The special vertex  $u_1$  forms a  $\mathcal{C}_V$  pattern and  $u_3$  a  $\mathcal{C}_N$  pattern disjoint from  $S'$  by property A and planarity.  $u_2$  forms a  $\mathcal{C}_V$  and  $u_4$  a  $\mathcal{C}_N$  pattern, unless the length of  $u_2 \sim u_4$  in  $S$  is 1. In this case  $u_2, u_4$  form a  $\mathcal{C}_U$  pattern, since  $v_4, v_{123}$  are non-adjacent. The  $\mathcal{C}_N$  patterns are disjoint and may only touch  $\mathcal{C}_V$  patterns, hence the mapping is compatible.

The patterns used are  $\mathcal{C}_V(u_1), \mathcal{C}_N(u_3)$  and either  $\mathcal{C}_V(u_2)$  and  $\mathcal{C}_N(u_4)$  or  $\mathcal{C}_U(u_2, u_4)$ .

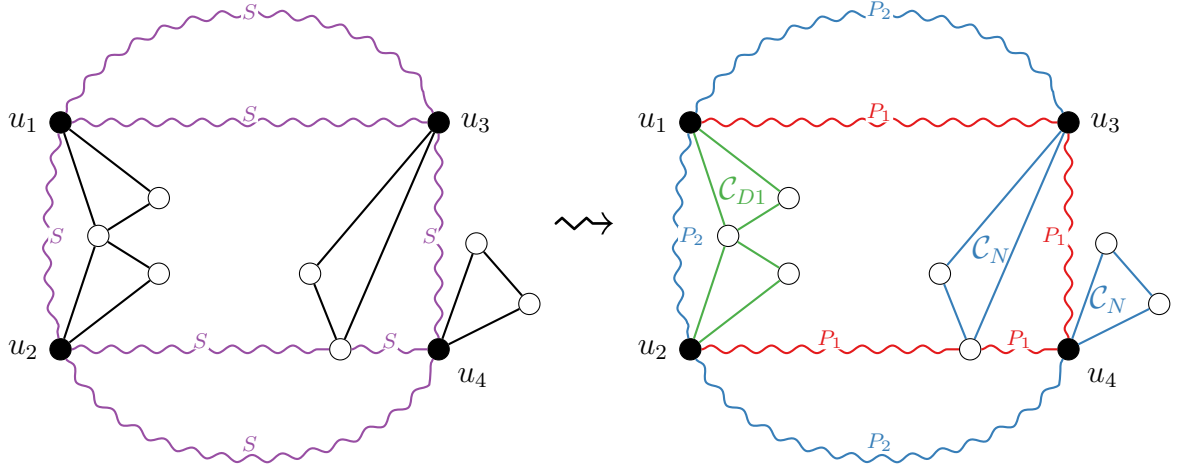

Figure 4.30:  $R_8$  when  $u_3$  causes a distant problem and  $u_1, u_2$  form a  $\mathcal{C}_{D1}$  configuration. Example of a 2-coloring of  $S$

### Configuration $R_8$

Properties:

- The graph has a strong  $C_{4+}^*$ -subdivision  $S$  rooted on  $u_1, u_2, u_3, u_4$ , such that  $u_1, u_2$  are 1-linked and  $u_1, u_3$  are 2-linked
- There is at most one distant problem, caused by  $u_3$  on a  $(u_2, u_4)$ -path of  $S$  if there is one
- $u_1, u_2$  share a remaining neighbor
- There is no remaining neighbor in common between one of  $u_1, u_2$  and one of  $u_3, u_4$
- Remark: if there is no distant problem,  $u_3$  and  $u_4$  may share a remaining neighbor

If  $u_3$  causes a distant problem, it is necessarily on a parallel  $(u_2, u_4)$ -path of  $S$  by property “1-linked” of  $S$  and property A, and then we may swap the colors of the two  $(u_2, u_4)$ -paths in a 2-coloring of  $S$  to inactivate this distant problem.

By the last property of this configuration,  $u_1, u_2$  form a  $\mathcal{C}_{D1}$  or  $\mathcal{C}_{D2}$  pattern, and  $u_3, u_4$  as well if  $u_3$  does not cause a distant problem.

The patterns used are thus  $\mathcal{C}_{Da}$ ,  $\mathcal{C}_{Db}$  or  $\mathcal{C}_{T2NA}$  for  $(u_1, u_2)$  and maybe for  $(u_3, u_4)$ , or  $\mathcal{C}_N(u_3)$ ,  $\mathcal{C}_N(u_4)$ .

### Configuration $R_9$

Properties:

- The graph has a strong  $C_{4+}^*$ -subdivision  $S$  rooted on  $u_1, u_2, u_3, u_4$ , such that  $u_1, u_2$  are 1-linked and  $u_1, u_3$  are 2-linked
- $u_2, u_4$  share exactly remaining neighbor  $v_{24}$ , and it belongs to a parallel  $(u_1, u_3)$ -path  $P_{13}$  of  $S$
- The other remaining neighbors  $v_2, v_4$  of  $u_2, u_4$  respectively are both adjacent to  $v_{24}$
- The remaining neighbors of  $u_1, u_3$  are disjoint from  $S$
- Remark: there is no distant problem

Let us write  $P_{13} = (u_1, Q_1, v_{24}, Q_2, u_3)$ . We transform the  $C_{4+}$ -subdivision  $S$  into another  $C_{4+}$ -(semi-)subdivision  $S'$  by removing the paths  $P_{13}$  and any of the two  $(u_2, u_4)$ -paths of  $S$ ,  $P_{24}$ , and adding  $(u_1, Q_1, v_{24}, u_2)$  and  $(u_3, Q_2, v_{24}, u_4)$ . This semi-subdivision has a contact between the two new paths on  $v_{24}$ , so in a 2-coloring of  $S'$  we may swap the



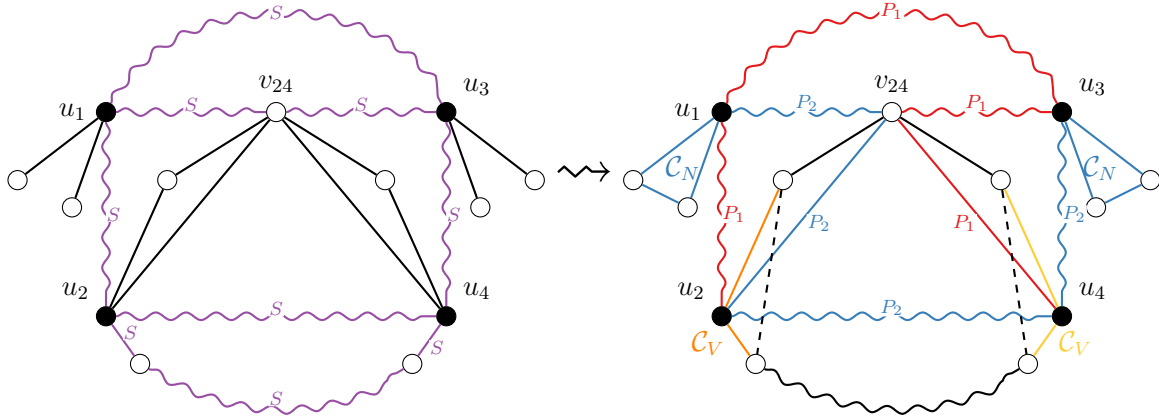

Figure 4.31: Reduction of configuration  $R_9$

colors of the two  $(u_1, u_2)$ -paths to have different colors on the new paths.

The special vertices  $u_2, u_4$  form  $\mathcal{C}_V$  patterns in  $S'$  by planarity, and since the remaining neighbors of  $u_1, u_3$  are disjoint from  $S$ , none of  $(u_1, u_2)$  or  $(u_3, u_4)$  form  $\mathcal{C}_{T2NA}$  patterns.

The patterns used are  $\mathcal{C}_N(u_1)$ ,  $\mathcal{C}_V(u_2)$ ,  $\mathcal{C}_N(u_3)$ ,  $\mathcal{C}_V(u_4)$ , or maybe  $\mathcal{C}_{T2NA}(u_1, u_2)$  or  $\mathcal{C}_{T2NA}(u_3, u_4)$ .

Before entering the proof of the final lemma of this chapter, let us show a useful claim.

**Claim 4.7.1.** *Let  $G$  be a planar graph with a  $(C_{II})$  configuration w.r.t. a 4-family  $U$ , with a  $\mathcal{K}$ -subdivision  $S$  rooted on  $U$ .*

*If  $u \in U$  has no remaining neighbors in common with other special vertices, then either  $u$  causes a distant problem in  $S$  or  $u$  is lone-settled.*

*Proof.* Let us assume that  $u$  does not cause a distant problem in  $S$ . Since it does not share remaining neighbors with other special vertices, it cannot form a  $\mathcal{C}_{T2NA}$  pattern w.r.t.  $S$ . Hence, since no pair of special vertices forms a  $\mathcal{C}_U$  pattern by property A, if the remaining neighbors of  $u$  are non-adjacent,  $u$  forms a  $\mathcal{C}_V$  pattern and is lone-settled.

If its remaining neighbors are adjacent, since  $u$  does not share remaining neighbors and does not cause a distant problem, either none or both of its remaining neighbors belong to  $S$ . Then either its remaining neighbors are disjoint from  $S$  and  $u$  forms a  $\mathcal{C}_N$  pattern, or by property B and planarity  $u$  has both remaining neighbors in  $S$  and forms a  $\mathcal{C}'_V$  pattern. In both cases, it is lone-settled.  $\square$

We can now show how all the remaining cases of  $\mathcal{K}$ -subdivisions with close problems can be taken care of with the previous close configurations.

**Lemma 4.7.2** (Close lemma). *Let  $G$  be a planar graph with a  $(C_{II})$  configuration w.r.t. a 4-family  $U$ , with a  $\mathcal{K}$ -subdivision  $S$  rooted on  $U$ , with at most 2 distant problems and some close problems w.r.t.  $S$ . Then  $G$  has a configuration among  $\{R_1, R_2, R_3, R_4, R_5, R_6, R_7, R_8, R_9, J_4\}$ .*

*Proof.* We start by solving **the  $C_{4+}$  cases**: see Figure 4.32 for the tree of cases.

If  $S$  is a  $C_{4+}^*$ -subdivision, let  $U = \{u_1, u_2, u_3, u_4\}$  be such that  $u_1, u_2$  are 1-linked, and  $u_1, u_3$  are 2-linked. We can assume that  $G$  does not have a  $K_4$ -subdivision rooted on  $U$ .

If  $S$  has distant problems, they are on parallel paths by property “1-linked” and property A. By Claim 4.5.3 (p. 99),  $S$  does not have two distant problems caused by 1-linked

special vertices. If  $S$  has two distant problems caused by two 0-linked special vertices, then by property “0-linked”, the other two 0-linked special vertices do not share remaining neighbors, and are thus lone-settled by definition of close problem and Claim 4.7.1 (p. 124). So  $S$  does not have close problems, which is a contradiction. If  $S$  has two distant problem caused by 2-linked special vertices, then by Claim 4.5.3 (p. 99), the other two special vertices have no remaining neighbor on  $S$ . By property “2-linked”, this means that they do not share remaining neighbors, which means that they are (lone-)settled and there is no close problem, a contradiction.

So  $S$  has at most one distant problem, caused by  $u_3$  if so. Let us first consider the case where remaining neighbors of  $\{u_1, u_2\}$  are disjoint from the ones of  $\{u_3, u_4\}$ . If  $u_3$  causes a distant problem, then by Claim 4.7.1 (p. 124)  $u_4$  is lone-settled, and thus  $(u_1, u_2)$  must form a  $\mathcal{C}_{D1}$  or  $\mathcal{C}_{D2}$  configuration to be unsettled. If  $u_3$  does not cause a distant problem, at least one pair among  $(u_1, u_2)$  and  $(u_3, u_4)$  forms a  $\mathcal{C}_{D1}$  or  $\mathcal{C}_{D2}$  configuration. In all cases, this is configuration  $R_8$ .

Now, let us consider the case where  $\{u_1, u_2\}$  share some remaining neighbors with  $\{u_3, u_4\}$ . By property “0-linked”, two 0-linked special vertices cannot share remaining neighbors. If  $u_2, u_4$  share remaining neighbors, by property “2-linked” they share exactly one and it belongs to a parallel  $(u_1, u_3)$ -path of  $S$ . Therefore, by Claim 4.5.3 (p. 99), the remaining neighbors of  $u_1, u_3$  are disjoint from  $S$ , thus disjoint, and this is configuration  $R_9$ .

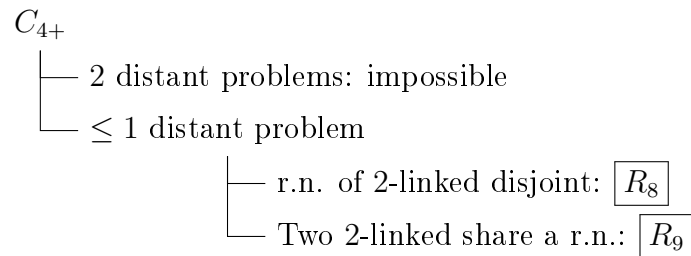

Figure 4.32: Close lemma: tree of  $C_{4+}$  cases

Let us now deal with **the  $K_4$  cases**: see Figure 4.33 for the tree of cases.

We first examine the cases in which there are only two vertices involved in a close problem: we assume w.l.o.g. that these two vertices are  $u_1, u_2$ , they share a remaining neighbor  $v$ , and  $u_3, u_4$  are either settled or cause distant problems. One may form a  $\mathcal{C}_N$  pattern disjoint from  $S$  and touching only patterns from settled vertices, but we treat it as settled.

We first examine the case where  $v \notin S$ . If  $u_1, u_2$  share only one remaining neighbor, this is configuration  $R_1$ . So now assume  $u_1, u_2$  share another remaining neighbor  $v'$ . If  $v' \notin S$ , then this is a  $\mathcal{C}_{D2}$  configuration where  $u_1, u_2$  form a  $\mathcal{C}_{T2NA}$  pattern, as no other special vertex can cause a close problem by hypothesis, and by property A no path of  $S$  can touch  $v$  or  $v'$ . Thus  $u_1, u_2$  are settled, a contradiction. Otherwise,  $v' \in S$  and this is configuration  $R_2$ .

Now let us assume that  $v \in S$ . By property A,  $v$  necessarily belongs to the path  $u_3 \sim u_4$ . We can immediately see that if  $u_1, u_2$  share another remaining neighbor  $v' \notin S$ , then this is a case that has already been treated, by swapping  $v$  and  $v'$ . Now  $u_1, u_2$  may have another common remaining neighbor  $v' \in S$ , necessarily in the path  $u_3 \sim u_4$ , or each of  $u_1, u_2$  can have another remaining neighbor  $v'_1, v'_2$  respectively, both adjacent to  $v$  to be unsettled. All these cases are treated as configuration  $R_3$ , except in one particular case:

there is a vertex  $w$  on  $u_1 \sim u_2$  that is a common neighbor of  $u_1, u_2, u_3, u_4$ , the special vertex  $u_4$  is adjacent to  $v'_1$ , while  $u_3$  is adjacent to  $v'_2$ , and in this case it is configuration  $J_4$ . This concludes the cases with two special vertices involved in a close problem.

Let us now examine the cases with 3 vertices involved in a close problem, say  $u_1, u_2, u_3$ . We can assume w.l.o.g. that  $u_1, u_3$  share a remaining neighbor  $v_{13}$ . There is at most one distant problem, caused by  $u_4$  if so; otherwise,  $u_4$  is lone-settled by definition of distant problem. The special vertices  $u_1, u_2, u_3$  each have another remaining neighbor  $v_1, v_2, v_3$  respectively, and  $u_2$  has another remaining neighbor  $v'_2$  (these vertices are not necessarily distinct).

We first examine the case where  $v_{13} \notin S$ .

If  $v_1 = v_3$ , we can denote this vertex  $v'_{13}$ . If  $u_2$  does not have  $v_{13}$  or  $v'_{13}$  as a remaining neighbor, it is lone-settled by Claim 4.7.1 (p. 124), a contradiction with the hypothesis on  $u_2$ ; so one of  $v_{13}, v'_{13}$  is also a remaining neighbor of  $u_2$ . By planarity,  $v_{13}, v'_{13}$  cannot both be remaining neighbors of  $u_2$ . So let us say that  $v_{13}$  is not a remaining neighbor of  $u_2$ , that the vertices  $u_1, u_2, u_3$  have a common remaining neighbor  $v_{123}$ , and that  $v_2 \neq v_{123}$ . Since  $u_2$  is unsettled,  $v_2, v_{123}$  are adjacent and this is configuration  $R_4$ .

Now let us take a look at the case where  $v_1 \neq v_3$ . We distinguish between the case where  $v_{13}$  is a shared remaining neighbor of  $u_1, u_2, u_3$  or not.

- $v_{13}$  is also a remaining neighbor of  $u_2$ , and we call it  $v_{123}$ . If w.l.o.g.  $v_1 = v_2$ , then this case is equivalent to the previous one, by swapping  $u_2$  and  $u_3$ ; hence we assume that  $v_1, v_2, v_3$  are pairwise distinct. If one of  $v_1, v_2, v_3$  is not adjacent to  $v_{123}$ , then its special vertex is lone-settled, a contradiction; so all three of  $v_1, v_2, v_3$  are adjacent to  $v$ . There are three  $\mathcal{C}_{D1}$  configurations on  $(u_1, u_2), (u_1, u_3), (u_2, u_3)$ , since by planarity and property A  $v_1, v_2, v_3$  are disjoint from  $S$ . Each of these configurations forms a  $\mathcal{C}_{Da}$  or  $\mathcal{C}_{Db}$  pattern by property C, so the three paths  $u_1 \sim_2, u_1 \sim u_3, u_2 \sim u_3$  have length 1. Then  $\{u_1, u_2, u_3\}$  is a 3-cut in  $G$  that separates two neighbors of  $u_1$ , a contradiction to the almost 4-connectivity of  $G$  w.r.t. the special vertices.
- $v_{13}$  is not a remaining neighbor of  $u_2$ . Since by Claim 4.7.1 (p. 124)  $u_2$  has a remaining neighbor in common with  $u_1$  or  $u_3$ , we can assume w.l.o.g. that  $v_1 = v_2$  and we call this vertex  $v_{12}$ .

First, assume  $v'_2 = v_3$  and call it  $v_{23}$ . Since  $u_1, u_2, u_3$  are unsettled, the graph contains the edges  $v_{13}v_{23}, v_{23}v_{12}, v_{12}v_{13}$ . Thus, the three  $\mathcal{C}_{D1}$  configurations on  $(u_1, u_2), (u_1, u_3)$  and  $(u_2, u_3)$  are all  $\mathcal{C}_{Da}$  patterns by property C. Thus the three paths between  $u_1, u_2, u_3$  all have length 1, which is again a contradiction to the almost 4-connectivity of  $G$  w.r.t. the special vertices.

Now assume  $v'_2 \neq v_3$ . Due to  $u_1, u_2, u_3$  being unsettled, the graph contains the edges  $v_{13}v_3, v_{13}v_{12}, v_{12}v'_2$ . By planarity, there is at most one edge among  $\{v_{13}v'_2, v_{12}v_3\}$ , so we can assume w.l.o.g. that  $v_{12}v_3$  is a non-edge and in this case we have configuration  $R_5$ .

We can now examine the case where  $v_{13} \in S$ .

By property A,  $v_{13}$  necessarily belongs to  $u_2 \sim u_4$ , thus  $u_2$  cannot have it as a remaining neighbor by property A. The vertex  $u_2$  must be involved in the close problem, so it is adjacent to  $v_1, v_3$ , or both.

First assume  $u_2$  is adjacent to both  $v_1, v_3$ . Since  $u_1, u_2, u_3$  are unsettled, we need to have the edges  $v_1v_3, v_1v_{13}, v_3v_{13}$ , otherwise one of them is a settled  $\mathcal{C}_V$  pattern. However, in this case  $\{v_{13}, v_1, v_3, u_2, (u_1 = u_3)\}$  form a  $K_5$ -minor, by contracting the path  $u_1 \sim u_3$  to a vertex, a contradiction with the planarity of  $G$ .

So now we assume w.l.o.g. that  $u_2$  is adjacent to  $v_3$  but not to  $v_1$ : we say that  $v_3 = v'_2$  and we call it  $v_{23}$ . Since  $u_2, u_3$  are unsettled, we need the edges  $v_2v_{23}$  and  $v_{13}v_{23}$ . But

then this is a  $\mathcal{C}_{X3}$  configuration, which contradicts property C of the subdivision. This concludes the cases of 3 special vertices involved in the close problem.

Let us finally examine the cases where all four special vertices are involved in one or two close problems. By definition, there are no distant problems in  $S$ .

For a special vertex to cause a close problem, it needs to share some of its remaining neighbors with another special vertex. Two cases may occur: either there are two independent close problems each involving two special vertices, or there is one close problem involving all four special vertices. We start with the first case:  $u_1, u_2$  are involved in a close problem, as well as  $u_3, u_4$ , but the remaining neighbors of  $\{u_1, u_2\}$  and those of  $\{u_3, u_4\}$  are disjoint. We examine all combinations of cases:

- $u_1, u_2$  share **exactly one** remaining neighbor  $v_{12}$ ;  $u_3, u_4$  share **exactly one** remaining neighbor  $v_{34}$ . For all special vertices to be unsettled, we assume that the other remaining neighbors  $v_1, v_2$  of  $u_1, u_2$  are adjacent to  $v_{12}$ , and the other remaining neighbors  $v_3, v_4$  of  $u_3, u_4$  are adjacent to  $v_{34}$ . If  $v_{12}, v_{34} \notin S$ , then none of  $v_1, v_2, v_3, v_4$  can belong to  $S$ , otherwise by property A the graph contains a redirection configuration  $\mathcal{C}_{X3}$ , forbidden by property C. So this is configuration  $R_6$ . By planarity, if one of  $v_{12}, v_{34}$  belongs to  $S$ , then the other one does too. If they both belong to  $S$ , this is configuration  $R_3$ .
- $u_1, u_2$  share **two** remaining neighbors  $v_{12}, v'_{12}$ ;  $u_3, u_4$  share **exactly one** remaining neighbor  $v_{34}$ . Since  $u_3, u_4$  are unsettled, their other remaining neighbors  $v_3, v_4$  are adjacent to  $v_{34}$ . If none of  $v_{12}, v'_{12}$  belongs to  $S$ , then neither do  $v_3, v_4, v_{34}$  by planarity. This is again configuration  $R_6$ . Now if say  $v_{12}$  belongs to  $S$ , it belongs to  $u_3 \sim u_4$  by property A, and then by planarity  $v_{34}$  belongs to the path  $u_1 \sim u_2$ . Thus, by planarity,  $v'_{12}$  must also belong to  $S$ . This is once more configuration  $R_3$ .
- $u_1, u_2$  share **two** remaining neighbors  $v_{12}, v'_{12}$ ;  $u_3, u_4$  share **two** remaining neighbors  $v_{34}, v'_{34}$ . Using the same argument, either none of  $v_{12}, v'_{12}, v_{34}, v'_{34}$  belong to  $S$ , or they all do. In the former case this is again configuration  $R_6$ , in the latter this is configuration  $R_3$ .

This concludes the case with two independent close problems. Let us now assume that all four special vertices are involved in the same close problem. Let us decompose according to the case ( $P_1$  or  $P_2$ ) of the remaining neighbors of  $u_1, u_2$ .

- $u_1, u_2$  share **two** remaining neighbors  $v_{12}, v'_{12}$ . We note that if at least one of  $v_{12}, v'_{12}$  belongs to  $S$ , then it is impossible by planarity and property A to have both  $u_3, u_4$  involved. So  $v_{12}, v'_{12} \notin S$ . Assume w.l.o.g. that  $v_{12}$  is also a remaining neighbor of  $u_3$ , and call it  $v_{123}$ . If  $u_3, u_4$  share a remaining neighbor  $v_{34}$  (different from  $v_{123}$  by planarity), then by property A if  $v_{34} \in S$  it can only belong to the path  $u_1 \sim u_2$ , but it is impossible in this case by planarity. Thus  $v_{34} \notin S$ , and by planarity  $v_{34}, v_{123}$  are not adjacent. But then  $u_3$  is a settled  $\mathcal{C}_V$  pattern, a contradiction. So  $u_3, u_4$  do not share a remaining neighbor. For  $u_4$  to be involved, it must have (by planarity)  $v'_{12}$  as a remaining neighbor. This is configuration  $R_7$ .
- $u_1, u_2$  share **exactly one** remaining neighbor  $v_{12}$ , and each have another remaining neighbor  $v_1, v_2$ , both adjacent to  $v_{12}$ . We first assume that  $v_{12} \notin S$ . If  $u_3$  has  $v_1$  as a remaining neighbor, then by planarity  $v_1, v_2, v_{12}$  must belong to the region of the graph delimited by the paths  $u_1 \sim u_2, u_2 \sim u_3, u_1 \sim u_3$ , and none of  $v_1, v_2, v_{12}$  can belong to  $S$  (by property A and planarity). It is then impossible for  $u_4$  to be involved with the close problem. So necessarily  $u_3$  has  $v_{12}$  as a remaining neighbor, we call it  $v_{123}$ . By the same argument it is impossible for  $u_4$  to be involved without making  $u_3$  a  $\mathcal{C}_V$  pattern, thus settled, a contradiction. So finally assume that  $v_{12}$  belongs to  $S$ : by property A it belongs to  $u_3 \sim u_4$ . We can assume w.l.o.g. that  $u_3$  has  $v_1$

as a remaining neighbor (it cannot have  $v_{12}$  by property A). By an argument used above,  $u_3$  cannot share a remaining neighbor with  $u_4$  without being a  $\mathcal{C}_V$  pattern, so  $u_4$  has  $v_2$  as a remaining neighbor. This is again configuration  $R_3$ . This concludes the proof.  $\square$

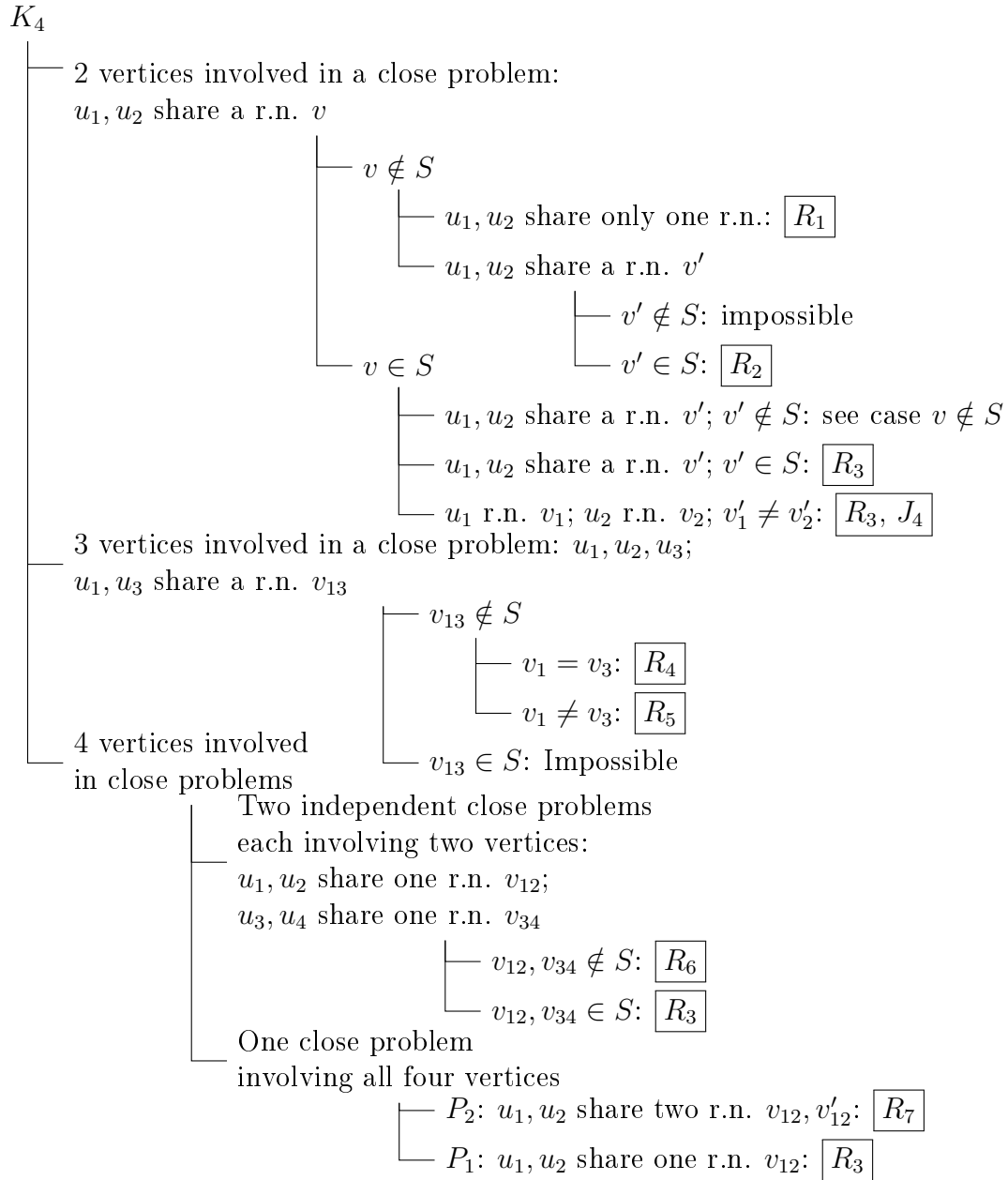

Figure 4.33: Close lemma: tree of  $K_4$  cases

Let us conclude this chapter by proving Lemma 4.4.2 (p. 98) and using it to prove Lemma 4.0.1 (p. 72).

*Proof of Lemma 4.4.2 (p. 98).* Let  $G$  be a planar graph with a  $(C_{II})$  configuration w.r.t. a 4-family  $U$ , that admits a strong  $\mathcal{K}$ -subdivision rooted on  $U$ . We prove that  $G$  contains a subdivision composite configuration made up of a semi-subdivision  $S$  rooted on  $U$  and a compatible mapping w.r.t.  $S$ .

By Lemma 4.5.5 (*Distant lemma*, p. 105), if  $G$  has at least 3 distant problems w.r.t. its strong subdivision  $S$ , then it contains a configuration among  $\{D_1, D_2, D_3, D_4\}$ . Each of these configurations is defined along with a semi-subdivision and a compatible mapping.

So let us assume  $G$  has at most 2 distant problems and no close problem w.r.t.  $S$ . By Lemma 4.6.2 (*Semi-distant lemma*, p. 114),  $G$  admits a semi-distant configurations among  $\{J_1, J_2, J_3, J_4, J_5, J_6\}$ , and we provided a semi-subdivision and a compatible mapping for each of these configurations. If  $G$  has at most 2 distant problems and some close problems w.r.t.  $S$ , then by Lemma 4.7.2 (*Close lemma*, p. 124), it contains a configuration among  $\{R_1, R_2, R_3, R_4, R_5, R_6, R_7, R_8, R_9, J_4\}$ , again associated with a semi-subdivision and a compatible mapping for each.  $\square$

*Proof of Lemma 4.0.1 (p. 72).* Let  $G$  be a minimum counterexample. By Lemma 3.1.1 (p. 43), it does not contain a configuration  $(C_I)$ .

Assume that  $G$  contains a  $(C_{II})$  configuration w.r.t. a 4-family  $U$ . By Claim 4.3.3 (p. 95),  $G$  admits a strong  $\mathcal{K}$ -subdivision  $S$  rooted on  $U$ . By Lemma 4.4.2 (p. 98),  $G$  contains a semi-subdivision  $S'$  rooted on  $U$  and a compatible mapping w.r.t.  $S'$ , which is a contradiction by Lemma 4.4.1 (p. 96).  $\square$

Lemma 2.6.2 (p. 40) ensues by combining Lemmas 3.1.1 (p. 43) and 4.0.1 (p. 72).



# Chapter 5

## The structure of minimum counterexample is contradictory

We complete the proof of Theorem 2.6.1 with the following lemma:

**Lemma 5.0.1.** *Every connected planar graph on at least 3 vertices contains a configuration  $(C_I)$  or  $(C_{II})$ .*

Lemmas 2.6.2 (p. 40) and 5.0.1 together guarantee that every connected planar graph other than  $K_3$  and  $K_5^-$  admits a good path decomposition – it is trivial to verify for connected planar graphs on at most 2 vertices. To prove Lemma 5.0.1, we first need some definitions and structural observations on planar graphs.

Given a planar graph  $G$ , a *1-contraction* of  $G$  is an induced subgraph  $H$  of  $G$  on at least 2 vertices together with a vertex  $u_1 \in V(H)$  such that all vertices have the same degree in  $G$  and  $H$ , except possibly for  $u_1$ . A graph  $H$  on at least 3 vertices is a *2-contraction* of  $G$  if there exists an edge  $u_1u_2 \in E(H)$  such that  $H \setminus u_1u_2$  is a subgraph of  $G$  and every vertex  $v \notin \{u_1, u_2\}$  satisfies  $d_H(v) = d_G(v)$ . Additionally, there exists a  $(u_1, u_2)$ -path in  $G$  with all internal vertices in  $V(G) \setminus V(H)$ .

The *damaged vertices* of a  $p$ -contraction ( $p \in \{1, 2\}$ ) are the vertices  $\{u_1\}$ ,  $\{u_1, u_2\}$  above. Note that any induced subgraph of  $G$  (on at least 2 vertices) can be turned into a 1-contraction by selecting an arbitrary vertex as  $u_1$ . Note that a 1-contraction with damaged vertex  $u_1$  can be turned into a 2-contraction by selecting an arbitrary neighbour of  $u_1$  in  $H$ , unless the vertex  $u_1$  has no neighbour in  $H$ . Note also that any  $p$ -contraction ( $p \in \{1, 2\}$ ) of  $G$  is a minor of  $G$  hence is planar.

A 2-contraction  $H'$  of  $G$  is *smaller* than a 2-contraction  $H$  of  $G$  with damaged vertices  $\{u_1, u_2\}$  if  $V(H') \subsetneq V(H)$  and each of  $u_1$  and  $u_2$  either does not belong to  $V(H')$  or is a damaged vertex of  $H'$ . We may simply refer to a *smaller 2-contraction than  $H$*  if the damaged vertices of  $H$  are clear from context. A 2-contraction  $H$  of  $G$  is *minimal* if  $G$  admits no smaller 2-contraction.

**Claim 5.0.2.** *Let  $G$  be a connected planar graph. Any minimal 2-contraction of  $G$  either contains a non-damaged vertex of degree at most 4 or is 3-connected.*

*Proof.* Assume for a contradiction that  $H$  with damaged vertices  $u_1, u_2$  is a counterexample to the statement:  $H$  is minimal, not 3-connected and every vertex in  $V(H) \setminus \{u_1, u_2\}$  has degree at least 5 in  $H$  (hence in  $G$ ). By definition of a 2-contraction,  $V(H) \setminus \{u_1, u_2\}$  is non-empty. We note that it suffices to exhibit a 2-contraction  $H'$  of  $G$  smaller than  $H$ .

Since  $H$  is minimal, it is connected. Note that  $H$  is in fact 2-connected. Otherwise, let  $x$  be a cut-vertex in  $H$ . There is a connected component  $C$  of  $H \setminus \{x\}$  containing none



of  $\{u_1, u_2\}$ . The graph  $G[C \cup \{x\}]$  is a 1-contraction of  $G$  with damaged vertex  $x$ . Note that  $C$  contains at least 5 vertices, as  $C$  is non-empty and every vertex in  $C$  has degree at least 5 in  $G$ . We select an arbitrary neighbour  $y$  of  $x$  in  $C$ , and note that  $G[C \cup \{x\}]$  is a 2-contraction of  $G$  with damaged vertices  $x, y$  and  $u_1, u_2 \notin C$ . This yields a smaller 2-contraction than  $H$ , a contradiction.

Therefore,  $H$  is 2-connected but not 3-connected. Let  $x_1, x_2$  be a vertex cut of  $H$ . Since  $u_1 u_2 \in E(H)$ ,  $u_1$  and  $u_2$  do not belong to different connected components of  $H \setminus \{x_1, x_2\}$ . Let  $C$  be a connected component  $H \setminus \{x_1, x_2\}$  that contains no  $u_i$ . Since  $H$  is 2-connected, there is a path between  $x_1$  and  $x_2$  whose internal vertices belong to  $V(H) \setminus C$ . We obtain a 2-contraction of  $G$  with damaged vertices  $\{x_1, x_2\}$  where each  $u_i$  either does not belong to it or is a damaged vertex, hence a contradiction.  $\square$

**Claim 5.0.3.** *Let  $H$  be a minimal 2-contraction of a planar graph  $G$ . Either  $H$  contains a non-damaged vertex of degree at most 4, or there are four non-damaged vertices  $\{v_1, v_2, v_3, v_4\}$  of degree 5 with respect to which  $H$  is almost 4-connected.*

*Proof.* Assume that  $H$  does not contain any non-damaged vertex of degree 4 or less, and let  $u_1, u_2$  be the damaged vertices of  $H$ .

We first assume that  $H$  is 4-connected. Then it suffices to argue that there are four vertices of degree 5 in  $V(H) \setminus \{u_1, u_2\}$ . Since  $H$  is 4-connected, we have  $d_H(u_1), d_H(u_2) \geq 4$ . By Euler's formula, we have  $\sum_{x \in V(H)} (d(x) - 6) \leq -12$ , hence  $\sum_{x \in V(H) \setminus \{u_1, u_2\}} (d(x) - 6) \leq -8$ . Since every non-damaged vertex of  $H$  has degree at least 5, the conclusion follows.

Therefore, we may assume the graph  $H$  is not 4-connected. Consider an embedding of  $H$  where  $u_1$  and  $u_2$  lie on the outer-face. Since  $u_1 u_2 \in E(H)$  and  $H$  is planar since it is a 2-contraction of  $G$ , such an embedding exists. For any vertex cut  $X$  of  $H$  that has size 3, let  $p$  be the number of connected components in  $H \setminus X$ . Consider the minor of  $H$  obtained by contracting each connected component into a single vertex. Since  $H$  is 3-connected (by Claim 5.0.2), every resulting vertex is adjacent to all three vertices in  $X$ , which yields a  $K_{3,p}$ -minor where  $p$  is the number of connected components. Since  $H$  is planar, there is no  $K_{3,3}$ -minor, hence  $p = 2$ . At most one of the two connected components of  $H \setminus X$  contains damaged vertices. If one of them contains damaged vertices, we let  $I(X)$  be the connected component of  $H \setminus X$  that does not contain damaged vertices and  $E(X)$  be the connected component of  $H \setminus X$  that contains a damaged vertex. If neither component contains damaged vertices, then  $u_1, u_2 \in X$ . Since  $H$  is 3-connected and  $u_1, u_2$  belong to the outer-face, there is exactly one connected component that contains no vertex of the outer-face; We let  $I(X)$  be that component. Let  $E(X)$  be the other component. Observe that  $E(X)$  contains at least one vertex of the outer-face.

Among all vertex cuts of  $H$  that have size 3, we select a vertex cut  $\{x_1, x_2, x_3\}$  which minimizes  $|I(\{x_1, x_2, x_3\})|$ . We first argue that  $C = I(\{x_1, x_2, x_3\})$  contains at least four vertices of degree 5. Indeed, since  $\{x_1, x_2, x_3\}$  is minimal, every  $x_i$  has at least 2 neighbors in  $C$ . Hence by Euler's formula on the graph  $C$ , we have  $\sum_{x \in C} (d(x) - 6) + 3 \times 2 \leq -12$ . Since every vertex in  $C$  has degree at least 5 in  $H$ , there are four non-damaged vertices  $\{v_1, v_2, v_3, v_4\}$  in  $C$  that have degree 5 in  $H$ .

It remains to argue that  $H$  is almost 4-connected with respect to them. We show that no 3-cut of  $H$  separates two vertices of  $X \cup C$ . Observe that this proves the two properties of almost 4-connectivity. Assume for a contradiction that there is a vertex cut  $Y = \{y_1, y_2, y_3\}$  such that two vertices  $z_1, z_2 \in X \cup C$  are in different connected components of  $H \setminus Y$ . Without loss of generality, consider  $z_1 \in I(Y)$  and  $z_2 \in E(Y)$ .

Note that  $H[X \cup C]$  is connected and  $z_1, z_2 \in X \cup C$ . However,  $z_1$  and  $z_2$  are in different connected components of  $H \setminus Y$ . Since  $z_1, z_2$  cannot be separated by a vertex cut

contained in  $X \cup E(X)$ , at least one of  $\{y_1, y_2, y_3\}$ , say  $y_1$ , belongs to  $C$ . Since  $\{x_1, x_2, x_3\}$  minimizes  $|I(\{x_1, x_2, x_3\})|$  over all vertex cuts of  $H$  of size 3, at least one of  $\{y_1, y_2, y_3\}$ , say  $y_3$ , belongs to  $E(\{x_1, x_2, x_3\})$ .

We consider two cases depending on the cardinal of  $\{x_1, x_2, x_3\} \cap I(Y)$ .

- Assume that  $I(Y)$  contains exactly one vertex in  $\{x_1, x_2, x_3\}$ , say  $x_1$ .  
If  $y_2 \in E(X)$ , then we claim that  $\{x_1, y_1\}$  is a 2-cut that separates  $z_1$  from  $z_2$ , a contradiction with the 3-connectivity of  $H$ . To prove it, we note that in  $Y \cup I(Y)$ , there is a path between  $z_1$  and each of  $\{y_1, y_2, y_3\}$  whose internal vertices belong to  $I(Y)$ . However, since  $\{x_1, x_2, x_3\}$  is a vertex cut of  $H$  and neither  $x_2$  nor  $x_3$  belongs to  $Y \cup I(Y)$ , every path between  $z_1$  and  $y_2$  whose internal vertices belong to  $I(Y)$  involves the vertex  $x_1$ . Therefore,  $\{x_1, y_1\}$  separates  $z_1$  and  $y_2$ , hence the conclusion. So  $y_2 \in X \cup C$ , and we now claim that  $\{x_1, y_1, y_2\}$  is a vertex cut of  $H$ , by the same argument: each path between  $z_1$  and  $y_3$  with internal vertices in  $I(Y)$  involves  $x_1$ . Observe that it contradicts the choice of  $\{x_1, x_2, x_3\}$ .
- Assume from now on that  $I(Y)$  contains both  $x_2$  and  $x_3$ , while  $x_1 \in E(Y)$ . As above, we argue that  $\{y_1, x_2, x_3\}$  is a vertex cut of  $H$ , which contradicts the choice of  $\{x_1, x_2, x_3\}$ . For completeness, we include the adapted proof. We note that in  $\{x_1, x_2, x_3\} \cup I(\{x_1, x_2, x_3\})$ , there is a path between  $z_1$  and each of  $\{x_1, x_2, x_3\}$  whose internal vertices belong to  $I(\{x_1, x_2, x_3\})$ . However, since  $Y$  is a vertex cut of  $H$  and neither  $y_2$  nor  $y_3$  belongs to  $\{x_1, x_2, x_3\} \cup I(\{x_1, x_2, x_3\})$ , every path between  $z_1$  and  $x_1$  whose internal vertices belong to  $I(\{x_1, x_2, x_3\})$  involves the vertex  $y_1$ . Therefore,  $\{y_1, x_2, x_3\}$  separates  $z_1$  and  $x_1$ , hence the conclusion.

□

We can now use Claim 5.0.3 to obtain Lemma 5.0.1 (p. 130).

*Proof of Lemma 5.0.1.* Let  $G$  be a non-empty connected planar graph which contains no  $(C_I)$  configuration. Let  $u_1$  be the only vertex with degree at most 4 in  $G$  if any, and an arbitrary vertex otherwise. Note that since  $G$  is connected and contains at least 3 vertices, the graph  $G$  with damaged vertex  $u_1$  is a 1-contraction of  $G$ . Furthermore, the vertex  $u_1$  has at least one neighbour  $u_2$ , and the graph  $G$  with damaged vertices  $u_1$  and  $u_2$  is a 2-contraction of  $G$ . Let  $H$  be a minimal 2-contraction of  $G$  that is either precisely  $G$  with damaged vertices  $u_1, u_2$  or smaller than it.

Every non-damaged vertex in  $H$  has the same degree in  $H$  and in  $G$ , and  $u_1$  is not a non-damaged vertex in  $H$ . Therefore, Claim 5.0.3 applied to  $H$  yields that  $H$  is almost 4-connected w.r.t. a 4-family  $\{v_1, v_2, v_3, v_4\}$ . Hence  $G$  is almost 4-connected w.r.t.  $(\{v_1, v_2, v_3, v_4\})$ , as desired. □



# Conclusion and further research

Half a century after being stated, Gallai’s conjecture is an enduring source of questioning and exciting new developments for graph theory. Our proof of the conjecture on planar graphs is certainly a significant milestone, and we hope that this new result brings more people into studying the conjecture in the near future. The result on random graphs by Glock, Kühn and Osthus (Theorem 2.2.5, p. 31) makes us rather optimistic about the conjecture being true in the general case. The strong version of the conjecture stated by Marthe Bonamy and Thomas J. Perrett [6] in 2016 provides a welcome emphasis on what bound should be expected for a given graph. Not only did its floor bound greatly help us in our endeavor, but its sharper requirements demonstrate a better understanding of the problem, and prefigure more assured proof attempts in the future.

We shall mention that the proof of our main theorem not only proves the existence of a good coloring of any planar graph, but implicitly describes an algorithm to obtain such a coloring. Each reduction rule defined throughout Chapters 3 and 4 can indeed be used to construct a good coloring inductively, and  $K_3$  and  $K_5^-$  base cases can be treated with the recoloring methods of Lemmas 3.2.2 (p. 62) and 4.4.1 (p. 96). The only step of the proof we cannot certify is constructive is the acquisition of a  $K_4$ -subdivision when dealing with  $(C_{II})$  configurations. Yu’s proof [82] operates by minimum counterexample, and is therefore likely to yield an algorithm. However, its apparent opacity calls for a closer examination before asserting it with any kind of certainty. A possible solution to this issue is to consider the search for a  $K_4$ -subdivision or  $C_{4+}$ -subdivision rooted on four given special vertices as a special instance of the so-called *k disjoint paths problem*. For a given graph  $G$  with  $n$  vertices and a set of  $k$  pairs  $(u_i, v_i)$  of vertices of  $G$ , this problem asks for  $k$  internally-disjoint paths, each having a different pair  $(u_i, v_i)$  as ends. A result by Ken-ichi Kawarabayashi, Yusuke Kobayashi and Bruce Reed [54] from 2012 provides an algorithm solving this problem in time  $O(n^2)$  for fixed  $k$  (in our case  $k = 6$ ).

It is natural to ask for what extensions of our proof can be considered in the near future. To this end, we examine how essential planarity is in the conduct of our proof. The main lemma of Chapter 5 provides the final contradiction that allows us to conclude, and is based on a fine use of Euler’s formula. This formula is essential to our proof, since it basically restricts the problem to eliminating vertices of small degree from a minimum counterexample, and lays out a strategy that is impossible to apply in the general case. Note that the extension of Euler’s formula to a higher *genus* is well-known (for definitions related to genus, we refer to [67]). It is often contemplated to generalize planarity-related results to graphs embeddable on surfaces of higher genus, and even though Euler’s formula is not in itself a barrier to such a generalization, this is not the case for Yu’s theorem. Just like for the existence of a constructive algorithm, our use of this theorem as a black box is a major obstacle to any immediate extension of our proof to a superclass of planar graphs. One may want to consider a different kind of structure to link special vertices. Finally, micro-arguments of planarity (such as “*these vertices cannot be adjacent by planarity*”)

are used throughout the entirety of our proof. A proof attempt on a less restrictive class may ask for an even more consequent case analysis than the present one. We may argue that this approach has been pushed to the edge of what is reasonable, and the prospect of a gargantuan case analysis for the general case of Gallai’s conjecture is quite unappealing. If such an enterprise were to be pursued, it could be of great interest to automate the various reductions in the likes of the proof of the Four-color theorem [70].

A more modest and encouraging extension we hope to tackle soon is the class of  $K_5$ -minor-free graphs. Wagner showed in 1937 how these graphs are the ones that are constructed through successive *clique-sums*. More precisely, the 0-*sum* of two graphs is their disjoint union, a 1-*sum* is obtained by identification of one vertex, a 2-*sum* is obtained by identification of one edge, and possibly removing it, and a 3-*sum* identifies the three edges of a triangle in both graphs, with possible removal of some of these edges. Wagner proved [79] that the  $K_5$ -minor-free graphs are the ones that are constructed through successive 0-, 1-, 2- and 3-sums of planar graphs and the 8-vertex *Wagner graph*.

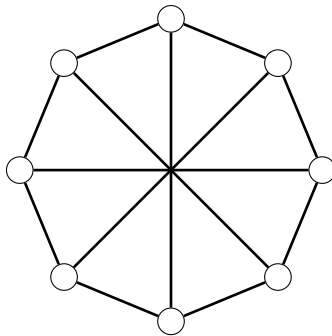

Figure 5.1: The Wagner graph

This construction thus defines an inductive structure of  $K_5$ -minor-free graphs, with many planar components, and we think that this class is a good candidate for a first adaptation of our proof. By Wagner’s theorem, planar graphs are the graphs that are  $K_5$ -minor-free and  $K_{3,3}$ -minor-free, and the class of  $K_{3,3}$ -minor-free graphs has a similar structure: a graph is  $K_{3,3}$ -minor-free if and only if it is constructed through successive 0-, 1- and 2-sums of planar graphs and  $K_5$  [76].

The general case of Gallai’s conjecture does not seem to be reachable in the immediate future. Indeed, very few is known about Gallai’s conjecture on dense graphs, as most of the classes on which it was proved are rather sparse (including planar graphs). Apart from the cases of complete and complete bipartite graphs [47], only the recent asymptotic result of Girão, Granet, Kühn and Osthus [34] about sufficiently large graphs of linear minimum degree touches on dense graphs. Local reductions like the ones from our proof do not apply for vertices of large degree, and a different approach should be considered. Would it be possible to solve the general case with a subtle combination of arguments from the sparse and the dense cases?

In the meantime, we think that the most natural graph class on which Gallai’s conjecture has not yet been confirmed is the class of bipartite graphs. This class may be a good starting point to develop new techniques susceptible to be used on dense graph classes.

# Bibliography

- [1] Kenneth Appel and Wolfgang Haken. “Every planar map is four colorable. Part I: Discharging”. In: *Illinois Journal of Mathematics* 21.3 (1977), pp. 429–490.
- [2] Kenneth Appel, Wolfgang Haken, and John Koch. “Every planar map is four colorable. Part II: Reducibility”. In: *Illinois Journal of Mathematics* 21.3 (1977), pp. 491–567.
- [3] Erik Benson, Abdulmelik Mohammed, Johan Gardell, Sergej Masich, Eugen Czeizler, Pekka Orponen, and Björn Högberg. “DNA rendering of polyhedral meshes at the nanoscale”. In: *Nature* 523.7561 (2015), pp. 441–444.
- [4] Norman Biggs, E. Keith Lloyd, and Robin J. Wilson. *Graph Theory, 1736-1936*. Clarendon Press, 1986. ISBN: 9780198539162.
- [5] Alexandre Blanché, Marthe Bonamy, and Nicolas Bonichon. “Gallai’s path decomposition in planar graphs”. In: (2021). arXiv: 2110.08870 [math.CO].
- [6] Marthe Bonamy and Thomas J. Perrett. “Gallai’s path decomposition conjecture for graphs of small maximum degree”. In: *Discrete Mathematics* 342.5 (2019), pp. 1293–1299. ISSN: 0012-365X. DOI: <https://doi.org/10.1016/j.disc.2019.01.005>.
- [7] Adrian Bondy. “Beautiful conjectures in graph theory”. In: *European Journal of Combinatorics* 37 (2014), 4–23. DOI: 10.1016/j.ejc.2013.07.006.
- [8] Fábio Botler and Andrea Jiménez. “On path decompositions of  $2k$ -regular graphs”. In: *Discrete Mathematics* 340.6 (2017), pp. 1405–1411. DOI: 10.1016/j.disc.2016.09.029.
- [9] Fábio Botler, Andrea Jiménez, and Maycon Sambinelli. “Gallai’s path decomposition conjecture for triangle-free planar graphs”. In: *Discrete Mathematics* 342.5 (2019), pp. 1403–1414. ISSN: 0012-365X. DOI: <https://doi.org/10.1016/j.disc.2019.01.020>.
- [10] Fábio Botler and Maycon Sambinelli. “Towards Gallai’s path decomposition conjecture”. In: *Journal of Graph Theory* 97.1 (2021), pp. 161–184. DOI: <https://doi.org/10.1002/jgt.22647>.
- [11] Fábio Botler, Maycon Sambinelli, Rafael S. Coelho, and Orlando Lee. “Gallai’s path decomposition conjecture for graphs with treewidth at most 3”. In: *Journal of Graph Theory* 93.3 (2020), pp. 328–349. DOI: 10.1002/jgt.22489.
- [12] Fábio Botler, Maycon Sambinelli, Rafael S. Coelho, and Orlando Lee. *On Gallai’s and Hajós’ Conjectures for graphs with treewidth at most 3*. 2017. arXiv: 1706.04334 [math.CO].
- [13] R. Leonard Brooks. “On colouring the nodes of a network”. In: *Mathematical Proceedings of the Cambridge Philosophical Society* 37.2 (1941), 194–197. DOI: 10.1017/S030500410002168X.

- [14] Timothy Cadman. “Design of printed circuit board layouts using graph theoretic methods”. PhD thesis. 1974.
- [15] Arthur Cayley. “On the Mathematical Theory of Isomers”. In: *Philosophical Magazine* 47 (1874), pp. 444–447.
- [16] Gregory J. Chaitin, Marc A. Auslander, Ashok K. Chandra, John Cocke, Martin E. Hopkins, and Peter W. Markstein. “Register allocation via coloring”. In: *Computer Languages* 6.1 (1981), pp. 47–57. ISSN: 0096-0551. DOI: [https://doi.org/10.1016/0096-0551\(81\)90048-5](https://doi.org/10.1016/0096-0551(81)90048-5).
- [17] Ian Chiswell and Wilfrid Hodges. *Mathematical Logic*. Vol. 3. Oxford, England: Oxford University Press, 2007, p. 34.
- [18] Yanan Chu, Genghua Fan, and Qinghai Liu. “On Gallai’s conjecture for graphs with maximum degree 6”. In: *Discrete Mathematics* 344.2 (2021), p. 112212. ISSN: 0012-365X. DOI: <https://doi.org/10.1016/j.disc.2020.112212>.
- [19] Fan Chung. “On the Coverings of Graphs”. In: *Discrete Mathematics* 30.2 (1980), 89–93. DOI: 10.1016/0012-365X(80)90109-0.
- [20] Thomas Cormen, Charles Leiserson, Ronald Rivest, and Clifford Stein. *Introduction to Algorithms*. 2nd. McGraw-Hill Science/Engineering/Math, 2003. ISBN: 0072970545.
- [21] Nathaniel Dean. “What is the smallest number of dicycles in a dicycle decomposition of an eulerian digraph?” In: *Journal of Graph Theory* 10.3 (1986), pp. 299–308. DOI: <https://doi.org/10.1002/jgt.3190100307>.
- [22] Nathaniel Dean and Mekkia Kouider. “Gallai’s conjecture for disconnected graphs”. In: *Discrete Mathematics* 213.1 (2000), pp. 43–54. ISSN: 0012-365X. DOI: [https://doi.org/10.1016/S0012-365X\(99\)00167-3](https://doi.org/10.1016/S0012-365X(99)00167-3).
- [23] Alan Donald. “An upper bound for the path number of a graph”. In: *Journal of Graph Theory* 4.2 (1980), pp. 189–201. ISSN: 1097-0118. DOI: 10.1002/jgt.3190040207.
- [24] Josef Eisl, David Leopoldseder, and Hanspeter Mössenböck. “Parallel Trace Register Allocation”. In: ManLang ’18. Linz, Austria: Association for Computing Machinery, 2018. ISBN: 9781450364249. DOI: 10.1145/3237009.3237010.
- [25] Paul Erdős. “On some of my conjectures in number theory and combinatorics”. In: *Proceedings of the Fourteenth Southeastern Conference on Combinatorics* 39 (1983), 3–19.
- [26] Paul Erdős, A. W. Goodman, and Louis Pósa. “The Representation of a Graph by Set Intersections”. In: *Canadian Journal of Mathematics* 18 (1966), 106–112. DOI: 10.4153/CJM-1966-014-3.
- [27] Leonhard Euler. “Elementa doctrinae solidorum - Demonstratio nonnullarum insignium proprietatum, quibus solida hedris planis inclusa sunt praedita”. (in Latin). In: *Novi commentarii Academiae Scientiarum Imperialis Petropolitanae* 4 (1752), pp. 109–140–160.
- [28] Leonhard Euler. “Solutio problematis ad geometriam situs pertinentis”. (in Latin). In: *Commentarii Academiae Scientiarum Imperialis Petropolitanae* 8 (1736), pp. 128–140.

- [29] Genghua Fan. “Path decompositions and Gallai’s conjecture”. In: *Journal of Combinatorial Theory, Series B* 93.2 (2005), pp. 117–125. ISSN: 0095-8956. DOI: <https://doi.org/10.1016/j.jctb.2004.09.008>.
- [30] Genghua Fan. “Subgraph Coverings and Edge Switchings”. In: *Journal of Combinatorial Theory, Series B* 84.1 (2002), pp. 54–83. ISSN: 0095-8956. DOI: <https://doi.org/10.1006/jctb.2001.2063>.
- [31] Genghua Fan and Baogang Xu. “Hajós’ conjecture and projective graphs”. In: *Discrete Mathematics* 252 (2002), pp. 91–101.
- [32] Amir H. Farrahi, Alan T. Goldberg, Leonard N. Bagasol, and Jaewoo Jung. “Applying graph theory to problems in air traffic management”. In: *17th AIAA Aviation Technology, Integration, and Operations Conference*. 2017, p. 3775.
- [33] Odile Favaron and Mekkia Kouider. “Path partitions and cycle partitions of Eulerian graphs of maximum degree 4”. In: *Studia Scientiarum Mathematicarum Hungarica* 23 (1988), pp. 237–244.
- [34] António José Ferra Gomes De Almeida Girão, Bertille Granet, Daniela Kühn, and Deryk Osthus. “Path and cycle decompositions of dense graphs”. In: *Journal of the London Mathematical Society* (2021). ISSN: 0024-6107. DOI: 10.1112/jlms.12455.
- [35] Piotr Formanowicz and Krzysztof Tanaś. “A survey of graph coloring - its types, methods and applications”. In: *Foundations of Computing and Decision Sciences* 37.3 (2012), pp. 223–238. DOI: doi:10.2478/v10209-011-0012-y.
- [36] Philip L. Frana and Thomas J. Misa. “An Interview with Edsger W. Dijkstra”. In: *Communications of the ACM* 53.8 (2010), 41–47. ISSN: 0001-0782. DOI: 10.1145/1787234.1787249.
- [37] Elke Fuchs, Laura Gellert, and Irene Heinrich. “Cycle decompositions of pathwidth-6 graphs”. In: *Journal of Graph Theory* 94.2 (2020), pp. 224–251. DOI: <https://doi.org/10.1002/jgt.22516>. eprint: <https://onlinelibrary.wiley.com/doi/pdf/10.1002/jgt.22516>.
- [38] Harold N. Gabow and Herbert H. Westermann. “Forests, Frames, and Games: Algorithms for Matroid Sums and Applications.” In: *Algorithmica* 7.5&6 (1992), pp. 465–497.
- [39] Michael R. Garey and David S. Johnson. *Computers and Intractability: A Guide to the Theory of NP-Completeness (Series of Books in the Mathematical Sciences)*. First Edition. W. H. Freeman, 1979. ISBN: 0716710455.
- [40] Xianya Geng, Minglei Fang, and Dequan Li. “Gallai’s conjecture for outerplanar graphs”. In: *Journal of Interdisciplinary Mathematics* 18.5 (2015), pp. 593–598. DOI: 10.1080/09720502.2014.1001570.
- [41] Stefan Glock, Daniela Kühn, and Deryk Osthus. “Optimal path and cycle decompositions of dense quasirandom graphs”. In: *Journal of Combinatorial Theory, Series B* 118 (2016), pp. 88–108. ISSN: 0095-8956. DOI: <https://doi.org/10.1016/j.jctb.2016.01.004>.
- [42] Daniel Gonçalves. “Edge Partition of Planar Graphs into Two Outerplanar Graphs”. In: *Proceedings of STOC ’05*. United States, 2005, pp. 504–512.



- [43] Andrew Granville and Alexandros Moisiadis. “On Hajós’ conjecture (minimum cycle-partitions of the edge-set of Eulerian graphs)”. In: *Congr. Numer.* 56 (1987). Sixteenth Manitoba conference on numerical mathematics and computing (Winnipeg, Man., 1986), pp. 183–187. ISSN: 0384-9864.
- [44] F. Hadlock. “Finding a Maximum Cut of a Planar Graph in Polynomial Time”. In: *SIAM Journal on Computing* 4.3 (1975), pp. 221–225.
- [45] Hugo Hadwiger. “Über eine Klassifikation der Streckenkomplexe”. (in German). In: *Vierteljschr. Naturforsch. Ges. Zürich* 88.2 (1943), pp. 133–142.
- [46] Frank Harary and David Hsiao. “A Formal System for Information Retrieval from Files”. In: *Communications of the ACM* 13.2 (1970), 67–73. ISSN: 0001-0782. DOI: 10.1145/362007.362015.
- [47] Frank Harary and Allen J. Schwenk. “Evolution of the path number of a graph: covering and packing in graphs. II”. In: *Graph Theory and Computing* (1972).
- [48] Peter Harding and Sean McGuinness. “Gallai’s Conjecture For Graphs of Girth at Least Four”. In: 75 (2014).
- [49] Irene Heinrich, Marco V. Natale, and Manuel Streicher. “Hajós’ cycle conjecture for small graphs”. In: (2017). arXiv: 1705.08724 [math.CO].
- [50] Wolfgang Huber, Vincent J. Carey, Li Long, Seth Falcon, and Robert Gentleman. “Graphs in molecular biology”. In: *BMC Bioinformatics* 8.S8 (2007).
- [51] Andrea Jiménez and Yoshiko Wakabayashi. “On path-cycle decompositions of triangle-free graphs”. In: *Discrete Mathematics and Theoretical Computer Science* 19 (2014).
- [52] Michał Karoński, Tomasz Łuczak, and Andrew Thomason. “Edge Weights and Vertex Colours”. In: *Journal of Combinatorial Theory, Series B* 91.1 (2004), 151–157. ISSN: 0095-8956. DOI: 10.1016/j.jctb.2003.12.001.
- [53] Richard M. Karp. “Reducibility Among Combinatorial Problems.” In: *Complexity of Computer Computations*. Ed. by Raymond E. Miller and James W. Thatcher. The IBM Research Symposia Series. Plenum Press, New York, 1972, pp. 85–103. ISBN: 0-306-30707-3.
- [54] Ken-ichi Kawarabayashi, Yusuke Kobayashi, and Bruce Reed. “The disjoint paths problem in quadratic time”. In: *Journal of Combinatorial Theory, Series B* 102.2 (2012), pp. 424–435. ISSN: 0095-8956. DOI: <https://doi.org/10.1016/j.jctb.2011.07.004>.
- [55] Philipp Kindermann, Lena Schlipf, and André Schulz. “On Gallai’s conjecture for series-parallel graphs and planar 3-trees”. In: *CoRR* abs/1706.04130 (2017). arXiv: 1706.04130.
- [56] Casimir Kuratowski. “Sur le problème des courbes gauches en Topologie”. (in French). In: *Fundamenta Mathematicae* 15.1 (1930), pp. 271–283.
- [57] Adrien-Marie Legendre. *Éléments de géométrie*. (in French). Firmin Didot, Paris, 1794.
- [58] László Lovász. “On covering of graphs”. In: *Theory of Graphs (ed. P. Erdős, G. Katona)*. Akadémiai Kiadó, Budapest, 1968, pp. 231–236.
- [59] Édouard Lucas. *Récréations mathématiques*. (in French). Récréations mathématiques vol. 2. Gauthier-Villars, 1883.

- [60] Joseph Malkevitch. “The first proof of Euler’s formula”. In: *Mitteilungen aus dem Mathematischen. Seminar Giessen* 165 (1984), pp. 77–82.
- [61] Karl Menger. “Zur allgemeinen Kurventheorie”. (in German). In: *Fundamenta Mathematicae* 10.1 (1927), pp. 96–115.
- [62] Batul J. Mirza, Benjamin J. Keller, and Naren Ramakrishnan. “Studying recommendation algorithms by graph analysis”. In: *Journal of intelligent information systems* 20.2 (2003), pp. 131–160.
- [63] Flaviano Morone, Byungjoon Min, Lin Bo, Romain Mari, and Hernán A Makse. “Collective influence algorithm to find influencers via optimal percolation in massively large social media”. In: *Scientific reports* 6.1 (2016), pp. 1–11.
- [64] Øystein Ore. *Theory of graphs*. AMS, 1962.
- [65] Bernard Péroche. “Complexité de l’arboricité linéaire d’un graphe II”. (in French). In: *RAIRO-Oper. Res.* 19.3 (1985), pp. 293–300. DOI: 10.1051/ro/1985190302931.
- [66] Bernard Péroche. “NP-completeness of some problems of partitioning and covering in graphs”. In: *Discrete Applied Mathematics* 8.2 (1984), pp. 195–208. ISSN: 0166-218X. DOI: [https://doi.org/10.1016/0166-218X\(84\)90101-X](https://doi.org/10.1016/0166-218X(84)90101-X).
- [67] Patrick Popescu-Pampu. *What is the Genus?* 2016. ISBN: 978-3-319-42312-8.
- [68] László Pyber. “An Erdős-Gallai conjecture”. In: *Combinatorica* 5 (1985), pp. 67–79.
- [69] László Pyber. “Covering the Edges of a Connected Graph by Paths”. In: *Journal of Combinatorial Theory, Series B* 66.1 (1996), pp. 152–159. ISSN: 0095-8956. DOI: <https://doi.org/10.1006/jctb.1996.0012>.
- [70] Neil Robertson, Daniel P. Sanders, Paul Seymour, and Robin Thomas. “Efficiently Four-Coloring Planar Graphs”. In: *Proceedings of the Twenty-Eighth Annual ACM Symposium on Theory of Computing*. STOC ’96. Philadelphia, Pennsylvania, USA: Association for Computing Machinery, 1996, 571–575. ISBN: 0897917855. DOI: 10.1145/237814.238005.
- [71] Neil Robertson, Paul Seymour, and Robin Thomas. “Hadwiger’s conjecture for  $K_6$ -free graphs”. In: *Combinatorica* 13.3 (1993), pp. 279–361.
- [72] Karen Seyffarth. “Hajos’ Conjecture and Small Cycle Double Covers of Planar Graphs”. In: *Discrete Mathematics* 101.1-3 (1992), pp. 291–306. ISSN: 0012-365X. DOI: 10.1016/0012-365X(92)90610-R.
- [73] ACM SIGACT. *Frank Harary*. Dec. 2007. URL: <https://web.archive.org/web/20071226023748/http://sigact.acm.org/harary.htm> (visited on 10/20/2021).
- [74] Ralph G. Stanton, Donald D. Cowan, and L. O. James. “Some results on path numbers”. In: *Proceedings of the Louisiana Conference on Combinatorics, Graph Theory, and Computing* (1970), 112–135.
- [75] Jiang Tao. “On Hajós’ Conjecture”. (in Chinese). In: *J. China Univ. Sci. Tech.* 14 (1984), 585–592.
- [76] Robin Thomas. “Recent excluded minor theorems for graphs”. In: *London Mathematical Society Lecture Note Series* (1999), pp. 201–222.
- [77] Vadim G. Vizing. “On an estimate of the chromatic class of a  $p$ -graph”. (in Russian). In: *Diskret. Analiz* 3 (1964), pp. 25–30.

- [78] Klaus Wagner. “Über eine Eigenschaft der ebenen Komplexe”. (in German). In: *Mathematische Annalen* 114 (1937), pp. 570–590.
- [79] Klaus Wagner. “Über eine Erweiterung des Satzes von Kuratowski”. (in German). In: *Deutsche Mathematik* 2 (1937), pp. 280–285.
- [80] Lirong Yan. “On Path Decompositions of Graphs”. PhD thesis. Arizona State University, 1998.
- [81] Byoung-Ha Yoon, Seon-Kyu Kim, and Seon-Young Kim. “Use of Graph Database for the Integration of Heterogeneous Biological Data”. In: *Genomics & Informatics* 15.1 (2017), pp. 19–27. DOI: 10.5808/GI.2017.15.1.19.
- [82] Xingxing Yu. “Subdivisions in Planar Graphs”. In: *Journal of Combinatorial Theory, Series B* 72.1 (1998), pp. 10–52. ISSN: 0095-8956. DOI: <https://doi.org/10.1006/jctb.1997.1774>.