



HAL
open science

Congestion mitigation and network selection management in a heterogeneous C-ITS communication architecture

Mouna Karoui

► **To cite this version:**

Mouna Karoui. Congestion mitigation and network selection management in a heterogeneous C-ITS communication architecture. Other [cs.OH]. Université Clermont Auvergne, 2021. English. NNT : 2021UCFAC010 . tel-03554685

HAL Id: tel-03554685

<https://theses.hal.science/tel-03554685v1>

Submitted on 3 Feb 2022

HAL is a multi-disciplinary open access archive for the deposit and dissemination of scientific research documents, whether they are published or not. The documents may come from teaching and research institutions in France or abroad, or from public or private research centers.

L'archive ouverte pluridisciplinaire **HAL**, est destinée au dépôt et à la diffusion de documents scientifiques de niveau recherche, publiés ou non, émanant des établissements d'enseignement et de recherche français ou étrangers, des laboratoires publics ou privés.



UNIVERSITÉ DE CLERMONT AUVERGNE

ÉCOLE DOCTORALE DES SCIENCES POUR L'INGÉNIEUR (ED-SPI)

THÈSE

Présentée et soutenue le 29/04/2021 par :
MOUNA KAROUI

pour obtenir le grade de
DOCTEUR D'UNIVERSITÉ

SPÉCIALITÉ: INFORMATIQUE

Gestion de congestion et de sélection d'un réseau dans une architecture de communication hybride pour les C-ITS

Membres du jury

Rapporteurs :

NADJIA KARA, PROFESSEURE À L'ÉTS, UNIVERSITÉ DU QUÉBEC

HACÈNE FOUCAL, PROFESSEUR À L'UNIVERSITÉ DE REIMS CHAMPAGNE-ARDENNE

Examineurs :

MARION BERBINEAU, HDR, DIRECTRICE DE RECHERCHE À L'UNIVERSITÉ GUSTAVE EIFFEL

HASNAA ANISS, INGÉNIEURE DE RECHERCHE À L'UNIVERSITÉ GUSTAVE EIFFEL

MOHAMED KASSAB, MCF À L'ISIMM, UNIVERSITÉ DE MONASTIR

Encadrant :

ANTONIO FREITAS, MCF À L'UNIVERSITÉ CLERMONT AUVERGNE

Directeur de thèse :

GÉRARD CHALHOUB, HDR, MCF À L'UNIVERSITÉ CLERMONT AUVERGNE



UNIVERSITÉ CLERMONT AUVERGNE

ÉCOLE DOCTORALE DES SCIENCES POUR L'INGÉNIEUR (ED-SPI)

A THESIS SUBMITTED IN FULFILLMENT OF THE REQUIREMENTS
FOR THE DEGREE OF PHD IN COMPUTER SCIENCE

Presented on April 29, 2021 by

Mouna Karoui

Congestion mitigation and network selection management in a heterogeneous C-ITS communication architecture

Reviewers:

NADJIA KARA, FULL PROFESSOR AT ÉCOLE DE TECHNOLOGIE SUPÉRIEURE
(ETS)

HACENE FOUCHAL, FULL PROFESSOR AT UNIVERSITÉ DE REIMS
CHAMPAGNE-ARDENNE

Examiners:

MARION BERBINEAU, HDR, RESEARCH DIRECTOR AT UNIVERSITÉ
GUSTAVE EIFFEL

HASNAA ANISS, RESEARCH ENGINEER AT UNIVERSITÉ
GUSTAVE EIFFEL

MOHAMED KASSAB, ASSOCIATE PROFESSOR AT UNIVERSITÉ DE MONASTIR

Supervisor:

ANTONIO FREITAS, ASSOCIATE PROFESSOR AT UNIVERSITÉ
CLERMONT-AUVERGNE

Research director:

GERARD CHALHOUB, HDR, ASSOCIATE PROFESSOR AT UNIVERSITÉ
CLERMONT-AUVERGNE

Acknowledgments

This dissertation manuscript is the outcome of three years of research work. Along the way, many people have been involved in the completion of this work. I want to acknowledge the efforts of these people who encouraged and helped me during my doctoral studies.

I would like to begin by thanking my research director, **Dr. Gerard Chalhoub**, for his dedicated involvement and invaluable advice. His insightful comments helped me develop critical thinking skills. I would also like to express my thanks to my supervisor **Dr Antonio Freitas** for providing guidance and support.

I would like to express my thanks to **Prof. Nadjia Kara** and **Prof. Hacene Fouchal** for accepting to review and evaluate my thesis. Thank you for your availability and your relevant and constructive comments.

I would also like to thank **Dr. Marion Berbineau**, **Dr. Hasnaa Aniss**, and **Dr. Mohamed Kassab** for accepting to be members of the jury.

Many thanks to my colleague **Ali Mamadou Mamadou** for his collaboration with me during the last part of my doctoral studies. Big thanks to all the other colleagues (**Ibrahim, Sylvestre, Hamadoun, Jinpeng, Hayfa, and Imad**) for the time we spent together in our C6 office. It was a beautiful experience to meet such kind people from different countries around the world.

Last but not least, I would like to express my deepest gratitude to my family, whose unconditional love and encouragement keep me motivated and self-confident. My accomplishments and successes are owed to the fact they believed in me and always supported and respected my decisions.

Résumé

Avec la croissance massive des usagers de la route (voitures, vélos, piétons, véhicules autonomes, transports publics, etc.), la gestion optimale du trafic routier devient l'une des préoccupations de l'industrie des transports. Certaines études et statistiques ont montré que la plupart des accidents de la route sont dus à une erreur humaine, et que 60 % de ces accidents peuvent être évités si le conducteur est averti du danger au moins 0,5 seconde avant l'accident [1]. Ainsi, une bonne exploitation de la multimodalité permet à l'utilisateur d'avoir un trajet plus fluide et plus sécurisé grâce à l'interaction intelligente des différents moyens de transport. Cela motive l'industrie automobile et la communauté scientifique à travailler en collaboration pour la mise au point de solutions innovantes telles que les systèmes de transport intelligents coopératifs (C-ITS).

Des techniques de communication efficaces sont nécessaires pour répondre aux exigences des différents services C-ITS. Afin de garantir une communication fiable et ininterrompue, des architectures hybrides sont essentielles pour répondre aux exigences de faible latence et de haute fiabilité. Ces dernières années, les architectures hybrides ont fait l'objet de nombreuses études montrant leurs avantages. Toutefois, les problématiques de mise en œuvre et les questions liées à l'efficacité des algorithmes de décision ne sont pas entièrement résolues. Répondre à ces questions représente l'un des principaux objectifs de cette thèse. Nous proposons DICART un mécanisme distribué visant à gérer la sélection d'un réseau offrant les meilleures performances selon le profil de l'utilisateur. En premier lieu, ce mécanisme commence par une étape de collecte de données tenant en compte de la fraîcheur des informations constituant les critères impliqués dans le processus de décision. En second lieu, nous avons défini une étape pour extraire les poids subjectifs des différents critères utilisés dans le processus de prise de décision en considérant quelques services C-ITS. La technique de préférence d'ordre par similarité à une solution idéale (TOPSIS) a ensuite été adoptée pour le classement des interfaces radio disponibles. L'interface radio qui a le meilleur rang sera choisie pour la transmission en cours.

L'efficacité de DICART a été évaluée à l'aide d'un simulateur réseau qui implémente la pile protocolaire de chacun des deux standards: IEEE 802.11p et LTE-V2X (mode 4). Des services de sécurité routière et de gestion du trafic (par exemple, la prévention coopérative des collisions (CCA), les usagers vulnérables de la route (VRU), etc.) ont également été pris en compte dans ce processus d'évaluation.

Dans le cadre du projet C-ROADS, nous avons également étudié les performances de la technologie ITS-G5 en nous concentrant sur le service de gestion du trafic routier, GLOSA. Après une série d'études qualitatives sur les performances, nous avons constaté que l'ITS-G5 montre rapidement ses limites, en particulier dans un scénario de forte densité de trafic. Pour optimiser les performances de la technologie ITS-G5, nous avons proposé un mécanisme de contrôle de congestion, à savoir DRC/ATCL, qui vise à améliorer la diffusion des données dans les scénarios à forte charge.

Mots-clés: C-ITS, ITS-G5, LTE-V2X, architecture hybride, contrôle de congestion.

Abstract

With the massive growth of road users (e.g. cars, bicycles, autonomous vehicles and pedestrians, etc.), optimal mobility management is becoming a crucial concern for industrial and academic stakeholders. Some studies and statistics have also shown that most road accidents are due to human error, and 60% of these accidents can be avoided if the driver is warned of the danger at least 0.5 second before the accident [1]. Automotive industry and academia cooperatively work to develop innovative solutions such as C-ITS to improve traffic management and road safety.

Efficient communication techniques are needed to answer C-ITS service requirements. Heterogeneous architectures appear to be a promising solution for ensuring seamless network communication, reducing overhead and meeting low latency requirements.

In recent years, heterogeneous architectures have been the subject of numerous studies showing their advantages. Many research projects were conducted to show its ability to provide reliable connectivity. However, implementation challenges and questions related to decision-maker architectures and algorithms' efficiency are still open issues. Answering questions related to the before-mentioned issues represent one of the main goals of this thesis. In the present thesis, we propose a RAT selection framework, namely, DICART. Within this framework, a set of steps is followed to formulate the decision-making process. Furthermore, weighting technique to derive subjective weights of network criteria depending on C-ITS services requirements are also formulated. The Technique for Order Preference by Similarity to an Ideal Solution (TOPSIS) was then adopted to rank available RATs.

As opposed to most related work proposals that have only been formally implemented and evaluated, the effectiveness and efficiency of DICART are evaluated using a full-stack network simulator considering two typical vehicular networks RAT: IEEE 802.11p and LTE-V2X. Cooperative awareness and traffic efficiency services (e.g. Cooperative Collision Avoidance (CCA), Vulnerable Road Users (VRU),...) were also considered within this evaluation process.

We also investigated ITS-G5 network performance under the C-ROADS European project, pointing out a particular traffic efficiency service, namely GLOSA. After a set of comprehensive and qualitative studies, we observed that ITS-G5 rapidly shows its limitations, especially in high traffic load. To improve the performance of the ITS-G5 technology, we have proposed a congestion control mechanism, namely DRC/ATCL, which aims to improve data dissemination in high traffic load scenarios.

keywords: C-ITS, ITS-G5, LTE-V2X, heterogeneous network architecture, RAT selection, congestion control.

Table of contents

Résumé	v
Abstract	vi
List of Figures	x
List of Tables	xii
List of Acronyms	xiii
List of Symbols	xvii
1 Introduction	1
1.1 European C-ITS research projects and deployment challenges	1
1.2 C-ITS services and main requirements	2
1.3 Frequency allocation plan for C-ITS	4
1.4 Motivations	6
1.5 Objectives and research methodology	7
1.5.1 Thesis objectives	7
1.5.2 Research methodology	7
1.6 Thesis contributions	8
1.7 Structure of the manuscript	8
2 Standardization efforts on C-ITS network architectures	10
2.1 Comparative overview of C-ITS network architectures	10
2.2 ISO ITS reference architecture	12
2.2.1 Geo-Networking (GN)	13
2.2.2 Basic Transport Protocol (BTP)	14
2.2.3 Facilities	14
2.3 ITS-G5 ad-hoc technology	15
2.3.1 Physical layer	15
2.3.2 MAC layer	16
2.3.3 Decentralized Congestion Control (DCC) cross layer mechanism	17
2.4 LTE-V2X (LTE-Uu/PC5)	19
2.4.1 "Mode 3" (In-coverage)	20
2.4.2 "Mode 4" (Out-of-coverage)	21
2.5 Summary	25
3 State of the art review	27
3.1 Related work on C-ITS network communications	27
3.2 Research efforts on ITS-G5 network performance	30
3.2.1 Related work on C-ITS service requirements: GLOSA case study	30
3.2.2 Related work on data rate and congestion control for ITS-G5 . .	31
3.3 Research efforts on RAT selection	33

3.3.1	Network decision-making architectures	34
3.3.2	Quick overview of decision-making algorithms	36
3.4	Multi-Criteria Decision-Making (MCDM) principles	42
3.4.1	Normalization	44
3.4.2	Weighting	45
3.4.3	Ranking	47
3.5	Summary	47
4	Contributions	49
4.1	Investigations on the effectiveness of GLOSA	49
4.1.1	Speed Advisory Boundary fINder for Simple Segment (SABIN-SS)	50
4.1.2	Multiple segments approach algorithm (SABIN-MS)	51
4.1.3	Efficient Path Planning GLOSA-based (EPP-GLOSA) approach	52
4.2	Congestion mitigation for ITS-G5	53
4.2.1	Data Rate Control (DRC)	54
4.2.2	Data Rate Control with Adaptive Traffic Control based on LIMERIC (DRC/ATCL)	57
4.3	DIstributed Context-Aware Radio access Technology (DICART) selec- tion framework	58
4.3.1	Decision criteria	60
4.3.2	Data processing stage	60
4.3.3	Decision making process	62
4.4	Summary	65
5	Evaluation scenarios and main findings	66
5.1	Simulation environment	66
5.1.1	Mobility simulator: SUMO	66
5.1.2	Network simulator: OMNeT++	67
5.2	Performance evaluation of GLOSA with ITS-G5 communication technology	70
5.2.1	Discussions on the effectiveness of GLOSA within a small-scale scenario	70
5.2.2	Evaluation of GLOSA algorithms under a large-scale scenario	72
5.3	Comparative evaluation on the efficiency of congestion control mecha- nisms in ITS-G5	74
5.3.1	Simulation scenario	75
5.3.2	Simulation results	76
5.4	Performance evaluation of DICART selection framework	79
5.4.1	Description of selected C-ITS services	79
5.4.2	Subjective weights calculation for C-ITS services	79
5.4.3	Simulation scenario	80
5.4.4	Simulation results	82
A.	Single-RAT: Decision-makers with two IEEE 802.11p interfaces	83
B.	Multi-RAT: Decision-makers with IEEE 802.11p and LTE- V2X (mode 4) interfaces	84
5.5	Summary	86
6	Conclusion and perspectives	88
6.1	Accomplished goals	88
6.1.1	Study on the effectiveness of GLOSA under ITS-G5 technology	88
6.1.2	Study of congestion control mechanisms for ITS-G5	89

6.1.3	Network selection management in a heterogeneous C-ITS communication architecture	90
6.2	Future directions	90
6.2.1	Emerging technologies for C-ITS networks: IEEE 802.11bd and NR-V2X	90
6.2.2	Possible upgrades for DICART selection framework	91
Appendix A		93
Publications		94
Bibliography		104

List of Figures

1.1	Classification of some C-ITS services.	3
1.2	Illustration of CAMs and DENMs dissemination.	5
1.3	Frequency allocation plans for Europe and the USA.	5
2.1	ISO ITS-S ITS reference architecture.	13
2.2	The resulting PHY packet, PPDU ready for transmission.	16
2.3	Decentralized Congestion Control simplified architecture.	17
2.4	Reactive approach.	18
2.5	DCC state machine.	18
2.6	Adaptive approach.	19
2.7	LTE-V2X architecture.	19
2.8	Mode 3 resource management.	20
2.9	Mode 4 autonomous resource management.	21
2.10	LTE-V2X frame structure and resource allocation schemes.	22
2.11	SPS sensing process.	23
2.12	Average RSSI calculation of a CSR.	23
2.13	SPS flow chart.	24
2.14	SCI content.	24
3.1	DM architecture's classification.	34
3.2	MIH architecture.	36
3.3	Hierarchical structure of MCDM problem.	43
3.4	Decision matrix template.	43
4.1	EPP-GLOSA algorithm flow chart.	52
4.2	Calculation of the Channel Busy Ratio (CBR).	55
4.3	Number of node's neighbors from location table.	57
4.4	DICART framework conceptual model: a multi-interface node architecture.	59
4.5	Data Life Time (DLT) function.	61
4.6	Alternatives as points in two dimensional space corresponding to criteria and their distances from positive-ideal A^+ and an negative-ideal A^-	64
5.1	Illustration of SUMO simulation.	66
5.2	Simulation architecture	68
5.3	Deployment diagram of a network node in HeteroSIM framework.	69
5.4	Impact of traffic density on GLOSA performance.	71
5.5	Impact of the activation distance on GLOSA.	71
5.6	Simulation scenario of Luxembourg city.	72
5.7	Performance evaluation of driving strategies in free-flow conditions.	73
5.8	Performance evaluation of driving strategies in rush hour conditions.	74
5.9	Average message rate measurements.	76
5.10	Channel load measurements.	77
5.11	Average End-to-end delay measurements.	77

5.12	Packet Error Rate measurements.	78
5.13	Illustration of the simulation scenario for DICART evaluation.	81
5.14	Average throughput and E2E delay for single-RAT scenario depending on disruptive traffic rate under low and medium traffic conditions.	83
5.15	Average throughput and E2E delay for single-RAT scenario depending on disruptive traffic rate under high traffic conditions.	84
5.16	Average throughput and E2E delay for multi-RAT scenario depending on disruptive traffic rate under low traffic conditions.	84
5.17	Average throughput and E2E delay for multi-RAT scenario depending on disruptive traffic rate under medium traffic conditions.	85
5.18	Average throughput and E2E delay for multi-RAT scenario depending on disruptive traffic rate under high traffic conditions.	86

List of Tables

1.1	Performance requirements of some C-ITS services [12] [11].	4
2.1	Summary table of the main features of the C-ITS network architectures.	12
2.2	Transfer rates, coding rates in 802.11p [33], [34] [35].	15
2.3	Mapping of UP in 802.1D to the AC of QoS facility in 802.11.	16
2.4	The resulting AIFS and CW sizes for 802.11p's ACs.	16
2.5	Reactive DCC parameter look-up table.	18
2.6	RRI and re-selection counter values [45].	22
2.7	CBR and CR_{limit} thresholds.	24
3.1	Summary table of vehicular network technologies advantages and limitations.	29
3.2	Summary table of research efforts on RAT selection.	41
3.3	Summary table of normalized techniques features in [101].	45
5.1	Summary table of simulation settings.	70
5.2	Scenario configuration.	73
5.3	Simulation configuration parameters	75
5.4	Performance requirements of the selected C-ITS use cases [135] [134].	80
5.5	Normalized performance requirements.	80
5.6	Weight vector obtained from pair wise matrix A_s	80
5.7	Summary table of simulation settings.	82

List of Acronyms

DICART	DIstributed Context-Aware Radio access Technology
GLOSA	Green Light Optimal Speed Advisory
C-ITS	Cooperative Intelligent Transport Systems
RAT	Radio Access Technology
GN	Geo-Networking
BTP	Basic Transport Protocol
DCC	Decentralized Congestion Control
MCDM	Multi-Criteria Decision-Making
SPS	Semi-Persistent Scheduling
RSSI	Received Signal Strength Indicator
CSR	Candidate Single Subframe
SCI	Sidelink Control Information
DLT	Data Life Time
UP	User Priority
RRI	Resource Reservation Interval
GST	Global System for Telematics enabling online safety services
CVIS	Cooperative Vehicle Infrastructure Systems
SAFESPOT	Cooperative systems for road safety "Smart Vehicles on Smart Roads"
DRIVE C2X	Driving implementation and Evaluation of C2X communication
FOTs	Field Operational Tests
ITS	Intelligent Transport Systems
TI	Traffic Information
CCA	Cooperative Collision Avoidance
VRU	Vulnerable Road Users
I2V	Infrastructure-to-Vehicle
V2V	Vehicle-to-Vehicle
V2P	Vehicle-to-Pedestrian

- V2I** Vehicle-to-Infrastructure
- V2X** Vehicle-to-Everything
- CAM** Cooperative Awareness Message
- DENM** Decentralized Environmental Notifications Message
- FCC** Federal Communications Commission
- 3GPP** 3rd Generation Partnership Project
- QoS** Quality of Service
- SABIN-SS** Speed Advisory Boundary Finder for Simple Segment
- SABIN-MS** Speed Advisory Boundary Finder for Multiple Segment
- EPP-GLOSA** Efficient Path Planning GLOSA-based
- DRC** Data Rate Control
- CBR** Channel Busy Ratio
- DRC/ATCL** Data Rate Control with Adaptive Traffic Control based on LIMERIC
- TOPSIS** Technique for Order Preference by Similarity to Ideal Solution
- WAVE** Wireless Access in Vehicular Environment
- WSMP** WAVE Short Message Protocol
- CCH** Control Channel
- SCH** Service Channel
- OBU** On-Board Unit
- RSU** Road Side Unit
- MAC** Medium Access Control
- HMI** Human-Machine Interface
- VANETs** Vehicular Ad-hoc Networks
- LT** Location Table
- LDM** Local Dynamic Map
- OFDM** Orthogonal Frequency-Division Multiplexing
- OCB** Outside the Context of BSS
- EDCA** Enhanced Distributed Coordination Access
- DCF** Distributed Coordination Function
- AIFS** Arbitration Inter-Frame Space
- CW** Contention Window

AC	Access Category
MCO	Multi-Channel Operations
TC	Traffic Class
NDL	Network Design Limits
TPC	Transmit Power Control
TRC	Transmit Rate Control
TDC	Transmit Data rate Control
FSM	Finite State Machine
ProSe	Proximity Services
HARQ	Hybrid Automatic Repeat reQuest
TDM	Time-Division Multiplexing
FDM	Frequency-Division Multiplexing
SC-FDMA	Single-Carrier Frequency-Division Multiple Access
RBs	Resource Blocks
MCS	Modulation Coding Scheme
PSCCH	Physical Sidelink Control Channel
PSSCH	Physical Sidelink Shared Channel
TB	Transport Blocks
CR	Channel occupancy Ratio
DSRC	Dedicated Short Range Communications
MBMS	Multimedia Broadcast Multicast Services
eMBB	enhanced Mobile BroadBand
mMTC	massive Machine Type Communication
URLLC	Ultra-Low Latency Communications
LAA	Licensed-Assisted Access
LBT	Listen-Before-Talk
MIMO	Multiple-Input Multiple-Output
DM	Decision-Maker
MIH	Media Independent Handover
SAPs	Service Access Points
AHP	Analytic Hierarchy Process

- GRA** Grey Relational Analysis
- VIKOR** Vlse Kriterijumska Optimizacija Kompromisno Resenje
- VHD** Vertical Handover Decision
- RSS** Received Signal Strength
- VHO** Vertical Handover
- AI** Artificial Intelligence
- ML** Machine Learning
- SI** Swarm Intelligence
- SL** Supervised Learning
- UL** Unsupervised Learning
- RL** Reinforcement Learning
- ANN** Artificial Neural Network
- MARL** Multi-Agent Reinforcement Learning
- BBO** Biogeography-Based Optimization
- PSO** Particle Swarm Optimization
- ACO** Ant Colony Optimization
- RRP** Rank Reversal Problem
- WLS** Weighted Least Squares
- SAW** Simple Additive Weighting
- PDR** Packet Delivery Ratio
- LIMERIC** Linear Adaptive Message Rate for Congestion Control
- EMA** Exponential Moving Average

List of Symbols

A^+ The positive-ideal solution

A^- The negative-ideal solution

R_b Channel busy ratio

R_c Collision ratio

R_s Successful transmission ratio

σ Time slot

T_s The time duration for a successful transmission

T_c The time duration of a failed transmission due to a collision

T_h The duration of the Physical Layer Convergence protocol (PLCP)

λ Packet arrival rate

W Contention window size

$cbrTh$ CBR threshold

$hyst_{factor}$ Hysteresis factor

r_j The message rate of j^{th} vehicle

CL_t Target channel load

CL_m Measured channel load

CL_{conv} Convergence channel load

A_s Pair-wise comparison matrix

w_s Subjective weight

D_i^+ The shortest euclidean distance from the positive ideal solution

D_i^- The farthest euclidean distance from the negative ideal solution

C The relative closeness to the positive-ideal solution

Chapter 1

Introduction

With the tremendous expansion of human mobility in different urban areas, accidents and road risks increase rapidly. Effective mobility management is, therefore, necessary to alleviate road traffic issues. The development of ITS services seems to be urgent to manage human mobility better. The main goal is to improve traffic management efficiency and increase road safety. C-ITS is also seen as one of the promising solutions for green mobility. The proper functioning of the C-ITS requires reliable and ubiquitous communication systems. These systems imply that different road actors, such as drivers, passengers, and road operators, interact directly or via communication systems on the backbone infrastructure. ITS components communicate cooperatively to meet current and future needs in terms of traffic congestion and road safety. Accordingly, low-latency communication technologies are needed to ensure an acceptable Quality of Service (QoS) and high Quality of Experience (QoE).

We start this chapter by presenting some European research projects about C-ITS deployment highlighting related challenges in section 1.1. This chapter outlines a brief description of different C-ITS service categories in section 1.2. In section 1.3, we present the C-ITS frequency allocation plan in Europe and USA. We then present our motivation in section 1.4. Section 1.5 introduces thesis objectives giving some rationales for the adopted research methodology. In section 1.6, we enumerate the main contributions of this thesis. Finally, we summarize this manuscript's structure in section 1.7.

1.1 European C-ITS research projects and deployment challenges

During the last few years, several projects have been conducted in Europe, mainly focusing on C-ITS research field. Research projects such as GST [2], CVIS [3], and SAFESPOT [4, 5] were a great opportunity for developing and studying a different range of C-ITS services.

Other projects like SCOOP@F [6] and DRIVE C2X [7] have been conducted to investigate the benefits of C-ITS on road safety and traffic efficiency throughout carrying out a set of comprehensive FOTs and broad evaluation of C-ITS.

The work of this thesis is part of C-ROADS France [8], which is one of the recent European C-ITS projects that aim to bring the C-ITS deployment closer to reality.

C-ROADS project is a cooperation between different stakeholders and operators working on the deployment of harmonized C-ITS services in Europe. The deployment of C-ITS covers a set of evolutionary stages such as the definition of key factors and scenarios to facilitate the assessment process. As a first step, C-ROADS starts by identifying less complex C-ITS use cases which are referred to as "Day-1-services" encompassing safety and traffic efficiency categories.

As part of this project, a user-centric platform was developed supporting a different range of "Day-1-services" such as GLOSA and traffic information services aiming to increase driving comfort (e.g. smart routing, information on truck parking, and so on).

In C-ROADS France, ITS-G5 and cellular technologies are chosen as leading technologies for FOTs deployment [9]. One of the C-ROADS project's goals is to cover various C-ITS services by evolving a heterogeneous architecture between ITS-G5 and cellular networks which will be capable of maximizing bandwidth and ensuring low latency. In this context, our research interest lies in evaluating network technologies dedicated to ITS. We particularly focused on the design of a RAT selection framework for heterogeneous network architecture. In this thesis, our technological choice is based on the context of C-ROADS France hybrid architecture. Thus, we assume that our architecture could be composed of nodes capable of handling the ITS-G5 and LTE-V2X communication network interfaces. We also chose to focus on specific C-ITS use cases included in "Day-1-services" of C-ROADS such as GLOSA, TI, CCA, and VRU.

Deployment projects often face problems and challenges of a different nature. Some are technical, operational, and others concern financial and business plans. In fact, managing and exploiting FOTs results is not a trivial task. It needs detailed steps under well-defined methodology. Many challenges and issues have been discussed and identified in literature [10]. For instance, analyzing and exploiting the huge amount of data gathered in FOTs is a costly task that requires tremendous resources (e.g. storage capacities, back up servers). Furthermore, an incident like precious data loss can frequently happen in FOTs. Ethical issues can also be one of the barriers that should be resolved before conducting FOTs. For example, collecting people's driving destination may be quite sensitive to their privacy [10].

1.2 C-ITS services and main requirements

C-ITS services aim to widely enhance road safety by improving driver awareness about upcoming potential hazards. Through alert notifications, drivers can avoid collisions and sudden threats from different actors on the roads. These systems can also solve environmental and traffic congestion problems by reducing fuel consumption and travel time.

C-ITS services are classified as *traffic safety*, *traffic efficiency*, and *infotainment*. Figure 1.1 shows some examples of C-ITS services for each category.

A. Traffic Safety

It includes cooperative forward collision warning, pre-cash/warning, and hazardous location notification. These services essentially contribute to minimizing the number of accidents. Indeed, they aim to alert vehicles about potential hazards on the road by offering them awareness and assistance information. Forward collision warning is based on sharing information about position, speed, and heading.

B. Traffic efficiency

It targets the goal of improving road traffic management by exploiting information about road actors state and their travel plan. This class also offers enhanced route guidance and navigation. For instance, in-vehicle dynamic speed limit information service provided knowledge about current and recommended speed limits. GLOSA is another example that exploits the available traffic light timing information via direct

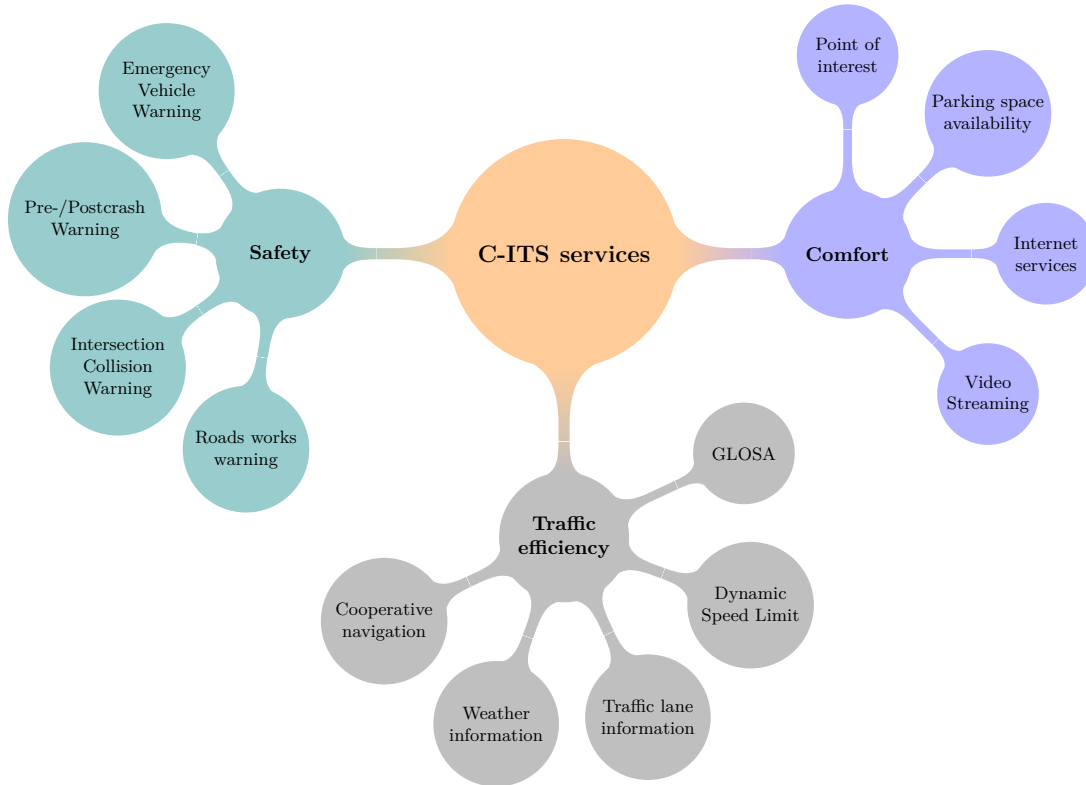

FIGURE 1.1: Classification of some C-ITS services.

short-range communications to recommend the optimal speed enabling the driver to catch the green phase.

C. Infotainment

These services provide additional services such as downloading multimedia and exchanging audio and video data with other vehicles or with the infrastructure. Point of interest (POI) notification is another example of comfort applications that provide real-time information about energy supply stations, maintenance facilities, and free parking slots.

The effectiveness of C-ITS services mainly depends on communication technology performances that should answer the C-ITS reliability and latency requirements and provide better Quality of Service (QoS). I2V V2V, V2P, and V2I collectively referred to V2X communication modes aim to enable data exchanges between vehicles and their surroundings. Different service requirements are defined in ETSI specifications [11] according to a set of criteria. First of all, the maximum absolute velocity 160 km/h and the maximum relative velocity 280 km/h shall be supported. Second, a suitable communication range should be adjusted according to the C-ITS service needs (e.g., it should be larger than the distance calculated as the great response (e.g., 4 seconds) for the drivers to avoid collision according to maximum relative speed).

Use Case type	V2X Mode	E2E latency	Reliability	Data Rate per veh (kbps)	Comm. range
Cooperative Awareness	V2V V2I	100 ms to 1 s	90-95%	5-96	200 m to 500 m
Cooperative sensing	V2V V2I	3 ms -1 s	> 95%	5-25000	< 200m
Cooperative Maneuver	V2V V2I	< 3 ms	> 99%	10-5000	200 m to 500 m
Vulnerable Road User	V2P	100 ms to 1 s	95 %	5-10	< 200 m
Traffic efficiency	V2N V2I	> 1s	< 90%	10-2000	> 500 m
Tele-operating driving	V2N	5-20 ms	> 99%	25000	> 500 m

TABLE 1.1: Performance requirements of some C-ITS services [12] [11].

As for latency requirements, the maximum tolerable value between two devices supporting V2V, V2P, and V2I services shall be 100 ms. The communication technology should also support high reliability without requiring application-layer message re-transmissions. For some cases (i.e., pre-cash sensing), the communication system should be capable of transferring messages between two nodes supporting V2V services with a maximum latency of 20 ms. Table 5.4 gives a summary of performance requirements of some C-ITS use cases derived from [12] [11]. ITS safety services typically consist of sharing two kinds of information contents as follows:

- **Local scope information:** this information is mainly related to the knowledge of the vehicle’s surroundings over a given range. It is conveyed by specific messages known as CAM [13] in European standardization, and Basic Safety Message [14] in US standards. These messages are transmitted periodically in single-hop broadcast mode with payloads ranging from 50 to 300 bytes carrying data such as geographical position, speed and direction.
- **Global scope information:** this category of information deal with the occurrence of an event on the road that could be weather condition changes (e.g., fog, snow, etc.) or hazardous situations (e.g., accidents, animal on the road, and so on.). When such a road emergency is detected, specific messages are therefore transmitted using a multi-hop broadcast mode containing information on the position of the hazard in a specific area of the road. These event-triggered messages are known as DENM in Europe, and are defined in US SAE 2735 message library [14]. Payloads of such messages can be up to 1200 bytes.

In the remainder of this thesis, we use European safety messages terminologies (CAM and DENM). A case scenario showing CAM and DENM dissemination is depicted in figure 1.2. CAM messages may be sent using direct communication generally with V2V mode to ensure seamless connectivity between different road users [13].

1.3 Frequency allocation plan for C-ITS

EU Union and the US have allocated dedicated spectrum to vehicular communications, as shown in figure 1.3. Both allocations are in the 5.9 GHz band, between 5855 and 5925

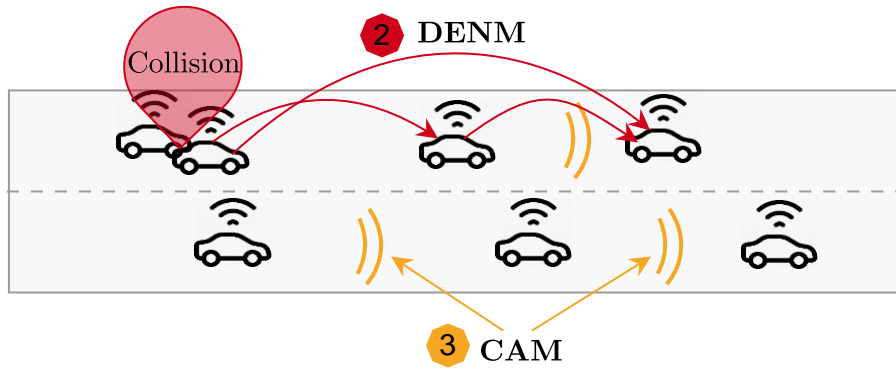

FIGURE 1.2: Illustration of CAMs and DENMs dissemination.

MHz. In Europe, 50 MHz were allocated [15], whereas in the US, the FCC allocated 75 MHz of dedicated spectrum [16].

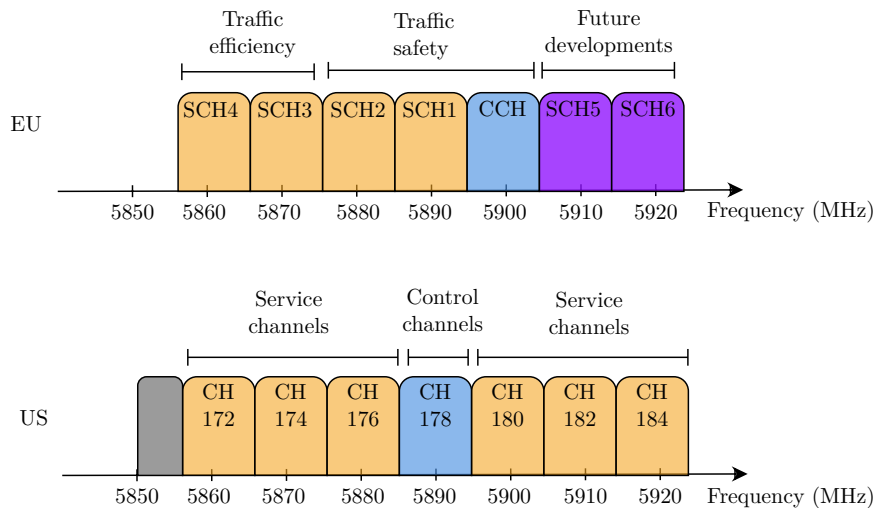

FIGURE 1.3: Frequency allocation plans for Europe and the USA.

Dedicated ITS spectrum at 5.9 GHz is proposed to deliver safety-related services using a different range of technologies, namely ITS-G5 and LTE-V2X. Furthermore, ITS-G5 is a European standard dedicated for ad-hoc short-range vehicular communications. It refers to the approved amendment of IEEE 802.11p standard. LTE-V2X is a cellular technology introduced by 3GPP to support ITS in both short and long communication range. Moreover, The technology-neutral nature of spectrum regulations in Europe means that LTE-V2X and 802.11p have equal rights to operate in the 5.9 GHz band, subject to compliance with the relevant regulatory technical conditions. The 5.9 GHz, ITS frequency band is already being used to deploy C-ITS services through ITS-G5 technology [17]. When it comes to LTE-V2X technology, dedicated spectrum allocation is highly suggested considering the high-performance demand of safety-related services. For non-safety-related services (e.g., automated parking system, traffic flow optimization, etc.), allocation of spectrum in a shared manner can be considered to improve the spectrum utilization.

The co-existence problem presents one of the current C-ITS challenges among industrial and academic communities. Some research associations discuss this issue, highlighting the importance of the antenna installation at the 5.9 GHz frequency band regardless of the choice of technology. Furthermore, Europe's automobile manufacturers support investigation and research into other V2X technologies at a carrier frequency between 3.4 and 3.8 GHz [18]. For instance, the 5GAA research association proposes splitting the lower 30 MHz between ITS-G5 and LTE-V2X and address the upper 45 MHz allocation in the future [19].

In this thesis, we assume that both technologies co-exist with non interfering manner. We do not focus on frequency allocation plan issues of both technologies. The co-existence interference scenario related issues are outside the scope of this work.

1.4 Motivations

Advanced driving and the tremendous expansion of C-ITS services conduct the evolution of current vehicular communication technology's performances towards ultra-reliability and low latency requirements. Networks with heterogeneous access technologies are fundamental features of the recent generation of communication techniques to support a wide range of novel applications for indoor and outdoor use cases. Therefore, improved spectrum efficiency and innovative heterogeneous network deployments with astute resource sharing are essential to meet traffic demands expected in the near-future [20].

Efficient communication techniques are also necessary to offer more satisfying performances to several C-ITS services. Vehicular communications support both short-range (e.g., ad hoc technologies) and long-range (e.g., cellular technologies) technologies. They also enable different architectural components for cooperative and efficient communication. The choice of the appropriate technology that will best meet the V2X service's requirements remains an inevitable debate between all the actors involved in C-ITS's ongoing deployment.

Certain communication technologies are specifically designed to support V2X functionalities and achieve C-ITS primary goals. LTE-V2X and ITS-G5 are the main used technologies, which are standardized by 3GPP (3rd Generation Partnership Project) and ETSI (European Telecommunications Standards Institute), respectively. The choice between these technologies looks to be a challenging question that needs further investigation. Conceiving a heterogeneous network architecture might be a suitable solution to maintain ubiquitous connectivity between different C-ITS users, which better exploits the co-existence of multiple Radio Access Technologies (RATs). This possibility has already been discussed in 3GPP release 16 [21].

Heterogeneous network architecture is intended to offer users with an Always Best Connected (ABC) facility, good QoS, and high bandwidth. However, implementing such architecture invokes many technical challenges and aspects that should be studied and solved to answer services requirements and satisfy user preferences while switching through different access technology interfaces.

Taking advantage of the coexistence of different radio access technologies to improve the overall network performance is one of the main incentives of this thesis. Our motivation is to study the efficiency of communication techniques dedicated to C-ITS and their ability to meet the requirements of C-ITS services.

1.5 Objectives and research methodology

This thesis aims to explore possible performance improvements for ITS-G5 technology and a network selection management under a heterogeneous communication architecture to provide enhanced support for C-ITS services.

1.5.1 Thesis objectives

Our primary focus is to improve the vehicular communication network's performances to support a wide range of C-ITS services. Our specific research objectives will be identified in this section.

- 1. Investigate and evaluate the efficiency of ITS-G5 in handling GLOSA service:** For the sake of evaluating C-ITS network performance, we first focus on a C-ITS service called GLOSA, which is one of the studied services under the C-ROADS project. We aim to study its performance under an ITS-G5 communication network architecture.
- 2. Improve ITS-G5 network performance in congested scenarios:** One of our goals is to tackle the congestion control problem for ITS-G5. We focus on congestion mitigation in ITS-G5 technology. We aim to raise its capability in handling road safety, and traffic management C-ITS services where latency and reliability play an essential role in the functional efficiency of that services.
- 3. Manage network selection under a heterogeneous C-ITS communication architecture:** We emphasize the importance of network selection management by targeting the design of a suitable network selection scheme for heterogeneous network architecture, considering multiple criteria and different C-ITS service profiles. Using a network selection based on the user's profile (e.g., delay or throughput preference), we aim for a better quality of user experience (QoE) for C-ITS use cases.

1.5.2 Research methodology

To address the thesis objectives detailed previously, we define and justify our research methodologies in this section.

On the one hand, we adopt a qualitative approach to study and review research work about the C-ITS communication network in detail. We investigate standardization efforts on C-ITS network architectures where we will deeply explore ITS-G5 and LTE-V2X radio access technologies features. We will also detail review research efforts for each of the mentioned objectives to position our contributions to state of the art. Using qualitative performance analysis of C-ITS dedicated technologies is an essential step to identifying each technology's limitations. ITS-G5 and LTE-V2X limitations were reviewed and studied.

On the other hand, we chose a quantitative research methodology to realize our objectives detailed in subsection 1.5.1. We particularly adopt a simulation-based evaluation that addresses our need to realistically model the C-ITS environment regarding mobility constraints and network protocol stack. Our choice is motivated by the fact that quantitative simulation methods are so flexible and can yield so many valuable results compared to FOTs that may present many deployment challenges as explained in section 1.1. C-ITS FOTs encounters a lot of technical and operational issues. Indeed, the collection and processing of FOTs results are relatively costly and resource consuming. Precious data loss incidents are frequent in such an evaluation process.

Challenges related to testing multiple services and communication technologies dealing with large data sets are the shortcomings of FOTs that have led us to choose simulation environment as an evaluation tool for our contributions.

A full-stack network simulation environment will be adopted to evaluate our contributions under realistic C-ITS scenarios taking into account mobility and road topology.

1.6 Thesis contributions

The contributions brought by this thesis are enumerated in the remainder of this section. Our contributions are organized as follow:

1. At the first stage of this thesis, we deeply studied the ITS-G5 technology limitations. Some results about performance evaluation comparing LTE-V2X and ITS-G5 have been published in this conference paper [22]. Under the umbrella of C-ROADS, we particularly focused on GLOSA service evaluating its efficiency and the impact of ITS-G5 performance on its proper functioning. We proposed a study investigating the impact of network state on GLOSA that covers evaluating different proposed strategies for this service. In the context of this study, we introduced three different strategies for GLOSA, namely, SABIN-SS, SABIN-MS, and EPP-GLOSA. This contribution has been published in this journal paper [23] comparing the performance of the proposed GLOSA algorithms. After studying GLOSA and carrying out quantitative and qualitative evaluations of ITS-G5 technology, we noted the need to improve data dissemination under high traffic condition scenarios.
2. At high traffic loads, network congestion has undesirable consequences for ITS-G5 (e.g. high latency and packet loss). Congestion control schemes are therefore needed to improve ITS-G5 network performance. We introduced a DRC mechanism. The motivation for this proposal is to enhance data dissemination performance under high traffic loads. It is mainly based on a proactive calculation of CBR thresholds with a target of maximizing transmission opportunities. It triggers a dynamic adjustment of the data rate based on a comparison between the calculated CBR thresholds and the channel busy ratio acquired by a periodic channel probing. We then extended DRC to DRC/ATCL whose main goal is to better support congestion control. It consists of adjusting both data rate and message rate to keep channel load as low as possible. Results of this contribution have been published in this conference paper [24].
3. As previously mentioned, different C-ITS networks are available to answer C-ITS services requirements. While the main objective remains to guarantee the best quality of service and optimal use of radio resources, efficient management of this heterogeneous communication architecture should be considered. To deal with the network selection problem, we have designed DICART, a distributed context-aware RAT selection framework, which triggers switches to the network interface, offering the best performance. It is based on multi-criteria decision making where the TOPSIS method is used to rank the available networks taking into account criteria such as delay and available bandwidth.

1.7 Structure of the manuscript

This manuscript is organized into six chapters. An introduction to the C-ITS is given in **chapter 1** highlighting its impact on road safety and traffic management efficiency. The

motivation of this thesis and a summary of different contributions are also introduced in this chapter.

Chapter 2 present standardization efforts on C-ITS networks. It also gives the necessary elements and terminologies for understanding the rest of this manuscript. It mainly gives a comprehensive overview of both ad-hoc and cellular technologies.

A detailed state of the art is then presented **in chapter 3** to support the motivation for this work and justify the purpose of our different contributions. The research efforts related to the effectiveness of communication networks in supporting C-ITS such as GLOSA are given. Furthermore, congestion control mechanisms for ITS-G5 are reviewed and organized by methodology. This chapter also provides a taxonomy of decision algorithms and decision-maker architectures, with a comprehensive review of RAT selection research efforts.

In chapter 4, we present our main contributions, in particular, we begin by investigating GLOSA. Next, we detail our proposals for congestion control aiming to improve ITS-G5 data dissemination. We then tackle the RAT selection problem by proposing DICART mechanism.

In chapter 5, we perform performance evaluations of our contributions using a realistic simulation environment where discussions about our main findings are given.

Chapter 6 concludes this thesis by summarizing our contributions and assessments, and opening up some future directions.

Chapter 2

Standardization efforts on C-ITS network architectures

C-ITS communication networks have attracted much attention from academia and industry recently owing to the broad range of new V2X services. These communication systems will enable the exchange of information between vehicles and different nodes (e.g., infrastructure and pedestrian) and vice versa. These communication modes offer multiple services categories such as safety, traffic efficiency, and user comfort. Traffic safety-related systems particularly indicate an increased number of requirements and challenges for wireless and cellular communications.

We begin this chapter with section 2.1, highlighting the standardization efforts on the C-ITS communication architectures by giving rationales for using ISO ITS reference architecture. We then detail the ISO ITS architectural components in section 2.2.

This chapter also provides a comprehensive overview of the most used C-ITS communication technologies, which is presented as seen from multiple perspectives. The state of these communication standards will be analyzed in detail, starting from the earliest activities related to C-ITS communications and particularly interested in studying ITS-G5 access technology in section 2.3 and LTE-V2X released by the 3GPP in section 2.4.

We finally summarize this chapter in section 2.5 discussing strengths and weaknesses of each presented communication technology.

2.1 Comparative overview of C-ITS network architectures

Numerous standardization efforts have been devoted to providing flexible and comprehensive ITS network architecture. Standardization bodies, research institutions and many stakeholders have been working towards the establishment of such an architecture. In the following, we describe some of these efforts. In literature, different architectures are available [25, 26]. IEEE proposed WAVE (Wireless Access in Vehicular Environment) architecture and Car-to-Car Communication Consortium / GeoNet (C2C-CC) architecture. ISO has also introduced ITS reference architecture. These architectures are briefly presented in subsequent subsections.

A. WAVE architecture

Driven by achieving a high level of security, comfort, and efficiency, the IEEE developed an amendment of the 802.11 standards to include vehicular environments. This is known as IEEE 802.11p. WAVE architecture is composed of two families of IEEE standards: IEEE 802.11p and IEEE 1609. IEEE 802.11p defines the lower layers, while IEEE 1609 defines the upper layers. To manage the different layers, WAVE defines six sub-standards of IEEE 1609. The IEEE 1609.1 standard deals with the management

activities required by applications. Standard IEEE 1609.2 describes the considerations for security parameters. IEEE 1609.3 provides the WSMP for transporting and managing the network layer of security applications. IEEE 1609.4 defines the coordination between different MAC channels. IEEE 1609.5 addresses layer management, while IEEE 1609.6 provides an additional intermediate layer (between the transport layer and the application layer) for managing additional facilities at the application layer.

WAVE supports non-safety ITS services, and it uses the WSMP protocol specifically designed to ensure fast single-hop reliable broadcast of safety messages [27].

Moreover, WAVE architecture defines many functionalities related to applications, networking, management, communication and security. In addition, this architecture can manage multiple radio channels such as CCH and SCH. The CCH is used for service announcement and safety services, while the SCH uses for Internet Protocol (IP) data transmission.

Despite its ability to manage several radio channels, this architecture does not allow the management of heterogeneous access technologies.

B. C2C-CC architecture

The Car-2-Car Communication Consortium (C2C-CC) worked to standardize interfaces and protocols of wireless communication between vehicles and their environment. The architecture proposed by C2C-CC is an extension of WAVE architecture. It evolves WAVE to support the allocation of a frequency band (e.g. ITS-G5) for road safety, and it allows the use of urban Wi-Fi (e.g. IEEE 802.11 a/b/g) for Internet communication using IPv6 [28]. The architecture was designed to support both safety and non-safety services. C2C-CC uses addressing scheme based on geographical routing. It provides a beaconing location service and data forwarding feature. C2C-CC offers flexibility. For instance, safety services are not limited to the use of C2C-CC transport and the network layer. Similarly, non-safety services can also use the IP stack to access wireless multi-hop communication with OBU, and RSU.

C. ISO ITS reference architecture

The ISO ITS architecture was introduced in the framework of ISO 21217 standardization [29]. It was conceived to support a large variety of C-ITS services with divergent performance requirements and maintain efficient information sharing. It provides adaptability and flexibility features, and it supports the management of different heterogeneous architectures. It offers a variety of communication protocols (e.g., Internet Protocol (IPv6) and non-IP (ETSI GeoNetworking / ISO FNTP)). Various ITS services with divergent requirements cannot be handled using one access technology. Different communication technologies must be supported in a specific ITS station unit. The ITS reference architecture was designed for this purpose to allow the combination of different RATs. The first proof of concept of this aspect was demonstrated in CVIS European Project. From 2019 onwards, the need for heterogeneous communication solutions is expressed in the pilot deployment of C-ITS services, particularly within the C-ROADS European project [30].

After reviewing some standardization efforts, we observed that all ITS architectures offer a typical management plan design. Main features of different architectures are presented in table 2.1. Among the before-mentioned architectures, ISO ITS presents the most advanced conceptual design. This architecture can handle several access technologies; it also offers a mobility management plan at the network layer, allowing seamless connectivity.

Architecture Feature	WAVE	C2C-CC	ISO ITS
Main focus	Single-hop	V2V V2I multi-hop	Multiple technologies and interfaces
Communication mode	Broadcast	Broadcast Unicast Geo-broadcast, Geo-unicast	Broadcast Unicast Geo-broadcast, Geo-unicast
Addressing schemes	IP addressing	Geo-routing	Geo-routing IP addressing
Wireless technologies	Only 801.11 p	802.11 p + other Wi-Fi standards	LTE Wi-Fi ..
Target services	Safety	Safety	Safety Non-safety

TABLE 2.1: Summary table of the main features of the C-ITS network architectures.

Therefore, we chose to work with the ISO ITS architecture because it offers a comprehensive model that supports multi-interface and multi-RAT scenarios, as opposed to the WAVE and C2C-CC architectures. Different components of the ISO ITS reference architecture will be detailed in section 2.2.

2.2 ISO ITS reference architecture

This section provides a detailed insight overall ISO/ETSI reference architecture that will be adopted during this work. As shown in figure 2.1 ITS station (ITS-S) architecture is mainly composed of four horizontal layers, namely access, networking & transport, facilities, and application. Two cross layers called management and security are also present.

- **Access** layer is conceived to support different interfaces such as vehicular ad-hoc technologies (e.g., ITS-G5 in Europe, DSRC in the USA), urban Wi-Fi (e.g. 802.11 g/n/ac), and cellular (3G, 4G and ongoing 5G). This layer is responsible for MAC, and it provides data transmission over physical links. In respective sections 2.3 and 2.4, we particularly detail the ITS-G5 and LTE-V2X technologies that will be used in this thesis.
- **Networking & transport** layer is responsible to execute functions such as packet routing, path establishment, path monitoring and IP mobility, etc. Geo-networking protocol and Basic Transport Protocol (BTP) are respectively detailed in subsections 2.2.1 and 2.2.2.
- **Facilities** offers the support of various applications. For instance, one of the main operations executed by this layer is to encode/decode messages. More details about facilities layer are given subsection 2.2.3.
- **Application** is an entity that could host different services. Such a layer can provide a HMI to facilitate the various user manipulations.

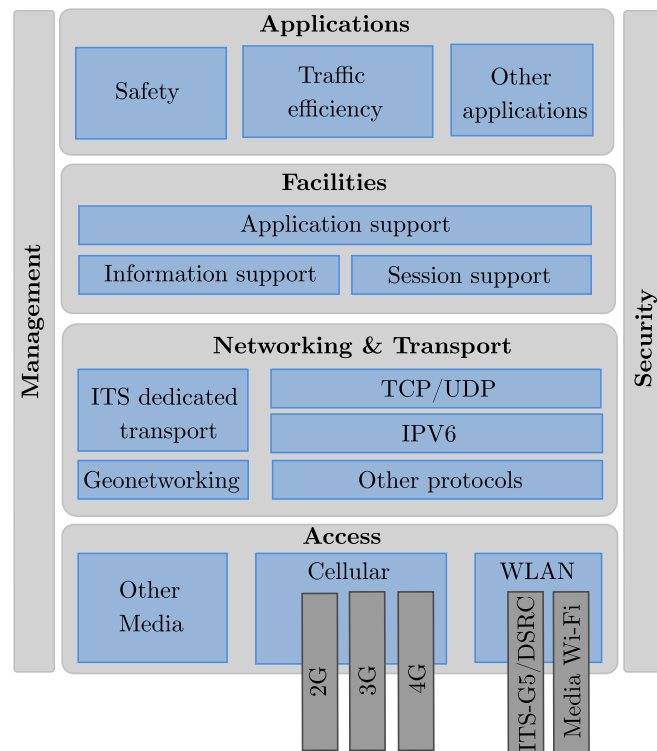

FIGURE 2.1: ISO ITS-S ITS reference architecture.

- **Management** is an entity in which role is to monitor different process in the ITS-S (e.g communication profile selection, application management and communication interfaces management).
- **Security** is a cross-layer entity that offers security and privacy procedures. It is the responsible entity for allowing a trust communication (e.g. cryptography, authentication management, firewall, and intrusion management). The security in C-ITS architecture is essential; it must have a robust cybersecurity background to protect vehicles from cyberattacks.

2.2.1 Geo-Networking (GN)

Many use cases in ITS communications involve the dissemination of information in a particular geographic region. This aspect has led to the development of GN protocol, which is a location-based addressing concept. In this section, we introduce the GN routing protocol and BTP transport protocol.

GN protocol is initially proposed for general mobile ad-hoc networks. It has been introduced specifically for communication networks such as VANETs, mesh networks, and wireless sensor networks.

This protocol makes use of geographical positions for information dissemination and data packet transport. It supports communication among individual ITS stations as well as the distribution of packets in geographical areas. Indeed, every node should maintain a LT that contains information about the position and direct neighbours (nodes that are one hop away). This set of information is obtained by employing a beaconing algorithm. Each node periodically broadcasts a message advertising its GN address and its current position, speed, heading, station type, and so on to all its direct neighbours. Consequently, nodes store in their LT the information extracted from

these messages. Message redundancy and periodicity allow nodes to maintain their LT updated with other nodes' current position. However, this fact introduces some network overhead. Thus, there is a trade-off between the network overhead produced by the beaconing algorithm and the freshness of the information stored in the LT, which is needed for the GN protocol's proper operation. The smaller the beacon frequency is, the higher the network overhead is, the fresher the LT's information is. Nevertheless, the GN standard resets the beacon timer whenever a GN packet is sent to reduce the beaconing algorithm's network overhead. This is because the protocol uses beacon piggy-backing, and the information of a beacon is also included in the GN common header of all GN packets. Due to the high mobility of VANETs environment, information may become obsolete quickly, so every LT entry has a lifetime. When the lifetime of an entry expires, it is removed from the LT. The LT entry lifetime also impacts the GN protocol's performance because it influences the freshness of the LT information.

GN protocol is a network layer mechanism that implements position-based routing in ad-hoc networks by coupling geographical addressing and geographical forwarding functions. Unlike usual addressing in conventional networks, in which a node uses IP address, GN protocol sends data packets to a node using its position or multiple nodes in a geographical area. Concerning forwarding, this protocol assumes that every node has a partial view of the network topology in its vicinity and the geographical address that every packet carries. An autonomous forwarding decision is made when a node receives a data packet after comparing the geo-address and its view on the network topology. As a result, packets are forwarded "on the fly" without building routing tables in each node. GN protocol mainly supports the following forwarding schemes:

- **Geo-Unicast:** When the node wants to send a unicast packet, it starts by determining the destination's position and then forwards the data packet until it reaches its destination.
- **Geo-Broadcast:** The packet is forwarded hop-by-hop until it reaches the destination area determined by the packet.
- **Topologically scoped-broadcast:** it consists of the re-broadcast of a packet from a source to all nodes in the n-hop neighborhood.

2.2.2 Basic Transport Protocol (BTP)

BTP provides a connectionless, unreliable end-to-end packet transport similar to UDP. BTP's main goal is the multiplexing/de-multiplexing of facility layer messages based on the port's concept. It also adopts the concept of "well-known ports" from the IP protocol suites that assign fixed ports to specific ITS facilities layer. Moreover, BTP defines two header protocols: BTP-A for interactive packet transport and BTP-B for non interactive packet transport.

2.2.3 Facilities

Facilities layer is a middleware that represents the core intelligence of the architecture as it provides functions and services to the upper and lower layers and manages storage of information in several data elements. The facilities layer defines specific requirements and functions supporting applications communication and messaging protocols. LDM is one of the available facilities in ITS that can maintain useful information about objects influencing or influenced by road traffic. For instance, LDM can provide location referencing and timestamped of surrounding vehicles and roadside units to any authorized application that requests it.

2.3 ITS-G5 ad-hoc technology

ITS-G5 is an access technology conceived by ETSI to support different communication modes. ITS services messages such as safety or non-safety applications are encapsulated into CAM and DENM, which are, in turn, encapsulated into Geo-networking messages and transferred to the access layer going through the DCC.

2.3.1 Physical layer

The physical layer of ITS-G5 is derived from IEEE 802.11 a. The basic idea is to divide the available frequency spectrum into narrow sub-channels (sub-carriers). The high rate data stream is split into some lower rate data streams transmitted simultaneously over some sub-carriers, where each sub-carrier is narrow banded. OFDM is used with 52 sub-carriers, of which 48 are for data and 4 are for pilots [17]. The OFDM PHY layer supports eight different transfer rates, which are achieved using different modulation schemes and coding rates.

For the spectrum bands ITS-G5A and ITS-G5B, the channel spacing is ten Mhz. The OFDM symbol duration is $8 \mu s$ which includes a cyclic prefix (guard interval) of $1.6 \mu s$. The maximum delay spread should ideally not exceed $1.6 \mu s$, which corresponds to a distance of about 480 meters with a maximum communication range of less than 1 km [31]. The MAC layer of ITS-G5 has the same scheme as defined in IEEE 802.11-2012. Also, ITS-G5 technology adopts an Adhoc mode called OCB. This mode enables ITS-G5 stations to avoid channel scanning, authentication, and association operations required for establishing a BSS [32]. ITS-G5 station uses a wild-card BSS identifier to maintain a direct and immediate message transmission without a time-consuming delay for the exchange of control frames. Table 2.2 summarizes the existing data rates and modulation schemes for IEEE 802.11p.

Transfer rate (Mbps)	Modulation scheme	Coding rate	SNR th [dB]	SINR th [dB]
3	BPSK	1/2	0	5
4.5	BPSK	3/4	1	6
6	QPSK	1/2	3	8
9	QPSK	3/4	5	11
12	16-QAM	1/2	8	15
18	16-QAM	3/4	12	20
24	64-QAM	2/3	16	25
27	64-QAM	3/4	17	N/A

TABLE 2.2: Transfer rates, coding rates in 802.11p [33], [34] [35].

The preamble is used for synchronizing the receiver, and the signal field contains information about the packet length and at what data rate the data field is transmitted. The signal field is always transmitted using BPSK with a coding rate of 1/2, which corresponds to a bit rate of 3 Mbps, according to table 2.2.

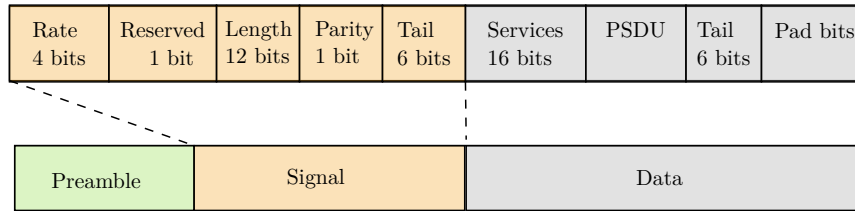

FIGURE 2.2: The resulting PHY packet, PPDU ready for transmission.

The duration of one OFDM symbol is $8 \mu\text{s}$ in 802.11p, and depending on the modulation scheme, and coding rate, different numbers of data bits can be carried in each OFDM symbol. The signal field consists of 24 bits transmitted with the lowest transfer rates, and therefore it takes $8 \mu\text{s}$ [33]. The preamble and signal field have fixed duration [33]. The duration of data depends on the selected transfer rate and the packet length.

2.3.2 MAC layer

MAC layer of ITS-G5 has the same scheme as defined in IEEE 802.11-2012. ITS-G5 station must operate under Outside the Context of BSS (OCB) mode. MAC layer uses EDCA. It is based on the basic DCF, which uses CSMA/CA algorithm. In EDCA, there is four different queues with different listening periods AIFS and CW settings that aim to prioritize data traffic on MAC access layer. In EDCA, every node maintain queues with different AIFS values and CW sizes with the purpose of giving data traffic with high priority increased probability to access the channel before data traffic with lower priority. The QoS of IEEE 802.11 defines eight User Priority (UP) which are inherited from 802.1D standard. They are mapped to four access categories AC where the lowest priority is 0, and the highest is seven [36].

UP in 802.1D	Data traffic type in 802.1D	AC in 802.11	Data traffic type in 802.11
1	Background (BK)	AC_{BK}	Background
2	Spare (-)	AC_{BK}	Background
0	Best effort (BE)	AC_{BE}	Best effort
3	Excellent effort (EE)	AC_{BE}	Best effort
4	Controlled load	AC_{VI}	Video
5	Video (VI)	AC_{VI}	Video
6	Video (VO)	AC_{VO}	Video
7	Network control (NC)	AC_{VO}	Voice

TABLE 2.3: Mapping of UP in 802.1D to the AC of QoS facility in 802.11.

AC	CW_{\min}	CW_{\max}	AIFS (μs)
AC_{VO}	3	7	58
AC_{VI}	7	15	71
AC_{BE}	15	1023	110
AC_{BK}	15	1023	149

TABLE 2.4: The resulting AIFS and CW sizes for 802.11p's ACs.

The MAC layer extensions maintain two principal functions: gatekeeper and MCO. The gatekeeper aims to guarantee that upper-layer entities transmit packets with a maximum rate bound for a TC. MCO for ITS-G5 uses a multi-transceiver configuration where there is a transceiver usually fixed to the CCH. The role of MCO is to control an ITS-G5 transceiver to tune to a specific service channel [32].

2.3.3 Decentralized Congestion Control (DCC) cross layer mechanism

ETSI defines DCC as an essential component for C-ITS stations in order to mitigate network congestion. DCC uses CBR measurements to fairly allocate resources between different C-ITS stations according to channel conditions. CBR is calculated as the proportion of time the channel is sensed busy.

DCC is a cross-layer mechanism. DCC architecture is composed of DCC facilities, DCC access, and DCC management, as shown in figure 2.3. DCC's operational requirement is to keep the actual channel load below predefined limits that are part of the NDL. The NDL database contains all relevant information used by DCC access, i.e., configuration parameters, controlled parameters, and DCC status information. The NDL database is part of DCC management [37].

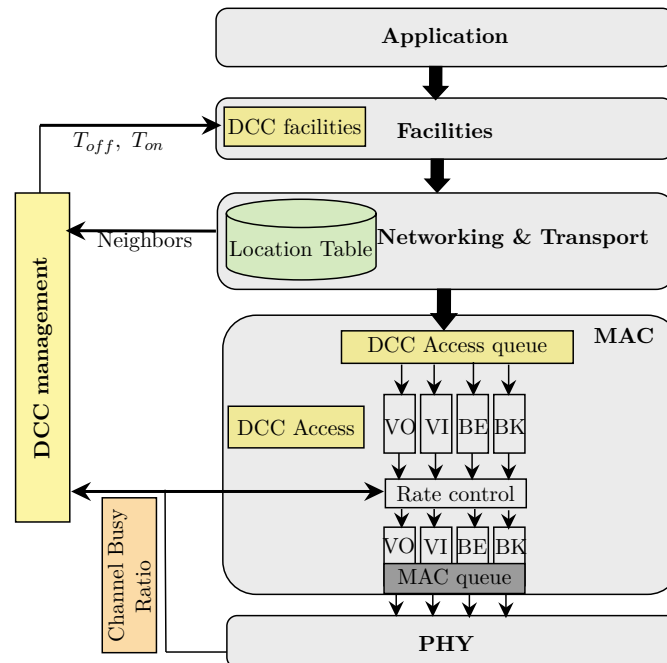

FIGURE 2.3: Decentralized Congestion Control simplified architecture.

In European DCC standards, the following operations are specified:

- **TPC:** it adapts transmit power to control the channel load.
- **TRC:** DCC access can limit the number of packets released into the medium via queuing and flow control. DCC Facilities limit the number of packets generated by V2X services.
- **TDC:** is a mechanism that can be used by wireless systems offering several transfer rate options. During high utilization periods and depending on the application, a higher transfer rate can decrease transmission duration.

Moreover, the DCC algorithms' main goal is to ensure network stability and to efficiently schedule traffic of the same class among ITS station (ITS-S) and multiple traffic classes per ITS-S. Specification [38] defines two types of DCC algorithms: reactive and adaptive.

(i) Reactive approach

The reactive approach depends on the CBR evaluation and does not take into account previous values of the control variables as depicted in figure 2.4. This "static" nature of reactive algorithms may not be effective enough to handle complex congestion situations.

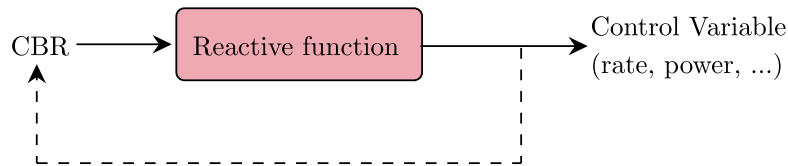

FIGURE 2.4: Reactive approach.

DCC reactive approach implements a FSM [39]. It triggers state change when CBR measurements exceeds CBR threshold defined in the look up table 2.5. As shown in figure 2.5, this FSM is mainly composed of three states: Relaxed, Active and Restrictive. Note that the active state can have several sub-states as shown in figure 2.5.

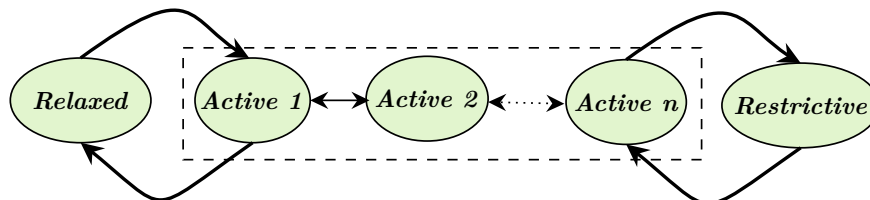

FIGURE 2.5: DCC state machine.

The packet rate illustrates the message frequency. The output parameter is the time between two transmissions, defined as T_{off} . As shown in figure 2.3, every message arriving at the MAC layer is first en-queued per packet priority in one of the four DCC access queues. Then, DCC access acts as a traffic shaping gatekeeper located under DCC queues. This gatekeeper is kept closed for the next transmission duration of T_{off} . On the other hand, DCC facilities also limit the message generation by adapting the packet rate, as shown in table 2.5.

States	CBR (%)	Packet rate (Hz)	$T_{off}(ms)$
Relaxed	< 30	10	60
Active 1	30 to 39	5	100
Active 2	40 to 49	2.5	200
Active 3	50 to 60	2	500
Restrictive	> 60	1	1000

TABLE 2.5: Reactive DCC parameter look-up table.

(ii) Adaptive approach

In the adaptive approach, the measured CBR is compared to a target CBR, and according to the implemented technique, it lets CBR converge to this target CBR.

In contrast to the reactive approach, the adaptive one uses the adaptation error and the prior control variable values because it actively drives the CBR toward the target threshold as shown in figure 2.6. The utilization of adaptive approach aims to achieve a steady-state CBR that is approximately independent of ITS stations' density.

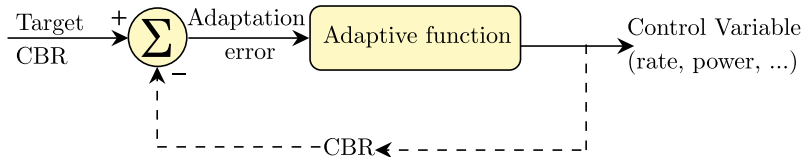

FIGURE 2.6: Adaptive approach.

2.4 LTE-V2X (LTE-Uu/PC5)

LTE-V2X is designed specifically to support vehicular communication scenarios. It is based on ProSe communications. LTE-V2X, inherently, employs the SC-FDMA, enabling a UE to access radio resources both in time and frequency domain. LTE-V2X uses a side-link that describes physical channels and which is based on LTE uplink waveform. LTE-V2X technology also supports HARQ retransmissions, a combination of high-rate forward error-correcting coding (FEC) and ARQ error-control, where corrupted messages are still useful for recovering the original data [40].

In LTE-V2X, two communication radio interfaces are available:

- LTE-PC5, also known as LTE side-link (it refers to the radio interface name where the User Equipment (UE) directly communicates with another UE over the direct channel).
- LTE-Uu (The radio interface between the eNodeB and the User Equipment) as shown in figure 2.7.

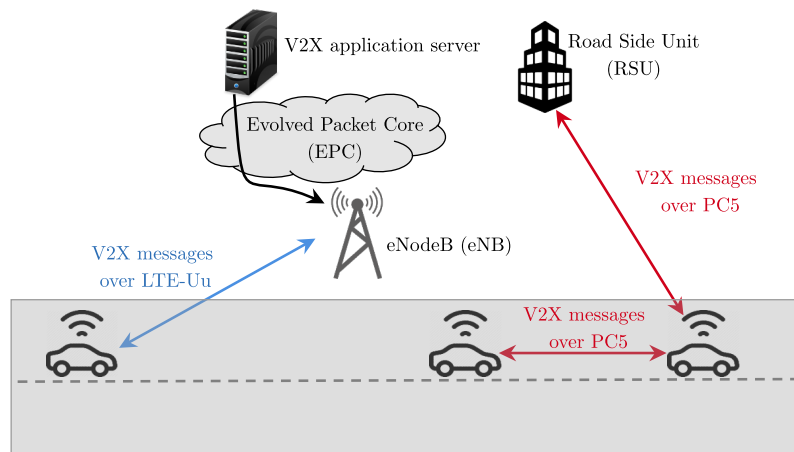

FIGURE 2.7: LTE-V2X architecture.

PC5 interface ensures direct communications, and it has enhancements to accommodate high speeds/high Doppler, high vehicle density, improved synchronization, and decreased message transfer latency. In fact, as a multiplexing technique, it uses TDM and FDM. This mode is suitable for proximate direct communications (hundreds of meters) and for V2V safety applications that require low latency (e.g., ADAS (Advanced Driver Assistance Systems), awareness). For LTE-V2X technology, release 14 3GPP specifications define two communications modes specifically designed for vehicular communications: Mode 3 and Mode 4.

2.4.1 "Mode 3" (In-coverage)

This mode is also referred to as "base station-scheduled" [41] and "cellular-assisted" [42]. In this mode, vehicles need to be in the base station's coverage zone because UEs' radio resources are managed and selected under eNodeB station via control signaling over the Uu interface. Thus, the frequency channel under license by the operator will be used.

In "mode 3", each vehicle reports its location and coordinates to assist the eNB in resource scheduling, as shown in figure 2.8. Mode 3 is only available when vehicles are within network coverage. 3GPP has proposed network architecture enhancements to support V2X. Among these enhancements is the V2X control function, mainly used to manage radio resources and provide vehicles with the side-link V2X configurable parameters. 3GPP specifications do not define a resource management algorithm for "mode 3". Each operator can develop and implement its solution that can be one of two categories: (i) dynamic scheduling, (ii) Semi-persistent Scheduling (SPS) [43].

(i) Dynamic scheduling

where the vehicles request subchannels every packet transmission. For each TTI, the MAC layer checks the UEs to be scheduled, the availability of data for each UE to be scheduled, and the UE feedback on the channel conditions.

(ii) Semi-Persistent Scheduling

Where the base station reserves sub-channels for the periodic transmission of a vehicle, vehicles using "mode 3" must also transmit an associated SCI/TB, and the transmission of the SCI/TB must take place in the same sub-frame. The eNB decides how long the reservation should be maintained. The vehicle must inform the eNB of the size, the priority, and the transmission frequency of its packet so that the eNB can semi-persistently reserves the appropriate sub-channels.

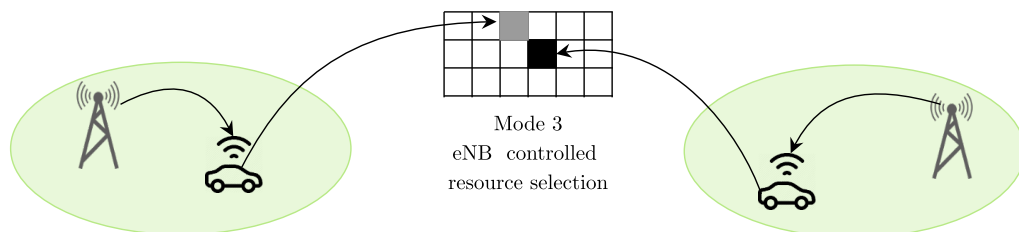

FIGURE 2.8: Mode 3 resource management.

2.4.2 "Mode 4" (Out-of-coverage)

This mode is also known as "pure Adhoc V2V" [42] and "autonomously-scheduled" [41]. In this mode, vehicles do not need to be in the base station's coverage zone because vehicles implement a mechanism for autonomous radio resource selection based on sensing before transmission with SPS, as shown in figure 2.9. In this mode, the license-exempt band will be targeted, namely the 5.9 GHz band.

Consequently, LTE-V2X can work both in and out of network coverage. However, network-based communication that uses the LTE-Uu interface is supported only when UEs are inside network coverage where UEs can receive V2X messages via downlink unicast or uplink broadcast. It also uses the existing LTE Wide Area Network (WAN), and it is suitable for more latency-tolerant use cases (e.g., situational awareness, mobility services). This mode will be used for the V2V communications use case since communication between vehicles cannot be dependant on cellular coverage. For this purpose, an autonomous SPS resource scheduling mechanism is conceived by 3GPP.

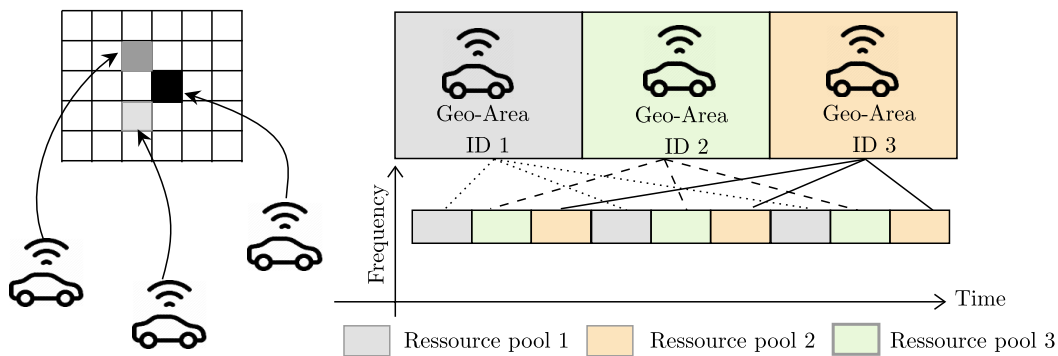

FIGURE 2.9: Mode 4 autonomous resource management.

LTE-V2X mode 4 supports 10MHz and 20MHz channels, and uses SC-FDMA. The channel is divided into 1 ms sub-frames and into RBs of 180kHz each. Mode 4 defines a sub-channel as a group of RBs in the same sub-frame. The number of RBs per sub-channel can vary depending on the packet size and the utilized MCS. Sub-channels are used to transmit data and control information. In mode 4 the channel is divided into PSCCH and the PSSCH, comprised of RBs. The PSSCH transmits application layer/data packets, known as TB. The PSCCH is used to transmit scheduling control information known as SCI [44]. LTE-V2X mode 4 specifies two sub-channelization schemes: (i) adjacent and (ii) non-adjacent modes as shown in figure 2.10. The PSCCH and PSSCH can have individual bandwidth sections dedicated to them (non-adjacent mode) or share the full bandwidth interchangeably (adjacent mode).

(i) Adjacent mode

TB and its associated SCI are transmitted in adjacent RBs. PSCCH always uses the first two RBs of each subchannel. PSSCH uses the following RBs. If PSSCH occupies more than one subchannel, it will be overlapping with the next PSCCH opportunities (that might or might not contain actual PSCCH messages).

(ii) Non-Adjacent mode

Using this configuration, the RBs are divided into pools. One pool is dedicated to transmitting only SCIs, and SCIs messages occupy 2 RBs. The second pool is reserved

for transmitting the only TB and is divided into subchannels. TB can be transmitted using QPSK or 16 QAM, whereas SCI is always transmitted using QPSK.

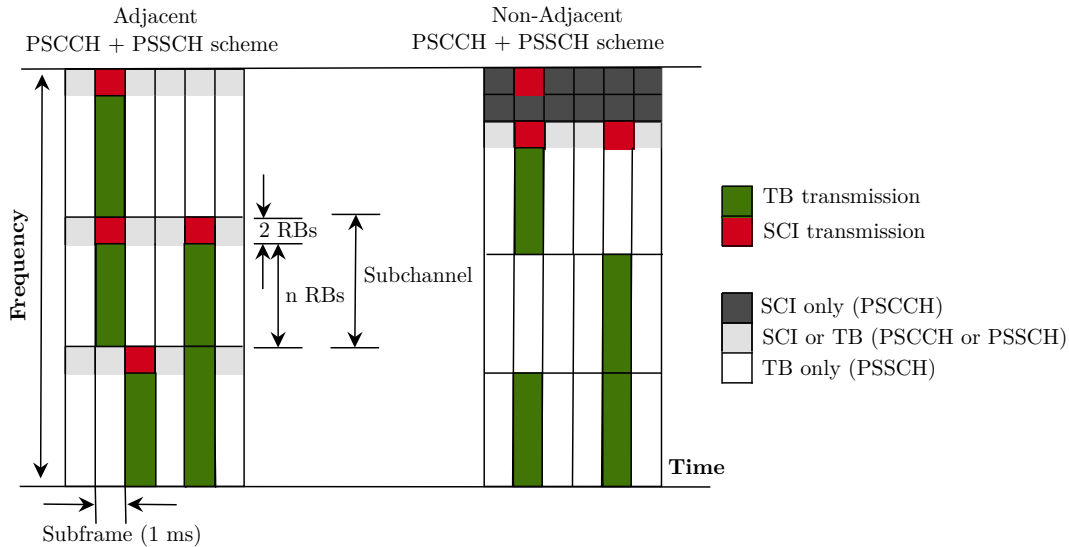

FIGURE 2.10: LTE-V2X frame structure and resource allocation schemes.

A. Distributed Semi-Persistent scheduling (SPS)

The distributed SPS algorithm enables the selection of radio resources for the node without the assistance of cellular infrastructure eNB. A vehicle reserves the selected resource(s) for a random number of consecutive packets. This number depends on the number of packets transmitted per second λ , or inversely the packet transmission interval.

RRI (ms)	100	50	20
$[C_1, C_2]$	[5,15]	[10,30]	[25,75]

TABLE 2.6: RRI and re-selection counter values [45].

For instance, it is between 5 and 15 when $\lambda = 10Hz$. The range of this reselection counter is specified in release 14, and as shown in table 2.6, it depends on RRI values, which design the periodicity of the transmission [46].

When a vehicle demands to reserve new resources, it randomly picks a reselection counter. Following each transmission, the reselection counter is decremented by one unit. When it equals zero, new resources need to be chosen and reserved with a probability $(1 - P)$, where P represents the resource keep probability of $\{0, 0.2, 0.4, 0.6, 0.8\}$. Each vehicle carries its packet transmission interval and the value of its reselection counter in its SCI. Vehicles utilize this information to evaluate what resources are available when making their reservation to reduce packet collisions. The resource selection process is organized into three steps :

Step 1:

As shown in figure 2.11 within the selection window, which is a time window that initiates with the packet generation, vehicle v_t identifies all possible CSR (1 ms) resources that can be reserved. CSR are groups of adjacent sub-channels within a given subframe

that are large enough to fit in the SCI and the TB, which will be transmitted. The selection window's length is defined in the standard as the maximum latency, and a CSR should be selected within this duration.

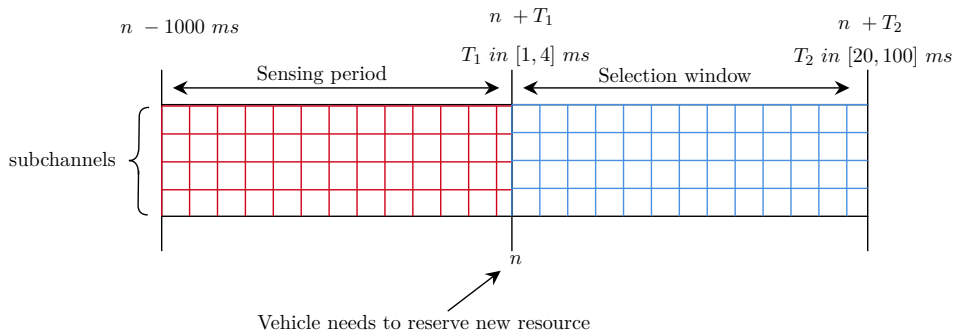

FIGURE 2.11: SPS sensing process.

Step2:

v_t creates a list L_A that consists of available CSRs it can reserve, based on information it receives in the previous 1000 subframes (sensing window). L_A includes all the CSRs previously identified in step 1 except those that satisfy the following conditions:

1. CSRs used by vehicle v_t during the sensing window. The aforementioned is due to v not being able to sense these CSRs during its half-duplex transmissions.
2. CSRs that have a RSSI value above a threshold level (l_{th}), and are being used by other vehicles at the time v_t tries to utilize them.

If L_A contains more than 20% of the total CSRs in the selection window, the system moves to step 3. Otherwise, l_{th} is increased by 3 dB, and step 2 is repeated.

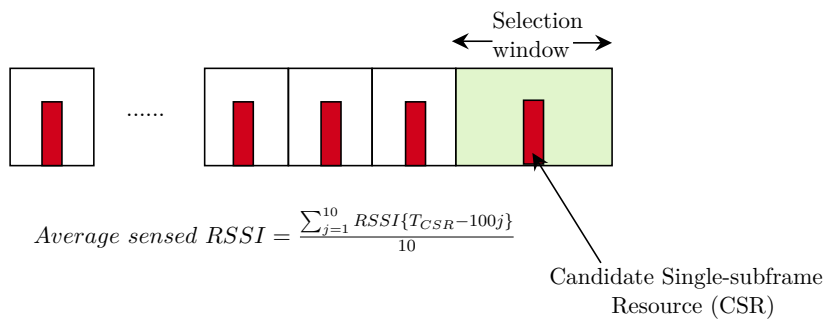

FIGURE 2.12: Average RSSI calculation of a CSR.

Step 3:

v_t creates a list of candidate resources L_C that includes the resources in L_A that experienced the lowest average RSSI. The size of L_C must be equal to the 20% of all the resources in the selection window identified throughout step 1. As shown in figure 2.12 The average of RSSI is calculated based on the previous $(T_{CSR} - 100 * j)$ sub-frames, $(1 \leq j \leq 10)$.

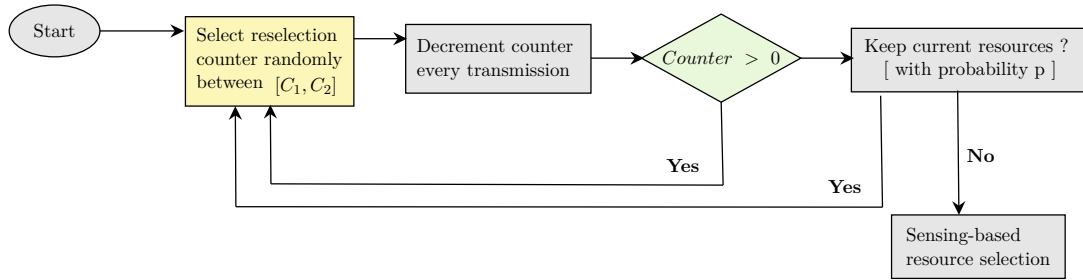

FIGURE 2.13: SPS flow chart.

SPS procedures are presented in flow chart 2.13. The station announces the reserved resource using its source reservation field in the SCI. This field uses 4 bits to indicate the packet transmission interval, as shown in figure 2.14.

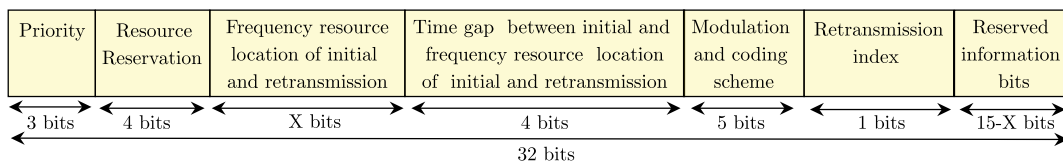

FIGURE 2.14: SCI content.

B. Congestion control in LTE-V2X (mode 4)

3GPP Release 14 supports congestion control in mode 4 [47]. The standard does not specify a particular congestion control mechanism, but it defines some metrics and considerations to take into account while developing congestion control mechanisms. For every transmission or a retransmission of a packet, vehicle estimates CBR and CR.

Measured CBR	CR_{limit}
$CBR \leq 0.65$	no limit
$0.65 < CBR \leq 0.675$	$1.6e^{-3}$
$0.675 < CBR \leq 0.7$	$1.5e^{-3}$
$0.7 < CBR \leq 0.725$	$1.4e^{-3}$
$0.725 < CBR \leq 0.75$	$1.3e^{-3}$
$0.75 < CBR \leq 0.775$	$1.2e^{-3}$
$0.8 < CBR \leq 0.825$	$1.1e^{-3}$
$0.825 < CBR \leq 0.85$	$1.1e^{-3}$
$0.85 < CBR \leq 0.875$	$1.0e^{-3}$
$0.875 < CBR$	$0.8e^{-3}$

TABLE 2.7: CBR and CR_{limit} thresholds.

CBR indicates the level of channel congestion and is defined as the number of sub-channels in the previous 100 sub-frames that experience an average RSSI higher than a pre-configured threshold. The CR quantifies the channel occupancy generated by the transmitting vehicle. If the packet is going to be transmitted at sub-frame n, the measurements are done at sub-frame n-4 [48]. When a vehicle has to transmit or retransmit a packet, the vehicle must decrease its CR below CR_{limit} as shown in table 2.7.

The 3GPP specification defines several considerations for possible congestion mechanisms [49] [50]. The following strategies for congestion control [46] are organized as follow:

- **Packet transmission dropping:** The vehicle reduces its CR by not transmitting some packets generated by the application (but it maintains the reserved sub-channels).
- **Packet retransmission dropping:** It consists of reducing the number of transmission per packet. It avoids redundant transmission. In LTE-V2X, stations can send packet twice following the blind retransmission process. If retransmission is allowed, the vehicle indicates in the SCI message, whether it is the first or second transmission, using the retransmission index field.
- **Modulation and coding scheme (MCS) control:** The vehicle can decrease its CR by increasing MCS. Indeed, this is possible if the preconfigured subchannelization and the initial MCS results in that the packet transmission requires various subchannels. In this case, a packet can be transmitted using a lower number of subchannels by increasing the MCS, which will reduce the CR.
- **Sub-channels reserved adaptation:** The vehicle can reduce its CR by reducing the number of sub-channels it reserves per transmission. This can be performed, for instance, by increasing the MCS that reduces the number of RBs necessary to transmit a packet.
- **Transmission power control:** Decreasing transmission power reduces CBR. When the resulting CBR level falls below a lower CBR interval, the CR_{limit} increases. In this situation, a vehicle may meet the condition that the CR is below the CR_{limit} without directly decreasing its CR.

2.5 Summary

This chapter is directed at providing a comprehensive overview of ITS standardization efforts. We have first gone through the available ITS network architectures. Furthermore, the various initiatives from standardization bodies to propose communication architectures have been described. We have then discussed the different properties of vehicular communications with a particular insight into ITS-G5 and LTE-V2X technologies that we have chosen to focus on in the context of C-ROADS France project.

In the remainder of this thesis, ITS-G5 and LTE-V2X technologies will be further investigated and reviewed. These technologies present advantages and shortcomings that will be surveyed and discussed in the next chapter.

The expansion and the variety of C-ITS services need comprehensive studies and further research investigations about existing C-ITS network communications and their offered performances. Both technologies may suffer from performance decay in high density, making it challenging to provide effective C-ITS services. Channel congestion problem is a severe issue for vehicular communication environment, especially for ad-hoc based technologies such as ITS-G5. Due to the concentration of several vehicles in a small area (e.g., traffic jams), the number of transmissions rapidly increases, making collisions systematically important. Moreover, most C-ITS services use a broadcast mode which may intensify congestion. Standardized congestion control approaches for ITS-G5 referred to as DCC have been described briefly. In the next chapter, we focus on reviewing the related works about congestion control mechanisms for ITS-G5.

Currently, there is no standardization activity to define the inter-workings between ITS-G5 and LTE-V2X. In the next chapter, we will study research efforts devoted to RAT selection. These schemes are essential to maintain seamless connectivity and to answer low latency and high-reliability requirements better. Different road users must automatically detect and select the best network interface, ensuring the user's smoothest transition.

Chapter 3

State of the art review

This chapter reviews some recent studies on research efforts related to network selection management in heterogeneous architecture and congestion mitigation in ITS-G5 technology. We begin this chapter with section 3.1 that presents a comprehensive state of the art of communication technologies dedicated to C-ITS services. We end this section by resuming the benefits and shortcomings of both ad-hoc and cellular technologies. In section 3.2, we survey research efforts on the performance of the ITS-G5 network. We particularly focus on studying relevant papers that evaluate the effectiveness of GLOSA service by highlighting the crucial role of the communication network performances. Data rate and congestion control proposals for ITS-G5 are also reviewed in this section. In section 3.3, we survey research efforts on RAT selection for heterogeneous architectures, and we give a detailed classifications of related works based on decision-maker architecture and decision algorithms. In section 3.4, we present a comprehensive overview on MCDM techniques highlighting their main steps. Finally, we summarize this chapter in section 3.5 by providing persuasive arguments to support the choice of decision-maker location and decision-making technique that will be adopted in our proposal dealing with RAT selection.

3.1 Related work on C-ITS network communications

This section will review some of the leading papers about vehicular communications standards, highlighting their different features and issues. We end this section with the summary table 3.1, which resume advantages and issues of vehicular network technologies based on the surveyed papers.

Paper [51] presented a survey of V2X technologies and heterogeneous architecture. Authors compared Dedicated Short Range Communications (DSRC) standards and cellular communications. Then, they presented DSRC-cellular hybrid architecture with different network components. They classified the proposed DSRC-cellular hybrid architecture according to many aspects like scenario, supported vehicular communication type, MBMS/eMBMS usage, etc. The authors gave a taxonomy of DSRC-cellular communication according to network topology, either hierarchical or flat. They also described the vehicle's mobility management as a critical issue to be considered one of the important criteria in heterogeneous architecture design. Especially on the highway, high speed can cause Spatio-temporal variations in network topology, which affect the performance of the network standards. They also studied handover strategies and network selection schemes. They also reviewed commercial V2X products and R&D platforms used to test and implement V2X solutions. The main modules include OBU, RSU and portable DSRC devices. The main DSRC providers are NXP, Autotalks, and Qualcomm. V2X modules have the same DSRC protocol stack when the same supplier produces it. However, these platforms show differences in system interface, enclosure type, and power supply method. For instance, an RSU or a portable DSRC device does

not require a connector to the vehicle controller area (e.g., CAN bus to receive or read from the built-in vehicle sensors), contrary to an OBU may have a connector to such a similar interface. Most of these platforms are based on the Linux operating system with a secure shell (SSH) or telnet provided to interact with the platform. Also, some suppliers may develop a GUI interface for controlling and monitoring the hardware platforms.

In paper [40], the authors presented an overview of cellular technologies for V2X applications. The authors discussed multiple aspects of V2X standards. They presented 3GPP requirements to support V2X scenarios according to different levels of automation. They started by comparing LTE-V2X with IEEE 802.11p standards regarding re-transmission mechanisms, resource selection, and resource multiplexing across vehicles. They also compared LTE-V2X with 802.11p in modulation scheme, media access control, operating frequency range, and synchronization. Furthermore, they gave a summary of LTE-Uu and PC5 V2X communications in both cases with MBMS and without MBMS. The authors also discussed security and privacy issues for V2X scenarios. They enumerated 3GPP new scenarios for V2X, such as advanced driving, extended sensors, and remote driving.

Authors in [52] proposed an overview of LTE release 14. They reviewed future requirements for future 5G radio access. They identified the main technologies and components for LTE evolution. The authors surveyed different techniques that will revolutionize intelligent transport communications and will accommodate data traffic growth. Indeed, they studied latency reduction support, enhancements for machine-type communications (MTC). Furthermore, they deeply detailed different techniques that will be used for the new 5G air interface and different requirements for new radio access. They enumerated the most important use cases for radio access which are: (i) eMBB, (ii) mMTC and (iii) URLLC. Responding to high data rates in dense network scenarios requires a licensed and unlicensed spectrum and improved spectral efficiency. This lead 3GPP to introduce LAA in release 13 and massive multiple antenna systems. LAA is developed in order to enable LTE DL transmissions in secondary cells operating in an unlicensed spectrum. These transmissions are assisted by primary cells operating in licensed bands. This introduced technique will enable operators to enhance capacity and get additional bandwidth. However, it will create coexistence problems with 802.11 standards. This issue can be covered by developing LBT procedures. In addition, authors described MIMO enhancements study of 3GPP release 13. This technique was extended to support eight and up to 64 transmit antennas to target many controllable antennas at the base station.

Paper [53] presented a review about the latest advances in 3GPP D2D specifications and V2X applications requirements. On one hand, authors gave an overview about D2D communication architecture. On the other hand, they modeled power consumption of the end user devices and base station. They analyzed energy consumption model using different communication technologies such as LTE, 802.11ac, 802.11ad and WI-FI. Authors also reviewed the potential application areas including IoT, wearables, and automated driving. They also investigated reviewed the status of D2D technology in 3GPP standardization. In addition, they analyzed D2D-enhanced cellular networks both from the base station and from the end user perspectives. Authors's findings showed that the efficient option for saving energy in D2D communications using the latest LTE and WI-FI models is to send the data with the best possible data rate. They also observed that in terms of base station results, D2D transmission achieved the largest gain in macro cells up to 70 % of energy reductions.

Paper [54] presented heterogeneous vehicular network. They said that LTE is much more suitable for V2I communications than DSRC and that DSRC is more practical

for V2V communications. They presented the pros and cons of LTE D2D and DSRC for both V2I and V2V communications. In this paper, the authors enumerated the following open issues of heterogeneous architecture: inter-system handover, big data issues, cooperation issues, cross-layer design issues, and Vehicular Cloud Networking (VCN). Authors cited problems related to DSRC when using it for V2I communications: sparse pilot design, channel congestion with a large number of vehicles, unbalanced link, prioritization, and service selection. Indeed, authors enumerated challenges for existing broadcast mechanisms of DSRC technologies (i.e., hidden node problem, fixed size of contention window, limited lifetime of safety messages, broadcast storm problem that is a well-known problem caused by packet re-transmissions DENM messages). The authors also highlighted the existing problem of scheduling mechanisms in cellular networks, and they point out that it is necessary to adapt these scheduling schemes to satisfy vehicular network requirements.

Authors of paper [55] compared ITS-G5 and LTE-V2X "mode 4" technologies in terms of Packet Error Rate (PER) and latency. Results showed that for the same data rate, "mode 4" had better performance than ITS-G5. The wide variety of MAC parameterization of the LTE-V2X "mode 4" accentuates this gain with improved communication range, mainly when retransmission is considered. The authors also showed that LTE-V2x performance deteriorates more severely than ITS-G5 when the level of congestion increases.

TABLE 3.1: Summary table of vehicular network technologies advantages and limitations.

Technologies	Advantages	Shortcomings
<ul style="list-style-type: none"> • Ad hoc-based 	<ul style="list-style-type: none"> • Adequate for single-hop dissemination • Easy deployment and low cost 	<ul style="list-style-type: none"> • Short-range • Channel congestion problem for high density • Hidden terminals problem • Broadcast storm
<ul style="list-style-type: none"> • Cellular-based 	<ul style="list-style-type: none"> • Long range • High spectrum efficiency • efficient scheduling mechanisms 	<ul style="list-style-type: none"> • High latency (e.g., handover effects, resource scheduling) • High mobility may degrade network performances

Most C-ITS communication technologies introduced in different papers present advantages but also face various challenges. We summarize some of their strengths and weaknesses in table 3.1.

3.2 Research efforts on ITS-G5 network performance

This section reviews research efforts dealing with ITS-G5 network performance and its effectiveness on supporting different C-ITS use cases. We mainly focus on the use case of GLOSA as it is chosen in the C-ROADS project framework. We then survey congestion control mechanisms for ITS-G5 technology.

3.2.1 Related work on C-ITS service requirements: GLOSA case study

Vehicle speed and trajectories play an essential role in influencing fuel consumption, gas emissions, and travel time. ITS services are often proposed to reduce the impact of these issues on the environment and drivers' comfort.

Green Light Optimal Speed Advisory (GLOSA) is one of the traffic efficiency services that can significantly reduce fuel consumption and decrease waiting time at intersections. When approaching a signalized intersection, GLOSA notifies the driver with an advised speed to reach that intersection while the light is green. This service has attracted much interest from academia and industry due to its essential role in modern transport systems' progress towards green mobility.

Many studies focused on GLOSA service algorithms, proving its advantages and potentials in reducing stop-and-go driving phenomena and saving energy. Paper [56] compared single and multi-segment approaches of GLOSA in terms of travel time and fuel consumption. The authors proposed a solution based on genetic algorithms to solve the speed optimization problem, which consists of finding a speed that minimizes travel time or fuel consumption. In this paper, different strategies of GLOSA are compared. Those aimed at optimizing fuel consumption, and others aimed at reducing travel time. Their findings showed that the multi-segment approach outperforms the single-segment approach. In this study, the authors made the results with the assumption of non-congested traffic flow.

In paper [57], authors also assessed both GLOSA approaches, and outcomes showed a comparable conclusion, where the multi-segment strategy is more efficient for fuel consumption. Furthermore, the paper discusses the impact of the activation distance on GLOSA. This paper's main drawback is the used simulation platform that does not include a realistic driver model or a realistic communication model.

In paper [58], the authors evaluated GLOSA benefits and limitations in different traffic densities states. In free-flow conditions, authors found that GLOSA meets all its expected goals of reducing CO2 emissions and waiting time. With a penetration rate of 100% and free-flow conditions, they observed improvement of about 11% of CO2 emissions, a gain of 17% in terms of waiting time, and 13.7 % of fuel consumption gain. However, in a congested traffic scenario, the authors noticed a deterioration of GLOSA performances. They also observed that dense traffic scenarios could cause longer waiting time, more CO2 emissions, and more frequent stop numbers.

Paper [59] proposed a performance study for GLOSA in urban areas. The authors used both simulation environment and field operational test measurements. For this evaluation, they used an algorithm proposed in paper [60]. They evaluated waiting time and average of CO2 emissions for GLOSA and without GLOSA considering different penetration rate levels. The authors observed reliability between simulated results and real measurements. For a penetration rate of 100%, they achieved a reduction of CO2 emission of about 10%. They concluded that a penetration rate of 50% is sufficient to give significant results in terms of fuel consumption and waiting time.

Paper [61] proposed estimation of optimal late deceleration for GLOSA application. It is based on calculating the needed deceleration to reach the stop line at the estimated time of departure. Then, they evaluated the CO2 emission in the free-flow situation and peak-hour scenarios. In the peak-hour situation, they achieved a reduction of CO2 emission of about 7%. They also perceived that the number of stopping vehicles is increasing during peak-hour conditions.

Paper [62] proposed an optimal acceleration advice algorithms. This paper presents a set of acceleration advice algorithms aiming to minimize speed changes. Evaluating different metrics, such as vehicle stop number ratio and fuel consumption, proved the multiple benefits of using their proposed acceleration advice algorithms. In free-flow conditions, they achieved an improvement in fuel consumption of about 25%. They also compared the average delay for GLOSA and without GLOSA using simple traffic models and an Intelligent Driver Model (IDM). In this paper, the authors gave an insight into comparing cases where advisory speed is given only to the leader vehicle and given both to the leader and the follower vehicle. Their results showed an enhancement between 31% and 32% of average delay using a simple traffic model, and they noticed that their algorithm could save an average of fuel consumption between 21% and 23%. However, using the IDM traffic model, they obtained an improvement of 48% of average delay and 17% of fuel consumption reduction.

In paper [63], the authors proposed a solving method for multiple segment speed optimization based on genetic algorithms. With this proposal, a gain of 46% in terms of the total number of stops is achieved. They also showed a gain of fuel consumption of about 30%. They tested their algorithm under real traffic topology composed of three traffic lights using different traffic conditions.

Paper [64] proposed an algorithm for GLOSA based on calculating the distance that the vehicle will need to travel during the remaining red signal time or the remaining green time "NOGO" or "GO" indicators according to the paper terminology. If the vehicle is already traveling during the "GO" indicator, there is no need to decelerate. Contrary to the "NOGO" indicator, which advises the vehicle to decelerate at $1m/s^2$ until it reaches the green zone indicator. The authors showed that their proposed GLOSA approach performs well for traffic demand between 400 vehicles per hour to 500 vehicles per hour. In other traffic situations, the efficiency level of the proposed solution was worse than the unequipped vehicle.

Paper [65] formulated GLOSA as an optimization problem. They presented a new formulation, including a trade-off between fuel consumption and travel time. The proposed solution is evaluated using different driving patterns. The solution consists of presenting a dynamic-GLOSA algorithm that chooses the best green window to pass the traffic light. The authors used the Matlab "FMINCON" function for minimizing the objective function. The proposed algorithm shows better energy saving compared to other tested optimization methods. Paper [66] presented a dynamic eco-driving optimization method based on GLOSA and trajectories optimization via evaluating the fuel consumption per trip. The proposed eco-driving model showed a significant improvement in fuel consumption.

We observe that most cited papers have made their evaluation using simple traffic topology. Also, most of them did not consider the impact of network communications parameters on GLOSA.

3.2.2 Related work on data rate and congestion control for ITS-G5

In this section, we review some of the congestion control techniques proposed in previous work. Indeed, many research studies have been devoted to enhancing vehicular

communications in congested scenario conditions. These approaches are generally based on either adjusting the message rate, transmit power or data rate.

Papers [35, 67] investigated and studied the choice of bit rate used in vehicular communications. Authors of paper [35] mentioned that the use of 6 Mbps as the default bit rate is not always optimal. This paper provided an evaluation of broadcast transmission under a different scenario of data rate use cases. The authors also gave an insight into the used scenario and simulation setup conducted under the NS-2 network platform. The road topology they used consists of a tree-lane highway scenario. In this study, different road congestion possibilities are evaluated. Also, the authors evaluated reception probability as a performance metric using different message size configurations. In conclusion, the authors observed that 6 Mbps gave good results only when the channel conditions are not overloaded.

Paper [67] conducted a performance scenario based on both simulation and experiments to study the efficiency of using default data rate 6 Mbps for the vehicular communications network. They used the NS-2 simulation platform in this evaluation study. In this paper, the authors demonstrated that the default bit rate of 6 Mbps is not always the data rate that minimizes the channel load and ensures the best application requirements. Authors used CBR, communication range (CR), and PDR as metrics to compare different data rates' performance. Through the conducted scenarios, the authors concluded that it is essential to develop a new dynamic data rate adaptation mechanism to mitigate network congestion for VANETs.

In paper [68], the authors proposed a comprehensive performance evaluation comparison of DCC algorithms for multi-platooning applications. They started by reviewing the previous work about DCC mechanisms as well as its standardization. As a simulation platform, they used the PLEXE (Platooning Extension for Veins) framework, which permits the realistic simulation of platooning. It is based on VEINS, OMNeT++ network simulator, and SUMO traffic mobility simulation environment. In this study, different approaches were analyzed based on evaluation metrics such as inter-reception time, CBR, and fairness.

Paper [69] discussed the strength and weaknesses of the ETSI DCC mechanism. They also proposed improvements in terms of the algorithm's convergence time using an analytic approach. The convergence time needed by the proposed approach is 25 % compared to 35% of the DCC presented in the standard. The authors will validate the proposed enhancements using Artery simulation framework based OMNeT++ network simulator in future work.

In paper [70], authors proposed a Fair Decentralized Data-Rate Congestion Control. This algorithm is developed to ensure fairness. It selects a corresponding data rate from 3 Mbps to 24 Mbps based on both packet count and P_C and CBR as selection criteria. P_C metric represents the total number of packet sensed by a vehicle throughout θ period. The authors validated their approach using the NS-3 network simulator in conjunction with the SUMO traffic mobility simulator. As for performance metrics, they measured CBR, Jain's fairness index, and application reliability. The authors' findings showed that the proposed approach outperforms the standardized DCC mechanism and LIMERIC (A LInear Adaptive Message Rate Algorithm for Congestion Control) in terms of application reliability and fairness. They concluded that the proposed packet count-based algorithm offered a fair data rate allocation and a better awareness range.

Paper [71] evaluated DCC mechanism for platooning use case. The authors demonstrated that further DCC optimization is needed to enhance ITS-G5 performance. They also highlighted the limitations of DCC. According to the authors, mathematical models of the DCC mechanism need to be developed to characterize C-ITS dynamics and

better answer its service requirements.

Paper [72] presented a novel approach of DCC that combines the data rate and message rate adaptation to avoid congestion and enhance application-reliability. The authors implemented their approach using the NS-3 simulation platform and SUMO mobility simulator, considering a realistic highway scenario. The authors measured CBR, message rate, Jain's fairness index, and application reliability for performance metrics. Their findings showed that the proposed approach outperforms LIMERIC, PDR-DDC (their proposed approach for data rate control) in terms of reliability.

Paper [73] presented a congestion control mechanism called TPA+IAB based on power and beacon generation rate adaptation to distribute the load equitably. It stands respectively for Transmit Power Adaptation and Intelligent Adaptive Beaconing. On the one hand, the authors used the message generation rate to adapt message dissemination according to congestion conditions. On the other hand, they controlled transmission power to adapt vehicles' communication to its most relevant neighbors. The proposed approach was implemented and evaluated under the NS-3 network simulator with the VanetMobiSim tool to generate a realistic mobility model. Authors compared their algorithm with another from literature called D-FPAV, a transmission-power-based DCC algorithm proposed in [74]. The proposed approach showed enhancements compared to D-FPAV. However, their strategy presented lower fairness at high and medium densities.

Paper [75] proposed a congestion control algorithm called Beacon inter-reception time Ensured Adaptive Transmission (BEAT). The authors compared their proposal with LIMERIC and DCC conventional algorithms. "BEAT" uses a Beacon Inter-Reception Time (BIRT) as a control metric, and it is measured every time vehicle receives the beacon. BIRT is calculated as the time difference between two beacon reception according to vehicle ID. Based on this measurement, the vehicle can indirectly guess the channel conditions, and it adjusts message frequency to guarantee message reception. The authors used OMNeT++ and SUMO simulation environment to evaluate their approach. As a result, they showed the importance of considering the BIRT metric in the message frequency adaptation process. The authors did not evaluate the fairness of their proposal. They also consider BIRT measurement based on previous receptions without highlighting the high mobility feature of VANETs, which can penalize their approach due to the lack of information freshness.

Most of the papers consider CBR-based mechanisms based on selecting data rate or message rate using a fixed CBR threshold. The aforementioned leads us to discuss enhancements of the data rate control in ITS-G5, taking into account CBR measurements and an adaptive CBR limits estimation based on packet size, bit rate, target PDR, transmission probability, and other parameters.

3.3 Research efforts on RAT selection

Modern wireless devices tend to contain multiple RAT interfaces that are cooperatively used to provide seamless connectivity. When a handover session occurs in heterogeneous network architecture, a decision must astutely be made as to which RAT it should be associated with. We focus on studying RAT selection features in this section. In subsection 3.3.1, we propose a taxonomy on network decision-makers. We classify RAT selection algorithms as deterministic and AI-based in subsection 3.3.2. We end this section with the summary table 3.2, which reviews the most relevant papers and classifies them according to the proposed taxonomies.

3.3.1 Network decision-making architectures

Many papers classified the network decision process based on the DM location. Network decision-making architectures are classified into the main three categories: Network-centric or centralized, User-centric or distributed, and collaborative or semi-centralized [76].

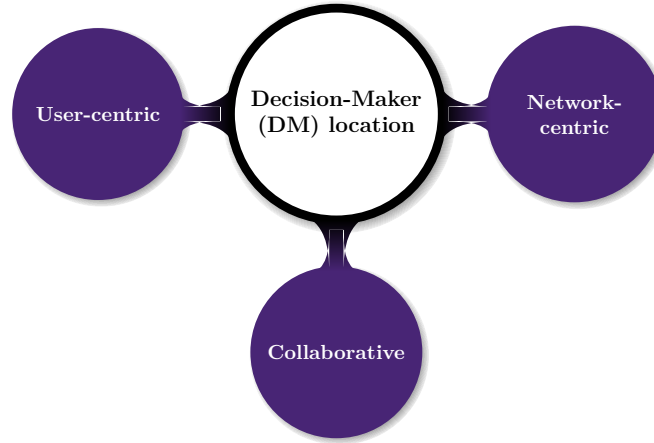

FIGURE 3.1: DM architecture's classification.

A. Network-centric

In the network-centric approach, decisions are made at the network side with or without assistance from the user terminal. The network operators generally control such decisions. The before-mentioned approach is generally based only on the operator's profit even though some mechanisms may also take into consideration the user's requirements before making a decision. Schemes within this category deal with how the network can optimize bandwidth, and thus bandwidth allocation problem are the most crucial concern.

One of the limitations of the network-centric approach is to overload the network as it requires a constant connection between the terminals and the network infrastructure to allow the DM to have a context-awareness of the different stakeholders (e.g. access networks, application requirements and user preferences).

Handover between networks managed by different operators is another challenge in network-centric decisions. The routing of flows between the networks of different operators implies close collaboration agreements. Therefore, in such an approach, flows are generally limited to a single network operator, i.e. they are routed through different access networks belonging to the same operator.

In centralized approaches, RAT selection is formulated as a centralized optimization task (e.g., using linear and nonlinear programming models) whose objective is to maximize throughput or equivalently minimize the delay. These centralized approaches are the most straightforward to apprehend the issue of RAT selection. However, the requirements and practical intractability of optimal solutions make them challenging to implement in real life.

B. User-centric

In this category, decisions are made at the user terminal, and they are based only on the user's profit without considering network load balancing or other users. Therefore, the schemes in this approach mostly deal with network selection problem, which is to

find the most effective network for the user's application. There is some discussion about this approach because new users only consider their profit and are not concerned about network load balancing. Thus, the network may quickly reach congestion's peaks, resulting in quality degradation of ongoing users.

In contrast to the network-centric approach, the user-centric approach can easily manage access to heterogeneous networks. Once the mobile terminal can connect to multiple access technologies, the DM can take advantage of the available access networks independently of the network operator. Despite this flexibility in routing flows across different networks, a terminal-centric decision does not guarantee the efficient use of infrastructure resources. It has limited knowledge of network conditions.

In distributed approaches, mobile users try to improve their performance by themselves, without a central coordinator, generally using heuristic rules. This aspect does not always guarantee optimal solutions for mobile users but has the advantage of not requiring extra signaling for coordination, unlike centralized approaches.

C. Collaborative

In the collaborative approach, both the network and the terminal are involved in the decision-making process. An example of a collaborative approach is the IEEE 802.21 Media Independent Handover (MIH) standard, which allows mobile devices and specific network entities to exchange information to facilitate the handover process between heterogeneous networks.

To maintain a seamless connection during a transition from one network to another, IEEE 802.21 standard defines this transition as Media Independent Handover (MIH).

This standard provides mechanisms at the data link layer and other network information adapted in the upper layers to optimize the handover between heterogeneous networks. IEEE 802.21 enables cooperative handover decision making supporting both terminal-based and network-based mobility management schemes.

This standard supports handover for users using fixed and mobile devices. For mobile users, handover may occur due to wireless conditions (network out of range or other more attractive networks) resulting from customer movement. In the case of fixed users, switching from one network to another can be useful when the environment changes or a new, more attractive network appears.

If the user is downloading a large media or data file, it may require more bandwidth than is currently available, so a handover can be made to a network that is either less congested or has higher throughput by nature.

The IEEE 802.21 standard supports the cooperation of mobile users in addition to the network infrastructure. The mobile users can detect available networks, and the infrastructure can store the necessary network information such as the list of neighboring cells and the location of mobile equipment. In general, both the users equipment and the network attachment points (WiMAX base stations or WiFi access points) can support multiple wireless standards (multimode) and, in some cases, use more than one interface simultaneously.

As shown in figure 3.2, MIH is a layer within the mobility management protocol stack of the mobile node and network elements. It enables the association for handover between heterogeneous networks. This function provides services to the upper layers through one interface (independent of technology). It also obtains services from the lower layers through various interfaces and SAPs

This function also assists in the handover decision process. The upper layers decide to switch from one network to another based on the information available to them and

the MIH context. The key components of this standard recognize the need for handover and the discovery of information on making these decisions.

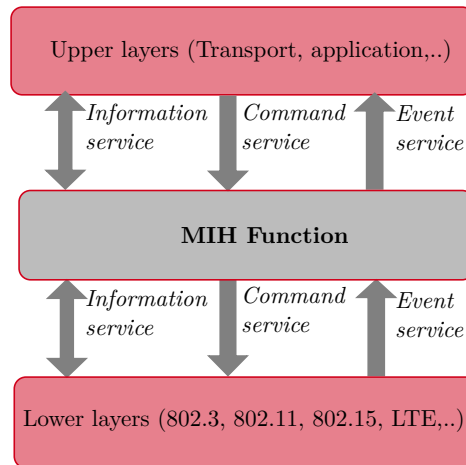

FIGURE 3.2: MIH architecture.

The MIH provides a unified interface to the higher layers. The core services exposed by the MIH function are independent of multiple access networks' technology specification protocols. The MIH communicates with the lower layers of the mobility management protocol stack through specific technology interfaces. These types of interfaces are already specified as within the standards that respectively belong to these access technologies, including IEEE 802.3 (Ethernet), IEEE 802.11 (WLAN), IEEE 802.16 (WiMAX), and 3GPP2. The MIH function helps maintain user connections, enables optimal network discovery and selection, and can start or disable connections based on network availability and thus extend user equipment's battery life.

In IEEE 802.21, centralized infrastructure support is required to assist the handover process between heterogeneous networks. For instance, network infrastructure can provide information about different access technologies' performance, while the mobile terminal can handle applications requirements and decision-making. However, the design of a DM, which strictly works in a collaborative approach is inherently limited when the user or the network infrastructure is not able to provide the information expected by the DM.

In the present thesis, we aim to conceive a user-centric decision-making architecture for network selection, which can make a decision independently of the network infrastructure. The motivations are to provide a framework based on decision metrics that nodes can collect locally without the need for a specific coordination mechanism with other nodes and by using their standard interfaces.

3.3.2 Quick overview of decision-making algorithms

In a network-centric, user-centric or collaborative approach, the issue of RAT selection always presents a challenge. Many papers studied and compared decision-making algorithms for network selection. Some of these papers gave a classification based on criteria used in the decision process. Indeed, decisions can be taken according to network conditions (.e.g, load, link quality, bandwidth), QoS, terminal characteristics (.e.g, velocity, battery), user preferences (.e.g, cost, security), operator preferences, and so on [77, 78]. In this context, we propose a taxonomy of different decision-making algorithms for selecting the best RAT which we grouped into two categories: deterministic and

AI-based. In this section, we review some related work highlighting the use of these algorithms in RAT selection.

A. Deterministic decision-making methods

Many algorithms have dealt with the RAT selection problem. This section focuses on those that use processes without any random factor in the overall runtime that we classify as deterministic methods. MCDM algorithms are one of these methods which are widely used in the context of RAT selection. Typical MCDM algorithms are AHP, TOPSIS, GRA, and VIKOR [79]. When dealing with inaccurate data, fuzzy logic is applied with MCDM methods. Function-based decision algorithms are also included among the deterministic category and widely used in literature. These techniques are based on defining a utility function which goal is to select the best network that maximizes the objective function, which is a weighted sum of QoS, cost trust, compatibility, preference, and capacity parameters.

In paper [80], a centralized approach that applies the TOPSIS method on network attribute and user preferences such as velocity to rank network association alternatives WiMAX, LTE, or WLAN is proposed. Simulation results indicate that the proposed algorithm reduced handovers failure probabilities compared to a network decision algorithm based on Received Signal Strength (RSS).

In paper [78], the authors presented a survey on VHD algorithms, and research efforts proposed to improve this VHD's efficiency. The authors proposed a taxonomy of these algorithms based on the utilized criteria. For instance, the most used criteria are RSS, available bandwidth, network connection time, power consumption, monetary cost, security, and user preferences. Furthermore, authors classified VHD algorithms as RSS-based, cost function-based, bandwidth-based, and combination-based, where the input parameters depend on different methods. Authors compare these different approaches in terms of complexity as well as efficiency. RSS-based and bandwidth-based are simple algorithms compared to cost function-based and combination-based algorithms, but they reduce reliability because of RSS fluctuation.

Authors in [81] presented an analytical model of a novel VHO mechanism that uses vehicle speed as a crucial criterion calling their approach (VHO-S). Then the authors supported their model by simulation results. Their algorithm takes into account the "cell crossing time" as a decision criterion. This time is defined as the time spent by a vehicle for crossing a wireless cell. The authors estimated the throughput metric in serving candidates. The authors obtained the equation of throughput θ experienced at the receiver node as a function of speed and the time spent by the cell's vehicle. As for performance metrics, they measured throughput and the number of VHO. They compared their approach to another one from literature. They showed that VHO-S gave better results in terms of throughput.

Paper [82] proposed an intelligent network selection scheme for audio and video streaming applications in vehicular networks. The authors used three metrics: faded Signal-to-Noise ratio, residual channel capacity, and connection lifetime to develop a maximization scoring function that collects data from each network candidate during the selection process. Results showed that their proposed algorithm decreased handover delays and end-to-end latency for VoIP and video applications.

In paper [83], the authors presented a Hybrid Overlay Protocol (HOP). The authors started by studying the existing solutions. Their proposed layer is located between the transport and application layers. As a simulation tool, they used OMNeT++, INET framework, and SimuLTE to implement this solution. The decision to network candidate selection is based on status information received via the lower (ad hoc/cellular)

communication layers and in-vehicle sensors. Authors chose different criteria (e.g., the number of neighbors observed in one and two-hop ranges, the packet error rate (PER), average uplink/downlink data, the availability of cellular data connection, and current vehicle speed). Moreover, this protocol takes into consideration the service requirement in terms of delay and priority. They evaluated delay for the communication mode against the distance between the originator and the receiver. The authors' findings showed potential performance gain of the developed layer showing the advantage of heterogeneous architecture usage.

A RAT selection mechanism considering the user and the network context is derived in [84], adopting the Analytical Hierarchical Process (AHP) for weighing the importance of selection criteria and the Technique for Order Preference by Similarity to an Ideal Solution (TOPSIS) for ranking available RATs. The framework consists of a *context provider* collecting network information from a *context manager* and user preferences and status from a *context consumer* to apply mechanisms toward decision making for the target RAT.

Authors in [85] propose a network selection algorithm combining three typical MADM methods. FAHP is first used to calculate subjective weights of network attributes (e.g., bandwidth) and subjective utility values of four traffic classes (conversational, interactive, streaming, and background). Then Entropy and TOPSIS are used to respectively get the objective weights of network attributes and all alternatives' objective utility values. The most appropriate network, whose overall utility value is maximum and higher than the current mobile terminal network's corresponding value, is selected for access.

Authors in [86] propose a utility function based RAT selection mechanism taking into account user preferences, channel state information as well as network loads and service cost into account. The mechanism consists of central modules that periodically collect and broadcast network loads as part of the input of a normalized user utility function taking into account the quality of service requirements per service. Then the network having the highest utility function is selected for access.

The approaches in [87] and [88] are different. Motivated by guaranteeing QoS for different service flows with diverse QoS requirements, authors in [87] propose a handover framework with scheduling and admission control mechanisms in the MAC layer. The work proposed to extend the Media Independent Handover framework in the IEEE 802.21 standard by a cross-layer architecture with new modules in different layers and new service primitives to facilitate the communication.

In [88], an optimization approach to the RAT selection problem using a linear programming model considering the downlink of a heterogeneous network with two broadband RATs (Wi-Fi and LTE) is first proposed. Then heuristic approaches based on simple decisions made by the users that necessitate no signaling information are proposed.

The question related to choosing an MCDM algorithm instead of another is among the tough questions to answer while using MCDM for the RAT selection problem. Each algorithm has its strengths and weaknesses, and none of them can ideally solve RAT selection [79]. Most cited papers used deterministic methods for typical traffic types (e.g., conversation, streaming, interaction, and background) without specifically addressing C-ITS use cases context.

B. Artificial Intelligence-based decision-making methods

RAT selection problem be formulated using game theory or reputation-based approaches that use robust mathematical models to identify optimal strategies by analyzing previous observations, thus predicting the outcomes of decision process interactions. In this section, we survey some AI based network selection algorithms. We begin with a brief description of the operating principles of these algorithms. We then review the proposals and classify them into two main groups: ML and SI.

ML-based solutions are divided in three main subcategories: (i) SL, (ii) UL, and (iii) RL. SL and UL are offline ML algorithms where the prediction model has to be built prior to use. Indeed, SL techniques learn on a labeled data set, providing key elements that the algorithm can use to evaluate its accuracy on training data. In contrast to UL techniques that provide unlabeled data in which the algorithm attempts to make sense by extracting useful features. Whereas, RL approaches are generally classified as online ML algorithms which differ from SL and UL in not needing learning data beforehand. It is mainly based on how software agents ought to take actions in an environment to maximize the notion of reward (i.e feedback).

SI-based techniques were also used to formulate network selection problem in heterogeneous architectures. SI algorithms are biologically inspired by the behavior of social insects like ants and bees. It is mainly based on collective intelligence behavior of agents which are able to communicate with each other through the shared environment to cooperatively learn its properties.

To begin with, we review ANN based techniques included in SL subcategory. Many papers used ANN to predict the optimal network based on multiple input criteria. ANN algorithms are inspired by the biological neural networks that constitute human brains. Targeting the goal of achieving uninterrupted connectivity taking into account multiple criteria, authors in papers [89, 90], proposed ANN-based solutions. In paper [89], authors' findings showed an improvement of QoS performance compared to traditional RSS-based scheme. Authors of [90] also showed the benefits of their ANN-based scheme in reducing the number of handovers.

Clustering is a UL technique frequently used to resolve network selection problem. In the context of wireless sensor networks (WSNs), papers [91, 92] used clustering techniques for decision-making in centralized architectures. Authors in [92] compared Grouped Vertical Handover (GVHO) scheme with traditional vertical handover for single user where each mobile station just selects the best network without considering the influence from other concurrent handover decision making users. GVHO scheme has been introduced to avoid simultaneous decision-making for mass handover users.

Other papers adopt the game theory to analyze the network selection problem where the focus is to design an efficient MARL algorithm to solve it. In this context, authors of paper [93] proposed a network selection problem formulation based on Tag-of-war (TOW) algorithm which is inspired by the behavior of the amoeboid organism. The algorithm is based on observing the performance of selected network and deciding whether the rewards or the punishments is to be given.

Authors in paper [94] formulated context-aware network selection as a Markov Decision Process (MDP) model by generalizing the state to context information. They used a centralized heterogeneous network architecture formed by LTE, Wlan, and Visible Light Communication (VLC). Authors used the Q-learning algorithm reducing the learning complexity. They proposed a set of Q-learning enhancements that engender fast convergence and large average reward compared to standard Q-learning for network selection.

In an attempt to resolve the radio access technologies selection game in 5G HetNets, authors in paper [95] proposed an ML-based framework where the throughput is the main objective function. Indeed, authors tackled the problem of determining which RAT standard and spectrum to utilize and which Base stations or users to associate within the context of 5G HetNets. The proposed framework combined different machine learning algorithms.

Paper [96] proposed an intelligent handover mechanism for vehicular networks. Authors formulate VHO decision-making as a BBO and markov chain decision process. Indeed, they defined their cost function based on the AHP method. This analytic process offers the ability to change weight between each factor based on network conditions and user preferences. To implement their approach, they used OMNeT++ and MATLAB as simulation tools. The cost function they developed takes into account latency, packet loss, and throughput. They compared their method to TOPSIS and GRA measuring packet loss ratio, throughput, and handover latency.

Authors in papers [97, 98] proposed SI-based solution for network selection based on Artificial Bee Colony (ABC), PSO, and ACO algorithms.

Authors in paper [97] proposed an hybrid intelligent handover decision algorithm primarily founded on two main heuristic algorithms: Artificial Bee Colony (ABC) and Particle Swarm Optimization (PSO) named ABC-PSO to select best wireless network during vertical handover process. Authors considered single and multiple attributes cases with the objectives of minimizing the expected total cost and the average number of unnecessary handovers. Authors' numerical results demonstrated that ABC-PSO achieved lower cost, delay, and number of handover, higher available bandwidth compared to the related work.

Ant Colony (ACO) based handover decision method is proposed in [98] to select the most suitable network in terms of QoS for mobile users. Ant colonies behavior fascinates in different ways because of its capabilities to accomplish complex tasks. Ants deposit pheromone trail while searching for food source. Other ants are able to smell this pheromone and make probabilistic movement based on the intensity of pheromone to find the shortest paths between their nest and the food source. Ants tend to follow the strongest pheromone concentrations. ACO algorithm use similar agents called artificial ants which have the same properties of the real-life ants. The proposed mechanism minimized the number of handover failures as well as unnecessary handover between cellular networks and WLANs while offering better QoS with less cost and power consumption.

Most cited papers highlight the benefits of using AI techniques for network selection. However, these AI-based algorithms' efficiency needs to be proven using realistic implementations and experimental demonstrations in different environments. These so-called intelligent algorithms must be iterated many times by probabilistic and heuristic rules to obtain sub-optimal results gradually. Without enough iterations, any algorithms' intelligence will not be reflected, undesirable, or even harmful, results may yield. Convergence rate of these algorithms is one of the issues that can be encountered in their applicability to the RAT selection problem. The retrieval speed of a sub-optimal solution strongly depends on the algorithm's convergence time [99].

TABLE 3.2: Summary table of research efforts on RAT selection.

Rf.	DM algo.	Tech.	DM archi.	Services	Criteria
[80]	TOPSIS	WiMAX, LTE, Wi-Fi.	Network centric	Baseline	Number of nodes associated, User velocity, Service price, RSS
[81]	VHO based on speed	LTE VANET	Collaborative	Baseline	Cell crossing Speed
[82]	Intelligent network selection	HetNets context	User centric	VoIP, Video.	Faded SNR, residual channel capacity connection life time
[83]	Hybrid Overlay Protocol	Adhoc cellular	All	Baseline	Status information
[84]	AHP, TOPSIS	LTE-A, Wi-Fi	Collaborative	Baseline	RSS, Network load, User velocity
[85]	TOPSIS, FAHP, Entropy	GSM, UMTS, LTE-A, Wi-Fi	User centric	Voice, Streaming, Interactive, Background.	Bandwidth, latency, delay jitter, packet loss rate, service price
[86]	Utility function	LTE, Wi-Fi	Collaborative	Voice, Streaming	Throughput, Network load, Service cost
[88]	Game theory	LTE, Wi-Fi	Network centric	Baseline	Throughput, Network load, RSS
[87]	Game theory	LTE, Wi-Fi IEEE 802.21	Collaborative	Real-time, Background.	Bandwidth, Delay, SNIR, user velocity.
Continued on next page...					

Table 3.2 – continued from previous page.

Rf.	DM algo.	Tech.	DM archi.	Services	Criteria
[89]	ANN-based	LTE WiMAX Wi-Fi	Collaborative	Real-time, Data.	Data rate, coverage, Mobility, BER, Cost packet process
[90]	ANN-based	LTE WLAN	Collaborative	Multimedia.	RSSI, Bandwidth, mobile speed, monetary cost
[92]	Fuzzy clustering	HetNets context	Network centric	Real-time, Non real-time	Data rate, delay, affordable cost
[93]	RL-based	802.11 ac/n LTE	Not specified	Baseline	Throughput, delay
[95]	Q-learning clustering classification	5G	Collaborative	Baseline	Throughput, number of users
[97]	ABC-PSO	LTE, WiMAX, Wi-Fi	Not specified	Streaming, Voice	QoS
[96]	BBO, Markov chain	IEEE 802.21 WiMAX, Wi-Fi, UMTS.	Collaborative	Baseline	Latency packet loss Throughput
[98]	Updated version of ACO	4G, Wi-Fi	Not specified	Baseline	Available bandwidth, monetary cost, security level, power consumption, and RSS

3.4 Multi-Criteria Decision-Making (MCDM) principles

To tackle the RAT selection problem formulation, we have chosen the MCDM approaches because they do not require a high computational complexity and seem compatible with C-ITS networks' mobile nature. Unlike artificial intelligence algorithms, MCDMs can search for the best network instantaneously without needing any iteration loops to converge to the optimal solution. In this section, we provide a comprehensive overview of MCDM algorithms, justifying at each step our choice of methods.

MCDM algorithms are used in different areas and domains for situations that require a decision-making process based on multiple criteria. These approaches are recognized for their capability to resolve a multiple criteria decision-making problem by selecting the best alternative based on weighted criteria with well-defined preferences

for each of those criteria. The main focus of the MCDM field is to introduce analytical procedures and methods as well as tools for solving problems and consequently support decision-makers (DM) to make better decisions. Figure 3.3 shows the general hierarchical structure of an MCDM problem.

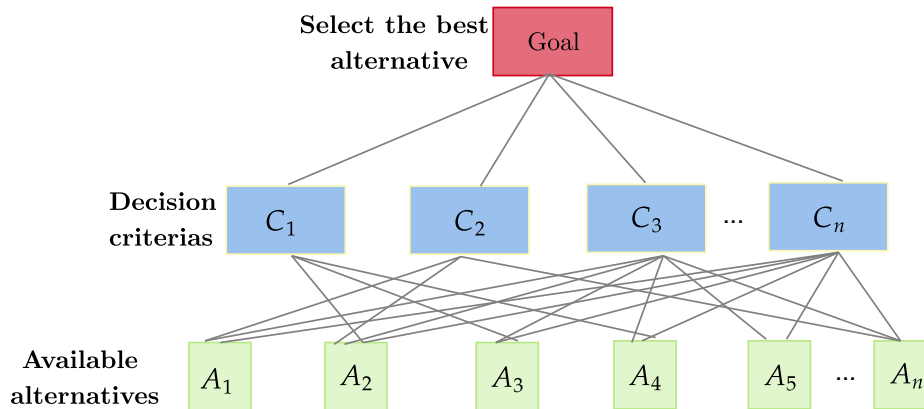

FIGURE 3.3: Hierarchical structure of MCDM problem.

It is assumed that the DM can express his/her opinion of each alternative’s performance in terms of each one of the decision criteria. The problem then is how to rank the alternatives when all the decision criteria are considered simultaneously. The decision process involves a series of different steps. The first step consists of identifying the problem by figuring out how many criteria or attributes exist. In the second step, adequate data need to be collected and processed in which the preferences of DM can be correctly reflected upon and considered (i.e., constructing the preferences). In the next step, a set of possible alternatives is constructed to ensure that the objective will be reached (i.e., evaluating the alternatives). Finally, an appropriate ranking method must be chosen to determine the best alternative (i.e., finding the best alternative).

The first step of every MCDM process is to define the decision matrix as shown in figure 3.4. It is a matrix ($I \times J$) in which each element represents the values associated with each criterion $j \in \{1..J\}$ for each alternative $i \in \{1..I\}$. I and J are respectively the number of criteria and the number of alternatives. Each potential alternative is described in terms of its criteria (a_{IJ}). In the RAT selection context, A_J represents the network technology, and C_I is its associated criterion.

		<i>Criteria</i>			
		C_1	C_2	...	C_I
<i>Alternatives</i>	A_1	a_{11}	a_{12}	...	a_{1I}
	A_2	a_{21}	a_{22}	...	a_{2I}
	\vdots	\vdots	\vdots	\ddots	\vdots
	A_J	a_{J1}	a_{J2}	...	a_{JI}

FIGURE 3.4: Decision matrix template.

In MCDM, three stages are required for the decision-making process: normalization, weighting and ranking. In what follows, we give definitions for each step justifying our choices.

3.4.1 Normalization

This procedure aims to eliminate dimensional data units in the decision matrix to obtain numerical and comparable input data using a common scale.

A common issue of normalization procedure is to affect the RRP which is the change in ranking of the alternatives as a consequence, for example, of the addition or deletion of an alternative [100]. In the context of handover, this problem can directly lead to ping-pong effects. A suitable choice of normalization technique may significantly reduce latency and the number of handover as a consequence of this effect.

Max-Min normalization are a used technique for relative comparison between alternatives, i.e. any criteria normalized value provides either the distance from the best candidate (benefit criteria) or from the worst candidate (cost criteria).

Three main Max-Min based normalization techniques are presented and discussed in paper [101]. For these techniques, the "larger-the-better" and "smaller-the-better" parameters categories are computed. These respective values are useful for network parameters classifications. For instance, end-to-end delay is a "smaller the better" criterion, as it is preferable to receive information with the lowest latency. Delay is a crucial network indicator that impacts the information freshness, especially for safety services. Throughput is a "larger-the-better" criterion since it is directly related to the successful message delivery rate, which is better when it is maximized.

- **Norm1:** the first technique consists of determining the absolute min-max values to keep the normalized values unchanged using eq. 3.1 and 3.2. Authors showed that this technique completely eliminates RRP. However, the disadvantage of this approach is that the distance between normalized values can be very small. This in consequence may reduce the evidence of choice between the alternatives after ranking stage.

$$x_{ij} = \frac{E_{maxj} - s_{ij}}{E_{maxj} - E_{minj}}, \text{ If } j^{th} \text{ criterion is considered as "smaller-the-better"} \quad (3.1)$$

$$x_{ij} = \frac{s_{ij} - E_{minj}}{E_{maxj} - E_{minj}}, \text{ If } j^{th} \text{ criterion is considered as "larger-the-better"} \quad (3.2)$$

where E_{minj} and E_{maxj} are respectively the absolute min and max of j^{th} criterion of alternative i , s_{ij} is the value to be normalize, and x_{ij} is the normalized value.

- **Norm2:** the second technique is similar to the first one, but it uses the absolute bound only in the unwanted direction of an attribute using eq. 3.3 and 3.4. For instance, in case of the "smaller-the-better" attribute an absolute maximum is determined and vice versa. This choice is justified by the fact that network will become unreachable in the case where the "larger-the-better" attribute become

small (e.g the network will disappear when the signal strength or the throughput become very low). This technique do not completely eliminate RRP.

$$x_{ij} = \frac{E_{maxj} - s_{ij}}{E_{maxj} - l_j}, \text{ If } j^{th} \text{ criterion is considered as "smaller-the-better"} \quad (3.3)$$

$$x_{ij} = \frac{s_{ij} - E_{minj}}{u_j - E_{minj}}, \text{ If } j^{th} \text{ criterion is considered as "larger-the-better"} \quad (3.4)$$

where l_j and u_j are respectively the minimal and the maximal value of the j^{th} criterion.

- **Norm3:** the third technique aims to eliminate the usage of absolute min-max values using eq. 3.5 and 3.6. This aspect guarantee higher distance between normalized values of an alternative compared to Norm2, thus the ranking order will be clearer. This technique did not resolve the RRP, but it reduces its occurrence probability.

$$x_{ij} = \frac{l_j}{s_{ij}}, \text{ If } j^{th} \text{ criterion is considered as "smaller-the-better"} \quad (3.5)$$

$$x_{ij} = \frac{s_{ij}}{u_j}, \text{ If } j^{th} \text{ criterion is considered as "larger-the-better"} \quad (3.6)$$

Techniques \ Features	Rank reversal	Distance between normalized values of an attribute
Norm1	Completely resolved	Very small
Norm2	Moderately resolved	Medium
Norm3	Very moderately resolved	Large

TABLE 3.3: Summary table of normalized techniques features in [101].

Table 3.3 summarizes the comparison between different proposed normalization techniques in terms of RRP resolution and the distance closeness between normalized values of an attribute. It can be observed that the greater the distance between the normalized values of an attribute, the clearer the ranking order becomes. The choice of a normalized technique is a compromise between RRP resolution and the clarity of rank order.

Norm3 method does not depend on absolute min-max values. Also, it reduces the occurrence of RRP problem while keeping a considerable distance between normalized values. This aspect can reduce conflicting situations during the ranking stage and make it more straightforward.

3.4.2 Weighting

The weighting stage's goal is to introduce in the decision process the relative importance order of the criteria, which is crucial for the selection of optimal alternative. Weights of importance are assigned to each criterion. Usually, the sum of these weights should

equal to 1. Three different categories of weighting techniques are known in literature: objective, subjective, and hybrid.

(i) Objective

These methods are generally used when there is a lack of background knowledge on the decision-maker (e.g. the operator or the user) preferences. It is also useful when the decision-maker does not have any special requirements. The idea of these so-called objective methods is to give the most weight to the criterion whose values concerning the different alternatives are the most diverse. Objective weights can be determined based on the calculation of standard deviation or entropy of values among all alternatives (see [102, 103] for an example).

(ii) Subjective

As opposed to objective methods, subjective weighting allows considering the decision maker's preference (such as traffic classing) in the decision process. Usually, the user's preferences are expressed as the weight vector (w) of the relative importance of the criteria regarding each traffic class before the start of the decision-making process. Nevertheless, in general, to allow a more refined expression of user (or operator) preferences, the decision-maker gives a matrix (denoted as A one per traffic class) of pairwise comparison on the importance of the criteria (e.g. on a scale from 1 to 9) instead. Then from this matrix, the weight vector (w) used in the actual decision process is determined. There are several methods of determining w from A in the literature. In [104], two methods, namely WLS and EigenVector, are evaluated and compared. The study showed that it is better to use the WLS method since it offers more scalability than Eignevector when a large number of criteria are considered. However, below a certain number of the criteria (near 23), the two methods give similar results.

(iii) Hybrid

Combining objective and subjective techniques is known as hybrid weighting, which is appropriate when various services are simultaneously operating; in this case, it is complicated to attribute weights according to distinguished user preferences. Thus, the combination between both techniques may lead to a better weights calculation. In paper [104], authors proposed a hybrid weighting technique that allows partial exploit of properties of both subjective and objective approaches with a manageable priority for each approach using a factor "k". A Hybrid approach offers a compromise solution that takes advantage of subjective and objective weighting methods with a relation of priority.

After analyzing and studying different weighting approaches, we conclude that the use of subjective weighting is adequate with RAT selection since it is possible to express end-user profiles based on C-ITS services' performance requirements. For this reason, we use AHP to assess the relative weight of different decision criteria. This method is mainly based on expressing each criterion's relative importance using pairwise comparisons matrix also called AHP matrix. We additionally use EigenVector method to extract the priority vector from the AHP matrix since we will not consider a large number of network criteria [104]. This step is necessary to solve the AHP matrix as a system of linear equations allowing to extract the effective weight as a vector in which each value corresponds to the weight of each network criterion included in the decision matrix.

3.4.3 Ranking

This procedure establishes a rank of order for each criterion by considering the normalized matrix and the criteria's relative importance order. In this stage, the best alternative can be decided according to the order of preference. Many strategies are available for the rank calculation stage, such as SAW, GRA, and TOPSIS. As shown in section 3.3.2, many MCDM algorithms are used to solve network selection problem. In particular, TOPSIS is commonly used for network selection problems and handover mechanisms.

In our proposal, we chose to use TOPSIS algorithm since its clear and simple concept characterizes it and as it offers more accuracy in identifying the alternative rank compared to other MCDM algorithms [105]. However, TOPSIS algorithm suffers from RRP. To reduce this problem's occurrence, we use TOPSIS with linear normalization instead of its conventional usage with vector normalization methods [106].

TOPSIS selects the best alternative based on the "closeness to the ideal" concept. The best alternative would be the one that is closest to the positive ideal solution and furthest away from the negative ideal solution. The positive ideal solution is the one that maximizes the benefit criteria and minimizes the cost criteria. The negative ideal solution maximizes the cost criteria and minimizes the benefit criteria. In summary, the positive ideal solution is composed of all the best possible values of the criteria. The negative ideal solution is composed of all the worst possible values of the criteria.

3.5 Summary

In this chapter, we reviewed different aspects of vehicular communication technologies. First of all, we surveyed ITS-G5 and LTE-V2X evaluation performance studies highlighting their advantages and shortcomings.

According to some papers, ITS-G5 performances become limited in congestion scenarios. With the default fixed data rate of 6 Mbps, answering C-ITS services latency and reliability is not always feasible and requires further investigations. Enhancing the ITS-G5 congestion control mechanism is widely discussed in the literature. ITS-G5 data rate control mechanism is therefore needed to improve dissemination performance of C-ITS services.

The co-existence of ITS-G5 and LTE-V2X technologies will provide better network infrastructure for C-ITS. Thanks to a heterogeneous architecture that can combine each technology's advantages to generate a more comprehensive and promising solution, the requirements of V2X services will be better met.

Selecting the best access network technology for different C-ITS services profiles is challenging because it needs to consider multiple criteria. An optimal solution should be targeted, considering real-time situations and application preferences.

Decision-maker architecture's choice for RAT selection is one of the tricky questions we tried to answer in this chapter. To overcome network-centric and collaborative approach limitations, in the present work, we propose a user-centric mechanism able to take decisions independently of the network infrastructure.

Concerning the decision-making process, we chose an MCDM method called TOPSIS to perform network selection. MCDM do not require high computational complexity, making them compatible with the dynamic nature of the C-ITS networks environment. Compared to AI-based algorithms, MCDM algorithms are relatively comprehensive and straightforward without any random factors in the whole runtime. They can obtain the definite result almost directly, relying only on their corresponding steps

rather than multiple loops. Unlike AI-based algorithms, the best alternative's resolution does not depend on the algorithm's convergence time.

Chapter 4

Contributions

Network technologies dedicated to C-ITS must meet different service profiles requirements. Several challenges for C-ITS networks are already studied in the literature (e.g. network congestion, and insufficient coverage). For instance, in traffic jams, hundreds of vehicles may be present in the same area, requiring seamless connectivity to maintain a high level of awareness among different road users. In this work, we focus essentially on studying C-ITS networks in the context of direct communications and one-hop broadcast services. This chapter details our significant contributions for enhancing C-ITS dissemination and our main efforts in improving network performance in terms of latency and throughput. In the present work, our contributions mainly address congestion control and RAT selection problems for C-ITS networks. Our contributions will be organized as follows:

- Driven by the C-ROADS project, GLOSA is one of the C-ITS services we are focusing on. Section 4.1 starts studying strategies for GLOSA. We propose three algorithms for this service to evaluate its efficiency, which mainly depends on network communication performance.
- In an attempt to enhance DCC cross-layer for congestion control in ITS-G5, we discuss congestion problem in section 4.2. We propose in subsection 4.2.1 a data rate adaptation mechanism called Data Rate Control (DRC). This mechanism is proposed as a complementary solution to DCC since a set of modulation coding schemes (MCS) are available in IEEE 802.11p standard. In sub-section 4.2.2, we upgrade DRC to DRC/ATCL, seeking to improve broadcast performance during congestion scenarios for ITS-G5 ad hoc technology.
- Addressing the RAT selection problem in the context of heterogeneous network architecture, section 4.3 presents DICART which is a distributed and context-aware mechanism for network management. It is formulated as a multi-criteria decision-making (MCDM) problem giving the different steps of the selection framework dealing with MCDM steps.

We summarize this chapter in section 4.4.

4.1 Investigations on the effectiveness of GLOSA

Fuel consumption and Co2 emissions are one of encountered challenges in our efforts towards a green and clean environment. C-ITS systems can be used to contribute to the resolution of this issue. Indeed, the ability to mutually exchange information allows the road environment's improvement and reduces traffic congestion. Furthermore, C-ITS offers multiple services that play an essential role in saving energy and making the world less polluted. One such application called GLOSA is a C-ITS traffic efficiency

service that can reduce excessive stop-and-go driving in urban areas. Based on I2V communications, GLOSA uses received information about traffic light position and its signal phase timing to calculate an advisory speed that enables the driver to pass at the green phase. It updates the advisory speed periodically according to the current situation. In literature, two strategies of GLOSA were proposed:

- **Simple segment approach**, which consists of giving an advisory speed dedicated to passing the upcoming traffic light at the green phase.
- **Multiple segment approach**, which provides an advisory speed taking into account all next intersections parameters to pass more than one traffic light at the green phase with minimum speed variation.

Under C-ROADS project, we focus on studying GLOSA effectiveness using ITS-G5 technology. In what follows, we propose three algorithms for GLOSA: Speed Advisory Boundary finder for Simple Segment (SABIN-SS), Speed Advisory Boundary finder for Multiple Segment (SABIN-MS), and Efficient Path Planning GLOSA-based (EPP-GLOSA).

4.1.1 Speed Advisory Boundary finder for Simple Segment (SABIN-SS)

The idea is to propose an algorithm that calculates advisory speeds for GLOSA.

Algorithm 4.1 SABIN-SS

Input: $\{t_1, t_2\}$: Green phase, d : Distance to traffic light, t_0 : current Time, v_0 : current speed

Result: (v_1, v_2)

```

1 Calculate  $t_{pmax}$ : the time to pass the traffic light with  $v_{max}$  speed  if (  $t_{pmax} > t_2$  )
2    $v_1 = v_2 = -1$  ; // In this case, we check if the driver can pass the traffic
   light at the next phase. If it is not the case, we recursively call the algorithm
   with the inputs  $t_1 + \text{"cycleDuration"}$  and  $t_2 + \text{"cycleDuration"}$ .
3  $v \leftarrow a((t_1 - t_0) - \sqrt{(t_1 - t_0)^2 - \frac{2(d - v_0(t_1 - t_0))}{a}}) + v_0$  if (  $t_{pmax} < t_1$  )
4   if (  $v \leq v_{min}$  )
5      $v_1 = v_{min}$ 
6   else
7      $v_1 = v$ 
8 else
9    $v_1 = v_{max}$ 
10  $v \leftarrow a((t_2 - t_0) - \sqrt{(t_2 - t_0)^2 - \frac{2(d - v_0(t_2 - t_0))}{a}}) + v_0$  if (  $v \leq v_{min}$  )
11    $v_2 = v_{min}$ 
12 else
13   if (  $v_2 \geq v_{max}$  )
14      $v_2 = v_{max}$ 
15   else
16      $v_2 = v$ 

```

According to a certain strategy, we can choose an advisory speed between two boundaries v_1 and v_2 . v_1 is the calculated speed as fast as possible the green phase. v_2 is the

calculated speed to pass the green phase as slow as possible. As shown in algorithm 4.1, SABIN-SS takes the following input parameters: t_1 and t_2 are respectively the start and the end of the green phase, the distance to traffic light d , current time t_0 , and current speed v_0 .

In what follows, we detail the different steps of the algorithm 4.1. In **(line 1)**, SABIN-SS starts by calculating arrival time denoted as t_{pmax} using maximum authorized speed and compares its value with the end of the green phase (time t_2). An essential check is conducted in **(line 1)** to define cases in which the driver can't pass during the current green phase. In this case, we need to recursively call the algorithm with $(t_1 + \text{"cycleDuration"}$ and $t_2 + \text{"cycleDuration"}$) to get an adequate advisory speed, enabling him to pass the upcoming green phase. **(Line 3)** calculates speed during the time interval between t_1 and t_0 , and if the driver is not passed yet the traffic light as verified in **(line 3)**, we always ensure that the calculated speed is higher than v_{min} and lower than v_{max} **(lines 4, 9)**. **(Line 10)** to **(line 16)**, correspond to the calculations steps of speed v_2 . v_1 and v_2 are always between minimum and maximum authorized speeds where we suppose that at every location there are two speeds that drivers need to respect: maximum authorized speed over which drivers will be fined, and minimum authorized speed below which drivers are not allowed to drive in order not to block traffic. This contribution has been published in this conference paper [107].

4.1.2 Multiple segments approach algorithm (SABIN-MS)

We extend SABIN-SS to a multiple segments approach called (SABIN-MS) as illustrated in algorithm 4.2.

Algorithm 4.2 Multiple segments algorithm (SABIN-MS)

Input: Number of road segments N

Result: Joint speed to pass a set of traffic lights at green phase.

```

1 Collect data from different Road Side Units (RSUs). Calculate  $v_1$  and  $v_2$  for
  each segment using SABIN-SS while ( $i < N$ ) do
2   // Search for joint speed, enabling to pass more than one segment.
3   if ( $[v_2, v_1]_i \cap [v_2, v_1]_{i+1} = true$ )
4     if (segment  $i$  is not yet passed)
5       Use the joint speed " $s$ " to pass the segment  $i$  and  $i+1$ 
6     else
7        $i = i - 1$  // If a segment  $i$  is already passed, we shift the counter  $i$  to
          not consider past segments, and we restart the search process for a
          joint speed between the rest of the segments.
7       Call SABIN-SS // In this case there are no intersections between
          consecutive speed intervals

```

This algorithm aims to keep the speed as constant as possible to reduce fuel consumption and avoid unnecessary acceleration or deceleration every time we pass a consecutive set of traffic lights.

In **(line 1)**, we begin by collecting data from available RSUs in the coverage area of communication. We then calculate speed Bounds (v_1 and v_2) for each segment in **(line 1)**. In **(line 1)**, while the segment index i is lower than N the number of road segments, we start searching for a joint speed enabling to pass more than one segment. **Lines 2)** examine if a common speed exists between segment i and segment $i + 1$. **(line**

3), checks if the segment i is not yet passed. If this test is true, the obtained common speed will be adopted in (line 4). If the segment of index i is already passed, we shift the counter and we restart the search process as depicted in (line 5). If there is no possible common speed, we use simple segment approach as shown in (line 7). This contribution has been published in this conference paper [108].

4.1.3 Efficient Path Planning GLOSA-based (EPP-GLOSA) approach

This work's primary motivation is to find the fastest route using the Dijkstra algorithm, including the impact of the traffic light states along the path. According to our knowledge, none of the existing work combined GLOSA with the path calculation services. This leads us to propose EPP-GLOSA, an efficient path planning GLOSA-based approach that considers the impact of traffic lights and travel time.

EPP-GLOSA approach aims to optimize route planning considering signalized intersections. The main idea is to compute a route to destination that minimizes travel time with coordination of GLOSA service that gives an advisory speed allowing the driver to pass the green light. Dijkstra algorithm is used for route establishment considering a graph formed of segments and intersections. Figure 4.1 illustrates an example of a graph thus created. Each segment has a weight that is relative to the time needed to cross it taking into account GLOSA information. Weights are thus updated every time the algorithm is called depending on the states of traffic lights. Indeed, traffic light states are the key element used to calculate advisory speed that impacts the segment travel time which is used in turn to weight Dijkstra graph.

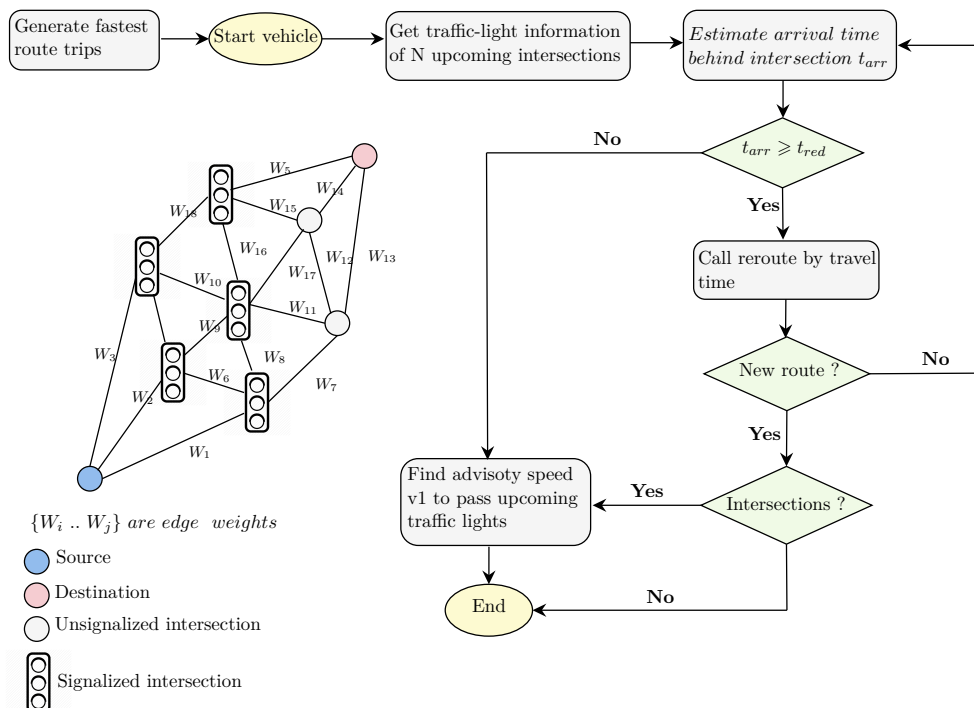

FIGURE 4.1: EPP-GLOSA algorithm flow chart.

The algorithm steps are given in Figure 4.1. Before a vehicle starts a path, Dijkstra routing process is used to generate initial trips. When the vehicle starts its activity, it receives information about upcoming intersections traffic light states as well as corresponding distances. The vehicle controller calculates the arrival time t_{arr} related to each signalized intersection data to check the possibility of passing the traffic light by

comparing it with the corresponding red time period t_{red} . If it is possible to pass the traffic light considering the current green light window, the vehicle adopts the advisory speed to pass the green light which is calculated based on Speed Boundary Advisory Finder (SABIN) approach proposed. SABIN algorithm supposes that at every location there are two speeds that drivers need to respect: maximum authorized speed over which drivers will be fined, and minimum authorized speed below which drivers are not allowed to drive in order not to block traffic.

In case there is no possibility to pass traffic lights in the current trip route, the algorithm starts searching for a new path considering dynamic edge weights by calling reroute by travel time function. In this step, adaptive Dijkstra is called which makes use of information that becomes available during the trip. A new route is computed for a vehicle as soon as the vehicle is inserted. This route can be update during the next 5 minutes after adopting it in case a new route is found with a faster path. Updating the route every 5 minutes is a recommended rerouting interval as proved in paper [109] since it helps to produce favorite traffic conditions enabling the convergence to an optimal solution.

As shown in the graph of figure 4.1, the road network is represented as a graph $G = (N, E)$ where N is a set of nodes and E is a set of directed edges between pairs of nodes. An optimal routing problem is defined as finding a path $p = \{e_1, e_2, e_3, \dots, e_j\}$ from starting node S to destination node D , given a departure time t_s , such that the travel time is as low as possible. The weight of an edge is defined as the travel time of the edge referred as w_e which depends on the travel speed of the edge. Historical speed data $\{v_e^{t_1}, v_e^{t_2}, \dots, v_e^{t_h}\}$ are recorded for each edge for a set of discrete and equidistant times $\{t_1, t_2, \dots, t_h\}$. The travel time of an edge e is computed by dividing the distance of the edge $\|e\|$ by the average speed. To make the speed a continuous function of the departure time, linear interpolation between data points is used. Suppose that the departure time t_s lies between two time points for which the average speed is known: $t_a < t_s \leq t_b$, then the travel time is expressed in equation 4.1 as follows:

$$w_e = \frac{\|e\|}{(t_b - t_s)v_e^{t_b} + (t_s - t_a)v_e^{t_a}} \quad (4.1)$$

As shown in the flowchart of figure 4.1, if the new route contains traffic light an advisory speed will be re-calculated else process is ended.

This contribution was published in a journal paper [23].

4.2 Congestion mitigation for ITS-G5

Channel utilization inefficiencies such as competition between several nodes for channel resources access typically result in congestion when resource demands exceed the channel capacity. Network congestion leads to reduced quality of service (QoS) when a network node or link carries more data than it can handle. Typical effects are queuing delay and packet loss. Another consequence of congestion is the gradual increase in the offered load, which leads to a slight increase or even decrease in network throughput. Network congestion is one of the challenging problems encountered in the C-ITS environment. These systems are expected to play a crucial role in future road safety, requiring efficient communication techniques to meet latency and reliability constraints. Congestion mitigation mechanisms are therefore essential to improve network performance under these conditions.

ITS-G5 stations mainly inherit the IEEE 802.11p MAC layer, which introduces a distributed channel access scheme based on the CSMA/CA mechanism. One of the

CSMA/CA characteristics is providing fair access to the contending nodes (i.e. on average, it allows nodes to access the channel the same number of times in a given period). In high density, it may lead to an inherently unpredictable situation due to the random exponential backoff procedure, which in turn can drive to unlimited channel access delays and interference between competing transmissions that may result in transmission failure.

To ease the congestion problem and its undesirable consequences mentioned above, the European Telecommunications Standards Institute (ETSI) has defined a mandatory cross-layer under ITS stations called Decentralized Congestion Control Mechanism (DCC) in the ITS-G5 standardization detailed in the 2.3.3 subsection of the chapter 2.

This cross-layer enables setting up various congestion control techniques that aim to enhance reliability by manipulating transmission behavior in response to channel load. Most C-ITS services use a broadcast mode, which makes feedback infeasible. Thus, the best channel evaluation in IEEE 802.11p networks can be performed using CBR measurements. If there is no congestion control, the channel can be rapidly overloaded when the vehicle density increases. Congestion control enhances predictability, reliability and guarantees efficient channel resource utilization. It is therefore considered a necessary function in vehicular networks.

As mentioned in subsection 3.2.2 of chapter 3, many studies investigated DCC efficiency in handling network congestion mitigation. Most of papers focused on reactive approaches based on comparing the current channel state with a fixed threshold as described in the 2.3.3 subsection of the chapter 2. In an attempt to enhance DCC inefficiencies, we focus on proposing an adaptive approach whose goal is to dynamically alleviate the network congestion. DCC exploits local knowledge about the state of the channel to trigger adjustments to the parameters characterizing the node. Channel conditions information is acquired using channel probing, and the resulting measurements of CBR are used to enable the following adjustments:

(i) **Transmit Data-rate Control (TDC)**, which deal with the determination of the data rate used by the node to transmit its packet. (ii) **Transmit Rate Control** which is performed at DCC facilities layer to limit the number of packets generated by V2X services. (iii) **Transmit Power Control (TPC)** which manage the average transmit power per packet.

In this section, we focus on proposing mechanisms based on **TDC and TRC approaches following an adaptive trend**. We do not deal with TPC-based mechanisms since they are typically performed in a reactive way [110], which has proven to lead to poor performance due to the coarse settings defined in the standard [111].

4.2.1 Data Rate Control (DRC)

We propose a TDC-based mechanism called DRC, aiming to improve ITS-G5 network performance in terms of latency, reliability and exploit available data rates well. DRC is a data rate adaptation mechanism for ITS-G5 based on providing a new paradigm of Channel Busy Ratio (CBR) estimation related to a target Packet Delivery Ratio to be defined according to the service requirement. This estimation model presents the foundation element of this contribution.

Conventionally, IEEE 802.11 p used fixed data rate configuration for simplicity, which is not always efficient, especially for congested scenarios. Other solutions can be developed based on the adaptive selection of data rates according to a set of defined criteria. As specified in [34] IEEE 802.11p/ITS-G5 provides a set of data rates (from 3 Mbps to 27 Mbps) associated with modulation coding schemes as described in section 2.3.

We exploit the local knowledge about the channel state to decide on data rate. The channel probing is allowed thanks to channel busy ratio, namely CBR measurements. As shown in figure 4.2, CBR is calculated as the proportion of time the channel is sensed busy. It is an estimate of how much a channel is used based on listening on surrounding radio transmitters.

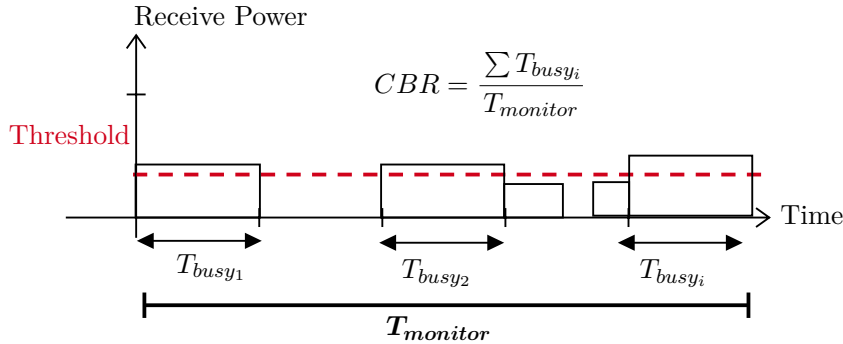

FIGURE 4.2: Calculation of the Channel Busy Ratio (CBR).

The motivation for this proposal lies in the maximization of the transmission opportunities, and consequently, in the improvement of data dissemination performance for the ITS-G5. Thus, we expressed the busyness probability as a function of successful transmission probability. This way we can regulate CBR value according to a target PDR. Note that for this work, we ignore channel errors and hidden terminals.

CBR is used to determine the node transmission behavior and is usually measured as a ratio between the busy period and monitoring interval.

We note R_b the channel busy ratio where we consider that $R_b = CBR$, R_c the collision ratio, and R_s the ratio of successful transmissions given by the set of equations in (4.2).

$$\begin{cases} R_b = R_c + R_s \\ R_c = \frac{p_c T_c}{p_i \sigma + p_s T_s + p_c T_c} \\ R_s = \frac{p_s T_s}{p_i \sigma + p_s T_s + p_c T_c} \end{cases} \quad (4.2)$$

Where p_i is the probability that the observed time slot is idle, p_s is the probability that there is one successful transmission, and p_c is the collision probability that there are at least two concurrent transmissions at the same time slot σ .

T_s illustrates the time duration for the successful transmission of one frame, and it is given in equation (4.3):

$$T_s = T_h + L/R + AIFS \quad (4.3)$$

T_c is the time duration of a failed transmission due to a collision. T_c is expressed using Extended Inter-Frame Space (EIFS), which is used instead of Arbitrary Inter-Frame Space (AIFS) whenever the physical layer indicates a non-successful transmission event. It is exposed in equation (4.4):

$$T_c = T_h + L/R + EIFS \quad (4.4)$$

L is the packet length, R the data rate, and T_h the duration of the Physical Layer Convergence Protocol (PLCP) preamble and header. The Packet Delivery Ratio (PDR)

is expressed as follow:

$$PDR = 1 - p_c \quad (4.5)$$

Equation (4.5) in equation (4.2) gives equation (4.6).

$$R_b = R_s + \frac{(1 - PDR)T_c}{p_i\sigma + p_sT_s + (1 - PDR)T_c} \quad (4.6)$$

Each vehicle can be modeled as an M/G/1 queuing system where the frame arrival follows the Poisson process with arrival rate λ [packet/sec]. The MAC layer service time of a frame follows general distribution [112]. Applying Pollaczek-Khinchine formula as demonstrated in appendix A, it gives equation (4.7):

$$R_s = \lambda T_s + \frac{(\lambda T_s)^2}{2(1 - \lambda T_s)} \quad (4.7)$$

Using equation (4.7) in equation (4.6), we get the following equation:

$$R_b = \lambda T_s + \frac{(\lambda T_s)^2}{2(1 - \lambda T_s)} + \frac{(1 - PDR)T_c}{p_i\sigma + p_sT_s + (1 - PDR)T_c} \quad (4.8)$$

According to [113], p_s and p_i are expressed as a function of the number of vehicle's neighbors and τ , which is the probability that a node transmits in a randomly chosen time slot which is expressed using the contention window size W based on [114].

$$\begin{cases} p_s = n\tau(1 - \tau)^{n-1} \\ p_i = (1 - \tau)^n \\ T_s = T_h + L/R + AIFS \\ T_c = T_h + L/R + EIFS \\ \tau = \frac{2}{W + 1} \end{cases} \quad (4.9)$$

We obtain equation (4.8) and the system of equations (4.9), which are the crucial ingredient of our approach based on finding CBR thresholds promising a target PDR. In the present contribution, DRC mechanism is introduced as a complementary approach for Finite State Machine (FSM) algorithm (the standardized DCC algorithm described in subsection 2.3.3 of chapter 2). DRC is based on adjusting data rate levels following TDC technique considering the dynamic changes of channel conditions. This adaptation focuses on keeping CBR levels below a target CBR threshold ensuring a target PDR. In algorithm 4.3, we further explain the different steps of DRC. We begin with initializing the data rate value to 6 Mbps in **(line 1)**. We then access the Location Table (LT) to get the number of vehicle' neighbors in **(line 1)**. We assume that each vehicle can exploit the location table built and updated by the geo-networking routing algorithm.

As illustrated in figure 4.3, this table contains information about nearby ITS stations. It is additionally found in the Local Dynamic Map (LDM) and its associated neighbor location table built from facilities messages (e.g. CAM/DENM) received from nearby ITS stations. Cached messages are purged when their lifetime is exceeded or when they are canceled. In **(line 1)**, we calculate the CBR thresholds corresponding to the range of available data rates (6, 9, 12, 18 and 24) in Mbps. From **(line 1 to line 8)**, instantaneous measured refereed as cbr is compared with the calculated thresholds denoted as $cbrTh$, a switch to the suitable data rate level is therefore performed.

Algorithm 4.3 Data Rate Control (DRC)**Input:** Channel Busy Ratio (CBR)**Result:** {data rate}

-
- 1 Initial data rate = 6 Mbps Get the number of neighboring vehicles from the location table (LT) Calculate CBR thresholds $cbrTh$ dynamically **if** ($cbrTh_6 + hys_6 \leq cbr < cbrTh_9$)
 - 2 | data rate= 9 Mbps
 - 3 **else if** ($cbrTh_9 + hys_9 \leq cbr < cbrTh_{12}$)
 - 4 | data rate=12 Mbps
 - 5 **else if** ($cbrTh_{12} + hys_{12} \leq cbr < cbrTh_{18}$)
 - 6 | data rate=18 Mbps
 - 7 **else**
 - 8 | data rate=24 Mbps
-

Note that when the cbr measurements become very close to the estimated threshold $cbrTh$, frequent changes from one data rate level to another may occur. These fluctuations are avoided by introducing a hysteresis value of CBR as given in equation (4.10):

$$Hysteresis = \frac{\Delta(cbrTh_{ij})}{hyst_{factor}}, \quad \text{where } i < j \quad (4.10)$$

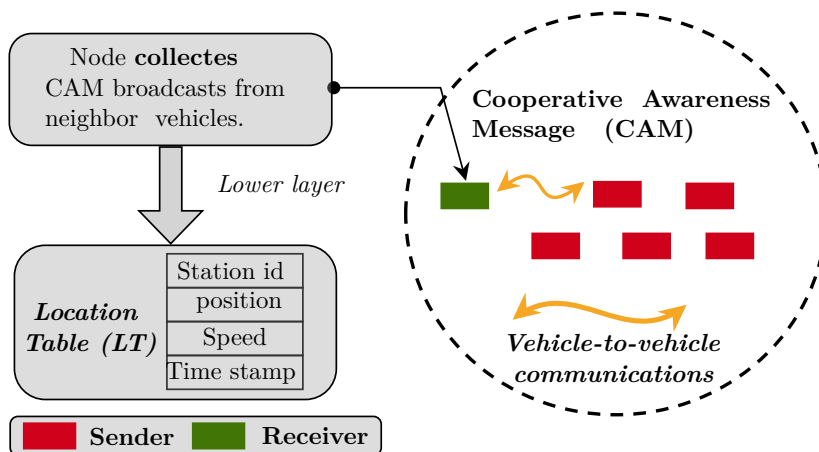

FIGURE 4.3: Number of node's neighbors from location table.

4.2.2 Data Rate Control with Adaptive Traffic Control based on LIMERIC (DRC/ATCL)

We have extended DRC to support adaptive traffic control to reduce collisions and improve message delivery.

We propose DRC/ATCL, an adaptive data rate and congestion control mechanism based on the combination of both techniques: TRC and TDC. The main purpose is to improve reliability and ensure low latency by the combination of both data rate and message rate adaptations. The LIMERIC algorithm will ensure TRC function and TDC is supported by DRC algorithm. LIMERIC is a distributed and adaptive linear rate control algorithm where each node adjusts its message rate such that the total

channel load converges to a target value [115]. The message rate for the j^{th} vehicle denoted as r_j is adapted according to equation (4.11) [116]:

$$r_j(t) = (1 - \alpha)r_j(t - 1) + \beta(CL_t - CL_m(t - 1)) \quad (4.11)$$

Where CL_t represents the target channel load for all vehicles in a given location area, CL_m is the measured channel load, and $\{\alpha, \beta\}$ represents the adaptations parameters allowing the stability control, fairness, and steady-state convergence. β parameter depends on frame duration denoted as d .

It is proved in [115], that in steady state LIMERIC converges to a unique and fair rate for all K vehicles such that:

$$CL_{conv} = \frac{d * K * \beta}{\alpha + d * K * \beta} CL_t \quad (4.12)$$

According to equation (4.12), the convergence channel load CL_{conv} can be adjusted using CL_t . The channel load is calculated based on CBR metric as follow:

$$CL_n = (1 - \phi)CL_{n-1} + \phi CBR_n \quad (4.13)$$

In equation (4.13), CBR_n is the CBR measured at the n^{th} monitoring interval and CL_n is the channel load calculated recursively upon measurements of CBR_n . The weighting factor ϕ allows to express the channel load either based only on the current CBR by setting ($\phi = 1$) or taking into account its history by applying first-order discrete-time low-pass filtering to the CBR ($\phi \neq 1$).

Based on equation (4.8) detailed in section 4.2.1, we express target CBR based on a specified target PDR as follow:

$$CBR_t = \lambda T_s + \frac{(\lambda T_s)^2}{2(1 - \lambda T_s)} + \frac{(1 - PDR_t)T_c}{p_i \sigma + p_s T_s + (1 - PDR_t)T_c} \quad (4.14)$$

The equations (4.11) and (4.14) are therefore the basis of our congestion control mechanism. DRC/ATCL adjusts message sending rate and data rate to dynamically cope with channel load conditions, helping to reduce congestion and thus improve network performance.

This contribution answering one of this thesis main objectives has been led to this publication [24].

4.3 DIstributed Context-Aware Radio access Technology (DICART) selection framework

This work's primary purpose is to provide road users with an Always Best Connected (ABC) facility, good quality of service, and high bandwidth [117]. Taking advantage of the coexistence of different technologies in heterogeneous architectures can be a promising solution for C-ITS. However, choosing an appropriate network that dynamically meets service requirements is not a trivial task. This involves many technical challenges and aspects that should be studied and solved to answer service requirements and satisfy user preferences while switching through different access technologies. One of the critical issues is the network selection procedure that must fit specific service QoS requirements. Thus selecting a network according to multiple criteria seems to be a complex problem that requires an efficient optimization method. This section specifies DICART, a distributed and context-aware RAT selection framework.

In the present work, we deploy our framework under an architecture composed of IEEE 802.11p and LTE-V2X networks which are the key network technologies adopted in the C-ROADS project. The choice of these two technologies is also driven by providing a decision framework based on decision metrics that decision-making network nodes can collect locally without the need for a specific coordination mechanism with other nodes and by using their standard interfaces. Typical targeted traffic in this framework is mainly based on cooperative road safety and efficiency services.

In DICART framework, we consider network nodes having a set of service profiles, and a set of access technologies where each access technology can have one or multiple interfaces. Each application profile generates data where a functional module called *Decider* (with two sub-modules *Queue* and *packet dispatcher*) decides which transmission interface to use based on local statistics. Figure 4.4 illustrates the conceptual model of DICART.

Packet dispatcher component of *Decider* module illustrated in Figure 4.4 makes decisions based on local statistics using algorithm 4.4.

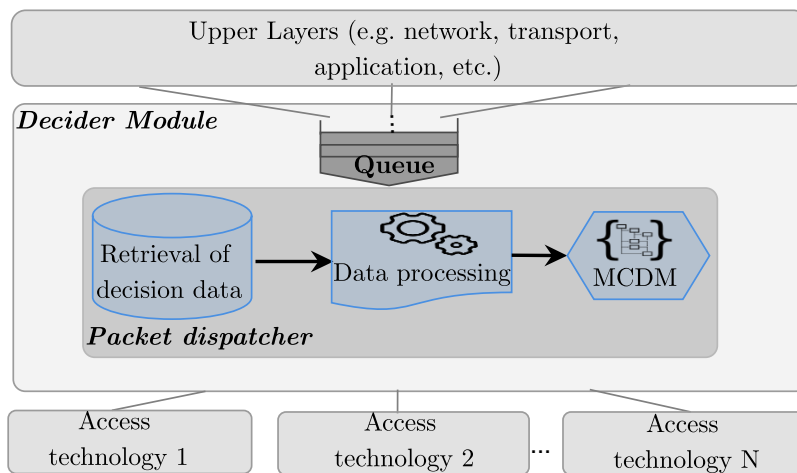

FIGURE 4.4: DICART framework conceptual model: a multi-interface node architecture.

In algorithm 4.4, the following steps are performed to assign access network to an application packet. **(Steps 4,5)** Alternative access networks are determined as well as the network selection criteria. In the simulation, we have considered that the set of network selection criteria is predefined and fixed, as well as the set of network alternatives. The considered decision criteria used in the decision-making process will be carefully described in section 4.3.1. **(Step 6)** *PrepareNetAttributes* is a procedure that prepares decision data in the form of a matrix called *decision matrix* considering Data Life Time (DLT) duration. The decision matrix is a matrix of values x_{ij} of the criteria of the different network alternatives, where i is the index of the alternative and j is that of the criterion. The DLT parameter per interface criterion is initialized by a random value at the beginning in **(Step 1)** and will be updated by the same procedure by taking into account the fluctuation of the interface statistics as well as its utilization rate. This will be detailed in section 4.3.2. **(Step 7)** The *rankIndex* method uses decision process which includes normalization of the decision data, the determination of criterion weight of current application (namely $P_{profile}$), as well as the ranking algorithm. These steps will be detailed in subsection 4.3.3.

Algorithm 4.4 Access technology selection algorithm.

Input: Application packets *Queue*.

Result: Target access interface for each application packet.

```

1 Initialize DLT
2 while Queue not empty do
3   Pop packet P from Queue
4   NetSet ← available network indexes
5   criteria ← networks attributes
6   DM ← PrepareNetAttributes(NetSet, DLT)
7   targetNet ← rankIndex(DM, Pprofile)
8   Assign P to targetNet
9 end

```

4.3.1 Decision criteria

In general, connecting an application to the best network means choosing the one that maximizes its throughput while minimizing delay and packet loss. In the present work, we focus on safety and traffic efficiency services where the broadcast mode is typically used to disseminate information. However, DICART framework could be applied without constraint to other types of applications with other decision criteria. In the broadcast context, it is pretty complicated to qualify the channel link due to the lack of ACK information. Thus, we consider as network performance criteria a throughput indicator, namely *available bandwidth*, and a delay indicator, namely *access layer delay*.

A. Available bandwidth

Denoted as (*AvBW*), Available bandwidth of a wireless link denotes the bandwidth a flow can use without disturbing the ongoing flow. We use the CBR as an indicator to estimate the available bandwidth [118]. Most C-ITS services use a broadcast mode which means that there is no feedback. Thus, one of the best ways to keep nodes aware of the channel state is to consider CBR in the available bandwidth calculation. This feature makes the CBR measurement one of the few indicators for nodes to be aware of the channel status. *AvBW* is given in equation (4.15).

$$AvBW = (1 - CBR) * datarate \quad (4.15)$$

Where *datarate* depends on the current modulation and coding scheme of the technology.

B. Access layer delay

Denoted as (*AD*), access layer delay is defined as the time elapsed between the instant the packet arrives at the decision module until it leaves the access layer for transmission (or its destruction if the transmission attempt fails). This delay, includes access and all queuing delays. In the present work, we particularly consider C-ITS delay-sensitive services which motivate our consideration of this delay as a decision criterion.

4.3.2 Data processing stage

In the data-processing stage, each criterion data is collected and processed based on steps described in algorithm 4.5 to update its DLT and to obtain the decision matrix.

Algorithm 4.5 Decision data processing algorithm.

Input: Available networks $NetSet$, network attributes $criteria$ and their respective DLT.

Result: Decision matrix DM and updated DLT.

```

1 for ( network  $n \in NetSet$  )
2   for ( criterion  $c \in criteria$  )
3      $V \leftarrow$  collected data in interval  $[t - DLT_{n,c}, t[$     $cv \leftarrow$ 
      coefficient of variation of  $V$     $DLT_{n,c} \leftarrow f(cv)$     $d \leftarrow$ 
       $EMA(V)$     $DM_{n,c} \leftarrow d$ 
4   do
5 do
6 return  $DM$ 
    
```

The following paragraphs detail the steps performed by algorithm 4.5 at time t of decision.

(Step 3) Criterion data-set of current network index is retrieved using its DLT duration to control the freshness of the data. These data are statistic samples recorded and time-stamped in background, either through data traffic or a periodic control traffic.

(Step 3) The coefficient of variation (cv) of the network criterion is calculated from its statistic samples to update its DLT duration. cv is a statistical measure defined as the relative variation to the mean of a given data [119].

(Step 3) f determines DLT based on the cv of the network criterion. The goal of this function is to reduce the DLT when the cv increases and to increase the DLT when the cv decreases as shown in Figure 4.5. The rational is to increase the update frequency of the decision matrix (by reducing DLT) in proportion to the instability of cv due to data fluctuation. And conversely, to reduce this frequency proportionally to the trend of data stability. Based on the above reasoning, f is a decreasing function of cv , which can be obtained using exponential modeling.

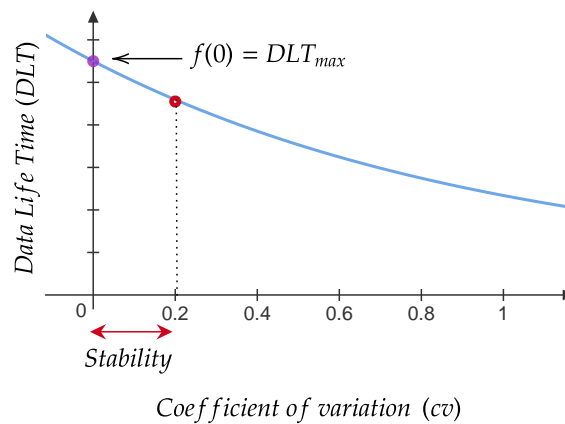

FIGURE 4.5: Data Life Time (DLT) function.

For stable values of cv ($cv \leq 0.2$), DLT values need to be close to the image of ($x = 0$). The following condition can be satisfied when f graph crosses the y-axes to form a y-intercept point denoted as $f(0)$ that systematically gives the maximum DLT

value denoted as DLT_{max} . $f(x)$ can be modeled as a parametric function depending on DLT_{max} as given in equation (4.16).

$$f(x) = e^{-x+\ln(DLT_{max})} \quad (4.16)$$

For each interface, decision statistics are collected according to the transmission it makes. Thus, equation (4.17) gives the relationship between DLT_{max} , the interface usage period τ , and statistic samples size γ . The value of γ should be controlled to avoid making decisions based on underestimated or overestimated data. Its actual value would depend on the expectation of the network criteria dynamics; for example, its value would tend to be small in a highly dynamic wireless environment such as vehicular ad-hoc networks.

$$\frac{DLT_{max}}{\tau} = \gamma \quad (4.17)$$

From (4.17) and (4.16) we derive eq. (4.18) as the DLT function.

$$f(x) = e^{-x+\ln(\gamma*\tau)} \quad (4.18)$$

(Step 3) EMA will then be applied to each selected criterion data-set to form the actual decision matrix. EMA is a moving average that places a greater weight and significance on the most recent data points. The EMA of a series of data denoted as Y is recursively calculated as given in equation (4.19).

$$S_t = \begin{cases} Y_1, & t = 1 \\ Y_t = \alpha Y_t + (1 - \alpha)S_{t-1}, & t > 1 \end{cases} \quad (4.19)$$

The coefficient α represents a smoothing constant between 0 and 1. A higher value of α allows faster discounting of older observations. Commonly, α is expressed by equation (4.20) to give the higher priority to the most recent value in the selected list of size N . A detailed proof of equation (4.20) is given in [120].

$$\alpha = \frac{2}{(N + 1)} \quad (4.20)$$

4.3.3 Decision making process

In the next parts, we will present how we formulate the RAT selection problem as an MCDM problem. We will discuss in detail MCDM steps such as normalization, weighting and ranking defined in section 3.4 of chapter 3, giving each time the rationales of methods for this proposal.

A. Normalization stage

We chose to use a variant of enhanced min-max normalization techniques which aims to eliminate the usage of absolute min-max values using equations (4.21) and (4.22). This technique allows for a greater distance between an alternative's normalized values so that the ranking order will be clearer. Also, it reduces occurrence probability of changes in ranking of the alternatives as a consequence, for example, of the addition or deletion of an alternative, commonly referred as RRP [101].

$$x_{ij} = \frac{l_j}{s_{ij}} \quad \text{If } j^{th} \text{ criterion is considered as "smaller-the-better"} \quad (4.21)$$

$$x_{ij} = \frac{S_{ij}}{u_j} \quad \text{If } j^{\text{th}} \text{ criterion is considered as "larger-the-better"} \quad (4.22)$$

where l_j and u_j are respectively the minimal and the maximal value of the j^{th} criterion of alternative i .

B. Weighting stage

In the present work, service profile is expressed taking into account network performance requirements related to each service. In this step, we propose a weight determination method based on pair wise comparison matrix.

Considering m service, we start by normalizing the performance requirements denoted as r associated to j^{th} criterion for s^{th} service using equation (4.23) [121]:

$$n_{sj} = \begin{cases} \frac{r_{sj}}{\sum_{s=1}^m r_{sj}} & \text{if the } j^{\text{th}} \text{ is considered as "the larger the better"} \\ \frac{1/r_{sj}}{\sum_{s=1}^m 1/r_{sj}} & \text{if the } j^{\text{th}} \text{ is considered as "the smaller the better"} \end{cases} \quad (4.23)$$

The normalization step of performance requirements is to remove dimensional units and compare each criterion's importance for a defined service s .

We then use the pair-wise comparison matrix method to obtain subjective weights since it is a robust mathematical tool [122] capable of assessing the relative importance of different criteria based on binary comparisons matrix A_s of $J \times J$ having the following form:

$$A_s = \begin{bmatrix} a_{11} & a_{12} & \cdots & a_{1J} \\ a_{21} & a_{22} & \cdots & a_{2J} \\ \vdots & \vdots & \ddots & \vdots \\ a_{J1} & a_{J2} & \cdots & a_{JJ} \end{bmatrix}, \text{ where } \begin{cases} a_{ii} = 1 \\ a_{ji} = \frac{1}{a_{ij}} \end{cases} \quad (4.24)$$

In (4.24), J represents the number of criteria. And the a_{ij} values such that, $1 < i < J, 1 < j < J$ and $j > i$, are the relative importance degree of criterion i compared to criterion j for a service profile s . a_{ij} is the order of relative importance deduced using the ratio between normalized performance requirements n_{sj} . The subjective weight, denoted by w_s , is then extracted using a set of linear equations deduced from the A_s matrix. The general form of the weight-vector w_s looks as follows:

$$w_s = [w_{AvBW} \quad w_{Delay}] \quad (4.25)$$

w_s should also verify the condition $\sum_i^J w_s(i) = 1$. We then obtain the effective weight w_s of a service profile s by solving the following system of linear equations in Eq. (4.26):

$$(A_s - I_J)w_s = 0 \quad (4.26)$$

where I_J is $J \times J$ identity matrix.

C. Ranking stage

We apply TOPSIS technique in determining the best network. As described in section 3.4.3, TOPSIS determines the best network based on its closeness to the positive ideal solution. TOPSIS is considered to be the selection of the alternative having the shortest Euclidean distance from the positive ideal solution denoted as D_i^+ and the farthest Euclidean distance from the negative ideal solution, namely D_i^- [123]. D_i^+ and D_i^- are

calculated in step 2 respectively using equations 4.29 and 4.30. Figure 4.6 shows the domain of alternatives as a Euclidean space where each alternative is represented as a point.

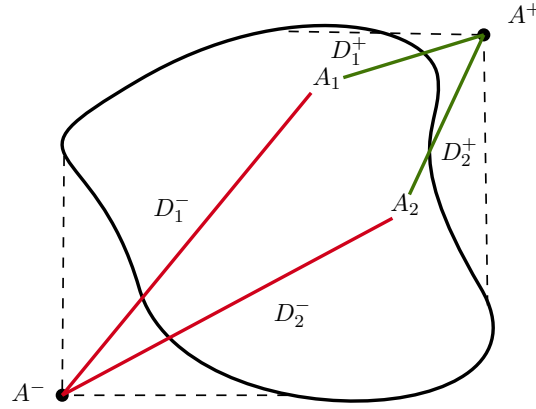

FIGURE 4.6: Alternatives as points in two dimensional space corresponding to criteria and their distances from positive-ideal A^+ and an negative-ideal A^- .

TOPSIS algorithm involves the following steps:

1. Determine the positive-ideal and negative-ideal solutions as shown in equations (4.27) and (4.28):

$$A^+ = \{v_1^+, \dots, v_n^+\} = \{(\max_j v_{ij} | j \in J'), (\min_i v_{ij} | j \in J'')\} \quad (4.27)$$

$$A^- = \{v_1^-, \dots, v_n^-\} = \{(\min_i v_{ij} | i \in J'), (\max_j v_{ij} | j \in J'')\} \quad (4.28)$$

Where J' is associated with benefit criteria, and J'' is associated with cost criteria.

2. Calculate the separation measures, using the n-dimensional Euclidean distance. The separation of each alternative from the ideal solution is given as:

$$D_i^+ = \sqrt{\sum_{j=1}^n (v_{ij} - v_j^+)^2}, \quad i = 1, \dots, I \quad (4.29)$$

Similarly, the separation from the negative-ideal solution is given as:

$$D_i^- = \sqrt{\sum_{j=1}^n (v_{ij} - v_j^-)^2}, \quad i = 1, \dots, I \quad (4.30)$$

3. Compute the relative closeness to the ideal solution. The relative closeness of alternative a_i with respect to A^+ is defined by C which is given in eq.(4.31):

$$C_i = \frac{D_i^-}{D_i^+ + D_i^-}, \quad i = 1, \dots, I \quad (4.31)$$

4. Rank the preference order. The best alternative corresponds to the index of the highest value of C .

4.4 Summary

In this chapter, we presented our contributions. We start by introducing algorithms for GLOSA, a C-ITS service among use cases of C-ROADS project. This work is achieved to conduct performance studies and investigations about its effectiveness. We aim to evaluate the impact of network communication state on the efficiency of this service.

Congestion control is a fundamental task to manage high-density situations considerably and thus provide better network performance. We proposed DRC, a data rate control mechanism allowing to switch to the adequate data rate to keep cbr levels at lower levels. To better support congestion control, we extended DRC to DRC/ATCL, making use of a linear message rate adaptation called LIMERIC. Our aim is to reduce congestion by adjusting data and message rates for improved data dissemination. The next chapter evaluates our proposal's performance, comparing it to different existing algorithms for congestion control.

Furthermore, meeting different C-ITS service requirements is not straightforward, and it requires a suitable RAT selection scheme. In this chapter, we also detailed our main contribution for network selection referred as to DICART which is based on an appropriate decision matrix and the efficient calculation of weight. According to our knowledge, few RAT schemes focused on the decision data-processing stage for the RAT selection problem, representing one of the decision processes' foundations elements. Indeed, the traffic history on which decision statistics are based should be controlled to avoid making decisions based on underestimated or overestimated data. A decision based on very ancient criteria data could lead to its underestimation. In contrast, a decision based on very recent data could lead to its overestimation, both resulting in undesirable or wrong decision-making.

This aspect led us to consider a data processing step based on the exponential moving average (EMA) calculation under a well-defined data lifetime interval for the collected data relating to each criterion for each network technology. Those steps are the key elements of an efficient ranking stage that decides on the best network interface.

Chapter 5

Evaluation scenarios and main findings

This chapter evaluates our contributions' performance using a comprehensive simulation environment, which allows for creating realistic C-ITS scenarios. In section 5.1, we present the simulation components by giving a brief insight into its main features. Section 5.2 shows scenarios and study results of GLOSA effectiveness using ITS-G5. In section 5.3, we evaluate the network performance of our data rate adaptation and congestion control proposals: DRC and DRC/ATCL. Section 5.4 describes conducted scenarios focusing on validating our RAT selection mechanism. Section 5.5 summarizes our main findings.

5.1 Simulation environment

Conducting Field Operational Tests (FOTs) for C-ITS is challenging due to cost and deployment issues as mentioned in chapter 1. As detailed in 1.5, we adopt a simulation-based evaluation to overcome FOTs challenges. In what follows, we present two kinds of simulation tools: mobility and network simulators.

5.1.1 Mobility simulator: SUMO

SUMO is a purely microscopic traffic simulator. Each vehicle is given explicitly, defined at least by an identifier (name), the departure time, and the vehicle's route through the road topology.

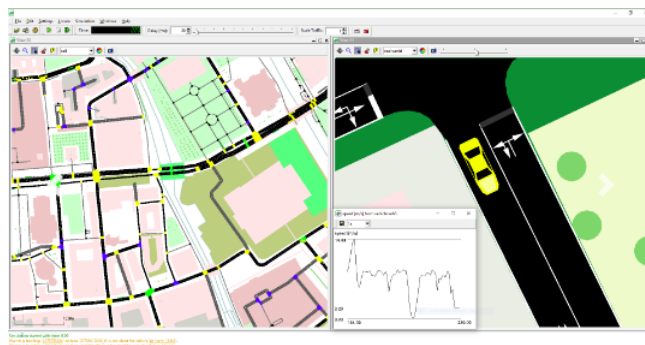

FIGURE 5.1: Illustration of SUMO simulation.

If wanted, each vehicle can be described more detailed. The departure and arrival properties, such as the road lane to use, the velocity, or the position can be defined. Each vehicle can get a type assigned which describes the vehicle's physical properties

and the variables of the used movement model. Each vehicle can also be assigned to one of the available pollutant or noise emission classes.

Additional variables allow the definition of the vehicle's appearance within the simulation's graphical user interface. The car-following model describes how the following vehicle reacts with the leader vehicle in the same lane. Krauss traffic model is the default car following model used in SUMO simulator. As shown in figure 5.1, SUMO supports importing a real map from OpenStreetMap (OSM), which is a valuable source for real-world map data. SUMO deploys tools such as "Netconvert", which enables to smoothly convert OSM files to SUMO road network topology in XML format.

5.1.2 Network simulator: OMNeT++

OMNeT++ is an object-oriented modular discrete event simulator. It is open-source, and it can be used either under the GNU (General Public License) or under its own license that also makes the software free for non-profit use. The motivation for developing OMNeT++ was to produce a comprehensive simulation tool, which can be used by academic, educational or research-oriented commercial institutions to simulate computer networks and distributed or parallel systems.

An OMNeT++ model consists of hierarchically nested modules. OMNeT++ simulations can feature different user interfaces for different purposes: debugging, demonstration and batch execution. Advanced user interfaces make the inside of the model visible to the users, allowing them to start/stop simulation execution and intervene by changing variables/objects inside the model. This feature is beneficial in the development/debugging phase of the simulation project. User interfaces also facilitate the demonstration of how a model works.

The simulator, including user interfaces and tools, is portable: they are known to work on Windows and several Unix flavors, using various C++ compilers.

A. INET framework

INET Framework [124] is an open-source communication networks simulation package for the OMNeT++ simulation environment. It includes different features and modules such as implementing OSI layers, transport protocols TCP and UDP followed by support of various protocols of wired and wireless links. INET is especially useful for designing and validating new protocols or exploring exotic scenarios. INET Framework builds upon OMNeT++ and uses the same concept: modules that communicate by message passing. OMNeT++ compound modules represent hosts, routers, switches and other network devices. These compound modules are assembled from simple modules that represent protocols, applications, and other functional units. A network is again an OMNeT++ compound module that contains host, router and other modules. The modules' external interfaces are described in NED (Network Description) files that explain the parameters and gates (i.e. ports or connectors) of modules and the sub-modules and connections of compound modules. INET supports different versions of 802.11 standards. It also gives a variety of different propagation and error models for the physical layer realistic modeling [125].

B. SimuLTE framework

SimuLTE is a simulation framework [126], enabling system-level performance-evaluation of LTE and LTE Advanced networks (e.g. 3GPP Release 8 and beyond). It is an open-source project built on top of OMNeT++ and INET framework. Indeed, SimuLTE

consider INET as an essential ingredient to build different LTE architectural components (e.g. eNB, UE, ..). Under this framework, the MAC layer supports different resource scheduling schemes. However, some aspects are not fully modeled. For example, symbols-level is not considered in the PHY layer, which does not affect the framework model at the operational side [127].

C. Artery framework

Artery framework is one of the existing frameworks providing an implementation that integrates European standardization ITS-G5 for vehicular communications. It exploits VEINS, INET and SimuLTE to offer the possibility of using a range of communication techniques mainly based on cellular and ad-hoc technologies [128]. Originally, Artery answers exactly these questions: running several applications per vehicle and facilitating the support of C-ITS European standards. Initially, Artery was just an extension of VEINS framework, which focused on IEEE Wireless Access in Vehicular Environments (WAVE) and supported only a single application type per simulation setup. Artery was then upgraded to support two options for modeling MAC and PHY layers. The first one is to use VEINS as the core of the protocol stack that specifically addresses US standards for C-ITS used in WAVE architecture. The second option is to employ INET framework for simulating the radio-related aspects (e.g. the wireless medium, the propagation models, and the transmitting and receiving Network Interface Cards (NICs)).

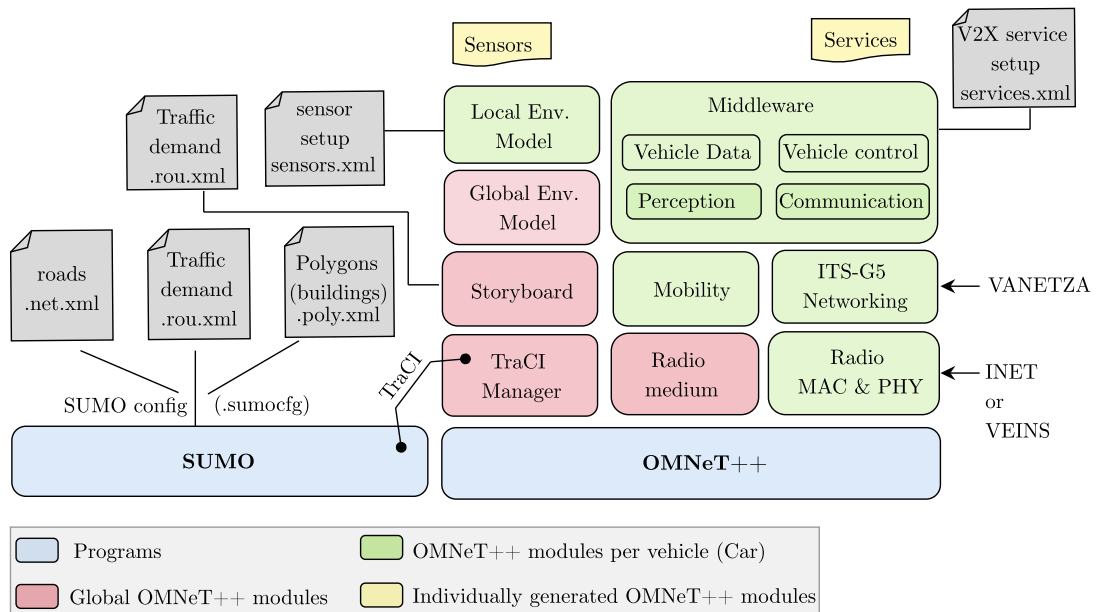

FIGURE 5.2: Simulation architecture

It is also possible to produce a coupled simulation between OMNeT++ and SUMO via Traffic Control Interface (TraCI) as shown in figure 5.2. "TraCI manager" is a global OMNeT++ module, which is responsible for launching the SUMO process and connecting to SUMO's TraCI via TCP. Artery enable to retrieve vehicle settings (e.g. the position, speed, heading, etc) via this TraCI connection for each SUMO simulation step. Compared to other existing frameworks, Artery has many advantages over C-ITS networks simulation according to European standards. Nevertheless, it does not fully meet our need to merely simulate a heterogeneous network architecture. This aspect

led us to develop HeteroSIM framework, which will be presented in the subsequent section.

D. HeteroSIM framework

The purpose of developing the HeteroSIM framework [129] is to facilitate the support of a heterogeneous C-ITS networks architecture and to be able to configure and upgrade nodes included in this architecture flexibly. HeteroSIM framework is mainly based on INET 3.x framework [130], and an extended version of SimuLTE to support LTE-V2X (mode 4) networks [131]. As shown in figure 5.3, a node can deploy one or more services under the upper layers middleware by configuring "numApps" parameter. The "Decider" module can be easily configured to use a traffic management policy for services deployed under the upper layers. A set of MCDM algorithms is available and can be used flexibly by modifying the "decisionPolicy" parameter. Random strategy and traffic distribution to a single interface according to the user's choice is also possible by configuring the "decider" module in a dummy state. The number of network interfaces can be flexibly configured using the "numRadios". These Network Interfaces Cards (NICs) are inherited from the INET and SimuLTE frameworks. "VanetNic" a VANET network interface card, is created based on INET's "Ieee80211Nic" module following the required adoptions:

- Enable ad-hoc communication by employing "Ieee80211MgmtAdhoc" management entity instead of infrastructure-based communication.
- Set the operating mode to "p" so that the associated modulation schemes are used.
- Adjust radio channel bandwidth to 10 MHz and carrier frequency to 5.9 GHz.

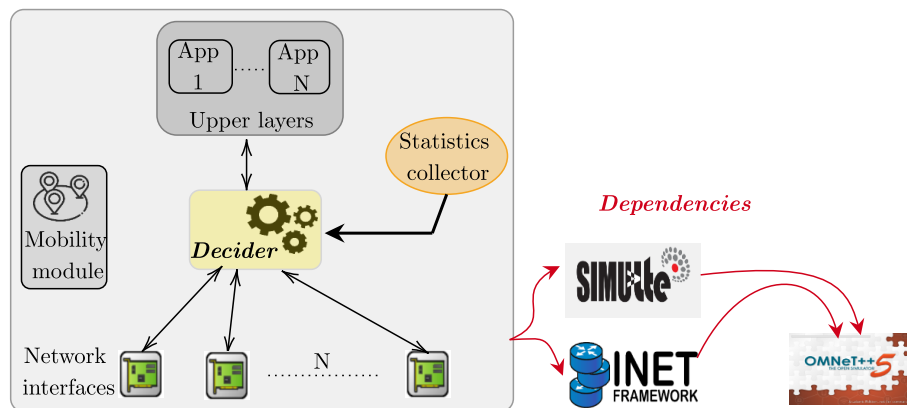

FIGURE 5.3: Deployment diagram of a network node in HeteroSIM framework.

Furthermore, "Statistics Collector" is a utility module developed to collect network statistics that the "Decider" module can easily exploit. HeteroSIM framework also supports mobility using the "Mobility" module of INET framework that offers a wide range of motions models. In vehicular networks, it is crucial to simulate mobility since the signal strength depends on the position and orientation of the transmitter and receiver nodes, which in turn decides the success of packet reception.

5.2 Performance evaluation of GLOSA with ITS-G5 communication technology

In this section, we used Artery framework (described in subsection 5.1.2) to simulate GLOSA service under a set of realistic scenarios. Our aim is to evaluate GLOSA performance under different traffic conditions and using different scenarios: small-scale, and large-scale. Thus, we measure the gain between equipped and non-equipped vehicles in terms of average stopping time behind a traffic light and fuel consumption. Average stopping duration is defined as the cumulative time a driver spends behind a traffic light while failing to catch up with the green light phase. Fuel consumption is measured using "PHEMlight Gasoline Euro 4" emission model proposed under SUMO mobility simulator.

5.2.1 Discussions on the effectiveness of GLOSA within a small-scale scenario

We simulate GLOSA algorithms under a realistic road section composed of five traffic lights where each traffic light is equipped with RSU implementing ITS-G5 network protocol stack. In this section, we focus on studying the impact of network state on SABIN-SS and SABIN-MS algorithms detailed in section 4.1. In this scenario, we assume that traffic lights are static (i.e., they change their phase at the same time), and their periodic cycle equals 60 seconds composed of three states: red (30 s), green (25 s), and amber (5 s). The communication range of both RSUs and vehicles is fixed to 900 m to coverage a maximum number of road users. Message generation is fixed to 2 Hz as recommended in ETSI specification [132]. Table 5.1 summarizes simulation scenario settings.

TABLE 5.1: Summary table of simulation settings.

Mobility-related	
Max speed (km/h)	50
Min speed (km/h)	20
Total Road length (km)	2.7
Network-related	
Communication range (m)	900
Message generation (Hz)	2
Bitrate of 802.11p (Mbps)	6

Figure 5.4 illustrates the gain in stop delay regarding traffic demand variation (from 200 veh/h to 1200 veh/h). In unsaturated conditions, we observe that the SABIN-SS achieves a 100% gain in stop delay for a traffic flow varying from 300 veh/h to 1000 veh/h against a value of 90% for a traffic flow between 300 and 600 veh/h performed by the SABIN-MS.

For a medium traffic flow between 600 veh/h and 800 veh/h, stop delay gain scales between 85% and 60%. In high traffic flow of about 1000 veh/h, stop time gain decreases for both approaches, but it influences SABIN-MS more than SABIN-SS, which achieves a respective gain of 15% and 62%. This significant difference is explained by the fact that the multi-segment approach's driving speed is lower than the simple-segment approach's driving speed. Consequently, with low speeds, high traffic densities are rapidly reached. This aspect is proved by the relationship between traffic density k , speed V and traffic demand Q ($k = \frac{Q}{V}$).

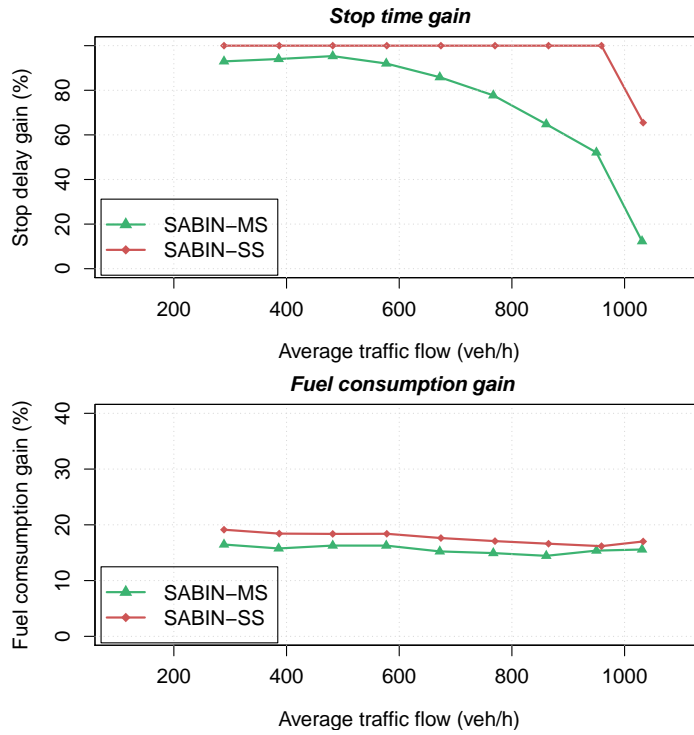

FIGURE 5.4: Impact of traffic density on GLOSA performance.

Results in figure 5.5 highlight the impact of activation distance on GLOSA service under a medium traffic flow of 600 veh/h. We assume that the service activation distance corresponds to the communication range.

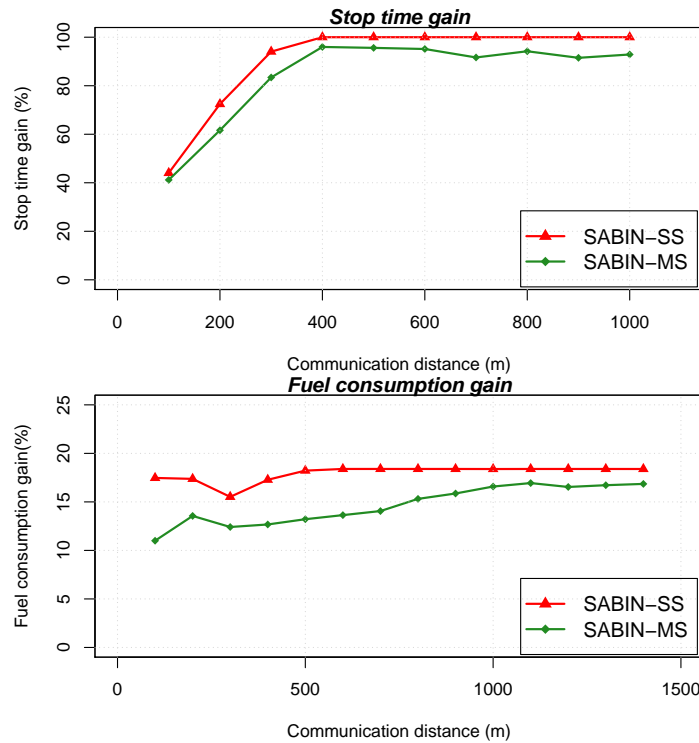

FIGURE 5.5: Impact of the activation distance on GLOSA.

Under these traffic conditions, we observe that stop delay gain of SABIN-SS and SABIN-MS reaches around 100% for a communication range greater than 400 m. This aspect can be explained by the fact that the speed regulation is closely related to traffic light distance. To sum up, selecting an optimal activation distance for GLOSA can be calculated for each intersection according to traffic light phases duration.

For our scenario, we note an optimal activation distance of about 400 m which is adequate for stop time minimization. In SABIN-SS, an optimal activation distance of about 500 m gives a maximum fuel consumption gain of about 18%.

However, the fuel consumption gain of SABIN-MS reaches its maximum value with an activation distance of about 1000 m. This is an expected result since the optimal speed adaptation when dealing with multiple segments requires a greater distance to allow for multiple light phases to reach the right sequence.

5.2.2 Evaluation of GLOSA algorithms under a large-scale scenario

A large scale scenario is also conducted for the sake of approving the efficiency of the proposed GLOSA algorithms detailed in section 4.1 of the previous chapter 4. We compare EPP-GLOSA to the following driving strategies: SABIN-SS, SABIN-MS, and Dijkstra road planning which consists of finding the fastest route based on creating a tree of fastest paths from the starting vertex, the source, to all other points in the weighted graph.

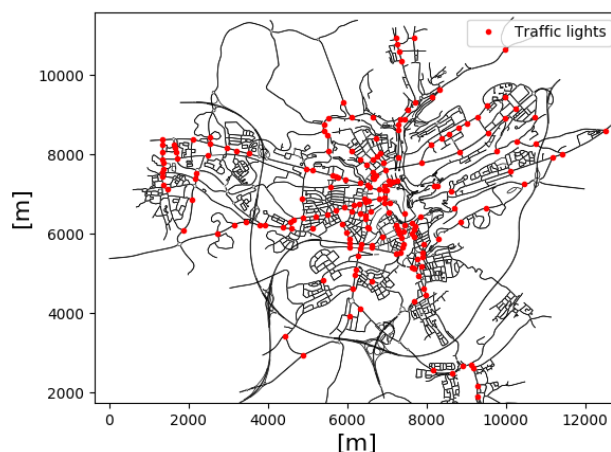

FIGURE 5.6: Simulation scenario of Luxembourg city.

We compare the performance of these driving strategies in terms of waiting time, travel time and fuel-saving gains over free-flow and rush hour conditions. We chose Luxembourg SUMO Traffic Scenario (LuST) scenario under SUMO traffic mobility simulator interacting with Traffic Control Interface (TraCI) from a python script. LuST scenario suits our needs for a realistic and pre-configured large scale scenario. It is specifically developed to support different use cases such as testing protocols and applications on different scales and on-board road planning system [109].

LuST is capable of providing different congestion levels controlled by adjusting adequate simulation time that corresponds to the time of the day which causes a variation in the traffic volume. Congestion level reaches its maximum in rush hours when traffic volume closely approaches the maximum capacity of the road network. LuST scenario also includes different road categories (e.g. residential, arterial and highway) as shown in figure 5.6. LuST uses Krauss a microscopic, space-continuous, car-following

model based on safe speed as shown in table 5.2. The simulation model makes use of a binomially distributed flow (which approximates a Poisson distribution for small probabilities).

TABLE 5.2: Scenario configuration.

LuST Topology configuration		Mobility configuration	
Total Area [km^2]	155.95	Driver imperfection	0.5
Total roads[km]	930.11	Acceleration [m/s^2]	[2.3, 2.4, 2.6, 2.8, 3]
Total highways [km]	88.79	Deceleration [m/s^2]	4.5
Number of traffic lights	203	Min and Max speeds [km/h]	20 and [30, 50, 70]
Traffic light type	Static	Emission class	PHEMlight

In this section, we suppose that communication network conditions using ITS-G5/IEEE 802.11p standard are sufficiently reliable for receiving the message about traffic light state through the infrastructure to vehicle (I2V) mode. We measure the gain in terms of waiting time behind traffic lights, the gain in total travel time and in fuel consumption. This is done under both free-flow and rush-hours conditions, and this for the following driving strategies described above: (i) Dijkstra road planning, (ii) SABIN-SS, (iii) SABIN-MS, and (iv) EPP-GLOSA. All these strategies are compared to default driving.

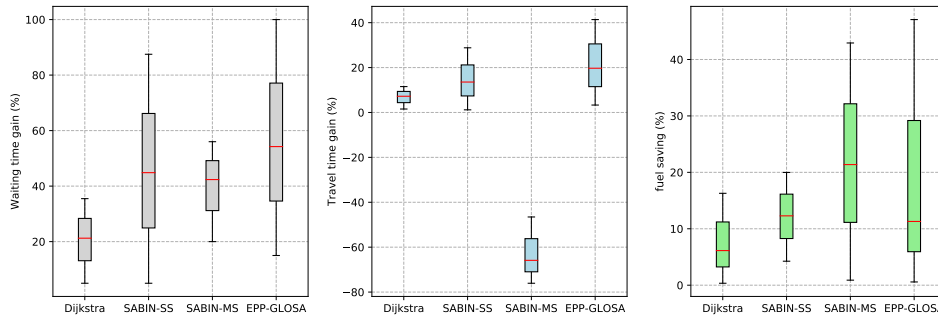

FIGURE 5.7: Performance evaluation of driving strategies in free-flow conditions.

In figure 5.7, results are shown for free-flow conditions. We observe that EPP-GLOSA achieves an average of waiting time gain of about 54%. With SABIN-SS and SABIN-MS, we reach more than 40% of waiting time gain compared to 20% using Dijkstra rerouting. With regard to trip travel time, EPP-GLOSA achieves a gain of around 20% compared to 13% and 7% respectively for SABIN-SS and Dijkstra. For SABIN-MS, travel time increases due to the fact that advisory speed in multi-segment approach is lower than advisory speed in simple-segment approach. EPP-GLOSA outperforms the other strategies mainly due to the effective cooperation between both speed advisory calculation and optimized route planning. In terms of percentage of fuel-saving per vehicle and per trip, EPP-GLOSA achieves about 11% of saving on average and a maximum level of fuel-saving that reaches 47.4%. SABIN-MS outperforms the other driving strategies in terms of fuel-saving to reach 21% compared to 6% and 12% achieved respectively by Dijkstra and SABIN-SS. This is due to the fact that the driver does not try to reach the maximum allowed speed, but rather keeps the speed as constant as possible during intersection crossing. Globally, SABIN-MS and SABIN-SS

outperforms EPP-GLOSA in terms of average fuel-saving mainly because EPP-GLOSA can choose longer routes compared to classical GLOSA strategies.

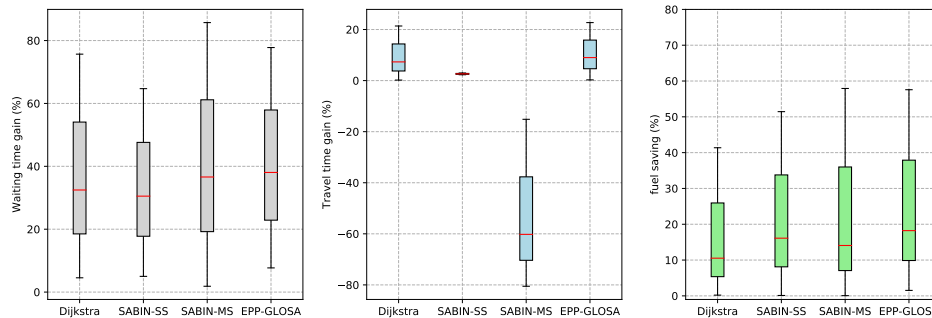

FIGURE 5.8: Performance evaluation of driving strategies in rush hour conditions.

Figure 5.8 shows performance evaluation in rush-hour conditions. We observe that waiting time gain decreases to values below 40% for all strategies. This fact is explained by the accumulated vehicle queues behind traffic intersections that cause a delay accumulation during peak hours. For EPP-GLOSA the average travel time gain decreases to values below 10%. this can be explained by the fact that vehicles spend more time stopped during peak hours. It is noticeable also that SABIN-MS achieve the worst result in terms of travel time. This is an expected result since this strategy will more often adopt a lower traveling speed than other strategies. In terms of fuel-saving, we observe that strategies with GLOSA information achieve better fuel savings. Globally, we can note that traffic congestion negatively influences all strategies which is mainly due to the fact that GLOSA does not take into account the queue of vehicles stopped at traffic lights.

5.3 Comparative evaluation on the efficiency of congestion control mechanisms in ITS-G5

In this section, we discuss the effectiveness of our proposal DRC and DRC/ATCL respectively detailed in sections 4.2.1 and 4.2.2 of chapter 4. Simulations are performed using Artery, a simulation toolkit that implements ETSI ITS-G5 as detailed in subsection 5.1.2. We use the INET option for the MAC and PHY layer models. In physical layer, the Two-Ray interference model is chosen since it is suitable for modeling signal propagation in the vehicular environment, as shown in [133]. We compare DRC/ATCL and DRC with the following standardized algorithms:

- Finite State Machine (FSM) is the standardized reactive version of DCC.
- LIMERIC is the basis of the adaptive approach of DCC.

FSM and LIMERIC are both based on transmit message rate control approach (TRC). These algorithms are the most used in literature since they are part of DCC specification [39].

5.3.1 Simulation scenario

We evaluate our congestion mechanisms in the context of an urban scenario. We considered a four-way intersection with realistic and equal traffic demand in each direction.

Message generation follows the Poisson process as it is simple and widely used stochastic process for modeling the time at which packets are generated and arrives to the lower layers. More details about simulation scenario settings are summarized in table 5.3.

Throughout this simulation scenario, we seek to evaluate the effectiveness of combining the Transmit Data Rate Control (TDC) and Transmit Message Rate Control (TRC) approaches in mitigating congestion for ITS-G5 ad-hoc technology. This goal led us to compare the following configurations:

- **"DRC/ATCL"**: Our adaptive congestion control proposal that combines data rate and message rate adaptation.
- **"6 Mbps/FSM"**: FSM reactive algorithm with a fixed data rate of 6 Mbps (the default data rate used in ITS-G5).
- **"24 Mbps/FSM"**: FSM reactive algorithm with a fixed data rate of 24 Mbps (the maximum available data rate).
- **"DRC/FSM"**: Our adaptive data rate control mechanism (DRC) with FSM.
- **"6 Mbps/LIMERIC"**: LIMERIC algorithm with a fixed data rate of 6 Mbps.

For this evaluation scenario, we measure the following network indicators:

- **Message rate** is defined as the average number of messages generated per second.
- **Channel load** is the percentage of time the radio channel is being busy.
- **End-to-End (E2E) packet delay** is the average time taken for a packet to be transmitted across the network from source to destination.
- **Packet Error Rate (PER)** which indicates the number of incorrectly received data packets.

TABLE 5.3: Simulation configuration parameters

Mobility-related	
Vehicle's speed (km/h)	30
Number of vehicles per direction	[40..140]
Network-related	
Time slot σ [μ s]	13
Contention Windows size W	1023
AC category	AC_{VO}
AIFS [μ s]	58
EIFS [μ s]	188
PHY header + preamble T_h [μ s]	40
Communication range (m)	450
Message size (bytes)	800

5.3.2 Simulation results

We note that "6Mbps/LIMERIC" provides the lowest message rate since it uses a fixed data rate of 6 Mbps while being compelled to converge to CBR values below a predefined target threshold. This is why it maintains the message rate between 15 Msg/sec and 11 Msg/sec as shown in figure 5.9. We observe that "6 Mbps/FSM", "24 Mbps/FSM", and "DRC/FSM" message rate graphs are superposed, keeping message rates constant at 16.7 Hz value which corresponds to the relaxed state as shown in table 2.5. This result can be explained by the FSM algorithm's reactive nature, which controls the message rate staidly based on a state machine composed of three states. The transition from one state to another depends on the fixed CBR thresholds defined in the ETSI specifications, as shown in table 2.5.

For 40 to 60 vehicles, "DRC/ATCL" gives the highest message rates since data rate adaptation contributes to decreasing transmission duration. Consequently, it allows to generate and transmit more messages. With "DRC/ATCL", message rate begins to become lower than that of "DRC/FSM" after reaching 80 vehicles per direction. Convergence of CBR to lower levels requires a shift to higher data rate levels, which affects the estimated message rate and forces some nodes to generate messages less frequently. "DRC/ATCL" generates an acceptable message since it is greater than 10 msg/sec, which is the mandatory minimum message rate for CAM messages [13].

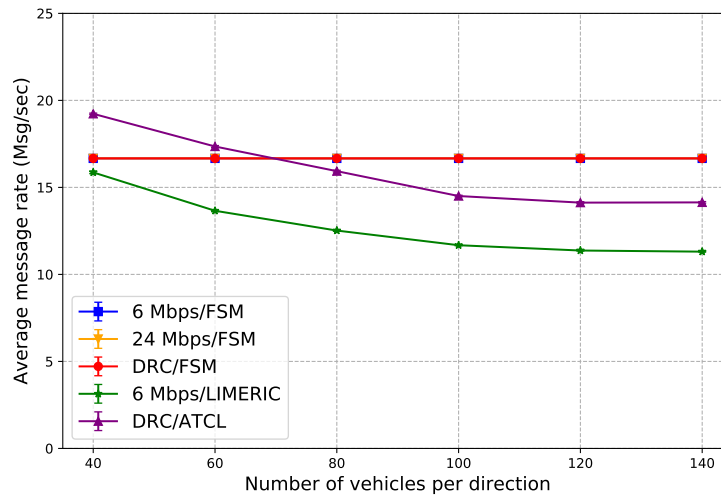

FIGURE 5.9: Average message rate measurements.

In figure 5.10, we compare CBR levels of different algorithms. We note that "DRC/ATCL" keeps lower levels of CBR and "6 Mbps/LIMERIC" maintains the value of CBR below a threshold of 68 %.

"6 Mbps/LIMERIC" provides the highest channel load due to its adaptive nature, which generates and transmits messages within a fixed CBR threshold. "DRC/ATCL" mechanisms pushes channel load to converge to an adaptive target CBR which changes according to data rate, number of vehicle's neighbors, and target PDR parameters. The reason that explains that both approaches keep lower levels of channel loads. "6 Mbps/FSM" gives higher CBR values than "24 Mbps/FSM" which is an expected result since this latter uses a higher data rate that reduces packet transmission duration.

In figure 5.11, we measure the end-to-end delay (E2E). With the "6 Mbps/FSM" and "DRC/FSM" mechanisms, we obtain the highest E2E delays respectively of about

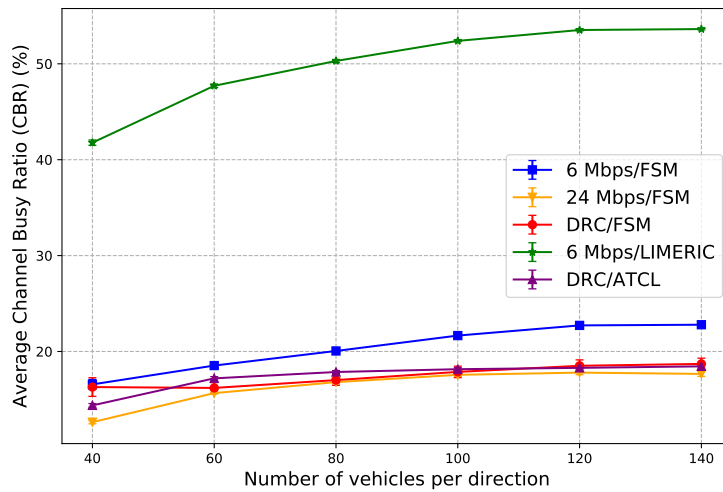

FIGURE 5.10: Channel load measurements.

120 ms and 90 ms. This result is expected, since with "6 Mbps/FSM" and "DRC/FSM", message generation is higher than "6 Mbps/LIMERIC" and "DRC/ATCL". So there is more competition for channel access, and therefore high access delays. "24 Mbps/FSM" generate the same amount of messages as "DRC/FSM" and "6 Mbps/FSM", but gives delays between 40 ms and 50 ms since messages are always sent with a data rate of 24 Mbps, which lead to lower transmission duration compared to mechanisms that uses a fixed data rate of 6 Mbps or an adaptive data rate control. "6 Mbps/LIMERIC" achieves an average E2E delay between 40 ms and 60 ms. "DRC/ATCL" gives a better E2E delay (between 29 ms and 34 ms according to figure 5.11) compared to "6 Mbps/LIMERIC", although it generates more messages than "6 Mbps/LIMERIC" (according to figure 5.9). But, unlike "6 Mbps/LIMERIC", it also adapts the data rate, resulting in shorter transmission duration and increased transmission opportunities.

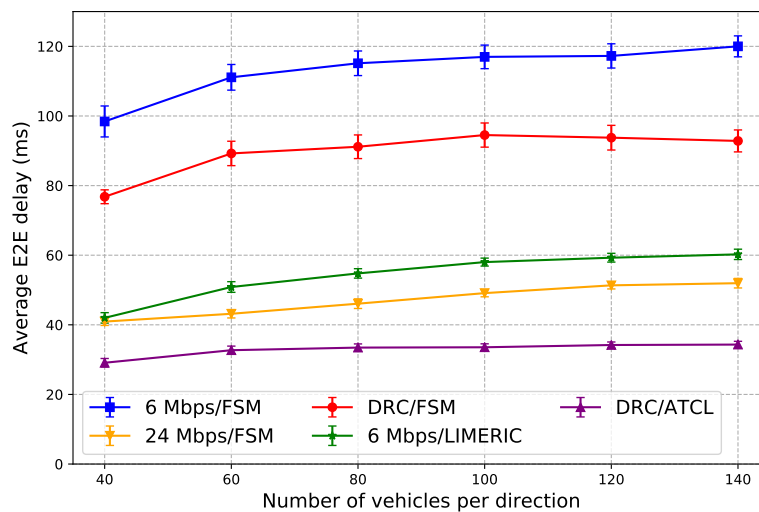

FIGURE 5.11: Average End-to-end delay measurements.

"DRC/ATCL" outperforms "24 Mbps/FSM" since it combines both techniques TRC and TDC to keep the network as stable as possible contrary to "24 Mbps/FSM" that uses only TRC according to reactive steady-state adaptation. On the one hand, "DRC/ATCL" increases the data rate allowing the transmission of a packet to take less time than the fixed data rate at 6 Mbps. On the other hand, the message rate is adapted to decrease collisions by re-programming the transmission according to channel conditions. Therefore, the transmission interval will vary according to CBR measurements that do not exceed a target channel load.

In figure 5.12, we measure Packet Error Rate (PER), which is a measure of reliability. The error model computes bit error rate (BER) from the Signal-to-Noise-plus-Interference-Ratio (SNIR). PER is computed from BER according to $PER = 1 - (1 - BER)^N$, where N denotes the number of bits in a packet.

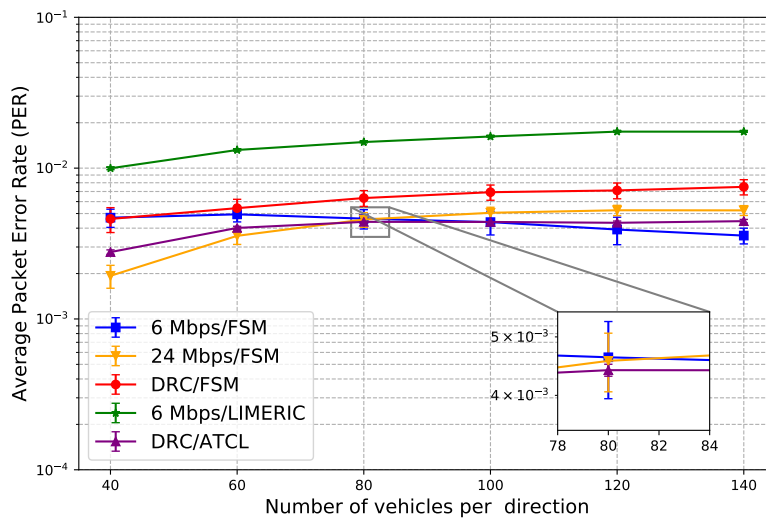

FIGURE 5.12: Packet Error Rate measurements.

Note that LIMERIC gives the highest value of PER around 10^{-3} . This aspect is explained by the high CBR measurements obtained with "6 Mbps/LIMERIC", which results in the highest collisions. For a number of vehicles between 40 and 60, "24 Mbps/FSM" slightly outperforms other techniques due to its reactive nature (i.e. it rapidly adapts the message rate using a look-up table rather than pushing the channel load to converge to an optimal target value). After 80 vehicles, "DRC/ATCL" slightly outperforms other methods since it keeps the CBR values below 20% as it dynamically controls congestion using both data rate and message rate adaptations.

The importance of congestion control approaches in enhancing dissemination performances has been discussed in this section. We carried out the validation process of our proposals using a realistic simulation setup to better evaluate its performance. Our findings showed enhancements made by DRC/ATCL in terms of end-to-end delay and packet error rate. Thus, throughout this evaluation, we proved that combining both techniques dealing with message sending rate and data rate adaptation, improves user satisfaction by reducing latency and enhancing channel capacity utilization.

5.4 Performance evaluation of DICART selection framework

In this section, we focus on the evaluation of DICART proposal. For that purpose, we use the HeteroSIM framework [129] detailed in section 5.1 to carry out a realistic scenario and merely implement a heterogeneous communication architecture to validate the effectiveness of such a mechanism.

In what follows, we present a brief description of some selected C-ITS services in the context of our validation process, highlighting their performance requirements in terms of delay and data rate in subsection 5.4.1. In subsection 5.4.2, we provide the numerical application of weighting stage detailed previously in subsection 4.3.3 of chapter 4. We then describe the simulation scenario in subsection 5.4.3.

5.4.1 Description of selected C-ITS services

For the present evaluation, we have considered some C-ITS road safety and efficiency services, namely Cooperative Collision Avoidance (CCA), Vulnerable Road Users (VRU), and Traffic Information (TI). The choice of these use cases is motivated by the fact that they require different performance in terms of delay and throughput, as they have different operational features which will be explained in the following paragraphs.

CCA is a road safety service included in cooperative collision avoidance class. It applies CAM or DENM to broadcast crash situations through direct V2V communication mode. This service is latency-sensitive since maximum end-to-end delay should be less than 10 ms. And it also requires a large bandwidth of about 10 Mbps as specified in release 15 [134]. It can be said that delay and throughput are equally relevant to the smooth functioning of this service.

VRU service is also included in the road safety category. Its role is to afford notifications to vehicles about the presence of vulnerable road users (,e.g. pedestrian or cyclist). For this service, the delay is more critical than bandwidth. The more speedily drivers receive the message, the faster they can react. Thus, accidents involving motorcyclists or passengers can easily be avoided.

TI traffic management service allows vehicles to be informed about some specific situations in the road (e.g. traffic jam). Decentralized Environmental Notifications Message (DENM) can trigger such events [135]. For this service, bandwidth has more meaning than delay. Indeed, TI is not a safety-critical service, and information delay does not have dangerous consequences on road safety, but it can affect driver comfort and road management efficiency. In road bottleneck situations, the information will be more useful if disseminated to as many vehicles as possible. For example, drivers will be informed by the TI service that they will be stuck in traffic jams at a given distance from their journey. Based on this notification, they can take a different route to avoid such a situation.

Table 5.4 summarizes the performance requirements in terms of end-to-end latency and data rate of the before-mentioned C-ITS services.

5.4.2 Subjective weights calculation for C-ITS services

The weighting stage specifically depends on the identified C-ITS use cases. The first step consists on normalizing the table of requirements 5.4 considering data rate and E2E latency network indicators respectively equivalent to the available bandwidth ($AvBW$) and access delay (AD) criteria defined in section 4.3.1.

Use cases	Communication mode	Data Rate per user (Kbps)	End-to-End Latency
Road safety			
Cooperative Collision Avoidance (CCA)	V2V	≤ 10000	≤ 10 ms
Vulnerable Road User (VRU)	V2P	≤ 10	≤ 1000 ms
Traffic efficiency			
Traffic Information (TI)	V2I	≤ 2000	≤ 500 ms

TABLE 5.4: Performance requirements of the selected C-ITS use cases [135] [134].

Table 5.5 is obtained by using a normalization step defined by equation 4.23 and applied to the table 5.4. It consists in dividing the value to be normalized by the sum of the other values of all the services corresponding to the same criterion. This step is essential to remove dimensional units and thus be able to compare each criterion's importance for a defined service s .

	n_{AvB}	n_{delay}
CCA	0.8326	0.9708
VRU	0.0008326	0.009708
TI	0.16652	0.01941

TABLE 5.5: Normalized performance requirements.

Table 5.6 is obtained by applying equations (4.24 - 4.26) to the table 5.5. The first column of table 5.6 deals with calculating the pairwise comparison matrix (or AHP matrix). Furthermore, the second column contains the weighting vector w_s after undergoing the algebraic transformation by solving a system of linear equations to extract the effective weight from the matrix A_s .

A_s	Weight vector w_s
$A_{CCA} = \begin{bmatrix} 1 & 0.8576 \\ 1.1660 & 1 \end{bmatrix}$	$w_{CCA} = \begin{bmatrix} 0.4616 \\ 0.5383 \end{bmatrix}$
$A_{VRU} = \begin{bmatrix} 1 & 0.0857 \\ 11.6601 & 1 \end{bmatrix}$	$w_{VRU} = \begin{bmatrix} 0.0789 \\ 0.9210 \end{bmatrix}$
$A_{TI} = \begin{bmatrix} 1 & 8.57618 \\ 0.116601 & 1 \end{bmatrix}$	$w_{TI} = \begin{bmatrix} 0.8955 \\ 0.1044 \end{bmatrix}$

TABLE 5.6: Weight vector obtained from pair wise matrix A_s .

5.4.3 Simulation scenario

We aim to assess the efficiency of our proposal under different traffic conditions, considering the before-mentioned C-ITS use cases. As shown in figure 5.13, we have considered two groups of nodes. The first group of nodes is called "Decision-makers", which are

nodes equipped with two interfaces, namely "interface 0" and "interface 1" and use DICART to choose one or the other interface for the same traffic, but with distinct criteria weights corresponding to the before-mentioned C-ITS use cases. The second group of nodes called "Dummy traffic generators" composed of standard nodes that run a dummy service sent over their "interface 0". These nodes operate under the same channel as "interface 0" of the "Decision-makers" group of nodes.

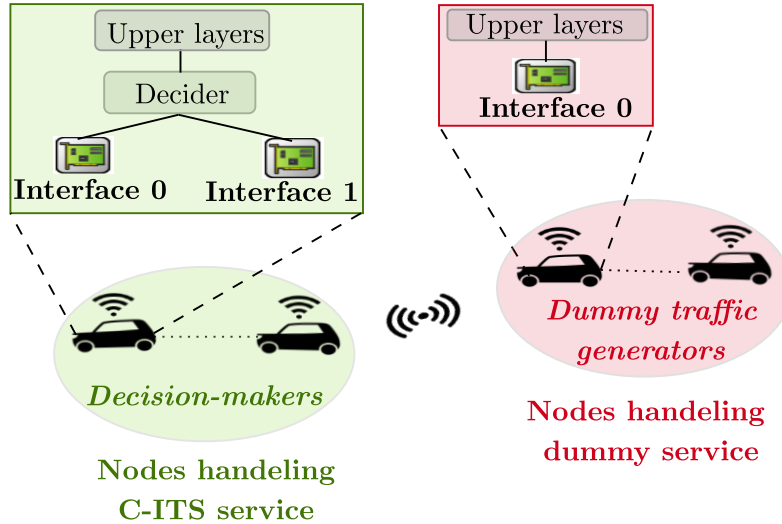

FIGURE 5.13: Illustration of the simulation scenario for DICART evaluation.

Thus, "Dummy traffic generators" send traffic (which is varied from 10% to 100% of the offered load on the shared channel) that acts as disruptive traffic for "Decision-makers" on their "interface 0".

Network performance of services of "Decision-makers" is evaluated in a scenario where the nodes use DICART and in another where they use a random selection mechanism, both depending on the disruptive traffic level of "Dummy traffic generators" group of nodes on their interfaces 0.

Random selection mechanism consists of network selection based on Bernoulli distribution (with $p = 0.5$) where a node chooses "interface 0" if it succeeds and chooses "interface 1" otherwise. Bernoulli distribution is a discrete probability distribution of a random variable that takes the value 1 with probability p and the value 0 with probability $q = 1 - p$. Less formally, it can be considered as a model for the set of possible outcomes of a single experiment that asks a yes/no question.

The choice of the Bernoulli-based random network selection mechanism as the baseline is motivated by the fact that the reviewed papers do not present any approach similar to DICART. Therefore, this choice of baseline could satisfy our need to evaluate DICART decisions against arbitrary decisions with equal probability on both interfaces (i.e. both interfaces have the same chance of being selected).

Table 5.7 summarizes additional simulation settings.

DICART is evaluated in a first scenario, namely *single-RAT* where "Decision-makers" nodes use two IEEE 802.11p interfaces on a distinct channel. Furthermore, DICART is assessed in a second scenario namely *multi-RAT* where "interface 0" of "Decision-makers" nodes uses IEEE 802.11p, and the other uses LTE-V2X (mode 4).

The choice of these scenarios is motivated by proving the effectiveness of DICART selection framework under a comprehensive evaluation and validation process. On

TABLE 5.7: Summary table of simulation settings.

Mobility-related	
Node's speed (km/h)	20
Road length (m)	500
Number of dummy service users	10
Number of decision-makers	20, 40, 80
Network-related	
Message size (Bytes)	204
Data message generation (Hz)	50
Control message generation (Hz)	2
Channel bandwidth (MHz)	10
Carrier frequency (GHz)	5.9
Bitrate of 802.11p (Mbps)	6
Bitrate of LTE-V2X (mode 4)	6.7
DICART-related	
γ	3

the one hand, the *single-RAT* scenario aims to validate the decision-making process independently of the encountered challenges when dealing with different network technologies. On the other hand, the *multi-RAT* scenario gives an idea of the expected network performance using DICART selection framework in a heterogeneous communication architecture that strongly depends on the network capacity of the technologies involved in this case study (i.e. IEEE 802.11p and LTE-V2X (mode4)).

For each of these scenarios, three densities of nodes are considered: Low density (20 "Decision-makers" nodes), Medium density (40 "Decision-makers" nodes), and High density (80 "Decision-makers" nodes). Considering the message generation rate per node (52 packets/second), the message size (204 bytes), and the technology's data rates (6 Mbps for IEEE 802.11 and 6.7 Mbps for LTE-V2X mode 4), 80 is approximately the number of "Decision-maker" nodes that maximizes the reception capacity offered by their two interfaces when the "Dummy traffic users" nodes generate also 100% of traffic.

The evaluation scenarios are somewhat pessimistic, as we considered a situation where one interface is overloaded for all vehicles at the same time. We are aware that in real life this will rarely happen. Nevertheless, these scenarios were chosen for the sake of validating the soundness of our decision mechanism. These scenarios are also beneficial because they allow us to push our proposal to show its shortcomings.

5.4.4 Simulation results

We measure the network performance of "Decision-makers" group of nodes using the following network indicators:

- **Effective application throughput:** It represents the success rate of message transmission over a communication channel. It is calculated based on the average of the received data divided by a time interval.
- **End-to-End (E2E) packet delay:** It refers to the time it takes for a packet to be transmitted over a network from source to destination. We collect the average E2E delay statistics at the application layer level based on the received packets' timestamps.

A. Single-RAT: Decision-makers with two IEEE 802.11p interfaces

Figure 5.14 show average throughput and E2E delay performance for the single-RAT scenario. Under low and medium densities, DICART outperforms random selection for different services. Indeed, DICART shows its benefits in terms E2E delay and throughput. For a low density, the random selection mechanism undergoes significant deterioration in throughput which is gradually reduced to values around 0.9 Mbps using a rate of disruptive traffic of 100%. However, using DICART, the application throughput maintain its value to 1.3 Mbps under all rate of disruptive traffic. The well-controlled interface ranking process in DICART can explain this result, which decides on the best interface based on well-defined criteria.

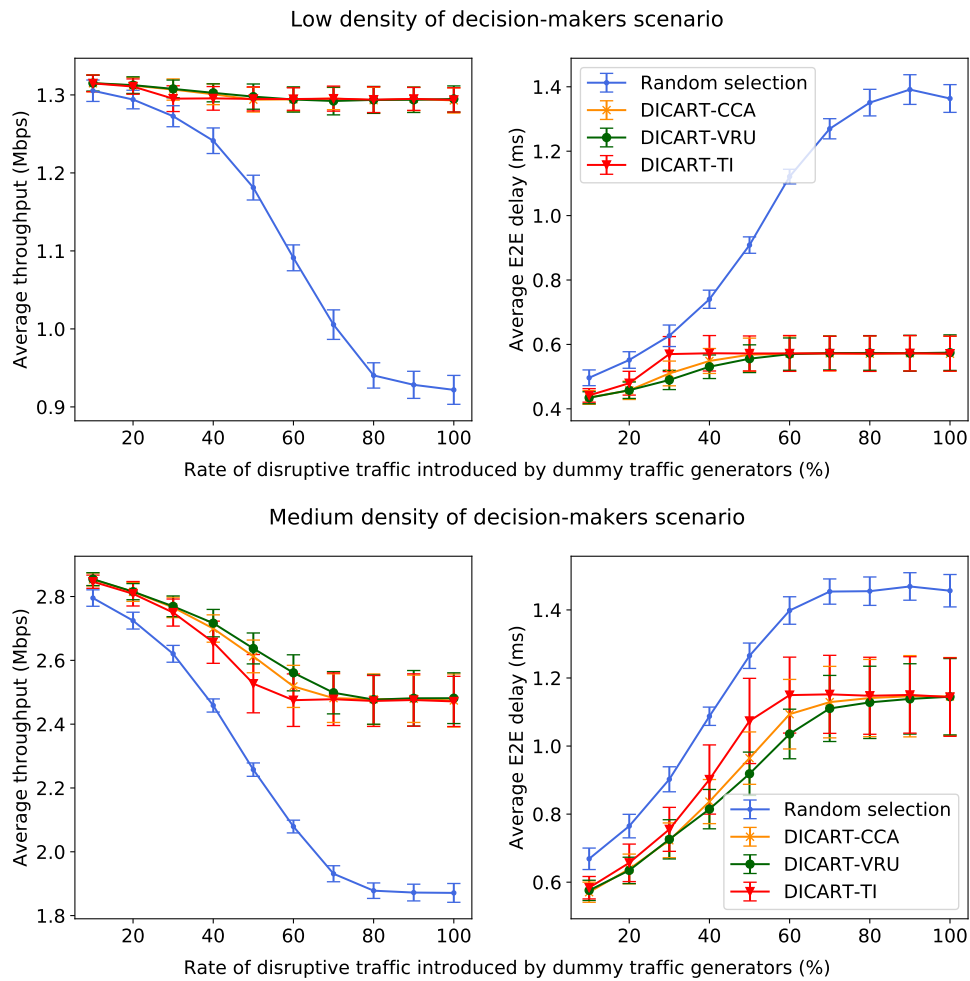

FIGURE 5.14: Average throughput and E2E delay for single-RAT scenario depending on disruptive traffic rate under low and medium traffic conditions.

However, as shown in figure 5.15, DICART shows its shortcomings in high traffic density case compared to the random selection. Under these conditions, most nodes favor choosing the interface that offers the best performance but resulting in consequent concurrent migration and rapid overloading of that interface. This does not happen with the random selection, which makes blind and different decisions leading to a kind of load balancing between interfaces and results in better performance by doing so.

Decision-makers using "DICART-TI" do not care about the delay but present a greedy behavior by gaining as much of the available bandwidth as possible. This

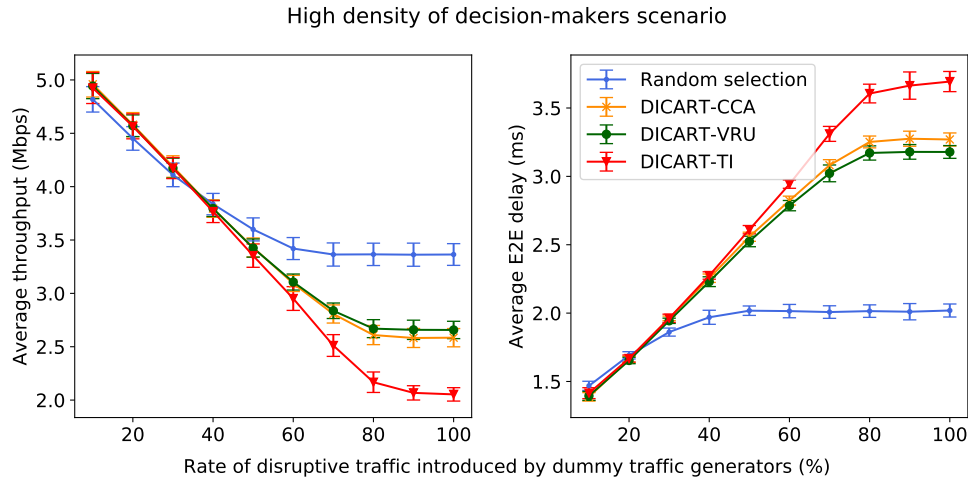

FIGURE 5.15: Average throughput and E2E delay for single-RAT scenario depending on disruptive traffic rate under high traffic conditions.

behavior makes all nodes switch to the less congested interface which in turn makes it congested. In high density cases with a high interference level, this aspect leads to more noticeable reception losses compared to decisions made based on favoring the access delay or equally both criteria, in which decision-makers are less greedy in exploiting the radio channel offering the best performance.

To sum up, in single-RAT scenario, DICART outperforms the baseline algorithm in low and medium density. However, in high density, DICART undergoes degradation in average E2E delay and throughput. This result mainly depends on IEEE 802.11 p technology, which has limitations in high-density scenarios.

B. Multi-RAT: Decision-makers with IEEE 802.11p and LTE-V2X (mode 4) interfaces

When using 2 different technologies, we note that "DICART-TI" outperforms the random selection in terms of throughput under the three different traffic conditions but each time with a longer delay (see figures 5.16, 5.17, and 5.18).

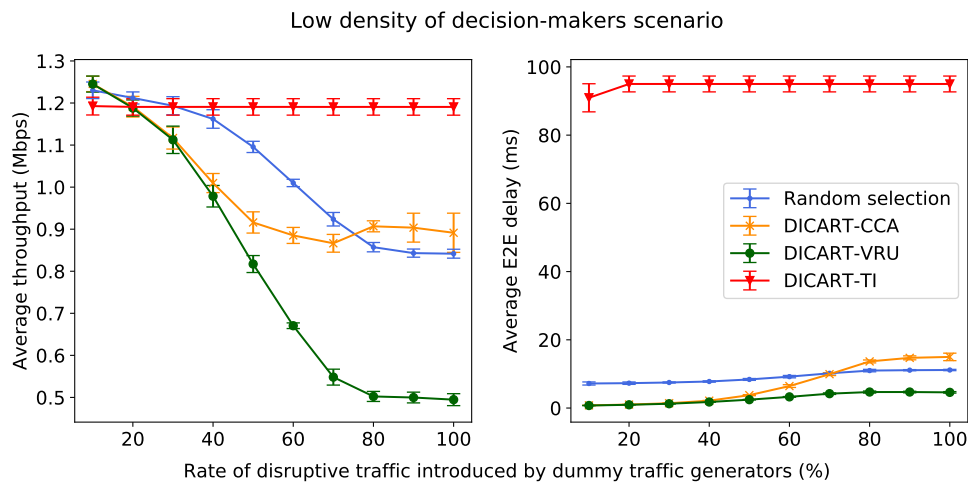

FIGURE 5.16: Average throughput and E2E delay for multi-RAT scenario depending on disruptive traffic rate under low traffic conditions.

This result is explained by the fact that "DICART-TI" favors the throughput metric in the decision and mainly chooses LTE-V2X (mode 4) since it has a higher available bandwidth compared to 802.11p. But, contrary to IEEE 802.11p, the considered throughput performance metric is not correlated with one of the delay in LTE-V2X (mode 4); the gain in throughput is obtained due to the fact that parallel transmissions can occur through different sub-channels, but the inter-packet delay, which is the resource reservation interval is on average 50 ms [46].

We note that "DICART-VRU" outperforms the random selection in terms of delay under the three different traffic (see figures 5.16, 5.17, and 5.18)) conditions but each time with a lower throughput. This is explained by the fact that, as opposed to "DICART-TI", "DICART-VRU" favors more the delay criterion in the decision and mainly chooses the IEEE 802.11p interface having a worst-case delay more than 10 times less (3.5 ms according to figure 5.18 in high density scenario) than the average delay in LTE-V2X (mode 4). However, the throughput performance is lower because the traffic is not well disseminated by the IEEE 802.11p interface compared to LTE-V2X notably due to collisions under high traffic load.

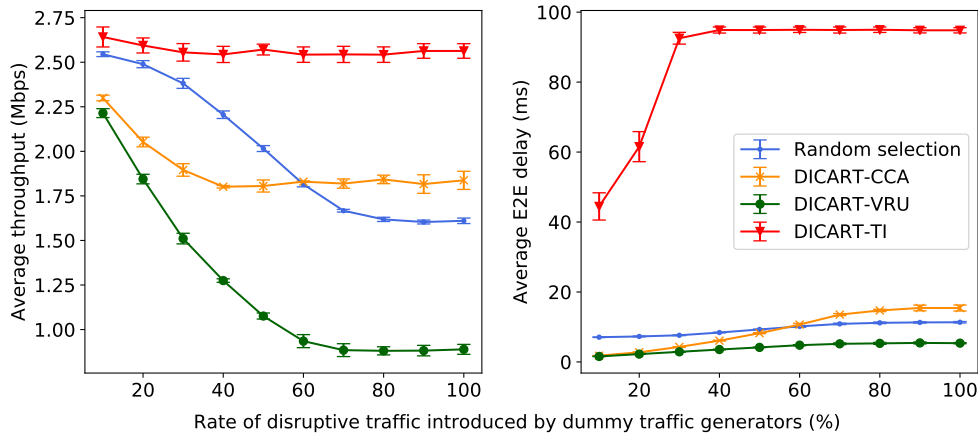

FIGURE 5.17: Average throughput and E2E delay for multi-RAT scenario depending on disruptive traffic rate under medium traffic conditions.

It is to be noted that the throughput performance of "DICART-VRU" in the single-RAT scenario is lower than that of the multi-RAT (e.g. with high node density) because, the traffic of the "Decision-maker" is better distributed between the two IEEE 802.11p interfaces in the single-RAT scenario since they offer similar delay performance. Consequently, this reduces the probability of losses (e.g. due to collisions) compared to the multi-RAT scenario where the traffic is almost exclusively sent over the single IEEE 802.11 interface.

Unlike "DICART-TI" and "DICART-VRU", with "DICART-CCA" the delay and throughput metrics are both favored in the decision, so nodes choose both IEEE 802.11p (having usually the best delay) and LTE-V2X (mode 4) (having usually the best throughput) interfaces. That is the reason each time (whether it is low, medium, or high node density) the delay performance is better than the random choice (mainly because of the IEEE 802.11p choice), the throughput performance is lower. And conversely, each time the throughput performance is better than the random choice (mainly due to the LTE-V2X (mode 4) choice), the delay performance is worse.

In our simulated evaluation scenarios, DICART shows its benefits in achieving better end-user satisfaction according to user profiles (i.e. weighted criterion) for three

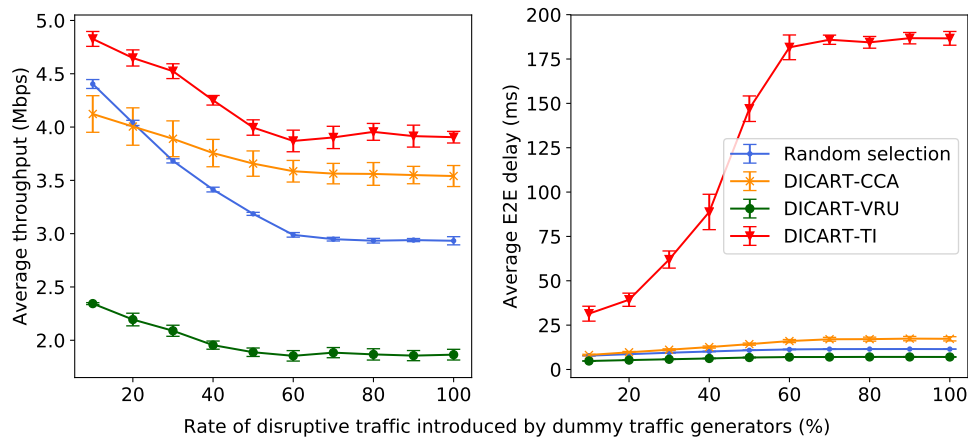

FIGURE 5.18: Average throughput and E2E delay for multi-RAT scenario depending on disruptive traffic rate under high traffic conditions.

diversified evaluated services. However, DICART trade-offs compared to baseline algorithms are performance reduction of the less-favored metrics. In addition, DICART overloads the network with background traffic in order to obtain more accurate channel estimations. The study on the impact of this overhead and its reduction will be studied in our future work.

5.5 Summary

This chapter has defined several evaluation scenarios for each of our contributions to approve our proposals and discuss their effectiveness under different conditions. We have defined scenarios for investigating the performance of GLOSA service within the ITS-G5 communication infrastructure. We have carried out small and large scale scenarios to study this service under the most realistic conditions. GLOSA shows its limits in terms of saving fuel consumption and stopping time behind the traffic light in case of high traffic density. Using the SABIN-MS algorithm, we have retained from this study an optimal activation distance of 1000 m for fuel savings. For the SABIN-SS, it has been shown that an optimal activation distance of about 500 m allowed to save up to 18% of the fuel consumption.

As previously mentioned, ITS-G5 technology suffers from congestion problems that may lead to a rapid overload in case of high traffic density. On this subject, we have proposed a DRC and DRC/ATCL, which allow preserving a more or less stable CBR level, that in turns can promise fewer collisions and, therefore, guarantees lower latency. We compared DRC and DRC/ATCL with existing algorithms under a realistic four-way scenario. Results show that DRC/ATCL gives better latency performance than FSM/24Mbps as it is able to keep the network state as stable as possible. In the last part of this chapter, we focused on the performance evaluation of DICART in a heterogeneous architecture composed of ITS-G5 and LTE-V2X technologies retained in the C-ROADS project. Managing coexistence and RAT selection are challenging for these heterogeneous architectures since it relies on decision data and decision algorithms.

We first evaluated our proposal under a "single-RAT" scenario (i.e. decision-maker nodes with two 802.11p interfaces) to smoothly validate the decision process, regardless of the difference in network performance that two different technologies may offer.

In a follow-up step, we studied DICART in a "multi-RAT" scenario (i.e. decision-maker nodes with IEEE 802.11p and LTE-V2X interfaces) to investigate its efficiency under a heterogeneous communication architecture. Our conclusions show significant improvements in packet end-to-end delay and application throughput in medium and low traffic density cases.

In the single-RAT scenario, DICART selection framework provides an E2E delay of no more than about 0.5 ms in low density and about 1 ms in medium traffic density compared to 1.5 ms using random selection. As for application throughput, DICART achieves values around 2.5 Mbps in medium traffic density compared to 1.8 Mbps using random selection.

In the multi-RAT scenario, we note that "DICART-TI" outperforms random selection under all three traffic densities (low, medium and high) but each time with a longer delay. We explain this result by the fact that "DICART-TI" favors the available bandwidth criterion, and we observed that "DICART-TI" frequently selects LTE-V2X (mode 4) since it has higher available bandwidth than IEEE 802.11p. In LTE-V2X (mode 4), better throughput performance is obtained due to the parallel transmissions that may occur over different sub-channels. However, the E2E delay can exceed 100 ms because it depends on the resource reservation interval, which is, on average, 50 ms. Contrary to "DICART-TI", "DICART-VRU" favors the access delay criterion. "DICART-VRU" gives lower E2E delay than random selection in all three traffic densities. This result is due to the frequent selection of the IEEE 802.11p, whose worst-case delay is approximately ten times lower than the average E2E delay of the LTE-V2X (mode 4) technology. However, the throughput performance of "DICART-VRU" is low compared to random selection, mainly due to the inefficient dissemination of data through the IEEE 802.11p interface, which suffers from numerous collisions during high traffic loads. The considerable gap in network performance between IEEE 802.11p and LTE-V2X (mode 4) may have undesirable consequences on the less weighted criterion's performance.

Chapter 6

Conclusion and perspectives

Mobility management of road users is becoming one of the crucial concerns for stakeholders and industrial automakers. The alarming increase in the number of fatalities resulting from road accidents caused by inefficient road management has pushed these different actors to invest in the research and development of C-ITS. These systems promote smart and eco-friendly mobility for better road management. Communication techniques dedicated to C-ITS have become a necessary player in developing and supporting such systems.

QoS demand for C-ITS services is also witnessing considerable growth since new advanced driving use cases will be evolved in the next few years, including autonomous driving, remote driving, and platooning services. Efficient communication techniques are required to handle such services, ensuring their proper functioning.

In this thesis, we highlighted some issues and challenges encountered by C-ITS network technologies. This chapter concludes the present work by reminding the addressed problems, summarizing our contributions, and highlighting some future directions.

6.1 Accomplished goals

The work that has been accomplished under the scope of this thesis will be summarized in the present section.

6.1.1 Study on the effectiveness of GLOSA under ITS-G5 technology

Under the C-ROADS project, we focused on studying GLOSA, one of the C-ITS services that allows smart driving assistance by giving advisory speeds to catch the green phase, enhancing driver comfort and reducing environmental side effects of driving. We studied GLOSA performance under small and large scale scenarios. We have introduced three algorithms for GLOSA, namely SABIN-SS (single segment approach), SABIN-MS (multiple segment approach) and EPP-GLOSA (GLOSA with fastest route planning). To evaluate GLOSA efficiency, we measured the average gain in stopping time behind traffic lights and fuel consumption as performance indicators.

Under the small scale scenarios, for high traffic conditions, the gain in stopping time decreases for both approaches (SABIN-SS and SABIN-MS), but it influences more SABIN-MS than SABIN-SS. The significant difference is explained by the fact that the SABIN-MS driving speed, which is lower than that of the single-segment approach leading to a rapid traffic jam. We studied the impact of activation distance (i.e. communication range) on GLOSA performance. In the studied scenario, we noted an optimal activation distance of about 400 m adequate for stopping time minimization. We also noticed an optimal activation distance of about 500 m giving the maximum fuel consumption gain for SABIN-SS. For SABIN-MS, fuel economy optimization reaches its maximum with an activation distance of 1000 m. This significant difference between

SABIN-MS and SABIN-SS in terms of optimal activation distance is due to the speed adaptation regarding multiple segments requiring higher coverage, allowing the driver to catch a maximum number of green phases and keep speed as constant as possible.

We also conducted a large scale simulation scenario where we compared different driving strategies of GLOSA in free-flow and rush-hour conditions. In free-flow conditions, findings show that the EPP-GLOSA algorithm offers better path planning than the other strategies with a balanced proportion of fuel consumption and trip travel time. The proposed algorithm presents its limitation in peak hours, where the gain in waiting time and travel time decrease. In this study, we assumed that information from traffic lights was available when needed. This information might not be entirely accurate in a real-life deployment since it might not be obtained when needed. We also considered that all advisory speeds were fully respected by drivers, which is only possible in autonomous driving mode and may be subject to further assessment in the case of human driving mode. To sum up, in a high traffic density context, GLOSA's strategies quickly show a deterioration in its performance.

6.1.2 Study of congestion control mechanisms for ITS-G5

Network congestion is one of the challenges facing C-ITS. These systems are considered as the cornerstone of future mobility, requiring efficient communication networks to better meet latency and reliability requirements.

The European Telecommunications Standards Institute (ETSI) has defined a mandatory cross-layer within ITS stations, called Decentralized Congestion Control (DCC), as a congestion mitigation technique for ITS-G5 technology. In an attempt to enhance DCC, we proposed two mechanisms, namely Data Rate Control (DRC) and Data Rate Control with Adaptive Traffic Control based on LIMERIC (DRC/ATCL). This contribution aims to guarantee efficient channel resource utilization by keeping channel load as minimum as possible through data rate and message rate adaptation techniques. The overall idea is to control data and message rates based on a proactive calculation of CBR thresholds. Thus, the switch to a different data or message rate is triggered depending on the channel status.

Using Artery framework, a comprehensive simulation setup for ITS-G5, we conducted our evaluation scenario under realistic traffic conditions. In this scenario, we compared our proposal with existing algorithms namely, FSM (the reactive standardized version of DCC) and LIMERIC (an adaptive linear message control approach widely used in literature).

Throughout the evaluation scenario, we show that DRC/ATCL gives better results regarding the end-to-end delay and CBR measurements. DRC/ATCL also offers an acceptable message rate that allows the node to be sufficiently informed of what is happening in its surroundings.

The applicability of adaptive traffic generation in the context of C-ITS can be further discussed for safety-critical services that require high context awareness, more frequent and timely information about what is happening to nearby vehicles. The mechanisms of our proposal are mostly dedicated to non safety-critical C-ITS services. Our mechanisms can be upgraded to support critical-safety service by imposing a minimum message rate to be respected.

6.1.3 Network selection management in a heterogeneous C-ITS communication architecture

The number of road users in C-ITS architecture, along with the traffic demands, is growing exponentially. Therefore, a single Radio Access Technology (RAT) wireless resources might not be sufficient to meet this increase in traffic demand. Heterogeneous architectures may be a promising solution for ubiquitous communication, offering the opportunity to exploit different network technologies' co-existence. RAT selection is one of the problems that has been addressed in this thesis. Managing network selection relies on decision criteria and the decision-making algorithm. Indeed, we answered some questions dealing with the decision maker's location and the steps of the decision algorithm. We then proposed DICART, a distributed (or user-centric) and context-aware selection framework based on multiple criteria decision-making (MCDM). We carefully defined rationales for different MCDM stages (i.e., decision criteria matrix definition, normalization, weighting, and ranking steps). Under this framework, we particularly focused on broadcast awareness traffic. To validate this proposal, we have defined a scenario considering C-ITS services favoring either delay (VRU) or throughput (TI) or demanding equal requirements in terms of delay and throughput (CCA).

In this scenario, we have envisaged a situation where one interface of the decision-maker nodes is disrupted by other standard nodes that do not make decisions. Under these conditions, we compared DICART with a random selection mechanism.

To validate the decision-making process, we first evaluated DICART in the context of a single RAT scenario (i.e. decision-maker nodes with two IEEE 802.11p interfaces). We then carried out a multi-RAT scenario (i.e. decision-maker nodes with IEEE 802.11p and LTE-V2X (mode 4) interfaces) to examine its effectiveness in handling network selection within a heterogeneous communication architecture.

For each of these scenarios, we considered three densities of decision-maker nodes (low, medium and high). At low and medium densities, DICART outperforms the baseline selection algorithm in Single-RAT in terms of E2E packet delay and application throughput. However, in high traffic density, DICART show some limitations under the single-RAT scenario. This point needs further investigation as the evaluated Single-RAT scenario depends mainly on the performance of the IEEE 802.11p network, which has deficiencies in high density scenarios.

For the multi-RAT scenario, DICART framework shows its benefits in achieving better end-user performances according to user profile (i.e. more weighted criterion) for all evaluated services. However, DICART presents two trade-offs compared to baseline algorithm. On the one hand, the performance reduction of metrics less user-preferred. On the other hand, the continued use of background traffic for an accurate decision matrix. These points need further investigations in our future work.

6.2 Future directions

The contributions of this thesis can be extended in several directions. In what follows we enumerate two of them.

6.2.1 Emerging technologies for C-ITS networks: IEEE 802.11bd and NR-V2X

In the present work, we mainly focused on IEEE 802.11p and LTE-V2X since these technologies were retained in the C-ROADS project. Furthermore, these technologies'

specifications were entirely available and ready to be studied at the starting time of this PhD. Nowadays, a new generation of communication networks for C-ITS is available.

It is shown in this thesis and in other studies that IEEE 802.11p and LTE-V2X can reliably support safety services requiring an end-to-end latency of approximately 100 ms as long as the vehicle density is not very high [46]. However, since the QoS requirements of V2X use cases are becoming more stringent, which is the case in many advanced V2X services [136], the two current V2X RATs [136] are not up to the desired performances. To reduce the performance gap between IEEE 802.11p and LTE-V2X, support additional operating modes and increase offered throughput, a new study group called IEEE 802.11 Next Generation V2X was created in March 2018 [137]. This led to the development of IEEE 802.11 Next Generation V2X referred to as 802.11bd (TGbd) working group, in January 2019. In counterpart, 3GPP developed New Radio (NR) called NR-V2X in his Release 16 based on the 5G NR, which is standardized in 3GPP Rel.15 [136]. NR-V2X is expected to support advanced driving services requiring higher QoS than those that LTE-V2X can support. Some of these services require an end-to-end latency that does not exceed 3 ms and reliability of 99.99% [11]. These restrictive requirements make the design of 802.11bd and NR-V2X extremely challenging.

Concerning their design objectives, 802.11bd and NR-V2X have some similarities. For example, both evolutionary RATs are mainly designed to improve the reliability of offered services and reduce end-to-end latency. However, their design methodologies are quite different.

The Task Group bd requires that 802.11bd must be backwards compatible with 802.11p. This constraint implies that 802.11bd and 802.11p devices must communicate while operating on the same channel. IEEE 802.11bd must support several features to coexist with IEEE 802.11p. Indeed, IEEE 802.11p devices must be capable of decoding (at least one mode of) transmissions from 802.11bd devices, and vice-versa. Moreover, 802.11bd must be able to detect 802.11p transmissions and defer channel access and vice-versa. Also, IEEE 802.11bd design should maintain fairness (i.e. in co-channel scenarios, 802.11bd and 802.11p devices must get equal channel access opportunities).

On the other hand, 3GPP does not impose a "co-channel scenario" constraint on NR-V2X. Vehicles equipped with NR-V2X can always communicate with LTE-V2X devices. However, this can be achieved by a double radio system (i.e. a radio for LTE-V2X and another one for NR-V2X). Thus, NR-V2X is promoted to coexist with LTE-V2X in non co-channel scenarios where LTE-V2X and NR-V2X operate in different channels.

IEEE 802.11bd and NR-V2X technologies need further examinations to prove their ability in sustaining advanced V2X services such as remote driving and vehicle platooning.

6.2.2 Possible upgrades for DICART selection framework

In DICART selection framework, we have adopted a user-centric approach without any network infrastructure assistance. We then used the CBR metric as an indicator of channel status awareness. However, this can be limited in some situations since we are not entirely aware of the other nodes' real-time decisions. Consequently, it may lead to some nodes' greedy behavior that can excessively exploit the interface offering the best performance, engendering unfair resource sharing regarding the other nodes. This aspect also can lead to the rapid overload of that interface. In what follows, we highlight some points of DICART that are subject to further improvements in our future work:

- To better support single-RAT scenario, DICART can be enhanced by adopting a semi-collaborative (or opportunistic) approach. As opposed to the user-centric

approach, opportunistic RAT selection can exploit infrastructure availability to enhance the decision-making process. The decider can enhance decision accuracy by having a global vision of the other nodes' decisions. This aspect could improve the performance of DICART in a high traffic density scenario by defining a load balancing policy to reduce the greedy behavior of some nodes and establish fair resource sharing.

- We note that DICART mainly uses decision data collected locally, which does not give a very accurate network state vision. DICART also uses background traffic to be informed frequently about the changes of decision data. This aspect can contribute to network overload and create undesired congestion. Thus, decision-data matrix accuracy can also be improved using infrastructure instead of background traffic, enabling a better decision-making process.
- In the present work, we specifically targeted broadcast traffic. As a result, there are no acknowledgment (ACK) messages, making it challenging to qualify reception losses accurately. As a potential extension, we will target unicast traffic where new decision criteria will be supported to accurately measure packet loss and better manage the decision process.
- In our future work, DICART framework can be evaluated using other technologies and under complex scenarios where many services may co-exist, as is usually the case in real life.

Appendix A

Modeling channel utilization using queuing theory

We chose to model each vehicle as a M/G/1 queue system because it is close to our situation where we suppose that packets arrival follows Poisson law. And the service time have a general distribution. Thus, it gives a general solution for the average number of packets in the queue. The channel utilization is given by equation (6.1).

$$R_s = \lambda E[T] \quad (6.1)$$

Where $E[T]$ presents the total service time given by equation (6.2).

$$E[T] = T_s + W \quad (6.2)$$

Where W is the waiting time in the queue. The mean length of the M/G/1 queue is given by *Pollazcek-Khintichine* [112] formula in equation (6.3) as follows:

$$L_q = \frac{\lambda^2 \sigma_s^2 + \rho^2}{2(1 - \rho)} \quad (6.3)$$

Where ρ is the queue utilization, and σ_s is the variance of service time. The queue utilization ρ is given by equation 6.4

$$\rho = \lambda T_s \quad (6.4)$$

It is assumed that $\sigma_s \rightarrow 0$, thus obtaining a simplified equation of L_q as follows :

$$L_q = \frac{\rho^2}{2(1 - \rho)} \quad (6.5)$$

By applying **Little's law**, we obtain the waiting time in the queue equation as follows:

$$W = \frac{L_q}{\lambda} \quad (6.6)$$

Equation (6.6) in (6.5) gives expression (6.7).

$$W = \frac{\rho^2}{2\lambda(1 - \rho)} \quad (6.7)$$

So the channel utilization expression is given, by equation (6.8):

$$R_s = \lambda T_s + \frac{(\lambda T_s)^2}{2(1 - \lambda T_s)} \quad (6.8)$$

Publications

Contributions of this thesis have been published in an international journal article and in several international peer-reviewed conferences.

International journal paper

- [23] Mouna Karoui, Gérard Chalhoub, and Antonio Freitas. “An efficient path planning GLOSA-based approach over large scale and realistic traffic scenario”. In: *Internet Technology Letters*, Wiley (2020).

International conference papers

- [22] Mouna Karoui, Antonio Freitas, and Gerard Chalhoub. “Performance comparison between LTE-V2X and ITS-G5 under realistic urban scenarios”. In: *2020 IEEE 91st Vehicular Technology Conference (VTC2020-Spring)*. IEEE, 2020, pp. 1–7.
- [24] Mouna Karoui, Gérard Chalhoub, and Antonio Freitas. “A study of congestion control approaches for vehicular communications using ITS-G5”. In: *2020 IEEE 31st Annual International Symposium on Personal, Indoor and Mobile Radio Communications (PIMRC)*. IEEE, pp. 1–7.
- [107] Mouna Karoui, Antonio Freitas, and Gérard Chalhoub. “Efficiency of Speed Advisory Boundary fINder (SABIN) strategy for GLOSA using ITS-G5”. In: *The 7th IFIP/IEEE International Conference on Performance Evaluation and Modeling in Wired and Wireless Networks*. 2018.
- [108] Mouna Karoui, Antonio Freitas, and Gérard Chalhoub. “Comparative evaluation study of GLOSA approaches under realistic scenario conditions”. In: *International Conference on Ad-Hoc Networks and Wireless (AdHoc-NOW)*. Springer, 2019, pp. 407–419.

Bibliography

- [1] Marc Green and John Senders. “Human error in road accidents”. In: *Visual Expert* (2004).
- [2] FP6-IST Information Society Technologies. *GST: Global System for Telematics enabling On-line Safety Services*. URL: http://cordis.europa.eu/project/rcn/71449_en.html.
- [3] European commission. *Cooperative Vehicle-infrastructure System*. URL: [\url{http://cordis.europa.eu/project/rcn/79316_en.html}](http://cordis.europa.eu/project/rcn/79316_en.html).
- [4] European commission. *Cooperative vehicles and road infrastructure for road safety*. URL: http://cordis.europa.eu/news/rcn/31165_en.html.
- [5] Fabien Bonnefoi et al. “SAFESPOT: Applications for Infrastructure-based Cooperative Road Safety”. In: *14th World Congress and Exhibition on Intelligent Transport Systems and Services*. Beijing, China, Oct. 2007. URL: <https://hal.archives-ouvertes.fr/hal-01334863>.
- [6] French industrial, public stakeholders, and the European Commission. *SCOOP: Cooperative Intelligent Transportation Systems Pilot Deployment Project*. URL: <http://www.scoop.developpement-durable.gouv.fr/>.
- [7] European (7th RTD Framework Program). *DRIVE C2X: DRIVing implementation and Evaluation of C2X communication technology in Europe*. URL: <https://trimis.ec.europa.eu/project/drive-c2x-driving-implementation-and-evaluation-c2x-communication-technology-europe>.
- [8] European commission. *C-Roads France: a C-ITS pilot deployment project*. URL: <https://www.c-roads.eu/pilots/core-members/france/Partner/project/show/c-roads-france.html>.
- [9] *Report on Legal and Organisational Structures for C-ITS Operation*. 2018. URL: https://www.c-roads.eu/fileadmin/user_upload/media/Dokumente/Report_on_legal_structures_for_C-ITS_operation_v1_Final.pdf.
- [10] Yvonne Barnard and Oliver Carsten. “Field Operational Tests: challenges and methods”. In: *Proceedings of European Conference on Human Centred Design for Intelligent Transport Systems*, Eds edn. HUMANIST publications, Lyon. 2010, pp. 323–332.
- [11] *3GPP TR 22.186 V15.0.0: Service requirements for enhanced V2X scenarios (Release 15)*, 3GPP Std. March 2017.
- [12] Mate Boban et al. “Connected roads of the future: Use cases, requirements, and design considerations for vehicle-to-everything communications”. In: *IEEE vehicular technology magazine* 13.3 (2018), pp. 110–123.
- [13] *ETSI TS 102 637-2 V1.1.1, Intelligent Transport Systems (ITS); Vehicular Communications; Basic Set of Applications; Part 2: Specification of Cooperative Awareness Basic Service*. April, 2010.

- [14] *Dedicated Short Range Communications (DSRC) Message Set Dictionary; SAE Std J2735. Technical report, SAE International, DSRC Committee.* November 2009.
- [15] *Intelligent Transport Systems (ITS); European profile standard for the physical and medium access control layer of Intelligent Transport Systems operating in the 5 GHz frequency band, ETSI.* 2009.
- [16] *Federal Communications Commission. FCC 99-305. FCC Report and order. Tech rep.* 1999.
- [17] Andreas Festag. “Cooperative intelligent transport systems standards in Europe”. In: *IEEE communications magazine* 52.12 (2014), pp. 166–172.
- [18] *ACEA Position Paper Frequency bands for V2X.* 2018.
- [19] *Coexistence of C-V2X and ITS-G5 at 5.9GHz.* 2018.
- [20] Ali Mamadou Mamadou, Joel Toussaint, and Gerard Chalhoub. “Survey on wireless networks coexistence: resource sharing in the 5G era”. In: *Mobile Networks and Applications* (2020). DOI: [10.1007/s11036-020-01564-w](https://doi.org/10.1007/s11036-020-01564-w). URL: <https://doi.org/10.1007/s11036-020-01564-w>.
- [21] *3GPP TR 22.886 V16.1.1; Technical Specification Group Services and System Aspects; Study on enhancement of 3GPP Support for 5G V2X Services (Release 16).* Septembre 2018.
- [22] Mouna Karoui, Antonio Freitas, and Gerard Chalhoub. “Performance comparison between LTE-V2X and ITS-G5 under realistic urban scenarios”. In: *2020 IEEE 91st Vehicular Technology Conference (VTC2020-Spring)*. IEEE, 2020, pp. 1–7.
- [23] Mouna Karoui, Gérard Chalhoub, and Antonio Freitas. “An efficient path planning GLOSA-based approach over large scale and realistic traffic scenario”. In: *Internet Technology Letters, Wiley* (2020).
- [24] Mouna Karoui, Gérard Chalhoub, and Antonio Freitas. “A study of congestion control approaches for vehicular communications using ITS-G5”. In: *2020 IEEE 31st Annual International Symposium on Personal, Indoor and Mobile Radio Communications (PIMRC)*. IEEE, pp. 1–7.
- [25] Hans-Joachim Fischer. “Standardization and harmonization activities towards a global C-ITS”. In: *Vehicular ad hoc Networks*. Springer, 2015, pp. 23–36.
- [26] Sana Ajmal et al. “Classification of VANET MAC, Routing and Approaches A Detailed Survey.” In: *J. UCS* 20.4 (2014), pp. 462–487.
- [27] Claudia Campolo, Antonella Molinaro, and Riccardo Scopigno. “From today’s VANETs to tomorrow’s planning and the bets for the day after”. In: *Vehicular Communications* 2.3 (2015), pp. 158–171.
- [28] Roberto Baldessari et al. “Car-2-car communication consortium-manifesto”. In: (2007).
- [29] ISO TC204 WG16. *ISO 21217: 2010: Intelligent transport systems-Communications access for land mobiles (CALM)-Architecture.* 2010.
- [30] Botte Marilisa, Pariota Luigi, Bifulco Gennaro Nicola, et al. “C-ITS communication: an insight on the current research activities in the European Union”. In: *International Journal of Transportation Systems* 3 (2018).

- [31] Erik G Ström. “On medium access and physical layer standards for cooperative intelligent transport systems in Europe”. In: *Proceedings of the IEEE* 99.7 (2011), pp. 1183–1188.
- [32] Andreas Festag. “Cooperative intelligent transport systems standards in Europe”. In: *IEEE Communications Magazine* (2014). ISSN: 01636804. DOI: [10.1109/MCOM.2014.6979970](https://doi.org/10.1109/MCOM.2014.6979970).
- [33] *Intelligent Transport Systems (ITS); Access layer specification for Intelligent Transport Systems operating in the 5 GHz frequency band*. 2012-11. URL: https://www.etsi.org/deliver/etsi_en/302600_302699/302663/01.02.00_20/en_302663v010200a.pdf.
- [34] *ETSI TS 102 687 V1.1.1 (2011-07) Technical Specification Intelligent Transport Systems (ITS); Decentralized Congestion Control Mechanisms for Intelligent Transport Systems operating in the 5 GHz range; Access layer part*. 2011-07. URL: https://www.etsi.org/deliver/etsi_ts/102600_102699/102687/01.01.01_60/ts_102687v010101p.pdf.
- [35] Daniel Jiang, Qi Chen, and Luca Delgrossi. “Optimal data rate selection for vehicle safety communications”. In: *Proceedings of the fifth ACM international workshop on VehiculAr Inter-NETworking*. ACM. 2008, pp. 30–38.
- [36] ETSI. *ETSI TS 102 724 V1.1.1 (2012-10) Intelligent Transport Systems (ITS); Harmonized Channel Specifications for Intelligent Transport Systems operating in the 5 GHz frequency band*. 2012. URL: https://www.etsi.org/deliver/etsi_ts/102700_102799/102724/01.01.01_60/ts_102724v010101p.pdf.
- [37] Irfan Khan and Jérôme Härri. “Integration challenges of facilities-layer DCC for heterogeneous V2X services”. In: *2018 IEEE Intelligent Vehicles Symposium (IV)*. IEEE. 2018, pp. 1131–1136. URL: <http://www.eurecom.fr/fr/publication/5541/download/comsys-publi-5541.pdf>.
- [38] *ETSI TS 103 175 V1.1.1 Intelligent Transport Systems (ITS); Cross Layer DCC Management Entity for operation in the ITS G5A and ITS G5B medium*. 2015-06. URL: https://www.etsi.org/deliver/etsi_ts/103100_103199/103175/01.01.01_60/ts_103175v010101p.pdf.
- [39] *ETSI TS 102 687 V1.2.1; Intelligent Transport Systems (ITS); Decentralized Congestion Control Mechanisms for Intelligent Transport Systems operating in the 5 GHz range; Access layer part*. 2018-04. URL: https://www.etsi.org/deliver/etsi_ts/102600_102699/102687/01.02.01_60/ts_102687v010201p.pdf.
- [40] Xuyu Wang, Shiwen Mao, and Michelle X Gong. “An Overview of 3GPP Cellular Vehicle-to-Everything Standards”. In: *GetMobile: Mobile Computing and Communications* 21.3 (2017), pp. 19–25.
- [41] Vladimir Vukadinovic et al. “3GPP C-V2X and IEEE 802.11 p for Vehicle-to-Vehicle communications in highway platooning scenarios”. In: *Ad Hoc Networks* 74 (2018), pp. 17–29.
- [42] European Automobile Manufacturers Association (ACEA). “Frequency bands for V2X”. In: 7 (2018). URL: <https://www.acea.be/publications/article/position-paper-frequency-bands-for-v2x>.
- [43] Giovanni Nardini et al. “Cellular-V2X Communications for Platooning: Design and Evaluation”. In: *Sensors* 18.5 (2018), p. 1527.

- [44] 3 GPP TS 36.213 v15.2.0 3GPP Technical Specification Group Radio Access Network; Evolved Universal Terrestrial Radio Access (E-UTRA); Physical layer procedures (Tech. Rep.) Release 15. 2018-06.
- [45] Amr Nabil et al. "Performance analysis of sensing-based semi-persistent scheduling in C-V2X networks". In: *2018 IEEE 88th Vehicular Technology Conference (VTC-Fall)*. IEEE. 2018, pp. 1–5.
- [46] Rafael Molina-Masegosa and Javier Gozalvez. "LTE-V for sidelink 5G V2X vehicular communications: A new 5G technology for short-range vehicle-to-everything communications". In: *IEEE Vehicular Technology Magazine* 12.4 (2017), pp. 30–39.
- [47] TS 36.300 Evolved Universal Terrestrial Radio Access (E-UTRA) 3GPP and Evolved Universal Terrestrial Radio Access Network (E-UTRAN); Overall description; Stage 2 (v14.3.0) Release 14) (Tech. Rep.) 2017-06.
- [48] TS 36.213 Evolved Universal Terrestrial Radio Access (E-UTRA); Physical layer procedures (v14.3.0) Release 14) (Tech. Rep.) 3GPP. 2017-06.
- [49] Tech. Rep. TS 36.321 Evolved Universal Terrestrial Radio Access (E-UTRA); Medium Access Control (MAC) protocol specification (v14.3.0 Release 14). 2017-06.
- [50] Release 14) (Tech. Rep.) 3GPP TS 36.331 Evolved Universal Terrestrial Radio Access (E-UTRA); Radio Resource Control (RRC); Protocol specification (v14.3.0. 2017-07.
- [51] Khadige Abboud, Hassan Aboubakr Omar, and Weihua Zhuang. "Interworking of DSRC and cellular network technologies for V2X communications: A survey". In: *IEEE transactions on vehicular technology* 65.12 (2016), pp. 9457–9470.
- [52] Christian Hoymann et al. "LTE release 14 outlook". In: *IEEE Communications Magazine* 54.6 (2016), pp. 44–49.
- [53] Marko Höyhty, Olli Apilo, and Mika Lasanen. "Review of latest advances in 3GPP standardization: D2D communication in 5G systems and its energy consumption models". In: *Future Internet* 10.1 (2018), p. 3.
- [54] Kan Zheng et al. "Heterogeneous vehicular networking: A survey on architecture, challenges, and solutions". In: *IEEE communications surveys & tutorials* 17.4 (2015), pp. 2377–2396.
- [55] Valerian Mannoni et al. "A Comparison of the V2X Communication Systems: ITS-G5 and C-V2X". In: *2019 IEEE 89th Vehicular Technology Conference (VTC2019-Spring)*. IEEE. 2019, pp. 1–5.
- [56] Marcin Sredynski, Bernabe Dorronsoro, and Djamel Khadraoui. "Comparison of Green Light Optimal Speed Advisory approaches". In: *Intelligent Transportation Systems-(ITSC), 2013 16th International IEEE Conference on*. IEEE. 2013, pp. 2187–2192.
- [57] Mahdi Sharara, Marc Ibrahim, and Gerard Chalhoub. "Impact of Network Performance on GLOSA". In: *2019 16th IEEE Annual Consumer Communications & Networking Conference (CCNC)*. IEEE. 2019, pp. 1–6.
- [58] David Eckhoff, Bastian Halmos, and Reinhard German. "Potentials and limitations of Green Light Optimal Speed Advisory systems". In: *Vehicular Networking Conference (VNC), 2013 IEEE*. IEEE. 2013, pp. 103–110.

- [59] Marie-Ange Lebre et al. “Real scenario and simulations on GLOSA traffic light system for reduced CO2 emissions, waiting time and travel time”. In: *arXiv preprint arXiv:1506.01965* (2015).
- [60] Konstantinos Katsaros et al. “Performance study of a Green Light Optimized Speed Advisory (GLOSA) application using an integrated cooperative ITS simulation platform”. In: *Wireless Communications and Mobile Computing Conference (IWCMC), 2011 7th International*. IEEE. 2011, pp. 918–923.
- [61] Ronald T Van Katwijk and Sabine Gabriel. “Optimising a vehicle’s approach towards an adaptively controlled intersection”. In: *IET Intelligent Transport Systems* 9.5 (2015), pp. 479–487.
- [62] Simon Stebbins et al. “Characterising Green Light Optimal Speed Advisory trajectories for platoon-based optimisation”. In: *Transportation Research Part C: Emerging Technologies* 82 (2017), pp. 43–62.
- [63] Yugong Luo et al. “Green Light Optimal Speed Advisory for hybrid electric vehicles”. In: *Mechanical Systems and Signal Processing* 87 (2017), pp. 30–44.
- [64] Hironori Suzuki and Yoshitaka Marumo. “A new approach to Green Light Optimal Speed Advisory (GLOSA) systems and its limitations in traffic flows”. In: *International Conference on Human Systems Engineering and Design: Future Trends and Applications*. Springer. 2018, pp. 776–782.
- [65] Lior Simchon and Raul Rabinovici. “Real-Time Implementation of Green Light Optimal Speed Advisory for Electric Vehicles”. In: *Vehicles* 2.1 (2020), pp. 35–54.
- [66] Xiangmo Zhao et al. “Dynamic Eco-Driving on Signalized Arterial Corridors during the Green Phase for the Connected Vehicles”. In: *Journal of Advanced Transportation* 2020 (2020).
- [67] Miguel Sepulcre, Javier Gozalvez, and Baldomero Coll-Perales. “Why 6 mbps is not (always) the optimum data rate for beaconing in vehicular networks”. In: *IEEE Transactions on Mobile Computing* 16.12 (2017), pp. 3568–3579.
- [68] Ali Balador, Chumeng Bai, and Foroogh Sedighi. “A Comparison of Decentralized Congestion Control Algorithms for Multiplatooning Communications”. In: *2019 IEEE International Conference on Pervasive Computing and Communications Workshops (PerCom Workshops)*. IEEE. 2019, pp. 674–680.
- [69] Ignacio Soto et al. “Strengths and Weaknesses of the ETSI Adaptive DCC Algorithm: A Proposal for Improvement”. In: *IEEE Communications Letters* 23.5 (2019), pp. 802–805.
- [70] Chetan Belagal Math et al. “Fair decentralized data-rate congestion control for V2V communications”. In: *2017 24th International Conference on Telecommunications (ICT)*. IEEE. 2017, pp. 1–7.
- [71] Nikita Lyamin et al. “Etsi dcc: Decentralized congestion control in c-its”. In: *IEEE Communications Magazine* 56.12 (2018), pp. 112–118.
- [72] Chetan Belagal Math et al. “A combined fair decentralized message-rate and data-rate congestion control for V2V communication”. In: *2017 IEEE Vehicular Networking Conference (VNC)*. IEEE. 2017, pp. 271–278.
- [73] Matthias Sander Frigau. “Fair decentralized congestion and awareness control for vehicular networks”. In: *2015 IEEE 21st International Conference on Parallel and Distributed Systems (ICPADS)*. IEEE. 2015, pp. 172–180.

- [74] Marc Torrent-Moreno et al. “Vehicle-to-vehicle communication: Fair transmit power control for safety-critical information”. In: *IEEE Transactions on Vehicular Technology* 58.7 (2009), pp. 3684–3703.
- [75] Sunghwa Son and Kyung-Joon Park. “BEAT: Beacon Inter-Reception Time Ensured Adaptive Transmission for Vehicle-to-Vehicle Safety Communication”. In: *Sensors* 19.14 (2019), p. 3061.
- [76] Kandaraj Piamrat et al. “Radio resource management in emerging heterogeneous wireless networks”. In: *Computer Communications* 34.9 (2011), pp. 1066–1076.
- [77] Mariem Zekri, Badii Jouaber, and Djamel Zeglache. “A review on mobility management and vertical handover solutions over heterogeneous wireless networks”. In: *Computer Communications* 35.17 (2012), pp. 2055–2068.
- [78] Xiaohuan Yan, Y Ahmet Şekercioglu, and Sathya Narayanan. “A survey of vertical handover decision algorithms in Fourth Generation heterogeneous wireless networks”. In: *Computer networks* 54.11 (2010), pp. 1848–1863.
- [79] Ramona Trestian, Olga Ormond, and Gabriel-Miro Muntean. “Performance evaluation of MADM-based methods for network selection in a multimedia wireless environment”. In: *Wireless Networks* 21.5 (2015), pp. 1745–1763.
- [80] Radhwan Mohamed Abdullah, Abedallah Zaid Abualkishik, and Ali A. Alwan. “Improved Handover Decision Algorithm Using Multiple Criteria”. In: *Procedia Computer Science* 141 (2018). The 9th International Conference on Emerging Ubiquitous Systems and Pervasive Networks (EUSPN-2018) / The 8th International Conference on Current and Future Trends of Information and Communication Technologies in Healthcare (ICTH-2018) / Affiliated Workshops, pp. 32–39. ISSN: 1877-0509. DOI: <https://doi.org/10.1016/j.procs.2018.10.146>. URL: <http://www.sciencedirect.com/science/article/pii/S1877050918317952>.
- [81] Anna Maria Vegni and Flavio Esposito. “A speed-based vertical handover algorithm for VANET”. In: *Proc. of 7th Int. Workshop on Intelligent Transportation, Hamburg*. 2010.
- [82] Ali Safa Sadiq et al. “An intelligent vertical handover scheme for audio and video streaming in heterogeneous vehicular networks”. In: *Mobile Networks and Applications* 18.6 (2013), pp. 879–895.
- [83] Smriti Gopinath et al. “Hybrid solutions for data dissemination in vehicular networks”. In: *Wireless Days (WD), 2016*. IEEE. 2016, pp. 1–4.
- [84] Adib Habbal, Swetha Indudhar Goudar, and Suhaidi Hassan. “A Context-aware Radio Access Technology selection mechanism in 5G mobile network for smart city applications”. In: *Journal of Network and Computer Applications* 135 (2019), pp. 97–107.
- [85] He-Wei Yu and Biao Zhang. “A heterogeneous network selection algorithm based on network attribute and user preference”. In: *Ad Hoc Networks* 72 (2018), pp. 68–80.
- [86] Xiaoyan Wu and Qinghe Du. “Utility-function-based radio-access-technology selection for heterogeneous wireless networks”. In: *Computers & Electrical Engineering* 52 (2016), pp. 171–182. ISSN: 0045-7906. DOI: <https://doi.org/10.1016/j.compeleceng.2015.06.010>. URL: <http://www.sciencedirect.com/science/article/pii/S0045790615002141>.

- [87] Wahida Mansouri et al. “Cross layer architecture with integrated MIH in heterogeneous wireless networks”. In: *Computer Networks* 127 (2017), pp. 126–137.
- [88] Kinda Khawam et al. “Radio access technology selection in heterogeneous networks”. In: *Physical Communication* 18 (2016). Special Issue on Radio Access Network Architectures and Resource Management for 5G, pp. 125–139. ISSN: 1874-4907. DOI: <https://doi.org/10.1016/j.phycom.2015.10.004>. URL: <http://www.sciencedirect.com/science/article/pii/S1874490715000518>.
- [89] Nasser M Alotaibi and Sami S Alwakeel. “A neural network based handover management strategy for heterogeneous networks”. In: *2015 IEEE 14th international conference on machine learning and applications (ICMLA)*. IEEE, 2015, pp. 1210–1214.
- [90] Sunisa Kunarak and Raungrong Sulesathira. “Vertical handover decision management on the basis of several criteria for LVQNN with ubiquitous wireless networks”. In: *International Journal of GEOMATE* 12.34 (2017), p. 123.
- [91] Ganesh Kumar Thakur, Bandana Priya, and Pawan Kumar Sharma. “Optimal selection of network in heterogeneous environment based on fuzzy approach”. In: *J. Math. Comput. Sci.* 10.3 (2020), pp. 554–571.
- [92] Lei Ning et al. “Fuzzy clustering based group vertical handover decision for heterogeneous wireless networks”. In: *2013 IEEE Wireless Communications and Networking Conference (WCNC)*. IEEE, 2013, pp. 1231–1236.
- [93] Koji Oshima et al. “Efficient wireless network selection by using multi-armed bandit algorithm for mobile terminals”. In: *Nonlinear Theory and Its Applications, IEICE* 11.1 (2020), pp. 68–77.
- [94] Zhiyong Du et al. “Learning the Optimal Network with Context Awareness: Transfer RL Based Network Selection”. In: *Towards User-Centric Intelligent Network Selection in 5G Heterogeneous Wireless Networks*. Springer, 2020, pp. 65–78.
- [95] Parnia Naghavi et al. “Learning RAT selection game in 5G heterogeneous networks”. In: *IEEE Wireless Communications Letters* 5.1 (2015), pp. 52–55.
- [96] Shidrokh Goudarzi et al. “Intelligent Technique for Seamless Vertical Handover in Vehicular Networks”. In: *Mobile Networks and Applications* 23.6 (2018), pp. 1462–1477.
- [97] Shidrokh Goudarzi et al. “ABC-PSO for vertical handover in heterogeneous wireless networks”. In: *Neurocomputing* 256 (2017), pp. 63–81.
- [98] Imad El Fachtali, Rachid Saadane, and Mohammed ElKoutbi. “Vertical handover decision algorithm using ants’ colonies for 4G heterogeneous wireless networks”. In: *Journal of Computer Networks and Communications* 2016 (2016).
- [99] Alex Potapov and MK Ali. “Convergence of reinforcement learning algorithms and acceleration of learning”. In: *Physical Review E* 67.2 (2003), p. 026706.
- [100] Hamed Maleki and Sajjad Zahir. “A comprehensive literature review of the rank reversal phenomenon in the analytic hierarchy process”. In: *Journal of Multi-Criteria Decision Analysis* 20.3-4 (2013), pp. 141–155.
- [101] A Huszak and Sándor Imre. “Eliminating rank reversal phenomenon in GRA-based network selection method”. In: *2010 IEEE International Conference on Communications*. IEEE, 2010, pp. 1–6.

- [102] Lusheng Wang and Geng-Sheng GS Kuo. “Mathematical modeling for network selection in heterogeneous wireless networks—A tutorial”. In: *IEEE Communications Surveys & Tutorials* 15.1 (2012), pp. 271–292.
- [103] Momčilo D Vujičić, Miloš Z Papić, and Marija D Blagojević. “Comparative analysis of objective techniques for criteria weighing in two MCDM methods on example of an air conditioner selection”. In: *Tehnika* 72.3 (2017), pp. 422–429.
- [104] Radion Bikmukhamedov, Yevgeniy Yeryomin, and Jochen Seitz. “Evaluation of MCDA-based handover algorithms for mobile networks”. In: *2016 Eighth International Conference on Ubiquitous and Future Networks (ICUFN)*. IEEE. 2016, pp. 810–815.
- [105] Phuoc Nguyen Tran and Nadia Boukhatem. “Comparison of MADM decision algorithms for interface selection in heterogeneous wireless networks”. In: *2008 16th international conference on software, telecommunications and computer networks*. IEEE. 2008, pp. 119–124.
- [106] Serafim Opricovic and Gwo-Hshiung Tzeng. “Compromise solution by MCDM methods: A comparative analysis of VIKOR and TOPSIS”. In: *European journal of operational research* 156.2 (2004), pp. 445–455.
- [107] Mouna Karoui, Antonio Freitas, and Gérard Chalhoub. “Efficiency of Speed Advisory Boundary fINDER (SABIN) strategy for GLOSA using ITS-G5”. In: *The 7th IFIP/IEEE International Conference on Performance Evaluation and Modeling in Wired and Wireless Networks*. 2018.
- [108] Mouna Karoui, Antonio Freitas, and Gérard Chalhoub. “Comparative evaluation study of GLOSA approaches under realistic scenario conditions”. In: *International Conference on Ad-Hoc Networks and Wireless (AdHoc-NOW)*. Springer. 2019, pp. 407–419.
- [109] Lara Codeca et al. “Luxembourg sumo traffic (lust) scenario: Traffic demand evaluation”. In: *IEEE Intelligent Transportation Systems Magazine* 9.2 (2017), pp. 52–63.
- [110] Sundar Subramanian et al. “Congestion control for vehicular safety: synchronous and asynchronous MAC algorithms”. In: *Proceedings of the ninth ACM international workshop on Vehicular inter-networking, systems, and applications*. 2012, pp. 63–72.
- [111] ETSI. *ETSI TS 102 687, Intelligent Transport Systems (ITS); Decentralized Congestion Control Mechanisms for Intelligent Transport Systems operating in the 5 GHz range; Access layer part*. 2011.
- [112] Leonard Kleinrock. “Queueing systems. Volume I: theory”. In: (1975).
- [113] Hongqiang Zhai, Xiang Chen, and Yuguang Fang. “How well can the IEEE 802.11 wireless LAN support quality of service?” In: *IEEE Transactions on Wireless Communications* 4.6 (2005), pp. 3084–3094.
- [114] Giuseppe Bianchi. “Performance analysis of the IEEE 802.11 distributed coordination function”. In: *IEEE Journal on selected areas in communications* 18.3 (2000), pp. 535–547.
- [115] Gaurav Bansal, John B Kenney, and Charles E Rohrs. “LIMERIC: A linear adaptive message rate algorithm for DSRC congestion control”. In: *IEEE Transactions on Vehicular Technology* 62.9 (2013), pp. 4182–4197.

- [116] *ETSI TR 101 613 v1.1.1 Intelligent Transport Systems (ITS); Cross layer DCC Management Entity for operation in the ITS-G5A and the ITS-G5B medium; Validation set-up and results.*
- [117] The IEEE 802.21 Working Group on Media access Independent Services (MIS) developed standards. *IEEE 802.21-2017 - IEEE Standard for Local and metropolitan area networks—Part 21: Media Independent Services Framework.* 2017. URL: https://standards.ieee.org/standard/802_21-2017.html.
- [118] Peter Dely, Andreas J Kassler, and Dmitry Sivchenko. “Theoretical and experimental analysis of the channel busy fraction in IEEE 802.11”. In: *2010 Future Network & Mobile Summit.* IEEE. 2010, pp. 1–9.
- [119] K Hima Bindu et al. *Coefficient of variation and machine learning applications.* CRC Press, 2019.
- [120] Robert Goodell Brown. *Smoothing, forecasting and prediction of discrete time series.* Courier Corporation, 2004.
- [121] Nazanin Vafaei, Rita A Ribeiro, and Luis M Camarinha-Matos. “Normalization techniques for multi-criteria decision making: analytical hierarchy process case study”. In: *doctoral conference on computing, electrical and industrial systems.* Springer. 2016, pp. 261–269.
- [122] Esther Dopazo and Jacinto González-Pachón. “Consistency-driven approximation of a pairwise comparison matrix”. In: *Kybernetika* 39.5 (2003), pp. 561–568.
- [123] K Yoon. *Multiple Attribute Decision Making. Methods and Applications.* 1981.
- [124] OMNET++ User community. *Inet Framework.* 2020. URL: <https://inet.omnetpp.org/>.
- [125] Levente Mészáros, Andras Varga, and Michael Kirsche. “INET Framework”. In: *Recent Advances in Network Simulation: The OMNeT++ Environment and its Ecosystem.* Ed. by Antonio Virdis and Michael Kirsche. Cham: Springer International Publishing, 2019, pp. 55–106. ISBN: 978-3-030-12842-5. DOI: [10.1007/978-3-030-12842-5_2](https://doi.org/10.1007/978-3-030-12842-5_2). URL: https://doi.org/10.1007/978-3-030-12842-5_2.
- [126] Italy Computer Networking Group of the University of Pisa. *LTE User Plane Simulation Model for INET & OMNeT++.* 2020. URL: <https://simulte.com/>.
- [127] Antonio Virdis, Giovanni Stea, and Giovanni Nardini. “SimuLTE-A modular system-level simulator for LTE/LTE-A networks based on OMNeT++”. In: *2014 4th International Conference On Simulation And Modeling Methodologies, Technologies And Applications (SIMULTECH).* IEEE. 2014, pp. 59–70.
- [128] Raphael Riebl, Christina Obermaier, and Hendrik-Jörn Günther. “Artery: Large Scale Simulation Environment for ITS Applications”. In: *Recent Advances in Network Simulation.* Springer, 2019, pp. 365–406.
- [129] Mouna Karoui and Ali Mamadou Mamadou. *HeteroSIM framework.* 2020. URL: <https://github.com/MounaKaroui/HeteroSIM>.
- [130] Mouna Karoui and Ali Mamadou Mamadou. *HeteroSIM framework INET dependency.* 2020. URL: <https://github.com/MounaKaroui/inet/tree/v3.6.6-HeteroSIM>.
- [131] Mouna Karoui and Ali Mamadou Mamadou. *HeteroSIM framework SimuLTE dependency.* 2020. URL: <https://github.com/MounaKaroui/simulte/tree/v1.3.0-HeteroSIM>.

-
- [132] ETSI. *Intelligent Transport Systems (ITS); Vehicular Communications; Basic Set of Applications; Part 2: Specification of Cooperative Awareness Basic Service*. 2011.
 - [133] Christoph Sommer, Stefan Joerer, and Falko Dressler. “On the applicability of two-ray path loss models for vehicular network simulation”. In: *2012 IEEE Vehicular Networking Conference (VNC)*. IEEE. 2012, pp. 64–69.
 - [134] *ETSI TS 122 186 V15.3.0)5G;Service requirements for enhanced V2X scenarios (3GPP TS 22.186 version 15.3.0 Release 15)*. 2018-07.
 - [135] *ETSI TR 102 638 V1.1.1 Intelligent Transport Systems (ITS);Vehicular Communications;Basic Set of Applications;Definitions*. 2009-06.
 - [136] 3GPP. *3GPP TR 22.886: Study on enhancement of 3GPP Support for 5G V2X Services (v16.2.0, Release 16)*. Dec. 2018.
 - [137] IEEE P802.11 NEXT GENERATION V2X STUDY GROUP. *Status of Project IEEE P802.11bd*. 2018.