



**HAL**  
open science

# A Techno-Economic Analysis of the Electric Vehicle Transition: Policy, Infrastructure, Usage, and Design

Bassem Haidar

► **To cite this version:**

Bassem Haidar. A Techno-Economic Analysis of the Electric Vehicle Transition: Policy, Infrastructure, Usage, and Design. Electric power. Université Paris-Saclay, 2021. English. NNT : 2021UP-AST122 . tel-03557817

**HAL Id: tel-03557817**

**<https://theses.hal.science/tel-03557817>**

Submitted on 4 Feb 2022

**HAL** is a multi-disciplinary open access archive for the deposit and dissemination of scientific research documents, whether they are published or not. The documents may come from teaching and research institutions in France or abroad, or from public or private research centers.

L'archive ouverte pluridisciplinaire **HAL**, est destinée au dépôt et à la diffusion de documents scientifiques de niveau recherche, publiés ou non, émanant des établissements d'enseignement et de recherche français ou étrangers, des laboratoires publics ou privés.

# A Techno-Economic Analysis of the Electric Vehicle Transition: Policy, Infrastructure, Usage, and Design

Thèse de doctorat de l'Université Paris-Saclay

École doctorale n°573 : interfaces : approches interdisciplinaires, fondements,  
applications et innovation (Interfaces)  
Spécialité de doctorat: Ingénierie des systèmes complexes  
Unité de recherche : Université Paris-Saclay, CentraleSupélec, Laboratoire Génie  
Industriel, 91190, Gif-sur-Yvette, France.  
Référent : CentraleSupélec

Thèse présentée et soutenue à Paris-Saclay, le 10 Décembre 2021, par

**Bassem HAIDAR**

## Composition du Jury

|   |                            |
|---|----------------------------|
| <b>Yannick PEREZ</b><br>Professeur, CentraleSupélec                                 | Président                  |
| <b>Carole DONADA</b><br>Professeure, ESSEC Business School                          | Rapportrice & Examinatrice |
| <b>Frédéric LANTZ</b><br>Professeur, IFP School                                     | Rapporteur & Examinateur   |
| <b>Frances SPREI</b><br>Professeure Associée, Université de Technologie de Chalmers | Examinatrice               |
| <b>François LEVEQUE</b><br>Professeur, Mines ParisTech                              | Examinateur                |
| <b>Willett KEMPTON</b><br>Professeur, Université du Delaware                        | Examinateur                |
| <b>Clément DUMAND</b><br>Ingénieur Chercheur, Stellantis                            | Invité Industriel          |
| <b>Pascal DA COSTA</b><br>Professeur, CentraleSupélec                               | Directeur de thèse         |
| <b>Jan LEPOUTRE</b><br>Professeur, ESSEC Business School                            | Co-Encadrant de thèse      |
| <b>Fabrice VIDAL</b><br>Ingénieur Chercheur, Stellantis                             | Co-Encadrant de thèse      |



**Titre :** Une analyse technico-économique de la transition vers les véhicules électriques : politique, infrastructure, usages et conception

**Mots clés :** capacité de batterie, infrastructure de recharge, véhicule électrique, véhicule hybride rechargeable, étude technico-économique

**Résumé :** Le transport routier représentant une part importante des émissions mondiales de gaz à effet de serre. Les véhicules électriques (VE), y compris les VE à batterie (BEV) et les VE hybrides rechargeables (PHEV), offrent une alternative prometteuse pour remplacer les véhicules à moteur à combustion interne (ICEV), dépendants des combustibles fossiles, pour une solution de transport à émissions faibles ou nulles. Bien que l'adoption de ces technologies ait rapidement augmenté au cours de la dernière décennie, leur part de marché reste limitée par des obstacles socio-technico-économiques dans la plupart des pays. Surmonter ces barrières est une étape essentielle vers un marché massive des véhicules électriques. Cette thèse vise donc à étudier des modèles économiques innovants, en examinant les transactions entre les membres de l'écosystème des VE. Cette thèse traite de recherches prospectives et multidisciplinaires en sciences économiques et de gestion, et sciences de l'ingénieur, sur l'avenir des systèmes automobiles décarbonés. Tout d'abord, cette thèse aborde les principaux obstacles au déploiement des infrastructures de recharge, en présentant

une revue de la littérature sur les méthodologies de déploiement et en soulignant l'ensemble des paramètres négligés dans la littérature, lesquels présentent des questions de recherche que la thèse aborde par la suite. Ensuite, cette thèse étudie les compromis entre infrastructure de recharge de différentes puissances et autonomie des BEV. Nous concluons sur la capacité de la batterie du BEV la plus adaptée aux besoins urbains et ruraux, et sur l'investissement dans les chargeurs rapides. De plus, cette thèse analyse l'influence des facteurs socio-démographiques, économiques et techniques sur l'adoption des VE dans les départements français au moyen d'une régression à effets mixtes. Nous concluons à travers des recommandations de politiques économiques pour accélérer la transition vers la mobilité électrique. Enfin, cette thèse analyse l'influence du règlement européen (EU)2019/631 sur l'offre des constructeurs automobiles et permet de discuter les résultats attendus par la directive de la Commission européenne.

**Title:** A Techno-Economic Analysis of the Electric Vehicle Transition: Policy, Infrastructure, Usage, and design

**Keywords:** battery capacity, recharging infrastructure, electric vehicle, plug-in hybrid vehicle, techno-economic study

**Abstract:** Since road transport accounts for a high share of global Greenhouse Gas (GHG) emissions, Electric Vehicles (EVs), including Battery EVs (BEVs) and Plug-in Hybrid EVs (PHEVs), offer a promising alternative to replace fossil-fuel dependent Internal Combustion Engine Vehicles (ICEVs), with a low-or zero-emission transport solution. While this technology's adoption has been rapidly increasing over the last decade, its market share remains restrained by socio-techno-economic barriers in most countries. Overcoming these barriers is an essential step into a massive purchasing activity of electric vehicles. This dissertation aims at investigating innovative business models by examining the transactions within the members of the EV ecosystem. This dissertation deals with future and multidisciplinary research in economics, management, and engineering sciences on decarbonised car systems' future. First, this thesis addresses the main charging infrastructure deployment barrier by presenting a

literature review about the deployment methodologies and pointing out the neglected set of parameters that present our research gaps. Second, it investigates the trade-offs between the different-power charging infrastructure and the BEV owner by considering: BEV investment and range, public infrastructure availability, at-home charger availability, and the adaptability between charger and BEV in terms of technical constraints. It also concludes with the most suitable BEV battery capacity for urban and rural needs, and the installation of fast chargers. Next, it analyses the influence of socio-demographic, economic, and technical factors on electric vehicle adoption in French departments, using mixed-effects regression. This chapter points out policy recommendations to accelerate the electric mobility transition. Finally, this thesis analyses the influence of the Regulation number (EU)2019/631 on the automotive manufacturers' portfolio, and compares the results with the directive of the European Commission.

## *Acknowledgements*

The Armand Peugeot Chair in collaboration with Stellantis (the fusion between Groupe PSA and FCA Group), CentraleSupélec Engineering School (Université Paris-Saclay), Laboratoire Genie Industriel / Sustainable Economics Group, and ESSEC Business School fund Bassem Haidar's thesis under the 'ANRT-CIFRE' contract 2018/1162.

## *Remerciements*

Mes premiers remerciements s'adressent à mes directeurs de thèse : Pascal da Costa, Jan Lepoutre et Fabrice Vidal. Merci Pascal pour ton temps, tes encouragements, ton soutien et ton aide afin de réaliser cette thèse ! Merci parce que tu étais disponible à chaque fois que je t'appelais ! Merci Jan pour ton aide : c'était grâce à tes conseils et critiques que j'ai pu autant monter en compétences ! Merci Fabrice pour ton temps, tes précieux conseils et ton soutien constant. Merci à vous trois pour votre confiance ! J'aimerais également vous dire à quel point j'ai apprécié vos grandes disponibilités et votre respect sans faille des délais serrés de relecture des documents que je lui ai adressés. Enfin, j'ai été extrêmement sensible à vos qualités humaines d'écoute et de compréhension tout au long de ce travail doctoral.

Merci également à Yannick Perez, Titulaire de la Chaire Armand Peugeot en Electromobilité pour m'avoir accordé une confiance totale : merci pour tes encouragements depuis mes années de Master. Merci à Stellantis de m'avoir soutenu financièrement durant ces trois années. C'est toujours une grande fierté de faire partie d'un groupe mondial fort de 400,000 employés dans 50 pays.

Je remercie également les deux rapporteurs: Carole Donada et Frédéric Lantz ; ainsi que les examinateurs: Frances Sprei, François Lévêque, Willett Kempton et Clément Dumand pour avoir accepté de faire partie de mon jury de thèse. Merci à Yannick Perez d'accepter de présider mon jury.

Ce travail n'aurait pu être mené à bien sans la disponibilité et l'aide de mes encadrants de thèse et d'Olivier Massol, Elisa Operti, Sen Chai et Adelaïde Fadhuile. Merci pour vos conseils, votre aide et vos critiques sur mes travaux. Merci à Maria Teresa Aguilar Rojas avec qui j'avais le plaisir de travailler sur une étude.

Je remercie chaleureusement l'équipe d'organisation de la conférence internationale IAEE2021. Merci Yannick de m'avoir accordé cette responsabilité : j'espère que j'étais à la hauteur de tes attentes. Merci également à Olga Pushkash, Albert Hiesl, Chiara Canestrini, au Président IAEE/FAEE Christophe Bonnery et à toute l'équipe de 30 personnes avec qui j'avais l'honneur de travailler.

Merci encore à Pascal da Costa, Yannick Perez, Arnaud Lafont et Pierre Jehel qui m'ont donné l'opportunité de donner des cours et d'encadrer des projets à CentraleSupélec/Université Paris-Saclay. Merci à mes étudiants car c'est grâce à eux que j'ai pu monter autant en compétence.

Je remercie encore mes autres camarades du LGI pour l'ambiance de ces belles années. Merci donc à Lara Qasim, Naouress Fatfouta, Yasmine Salehy, Icaro Gomes, Marc-Olivier Metals, Tjark Gall, Joseph Mansour, Robin Lecomte, Gustavo Santamaria, Emilien Ravigné, Emma Jagu, Quentin Hoarau, Fawaz Salihou, Maxime Guymard, Félix Carreira, Jean Hassler, Felipe Venegas, Mariana Reyes... Vous êtes très nombreux! Je souhaite également une très bonne thèse pour les nouveaux arrivants. Merci à l'équipe administrative du LGI : Delphine Martin, Corinne Ollivier, Carole Stoll, Astrid Blanchard, Sylvie Guillemain et Mathieu Tournadre, ainsi qu'à l'ESSEC : Zoubida Berkane et Christine Gil. Merci au directeur du Laboratoire Génie Industriel de CentraleSupélec Professeur Bernard Yannou.

Merci encore à ma seconde famille -mes amis- avec leur question récurrente : « quand est-ce que tu la soutiens cette thèse ? »: Andreas Markoulidakis, Kifah Dakdouk, Elissar Khatib, Hilda Narch, Elias Chiti, Naji Nassar, Myriam Bahja, Samer Murr, Sarah Jnad, Niklass Wulff, Nagham Chehade, Georges Everikian et Gilbert Yaman.

Je remercie aussi l'équipe R&D SEPC avec qui j'avais l'honneur de travailler et, en particulier, Clément Dumand, Bernard Sahut, Ladimir Prince et Eric Lalliard. Merci encore à l'équipe d'animation PhD de Stellantis: Jamila Leite Costa, Sandrine Loze, Mathieu Moze et Stéphane Delalande.

Un grand merci à CentraleSupélec : ma seconde maison où j'ai passé 5 ans de ma vie. Je n'oublierai jamais les moments passés sur les trois bâtiments de ce grand campus ! Je tiens à remercier le directeur Patrick Aldebert, Xavière Marcy, Divya Madhavan Brochier et Claude Mézin-Wilkinson.

Enfin, au terme de ce parcours, je remercie enfin celles et ceux qui me sont chers et que j'ai quelque peu délaissés ces derniers mois pour achever cette thèse. Leurs attentions et encouragements m'ont accompagné tout au long de ces années. Je suis redevable à mes parents, Nariman et Bassam, pour leur soutien moral, matériel et leur confiance indéfectible dans mes choix. Leur présence et leurs encouragements sont pour moi les piliers fondateurs de ce que je suis et de ce que je fais. Il ne me reste plus qu'à saluer mon frère Karim qui était là... quand personne d'autre ne l'était.

Bassem Haidar

France, Décembre 2021

*It's not about being the biggest... It's about pursuing greatness!*





## Table of Contents

|  |    |
|--|----|
| List of Figures .....  | 5  |
| List of Tables.....  | 7  |
| List of Abbreviations.....   | 8  |
| Summary .....  | 9  |
| Résumé.....  | 13 |
| Chapter 1: General Introduction.....   | 17 |
| 1. Climate Change: from Global Warming to Road Transportation Decarbonization.....                                     | 19 |
| 1.1. Definition of Climate Change .....  | 19 |
| 1.2. The Necessity for Public Interventions .....  | 22 |
| 1.3. Solutions for a Decarbonized Road Transportation .....  | 23 |
| 2. Electric Vehicles as a Solution.....  | 25 |
| 2.1. Definition of Electric Vehicles.....  | 25 |
| 2.2. Types of Electric Vehicles.....   | 25 |
| 2.3. Brief History of Electric Vehicles .....  | 26 |
| 2.4. Technical Components of EV .....  | 28 |
| 2.5. The Environmental Footprint of EV.....  | 33 |
| 3. Barriers to Adoption of EV .....  | 36 |
| 3.1. Technical Barriers .....  | 36 |
| 3.2. Social Barriers .....   | 37 |
| 3.3. Economic Barriers.....  | 37 |
| 3.4. Infrastructure Barriers .....   | 38 |
| 3.5. Policy Barriers.....  | 38 |
| 4. Charging Infrastructure for Electric Vehicles .....   | 40 |
| 4.1. EV Infrastructure Characteristics .....   | 40 |
| 4.2. The Chicken and Egg Electric-Mobility Dilemma.....  | 41 |
| 5. Business model and scenario definition .....  | 42 |
| 5.1. Business Model Definition .....   | 42 |
| 5.2. Electric Vehicle Ecosystem Members.....   | 43 |
| 6. Contributions of This Dissertation .....  | 47 |
| 6.1. Research Gaps Identification.....   | 47 |
| 6.2. Research Questions and Scope.....   | 48 |
| 6.3. Graphical Presentation of the Research Questions.....   | 49 |
| 6.4. Description of Chapters.....  | 49 |
| References .....   | 56 |
| Chapter 2: Review of Optimization Objectives and Their Consequences for Electric-Vehicle Charging Infrastructure ..... | 63 |

## Table of Contents

|   |     |
|---|-----|
| 1. Introduction .....   | 65  |
| 2. Methodology .....  | 67  |
| 2.1. Literature Selection .....   | 67  |
| 2.2. Structure of Reviewed Articles .....   | 67  |
| 3. Introduction to Technical Aspects.....   | 71  |
| 3.1. Electric Vehicles.....   | 71  |
| 3.2. Charging Infrastructure .....  | 71  |
| 3.3. Problem Identification.....  | 72  |
| 4. Analysis of Charging Infrastructure Optimization Objectives.....   | 73  |
| 4.1. Minimizing the Cost.....   | 73  |
| 4.2. Maximizing Coverage .....  | 75  |
| 4.3. Minimizing Failed Trips.....   | 77  |
| 4.4. Minimizing the Environmental Impact.....   | 78  |
| 4.5. Minimizing the Distance between Demand and Charging Points .....   | 78  |
| 4.6. Other Optimization Objectives.....   | 79  |
| 5. Discussion and determination of research gaps .....  | 80  |
| 5.1. Gaps in Input Data.....  | 80  |
| 5.2. Gaps in the Optimization Procedure.....  | 86  |
| 6. Conclusion and Perspectives .....  | 88  |
| References .....  | 100 |
| Chapter 3: Assessing the trade-offs between battery capacity and public charging infrastructure of electric vehicles: urban and rural French case studies for daily needs ..... | 109 |
| 1. Introduction .....   | 111 |
| 2. Literature Review .....  | 114 |
| 2.1. Estimating drivers' needed range .....   | 114 |
| 2.2. Determining The Optimal Battery Capacity.....  | 115 |
| 2.3. Deployment of Charging Infrastructures .....   | 116 |
| 2.4. Investments in Both Technologies .....   | 117 |
| 3. Methodology .....  | 118 |
| 3.1. Modelling the BEV Charging Needs.....  | 119 |
| 3.2. Modelling the Charging Infrastructure Demand .....   | 119 |
| 3.3. Cost Model .....   | 120 |
| 4. Data and Techno-Economic Parameters .....  | 123 |
| 5. Results .....  | 125 |
| 5.1. Individual Driving Profiles.....   | 126 |
| 5.2. Charging Infrastructure Demand .....   | 126 |
| 5.3. Costs Models .....   | 127 |
| 5.4. Sensitivity Tests .....  | 131 |

## Table of Contents

|   |     |
|---|-----|
| 6. Conclusion and Policy Recommendations .....  | 138 |
| 6.1. Conclusion.....  | 138 |
| 6.2. Policy Recommendations .....   | 139 |
| References .....  | 141 |
| Appendix 3.A Techno-Economic Parameters of the Cost Models .....  | 145 |
| Chapter 4: The Influence of Public Charging Infrastructure Deployment and Other Socio-Economic Factors on Electric Vehicle Adoption in France ..... | 147 |
| 1. Introduction .....   | 149 |
| 2. Literature Review .....  | 151 |
| 3. Data and Methodology .....   | 154 |
| 3.1. Data .....   | 154 |
| 3.2. Methodology .....  | 159 |
| 4. Results .....  | 162 |
| 4.1. BEV Model Regression.....  | 162 |
| 4.2. PHEV Model Regression .....  | 164 |
| 4.3. Comparison of BEV and PHEV Models with the Literature .....  | 165 |
| 4.4. Policy Recommendations .....   | 167 |
| 5. Robustness Checks .....  | 169 |
| 5.1. Robustness Check 1: Removing Random Departments .....  | 170 |
| 5.2. Robustness Check 2: Excluding Departments with Big Cities.....   | 170 |
| 5.3. Robustness Check 3: Removing Charging Infrastructure Control Variables .....   | 170 |
| 6. Conclusion.....  | 171 |
| References .....  | 173 |
| Appendix 4.A: Overview of the BEV and PHEV Evolution in France .....  | 177 |
| Appendix 4.B: Correlation Between Model Covariates.....   | 178 |
| Appendix 4.C: Results of Regressions with Robustness Checks.....  | 179 |
| Chapter 5: Assessing the 2021-2025-2030 CO2 Standards on Automakers' Portfolio Vehicles' Segments .....   | 183 |
| 1. Introduction .....   | 185 |
| 2. Literature Review .....  | 188 |
| 3. Methodology .....  | 191 |
| 3.1. Calculation of CO2 Targets.....  | 191 |
| 3.2. Determination of PHEV/BEV sales share .....  | 193 |
| 4. Data .....   | 194 |
| 4.1. PHEV and BEV Cost Assumptions.....   | 194 |
| 4.2. PHEV and BEV Techno-environmental Assumptions.....   | 196 |
| 5. Results .....  | 198 |
| 5.1. Results .....  | 199 |

## *Table of Contents*

|   |     |
|---|-----|
| 5.2. Discussion .....   | 204 |
| 6. Conclusion and Future Research .....                                   | 207 |
| References .....  | 209 |
| Chapter 6: General Conclusion .....                                       | 213 |
| 1. Summary of Chapters .....  | 213 |
| Chapter 1 .....   | 213 |
| Chapter 2 .....   | 214 |
| Chapter 3 .....   | 214 |
| Chapter 4 .....   | 215 |
| Chapter 5 .....   | 216 |
| 2. Transversal Considerations .....                                       | 216 |
| 2.1. Ecosystem Cooperation .....  | 216 |
| 2.2. Policies Identification .....  | 217 |
| 3. Future Works .....   | 218 |
| 3.1. Battery Capacity and Public Charging Infrastructure Trade-Offs ..... | 218 |
| 3.2. Analysis of the BEV and PHEV Markets in France .....                 | 219 |
| 3.3. Analysis of the CO2 Regulations on the OEM's Portfolio .....         | 219 |
| 3.4. Beyond the Chapters .....  | 220 |

## List of Figures

|  |     |
|--|-----|
| Figure 1.1 Global Average Temperature Anomaly from 1850 to 2018.....   | 19  |
| Figure 1.2 Atmospheric CO <sub>2</sub> Concentration, 803719 BCE to 2018 .....   | 20  |
| Figure 1.3 Annual Total CO <sub>2</sub> Emissions, by World Region, from 1751 to 2017 .....  | 20  |
| Figure 1.4 Per Capita CO <sub>2</sub> Emissions (in t CO <sub>2</sub> /cap/yr) from Fossil Fuel Use, industrial processes, and product use ..... | 21  |
| Figure 1.5 Total Global Annual Emissions of Fossil CO <sub>2</sub> in Gt CO <sub>2</sub> /yr by Sector .....                                     | 21  |
| Figure 1.6 GHG Emissions by the Transportation Sector.....   | 22  |
| Figure 1.7 Different Configurations of Electric Vehicles .....   | 28  |
| Figure 1.8 Charging process of electric vehicles .....   | 32  |
| Figure 1.9 Charging Connector in Electric Vehicles .....   | 33  |
| Figure 1.10 Simplified View of the Well-to-Wheels and Equipment Flows .....  | 34  |
| Figure 1.11 EV Ecosystem Members.....  | 43  |
| Figure 1.12 Characteristics of the BEV Considered in this Thesis.....  | 44  |
| Figure 1.13 Characteristics of the BEV Considered in this Thesis.....  | 45  |
| Figure 1.14 Characteristics of the Charging Infrastructure Considered in this Thesis .....   | 47  |
| Figure 1.15 Graphical Presentation of the Research Questions .....   | 49  |
| <br>   |     |
| Figure 2.1 Number of Publications in Google Scholar (until October 2019) .....   | 68  |
| Figure 2.2 Structure of Reviewed Articles.....   | 69  |
| Figure 2.3 Problem Identification within the Three Parties .....   | 74  |
| <br>   |     |
| Figure 3.1 Model Overview .....  | 118 |
| Figure 3.2 Urban and Rural Case Studies Areas .....  | 125 |
| Figure 3.3 Number of BEVs That Use One Charger as a Function of Battery Capacity.....  | 127 |
| Figure 3.4 The Cost Model ( $\Delta$ EAC) and Monthly Charging Duration for the BEV Customer (Urban & Rural Needs) .....                         | 129 |
| Figure 3.5 The Cost Model of the Charging Point Operator.....  | 130 |
| Figure 3.6 Win-Win situations presentation .....   | 131 |
| Figure 3.7 Sensitivity Test 1 Results: BEV Purchasing Subsidies Variation .....  | 132 |
| Figure 3.8 Sensitivity Test 1 Results: Charger Instalment Subsidies Variation .....  | 133 |
| Figure 3.9 Sensitivity Test 2 Results on the Urban Case Study Variation.....   | 134 |
| Figure 3.10 Sensitivity Test 3 Results on the Urban Case Study Variation.....  | 135 |
| Figure 3.11 Sensitivity Test 3 Results on the Rural Case Study Variation.....  | 135 |
| Figure 3.12 Sensitivity Test 4 Results on the Urban Case Study.....  | 136 |
| Figure 3.13 Sensitivity Test 4 Results on the Rural Case Study Variation.....  | 136 |
| <br>   |     |
| Figure 4.1 Evolution Percentage of the BEV (Left) and PHEV (Right) Market Shares in 95 French Departments between 2015 and 2019. ....            | 176 |
| <br>   |     |
| Figure 5.1 Schematic Illustration of a New Car Average CO <sub>2</sub> Emission Levels in the E.U. in 2000–2030.....                             | 183 |
| Figure 5.2 Methodology Overview .....  | 188 |
| Figure 5.3 Calculation of CO <sub>2</sub> Targets Methodology.....   | 189 |
| Figure 5.4 Representation of the Transportation Sector's Structure Used in this Study .....  | 191 |
| Figure 5.5 Li-Ion Battery Packs Price Projection .....   | 192 |
| Figure 5.6 Incremental Costs of BEV and PHEV for 2020, 2025, 2030 .....  | 193 |
| Figure 5.7 Simplified View of the Well-to-Wheels and Equipment Flows .....   | 194 |
| Figure 5.8 The determination of 2021 CO <sub>2</sub> Targets of Different Scenarios in gCO <sub>2</sub> /km.....                                 | 197 |
| Figure 5.9 Total Costs (Incremental Costs and CO <sub>2</sub> Fines) for Four Vehicles Segments and  |     |

*List of Figures*

|  |     |
|--|-----|
| 2021, 2025, 2030 .....   | 200 |
| Figure 5.10 BEV and PHEV Sales Shares That Ensure the Minimization of the Costs .....  | 200 |
| Figure 5.11 Combinations of BEV and PHEV Sales Shares That Ensure the Minimum Cost<br>and the Respect of CO2 Engagement (P=0) for four Segments and 2021, 2025, 2030 ..... | 201 |

## List of Tables

|  |     |
|--|-----|
| Table 1.1 Typical Electric Vehicles and Their Main Characteristics.....  | 29  |
| Table 1.2 ICEV, BEV, and PHEV Main Components.....   | 31  |
| Table 1.3 Barriers Types Considered in this Thesis.....  | 41  |
| Table 1.4 Charging Infrastructure Main Characteristics.....  | 44  |
| Table 1.5 Literature Gaps Considered in this Thesis.....   | 51  |
|  |     |
| Table 2.1 Methods Names Abbreviations.....   | 71  |
| Table 2.2 Charging Modes Parameters.....   | 73  |
| Table 2.3 Publications Having Cost Minimization as the Optimization Objective.....   | 92  |
| Table 2.4 Publications Having Maximization Demand Coverage as the Optimization Objective.....                                  | 96  |
| Table 2.5 Publications Having Minimization of Failed Trips as the Optimization Objective.....                                  | 97  |
| Table 2.6 Publications Considering Minimizing the Distance between Demand and Charging Points.....                             | 98  |
| Table 2.7 Publications Considering Various Optimization Objectives.....  | 99  |
|  |     |
| Table 3.1 Techno-Economic Parameters of $EAC_{VEH}$ .....  | 122 |
| Table 3.2 Techno-Economic Parameters of $EAC_{CPO}$ .....  | 123 |
| Table 3.3 Summary of sensitivity tests.....  | 137 |
| Table 3.4 Charging Tariffs of Different Operators.....   | 145 |
| Table 3.5 BEV Techno-Economic Parameters.....  | 145 |
| Table 3.6 ICEV Techno-Economic Parameters.....   | 146 |
| Table 3.7 Charging Infrastructure Techno-Economic Parameters.....  | 146 |
|  |     |
| Table 4.1 Overview of Econometric Studies Presented in the Literature Review.....  | 155 |
| Table 4.2 Charging Costs of Different Charging Powers.....   | 156 |
| Table 4.3 Summary Statistics of Covariates.....  | 159 |
| Table 4.4 Regression Results of Logarithmic form of BEV and PHEV Market Shares $\log(PEV)$ .....                               | 165 |
| Table 4.5 Variable Correlation Coefficients.....   | 177 |
| Table 4.6 Sensitivity of Regression Results for Models against the Departments Exclusion.....                                  | 178 |
| Table 4.7 Sensitivity of Regression Results for Models against the Exclusion of Big Cities.....                                | 179 |
| Table 4.8 Sensitivity of Regression Results for Models against the Exclusion of Charging Infrastructure Control Variables..... | 180 |
|  |     |
| Table 5.1 Variables Definition.....  | 190 |
| Table 5.2 Variables Definition.....  | 190 |
| Table 5.3 ICEV, BEV, and PHEV Parameters.....  | 193 |
| Table 5.4 Weight and CO2 Emissions of Passenger Car fleet used in this Study.....  | 195 |
| Table 5.5 Comparing the arguments of defending PHEVs and BEVs.....   | 204 |



## List of Abbreviations

|                 |   |
|-----------------|---|
| AFVs            | Alternative Fuel Vehicles                               |
| AC              | Alternative Current                                     |
| BEVs            | Battery Electric Vehicles                               |
| CAFE            | Corporate Average Fuel Economy                          |
| CAPEX           | Capital Expenditure                                     |
| CO <sub>2</sub> | Carbon dioxide  |
| CPO             | Charging Point Operator                                 |
| C-Rate          | Charging Rate   |
| DC              | Direct Current  |
| EC              | European Commission                                     |
| EMSP            | Electric Mobility Service Provider                      |
| EU              | European Union  |
| EVs             | Electric Vehicles                                       |
| FCEVs           | Fuel Cell Electric Vehicles                             |
| GHG             | Greenhouse Gas  |
| GPS             | Global Positioning System                               |
| HEVs            | Hybrid Electric Vehicles                                |
| ICEVs           | Internal Combustion Engine Vehicles                     |
| kW              | Kilowatt  |
| kWh             | Kilowatt-hour   |
| LCA             | Life Cycle Assessment                                   |
| NEDC            | New European Driving Cycle                              |
| OPEX            | Operational Expenditure                                 |
| PEVs            | Plug-in Electric Vehicles                               |
| PHEVs           | Plug-in Hybrid Electric Vehicles                        |
| SoC             | State of Charge   |
| TTW             | Tank-To-Wheel   |
| V2G             | Vehicle-to-Grid   |
| WLTP            | Worldwide Harmonized Light-Duty Vehicles Test Procedure |
| WTT             | Well-To-Tank  |
| WTW             | Well-To-Wheel   |

## Summary

Climate change is a global phenomenon characterized by changes in the normal climate in terms of temperature, precipitation, and wind, over 30 years worldwide, and presents one of the world's most pressing challenges. According to the European Environment Agency, around 22% of the total global emissions are related to the transportation sector (and combustion engines - except in the industry). Road transportation emits 70% of the whole transportation sector's GHG emissions. More specifically, standard cars emit 44.3% of the GHG emissions associated with transportation. Public authorities, governments and world unions need to stop this upward trend by applying several public interventions. In 2011, The European Union set the goal to reduce 60% of all GHG emissions from the transportation sector by 2050, compared to 1990. Therefore, additionally to the Paris Agreement of 2016, The European Commission (EC) implemented the directive *(EC)443/2009* and The European Parliament and the Council adopted Regulation *(EU)2019/631*. These directives force automotive industries to reach an average of 95 gCO<sub>2</sub>/km/vehicle by 2020 in all European markets, based on their vehicle's weight sales, and to respect a decrease of these emissions by 37.5% in 2030 compared to 2020.

Several solutions could be applicable to limit the CO<sub>2</sub> emitted by vehicles. First, automakers have initiated a solution that ensures a decrease in the fleet's CO<sub>2</sub> emissions: technical improvements, such as lightweight design and improving aerodynamics. While technical improvements could considerably reduce a vehicle's CO<sub>2</sub> emissions, they come with additional costs on both the automaker and the customer, and meeting CO<sub>2</sub> long-term engagement decarbonisation could hardly be achieved with. Switching to lower-carbon fuels, such as ethanol, natural gas, biofuels, synthetic fuels, hydrogen, and electricity, could be another solution for achieving strict CO<sub>2</sub> emissions targets. Electric Vehicles, Battery Electric Vehicles (BEVs) or Plug-In Hybrid Electric Vehicles (PHEVs) present a promising solution for replacing Internal Combustion Engine Vehicles (ICEVs) thanks to their low or zero-emission. Indeed, these emissions highly depend on the electricity mix of the country. However, several barriers are still facing its widespread purchasing activity: namely technical (battery technology and Research & Development (R&D)), social (lack of knowledge, and perspective, acceptability or social feasibility), economic (vehicle price, battery cost), infrastructure (charging infrastructure coverage), and policy (lack of clear governmental roadmap). Additionally to the automaker and the client, a new member is involved in the charging infrastructure's business ecosystem. Such infrastructure development is very capital intensive and requires the high adoption of electric vehicles. This so-called "egg and chicken problem"

## *Summary*

dilemma is a significant issue in the electrification of passenger cars and has significant consequences on the design of support policies. Moreover, the emergence of EVs as an alternative to conventional cars (with an internal combustion engine) is pushing automotive manufacturers to adjust their business models and investigate new innovative ones.

This dissertation aims at investigating innovative business models by examining the transactions within the members of the EV ecosystem. This dissertation deals with prospective and multidisciplinary research in economics, management sciences, and engineering sciences on decarbonised car systems' future. This thesis explores various facets of the electric cars transition. It evaluates the technical, economic, and environmental perspectives of specific questions that ensure the decarbonisation of the automotive transportation sector and boost the electric vehicle market in Europe and especially in France. This report comprises autonomous and heterogeneous chapters that share the same goal: boosting the energy transition in the automobile sector by eliminating the barriers stopping the electric vehicle uptake.

The **First Chapter** exposes the background of this thesis by providing an overview of techno-economic-environmental aspects of electric mobility transition, detailing the main key factors, and pointing out the main research gaps and questions in the literature. The **Second Chapter** addresses the charging point operator member interactions within the ecosystem by addressing the infrastructure deployment main barriers. This chapter presents a literature review about the charging infrastructure deployment methodologies, and it mentions the neglected set of parameters that are noteworthy and should be considered in further studies of charging network deployment: namely the application in urban and rural areas while considering driving behaviours and the driver's comfort, temporal horizon, environmental impact (LCA chargers), new mobility services, and external conditions. The **Third Chapter** investigates the trade-offs between the different-power charging infrastructure and the BEV owner by considering: BEV investment and range, public infrastructure availability, at-home charger availability, and the adaptability between charger and BEV in terms of technical constraints. We concluded with the most suitable BEV battery capacity for urban and rural different needs, and the installation of fast chargers. The main goal of the **Fourth Chapter** is to analyse the influence of socio-demographic (population density, age, unemployment rate), economic (subsidies, taxes exemption, income, gasoline price), availability (number of BEV models, number of PHEV models), and technical (density of slow-and-normal chargers, density of fast chargers, density of ultra-fast chargers) factors on the electric vehicle adoption in French departments, from 2015 to 2019, using mixed-effects regression. This chapter points out policy recommendations to accelerate the electric mobility transition. The **Fifth Chapter** analyses the influence of the

## *Summary*

Regulation number (EU)2019/631 adopted by The European Union and Commission on the automotive manufacturers' portfolio and compares the results with the directive of the European Commission.

These findings could be analysed using a transversal approach to link the chapters. We identify two main dimensions. First, this dissertation focuses on ecosystem cooperation by providing solutions that maximize the utilities of all members in terms of battery capacity and charging power. Second, this dissertation comes with policy identification that helps to identify roadmaps for electric mobility transition.



## Résumé

Le dérèglement climatique est un phénomène global caractérisé par des modifications du climat en termes de température, de précipitations et de vent, depuis une période de 30 ans, à l'échelle mondiale, et constitue l'un des défis les plus pressants pour la Planète. Selon l'Agence européenne pour l'environnement, environ 22 % du total des émissions mondiales sont liées au secteur des transports (et aux moteurs à combustion - sauf dans l'industrie). Le transport routier émet 70 % des émissions de GES de l'ensemble du secteur des transports. Plus précisément, les voitures standard émettent 44,3 % des émissions de GES associées au transport. Les autorités publiques, les gouvernements et les organisations mondiales doivent arrêter cette tendance à la hausse en appliquant plusieurs modes d'interventions publiques. En 2011, l'Union européenne s'est fixé pour objectif de réduire de 60 % les émissions de GES du secteur des transports d'ici 2050, par rapport à 1990. Par conséquent, en plus de l'accord de Paris de 2016, la Commission européenne (CE) a mis en œuvre la directive (CE)443/2009 et le Parlement européen avec son Conseil ont adopté le règlement(UE)2019/631 : ces directives obligent les industries automobiles à atteindre une moyenne de 95 gCO<sub>2</sub>/km/véhicule d'ici 2020 sur tous les marchés européens, sur la base du poids des véhicules vendus, et à respecter une diminution de ces émissions de 37,5% en 2030, par rapport à 2020.

Plusieurs solutions pourraient être appliquées pour limiter les émissions de CO<sub>2</sub> des véhicules. Tout d'abord, les constructeurs automobiles ont lancé des solutions qui garantissent ensemble une diminution des émissions de CO<sub>2</sub> de la flotte : toutes les améliorations techniques, telles que la conception légère et l'amélioration de l'aérodynamisme, etc. Bien que ces améliorations techniques puissent réduire considérablement les émissions de CO<sub>2</sub> d'un véhicule, elles s'accompagnent de coûts supplémentaires tant pour le constructeur que pour le client, et semblent insuffisantes pour respecter l'engagement de décarbonisation à long terme. Le passage à des carburants à faible teneur en carbone, comme l'éthanol, le gaz naturel, les biocarburants, les carburants synthétiques, l'hydrogène et l'électricité, pourrait être une autre solution pour atteindre des objectifs stricts en matière d'émissions de CO<sub>2</sub>. Les véhicules électriques, les véhicules électriques à batterie (BEV) ou les véhicules électriques hybrides rechargeables (PHEV) constituent une solution prometteuse pour remplacer les véhicules à moteur à combustion interne (ICEV), grâce à leurs émissions faibles ou nulles. Ces émissions dépendent fortement du mix électrique du pays. Cependant, plusieurs obstacles se dressent encore devant la généralisation de l'achat de ces véhicules : des obstacles techniques (technologie des batteries et recherche et développement (R&D)), sociaux (manque de

## *Résumé*

connaissances et de perspectives, acceptabilité ou faisabilité sociale), économiques (prix des véhicules, coût des batteries), d'infrastructures (couverture de l'infrastructure de recharge) et politiques (absence de feuille de route gouvernementale claire, précise). En plus du constructeur automobile et du client, un nouveau membre est impliqué dans l'écosystème : l'infrastructure de recharge. Le développement d'une telle infrastructure est capitalistique et nécessite une forte adoption des véhicules électriques. Ce dilemme dit de "l'œuf et de la poule" est un problème central dans l'électrification des voitures particulières et a des conséquences significatives sur la conception des politiques de soutien. De plus, l'émergence des VE en tant qu'alternative aux voitures conventionnelles (avec un moteur à combustion interne) pousse les constructeurs automobiles à ajuster leurs modèles d'affaires et à en rechercher de nouveaux.

Cette thèse vise donc à étudier les modèles commerciaux innovants en examinant les transactions au sein des membres de l'écosystème des VE. Cette thèse traite de recherches prospectives et multidisciplinaires en sciences économiques et de gestion, et sciences de l'ingénieur, sur l'avenir des systèmes automobiles décarbonés. Cette thèse explore les différentes facettes de la transition vers la voiture électrique. Elle évalue les perspectives techniques, économiques et environnementales de questions spécifiques, permettant d'assurer la décarbonisation du secteur du transport automobile et de dynamiser le marché du véhicule électrique en Europe et notamment en France. Ce rapport est composé de chapitres autonomes et hétérogènes qui partagent le même objectif : favoriser la transition énergétique dans le secteur automobile en éliminant les barrières qui freinent l'adoption du véhicule électrique.

Le premier chapitre expose le contexte de cette thèse en fournissant une vue d'ensemble des aspects technico-économiques-écologiques de la transition vers la mobilité électrique, en détaillant les principaux facteurs clés et en soulignant les principales lacunes et questions de recherche. Le deuxième chapitre traite des interactions entre les membres de l'opérateur de borne de recharge au sein de l'écosystème, en abordant les principaux obstacles au déploiement de l'infrastructure. Ce chapitre présente une revue de la littérature sur les méthodologies de déploiement des infrastructures de recharge et mentionne l'ensemble des paramètres négligés qui sont dignes d'intérêt et qui devraient être pris en compte dans les études ultérieures sur le déploiement des réseaux de recharge : à savoir l'application dans les zones urbaines et rurales, tout en tenant compte des comportements de conduite et du confort du conducteur, de l'horizon temporel, de l'impact environnemental (chargeurs LCA), des nouveaux services de mobilité et des conditions extérieures. Le troisième chapitre étudie les compromis entre infrastructure de recharge de différentes puissances et l'autonomie du BEV, ainsi que la disponibilité de l'infrastructure publique, la disponibilité du chargeur à domicile, et l'adaptabilité entre le

## *Résumé*

chargeur et le BEV en termes de contraintes techniques. Nous concluons sur la capacité de la batterie du BEV la plus adaptée aux besoins urbains et ruraux, et sur l'installation de chargeurs rapides. L'objectif principal du quatrième chapitre est d'analyser l'influence des facteurs sociodémographiques (densité de population, âge, taux de chômage), économiques (subventions, exonération d'impôts, revenus, prix de l'essence), de disponibilité (nombre de modèles de BEV, nombre de modèles de PHEV) et techniques (densité de chargeurs lents et normaux, densité de chargeurs rapides, densité de chargeurs ultra-rapides) sur l'adoption des véhicules électriques dans les départements français, de 2015 à 2019, en utilisant une régression mixed-effects. Ce chapitre met en avant des recommandations politiques pour accélérer la transition vers la mobilité électrique. Le cinquième chapitre analyse l'influence du règlement numéro (UE)2019/631 adopté par l'Union européenne et la Commission sur le portefeuille des constructeurs automobiles et compare les résultats obtenus avec ceux de la directive européenne.

Nos résultats pourraient être analysés en utilisant une approche transversale pour relier les chapitres de la thèse. Nous pouvons identifier deux dimensions principales. Premièrement, cette thèse se concentre sur la coopération de l'écosystème en fournissant des solutions qui maximisent les utilités de tous les membres, en termes de capacité de batterie et de puissance de charge. Deuxièmement, cette thèse s'accompagne d'une identification des politiques laquelle permet de définir des feuilles de route pour une transition vers la mobilité électrique.





## **Chapter 1: General Introduction**

This dissertation deals with prospective multidisciplinary research on the future of decarbonised transportation systems in economics, management sciences, and engineering sciences. We evaluated the technical, economic, and environmental trade-offs of specific questions that deal with the decarbonisation of the automotive transportation sector and aims to boost the electric vehicle market in Europe, especially in France. These questions are issued from the interactions between the members or stakeholders of the electric vehicle (EV) ecosystem, such as building new innovative business models for charging operators, investigating the CO<sub>2</sub> regulations and their influence on the automotive manufacturers. The following sections of this introductory chapter will provide the readers with a general review of global warming and the role of electric vehicles in decarbonizing the road transportation sector. Section 2 develops the techno-economic-environmental parameters of electric vehicles before detailing the different types of barriers facing a high adoption of EVs. Section 3 provides an overview of charging infrastructure characteristics before detailing the electric vehicle ecosystem members and the scenario considered in this thesis in Section 4. This Chapter ends with identifying the research gaps in the literature, the research questions of this Thesis, and a summary of the Chapters of this dissertation.



# 1. Climate Change: from Global Warming to Road Transportation Decarbonization

## 1.1. Definition of Climate Change

Climate change is a global phenomenon characterized by changes in the “normal” climate, temperature, precipitation, and wind, over 30 years worldwide. It is one of the world's most human pressing challenges. Emissions of greenhouse gases (GHG), including carbon dioxide (CO<sub>2</sub>), nitrous oxide, methane, and others, have significantly increased global temperatures by around 1°C since pre-industrial times. It is now well accepted that GHG emissions mainly come from human activities' burning fossil fuels (oil, gas, or coal). Figure 1.1 presents the global average temperature anomaly, due to its sharp increase, between 1850 and 2018. After the Industrial Revolution in 1760-1840, global temperatures have risen to around 0.7°C higher than the baseline of 1960-1990, and around 1.1°C compared to 1850.

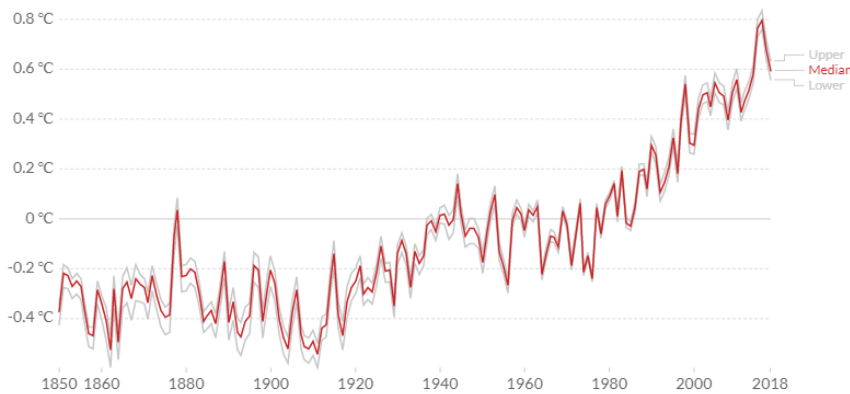

Figure 1.1 Global Average Temperature Anomaly from 1850 to 2018 (Source: Hadley Centre)

Figure 1.2 presents the CO<sub>2</sub> concentrations in the atmosphere in a different period, from 800,000 years BCE to 2018, and shows a link between global temperatures and CO<sub>2</sub> concentrations throughout Earth's history. The CO<sub>2</sub> concentration fluctuated over this period, between 170 ppm (parts per million) and 300 ppm, identifying two essential periods in history: when CO<sub>2</sub> levels are low as it is captured in ice ages and interglacial when CO<sub>2</sub> scored high values. Since the Industrial Revolution, the CO<sub>2</sub> concentration sharply jumped to exceed 400 ppm in 2018. This rise is mainly explained by the dependency of human activities on fossil fuels, especially after the revolution era. The Intergovernmental Panel on Climate Change (IPCC) clearly stated that humans are the main reason behind climate change: "*Human influence on climate has been the dominant cause of observed warming since the mid-20th century, while global average surface temperature warmed by 0.85°C between 1880 and 2012*" (IPCC, 2018).

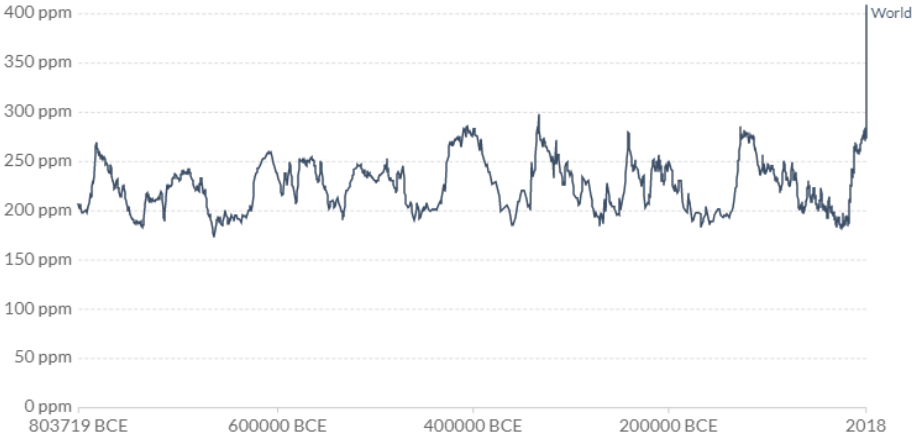

Figure 1.2 Atmospheric CO<sub>2</sub> Concentration, 803719 BCE to 2018 (Source: EPICA Dome C CO<sub>2</sub> record (2015) & NOAA (2018))

Not all countries around the world share the same trend of CO<sub>2</sub> emissions. As illustrated in Figure 1.3, the annual total CO<sub>2</sub> emissions are experiencing modest downward trends for Europe, The United States of America, Africa, and the Middle East. Contrary to these regions, the related emissions emitted by the Asian regions, especially in China, are steeply growing. It should be noted that, according to Figure 1.4, the contribution of the CO<sub>2</sub> emissions per capita is the highest for the United States, followed by Russia, China and the European Union countries.

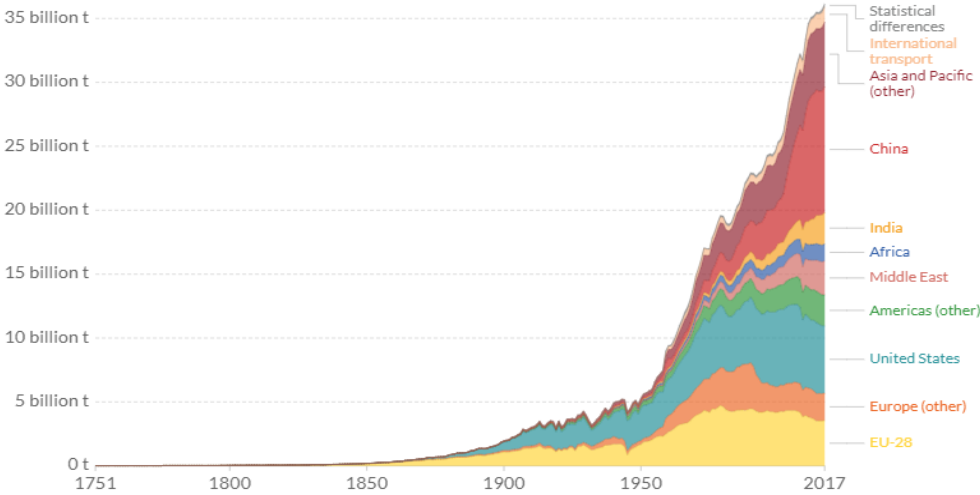

Figure 1.3 Annual Total CO<sub>2</sub> Emissions, by World Region, from 1751 to 2017 (Source: Carbon Dioxide Information Analysis Center (CDIAC) & Global Carbon Project (GCP))

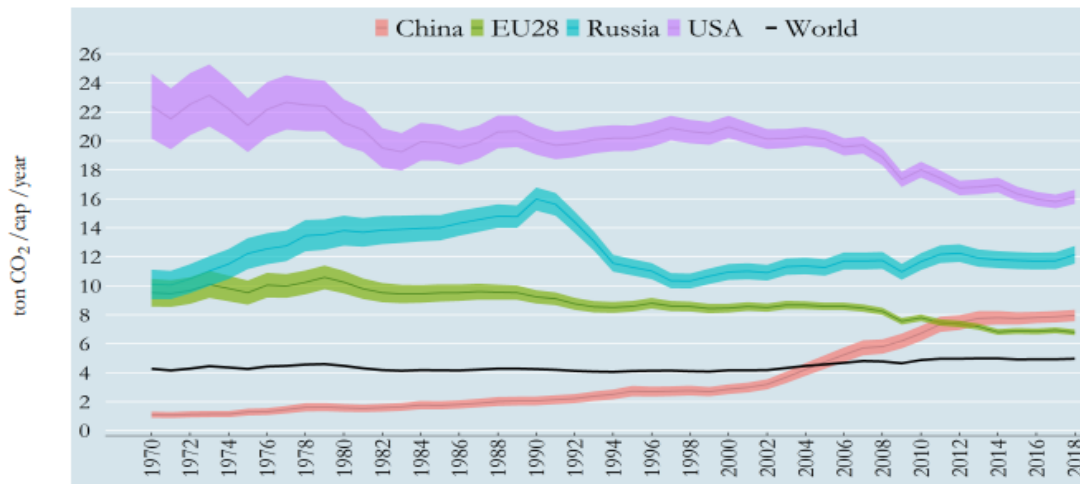

Figure 1.4 Per Capita CO<sub>2</sub> Emissions (in t CO<sub>2</sub>/cap/yr) from Fossil Fuel Use, industrial processes, and product use (Source: (Crippa et al., 2019))

Figure 1.5 shows global GHG emissions by primary sectoral utilization: power industry, other industrial combustion, buildings, transportation, and other services. The CO<sub>2</sub> emissions associated with the power industry accounts for the highest value: more than 33% of the total emissions. Around 22% of the total emissions are related to each of the transportation and other industrial combustion sectors. Similarly, each of the buildings and other sectors emits around 10% of the total value.

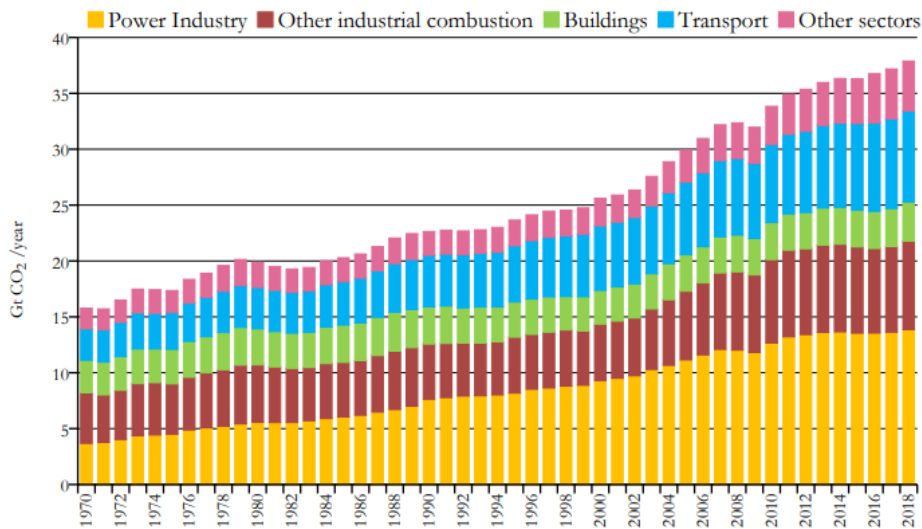

Figure 1.5 Total Global Annual Emissions of Fossil CO<sub>2</sub> in Gt CO<sub>2</sub>/yr by Sector (Source: (Crippa et al., 2019))

According to the European Environment Agency (Figure 1.6), road transportation emits the most GHG emissions (71.7%), followed by aviation (13.9%) and maritime transportation (13.3%). Regarding the road transportation sector, 44.3% of the GHG emissions associated with the transportation sector are emitted by standard cars. Heavy-duty trucks and buses emit around

19% of these emissions, while light-duty trucks emit 8.7%.

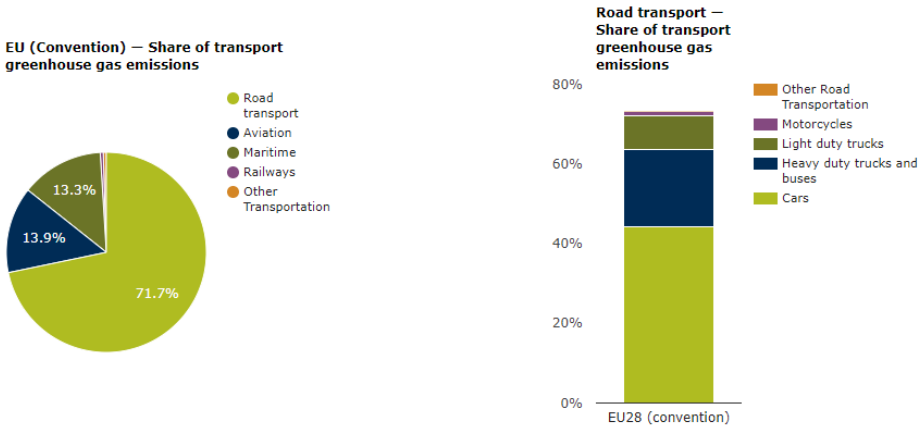

Figure 1.6 GHG Emissions by the Transportation Sector (Source: European Environment Agency, 2020)

Moreover, the problem of "Air quality" recently received widespread attention. It refers to the condition of the air in our surroundings. Local air quality is determined by evaluating various pollution indicators: natural or manufactured factors. Natural resources include volcanic eruptions and storm dust. Manufactured pollution sources include emissions caused by moving vehicles, toxic gases produced by industries, coal power plants, open burning of wood or other materials, and landfills. Both sources affect the overall air quality and may cause serious human health problems. Good air quality is related to the degree of air being clean, clean, free of pollutants (such as smoke, dust and smog) and other gaseous impurities in the air. The issue of air quality has become critical in recent years and concerns most major cities and some industrial regions of the world, mainly in Asia, where air quality regulation has struggled to keep pace with rapid industrial development and urbanisation (IEA, 2016). Local air quality and global climate change prove two sides of the same coin: policies are aimed at reducing greenhouse gas emissions and other pollutants from current transportation, especially cars. Isaac (2020) divided the interventions into vehicle/fuel, planning design, industrial agricultural, and behavioral interventions. Regarding road transportation interventions – the scope of the thesis - air quality is likely to be improved by any intervention that promotes the uptake of low and zero-exhaust emission vehicles, particularly electric vehicles.

1.2.The Necessity for Public Interventions

As seen in Figure 1.5, global GHG emissions have been steeply rising over the last few decades. Therefore, governments need to stop this upward trend. Since 1992, fruitful

international agreements have been reached during negotiations at events like the Conference of the Parties (COP), such as The United Nations Framework Convention on Climate Change (1992), The Paris Agreement (2015), and recent COPs. All these summits had well-defined objectives: to limit the global temperature rise, build a global strategy for the fight against climate change for the post-2020 period, and provide financial support for this roadmap. The long-term objective is to stabilise atmospheric greenhouse gas concentrations at a level that would prevent dangerous anthropogenic interference with the climate system. Regarding national interventions, each country – or a group of countries - has set itself a goal of GHG reductions and decided to adopt specific laws, such as The adoption of the Corporate Average Fuel Economy in the United States of America in 1975, the European Commission (EC) implemented EC directive 443/2009 and 631/2019, and the recent European green Deal. In this thesis, we will exclusively consider European regulations.

The European Union (EU) has set the goal to reduce 60% of all GHG emissions from the transportation sector by 2050, compared to 1990. The European Commission (EC) implemented EC directive 443/2009 and 631/2019 (EC, 2019), forcing automotive industries to reach an average of 95 gCO<sub>2</sub>/km/car by 2020 in all European markets. This goal is reduced to 20 gCO<sub>2</sub>/km by 2050 to reach a decrease of 2°C (Gnann, 2015).

From the 30th of November 2015 to the 12th of December 2015, the 21st Conference of Parties on Climate Change was held in Paris, resulting in a signature of a historical agreement of 196 countries to undertake ambitious efforts to combat climate change. It required all parties to put forward their best efforts through "nationally determined contributions". The 196 parties agreed on a common goal to "*hold the increase in the global average temperature to well below 2°C above pre-industrial levels and pursuing efforts to limit the temperature increase to 1.5°C*" (UNFCCC Secretariat, 2015). In order to ensure environmental integrity, a transparency framework was created, and 5-yearly Global Stocktakes from 2023 onwards were planned.

### **1.3.Solutions for a Decarbonized Road Transportation**

Policymakers decided to impose stringent regulation on fleet GHG Tailpipe emissions to stimulate the R&D efforts of automotive manufacturers, leading to less-polluting vehicles. As mentioned before, it could be achieved by boosting the energy efficiency for ICEVs or by battery technologies and electric engines for EVs if decarbonisation of the energy sector accompanies it. Therefore, automotive manufacturers must diversify their alternative fuel vehicles and make these vehicles attractive to customers. This regulation was first introduced in 1975 in the U.S. under the CAFE standard "Corporate Average Fuel Economy". This



standard aims to reduce light-duty vehicle fossil fuel use, GHG emissions, and fuel costs by requiring automakers to produce more fuel-efficient vehicles (Luk et al., 2016). The yearly production-weighted average consumption of vehicles produced by each manufacturer is calculated. Similarly, The European Parliament and the Council adopted Regulation number (EU)2019/631, setting new EU fleet-wide CO<sub>2</sub> emission targets for 2025 and 2030, both for newly registered passenger cars and for newly registered vans (EC, 2019). In 2021, EU car manufacturers must fix their CO<sub>2</sub> targets based on their new sold fleets' weights. CO<sub>2</sub> limits regulations become stricter for the long term, explicitly reducing 15% and 37.5% compared to 2021 must be achieved by 2025 and 2030, respectively (EC, 2019). In the case of non-respect of these targets, manufacturers must pay a penalty of €95 per car per exceeded gram CO<sub>2</sub>/km (EC, 2019).

Several solutions could be applicable to limit the CO<sub>2</sub> emitted by vehicles. First, automakers have initiated a type of solutions that ensure a decrease in the fleet's CO<sub>2</sub> emissions: technical improvements, such as lightweight design, improving aerodynamics, low rolling resistance tyres, thermal engine management and friction reduction, Brake Energy Recuperation (BER), and transmission upgrade. While technical improvements could considerably reduce vehicle's CO<sub>2</sub> emissions, they come with additional costs on both the automaker and the customer, and full road decarbonisation could hardly be achieved (IEA, 2020). Second, governments proposed policies characterized by reducing driving by increasing the gas tax to trips more expensive or implementing congestion taxes to disincentives driving in high-traffic areas and during high-traffic times, limiting parking, increasing density, and increasing density reallocating urban space. These solutions have worked in several cities; however, they do not guarantee a decarbonized road transportation sector. Third, switching to lower-carbon fuels, such as ethanol, natural gas, biofuels, synthetic fuels, hydrogen, and electricity, could be another solution for a CO<sub>2</sub> emissions decrease. However, these substitutions have a higher cost; some could have lower energy density than fossil-fuel dependent solutions, and have direct or indirect emissions, leading to another complex problem: decarbonising the energy/electricity mix. Also, creating the necessary infrastructure is mandatory to avoid the 'Chicken and egg dilemma'. To ensure a drastic reduction of CO<sub>2</sub> emissions, car manufacturers have already initiated the electric vehicles' market introduction (Hüls et al., 2020).

Alternative Fuel Vehicles (AFVs), especially Battery Electric Vehicles (BEVs), Plug-in Hybrid Electric Vehicles (PHEVs) or Fuel Cell Electric Vehicles (FCEVs), could provide a means to reduce emissions from the transportation sector because they are not unconditioned

to fossil fuel. Yet, they could emit indirect emissions, depending on their Life Cycle Assessment and the decarbonisation of the electricity sector, that are lower than ICEV's direct emissions. The environmental impact will be further discussed in this introductory chapter.

## 2. Electric Vehicles as a Solution

This section presents an overview of electric vehicles and introduces their main elements and charging infrastructures. First, we will present some generalities about electric vehicles (definitions, categories, history of EVs, advantages and EVs, advantages and disadvantages, architectures and main components). Then, we will discuss their charging, the different energy sources, and the different topologies and means of charging. Finally, we address the energy flows in a charging system, namely the flows from the network to the vehicle (G2V) and from the vehicle to the network (V2G).

### 2.1. Definition of Electric Vehicles

An electric vehicle (EV) is an alternative fuel automobile that uses electric motors and motor controllers instead of more common propulsion methods such as the Internal Combustion Engine Vehicle (ICEV). EVs partially or rely on electricity, stored in an energy storage device - i.e. a battery or a fuel cell-, as a transportation fuel to power their propulsion. The job of an electric motor transfers the energy from the battery to the vehicle's wheels. Batteries are charged using an external electrical source using a charger. EVs are different from ICEVs in that they can receive their energy from a wide range of sources, depending on their types, such as fossil fuels, nuclear power, and renewable sources (tidal power, solar power, and wind power).

### 2.2. Types of Electric Vehicles

There are several types of EVs: Battery Electric Vehicles (BEVs), Plug-In Hybrid Electric Vehicles (PHEVs), Hybrid Electric Vehicles (HEVs), and Fuel Cells Electric Vehicles (FCEVs). Table 1.1 shows several details of one of the most famous electric vehicles models in 2020-2021. Regarding the scope of this study, only BEV and PHEV are considered.

- **Battery Electric Vehicle (BEV):** These vehicles rely on batteries as a primary energy source. The energy sources for this type of vehicle are batteries recharged by the electrical grid or other renewable energies, such as renewable energies (solar, wind). These vehicles' batteries are recharged by fixed electrical outlets or by battery exchange.

- **Plug-in Hybrid Electric Vehicle (PHEV):** These vehicles rely on the fossil fuel tank as a primary energy source and battery as a second energy source. These vehicles are powered by an internal combustion engine, replaced by an electric motor for city traffic. The latter is powered by a battery coupled, charged by external sockets, with an internal combustion engine via an alternator.
- **Hybrid Electric Vehicle (HEV):** HEVs contains a conventional internal combustion engine and an electric propulsion system. The primary engine is the internal combustion one, while the electric motor assists the engine, with its primary purpose being to increase the fuel economy. Batteries cannot plug-in and recharge from the grid, so they use their internal combustion engines and regenerative braking systems to recharge their propulsion vehicle batteries.
- **Fuel Cell Electric Vehicle (FCEV):** FCEVs do not have a combustion engine nor battery, but electrochemical cells transform hydrogen into power.

Table 1.1 Typical Electric Vehicles and Their Main Characteristics (Source: official websites of brands)

| Vehicle Model                       | Peugeot<br>e208 | Citroën<br>ami | Toyota<br>Prius | Mitsubishi<br>Outlander | Toyota Mirai     |
|-------------------------------------|-----------------|----------------|-----------------|-------------------------|------------------|
| Release year                        | 2020            | 2020           | 2018            | 2018                    | 2018             |
| Type                                | BEV             | BEV            | HEV             | PHEV                    | FCEV             |
| Entry price (€)                     | 33000           | 7000           | 32300           | 37000                   | 78900            |
| Battery size (kWh)                  | 46              | 5.5            | 1.3             | 13.8                    | 1.6              |
| Fossil-fuel autonomy (km)           | 0               | 0              | 500             | 550                     | 650 <sup>1</sup> |
| Electric autonomy <sup>2</sup> (km) | 450             | 75             | 0               | 55                      | 0                |
| CO2 emissions (g/km)                | 0               | 0              | 106             | 46                      | 0                |

### 2.3. Brief History of Electric Vehicles

The idea of using electrical energy to move vehicles is not new and was introduced more than 100 years ago. During this period, EV technology experienced several starts and stops. The creation of EVs was a series of breakthroughs and was not associated with one inventor or a country. It was during the 19<sup>th</sup> century that the first electric vehicle was introduced.

In the early 19<sup>th</sup> century, innovators in Hungary, the Netherlands and the United States began developing batteries-powered vehicles and created the first small-scale electric vehicles.

<sup>1</sup> Toyota Mirai uses Hydrogen as a source of energy.

<sup>2</sup> In WLTP needs.

During the second half of the 19<sup>th</sup> century, specifically in 1880, French inventors Charles Jeantaud, Camille Faure, Gustave Trouvé and Nicolas Raffard created the first electric vehicles. This technological feat could not have been achieved without the lead battery invention by Gaston Planté and Camille Faure twenty years earlier. Nevertheless, in May 1899, the viability of the electric car was revealed to the world. Indeed, the "*Jamais Contente*" driven by the Belgian Camille Jenatzy exceeded 105 km/h (Høyer, 2008; Kant, 1995; Nouh, 2008).

In the 20<sup>th</sup> century, there was no considerable advancement in the technology of electric vehicles. Research and development mainly focused on technological updates of ICEVs, made these vehicles cheaper and more ecological with lower GHG emissions. In 1976, the US Congress and various automakers, such as General Motors, decided to invest in the Electric and Hybrid Vehicle Research and Development due to several worldwide crises, namely the oil prices that rocketed and the shortage in gasoline, especially with the 1973 Arab Oil Embargo (Matulka, 2014).

In the 21st century, and after the 2008 oil shock, electric mobility was believed to become the "*Second Automobile Revolution*" (Villareal, 2014). The automotive sector, which has already been challenged with various oil obstacles, are now confronted with the inevitable scarcity of oil, global warming, and emissions standards imposed on the industry as a whole by local and international authorities. The automotive industry proposes more ecological, environmental, and independent of fossil fuels alternative solutions to address these issues. Among the solutions put forward by car manufacturers are cars that run on biofuels, such as ethanol gasoline, and those using other types of vehicles: electric cars.

During the 21st century, the true revival of commercial electric vehicles happened. Released by Toyota in Japan in 1997 and worldwide in 2000, the Prius became the world's first commercial and mass-produced hybrid electric vehicle (Matulka, 2014). In 1997, the Citroën Berlingo was released, and it represented the first generation of this type of vehicle (Mkahl, 2015). In February 2008, Tesla released the first highway legal serial production BEVs to use lithium-ion battery cells, with a range of more than 320 kilometres per charge (Shahan, 2015). In late 2010, Chevrolet released the first PHEV in the US market: the Chevy Volt, a gasoline engine and an electric drive (Matulka, 2014). Volt drivers use the electric part for most trips and gasoline to extend their range when depleting the battery. Since late 2015, Toyota released the Toyota Mirai, and it is recognized as the world's first FCEV car to be produced on a large scale (Automobile Propre, 2020).

## 2.4. Technical Components of EV

As mentioned earlier, an EV is powered by an electric motor driven by an energy source (fuel cell, battery or internal combustion engine generator), and thus, differences are noticed regarding the technical components of EVs.

The powertrains' technological differences are detailed in Table 1.2. ICEVs are fully powered by traditional gasoline, diesel, biofuels, or even natural gas engines. On the contrary, BEVs have no internal combustion engine, emission control, nor fuel tank and run on a fully electric drivetrain powered by batteries that could be charged by plugging into an external power source. Regarding PHEV, this type of vehicle contains a hybrid drivetrain and uses both an internal combustion engine and an electric engine. Their battery could be charged externally by plugging into an external power source. When the battery is depleted, the PHEV starts acting as a regular hybrid, with the combustion engine taking the primary power source role. Yet, since the battery is a second power source in a PHEV, its capacity is much smaller than BEV. Figure 1.7 represents the different configurations of these types of vehicles.

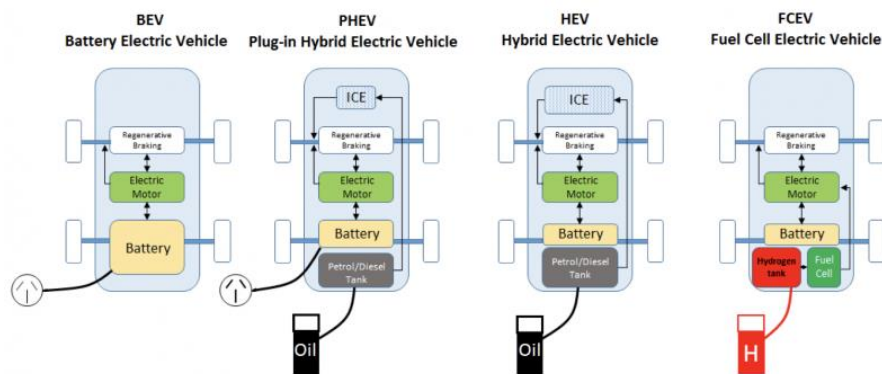

Figure 1.7 Different Configurations of Electric Vehicles<sup>3</sup>

<sup>3</sup> <https://thedriven.io/2018/11/14/the-ice-age-is-over-why-battery-cars-will-beat-hybrids-and-fuel-cells/>

Table 1.2 ICEV, BEV, and PHEV Main Components

|                               | ICEV | BEV | PHEV |
|-------------------------------|------|-----|------|
| Glider                        | ✓    | ✓   | ✓    |
| Emission control              | ✓    |     | ✓    |
| Integrated traction drive     |      | ✓   | ✓    |
| Combustion engine             | ✓    |     | ✓    |
| Electric engine               |      | ✓   | ✓    |
| Battery                       |      | ✓   | ✓    |
| Generator, transmission, rest | ✓    | ✓   | ✓    |

#### 2.4.1. Electric Engine

Different types of motors can be used to drive electric vehicles — motors with brushes (e.g. DC motor) or brushless motors (e.g. synchronous or asynchronous motor) (Mkahl, 2015). Direct current motors (DCM) are the most widely used motors. However, because of the recent development of power electronics associated with permanent magnets, other motors could be used in EVs, such as synchronous, synchronous, and asynchronous motors (MSAP) (Nouh, 2008).

#### 2.4.2. Battery

Alessandro Volta invented the first battery in a voltaic cell in the 1800s (Becherif et al., 2011). There are two types of batteries: the first one that, once used, cannot be recharged, and the second one, which is installed in an EV, can be recharged using an external power source and reused. The EV differs from the hybrid vehicle because it must also store the energy necessary to ensure broader autonomy and acceptable performances. The storage requirements are not the same for both types of vehicles. Indeed, for an EV, a high storage capacity is needed.

Batteries are "reversible" generators. They can store electrical energy in chemical form and then restore it at any time, thanks to the reversibility of the transformation (Loukakou et al., 2012). With the development of EVs, several battery technologies have emerged: Lead, Nickel-Cadmium (Ni-Cd), Lithium-Ion (Li-Ion), Lithium iron phosphate (Li-phosphate), Lithium Polymer (Li-Polymer), Nickel-Metal Hydride (Ni-MH), Zebra, and Zinc-air battery (Mkahl, 2015). The most common type of battery installed in EVs is the Li-Ion battery. Lithium-ion batteries have many advantages: a high power-to-weight ratio, a high energy efficiency, and good high-temperature performance. Also, Li-Ion batteries have a low "self-discharge" rate -i.e. they can maintain a full charge over time- compared to other technologies.

Additionally, most Li-Ion battery parts are recyclable, making this technology an eco-friendly one. The following three parameters characterize a battery:

- *Usable power ( $P = V.I$ ) in kW*: The usable power is the battery voltage (V) product and the maximum current it can deliver (I). The usable power must be at least equal to the electric motor's peak power to allow it to be powered over its entire operating range.
- *Stored energy in kWh*: This energy can be comparable to the volume of a vehicle's fuel tank. The stored energy will determine an EV's autonomy and the possibilities of recovery for a hybrid vehicle. An electric battery's energy is expressed as a function of its capacity in Ampere hours (Ah) and its voltage.
- *Charging Rate (C-Rate)*: First, battery sizing mainly depends on the capacity (Ah) and the charging current (A), two parameters that define the battery C-rate: the battery capacity rate is charged/discharged (Yong et al., 2015). The link between the battery capacity and the charging power could be defined by the C-rate formula, using Equation 1.1:

$$C_r = \frac{I}{E_r} \quad (1.1)$$

Where:

- $C_r$ : is the C-rate ( $h^{-1}$ )
- $I$ : is the charging current (A)
- $E_r$ : is the Energy rated (Ah).

A C-rate of 1C is also known as a one-hour discharge; 0.5C or C/2 is a two-hour discharge, and 0.2C or C/5 is a 5-hour discharge. Some high-performance batteries can be charged and discharged above 1C with moderate stress. The main challenge is identifying the C-rate that makes capacity utilization and battery charging speed well balanced (Duru et al., 2021). Indeed, achieving a high capacity utilization with low charging current rates could aggravate the battery premature ageing process, cause the slowdown of the battery's speed and further hurt BEV usage (Duru et al., 2021). This problem reveals the complexity of adapting battery sizes to charging powers since charging a small battery capacity with a high current could decrease the battery's energy storage efficiency (Waldmann et al., 2018). As EVs are

evolving fast, the batteries need to improve and adapt to the stringent requirements of automotive EVs. The Battery Management System (BMS) is a critical part of EVs to guarantee that batteries operate safely, are protected, and last longer. The BMS will also monitor voltage, different temperature parameters, and coolant flow (EVreporter, 2020). To clarify, when the battery is charging, the EV BMS determines the maximum current that an individual cell could receive. Therefore,

Overall, the literature in (Bhagavathy et al., 2021) shows that charging rates above 1C-rate negatively affect battery life. Indeed, rapid chargers can accelerate the degradation of batteries in vehicles. Therefore, the battery management system installed in vehicles will limit the level of power received to prevent accelerated degradation. Therefore, the impact of rapid charging also depends on these limits, which can be used as the numerator instead of the charger's power level to calculate the C-rate. Yet, the optimal C-rate varies with the chemical composition of the battery itself.

- *State of charge of the battery (SoC):* The State of Charge (in %) is the level of charge of an electric battery relative to its capacity at a given time. When a battery is fully charged, its state of charge is charged, its state of charge is SOC = 100%. The SoC of the battery should always stay between 20% and 80%, leading to a higher battery lifetime (Redondo-Iglesias et al., 2019).

The range of an electric vehicle primarily depends on its battery capacity –i.e. the stored amount of electricity. Also, an EV's autonomy is affected by other factors, such as the average driving speed, energy efficiency, acceleration intensity, road topography, weather, number of passengers, and baggage weight in the trunk. Therefore, two vehicles with the same battery capacity do not share the same range; two people driving the same EV will not necessarily obtain the same range. Since potential EV buyers aim to analyse and compare the range of different vehicles on the market using a universal standard, several test protocols have been developed to limit the difference between theoretical and actual ranges. Introduced by the European Union in 1992, the standardised New European Driving Cycle (NEDC) provided comparable fuel consumption values for all passenger vehicles and light commercial vehicles. In September 2017, The Worldwide Harmonized Light-Duty Vehicles Test Procedure (WLTP), a worldwide standard for testing passenger vehicles and light commercial vehicles, replaced the NEDC standard. WLTP standard was introduced to close the gap between theoretical and actual ranges by providing range values similar to those that a driver might experience in their daily



trips, including a combination of usages: urban, suburban, and freeway travel. Indeed, driving on highways consume up to two more than city usage. For instance, a Peugeot e208 with a 50 kWh battery capacity provides 340 kilometres of autonomy in the WLTP cycle or 450 km with the old NEDC standard.

### 2.4.3. Power Converter

The third main component of an EV is the power converter. Since different energy sources with different characteristics are used, deploying a power converter is necessary. It is noteworthy to note that a Direct Current charges a battery. Figure 1.8 presents the current conversion placement. The power converters that can be used on an EV are of the following types (Boucherit, 2011; Nouh, 2008):

- *Chopper*: a DC to DC converter of different voltage DC/DC.
- *Inverter*: a DC to AC converter.
- *Rectifier*: an AC to DC converter.

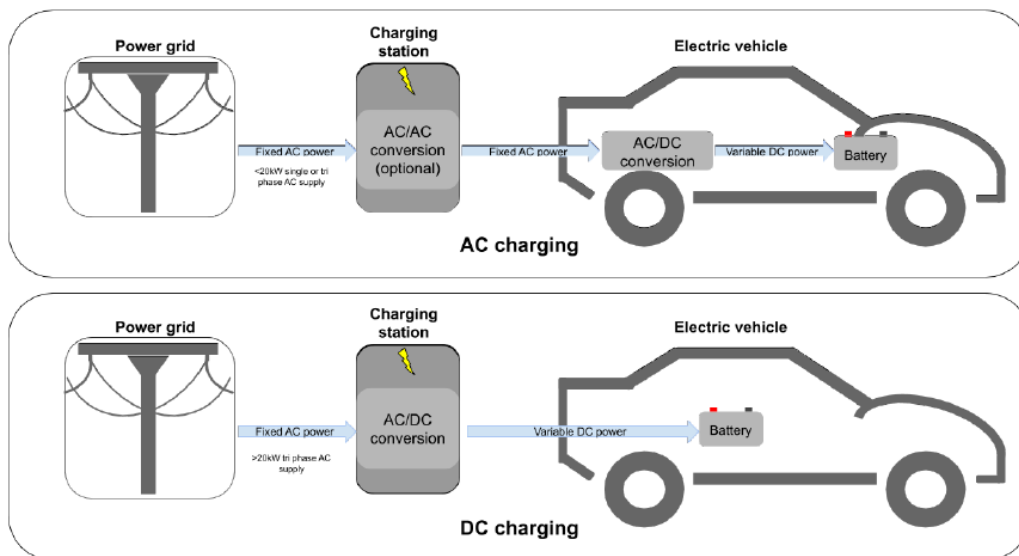

Figure 1.8 Charging process of electric vehicles (Source:(Metais et al., 2021))

### 2.4.4. Charging Connector

The choice of the power converter, which depends on the vehicle and thus the automaker's strategy, Figure 1.19, will determine the charging technology compatible with the

vehicle. There is no clear charging connector standardization. Generally, vehicles are equipped with a Type 1 (the standard connector in America and Japan) or a Type 2 (the standard connector in Europe) connector for AC charging. Only some vehicles have a second connector prepared for DC charging (CHAdEMO or Combined Charging System (CCS)). CCS plug is an improved version of the Type 2 plug with two additional contacts and allows fast charging. It also supports both AC and DC charging. More information on charging sockets are detailed in the charging infrastructure section.

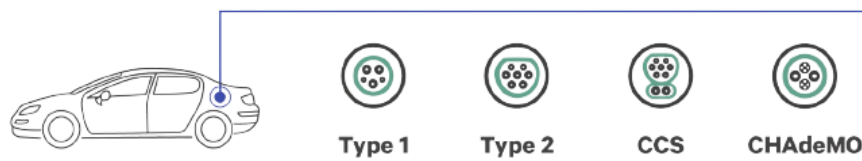

Figure 1.9 Charging Connector in Electric Vehicles<sup>4</sup>

## 2.5. The Environmental Footprint of EV

BEV, PHEV, HEV, and FCEV are not pollution-free due to their full-electric modes indirectly emit air pollutants, especially CO<sub>2</sub>. GHG emissions related to EVs should be evaluated based on their Life Cycle Assessment, a methodology for assessing environmental impacts associated with all the life-cycle stages of a commercial product, process, service, and components recycling. Figure 1.10 presents a simplified view of the Life Cycle Assessment of the production process of a vehicle. Vehicles emit GHG emissions throughout their life cycle, called Well-To-Wheels emissions (WTW), which focuses on the energy carrier's life cycle used to move the vehicle, such as fossil fuel or electricity. The TWT life cycle can be divided into the Well-To-Tank (WTT) and the Tank-To-Wheel stage. The WTT stage defines the emissions required to deliver energy from its source to the vehicle's storage equipment by considering all processes from harnessing a primary energy flow or stock to different conversion forms, distribution, and energy carriers' storage. The TTW stage defines the emissions where the energy carrier is used to move the vehicle while driving. The environmental burden of the WTT stage differs a lot, depending on how the energy carrier is produced.

---

<sup>4</sup> [www.wallbox.com](http://www.wallbox.com)

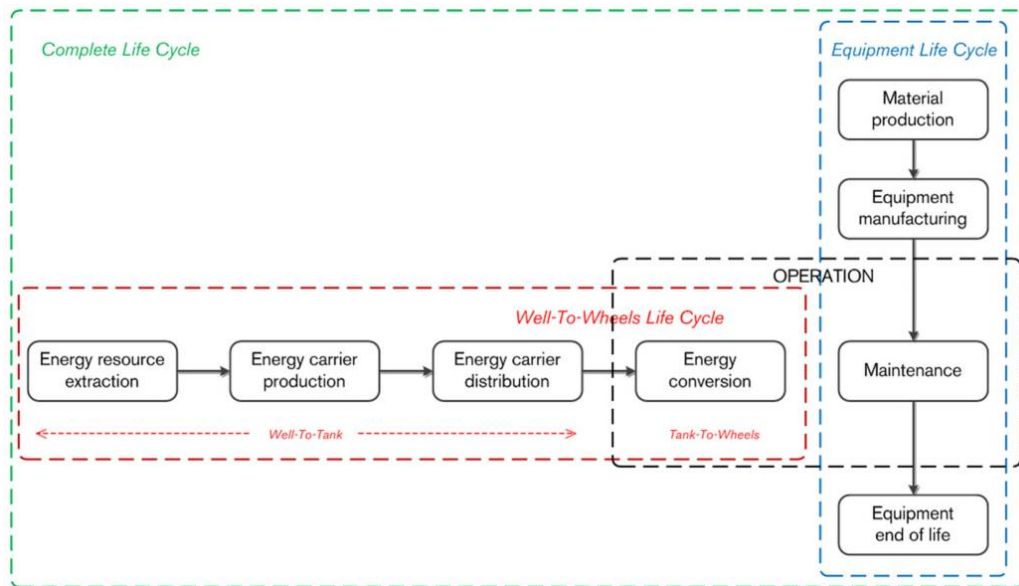

Figure 1.10 Simplified View of the Well-to-Wheels and Equipment Flows (a more detailed view would include, for example, recycling options) (Source: (Nordelöf et al., 2014))

The main factors influencing the life-cycle CO<sub>2</sub> emissions of electric vehicles are: the carbon content of the electricity used for charging, the battery size and its manufacturing and the vehicle mileage (Ellingsen et al., 2017; Jochem et al., 2015; Temporelli et al., 2020). Life Cycle Assessment of EVs varies along with the country's electricity mix. As the power mix may vary on several temporal scales (from hour to decades), it has been advised to control EVs' charging could lower their indirect emissions from electricity (Jochem et al., 2015). Although the WtT GHG emissions of electricity far from zero depend on a country's electricity mix, it is however ignored by the European and worldwide legislations in favour of the TtW GHG emissions, which is equal to close to zero for electric vehicles (Helmers and Marx, 2012; Jang and Song, 2015; Jeon et al., 2020; Khan et al., 2019). Hence, our study focuses on analyzing TtW GHG emissions considered for assessing CO<sub>2</sub> standards in Europe.

In BEV, no CO<sub>2</sub> emissions are released *while driving*, leading to zero TtW emissions. On the contrary, since a PHEV is partially dependent on fossil fuels, the emissions of PHEVs are calculated as a combination of the combustion engine's emissions and the electric engine, depending on the electric driving range and with differences in the regional legislation (Hüls et al., 2020). Thus, its TtW emissions are positive and dependent on the vehicle's segment and driving and behaviours.

Additionally to TtW emissions, electric vehicles also have other environmental impacts due to Particulate Matter emissions from erosion of road usage, brake and tyres erosion. Also, battery production and recycling have environmental implications in mineral depletion and

mining, acidification, photochemical smog pollution and air acidification, ecotoxicity and water pollution, and GHGs emissions. Several life-cycle assessments (LCA) evaluate EVs' impact on water and local pollution, metal rarefaction, scarce earth material. Nevertheless, battery technology received recent widespread attention from researchers to limit its impact by improving its technology (Hoekstra, 2019). (Aichberger and Jungmeier, 2020) provides an extensive literature review of 50 published articles from 2005–2020 about LCA of Li-ion batteries to assess the environmental effects of production, use, and end of life for application in electric vehicles. Investigated LCAs showed that a battery pack of 280 kWh for the primary energy consumption is around 120 kgCO<sub>2</sub>-eq/kWh for greenhouse gas emissions. The review demonstrates the significant contributing aspects for the production and end-of-life life cycle steps of EV batteries. Also, the environmental impact of battery production depends on the country's electricity mix where these batteries are produced. Indeed, the environmental impact will be higher for a fossil-fuel dependent electricity mix than a renewable-based one. The European Commission, as part of the European Green Deal, the Circular Economy Action, and the New Industrial Strategy, aims to ensure a competitive, circular, sustainable and safe value chain for all batteries placed on the European market. The production of these batteries in Europe is accompanied with a storing intermittent renewable energy mix. One of the European Commission objectives, reducing GHG emissions during the entire life cycle of batteries, will increase the expected CO<sub>2</sub> emission reduction even further (EC, 2020). Also, regarding recycling processes, GHG emissions outweigh the negative environmental impacts of recycling and can reduce the life cycle greenhouse gas emissions by 20 kgCO<sub>2</sub>-eq/kWh (Aichberger and Jungmeier, 2020).

Finally, (van Essen et al., 2011) proved that the transportation sector's, primarily passenger cars, environmental impact has severe economic consequences. The cost could vary from 30 €/1000 km for car usage to 15 €/1000 km for rail passengers. In 2008, the total external transport costs in the European Union (added to Norway and Switzerland) amounted to more than € 500 billion/year. Passenger transport causes 77% of these costs, and the responsibility relies on passenger car usage that accounts for the highest part. Therefore, limiting the environmental impact of the fossil-fuel dependent road transportation sector could decrease the CO<sub>2</sub> emissions and the economic implications of such externalities.

### 3. Barriers to Adoption of EV

The adoption activity of EVs has been increasing since 2015. Yet, several barriers are still facing its widespread purchasing activity. Various articles investigated the modest electric mobility market and pointed to many barriers to the successful diffusion of EVs throughout Europe, China, India, and the U.S., based on surveys and questionnaires. This Section aims at defining the significant barriers presented in Table 1.3 that are facing EV adoption. For a more detailed analysis of barriers, please refer to (Adhikari et al., 2020; Biresselioglu et al., 2018; Noel et al., 2020; Shetty et al., 2020). The identified barriers are classified into five categories: technical, social, economic, infrastructure, and policy. Also, we define the barriers that will be considered in this thesis.

#### 3.1. Technical Barriers

Technical progress in the vehicle industry plays an important role in the purchasing activity towards the client. EVs are a relatively new technology, and potential users are unwilling to pay for a new invention due to the lack of evidence regarding reliability and performance (Goel et al., 2021). Also, as mentioned before, an EV has a limited range due to the battery size. A BEV ranges from 75 km (Citroën Ami) to 620 km (Tesla Model 3). Indeed, purchasing a large-battery BEV comes with a higher cost to the owner than small- or medium-battery BEVs. If a driver wants to limit the price of the vehicle by purchasing a small-battery BEV, he/she could suffer from range anxiety. Range anxiety, the fear of blackout in the middle of the trip, presents one of the significant barriers hindering EV purchasing (Noel et al., 2020; Zhang et al., 2013). This anxiety could impact the driver's daily trips (Home-Work and Work-Home) and the driver's long trips (Vacations), leading to higher charging frequency to keep the battery's SoC around 80%.

Another technical barrier is the battery life that requires frequent replacements, which is a significant burden on EV drivers (Graham-Rowe et al., 2012, p.). Indeed, EV batteries, similarly to other types of batteries, will deteriorate over time. However, certain circumstances can promote faster degradation, such as severe weather conditions. Drivers who are willing to purchase an EV face this obstacle that could lead to higher expenses regarding the battery replacement. Moreover, (Goel et al., 2021) and (Egbue and Long, 2012) concluded that the charging duration obstacle could reach more than 10 hours. Charging a 50-kWh BEV with a 3 kW charger (so-called at-home charger) could take more than 10 hours. A charging event could take more than an overnight, discouraging customers from buying electric vehicles. Indeed, many solutions are available for drivers who want to use fast chargers. More information about

the charging process and parameters are detailed in the Section related to the charging infrastructure. Finally, a few models number of EVs could lead to limited EV market visibility (Xue et al., 2014). Certainly, limited models of EVs will not give the customer a variety of choices to choose from, leading to lower sales.

### **3.2.Social Barriers**

Social factors, identified by information communication and the consumer understanding of EVs, are being recognized as significant influencing variables for users switching from ICEVs to EVs (Noel et al., 2020). Many potential EV buyers lack sufficient information on electric vehicles and their environmental benefits (Barisa et al., 2016). Additionally, these EV buyers are uncertain of the potential impact of EVs in decreasing CO<sub>2</sub> emissions, thus benefiting the environment. EV buyers think that “if electric vehicles are electricity-dependent; therefore, an increase in electric power demand will lead to higher CO<sub>2</sub> emissions” (Kasten and Hacker, 2014). Indeed, many potential EV buyers do not have the information about the energy mix; thus, they question the environmental-friendliness of EVs. Besides the increased power demand, potential EV drivers consider the disposal of used batteries as harmful to the environment, increasing uncertainty about environmental benefits (Haddadian et al., 2015). Such concerns may be alleviated by providing consumers with reliable information about the environmental impact of EVs (Goel et al., 2021; Shetty et al., 2020).

### **3.3.Economic Barriers**

ICEVs have an economic advantage because they come with lower purchasing prices than EVs. This ICEV relative advantage hinders EV uptake, leading to a significant barrier (Bireselioglu et al., 2018; Noel et al., 2020; Sierzchula et al., 2014). Even though the total cost of ownership of electric vehicles is lower than in ICEVs, due to fuel savings and lower maintenance costs, many potential EV users are not aware of these benefits and only compare the price of both types of vehicles. Also, battery replacement presents one of the barriers due to the high cost of battery packs and their limited lifetime (Krause et al., 2013). Besides, since EV uses electricity as a primary energy source, high electricity prices do not motivate the potential customers to buy an EV, leading to high charging fees compared to refuelling an ICEV (Goel et al., 2021). Finally, lack of monetary incentives, such as subsidies and tax exemption, decrease the interest of customers in these types of vehicles (Farla et al., 2010; Wikström et al., 2016),

### **3.4. Infrastructure Barriers**

As mentioned before, range anxiety is a primary barrier that is stopping mass EV adoption. Indeed, range anxiety could be solved by installing more charging stations. However, this solution reveals complexity due to the “Chicken and egg electric mobility dilemma”. Operators will not deploy charging infrastructure before high EV market share. Meanwhile, a driver will not buy an EV if no charging stations are installed. The lack of charging networks has been recognized as a crucial factor for consumers to buy EVs (Biresselioglu et al., 2018; Krupa et al., 2014; Noel et al., 2020). Until today, the early adopters of EVs have deployed private chargers at their homes. (Noel et al., 2020) and (Caperello and Kurani, 2012) identified a lack in deploying at-home private chargers. Many households are not equipped with private parking and should rely on public or semi-public charging infrastructure. (Lane and Potter, 2007) concluded with the insufficient number of charging stations on highways, which are a solution for long-distance trips. Also, (Noel et al., 2020) and (Jensen et al., 2013) zoomed into the absence of workplace charging infrastructure deployment. Besides, current EV owners are disappointed due to the shortage in EV repair and maintenance centres or workshops compared to ICEVs (Adhikari et al., 2020; Weiller and Neely, 2014).

### **3.5. Policy Barriers**

While some countries already established a clear vision about neutral climate and the diffusion of EVs, especially in Europe, The US, and China, other countries still face some delays. The lack of long-term planning and goals on the government's part is identified as a barrier for EV uptake (Broadbent et al., 2018). Also, the absence of an annual tax exemption strategy encourages customers to switch to electric mobility (Farla et al., 2010). Table 1.3 details various barriers facing the adoption of electric vehicles and those considered in this thesis.

Table 1.3 Barriers Types Considered in this Thesis

| Barrier Type                   | Barrier   | Sources  | Considered in this thesis |
|--------------------------------|---|--|---------------------------|
| <b>Technical Barriers</b>      | Lack of evidence on reliability and performance               | (Goel et al., 2021)  |                           |
|                                | Limited range   | (Noel et al., 2020; Zhang et al., 2013)                                  | ✓                         |
|                                | Limited battery lifetime                                      | (Graham-Rowe et al., 2012, p.)   |                           |
|                                | Charging duration   | (Egbue and Long, 2012; Goel et al., 2021)                                | ✓                         |
|                                | Fewer EV models   | (Xue et al., 2014)   |                           |
| <b>Social Barriers</b>         | Lack of knowledge on EVs                                      | (Noel et al., 2020)  |                           |
|                                | Lack of environmental awareness regarding EVs                 | (Goel et al., 2021; Shetty et al., 2020)                                 |                           |
| <b>Economic Barriers</b>       | High purchase price   | (Biresselioglu et al., 2018; Noel et al., 2020; Sierzchula et al., 2014) | ✓                         |
|                                | Battery replacement cost                                      | (Krause et al., 2013)  |                           |
|                                | Higher electricity price for charging                         | (Goel et al., 2021)  |                           |
|                                | Lack of credit access for EVs                                 | (Wikström et al., 2016)  |                           |
| <b>Infrastructure Barriers</b> | Lack of public charging stations                              | (Biresselioglu et al., 2018; Krupa et al., 2014; Noel et al., 2020)      | ✓                         |
|                                | Lack of public charging stations on highways                  | (Lane and Potter, 2007)  |                           |
|                                | Lack of charging stations at workplace                        | (Jensen et al., 2013; Noel et al., 2020)                                 |                           |
|                                | Lack of charging stations at home                             | (Caperello and Kurani, 2012; Noel et al., 2020)                          | ✓                         |
|                                | Lack of repair and maintenance workshops                      | (Adhikari et al., 2020; Weiller and Neely, 2014)                         |                           |
| <b>Policy Barriers</b>         | Lack of long-term planning and goals on the government's part | (Broadbent et al., 2018)   |                           |
|                                | Absence of an annual tax exemption                            | (Farla et al., 2010)   |                           |



## 4. Charging Infrastructure for Electric Vehicles

With electric vehicles, the fact that oil is replaced by electricity stored in batteries means that the charging infrastructure operator plays a significant role in the emergence of EVs. As mentioned before, the lack of charging infrastructure deployment is one of the main barriers facing the uptake of EVs. Also, charging a BEV takes a much longer duration (30 minutes to more than 10 hours) than refuelling an ICEV (2.5 minutes). This Section aims at identifying a global review of the charging infrastructure issues.

### 4.1. EV Infrastructure Characteristics

Three main infrastructure characteristics that differentiate chargers from one another (IEA, 2018):

- *Level: the power output range of the charger;*
- *Type: the socket and connector used for charging;*
- *Mode: the communication protocol between the vehicle and the charger.*

There are many charging techniques: parked charging (conductive or wireless), battery swapping, and supply while driving (conductive or wireless) (Grauers et al., 2013). This thesis will cover only the conductive parked charging technique, using "a charger". The charging time depends on the charger's speeds (amperage), battery capacity, battery SoC, vehicle's technology (AC/DC alternative, direct current), and charging cable. We can identify and qualify a charging point by its location, power, socket model, and current type (AC/DC, single or triple phase). According to the international standard IEC 61851, the slowest is Mode 1, usually installed in houses, and has a power of 3 kW using AC. Home-charging represents the primary location of EV charging, with 80-90% of charging events (IEA, 2020). However, charging a 50 kWh BEV could take more than 12 hours. Also, households need to be occupied with an individual and easily accessible parking space. However, private parking availability depends on the urbanity degree: while households are equipped with private parking in rural areas, this is not the case for urban ones (INSEE, 2020). Yet, long charging durations push EV owners to install Level 2 chargers or search for a vacant Level 2 public charger. Mode 2 chargers power between 3 and 22kW at AC is generally found in homes or private or public parking spaces (such as parking lots, workplaces, commercial centres). A Mode 3 charger operates at up to 50kW, using DC, and is generally not found in personal homes. These charging points are preferably installed in public and parking spaces. Finally, ultra-fast chargers or Mode 4 operate at powers above 50kW using DC and are generally installed on corridors (highways). Table 1.4 provides an overview of these charging modes, and the time is generally taken for a car to charge for 160 km. Besides,

different communication protocols, which rely on different physical connections, are used by chargers. There is a single protocol per type in Level 2 and 3 AC chargers, and the same protocol is also used for Tesla connectors. In the case of DC fast chargers, Combined Charging System (CCS) connectors are coupled with Power Line Communication (PLC) protocols (typically used in smart grid communications). In contrast, CHAdeMO, Tesla and GB/T use Controller Area Network Communication (developed initially for components inside cars)<sup>5</sup>.

A more detailed analysis about geographic spread, the calculation of charging points while respecting the EV owner waiting time is provided in Chapter 2 and Chapter 3 of this dissertation.

Table 1.4 Charging Infrastructure Main Characteristics

| Mode [IEC 6185]    | Power (kW) | Type                | Location             | Current type | Charging time |
|--------------------|------------|---------------------|----------------------|--------------|---------------|
| Mode 1 (Level 1)   | 1 - 3      | Private             | Home                 | AC           | >10h          |
| Mode 2 (Level 2)   | 3 - 22     | Private/Semi-public | Home, Workplace      | AC           | 2 – 12h       |
| Mode 3 (Level 3)   | 22 - 50    | Semi-public/Public  | Workplace, on-street | DC           | 0.5 – 1.5h    |
| Mode 4 (Level 3)   | >50        | Public              | Highways             | DC           | <30 min       |
| Refuelling an ICEV | -          | Public              | Everywhere           | -            | 2.5 minutes   |

#### 4.2. The Chicken and Egg Electric-Mobility Dilemma

To follow the EV uptake, deploying chargers at home and the workplace is insufficient. Public charging infrastructure deployment at different powers, from slow charging to fast and ultra-fast charging, is needed, and it presents an essential element for EV large-scale diffusion (Hardman, 2019). However, such infrastructure development is very capital intensive and requires the high adoption of electric vehicles. As long as there is not a sufficient number of EVs, a potential charging infrastructure operator is unlikely to take the risk of installing and operating charging infrastructure on a significant scale. On the other hand, there will not be enough EVs in the first place as long as there are not many charging points to support them. This lock-in effect is often called a “chicken-egg dilemma” where neither of the two parties acts; neither charging infrastructure operators nor EV manufacturers will act before the other. It has significant consequences on the design of support policies (Lepoutre et al., 2019; Meunier and Ponsard, 2020).

The problem of deploying public charging infrastructure for EVs transforms a double

<sup>5</sup> www.chademo.com

transaction between the driver and the charging operator into complex businesses between different stakeholders. Beyond the "egg or chicken problem", EV charging gathers multiple actors, forming a business ecosystem (Kley et al., 2011; Madina et al., 2016). Infrastructure operators install charging points and ensure their maintenance. Mobility service providers propose EV owners an interface to use charging points. They can typically provide users with phone apps that indicate locations of charging stations and offer roaming services. They can also handle payment aspects. Infrastructure operators may be mobility service providers. Interoperability platforms intermediate mobility services providers and infrastructure operators and allow them to contract roaming agreements. Network operators ensure the connection between charging points and the power grid.

## 5. Business model and scenario definition

### 5.1. Business Model Definition

A clear definition is given by (Zott et al., 2011): "*The business model depicts "the content, structure, and governance of transactions designed to create value through the exploitation of business opportunities. Based on the fact that transactions connect activities, the authors further evolved this definition to conceptualize a firm's business model as "a system of interdependent activities that transcends the focal firm and spans its boundaries".* Every elaboration of business models should consider (Afuah, 2002):

- Possible revenues of the solution under the realistic hypothesis of market rules;
- Costs of implementation of the solution;
- Risks associated with the development of the solution;
- The willingness of users to adopt the solution;
- Cooperation with other actors of the value chain and interfaces to develop.

In order to identify the most suitable business model for the EVs industry, it is essential to resume vital information about ICEVs. ICEVs manufacturers use the classical business model, which is product-oriented. The car manufacturer is engaged to deliver the customer a high-quality vehicle with the customer's features. These features could vary from the type of the vehicle (sports car, hatchback, sedan), the colour, type of transmission (automatic or manual), etc. One possibility to increase the ICEVs market penetration is to offer after-sales services such as operation and maintenance, insurance, repair, financing. The fuelling process is not facing market penetration because of the considerable autonomy of the vehicle, the availability of fuelling stations, and the limited charging process. EVs and ICEVs differ in techno-economic-environmental aspects, especially propulsion technology, which has a

considerable impact on the functioning and driving experience of the vehicle regarding the driver (Bohnsack et al., 2014). Therefore, the product-oriented business model applied in ICEVs is no longer valid for electromobility due to various technical restrictions. Although EVs have been getting widespread attention in the last few years, some barriers are facing their adoption; mainly, the price, the charging duration, and the availability of charging stations. The creation of economic value is, therefore, inescapable to boost the market penetration of EVs. The emergence of EVs as an alternative to conventional cars with an internal combustion engine pushes these firms to adjust their business models and investigate new innovative ones (Amit and Zott, 2001). This step can amplify the benefits for the client and attract a large number of customers, making the product more competitive among the companies (Bohnsack et al., 2014; Budde Christensen et al., 2012; Fähnrich and Opitz, 2003; Kley et al., 2011; Madina et al., 2016).

The diffusion of EVs could move from product-based to service-based business models (Ceschin and Vezzoli, 2010) while empowering more mobility services (Kley et al., 2011). Consequently, automotive firms' perspectives will adopt the service-oriented business models: either user-oriented, result-oriented, or both. This thesis will focus on the result-oriented business model by detailing different business models considering the charging point operator.

## 5.2. Electric Vehicle Ecosystem Members

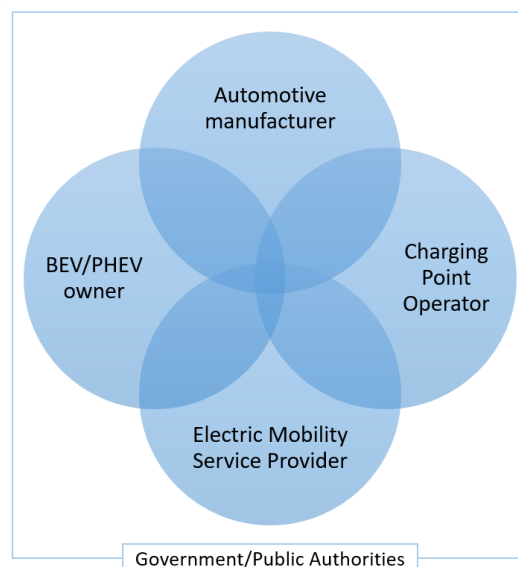

Figure 1.11 EV Ecosystem Members

It can be seen, from Figure 1.11, that the EV industry ecosystem is a complex one, where different transactions could be operated either from Business to Customer or Business to Business between different members that do not share the same goals. We will present the different scenarios of utilization elaborated by (Gnann, 2015; Kley et al., 2011; Madina et al.,

2016) using morphological boxes for the customer and the charging point operator:

- *Automotive manufacturer:* In this dissertation, we consider that automotive manufacturers aim to reduce the CO2 emissions of their sold fleet (in order to comply with regulatory requirements by feet electrification : BEV and PHEV) while maximizing their revenues. Figure 1.12 describes the business models for batteries and vehicles using morphological boxes. Looking at the box, it becomes evident that several utilisation scenarios that refer to business models for the automotive manufacturer could be studied adopted from (Kley et al., 2011). One simple question to answer when considering new business models is who owns the vehicle or the battery. We consider that the vehicle and the battery belong to the client and are only used by the owner. Also, we will only take into account privately-purchased vehicles. The owner will charge the vehicle using charging infrastructure that belongs to an independent operator. Also, we estimate that the automaker provides after-sales services.

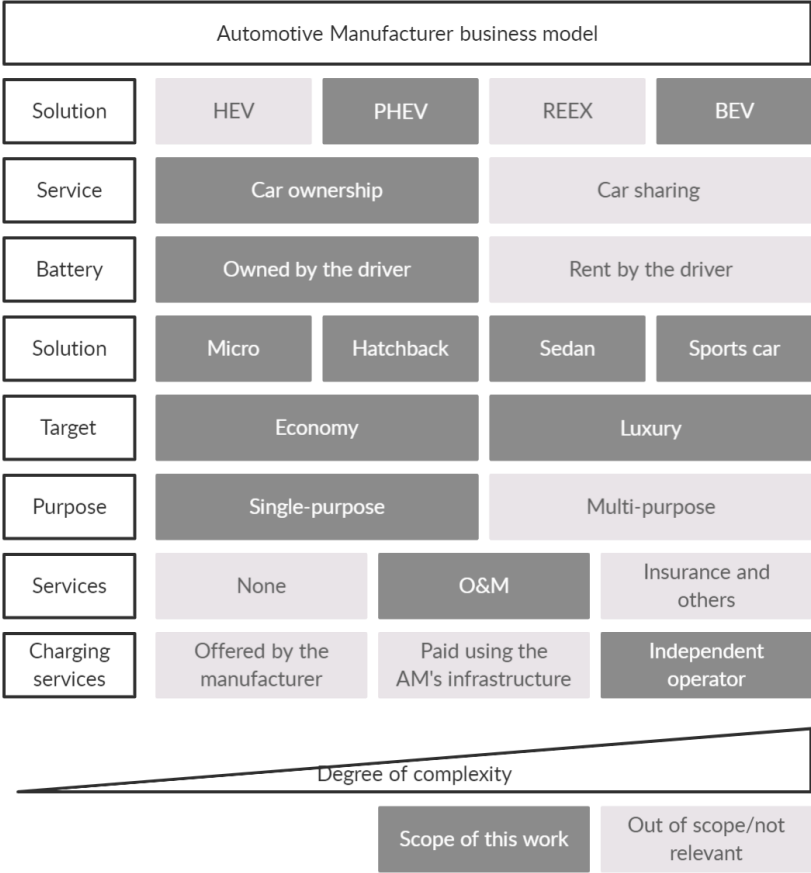

Figure 1.12 Characteristics of the BEV Considered in this Thesis (Concerning the Automaker) (Source: adopted from (Kley et al., 2011))

- *BEV/PHEV owner*: The BEV/PHEV owner/driver is the centre of interest in the business model since the main target is to convince the driver to purchase a BEV. All relationships with other members are considered as Business-to-Customer. Figure 1.13 describes the business models for the BEV owner using morphological boxes. We consider that the customer, who is the only owner of the car, will pay at one time to purchase the vehicle, including the battery, rather than renting them and paying a monthly fixed rate. Government subsidies are received regarding the BEV price. Vehicles users consider many aspects when deciding which type, brand, and model of vehicle they buy (Kley et al., 2011). The customer will use the BEV for daily purposes; therefore, he/she will search for the most economical solution that comes with lower costs rather than a luxurious one. Regarding the relationships with CPO, charging procedures considered in our case are only using the public infrastructure and using the "per hour" billing type. Subscription fees are paid to the EMSP in order to have access to the charging stations. We consider zero additional incomes from other services in this thesis. Figure 1.13 describes the business models for batteries and vehicles using morphological boxes.

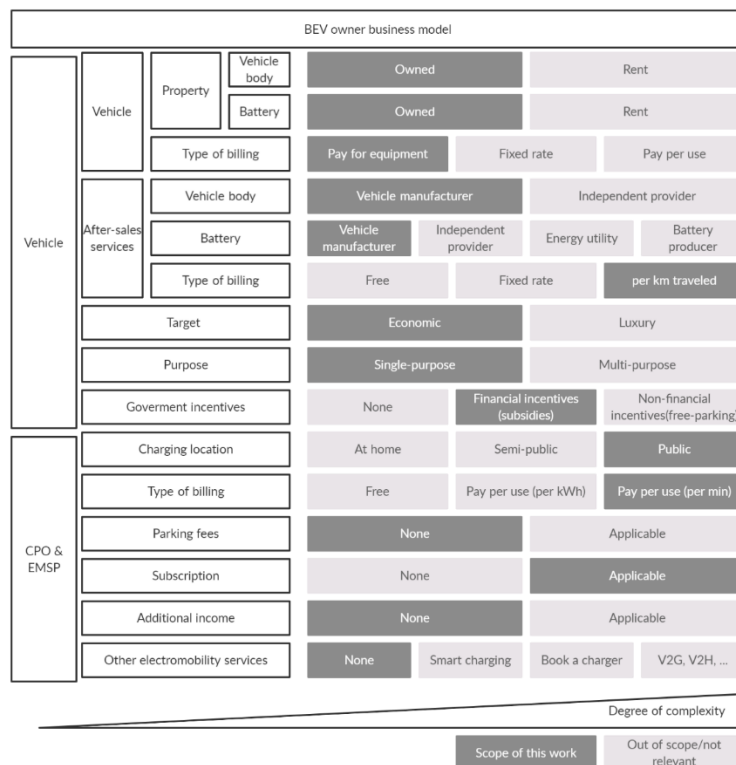

Figure 1.13 Characteristics of the BEV Considered in this Thesis (Concerning the BEV Owner) (Source: adopted from (Kley et al., 2011))

- *Charging Point Operator (CPO)*: Different publications elaborated on the CPO business model (Kley et al., 2011; Madina et al., 2016; Markkula et al., 2013). Figure 1.14 describes the business models for batteries and vehicles using morphological boxes. The CPO has the role of physically operating infrastructure to supply the charging process of the EV. Additional roles are the management of the charging sessions, monitoring, maintaining, and controlling charging stations. B2B coordination with the EMSP is essential either directly or through an agreement with a third party, such as a marketplace operator (Madina et al., 2016). Upon this accord, the CPO offers access to the charging infrastructure and electricity to the EMSP. We consider that charging could be accomplished using a cable (charger) rather than the wireless and battery swapping technologies. The accessibility category could differentiate three types of charging infrastructure: private (at home), semi-public (at work, supermarkets), and the public case that is our study case (on roads). These types are categorized based on their current charging power levels: <3.7 kW-AC for low speed, 3.7- 22 kW-AC for normal ones, 22 – 50 kW-DC for fast ones, and > 50 kW-DC for ultra-fast ones. Additionally, charging stations could come with either a unidirectional or a bidirectional current flow. Only 7, 22, 50 kW unidirectional chargers are studied in this thesis. We will not consider a charger-driver; therefore, he/she will not know any information about the availability of the charger and cannot book it. Possible operators, which take on the responsibility for installation, maintenance, and repair of the infrastructure, are private households, semi-public organizations, energy utilities, other independent operators, or the state. How the operator bills the user can vary: no fee, pay per use (per kWh or per charging duration), or a fixed rate.
- *Electric Mobility Service Provider (EMSP)*: This actor has one of the most crucial roles in the EV industry business model, similar to the CPO. It offers electromobility services for EV drivers such as charging services, booking a charger, etc. An identification card bought by the driver is mandatory to access the infrastructure. Its price is in the upper bound of 10 – 200 USD (Wiederer and Philip, 2010). No additional revenues for the client are measured; since Vehicle-to-Home (V2H), Vehicle-to-Grid (V2G), smart charging, charging level control, and other services are not the scope of the Chapter.

Due to the lack of data, we consider that CPO and EMSP are one actor, and it will be

noted under CPO for the rest of the thesis. Figure 1.14 describes the business models for batteries and vehicles using morphological boxes.

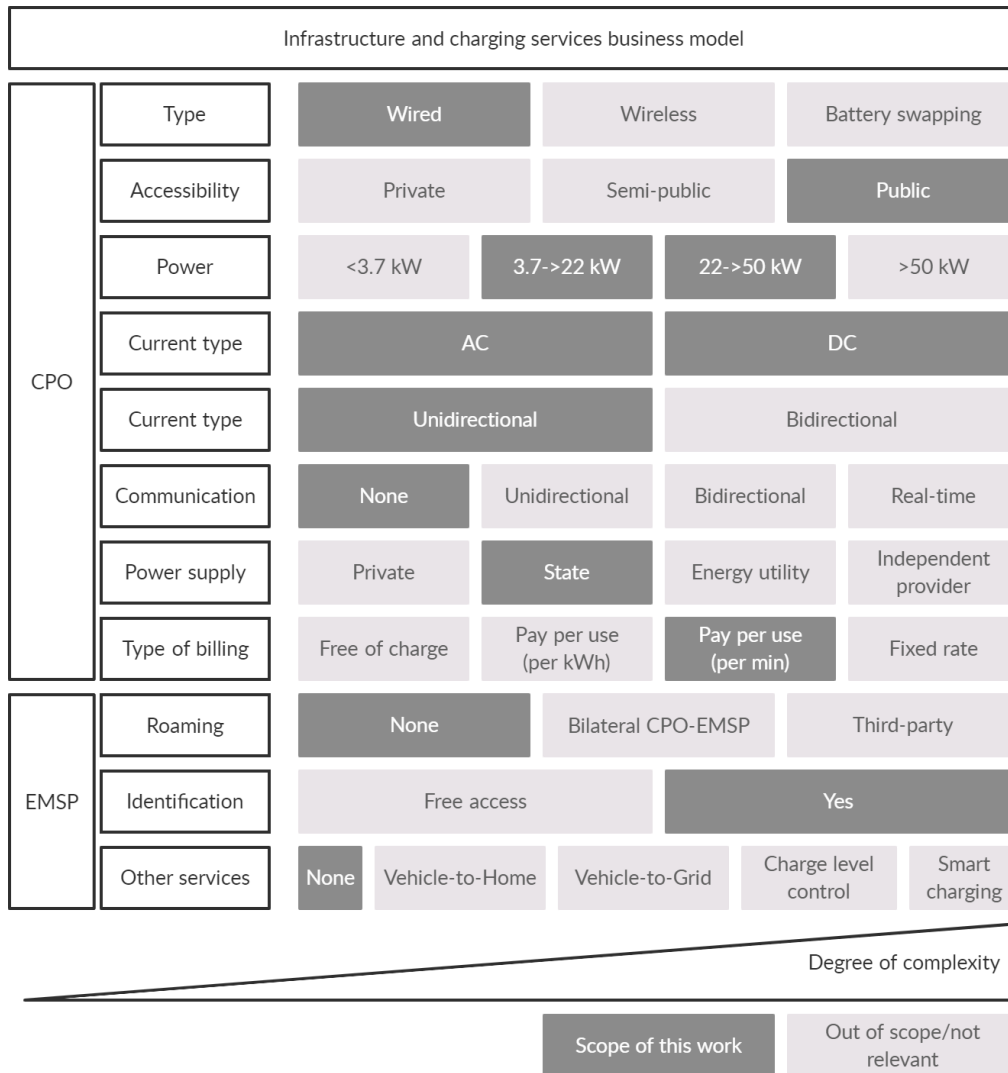

Figure 1.14 Characteristics of the Charging Infrastructure Considered in this Thesis (Source: adopted from (Kley et al., 2011))

## 6. Contributions of This Dissertation

### 6.1. Research Gaps Identification

We identified different literature gaps that cover all the BEV ecosystem members. Table 1.5 presents the research gaps, the papers trying to bridge this gap, and the remaining gaps that were not considered.

First, we identified the question regarding the trade-offs between bigger battery capacity and higher power charging infrastructure. Funke et al. (2019) analysed the trade-off between bigger battery capacity and higher-power charging infrastructure for German long-trips needs.



However, some gaps remain regarding the trade-off for daily-trips needs and for drivers who cannot install a private charger is not considered. This question presents a crucial element for a better electric mobility transition, especially for laggards who are an essential part of the drivers.

The second question was recognized regarding the key factors that boost the electric mobility transition, especially the different power charging infrastructure. Many articles tried to fill the gaps by analysing the effect of deploying charging infrastructure in various countries (Münzel et al., 2019; Sierzchula et al., 2014; Wee et al., 2018). Yet, none of these papers considered the influence of multi-power charging infrastructure on the EV market, which reveals complexity for charging operators' strategy and investments.

Finally, the third question is picked out concerning the influence of electrification on the automotive manufacturer's budget. Al-Alawi and Bradley (2014) quantified the value of PHEVs in estimating the cost of CAFE compliance for Fiat-Chrysler, Ford, and General Motors. Nevertheless, the quantification of BEVs in estimating the cost of CAFE compliance and the trade-off between paying the penalty and electrification is not considered.

*Table 1.5 Literature Gaps Considered in this Thesis*

| <b>Research questions</b>   | <b>Papers trying to bridge this gap</b>   | <b>Remaining gaps that were not considered</b>  |
|---|---|---|
| What are the trade-offs between bigger battery capacity and higher-power charging infrastructure? | Funke et al. (2019) analysed the trade-off between bigger battery capacity and higher-power charging infrastructure for German long-trips needs.  | The trade-off for daily-trips needs and for drivers who cannot install a private charger is not considered. |
| Which charging power should publicly be installed to boost the electric mobility transition?      | (Münzel et al., 2019; Sierzchula et al., 2014; Wee et al., 2018) analysed the effect of deploying charging infrastructure in various countries.   | None considered the effect of deploying different charging power chargers.                                  |
| The influence of electrification on the automotive manufacturer's budget.                         | (Al-Alawi and Bradley, 2014) quantified the value of PHEVs in estimating the cost of CAFE compliance for Fiat-Chrysler, Ford, and General Motors. | The quantification of BEVs in estimating the cost of CAFE compliance is not considered.                     |

## 6.2. Research Questions and Scope

This thesis explores various facets of the electric mobility transition. It is divided into four chapters, each self-contained and arranged according to a transformation chronology. Indeed, this dissertation does not claim to include all facets of the automotive system's energy transition. Chapter one deals with the charging infrastructure optimization methods. Chapter two considers the trade-offs between the battery capacity of BEVs and charging infrastructure

deployment of different powers. Chapter three analyses the BEV and PHEV purchasing activity in France between 2015-2019 using mixed-effects regression. Chapter four focuses on the assessment of 2021-2025-2030 CO2 standards on automakers' portfolio vehicles' segments.

### 6.3. Graphical Presentation of the Research Questions

Figure 1.15 illustrates the research questions that will be treated in the following chapters of this literature. As it can be seen, this thesis evaluated different research questions that are identified based on the interaction between the members of the EV ecosystem. Research Question 1 evaluates the interaction of all the ecosystem members to evaluate the key factors that boost electric vehicle adoption. Regarding Research Question 2, it comes to evaluate the intersection between the EV owner and the charging point operator by determining the trade-offs between charging infrastructure and battery capacities for laggards. Finally, Research Question 3 assesses the CO2 regulations on the OEM's portfolio; and thus considers two members of the ecosystem: the automaker and public authorities.

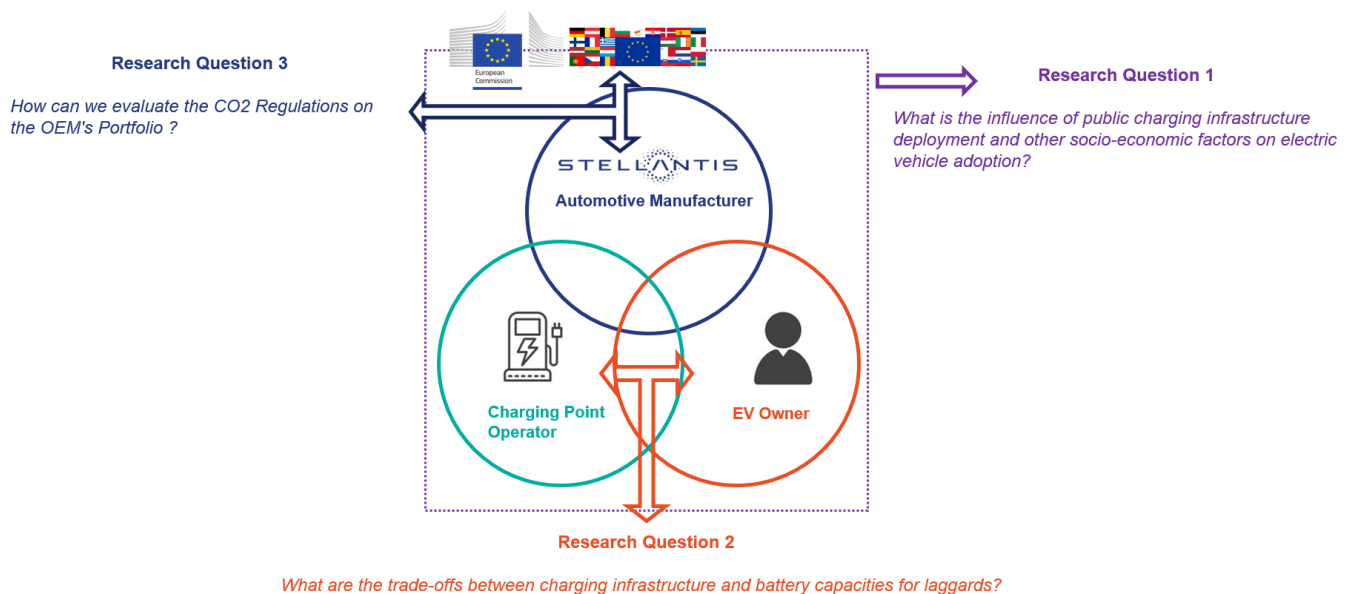

Figure 1.15 Graphical Presentation of the Research Questions

### 6.4. Description of Chapters

#### 6.4.1. Chapter Two: Charging Infrastructure Deployment Methods

The Second Chapter focuses on the charging infrastructure deployment methods for electric vehicles through a literature review.

Range anxiety, the fear of not reaching one's destination conveniently, is one of the main barriers that stop EV uptake. It is related to the limited battery technology on the one hand, and the availability of recharging networks on the other. Both variables determine the range of the vehicle and the time needed to charge the battery. While one solution to reduce range anxiety

could be to increase the battery size simply, this significantly increases the cost of the vehicle, as the battery remains one of the most expensive components of an EV. Another solution could then be to reduce the battery size in the vehicle and depend more on the presence of optimal and easy-access charging infrastructure by an optimized spatial localization. The optimal way to deploy recharging infrastructure depends on a complex set of variables that need to be considered: specific times and locations, electricity grid problems (peak load and voltage fluctuations). Concerning the EV user, the deployment of these infrastructures must be aligned with the EV drivers' behaviour and allow the driver to charge where and when s/he wants and in the most convenient and generally the fastest way possible. The study of charging sites placement gained increasing attention in the last few years since it is a complex and dynamic problem (Gnann and Plötz, 2015; Islam, 2015; Jing et al., 2016; Shareef et al., 2016). While previous literature reviews made significant contributions to our understanding of EV charging infrastructure localization methods, they fall short of providing an overview of optimization goals used in these studies and the broader interdependencies between them, pointing out only some of the mandatory research gaps.

This chapter aims to analyse 64 research publications better to understand the actual scientific development in infrastructure location using optimization methods. Then, we discuss the selected articles in detail concerning their used data for optimization and theoretical methods to solve the charging infrastructure deployment. The Chapter ends by identifying eleven research questions unanswered in the existing literature and proposes recommendations for further research to answer them. We conclude that the studied papers were primarily data-oriented, but data is the main restriction for the charging infrastructure deployment. Therefore, we derived the literature's research gaps that were not covered or covered too briefly by categorising the publications regarding the used input data. We consider that some factors should be reviewed in more detail, such as GPS-based geographic resolution, distribution grid constraints, driver's data (daily travelled mileage, destinations, charging behaviour), technical parameters, temporal horizon, environmental impact, new mobility services, and external conditions. Additionally, since queues can occur at stations, queuing theory can play an essential role concerning the number, the speed of the chargers, and the service pricing. Based on the discussed publications, we recommend further studies to consider more real-data oriented models by considering a time resolution, different charging levels, the driver's comfort factor while minimizing the cost, and taking chargers and battery LCAs as main constraints.

6.4.2. Chapter Three: Assessing the trade-offs between battery capacities and public charging infrastructure

The Third Chapter evaluates the trade-offs between battery capacities and different power public charging infrastructure for BEVs for daily trips needs.

To reach mass penetration, BEVs will have to offer solutions that address customer concerns in terms of economic cost (purchasing price) and daily mobility needs, as well as convenience, such as the ability to reach one's destination in a timely and trouble-free manner. Eliminating these barriers involves a trade-off: while integrating bigger batteries in cars provides more range (and hence less worry about conveniently reaching one's destination), this also comes with a higher vehicle-purchasing price. If one wants to keep purchasing prices low by integrating smaller batteries in the vehicle, range anxiety can only be addressed by fostering a high penetration of public charging infrastructure, with additional investments for the charging operator. Also, destination recharging comes with a last (but not least) dilemma: Battery size influences charging infrastructure since not all vehicles are adapted with all charging powers. The question of adaptability between battery capacity and charging power transfers a simple-unitary transaction for the automotive manufacturer (one car, one battery), into complicated and costly-shared infrastructure investment, since charging operators have to deploy various power chargers to fill the needs of all-sizes BEVs. Studying the battery size / public recharging network question by considering different types of charging speeds and specificities of different territories - urban versus rural areas - with real data is essential if one wants to understand how to create the conditions for mass BEV adoption. Customer-range needs are higher for rural areas than urban ones, making the BEV autonomy diverse the private parking availability where at-home chargers are installed.

While determining the optimal battery size of BEVs and optimizing the charging network have received widespread attention in the literature, the implication that battery size influences - or makes necessary particular - charging speeds has rarely been considered. Moreover, answering the question of battery size - public charging infrastructure combinations reveals complexity. The customer's dual goals are to minimize purchase and operating costs and the time spent charging the vehicle. The charging operator aims to deploy the optimal number of chargers and minimize investment and operating costs. Since these members of the BEV ecosystem's goals are often antagonistic, it is crucial to determine which combination of battery capacity and recharging network investment is the most cost-efficient for each, the customer and the charging operator.

This Chapter will analyze and compare BEV owner purchasing and usage costs,

considering French government subsidies and environmental taxes, on the one hand, and CPO investment and operational costs, taking into account French real-market charging tariffs, on the other hand. We computed the cost and revenue models based on the Equivalent Annual Cost (EAC) method, i.e. the cost of owning, operating, and maintaining an asset over its entire lifetime. We assess the trade-off between bigger batteries and more chargers, with mainly four relevant and novel contributions by i) Considering spatial analysis in terms of French urban- and rural-mobility needs and availability of at-home chargers – considering drivers who cannot install private chargers at-home and are obliged to use the public charging infrastructure, ii) Taking into account technical constraints regarding the combinations of battery size and charger speed, based on their compatibility, iii) Addressing the two main cost EAC models of the BEV ecosystem: BEV customer and charging point operator, and iv) Concluding about profitable - win-win - solutions for both parties based on Pareto fronts concept.

#### 6.4.3. Chapter Four: Analyzing the BEV and PHEV sales in France

The Fourth Chapter analyses the influence of different power charging network instalments, and other socio-economic factors, on the BEV and PHEV sales in 95 French departments between 2015 and 2019.

French authorities have set an ambitious goal to reduce CO<sub>2</sub> emissions and the dependency of petroleum products from the transport sector by 20% by 2020, to bring them back to the level they had in 1990. However, PEVs sales presented only a modest market share of total vehicles sales in 2020, around 2%. While these technologies have been rapidly increasing over the last decade, their market share remains low in most countries. The reasons for the slow uptake of EVs are generally divided into technical (charging time, limited BEV range), economic (PEV purchase, electricity, and fuel prices), awareness (client behaviour towards new inventions, charging stations visibility, number of PEV models), and socio-demographic factors (age, education, income, environmentalism, and urbanity degree). To boost market share, the local authorities, such as municipalities, contributed to making EVs more attractive to consumers by offering financial subsidies of a maximum of 5000€ to each driver switching to electric mobility additionally to tax exemption, free parking, and access to bus lanes. Since the lack of charging infrastructure still presents a barrier to growth in the EV market, national and local authorities in France boosted the deployment of this infrastructure by both installing more on-street chargers (e.g. Corri-door project) and offering up to 50% of the cost of the charger for both private and public usage (e.g. ADVENIR project).

Based on a state-of-the-art of 16 published articles that analyzed the purchasing activity of PEVs in 30 countries using local- and country-level approaches, we begin by identifying the market-stimulating factors associated with these studies. The impact of these factors differs significantly between countries, as consumer behaviour varies. While investigating the influence of these factors on the market penetration of PEVs received widespread attention in the literature and is a vast field of research, only limited investigation has been carried out about the potential impact of the charging infrastructure on demand for BEV/PHEV. Another research gap, which we will try to fill in this Chapter, remains on the influence of different power charging infrastructure deployment on PEV adoption. Finally, we aim to evaluate how the studied factors vary between the BEV and PHEV markets.

To fill these three research gaps, we analyze the influence of different covariates on privately-purchased BEV and PHEV markets, separately, in French departments from 2015 to 2019 using mixed-effects regression. These factors are divided into different categories: socio-demographic (population density, age, unemployment rate), economic (subsidies, taxes exemption, income, gasoline price), availability (number of BEV models, number of PHEV models), and technical (density of slow-and-normal chargers, density of fast chargers, density of ultra-fast chargers) covariates. The data of these factors were gathered from different sources, including government websites and WordPress articles. To the best of our knowledge, our study is the first to isolate the impacts of local-level incentives and four charging speeds (slow, normal, fast, and ultra-fast chargers) on the adoption rate of BEVs PHEVs in France. We find different sets of covariates to be significantly correlated with BEV and PHEV market shares, respectively, leading to different interpretations regarding the vehicle's technology. The number of available BEV/PHEV models and energy prices are positively associated with BEV and PHEV adoption. While fast, ultrafast charger density and financial incentives boost BEV sales, more slow-and-normal charger density leads to higher PHEV sales. On the contrary, financial incentives for PHEVs, relative to vehicles' prices, do not boost sales and is open for further studies.

Policy recommendations are discussed based on the results for the automotive industry, the charging operator, and the local authorities. First, it is recommended that the automotive industry provide various models on the market of different sizes, battery capacities/autonomies, styles, and designs. A variety of choices could increase the awareness towards clients, resulting in buying a BEV/PHEV. Second, charging infrastructure operators should consider a strategic plan while deploying chargers by providing public fast and ultrafast chargers rather than slow-and-normal speeds. In addition, we recommend operators provide different charging pricing

methods and tariffs, taking into account a variety of BEV and PHEV types, with different battery sizes. Finally, local and national governments should consider economic incentives such as gasoline taxes and subsidies as tools to encourage clients to buy PEVs. Besides, we recommend local authorities concentrate their efforts on providing and/or increasing economic incentives (e.g. subsidies) to the instalment of fast and ultrafast public chargers instead of providing incentives to the instalment slow-and-normal public chargers.

#### 6.4.4. Chapter Five: Assessing the 2021-2025-2030 CO<sub>2</sub> standards on automakers' portfolio vehicles' segments

The Fifth Chapter analyses the assessment of the 2021-2025-2030 CO<sub>2</sub> standards on automakers' portfolio vehicles' segments.

To achieve an intermediate target of at least 55% net reduction in GHG emissions by 2030 and a climate-neutral EU by 2050, the European Parliament and the Council adopted Regulation number (EU)2019/631, setting new EU fleet-wide CO<sub>2</sub> emission targets for 2025 and 2030, both for newly registered passenger cars and for newly registered vans. In 2021, EU car manufacturers should fix their CO<sub>2</sub> targets based on their new sold fleets' weights. For the long term, CO<sub>2</sub> limits regulations become stricter, explicitly reducing 15% and 37.5% compared to 2021 must be achieved for 2025 and 2030, respectively. In the case of non-respect of these targets, manufacturers must pay a penalty of €95 per gram CO<sub>2</sub> of exceedance per sold car. While technical improvements could considerably reduce the fleet's CO<sub>2</sub> emissions, long-term emissions targets could hardly be achieved. Therefore, car manufacturers have already initiated fleet hybridisation and electrification, i.e. selling more electric and hybrid vehicles, which proves to be one of the promising solutions to achieve strict CO<sub>2</sub> targets. Recently, the discussion regarding the cost-effectiveness of CO<sub>2</sub> regulations has been modernized due to the stricter CO<sub>2</sub> targets, pushing researchers to evaluate the cost implication of technical improvements on both the client and the automotive manufacturer. While the impact of technical improvements has received widespread attention in the literature, questions remain on the influence of fleet electrification, using both BEVs and PHEVs on the automaker's budget.

This Chapter aims to close the literature gap, to investigate whether BEVs and PHEVs can offer an economic value in helping an automobile manufacturer comply with CO<sub>2</sub> standards. This study also focuses on assessing the trade-off between BEV/PHEV incremental costs – the difference in production cost between a BEV/PHEV and ICEV of the same segment - and the penalty cost under the EU CO<sub>2</sub> regulations. To address this question, this Chapter describes a model of the CO<sub>2</sub> compliance for the automaker for the years 2021–2030, using

four vehicle segments. First, we calculate the 2021-2025-2030 CO<sub>2</sub> targets based on the weight of the vehicle. Second, we determine the combinations of BEV and PHEV sales shares that ensure minimum costs (incremental costs and penalty if applied). Third, we determine the combinations of BEV and PHEV sales shares that ensure respect for the CO<sub>2</sub> targets (no penalty applied for non-respect of the regulations). Finally, we evaluated the trade-offs between these two options to address this trade-off for every segment and year. Based on our assumptions, we found that the minimum costs are conditioned with three criteria: the evolution of regulations per year, the vehicle's size –i.e. weight and emissions–, and the electrification type (BEV/PHEV).

Globally, we found that minimizing the costs comes concerning CO<sub>2</sub> standards, thus, zero fines. Results could be presented based on two dimensions: per year and segment. First, since long-term standards become stricter, fines will sharply increase with 0% BEV/PHEV sales. Also, respecting long-term CO<sub>2</sub> targets by electrification comes with a trade-off: Indeed, while electrification will ensure the CO<sub>2</sub> engagement, it comes with higher costs than fines, especially with a 100% BEV scenario compared to 100% PHEV scenario, since the battery packs price presents most of the vehicle's incremental cost. Therefore, even if the battery packs price would decrease, the optimum would be achieved with specific BEV/PHEV sales combinations. Regarding the Segment analysis, selling more oversized vehicles comes with several trade-offs: more weight leads to less strict CO<sub>2</sub> standards, more CO<sub>2</sub> emissions, and more incremental costs due to the battery price. Results showed that the bigger the vehicle, the more BEV/PHEV sales are needed.



## References

- Adhikari, M., Ghimire, L.P., Kim, Y., Aryal, P., Khadka, S.B., 2020. Identification and Analysis of Barriers against Electric Vehicle Use. *Sustainability* 12, 4850. <https://doi.org/10.3390/su12124850>
- Afuah, 2002. Afuah, A. (2004): Business models: a strategic management approach, 1, Bier-nat, J.E. (Hrsg.), New York: McGraw-Hill/Irwin. [WWW Document]. URL <https://www.abeebooks.fr/9780072883640/Business-Models-Strategic-Management-Approach-0072883642/plp> (accessed 4.20.20).
- Aichberger, C., Jungmeier, G., 2020. Environmental Life Cycle Impacts of Automotive Batteries Based on a Literature Review. *Energies* 13, 6345. <https://doi.org/10.3390/en13236345>
- Al-Alawi, B.M., Bradley, T.H., 2014. Analysis of corporate average fuel economy regulation compliance scenarios inclusive of plug in hybrid vehicles. *Appl. Energy* 113, 1323–1337. <https://doi.org/10.1016/j.apenergy.2013.08.081>
- Amit, R., Zott, C., 2001. Amit, R., Zott, C., 2001. Value creation in E-business. *Strategic Management Journal* 22, 493–520. *Strateg. Manag. J.* 22, 493–520. <https://doi.org/10.1002/smj.187>
- Automobile Propre, 2020. Hydrogène : les voitures et utilitaires légers disponibles en France. URL <https://www.automobile-propre.com/hydrogene-les-voitures-et-utilitaires-legers-disponibles-en-france/> (accessed 4.10.21).
- Barisa, A., Rosa, M., Kisele, A., 2016. Introducing Electric Mobility in Latvian Municipalities: Results of a Survey. *Energy Procedia* 95, 50–57. <https://doi.org/10.1016/j.egypro.2016.09.015>
- Becherif, M., Ayad, M.Y., Hissel, D., Mkahl, R., 2011. Design and sizing of a stand-alone recharging point for battery electrical vehicles using photovoltaic energy, in: 2011 IEEE Vehicle Power and Propulsion Conference. Presented at the 2011 IEEE Vehicle Power and Propulsion Conference, pp. 1–6. <https://doi.org/10.1109/VPPC.2011.6043075>
- Bhagavathy, S.M., Budnitz, H., Schwanen, T., McCulloch, M., 2021. Impact of Charging Rates on Electric Vehicle Battery Life. *Findings* 21459. <https://doi.org/10.32866/001c.21459>
- Biresselioglu, M.E., Demirbag Kaplan, M., Yilmaz, B.K., 2018. Electric mobility in Europe: A comprehensive review of motivators and barriers in decision making processes. *Transp. Res. Part Policy Pract.* 109, 1–13. <https://doi.org/10.1016/j.tra.2018.01.017>
- Bohnsack, R., Pinkse, J., Kolk, A., 2014. Business models for sustainable technologies: Exploring business model evolution in the case of electric vehicles. *Res. Policy* 43, 284–300. <https://doi.org/10.1016/j.respol.2013.10.014>
- Boucherit, A., 2011. Conception d'un convertisseur de puissance pour véhicules électriques multi-sources. Université de Technologie de Belfort-Montbeliard.
- Broadbent, G.H., Drozdowski, D., Metternicht, G., 2018. Electric vehicle adoption: An analysis of best practice and pitfalls for policy making from experiences of Europe and the US. *Geogr. Compass* 12, e12358. <https://doi.org/10.1111/gec3.12358>
- Budde Christensen et al., 2012. Budde Christensen, T., Wells, P., Cipcigan, L., 2012. Can innovative business model overcome resistance to electric vehicles? Better place and battery electric cars in Denmark. *Energy Policy* 48, 498–505. [WWW Document]. URL <https://www.sciencedirect.com/science/article/abs/pii/S0301421512004673> (accessed 4.20.20).
- Caperello, N.D., Kurani, K.S., 2012. Households' Stories of Their Encounters With a Plug-In Hybrid Electric Vehicle. *Environ. Behav.* 44, 493–508. <https://doi.org/10.1177/0013916511402057>
- Ceschin and Vezzoli, 2010. Ceschin, F., Vezzoli, C., 2010. The role of public policy in stimulating radical environmental impact reduction in the automotive sector: the need to focus on product-service system innovation. *International Journal of Automotive Technology and Management* 10, 321–341. [WWW Document]. ResearchGate. URL [https://www.researchgate.net/publication/240295761\\_The\\_role\\_of\\_public\\_policy\\_in\\_stimulating\\_radical\\_environmental\\_impact\\_reduction\\_in\\_the\\_automotive\\_sector\\_The\\_need\\_to\\_focus\\_on\\_product-service\\_system\\_innovation](https://www.researchgate.net/publication/240295761_The_role_of_public_policy_in_stimulating_radical_environmental_impact_reduction_in_the_automotive_sector_The_need_to_focus_on_product-service_system_innovation) (accessed 4.20.20).
- Crippa, M., Oreggioni, G., Guizzardi, D., Muntean, M., Schaaf, E., Lo Vullo, E., Solazzo, E., Monforti-Ferrario, F., Olivier, J.G.J., Vignati, E., European Commission, Joint Research Centre, 2019. Fossil CO<sub>2</sub> and GHG emissions of all world countries: 2019 report.

- Duru, K.K., Karra, C., Venkatachalam, P., Betha, S.A., Madhavan, A.A., Kalluri, S., 2021. Critical Insights Into Fast Charging Techniques for Lithium-Ion Batteries in Electric Vehicles. *IEEE Trans. Device Mater. Reliab.* 21, 137–152. <https://doi.org/10.1109/TDMR.2021.3051840>
- EAFO, 2020. Passenger cars | EAFO [WWW Document]. URL <https://www.eafo.eu/vehicles-and-fleet/m1> (accessed 7.26.20).
- EC, 2020. Batteries — moderniser les règles de l’UE.
- EC, 2019. CO2 emission standards for passenger cars and light-commercial vehicles in the European Union | International Council on Clean Transportation.
- Egbue, O., Long, S., 2012. Barriers to widespread adoption of electric vehicles: An analysis of consumer attitudes and perceptions. *Energy Policy* 48, 717–729. <https://doi.org/10.1016/j.enpol.2012.06.009>
- Ellingsen, L.A.-W., Hung, C.R., Strømman, A.H., 2017. Identifying key assumptions and differences in life cycle assessment studies of lithium-ion traction batteries with focus on greenhouse gas emissions. *Transp. Res. Part Transp. Environ.* 55, 82–90. <https://doi.org/10.1016/j.trd.2017.06.028>
- EVreporter, 2020. Why is a Battery Management System needed in Electric Vehicles? • EVreporter [WWW Document]. URL <https://evreporter.com/battery-management-system-for-electric-vehicles/> (accessed 6.24.21).
- Fähnrich, K.-P., Opitz, M., 2003. Fähnrich, K.-P.; Opitz, M. (2006): Service-Engineering – Entwicklungspfad und Bild einer jungen Disziplin. In: Bullinger, H.-J.; Scheer, A.-W.: Service-Engineering. Entwicklung und Gestaltung innovativer Dienstleistungen, S. 85-112., in: Bullinger, H.-J., Scheer, A.-W. (Eds.), Service Engineering: Entwicklung und Gestaltung innovativer Dienstleistungen. Springer, Berlin, Heidelberg, pp. 83–115. [https://doi.org/10.1007/978-3-662-09871-4\\_4](https://doi.org/10.1007/978-3-662-09871-4_4)
- Farla, J., Alkemade, F., Suurs, R., 2010. Analysis of barriers in the transition toward sustainable mobility in the Netherlands. *Technol. Forecast. Soc. Change* 77, 1260–1269. <https://doi.org/10.1016/j.techfore.2010.03.014>
- Funke, S.Á., Plötz, P., Wietschel, M., 2019. Invest in fast-charging infrastructure or in longer battery ranges? A cost-efficiency comparison for Germany. *Appl. Energy* 235, 888–899. <https://doi.org/10.1016/j.apenergy.2018.10.134>
- Gnann, T., 2015. Market diffusion of plug-in electric vehicles and their charging infrastructure, Book series “Innovation potentials.” Fraunhofer-Verl, Stuttgart.
- Gnann, T., Plötz, P., 2015. A review of combined models for market diffusion of alternative fuel vehicles and their refueling infrastructure. *Renew. Sustain. Energy Rev.* 47, 783–793. <https://doi.org/10.1016/j.rser.2015.03.022>
- Goel, S., Sharma, R., Rathore, A.K., 2021. A review on barrier and challenges of electric vehicle in India and vehicle to grid optimisation. *Transp. Eng.* 4, 100057. <https://doi.org/10.1016/j.treng.2021.100057>
- Graham-Rowe, E., Gardner, B., Abraham, C., Skippon, S., Dittmar, H., Hutchins, R., Stannard, J., 2012. Mainstream consumers driving plug-in battery-electric and plug-in hybrid electric cars: A qualitative analysis of responses and evaluations. *Transp. Res. Part Policy Pract.* 46, 140–153. <https://doi.org/10.1016/j.tra.2011.09.008>
- Grauers, A., Sarasini, S., Karlström, M., 2013. Why electromobility and what is it? [WWW Document]. URL <https://research.chalmers.se/en/publication/211430> (accessed 6.23.20).
- Hardman, S., 2019. Understanding the impact of reoccurring and non-financial incentives on plug-in electric vehicle adoption – A review. *Transp. Res. Part Policy Pract.* 119, 1–14. <https://doi.org/10.1016/j.tra.2018.11.002>
- Helmers, E., Marx, P., 2012. Electric cars: technical characteristics and environmental impacts. *Environ. Sci. Eur.* 24, 14. <https://doi.org/10.1186/2190-4715-24-14>
- Hoekstra, A., 2019. The Underestimated Potential of Battery Electric Vehicles to Reduce Emissions. *Joule* 3, 1412–1414. <https://doi.org/10.1016/j.joule.2019.06.002>
- Høyer, K.G., 2008. The history of alternative fuels in transportation: The case of electric and hybrid cars. *Util. Policy, Sustainable Energy and Transportation Systems* 16, 63–71. <https://doi.org/10.1016/j.jup.2007.11.001>

- Hüls, C., Thies, C., Kieckhäfer, K., Spengler, T.S., 2020. Limiting CO<sub>2</sub> fleet emissions in the automotive industry – a portfolio planning approach. *Int. J. Automot. Technol. Manag.* 20, 349–368.
- IEA, 2020. *Global EV Outlook 2020 – Analysis*.
- IEA, 2018. *Global EV Outlook 2018 Towards cross-modal electrification*.
- IEA, 2016. *WEO-2016 Special Report: Energy and Air Pollution – Analysis*.
- INSEE, 2020. Définition - Espace rural / Espace à dominante rurale / Espace à dominante rurale | Insee [WWW Document]. URL <https://www.insee.fr/fr/metadonnees/definition/c1034> (accessed 2.16.21).
- IPCC, 2018. Allen, M.R., O.P. Dube, W. Solecki, F. Aragón-Durand, W. Cramer, S. Humphreys, M. Kainuma, J. Kala, N. Mahowald, Y. Mulugetta, R. Perez, M. Wairiu, and K. Zickfeld, 2018: Framing and Context. In: *Global Warming of 1.5°C. An IPCC Special Report on the impacts of global warming of 1.5°C above pre-industrial levels and related global greenhouse gas emission pathways, in the context of strengthening the global response to the threat of climate change, sustainable development, and efforts to eradicate poverty* [Masson-Delmotte, V., P. Zhai, H.-O. Pörtner, D. Roberts, J. Skea, P.R. Shukla, A. Pirani, W. Moufouma-Okia, C. Péan, R. Pidcock, S. Connors, J.B.R. Matthews, Y. Chen, X. Zhou, M.I. Gomis, E. Lonnoy, T. Maycock, M. Tignor, and T. Waterfield (eds.)]. In Press.
- IPCC, 2014. Summary for Policymakers, *Climate Change 2014: Mitigation of Climate Change. Contribution of Working Group III to the Fifth Assessment Report of the Intergovernmental Panel on Climate Change*. URL <https://www.ipcc.ch/report/ar5/wg3/> (accessed 6.17.20).
- Isaac, J., 2020. Review of interventions to improve outdoor air quality and public health: Principal interventions for local authorities. *Public Health England*.
- Islam, Md., 2015. A Review of Techniques for Optimal Placement and Sizing of Electric Vehicle Charging Stations. *PRZEGLĄD ELEKTROTECHNICZNY* 1, 124–128. <https://doi.org/10.15199/48.2015.08.29>
- Jang, J.J., Song, H.H., 2015. Well-to-wheel analysis on greenhouse gas emission and energy use with petroleum-based fuels in Korea: gasoline and diesel. *Int. J. Life Cycle Assess.* 20, 1102–1116. <https://doi.org/10.1007/s11367-015-0911-x>
- Jensen, A.F., Cherchi, E., Mabit, S.L., 2013. On the stability of preferences and attitudes before and after experiencing an electric vehicle. *Transp. Res. Part Transp. Environ.* 25, 24–32. <https://doi.org/10.1016/j.trd.2013.07.006>
- Jeon, S., Roh, M., Heshmati, A., Kim, S., 2020. An Assessment of Corporate Average Fuel Economy Standards for Passenger Cars in South Korea. *Energies* 13, 4533. <https://doi.org/10.3390/en13174533>
- Jing, W., Yan, Y., Kim, I., Sarvi, M., 2016. Electric vehicles: A review of network modelling and future research needs. *Adv. Mech. Eng.* 8, 1687814015627981. <https://doi.org/10.1177/1687814015627981>
- Jochem, P., Babrowski, S., Fichtner, W., 2015. Assessing CO<sub>2</sub> emissions of electric vehicles in Germany in 2030. *Transp. Res. Part Policy Pract.* 78.
- Kant, M., 1995. La voiture électrique. *Tech. L'ingénieur Traitée Génie Électr.* 21.
- Kasten, P., Hacker, F., 2014. *DEFINE: Development of an Evaluation Framework for the Introduction of Electromobility*, Öko-Institut. Germany.
- Khan, M.I., Shahrestani, M., Hayat, T., Shakoor, A., Vahdati, M., 2019. Life cycle (well-to-wheel) energy and environmental assessment of natural gas as transportation fuel in Pakistan. *Appl. Energy* 242, 1738–1752. <https://doi.org/10.1016/j.apenergy.2019.03.196>
- Kley, F., Lerch, C., Dallinger, D., 2011. New business models for electric cars—A holistic approach. *Energy Policy* 39, 3392–3403. <https://doi.org/10.1016/j.enpol.2011.03.036>
- Krause, R.M., Carley, S.R., Lane, B.W., Graham, J.D., 2013. Perception and reality: Public knowledge of plug-in electric vehicles in 21 U.S. cities. *Energy Policy* 63, 433–440. <https://doi.org/10.1016/j.enpol.2013.09.018>
- Krupa, J.S., Rizzo, D.M., Eppstein, M.J., Brad Lanute, D., Gaalema, D.E., Lakkaraju, K., Warrender, C.E., 2014. Analysis of a consumer survey on plug-in hybrid electric vehicles. *Transp. Res. Part Policy Pract.* 64, 14–31. <https://doi.org/10.1016/j.tra.2014.02.019>

- Lane, B., Potter, S., 2007. The adoption of cleaner vehicles in the UK: exploring the consumer attitude–action gap. *J. Clean. Prod., The Automobile Industry & Sustainability* 15, 1085–1092. <https://doi.org/10.1016/j.jclepro.2006.05.026>
- Lebrun, P., 2003. Conception et réalisation d'un véhicule électrique. *Rev. Technol.* 56–58.
- Lepoutre, J., Perez, Y., Petit, M., 2019. Energy Transition and Electromobility: A Review, in: Gawel, E., Strunz, S., Lehmann, P., Purkus, A. (Eds.), *The European Dimension of Germany's Energy Transition: Opportunities and Conflicts*. Springer International Publishing, Cham, pp. 509–525. [https://doi.org/10.1007/978-3-030-03374-3\\_29](https://doi.org/10.1007/978-3-030-03374-3_29)
- Loukakou, D., Espanet, C., Dubas, F., 2012. Modélisation, Conception et Expérimentation d'un véhicule hybride léger pour usages urbains (Sciences de l'ingénieur [physics]). Université de Franche-Comté.
- Madina, C., Zamora, I., Zabala, E., 2016. Methodology for assessing electric vehicle charging infrastructure business models. *Energy Policy* 89, 284–293. <https://doi.org/10.1016/j.enpol.2015.12.007>
- Markkula, J., Rautiainen, R., Järventausta, P., 2013. The business case of electric vehicle quick charging – no more chicken or egg problem. EVS27 Symposium. November. Barcelona. [WWW Document]. ResearchGate. URL [https://www.researchgate.net/publication/318306674\\_The\\_business\\_case\\_of\\_electric\\_vehicle\\_quick\\_charging\\_-\\_no\\_more\\_chicken\\_or\\_egg\\_problem](https://www.researchgate.net/publication/318306674_The_business_case_of_electric_vehicle_quick_charging_-_no_more_chicken_or_egg_problem) (accessed 4.16.20).
- Matulka, R., 2014. The History of the Electric Car [WWW Document]. Energy.gov. URL <https://www.energy.gov/articles/history-electric-car> (accessed 4.10.21).
- Metais, M., Jouini, O., Perez, Y., Berrada, J., Suomalainen, E., 2021. Too much or not enough? Planning electric vehicle charging infrastructure: a review of modeling options.
- Meunier, G., Ponsard, J.-P., 2020. Optimal policy and network effects for the deployment of zero emission vehicles. *Eur. Econ. Rev.* 126, 103449. <https://doi.org/10.1016/j.eurocorev.2020.103449>
- Mkahl, R., 2015. Contribution à la modélisation, au dimensionnement et à la gestion des flux énergétiques d'un système de recharge de véhicules électriques : étude de l'interconnexion avec le réseau électrique (Theses). Université de Technologie de Belfort-Montbéliard.
- Münzel, C., Plötz, P., Sprei, F., Gnann, T., 2019. How large is the effect of financial incentives on electric vehicle sales? – A global review and European analysis. *Energy Econ.* 84, 104493. <https://doi.org/10.1016/j.eneco.2019.104493>
- Noel, L., Zarazua de Rubens, G., Kester, J., Sovacool, B.K., 2020. Understanding the socio-technical nexus of Nordic electric vehicle (EV) barriers: A qualitative discussion of range, price, charging and knowledge. *Energy Policy* 138, 111292. <https://doi.org/10.1016/j.enpol.2020.111292>
- Nouh, A., 2008. Contribution Au Développement d'un Simulateur Pour Les Véhicules Électriques Routiers.
- Redondo-Iglesias, E., Vinot, E., Venet, P., Pelissier, S., 2019. Electric vehicle range and battery lifetime: a trade-off, in: EVS32. Lyon, France, p. 9p.
- Shahan, Z., 2015. Electric Car History (In Depth) [WWW Document]. CleanTechnica. URL <https://cleantechnica.com/2015/04/26/electric-car-history/> (accessed 4.10.21).
- Shareef, H., Islam, Md.M., Mohamed, A., 2016. A review of the stage-of-the-art charging technologies, placement methodologies, and impacts of electric vehicles. *Renew. Sustain. Energy Rev.* 64, 403–420. <https://doi.org/10.1016/j.rser.2016.06.033>
- Shetty, D.K., Shetty, S., Raj Rodrigues, L., Naik, N., Maddodi, C.B., Malarout, N., Sooriyaperakasam, N., 2020. Barriers to widespread adoption of plug-in electric vehicles in emerging Asian markets: An analysis of consumer behavioral attitudes and perceptions. *Cogent Eng.* 7, 1796198. <https://doi.org/10.1080/23311916.2020.1796198>
- Sierzchula, W., Bakker, S., Maat, K., van Wee, B., 2014. The influence of financial incentives and other socio-economic factors on electric vehicle adoption. *Energy Policy* 68, 183–194. <https://doi.org/10.1016/j.enpol.2014.01.043>
- Temporelli, A., Carvalho, M.L., Girardi, P., 2020. Life Cycle Assessment of Electric Vehicle Batteries: An Overview of Recent Literature. *Energies* 13, 2864. <https://doi.org/10.3390/en13112864>

- van Essen, H., Schrotten, A., Matthijs, O., Sutter, D., Schreyer, C., Remo, R., Maibach, M., Doll, C., 2011. External costs of transport in Europe. CE Delft, Infrac, Fraunhofer ISI.
- Villareal, A., 2014. L'industrie automobile à l'épreuve des voitures électriques : entre changement et continuité (Theses). Université de Bordeaux.
- Waldmann, T., Hogg, B.-I., Wohlfahrt-Mehrens, M., 2018. Li plating as unwanted side reaction in commercial Li-ion cells – A review. *J. Power Sources* 384, 107–124.  
<https://doi.org/10.1016/j.jpowsour.2018.02.063>
- Wee, S., Coffman, M., La Croix, S., 2018. Do electric vehicle incentives matter? Evidence from the 50 U.S. states. *Res. Policy* 47, 1601–1610. <https://doi.org/10.1016/j.respol.2018.05.003>
- Weiller, C., Neely, A., 2014. Using electric vehicles for energy services: Industry perspectives. *Energy* 77, 194–200. <https://doi.org/10.1016/j.energy.2014.06.066>
- Wiederer and Philip, 2010. Wiederer, A., Philip, R., 2010. Policy options for electric vehicle charging infrastructure in C40 cities. Transportation Clinton Climate Initiative. [WWW Document]. URL <https://www.innovations.harvard.edu/policy-options-electric-vehicle-charging-infrastructure-c40-cities> (accessed 4.20.20).
- Wikström, M., Hansson, L., Alvfors, P., 2016. Investigating barriers for plug-in electric vehicle deployment in fleets. *Transp. Res. Part Transp. Environ.* 49, 59–67.  
<https://doi.org/10.1016/j.trd.2016.08.008>
- Xue, Y., You, J., Shao, L., 2014. Understanding Socio-Technical Barriers to Sustainable Mobility – Insights from Demonstration Program of EVs in China (SSRN Scholarly Paper No. ID 2383759). Social Science Research Network, Rochester, NY.
- Yong, J.Y., Ramachandaramurthy, V.K., Tan, K.M., Mithulananthan, N., 2015. A review on the state-of-the-art technologies of electric vehicle, its impacts and prospects. *Renew. Sustain. Energy Rev.* 49, 365–385. <https://doi.org/10.1016/j.rser.2015.04.130>
- Zhang, X., Wang, K., Hao, Y., Fan, J.-L., Wei, Y.-M., 2013. The impact of government policy on preference for NEVs: The evidence from China. *Energy Policy* 61, 382–393.  
<https://doi.org/10.1016/j.enpol.2013.06.114>
- Zott, C., Amit, R., Massa, L., 2011. The Business Model: Recent Developments and Future Research. *J. Manag.* 37, 1019–1042. <https://doi.org/10.1177/0149206311406265>





## **Chapter 2: Review of Optimization Objectives and Their Consequences for Electric-Vehicle Charging Infrastructure**

Since road transport accounts for a high share of Greenhouse Gas (GHG) emissions, Electric Vehicles (EVs) offer a promising alternative to replace fossil-fuel dependent Internal Combustion Engine Vehicles (ICEVs) with a low-or zero-emission transport solution. While an essential lever in the transition towards higher diffusion of EVs is the availability of public charging stations, our knowledge about how to organize best and physically distribute these recharging networks is still emerging. In this chapter, we address this research gap by presenting an extensive review of our current knowledge and literature about the location optimization of public charging stations. A classification scheme is proposed regarding optimization objectives with a detailed analysis of each publication, highlighting neglected essential constraints such as queuing model, temporal horizon, and environmental impact. This chapter ends with suggestions and recommendations for future research.

### **This Chapter will be submitted as follows:**

Bassem Haidar, Pascal Da Costa, Jan Lepoutre, Fabrice Vidal. Review of Optimization Objectives and Their Consequences for Electric-Vehicle Charging Infrastructure.



*Chapter 2: Review of Optimization Objectives and Their Consequences for Electric-Vehicle Charging Infrastructure*

## 1. Introduction

The transportation sector is responsible for 20% of global CO<sub>2</sub> emissions, of which 72% are emitted by road transportation (IPCC, 2018). Electric Vehicles (EVs), including Battery EVs (BEVs) and Plug-in Hybrid EVs (PHEVs), are considered one of the most promising solutions for the replacement of Internal Combustion Engine Vehicles (ICEVs) because of their potential to significantly reduce Greenhouse Gas Emissions (GHG) and particle emissions. These types of vehicles have gained much recent attention because of their economic and environmental benefits (Amjad et al., 2018), compelling governments to promote EVs as a viable solution (Cao et al., 2020; H. Chen et al., 2017; Moradijuz et al., 2013). However, the apparent fast-growing number of EVs remains, in reality, a modest absolute proportion of the market. The literature generally relates this limited uptake to several reasons, but with “range anxiety” and “purchase price” being mentioned as the main hurdles (Dong et al., 2014). Range anxiety, the fear of not being able to reach one’s destination conveniently, is related to the limited by battery technology on the one hand, and the availability of recharging networks on the other hand (Eberle and Helmolt, 2010; Gert Berckmans et al., 2017; Pelletier et al., 2018, 2017; Shen et al., 2019). Both of these variables determine the range of the vehicle and the time needed to charge the battery. While one solution to reduce range anxiety could be to increase the battery size, this significantly increases the cost of the vehicle, as the battery remains one of the most expensive components of an EV. Another solution could then be to reduce the battery size in the vehicle, and depend more on the presence of optimal and easy-access charging infrastructure (Funke et al., 2019). In other words, in order to alleviate buyer concerns about EV driving range and to convince ICEV drivers to switch into electromobility, it is crucial not only to increase the availability of electric charging infrastructure, but also to optimize its spatial localization (Deb et al., 2019; Graham-Rowe et al., 2012).

However, the optimal way to deploy recharging infrastructure depends on a complex set of variables that need to be considered. For example, when charging infrastructure is concentrated in specific times and locations, this may lead to balancing problems on the electricity grid, such as peak load and voltage fluctuations, especially on the low-voltage distribution network. In order to decrease the costs that would be required to reinforce grid capacity to deal with such conditions, it may be required to spread out charging stations and trigger optimal use in time. However, from the EV user’s perspective, the deployment of these infrastructures must be aligned with the EV drivers’ behaviour, and therefore allow the driver to charge where and when s/he wants and in the most convenient and hence generally the fastest

## *Chapter 2: Review of Optimization Objectives and Their Consequences for Electric-Vehicle Charging Infrastructure*

way possible. Because this situation induces trade-offs between infrastructure costs and BEV owner convenience, the study of charging sites placement gained increasing attention in the last few years since it is a complex and dynamic problem.

Previous state-of-arts considered reviewing the optimal development of the existing stations by adding more chargers or building new stations to satisfy or anticipate the demand. Jing et al. (2016) studied traffic assignment problems with EVs in the network and limited charging facilities. Islam (2015) and Shareef et al. (2016) presented an extensive review of the three critical areas of EV research: charging technologies, the various impacts of EVs on the electric power system, and the optimal EV charging station placement and sizing using heuristic approaches towards a satisfactory solution rather than a guaranteed one. Gnann and Plötz (2015) reviewed refuelling/charging infrastructure models for Alternative Fuel Vehicles (AFVs), which combine EVs and FCEVs and refuelling infrastructure to identify research gaps. Pagany et al. (2018) provided an extensive overview of spatial charging infrastructure methods. Shen et al. (2019) reviewed the state-of-art of mathematical modelling methods and classified the papers according to recurring themes: charging infrastructure planning, charging operations, public policy, and business models. Deb et al. (2018) started by describing the charging infrastructure planning across selected countries and then presented a general overview and brief classification of the problem before identifying the future direction of work.

While these articles made significant contributions to our understanding of EV charging infrastructure localization methods, they fall short of providing an overview of optimization goals, pointing out only some of the mandatory research gaps. This Chapter presents an in-depth review of optimization objectives for charging infrastructure localization by grouping the publications according to their optimization objectives, and concluding with mandatory research gaps.

In this chapter, we aim to analyse research publications to better extrapolate the actual scientific development in infrastructure location using optimization methods. Therefore, a new approach for the classification of optimization goals was derived, accompanied by an in-depth analysis of 64 publications, to understand better locating processes. The selected papers are then discussed in detail concerning their optimization objective, used data for optimization, theoretical methods solving the problem. This article identifies eleven research questions and proposes recommendations to fill these gaps providing new perspectives for further research studies.

Section 2 presents the methodology, including literature selection and the structure of the reviewed publications. Section 3 discusses technical aspects of EVs, charging infrastructure

and the interaction between them. Section 4 provides a detailed overview of the various optimization objectives. Section 5 will discuss the data used to solve the location problem and highlight future research directions before concluding in Section 6.

## 2. Methodology

### 2.1. Literature Selection

In order to gauge a quantitative assessment of recent evolutions in the literature on BEV charging infrastructure optimization, we used Google Scholar as a search tool, as it includes a broad range of electronic databases (Martín-Martín et al., 2018), including ScienceDirect, Elsevier, and IEEE. We chose to focus on both conference and journal papers in English from 2005 to (October) 2019. We used a combination of the search terms “charging infrastructure”, “optimization methods”, “charging stations”, and “electric vehicles”. Papers not directly related to the focus of our review, such as battery-swapping station localization, Vehicle-to-Grid (V2G), or wireless charging, were excluded.

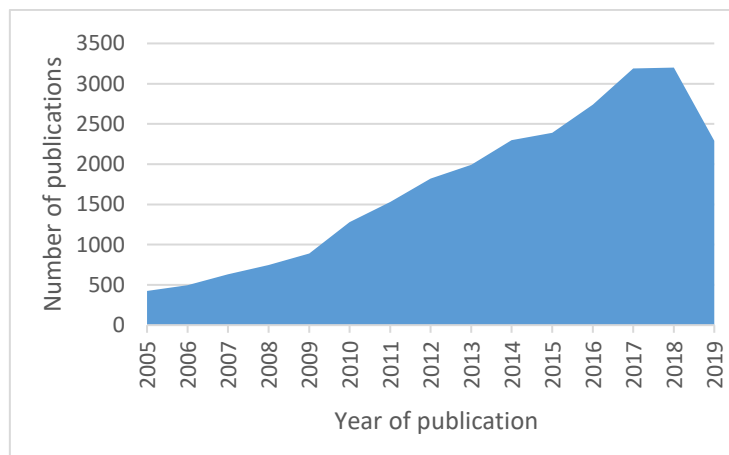

*Figure 2.1 Number of Publications in Google Scholar (until October 2019)*

### 2.2. Structure of Reviewed Articles

In this sub-section, we offer a descriptive analysis of the reviewed articles. Figure 2.1 shows the evolution of the number of papers published on the topic reviewed. As one can see, the number of publications has multiplied by seven between 2005 and 2018 and shows a linear increase over time. In terms of content, Figure 2.2 offers a structural overview of the variety of topics covered by these articles. This structure is divided into three main parts: input data, optimization process that groups the optimization procedure and the constraints, and the type of the results.

## Chapter 2: Review of Optimization Objectives and Their Consequences for Electric-Vehicle Charging Infrastructure

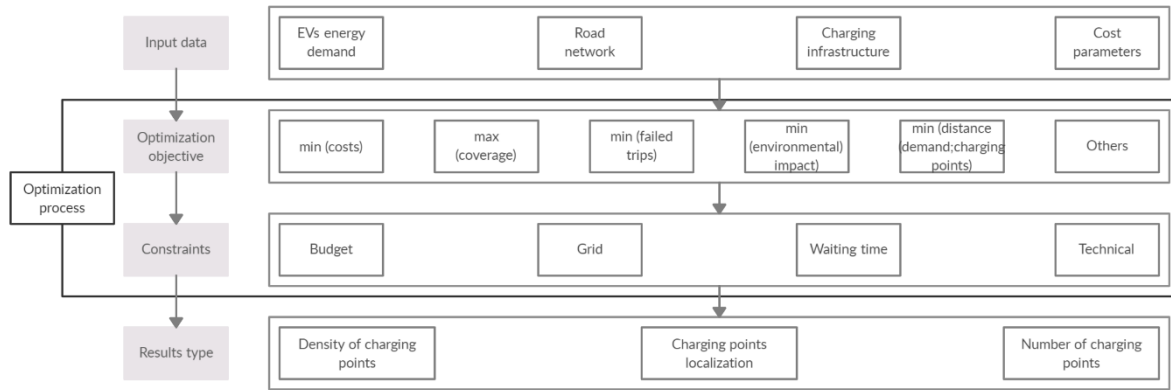

Figure 2.2 Structure of Reviewed Articles

### 2.2.1. Input Data

As a first distinguishing structural element in the literature, we noticed that the articles took four input parameters into account as part of the optimization of localization methodology: Charging needs, route parameters, charging infrastructure, and cost parameters.

First, charging needs are derived either from case studies, e.g., taxi connected fleet (Han et al., 2016; Salmon, 2016; Yang et al., 2017) or from a theoretical approach (Chen and Hua, 2014; Davidov and Pantoš, 2017; Zeng et al., 2016). The charging needs are conducted either from the remaining stored electricity in the EVs' battery (known by SoC, State of Charge) (Baouche et al., 2014; Hidalgo et al., 2016; Wood et al., 2017) or from charging demand density of specific areas (Andrenacci et al., 2016; Brooker and Qin, 2015; Wood et al., 2015). Additionally, some publications inferred the energy needs from travel data of fossil-fuel-based vehicles (Funke et al., 2019; Gnann et al., 2018, 2016). Route parameters tend to be GPS-based (Wang and Wang, 2010; Wood et al., 2017; Yi and Bauer, 2016). Some papers added additional information, such as route type, e.g., highway (Z. Chen et al., 2017; Chung and KWon, 2015; Sathaye and Kelley, 2013) and route elevation level (Yi and Bauer, 2016). Various charging assumptions about charging options are considered, such as charging speeds (slow, fast, or a mix of different speeds) and charging modes (alternative or direct current). Furthermore, cost parameters are included in the model, such as electricity price (Gnann et al., 2018, 2016; Nie and Ghamami, 2013; Salmon, 2016) and fuel price (Funke et al., 2019).

### 2.2.2. Optimization Procedure

Two models can be used to achieve the charging needs under several conditions: The bottom-up or the top-down approaches. A bottom-up approach combines several detailed assumptions of limited areas, such as technological and economic parameters, to conclude the

whole system. They can be divided into optimization models, simulation models, and accounting frameworks (Gnann and Plötz, 2015). On-street charger localization is a perfect example of the bottom-up approach; since GPS locations, battery energy demand, drivers' destination, and many other micro-input data are analyzed to suitably locating stations.

As mentioned in Figure 2.2, a second structural parameter relates to the optimization objectives used to determine the optimum level of charging infrastructure deployment, responding to an objective function with several data as control variables and as constraints. Studies using optimization methods to determine charging-station location distribution employ generalized mathematical formulation (1) to (7).

$$\min(F) = f(p, u_{speed}) \quad (2.1)$$

Where  $F$  is the objective function, and  $p$  and  $u$  represent the decision variables being optimized. Depending on the particular focus of the study,  $p$  can represent the number of locations of charging stations on nodes of the electricity distribution network, on nodes of the road network, or others.  $U$  represents the number of chargers divided into different groups regarding the charging speed (Section 3.2).  $F$  can include the cost, EV flow (traffic), distance from the demand point into the supply point, exact demand localization. Equation (2.1) is subjected to several constraints, generally are equality and/or inequality constraints, elaborated from equation (2.2) to (2.7).

$$g_i(p, u_{speed}) = 0 \quad (2.2)$$

$$u_{speed}^{min} \leq u_{speed} \leq u_{speed}^{max} \quad (2.3)$$

$$h_j(q * u_{speed}) \leq M \quad (2.4)$$

$$d_k(x, y) \leq N \quad (2.5)$$

$$20\% \leq SoC \leq 80\% \quad (2.6)$$

$$W_q \leq a \text{ mins} \quad (2.7)$$

$$i = 1, \dots, I$$

$$j = 1, \dots, J$$

$$k = 1, \dots, K$$

Equation (2.2), an equality constraint, can balance the charging or power demand. Equation (2.3), an inequality constraint, indicates the minimum and the maximum number of charging stations of the studied area. Another inequality constraint given by Equation (2.4) can include

*Chapter 2: Review of Optimization Objectives and Their Consequences for Electric-Vehicle Charging Infrastructure*

voltage limit, current limit, budget limit, where  $q$  is a parameter depending on the optimization objective (cost, power, current of a charger) and  $M$  the maximum value. (2.5) can be used to determine the maximal distance between two charging points ( $x$  and  $y$ ). (2.6) is a mandatory one and implies technical constraints on the battery's state of charge. Comfort constraints such as an  $a$ -minute maximum waiting time of the passenger or charging delay time are implied by the 7th constraint.

Different mathematical methods are used to solve these problems, e.g., linear, mixed-integer linear and non-linear programming (see abbreviations of methods in Table 2.1) using a variety of software: IBM ILOG CPLEX, MATLAB, LINGO, NOMAD, EXCEL, etc. In the context of our Chapter, optimization models allow us to suggest potential pathways or representations of the future minimizing costs, loads, grid impacts, or maximizing global welfare coverage area. These parameters and the different assumptions considered will be detailed in Sections 4 and 5.

*Table 2.1 Methods Names Abbreviations*

| <b>Abbreviation</b> | <b>Method name</b>                              | <b>Example of papers</b>       |
|---------------------|---|--------------------------------|
| <b>BIP</b>          | Binary Integer Program                          | (Shukla et al., 2011)          |
| <b>FCLM</b>         | Flow-Capturing Location Model                   | (Cruz-Zambrano et al., 2013)   |
| <b>FCDLM</b>        | Flow Charge Dispersion Location Model           | (Baouche et al., 2014)         |
| <b>FLPM</b>         | Facility Location Planning Model                | (Eisel et al., 2014)           |
| <b>FRLM</b>         | Flow Refuelling Location Model                  | (Chung and KWon, 2015)         |
| <b>GA</b>           | Genetic Algorithm                               | (Spieker et al., 2017)         |
| <b>MBINLP</b>       | Multi Binary Integer Non Linear Model           | (He et al., 2016)              |
| <b>MILPM</b>        | Mixed Integer Programming Linear Model          | (Jia et al., 2014)             |
| <b>MINLP</b>        | Mixed Integer Non Linear Programming            | (Sadeghi-Barzani et al., 2014) |
| <b>MIP</b>          | Mixed Integer Programming                       | (Sun et al., 2018)             |
| <b>MOGA</b>         | Multi-Objective Genetic Algorithm               | (Hidalgo et al., 2016)         |
| <b>MRLM</b>         | Multipath Refuelling Location Model             | (Huang et al., 2015)           |
| <b>STDCLM</b>       | Spatial-Temporal Demand Coverage Location Model | (Tu et al., 2016)              |

2.2.3. Results Types

Finally, we noticed three types of results in the literature. In order to fulfil the EV energy needs, some papers identified exact locations to build charging stations (Chen et al., 2016; Guo et al., 2016; M. Li et al., 2017), others reported a charging density (charging points per km<sup>2</sup>) for a given territory (Efthymiou et al., 2012; Li and Huang, 2014; Namdeo et al., 2014). A third

objective is not to report on a specific localization but an optimal number of charging stations or points (Farkas and Prikler, 2012; Gnann et al., 2018; Funke et al., 2019).

## 3. Introduction to Technical Aspects

### 3.1. Electric Vehicles

We define electro-mobility as the act of using electricity as a source of energy for the propulsion of a vehicle, either as a replacement of diesel or fuel as used for ICEVs or as an addition to such energy sources (hybrid vehicles). The energy source for powering the electric engines can be drawn from a battery (Battery EVs or Hybrid EVs) or a Fuel Cell EV (FCEVs), with the latter using a fuel cell to turn hydrogen into electricity. In the case of BEVs, the electricity is drawn from either an external electricity source that is plugged into the vehicle (Plug-in EVs) or from power recovered in braking cycles (non-plug-in Hybrid EVs). In the case of Plug-in Hybrid EVs (PHEV), cars use electricity as a source of energy, but in combination with an ICE motor that requires fuel.

### 3.2. Charging Infrastructure

There are many charging techniques: Parked charging (conductive or wireless), battery swapping, and supply while driving (conductive or wireless) (Grauers et al., 2013). This Chapter will cover only the conductive parked charging technique, using “a charger”. The charging time not only depends on the charger’s speeds (amperage) but also on the battery capacity, the battery SoC, the vehicle’s technology (AC/DC alternative, direct current conversion), and the charging cable. We can identify and qualify a charging point by its location, power, socket model, and current type (AC/DC, single or triple phase). According to the international standard IEC 61851, the slowest is Mode 1, usually installed in houses, and has a power of 3 kW using AC. Mode 2 chargers power between 3 and 22kW at AC are generally found in homes or private or public parking spaces (such as parking lots). A Mode 3 charger operates at up to 50kW, using DC, and is generally not found in personal homes. These charging points are preferably installed in public and parking spaces. Finally, ultra-fast chargers or Mode 4 operate at powers above 50kW using DC and are generally installed on corridors (highways). Table 2.2 provides an overview of these charging modes, and the time is generally taken for a car to charge for 160 km.



Table 2.2 Charging Modes Parameters

| Mode [IEC 6185]  | Power (kW) | Type                | Location             | Current type | Charging time |
|------------------|------------|---------------------|----------------------|--------------|---------------|
| Mode 1 (Level 1) | 1 - 3      | Private             | Home                 | AC           | >10h          |
| Mode 2 (Level 2) | 3 - 22     | Private/Semi-public | Home, Workplace      | AC           | 2 – 12h       |
| Mode 3 (Level 3) | 22 - 50    | Semi-public/Public  | Workplace, on-street | DC           | 0.5 – 1.5h    |
| Mode 4 (Level 4) | >50        | Public              | Highways             | DC           | <30 min       |

### 3.3.Problem Identification

In the ICEV case, there is a direct relation between the client and the automotive manufacturer thanks to the considerable autonomy and the availability of gas stations everywhere. However, a new private actor is involved in the EV case: The charging operator under public recommendations from the state and authorities, as mentioned in Figure 2.3 (Shen et al., 2019).

Based on Egbue and Long (2012b)’s survey and the 40-paper review of W. Li et al. (2017), the interaction between EV manufacturers and EV drivers presents a lack of confidence: the future of EV development remains uncertain due to the immaturity and the high price of the battery technology. Similarly, the relation between EV manufacturers and charging infrastructure operators can be reflected in the “Chicken and Egg Dilemma” discussed earlier in this Chapter. Thus, research and development cooperation is inescapable for the growth of EV sales.

The relation between charging operators and clients is not well established: the modest awareness of the public infrastructure development and pricing rules according to the charging speeds, e.g., different subscriptions and parking fees. According to the results of econometrics models based on EV sales and client surveys, an increase in the EV market share is not only related to locating more charging stations but also to the accessibility of charging stations and charging speeds (Axsen et al., 2017; Bailey et al., 2015; Egbue and Long, 2012; Hackbarth and Madlener, 2013; Hidrue et al., 2011; S. Li et al., 2017; Mersky et al., 2016; Sierzchula et al., 2014; Springel, 2017; Tran et al., 2012).

Governments and public authorities play a crucial role in introducing and boosting the EV market by regulating all three parties. They are implementing various policies, including financial and non-financial incentives, consumer subsidies, tax exemption on EV, more taxes on fossil fuel, public charging infrastructure.

Concerning the scope of our article, we will be interested in the interaction between charging infrastructure operators and drivers to suitably develop methods for optimal location stations based on consumers' preferences.

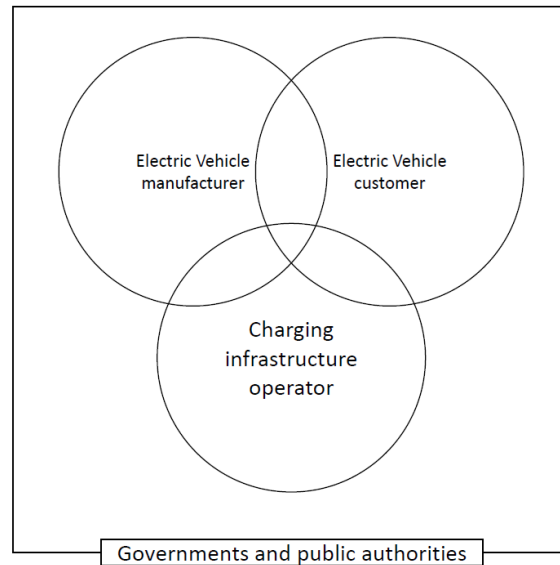

*Figure 2.3 Problem Identification within the Three Parties*

## 4. Analysis of Charging Infrastructure Optimization Objectives

Ensuring the availability, visibility, and exact number of charging stations is imperative to building an extensive public infrastructure. For a more detailed literature review, 64 publications, whose common objective is identifying candidate areas for charging stations, are selected. Our review is based on grouping papers with similar optimization objectives, as mentioned in Figure 2.2, and on mentioning the used data in the optimization procedure detailing parameters of the paper: different authors' names, methodology (method, model, and used software), the results type, geographic, EV, drivers, demographic parameters as well as constraints. Therefore, tables grouping all these data are detailed after every optimization goal section.

### 4.1. Minimizing the Cost

A variety of studies have proposed various optimization approaches. Our review showed that the optimization models generally had as their objective function to minimize overall costs (Equation 2.8). We identified different costs: technical such as charging infrastructure (CI) CAPEX and OPEX (Ahn and Yeo, 2015), comfort (waiting and service times (He et al., 2016), the additional trip to reach the station (Liu and Wang, 2017), and environment costs (Zhang et

al., 2015). The papers reviewed also vary along with their choices between two business models: the first one aggregates the costs as if carried by charging infrastructure operators and aims to minimize deployment costs and maximizing profits. The second business model aggregates the costs from customer perspectives and aims to minimize the costs paid by the EV owner, including comfort-related costs (waiting time). Table 2.3 detailed all the reviewed papers considering the minimization of costs as the primary function. The minimization equation (2.8) is formulated as follows:

$$\min F = f(CI_{CAPEX}, CI_{OPEX}, BEV_{CAPEX}, BEV_{OPEX}, Cost_{comfort}, Cost_{environment}) \quad (2.8)$$

Subjected to similar constraints in Section 2.2.2.:

$$0 \leq X \leq M \quad (2.9)$$

$$g(x_i, y_j) \leq M \quad (2.10)$$

$$W_q \leq 5 \text{ mins} \quad (2.11)$$

Where:

$x_i$ : charging point location

$y_j$ : demand location

Yang et al. (2017), Davidov and Pantoš (2017), Zeng et al. (2016), Baouche et al. (2014), Hidalgo et al. (2016), Gnann et al. (2018), Wang and Wang (2010), and Yi and Bauer (2016) took into account the charger's investments as well as building, construction costs in the optimization procedure. Huang et al. (2015), Li and Huang (2014), and Zhang et al. (2015) mixed the investments in charging points and operation and yearly management expenses. Chen and Hua (2014), Jia et al. (2014), Islam et al. (2016), Islam et al. (2015) proposed to transform gas stations into electric ones; thus, transformation costs are included in addition to investments. Funke et al. (2019b) and Nie and Ghamami (2013) compared the investment in increasing the charging infrastructure, on the one hand, with adding more battery capacity in the EVs, on the other hand, using technical costs: the costs of chargers and batteries. The novelty of Gnann et al. (2016) is to include the annual paid cost in the model, such as taxes, charger's operating costs, and electricity expenses. Han et al. (2016), Chen et al. (2016), Z. Chen et al. (2017), Ahn and Yeo (2015) combined technical and comfort costs. They minimized the additional trip from the demand point into the charging stations' location and the delay time in the queue waiting to

access the charger. Zhang et al. (2015) considered diversification and selected the minimum costs of investment, operation, and environment, the originality of this paper. Salmon (2016) investigated the location and number of charging stations that would be required to meet the demands of a subset of the electric taxi while maximizing their profits. Based on a theoretical study, Guo et al. (2016) maximized the net benefits during the operational stage minus the total investment (land acquisition and equipment purchase). Deb et al. (2019)'s allocation problem, for Guwahati city in India, was framed in a multi-objective framework considering the economic factors, power grid characteristics (voltage stability, reliability, power loss) additionally to EV user's convenience, and random road traffic. Mohsenzadeh et al. (2015) presented optimal planning of CS in the presence of capacitors to maintain voltage and improve power loss in electrical distribution networks while minimizing the cost of chargers' investments and power loss costs;

Since generating electricity can produce pollutants such as SO<sub>2</sub>, NO<sub>x</sub>, CO<sub>2</sub>, Co, and TSP, Zhang et al. (2015) minimized the environmental cost, which remains strongly lacking in the literature.

The most used optimization goal to deploy charging infrastructure is to minimise costs for different members of the EV industry. Investments and operation and maintenance costs are identified for both charging infrastructure operators and EV drivers. Additional costs associated with the driver's comfort, namely waiting time cost and additional trip cost, are also optimized in some publications. Taking into account the environmental costs of the LCA of both charging infrastructure and EVs is entirely lacking in the literature.

#### **4.2. Maximizing Coverage**

A second optimization objective found in the reviewed papers is to maximize the coverage of charging stations in the studied area. This optimization objective reveals to select the candidate locations for installing on-street chargers that captures the most potential customers in the coverage area. It is argued that the benefits of maximizing coverage increase public visibility of charging stations on the one hand and maximize the availability of charging stations, especially along high-density traffic routes. Since charging stations are non-optimally deployed, they are not best used (Funke et al., 2019). Locating the charging infrastructure based on maximizing coverage locations may be, therefore, the key to increase their usage (Spieker et al., 2017). Economic parameters such as costs are rarely taken into account in these types of methods as constraints.

Throughout Spieker et al. (2017)'s paper, dual-optimisation methods are taken into account: Maximizing demand coverage of the points of interest areas and maximizing traffic coverage leads to placing charging stations close to high traffic points. Chung and KWon (2015)'s objective is to maximize the traffic flow using a multi-period optimization model for strategic charging station location planning on Korean corridors. Xi et al. (2013) developed an optimization model to maximize demand coverage and apply it in the Ohio region. Tu et al. (2016) used the case study of electric taxis to develop a spatial-temporal demand-coverage approach for maximizing the demand coverage, taking travelled distances into account. Zhang et al. (2017) provided an arc cover-path cover model (AC-PC) to maximize traffic flow across all periods. Wanting Lin and Guowei Hua (2015)'s optimization method is to maximize the intercepted traffic flow based on a particle swarm optimization algorithm using economic constraint. Yi and Bauer (2016) and Wang and Wang (2010) had not only a cost optimization procedure but also maximization of demand coverage from the viewpoint of reaching the most significant number of customers or households. Sun et al. (2018) proposed a maximization of the demand coverage location model for charging stations based on the characteristics of urban EV driver travel behaviors pointing out that the economic aspect is a critical factor. Their model can be divided into two parts: slow charging speed for short trips and fast chargers for long ones. Gao and Guo (2013) applied the same model using the branch and bound method under the Voronoi diagram that guarantees a reasonable distribution and taking into account queuing models as constraints. They also calculated the number of chargers based on budget minimization. Frade et al. (2011) presented a study for an urban area of Lisbon, Portugal characterized by a high population density and a strong rate of employment. They applied the maximal coverage goal of slow chargers since the EV in this area park for several hours within the 24-h period.

An optimization target of maximizing coverage will increase the usage of charging infrastructure by increasing their visibility. Maximizing coverage could be one of the ideal optimization objectives to locate the charging infrastructure for EVs. Table 2.4 details all the reviewed papers considering the maximization demand coverage as the primary function. The following equation (2.12) then formulates the main equation of maximizing demand coverage:

$$\max F = \sum_{v \in V} f_v y_v \quad (2.12)$$

Where:

$f_v$ : is the rate of traffic flow along any path  $v \in V$

$$y_v = \begin{cases} 1 & \text{if at least one charging point is installed on path } v \\ 0 & \text{otherwise} \end{cases}$$

Subjected to similar constraints in Section 2.2.2.

### 4.3. Minimizing Failed Trips

As was mentioned before, one of the main hurdles in the adoption of EVs is range anxiety. In order to optimize the locations of recharging infrastructure, one would need to minimize the likelihood that an EV driver experiences a failed trip as a result of lacking recharging infrastructure. A failed trip is then defined as the EV driver's obligation to search for a charging station to recharge his vehicle with electricity, waste time reaching a charging station, and/or waste time while recharging. Dong et al. (2014) examined the impact of deploying different charging levels on reducing range anxiety using an optimization model that minimizes the missed trips based on real data and is subjected to an economic constraint. Hidalgo et al. (2016) had dual objectives: minimizing the total cost in addition to the number of missed trips in Singapore. Asamer et al. (2016) maximized the sum of covered taxi trip counts, which reduces failed trips using more than 720,000 BEV taxi trips in Vienna with known start and end positions. Similar to the above, Shahraki et al. (2015) enlarged the part of vehicle-miles-travelled being electrified, focusing on PHEV rather than BEV. The allocation model presented in Alhazmi et al. (2017) has two stages: modelling the trip-success ratio indicator to estimate the range and allocation of the charging stations. Their proposed model evaluates the charging station network based on two components: the service range of charging stations and the completed (virtual) trips by EVs.

After all, minimizing the failed trips of EVs is the ideal optimization goal that addresses the driver's range anxiety for BEVs drivers and the most suitable objective to maximize the usage of the battery for PHEV case studies. Table 2.5 details all the reviewed papers considering the minimization of failed trips as the main function. The general optimization equation (2.13) can be detailed as follow, subjected to similar constraints as Section 2.2.2:

$$\min f(x) = \sum_j \sum_d y_{j,d} \quad (2.13)$$

Where:  $y_{j,d}$ : is the failed trip of the driver "j", on the day "d"

#### **4.4. Minimizing the Environmental Impact**

Among the papers that have other objectives than the ones reviewed already and that generally only had a few papers focusing on these objectives, the first set of papers focused on minimising environmental impact. Surprisingly, GHG emissions of EVs, however, were never evaluated in the papers reviewed. It should be noted that EVs have zero emissions only while driving, but not during the manufacturing, recycling, and charging processes, namely Life Cycle Assessment, and in the production of electricity (power mix of the studied country). Shahraki et al. (2015), which included the environmental aspect while maximizing the electrified mileage fleet, did not ensure maximum benefits regarding the environment. Besides, as mentioned before, Zhang et al. (2015) did not only minimize the investment and operation costs, but also they included environmental ones while taking into account GHG emissions per unit of electricity, per power generation technology, and per pollutant (SO<sub>2</sub>, NO<sub>x</sub>, CO<sub>2</sub>, CO, and TSP).

Studying the environmental impact while deploying the charging infrastructure of EVs is scarcely considered in the reviewed publications. While some articles considered the environmental impact of BEVs, they failed to expand the impact to cover the charging infrastructure emissions. It is recommended that researchers aim to study the environmental impact of the deployment of charging stations to minimise the environmental impact.

#### **4.5. Minimizing the Distance between Demand and Charging Points**

Another optimization target is to minimize the total distance between demand and supply (charging) points. Sathaye and Kelley (2013)'s approach is to estimate the minimum EV charging infrastructure needs based on minimizing the deviation along the corridor from drivers' initial trip paths. Andrenacci et al. (2016) used Euclidean distance as driving criteria while minimizing the sum of the distances when drivers search for their nearest charging station. As discussed in Section 4.1, some papers consider minimising additional trip costs from the demand point into the charging station. For this reason, the distance between demand and charging point is considered in the optimization procedure of Han et al. (2016), Yi and Bauer (2016), Chen et al. (2016), Ahn and Yeo (2015), Liu and Wang (2017), He et al. (2015), Li et al. (2016), Tian et al. (2018), Y. Zhang et al. (2016), and H. Zhang et al. (2016).

The distance between demand and supply points is indirectly considered in various optimization objectives discussed earlier in this Chapter. Contrary, other publications decided to minimise the distances as the main target of the paper to alleviate range anxiety and concerns about charging convenience. Table 2.6 detailed all the reviewed papers considering the minimization of the distance between demand and charging points. The optimization equation

(2.14) is formulated as follow, subjected to similar constraints as Section 2.2.2.:

$$\min f(x, y) = d(x_i; y_j) \quad (2.14)$$

Where:

$x_i$ : The demand point localization

$y_j$ : The charging station localization

#### 4.6. Other Optimization Objectives

In this section, we will present many objectives that cannot be grouped according to previous goals. Table 2.7 presents an exhaustive review of the reviewed publications.

Brooker and Qin (2015), Pagany et al. (2019), and Morrissey et al. (2016) identified the location of charging stations regarding the points of interest and the destination and based on real-world data. Efthymiou et al. (2012) proposed a linear model based on a multi-criteria analysis technique to identify candidate locations of charging stations after analyzing variables such as population, point of interest, and electric grid characteristics. Increasing the visibility of fuelling stations is proposed by Eisel et al. (2014), based on implementing customers' preferences into a facility location planning model. Yaping Gao and Xiaochun Lu (2015) considered the real-road conditions and population density while improving the travelling simulation model of EVs.

Based on real electric taxi trajectories in Beijing, M. Li et al. (2017) conducted a time-series simulation to derive perceptions for the public charging station deployment plan: location, number, and types of chargers. Namdeo et al. (2014) adopted a multi-dimensional spatial modelling framework, taking as input a combination of socio-demographic and travel data to determine candidate locations of stations. The approach presented in Rajabi-Ghahnavieh and Sadeghi-Barzani (2017) aims to determine charging stations' optimal capacity and location based on urban traffic circulation EV user behaviour, hourly electric grid load scenarios. Furthermore, Said et al. (2013) relied on a model of communication between vehicles and charging infrastructure operators beforehand to minimize the service time at stations. He et al. (2013) applied an active-set algorithm while maximizing the social welfare associated with coupled networks. Based on a theoretical approach, Farkas and Prikler (2012) compared the installation of a large number of slow charging points with a low number of fast chargers taking into account M/M/c/N queuing model consequences, which can be applied to semi-public locations, e.g., malls, schools, etc. Jung et al. (2014) proposed a dual-level minimization procedure based on shared EV taxis' data taking into account queues delays. A lower-level



minimizes the passenger's waiting and travel time, and an upper-level reduces the EV's queue delay and travel time. Martins and Trindade (2015) studied the allocation of fast charging stations in an urban area based on time series analysis considering the variation of load during the day and minimizing the power losses caused by the installation of fast-charging stations.

Table 2.7 details all the reviewed papers considering various optimization objectives. To sum up, various charging optimization goals are not fully elaborated and used by researchers in the literature, taking into account socio-techno-economic data.

## 5. Discussion and determination of research gaps

Although many works have been conducted on EV charging station localization purposes, we believe that significant research gaps remain. Based on the reviewed papers, we highlight a variety of possible research directions that should be detailed from different perspectives. Section 5 provided the reader with a detailed analysis of the different parameters of the reviewed publications. We found around eleven research gaps and recommendations that will be conducted after analyzing them in detail. We divided these gaps into main groups: the first one analyses the gaps of input data, and the second one details the ones of the optimization procedure.

### 5.1. Gaps in Input Data

#### 5.1.1. Spatial Resolution

Almost all reviewed papers applied the optimization procedure on a specific area of study to validate the methodology rather than a theoretical study using online maps software (ArcGIS, QGIS, Google maps, etc.). We identified two central future research positions in terms of geographical resolution: not applying the optimization process on rural areas, the non-usage of GPS data for spatial localization.

Based on the reviewed literature, most of the models are tested in urban areas, such as Rome (Andrenacci et al., 2016), Beijing (Liu et al., 2012), Washington (Wood et al., 2015), New York (Salmon, 2016), where socio-demographic parameters: population density, driving behaviour, types of accommodation, GDP, roads, carpooling, traffic are not similar to those in rural areas. Since the input data for locating charging stations could determine the urbanity level, it will not directly impact the optimization procedure. However, to overcome the "Chicken and Egg Dilemma" between EVs adoption trend and public charging infrastructure deployment in rural regions, we strongly recommend applying optimization procedure charging-station localization in a rural area.

## *Chapter 2: Review of Optimization Objectives and Their Consequences for Electric-Vehicle Charging Infrastructure*

As mentioned in Figure 2.2, three results were identified: locating the exact GPS location of charging stations, determining the station densities in the studied regions, or the number of charging points. Since GPS-based models allow for reaching very high spatial resolution through mapping large sets of data, it is vital to use GPS data that reflects the real situation of the studied area. It can help us to determine the exact location of every charging point and to know the geographical constraints in terms of flow direction, nodes, highways, public areas, existing gas stations which locations could be candidate ones such as (Baouche et al., 2014), (Nie and Ghamami, 2013), (Shahraki et al., 2015), and (Alhazmi et al., 2017). Cai et al. (2014) concluded that charging at gas stations using fast chargers will not affect the driver's habits, and it will maintain the utilization of the public infrastructure in the long term after the pure electrification of the road transportation sector. However, it is not ideal for charging using slow and normal chargers since drivers cannot wait for hours in the queue.

Regarding parking-lot-based locations, where parking fees are applicable, they are best suited for long-duration charging, such as companies, supermarkets, hospitals, theatres, museums. Yi and Bauer (2016) used the locations of drivers' destinations (malls, universities, airports) while maximizing the number of reachable households and minimized overall e-transportation energy cost. Modelling real GPS data of drivers' trajectories on maps and other sources can precisely determine the traffic flow on roads, highways, corridors, and nodes, especially during holidays and peak hours. This parameter can indicate where more charging points are needed, the charging power, or the number of chargers.

To sum up, all models present limitations. We believe that an approach that uses real input data like GPS locations will significantly benefit our ability to optimize recharging infrastructure locations. A widely adopted approach to this design problem aims to locate charging facilities near the urban activity centers of EV owners (homes, shopping malls, gas stations, and workplaces) to maximize the overall accessibility and minimize the cost of transformation. However, these findings are unfit for rural areas where the optimization may have to follow a very different logic and where equilibria between costs for recharging infrastructure operators and EV drives may have to be balanced differently. Finally, the remaining question concerns the degree of accuracy to be reached depending on the research question and the level of complexity that will surely change over time.

## *Chapter 2: Review of Optimization Objectives and Their Consequences for Electric-Vehicle Charging Infrastructure*

### 5.1.2. Driver's Data

#### 5.1.2.1. EV Market Share Penetration

A multi-type vehicle research design is almost inexistent in the papers reviewed. This is the case of almost all of the reviewed papers, especially taxi fleet case studies which used identical 24 – 40 kWh electric vehicles fleets, such as in (Han et al., 2016), (Salmon, 2016), (Yang et al., 2017), (Z. Chen et al., 2017). It is known that a variety of PEV models is available on the market, regardless of their type BEV or PHEV, with different battery capacities between 2 kWh and can exceed 100 kWh. In order to achieve a realistic perspective on the trade-offs between infrastructure costs, it is necessary to consider a scenario with both types of vehicles on the market. A notable exemption is a paper by Soylu et al. (2016), where they weigh different scenarios with a different market share of PHEV and BEV. Besides, Jia et al. (2014) took into account BEV and PHEV and classed the vehicles regarding their type: short-term taxi, long-term taxi, and private EVs.

Eventually, various penetration rates of electric mobility can stimulate the need to install (or lack thereof) new public charging stations and, therefore, optimize unnecessary costs.

#### 5.1.2.2. Charging Behaviour

Based on surveys and data analyses in Columbia (Dunckley, 2016), in Norway (Figenbaum and Kolbenstvedt, 2016), in Germany (Gnann et al., 2018, 2016), in Spain (Martínez-Lao et al., 2017) and (Brady and O'Mahony, 2016; Morrissey et al., 2016), between 75 and 95% of EVs owners prefer to charge their vehicle at home during residual peak hours. Data from 79 EV users were assessed during a 6-month study in Germany (Franke and Krems, 2013), and on average, only between 1% and 4.8% of the users charged using public infrastructure similarly to (Franke and Krems, 2013).

These studies can confirm Funke et al. (2019)'s contribution that public infrastructure is barely used and oversized. We can conclude that almost 80% of owners charge their vehicles at home. A private charger is then a factor that should be adapted in the optimization procedure. This is the case of Han et al. (2016), Yang et al. (2017), Hidalgo et al. (2016), Yi and Bauer (2016), Z. Chen et al. (2017), Sathaye and Kelley (2013), M. Li et al. (2017), Xi et al. (2013), Zhang et al. (2017), and Jung et al. (2014), that considered a full initial battery SoC, assuming that all vehicles can charge at home. This hypothesis should be revised since private charger installation differs from one city to another depending on the degree of urbanity and the type of households.

Besides, the real energy-charged using the public charging infrastructure remains unclear. Since keeping the battery SoC between 20% and 80% is recommended because charging till 100% could harm the battery technology and takes a longer time than predicted, the charging frequency using the public infrastructure is still blurry. Also, the driver's preferences regarding charging speeds remain fuzzy, introducing a trade-off between charging duration, charging power, and fees. Contrary to a fast charger, the usage of a slow charger comes with low fees and long charging durations. Since various charging speeds are available on the market (Table 2.2), we recommend further researchers investigate the drivers' preferences regarding the trade-off power/duration/fees and consider it in the charging infrastructure deployment.

Eventually, taking into account the driver's charging behaviour is essential, especially the private charger installation, the usage frequency of the public charging infrastructure, and the preferable charging power for the driver. These recommendations will optimize the charging infrastructure and improve the EV adoption trend for drivers who are not equipped with at-home or at-work chargers.

#### 5.1.2.3. Driver's Satisfaction

This parameter is a qualitative factor that can interpret the psychological aspect of the driver. The goal of optimizing charging point locations is to overcome the driver's range anxiety by not changing his/her daily habits. For instance, whether the use of radio, air-conditioning, driving speed, charging times, and acceleration should remain unchanged after switching to PEV may be a vital factor to consider when one intends to understand how to increase the diffusion of EVs. Thus, while increasing the infrastructure quality of service (QoS) by installing fast chargers depending on maximum range, this may result by adding the costs related to the client's satisfaction, such as in (Davidov and Pantoš, 2017) where the QoS is improved by minimizing the total cost.

Besides, as mentioned in Section 5.2, waiting time due to queues can occur if the demand for EVs and the supply of charging points are not equal. For Funke et al. (2019), Gnann et al. (2018), and Gnann et al. (2016), EV drivers are only willing to wait up to 15 minutes in order to plug in their vehicles. Eventually, taking into account the driver's satisfaction is a mandatory psychological factor that will help improve the EV market share after eliminating the range anxiety.

#### 5.1.2.4. New Mobility Services

EV car-sharing, booking a charging station, and various new electromobility services can change the driver's behaviour. Car sharing, where individuals rent cars to other individuals in peer-to-peer or from companies, is gaining popularity in many countries. Recent studies show that these vehicles are generally used for a short period, usually for up to one to two hours per day (Shen et al., 2019). Not only is car-sharing gaining traction among the population, but many local governments are also stimulating electromobility by designing new offers for this service (Bakker and Jacob Trip, 2013). As the business model associated with these services is not mature enough, it seems likely that drivers can overcome barriers using shared cars (Shen et al., 2019). Another electric mobility service is to book a charging station.

Similarly to car-sharing services, ensuring chargers' reservations is an ongoing business. However, it will ensure the driver's freedom to charge his/her EV depending on his/her time preferences by booking a charger on an application. These services are being developed and forecasted to be more favoured by future EV clients; they are, therefore, parameters to add in the driver's input data.

#### 5.1.3. Technical Parameters

Although the scope of our review is not to detail the electric transfer from the grid to the battery, we will briefly elaborate on two critical technical factors of the charging infrastructure and battery technology. Han et al. (2016), Davidov and Pantoš (2017), Zeng et al. (2016), Hidalgo et al. (2016), Yi and Bauer (2016), Z. Chen et al. (2017) and Islam et al. (2016) included the energy conversion factor of the charging process whose value varies between 88% and 94% depending on the current type (AC/DC), charger's power, and conversion techniques. More detailed efficiency parameters of the battery, power converter, e-motor controller, e-motor, and mechanical powertrain are taken into account in the study of Yi and Bauer (Yi and Bauer, 2016) while analyzing the energy demand of a specific GPS location. In addition to this factor, battery deterioration can occur due to multiple charge/discharge cycles. For more details please refer to (Pelletier et al., 2018) and (Pelletier et al., 2017).

Since the optimization of charging infrastructure is interdependent on technical features of both charging infrastructure and the vehicle, technical parameters should ideally also be taken into accounts, such as the energy conversion factor and the real duration of the charging process.

#### 5.1.4. Temporal Horizon

While no clear time horizon was identified in the studies, researchers only analyzed an actual situation without comparing it to the future evolution of EVs' number in the studied area. Soylyu et al. (2016)'s study is based on the European Commission suggestions: to achieve 1.5 million charging points in Germany by 2020, 150,000 should be publicly accessible charging points to fulfil the forecasted EV market share needs. The variability of the EV market requires an adequate temporal resolution in order to be adequately addressed. Indeed, concerning future developments, new fast chargers (Power > 150 kW) will be available on the market (Serradilla et al., 2017), battery technology is accompanied by a price decrease (Gnann et al., 2018) will be improved thanks to the non-stopped research and development studies. The cost of 1 kWh Lithium-Ion battery packs was up to USD 800 in 2012 and is forecasted to fall to USD 125 in 2022 (Pelletier et al., 2017) and reach around USD 100 in 2030 (Gert Berckmans et al., 2017). Similarly, the investments in charging stations are predicted to decrease in the next few years (Schroeder and Traber, 2012).

In order to capture this potential, an essential factor that should be taken into account is the temporal horizon of the considered models. Therefore, neglecting this potential due and zooming into a specific situation may lower the accuracy of the results. Taking 2030-2050 as a temporal horizon could help the different stakeholders of the EV industry avoid additional costs, overcome barriers facing the EV adoption, and manage the future EV market penetration.

#### 5.1.5. External Conditions

Based on the reviewed publications, weather parameters were scarcely considered as external conditions in the models. Temperature and wind speed can be added as external factors since they directly impact battery degradation; thus, the vehicle's energy needs. Under extreme temperatures, heating or air conditioning can be turned on, which will lead to a decrease in the driving range and, therefore, an increase in charging demands. Han et al. (2016) gathered experimental data from three EV taxis in September 2013 (average temperature was 21.4°C). They noticed that the differences in the charging time in the EV data come mainly from the battery temperature. Han et al. (2016) and H. Zhang et al. (2016) studied three scenarios of day temperature: 6, 20, and 35 °C, and concluded on the significance of this factor. Wood et al. (2015) and Yi and Bauer (2016) localized Level 2 chargers in the Seattle area in the United States and used BLAST-V (an EV simulator) that takes as input temperature and vehicle's driving speed. The environmental information can include weather conditions such as wind speed, temperature, and road surface conditions. The energy consumption can be computed by

integrating a differential equation that provides an EV's instantaneous power (Yi and Bauer, 2016). While some papers zoomed into the impact of temperature on the charging process (Lindgren and Lund, 2016) and (Motoaki et al., 2018), this topic remains open for further researches.

Last but not least, in order to avoid theoretical results, the influence of weather conditions in the target area should be carefully taken into account, which may vary from a study case to another.

## 5.2. Gaps in the Optimization Procedure

These recommendations present mandatory constraints to take into account in the optimization process.

### 5.2.1. Queuing Models

As mentioned in Section 4.1, queues can occur when there is no balance between supply and demand. Queuing theory is a branch of operational research that investigates the relationships between the demand and the supply for a system (Marchi et al., 2018). To begin with, a queuing model can be defined as follows:  $X/X/c/N$ . The first "X" represents the inter-arrival time distribution of EVs and can model the EV arrival rate; the second "X" refers to service-time distribution, charging time in our case, modelled by service rate as a parameter. For these two parameters: "M" refers to Markovian exponential distribution and "G" the general one; "c" is for the number of service points (chargers) per station, and "N" is the system capacity (number of parking stations, including "c"). For more information, please refer to Bhat (Bhat, 2015).

Funke et al. (2019) used M/G/c model while finding cost-efficient ways to address the trade-off between battery ranges and the availability of public fast chargers. Gnann et al. (2018) analyzed current charging behaviour taking the M/G/1 model for future fast-charging needs. Tian et al. (2018), Y. Zhang et al. (2016) determined the number of sockets per charging station while minimizing the total cost using M/M/s model. The second group of publications took the parking constraints into account, such as M/M/c/N for Yang et al. (2017) and M/M/1/2 (Gnann et al., 2016). Marchi et al. (2018) compared two analytical models to conclude with the effect of the limited parking places model considering variable rates for EV arrivals and services (high, medium, and low), the paper's novelty. Besides, Farkas and Prikler (2012) proposed a purely mathematical model of charging stations by comparing two scenarios: few fast chargers and parking places (M/M/20/50) compared to a large number of slow chargers and parking places (M/M/100/150).

Finally, queuing theory is a significant constraint to take into account while determining the number of chargers in a charging station towards avoiding queues, increasing the client's comfort, and improving the quality of service, especially on the waiting and delay time. Since 'X/X/c' queue model with constant arrival and service rate, which is considered in almost all the publications that include queueing constraint, does not reflect the real situation, we strongly urge future studies to simulate the 'X/X/c/N' model with variable arrival and service rates, in order to achieve results that are more real. Some add-in features could be taken into account to characterize the natural behaviour of the driver: baulking when the driver leaves and comes back and renegeing when he/she cannot wait any longer in the queue and quits.

### 5.2.2. Distribution Grid

Merging non-controlled EV charging events with typical consumption, mostly during peak hours, can severely impact the grid, especially the distribution network, e.g., harmonics parasites, power loss, breakdowns, peak loads. The scope of this Chapter does not allow us to go into details in technical aspects (distribution, grid, network) but to present an overview of the used methods. Fast charging might dramatically impact the local grid by increasing peak loads; there are benefits to be gained by controlled charging (Azadfar et al., 2015; Babrowski et al., 2014) to avoid low voltage distribution problems (Heinrichs and Jochem, 2016). Le et al. (2015), Mehboob et al. (2014), Mets et al. (2012), and Torabikalaki and Gomes (2014) developed a method of minimizing peak loads using different approaches without changing the drivers' habits. Furthermore, other papers fixed, as an objective for their study, avoiding grid problems such as frequency and voltage fluctuations, harmonics, power losses, such as (Deilami et al., 2011), (Oliveira et al., 2013), (Rahimi et al., 2014), (Ruiqin and Zhongjing, 2015), and (Zhou and Cai, 2014). Some papers took grid issues as constraints while optimizing the total cost, such as in (Sadeghi-Barzani et al., 2014) and (Zhang et al., 2015). Building charging stations can generate costs, e.g., improving the grid (cables, transformer) and losses due to electricity problems; thus, clients' charging prices will increase to compensate for the loss. Including grid issues as constraints in the procedure regardless of the optimization goal presented. For more information about energy optimization methods for EV charging events, please refer to the literature review provided by (Amjad et al., 2018).

### 5.2.3. Environmental Impact

Minimizing the environmental impact infrequently occurs in the literature. Although EVs' LCA depends on the fuel mix of electricity generation (Torchio and Santarelli, 2010),



charging the vehicle instead of using fossil-based fuels can relocate emissions from “while driving” emissions into “while charging” in power plant emissions. Zhang et al. (2015) and Shahraki et al. (2015) included EV GHG emissions during the optimization procedure. However, the LCA of charging points is not covered at all, to the best of our knowledge, while locating charging stations. Lucas et al. (2012) concluded that EV charging infrastructure is more carbon-intensive than ICEV supply infrastructure in Portugal: 3.7-8.5 gCO<sub>2</sub>eq/km for EV compared to 0.03-1.5 gCO<sub>2</sub>eq/km for ICEV that depends on the gasoline and diesel energy source. In China, chargers' exigent global potential warming values are 94.06 gCO<sub>2</sub>eq/kWh (Zhang et al., 2019).

It might seem an unexpected conclusion, where under specific hypotheses, the environmental impact is either ignored or demonstrated as higher for electromobility than for ICEVs. An optimized solution of locating charging points should be investigated to guarantee lower emissions of the overall system: infrastructure and vehicles. Therefore, we propose that researchers expand their optimisation focus to include the environmental impact of recharging networks.

## 6. Conclusion and Perspectives

This chapter gives the reader a broad overview of the literature for charging infrastructure optimization goals. It shows that charging station localization uses several approaches, methods, models, and data. The diversity of reviewed published articles ranges from pure theoretical mathematical to real-world on-street localization.

We first identified our methodology and the past-published literature reviews focusing on charging station localization in this comprehensive state-of-art literature. Then, we briefly discussed technical aspects as well as the business model for this infrastructure. Subsequently, several publications were classified regarding their optimization objectives; We summarized every publication and detailed every goal. Next, we identified the future research opportunities that should be carefully considered in the optimization procedure.

In the EV context, charging infrastructure remains a primary barrier to developing the electric mobility sector. This infrastructure is strongly correlated and highly significant to EV sales based on discussed surveys, questionnaires, and econometrics studies that reflect the drivers' behaviour. ICEV drivers are not ready yet to purchase an EV since charging stations are not optimally distributed, and not mature enough. Thus, the “Chicken and Egg Dilemma” is not surpassed today, since neither charging infrastructure operators nor EV manufacturers

will act before the other. Optimal allocation of electric charging infrastructure can be the leading solution to gain driver confidence.

Almost all publications have the same organization. First, hypotheses are fixed regarding the territory of study, the charging speed, and the EV data, especially the demand or SoC (collected from study cases of fleets, surveys, connected vehicles, or theoretical approaches). Second, one (or more) optimization goals are fixed and solved under a specific method or model using the collected data of step 1 and solved using various well-known software. Finally, results can be represented in three primary forms: exact localization, chargers density of the studied territory, or merely the number of charging points.

Based on the reviewed publications, there is a diversity of optimization goals for locating charging stations: Minimization of technical, social, and environmental costs, maximizing coverage area, minimizing the grid impact. Indeed, minimizing the budget remains one of the most used optimization objectives since it is a severe constraint in these types of problems: The prices of chargers and batteries remain incredibly high. Maximizing coverage could be one of the ideal optimization objectives to locate the charging infrastructure for EVs. It is recommended that researchers be willing to include the battery range in the deployment of charging stations to minimise the vehicles' failed trips. Minimizing the environmental impact is the optimization objective for researchers aiming to elaborate on the LCA aspect of the charging stations' deployment procedure.

Based on our state of the art, the studied papers were data-oriented, and lack of data proves the main restriction. This may also justify the low number of real-world case studies. Therefore, this chapter also derived the research gaps that were not covered or covered too briefly by the literature by categorising the publications regarding the user input data. While some constraints are considered in the optimization procedure, such as GPS-based geographic resolution, distribution grid constraints, driver's data (daily travelled mileage, destinations, charging behaviour) and technical parameters, we strongly consider these factors to be reviewed in detail. However, temporal horizon, environmental impact, new mobility services, and external conditions were scarcely considered in studies. Due to the restricted and neglected set of parameters, charging station allocation is not yet controlled: They are not optimally localized and used. Besides, we strongly suggest adding the environmental LCA chargers towards minimizing GHG emissions to future research studies. Additionally, since queues can occur at stations, queuing theory can play an essential role concerning the number, the speed of the chargers, and the service pricing.

## *Chapter 2: Review of Optimization Objectives and Their Consequences for Electric-Vehicle Charging Infrastructure*

Concerning the identified optimization goals for modelling charging infrastructure for EVs, we conclude that more research should develop these approaches. Based on the discussed publications, huge limitations are identified due to the strictly required assumptions and hypotheses. More real-data-oriented models should be considered for further research on this topic to fill the research gaps. Solving the charging station placement requires positioning the charging sites in the road network, considering a time resolution, different levels of charging, the driver's comfort factor while minimizing the cost, and taking chargers and battery LCAs as main constraints.

Chapter 2: Review of Optimization Objectives and Their Consequences for Electric-Vehicle Charging Infrastructure

Table 2.3 Publications Having Cost Minimization as the Optimization Objective

| Papers                       | Methodology         |                         | Results type  |                        | Spatial data |                   | EV technical data |              | Driver's behavior |               |                 |                        | Charging infrastructure |                                   |                | Costs parameters |                    |                         |                 |                |                             |                   |                 |                |           |               |                   |                     |                        |                   |                      |                 |       |                                |
|------------------------------|---------------------|-------------------------|---------------|------------------------|--------------|-------------------|-------------------|--------------|-------------------|---------------|-----------------|------------------------|-------------------------|-----------------------------------|----------------|------------------|--------------------|-------------------------|-----------------|----------------|-----------------------------|-------------------|-----------------|----------------|-----------|---------------|-------------------|---------------------|------------------------|-------------------|----------------------|-----------------|-------|--------------------------------|
|                              | Model               | Software                | Queuing Model | Case/Theoretical Study | CS density   | CS exact location | CS number         | Traffic flow | GPS location      | Highway Study | Type (BEV/PHEV) | Battery capacity (kWh) | SoC                     | Externalities(Temperature, Speed) | Demand density | Travel distance  | Origin/Destination | Demand-Station distance | Private charger | Charging hours | Charging level (Power (kW)) | Efficiency factor | Charger's CAPEX | Charger's OPEX | Land cost | Building cost | Distribution cost | Transformation cost | EV cost (battery cost) | Missed trips cost | Additional trip cost | Delay time cost | Taxes | Revenues (from charging event) |
| (Ahn and Yeo, 2015)          |                     |                         | X             | CS                     | X            |                   |                   | X            | X                 |               | 22              | X                      |                         |                                   | X              |                  |                    |                         |                 |                | Fast                        |                   | X               | X              |           |               |                   |                     |                        |                   |                      | X               | X     |                                |
| (Baouche et al., 2014)       | FCDL                | CPLE<br>X<br>MATL<br>AB |               | CS                     |              | X                 |                   | X            | X                 |               | 20              | X                      | X                       | X                                 | X              | X                |                    |                         |                 |                | L2-4<br>(22-50)             |                   | X               |                |           | X             |                   |                     |                        |                   |                      |                 |       |                                |
| (Chen and Hua, 2014)         | Monte Carlo         | LINGO                   |               | TS                     | X            | X                 | X                 |              | X                 |               |                 |                        |                         |                                   | X              |                  |                    |                         |                 |                | L1-2-3-4                    |                   |                 |                |           |               | X                 |                     |                        |                   |                      |                 |       |                                |
| (Chen et al., 2016)          | MINLP               | CPLE<br>X               |               | CS                     |              | X                 | X                 | X            |                   |               | 24              | X                      |                         |                                   |                | X                | X                  |                         |                 |                | L1-2-4<br>(1.4 – 91)        |                   |                 |                |           | X             |                   |                     |                        |                   | X                    |                 |       |                                |
| (Z. Chen et al., 2017)       | MILP                | CPLE<br>X               |               | CS                     |              |                   |                   | X            | X                 |               | 24              | X                      |                         |                                   | X              | X                |                    |                         | X               |                | Fast<br>(100)               | X                 | X               |                |           | X             |                   |                     |                        |                   | X                    |                 | X     |                                |
| (Cruz-Zambrano et al., 2013) | FCLM                | CPLE<br>X               |               | CS                     | X            |                   |                   | X            |                   |               |                 |                        |                         |                                   | X              | X                |                    |                         |                 |                | Fast (50)                   |                   | X               |                |           |               |                   |                     |                        |                   |                      |                 |       |                                |
| (Han et al., 2016)           | Based flow-intercep |                         | X             | CS                     | X            | X                 |                   | X            |                   |               | 22              | X                      | X                       |                                   | X              |                  |                    |                         | X               |                | Fast                        | X                 | X               | X              |           |               |                   |                     |                        |                   | X                    | X               |       |                                |

Chapter 2: Review of Optimization Objectives and Their Consequences for Electric-Vehicle Charging Infrastructure

| Author                     |                          | Model  |         | Objective |     |    |       | Constraint |         |      |    | Vehicle |      | Charging             |     | Infrastructure |    |     |   |
|----------------------------|--------------------------|--------|---------|-----------|-----|----|-------|------------|---------|------|----|---------|------|----------------------|-----|----------------|----|-----|---|
|                            |                          |        |         | Min       | Max | Eq | Other | EV         | BEV     | PHEV | EV | BEV     | PHEV | EV                   | BEV | PHEV           | EV | BEV |   |
| (Davidov and Pantoš, 2017) | Linear program           | MATLAB | TS      | X         | X   | X  |       |            | X       |      |    |         |      | Slow & Fast          | X   | X              |    | X   |   |
| (Funke et al., 2019)       | Queueing model           |        | M/G/s   | CS        |     |    | X     | X          |         |      |    |         |      | Fast (50-150)        | X   | X              | X  | X   | X |
| (Gnann et al., 2016)       | Queueing model           | ALADIN | M/M/1/2 | CS        | X   |    |       | BEV        | 40      |      | X  |         | X    | Fast (50)            |     | X              |    |     | X |
| (Gnann et al., 2018)       | Queueing model           |        | M/G/1   | CS        |     |    |       |            |         | X    | X  |         | X    | Fast (50-150)        | X   | X              |    |     |   |
| (He et al., 2015)          | MBINLP                   | CPLEX  |         | CS        | X   | X  | X     | BEV        | 24      | X    | X  | X       |      | L1-2-3 (1.4 – 90)    |     |                | X  |     | X |
| (Hidalgo et al., 2016)     | MOGA                     |        | X       | X         |     |    |       |            | 13 - 56 | X    | X  |         | X    | L1-2-3 (3 – 50)      | X   | X              |    |     |   |
| (Huang et al., 2015)       | MRLM                     | CPLEX  |         | CS        |     | X  | X     |            |         |      | X  | X       | X    |                      | X   | X              |    |     |   |
| (Islam et al., 2015)       | Binary firefly algorithm |        |         | CS        | X   |    | X     |            |         | X    |    |         |      | Fast (96)            | X   | X              | X  | X   | X |
| (Islam et al., 2016)       |                          |        |         | CS        | X   |    | X     |            | 5 - 36  | X    | X  |         |      | Fast (50)            | X   | X              | X  | X   | X |
| (Jia et al., 2014)         | P-center MILPM           | CPLEX  | X       | CS        |     | X  | X     | BEV/PHEV   | 34      | X    | X  | X       |      | Slow & Fast (3 – 80) | X   | X              |    | X   | X |
| (Li and Huang, 2014)       | Genetic Algorithm        | CPLEX  | X       | CS        | X   | X  | X     |            |         |      |    | X       | X    |                      | X   | X              |    |     |   |
| (Li et al., 2016)          | Genetic Algorithm        | CPLEX  |         | CS        | X   | X  | X     | X          |         |      | X  | X       |      | Fast                 | X   |                | X  | X   | X |

Chapter 2: Review of Optimization Objectives and Their Consequences for Electric-Vehicle Charging Infrastructure

|   |                                  |                     |           |    |   |   |   |     |       |    |   |   |   |   |                   |                |                          |      |   |   |   |   |   |   |
|---|----------------------------------|---------------------|-----------|----|---|---|---|-----|-------|----|---|---|---|---|-------------------|----------------|--------------------------|------|---|---|---|---|---|---|
|   | m                                |                     |           |    |   |   |   |     |       |    |   |   |   |   |                   |                |                          |      |   |   |   |   |   |   |
| (Liu and Wang, 2017)                        | MBINLP<br>P<br>Gurobi            | CPLE<br>X<br>Gurobi | CS        | X  | X | X |   | BEV | 24    | X  |   | X | X |   | Fast              |                | X                        |      | X |   |   |   |   |   |
| (Liu et al., 2012)                          | Swarm<br>Optimization            |                     |           | X  | X |   | X |     |       |    |   | X |   |   | L1-2-3-4          |                | X                        | X    |   |   |   |   |   |   |
| (Nie and Ghamami, 2013)                     | Integer program                  | CPLE<br>X           | CS        |    | X |   |   |     |       |    |   | X | X |   | L1-2<br>(1.4-7.2) |                | X                        |      | X | X |   | X |   |   |
| (Rajabi-Ghahnavi and Sadeghi-Barzani, 2017) | MINLP                            |                     | TS        |    |   |   |   |     |       |    |   |   |   | X |                   |                | X                        |      | X |   |   |   |   |   |
| (Salmon, 2016)                              | Genetic algorithm<br>m           |                     | CS        | X  | X |   | X | X   | BEV   | 24 | X |   | X |   | X                 | Fast           |                          |      |   |   |   |   | X |   |
| (Tian et al., 2018)                         | SCE-UA<br>algorithm<br>m         | MATL<br>AB          | M/M<br>/s | CS |   | X | X |     | BEV   |    | X | X | X | X | X                 |                | X                        | Fast |   |   |   |   | X | X |
| (Wang and Lin, 2009)                        | FRLM                             | ILOG                | CS        | X  | X |   | X | X   |       |    |   |   | X | X |                   | Slow &<br>Fast |                          | X    |   | X | X |   |   |   |
| (Wang and Wang, 2010)                       | Branch-and-bound                 | LINGO               | CS        | X  | X |   | X | X   |       |    |   |   | X | X |                   | Fast           |                          | X    |   | X | X |   |   |   |
| (Xiang et al., 2016)                        | Network equilibrium traffic flow | MATL<br>AB          | M/M<br>/s | CS |   | X | X | X   | Buses |    |   |   |   | X |                   | X              | Slow &<br>Fast<br>(2-30) |      | X |   | X |   | X |   |

Chapter 2: Review of Optimization Objectives and Their Consequences for Electric-Vehicle Charging Infrastructure

|                         |  |        |          |    |   |   |   |   |     |       |   |   |   |   |   |              |   |   |   |   |   |   |   |
|-------------------------|--|--------|----------|----|---|---|---|---|-----|-------|---|---|---|---|---|--------------|---|---|---|---|---|---|---|
| (Yang et al., 2017)     | Linear program                           | Gurobi | M/M /s/N | CS | X |   |   | X | BEV | 40    | X | X | X | X | X | L2-3 (13-80) | X | X | X |   |   |   |   |
| (Yi and Bauer, 2016)    | No-linear program                        | NOMA D |          | CS | X | X | X | X | BEV | 24-95 | X | X | X | X | X |              | X |   | X |   |   |   |   |
| (Zeng et al., 2016)     | Chaos & harmony search algorithm         |        |          | TS | X | X |   |   | BEV | 60    | X | X | X |   |   | Fast (50)    | X | X | X | X | X |   |   |
| (Zhang et al., 2015)    |  |        |          | TS |   |   |   |   |     |       |   |   |   |   |   |              | X | X |   |   |   |   |   |
| (Y. Zhang et al., 2016) |  |        | M/M /s   | CS | X | X | X |   | BEV | 80    |   |   | X |   | X | L1-2-3       | X | X | X | X | X | X | X |
| (H. Zhang et al., 2016) | Voronoi diagram / Monte-Carlo simulation |        | X        | CS | X | X | X | X | BEV | 24    | X | X | X |   | X | Fast         | X | X | X | X | X | X | X |
| (Zhu et al., 2016)      | Genetic Algorithm                        |        |          | CS | X | X | X | X |     |       |   |   | X |   |   |              |   |   | X |   | X |   |   |

Chapter 2: Review of Optimization Objectives and Their Consequences for Electric-Vehicle Charging Infrastructure

Table 2.4 Publications Having Maximization Demand Coverage as the Optimization Objective

| Papers                             | Methodology     |          |               |                        | Results type |          |        | Spatial data |              | EV technical data |                 |                        |     | Driver's behavior        |                |                 | Charging data      |                         | Demographic data | Constraints    |                |                       |                   |                 |
|------------------------------------|-----------------|----------|---------------|------------------------|--------------|----------|--------|--------------|--------------|-------------------|-----------------|------------------------|-----|--------------------------|----------------|-----------------|--------------------|-------------------------|------------------|----------------|----------------|-----------------------|-------------------|-----------------|
|                                    | Model           | Software | Queuing Model | Case/Theoretical Study | Density      | Location | Number | Traffic      | GPS location | Highway Study     | Type (BEV/PHEV) | Battery capacity (kWh) | SoC | Temperature, Speed, etc. | Demand density | Travel distance | Origin/Destination | Demand-Station distance | Private charger  | Charging hours | Charging level | Population/Employment | Budget constraint | Grid constraint |
| (Spieker et al., 2017)             | GA              |          |               | CS                     | X            | X        | X      | X            |              | B                 |                 |                        |     |                          | X              | X               | X                  |                         | X                | 2              | (22 kW)        |                       | X                 |                 |
| (Chung and KWon, 2015)             | FRLM            | CPLEX    |               | CS                     | X            | X        | X      | X            | X            |                   |                 |                        |     |                          | X              | X               | X                  | X                       |                  |                |                |                       |                   |                 |
| (Xi et al., 2013)                  | Linear model    |          |               | CS                     |              |          |        |              |              | P                 | ~2              |                        |     | X                        | X              | X               |                    | X                       |                  | L1,2,3         |                |                       | X                 |                 |
| (Tu et al., 2016)                  | STDCLM          |          |               | CS                     | X            |          |        | X            | X            |                   |                 | X                      |     | X                        | X              | X               |                    |                         |                  | Fast           |                |                       | X                 |                 |
| (Zhang et al., 2017)               | MINLP           | CPLEX    |               | CS                     |              |          |        | X            | X            |                   |                 |                        |     | X                        | X              |                 |                    | X                       |                  | Fast           |                |                       | X                 |                 |
| (Wanting Lin and Guowei Hua, 2015) | MINLP           | CPLEX    |               | CS                     | X            |          |        | X            | X            |                   |                 |                        |     |                          |                |                 |                    |                         |                  |                |                |                       |                   |                 |
| (Shukla et al., 2011)              | BIP             | CPLEX    |               | CS                     | X            | X        | X      | X            |              |                   |                 |                        |     |                          | X              | X               | X                  | X                       |                  |                |                |                       |                   |                 |
| (Yi and Bauer, 2016)               | MIP             | EVRE     |               | CS                     | X            | X        | X      | X            |              |                   |                 |                        | X   | X                        | X              | X               | X                  |                         |                  |                |                |                       |                   |                 |
| (Sun et al., 2018)                 | MIP             | CPLEX    |               | CS                     | X            | X        | X      | X            | X            |                   |                 |                        |     |                          | X              | X               | X                  |                         |                  |                | Slow<br>Fast   |                       | X                 |                 |
| (Wang and Wang, 2010)              | MIP             | Lingo    |               | CS                     | X            | X        | X      | X            | X            |                   |                 |                        |     |                          | X              | X               | X                  |                         |                  |                | Fast           |                       | X                 |                 |
| (Gao and Guo, 2013)                | Voronoi diagram | Lingo    | M/M/s         | TS                     | X            | X        | X      |              |              | B                 | 20              |                        |     | X                        |                | X               | X                  |                         |                  |                |                |                       | X                 |                 |
| (Frade et al., 2011)               | p-median        |          |               | CS                     | X            | X        | X      | X            |              | B                 | ~20             |                        |     | X                        | X              |                 |                    |                         | X                | L1             | (3 kW)         | X                     |                   |                 |



Table 2.5 Publications Having Minimization of Failed Trips as the Optimization Objective

| Papers                  | Methodology          |                |                        | Results type |          |        | Spatial data |              |               | EV technical data |                        |     |                | Driver's behavior |     |                         | Charging data   |                |                     | Constraints       |                   |                 |                        |  |
|-------------------------|----------------------|----------------|------------------------|--------------|----------|--------|--------------|--------------|---------------|-------------------|------------------------|-----|----------------|-------------------|-----|-------------------------|-----------------|----------------|---------------------|-------------------|-------------------|-----------------|------------------------|--|
|                         | Model                | Software       | Case/Theoretical Study | Density      | Location | Number | Traffic      | GPS location | Highway Study | Type (BEV/PHEV)   | Battery capacity (kWh) | SoC | Demand density | Travel distance   | O/D | Demand-Station distance | Private charger | Charging hours | Charging level      | Efficiency factor | Budget constraint | Grid constraint | Environment constraint |  |
| (Hidalgo et al., 2016)  | MOGA                 |                | CS                     | X            |          |        |              |              |               | BEV               | 13-56                  | X   | X              |                   |     |                         | X               | X              | L1,2,3<br>3-50 kW   | X                 | X                 |                 |                        |  |
| (Asamer et al., 2016)   | MILP                 | CPLEX          | CS                     |              | X        | X      |              | X            |               | BEV               | 24                     | X   |                | X                 | X   |                         |                 |                | L1,2,3<br>2-240 kW  |                   |                   |                 |                        |  |
| (Shahraki et al., 2015) | MINLP                | GAMS/C<br>PLEX | CS                     | X            | X        |        |              |              |               | PHEV/<br>BEV      |                        |     | X              | X                 |     |                         |                 |                | L1,2,3<br>7-37 kW   |                   |                   |                 | X                      |  |
| (Alhazmi et al., 2017)  | MCLP                 |                | CS                     |              | X        | X      | X            | X            | X             | BEV               | 16 -<br>><br>54        | X   | X              | X                 | X   | X                       |                 | X              |                     |                   |                   |                 | X                      |  |
| (Dong et al., 2014)     | Genetic<br>algorithm | [at]risk       | CS                     |              |          | X      | X            | X            |               | BEV               |                        |     | X              | X                 | X   |                         |                 |                | L1,2,3<br>1.4-90 kW |                   | X                 |                 |                        |  |

Table 2.6 Publications Considering Minimizing the Distance between Demand and Charging Points

| Papers                     | Methodology       |          | Results type           |            |             | Spatial data |              |              | EV technical data |                 |                        | Driver's behavior |                 |                | Charging data   | Constraints |                         |                 |                |                |                   |                 |                    |
|----------------------------|-------------------|----------|------------------------|------------|-------------|--------------|--------------|--------------|-------------------|-----------------|------------------------|-------------------|-----------------|----------------|-----------------|-------------|-------------------------|-----------------|----------------|----------------|-------------------|-----------------|--------------------|
|                            | Model             | Software | Case/Theoretical Study | CS density | CS location | CS number    | Traffic flow | GPS location | Highway Study     | Type (BEV/PHEV) | Battery capacity (kWh) | SoC               | Speed of the EV | Demand density | Travel distance | O/D         | Demand-Station distance | Private charger | Charging hours | Charging level | Budget constraint | Grid constraint | Income, Population |
| (Sathaye and Kelley, 2013) | Non linear model  |          | CS                     |            |             | X            | X            | X            | X                 | Both            |                        |                   |                 | X              | X               | X           | X                       | X               |                | L3             | X                 | X               | X                  |
| (Andrenacci et al., 2016)  | k-mean clustering | MATLAB   | CS                     | X          |             |              | X            | X            |                   | BEV             | 16-22                  | X                 |                 |                | X               |             |                         | X               | X              |                |                   |                 |                    |

Chapter 2: Review of Optimization Objectives and Their Consequences for Electric-Vehicle Charging Infrastructure

Table 2.7 Publications Considering Various Optimization Objectives

| Papers                             | Methodology       |           | Results type           |               |            |                   | Spatial parameters |         | EV technical data |               | Driver's behavior |                        |     |                | CS technical parameters | Demographic parameters | Constraints             |                 |                |                |                       |                   |                       |
|------------------------------------|-------------------|-----------|------------------------|---------------|------------|-------------------|--------------------|---------|-------------------|---------------|-------------------|------------------------|-----|----------------|-------------------------|------------------------|-------------------------|-----------------|----------------|----------------|-----------------------|-------------------|-----------------------|
|                                    | Model             | Software  | Case/Theoretical Study | Queuing model | CS density | CS exact location | CS number          | Traffic | GPS location      | Highway Study | Type (BEV/PHEV)   | Battery capacity (kWh) | SoC | Demand density | Travel distance         | Destination            | Demand-Station distance | Private charger | Charging hours | Charging level | Population/Employment | Budget constraint | Grid constraint       |
| (Brooker and Qin, 2015)            |                   |           | CS                     | X             |            |                   |                    |         |                   |               |                   | X                      | X   | X              | X                       |                        |                         | X               | X              | L1-2           |                       | X                 | X                     |
| (Pagany et al., 2019)              | Spatial modelling |           | CS                     | X             |            |                   |                    |         |                   |               |                   |                        |     | X              | X                       | X                      |                         | X               | X              | L2             |                       | X                 | X                     |
| (Morrissey et al., 2016)           |                   |           | CS                     | X             |            |                   |                    |         |                   |               |                   |                        |     | X              | X                       |                        |                         |                 | X              | Fast           |                       | X                 |                       |
| (Efthymiou et al., 2012)           | Linear model      | ArcGIS    | CS                     | X             |            |                   |                    |         |                   |               |                   |                        |     |                | X                       | X                      |                         |                 |                |                |                       | X                 | X                     |
| (Eisel et al., 2014)               | FLPM              |           | CS                     | X             |            |                   |                    | X       | X                 |               | PHEV              |                        |     | X              | X                       |                        |                         |                 |                |                |                       | X                 |                       |
| (Yaping Gao and Xiaochun Lu, 2015) |                   | ANYL OGIC | CS                     | X             |            | X                 |                    |         |                   |               |                   |                        |     |                | X                       | X                      |                         |                 |                |                |                       | X                 | X                     |
| (S. Li et al., 2017)               | K-means cluster   |           | CS                     | X             |            |                   |                    |         | X                 |               | PHEV              | X                      | X   | X              | X                       |                        |                         | X               | X              |                |                       |                   | Slow & Fast (6-60 kW) |
| (Namdeo et al., 2014)              | Spatial modelling | ArcGIS    | CS                     |               |            |                   |                    | X       | X                 |               |                   |                        |     | X              | X                       | X                      |                         |                 |                |                |                       | X                 |                       |

Chapter 2: Review of Optimization Objectives and Their Consequences for Electric-Vehicle Charging Infrastructure

|   |                       |           |    |       |   |   |   |   |  |      |    |   |   |   |                     |       |         |   |
|---|-----------------------|-----------|----|-------|---|---|---|---|--|------|----|---|---|---|---------------------|-------|---------|---|
| (Rajabi-Ghahnavieh and Sadeghi-Barzani, 2017) |                       | CS        |    |       | X | X | X |   |  | X    | X  | X | X | X | Fast (96 kW)        | X     | X       |   |
| (Said et al., 2013)                           |                       | MATLAB    | TS | M/AB  |   | X | X |   |  | X    |    |   | X |   |                     |       |         |   |
| (He et al., 2013)                             |                       |           | TS |       |   | X | X |   |  | PHEV |    |   |   |   |                     |       |         |   |
| (Farkas and Prikler, 2012)                    | Mathematical approach | EXCEL VBA | TS | M/c/N |   |   |   |   |  |      |    |   |   |   | Comparing slow/fast |       |         |   |
| (Jung et al., 2014)                           | Bi-level optimization |           |    | M/c   | X |   | X | X |  | BEV  | 24 | X | X | X | X                   | X     | L 1-2-3 | X |
| (Martins and Trindade, 2015)                  | GA, Particle Swarm    |           | CS |       |   |   | X |   |  | BEV  | 30 |   | X | X | X                   | 20-50 | W       |   |

## References

- Ahn, Y., Yeo, H., 2015. An Analytical Planning Model to Estimate the Optimal Density of Charging Stations for Electric Vehicles. *PLoS ONE* 10, e0141307. <https://doi.org/10.1371/journal.pone.0141307>
- Alhazmi, Y.A., Mostafa, H.A., Salama, M.M.A., 2017. Optimal allocation for electric vehicle charging stations using Trip Success Ratio. *International Journal of Electrical Power & Energy Systems* 91, 101–116. <https://doi.org/10.1016/j.ijepes.2017.03.009>
- Amjad, M., Ahmad, A., Rehmani, M.H., Umer, T., 2018. A review of EVs charging: From the perspective of energy optimization, optimization approaches, and charging techniques. *Transportation Research Part D: Transport and Environment* 62, 386–417. <https://doi.org/10.1016/j.trd.2018.03.006>
- Andrenacci, N., Ragona, R., Valenti, G., 2016. A demand-side approach to the optimal deployment of electric vehicle charging stations in metropolitan areas. *Applied Energy* 182, 39–46. <https://doi.org/10.1016/j.apenergy.2016.07.137>
- Asamer, J., Reinthaler, M., Ruthmair, M., Straub, M., Puchinger, J., 2016. Optimizing charging station locations for urban taxi providers. *Transportation Research Part A: Policy and Practice* 85, 233–246. <https://doi.org/10.1016/j.tra.2016.01.014>
- Axsen, J., Langman, B., Goldberg, S., 2017. Confusion of innovations: Mainstream consumer perceptions and misperceptions of electric-drive vehicles and charging programs in Canada. *Energy Research & Social Science* 27, 163–173. <https://doi.org/10.1016/j.erss.2017.03.008>
- Azadfar, E., Sreeram, V., Harries, D., 2015. The investigation of the major factors influencing plug-in electric vehicle driving patterns and charging behaviour. *Renewable and Sustainable Energy Reviews* 42, 1065–1076. <https://doi.org/10.1016/j.rser.2014.10.058>
- Babrowski, S., Heinrichs, H., Jochem, P., Fichtner, W., 2014. Load shift potential of electric vehicles in Europe. *Journal of Power Sources* 255, 283–293. <https://doi.org/10.1016/j.jpowsour.2014.01.019>
- Bailey, J., Miele, A., Axsen, J., 2015. Is awareness of public charging associated with consumer interest in plug-in electric vehicles? *Transportation Research Part D: Transport and Environment* 36, 1–9. <https://doi.org/10.1016/j.trd.2015.02.001>
- Bakker, S., Jacob Trip, J., 2013. Policy options to support the adoption of electric vehicles in the urban environment. *Transportation Research Part D: Transport and Environment* 25, 18–23. <https://doi.org/10.1016/j.trd.2013.07.005>
- Baouche, F., Billot, R., Trigui, R., EL FAOUZI, N.-E., 2014. Electric Vehicle Charging Stations Allocation Model, in: *ROADEF - 15ème Congrès Annuel de La Société Française de Recherche Opérationnelle et d'aide à La Décision*. Société française de recherche opérationnelle et d'aide à la décision, Bordeaux, France.
- Bhat, U.N., 2015. *An Introduction to Queueing Theory: Modeling and Analysis in Applications*, 2nd ed, Statistics for Industry and Technology. Birkhäuser Basel. <https://doi.org/10.1007/978-0-8176-8421-1>
- Brady, J., O'Mahony, M., 2016. Modelling charging profiles of electric vehicles based on real-world electric vehicle charging data. *Sustainable Cities and Society* 26, 203–216. <https://doi.org/10.1016/j.scs.2016.06.014>
- Brooker, R.P., Qin, N., 2015. Identification of potential locations of electric vehicle supply equipment. *Journal of Power Sources* 299, 76–84. <https://doi.org/10.1016/j.jpowsour.2015.08.097>
- Cai, H., Jia, X., Chiu, A.S.F., Hu, X., Xu, M., 2014. Siting public electric vehicle charging stations in Beijing using big-data informed travel patterns of the taxi fleet. *Transportation Research Part D: Transport and Environment* 33, 39–46. <https://doi.org/10.1016/j.trd.2014.09.003>
- Cao, Y., Huang, L., Li, Y., Jermisittiparsert, K., Ahmadi-Nezamabad, H., Nojavan, S., 2020. Optimal scheduling of electric vehicles aggregator under market price uncertainty using robust optimization technique. *International Journal of Electrical Power & Energy Systems* 117, 105628. <https://doi.org/10.1016/j.ijepes.2019.105628>
- Chen, C., Hua, G., 2014. A New Model for Optimal Deployment of Electric Vehicle Charging and Battery Swapping Stations. *IJCA* 7, 247–258. <https://doi.org/10.14257/ijca.2014.7.5.27>

## *Chapter 2: Review of Optimization Objectives and Their Consequences for Electric-Vehicle Charging Infrastructure*

- Chen, H., Zhang, H., Hu, Z., Liang, Y., Luo, H., Wang, Y., 2017. Plug-in Electric Vehicle Charging Congestion Analysis Using Taxi Travel Data in the Central Area of Beijing. arXiv:1712.07300 [cs, math].
- Chen, Z., He, F., Yin, Y., 2016. Optimal deployment of charging lanes for electric vehicles in transportation networks. *Transportation Research Part B: Methodological* 91, 344–365. <https://doi.org/10.1016/j.trb.2016.05.018>
- Chen, Z., Liu, W., Yin, Y., 2017. Deployment of stationary and dynamic charging infrastructure for electric vehicles along traffic corridors. *Transportation Research Part C: Emerging Technologies* 77, 185–206. <https://doi.org/10.1016/j.trc.2017.01.021>
- Chung, S.H., KWon, C., 2015. Multi-period planning for electric car charging station locations: A case of Korean Expressways. *European Journal of Operational Research* 242, 677–687. <https://doi.org/10.1016/j.ejor.2014.10.029>
- Cruz-Zambrano, M., Corchero, C., Igualada-Gonzalez, L., Bernardo, V., 2013. Optimal location of fast charging stations in Barcelona: A flow-capturing approach, in: 2013 10th International Conference on the European Energy Market (EEM). Presented at the 2013 10th International Conference on the European Energy Market (EEM 2013), IEEE, Stockholm, pp. 1–6. <https://doi.org/10.1109/EEM.2013.6607414>
- Davidov, S., Pantoš, M., 2017. Planning of electric vehicle infrastructure based on charging reliability and quality of service. *Energy* 118, 1156–1167. <https://doi.org/10.1016/j.energy.2016.10.142>
- Deb, S., Tammi, K., Kalita, K., Mahanta, P., 2019. Charging Station Placement for Electric Vehicles: A Case Study of Guwahati City, India. *IEEE Access* 7, 100270–100282. <https://doi.org/10.1109/ACCESS.2019.2931055>
- Deb, S., Tammi, K., Kalita, K., Mahanta, P., 2018. Review of recent trends in charging infrastructure planning for electric vehicles. *WIREs Energy and Environment* 7, e306. <https://doi.org/10.1002/wene.306>
- Deilami, S., Masoum, A.S., Moses, P.S., Masoum, M.A.S., 2011. Real-Time Coordination of Plug-In Electric Vehicle Charging in Smart Grids to Minimize Power Losses and Improve Voltage Profile. *IEEE Transactions on Smart Grid* 2, 456–467. <https://doi.org/10.1109/TSG.2011.2159816>
- Dong, J., Liu, C., Lin, Z., 2014. Charging infrastructure planning for promoting battery electric vehicles: An activity-based approach using multiday travel data. *Transportation Research Part C: Emerging Technologies* 38, 44–55. <https://doi.org/10.1016/j.trc.2013.11.001>
- Dunckley, J., 2016. Plug-In Electric Vehicle Multi-State Market and Charging Survey. EPRI, Palo Alto, CA: 2016. 3002007495. 58.
- Eberle, D.U., Helmolt, D.R. von, 2010. Sustainable transportation based on electric vehicle concepts: a brief overview. *Energy Environ. Sci.* 3, 689–699. <https://doi.org/10.1039/C001674H>
- Efthymiou, D., Antoniou, C., Tyrinopoylos, Y., Mitsakis, E., 2012. Spatial Exploration of Effective Electric Vehicle Infrastructure Location. *Procedia - Social and Behavioral Sciences* 48, 765–774. <https://doi.org/10.1016/j.sbspro.2012.06.1054>
- Egbue, O., Long, S., 2012. Barriers to widespread adoption of electric vehicles: An analysis of consumer attitudes and perceptions. *Energy Policy* 48, 717–729. <https://doi.org/10.1016/j.enpol.2012.06.009>
- Eisel, M., Schmidt, J., Kolbe, L.M., 2014. Finding suitable locations for charging stations, in: 2014 IEEE International Electric Vehicle Conference (IEVC). Presented at the 2014 IEEE International Electric Vehicle Conference (IEVC), pp. 1–8. <https://doi.org/10.1109/IEVC.2014.7056134>
- Farkas, C., Prikler, L., 2012. Stochastic modelling of EV charging at charging stations. *REPQJ* 1046–1051. <https://doi.org/10.24084/repqj10.574>
- Figenbaum, E., Kolbenstvedt, M., 2016. Learning from Norwegian Battery Electric and Plug-in Hybrid Vehicle users: Results from a survey of vehicle owners. TØI Report.
- Frade, I., Ribeiro, A., Gonçalves, G., Antunes, A.P., 2011. Optimal Location of Charging Stations for Electric Vehicles in a Neighborhood in Lisbon, Portugal. *Transportation Research Record* 2252, 91–98. <https://doi.org/10.3141/2252-12>

## *Chapter 2: Review of Optimization Objectives and Their Consequences for Electric-Vehicle Charging Infrastructure*

- Franke, T., Krems, J.F., 2013. Understanding charging behaviour of electric vehicle users. *Transportation Research Part F: Traffic Psychology and Behaviour* 21, 75–89. <https://doi.org/10.1016/j.trf.2013.09.002>
- Funke, S.Á., Plötz, P., Wietschel, M., 2019. Invest in fast-charging infrastructure or in longer battery ranges? A cost-efficiency comparison for Germany. *Applied Energy* 235, 888–899. <https://doi.org/10.1016/j.apenergy.2018.10.134>
- Gao, Y., Guo, Y., 2013. Optimal Planning of Charging Station for Phased Electric Vehicle. *EPE* 05, 1393–1397. <https://doi.org/10.4236/epe.2013.54B264>
- Gert Berckmans, Maarten Messagie, Jelle Smekens, Noshin Omar, Lieselot Vanhaverbeke, Joeri Van Mierlo, 2017. Cost Projection of State of the Art Lithium-Ion Batteries for Electric Vehicles Up to 2030. *Energies* 10, 1314. <https://doi.org/10.3390/en10091314>
- Gnann, T., Funke, S., Jakobsson, N., Plötz, P., Sprei, F., Bennehag, A., 2018. Fast charging infrastructure for electric vehicles: Today's situation and future needs. *Transportation Research Part D: Transport and Environment* 62, 314–329. <https://doi.org/10.1016/j.trd.2018.03.004>
- Gnann, T., Goldbach, D., Jakobsson, N., Plötz, P., Bennehag, A., Sprei, F., 2016. A Model for Public Fast Charging Infrastructure Needs. *WEVJ* 8, 943–954. <https://doi.org/10.3390/wevj8040943>
- Gnann, T., Plötz, P., 2015. A review of combined models for market diffusion of alternative fuel vehicles and their refueling infrastructure. *Renewable and Sustainable Energy Reviews* 47, 783–793. <https://doi.org/10.1016/j.rser.2015.03.022>
- Graham-Rowe, E., Gardner, B., Abraham, C., Skippon, S., Dittmar, H., Hutchins, R., Stannard, J., 2012. Mainstream consumers driving plug-in battery-electric and plug-in hybrid electric cars: A qualitative analysis of responses and evaluations. *Transportation Research Part A: Policy and Practice* 46, 140–153. <https://doi.org/10.1016/j.tra.2011.09.008>
- Grauers, A., Sarasini, S., Karlström, M., 2013. Why electromobility and what is it? [WWW Document]. URL <https://research.chalmers.se/en/publication/211430> (accessed 6.23.20).
- Guo, Z., Deride, J., Fan, Y., 2016. Infrastructure planning for fast charging stations in a competitive market. *Transportation Research Part C: Emerging Technologies* 68, 215–227. <https://doi.org/10.1016/j.trc.2016.04.010>
- Hackbarth, A., Madlener, R., 2013. Consumer preferences for alternative fuel vehicles: A discrete choice analysis. *Transportation Research Part D: Transport and Environment* 25, 5–17. <https://doi.org/10.1016/j.trd.2013.07.002>
- Han, D., Ahn, Y., Park, S., Yeo, H., 2016. Trajectory-interception based method for electric vehicle taxi charging station problem with real taxi data. *International Journal of Sustainable Transportation* 10, 671–682. <https://doi.org/10.1080/15568318.2015.1104565>
- He, F., Wu, D., Yin, Y., Guan, Y., 2013. Optimal deployment of public charging stations for plug-in hybrid electric vehicles. *Transportation Research Part B: Methodological* 47, 87–101. <https://doi.org/10.1016/j.trb.2012.09.007>
- He, F., Yin, Y., Zhou, J., 2015. Deploying public charging stations for electric vehicles on urban road networks. *Transportation Research Part C: Emerging Technologies* 60, 227–240. <https://doi.org/10.1016/j.trc.2015.08.018>
- He, S.Y., Kuo, Y.-H., Wu, D., 2016. Incorporating institutional and spatial factors in the selection of the optimal locations of public electric vehicle charging facilities: A case study of Beijing, China. *Transportation Research Part C: Emerging Technologies* 67, 131–148. <https://doi.org/10.1016/j.trc.2016.02.003>
- Heinrichs, H.U., Jochem, P., 2016. Long-term impacts of battery electric vehicles on the German electricity system. *Eur. Phys. J. Spec. Top.* 225, 583–593. <https://doi.org/10.1140/epjst/e2015-50115-x>
- Hidalgo, P.A.L., Ostendorp, M., Lienkamp, M., 2016. Optimizing the charging station placement by considering the user's charging behavior, in: 2016 IEEE International Energy Conference (ENERGYCON). Presented at the 2016 IEEE International Energy Conference (ENERGYCON), pp. 1–7. <https://doi.org/10.1109/ENERGYCON.2016.7513920>
- Hidrué, M.K., Parsons, G.R., Kempton, W., Gardner, M.P., 2011. Willingness to pay for electric vehicles and their attributes. *Resource and Energy Economics* 33, 686–705. <https://doi.org/10.1016/j.reseneeco.2011.02.002>

## *Chapter 2: Review of Optimization Objectives and Their Consequences for Electric-Vehicle Charging Infrastructure*

- Huang, Y., Li, S., Qian, Z.S., 2015. Optimal Deployment of Alternative Fueling Stations on Transportation Networks Considering Deviation Paths. *Netw Spat Econ* 15, 183–204. <https://doi.org/10.1007/s11067-014-9275-1>
- IPCC, 2018. Allen, M.R., O.P. Dube, W. Solecki, F. Aragón-Durand, W. Cramer, S. Humphreys, M. Kainuma, J. Kala, N. Mahowald, Y. Mulugetta, R. Perez, M. Wairiu, and K. Zickfeld, 2018: Framing and Context. In: *Global Warming of 1.5°C. An IPCC Special Report on the impacts of global warming of 1.5°C above pre-industrial levels and related global greenhouse gas emission pathways, in the context of strengthening the global response to the threat of climate change, sustainable development, and efforts to eradicate poverty* [Masson-Delmotte, V., P. Zhai, H.-O. Pörtner, D. Roberts, J. Skea, P.R. Shukla, A. Pirani, W. Moufouma-Okia, C. Péan, R. Pidcock, S. Connors, J.B.R. Matthews, Y. Chen, X. Zhou, M.I. Gomis, E. Lonnoy, T. Maycock, M. Tignor, and T. Waterfield (eds.)]. In Press.
- Islam, Md., 2015. A Review of Techniques for Optimal Placement and Sizing of Electric Vehicle Charging Stations. *ELECTROTECHNICAL REVIEW* 1, 124–128. <https://doi.org/10.15199/48.2015.08.29>
- Islam, M.M., Mohamed, A., Shareef, H., 2015. Optimal allocation of rapid charging stations for electric vehicles, in: *2015 IEEE Student Conference on Research and Development (SCOReD)*. Presented at the 2015 IEEE Student Conference on Research and Development (SCOReD), pp. 378–383. <https://doi.org/10.1109/SCORED.2015.7449360>
- Islam, M.M., Shareef, H., Mohamed, A., 2016. Optimal siting and sizing of rapid charging station for electric vehicles considering Bangi city road network in Malaysia. <https://doi.org/10.3906/elk-1412-136>
- Jia, L., Hu, Z., Liang, W., Lang, W., Song, Y., 2014. A novel approach for urban electric vehicle charging facility planning considering combination of slow and fast charging, in: *2014 International Conference on Power System Technology*. Presented at the 2014 International Conference on Power System Technology, pp. 3354–3360. <https://doi.org/10.1109/POWERCON.2014.6993928>
- Jing, W., Yan, Y., Kim, I., Sarvi, M., 2016. Electric vehicles: A review of network modelling and future research needs. *Advances in Mechanical Engineering* 8, 1687814015627981. <https://doi.org/10.1177/1687814015627981>
- Jung, J., Chow, J.Y.J., Jayakrishnan, R., Park, J.Y., 2014. Stochastic dynamic itinerary interception refueling location problem with queue delay for electric taxi charging stations. *Transportation Research Part C: Emerging Technologies* 40, 123–142. <https://doi.org/10.1016/j.trc.2014.01.008>
- Le, T.N., Al-Rubaye, S., Liang, H., Choi, B.J., 2015. Dynamic charging and discharging for electric vehicles in microgrids, in: *2015 IEEE International Conference on Communication Workshop (ICCW)*. Presented at the 2015 IEEE International Conference on Communication Workshop (ICCW), pp. 2018–2022. <https://doi.org/10.1109/ICCW.2015.7247477>
- Li, M., Jia, Y., Shen, Z., He, F., 2017. Improving the electrification rate of the vehicle miles traveled in Beijing: A data-driven approach. *Transportation Research Part A: Policy and Practice* 97, 106–120. <https://doi.org/10.1016/j.tra.2017.01.005>
- Li, S., Huang, Y., 2014. Heuristic approaches for the flow-based set covering problem with deviation paths. *Transportation Research Part E: Logistics and Transportation Review* 72, 144–158. <https://doi.org/10.1016/j.tre.2014.10.013>
- Li, S., Huang, Y., Mason, S.J., 2016. A multi-period optimization model for the deployment of public electric vehicle charging stations on network. *Transportation Research Part C: Emerging Technologies* 65, 128–143. <https://doi.org/10.1016/j.trc.2016.01.008>
- Li, S., Tong, L., Xing, J., Zhou, Y., 2017. The Market for Electric Vehicles: Indirect Network Effects and Policy Design. *Journal of the Association of Environmental and Resource Economists* 4, 89–133. <https://doi.org/10.1086/689702>
- Li, W., Long, R., Chen, H., Geng, J., 2017. A review of factors influencing consumer intentions to adopt battery electric vehicles. *Renewable and Sustainable Energy Reviews* 78, 318–328. <https://doi.org/10.1016/j.rser.2017.04.076>



## *Chapter 2: Review of Optimization Objectives and Their Consequences for Electric-Vehicle Charging Infrastructure*

- Lindgren, J., Lund, P.D., 2016. Effect of extreme temperatures on battery charging and performance of electric vehicles. *Journal of Power Sources* 328, 37–45. <https://doi.org/10.1016/j.jpowsour.2016.07.038>
- Liu, H., Wang, D.Z.W., 2017. Locating multiple types of charging facilities for battery electric vehicles. *Transportation Research Part B: Methodological* 103, 30–55. <https://doi.org/10.1016/j.trb.2017.01.005>
- Liu, Z., Zhang, W., Ji, X., Li, K., 2012. Optimal Planning of charging station for electric vehicle based on particle swarm optimization, in: *IEEE PES Innovative Smart Grid Technologies*. Presented at the IEEE PES Innovative Smart Grid Technologies, pp. 1–5. <https://doi.org/10.1109/ISGT-Asia.2012.6303112>
- Lucas, A., Alexandra Silva, C., Costa Neto, R., 2012. Life cycle analysis of energy supply infrastructure for conventional and electric vehicles. *Energy Policy, Modeling Transport (Energy) Demand and Policies* 41, 537–547. <https://doi.org/10.1016/j.enpol.2011.11.015>
- Marchi, B., Zanoni, S., Pasetti, M., Zavanella, L., Ferretti, I., 2018. A queuing theory decision support model and discrete event simulations for the smart charging of electric vehicles [WWW Document]. ResearchGate. URL [https://www.researchgate.net/publication/327797233\\_A\\_queuing\\_theory\\_decision\\_support\\_model\\_and\\_discrete\\_event\\_simulations\\_for\\_the\\_smart\\_charging\\_of\\_electric\\_vehicles](https://www.researchgate.net/publication/327797233_A_queuing_theory_decision_support_model_and_discrete_event_simulations_for_the_smart_charging_of_electric_vehicles) (accessed 6.23.20).
- Martínez-Lao, J., Montoya, F.G., Montoya, M.G., Manzano-Agugliaro, F., 2017. Electric vehicles in Spain: An overview of charging systems. *Renewable and Sustainable Energy Reviews* 77, 970–983. <https://doi.org/10.1016/j.rser.2016.11.239>
- Martín-Martín, A., Orduna-Malea, E., Thelwall, M., López-Cózar, E.D., 2018. Google Scholar, Web of Science, and Scopus: a systematic comparison of citations in 252 subject categories. <https://doi.org/10.31235/osf.io/42nkm>
- Martins, M.C.S., Trindade, F.C.L., 2015. Time series studies for optimal allocation of electric charging stations in urban area, in: *2015 IEEE PES Innovative Smart Grid Technologies Latin America (ISGT LATAM)*. Presented at the 2015 IEEE PES Innovative Smart Grid Technologies Latin America (ISGT LATAM), pp. 142–147. <https://doi.org/10.1109/ISGT-LA.2015.7381143>
- Mehboob, N., Cañizares, C., Rosenberg, C., 2014. Day-ahead dispatch of PEV loads in a residential distribution system, in: *2014 IEEE PES General Meeting | Conference Exposition*. Presented at the 2014 IEEE PES General Meeting | Conference Exposition, pp. 1–5. <https://doi.org/10.1109/PESGM.2014.6939492>
- Mersky, A.C., Sprei, F., Samaras, C., Qian, Z. (Sean), 2016. Effectiveness of incentives on electric vehicle adoption in Norway. *Transportation Research Part D: Transport and Environment* 46, 56–68. <https://doi.org/10.1016/j.trd.2016.03.011>
- Mets, K., D’hulst, R., Develder, C., 2012. Comparison of intelligent charging algorithms for electric vehicles to reduce peak load and demand variability in a distribution grid. *Journal of Communications and Networks* 14, 672–681. <https://doi.org/10.1109/JCN.2012.00033>
- Mohsenzadeh, A., Pazouki, S., Haghifam, M.-R., Pang, C., 2015. Optimal planning of parking lots and demand response programs in distribution network considering power loss and voltage profile, in: *2015 IEEE Power Energy Society Innovative Smart Grid Technologies Conference (ISGT)*. Presented at the 2015 IEEE Power Energy Society Innovative Smart Grid Technologies Conference (ISGT), pp. 1–5. <https://doi.org/10.1109/ISGT.2015.7131899>
- Moradijuz, M., Parsa Moghaddam, M., Haghifam, M.R., Alishahi, E., 2013. A multi-objective optimization problem for allocating parking lots in a distribution network. *International Journal of Electrical Power & Energy Systems* 46, 115–122. <https://doi.org/10.1016/j.ijepes.2012.10.041>
- Morrissey, P., Weldon, P., O’Mahony, M., 2016. Future standard and fast charging infrastructure planning: An analysis of electric vehicle charging behaviour. *Energy Policy* 89, 257–270. <https://doi.org/10.1016/j.enpol.2015.12.001>
- Motoaki, Y., Yi, W., Salisbury, S., 2018. Empirical analysis of electric vehicle fast charging under cold temperatures. *Energy Policy* 122, 162–168. <https://doi.org/10.1016/j.enpol.2018.07.036>

## *Chapter 2: Review of Optimization Objectives and Their Consequences for Electric-Vehicle Charging Infrastructure*

- Namdeo, A., Tiwary, A., Dziurla, R., 2014. Spatial planning of public charging points using multi-dimensional analysis of early adopters of electric vehicles for a city region. *Technological Forecasting and Social Change* 89, 188–200. <https://doi.org/10.1016/j.techfore.2013.08.032>
- Nie, Y. (Marco), Ghamami, M., 2013. A corridor-centric approach to planning electric vehicle charging infrastructure. *Transportation Research Part B: Methodological* 57, 172–190. <https://doi.org/10.1016/j.trb.2013.08.010>
- Oliveira, D.Q., Zambroni de Souza, A.C., Delboni, L.F.N., 2013. Optimal plug-in hybrid electric vehicles recharge in distribution power systems. *Electric Power Systems Research* 98, 77–85. <https://doi.org/10.1016/j.epsr.2012.12.012>
- Pagany, R., Camargo, L.R., Dorner, W., 2018. A review of spatial localization methodologies for the electric vehicle charging infrastructure [WWW Document]. URL <https://www.tandfonline.com/doi/full/10.1080/15568318.2018.1481243> (accessed 6.23.20).
- Pagany, R., Marquardt, A., Zink, R., 2019. Electric Charging Demand Location Model—A User- and Destination-Based Locating Approach for Electric Vehicle Charging Stations. *Sustainability* 11, 2301. <https://doi.org/10.3390/su11082301>
- Pelletier, S., Jabali, O., Laporte, G., 2018. Charge scheduling for electric freight vehicles. *Transportation Research Part B: Methodological* 115, 246–269. <https://doi.org/10.1016/j.trb.2018.07.010>
- Pelletier, S., Jabali, O., Laporte, G., Veneroni, M., 2017. Battery degradation and behaviour for electric vehicles: Review and numerical analyses of several models. *Transportation Research Part B: Methodological, Green Urban Transportation* 103, 158–187. <https://doi.org/10.1016/j.trb.2017.01.020>
- Rahimi, S., Zhu, K., Massucco, S., Silvestro, F., Steen, D., 2014. Using the advanced DMS functions to handle the impact of plug-in Electric vehicles on distribution networks, in: 2014 IEEE International Electric Vehicle Conference (IEVC). Presented at the 2014 IEEE International Electric Vehicle Conference (IEVC), pp. 1–8. <https://doi.org/10.1109/IEVC.2014.7056127>
- Rajabi-Ghahnavieh, A., Sadeghi-Barzani, P., 2017. Optimal Zonal Fast-Charging Station Placement Considering Urban Traffic Circulation. *IEEE Transactions on Vehicular Technology* 66, 45–56. <https://doi.org/10.1109/TVT.2016.2555083>
- Ruiqin, D., Zhongjing, M., 2015. Resident electric vehicles charging optimization strategy in the smart grid, in: 2015 34th Chinese Control Conference (CCC). Presented at the 2015 34th Chinese Control Conference (CCC), pp. 9054–9059. <https://doi.org/10.1109/ChiCC.2015.7261072>
- Sadeghi-Barzani, P., Rajabi-Ghahnavieh, A., Kazemi-Karegar, H., 2014. Optimal fast charging station placing and sizing. *Applied Energy* 125, 289–299. <https://doi.org/10.1016/j.apenergy.2014.03.077>
- Said, D., Cherkaoui, S., Khoukhi, L., 2013. Queuing model for EVs charging at public supply stations, in: 2013 9th International Wireless Communications and Mobile Computing Conference (IWCMC). Presented at the 2013 9th International Wireless Communications and Mobile Computing Conference (IWCMC 2013), IEEE, Sardinia, Italy, pp. 65–70. <https://doi.org/10.1109/IWCMC.2013.6583536>
- Salmon, J., 2016. Systems optimization of charging infrastructure for electric vehicles, in: 2016 Annual IEEE Systems Conference (SysCon). Presented at the 2016 Annual IEEE Systems Conference (SysCon), pp. 1–8. <https://doi.org/10.1109/SYSCON.2016.7490573>
- Sathaye, N., Kelley, S., 2013. An approach for the optimal planning of electric vehicle infrastructure for highway corridors. *Transportation Research Part E: Logistics and Transportation Review* 59, 15–33. <https://doi.org/10.1016/j.tre.2013.08.003>
- Schroeder, A., Traber, T., 2012. The economics of fast charging infrastructure for electric vehicles. *Energy Policy* 43, 136–144. <https://doi.org/10.1016/j.enpol.2011.12.041>
- Serradilla, J., Wardle, J., Blythe, P., Gibbon, J., 2017. An evidence-based approach for investment in rapid-charging infrastructure. *Energy Policy* 106, 514–524. <https://doi.org/10.1016/j.enpol.2017.04.007>
- Shahraki, N., Cai, H., Turkay, M., Xu, M., 2015. Optimal locations of electric public charging stations using real world vehicle travel patterns. *Transportation Research Part D: Transport and Environment* 41, 165–176. <https://doi.org/10.1016/j.trd.2015.09.011>

## *Chapter 2: Review of Optimization Objectives and Their Consequences for Electric-Vehicle Charging Infrastructure*

- Shareef, H., Islam, Md.M., Mohamed, A., 2016. A review of the stage-of-the-art charging technologies, placement methodologies, and impacts of electric vehicles. *Renewable and Sustainable Energy Reviews* 64, 403–420. <https://doi.org/10.1016/j.rser.2016.06.033>
- Shen, Z.-J.M., Feng, B., Mao, C., Ran, L., 2019. Optimization models for electric vehicle service operations: A literature review. *Transportation Research Part B: Methodological* 128, 462–477. <https://doi.org/10.1016/j.trb.2019.08.006>
- Shukla, A., Pekny, J., Venkatasubramanian, V., 2011. An optimization framework for cost effective design of refueling station infrastructure for alternative fuel vehicles. *Computers & Chemical Engineering* 35, 1431–1438. <https://doi.org/10.1016/j.compchemeng.2011.03.018>
- Sierzychula, W., Bakker, S., Maat, K., van Wee, B., 2014. The influence of financial incentives and other socio-economic factors on electric vehicle adoption. *Energy Policy* 68, 183–194. <https://doi.org/10.1016/j.enpol.2014.01.043>
- Soylu, T., Anderson, J.E., Böttcher, N., Weiß, C., Chlond, B., Kuhnimhof, T., 2016. Building Up Demand-Oriented Charging Infrastructure for Electric Vehicles in Germany. *Transportation Research Procedia* 19, 187–198. <https://doi.org/10.1016/j.trpro.2016.12.079>
- Spieker, H., Hagg, A., Gaier, A., Meilinger, S., Asteroth, A., 2017. Multi-stage Evolution of Single- and Multi-objective MCLP. *Soft Comput.* 21, 4859–4872. <https://doi.org/10.1007/s00500-016-2374-9>
- Springel, K., 2017. Network Externality and Subsidy Structure in Two-Sided Markets: Evidence from Electric Vehicle Incentives 63.
- Sun, Z., Gao, W., Li, B., Wang, L., 2018. Locating charging stations for electric vehicles. *Transport Policy* S0967070X17306583. <https://doi.org/10.1016/j.tranpol.2018.07.009>
- Tian, Z., Hou, W., Gu, X., Gu, F., Yao, B., 2018. The location optimization of electric vehicle charging stations considering charging behavior. *SIMULATION* 94, 625–636. <https://doi.org/10.1177/0037549717743807>
- Torabikalaki, R., Gomes, A., 2014. Optimizing the Coordinated Charging of a Group of Electric Vehicles, in: 2014 IEEE Vehicle Power and Propulsion Conference (VPPC). Presented at the 2014 IEEE Vehicle Power and Propulsion Conference (VPPC), pp. 1–6. <https://doi.org/10.1109/VPPC.2014.7007116>
- Torchio, M.F., Santarelli, M.G., 2010. Energy, environmental and economic comparison of different powertrain/fuel options using well-to-wheels assessment, energy and external costs – European market analysis. *Energy* 35, 4156–4171. <https://doi.org/10.1016/j.energy.2010.06.037>
- Tran, M., Banister, D., Bishop, J.D.K., McCulloch, M.D., 2012. Realizing the electric-vehicle revolution. *Nature Clim Change* 2, 328–333. <https://doi.org/10.1038/nclimate1429>
- Tu, W., Li, Q., Fang, Z., Shaw, S., Zhou, B., Chang, X., 2016. Optimizing the locations of electric taxi charging stations: A spatial–temporal demand coverage approach. *Transportation Research Part C: Emerging Technologies* 65, 172–189. <https://doi.org/10.1016/j.trc.2015.10.004>
- Wang, Y.-W., Lin, C.-C., 2009. Locating road-vehicle refueling stations. *Transportation Research Part E: Logistics and Transportation Review* 45, 821–829. <https://doi.org/10.1016/j.tre.2009.03.002>
- Wang, Y.-W., Wang, C.-R., 2010. Locating passenger vehicle refueling stations. *Transportation Research Part E: Logistics and Transportation Review* 46, 791–801. <https://doi.org/10.1016/j.tre.2009.12.001>
- Wanting Lin, Guowei Hua, 2015. The flow capturing location model and algorithm of electric vehicle charging stations, in: 2015 International Conference on Logistics, Informatics and Service Sciences (LISS). Presented at the 2015 International Conference on Logistics, Informatics and Service Sciences (LISS), pp. 1–6. <https://doi.org/10.1109/LISS.2015.7369788>
- Wood, E., Neubauer, J.S., Burton, E., 2015. Measuring the Benefits of Public Chargers and Improving Infrastructure Deployments Using Advanced Simulation Tools. Presented at the SAE 2015 World Congress & Exhibition, pp. 2015-01–1688. <https://doi.org/10.4271/2015-01-1688>
- Wood, E., Raghavan, S., Rames, C., Eichman, J., Melaina, M., 2017. Regional Charging Infrastructure for Plug-In Electric Vehicles: A Case Study of Massachusetts (No. NREL/TP--5400-67436, 1339074). <https://doi.org/10.2172/1339074>

## *Chapter 2: Review of Optimization Objectives and Their Consequences for Electric-Vehicle Charging Infrastructure*

- Xi, X., Sioshansi, R., Marano, V., 2013. Simulation–optimization model for location of a public electric vehicle charging infrastructure. *Transportation Research Part D: Transport and Environment* 22, 60–69. <https://doi.org/10.1016/j.trd.2013.02.014>
- Xiang, Y., Liu, J., Li, R., Li, F., Gu, C., Tang, S., 2016. Economic planning of electric vehicle charging stations considering traffic constraints and load profile templates. *Applied Energy* 178, 647–659. <https://doi.org/10.1016/j.apenergy.2016.06.021>
- Yang, J., Dong, J., Hu, L., 2017. A data-driven optimization-based approach for siting and sizing of electric taxi charging stations. *Transportation Research Part C: Emerging Technologies* 77, 462–477. <https://doi.org/10.1016/j.trc.2017.02.014>
- Yaping Gao, Xiaochun Lu, 2015. Analysis of the electric vehicle charging station’s layout in Beijing based on improved traveling simulation model, in: *2015 International Conference on Logistics, Informatics and Service Sciences (LISS)*. Presented at the 2015 International Conference on Logistics, Informatics and Service Sciences (LISS), pp. 1–6. <https://doi.org/10.1109/LISS.2015.7369699>
- Yi, Z., Bauer, P.H., 2016. Optimization models for placement of an energy-aware electric vehicle charging infrastructure. *Transportation Research Part E: Logistics and Transportation Review* 91, 227–244. <https://doi.org/10.1016/j.tre.2016.04.013>
- Zeng, M., Zhan, X., Li, Y., 2016. Optimal Planning for Electric Vehicle Charging Station Considering the Constraint of Battery Capacity, in: *Proceedings of the 2016 International Conference on Artificial Intelligence: Technologies and Applications*. Presented at the 2016 International Conference on Artificial Intelligence: Technologies and Applications, Atlantis Press, Bangkok, Thailand. <https://doi.org/10.2991/icaaita-16.2016.86>
- Zhang, A., Kang, J.E., KWon, C., 2017. Incorporating demand dynamics in multi-period capacitated fast-charging location planning for electric vehicles. *Transportation Research Part B: Methodological* 103, 5–29. <https://doi.org/10.1016/j.trb.2017.04.016>
- Zhang, F., Liu, K., Zhang, Q., Tian, B., Li, W., Qin, L., 2015. The research on the planning model of rural distribution network containing diversification loads, in: *2015 5th International Conference on Electric Utility Deregulation and Restructuring and Power Technologies (DRPT)*. Presented at the 2015 5th International Conference on Electric Utility Deregulation and Restructuring and Power Technologies (DRPT), pp. 578–582. <https://doi.org/10.1109/DRPT.2015.7432295>
- Zhang, H., Hu, Z., Xu, Z., Song, Y., 2016. An Integrated Planning Framework for Different Types of PEV Charging Facilities in Urban Area. *IEEE Transactions on Smart Grid* 7, 2273–2284. <https://doi.org/10.1109/TSG.2015.2436069>
- Zhang, Y., Qi, D., Jiang, W., Lei, S., 2016. Optimal Allocation of Charging Station for Electric Vehicle Based on Queuing Theory. *PROMET* 28, 497–505. <https://doi.org/10.7307/ptt.v28i5.1974>
- Zhang, Z., Sun, X., Ding, N., Yang, J., 2019. Life cycle environmental assessment of charging infrastructure for electric vehicles in China. *Journal of Cleaner Production* 227, 932–941. <https://doi.org/10.1016/j.jclepro.2019.04.167>
- Zhou, K., Cai, L., 2014. Randomized PHEV Charging Under Distribution Grid Constraints. *IEEE Transactions on Smart Grid* 5, 879–887. <https://doi.org/10.1109/TSG.2013.2293733>
- Zhu, Z.-H., Gao, Z.-Y., Zheng, J.-F., Du, H.-M., 2016. Charging station location problem of plug-in electric vehicles. *Journal of Transport Geography* 52, 11–22. <https://doi.org/10.1016/j.jtrangeo.2016.02.002>

*Chapter 2: Review of Optimization Objectives and Their Consequences for Electric-Vehicle Charging Infrastructure*

## **Chapter 3: Assessing the trade-offs between battery capacity and public charging infrastructure of electric vehicles: urban and rural French case studies for daily needs**

### **Abstract**

Battery Electric Vehicles (BEVs) are considered a promising solution for the reduction of greenhouse-gas emissions. Despite increasing sales, techno-economic barriers still hinder their widespread adoption. Market stakeholders face a dilemma in overcoming these obstacles, especially as they seem to disagree on investment scenarios regarding battery capacity and charging infrastructure, with different implications as to who should bear the costs of addressing these dilemmas. While previous research has considered battery vs recharging infrastructure choices separately, they are interdependent in reality, as battery choices influence car price, charging speed and accessibility. These choices are all the more important for an often overlooked but important group of potential EV owners: households that cannot charge at home and for whom solutions that can address range anxiety are of particular importance. In this Chapter, we analyse how techno-economic barriers can overcome this customer group while considering the interdependencies mentioned.

Using data obtained for real-world mobility needs in France, we simulate BEV-owner and charging infrastructure-operator cost implications for several combinations of privately-purchased BEVs that vary in 1) battery capacity, 2) charging power and, 3) whether or not the owner lives in a rural or urban area. Furthermore, we explore Pareto fronts in order to determine optimal combinations. This Chapter shows that for urban (*vs rural*) areas, purchasing a 40-50-kWh (*55-kWh*) BEV and deploying 50-kW chargers (*50-kW*) proves to be the most social cost-efficient solution. Policy implications are then discussed, and we recommend a thorough review of the charging tariffs.

**This Chapter was presented at the 2021 IEW Workshop, the 2021 Applied Energy Symposium, and the 2021 International IAEE conference:**

- Bassem Haidar, Pascal da Costa, Jan Lepoutre, Fabrice Vidal. Addressing Electric-Vehicle Range Anxiety In Urban And Rural Areas. International Energy Workshop 2021, Fraunhofer Institute for Solar Energy Systems ISE, 2021, Fribourg, Germany.
- Bassem Haidar. Assessing the trade-offs between battery capacity and charging power of battery electric vehicles: A French case study. Applied Energy Symposium : MIT A+B, MIT and Harvard, 2021, Boston, United States.

*Chapter 3: Assessing the trade-offs between battery capacity and public charging infrastructure of electric vehicles: urban and rural French case studies for daily needs*

- Bassem Haidar, Pascal da Costa, Jan Lepoutre, Fabrice Vidal. Which combination of battery capacity and charging power for battery electric vehicles: urban versus rural French case studies. Energy, COVID, and Climate Change, 2021, Paris, France.

**This Chapter is submitted to Research in Transportation Economics Journal as follows:**

Bassem Haidar, Pascal da Costa, Jan Lepoutre, Fabrice Vidal. Assessing the trade-offs between battery capacity and public charging infrastructure of electric vehicles: urban and rural French case studies for daily needs.

## 1. Introduction

In order to reach ambitious climate change mitigation targets, the Intergovernmental Panel on Climate Change (IPCC) called for a reduction of greenhouse gas emissions (GHG), especially in the energy and transportation sectors that are currently heavily fossil-fuel dependent (IEA, 2019; IPCC, 2018). Transportation, responsible for 20% of global CO<sub>2</sub> emissions, of which 72% are emitted by road transportation, should become emission-free by 2050 to reach world ambitions (IPCC, 2018). Electric vehicles (EVs), including Battery EVs (BEVs) and Plug-in EVs (PHEVs), have the potential to improve the environmental impact of personal-road transportation because of their potential non-fossil-fuel dependency (Amjad et al., 2018). As a result, BEVs have attracted much attention, pushing governments to promote this technology as an auspicious solution (Gnann et al., 2018).

Although BEV sales have sharply risen in the past years in many developed countries, their sales remain limited in absolute terms. To reach BEV mass adoption, economic-, psychological-, comfort-customer concerns, etc. are still hindering its expansion: indeed, higher vehicle prices, anxiety about the ability to complete both daily and long mobility needs, the availability of either private or public chargers, and the often longer time required to recharge (vs refill) are some of the more essential barriers (Berkeley et al., 2017; Biresselioglu et al., 2018). In the specific case of France, for example, EVs represented only about 2% of total vehicles sales in 2020 (French Ministry of Ecological Transition, 2020). To boost sales, the French government has tried making EVs more attractive to consumers by offering various subsidies, on both national and local levels, tax exemptions, free parking, access to bus lanes to each driver switching to electric mobility. The main subsidy can go up to 5000€/BEV<sup>6</sup>, depending on the vehicle's initial price. Furthermore, since the lack of charging infrastructure still presents a significant barrier to EV adoption, the government has been boosting the deployment of the infrastructure by installing more chargers (EC, 2013), and currently offering up to 50% of the cost of the charger for both private and public usage (e.g. ADVENIR project (Advenir, 2020)).

Completing daily or long mobility needs (or eliminating the autonomy barriers) involves an economic trade-off. While integrating bigger batteries in cars provides more range and could solve the range anxiety concern by conveniently reaching one's destination, it comes with a

---

<sup>6</sup> Note that due to COVID19 crisis, and within the framework of the French recovery plan, the French government increased the subsidy up to 7000€/BEV, from the last quarter of 2020 for few months. (Service Public, 2020). These upward subsidies are temporary, which is why, in this study, we can consider a more permanent subsidy of 5000€/BEV.



higher vehicle-purchasing price. Contrary to small-battery BEVs, which come with lower purchasing costs but with a smaller range (around 75-125 km), large-battery BEVs offer extended autonomy (up to 450-630 km), yet significantly higher purchase cost.

In order to keep purchasing prices low by integrating smaller batteries in the vehicle, investing more in high penetration of public charging network is indispensable, especially near accommodation places and on highways, e.g. Corri-Door or Ionity projects France (EC, 2013; Ionity, 2021). The French Government recently allocated a budget of € 100 million for fast charging stations on motorways and the national road network, aiming to foster range-anxiety-free long-distance travel (Ministry of Ecological Transition, 2020). However, the cost of such infrastructure investments is not with the purchaser of the car and represents considerable expenditures for charging operators (Funke et al., 2019; Gnann et al., 2018; Greene et al., 2020). Spatial considerations further complicate this issue since charging needs vary between French rural and urban areas, with higher needs in rural (ENTD, 2019, 2008).

Finally, the fact that in France currently 90% of recharging events are done at home with private chargers (AVERE, 2020) shows that a large population of potential customers, who cannot install an at-home private charger, face a practical barrier that prevents them from buying an EV. Private charger installation depends mainly on the housing type (free standing house vs condominium apartment), private parking availability, and area type (rural vs urban). 37% of primary residences in France do not have any home parking, neither in individual or collective housing (Huguet and Stéphane, 2019). Indeed, home parking unavailability is lower in rural areas (where the housing type is mainly free-standing houses) than in urban ones (where the share of people living in condominiums is much higher) (INSEE, 2020a). Moreover, people living in rural or peri-urban areas tend to be more dependent on their cars due to lower penetration of alternative transport modes, such as public transport. Switching from ICEV to BEV is then a risky proposition for these drivers, as they have to anticipate, during their everyday trips (home-work, school-home, home-shopping, etc.), BEVs range limitations that come with their battery size, restricted availability of public charging infrastructure, various charging powers that adopt diverse charging tariffs and pricing methods, and the waiting time to access an on-street charger, especially during peak hours. These are all dilemmas that this Chapter aims to study. Studying solutions for non-home charging EV owners is important, as they represent a vital target customer for the BEV market's future, as withdrawing these “laggards’ obstacles” could strongly increase BEV penetration.

To make progress on this question, we must consider an often forgotten interdependence between battery size and recharging speed, technically called the C-Rate (Charging-Rate).

*Chapter 3: Assessing the trade-offs between battery capacity and public charging infrastructure of electric vehicles: urban and rural French case studies for daily needs*

Indeed, the smaller the battery size, the more limited the power at which the car can be charged, hence the charging speed (Electric Vehicle Database, 2021). Since charging speed depends on the combination of battery capacity and charging power, it transfers a simple-unitary transaction for the automotive manufacturer (one car, one battery) into a complicated and costly-shared infrastructure investment. Therefore, solving the recharging speed and cost question is a complex set of interdependent variables that connect battery size and charging power with diverse stakeholders: adopting large-battery BEVs to avoid range anxiety will oblige operators to install fast chargers and different charging speeds that come with high investments.

While determining the optimal battery size of BEVs and optimizing the charging network have received widespread attention in the literature, the implication that battery size influences charging powers has rarely been considered and reveals a high complexity level. To answer the battery sizes and charging power combinations question, this article will analyse and compare BEV owner purchasing and usage costs, considering French government subsidies and environmental (CO<sub>2</sub>) taxes on the one hand, and CPO investment and operational costs, taking into account French government subsidies and real-market charging tariffs, on the other hand. We computed the cost and revenue models based on the Equivalent Annual Cost (EAC) method, i.e. the cost of owning, operating, and maintaining an asset over its entire lifetime (Funke et al., 2019). The EAC method is appropriate since BEVs and charging infrastructure do not share identical lifetimes or own, operate, or maintain costs.

The trade-off question is highly individual and depends on the driver's needs and behaviour, which significantly depends on the urbanization level of the individual's home and work situation. Thus, we applied the cost comparison methodology by considering cluster areas using two typical examples of urban – Paris – and rural – Ambérieu-en-Bugey – French areas, which differ in their socio-economic characteristics.

To sum up, this article assesses the trade-off between bigger batteries and more chargers, with various relevant and novel contributions by:

- i) Considering several input data for the costs models, namely:
  - Spatial analysis in French urban- and rural-mobility needs, and non-availability of at-home chargers (Paris versus Ambérieu-en-Bugey).
  - Considering technical constraints regarding the combinations of battery size and charger speed, based on their C-Rate. Note we also address a sensitivity analysis of the mix of the BEV-charger compatibility.
- ii) Concluding with several innovative deductions:

- Addressing the two main cost EAC models of the BEV ecosystem: BEV customer and charging point operator.
- Concluding about profitable win-win solutions for both parties or Pareto fronts.
- Discussing policy implications for the whole BEV ecosystem: the automotive industry, the charging operator, and the policymaker.

The results of this article **suggest that the optimal overall investment strategy is to favour investment in fast-charging infrastructure rather than bigger batteries:** Based on Pareto fronts, purchasing a 40-50 kWh BEV for the selected urban area *-versus 55 kWh BEV for rural-* and deploying 50 kW chargers *-50 kW for the selected rural-* prove the most cost-efficient and profitable solutions, for both BEV owners as well as charging operators.

Our Chapter is structured as follows: Section 2 presents the literature review. Section 3 discusses the methodology and, in Section 4, the data and the techno-economic parameters. The results of the study are presented in Section 5. The conclusion, discussion, and policy recommendations are drawn up in Section 6.

## 2. Literature Review

The literature dedicated to understanding optimal responses to electric vehicle customer needs can be divided into four main streams. The first estimates the drivers' needed range. Second, the determination of the optimal battery capacity is elaborated. Third, a group of publications investigates the deployment of charging infrastructure. Last, the fourth stream compares the investment in both technologies.

### 2.1. Estimating drivers' needed range

The first stream of articles has focused on determining the appropriate battery capacity to satisfy customer transportation requirements. The question is challenging, as range requirements can vary with social and driving behaviours changes. Consequently, large datasets of trips for many drivers over a long period are required, for example, surveys and questionnaires at a national scale, data on long-mileage trips, and GPS-based trips.

The first articles use surveys and questionnaires, including national travel surveys, of all types of trips. Zhang et al. (2013) used a dataset of 20,295 privately owned vehicles in California travelling 83,005 single daily trips or 7.85 trips each, from the 2009 National Household Travel Survey (NHTS). They found that 88% of the trips could be operated using a BEV with a 95-km range, using only at-home charging. Similarly, Zhou et al. (2020) conducted a stated preference survey in Beijing to estimate the different recharging behaviours of two

clusters of BEV drivers in Beijing. They concluded that a 482-km BEV could cover 90% of the drivers' travel demands, while a 160-km BEV can satisfy 80%.

The second group of articles is based on survey data of long-distance trips. Since data on BEV trips are still rare, especially for long-distance trips, Weiss et al. (2014) used statistical mobility surveys: the German Mobility Panel study on individual car mileage and fuel consumption, and the long-distance travel survey INVERMO, from which they concluded that only 13% of private vehicles users never exceed 100 km, 16% of private vehicle data exceeded range requirements of 100 km for only 1-4 days a year, concluding with the unnecessary of a bigger range than 100 km for around 30% of users.

The last group of articles used GPS-based data of trips. Pearre et al. (2011) analyzed the driving patterns of 484 ICEVs over one year in the US and assumed that these drivers would not change their driving behaviour after switching to a BEV. They found that 9% of users never exceeded 160 km in a day, and 21% never exceeded 240 km and would satisfy their needs with a small battery BEV. This percentage could increase up to 32% if drivers were willing to adjust their driving behaviour for long-distance trips done once per month. Neubauer and Wood (2014) claimed that after analyzing the trips of 317 ICEVs over one year, a 120 km-range BEV could fill the needs of 75% of the drivers without public charging infrastructure and increase 90% with such charging infrastructure available. Meinrenken et al. (2020) concluded that the battery's optimal range would be 158 km, based on 412 cars and GPS data for 384,869 individual trips while maximizing GHG savings. Overall, this stream shows that range requirements are low for most of the population and uses (a 100-250 km BEV could satisfy the needs of a large group of drivers), but that diversity exists depending on geographical origin and exceptional trips.

## **2.2.Determining The Optimal Battery Capacity**

Determining the optimal battery<sup>7</sup> capacity for a BEV is subjected to technical (battery technology, charging power), economic (the price of the battery pack), and drivers' behaviour (needed range and access to charging infrastructure) factors (Mies et al., 2018). First, battery sizing mainly depends on the capacity (Ah) and the charging current (A), two parameters that define the battery C-rate: the rate at which a battery can be charged and discharged (Yong et al., 2015). A C-rate of 1C is also known as a one-hour discharge; 0.5C or C/2 is a two-hour discharge, and 0.2C or C/5 is a 5-hour discharge. The main challenge is identifying the C-rate

---

<sup>7</sup> We consider that the BEV battery is a lithium-ion one.

that makes capacity utilization and battery charging speed well balanced (Duru et al., 2021). Indeed, achieving a high capacity utilization with low charging current rates could speed up the battery wear and ageing process, cause the slowdown of the battery's charging speed and further hurt BEV usage (Duru et al., 2021). (Bhagavathy et al., 2021) shows that charging rates above 1C-rate negatively affects some batteries' lifetimes. Fast chargers can accelerate the degradation of batteries in vehicles, which may require premature replacement and, hence, increase the cost. This problem reveals the complexity of adapting battery sizes to charging powers since charging a small battery capacity with a high current could decrease the battery's energy storage efficiency (Waldmann et al., 2018). As a result, car manufacturers manage the C-rate of the battery through its Battery Management System (BMS), and generally, larger battery sizes can accommodate higher C-rates and, hence, charge speeds. Second, the battery size is linked to the BEV cost. Although battery pack prices are experiencing a downward trend, from 1037€/kWh in 2010 to 150€/kWh in 2020 (Groupe Renault, 2020), a battery pack still remains a significant cost in the car's purchase price. Thirdly, as elaborated in Section 2.1., sizing the battery capacity relies on the drivers' needed range and access to charging infrastructure (at home or not), and the tolerated charging duration if using the public charging infrastructure. In sum, while bigger battery capacities will provide extended autonomy and faster charging, they come with a higher purchasing cost for the driver. Based on these factors, a driver, who has an at-home charger and drives for short distances, is more likely to purchase a small-battery BEV than a large one, limiting the purchasing price.

### **2.3. Deployment of Charging Infrastructures**

The question of charging-station geo-locations has been extensively studied in the literature. Research has focused on optimizing the locations of charging infrastructure based on various objectives: minimizing the charging operator's costs (Yang et al., 2017), minimizing the travelled distance (Sathaye and Kelley, 2013), maximizing the coverage (Wang and Wang, 2010), minimizing failed trips (Alhazmi et al., 2017), minimizing the distance between demand and charging sites (Sathaye and Kelley, 2013). Various spatial-optimisation methods have also been considered in determining the optimal location of recharging network locations (Pagany et al., 2019; Shareef et al., 2016; Shen et al., 2019). These articles helped us to understand the empirical methodology behind the spatial localisation of the charging network. However, these studies generally only focus on the charging infrastructure geo-localization while ignoring or holding constant data related to the BEVs, such as the battery capacity or autonomy. Since some BEVs are not compatible with fast charging technologies (as mentioned before), our insight

into the appropriate recharging infrastructure deployment requires simultaneous consideration of both battery specifications and recharging network characteristics.

#### **2.4. Investments in Both Technologies**

The comparison between deploying charging infrastructure and increasing battery capacity has only received scarce attention in the literature. Jabbari and Mackenzie (2017) examined the trade-off between DC fast-charging availability, the capacity to charge many BEVs using a theoretical queuing model, and the cost of charging-infrastructure deployment. They concluded that for a charging station with few chargers, it is difficult to achieve cost effective levels of utilization while maintaining reliable access for arriving vehicles. Large numbers of chargers per station make it possible to maintain a high reliability of access and a high utilization rate. Wood et al. (2015) studied various fast-charging infrastructure deployment scenarios and found that adding 100 km to the BEV autonomy is more costly than deploying more fast-charging infrastructure. However, analyzing the interdependent effects of these deployment scenarios would require a greater understanding of both the nature of driving and charging behaviours.

The originality of (Funke et al., 2019)'s study is to combine all the three streams presented above: identification of BEV needs for German long-mileage trips, determining the number of needed fast chargers, and comparing both of them, using a techno-economic approach, in order to address this trade-off. They compared the EAC of owning a BEV and expanding the fast-charging infrastructure for doubled and tripled BEVs battery size. They concluded that the investments in only fast charging infrastructure (50 and 150 kW chargers) are low compared to larger batteries due to the high price of battery packs (350€/kWh). While (Funke et al., 2019) made significant improvements in this field, questions remain regarding socio-techno-economic assumptions.

First, various BEV types could be available on the market with different battery capacities, and each type is compatible with specified charging power. While some vehicles, especially small-battery ones, can only charge using 7-22 kW chargers due to their non-compatibility with fast charging technology, others can use all types of charging powers, mostly BEVs with battery capacity higher than 50 kWh. Furthermore, since the extended part of the BEV range is occasionally used (Funke et al., 2019), the question of the trade-off between battery capacity and charging infrastructure cost comparison for daily needs, such as home-work trips, has not been elaborated in the literature. Besides, the question of when there are no charging possibilities at home has not been addressed. Besides, none of the papers considered

real charging tariffs from operators on the market. Lastly, the question of the optimum battery capacity or the optimum deployment of charging infrastructure was only studied with a focus on one single actor, either society as a whole, the charging operator, or the BEV customer, neglecting the fact that their interests may be antagonistic, and only a small number of solutions to this trade-off could be profitable for all actors. This Chapter aims to close these research gaps.

### 3. Methodology

This section applies a techno-economic model to identify the investments related to batteries and the charging infrastructure network, inspired by (Funke et al., 2019). As illustrated in Figure 3.1, we simulated 12 scenarios of 5,000-identical BEVs, taking into account their daily trips' needs to determine their energy demands (Section 3.1). Based on the BEV's energy demands, the number of charging stations is identified based on M/M/2 queue model, taking into account a maximum waiting time of 15 minutes (Section 3.2). After, we aimed to identify an optimal balance of costs, considering costs and benefits for the customer and the Charge Point Operator (CPO). We then compared the BEV customer's and the charging operator's cost models before concluding about profitable solutions for both parties based on Pareto fronts (Section 3.3). In what follows, we offer a more detailed description of our methodological framework.

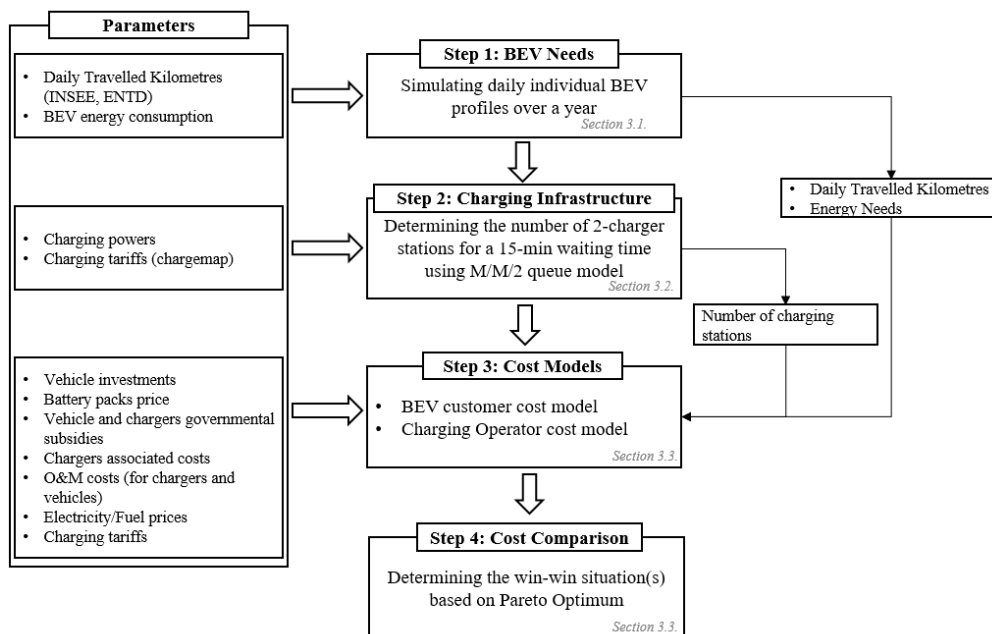

*Figure 3.1 Model Overview*

### 3.1. Modelling the BEV Charging Needs

We modelled the energy needs of 12 scenarios of 5,000 individual-identical private BEV profiles, taking into account their daily needed kilometres in urban and rural areas separately. We then increased the battery capacity by 5 kWh from a scenario to another. This section focuses on BEVs used for private transport and excluded BEVs used for professional transport such as taxis or delivery vans. To determine Worldwide harmonized Light vehicles Test Procedures (WLTP) needs, a conversion factor from real to WLTP standards was used for daily home-work-home trips. This conversion factor, which will be elaborated in the next data section, differs from the driving speed. For instance, driving on the highway requires a higher speed than in cities; thus, higher energy is needed for the same distance.

Furthermore, a random initial State of Charge (SoC) is given to all BEVs. We consider that drivers will charge their vehicles 80% if the next day's SoC reaches 20% (or less) before returning home. The SoC of the battery should always stay between 20% and 80%, leading to a higher lifetime of the battery (Redondo-Iglesias et al., 2019). The SoC is then calculated, taking into account technical parameters such as energy consumption ( $c_i^e$ ), the vehicle kilometres travelled of the next day ( $VKT$ ), and a normal distribution variable ( $a$ ) (Equation 3.1). After simulating all the BEV driving profiles and determining the number of charging stations that could fill the BEVs' energy needs, we determine the yearly charged energy for every BEV profile for the twelve scenarios:

$$SoC_{i,j} = \begin{cases} SoC_{i,j} - \left( \frac{a * VKT(j+1) * c_i^e}{c_i^{batt}} \right) * 100 & \text{if } (SoC_{i,j+1} \geq 20\%) \\ 80 & \text{if } (SoC_{i,j+1} \leq 20\%) \end{cases} \quad (3.1)$$

Where:

- $i = 1, \dots, N$  is the driving profile
- $j$  is the day
- $c_i^e$  the energy consumption,  $c_i^{batt}$  the battery capacity of the BEV 'i'

### 3.2. Modelling the Charging Infrastructure Demand

As mentioned in Section 2.3., different charging powers are available. We assume that every BEV size segment will charge at the maximum speed level it can technically take (i.e., what its BMS will allow). Therefore, a BEV with a battery capacity of less than 20 kWh will use a 7 kW charger; those BEVs with batteries between 20 kWh and 35 kWh will use a 22 kW charger. Finally, we consider that BEVs with a battery capacity higher than 40 kWh, which are compatible with fast charging technology (50 kW), will charge at this level. We do not consider



slow chargers (2.8 to 3.7 kW) because they are generally installed at home and are not available to our population sample. Also, ultra-fast chargers with power above 50 kW are excluded, as they are mainly used for recharging on long-distance trips and rarely regularly that is the focus of our study.

After determining the BEVs' daily energy needs that are consumed to accomplish the daily trips, we determine the number of charging stations to be installed to cover the demand based on a queuing model. On the one hand, users want to find a vacant CP when they arrive at a charging site. On the other hand, charging infrastructure operators cannot install an excessive number of on-street or destination chargers due to the charger price that is increasingly expensive for a higher power. Therefore, we determined the number of on-street two-charger stations using an M/M/s queuing model, neglecting the limited-parking lots constraint, and under the constraint of an average maximal waiting time of 15 minutes (Gnann et al., 2018).

For the M/M/s queuing model, the critical input parameters are the arrival rate and the service rate and are identified for every battery-capacity scenario. The BEVs arrival rate,  $\lambda$  [#BEVs/hour], is deduced from the number of BEVs that cannot charge at home and are obliged to use the charging stations at a particular hour. We consider that the BEVs arrival rate is equal on all charging stations, and the stations have two identical chargers ( $s=2$ ). We also realistically consider no arrival for BEVs to charging stations from 00:00 to 06:00 am; 62% of the BEVs arrive from 02:00 pm to 7:00 pm (the peak hours) (Groupe Alpha et al., 2018).

The service rate,  $\mu$  [BEV/hour], was derived from the charging need model (section 3.1) and was calculated based on the charging power for every battery capacity scenario. As mentioned before, the BEV will charge if its SoC is near 20%.  $\mu$  is the reciprocal value of the average charging time estimated in our study, taking into account an efficiency factor of  $\eta_{\text{charger}}=85\%$  for all chargers.

Finally, since we have defined a minimal quality of service, we ensure that users' waiting time remains limited. The average waiting time ( $W_q^{M/M/2}$ ) of 15 minutes maximum was applied to determine the number of stations for every charging power. For more information on queuing models, refer to (Bhat, 2015).

### 3.3. Cost Model

The method aims to minimize the total cost of both charging infrastructure and the BEV, which was calculated for every driving profile 'i' based on our assumptions discussed earlier in this Chapter. Based on (Funke et al., 2019), we decided to use the Equivalent Annual Cost (EAC) method for BEVs and charging infrastructure, yet extending it to allow for (1) different

charging power and battery combinations, (2) analyzing the various costs for different parties in the BEV ecosystem, and (3) for analysing both urban and rural household needs.

### 3.3.1. The Cost Model of the BEV Customer

Regarding the cost model of the BEV customer, we assume that the customer's goals are to minimize purchase and operating costs, and the time spent charging the vehicle, including the waiting time to access a non-home charger. Therefore, we compare the difference between purchasing a BEV and a conventional ICEV for every profile and every scenario, and we assume that a person would buy a BEV when the average associated profits  $\Delta EAC_i$ , as shown in Equation (3.2), are negative. And:

$$\Delta EAC_i = EAC_{ICEV,i} - EAC_{BEV,i} \quad (3.2)$$

Next, Equation 3.3 applies to all types of vehicles, electric or conventional: it is composed of the sum of amortized investments of the car body and the battery capacity (in the case of BEV), annual operating and maintenance costs that differ for every driving profile due to the individual  $aVKT_i$ , and charging or refuelling costs as noted in (Gnann, 2015; Plötz et al., 2014). While registration taxes for ICEVs are determined based on the vehicle's CO2 emissions,  $LCA_{ICEV,z}$  in Equation 3, (French Property, 2020), BEVs are exempted from these taxes. Note there is no battery cost, subsidy, or subscription fee to access a conventional vehicle's charging infrastructure.

$$EAC_{VEH,i} = \frac{(1 + r_{VEH})^{T_{VEH}} * r_{VEH}}{(1 + r_{VEH})^{T_{VEH}} - 1} (I_{VEH,z} + c_{batt,i} * p_{1kWh} - c_{BEV,subsidies}) + aVKT_i * (c_{VEH,O\&M,z} + c_{VEH,charging}) + c_{BEV,card} + LCA_{ICEV,z} * p_{CO2} \quad (3.3)$$

Where:

$$c_{VEH,charging} = \begin{cases} c_{f,el} * \frac{cons_{VEH,z}}{P_z * \eta}; & \text{if } VEH = BEV \\ c_{f,el} * cons_{VEH,z}; & \text{if } VEH = ICEV \end{cases}$$

-  $i = 1, \dots, N$  is the driving profile

-  $z = \begin{cases} Small; & \text{if } c_{batt} \leq 20 \text{ kWh} \\ Medium; & \text{if } 20 \text{ kWh} < c_{batt} < 50 \text{ kWh} \\ Large; & \text{if } c_{batt} \geq 50 \text{ kWh} \end{cases}$

Table 3.1 details the parameters of Equation 3.3, and all the values are presented in Appendix 3.A.

Table 3.1 Techno-Economic Parameters of  $EAC_{VEH}$

| $EAC_{VEH,i}$       | Equivalent Annual Cost of the driving profile ‘i’      | [€/Year]                 |
|---------------------|--|--------------------------|
| $r_{VEH}$           | Interest rate  | [-]                      |
| $T_{VEH}$           | Lifetime   | [Years]                  |
| $I_{VEH,z}$         | Vehicle investment of Type z (w/o battery)             | [€]                      |
| $c_{batt,i}$        | Battery capacity                                       | [kWh]                    |
| $p_{1kWh}$          | Price of 1 kWh   | [€/kWh]                  |
| $c_{BEV,subsidies}$ | Subsidies  | [€]                      |
| $aVKT_i$            | Annual Vehicle Km Travelled                            | [km/Year]                |
| $c_{VEH,O\&M,z}$    | Operation and Maintenance cost of a vehicle Type ‘z’   | [€/km]                   |
| $c_{VEH,charging}$  | Charging fees  | [€/Year]                 |
| $c_{f,el}$          | Fuel/Electricity cost                                  | [€/l] or [€/min]         |
| $cons_{VEH,z}$      | Fuel/Electricity consumption                           | [l/km] or [kWh/km]       |
| $P_z$               | Charging power mode according to battery type z        | [kW]                     |
| $\eta$              | The efficiency factor of the CP                        | [-]                      |
| $c_{BEV,card}$      | Subscription fee to access the charging infrastructure | [€/year]                 |
| $LCA_{ICEV,z}$      | Life Cycle Assessment of ICEV Type ‘z’                 | [tCO <sub>2</sub> /Year] |
| $p_{CO_2}$          | Price of 1 tonne of CO <sub>2</sub>                    | [€/tCO <sub>2</sub> ]    |

### 3.3.2. Charging Point Operator Business Model

The charging operator aims to deploy the optimal number of chargers to minimize investment and operating costs on the one hand, while considering various chargers of different powers that differ in investment cost, technical characteristics, and services, on the other hand. Based on a benchmark of charging operators (in Appendix 3.A), we consider these firms use third-degree price discrimination, charging prices differently based on the category of clients, and hence, on the used charging power and the battery capacity of the BEV. Equation 3.4 allows us to assess the profitability of its business model:

$$EAC_{CPO} = \sum_{i=1}^N EAC_{CPO,i} \quad (3.4)$$

Where:

- $i = 1, \dots, N$  is the CP

The costs for the CPO are related to the charging infrastructure that includes investments related to the charger, civil engineering works, installation costs, and grid reinforcement. Operation and maintenance costs, electricity expenses (per kWh consumed), and communication costs are added to the Model. Regarding the revenues, we consider government

Chapter 3: Assessing the trade-offs between battery capacity and public charging infrastructure of electric vehicles: urban and rural French case studies for daily needs

subsidies the operator receives for installing new charging stations and revenues from the BEV customer per charging event and a subscription fee.

$$EAC_{CPO,j} = - \left( \frac{(1 + r_{CPO})^{T_{CPO}} * r_{CPO}}{(1 + r_{CPO})^{T_{CPO}} - 1} (I_{CP,z} + I_{CPO,Civil\ works,z} + I_{CPO,Installation,z} + I_{CPO,Grid\ connections,z} - c_{CPO,subsidies}) + c_{CPO,O\&M} + c_{CPO,MB} + c_{CPO,com} \right) + \sum_{k=1}^r (c_{CPO,charging,k} + c_{CPO,card,k} - c_{CPO,elec} * YCE_k) \quad (3.5)$$

Where:

- $j$  is the charger
- $z = \begin{cases} 7\ kW \\ 22\ kW \\ 50\ kW \end{cases}$
- $k = 1, \dots, r$  is the BEV that uses the studied charger

Table 3.2 details the parameters of Equation 3.5, and the values are presented in Appendix 3.A.

Table 3.2 Techno-Economic Parameters of  $EAC_{CPO}$

| $EAC_{CPO,j}$                 | Equivalent Annual Cost of a charger 'j'   | [€/Year]   |
|-------------------------------|---|------------|
| $r_{CPO}$                     | Interest rate   | [-]        |
| $T_{CPO}$                     | Lifetime  | [Years]    |
| $I_{CP,z}$                    | CP investment of Type 'z'   | [€]        |
| $I_{CPO,Civil\ works,z}$      | Civil works investment of Type 'z'  | [€]        |
| $I_{CPO,Installation,z}$      | Installation investment of Type 'z'   | [€]        |
| $I_{CPO,Grid\ connections,z}$ | Grid connections investment of Type 'z'   | [€]        |
| $c_{CPO,subsidies,z}$         | Subsidies of Type 'z'   | [€]        |
| $c_{CPO,O\&M,z}$              | Operation and Maintenance cost of Type 'z'  | [€]        |
| $c_{CPO,MB}$                  | Metering and billing cost   | [€]        |
| $c_{CPO,com}$                 | Communication cost  | [€]        |
| $r$                           | The number of BEV that use one charger  | [-]        |
| $c_{CPO,charging,k}$          | Charging cost for the driver of the vehicle 'k'<br>(= $c_{BEV,charging,k}$ )      | [€]        |
| $c_{CPO,card,k}$              | Subscription fee to access the charging infrastructure 'k'<br>(= $c_{BEV,card}$ ) | [€/Year]   |
| $c_{CPO,elec}$                | Electricity cost for the CPO  | [€/kWh]    |
| $YCE_k$                       | Yearly Charged Energy of BEV 'k'  | [kWh/Year] |

## 4. Data and Techno-Economic Parameters

To determine range needs, we collected the average travelled kilometres for home-work trips per town from (ENTD, 2019), and those of the weekends is 25 km for a Saturday and 20

km for a Sunday (ENTD, 2008). To use realistic data, we chose data from Paris, and the rural village, Ambérieu-en-Bugey. The latter was chosen because it represented a typical village where 30% of the population lives in condominiums, with no ability to install home chargers, and where the majority of the population commutes to work outside the village. 70% of the population of Paris lives in residences non-equipped with private parking, while about 70% of the rural population live in individual houses equipped with private parking (INSEE, 2020a). Furthermore, people living in rural areas rely more on their vehicles than public transportation due to the lack of an extensive transportation services network: 33.5% of urban people - versus 79.5% of rural people - use the vehicle for their daily needs (ENTD, 2020). The vehicle-travelled kilometre per day is 15 km/day for Paris, compared to 70 km/day for Ambérieu-en-Bugey. These “real” kilometres were converted into WLTP autonomy-scale by multiplying them using a factor 0.75 for city trips, 1 for roads, and 2 for highways, since higher energy is required for highway trips than for city trips. The individual-annual kilometre travelled for regular daily trips varies between 5,000-12,000 for Paris and between 35,000-42,500 km/year for rural areas (ENTD, 2019, 2008). Figure 3.2 presents our two case studies.

Regarding cost models, we compare the EAC of a BEV and an ICEV of the same size. Vehicles were divided into three sizes depending on their battery capacity and detailed in Appendix 3.A (Tables 3.5 and 3.6). These parameters include energy consumption (electricity for BEV and fuel for ICEV), vehicle cost (without the battery), operation and maintenance costs, and CO<sub>2</sub> taxes. Our study assumed that vehicle ownership duration is 9.5 years for BEV and ICEV (ACEA, 2019). We consider the price of battery packs as 150 €/kWh (Groupe Renault, 2020) and the price of 1 tonne of CO<sub>2</sub> as € 100 (Fox et al., 2017; Quinet et al., 2009). A € 5,000 governmental subsidy in France is offered to the BEV customer if the battery capacity is less than 50 kWh. This amount decreases to € 3,000 if the battery capacity is between 50 kWh and 70 kWh and is cancelled for large BEVs with 70 kWh and more (French Government, 2020).

The CPO's EAC includes the amortized investments needed for charging infrastructure during the ownership of 15 years. The investment is the sum of the charger price, civil engineering works, installation costs, and grid reinforcement, which are summarised in Table 3.7 of Appendix 3.A. Similarly to the BEV customer, governmental subsidies (ADVENIR project) are offered to CPOs: 40% of the charger price for deploying a slow charger and 1,500€ for normal and fast ones (Advenir, 2020). The annual costs for operations and maintenance are assumed to be 10% of the charger price, communication costs are 100€ per charger, and metering and billing are 188€ per charger (Groupe Alpha et al., 2018). An efficiency factor of

*Chapter 3: Assessing the trade-offs between battery capacity and public charging infrastructure of electric vehicles: urban and rural French case studies for daily needs*

85% is applied to the conversion between the charger and the battery.

The charging/refuelling tariffs are fixed based on the French market. The fuel cost is fixed as 1.518€/liter (French Ministry of Economy and Finance, 2020), and the charging pass costs 5€/BEV/month. Charging tariffs are set as follow: 1 €/hour using a 7 kW charger, € 1.5 for the first hour and 0.2€/minute after the first hour for a 22 kW charger, and € 2 for the access to a 50 kW charger, plus a cost of 0.247€/min (Chargemap, 2020). The industrial electricity bought by the charging operator is 0.18€/kWh (Eurostat, 2020). A maximal interest rate for purchasing a BEV or ICEV is 3%, for the charging infrastructure is 5%.

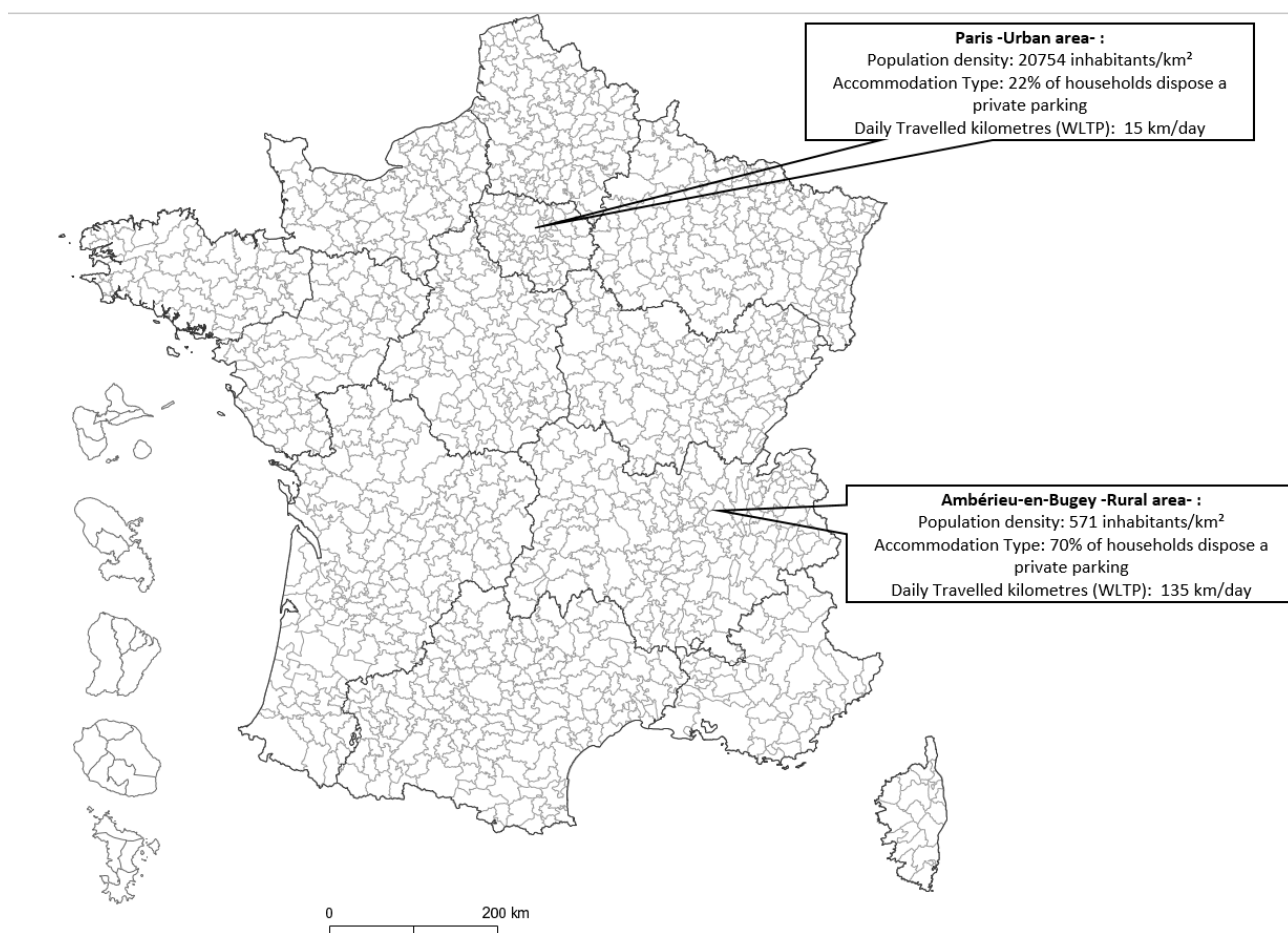

*Figure 3.2 Urban and Rural Case Studies Areas*

## 5. Results

Three steps present the results related to identifying a cost-efficient trade-off between longer BEV ranges and more charging stations. First, we simulate a fleet of BEVs to identify energy needs (Section 5.1). Second, we quantify the number of charging stations required to

respond to these needs, assuming that supply will match demand (Section 5.2). Third, the results compare the investments in both technologies and detail the cost models of the various BEV ecosystem members (Section 5.3).

### 5.1. Individual Driving Profiles

To quantify the BEVs' electric needs, we simulated 12 scenarios of 5,000 identical BEVs per scenario, separately for urban and rural needs, by increasing the battery capacity from 15 kWh to 120 kWh from one scenario to another in steps of 5 kWh. We modelled the individual driving profiles considering socio-technical parameters: daily travelled kilometres (ENTD, 2019, 2008), and electricity consumption per kilometre (Gnann, 2015), which varies with the size of the vehicle. The daily travelled kilometres for “home-work-home” trips on weekdays are on average 15 km<sup>9</sup>/day for urban needs and 135 km<sup>9</sup>/day for rural needs<sup>8</sup>.

Since each type of BEV could only charge using a well-defined charging power, the charging duration of a single charging event increases with battery capacity, contrary to the frequency of events.

### 5.2. Charging Infrastructure Demand

As mentioned earlier in this Chapter, some BEVs are not compatible with fast charging technology. For this reason, as mentioned in Section 3.2., we consider that every BEV size segment will always charge at a maximum of 1C-rate. Figure 3.3 presents how many BEVs an available charger could serve: It shows that the more the charging power, the less the need for charging infrastructure. For the same charging power, however, increasing BEV battery capacities increases the required number of chargers. Indeed, while larger battery BEVs will less frequently stop to charge, it will take more time than smaller battery capacity BEVs to charge (when charging power is held constant). In order to respect the 15 minutes maximum waiting time constraint, the required number of chargers having the same power increases with bigger battery capacities.

Furthermore, since more drivers can install private chargers at home in rural areas than in urban areas, results show that one charger can serve more BEVs in urban areas than in rural ones; thus, fewer deploying needs infrastructure comparing the two areas. Regarding the urban needs, on average, one 7 kW charger can serve up to 18 small-battery BEVs per day, one 22 kW charger up to 46 medium-battery BEVs per day, and one 50 kW charger up to 80 large-

---

<sup>8</sup> Since rural drivers travel higher distances than urban drivers, BEVs with a battery capacity between 15 kWh and 35 kWh were excluded, for the rural case study, due to their limited autonomy.

*Chapter 3: Assessing the trade-offs between battery capacity and public charging infrastructure of electric vehicles: urban and rural French case studies for daily needs*

battery BEVs per day. One 22 kW charger can serve up to 8 medium-battery BEVs per day in rural areas, and one 50 kW charger up to 26 large-battery BEVs per day.

We can conclude that having more BEVs with a bigger battery increases the need for charging infrastructure when holding charger speed constant. However, if we compare different charging powers' results, it is clear that the need for charging infrastructure becomes lower for a 50 kW charger than 22 kW and 7kW chargers. Currently, deploying charging infrastructure is based on technical factors and neglects some psychological factors such as range anxiety due to the limited data. Indeed, range anxiety, which will lead to higher charging frequency towards the drivers, could require a higher number of chargers.

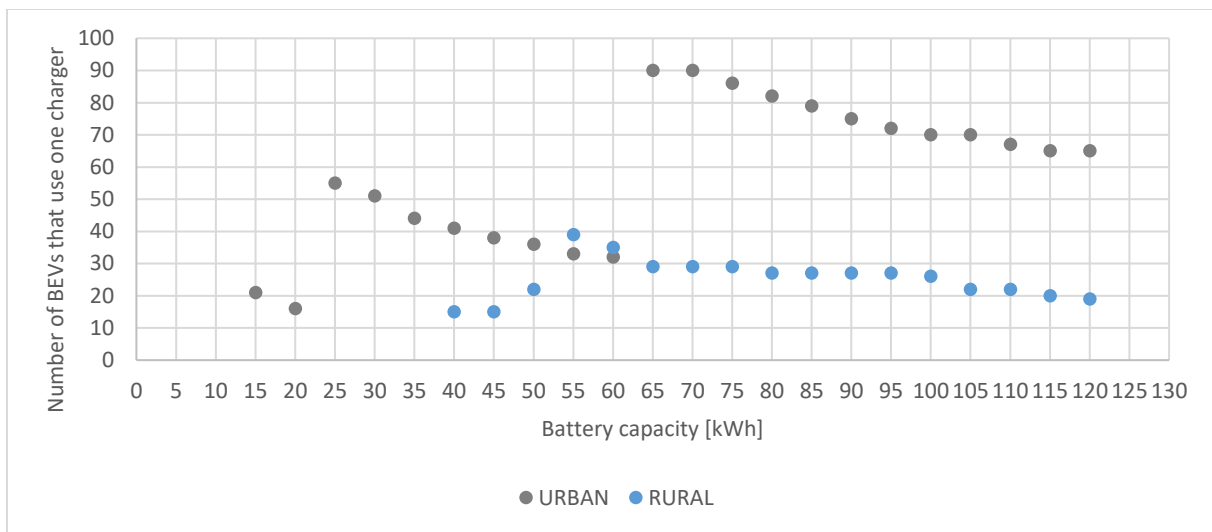

*Figure 3.3 Number of BEVs That Use One Charger as a Function of Battery Capacity*

### 5.3.Costs Models

In order to understand the cost implications of the trade-off between bigger batteries and charging stations, we compare their respective investments for the BEV customer on the one hand, and the CPO on the other hand, and seek to determine the most cost-efficient solution for both parties: Pareto optimum.

#### 5.3.1. The Cost Model of the BEV Customer

From the BEV customer's perspective, we first analyze the difference between the EAC of purchasing a BEV and an ICEV for the customer:  $\Delta EAC$ . A negative  $\Delta EAC$  indicates that a BEV comes with higher costs than an ICEV. Figure 3.4 indicates the average  $\Delta EAC$  and the monthly charging duration for every battery capacity, for both urban and rural case studies.

Regarding the urban needs (Figure 3.4), results show that negative  $\Delta EAC$  is guaranteed for purchasing a BEV with a battery capacity between 15 kWh and 50 kWh. Indeed, purchasing



*Chapter 3: Assessing the trade-offs between battery capacity and public charging infrastructure of electric vehicles: urban and rural French case studies for daily needs*

a 15 kWh BEV is the most cost-efficient for the customer (with the lowest  $\Delta EAC$ : 1120 €/BEV/Year). However, the driver will spend around 10 hours/month to charge his vehicle. For medium-battery BEV,  $\Delta EAC$  has a negative value between 35 kWh and 45 kWh, while the charging duration fluctuates around 5 hours/month. For large-battery BEVs, a 50 kWh vehicle comes with a dual-advantage: Lower cost than an ICEV ( $\Delta EAC=105\text{€/BEV/Year}$ ) and low charging duration (3 hours/month). Purchasing a BEV with a battery capacity of more than 55 kWh is not profitable for the client (negative  $\Delta EAC$ ), even though the charging duration does not exceed 3 hours/month.

For rural needs (Figure 3.4) (and after excluding BEVs with a battery capacity between 15 kWh and 35 kWh due to their limited autonomy), results show that purchasing a 55 kWh vehicle is the most cost-efficient solution for the driver: It comes with the lowest positive  $\Delta EAC$  ( $\Delta EAC=-85\text{€/BEV/Year}$ ) and the lowest charging duration (7hours/month). The BEV choice is highly individual because for some drivers, the autonomy of 40-50 kWh BEV represents a potential risk of blackout during the “home-work-home” trip, depending on the driver’s choice and the usual rural vehicle travelled kilometres. Based on our data, we found a positive  $\Delta EAC$  40-50 kWh BEV ( $\Delta EAC=-500$ ;  $-700\text{€/BEV/Year}$ ), due to the high charging frequency.

To conclude, our results indicate that, for the customer, there is a trade-off between cost and charging duration: small-battery BEVs are the most cost-efficient solution, but they come with a long charging duration. If customers search for an economical solution rather than a luxurious one, purchasing a BEV with a battery capacity between 15 kWh and 50 kWh is cost-efficient for urban needs ( $\Delta EAC$  is positive). A 55 kWh BEV would satisfy drivers' driving needs for rural areas, willing to eliminate the risk of limited autonomy, and comes with the lowest monthly charging duration. Yet, its  $\Delta EAC$  is negative.

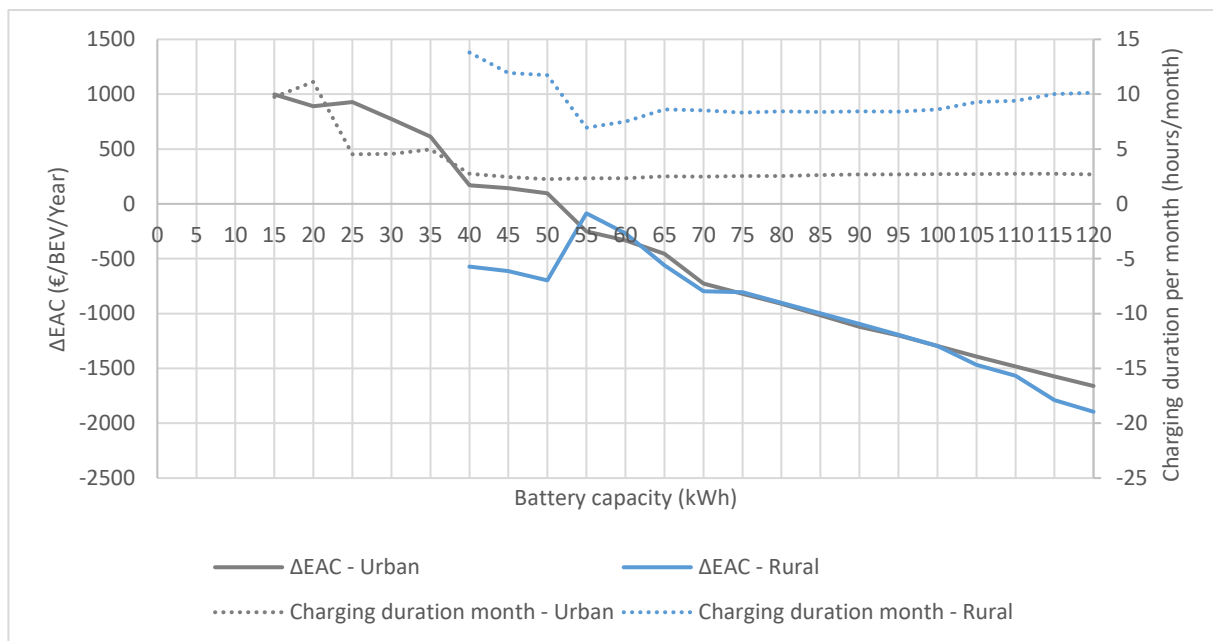

Figure 3.4 The Cost Model ( $\Delta EAC$ ) and Monthly Charging Duration for the BEV Customer (Urban & Rural Needs)

### 5.3.2. The Cost Model of the Charging Point Operator

We calculated the EAC of the whole infrastructure, in both urban and rural areas, regarding the CPO. Results are given in Figure 3.5. As a reminder, we consider that each BEV size is only compatible with one charging power, and charging pricing differs with charging powers (Benchmark of offers is provided in Appendix 3.A Table 3.4). It is assumed that all BEVs' customers purchased a subscription card to access the charging infrastructure.

Regarding urban needs, Figure 3.5 indicates that deploying a slow charging infrastructure is not profitable for the operator due to a high number of required chargers, resulting in higher charging tariffs than 1€/hour. Regarding the 22 kW infrastructure, a fleet of BEVs with a 25 and 30 kWh battery capacity is not profitable for the operator. Since the charging duration does not exceed 1 hour, it is recommended to review the first-hour tariff to avoid positive costs. It becomes profitable for the operator to deploy these chargers for battery capacity between 35 and 45 kWh, charging durations exceeding one hour. These profits increase with bigger battery capacity because of the exceeded minute pricing method. Regarding the fast charging infrastructure, the operator generates profits by deploying 50 kW chargers using real-market tariffs. It is essential to stress the fact that the profits slightly decrease with broader autonomy. Overall, the operator receives profits for a fleet of 35 to 120 kWh BEVs, with a maximum for a 40 kWh BEV, because of two main reasons: The 2-hour charging duration per vehicle and the “per exceeded minute” pricing method. Urban and rural

share the same results.

To sum up, based on our tariffs, a fleet of 45-120 kWh vehicles for urban and rural needs that use 50 kW charging infrastructure generates profits for the operator. These underline that the charging operator could have a profitable business model if the optimal number of chargers is deployed and the correct pricing method and tariffs are used.

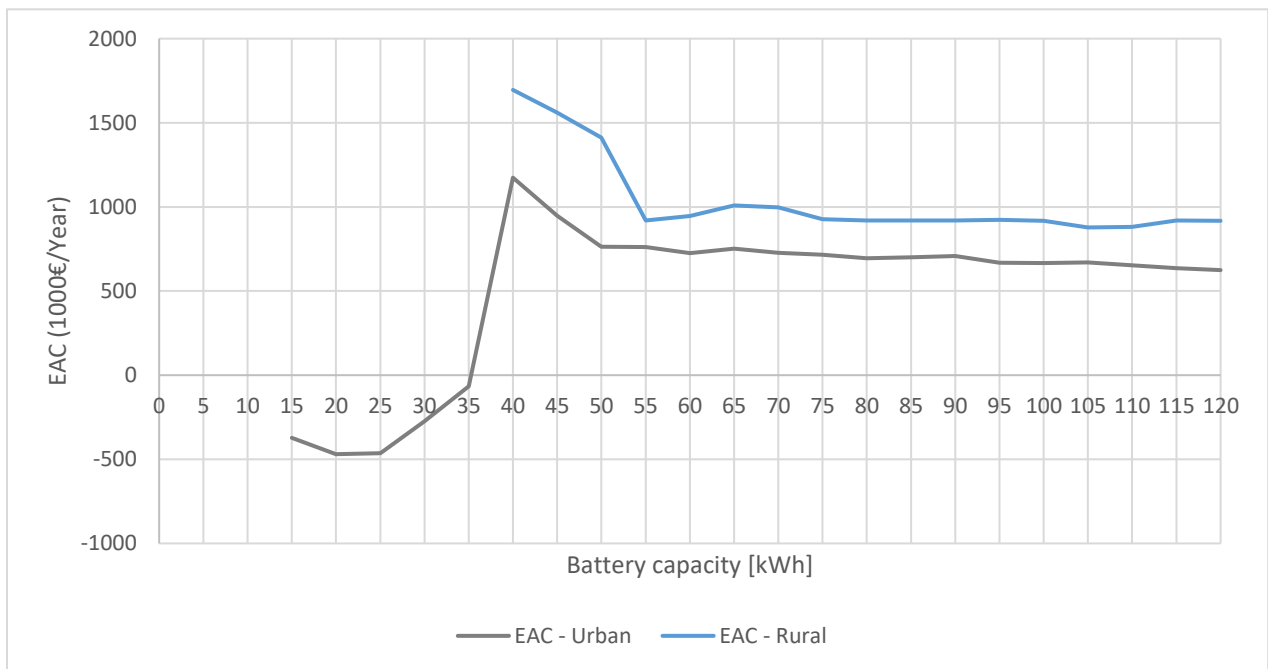

Figure 3.5 The Cost Model of the Charging Point Operator

### 5.3.3. Win-Win Situations

After detailing the cost models of the driver and the charging point operator, we will represent all the solutions found, based on the Pareto fronts, where none of both parties realizes a loss, i.e.  $\Delta EAC_{BEV\ customer} > 0$  and  $EAC_{CPO} > 0$  in Figure 3.6. Different solutions regarding the urban needs present a Pareto front: 40-50 kWh BEV and deploying 50 kW chargers. Similarly, a Pareto optimum solution for the rural case study is: 55 kWh BEV and 50 kW chargers (the driver's lowest costs and the charging operator's highest profits).

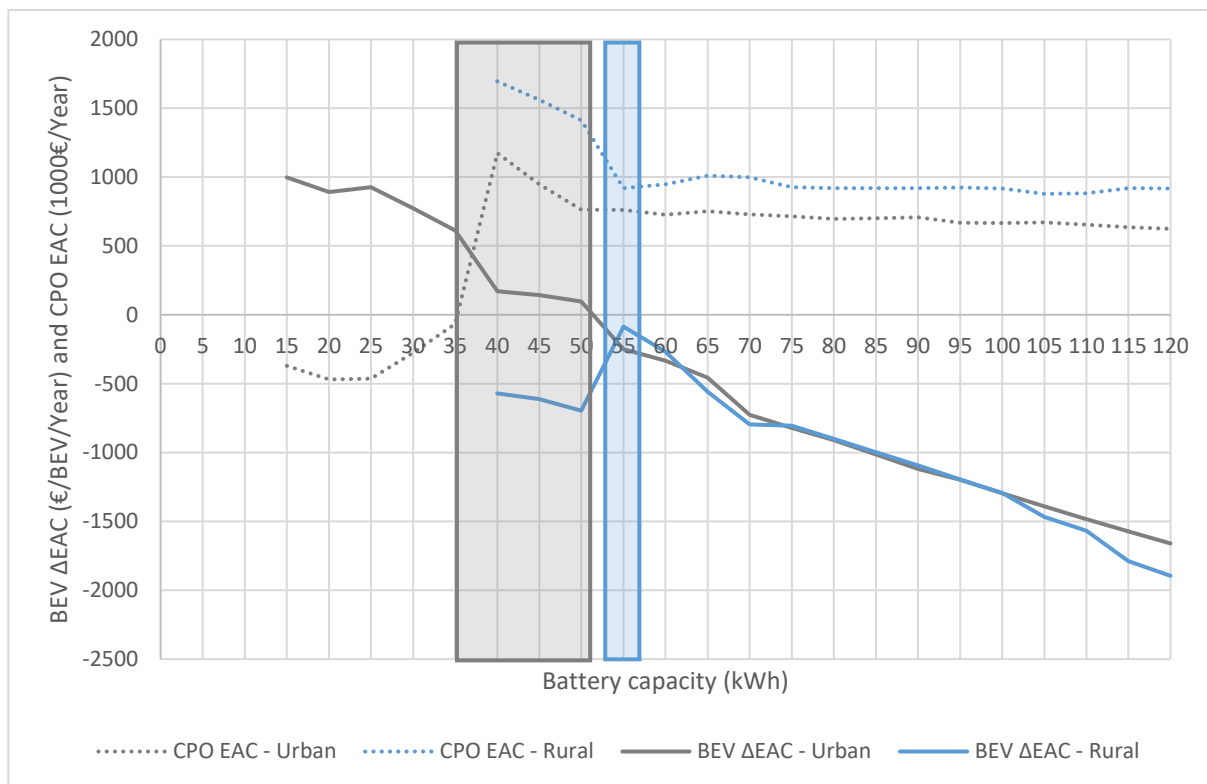

Figure 3.6 Win-Win situations presentation

#### 5.4.Sensitivity Tests

We apply four sensitivity tests to explore how charging behaviour changes and charging pricing methods would affect our results. First, we tested different amounts of purchasing subsidies for BEV owners and instalment subsidies for charging operators. Second, we evaluated the effect of a 50% increase on charging tariffs. Also, we evaluated the effect of mixing the adaptability between chargers and BEV battery size. Finally, we tested different charging tariffs from different operators. Table 3.3 presents a summary of the results of the sensitivity tests.

##### 5.4.1. Changes in Subsidies

###### 5.4.1.1.Changes in BEV Customer Purchasing Subsidies

As a first sensitivity test, we tested the effect of different amounts of subsidies on the cost model of the BEV customer. As mentioned before, we note Scenario 0 the actual subsidies, which depend on the price of the vehicle, and thus, on the battery capacity. We tested the effect of changing the subsidies on the cost model of the client by varying the governmental purchasing subsidies from 0 €/BEV (Scenario 1) to 7000 €/BEV (Scenario 2) for all vehicles.

Results, contained in Figure 3.7, show the effect of varying the amount of purchasing subsidies: The amount of subsidies affects the battery capacity range, where  $\Delta EAC_{BEV\ customer}$

*Chapter 3: Assessing the trade-offs between battery capacity and public charging infrastructure of electric vehicles: urban and rural French case studies for daily needs*

is positive. Changing BEV purchasing subsidies could provide urban drivers with various battery sizes that ensure a negative  $\Delta EAC$ ; contrary to rural drivers. For the urban case study, a negative  $\Delta EAC$  for the customer is guaranteed between 15 kWh and 35 kWh for Scenario 1 (75 kWh for Scenario 2). For the rural case study, a negative  $\Delta EAC_{BEV\ customer}$  for the customer is guaranteed for between 50 kWh and 60 kWh for 7000 €/BEV as purchasing subsidies (Scenario 2).

The Pareto fronts that guarantee win-win situations for both BEV owners and charging operators ( $\Delta EAC_{BEV\ customer} > 0$  and  $EAC_{CPO} > 0$ ) cannot be achieved without subsidies. Therefore, we recommend that public authorities keep (urban drivers), or increase (rural drivers), purchasing subsidies, especially for battery capacities higher than 35 kWh.

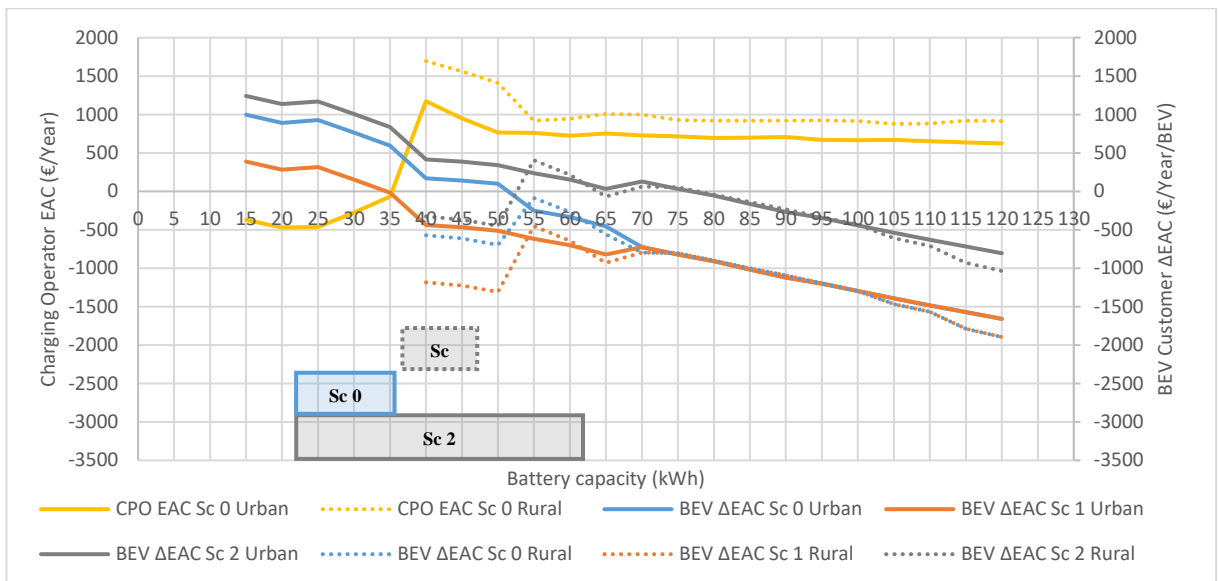

*Figure 3.7 Sensitivity Test 1 Results: BEV Purchasing Subsidies Variation (Sc 0: Base Scenario; Sc 1: 0€/BEV; Sc 2: 7000€/BEV)*

5.4.1.2.Changes in Charger Instalment Subsidies

We also tested the effect of 100% (Scenario 1) and 200% increase (Scenario 2) instalment subsidies increases (Scenario 1), compared to those provided in Table 3.7 (Scenario 0), on the charging operator cost model  $EAC_{CPO}$ . Generally, the results come in-line with our conclusions in Section 5.3.3. For the urban case study, providing more than a 100% increase in incentives could make the installation of 7 kW chargers profitable. Similarly, providing more than a 200% increase in incentives is could make the installation of 22 kW chargers profitable. For the rural case study, there are no modifications regarding the win-win situations. Results are provided in Figure 3.8. Overall, we recommend providing more incentives for charging operators to install 7 and 22 kW chargers rather than fast ones, especially in urban areas.

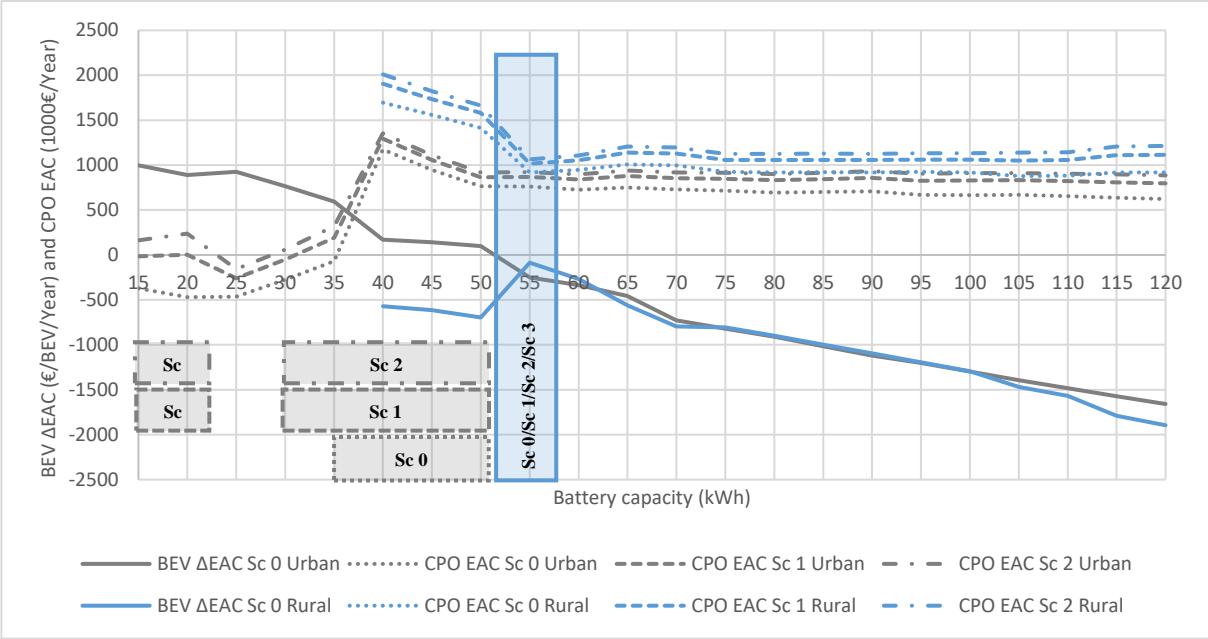

Figure 3.8 Sensitivity Test 1 Results: Charger Instalment Subsidies Variation (Sc 0: Base Scenario; Sc 1: 100% Increase of Subsidies; Sc 2: 200% Increase of Subsidies)

5.4.2. Increasing the Charging Tariffs

We evaluated a 50% charging tariffs' increase influence on the Pareto fronts as a second sensitivity test. Figure 3.9 presents the results for the urban and rural case studies. If the tariffs increase by 50%, we observe that the owners' costs ( $\Delta EAC_{BEV\ customer}$ ) increase by far more than 50%:  $\Delta EAC_{BEV\ customer}$  is highly elastic concerning tariffs for both urban and rural needs. We note that we have a high elasticity when we start using the 50 kW chargers, especially for the battery capacities between 40 kWh and 55 kWh for urban needs and between 55 kWh and 70 kWh for rural needs. Results in Figure 3.9, show that a 50% increase impacts the Pareto fronts: No Pareto fronts are detected for the urban and rural needs, leading to the high impact of the charging tariffs increase on the Model.

Chapter 3: Assessing the trade-offs between battery capacity and public charging infrastructure of electric vehicles: urban and rural French case studies for daily needs

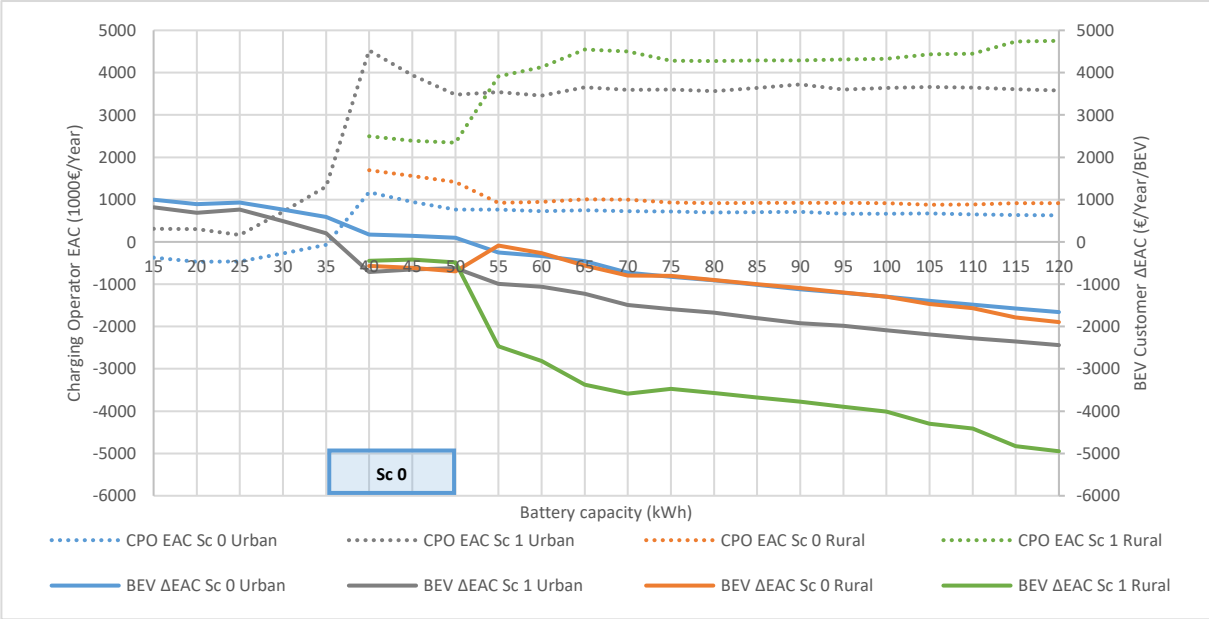

Figure 3.9 Sensitivity Test 2 Results on the Urban Case Study Variation (Sc 0: Base Scenario; Sc 1: 50% Increase Of Charging Tariffs)

5.4.3. Mixing the charging powers and the BEV battery size

In this study, small-battery BEVs use the 7 kW chargers, medium-battery BEVs use 22 kW, and large-battery BEVs use 50kW to charge (Scenario 0). Since it could depend on the drivers’ charging behaviour, we studied three additional scenarios by mixing chargers' usage with the battery sizes and disassociating battery size and charger power. Therefore, we defined three additional scenarios: Scenario 1, when all BEVs charge using 7 kW chargers; Scenario 2 using 22 kW; And Scenario 3, using 50 kW chargers (even though some BEVs are not compatible with fast charging technology). Results show that the customer's benefits and those of the operator are antagonistic but in-line with our conclusions (Figures 3.10-3.11). For urban needs, BEVs, with battery capacity between 35 kWh and 50 kWh, are the most cost-efficient with the deployment of 22 kW or 50 kW chargers. A 55 kWh BEV presents the Pareto optimum solution for the customer and the operator simultaneously regarding the rural needs.

Overall, based on our assumptions, we recommend that charging operators invest in 50 kW chargers rather than other charging powers.

Chapter 3: Assessing the trade-offs between battery capacity and public charging infrastructure of electric vehicles: urban and rural French case studies for daily needs

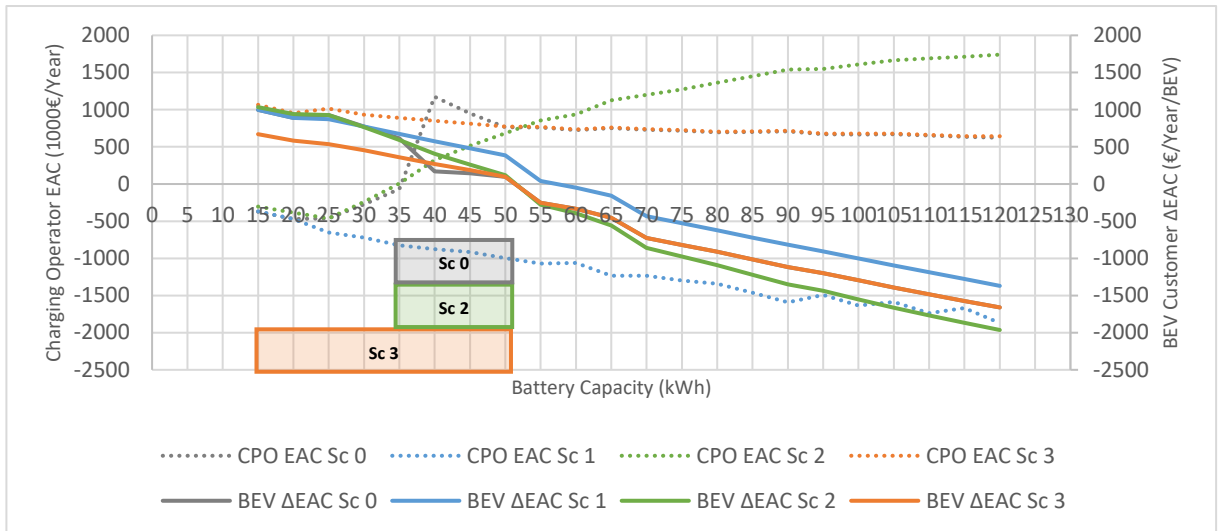

Figure 3.10 Sensitivity Test 3 Results on the Urban Case Study Variation (Sc 0: Base Scenario; Sc 1: 7 kW, Charger; Sc 2: 22 kW Charger; Sc 3: 50 kW Charger)

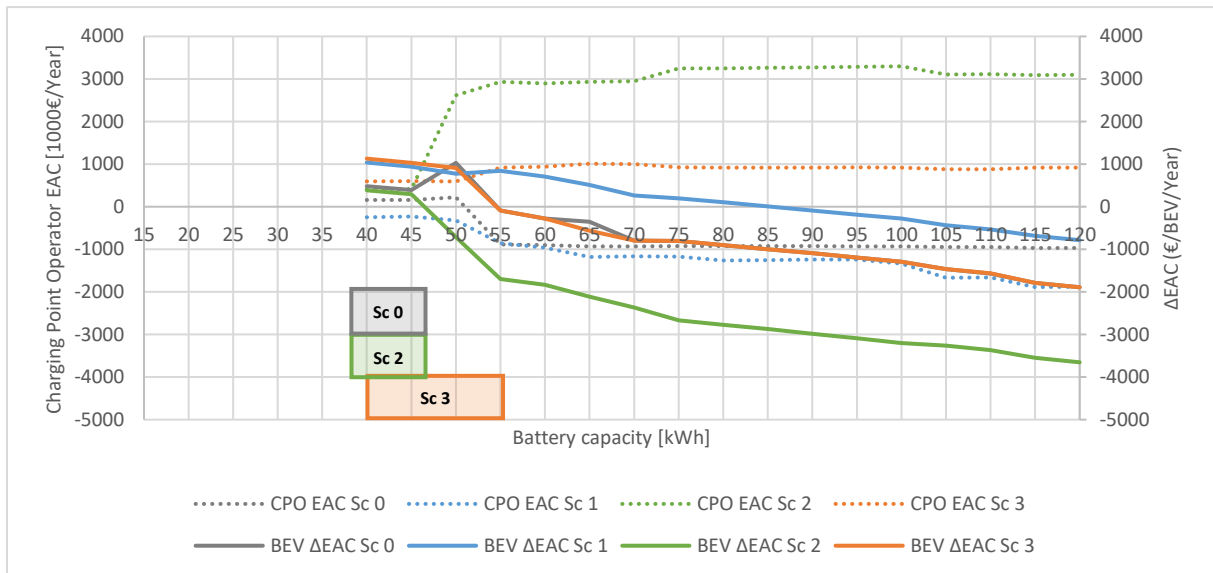

Figure 3.11 Sensitivity Test 3 Results on the Rural Case Study Variation (Sc 0: Base Scenario; Sc 1: 7 kW, Charger; Sc 2: 22 kW Charger; Sc 3: 50 kW Charger)

#### 5.4.4. Changing Charging Tariffs

As a fourth sensitivity test, we applied different charging tariffs than our Baseline Scenario: Indigo for 7 kW chargers, Belib for 22 kW, and Total for 50 kW (Table 3.4 in Appendix 3.A). Figures 3.12 and 3.13 present the results for the urban and rural case studies, respectively. Conclusions come in line with our study conclusions about the Pareto fronts for urban needs. No fronts were detected for rural ones. We recommend revising the 22 kW charging tariffs due to the positive  $EAC_{CPO}$ .



Chapter 3: Assessing the trade-offs between battery capacity and public charging infrastructure of electric vehicles: urban and rural French case studies for daily needs

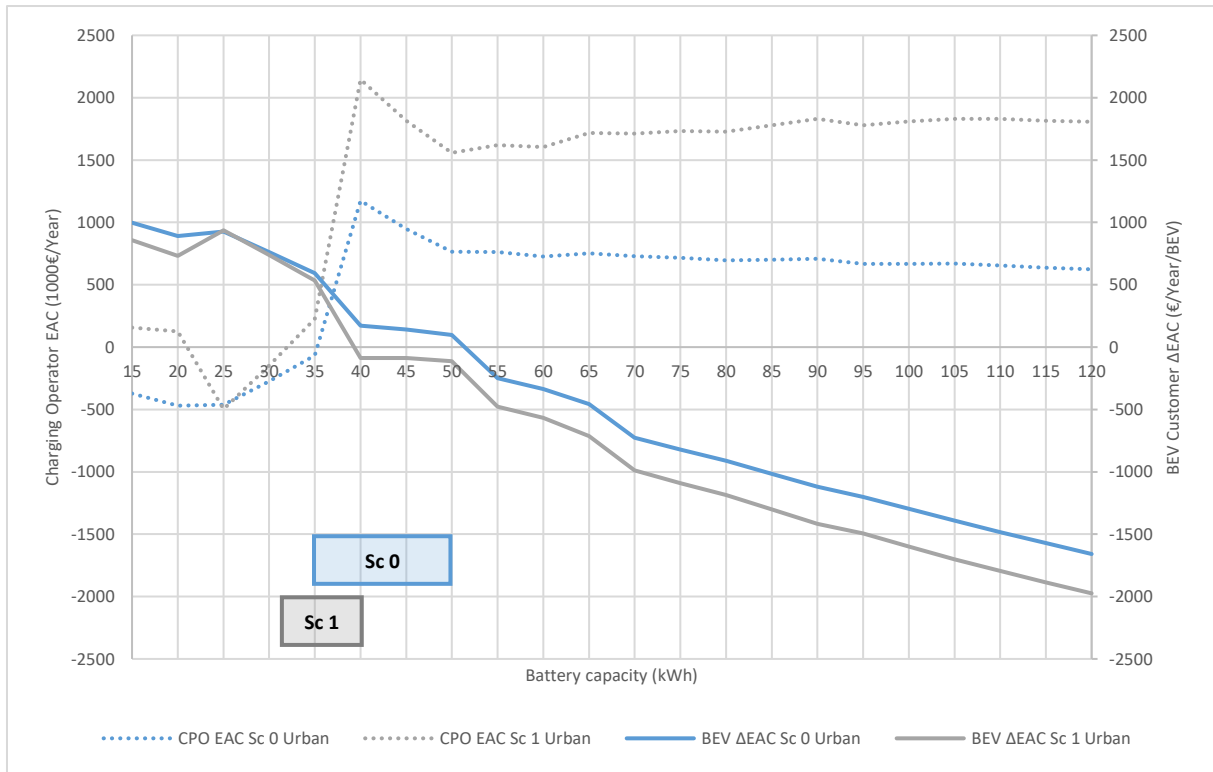

Figure 3.12 Sensitivity Test 4 Results on the Urban Case Study (Sc 0: Base Scenario; Sc 1: Changing Charging Tariffs)

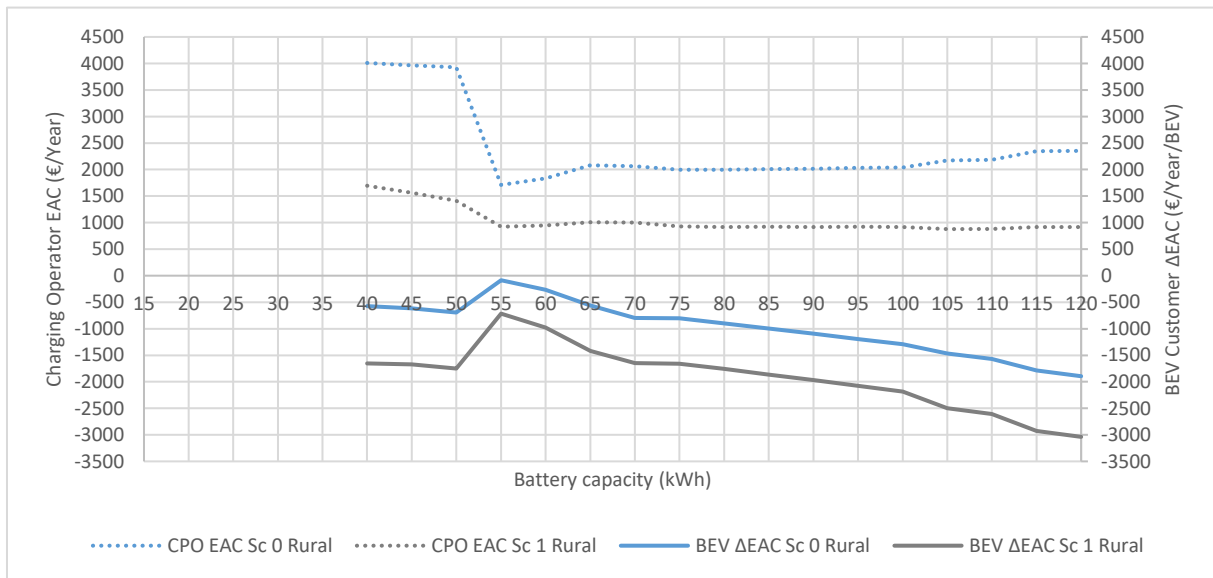

Figure 3.13 Sensitivity Test 4 Results on the Rural Case Study Variation (Sc 0: Base Scenario; Sc 1: Changing Charging Tariffs)

Table 3.3 Summary of sensitivity tests

| Sensitivity Test          | Contents   | Results   | Policy recommendations  |
|---------------------------|--|---|---|
| <b>Sensitivity Test 1</b> | Changes in BEV Customer Purchasing Subsidies from 0€/BEV to 7000€/BEV. | <u>Urban needs:</u> No win-win situations fronts are detected for a subsidy of 0€/BEV. More win-win solutions are detected for higher subsidies.  | <u>For governments/local authorities:</u><br>Urban needs: Maintain and increase the purchasing subsidies for more offers.   |
|                           |  | <u>Rural needs:</u> similar to our results. Yet, a subsidy of 7000€/BEV for 55 kWh and 60 kWh come with a negative $\Delta EAC_{BEV\ customer}$ .   | <u>For governments/local authorities:</u><br>Rural needs: Increase the purchasing subsidies in order to ensure a negative $\Delta EAC_{BEV\ customer}$ , especially for a 55 kWh BEV.                       |
|                           |  | Increasing the charger instalment subsidies by 100% and 200%.   | <u>Urban needs:</u> Win-win situations are achieved for increasing the subsidies by 100% for 7 kW chargers.   |
|                           |  | <u>Rural needs:</u> The conclusions are in-line with our results. Purchasing a 55 kWh BEV and instalment of 50 kW chargers, while keeping the charger instalment subsidies.                                     | <u>For governments/local authorities:</u> Rural needs: No policy recommendation   |
| <b>Sensitivity Test 2</b> | Increasing the Charging Tariffs by 50%.                                | <u>Urban and Rural needs:</u> No win-win situations are detected after the 50% tariffs increase.  | <u>For charging operators:</u> Consider the impact charging tariffs increase on the cost model of the BEV driver.   |
| <b>Sensitivity Test 3</b> | Mixing the charging powers and the BEV battery size.                   | <u>Urban and Rural needs:</u> The utilisation of 50 kW chargers is the most cost-efficient choice for both the BEV driver and the charging operator, among 7 and 22 kW chargers.                                | <u>For charging operators:</u> The instalment of 50 kW chargers would be a benefit for all BEV sizes.<br><u>For governments/local authorities:</u> Consider higher purchasing subsidies for 50 kW chargers. |
| <b>Sensitivity Test 4</b> | Changing Charging Tariffs by considering another existing operator.    | The conclusions are in-line with our results.<br><u>Urban needs:</u> Purchasing a 50 kWh BEV and instalment of 50 kW chargers.<br><u>Rural needs:</u> Purchasing a 55 kWh BEV and instalment of 50 kW chargers. | <u>For charging operators:</u> Revise charging tariffs for only 22 kW chargers where losses are extreme for operators in any tariffs cases.   |

## 6. Conclusion and Policy Recommendations

### 6.1. Conclusion

To reach global ambitions regarding GHG emissions, achieving growth in BEV market share is of paramount importance. Range anxiety, a primary barrier to BEV adoption, could be solved using two interdependent and complementary options: Increasing the battery capacity and/or enlarging the charging network. Both choices, however, come with costs that are either carried by car owners or by charge point operators. This Chapter presents a novel approach to answer the trade-offs involved in addressing range anxiety barriers to EV adoption by calculating the EAC of different battery capacity and recharging infrastructure development scenarios. Here, we addressed customer profiles that tend to be overlooked and may want to become EV owners, known as ‘laggards’: These customers do not have any possibility to charge at-home and are obliged to use the public charging infrastructure and aim to purchase a BEV for daily use, but not for holidays, such as those with an EV as a second car. Since the BEV choice is highly dependent on individual situations, we applied our study to two French areas: An urban metropole (Paris), and a small rural village (Ambérieux-en-Bugey). We modelled public infrastructure usage by simulating 5,000 privately-purchased BEVs, taking into account their daily driving needs for urban and rural scenarios separately (without long-distance trips, e.g. vacations), while aiming to minimize the BEV cost. We also categorized the vehicles into three parts based on their battery capacity, taking into account the BEV-charger adaptability (so-called c-rate): small-battery BEVs that can only charge using 7 kW chargers, medium-battery EVs using 22 kW chargers, and large-battery EVs that can connect to 50 kW fast chargers. This Model could be applied to different territories by changing the values of these parameters. However, it does not deliver a geo-spatial allocation of charging infrastructure since that was not the main scope of this Chapter.

Our analyses showed that bigger batteries come with a significant additional cost, both in terms of car cost and recharging infrastructure costs. In our study, the operator proposes specific charging tariffs and pricing methods for each vehicle size. Our outcomes demonstrate that the battery capacity and CPs are correlated since the charger usage depends on the battery size.

After detailing and comparing the different cost models of the BEV ecosystem parties, the analyses for urban needs showed that 40 kWh to 50 kWh BEVs with 50 kW chargers are cost-efficient based on the Pareto front. The used pricing method is fixed pricing one: A fee for access tariff per minute charged for 50 kW chargers. Similarly, the most cost-efficient solution for rural needs is a 55 kWh BEV with 50 kW chargers using a fixed pricing method: A fee for

access tariff per minute charged. Yet, the choice is highly individual, especially for rural needs, where more driving range could be needed.

Although our Model's design presents a dual analysis for both parties (i.e. BEV driver, and the charging infrastructure operator), it has some limitations due to several assumptions related to driving and charging behaviours due to the lack of data and parameters calibration choices. Therefore, we applied several sensitivity tests to measure the effect of different scenarios variations on the results, by (i) testing the different amounts of purchasing subsidies for BEV owners and instalment subsidies for charging operators, (ii) evaluating the effect of a 50% increase on charging tariffs, (iii) evaluating mixing the adaptability between chargers and BEV battery size, and (iv) testing different charging tariffs from different charging operators.

In future work, the assumption of driving and charging behaviour should be considered, because the driver could change their attitudes in terms of additional trips, such as home-school travels, or other activity centres, malls, where semi-public charging stations could be available. For this reason, the arrival rate to the charging stations may change, causing a different number of chargers. When simulating BEV profiles, we neglected comfort parameters such as heating, cooling, lights, radio, and data that may increase BEVs' energy demand. Besides driving behaviour, some hypotheses about the operator's cost model are not considered, such as avoiding grid expansion costs through smart charging or variations in land prices. Overall, it is vital to use real-world data that reflect BEV drivers' driving and charging behaviours, such as trip mileage, arrival rates, and actual charging durations. Finally, based on these real-data, charging tariffs and pricing methods should be revised, taking into account an oligopolistic market where charging operators are slowly emerging.

## **6.2. Policy Recommendations**

Based on our analysis results, this Chapter provides policy recommendations for the BEV ecosystem members: the automotive industry, the charging operator, and government or public authorities. First, our results offer insights into how car manufacturers can consider various models for different customer categories, especially those willing to limit their BEV investment, and have no home-charging availability. More 40-50 kWh BEVs should interest customers more in urban areas, while a minimum of 55 kWh BEVs should be more interesting in rural areas. These sizes present a dual solution for the drivers: Limited investments and comfort costs, i.e. reasonable monthly charging durations.

Second, charging operators should consider deploying more 50 kW chargers for urban and rural areas, ensuring the operator's profitability and the BEV driver (in terms of expenses

*Chapter 3: Assessing the trade-offs between battery capacity and public charging infrastructure of electric vehicles: urban and rural French case studies for daily needs*

and comfort cost –i.e. charging duration). Also, we recommend operators consider the impact of charging tariffs increases on the BEV driver's cost model and revise the charging tariffs of 22 kW chargers.

Finally, it is recommended to keep or increase BEV purchasing subsidies for urban areas and increase these subsidies for rural areas. Also, we suggest revising charger instalment subsidies, as 50 kW chargers come with high investment.

## References

- ACEA, 2019. ACEA Report Vehicles in use-Europe 2019 [WWW Document]. URL [https://www.acea.be/uploads/publications/ACEA\\_Report\\_Vehicles\\_in\\_use-Europe\\_2019.pdf](https://www.acea.be/uploads/publications/ACEA_Report_Vehicles_in_use-Europe_2019.pdf) (accessed 10.13.20).
- Advenir, project, 2020. ADVENIR | Primes CEE pour points de recharge des véhicules électriques [WWW Document]. ADVENIR. URL <https://advenir.mobi/> (accessed 10.26.20).
- Alhazmi, Y.A., Mostafa, H.A., Salama, M.M.A., 2017. Optimal allocation for electric vehicle charging stations using Trip Success Ratio. *Int. J. Electr. Power Energy Syst.* 91, 101–116. <https://doi.org/10.1016/j.ijepes.2017.03.009>
- Alizécharge, 2020. Alizé Charge - Bornes de recharge pour voitures électriques [WWW Document]. URL <https://alizecharge.com/fr/> (accessed 10.27.20).
- Amjad, M., Ahmad, A., Rehmani, M.H., Umer, T., 2018. A review of EVs charging: From the perspective of energy optimization, optimization approaches, and charging techniques. *Transp. Res. Part Transp. Environ.* 62, 386–417. <https://doi.org/10.1016/j.trd.2018.03.006>
- Berkeley, N., Bailey, D., Jones, A., Jarvis, D., 2017. Assessing the transition towards Battery Electric Vehicles: A Multi-Level Perspective on drivers of, and barriers to, take up. *Transp. Res. Part Policy Pract.* 106, 320–332. <https://doi.org/10.1016/j.tra.2017.10.004>
- Bhat, U.N., 2015. *An Introduction to Queueing Theory: Modeling and Analysis in Applications*, 2nd ed, Statistics for Industry and Technology. Birkhäuser Basel. <https://doi.org/10.1007/978-0-8176-8421-1>
- Biresselioglu, M.E., Demirbag Kaplan, M., Yilmaz, B.K., 2018. Electric mobility in Europe: A comprehensive review of motivators and barriers in decision making processes. *Transp. Res. Part Policy Pract.* 109, 1–13. <https://doi.org/10.1016/j.tra.2018.01.017>
- Carbone4, 2018. La France amorce le virage vers le véhicule électrique [WWW Document]. URL <http://www.carbone4.com/wp-content/uploads/2018/09/Publication-Carbone-4-Mobilite-electrique.pdf> (accessed 10.26.20).
- chargemap, 2020. Chargemap - bornes de recharge pour voitures électriques [WWW Document]. URL <https://fr.chargemap.com/> (accessed 10.26.20).
- Cox, B., Bauer, C., Mendoza Beltran, A., van Vuuren, D.P., Mutel, C.L., 2020. Life cycle environmental and cost comparison of current and future passenger cars under different energy scenarios. *Appl. Energy* 269, 115021. <https://doi.org/10.1016/j.apenergy.2020.115021>
- Duru, K.K., Karra, C., Venkatachalam, P., Betha, S.A., Madhavan, A.A., Kalluri, S., 2021. Critical Insights Into Fast Charging Techniques for Lithium-Ion Batteries in Electric Vehicles. *IEEE Trans. Device Mater. Reliab.* 21, 137–152. <https://doi.org/10.1109/TDMR.2021.3051840>
- EC, 2013. Corri-Door Project [WWW Document]. URL [https://ec.europa.eu/inea/sites/inea/files/download/project\\_fiches/multi\\_country/fichenew\\_2013eu92055s\\_final\\_1.pdf](https://ec.europa.eu/inea/sites/inea/files/download/project_fiches/multi_country/fichenew_2013eu92055s_final_1.pdf) (accessed 2.18.21).
- Electric Vehicle Database, 2021. EV Database [WWW Document]. EV Database. URL <https://ev-database.org/> (accessed 1.19.21).
- ENTD, 2020. Comment les Français se déplacent-ils en 2019 ? Résultats de l'enquête mobilité des personnes [WWW Document]. Données Études Stat. Pour Chang. Clim. Lénergie Environ. Logement Transp. URL <https://www.statistiques.developpement-durable.gouv.fr/comment-les-francais-se-deplacent-ils-en-2019-resultats-de-lenquete-mobilite-des-personnes> (accessed 3.26.21).
- ENTD, 2019. Enquête sur la mobilité des personnes 2018-2019 | Données et études statistiques [WWW Document]. URL <https://www.statistiques.developpement-durable.gouv.fr/enquete-sur-la-mobilite-des-personnes-2018-2019> (accessed 7.28.20).
- ENTD, 2008. Présentation statistique – Enquête nationale transports et déplacements 2007/2008 | Insee [WWW Document]. URL <https://www.insee.fr/fr/metadonnees/source/operation/s1367/presentation> (accessed 10.22.20).
- Eurostat, 2020. Statistiques sur le prix de l'énergie - Statistics Explained [WWW Document]. URL [https://ec.europa.eu/eurostat/statistics-explained/index.php?title=Energy\\_price\\_statistics/fr&oldid=291900](https://ec.europa.eu/eurostat/statistics-explained/index.php?title=Energy_price_statistics/fr&oldid=291900) (accessed 10.13.20).

*Chapter 3: Assessing the trade-offs between battery capacity and public charging infrastructure of electric vehicles: urban and rural French case studies for daily needs*

- Fox, J., Axsen, J., Jaccard, M., 2017. Picking Winners: Modelling the Costs of Technology-specific Climate Policy in the U.S. Passenger Vehicle Sector. *Ecol. Econ.* 137, 133–147. <https://doi.org/10.1016/j.ecolecon.2017.03.002>
- French Government, 2020. Bonus écologique pour un véhicule électrique ou hybride (voiture, vélo...) [WWW Document]. URL <https://www.service-public.fr/particuliers/vosdroits/F34014> (accessed 10.26.20).
- French Ministry of Ecological Transition, 2020. Données sur les immatriculations des véhicules [WWW Document]. Données Études Stat. Pour Chang. Clim. Lénergie Environ. Logement Transp. URL <https://www.statistiques.developpement-durable.gouv.fr/donnees-sur-les-immatriculations-des-vehicules> (accessed 1.12.21).
- French Ministry of Economy and Finance, 2020. Données publiques [WWW Document]. URL <https://www.prix-carburants.gouv.fr/rubrique/opendata/> (accessed 7.27.20).
- French Property, 2020. French car and vehicle carte grise registration taxes [WWW Document]. Fr.-Prop. URL <https://www.french-property.com/guides/france/driving-in-france/vehicule-registration-taxes> (accessed 12.9.20).
- Funke, S.A., Plötz, P., Wietschel, M., 2019. Invest in fast-charging infrastructure or in longer battery ranges? A cost-efficiency comparison for Germany. *Appl. Energy* 235, 888–899. <https://doi.org/10.1016/j.apenergy.2018.10.134>
- Gnann, T., 2015. Market diffusion of plug-in electric vehicles and their charging infrastructure, Book series “Innovation potentials.” Fraunhofer-Verl, Stuttgart.
- Gnann, T., Funke, S., Jakobsson, N., Plötz, P., Sprei, F., Bennehag, A., 2018. Fast charging infrastructure for electric vehicles: Today’s situation and future needs. *Transp. Res. Part Transp. Environ.* 62, 314–329. <https://doi.org/10.1016/j.trd.2018.03.004>
- Greene, D.L., Kontou, E., Borlaug, B., Brooker, A., Muratori, M., 2020. Public charging infrastructure for plug-in electric vehicles: What is it worth? *Transp. Res. Part Transp. Environ.* 78, 102182. <https://doi.org/10.1016/j.trd.2019.11.011>
- Groupe Alpha, INTERGROS (France), France, Direction générale des entreprises (2014-....), 2018. L’impact des mutations technologiques et de la digitalisation sur le modèle économique du commerce de gros. Direction générale des entreprises, Paris.
- Groupe Renault, 2020. Le prix d’une batterie de voiture électrique [WWW Document]. Easy Electr. Life. URL <https://easyelectriclelife.groupe.renault.com/fr/au-quotidien/recharge/quel-est-le-prix-dune-batterie-de-voiture-electrique/> (accessed 12.5.20).
- Huguet, T., Stéphane, P., 2019. Les scénarios technologiques permettant ’atteindre l’objectif d’un arrêt de la commercialisation des véhicules hermiques en 2040.
- IEA, 2019. Global Electric Vehicle Outlook 2019 [WWW Document]. IEA. URL <https://www.iea.org/reports/global-ev-outlook-2019> (accessed 6.17.20).
- INSEE, 2020a. Définition - Espace rural / Espace à dominante rurale / Espace à dominante rurale | Insee [WWW Document]. URL <https://www.insee.fr/fr/metadonnees/definition/c1034> (accessed 2.16.21).
- INSEE, 2020b. Estimation de la population au 1<sup>er</sup> janvier 2020 | Insee [WWW Document]. URL <https://www.insee.fr/fr/statistiques/1893198> (accessed 7.28.20).
- Ionity, 2021. IONITY EU [WWW Document]. URL <https://ionity.eu/> (accessed 2.20.21).
- IPCC, 2018. Allen, M.R., O.P. Dube, W. Solecki, F. Aragón-Durand, W. Cramer, S. Humphreys, M. Kainuma, J. Kala, N. Mahowald, Y. Mulugetta, R. Perez, M. Wairiu, and K. Zickfeld, 2018: Framing and Context. In: *Global Warming of 1.5°C. An IPCC Special Report on the impacts of global warming of 1.5°C above pre-industrial levels and related global greenhouse gas emission pathways, in the context of strengthening the global response to the threat of climate change, sustainable development, and efforts to eradicate poverty* [Masson-Delmotte, V., P. Zhai, H.-O. Pörtner, D. Roberts, J. Skea, P.R. Shukla, A. Pirani, W. Moufouma-Okia, C. Péan, R. Pidcock, S. Connors, J.B.R. Matthews, Y. Chen, X. Zhou, M.I. Gomis, E. Lonnoy, T. Maycock, M. Tignor, and T. Waterfield (eds.)]. In Press.
- Jabbari, P., Mackenzie, D., 2017. EV Everywhere or EV Anytime? Co-locating Multiple DC Fast Chargers to Improve Both Operator Cost and Access Reliability.
- Kley, F., Lerch, C., Dallinger, D., 2011. New business models for electric cars—A holistic approach. *Energy Policy* 39, 3392–3403. <https://doi.org/10.1016/j.enpol.2011.03.036>

*Chapter 3: Assessing the trade-offs between battery capacity and public charging infrastructure of electric vehicles: urban and rural French case studies for daily needs*

- Madina, C., Zamora, I., Zabala, E., 2016. Methodology for assessing electric vehicle charging infrastructure business models. *Energy Policy* 89, 284–293. <https://doi.org/10.1016/j.enpol.2015.12.007>
- Meinrenken, C.J., Shou, Z., Di, X., 2020. Using GPS-data to determine optimum electric vehicle ranges: A Michigan case study. *Transp. Res. Part Transp. Environ.* 78, 102203. <https://doi.org/10.1016/j.trd.2019.102203>
- Mies, J., Helmus, J., van den Hoed, R., 2018. Estimating the Charging Profile of Individual Charge Sessions of Electric Vehicles in The Netherlands. *World Electr. Veh. J.* 9, 17. <https://doi.org/10.3390/wevj9020017>
- Ministry of Ecological Transition, 2020. Objectif 100 000 bornes : tous mobilisés pour accélérer le virage du véhicule électrique [WWW Document]. Ministère Transit. Écologique. URL <https://www.ecologie.gouv.fr/objectif-100-000-bornes-tous-mobilises-accelerer-virage-du-vehicule-electrique> (accessed 3.24.21).
- Mock, P., 2019. CO2 emission standards for passenger cars and light-commercial vehicles in the European Union | International Council on Clean Transportation.
- Neubauer, J., Wood, E., 2014. Thru-life impacts of driver aggression, climate, cabin thermal management, and battery thermal management on battery electric vehicle utility. *J. Power Sources* 259, 262–275. <https://doi.org/10.1016/j.jpowsour.2014.02.083>
- Pagany, R., Camargo, L.R., Dorner, W., 2019. A review of spatial localization methodologies for the electric vehicle charging infrastructure. *Int. J. Sustain. Transp.* 13, 433–449. <https://doi.org/10.1080/15568318.2018.1481243>
- Pearre, N.S., Kempton, W., Guensler, R.L., Elango, V.V., 2011. Electric vehicles: How much range is required for a day's driving? *Transp. Res. Part C Emerg. Technol.* 19, 1171–1184. <https://doi.org/10.1016/j.trc.2010.12.010>
- Plötz, P., Gnann, T., Wietschel, M., 2014. Modelling market diffusion of electric vehicles with real world driving data — Part I: Model structure and validation. *Ecol. Econ.* 107, 411–421. <https://doi.org/10.1016/j.ecolecon.2014.09.021>
- Quinet, A., Baumstark, L., Centre d'analyse stratégique (France), 2009. La valeur tutélaire du carbone. Documentation française, Paris.
- Sathaye, N., Kelley, S., 2013. An approach for the optimal planning of electric vehicle infrastructure for highway corridors. *Transp. Res. Part E Logist. Transp. Rev.* 59, 15–33. <https://doi.org/10.1016/j.tre.2013.08.003>
- Service Public, 2020. Bonus écologique et prime à la conversion : ce qui change [WWW Document]. URL <https://www.service-public.fr/particuliers/actualites/A14391> (accessed 2.18.21).
- Shareef, H., Islam, Md.M., Mohamed, A., 2016. A review of the stage-of-the-art charging technologies, placement methodologies, and impacts of electric vehicles. *Renew. Sustain. Energy Rev.* 64, 403–420. <https://doi.org/10.1016/j.rser.2016.06.033>
- Shen, Z.-J.M., Feng, B., Mao, C., Ran, L., 2019. Optimization models for electric vehicle service operations: A literature review. *Transp. Res. Part B Methodol.* 128, 462–477. <https://doi.org/10.1016/j.trb.2019.08.006>
- Van Mierlo, J., Messagie, M., Rangaraju, S., 2017. Comparative environmental assessment of alternative fueled vehicles using a life cycle assessment. *Transp. Res. Procedia, World Conference on Transport Research - WCTR 2016 Shanghai. 10-15 July 2016* 25, 3435–3445. <https://doi.org/10.1016/j.trpro.2017.05.244>
- Waldmann, T., Hogg, B.-I., Wohlfahrt-Mehrens, M., 2018. Li plating as unwanted side reaction in commercial Li-ion cells – A review. *J. Power Sources* 384, 107–124. <https://doi.org/10.1016/j.jpowsour.2018.02.063>
- Wang, Y.-W., Wang, C.-R., 2010. Locating passenger vehicle refueling stations. *Transp. Res. Part E Logist. Transp. Rev.* 46, 791–801. <https://doi.org/10.1016/j.tre.2009.12.001>
- Weiss, C., Chlond, B., Heilig, M., Vortisch, P., 2014. Capturing the Usage of the German Car Fleet for a One Year Period to Evaluate the Suitability of Battery Electric Vehicles – A Model based Approach. *Transp. Res. Procedia, Planning for the future of transport: challenges, methods, analysis and impacts - 41st European Transport Conference Selected Proceedings* 1, 133–141. <https://doi.org/10.1016/j.trpro.2014.07.014>



*Chapter 3: Assessing the trade-offs between battery capacity and public charging infrastructure of electric vehicles: urban and rural French case studies for daily needs*

- Wiederer and Philip, 2010. Wiederer, A., Philip, R., 2010. Policy options for electric vehicle charging infrastructure in C40 cities. Transportation Clinton Climate Initiative. [WWW Document]. URL <https://www.innovations.harvard.edu/policy-options-electric-vehicle-charging-infrastructure-c40-cities> (accessed 4.20.20).
- Wood, E., Neubauer, J., Burton, E., 2015. Quantifying the Effect of Fast Charger Deployments on Electric Vehicle Utility and Travel Patterns via Advanced Simulation: Preprint (No. NREL/CP-5400-63423). National Renewable Energy Lab. (NREL), Golden, CO (United States). <https://doi.org/10.4271/2015-01-1687>
- Yang, J., Dong, J., Hu, L., 2017. A data-driven optimization-based approach for siting and sizing of electric taxi charging stations. *Transp. Res. Part C Emerg. Technol.* 77, 462–477. <https://doi.org/10.1016/j.trc.2017.02.014>
- Yong, J.Y., Ramachandaramurthy, V.K., Tan, K.M., Mithulananthan, N., 2015. A review on the state-of-the-art technologies of electric vehicle, its impacts and prospects. *Renew. Sustain. Energy Rev.* 49, 365–385. <https://doi.org/10.1016/j.rser.2015.04.130>
- Zhang, L., Brown, T., Samuelsen, S., 2013. Evaluation of charging infrastructure requirements and operating costs for plug-in electric vehicles. *J. Power Sources* 240, 515–524. <https://doi.org/10.1016/j.jpowsour.2013.04.048>
- Zhou, Y., Wen, R., Wang, H., Cai, H., 2020. Optimal battery electric vehicles range: A study considering heterogeneous travel patterns, charging behaviors, and access to charging infrastructure. *Energy* 197, 116945. <https://doi.org/10.1016/j.energy.2020.116945>

## Appendix 3.A Techno-Economic Parameters of the Cost Models

Table 3.4 Charging Tariffs of Different Operators

|                                 | Access fee       | P = 7 kW                       | P = 22 kW   | P = 50 kW                               | Availability on the market | Source                         |
|---------------------------------|------------------|--------------------------------|---|---|----------------------------|--------------------------------|
| <b>Belib</b>                    |                  | 1 €/hour *                     | 0,022 €/min<br>0,293 €/min after<br>1 hour                      |   | ++                         | (chargemap, 2020)              |
| <b>Indigo</b>                   |                  | 0,036 €/min                    | 0,036 €/min   |   | +                          |                                |
| <b>Virta</b>                    |                  |                                | 0,218 €/min   |   | -                          |                                |
| <b>Freshmile</b>                |                  | 0,011 €/min (no<br>access fee) | 1.5€ for the 1 <sup>st</sup><br>hour. 0,2 €/min<br>after 1 hour |   | +                          |                                |
| <b>New motion</b>               |                  | 0,027 €/min                    | 0,053 €/min   |   | +                          |                                |
| <b>EFFIA</b>                    | 4,4 €/event      | 0,587 €/min                    | 0,587 €/min   |   | +                          |                                |
| <b>Izivia</b>                   | 4,396<br>€/event | 0,053 €/min after 1<br>hour    | 0,053 €/min after<br>1 hour                                     |   | +                          |                                |
| <b>Electric 55<br/>charging</b> |                  | 0,026 €/min                    |   |   | -                          |                                |
| <b>Corri-door</b>               | 2 €/event        |                                |   | 0,247 €/min                             | ++                         |                                |
| <b>Seymaborne</b>               | 0,88<br>€/event  | 0,023 €/min                    | 0,068 €/min   |   | -                          |                                |
| <b>Total</b>                    |                  |                                |   | 0,428 €/min                             | +                          |                                |
| <b>ZEborne</b>                  |                  |                                |   | 0,218 €/min                             | -                          |                                |
| <b>Alizé</b>                    |                  |                                | 0,04 €/min  | 3,75 €/20 min<br>After, 0,1875<br>€/min | +                          | (Alizécharge, 2020)            |
| <b>Unknown 1</b>                |                  |                                |   | 5 €/45min                               |                            | (Groupe Alpha et al.,<br>2018) |
| <b>Unknown 2</b>                |                  |                                | 0,06 €/min  |   |                            |                                |
| <b>Unknown 3</b>                |                  |                                |   | 0,7 €/5min                              |                            |                                |

\* Sometimes free from 08:00 pm to 08:00 am

Table 3.5 BEV Techno-Economic Parameters

| Variables           |                                       | Small BEV  | Medium BEV                           | Large BEV                            | Source                         |
|---------------------|---------------------------------------|--|--------------------------------------|--------------------------------------|--------------------------------|
| $P_{Type,i}$        | Charging power [kW]                   | 7 kW   | 22 kW                                | 50 kW                                |                                |
| $\eta$              | Efficiency factor [%]                 |  | 85%                                  |                                      |                                |
| $r_{BEV}$           | Interest rate [%]                     |  | 3%                                   |                                      | (Funke et al., 2019)           |
| $T_{BEV}$           | Lifetime [Years]                      |  | 9.5                                  |                                      | (ACEA, 2019)                   |
| $I_{BEV,veh}$       | Vehicle investment [€]                | 10480  | 17600                                | 30930                                | (Gnann, 2015)                  |
| $c_{batt,i}$        | Battery capacity [kWh]                | Variable   |                                      |                                      |                                |
| $c_{BEV,subsidies}$ | Subsidies [€]                         | 5000€/BEV for $c_{batt} \leq 50$ kWh<br>3000€/BEV for $50 \text{ kWh} \leq c_{batt} \leq 70$ kWh<br>0€/BEV for $c_{batt} > 70$ kWh |                                      |                                      | (French<br>Government, 2020)   |
| $p_{1kWh}$          | Price of 1 kWh [€/kWh]                | 150€/kWh   |                                      |                                      | (Groupe Renault,<br>2020)      |
| $aVKT_i$            | Annual Vehicle Km Travelled [km]      | Depends on every BEV profile   |                                      |                                      | (ENTD, 2019)                   |
| $c_{BEV,charging}$  | Charging fees [€/hour]                | 1€/hour  | 1.5€ for the<br>1st hour<br>0.2€/min | 2€ for the 1st<br>hour<br>0.247€/min | (chargemap, 2020)              |
| $cons_i$            | Electricity consumption [kWh/km]      | 0.164<br>kWh/km  | 0.201<br>kWh/km                      | 0.216<br>kWh/km                      | (Gnann, 2015)                  |
| $c_{BEV,O\&M}$      | Operation and Maintenance cost [€/km] | 0.021€/km  | 0.040€/km                            | 0.062€/km                            | (Gnann, 2015)                  |
| $c_{BEV,card}$      | Card cost [€/year]                    | 5€/month   | 5€/month                             | 5€/month                             | (Wiederer and<br>Philip, 2010) |

Chapter 3: Assessing the trade-offs between battery capacity and public charging infrastructure of electric vehicles: urban and rural French case studies for daily needs

Table 3.6 ICEV Techno-Economic Parameters

| Variables       |                                       | Small ICEV                          | Medium ICEV | Large ICEV | Source                 |
|-----------------|---------------------------------------|-------------------------------------|-------------|------------|------------------------|
| $r_{ICEV}$      | Interest rate [%]                     |                                     | 5%          |            | (Funke et al., 2019)   |
| $T_{ICEV}$      | Lifetime [Years]                      |                                     | 11          |            | (Funke et al., 2019)   |
| $I_{ICEV,veh}$  | Vehicle investment [€]                | 12600                               | 19480       | 32980      | (Gnann, 2015)          |
| $aVKT_i$        | Annual Vehicle Km Travelled [km]      | <i>Depends on every BEV profile</i> |             |            | INSEE surveys          |
| $cons_i$        | Fuel consumption [L/km]               | 0.046 L/km                          | 0.057 L/km  | 0.071 L/km | (Gnann, 2015)          |
| $c_{fuel}$      | Fuel cost [€/L]                       | 1.518 €/L                           |             |            | (Funke et al., 2019)   |
| $c_{ICEV,O\&M}$ | Operation and Maintenance cost [€/km] | 0.018€/km                           | 0.048€/km   | 0.076€/km  | (Gnann, 2015)          |
| $LCA_{ICEV,i}$  | Life Cycle Assessment [tCO2/ICEV]     | 21.15                               | 32.1        | 44.8       | (Carbone4, 2018, p. 4) |
| $p_{CO2}$       | CO2 price [€/tCO2]                    | 100 €/tCO2                          |             |            | (Quinet et al., 2009)  |

Table 3.7 Charging Infrastructure Techno-Economic Parameters

| Variables                   |   | Slow charger                        | Normal charger                    | Fast charger                    | Source                      |
|-----------------------------|---|-------------------------------------|-----------------------------------|---------------------------------|-----------------------------|
|                             | <b>Power of the charger</b>                 | <b>7 kW</b>                         | <b>22 kW</b>                      | <b>50 kW</b>                    |                             |
|                             | <b>Availability</b>                         | <b>On-street</b>                    | <b>On-street</b>                  | <b>On-street parking spaces</b> |                             |
| $r_{CPO}$                   | Interest rate [%]                           |                                     | 5%                                |                                 | (Funke et al., 2019)        |
| $T_{CPO}$                   | Lifetime [Years]                            |                                     | 15                                |                                 | (Funke et al., 2019)        |
| $I_{CPO}$                   | Charging infrastructure investment [€]      | 2500€                               | 4000€                             | 25300€                          | (Groupe Alpha et al., 2018) |
| $I_{CPO,Civil\ works}$      | Civil works investment [€]                  | 1063€                               | 1063€                             | 1553€                           |                             |
| $I_{CPO,Installation}$      | Installation investment [€]                 | 817€                                | 817€                              | 1822€                           |                             |
| $I_{CPO,Grid\ connections}$ | Grid connections investment [€]             | 957€                                | 957€                              | 1611€                           |                             |
| $c_{CPO,subsidies}$         | Subsidies [€]                               | 40% of $I_{CI}$                     | 1500€                             | 1500€                           | (Advenir, 2020)             |
| $c_{CPO,com}$               | Communication cost [€]                      | 100€                                | 100€                              | 100€                            | (Madina et al., 2016)       |
| $c_{CPO,M}$                 | Metering and billing cost [€]               | 188€                                | 188€                              | 188€                            | (Madina et al., 2016)       |
| $c_{CPO,O\&M}$              | Operation and Maintenance cost [€/km]       |                                     | 10% of $I_{CI}$                   |                                 | Literature                  |
| $c_{CPO,elec}$              | Electricity cost for the CSO [€/kWh]        |                                     | 0.18€/kWh                         |                                 | (Eurostat, 2020)            |
| $YCE_i$                     | Yearly Charged Energy of BEV 'j' [kWh]      | <i>Depends on every BEV profile</i> |                                   |                                 | Our study                   |
| $c_{CPO,charging}$          | Electricity cost [€/kWh] Paid by the driver | 1€/hour                             | 1.5€ for the 1st hour<br>0.2€/min | 2€ to access<br>0.247€/min      | (chargemap, 2020)           |
| $c_{CPO,card}$              | Card cost [€/year]                          | 5€/month                            | 5€/month                          | 5€/month                        | (Wiederer and Philip, 2010) |

Excluded charging powers: 3 kW chargers available at-home, >50 kW chargers available on highways

## **Chapter 4: The Influence of Public Charging Infrastructure Deployment and Other Socio-Economic Factors on Electric Vehicle Adoption in France**

Battery Electric Vehicles (BEVs) and Plug-in Hybrid Electric Vehicles (PHEVs) offer a promising choice to replace fossil-fuel dependent Internal Combustion Engine Vehicles (ICEVs) with a low-emission transport solution. Governments, automotive manufacturers, and charging infrastructure operators have deployed market-boosting initiatives to overcome barriers hindering purchasing activity. Yet, their market diffusion is limited due to several barriers. To shed light on the main factors causing this situation, and based on an extensive state-of-the-art, we used an original database and statistically analyzed the influence of 14 socio-demographic, technical, and economic factors on the newly-registered BEV and PHEV markets, separately, in 94 French departments from 2015 to 2019, using mixed-effect regression. We find different sets of covariates to be significantly correlated with BEV and PHEV market shares, respectively, leading to different interpretations regarding the vehicle's technology. The number of available BEV/PHEV models and energy prices are positively associated with BEV and PHEV adoption. While fast, ultrafast charger density and financial incentives boost BEV sales, more slow-and-normal charger density leads to higher PHEV sales. On the contrary, financial incentives for PHEVs, relative to vehicles' prices, do not boost sales and is open for further studies. Based on the results, policy recommendations are considered for the automotive industry, the charging operator, and the local authorities to draw a roadmap for electric mobility transition in France.

**This Chapter was presented at the 2019 European IAEE conference and the 2021 International IAEE conference:**

- Bassem Haidar, Pascal da Costa, Jan Lepoutre, Yannick Perez. Corri-Door Project: Did It Really Boost The French Electric Vehicle Market?. Energy Challenges for the Next Decade, Aug 2019, Ljubljana, Slovenia.
- Bassem Haidar, Maria Teresa Aguilar Rojas. The Influence of Public Charging Infrastructure Deployment and Other Socio-Economic Factors on Electric Vehicle Adoption in France. Energy, COVID, and Climate Change, Jun 2021, Paris, France.

**This Chapter is submitted to Research in Transportation Economics Journal as follows:**

Bassem Haidar, Maria Teresa Aguilar Rojas. The Influence of Public Charging Infrastructure Deployment and Other Socio-Economic Factors on Electric Vehicle Adoption in France.

*Chapter 4: The Influence of Public Charging Infrastructure Deployment and Other Socio-Economic Factors on Electric Vehicle Adoption in France*

## 1. Introduction

Greenhouse gas (GHG) emissions contribute to the climate change phenomenon. France has set the ambitious goal to reduce CO<sub>2</sub> emissions and the dependency on petroleum products by 40% by 2030, with respect to the emissions level in 1990, and ban high-emission vehicles by 2030 (French National Assembly, 2021). Plug-in Electric Vehicles (PEVs) have noteworthy potential to reduce petroleum dependency and GHGs emissions related to the road transportation sector towards global decarbonization (Hainsch et al., 2021). PEVs encompass Battery Electric Vehicles (BEV), which use the electricity stored in the battery as a primary energy source, and Plug-in Hybrid Electric Vehicles (PHEV), which use both fossil fuel and battery as sources of energy. If the electricity is produced using renewable energy sources, the GHG emissions from transportation are significantly lower than fossil-fuel based transport. While this technology's adoption has been rapidly increasing over the last decade, its market share remains restrained by socio-techno-economic barriers (Egbue and Long, 2012). The reasons for the slow uptake of PEVs compared to ICEVs are generally divided into technical (long charging duration, limited BEV range), economic (PEV purchase, electricity, and fuel prices), awareness (client behaviour towards new inventions, charging stations visibility, number of PEV models), and socio-demographic factors (age, education, income, environmentalism, and urbanity degree) (Egbue and Long, 2012; Javid and Nejat, 2017; Sierzchula et al., 2014; Tran et al., 2012). To overcome these obstacles, governments applied national and local, monetary, and non-monetary policies for all the PEV supply chain members (Sykes and Axsen, 2017).

PEVs presented around 4% of France's total vehicle sales until 2020 (French Ministry of Ecological Transition, 2020a). France adopted several laws to reduce fossil-fuel dependencies, such as Provisions of the Energy Transition Law for Green Growth and the Mobility Orientation Law (French Ministry of Ecological Transition, 2021). Increasing fossil-fuel prices, a statute in these laws, proved to be a solution that pushes drivers to switch from ICEVs to PEVs in several countries (S. Li et al., 2017; Plötz et al., 2016). However, it led to the Yellow Vests social movement, pushing the French government to search for other solutions to accelerate the electric mobility transition. Meanwhile, local authorities, such as municipalities at Ile-de-France, Marseille, and Nice, contributed to making EVs more attractive to consumers by offering financial subsidies of a maximum of 5000€ to each driver switching to electric mobility to tax exemption, free parking, and access to bus lanes. Since the lack of charging infrastructure still presents a barrier to growth in the PEV market, as the driver suffers

#### *Chapter 4: The Influence of Public Charging Infrastructure Deployment and Other Socio-Economic Factors on Electric Vehicle Adoption in France*

from range anxiety –the fear of a blackout in the middle of the road– national and local authorities in France boosted the deployment of this infrastructure by both installing more on-street chargers (e.g. Corri-door project (EC, 2013)) and offering up to 50% of the cost of the charger for both private and public usage (e.g. ADVENIR project (Advenir, 2020)). In sum, the French government allocated 100 million euros to finance more than 45,000 new charging points by the end of 2023 (Advenir, 2020).

Investigating the key factors that could boost the BEV and PHEV uptake is crucial to accelerate the French electric mobility transition. Several studies evaluated the influence of socio-techno-economic factors on the PEV purchasing activity using empirical methods, such as Vergis and Chen (2015) in the U.S., Wang et al. (2017) in China, Mersky et al. (2016) in Norway, and Münzel et al. (2019) for a global review. Yet, several factors are still unexplored in the existing literature. First, as the influence of market-booster factors differs significantly between countries due to different consumer behaviours (Münzel et al., 2019), the French local-based case study is still lacking and needs to be considered to help the government attain ambitious national targets. Second, while the study on the influence of government policies has received widespread attention in the literature (Hardman, 2019; Jenn et al., 2018; Münzel et al., 2019), the influence of PEV subsidies is analyzed in the literature as a constant variable. Indeed, an adjustable measure of subsidies concerning the price of the purchased vehicle still lacks, as the vehicle's investment is essential to capture the battery packs cost variation. Third, charging infrastructure proved to be an essential factor in boosting PEV markets (X. Li et al., 2017; Plötz et al., 2016). Still, the literature considered charging infrastructure as one covariate and failed to mention that different charging speeds are available. Therefore, the potential impact of different-power charging infrastructure on BEV/PHEV demand is still missing (Morganti et al., 2016). Fourth, previous studies did not include a variable describing a vehicle's electric range, which could be an essential factor in solving the range anxiety problem, especially for BEV drivers and understanding the customers choice towards different-size vehicles. The novelty of our study will be to: (1) consider a department-level French case, (2) study the influence of different-power charging infrastructure deployment, (2) assess the influence of French department-level subsidies concerning the vehicle's price, (3) evaluate the influence of the vehicle's electric range on PEV adoption. We also contribute to the scarce literature, only considered in (Vergis and Chen, 2015), that suggests BEV and PHEV markets respond to different market shares' boosting strategies by evaluating how the studied factors vary between the two markets.

This Chapter seeks to fill these gaps by assessing the privately-purchased BEV and

PHEV market shares separately, using a mixed-effects regression on a local level in France from 2015 to 2019, taking into account the charging infrastructure deployment of different power speeds and other socio-economic factors. The data of these 14 covariates were gathered from various governmental and press sources and allow us to build an original and recent database of 94 French states for five years. These covariates could vary within three dimensions: the French-local level, the year, and EV type. To the best of our knowledge, our study is the first to isolate the impacts of local-level incentives regarding the vehicle's price, the vehicle's electric range, and four charging powers on the adoption rate of BEVs and PHEVs separately in France. Also, our work differs from existing studies in using mixed-effects regression that captures the effect of time-variant and constant covariates. It should be noted that methods applied in our study could help the French government build a clear roadmap for electric mobility transition by identifying the market-booster factors and concluding with policy recommendations rather than definitive causation.

The rest of this Chapter is organized as follows. Section 2 presents an extensive overview of econometrics studies on PEV adoption. In Section 3, we describe the data and methodology used. Section 4 details the BEV and PHEV models' regression results and policy recommendations, followed by robustness checks in Section 5. Conclusions are provided in Section 6.

## 2. Literature Review

Based on academic-published papers focusing on PEV adoption in different countries and periods, this section identifies the candidate variables that could boost the market. We will neglect other research papers focusing on AFVs (HEV, FCEV)<sup>9</sup>. Table 4.1 summarises the discussed papers, their case studies (countries, period), methodologies, datasets, and the used control variables.

Sierzchula et al. (2014) analyzed the relationship between governmental incentives, socio-economic factors, and 30 national electric-vehicle market shares in 2012, using a country-based multiple linear regression analysis. They found financial incentives, charging infrastructure, and the local presence of production facilities to significantly affect a country's electric vehicle market share. Results suggest that charging infrastructure was the strongest related factor to electric vehicle adoption. However, they pointed out that neither financial

---

<sup>9</sup> AFV: Alternative Fuel Vehicle; HEV: Hybrid Electric Vehicle (could not be charged using an external charger); FCEV: Fuel Cells Electric Vehicle.



incentives nor charging infrastructure could ensure high electric vehicle adoption rates. Plötz et al. (2016) analyzed country-based market shares of both BEV and PHEV market shares in different European countries and state-based PEV stock in the United States using a Pooled OLS regression with data from 2010 to 2014. Their results show that economic factors such as income and gasoline prices are mandatory in analysing policies since they could explain PEV adoption rates variance. Besides, both direct and indirect incentives positively affect PEV adoption, based on empirical PEV market data from the U.S. and Europe. They concluded that the effects of different factors, such as the electricity price and public charging infrastructure, remain open for further research.

Another group of publications used the stepwise linear regression<sup>10</sup> to analyze the PEV adoption. Mersky et al. (2016) analyzed the impact of socio-demographic factors (population, average kilometres travelled), economic factors (income), and EV infrastructure (number of charging points) on the BEV yearly sales in Norway from 2010 to 2013 on both regional and municipal level. The authors excluded financial incentives (tax benefits) since they were offered on national and non-financial incentives (free parking) since data was unavailable. Results showed that charging infrastructure is the most powerful predictor for BEV sales share. Wang et al. (2017) explored the key factors that promote EVs using a Partial Least Squares structural equation analysis to analyze the BEV and PHEV city-level sales in China, considering incentive measures and socio-demographic data between 2013 and 2014. Results show that the density of charging infrastructure, license fee exemption, no driving restriction, and priority to charging infrastructure construction lands are the four most important factors to promote EVs. This Chapter recommends that local municipalities or governments should strengthen the charging infrastructures as preferential policy by solving the problems related to civil construction, grid connections, and smart grids. Vergis and Chen (2015) examined the correlation between social, economic, geographic, and policy factors on both BEV and PHEV adoption across U.S. states in 2013. After applying a stepwise regression on state-level PEV market shares, their results showed that the significant variables are the consumer attribute variables (education, awareness of electric vehicles), geographic variables (average winter temperature, population density), variables related to the cost of energy (gasoline and electricity costs) and the ability to access charging infrastructure away from home. The variables that significantly influence PHEV market shares are market characteristics (the number of available PHEV models), incentives (financial and non-financial incentives), and average winter

---

<sup>10</sup> It should be noted that stepwise linear regression has been criticized for yielding over-confident predictors (Harrell, 2001; Münzel et al., 2019).

temperatures.

The third group of papers took advantage of their data's panel structure and built a panel data regression considering the temporal evolution. Gallagher and Muehlegger (2011) applied time and state fixed effects on BEV sales per capita on a quarterly U.S. state-level from 2000 to 2006, taking into account different socio-demographic (mean age, female percentage, education level), and economic (income, gasoline prices, incentives) variables. They found evidence that hybrid vehicle adoption is positively affected by incentives, income, and gasoline prices. Clinton and Steinberg (2019) applied the same model by adding charging infrastructure and electricity price covariates on the BEV sales per capita of the U.S. states between 2010 and 2015. Their findings indicate that incentives offered as state income tax credits do not have a statistically significant effect on BEV adoptions. Jenn et al. (2018) found that financial incentives have a significant and positive effect on PEV sales after analyzing monthly U.S. state-level data for 2010 to 2015, including fixed effects for time-varying, regional, and vehicle model-specific factors, using a Generalized Method of Moments (GMM) to estimate their regression. Also, they included a lagged-dependent variable to account for suspected endogeneity in their model. Wee et al. (2018) analyzed semi-annual state-level newly registered EV by make, from 2010 to 2015, and state-level policies using a panel data regression. They pointed out that an additional 1000€/BEV of subsidies could increase sales by 5 to 11%. Based on quarterly EV sales and charging station deployment in 353 metropolitan areas in the U.S. from 2011 to 2013, S. Li et al. (2017) found that sales incentives substantially affect EV sales. Also, results showed that the effect would be more significant if the subsidy had been directed toward charging infrastructure instead. Soltani-Sobh et al. (2017) conducted a cross-sectional/time-series panel analysis on the EV sales in the U.S. from 2003 to 2011, using socio-demographic (degree of urbanity, vehicle mileage travelled) and economic (income, gas prices, electricity prices, financial incentive) factors. The results showed that electricity prices were negatively associated with EV adoption, while urban roads and government incentives positively affected states' electric vehicle market share. Using a fixed-effects regression model, X. Li et al. (2017) studied the impacts of seven factors on EV densities from fourteen countries between 2010 and 2015. The authors found that the percentage of renewable energies in electricity generation, the number of charging stations, the education level, the population density have apparent and positive impacts on the demands, contrary to the GDP per capita and urbanization. The gasoline price affects the demands for BEVs more than that for PHEVs. Münzel et al. (2019) reviewed econometric studies on the effect size of purchase incentives and analyzed data on PEV sales from 32 European countries from 2010 to 2017 using panel data

regression. They used as control variables both monetary and non-monetary incentives, socio-economic variables, such as electricity and diesel prices, and slow and fast charging infrastructure. They found that energy prices and financial incentives influence PEV adoption positively.

We completed and adapted the literature review provided by Münzel et al. (2019) in Table 4.1, by adding the articles of (X. Li et al., 2017; Münzel et al., 2019; Soltani-Sobh et al., 2017), by considering only academic-published articles, and by eliminating the articles discussing the evolution of HEVs and FCEVs. We found that the independent variable is generally measured by the PEV market share and is analyzed using various econometric methods: OLS, panel, and stepwise regressions. Various social, demographic, economic, and technical covariates were used, primarily monetary and non-monetary incentives, income, energy prices, population density, and charging infrastructure deployment. As it can be seen in Table 4.1, the studied covariates do not share the same influence on the PEV sales since it is highly dependent on the year of study, the spatial resolution (national or local analysis), the owners' driving behaviour, and the technological progress of PEV. Therefore, general conclusions could not be transferred to the French local-based case study without a detailed market analysis.

While many articles in the literature zoomed into the impact of various covariates, the research gaps, which we will try to fill in this Chapter, remain on: (1) the influence of different-power charging infrastructure deployment, (2) the influence of the French department<sup>11</sup>-level subsidies concerning the vehicle's price, (3) the influence of the vehicle's electric range on PEV adoption, and (4) evaluating how the studied factors vary between the BEV and PHEV markets. Moreover, here we apply mixed-effects regression method, which was not considered in none of the existing studies - as we are aware - that captures the effect of both time-variant and constant covariates. As a final step, regression results are used to conclude with policy recommendations for the EV ecosystem members: the automotive manufacturer, the charging operator, and public authorities.

## 3. Data and Methodology

### 3.1. Data

To estimate the influence of different socio-techno-economic factors on the French BEV

---

<sup>11</sup> In the administrative divisions of France, the department (département) is one of the three levels of government under the national level, between the administrative "regions" and the "communes". France is composed of 13 regions, 95 departments (94 in metropolitan France (in French, *France métropolitaine*) and Corsica), and 34670 communes.

and PHEV market shares, we collected this dataset from different governmental sources and press articles sources for the 94 French departments from 2014 to 2019. It should be noted that we discarded five overseas departments<sup>12</sup> and the island of Corsica. Table 4.3 contains the summary statistics of the data used in our study, the sources, and the name and description of the variables used in the model.

#### 3.1.1. Dependent Variable: BEVs and PHEVs Market Shares

To address the PEV sales, we used BEVs and PHEVs yearly privately-purchased, neglecting other types of vehicles, car registration shares of 94 departments in France from 2015 to 2019 (French Ministry of Ecological Transition, 2020a). The collected dataset is balanced without any missing values in any years and departments<sup>13</sup>. Figure 4.1 in Appendix 4.A summarises both BEV and PHEV market share evolutions in the French departments from 2015 to 2019. The BEV market share's growth from 2015 to 2019 varies from 1% to more than 12%, and for the PHEV, market share fluctuates from 0% to more than 7%.

#### 3.1.2. Technical Factors

To investigate the effect of the recent deployment of public charging infrastructure on PEV adoptions, we collected the number of semi-public and public chargers per department and per power from the official French data website (French data official site, 2020). The at-home (private) charger density is not considered due to the lack of data. Also, we did not have the installation date for every charging station. Therefore, to build the backWard evolution trend of the infrastructure deployment from 2014 to 2018, we applied the percentage increase collected from (EAFO, 2020) equally to these departments. Chargers with 3-7 kW power are considered slow chargers, 22 kW as normal, between 50 kW as fast, and more than 150 kW as ultra-fast.

The results section should note that chargers with different powers do not share the same price, charging tariffs, or availability. Also, the charging tariffs depend on the charging operator. Table 4.2 details the charger's price, the tariffs, and the charging durations and fees for a 50-kWh BEV and a 17-kWh PHEV. It should be noted that most PHEVs are not compatible with fast and ultra-fast charging technology (Fastned, 2021).

---

<sup>12</sup> The five overseas departments (in French, *départements d'outre mer*) excluded from our study are the islands of Guadeloupe, Martinique, Mayotte, La Réunion, and the French Guiana.

<sup>13</sup> It should be noted that no PHEV sales were recorded in the department number 48 in 2016.

Chapter 4: The Influence of Public Charging Infrastructure Deployment and Other Socio-Economic Factors on Electric Vehicle Adoption in France

Table 4.1 Overview of Econometric Studies Presented in the Literature Review (adapted from (Münzel et al., 2019))

| Author (Year)                 | Observations                                | Time resolution      | Vehicle Type | N         | Method  | Dependent variable               | Covariates           |                          |                                   |                                  |               |        |           |                |                   |                    |         |                   |                      |                  |                                     |                             |   |   |
|-------------------------------|---|----------------------|--------------|-----------|---|----------------------------------|----------------------|--------------------------|-----------------------------------|----------------------------------|---------------|--------|-----------|----------------|-------------------|--------------------|---------|-------------------|----------------------|------------------|-------------------------------------|-----------------------------|---|---|
|                               |   |                      |              |           |   |                                  | Financial incentives | Non-Financial incentives | Charging infrastructure (Private) | Charging infrastructure (Public) | Vehicle price | Income | Education | Gasoline price | Electricity price | Population density | Mileage | Unemployment rate | Percentage of female | Environmentalism | Number of available vehicles models | Renewable Energy production |   |   |
| Clinton & Steinberg (2019)    | United States (State level)                 | 2010-2015, Monthly   | BEV          | 3864      | Fixed Effect panel data regression                              | Sales per capita                 | NA                   | -                        | +                                 | +                                |               |        | +         | +              | +                 | -                  |         |                   |                      | +                | +                                   |                             |   |   |
| Jenn et al. (2018)            | United States (State level)                 | 2010-2014, Quarterly | PEV          | 18644     | Fixed Effect panel data regression/LDV Model with GMM estimator | Absolute sales                   | NA                   | NA                       |                                   |                                  |               |        |           |                |                   |                    |         |                   |                      |                  |                                     |                             |   |   |
| Gallagher & Muehlegger (2011) | United States (State level)                 | 2000-2006, Quarterly | PEV          | 4630      | Fixed Effect panel data regression                              | Sales per capita                 | +                    |                          |                                   |                                  |               |        | +         | +              | +                 |                    |         |                   |                      |                  | +                                   |                             |   |   |
| Li et al. (2017)              | United States (Metro areas)                 | 2011-2013, Yearly    | PEV          | 14563     | OLS and GMM regressions   | Absolute sales                   | +                    |                          | +                                 | +                                |               |        | +         |                | +                 |                    |         |                   |                      |                  |                                     | +                           |   |   |
| X. Li et al. (2017)           | 14 countries                                | 2010 to 2015, Yearly | PHEV, BEV    | 84        | Fixed Effect panel data regression                              | EV density                       |                      |                          |                                   | +                                |               |        | NA        | +              | +                 |                    | NA      |                   |                      |                  |                                     |                             |   | + |
| Mersky et al. (2016)          | Norway (Municipality level)                 | 2000-2013, Yearly    | BEV          | 163/20    | Stepwise linear regression                                      | Sales per capita                 | 0                    | +                        | +                                 | +                                |               |        | NA        |                |                   |                    |         | -                 | NA                   |                  |                                     |                             |   |   |
| Munzel et al. (2019)          | A global review and 32 European countries   | 2010 to 2017, Yearly | PEV          | 189/226   | Fixed Effect panel data regression                              | Sales share                      | +                    |                          |                                   |                                  |               |        | +         |                | -                 | +                  |         |                   |                      |                  |                                     |                             |   |   |
| Plotz et al. (2016)           | 12 European countries and the United States | 2010-2014, Yearly    | PEV          | 35/125    | Pooled OLS regression   | Sales share and Stock per capita | NA                   | +                        |                                   | +                                |               |        | NA        | +              | -                 |                    |         |                   |                      |                  |                                     |                             |   |   |
| Sierzchula et al. (2014)      | 30 countries                                | 2012, Yearly         | PEV          | 30        | Pooled OLS regression   | Sales share                      | +                    |                          |                                   | +                                | +             |        | -         | +              | -                 | -                  | +       |                   |                      |                  |                                     | +                           | + |   |
| Soltani-Sobh et al. (2017)    | United States (State level)                 | 2003 to 2011, Yearly | PEV          | 171       | Fixed and random effect panel data regression                   | Sales share                      | +                    |                          |                                   |                                  |               |        | +         |                | +                 | -                  | +       | +                 |                      |                  |                                     |                             |   |   |
| Vergis & Chen (2015)          | United States (State level)                 | 2013, Yearly         | PHEV, BEV    | 50        | Stepwise linear regression                                      | Sales share                      | +                    | +                        |                                   | +                                |               |        | +         | +              | -                 | +                  | -       |                   |                      |                  |                                     | +                           | + |   |
| Wang et al. (2017)            | China (City level)                          | 2013-2014, Yearly    | PHEV, BEV    | 41        | Stepwise linear regression                                      | Sales per capita                 | 0                    | 0                        |                                   | +                                |               |        | 0         |                |                   |                    |         |                   |                      |                  |                                     |                             |   |   |
| Wee et al. (2018)             | United States (State level)                 | 2010-2015, Yearly    | PHEV, BEV    | 1952-4287 | Multi-level Fixed Effect regression                             | Absolute sales                   | +                    | -                        |                                   | -                                |               |        | +         |                | +                 | -                  | +       | +                 |                      |                  |                                     |                             |   |   |

« + » positive impact, « - » negative impact, « NA » Not Available impact, « 0 » not reported  
 Colors indicate the significance level: 'light grey': low significance, 'grey': modest significance, 'dark grey': high significance, 'white': no significance  
 Adapted from: (Münzel et al., 2019) by adding the articles of (X. Li et al., 2017; Münzel et al., 2019; Soltani-Sobh et al., 2017) and by eliminating the articles discussing the evolution of Hybrid EV (HEV) and Flex-Fuel Vehicles (FFV).

Finally, we included a variable describing the average electric range of sold BEV and PHEV models per department and per year, derived from the onboard battery, to explain adopters range anxiety issues. Indeed, a vehicle's electric range is influenced by various factors, such as the vehicle's weight and the driving behaviour (i.e. driving speed, number of stops, and weather conditions) (Sweeting et al., 2011). We gathered the vehicles' electric range in WLTP<sup>14</sup> worldwide standards from the official websites of brands. The range provided by the fuel tank of a PHEV is not considered. Indeed, BEVs' electric ranges are higher than those of PHEVs.

Table 4.2 Charging Costs of Different Charging Powers (Source: *chargemap.com*)

|                   |                |                 |  | 50 kWh BEV                        |                   | 17 kWh PHEV   |                   |               |
|-------------------|----------------|-----------------|--|-----------------------------------|-------------------|---------------|-------------------|---------------|
| Charging speed    | Charging power | Charger's price | Availability   | Charging pricing system           | Charging duration | Charging fees | Charging duration | Charging fees |
| Slow charger      | 3-7 kW         | 2000€           | At-home, on-street (Cities)                            | 1 €/hour<br>sometimes free        | 11 hours          | 11 €          | 4 hours           | 4 €           |
| Normal charger    | 22 kW          | 4000€           | On-street, points of interest (supermarkets), (Cities) | 1.5€/first hour<br>0.2€/min after | 2.7 hours         | 20 €          | 0.9 hours         | 1.2 €         |
| Fast charger      | 50 kW          | 25000€          | On-street, points of interest (supermarkets), (Cities) | 2€/access<br>0.4€/min             | 1.2 hours         | 25 €          | Not compatible    |               |
| Ultrafast charger | 150 kW         | 40000€          | Highways   | 4€/access<br>0.8€/min             | 0.4 hour          | 30 €          | Not compatible    |               |

### 3.1.3. Economic Factors

Several economic factors could stimulate PEV purchasing activity. First, financial incentives, such as local subsidies, could help overcome the vehicle's high cost (Sierzchula et al., 2014). Information on French-local subsidies was gathered from departments and municipalities' websites and press reviews. These local subsidies, which are fix for all vehicles' prices, vary between 0€ and 5000€ for BEV and between 0€ and 2500€ for PHEV, based on the department and the year. Indeed, the ratio of subsidies concerning the vehicle's investment could vary. For instance, regarding BEVs, the purchasing price of a Renault Zoé (52 kWh) is 32000€ compared to 45000€ for a Tesla Model 3 (75 kWh). Regarding PHEVs, a BMW Serie 2 (7.6 kWh) purchase price is 45000€ compared to 90000€ for a Porsche Cayenne (14.1 kWh). Hence, we considered the ratio of subsidies over the price of the most sold vehicle in each department and each year. We included the price of the most sold vehicle per department and per year, similarly to Sierzchula et al. (2014). Prices were gathered from different press articles (i.e. Automobile Propre, 2015-2019; Elite Auto, 2015-2019; La Revue Automobile, 2015-2019;

<sup>14</sup> World harmonized Light-duty vehicles Test Procedure

L'Argus, 2015-2019). We did not consider national subsidies, since they are offered equally on the French territory. Additionally, BEVs are exempt from either 50% or 100% of the total registration fee in specific departments during this study period. We collected the difference between BEV and ICEV registration fees from press articles (Le Figaro, 2019, 2018, 2017, 2016, 2015). This difference captures the monetary savings in taxes of a BEV compared to an ICEV. Registration fee exemption for PHEV adopters depends on the emissions cap of each vehicle. Since we do not know the distribution of PHEVs that are exempted per department, we decided not to consider this incentive for PHEVs. No reliable source was found for other local monetary and non-monetary incentives (free parking, access to restricted traffic zones, access to bus lanes), making it impossible to include them in our study.

Previous research indicates that energy costs played a crucial role in boosting PEV purchasing activity and were found to firmly affect switching into electric mobility (Gallagher and Muehlegger, 2011; S. Li et al., 2017; Plötz et al., 2016; Vergis and Chen, 2015). A high electricity cost discourages PEV purchase, while a high gasoline price does the opposite. To obtain the relative gain in energy prices, we compute the ratio between electricity and gasoline prices. We obtained the yearly-average electricity and gasoline prices per department using daily gasoline prices and yearly national-electricity prices for the studied period (French Ministry of Economy and Finance, 2020a).

Additionally, we grouped the average amount of income declared per household to the tax authorities from 2014 to 2018 (French Ministry of Economy and Finance, 2020b), according to existing literature (Gallagher and Muehlegger, 2011; S. Li et al., 2017).

Finally, to adjust for the effects of inflation/deflation during our analysis period, we divided all the economic covariates by the GDP deflator by considering 2015 as the base year (World Bank, 2020)<sup>15</sup>.

#### 3.1.4. Socio-demographic Factors

As described in the literature review section, socio-demographic factors could influence the adoption of PEVs, namely age, sex, education level, population density, and environmentalism (Clinton and Steinberg, 2019; S. Li et al., 2017; Soltani-Sobh et al., 2017; Vergis and Chen, 2015). Thus, we obtain official socio-demographic data for every department: the population density (INSEE, 2020a), the average age (INSEE, 2020b), and the average unemployment rate (INSEE, 2020c).

---

<sup>15</sup> The GDP deflator measures the change in prices for all goods and services in an economy. Constant prices are obtained by dividing nominal prices (the prices in a given year) to the GDP deflator (for a base year). Then, constant prices reflect the value of goods, with respect to a base year, correcting by the effects of inflation.

To evaluate the influence of drivers' daily trip's needs on the BEV and PHEV purchasing sales, we added a covariate that measures the average-daily vehicle travelled kilometres (home-work and work-home trips) of the drivers living in the department (ENTD, 2019).

Besides, we included a public availability factor, measured by the number of available BEV and PHEV models, which could significantly impact the PEV sales (Sierzchula et al., 2014; Vergis and Chen, 2015).

### **3.2.Methodology**

Based on the literature, we chose the mixed-effects regression for the analysis of PEV adoption. Mixed-effects are an extension to linear models since they allow for incorporating both fixed and random effects. Predictors in the model are considered fixed effects, while grouping variables are random effects (Garson, 2013). A simple fixed-effects model would treat data points as if they are entirely independent. However, data is not independent but somewhat hierarchical, and random effects need to be incorporated besides the fixed effects. Hierarchical structures could appear when several observations are taken from the same unit of observation over time or when those units of observations violate the independence assumption, as they are related to each other. In our case, PEV market shares are nested within the year but also nested within the department. Mixed-effects modelling is advantageous in our case since it gives us group-specific estimates of the parameters in the model, allowing us to understand precisely how the groups differ from one another. In addition, it takes into account the effect of variables, such as “Vehicle travelled mileage”, that do not vary in time (a fixed-effect model would draw that out) but are essential to explain PEV sales. An alternative to mixed-effects models could be Generalized Linear models (GLM), which is also helpful for nested data. When using mixed-effects models, factors may have both a fixed and a random component, differing from Generalized Linear Models (GLM), where one must consider each factor as either fixed or random. Still, parameter estimations in GLM can be problematic, which leads us to prefer the mixed-effects estimation (Garson, 2013).



Chapter 4: The Influence of Public Charging Infrastructure Deployment and Other Socio-Economic Factors on Electric Vehicle Adoption in France

Table 4.3 Summary Statistics of Covariates

| Variable                                 | Variable description                            | Years     | Unit                    | N   | Mean       | St. Dev.   | Min    | Max     | Sources   |
|--|---|-----------|-------------------------|-----|------------|------------|--------|---------|---|
| <i>Dependent variables</i>               |   |           |                         |     |            |            |        |         |   |
| $PEV_{ms_{BEV}}$                         | BEV market share                                | 2015-2019 | -                       | 470 | 0.014      | 0.005      | 0.002  | 0.045   | (French Ministry of Ecological Transition, 2020a)   |
| $PEV_{ms_{PHEV}}$                        | PHEV market share                               | 2015-2019 | -                       | 470 | 0.004      | 0.003      | 0.0004 | 0.023   |   |
| <i>Socio-demographic Covariates</i>      |   |           |                         |     |            |            |        |         |   |
| $d_{population}$                         | Population density                              | 2015-2019 | People/km <sup>2</sup>  | 470 | 592.696    | 2,461.916  | 15     | 21014   | (INSEE, 2020a)  |
| $age$                                    | Average age                                     | 2015-2019 | -                       | 470 | 42.285     | 2.682      | 35     | 48      | (INSEE, 2020b)  |
| $unemployment_{rate}$                    | Unemployment rate                               | 2015-2019 | -                       | 470 | 9.141      | 1.871      | 5.05   | 15.525  | (INSEE, 2020c)  |
| $VKT$                                    | Vehicle Travelled Kilometres                    | 2015-2019 | km                      | 470 | 12.734     | 2.764      | 7      | 20      | (ENTD, 2019)  |
| <i>Availability Covariates</i>           |   |           |                         |     |            |            |        |         |   |
| $nb\ models_{BEV}$                       | Number of available BEV models                  | 2015-2019 | -                       | 470 | 21         | 4,152      | 18     | 29      | (Avem, 2020)  |
| $nb\ models_{PHEV}$                      | Number of available PHEV models                 | 2015-2019 | -                       | 470 | 28.2       | 12.573     | 16     | 52      |   |
| <i>Economic Covariates</i> <sup>16</sup> |   |           |                         |     |            |            |        |         |   |
| $subsidies_{BEV}$                        | Subsidies for purchasing a BEV                  | 2015-2019 | €                       | 470 | 691.489    | 1,463.680  | 0      | 5,000   | (Automobile Propre, 2020; Beev, 2019; Charente Libre, 2016; CompteCO2, 2015; Nicematin, 2017) |
| $subsidies_{PHEV}$                       | Subsidies for purchasing a PHEV                 | 2015-2019 | €                       | 470 | 345.745    | 731.840    | 0      | 2,500   |   |
| $price_{BEV}$                            | Average price of the most sold BEV              | 2015-2019 | €                       | 470 | 38,480.07  | 1,853.241  | 23,250 | 40,030  | (Automobile Propre, 2015; Elite Auto, 2015; La Revue Automobile, 2015; L'Argus, 2015)         |
| $price_{PHEV}$                           | Average price of the most sold PHEV             | 2015-2019 | €                       | 469 | 49,772.340 | 14,020.320 | 26,100 | 111,902 |   |
| $diff_{taxes}$                           | Difference in registration taxes                | 2015-2019 | €                       | 470 | 36.019     | 14.298     | 0      | 51.2    | (Le Figaro, 2019, 2018, 2017, 2016, 2015)   |
| $p_{gasoline}$                           | Gasoline price (SP95)                           | 2015-2019 | €/l                     | 470 | 1.435      | 0.085      | 1.302  | 1.759   | (French Ministry of Economy and Finance, 2020)  |
| $p_{electricity}$                        | Electricity price                               | 2015-2019 | €/kWh                   | 470 | 0.174      | 0.005      | 0.168  | 0.180   | (French Ministry of Ecological Transition, 2020b)   |
| $income$                                 | Average amount of income declared per household | 2014-2018 | €                       | 470 | 24,815.910 | 3,835.549  | 19,249 | 44,794  | (French Ministry of Economy and Finance, 2020b)   |
| <i>Technical Covariates</i>              |   |           |                         |     |            |            |        |         |   |
| $d_{slow\ chargers}$                     | Slow chargers density                           | 2014-2018 | charger/km <sup>2</sup> | 470 | 0.104      | 0.791      | 0.001  | 11.61   | (EAFO, 2020; French data official site, 2020)   |
| $d_{normal\ chargers}$                   | Normal chargers density                         | 2014-2018 | charger/km <sup>2</sup> | 470 | 0.034      | 0.114      | 0.001  | 1.381   |   |
| $d_{fast\ chargers}$                     | Fast chargers density                           | 2014-2018 | charger/km <sup>2</sup> | 470 | 0.002      | 0.006      | 0      | 0.076   |   |
| $d_{ultra-fast\ chargers}$               | Ultra-fast chargers density                     | 2014-2018 | charger/km <sup>2</sup> | 470 | 0.001      | 0.006      | 0      | 0.090   |   |
| $electric\ range_{BEV}$                  | BEV electric range                              | 2015-2019 | km                      | 470 | 150.283    | 4.354      | 150    | 243     | Own sources and Official brands websites  |
| $electric\ range_{PHEV}$                 | PHEV electric range                             | 2015-2019 | km                      | 469 | 39.365     | 9.985      | 22     | 66      |   |

<sup>16</sup> The deflator is considered in the economic covariates.

#### *Chapter 4: The Influence of Public Charging Infrastructure Deployment and Other Socio-Economic Factors on Electric Vehicle Adoption in France*

We studied the logarithmic form of the new registered BEV and PHEV market shares for 94 departments in France, as the logarithmic form is highly recommended when the dependent variable is a percentage because it ensures the residuals' normality (Sprei, 2018; Wooldridge, 2012). Our analysis accounts for infrastructure availability because users will not buy vehicles they cannot recharge. However, charging infrastructure operators await a meaningful market share of vehicles so that charging stations become a profitable business.

The so-called “the chicken-egg electric mobility problem”, where each party awaits the other before acting. To avoid endogeneity problems from the simultaneity between PEV market shares and the installation of charging infrastructure, we studied the influence of the lagged form of charging infrastructure departments densities of slow-and-normal speed combined, fast and fast ultra-fast speeds on BEV/PHEV market shares. In other words, we consider the effect of charging infrastructure densities, in chargers/km<sup>2</sup>, for the year ‘*t-1*’ on the market shares of the year ‘*t*’ (i.e., 2014 to 2018). In addition, we consider the ratio of subsidies and the most sold vehicle in the department to capture the relative effect of subsidies over vehicle prices. Similarly, we compute the ratio of electricity prices (in €/kWh) and gasoline prices (in €/l), following Münzel et al. (2019), since only the ratio will allow us to obtain the relative savings of energy costs of PEVs compared to ICEVs. We only include gasoline prices since including diesel prices would lead to potential collinearity among the two prices. Besides, we include the vehicle’s electric range to account for range anxiety in the purchase decision and the vehicle travelled kilometre (VKT) daily trips. We transform the slow-and-normal chargers’ density and the electricity over gasoline price ratio to the logarithmic form to linearize the model. To avoid the loss of observations with zero values, we transformed the fast and ultrafast chargers densities, and the ratio of subsidies and the most sold vehicle price using  $\ln(x + \sqrt{1 + x^2})$  (Busse et al., 2010). We denote such transformations as  $\tilde{d}_{fast\ chargers}$  and  $\tilde{d}_{ultra-fast\ chargers}$  for the fast and ultrafast chargers’ densities, respectively, and  $\frac{\widetilde{subsidies}}{price}$  for the ratio of subsidies and vehicle price. In addition, we added the difference in registration taxes, which are measured in Euros/BEV for every department. We include the number of available models for BEVs and PHEVs to capture the influence of PEV availability on purchase. Our model also investigates the impact of socio-demographic-economic factors: income (in thousands of Euros) for the year ‘*t-1*’, the population density in people/km<sup>2</sup>, the average age of the population, and the unemployment rate.

We used a mixed-effects regression to analyze the impact of charging infrastructure deployment and other socio-economic factors separately on both BEV and PHEV market

shares, per department in France, from 2015 to 2019. Equation (4.1) describes the model:

$$\begin{aligned}
 \log(\text{PEV}_{i,t,z}) = & \beta_0 + \beta_1 \log(d_{\text{slow,normal chargers}_{i,t-1}}) + \beta_2 \tilde{d}_{\text{fast chargers}_{i,t-1}} + \beta_3 \tilde{d}_{\text{ultra-fast chargers}_{i,t-1}} \\
 & + \beta_5 \frac{\text{subsidies}_{i,t,z}}{\text{price}_{i,t,z}} + \beta_6 \text{diff taxes}_{i,t,z} + \beta_7 \text{nb models}_{t,z} + \beta_8 \frac{p_{\text{gasoline}}}{p_{\text{electricity}_{i,t}}} + \beta_9 \text{income}_{i,t-1} \\
 & + \beta_{10} d_{\text{population}_{i,t}} + \beta_{11} \text{age}_{i,t} + \beta_{12} \text{unemployment}_{i,t} + \beta_{13} \text{VKT}_{i,z} + \beta_{14} \text{electric range}_{i,t,z} \\
 & + \varepsilon_{i,t,z}
 \end{aligned} \tag{4.1}$$

Observations in our sample are Independent and Identically Distributed<sup>17</sup>, the subscript  $i$  denotes the department (from 1 to 94),  $t$  denotes the year (from 2015 to 2019), and  $z$  denotes the vehicle type (BEV or PHEV).

For each variable, we determined the regression coefficients  $\beta$ .  $\varepsilon_{i,t,z}$  is the random disturbance term.

## 4. Results

Looking at relationships between individual variables can help to highlight dynamics that are not evident in linear regression models. Table 4.5 in Appendix 4.B contains the correlation coefficients of all variables. The largest cross-correlation coefficient among a pair of independent variables is 0.93 (between the different charging infrastructure densities). We confirm the severity and magnitude of multicollinearity between the different charging infrastructure variables by considering the size of the Variance Inflation Factor (VIF). To correct multicollinearity, we used the logarithmic form of a variable that groups both the densities of slow-and-normal charging infrastructure. The absence of severe collinearity is then established, resulting in VIF values below 5.0. Regression results are presented separately for the BEV (Section 4.1) and PHEV models (Section 4.2).

### 4.1. BEV Model Regression

We perform a mixed-effect regression<sup>18</sup>, including different social, demographic, technical, and economic factors to estimate their impact on BEV market shares. Table 4.4 displays the results of the BEV model. The model (model 1 in Table 4.4) presents a high goodness-of-fit (conditional  $R^2 > 83.9\%$ , marginal  $R^2 > 32.4\%$ <sup>19</sup>), representing a high explanatory

<sup>17</sup> The errors are Independent and Identically Distributed if they meet the following two criteria: (1) Independence: The errors are independent, which implies that there is no correlation between consecutive residuals in time series data. (2) Homoscedasticity: The errors have constant variance conditional on the explanatory variables.

<sup>18</sup> We test for whether or not including a random effect structure is sustained, by comparing the AIC of the baseline model without random intercepts to the AIC of the model with random intercepts. A random effect structure is preferred since the AIC of the model with random intercepts is substantially lower than the AIC of the model without random intercepts (AIC random = 227.962 < AIC baseline = 428.3548).

<sup>19</sup> Conditional  $R^2$  takes into account the variance of both fixed and random effects. Marginal  $R^2$  corresponds to

power of our models.

Regarding economic factors, we obtain that subsidies, relative to the price of the vehicle, and registration tax exemption increase BEV purchase since they lower its upfront cost. A person receiving the largest amount of local subsidies, additional to the 5000€ national subsidies and paying zero registration fees, has a higher chance of purchasing a BEV. As expected, lower taxes for BEVs incentivize consumers to switch to this type of vehicle. On the other hand, the ratio of electricity price over the gasoline price negatively influences BEV sales at a 1% level. Higher gasoline prices increase the trip cost of ICEVs and decrease the utility of this type of vehicle. They could potentially motivate consumers to switch to BEVs, leading to lower travelling costs and higher market shares. Paralelly, higher electricity prices relative to gasoline prices act as a disincentive to buy battery electric vehicles since it could motivate consumers to buy an ICEV compared to a BEV. Income is also a relevant factor in explaining BEV sales.

Additionally, the  $\beta$  coefficient on the number of BEV models available on the market is positive and statistically significant at a 1% level. Indeed, a 1% increase in the number of models in the market increases BEV market share by 2.7 percentage points. Providing a variety of models on the market by the automotive industry will enhance the client's availability and, consequently, result in higher BEV sales.

Regarding the charging infrastructure deployment, we studied the impact of the lagged and logarithmic form of the public charging infrastructure densities on the  $\log(BEV_{ms})$ . Fast and ultrafast chargers densities coefficients are statistically significant at a 5% level with  $\beta$  coefficients of 6.01 and 3.99, respectively, meaning that an increase of 1 percentage point will increase 6.01 and 3.99 percentage points BEV sales in the following period. On the contrary, the coefficient of the slow-and-normal chargers density is not statistically significant. Since slow, normal, and fast chargers are generally available in cities, regression results (Table 4.4) show that fast public chargers mainly influence BEV adopters. Several reasons could interpret these results. We believe that charging tariffs and durations play a vital role in driver preferences: BEV owners prefer to spend the shortest time charging the vehicle and paying more for charging services. This result is justified by a French survey (EVBox, 2020), where most respondents (46 % of BEV drivers) are ready to pay more for the less charging duration. Yet, it is impossible to include charging tariffs and durations in the regressions because they do not vary in time nor within the departments. Alternatively, results show that BEV adopters are convinced by ultrafast charging, available on highways to solve long-distance trips. This result

---

the variance of the fixed effects only (Bartoń, 2020).

is justified by (EVBox, 2020), where most respondents (55 % of BEV drivers) privilege the usage of ultra-fast chargers available on highways. However, further studies are needed to draw definitive conclusions about the influence on charging tariffs and durations.

Population density, the average age, the unemployment rate, the daily travelled kilometres, and the vehicle's range showed no significant effect on BEV adoption.

#### **4.2.PHEV Model Regression**

We perform mixed-effect regression<sup>20</sup>, including different social, demographic, technical, and economic factors, to estimate their impact on PHEV market shares using the logarithmic form. Table 4.4 displays the results of these models. Since different incentives are given to PHEV buyers, it should be noted that the difference in registration taxes is not included in the PHEV model, and the PHEV subsidies account for 50% of those offered to BEV adopters. Additionally, the number of available models covariate accounts for PHEV models only, and the price of the most sold vehicle is that of PHEV. The model (model 2 in Table 4.4) presents a high goodness-of-fit measure (conditional  $R^2 > 83\%$ , marginal  $R^2 > 61.9\%$ ).

Regarding the socio-demographic covariates, only the daily vehicle travelled kilometre (VKT) is positively correlated at a 10% level. An increase of 1% on the VKT increases PHEV market share by 2.2 percentage points, meaning that owners, who drive daily long-distance trips, are more likely to purchasing PHEVs.

As for the economic factors, the ratio of electricity price over the gasoline price negatively influences PHEV sales at a 5% level: an increase of 1 percentage point in electricity price compared to gasoline price will lead to a decrease of 5 percentage points in the PHEV sales. Therefore, travel cost savings are achieved using a PHEV, leading to higher sales. Also, the  $\beta$  coefficient of the household's income is positive and significantly significant at a 1% level. An interesting result is achieved: the ratio of subsidies over the vehicle's price showed that it is negatively influencing PHEV sales. It should be noted that a maximum of 2500€ local subsidies, which presents less than 3% of a plug-in hybrid vehicle's price, a small part of the overall vehicle investment, is offered to newly PHEV owners, leading to a negative effect on overall sales.

Additionally, similarly to the BEV model, the  $\beta$  coefficient of the number of PHEV models available on the market is positive and statistically significant at a 1% level. An increase

---

<sup>20</sup> We test for whether or not including a random effect structure is sustained, by comparing the AIC of the baseline model without random intercepts to the AIC of the model with random intercepts. A random effect structure is preferred since the AIC of the model with random intercepts is substantially lower than the AIC of the model without random intercepts (AIC random = 728.479 < AIC baseline = 854.594).

of 1 percentage point in the number of models available increases PHEV market share by 1.2 percentage points. On the other hand, population density is negative and statistically significant at a 10% level.

The lagged form of slow-and-normal chargers densities coefficient is statistically significant at a 1% level regarding the charging infrastructure deployment. An increase of 1 percentage point in the density of slow-and-normal chargers will increase PHEV sales by 0.12 percentage points in the following period.

The vehicle's range, the unemployment rate, and the average age showed no significant effect on the model.

#### **4.3. Comparison of BEV and PHEV Models with the Literature**

Generally, the significant variables in our models, correlated with higher BEV and PHEV sales, are consistent with the literature (detailed in Table 4.1), such as subsidies, charging infrastructure deployment, income, electricity and diesel prices, population density. However, some factors, which existing literature found to be vital in higher PEV markets, do not have the same effect in France: namely daily travelled kilometres for BEV (Mersky et al., 2016), unemployment (Mersky et al., 2016), and the population density (Soltani-Sobh et al., 2017; Wee et al., 2018). In addition, other variables were not included due to the lack of data: private charger installation (Clinton and Steinberg, 2019; S. Li et al., 2017) and non-financial incentives (Plötz et al., 2016; Soltani-Sobh et al., 2017). These covariates are noteworthy for further studies to develop the BEV and PHEV market in France. We contribute to the literature by considering the effect of the different charging speeds in PEV adoption, analyzing a department-level French case study, and considering the price of the most sold PEV using mixed-effect regression.

Chapter 4: The Influence of Public Charging Infrastructure Deployment and Other Socio-Economic Factors on Electric Vehicle Adoption in France

Table 4.4 Regression Results of Logarithmic form of BEV and PHEV Market Shares  $\log(PEV)$

|                                      | <i>Dependent Variable</i> |                         |
|--------------------------------------|---------------------------|-------------------------|
|                                      | Log BEV Market Share      | Log PHEV Market Share   |
|                                      | (1)                       | (2)                     |
| Log Slow-and-normal Chargers Density | -0.019<br>(0.012)         | 0.123***<br>(0.017)     |
| Log Fast Chargers Density            | 6.014**<br>(2.367)        | -                       |
| Log Ultra-Fast Chargers Density      | 3.996**<br>(2.031)        | -                       |
| Log Subsidies/Vehicle_price          | 0.769*<br>(0.399)         | -2.870**<br>(1.366)     |
| Difference in Registration Tax       | 0.003***<br>(0.001)       | -                       |
| Number of Models                     | 0.027***<br>(0.003)       | 0.012***<br>(0.002)     |
| Log Electricity_price/SP95_price     | -1.570***<br>(0.308)      | -4.963***<br>(0.458)    |
| VKT                                  | 0.010<br>(0.011)          | 0.022*<br>(0.012)       |
| Vehicle's electric range             | -0.002<br>(0.002)         | -0.001<br>(0.002)       |
| Income                               | 0.00003**<br>(0.00001)    | 0.00006***<br>(0.00001) |
| Population Density                   | -0.00002<br>(0.0002)      | -0.00003*<br>(0.00002)  |
| Age                                  | 0.012<br>(0.012)          | -0.019<br>(0.014)       |
| Unemployment                         | -0.0005<br>(0.017)        | -0.007<br>(0.019)       |
| Constant                             | -9.498***<br>(1.048)      | -17.066***<br>(1.320)   |
| Observations                         | 470                       | 469                     |
| Conditional R <sup>2</sup>           | 0.839                     | 0.830                   |
| Marginal R <sup>2</sup>              | 0.324                     | 0.619                   |

Note: \* p<10%; \*\* p<5%; \*\*\* p<1%

By comparing the BEV and PHEV regression models, we found that the number of available PEV models, income, and energy prices positively affect the market shares. Therefore, an increase in these control variables will positively and significantly impact the transition into electric mobility, such as in (S. Li et al., 2017; Vergis and Chen, 2015). Regarding economic factors, clients receiving local subsidies and registration fees exemption are more likely to buy a BEV, similarly to (S. Li et al., 2017; Soltani-Sobh et al., 2017; Wee et al., 2018). On the contrary, since subsidies presents a small part of the PHEV's investment, the ratio of subsidies over vehicle price negatively affects PHEV sales, mainly due to the high price of PHEVs. Results prove that the ratio of energy prices has a stronger negative influence on PHEV sales than BEV sales: a one percentage point increase in the ratio leads to a decrease of 1.5 (4.9) percentage points in BEV (PHEV) sales. This result is expected since a PHEV is highly dependent on fossil fuels. Contrary to BEV users, PHEV users have to constantly do a tradeoff between using electricity or gasoline to fuel their vehicles.

Concerning the public charging infrastructure deployment, several studies found this covariate to be a vital factor for purchasing a PEV (S. Li et al., 2017; Münzel et al., 2019; Plötz et al., 2016). Indeed, the influence of different charging speeds, which presents the novelty of this Chapter, was not considered in previous literature. We found that setting up fast chargers in cities and ultrafast chargers on corridors could boost the BEV adoption trend. Contrary to the BEV market, where there is no effect, slow-and-normal chargers positively impact PHEV adoption. Since PHEVs cannot be charged using fast and ultra-fast chargers, these charging powers were not considered in our analysis of the plug-in hybrid market.

Among socio-demographic covariates, only the coefficient of daily travelled kilometres was significant and positively correlated to PHEV sales and did not influence BEV sales. Other covariates, namely vehicle's electric range, unemployment rate, and age, had no influence on the BEV and PHEV market shares in contrast to (Gallagher and Muehlegger, 2011; Mersky et al., 2016; Wee et al., 2018).

Overall, our results are in line with the existing literature on early PEV adopters across the countries. However, it is essential to consider other covariates in further studies, such as non-financial incentives and private charging infrastructure deployment.

#### **4.4. Policy Recommendations**

Based on our results and to accelerate the electric mobility transition in France, this Chapter provides policy recommendations for the members of the PEV ecosystem: the automotive industry, the charging operator, and government/local authorities.



#### *Chapter 4: The Influence of Public Charging Infrastructure Deployment and Other Socio-Economic Factors on Electric Vehicle Adoption in France*

First, our results found that the number of available models on the market is positively correlated to both BEV and PHEV sales. Also, we figured out that the daily vehicle travelled kilometre is positively influencing PHEV sales. Therefore, we recommend automotive manufacturers adopt a strategy to promote PEVs by (1) providing various models of different sizes, battery capacities/ranges, styles, and designs. This recommendation implies incurring in R&D and manufacturing costs but can potentially increase brand visibility and help differentiate from competitors. Furthermore, their strategy could concentrate on (2) raising the awareness of PHEVs in rural areas, where drivers travel daily long-distance trips.

Second, we confirm that deploying charging infrastructure could eliminate range anxiety towards the drivers. Results show that deploying fast and ultrafast chargers boost the BEV market, while slow-and-normal chargers boost the PHEV market. Therefore, charging infrastructure operators should consider a strategic plan that includes providing public fast chargers to target potential BEV users, public slow-and-normal chargers to target potential PHEV users and ultrafast chargers on highways rather than other charging speeds. However, we should consider that the installation of the different charging stations entails various costs and benefits. Regarding costs, fast and ultra-fast chargers come with higher investments than slow-and-normal chargers (Table 4.2) and additional costs, such as grid reinforcement and connection. Regarding benefits, charging operators should consider the charging behaviours of PEV users in order to evaluate their revenues and fix their charging tariffs.

As discussed before, economic factors present promising opportunities for new policies to achieve low-emissions goals. Results show that local subsidies and registration tax exemption are two crucial reasons for mass BEV adoption. Indeed, the higher the ratio subsidy over vehicle price, the higher the chance is to buy a BEV. Therefore, we suggest local authorities offer subsidies based on the vehicle's price: more subsidies should be offered for higher BEV prices. The relationship between the ratio of PHEV subsidies over the vehicle's investment presented a negative correlation with PHEV sales. Therefore, we recommend that local authorities offer purchasing subsidies for new BEV owners rather than PHEV ones. The case of PHEV remains open for further studies. By modifying these financial incentives and economic factors, local authorities and governments should expand their PEV markets and potentially help achieve their road electrification targets. Besides, we recommend local authorities concentrate their efforts on providing and/or increasing subsidies to the instalment of fast chargers where BEVs are ascending, slow-and-normal chargers where PHEVs are ascending, and ultrafast public chargers on highways.

Moreover, gasoline prices have a significant and positive impact on BEV and PHEV

markets. Since travel cost savings could be achieved by purchasing a PEV, governments should consider gasoline taxes as tools to encourage clients to buy PEVs. Indeed, the French government adopted their strategy to add taxes on fossil fuel prices, namely the carbon tax, the fourth governmental source of income (Senat, 2018). The government has been increasing the diesel price more than gasoline price due to its environmental impact, pushing ICEV owners to switch to low-emission vehicles (Pennec, 2017). Under the two laws: Energy Transition Law for Green Growth<sup>21</sup> and The National Low-Carbon Strategy<sup>22</sup>, this strategy provides price signals encouraging low-carbon mobility to drivers (French Ministry of Ecological Transition, 2020c; Pennec, 2017).

However, increasing the carbon tax led to social movements, namely the "Yellow Vests", pushing the French government to suspend additional taxes on fossil fuels prices. Indeed, increasing taxes has no social acceptability in France<sup>23</sup> since the country is one of the top-taxed countries in the European Union (OECD, 2021). Overall, the French government should create a roadmap that accompanies the electric mobility transition: by (1) increasing subsidies for BEVs and revising those for PHEVs, (2) decreasing the electricity price and/or increase gasoline price, (3) offering subsidies for charging operators to install the right charging power at the right place. Despite the influence of these recommendations on achieving climate targets, governments should consider social and budgetary costs in implementing them. For instance, increasing subsidies for consumers and charging operators entail increasing taxes, and governments should first determine the less costly option. Besides, increasing gasoline taxes, which presents a source of revenue for the government (Senat, 2018), could provoke social movements. As for decreasing electricity prices, the French government should evaluate its feasibility since prices are managed at the European level. Indeed, a Cost-Benefit Analysis, which is not the goal of this Chapter, is needed to prioritize policies according to their social, environmental and economic impacts.

## 5. Robustness Checks

We applied different robustness checks, such as omitting nineteen random regions, excluding big cities, removing charging infrastructure covariates to identify their impact on our models.

---

<sup>21</sup> Loi de la Transition Énergétique pour la Croissance Verte (LTCEV)

<sup>22</sup> Stratégie Nationale Bas-Carbone (SNBC)

<sup>23</sup> ("Les Français refusent de payer à nouveau la taxe carbone," 2019; "Relance économique," 2021)

### **5.1. Robustness Check 1: Removing Random Departments**

As a robustness check, we examined the impact of omitting random 19 departments on the model; results are shown in Table 4.5 in Appendix 4.C (models 2 and 4). It should be noted that the coefficients of the regression are an estimation of all the studied regions and are equally calculated for all the departments. We conclude that the model is robust since the estimation results of both BEVs and PHEVs market shares do not significantly change in any coefficients or significance.

### **5.2. Robustness Check 2: Excluding Departments with Big Cities**

We omit departments where Paris, Marseille, and Lyon<sup>24</sup> are located<sup>25</sup>. Results are shown in Table 4.6 in Appendix 4.C (models 2 and 4). We obtain that fast chargers density have no impact on BEV market share, mainly due to the different types of usage of BEV in small and big cities. In small cities, contrary to big ones, the fact that more private parking is available at households (INSEE, 2016), leads to a higher probability of at-home chargers installation; and, thus, lower usage for public fast chargers. Also, the ultra-fast charging density remains significant because it is mainly used for long-distance trips and these chargers are available on highways.

### **5.3. Robustness Check 3: Removing Charging Infrastructure Control Variables**

As a third robustness check, we exclude charging infrastructure variables. The results, which are shown in Table 4.7 in Appendix 4.C (models 2 and 4), showed slight variations in the coefficients and significance of the control variables of the BEV/PHEV regression models. For instance, the ratio of subsidies and price, and the ratio of electricity and gasoline price increase in absolute value, compared to the case with charging infrastructure. Not considering charging infrastructure leads to an overestimation of both the subsidies and the energy prices ratios in the BEV model.

Only a maximum of 1% of the variation in the conditional goodness-of-fit was measured for all the models. While the charging infrastructure variables are essential predictors of BEV and PHEV sales, these variables are not the largest predictors of vehicle sales. However, including charging infrastructure variables is essential since they slightly improve the goodness-of-fit and reduce the predicted value's bias in other independent variables of the model.

---

<sup>24</sup> We eliminated Paris, Lyon and Marseille as they are the most populated cities in France, and they have the largest metropolitan areas (INSEE, 2020d).

<sup>25</sup> The departments removed are Paris (75), Bouches du Rhône (13), and Rhône (69).

## 6. Conclusion

This Chapter explores the impact of different socio-techno-economic factors across the PEV adoption activity in 94 French departments between 2015 and 2019 using mixed-effects regression. We identified candidate factors that could potentially impact BEV or PHEV sales based on a literature review before gathering their datasets from various sources. Then, we chose to apply mixed-effects models to investigate BEV and PHEV purchasing activity evolution separately. The purpose of developing these two models is to: (1) study the influence of different-power charging infrastructure deployment, French department-level subsidies concerning the vehicle's price, and the vehicle's electric range on PEV adoption, and (2) conclude with policy recommendations to draw a roadmap for electric mobility transition in France.

Our BEV and PHEV models present goodness-of-fit measures (conditional  $R^2 > 83.9\%$  for the BEV model and conditional  $R^2 > 83\%$  for the PHEV model). The results show that the number of available PEV models, income, and energy prices positively affect BEV and PHEV market shares. Results indicate that the covariates with a positive effect on BEV sales include economic variables (income, taxes exemption, the ratio of subsidies over the vehicle's price), technical variables (fast and ultra-fast charging density), and the number of available BEV models. Yet, higher electricity price regarding gasoline price is negatively affecting BEV sales. Besides, the positively correlated variables with PHEV sales include the number of PHEV models, income, slow-and-normal chargers density, and daily travelled kilometres. However, subsidies accounting for a small part of the PHEV investment and electricity price significantly but negatively affect PHEV sales.

This Chapter ends with policy recommendations to the automakers by increasing the variety of PEV choices and the charging operator by providing fast chargers in BEV- ascending cities, slow-and-normal chargers in PHEV-ascending cities, and ultra-fast chargers on highways. Moreover, we proposed a roadmap for the French government to follow the electric mobility transition: by (1) increasing subsidies for BEVs and revising those for PHEVs, (2) decreasing the electricity price or increasing gasoline price, (3) offering subsidies for charging operators to install the right charging power at the right place.

While some of the findings of this study were expected and despite the high resolution of our analysis, further studies are suggested to boost these models by considering other socio-techno-economic factors that were not considered due to the lack of data, namely at-home and at-work charging infrastructures of both the department of residence and work, the tariffs of

*Chapter 4: The Influence of Public Charging Infrastructure Deployment and Other Socio-Economic Factors on Electric Vehicle Adoption in France*

public charging infrastructure, local non-financial incentives, and electric mobility services (Vehicle-to-Grid, smart charging, and carsharing). Our model can only draw general conclusions since the PEV market share in France represents less than 5%, so-called Early Adopters stage. It would be helpful to perform a follow-up study in a more developed market. Additionally, the model does not capture the customer's psychological effect, which could be affected by the marketing campaign of both automotive manufacturers and charging infrastructure operators. The Chapter aims to draw a clear roadmap for electric mobility transition by identifying the market-booster factors rather than concluding with definitive causation. Therefore, to know if these policies are efficient in a societal and economic sense, we recommend that future studies consider a cost-benefit analysis.

## References

- Advenir, project, 2020. ADVENIR | Primes CEE pour points de recharge des véhicules électriques [WWW Document]. ADVENIR. URL <https://advenir.mobi/> (accessed 10.26.20).
- Automobile Propre, 2020. Aides locales, prime et bonus : jusqu'à 18.000 € de remise sur votre voiture électrique ! [WWW Document]. Automob. Propre. URL <https://www.automobile-propre.com/aides-locales-prime-et-bonus-jusqua-18-000-e-de-remise-sur-votre-voiture-electrique/> (accessed 1.13.21).
- Automobile Propre, 2015. Essai Mitsubishi Outlander PHEV 2017 : subtiles évolutions [WWW Document]. URL <https://www.automobile-propre.com/essai-mitsubishi-outlander-phev-2017/> (accessed 7.5.21).
- Avem, 2020. Voiture électrique - Liste des modèles disponibles en France [WWW Document]. URL <http://www.avem.fr/voiture-electrique.html> (accessed 1.13.21).
- Bartoń, K., 2020. MuMin: Multi-Model Inference.
- Beev, 2019. Les aides régionales pour les voitures électriques en France [WWW Document]. Beev - Votre Voiture Électr. En Quelques Clics. URL <https://beev.co/financement/aides-regionales-voitures-electriques/> (accessed 1.13.21).
- Busse, M., Königer, J., Nunnenkamp, P., 2010. FDI promotion through bilateral investment treaties: more than a bit? *Rev. World Econ.* 146, 147–177. <https://doi.org/10.1007/s10290-009-0046-x>
- Charente Libre, 2016. Nouvelle Aquitaine: la prime de 1000€ pour l'achat d'un véhicule électrique n'est pas reconduite [WWW Document]. CharenteLibre.fr. URL <https://www.charentelibre.fr/2016/11/24/les-constructeurs-decouvrent-qu-ils-ont-perdu-le-super-banco-regional,3069882.php> (accessed 1.13.21).
- Clinton, B.C., Steinberg, D.C., 2019. Providing the Spark: Impact of financial incentives on battery electric vehicle adoption. *J. Environ. Econ. Manag.* 98, 102255. <https://doi.org/10.1016/j.jeem.2019.102255>
- CompteCO2, 2015. Super bonus écologique pour rouler électrique - Compte CO2 [WWW Document]. URL <https://www.compteco2.com//article/comment-marche-le-super-bonus-ecologique-vehicule-electrique/> (accessed 1.13.21).
- EAFO, 2020. Country detail electricity | EAFO [WWW Document]. URL <https://www.eafo.eu/countries/france/1733/infrastructure/electricity> (accessed 7.28.20).
- EC, 2013. Corri-Door Project [WWW Document]. URL [https://ec.europa.eu/inea/sites/inea/files/download/project\\_fiches/multi\\_country/fichenew\\_2013eu92055s\\_final\\_1.pdf](https://ec.europa.eu/inea/sites/inea/files/download/project_fiches/multi_country/fichenew_2013eu92055s_final_1.pdf) (accessed 2.18.21).
- Egbue, O., Long, S., 2012. Barriers to widespread adoption of electric vehicles: An analysis of consumer attitudes and perceptions. *Energy Policy* 48, 717–729. <https://doi.org/10.1016/j.enpol.2012.06.009>
- Elite Auto, 2015. PRIX ET TARIF BMW X5 G05 HYBRIDE PAR MANDATAIRE [WWW Document]. URL <https://www.elite-auto.fr/vente-voiture/bmw-4/x5-g05-6972.html> (accessed 7.5.21).
- ENTD, 2019. Enquête sur la mobilité des personnes 2018-2019 | Données et études statistiques [WWW Document]. URL <https://www.statistiques.developpement-durable.gouv.fr/enquete-sur-la-mobilite-des-personnes-2018-2019> (accessed 7.28.20).
- EVBox, 2020. Baromètre EVBox de la Mobilité : 4 Français sur 10 prêts à rouler électrique si les points de charge ultra-rapides se développent [WWW Document]. EVBox Salle Presse. URL <http://news.evbox.com/fr-FR/193214-barometre-evbox-de-la-mobilite-4-francais-sur-10-prets-a-rouler-electrique-si-les-points-de-charge-ultra-rapides-se-developpent> (accessed 12.15.20).
- Fastned, 2021. Can I charge at Fastned with my plug-in hybrid? [WWW Document]. Fastned Support. URL <https://support.fastned.nl/hc/en-gb/articles/205694697-Can-I-charge-at-Fastned-with-my-plug-in-hybrid-> (accessed 6.22.21).
- French data official site, 2020. Fichier consolidé des Bornes de Recharge pour Véhicules Électriques (IRVE) - data.gouv.fr [WWW Document]. URL [/fr/datasets/fichier-consolide-des-bornes-de-recharge-pour-vehicules-electriques/](https://data.gouv.fr/fr/datasets/fichier-consolide-des-bornes-de-recharge-pour-vehicules-electriques/) (accessed 7.27.20).
- French Ministry of Ecological Transition, 2021. Développer l'automobile propre et les voitures électriques [WWW Document]. Ministère Transit. Écologique. URL

#### *Chapter 4: The Influence of Public Charging Infrastructure Deployment and Other Socio-Economic Factors on Electric Vehicle Adoption in France*

- <https://www.ecologie.gouv.fr/developper-lautomobile-propre-et-voitures-electriques> (accessed 6.16.21).
- French Ministry of Ecological Transition, 2020a. Données sur les immatriculations des véhicules [WWW Document]. Données Études Stat. Pour Chang. Clim. Lénergie Environ. Logement Transp. URL <https://www.statistiques.developpement-durable.gouv.fr/donnees-sur-les-immatriculations-des-vehicules> (accessed 1.12.21).
- French Ministry of Ecological Transition, 2020b. Prix de l'électricité en France et dans l'Union européenne en 2019 [WWW Document]. Données Études Stat. Pour Chang. Clim. Lénergie Environ. Logement Transp. URL <https://www.statistiques.developpement-durable.gouv.fr/prix-de-lelectricite-en-france-et-dans-lunion-europeenne-en-2019-0> (accessed 7.5.21).
- French Ministry of Ecological Transition, 2020c. La Stratégie Nationale Bas-Carbone: La Transition Ecologique et Solidaire vers la neutralité carbone.
- French Ministry of Economy and Finance, 2020a. Données publiques [WWW Document]. URL <https://www.prix-carburants.gouv.fr/rubrique/opendata/> (accessed 7.27.20).
- French Ministry of Economy and Finance, 2020b. L'impôt sur le revenu par collectivité territoriale - data.gouv.fr [WWW Document]. URL [/fr/datasets/l-impot-sur-le-revenu-par-collectivite-territoriale/](https://www.data.gouv.fr/fr/datasets/l-impot-sur-le-revenu-par-collectivite-territoriale/) (accessed 12.10.20).
- French National Assembly, 2021. Projet de loi n° 3875 portant lutte contre le dérèglement climatique et renforcement de la résilience face à ses effets.
- Gallagher, K.S., Muehlegger, E., 2011. Giving green to get green? Incentives and consumer adoption of hybrid vehicle technology. *J. Environ. Econ. Manag.* 61, 1–15. <https://doi.org/10.1016/j.jeem.2010.05.004>
- Garson, G.D., 2013. Fundamentals of Hierarchical Linear and Multilevel Modeling, in: *Hierarchical Linear Modeling: Guide and Applications*. SAGE Publications, Inc., 2455 Teller Road, Thousand Oaks California 91320 United States, pp. 3–26. <https://doi.org/10.4135/9781483384450.n1>
- Hainsch, K., Burandt, T., Löffler, K., Kemfert, C., Oei, P.-Y., von Hirschhausen, C., 2021. Emission Pathways Towards a Low-Carbon Energy System for Europe: A Model-Based Analysis of Decarbonization Scenarios. *Energy J.* 42. <https://doi.org/10.5547/01956574.42.5.khai>
- Hardman, S., 2019. Understanding the impact of reoccurring and non-financial incentives on plug-in electric vehicle adoption – A review. *Transp. Res. Part Policy Pract.* 119, 1–14. <https://doi.org/10.1016/j.tra.2018.11.002>
- Harrell, F.E., 2001. Resampling, Validating, Describing, and Simplifying the Model, in: Harrell, F.E. (Ed.), *Regression Modeling Strategies: With Applications to Linear Models, Logistic Regression, and Survival Analysis*, Springer Series in Statistics. Springer, New York, NY, pp. 87–103. [https://doi.org/10.1007/978-1-4757-3462-1\\_5](https://doi.org/10.1007/978-1-4757-3462-1_5)
- INSEE, 2020a. Population de 1999 à 2020 | Insee [WWW Document]. URL <https://www.insee.fr/fr/statistiques/2012713> (accessed 7.28.20).
- INSEE, 2020b. Estimation de la population au 1<sup>er</sup> janvier 2020 | Insee [WWW Document]. URL <https://www.insee.fr/fr/statistiques/1893198> (accessed 7.28.20).
- INSEE, 2020c. Taux de chômage localisés au 2<sup>e</sup> trimestre 2020 | Insee [WWW Document]. URL <https://www.insee.fr/fr/statistiques/2012804> (accessed 11.16.20).
- INSEE, 2020d. Définition - Unité urbaine / Agglomération / Agglomération multicommunale / Agglomération urbaine / Agglomération / Agglomération multicommunale / Agglomération urbaine | Insee [WWW Document]. URL <https://www.insee.fr/fr/metadonnees/definition/c1501> (accessed 7.7.21).
- INSEE, 2016. Caractéristiques générales des résidences principales et de leurs occupants en 2013 – Les conditions de logement en 2013 | Insee [WWW Document]. URL <https://www.insee.fr/fr/statistiques/1912703?sommaire=1912749> (accessed 7.5.21).
- Javid, R.J., Nejat, A., 2017. A comprehensive model of regional electric vehicle adoption and penetration. *Transp. Policy* 54, 30–42. <https://doi.org/10.1016/j.tranpol.2016.11.003>
- Jenn, A., Springel, K., Gopal, A.R., 2018. Effectiveness of electric vehicle incentives in the United States. *Energy Policy* 119, 349–356. <https://doi.org/10.1016/j.enpol.2018.04.065>

#### *Chapter 4: The Influence of Public Charging Infrastructure Deployment and Other Socio-Economic Factors on Electric Vehicle Adoption in France*

- La Revue Automobile, 2015. Fiche technique Mitsubishi Outlander PHEV 2016 [WWW Document]. URL [https://www.larevueautomobile.com/Fiche-Technique-Auto/Caracteristique-Mitsubishi\\_Outlander\\_15843.2016](https://www.larevueautomobile.com/Fiche-Technique-Auto/Caracteristique-Mitsubishi_Outlander_15843.2016) (accessed 7.5.21).
- L'Argus, 2015. Prix Renault Zoé (2015) : des tarifs à partir de 21 900 euros [WWW Document]. [www.largus.fr](http://www.largus.fr). URL <https://www.largus.fr/actualite-automobile/prix-renault-zoe-2015-des-tarifs-a-partir-de-21-900-euros-6046386.html> (accessed 7.5.21).
- Le Figaro, 2019. Les prix de la carte grise pour 2019 [WWW Document]. URL <http://leparticulier.lefigaro.fr/article/les-prix-de-la-carte-grise-pour-2019/> (accessed 1.12.21).
- Le Figaro, 2018. Les prix de la carte grise pour 2018 [WWW Document]. URL [http://leparticulier.lefigaro.fr/jcms/p1\\_1708294/les-prix-de-la-carte-grise-pour-2018](http://leparticulier.lefigaro.fr/jcms/p1_1708294/les-prix-de-la-carte-grise-pour-2018) (accessed 1.12.21).
- Le Figaro, 2017. Prix de la carte grise 2017: jusqu'à 400 % de hausse [WWW Document]. URL [http://leparticulier.lefigaro.fr/jcms/p1\\_1625664/prix-de-la-carte-grise-2017-jusqu-a-400-de-hausse](http://leparticulier.lefigaro.fr/jcms/p1_1625664/prix-de-la-carte-grise-2017-jusqu-a-400-de-hausse) (accessed 1.12.21).
- Le Figaro, 2016. Carte grise: les prix du cheval fiscal en 2016 [WWW Document]. URL [http://leparticulier.lefigaro.fr/jcms/p1\\_1605335/carte-grise-les-prix-du-cheval-fiscal-en-2016](http://leparticulier.lefigaro.fr/jcms/p1_1605335/carte-grise-les-prix-du-cheval-fiscal-en-2016) (accessed 1.12.21).
- Le Figaro, 2015. Carte grise: les prix du cheval fiscal en 2015 [WWW Document]. URL [http://leparticulier.lefigaro.fr/jcms/p1\\_1578234/carte-grise-les-prix-du-cheval-fiscal-en-2015](http://leparticulier.lefigaro.fr/jcms/p1_1578234/carte-grise-les-prix-du-cheval-fiscal-en-2015) (accessed 1.12.21).
- Les Français refusent de payer à nouveau la taxe carbone [WWW Document], 2019. . Mieux Vivre Votre Argent. URL <https://www.mieuxvivre-votreargent.fr/vie-pratique/2019/03/20/les-francais-refusent-de-payer-a-nouveau-la-taxe-carbone/> (accessed 6.25.21).
- Li, S., Tong, L., Xing, J., Zhou, Y., 2017. The Market for Electric Vehicles: Indirect Network Effects and Policy Design. *J. Assoc. Environ. Resour. Econ.* 4, 89–133. <https://doi.org/10.1086/689702>
- Li, X., Chen, P., Wang, X., 2017. Impacts of renewables and socioeconomic factors on electric vehicle demands – Panel data studies across 14 countries. *Energy Policy* 109, 473–478. <https://doi.org/10.1016/j.enpol.2017.07.021>
- Mersky, A.C., Sprei, F., Samaras, C., Qian, Z. (Sean), 2016. Effectiveness of incentives on electric vehicle adoption in Norway. *Transp. Res. Part Transp. Environ.* 46, 56–68. <https://doi.org/10.1016/j.trd.2016.03.011>
- Morganti, E., Boutueil, V., Leurent, F., 2016. BEVs and PHEVs in France: Market trends and key drivers of their short term development.
- Münzel, C., Plötz, P., Sprei, F., Gnann, T., 2019. How large is the effect of financial incentives on electric vehicle sales? – A global review and European analysis. *Energy Econ.* 84, 104493. <https://doi.org/10.1016/j.eneco.2019.104493>
- Nicematin, 2017. Bénéficiez d'une subvention de 2.000 euros pour l'achat d'un véhicule électrique en 2017 [WWW Document]. *Nice-Matin*. URL <https://www.nicematin.com/vie-locale/beneficiez-dune-subvention-de-2000-euros-pour-lachat-dun-vehicule-electrique-en-2017-109683> (accessed 1.13.21).
- OECD, 2021. Taxing Wages 2021.
- Pennec, P., 2017. Le gazole plus cher que l'essence en 2021 ! Autoplus. URL <https://www.autoplus.fr/societe-economie/le-gazole-plus-cher-que-lessence-en-2021-404619.html> (accessed 6.22.21).
- Plötz, P., Gnann, T., Sprei, F., 2016. Can policy measures foster plug-in electric vehicle market diffusion? *World Electr. Veh. J.* 8, 789–797. <https://doi.org/10.3390/wevj8040789>
- Relance économique : les Français sont vivement opposés à la taxation de l'épargne [WWW Document], 2021. . Mieux Vivre Votre Argent. URL <https://www.mieuxvivre-votreargent.fr/vie-pratique/2021/04/20/relance-economique-les-francais-plebiscitent-la-taxation-des-plus-hauts-revenus/> (accessed 6.25.21).
- Senat, 2018. Hausse du prix des carburants - Sénat [WWW Document]. URL <https://www.senat.fr/questions/base/2018/qSEQ180605600.html> (accessed 6.22.21).



*Chapter 4: The Influence of Public Charging Infrastructure Deployment and Other Socio-Economic Factors on Electric Vehicle Adoption in France*

- Sierzchula, W., Bakker, S., Maat, K., van Wee, B., 2014. The influence of financial incentives and other socio-economic factors on electric vehicle adoption. *Energy Policy* 68, 183–194. <https://doi.org/10.1016/j.enpol.2014.01.043>
- Soltani-Sobh, A., Heaslip, K., Stevanovic, A., Bosworth, R., Radivojevic, D., 2017. Analysis of the Electric Vehicles Adoption over the United States. *Transp. Res. Procedia*, 19th EURO Working Group on Transportation Meeting, EWGT2016, 5-7 September 2016, Istanbul, Turkey 22, 203–212. <https://doi.org/10.1016/j.trpro.2017.03.027>
- Sweeting, W.J., Hutchinson, A.R., Savage, S.D., 2011. Factors affecting electric vehicle energy consumption. *Int. J. Sustain. Eng.* 4, 192–201. <https://doi.org/10.1080/19397038.2011.592956>
- Sykes, M., Axsen, J., 2017. No free ride to zero-emissions: Simulating a region’s need to implement its own zero-emissions vehicle (ZEV) mandate to achieve 2050 GHG targets. *Energy Policy* 110, 447–460. <https://doi.org/10.1016/j.enpol.2017.08.031>
- Tran, M., Banister, D., Bishop, J.D.K., McCulloch, M.D., 2012. Realizing the electric-vehicle revolution. *Nat. Clim. Change* 2, 328–333. <https://doi.org/10.1038/nclimate1429>
- Vergis, S., Chen, B., 2015. Comparison of plug-in electric vehicle adoption in the United States: A state by state approach. *Res. Transp. Econ., Sustainable Transportation* 52, 56–64. <https://doi.org/10.1016/j.retrec.2015.10.003>
- Wang, N., Pan, H., Zheng, W., 2017. Assessment of the incentives on electric vehicle promotion in China. *Transp. Res. Part Policy Pract.* 101, 177–189. <https://doi.org/10.1016/j.tra.2017.04.037>
- Wee, S., Coffman, M., La Croix, S., 2018. Do electric vehicle incentives matter? Evidence from the 50 U.S. states. *Res. Policy* 47, 1601–1610. <https://doi.org/10.1016/j.respol.2018.05.003>
- World Bank, 2020. GDP deflator (base year varies by country) - | Data [WWW Document]. URL <https://data.worldbank.org/indicator/NY.GDP.DEFL.ZS?locations=FR%20> (accessed 12.11.20).

## Appendix 4.A: Overview of the BEV and PHEV Evolution in France

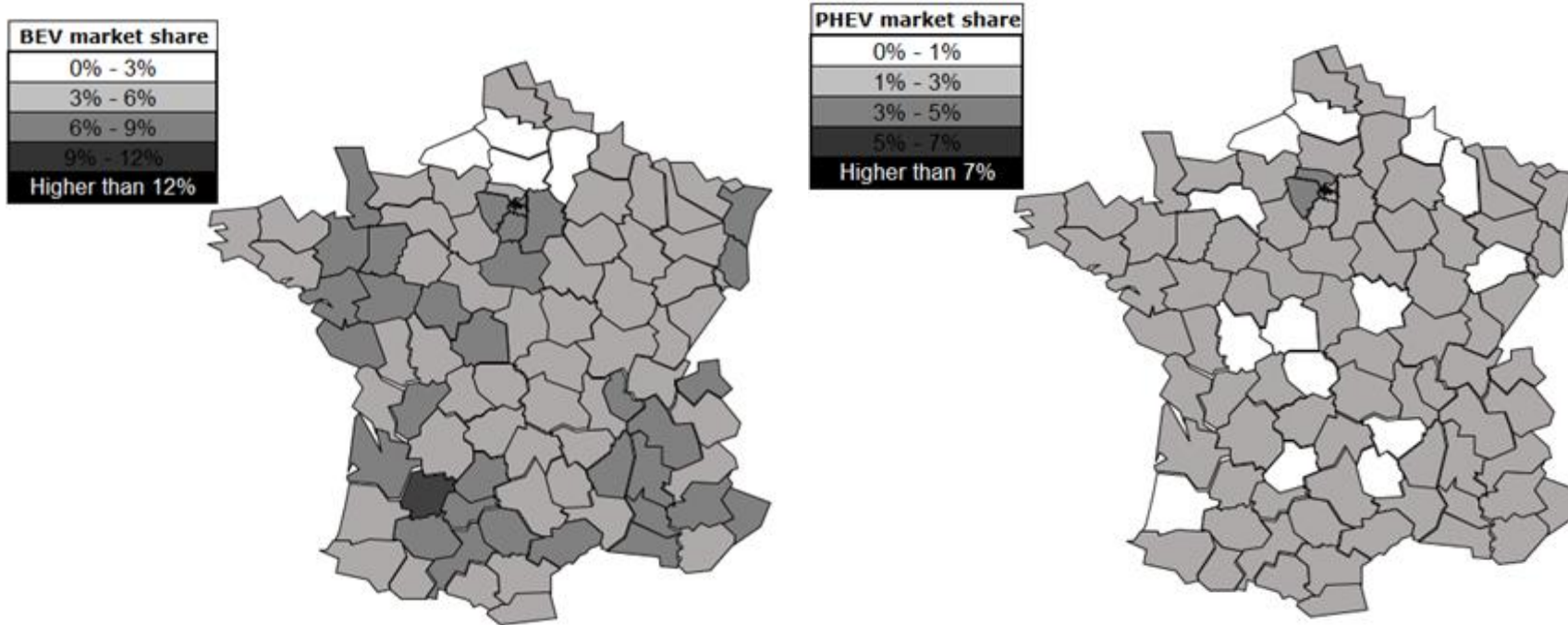

Figure 4.1 Evolution Percentage of the BEV (Left) and PHEV (Right) Market Shares in 95 French Departments between 2015 and 2019

## Appendix 4.B: Correlation Between Model Covariates

Table 4.5 Variable Correlation Coefficients

|                                      | Log(BEV MS) | log(PHEV MS) | Log slow and normal chargers' density | Density of slow chargers | Density of normal chargers | Density of fast chargers | Density of ultrafast chargers | Difference in taxes | Number of models BEV | Number of models PHEV | Log Subsidies BEV | Log Subsidies PHEV | VKT     | Vehicle's electric range BEV | Vehicle's electric range PHEV | Income   | Population density | Age | Unemployment |
|--------------------------------------|-------------|--------------|---------------------------------------|--------------------------|----------------------------|--------------------------|-------------------------------|---------------------|----------------------|-----------------------|-------------------|--------------------|---------|------------------------------|-------------------------------|----------|--------------------|-----|--------------|
| Log(BEV MS)                          | 1           |              |                                       |                          |                            |                          |                               |                     |                      |                       |                   |                    |         |                              |                               |          |                    |     |              |
| Log(PHEV MS)                         | 0.52***     | 1            |                                       |                          |                            |                          |                               |                     |                      |                       |                   |                    |         |                              |                               |          |                    |     |              |
| Log slow and normal chargers density | 0.35***     | 0.64***      | 1                                     |                          |                            |                          |                               |                     |                      |                       |                   |                    |         |                              |                               |          |                    |     |              |
| Density of slow chargers             | 0.25***     | 0.32***      | 0.49***                               | 1                        |                            |                          |                               |                     |                      |                       |                   |                    |         |                              |                               |          |                    |     |              |
| Density of normal chargers           | 0.30***     | 0.43***      | 0.68***                               | 0.93***                  | 1                          |                          |                               |                     |                      |                       |                   |                    |         |                              |                               |          |                    |     |              |
| Density of fast chargers             | 0.31***     | 0.43***      | 0.70***                               | 0.83***                  | 0.92***                    | 1                        |                               |                     |                      |                       |                   |                    |         |                              |                               |          |                    |     |              |
| Density of ultrafast chargers        | 0.17***     | 0.30***      | 0.50***                               | 0.35***                  | 0.54***                    | 0.48***                  | 1                             |                     |                      |                       |                   |                    |         |                              |                               |          |                    |     |              |
| Difference in taxes                  | 0.24***     | 0.26***      | 0.23***                               | 0.09                     | 0.13*                      | 0.16***                  | 0.11*                         | 1                   |                      |                       |                   |                    |         |                              |                               |          |                    |     |              |
| Number of models BEV                 | 0.43***     | 0.47***      | 0.34***                               | 0.07                     | 0.13*                      | 0.14**                   | 0.12*                         | 0.18***             | 1                    |                       |                   |                    |         |                              |                               |          |                    |     |              |
| Number of models PHEV                | 0.41***     | 0.49***      | 0.40***                               | 0.07                     | 0.13**                     | 0.15**                   | 0.12**                        | 0.21***             | 0.98***              | 1                     |                   |                    |         |                              |                               |          |                    |     |              |
| Subsidies BEV                        | 0.25***     | 0.38***      | 0.59***                               | 0.40***                  | 0.54***                    | 0.50***                  | 0.38***                       | 0.18***             | 0.19***              | 0.20***               | 1                 |                    |         |                              |                               |          |                    |     |              |
| Subsidies PHEV                       | 0.22***     | 0.34***      | 0.52***                               | 0.30***                  | 0.44***                    | 0.39***                  | 0.34***                       | 0.17***             | 0.20***              | 0.21***               | 0.97***           | 1                  |         |                              |                               |          |                    |     |              |
| VKT                                  | -0.00       | 0.02         | -0.14**                               | -0.20***                 | -0.24***                   | -0.23***                 | -0.19***                      | -0.14**             | 0.00                 | 0.00                  | -0.04             | -0.01              | 1       |                              |                               |          |                    |     |              |
| Vehicle's electric range BEV         | -0.01       | 0.02         | 0.03                                  | 0.06                     | 0.05                       | 0.04                     | 0.01                          | 0.02                | -0.00                | -0.00                 | -0.00             | -0.01              | -0.07   | 1                            |                               |          |                    |     |              |
| Vehicle's electric range PHEV        | 0.29***     | 0.26***      | 0.14**                                | -0.00                    | 0.02                       | 0.03                     | 0.01                          | 0.10*               | 0.62***              | 0.59***               | 0.06              | 0.08               | 0.06    | -0.06                        | 1                             |          |                    |     |              |
| Income                               | 0.33***     | 0.59***      | 0.59***                               | 0.50***                  | 0.61***                    | 0.53***                  | 0.33***                       | 0.13**              | 0.08                 | 0.08                  | 0.48***           | 0.42***            | -0.14*  | 0.01                         | -0.04                         | 1        |                    |     |              |
| Population density                   | 0.22***     | 0.39***      | 0.61***                               | 0.77***                  | 0.84***                    | 0.81***                  | 0.48***                       | 0.14**              | 0.00                 | 0.00                  | 0.46***           | 0.36***            | -0.29** | 0.03                         | -0.07                         | 0.61***  | 1                  |     |              |
| Age                                  | -0.02       | -0.33***     | -0.40***                              | -0.14**                  | -0.26***                   | -0.28***                 | -0.24***                      | -0.02               | 0.11*                | 0.11*                 | -0.40***          | -0.38***           | -0.03   | -0.01                        | 0.12**                        | -0.56*** | -0.30***           | 1   |              |
| Unemployment rate                    | -0.29***    | -0.22***     | -0.17***                              | -0.12**                  | -0.14**                    | -0.11*                   | -0.10*                        | -0.27***            | -0.29***             | -0.31***              | -0.12*            | -0.10*             | 0.15*   | 0.06                         | -0.14**                       | -0.39*** | -0.09              | -   | 1            |
|                                      |             |              |                                       |                          |                            |                          |                               |                     |                      |                       |                   |                    | *       |                              |                               |          | 0.05               |     |              |

Note: \*p<10%; \*\*p<5%; \*\*\*p<1%

## Appendix 4.C: Results of Regressions with Robustness Checks

Table 4.6 Sensitivity of Regression Results for Models against the Exclusion of Departments

|                                      | Dependent variable:    |                              |                         |                              |
|--------------------------------------|------------------------|------------------------------|-------------------------|------------------------------|
|                                      | Log BEV Market Share   |                              | Log PHEV Market Share   |                              |
|                                      | Base model<br>(1)      | Excluding departments<br>(2) | Base model<br>(3)       | Excluding departments<br>(4) |
| Log Slow and Normal Chargers Density | -0.019<br>(0.012)      | -0.012<br>(0.014)            | 0.123***<br>(0.017)     | 0.132***<br>(0.019)          |
| Log Fast Chargers Density            | 6.014**<br>(2.367)     | 5.918**<br>(2.515)           | -                       | -                            |
| Log Ultra-Fast Chargers Density      | 3.996**<br>(2.031)     | 4.033*<br>(2.096)            | -                       | -                            |
| Log Subsidies/Vehicle_price          | 0.769*<br>(0.399)      | 0.584<br>(0.487)             | -2.870**<br>(1.366)     | -2.980*<br>(1.563)           |
| Difference in Registration Tax       | 0.003***<br>(0.001)    | 0.003***<br>(0.001)          | -                       | -                            |
| Number of Models                     | 0.027***<br>(0.003)    | 0.025***<br>(0.003)          | 0.012***<br>(0.002)     | 0.011***<br>(0.002)          |
| Log Electricity_price/SP95_price     | -1.570***<br>(0.308)   | -1.728***<br>(0.356)         | -4.963***<br>(0.458)    | -4.950***<br>(0.518)         |
| VKT                                  | 0.010<br>(0.011)       | -0.002<br>(0.014)            | 0.022*<br>(0.012)       | 0.028**<br>(0.014)           |
| Vehicle's electric range             | -0.002<br>(0.002)      | -0.002<br>(0.002)            | -0.001<br>(0.002)       | -0.0003<br>(0.002)           |
| Income                               | 0.00003**<br>(0.00001) | 0.00003**<br>(0.00001)       | 0.00006***<br>(0.00001) | 0.00007***<br>(0.00002)      |
| Population Density                   | -0.00002<br>(0.0002)   | -0.00002<br>(0.0002)         | -0.00003*<br>(0.00002)  | -0.00003<br>(0.00002)        |
| Age                                  | 0.012<br>(0.012)       | 0.017<br>(0.014)             | -0.019<br>(0.014)       | -0.016<br>(0.016)            |
| Unemployment                         | -0.0005<br>(0.017)     | -0.001<br>(0.020)            | -0.007<br>(0.019)       | 0.002<br>(0.022)             |
| Constant                             | -9.498***<br>(1.048)   | -9.810***<br>(1.221)         | -17.066***<br>(1.320)   | -17.257***<br>(1.512)        |
| Observations                         | 470                    | 470                          | 469                     | 469                          |
| Conditional R <sup>2</sup>           | 0.839                  | 0.839                        | 0.830                   | 0.836                        |
| Marginal R <sup>2</sup>              | 0.324                  | 0.307                        | 0.619                   | 0.629                        |

Note:

\*p<10%; \*\*p<5%; \*\*\*p<1%

Chapter 4: The Influence of Public Charging Infrastructure Deployment and Other Socio-Economic Factors on Electric Vehicle Adoption in France

Table 4.7 Sensitivity of Regression Results for Models against the Exclusion of Big Cities

|                                      | Dependent variable:    |                             |                         |                             |
|--------------------------------------|------------------------|-----------------------------|-------------------------|-----------------------------|
|                                      | Log BEV Market Share   |                             | Log PHEV Market Share   |                             |
|                                      | Base model<br>(1)      | Excluding big cities<br>(2) | Base model<br>(3)       | Excluding big cities<br>(4) |
| Log Slow and Normal Chargers Density | -0.019<br>(0.012)      | -0.017<br>(0.012)           | 0.123***<br>(0.017)     | 0.128***<br>(0.017)         |
| Log Fast Chargers Density            | 6.014**<br>(2.367)     | 3.136<br>(3.164)            | -                       | -                           |
| Log Ultra-Fast Chargers Density      | 3.996**<br>(2.031)     | 4.445**<br>(2.047)          | -                       | -                           |
| Log Subsidies/Vehicle_price          | 0.769*<br>(0.399)      | 0.676<br>(0.427)            | -2.870**<br>(1.366)     | -2.918**<br>(1.443)         |
| Difference in Registration Tax       | 0.003***<br>(0.001)    | 0.003***<br>(0.001)         | -                       | -                           |
| Number of Models                     | 0.027***<br>(0.003)    | 0.026***<br>(0.003)         | 0.012***<br>(0.002)     | 0.012***<br>(0.002)         |
| Log Electricity_price/SP95_price     | -1.570***<br>(0.308)   | -1.555***<br>(0.313)        | -4.963***<br>(0.458)    | -4.953***<br>(0.468)        |
| VKT                                  | 0.010<br>(0.011)       | 0.011<br>(0.012)            | 0.022*<br>(0.012)       | 0.022*<br>(0.012)           |
| Vehicle's electric range             | -0.002<br>(0.002)      | -0.002<br>(0.002)           | -0.001<br>(0.002)       | -0.002<br>(0.002)           |
| Income                               | 0.00003**<br>(0.00001) | 0.00003**<br>(0.00001)      | 0.00006***<br>(0.00001) | 0.00007***<br>(0.00001)     |
| Population Density                   | -0.00002<br>(0.0002)   | -0.00002<br>(0.00003)       | -0.00003*<br>(0.00002)  | -0.00003<br>(0.00003)       |
| Age                                  | 0.012<br>(0.012)       | 0.013<br>(0.013)            | -0.019<br>(0.014)       | -0.015<br>(0.015)           |
| Unemployment                         | -0.0005<br>(0.017)     | -0.003<br>(0.017)           | -0.007<br>(0.019)       | -0.010<br>(0.019)           |
| Constant                             | -9.498***<br>(1.048)   | -9.377***<br>(1.082)        | -17.066***<br>(1.320)   | -17.281***<br>(1.349)       |
| Observations                         | 470                    | 470                         | 469                     | 469                         |
| Conditional R <sup>2</sup>           | 0.839                  | 0.834                       | 0.830                   | 0.812                       |
| Marginal R <sup>2</sup>              | 0.324                  | 0.280                       | 0.619                   | 0.593                       |

Note:

\*p<10%; \*\*p<5%; \*\*\*p<1%

*Chapter 4: The Influence of Public Charging Infrastructure Deployment and Other Socio-Economic Factors on Electric Vehicle Adoption in France*

*Table 4.8 Sensitivity of Regression Results for Models against the Exclusion of Charging Infrastructure Control Variables*

|                                      | Dependent variable:    |                            |                         |                            |
|--------------------------------------|------------------------|----------------------------|-------------------------|----------------------------|
|                                      | Log BEV Market Share   |                            | Log PHEV Market Share   |                            |
|                                      | Base model             | No charging infrastructure | Base model              | No charging infrastructure |
|                                      | (1)                    | (2)                        | (3)                     | (4)                        |
| Log Slow and Normal Chargers Density | -0.019<br>(0.012)      | -                          | 0.123***<br>(0.017)     | -                          |
| Log Fast Chargers Density            | 6.014**<br>(2.367)     | -                          | -                       | -                          |
| Log Ultra-Fast Chargers Density      | 3.996**<br>(2.031)     | -                          | -                       | -                          |
| Log Subsidies/Vehicle_price          | 0.769*<br>(0.399)      | 1.111***<br>(0.361)        | -2.870**<br>(1.366)     | -0.744<br>(1.396)          |
| Difference in Registration Tax       | 0.003***<br>(0.001)    | 0.003***<br>(0.001)        | -                       | -                          |
| Number of Models                     | 0.027***<br>(0.003)    | 0.026***<br>(0.003)        | 0.012***<br>(0.002)     | 0.016***<br>(0.002)        |
| Log Electricity_price/SP95_price     | -1.570***<br>(0.308)   | -1.765***<br>(0.303)       | -4.963***<br>(0.458)    | -4.623***<br>(0.474)       |
| VKT                                  | 0.010<br>(0.011)       | 0.007<br>(0.011)           | 0.022*<br>(0.012)       | 0.027**<br>(0.013)         |
| Vehicle's electric range             | -0.002<br>(0.002)      | -0.002<br>(0.002)          | -0.001<br>(0.002)       | -0.002<br>(0.002)          |
| Income                               | 0.00003**<br>(0.00001) | 0.00003***<br>(0.00001)    | 0.00006***<br>(0.00001) | 0.00007***<br>(0.00001)    |
| Population Density                   | -0.00002<br>(0.0002)   | -0.00001<br>(0.00002)      | -0.00003*<br>(0.00002)  | 0.00001<br>(0.00002)       |
| Age                                  | 0.012<br>(0.012)       | 0.012<br>(0.012)           | -0.019<br>(0.014)       | -0.020<br>(0.015)          |
| Unemployment                         | -0.0005<br>(0.017)     | 0.008<br>(0.015)           | -0.007<br>(0.019)       | -0.027<br>(0.020)          |
| Constant                             | -9.498***<br>(1.048)   | -9.903***<br>(1.046)       | -17.066***<br>(1.320)   | -16.750***<br>(1.399)      |
| Observations                         | 470                    | 470                        | 469                     | 469                        |
| Conditional R <sup>2</sup>           | 0.839                  | 0.836                      | 0.830                   | 0.824                      |
| Marginal R <sup>2</sup>              | 0.324                  | 0.322                      | 0.619                   | 0.582                      |

Note:

\*p<10%; \*\*p<5%; \*\*\*p<1%

*Chapter 4: The Influence of Public Charging Infrastructure Deployment and Other Socio-Economic Factors on Electric Vehicle Adoption in France*

## **Chapter 5: Assessing the 2021-2025-2030 CO2 Standards on Automakers' Portfolio Vehicles' Segments**

The E.U. vehicle emission standards defined by the European Commission adopted Regulation number (E.U.)2019/631, which will become stricter by 15% in 2025 and 35% compared to 2021, cannot be achieved without fleet electrification - either fully electric or a combination of electric and internal combustion propulsion. This study compares the costs of fleet portfolio changes in terms of both CO2 compliance and vehicles production costs. To address this trade-off, we calculated the minimized production costs, from the automaker's point of view, of replacing Internal Combustion Engine Vehicles with Battery Electric Vehicles and Plug-in Hybrid Electric Vehicles for 12 scenarios that combine four vehicle segments and three regulatory regimes: targets set for 2021, 2025 and 2030. Results show that the introduction of BEVs and PHEVs into the vehicle fleet reduces the costs of CO2 compliance relative to a pure ICEV scenario for all vehicle segments. However, our results also suggest optimal combinations of vehicle segments, BEVs and PHEVs relative to ICEV to ensure minimum costs to the automaker. Results show that it is more beneficial for automakers to respect the CO2 targets rather than paying penalties, but that generally, the minimum costs are achieved by favouring PHEVs rather than BEVs in the portfolio, regardless of the segment. Finally, we analyze the results and compare them to the directive of the European Commission. We recommend that future research consider the vehicle's actual fuel consumption instead of standard cycle fuel consumption.

**This Chapter was presented at the 2021 Gerpisa International Colloquium, 2021 Applied Energy Symposium, and 2021 ITEA international conference:**

- Bassem Haidar, Fabrice Vidal, Pascal da Costa, Jan Lepoutre. Assessment of 2021-2025-2030 CO2 standards on automakers' portfolio vehicles' segments. International colloquium of Gerpisa 2021, 2021, Paris, France.
- Bassem Haidar, Pascal da Costa, Jan Lepoutre, Fabrice Vidal. Assessment of 2021-2025-2030 CO2 standards on automakers' portfolio vehicles' segments. The Annual School and Conference of the International Transportation Economics Association, 2021, Rome, Italy.
- Bassem Haidar, Pascal da Costa, Jan Lepoutre, Fabrice Vidal. Assessing the trade-offs between battery capacity and charging power of battery electric vehicles: A French case study. Applied Energy Symposium : MIT A+B, MIT and Harvard, 2021, Boston, United States.





## 1. Introduction

In order to reach ambitious climate change mitigation targets, the Intergovernmental Panel on Climate Change (IPCC) called for a reduction of greenhouse gas emissions (GHG) emissions, especially in the energy and transportation sectors that are currently heavily fossil-fuel dependent (IEA, 2019; IPCC, 2018). The transportation sector, responsible for 20% of global CO<sub>2</sub> emissions, of which 72% are emitted by road transportation, should become emission-free by 2050 to reach world ambitions: *holding the increase in the global average temperature to well below 2°C above pre-industrial levels and pursuing efforts to limit the temperature increase to 1.5°C* (IPCC, 2018).

To achieve an intermediate target of at least 55% net reduction in GHG emissions by 2030 and a climate-neutral E.U. by 2050, the European Commission has set regulatory targets regarding the overall and average CO<sub>2</sub> fleet emissions of vehicles sold per year. The European Parliament and the Council adopted Regulation number (E.U.)2019/631, setting new E.U. fleet-wide CO<sub>2</sub> emission targets for 2025 and 2030, both for newly registered passenger cars and newly registered Light Duty Trucks (E.C., 2019a). Figure 5.1 represents a schematic illustration of a new car average CO<sub>2</sub> emission levels in the E.U. in 2000–2030. From 2021 onwards, car manufacturers are given CO<sub>2</sub> emission targets for the "average car", i.e. the total level of emissions of cars sold, divided by the number of cars sold, yet with weight specific corrections applied. Furthermore, CO<sub>2</sub> limits regulations are set to become stricter for the long term, explicitly reducing 15% and 37.5% compared to 2021 must be achieved for 2025 and 2030, respectively (E.C., 2019a). In the case of non-respect of these targets, manufacturers have to pay a penalty of €95 per excessive gram of CO<sub>2</sub> per sold car (E.C., 2019a).

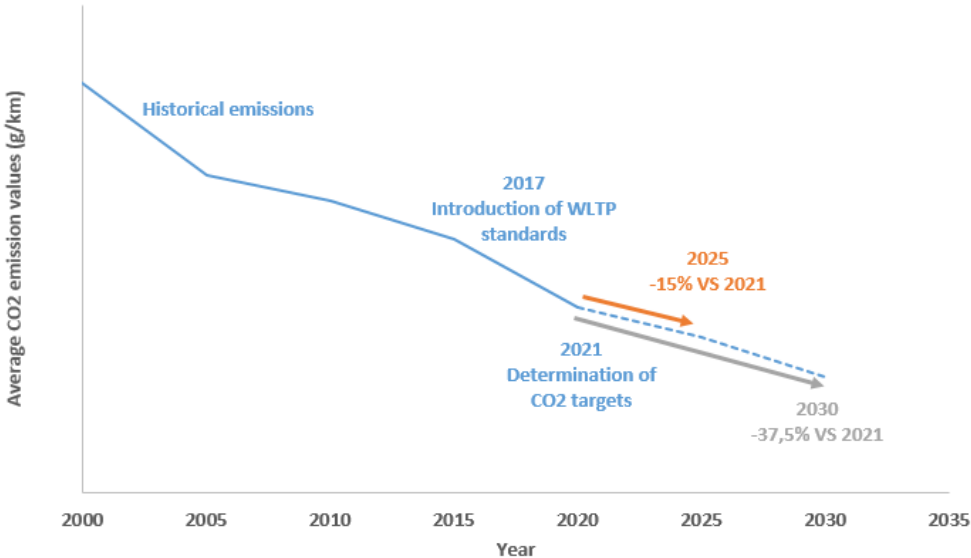

Figure 5.1 Schematic Illustration of a New Car Average CO2 Emission Levels in the E.U. in 2000–2030 (Source: European Commission (E.C., 2019a))

To reach CO2 targets, car manufacturers are challenged to develop new solutions and improve their existing ones to limit their fleet emissions relying on several technical and non-technical solutions. First, technical solutions, such as higher efficiency of combustion engines and lightweight design, have been suggested to potentially decrease a medium ICEV's (Internal Combustion Engine Vehicle) emissions from 140 gCO2/km to 70 gCO2/km by 2030 (Hüls et al., 2020). Second, fleet hybridization and electrification, i.e. selling more electric and hybrid vehicles, proves to be one of the promising solutions to achieve strict CO2 targets (Amjad et al., 2018). While technical improvements on ICEVs could considerably reduce a fleet's CO2 emissions, long-term emission targets are unlikely to be achieved with this approach only. Consequently, car manufacturers are forced to electrify their fleet, so most car manufacturers have already significantly increased the proportion of electrified vehicles in their portfolio (Hüls et al., 2020).

Electric vehicles (E.V.s), including Battery E.V.s (BEVs) and Plug-in E.V.s (PHEVs), have the potential to improve the environmental impact of personal-road transportation because of their ability to be non- and partial-fossil-fuel dependency (Amjad et al., 2018). E.U. regulatory standards consider BEVs to have 0 g CO2/km tank-to-wheel emission (Tank-to-Wheel focusing exclusively on the emissions produced by the car and excluding how the electricity was produced from the emissions analysis). Conversely, since PHEVs partially

depend on fossil fuels, their emissions are determined based on a combination of their ICE and electric engines' emissions and depend on the vehicle design.

Unfortunately, meeting the strict CO2 regulations has come with additional costs per vehicle for the automotive manufacturer. First, to meet CO2 regulations by technical improvements, R&D costs and higher production costs to embark new technologies in the vehicle have increased vehicle prices for the clients (Hüls et al., 2020; Islam et al., 2018; Luk et al., 2016). Most importantly, electric vehicles are relatively more expensive than ICEVs, primarily because of the high costs of the battery pack (Hüls et al., 2020; Islam et al., 2018).

Recently, the discussion regarding the cost-effectiveness of CO2 regulations has been modernized due to the stricter CO2 targets, pushing researchers to evaluate the cost implication of technical improvements on both the client and the automotive manufacturer. These studies proved that limiting CO2 emissions influences the vehicle purchasing price and thus the client's choice. Other articles concerning the automotive manufacturer showed that stricter CO2 regulations improve fleets' fuel economy, fleet composition, and job displacement (Al-Alawi and Bradley, 2014).

Moreover, policymakers, such as governments and public and local authorities, offer several financial incentives for newly BEV/PHEV adopters. The maximum amount of subsidies varies from one country to another: 4000€ in Germany and Belgium, 5000€ in the United Kingdom, 5700€ in Sweden, and 11000€ in France (Wavestone, 2019). These policymakers aim to evaluate the cost-effectiveness of CO2 regulatory compliance using non-technical improvements solutions, i.e. hybridization and electrification, which help reach emissions targets faster. Indeed, various articles zoomed into the value of PHEV towards the customers (Al-Alawi and Bradley, 2013). Until now, studies evaluating the value of E.V.s to automotive manufacturers and policymakers to achieve emissions targets remain limited. To the best of our knowledge, only (Al-Alawi and Bradley, 2014) studied whether PHEVs can offer a cost value in helping an automobile manufacturer comply with US CO2 standards, considering different PHEV scenarios in terms of sizes, fuel economy, and costs.

Al-Alawi and Bradley (2014) have calculated the relative value that PHEVs can have in reducing an automaker's costs of CAFE compliance and concluded that PHEVs have a lower cost of compliance with CAFE regulations than conventional technologies. However, questions remain on several assumptions: (1) the effect of European regulations (instead of U.S.

regulations) on the automotive manufacturers' portfolio, (2) the relative value of BEV and PHEV in avoiding costs of CO2 emission regulations, and (3) the trade-off between paying the CO2 penalty or increasing the BEV/PHEV sales shares. Our study aims to close these research gaps in the literature and evaluate the economic effect of electrification, both BEV and PHEV, on the automotive manufacturer. This study develops a model of the CO2 compliance for automakers for the regulatory regime years 2021, 2025, 2030, taking into account different segments of BEV and PHEV emerging technologies and considering European regulations. However, the European level puts PHEV technology under pressure because the E.U. policy plans to limit the transition technology by a shorter lifespan than envisaged by some leading automakers.

Our Chapter is structured as follows: Section 2 presents the literature review. Section 3 discusses the methodology and, in Section 4, the data and the techno-economic parameters. The results of the study and the discussions are presented in Section 5. The conclusions and future researches are drawn up in Section 6.

## 2. Literature Review

A voluntary agreement between the automakers was the origin of improving fuel economy in Germany, based on the ACEA 10-years roadmap. In 1978, the German automotive industry improved fuel efficiency by 15% from 1978 to 1985 and 25% from 1990 to 2008. These German voluntary agreements, so-called VDA Agreements, were achieved successfully (Gadesmann and Kuhnert, 2007). Then, the European automotive industry decided to respect the E.C.'s 1996 objective to reduce the average CO2 emissions of new passenger cars to 120 g/km by 2005. Technological developments mainly achieved the regulations' targets by improving car characteristics and market changes linked to these developments. After manufacturers announcing that they would not meet the 1998 commitment by 2008, in February 2007, the E.C. announced the imposition of CO2 emission targets for 2012, joining the U.S., China, and Japan to pass legally binding fuel economy targets. The objective is to reduce emissions from the average new car to 120 gCO<sub>2</sub>/km by 2012. An additional 10 gCO<sub>2</sub>/km could be added if the automaker achieved the targets using biofuels and other technological improvements. After that, the E.C. began setting up stricter regulations in order to reach carbon neutrality by 2050.

Respecting CO2 targets by electrification implies a transformation of powertrain portfolios – from combustion to electric engine - which is further complicated by dynamic and uncertain developments. Numerous studies studied the impact of CO2 standards on the automotive industry: higher CO2 targets are responsible and effective for improving fleet fuel economy (Goldberg, 1998; Greene, 2007, 1998). Also, other studies found that stricter standards lead to fleet makeup (Bezdek and Wendling, 2005), job displacement (Dacy et al., 1992), and higher budgets, especially in R&D (MacDuffie, 2018; Perkins and Murmann, 2018). Also, other researchers have debated the cost-effectiveness of CO2 standards in effectively improving fleet fuel economy and its impact on the automotive manufacturer and the customer, considering technical and non-technical solutions.

First, the impact of respecting CO2 standards on vehicle fleet attributes, i.e. technical specifications and vehicle's price, have received widespread attention in the literature. These techno-economic or econometric studies were mainly done in US-CAFE (Corporate Average Fuel Economic) regulations. These studies have shown that higher CO2 standards are responsible and effective for improving automotive manufacturers average fleet fuel economy, primarily by increasing the rate of technological improvements impacting CO2 emissions in new passenger cars (Wang and Miao, 2021). Also, several studies found that strict CO2 standards have unintended consequences to fleet makeup, such as smaller engine and a decrease in interior volume (Knittel, 2011; Luk et al., 2016), job displacement (Al-Alawi and Bradley, 2014), and novel portfolio planning (Hüls et al., 2020). Furthermore, research has also shown that respecting CO2 emissions comes with additional costs on the automotive manufacturer; and, thus, on the client by higher vehicle price. Luk et al. (2016) concluded that expected technology cost reductions over time would be insufficient to offset the costs of other fuel efficiency technologies that could be used to meet the 2025 fuel economy target while maintaining other vehicle attributes (acceleration and interior volume). Their results showed that a 66% increase in fuel economy from 2012 to 2025 could be achieved with only a 10% (\$2070) vehicle price increase. The National Highway Transportation Safety Administration concluded that vehicle prices would increase by \$1870–2120 in response to 2012–2025 fuel economy targets as automakers add fuel efficiency technologies to vehicles maintaining size and acceleration. Overall, while improving technical specifications, respecting strict CAFE engagement comes with a cost on both the automotive manufacturer and the client due to the fuel economy technologies costs and could affect the customer's choice.

Second, achieving long-term fuel economy by 2030 is challenging since automakers must respect strict CAFE standards. Hybridization and electrification are two unescapable solutions to achieve these standards. Several studies have quantified the cost and benefits of purchasing a PHEV/BEV to the customer, using several techno-economic approaches, such as Total Cost of Ownership (TCO) (Al-Alawi and Bradley, 2013) and Equivalent Annual Cost (EAC) (Haidar et al., 2020). To date, few studies have considered the cost implication of PHEVs to automotive manufacturers, considering updated electrification costs. Indeed, Cheah and Heywood evaluated the cost implication of electrification by considering only one PHEV design and its compliance costs with other HEV technologies' costs (Cheah and Heywood, 2011). They concluded that achieving an increase in fuel economy by 2030 is challenging but more feasible because the U.S. automotive manufacturer will have more time to respect their CAFE engagements. More rigorous quantification of PHEVs' value to the automaker is provided by (Al-Alawi and Bradley, 2014) by estimating the cost of CAFE compliance with two-design PHEVs as a component of the domestic passenger and light-truck vehicle fleet. They concluded that for many U.S. automakers (Fiat-Chrysler, Ford, and General Motors) and various PHEV design scenarios, passenger car PHEVs reduce CAFE regulation compliance costs for the U.S. automakers.

While Al-Alawi and Bradley (2014) made significant improvements in this field, questions remain regarding several hypotheses. First, they considered only PHEV as a means to achieve CO2 standards, neglecting the fact that BEVs offer a more effective solution because of their non-dependency on fossil fuels and their zero CO2 emissions. Yet, BEV comes with a higher manufacturing cost than PHEVs due to the higher battery capacity. Also, actual tests prove that PHEV could emit more CO2 emissions than expected. Second, their perspective was focused on compliance with US CAFE regulation, begging the question of whether similar conclusions could be drawn for other regulatory regimes, such as those in Europe. Our Chapter aims to close these research gaps. Based on this understanding of the field, the purpose of this study is to evaluate the economic value of electrification, both BEV and PHEV, on the automotive manufacturer. This study describes a model of CO2 compliance to meeting 2021-2025-2030 targets for European automakers. We consider four segments of PHEV/BEV of different sizes battery capacities to evaluate the trade-off between the production costs and penalty costs for on-respecting the standards.

### 3. Methodology

The trade-off between increasing BEV and PHEV sales is evaluated based on a three-step methodology, as shown in Figure 5.2. A differentiation per vehicle segment is proposed (Hüls et al., 2020; Islam et al., 2018). First, we determine the CO2 targets based on the weight of sold vehicles. Second, we determine the BEV and PHEV sales while minimizing the total costs associated with the automaker, including the incremental cost - i.e. the difference in production costs between a BEV/PHEV and an ICEV of the same type - and the penalty, if applicable, respecting the CO2 standards - i.e. with a zero penalty. Finally, we compared the results in order to address the trade-off. We repeat this methodology considering four vehicle's segments and for 2021, 2025, and 2030.

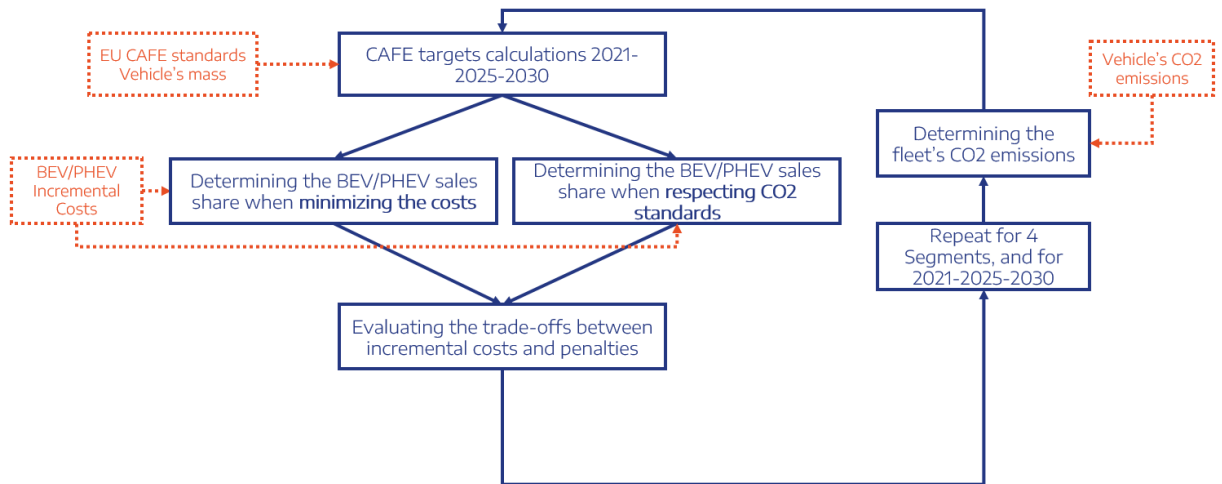

Figure 5.2 Methodology Overview

#### 3.1. Calculation of CO2 Targets

In 2021, European vehicle manufacturers must determine their short and long-term CO2 emissions targets, based on Figure 5.1. Table 5.1 details the variables and their significations. To begin with, it should be noted that a ZLEV (Zero- and Low- Emissions Vehicles) is defined as a passenger car with CO2 emissions between 0 and 50 g/km. For calculating the ZLEV sales share in a manufacturer's fleet, an accounting rule applies, giving greater weight to BEV than PHEV  $\left(\alpha_{PHEV} = \left(1 - \frac{0.7 * \min(e_{PHEV}, 50)}{50}\right) * \alpha_{BEV}\right)$ . A BEV will be counted as 30% of a PHEV that emits 50 gCO2/km. Regarding the calculation of CO2 targets, for 2021, this target is determined based on sold vehicles' weight, as mentioned in Figure 5.3 and Table 5.1. (E.C.,



2019a). For medium and long-term targets, a further emission reduction by 15% and 37.5% compared to 2021 must be achieved for 2025 and 2030, respectively. Then, a specific CO2 emission target will be relaxed if its share of ZLEV registered in a given year exceeds the following benchmarks: 15% ZLEV from 2025 and 35% ZLEV from 2030. Indeed, a one percentage point exceedance of the ZLEV benchmark will increase the manufacturer's CO2 target by one per cent. The target relaxation is capped at a maximum of 5% to safeguard the regulation's environmental integrity. If the CO2 targets are not respected, the automaker must pay a 95 €/exceeded gCO2/km/vehicle penalty. Figure 5.3 presents a detailed methodology for CO2 targets calculations.

| Contents                     | Calculation of CO2 targets for each vehicle manufacturer for newly registered passenger vehicles in the European Union in each calendar year.   |
|------------------------------|---|
| <b>ZLEV Quota</b>            | The PHEV quota is calculated based on their CO2 emissions:<br>$\alpha_{PHEV} = \left( 1 - \frac{0.7 * \min(e_{PHEV}, 50)}{50} \right) * \alpha_{BEV}$   |
| <b>CO2 targets [gCO2/km]</b> | <b>For 2020/2021:</b><br>$T_{CO2_{2021}} = 121 + 0.0333 * \left( \sum \alpha_i m_i - m_0 \right)$ <p>With:<br/>                     - <math>i</math>= type of the vehicle: BEV, PHEV, or ICEV<br/>                     - <math>\alpha_{ZLEV_{20xx}} = \alpha_{BEV_{20xx}} + \alpha_{PHEV_{20xx}}</math></p> <b>For 2025 and 2030:</b><br>- 2025: a reduction of 15% compared to 2020/2021 ( $r_{20xx}=15\%$ )<br>- 2030: a reduction of 37.5% compared to 2020/2021 ( $r_{20xx}=37.5\%$ )<br>$T_{CO2_{20xx}} = (1 - r_{20xx}) * (1 + \alpha_{ZLEV_{20xx}} - T_{ZLEV,20xx}) * T_{CO2_{2021}}$  |
| <b>Additional credits</b>    | <b>In the case if the automaker exceed a defined quota of ZLEV:</b><br>A one percentage point exceedance of the ZLEV benchmark will increase the manufacturer's CO2 target by one per cent, as a maximum of 5%.<br>- 2025: The defined quota is 15% ( $T_{ZLEV,20xx}=15\%$ )<br>- 2030: The defined quota is 35% ( $T_{ZLEV,20xx}=35\%$ )<br>$T_{CO2_{20xx}} = \begin{cases} (1 + \alpha_{ZLEV,20xx} - T_{ZLEV,20xx}) * (1 - r_{20xx}) * (1 + \alpha_{ZLEV_{20xx}} - T_{ZLEV,20xx}) * T_{CO2_{2021}} & : (\alpha_{ZLEV,20xx} - T_{ZLEV,20xx}) < 5\% \\ 1.05 * (1 - r_{20xx}) * (1 + \alpha_{ZLEV_{20xx}} - T_{ZLEV,20xx}) * T_{CO2_{2021}} & : (\alpha_{ZLEV,20xx} - T_{ZLEV,20xx}) \geq 5\% \end{cases}$ |
| <b>Penalty (if exceeded)</b> | 95 €/exceeded gCO2/km/vehicle   |

Figure 5.3 Calculation of CO2 Targets Methodology

Table 5.1 Variables Definition

| Variable          | Description                                      | Unit    |
|-------------------|--|---------|
| $T_{CO2\ 20xx}$   | CO2 Targets for the year 20xx                    | gCO2/km |
| $r_{20xx}$        | Emissions reduction for the year 20xx            | -       |
| $T_{ZLEV\ 20xx}$  | BEV and PHEV quota for the year 20xx             | -       |
| $\alpha_{i,20xx}$ | BEV, PHEV, or ICEV Sales Share for the year 20xx | -       |
| $e_{PHEV}$        | CO2 emissions of the vehicle                     | gCO2/km |
| $m_i$             | Weight of the vehicle 'i'                        | kg      |

### 3.2. Determination of PHEV/BEV sales share

To determine the BEV and PHEV sales share, using Equation 1, we minimize the total costs associated with the automaker, including the incremental cost per vehicle type and the penalty, if applied. Table 5.2 details the variables and their significations. We also determine the sales share that allows for respecting the CO2 targets and for which no penalties are applied. We solve these equations by simulation procedure: we vary the PHEV sales share from 0% to 100%, with a step of 1%, and we deduce the associated BEV sales share.

$$\begin{cases} \min_{\alpha_B, \alpha_{PHEV}} \left( - \sum \alpha_{i,20xx} * IC_{i,20xx} + p_{CO2} * (E - T_{CO2\ 20xx}) \right); \text{if } E > T_{CO2\ 20xx} \\ \min_{\alpha_B, \alpha_{PHEV}} \left( - \sum \alpha_{i,20xx} * IC_{i,20xx} \right); \text{if } E \leq T_{CO2\ 20xx} \end{cases} \quad (1)$$

With:

- $i$  = type of the vehicle: BEV, PHEV, or ICEV
- $E = \sum \alpha_{i,20xx} e_i$

Table 5.2 Variables Definition

| Variable          | Description   | Unit              |
|-------------------|---|-------------------|
| $T_{CO2\ 20xx}$   | CO2 Targets for the year 20xx                       | gCO2/km           |
| $\alpha_{i,20xx}$ | BEV, PHEV, or ICEV Sales Share                      | -                 |
| $IC_{i,20xx}$     | Incremental Costs of BEV and PHEV for the year 20xx | €/vehicle         |
| $e_i$             | CO2 emissions of the vehicle 'i'                    | gCO2/km           |
| $E$               | CO2 emissions of the fleet                          | gCO2/km           |
| $p_{CO2}$         | Penalty for non-respect of CO2 standards            | €/gCO2/km/vehicle |

## 4. Data

The structure of the passenger transportation sector is detailed in Figure 5.4. Despite air, ship, rail, and bus transportation methods, a passenger could use her vehicle to move, which is the study's scope. The passenger car sector includes four different sizes: Segment A (small sedan), Segment B (medium sedan), Segment C (large sedan), and Segment D (SUV). This study considers that each mode has three technology options: ICEV, BEV, and PHEV, additionally to HEV<sup>26</sup> and FCEV<sup>27</sup> that are not considered.

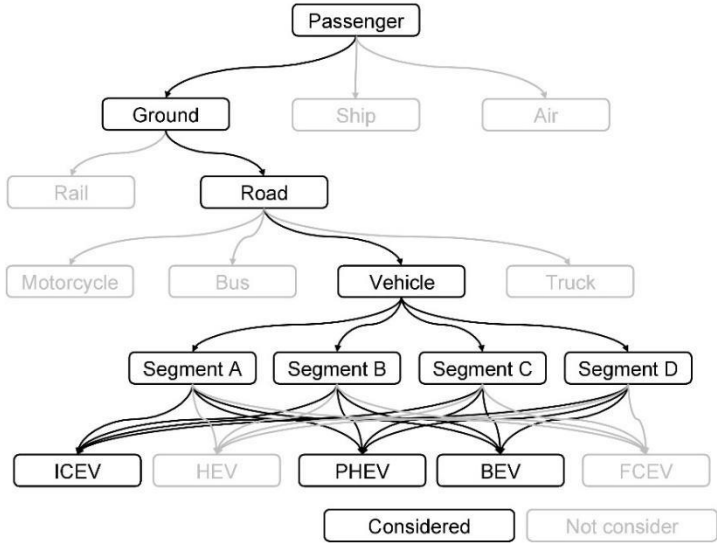

Figure 5.4 Representation of the Transportation Sector's Structure Used in this Study (Adapted from (Jeon et al., 2020)).

### 4.1. PHEV and BEV Cost Assumptions

The powertrains' technological differences, detailed in Table 5.3, come with economic implications on the automaker (Hüls et al., 2020; Islam et al., 2018; Proff and Fojcik, 2016). ICEVs are fully powered by traditional gasoline, diesel, biofuels, or even natural gas engines. On the contrary, BEVs have no internal combustion engine, emission control, nor fuel tank and run on a fully electric drivetrain powered by batteries that could be charged by plugging into an external power source. Regarding PHEV, this type of vehicle contains a hybrid drivetrain and uses both an internal combustion engine and an electric motor. Their battery could be charged externally by plugging into an external power source. When the battery is depleted, the PHEV starts acting as a regular hybrid, with the combustion engine taking the primary power

<sup>26</sup> Hybrid Electric Vehicle  
<sup>27</sup> Fuel Cell Electric Vehicle

*Chapter 5: Assessing the 2021-2025-2030 CO2 Standards on Automakers' Portfolio Vehicles' Segments*

source role. Yet, since the battery is a second power source in a PHEV, its capacity is much smaller than BEV. Battery costs for modern lithium-ion (Li-Ion) batteries are derived from several sources, as illustrated in Figure 5.5: Berckmans et al. (2017), BloombergNEF (2019), Hsieh et al., (2019), and Lutsey and Nicholas (2019). Overall, the cost for Li-Ion battery packs is expected to decrease by 43% for 2025 and 54% for 2030.

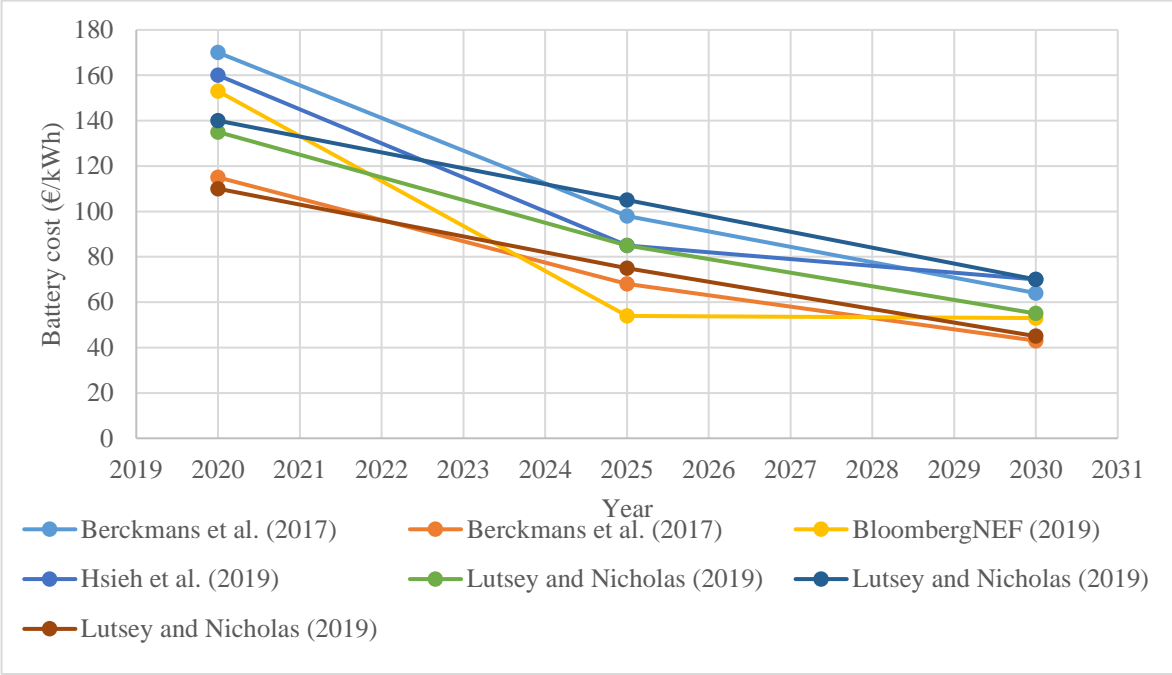

*Figure 5.5 Li-Ion Battery Packs Price Projection*

To evaluate the cost implication of electrification, we are interested in the BEV/PHEV incremental cost, which is the difference in costs between producing a BEV/PHEV and an ICEV of the same Segment. The incremental cost includes all vehicle components not available in an ICEV, such as electric drive, electric accessories, battery, energy storage systems, and internal charger. The costs for each Li-Ion battery are added to the incremental component cost to represent the incremental cost of BEV production. Figure 5.6 presents the incremental costs of BEV and PHEV of four segments for 2021-2025-2030. The incremental costs present our analysis based on different sources: Islam et al. (2018), Hüls et al. (2020), Lutsey and Nicholas (2019), and own sources<sup>28</sup>. Even though ICEs are more complex than electric engines and cost more, producing a BEV and PHEV is relatively more expensive due to the critical cost of the battery. As a result, the BEV incremental costs are higher than PHEV, having much smaller batteries. However, since battery pack prices are expected to decrease in the coming years

<sup>28</sup> Internal sources such as World Automotive Powertrain Outlook (WAPO)

compared to 2020, the incremental costs are expected to experience a downward trend for the long term.

Table 5.3 ICEV, BEV, and PHEV Parameters

|                               | ICEV | BEV | PHEV |
|-------------------------------|------|-----|------|
| Glider                        | ✓    | ✓   | ✓    |
| Emission control              | ✓    |     | ✓    |
| Integrated traction drive     |      | ✓   | ✓    |
| Combustion engine             | ✓    |     | ✓    |
| Electric motor                |      | ✓   | ✓    |
| Battery                       |      | ✓   | ✓    |
| Generator, transmission, rest | ✓    | ✓   | ✓    |

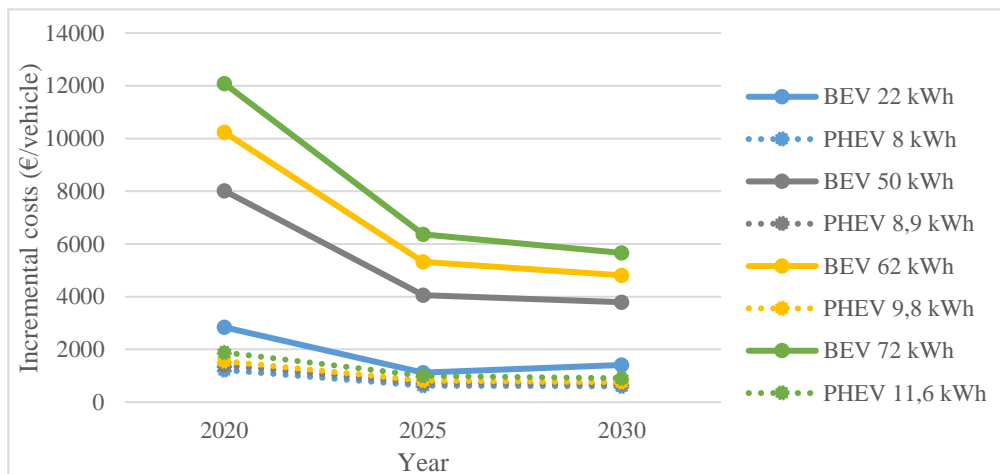

Figure 5.6 Incremental Costs of BEV and PHEV for 2020, 2025, 2030 (The Authors Define Vehicles Sizing, Costs Elements are Defined by (Islam et al., 2018), (Hüls et al., 2020), (Lutsey and Nicholas, 2019), and own sources)

## 4.2. PHEV and BEV Techno-environmental Assumptions

### 4.2.1. Vehicle Weight Assumptions

As mentioned in Equation 1, the average weight of sold vehicles is mandatory to determine the CO2 targets for 2021. We gathered data on vehicle weight from different official brands. They are detailed in Table 5.4.

4.2.2. Vehicle GHG Emissions Assumptions

Vehicles emit GHG emissions through their life cycle, called Well-To-Wheel emissions (WTW), which focuses on the energy carrier's life cycle used to move the vehicle, such as fossil fuel or electricity. Figure 5.7 presents a simplified view of the Life Cycle Assessment of the production process of a vehicle. The TWT life cycle can be divided into the Well-To-Tank (WTT) and the Tank-To-Wheel stage. The WTT stage defines the emissions required to deliver energy from its source to the vehicle's storage equipment by considering all processes from harnessing a primary energy flow or stock to different conversion forms, distribution, and energy carriers' storage. The TTW stage defines the emissions where the energy carrier is used to move the vehicle while driving. The environmental burden of the WTT stage differs a lot, depending on how the energy carrier is produced.

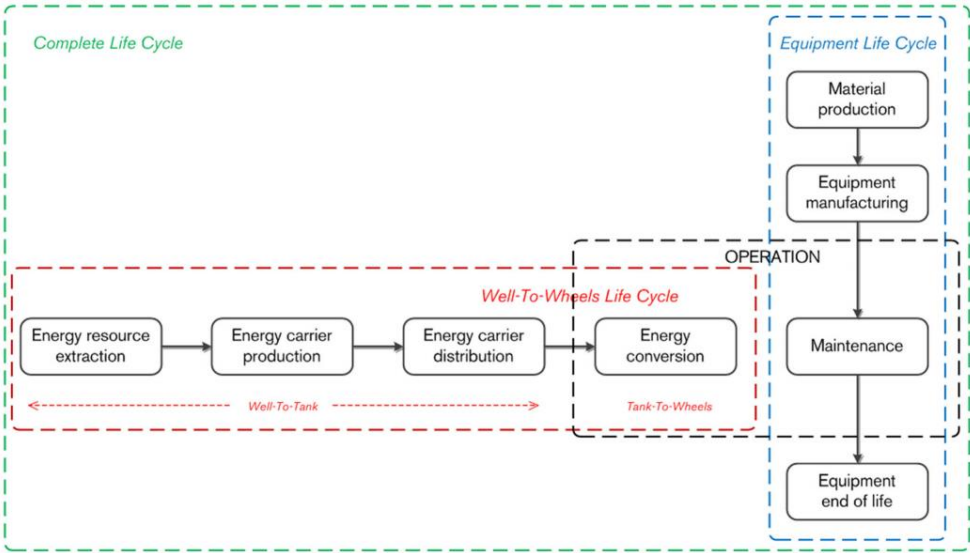

Figure 5.7 Simplified View of the Well-to-Wheels and Equipment Flows (a more detailed view would include, for example, recycling options) (Source:(Nordelöf et al., 2014))

The vehicles' emissions are based on the Life Cycle Assessment, which differs from a country to another, based on their energy mix. Several studies have found that TtW GHG emissions present the major contributor, 70%-90% of life-cycle GHG emissions (Jang and Song, 2015; Jeon et al., 2020; Khan et al., 2019). Hence, this study focuses on analyzing TtW GHG emissions considered for assessing CO2 standards in Europe.

In BEVs, no CO2 emissions are released during their use, leading to zero TtW emissions. On the contrary, since PHEVs are partially dependent on fossil fuels, the emissions are calculated as a combination of the combustion engine's emissions and the electric engine,

depending on the electric driving range and with differences in the regional legislation (Hüls et al., 2020). Thus, its TtW emissions are positive and dependent on the vehicle's segment. Indeed, the bigger the vehicle, the more GHG emissions are emitted. Data on CO2 emissions, gathered from different official brands, are detailed in Table 5.4.

Table 5.4 Weight and CO2 Emissions of Passenger Car fleet used in this Study (Source: Official brands sites)

|                                | <b>Example</b> | <b>Type</b>     | <b>Mass (kg)</b> | <b>CO2 Emissions (gCO2/km)</b> |
|--------------------------------|----------------|-----------------|------------------|--------------------------------|
| <b>Segment A</b>               | Peugeot 108    | ICEV Essence    | 840              | 109                            |
| <b>Segment A</b> <sup>29</sup> |                | ICEV Diesel     |                  |                                |
| <b>Segment A</b>               | Renault Twingo | BEV (22 kWh)    | 1160             | 0                              |
| <b>Segment A</b> <sup>30</sup> |                | PHEV (8 kWh)    | 1500             | 26                             |
| <b>Segment B</b>               | Peugeot 208    | ICEV Essence    | 1090             | 129                            |
| <b>Segment B</b>               | Peugeot 208    | ICEV Diesel     | 1090             | 108                            |
| <b>Segment B</b>               | Peugeot 208    | BEV (50 kWh)    | 1455             | 0                              |
| <b>Segment B</b>               | Hyundai Ioniq  | PHEV (8.9 kWh)  | 1570             | 26                             |
| <b>Segment C</b>               | Peugeot 308    | ICEV Essence    | 1203             | 139                            |
| <b>Segment C</b>               | Peugeot 308    | ICEV Diesel     | 1320             | 128                            |
| <b>Segment C</b>               | Nissan Leaf    | BEV (62 kWh)    | 1791             | 0                              |
| <b>Segment C</b>               | Renault Mégane | PHEV (9.8 kWh)  | 1603             | 28                             |
| <b>Segment D</b>               | Peugeot 508    | ICEV Essence    | 1420             | 161                            |
| <b>Segment D</b>               | Peugeot 508    | ICEV Diesel     | 1430             | 130                            |
| <b>Segment D</b>               | Tesla Model S  | BEV (72 kWh)    | 2100             | 0                              |
| <b>Segment D</b>               | Peugeot 508    | PHEV (11.6 kWh) | 1720             | 34                             |

## 5. Results

The European Commission's formulas calculate the total costs and CO2 fines for scenarios that vary engine types, segments and regulatory regimes for 2021, 2025, and 2030. In order to assess the trade-off between producing more ZLEVs on the one hand and paying CO2 fines for non-respect of targets on the other, we separately determined the BEV and PHEV sales

<sup>29</sup> An ICEV Diesel of Segment A does not exist.

<sup>30</sup> Until now, a Segment A PHEV does not exist on the market. Based on Gnann (Gnann, 2015), we identified a fictitious vehicle.

shares for every scenario and for both case studies: minimizing the total costs and respecting the CO2 targets. We found that BEV and PHEV sales shares for respecting CO2 targets are the same for minimizing the total costs. Indeed, the total costs account for the production cost of BEV/PHEV compared to ICEV of the same segment and the penalty if the CO2 standards are not respected.

5.1. Results

5.1.1. Determining The CO2 Targets

Based on the legislative requirements mentioned in Section 3.1., car manufacturers must set their CO2 targets for 2021 based on the weight of the newly sold passenger cars. Until 2025 (2030), a further emission reduction by 15% (37.5%) than 2021 must be achieved. Therefore, automotive manufacturers are required to sell electrified vehicles that respect these targets. Figure 5.8 presents the determination of 2021 CO2 targets of different scenarios in gCO2/km. Selling larger vehicles come with a trade-off: higher weight that made CO2 targets less strict, but higher CO2 emissions, as mentioned in Table 5.4. It should be noted that we consider an ICEV fleet composed of 60% of type Essence and 40% of type Diesel.

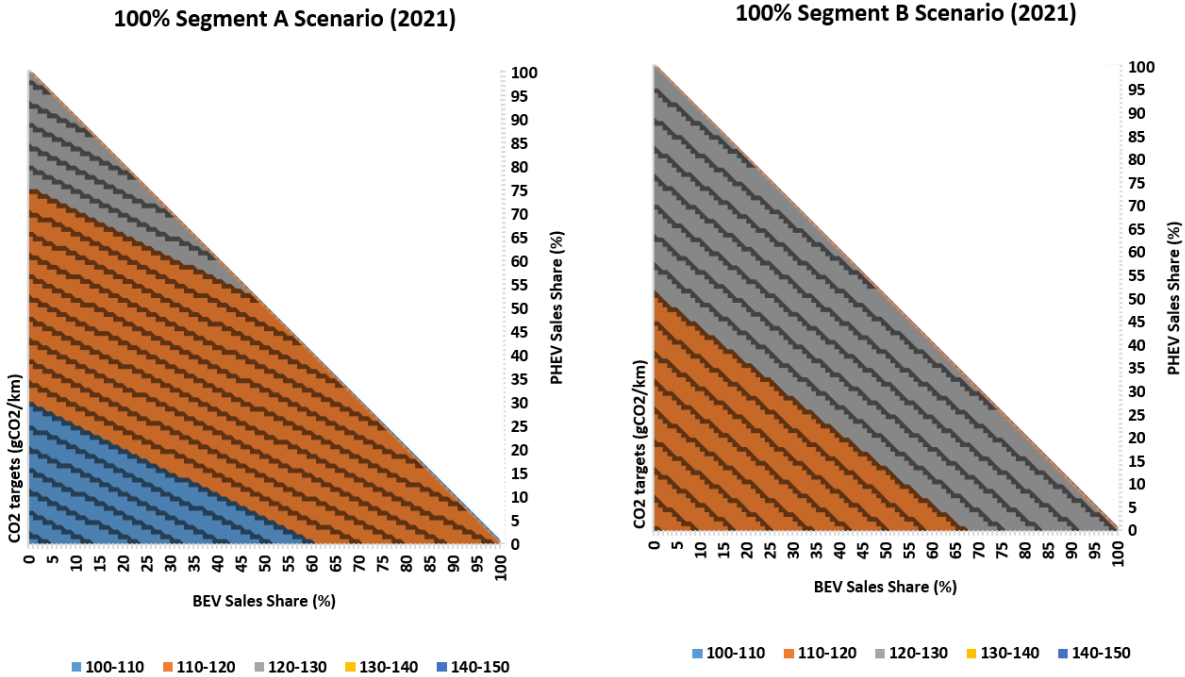



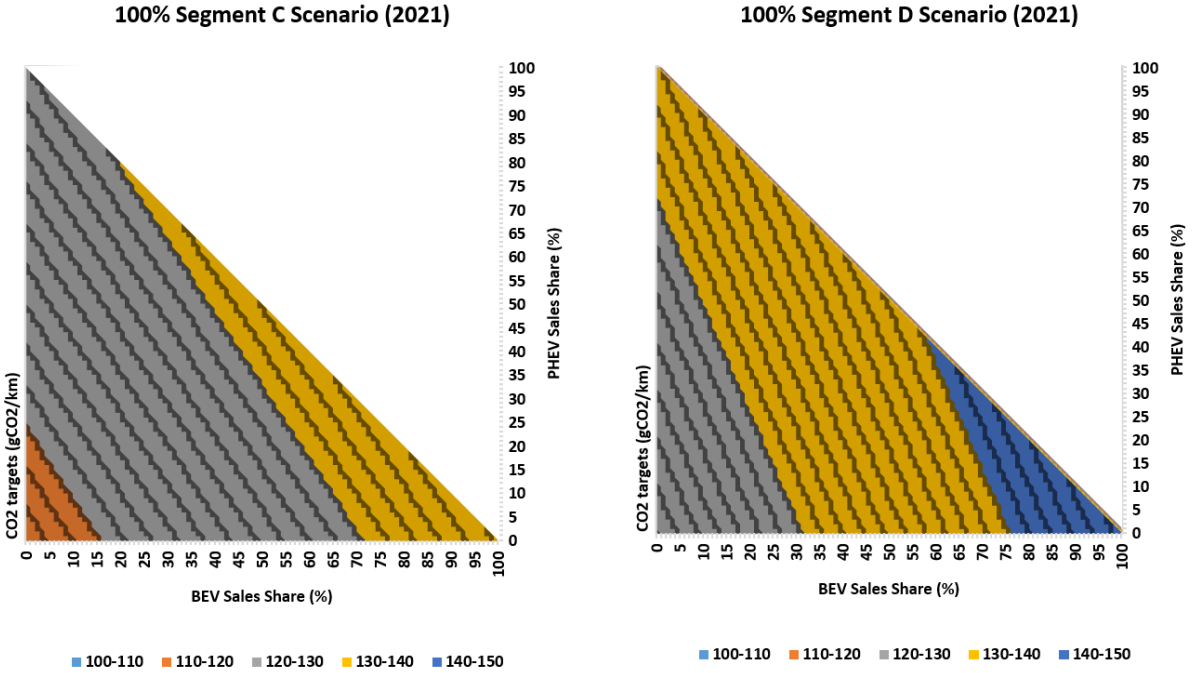

Figure 5.8 The determination of 2021 CO2 Targets of Different Scenarios in gCO2/km

5.1.2. Minimizing The Total Costs

Figure 5.9 presents the evolution of the total costs for 2021 (red dots), 2025 (blue dots), 2030 (black dots), and per vehicle segment. As shown, the results are similar for all scenarios and could be detailed with the same logic.

In the absence of ZLEVs, BEV and PHEV sales in a car manufacturer's portfolio, maximum penalties are applicable. These penalties amount to around 1000€/vehicle for segment A vehicles in 2021, but sharply increasing to 5000€/vehicle in 2030 for segment A vehicles. For other vehicles segments, fines vary between 1000€/vehicle (2020) and 5000€/vehicle (2030) for Segment B, 1900€/vehicle (2020) and 8100€/vehicle (2030) for Segment C, and 2200€/vehicle (2020) and 9500€/vehicle (2030) for Segment D. The total costs decrease to reach an optimum for every combination of BEV and PHEV sales share. As mentioned before, this Chapter does not consider the profitability margin of the automaker. On the one hand, since producing a PHEV/BEV comes with an additional cost compared to an ICEV – positive incremental costs – therefore, the total costs are all negative (Equation 2). On the other hand, it helps the automaker achieve their CO2 targets; and, thus, eliminate the fines.

Indeed, we determined the optimum for every segment and every year: more BEV/PHEV sales are needed to reach the optimum for more oversized vehicles and the long term. For instance, as mentioned in Figure 5.9, Segment A's optimums achieved vary between 90€/vehicle and 150 €/vehicle for 2020, and between 450 €/vehicle and 675 €/vehicle for 2030, compared to those of Segment D 450 €/vehicle and 1800 €/vehicle for 2020, and between 460 €/vehicle and 2380 €/vehicle for 2030. We have various costs because these optimums are achieved for every combination of BEV and PHEV sales share. Also, even though the battery packs price will decrease by around 55 % in 2030 compared to 2020, more losses are recorded for higher BEV sales share than PHEV sales.

After reaching the minimum of costs under a specific combination of BEVs and PHEVs sales shares, the total costs will experience a downward trend with a massive diffusion of these technologies. Indeed, more ZLEV production will come with additional costs on the automaker's budget. As shown in Figure 5.9, for 2021, due to the high price of the battery packs and the bigger battery capacity installed in BEV than in PHEV, a 100% BEV scenario comes with around 8000 €/vehicle compared to 900 €/vehicle for 100% PHEV scenario. Indeed, the total costs increased for other Segments because of the larger battery installed. For 2025 and 2030, these losses sharply decreased compared to 2021, leading to modest variation compared to the minimum costs.

Figure 5.10 shows the best compromise of BEV and PHEV sales shares that ensure the minimum costs of all the fleet to analyze the optimum values. Indeed, for all scenarios, a 100% PHEV sales lowest production budget on the automaker because of the battery capacity size and price. It is worth noting that, for Segment A and 2025 and 2030, the best compromise accounts for 99% of PHEV sales share compared to 1% of BEVs.

### 5.1.3. Respecting CO2 Targets

This section determines the BEV and PHEV sales shares that ensure the CO2 target's engagement. Figure 5.11 illustrates these results for all scenarios: the complete lines represent the combinations of BEV and PHEV sales shares for minimizing the total costs, and the dotted lines represent those that ensure the respect of CO2 targets. Results show that the minimum cost comes concerning CO2 targets for all Segments and time resolutions. Therefore, automakers must respect the CO2 targets by selling the indispensable BEV and PHEV quotas to ensure the minimum losses.

Chapter 5: Assessing the 2021-2025-2030 CO2 Standards on Automakers' Portfolio Vehicles' Segments

5.1.4. Trade-offs Analysis

In each scenario (Segment choice and year) assessed, the results of the BEV and PHEV sales shares were determined for two case studies: (1) minimizing the total costs - i.e. BEV and PHEV incremental costs and penalty if applicable -, and (2) respecting CO2 targets. Comparing the results elaborated before ensures that, for all scenarios, there is no trade-off between the two case studies: ensuring the minimum costs comes with zero fines.

Scenario: 100 % Segment A

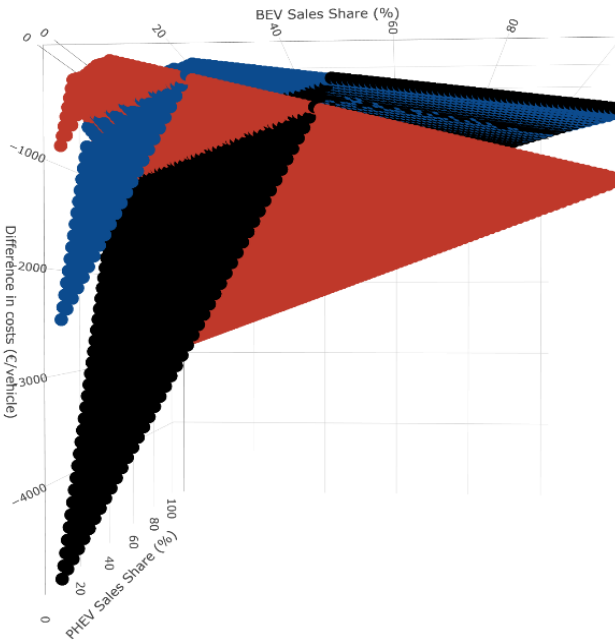

Scenario: 100 % Segment B

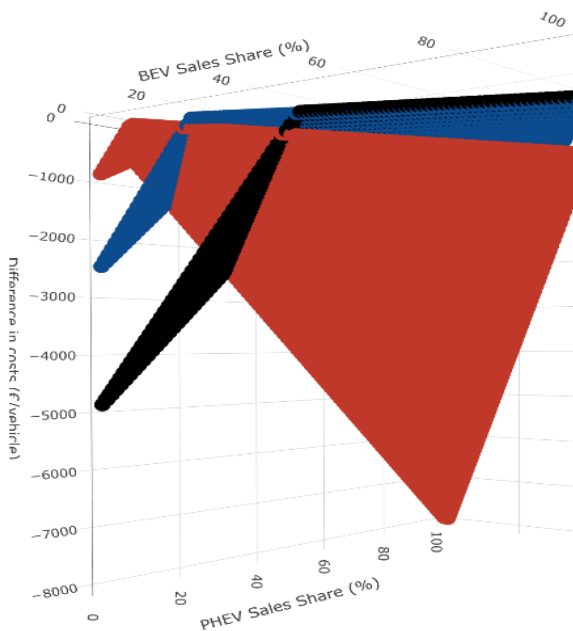

Scenario : 100 % Segment C

Scenario : 100 % Segment D

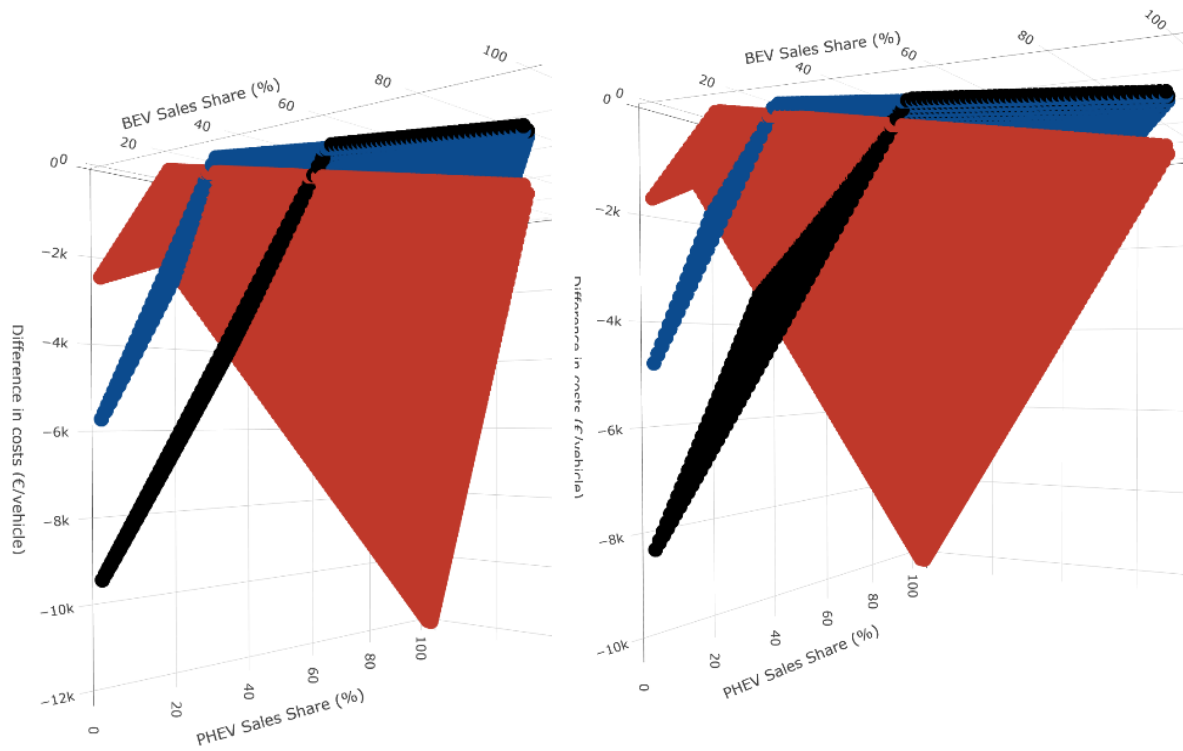

Figure 5. 9 Total Costs (Incremental Costs and CO2 Fines) for Four Vehicles Segments and 2021, 2025, 2030

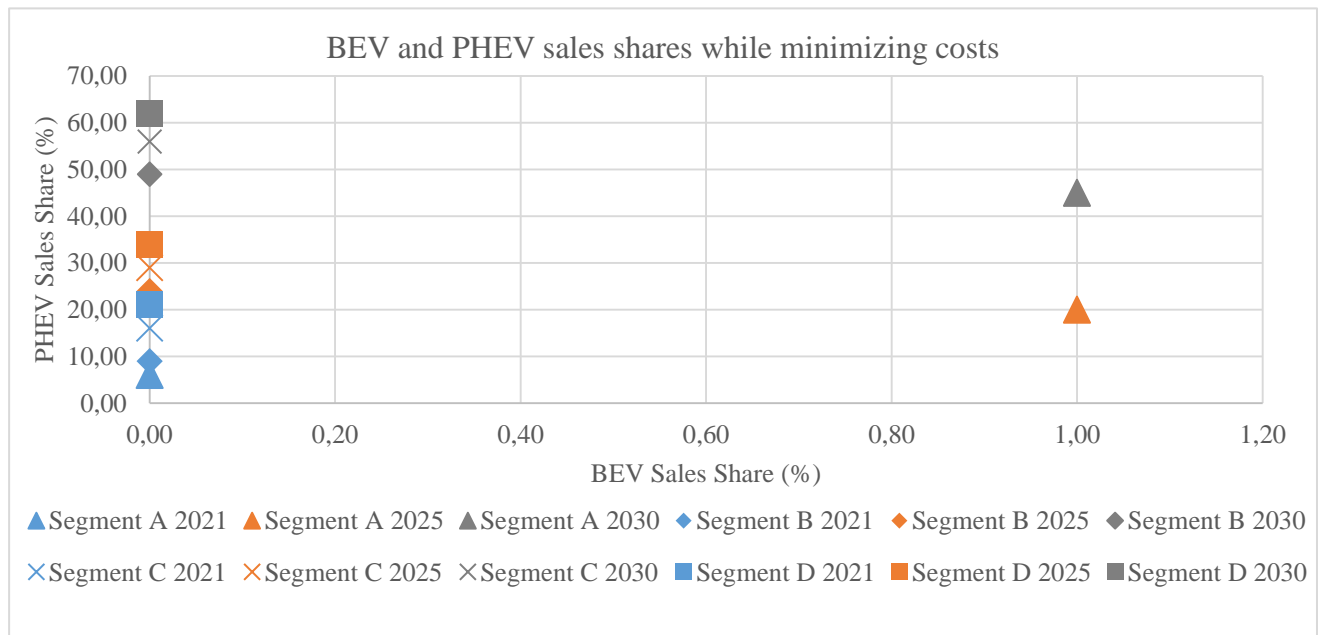

Figure 5.10 BEV and PHEV Sales Shares That Ensure the Minimization of the Costs

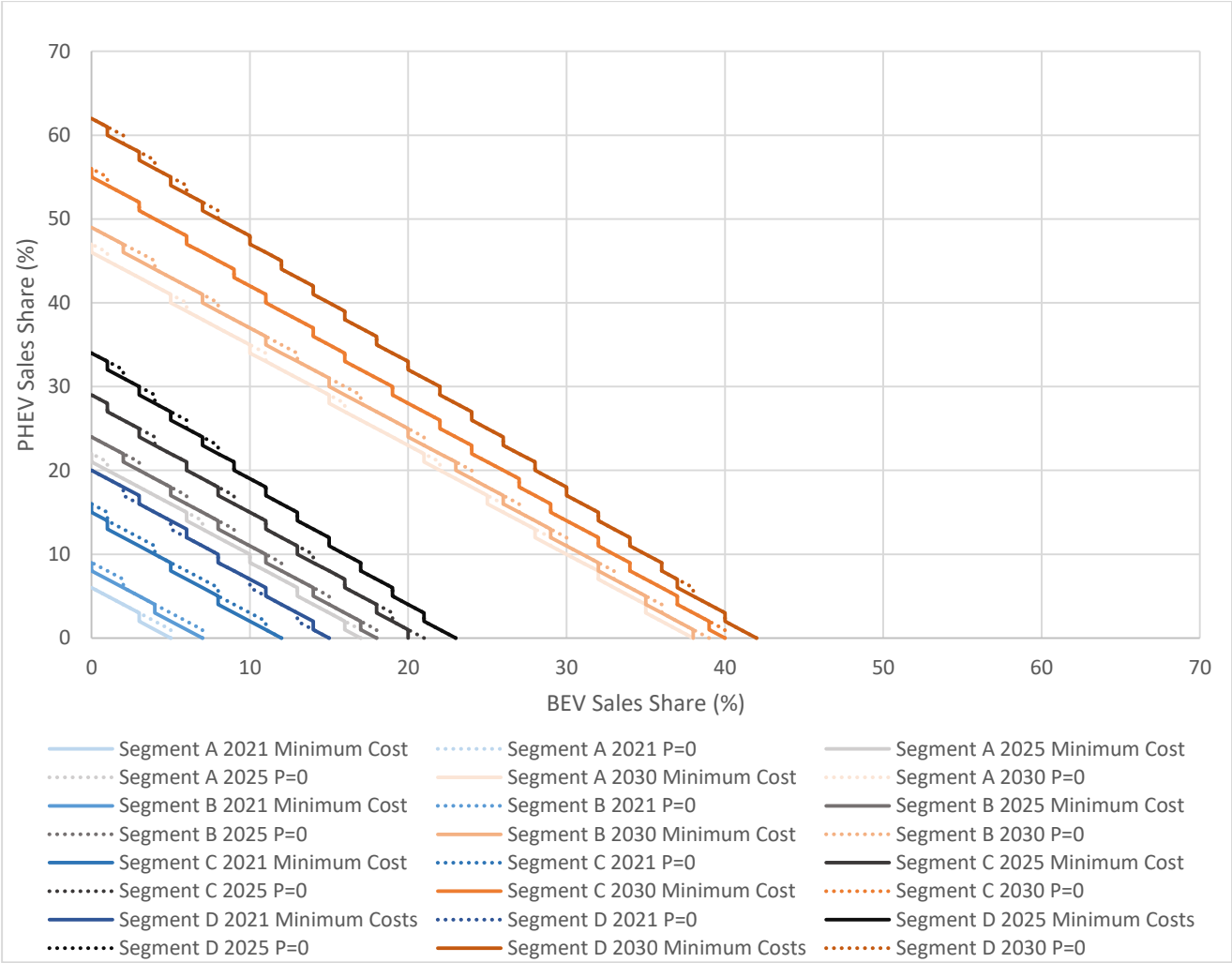

Figure 5.11 Combinations of BEV and PHEV Sales Shares That Ensure the Minimum Cost and the Respect of CO2 Engagement (P=0) for four Segments and 2021, 2025, 2030

5.2. Discussion

This study evaluates the assessment of European CO2 regulations on the automakers' product portfolio, considering various scenarios: four segments of vehicles and three regime targets. We explored combinations of BEVs and PHEVs that ensure the minimum costs for these automakers. Under current CO2 emissions regulations, we concluded that minimum overall cost is achieved by relying only on PHEV manufacturing, which comes with the lowest combination of regulatory and manufacturing costs for automotive manufacturers. However, the design of our analysis has limitations due to several reasons.

First, we only considered BEV/PHEV incremental costs - i.e. production costs - and assumed that automakers would maintain similar profit margins within segments. We assumed that the willingness to pay for a car in a particular segment would be insensitive to the

powertrain choice, so production costs entirely drive profit margins. Therefore, it also assumes that customers are not willing to pay a premium for hybrid or fully electric powertrains, which is likely to be realistic for the majority of the population. Also, we only studied privately-purchased vehicles of specific four segments, ignoring other types of vehicles sales, such as Light-Duty Vehicles and buses, which are also considered in the CO2-emissions calculation procedure. Finally, our analysis does not consider HEV nor FCEV since this type of vehicle shares similar CO2 emissions as ICEVs (Gaton, 2018).

Based on future E.U. regulations, especially "Green Finance" (E.C., 2019b), new E.U. rules may phase out PHEVs sooner than some automakers were speculating since these laws may ban manufacturers from labelling PHEVs as "sustainable investments" beyond 2025<sup>31</sup>. Yet, some countries, such as France, are still defending PHEVs as a promising solution to transition solutions towards BEVs<sup>32</sup>. Table 5.5 summarizes the reasons behind defending PHEVs and BEVs.

On the one hand, many E.U. member states are still defending PHEV as a viable solution to respect CO2 targets for many reasons. Regarding the drivers, PHEVs consider a bridge that could help reach acceptability towards BEVs. Also, PHEVs present a viable solution for drivers who travel daily long-distance trips and cannot rely on purchasing a BEV, especially that the charging infrastructure coverage is not well spread. Concerning the automakers, some manufacturers envisaged selling PHEVs until at least the end of this decade and will ensure carbon neutrality by the minimum of 2030<sup>33</sup> because it could convince drivers about electric cars. Also, applying the "Green Finance regulation" will add constraints to a sector already under pressure. Moreover, as mentioned before in this Chapter, producing PHEV comes with a lower cost than producing a BEV due to the high battery packs price, if we consider the same profit per vehicle for the automaker. Finally, banning PHEVs in the near term severely impacts recruitment activity and could lead to severe job losses in Europe, especially in those who work in internal combustion technology<sup>34</sup>.

On the other hand, other members are moving away from supporting plug-in hybrid technology for several reasons. First, research has shown that PHEV can emit more CO2

---

<sup>31</sup> <https://www.electrive.com/2021/04/14/is-this-the-end-of-plug-in-hybrids-in-the-eu/>

<sup>32</sup> <https://www.automobile-propre.com/emmanuel-macron-va-defendre-la-voiture-hybride-devant-leurope/>

<sup>33</sup> <https://www.forbes.com/wheels/news/automaker-ev-plans/>

<sup>34</sup> <https://www.cleanenergywire.org/factsheets/how-many-car-industry-jobs-are-risk-shift-electric-vehicles>

emissions than their ICE counterparts. These emissions depending on the customer's driving and charging behaviours and the energy mix used to produce the electricity used to charge the car. Most PHEVs are equipped with a 30–60 km battery (NEDC) and could electrify up to 10,000 km a year, increasing with range (Plötz et al., 2020). While PHEV can electrify a part of the vehicle travelled kilometres, the other part remains fossil fuel dependent. Longer trips rely more on the fuel tank than the battery as an energy source due to the limited battery range if the driver does not charge. Based on people's driving profiles in China, Europe, and North America, Plötz et al. (2020) showed significant differences between theoretical and real-world emissions. On average, PHEV fuel consumption and tail-pipe CO<sub>2</sub> emissions in real-world driving are two to four times higher than expected<sup>35</sup> (Plötz et al., 2020). Also, we do not consider a variety of usage between private and commercial drivers. Second, one of the Paris Agreement's main objectives, in line with the E.U.'s commitment, is the European Green Deal. Achieving a neutral climate by 2050, an economy with net-zero GHG emissions, cannot be done with a 100% PHEV sales share, leading to the uptake of other zero-emission vehicles such as BEVs and FCEVs (E.C., 2019b).

To sum up, our study shows that EU CO<sub>2</sub>-emission targets that manufacturers should set to minimize both regulatory and production costs could be achieved with a scenario of 100% PHEV sales. As such, it offers evidence that PHEVs are likely to be considered for the next few years as a means to switch to fully electric vehicles, but that such a change towards higher levels of BEVs will likely require policy changes. Indeed, PHEV technology is under pressure at the European level because the E.U. policy plans to limit the transition technology by a shorter lifespan than envisaged by some leading automakers. Therefore, European automakers will be confronted with two ways: either fighting for PHEVs or spending their financial and political capital accelerating BEVs and charging infrastructure. These manufacturers should rapidly decide in order to meet the E.U. regulation.

---

<sup>35</sup> <https://www.which.co.uk/news/2021/03/plug-in-hybrid-cars-use-more-fuel-than-official-figures-claim/>  
<https://www.theguardian.com/business/2021/mar/02/plug-in-hybrid-cars-burn-more-fuel-than-tests-record-says-which>

Table 5.5 Comparing the arguments of defending PHEVs and BEVs

|                          | Defending PHEVs  | Defending BEVs   |
|--------------------------|--|--|
| <i>Who is defending?</i> | <i>France</i>  | <i>European Commission</i>   |
| <b>Arguments</b>         | PHEVs present a bridge to BEVs.  | No Tank-to-Wheels emissions for BEVs.                                |
|                          | Higher autonomy for long-distance trips.   | Actual PHEVs CO2 emissions are higher than expected.                 |
|                          | Severe impacts recruitment activity and could lead to 100,000 job losses in Europe.  | European Green Deal cannot be achieved without a 100 % BEV scenario. |
|                          | Charging infrastructure is not mature.   |  |
|                          | PHEVs come with the minimum cost for the automaker compared to BEVs (if the profitability per vehicle remains the same for all types of vehicles). |  |

## 6. Conclusion and Future Research

Our Chapter presents an analysis of the relative contribution of electrification of an automaker's sales portfolio - i.e. selling more BEV and PHEV - in optimizing its costs associated with CO2 standards compliance. To perform that evaluation, we have developed a framework for modelling the effect of the share of BEV/PHEV in the automaker's portfolio, considering European CO2 regulations. We evaluated the trade-off between the required BEV and PHEV sales shares that minimized the total costs and those required to avoid the fines. The total costs account for the incremental costs – i.e. the difference in production costs between a BEV/PHEV and an ICEV of the same Segment -, neglecting the automaker's profitability margin the fines if CO2 engagement is not respected. Also, avoiding the fines comes with respect of CO2 targets. We modelled 12 scenarios 4 Segments of vehicles: Segment A (small sedan), Segment B (medium sedan), Segment C (large sedan), and Segment D (SUV), and for 2020, 2025, and 2030. As CO2 regulations become stricter with time, fines will also become higher in the future. We used vehicles' techno-economic-environmental data from different sources, including official brand websites.

First, results showed that with 0% BEV/PHEV sales, there is no respect for the CO2 targets, and fines may apply from 1000€/vehicle (2021) to 5000€/vehicle (2030) for Segment A. Indeed, higher fines are applicable for larger vehicles. Also, we find different combinations of BEV and PHEV sales for every scenario and year, which ensure the minimum cost. To respect long-term CO2 limitations, more electrification is needed to minimize the costs. On the one hand, an increase in BEV/PHEV sales will respect the CO2 engagement. On the other hand,



it comes with high costs, especially with a 100% BEV scenario, rather than a 100% PHEV scenario, since a larger (and hence costlier) battery is installed in a BEV.

Based on our assumptions, we found that the minimum costs depend on three variables: the evolution of regulations per year, the vehicle's size, and the electrification type (BEV or PHEV). Results suggest that automotive manufacturers respect CO2 targets for all time resolutions. This will lead to minimizing the total cost and thus ensuring the highest profitability. Generally, the minimum costs are achieved favouring PHEVs rather than on BEVs, regardless of the segment, because fewer batteries are installed, leading to fewer production costs.

Lastly, we compare the arguments defending PHEVs and BEVs, respectively. We concluded that European automakers would be faced with two ways: either fighting for PHEVs or spending their financial and political capital accelerating BEVs and charging infrastructure. These manufacturers should rapidly decide in order to meet the E.U. regulation.

We suggest the following avenues for further research. First, we recommend completing our analysis regarding the automaker's side by considering the emergence of zero and low emissions light-duty vehicles. Besides, our analysis accounts for the worst-case scenario of CO2 emissions; further studies are needed to evaluate Hybrid Electric Vehicles (HEVs) cost-effectiveness diffusion in respecting the standards. Also, we recommend considering the customer's side in the analysis. First, as mentioned before, PHEVs' CO2 emissions highly depend on the driving and charging behaviours (Plötz et al., 2020). If the battery is not used, the CO2 emissions of a PHEV are approximately similar or worse than those of an ICEV (Plötz et al., 2020). Many approaches could consider the actual emissions of PHEVs: additionally, to considering accurate data of PHEVs drivers' trips, a solution is to weigh CO2 emissions per vehicle usage. There are two main usages for passenger cars: rural and urban ones. Since more rural drivers' daily travelled kilometres are higher in urban usage (Haidar et al., 2020), more CO2 emissions are expected for PHEVs. Also, future research is needed by including the driver's cost model and willingness-to-pay in the analysis. Indeed, purchasing a PHEV does not come with the exact cost of a BEV, and it varies with the segment's choice (Björnsson and Karlsson, 2017; Palmer et al., 2018). We recommend future work to consider the European Green Deal for 2050, aiming to drastically reduce GHG emissions, especially in the energy and transportation sectors (E.C., 2019b). Meeting 2050's CO2 targets remain impossible without a massive penetration of zero-emission vehicles: BEV and Fuel Cells Electric Vehicles (FCEVs) (Nature Catalysis, 2020). Considering actual PHEV CO2 emissions in the regulations could help automakers include PHEVs and BEVs in their product portfolio.

## References

- Al-Alawi, B.M., Bradley, T.H., 2014. Analysis of corporate average fuel economy regulation compliance scenarios inclusive of plug in hybrid vehicles. *Applied Energy* 113, 1323–1337. <https://doi.org/10.1016/j.apenergy.2013.08.081>
- Al-Alawi, B.M., Bradley, T.H., 2013. Total cost of ownership, payback, and consumer preference modeling of plug-in hybrid electric vehicles. *Applied Energy* 103, 488–506. <https://doi.org/10.1016/j.apenergy.2012.10.009>
- Amjad, M., Ahmad, A., Rehmani, M.H., Umer, T., 2018. A review of E.V.s charging: From the perspective of energy optimization, optimization approaches, and charging techniques. *Transportation Research Part D: Transport and Environment* 62, 386–417. <https://doi.org/10.1016/j.trd.2018.03.006>
- Berckmans, G., Messagie, M., Smekens, J., Omar, N., Vanhaverbeke, L., Van Mierlo, J., 2017. Cost Projection of State of the Art Lithium-Ion Batteries for Electric Vehicles Up to 2030. *Energies* 10, 1314. <https://doi.org/10.3390/en10091314>
- Bezdek, R.H., Wendling, R.M., 2005. Potential long-term impacts of changes in U.S. vehicle fuel efficiency standards. *Energy Policy* 33, 407–419. <https://doi.org/10.1016/j.enpol.2003.08.015>
- BloombergNEF, 2019. A Behind the Scenes Take on Lithium-ion Battery Prices. BloombergNEF. URL <https://about.bnef.com/blog/behind-scenes-take-lithium-ion-battery-prices/> (accessed 4.17.21).
- Cheah, L., Heywood, J., 2011. Meeting U.S. passenger vehicle fuel economy standards in 2016 and beyond. *Energy Policy* 39, 454–466. <https://doi.org/10.1016/j.enpol.2010.10.027>
- Dacy, D.C., Kuenne, R.E., McCoy, P., 1992. *Employment Impacts of Achieving Automobile Efficiency Standards in the United States* (Palgrave Macmillan Books). Palgrave Macmillan.
- E.C., 2019a. CO<sub>2</sub> emission standards for passenger cars and light-commercial vehicles in the European Union | International Council on Clean Transportation.
- E.C., 2019b. E.U. climate action and the European Green Deal [WWW Document]. *Action pour le climat - European Commission*. URL [https://ec.europa.eu/clima/policies/eu-climate-action\\_en](https://ec.europa.eu/clima/policies/eu-climate-action_en) (accessed 4.7.21).
- Gadesmann, K., Kuhnert, F., 2007. The automotive industry and climate change. *Framework and dynamics of the CO<sub>2</sub> (r)evolution*.
- Gaton, B., 2018. BEV, PHEV, HEV or FCEV: Choose your E.V. acronym! *ReNew: Technology for a Sustainable Future* 80–83.
- Goldberg, P.K., 1998. The Effects of the Corporate Average Fuel Efficiency Standards in the U.S. *The Journal of Industrial Economics* 46, 1–33. <https://doi.org/10.1111/1467-6451.00059>
- Greene, D.L., 2007. CAFE OR PRICE?: An Analysis of the Effects of Federal Fuel Economy Regulations and Gasoline Price on New Car MPG, 1978–89, in: *Controlling Automobile Air Pollution*. Routledge.
- Greene, D.L., 1998. Why CAFE worked. *Energy Policy* 26, 595–613.
- Haidar, B., da Costa, P., Lepoutre, J., Vidal, F., 2020. Which combination of battery capacity and charging power for battery electric vehicles: urban versus rural French case studies (No. hal-03071656), Post-Print, Post-Print. HAL.
- Hsieh, I.-Y.L., Pan, M.S., Chiang, Y.-M., Green, W.H., 2019. Learning only buys you so much: Practical limits on battery price reduction. *Applied Energy* 239, 218–224. <https://doi.org/10.1016/j.apenergy.2019.01.138>

- Hüls, C., Thies, C., Kieckhäfer, K., Spengler, T.S., 2020. Limiting CO2 fleet emissions in the automotive industry – a portfolio planning approach. *International Journal of Automotive Technology and Management* 20, 349–368.
- IEA, 2019. Global Electric Vehicle Outlook 2019 [WWW Document]. IEA. URL <https://www.iea.org/reports/global-ev-outlook-2019> (accessed 6.17.20).
- IPCC, 2018. Allen, M.R., O.P. Dube, W. Solecki, F. Aragón-Durand, W. Cramer, S. Humphreys, M. Kainuma, J. Kala, N. Mahowald, Y. Mulugetta, R. Perez, M. Wairiu, and K. Zickfeld, 2018: Framing and Context. In: *Global Warming of 1.5°C. An IPCC Special Report on the impacts of global warming of 1.5°C above pre-industrial levels and related global greenhouse gas emission pathways, in the context of strengthening the global response to the threat of climate change, sustainable development, and efforts to eradicate poverty* [Masson-Delmotte, V., P. Zhai, H.-O. Pörtner, D. Roberts, J. Skea, P.R. Shukla, A. Pirani, W. Moufouma-Okia, C. Péan, R. Pidcock, S. Connors, J.B.R. Matthews, Y. Chen, X. Zhou, M.I. Gomis, E. Lonnoy, T. Maycock, M. Tignor, and T. Waterfield (eds.)]. In Press.
- Islam, E., Moawad, A., Kim, N., Rousseau, A., 2018. An Extensive Study on Sizing, Energy Consumption, and Cost of Advanced Vehicle Technologies (Technical Report) | OSTI.GOV. Argonne National Lab., Argonne, Illinois.
- Jang, J.J., Song, H.H., 2015. Well-to-wheel analysis on greenhouse gas emission and energy use with petroleum-based fuels in Korea: gasoline and diesel. *Int J Life Cycle Assess* 20, 1102–1116. <https://doi.org/10.1007/s11367-015-0911-x>
- Jeon, S., Roh, M., Heshmati, A., Kim, S., 2020. An Assessment of Corporate Average Fuel Economy Standards for Passenger Cars in South Korea. *Energies* 13, 4533. <https://doi.org/10.3390/en13174533>
- Khan, M.I., Shahrestani, M., Hayat, T., Shakoor, A., Vahdati, M., 2019. Life cycle (well-to-wheel) energy and environmental assessment of natural gas as transportation fuel in Pakistan. *Applied Energy* 242, 1738–1752. <https://doi.org/10.1016/j.apenergy.2019.03.196>
- Knittel, C.R., 2011. Automobiles on Steroids: Product Attribute Trade-Offs and Technological Progress in the Automobile Sector. *American Economic Review* 101, 3368–3399. <https://doi.org/10.1257/aer.101.7.3368>
- Luk, J.M., Saville, B.A., MacLean, H.L., 2016. Vehicle attribute trade-offs to meet the 2025 CAFE fuel economy target. *Transportation Research Part D: Transport and Environment* 49, 154–171. <https://doi.org/10.1016/j.trd.2016.09.005>
- Lutsey, N., Nicholas, M., 2019. Update on electric vehicle costs in the United States through 2030 | International Council on Clean Transportation. ICCT.
- MacDuffie, J.P., 2018. Response to Perkins and Murmann: Pay Attention to What Is and Isn't Unique about Tesla. *Management and Organization Review* 14, 481–489. <https://doi.org/10.1017/mor.2018.32>
- Perkins, G., Murmann, J.P., 2018. What Does the Success of Tesla Mean for the Future Dynamics in the Global Automobile Sector? *Management and Organization Review* 14, 471–480. <https://doi.org/10.1017/mor.2018.31>
- Plötz, P., Moll, C., Li, Y., 2020. Real-world usage of plug-in hybrid electric vehicles: Fuel consumption, electric driving, and CO2 emissions | International Council on Clean Transportation.
- Proff, H., Fojeik, T.M., 2016. Pricing and commercialization of electric mobility - dealing with high market uncertainty. *International Journal of Automotive Technology and Management* 16, 30–54.

*Chapter 5: Assessing the 2021-2025-2030 CO2 Standards on Automakers' Portfolio Vehicles' Segments*

- Wang, Y., Miao, Q., 2021. The impact of the corporate average fuel economy standards on technological changes in automobile fuel efficiency. *Resource and Energy Economics* 63, 101211. <https://doi.org/10.1016/j.reseneeco.2020.101211>
- Wavestone, 2019. Véhicules électriques : quelles incitations en France et en Europe ? [WWW Document]. TransportShaker. URL <https://www.transportshaker-wavestone.com/vehicules-electriques-quelles-incitations-en-france-et-en-europe/> (accessed 4.22.21).



## Chapter 6: General Conclusion

This dissertation looked at the main facets of the automotive industry's energy transition. Reaching at least a 55% net reduction in GHG emissions by 2030 and a climate-neutral EU by 2050 requires several strict policies that represent complex challenges. Switching from internal combustion engines to electric vehicles, one of the primary keys to achieving these ambitious environmental targets, is faced with several challenges and comes with several consequences.

On the one hand, banning thermal vehicles induces high losses for various actors due to integrating new technology. On the other hand, fleet electrification requires ecosystem reconfiguration by including an essential member: the charging point operator. We began by elaborating the prominent members and their goals of the electric vehicle ecosystem: the automotive manufacturer, the charging point operator, the vehicle owner, and the society. Indeed, the development of synergies across the EV industry members is fundamental for the successful development of the electric vehicle market and energy transition. Then, we evaluated the interactions of the members by considering several case studies.

**Chapter two** examined the deployment strategies of the charging network and concluded with the mandatory data to consider. **Chapter three** assessed the interaction of the charging point operator and the electric vehicle owner by addressing the range anxiety barrier for daily needs while considering their cost models and concluding with policy recommendations regarding the charging tariffs. **Chapter four** considered the synergy between the ecosystem members by evaluating France's electric vehicle purchasing activity and identifying the main factors that could boost the transition to electrification. **Chapter five** explored the influence of the European regulations imposed by public authorities - European Union and Commission -, on the automotive manufacturers' portfolio by considering its cost model.

This concluding chapter is divided into three sections. The first section outlines each Chapter's results. The second section revisits the findings made in each Chapter and connects them using transversal dimensions. The third part offers some future research perspectives.

### 1. Summary of Chapters

#### Chapter 1

The **First Chapter** of this thesis exposed the background. The transportation sector is one of the first GHG emitters due to the fossil fuel dependency of transportation means. Reaching the Green Deal by 2050 requires an urgent need to decarbonise this sector, which could be achieved by fleet electrification. Increasing the electric vehicle market is facing several

barriers and needs various public interventions, such as a decrease in the battery packs price, a diversification of the models proposed by car manufacturers, and a development of charging infrastructure. We began by presenting the key information about electric vehicle's and charging infrastructure's technical, economic, and environmental parameters. After, we detailed the main members of the electric vehicle ecosystem: the automotive manufacturer, the charging point operator, the vehicle owner, and the society. Also, we developed the scenarios considered in this thesis, and we presented the thesis organisation.

### **Chapter 2**

The **Second Chapter** addresses the charging point operator member interactions by addressing the infrastructure deployment main barrier. While an essential lever in the transition towards higher diffusion of EVs is the availability of public charging stations, our knowledge about organising best and physically distribute these recharging networks is still emerging. A classification scheme of 64 published articles is proposed regarding optimisation objectives with a detailed analysis of each publication. A diversity of optimisation goals for locating charging stations is considered: minimising technical, social, and environmental costs, maximising coverage area, minimising the grid impact. Indeed, minimising the budget remains one of the most used optimisation objectives since it is a severe constraint in these types of problems: the prices of chargers and batteries remain incredibly high. Also, we highlighted neglected, or covered too briefly, essential constraints regarding the input data and optimisation constraints. While some constraints are considered in the optimisation procedure, such as GPS-based geographic resolution, distribution grid constraints, driver's data (daily travelled mileage, destinations, charging behaviour) and technical parameters, we strongly consider these factors to be reviewed in detail. However, temporal horizon, environmental impact, new mobility services, and external conditions were scarcely considered in studies and articles. Due to the restricted and neglected set of parameters, charging station allocation is not yet controlled: they are not optimally localised and used. We strongly suggest adding the environmental LCA chargers towards minimising GHG emissions to future research studies. Additionally, since queues can occur at stations, queuing theory can play an essential role concerning the number, the speed of the chargers, and the service pricing.

### **Chapter 3**

The **Third Chapter** looks into the interactions between the charging point operator and the BEV owner, and concludes with policy recommendations. Despite increasing sales, techno-economic barriers still hinder their widespread adoption. This Chapter aims at zooming into several barriers: BEV investment and range, public infrastructure availability, at-home charger

availability, and the adaptability between charger and BEV in terms of technical constraints. Market stakeholders are faced with a dilemma to address these barriers, especially since different scenarios about investments in car battery capacity and recharging infrastructure investment have different implications for who will carry the most significant investment costs. Indeed, many households in France, assessed to 10 million today, can not charge at home: For the moment, they are excluded from the electric vehicle market because of these barriers. To close this gap, we explored various combinations of battery capacity size and charging power. Then, we compare these options for both the EV owners that can not charge at home, and infrastructure operators. Using French data, we simulate BEV-owner and charging infrastructure-operator cost implications for 12 combinations of privately-purchased BEVs that vary in 1) battery capacity, 2) charging power and, 3) whether or not the owner lives in a rural or urban environment. Furthermore, we explore Pareto fronts in order to determine optimal combinations. We find that for urban (*vs. rural*) areas, purchasing a 35-50-kWh (*50-kWh*) BEV and deploying 22- and 50-kW chargers (*50-kW*) proves to be the most cost-efficient solution. For urban areas, purchasing 35 kWh (50 kWh) BEV comes with a 600€/year (100€/year) gain to the owner compared to buying an ICEV of the same size. Similarly, for rural areas, this gain is around 1000€/year. Policy implications are discussed, and we recommend revising current charging tariffs and pricing methods.

### Chapter 4

The **Fourth Chapter** examines the interactions within all the electric vehicle ecosystem members. Governments, automotive manufacturers, and charging infrastructure operators have deployed market-boosting initiatives to overcome barriers hindering purchasing activity. The main goal of this Chapter is to analyse past electric vehicle purchasing activity to conclude with policy recommendations. Here, we analysed the influence of socio-demographic (population density, age, unemployment rate), economic (subsidies, taxes exemption, income, gasoline price), availability (number of BEV models, number of PHEV models), and technical (density of slow-and-normal chargers, density of fast chargers, density of ultra-fast chargers) factors on the electric vehicle adoption in French departments, from 2015 to 2019. We studied the case of BEV and PHEV separately using mixed-effects regression. We find different sets of covariates to be significantly correlated with BEV and PHEV market shares, respectively, leading to different interpretations regarding the vehicle's technology. The number of available BEV/PHEV models and energy prices are positively associated with BEV and PHEV adoption. While fast, ultrafast charger density and financial incentives boost BEV sales, more slow-and-normal charger density leads to higher PHEV sales. On the contrary, financial incentives for



## *Chapter 6: General Conclusion*

PHEVs, relative to vehicles' prices, do not boost sales and is open for further studies. Based on the results, policy recommendations are discussed for the automotive industry (providing various models), the charging operator (providing public fast and ultrafast chargers, rather than slow-and-normal speeds and revising their charging tariffs), and the local authorities (considering economic incentives to the instalment of fast and ultrafast public chargers and gasoline taxes).

### **Chapter 5**

The **Fifth Chapter** analyses the influence of the regulations of public authorities, namely the Regulation number (EU)2019/631 adopted by The European Union and Commission) on the automotive manufacturer cars portfolio. Automotive manufacturers must determine their targets for CO<sub>2</sub> targets based on their fleets' weight in 2021. These standards, which will become stricter by 15% in 2025 and 35% compared to 2021, cannot be achieved without fleet electrification. This study compares ICEVs fleet replacement effects by BEVs and PHEVs on CO<sub>2</sub> compliance and production costs. To address this trade-off, we minimised the production costs of replacing ICEVs with BEVs and PHEVs for 12 scenarios: 4 vehicles Segments and three years: 2021, 2025, 2030. We only considered the newly registered passenger cars market. Results show that for all vehicles Segments, the introduction of BEVs and PHEVs into the vehicle fleet reduces the costs of CO<sub>2</sub> compliance relative to a pure ICEV scenario. Automotive manufacturers must sell the required quotas identified in this study to ensure minimum costs, depending on the vehicle's Segment, BEVs, and PHEVs. With zero BEV and PHEV sales shares, fines for non-respect of CO<sub>2</sub> emissions may apply from 1000€/vehicle (2021) to 5000€/vehicle (2030) for Segment A. Indeed, higher fines are obtained for more oversized vehicles. Also, results indicate that it is more beneficial for automakers to respect the CO<sub>2</sub> engagement than to pay penalties. Generally, the minimum costs are achieved favouring PHEVs rather than on BEVs, regardless of the segment, because of fewer batteries installed. Finally, we analysed the results and compared them to the directive of the European Commission.

## **2. Transversal Considerations**

This thesis comprises autonomous and heterogeneous chapters that share the same goal: Boost the automobile sector's energy transition by eliminating the barriers stopping the electric vehicle uptake. These findings could be analysed using a transversal approach to link the chapters. We identify two main dimensions: Ecosystem cooperation and policies identification.

### **2.1. Ecosystem Cooperation**

As elaborated in this dissertation: The electric vehicle ecosystem is composed of several

members or stakeholders: The automotive manufacturer, the charging point operator, the vehicle owner, and the public authorities. These members do not share the same goals; Instead, they have antagonist objectives. While the automotive manufacturer aims at maximising their revenues and respecting the CO<sub>2</sub> targets, the electric vehicle owner's objective is to minimise their costs. Meanwhile, the charging operator's goal is to maximise their revenues and public authorities should identify the right place to invest. This thesis encompasses different interactions with different members: Charging operator - all members (in Chapter Two), charging operator - electric vehicle owner (in Chapter Three), public authorities - all members (in Chapter Four), and automaker - public authorities (in Chapter Five). In each of the studies, we identified trade-offs that result from the interactions. In Chapter Two, through a literature review, we saw that the deployment of charging stations should consider several data, such as the EV owner and the EV techno-economic parameters. In Chapter Three, we identified the trade-offs of all-power charging infrastructure and different sizes of BEVs for two case studies: French urban and rural. We concluded with the battery capacity and the charging power that could ensure the profitability of both members. Chapter Four concluded with policy recommendations to all the EV ecosystem members after evaluating the EV uptake in France. Based on Chapter Three and Chapter Four, we found that fast charging, among all other charging powers, could boost the EV market and could ensure profitability to the charging operator and the comfort to the BEV driver because of the low charging duration. In Chapter Five, we evaluated the assessment of the European CO<sub>2</sub> regulations on the automotive industry's portfolio. This preliminary study could help governmental authorities to review their strategies regarding the production of PHEVs.

## **2.2. Policies Identification**

Policies are a set of ideas and roadmaps that identifies solutions for particular situations agreed to officially by groups of people, business organisations, governments, or political parties. This dissertation focused on policy recommendations for all the members of the EV ecosystem, to accelerate EV uptake.

Based on the findings of Chapters Three and Five, it is recommended that the automotive manufacturers increase their variety of BEV and PHEV models that could raise the visibility towards the customers. Also, results showed that automotive manufacturers should promote PHEVs rather than BEVs where higher income, daily long-distance trips and lower population densities are recorded. Also, we concluded that promoting PHEVs during the transition period towards is essential because it comes with the lowest cost compared to BEVs

on the automaker's budget. Indeed, this transition period will last until the production cost of BEV becomes equal to that of a PHEV and an ICEV of the same segment, that could be achieved after a decrease in the battery packs price. Nevertheless, these conclusions are open for further research that could change automaker's strategy regarding PHEVs production in the near term.

Based on Chapter Two and Four results, we concluded with policy recommendations for the charging point operators. To ensure a reasonable waiting time for the BEV driver who cannot charge at-home, and are obliged to use the public charging network, higher battery capacities require more charging stations of the same power. Results showed that deploying fast and ultra-fast chargers (power higher than 50 kW) rather than slow and normal chargers (power lower than 50 kW) is the key to higher EV uptake. Also, based on Pareto fronts, we concluded that installing on-street public fast chargers (power equals 50 kW) ensures the profitability of all-sizes BEV owners by lower charging durations and costs and that of the charging operator. Moreover, we deducted the necessity to revise the impact of charging tariffs on the BEV/PHEV owners, especially for 7 and 22 kW powers.

Finally, based on Chapters Three, Four, and Five, we concluded with policy guidelines for the public authorities. We proposed a roadmap for the French government to follow the electric mobility transition: by (1) increasing subsidies for BEVs and revising those for PHEVs, (2) decreasing the electricity price or increasing gasoline price simultaneously, (3) offering subsidies for charging operators to install the right charging power at the right place. We recommend local authorities concentrate their efforts on providing and/or increasing economic incentives (e.g. subsidies) to install fast and ultrafast public chargers for BEV-ascending cities, and slow-and-normal public chargers for PHEV-ascending cities. However, increasing the carbon tax led to social movements, namely the "Yellow Vests" in France, pushing the government to suspend additional taxes on fossil fuels prices. Indeed, increasing taxes on energy prices could have no social acceptability in some countries, especially if they are top-taxed countries. In summary, to limit the consequences of social movements associated with an increase in gasoline prices, governments should consider providing financial incentives for both purchasing vehicles and instalment of charging infrastructure, decreasing electricity and charging tariffs, and maintaining registration tax exemption.

### 3. Future Works

#### 3.1. Battery Capacity and Public Charging Infrastructure Trade-Offs

The assumption of driving and charging behaviour should be considered in future work, because the driver could change their attitudes in terms of additional trips, such as home-school

travels or other activity centres, malls, where semi-public charging stations could be available. For this reason, the arrival rate to the charging stations may change, causing a different number of chargers. When simulating BEV profiles, we neglected comfort parameters such as heating, cooling, lights, radio, and data to increase BEVs' energy demand. Besides driving behaviour, some hypotheses about the operator's cost model are not considered, such as grid expansion, because technical problems could be resolved by smart charging and land prices due to the non-spatial model, and the wide variety of these prices. Overall, it is vital to use real-world data that reflect BEV drivers' driving and charging behaviours, such as trip mileage, arrival rates, and actual charging durations. Finally, based on these real data, charging tariffs and the pricing methods should be revised, taking into account an oligopolistic market where competition between charging operators stakes.

### **3.2. Analysis of the BEV and PHEV Markets in France**

While some of the findings of this Chapter were expected, and despite the high resolution of our analysis, further studies are suggested to boost these models by taking into account socio-techno-economic factors. Our model can only draw general conclusions since the EV market share in France represents less than 5%. It would be helpful to perform a follow-up study in a more developed market. Moreover, we recommend further studies to consider the availability of at-home and at-work charging infrastructures of both the department of residence and work, the tariffs of public charging infrastructure, and the adaptability of charging infrastructure sockets and vehicles. We further urge upcoming research to account for local non-financial incentives that were not considered due to the lack of data. Additionally, the model does not capture the customer's psychological effect, which could be affected by the marketing campaign of both automotive manufacturers and charging infrastructure operators. The influence of additional electric mobility services is also not considered in our study, namely Vehicle-to-Grid, smart charging, and car-sharing. Finally, the relationship between BEV and PHEV market shares are worthy of further study and refinement.

### **3.3. Analysis of the CO<sub>2</sub> Regulations on the OEM's Portfolio**

Chapter 5 is still preliminary, and several additions are needed because our analysis remains limited to various assumptions. First, we recommend completing our analysis regarding the automaker's side by considering the emergence of zero and low emissions light-duty vehicles. Besides, our analysis accounts for the worst-case scenario of CO<sub>2</sub> emissions; Further studies are needed to evaluate Hybrid Electric Vehicles (HEVs) cost-effectiveness diffusion in respecting the standards. Also, we recommend considering the customer's side in the analysis. As mentioned before, PHEVs' CO<sub>2</sub> emissions highly depend on driving and

charging behaviours. If the battery is not used, the CO<sub>2</sub> emissions of a PHEV are approximately similar to those of an ICEV. Many approaches could consider the actual emissions: Additionally, to consider accurate data of PHEVs drivers' trips, a solution is to weigh CO<sub>2</sub> emissions per vehicle. There are two main usages for passenger cars: rural and urban ones. Since more rural drivers' daily travelled kilometres are higher in urban usage, more CO<sub>2</sub> emissions are expected for PHEVs. Also, future research is needed by including the driver's cost model and willingness-to-pay in the analysis. Indeed, purchasing a PHEV does not come with the exact cost of a BEV, and it varies with the segment's choice. Finally, we recommend future work considering the European Green Deal for 2050, aiming to drastically reduce GHG emissions, especially in the energy and transportation sectors. Meeting 2050's CO<sub>2</sub> targets remain impossible without a massive penetration of zero-emission vehicles: BEV and Fuel Cells Electric Vehicles (FCEVs).

### **3.4. Beyond the Chapters**

Several aspects were not considered in this thesis and should noteworthy be considered in future research. First, new mobility solutions, such as autonomous vehicles, mobility as a service (car-sharing), and charging services (booking a charger or Vehicle-to-Grid), require an extended business model. Also, the needed charging infrastructure, customer acceptance, the automotive manufacturer's strategy, and cost models could considerably vary. This thesis could be extended by considering case studies and several scenarios of these new mobility services. Also, future research should consider the temporal horizon for applying these services that meet the long-term European targets.

Second, externalities and the environmental impact of electric vehicles examined by the LCA, especially the battery recycling act, are not modelled since they are not the thesis's scope. It is open for further studies to consider the economic impact of the ecological footprint of both electric vehicles and the charging operator. Indeed, the environmental impact analysis relies on the country's energy mix, and its associated conclusions could vary from a country to another. Also, we did not consider externalities associated to the battery production, such as the environmental and health cost of mining, chemical leaching, and the limited amount of raw materials in the world.

Third, governments should strengthen several policy implications to meet the 2050 Green Deal that ensures a zero-emission road transportation sector. Future studies should consider the impact of policies - i.e. limiting the vehicles in cities, relying on public transportation means, banning the sales of ICEVs and HEVs, and releasing FCEV as passenger cars. Also, a cost-efficient study that compares the trade-offs between the economic costs and

## *Chapter 6: General Conclusion*

environmental benefits is mandatory to consider new mobility services and policies.

Finally, the usage of actual data that could capture the driving behaviour, charging behaviour, and while-driving emissions are key factors for results validation.

**Titre :** Une analyse technico-économique de la transition vers les véhicules électriques : politique, infrastructure, usages et conception

**Mots clés :** capacité de batterie, infrastructure de recharge, véhicule électrique, véhicule hybride rechargeable, étude technico-économique

**Résumé :** Le transport routier représentant une part importante des émissions mondiales de gaz à effet de serre. Les véhicules électriques (VE), y compris les VE à batterie (BEV) et les VE hybrides rechargeables (PHEV), offrent une alternative prometteuse pour remplacer les véhicules à moteur à combustion interne (ICEV), dépendants des combustibles fossiles, pour une solution de transport à émissions faibles ou nulles. Bien que l'adoption de ces technologies ait rapidement augmenté au cours de la dernière décennie, leur part de marché reste limitée par des obstacles socio-technico-économiques dans la plupart des pays. Surmonter ces barrières est une étape essentielle vers un marché massive des véhicules électriques. Cette thèse vise donc à étudier des modèles économiques innovants, en examinant les transactions entre les membres de l'écosystème des VE. Cette thèse traite de recherches prospectives et multidisciplinaires en sciences économiques et de gestion, et sciences de l'ingénieur, sur l'avenir des systèmes automobiles décarbonés. Tout d'abord, cette thèse aborde les principaux obstacles au déploiement des infrastructures de recharge, en présentant

une revue de la littérature sur les méthodologies de déploiement et en soulignant l'ensemble des paramètres négligés dans la littérature, lesquels présentent des questions de recherche que la thèse aborde par la suite. Ensuite, cette thèse étudie les compromis entre infrastructure de recharge de différentes puissances et autonomie des BEV. Nous concluons sur la capacité de la batterie du BEV la plus adaptée aux besoins urbains et ruraux, et sur l'investissement dans les chargeurs rapides. De plus, cette thèse analyse l'influence des facteurs socio-démographiques, économiques et techniques sur l'adoption des VE dans les départements français au moyen d'une régression à effets mixtes. Nous concluons à travers des recommandations de politiques économiques pour accélérer la transition vers la mobilité électrique. Enfin, cette thèse analyse l'influence du règlement européen (EU)2019/631 sur l'offre des constructeurs automobiles et permet de discuter les résultats attendus par la directive de la Commission européenne.

**Title:** A Techno-Economic Analysis of the Electric Vehicle Transition: Policy, Infrastructure, Usage, and design

**Keywords:** battery capacity, recharging infrastructure, electric vehicle, plug-in hybrid vehicle, techno-economic study

**Abstract:** Since road transport accounts for a high share of global Greenhouse Gas (GHG) emissions, Electric Vehicles (EVs), including Battery EVs (BEVs) and Plug-in Hybrid EVs (PHEVs), offer a promising alternative to replace fossil-fuel dependent Internal Combustion Engine Vehicles (ICEVs), with a low-or zero-emission transport solution. While this technology's adoption has been rapidly increasing over the last decade, its market share remains restrained by socio-techno-economic barriers in most countries. Overcoming these barriers is an essential step into a massive purchasing activity of electric vehicles. This dissertation aims at investigating innovative business models by examining the transactions within the members of the EV ecosystem. This dissertation deals with future and multidisciplinary research in economics, management, and engineering sciences on decarbonised car systems' future. First, this thesis addresses the main charging infrastructure deployment barrier by presenting a literature review about the deployment methodologies and

pointing out the neglected set of parameters that present our research gaps. Second, it investigates the trade-offs between the different-power charging infrastructure and the BEV owner by considering: BEV investment and range, public infrastructure availability, at-home charger availability, and the adaptability between charger and BEV in terms of technical constraints. It also concludes with the most suitable BEV battery capacity for urban and rural needs, and the installation of fast chargers. Next, it analyses the influence of socio-demographic, economic, and technical factors on electric vehicle adoption in French departments, using mixed-effects regression. This chapter points out policy recommendations to accelerate the electric mobility transition. Finally, this thesis analyses the influence of the Regulation number (EU)2019/631 on the automotive manufacturers' portfolio, and compares the results with the directive of the European Commission.