



HAL
open science

Reproducing the complex development of human Follicular Lymphoma in mouse models

Lina Zawil

► **To cite this version:**

Lina Zawil. Reproducing the complex development of human Follicular Lymphoma in mouse models. Human health and pathology. Université de Limoges, 2021. English. NNT : 2021LIMO0069 . tel-03560858

HAL Id: tel-03560858

<https://theses.hal.science/tel-03560858>

Submitted on 7 Feb 2022

HAL is a multi-disciplinary open access archive for the deposit and dissemination of scientific research documents, whether they are published or not. The documents may come from teaching and research institutions in France or abroad, or from public or private research centers.

L'archive ouverte pluridisciplinaire **HAL**, est destinée au dépôt et à la diffusion de documents scientifiques de niveau recherche, publiés ou non, émanant des établissements d'enseignement et de recherche français ou étrangers, des laboratoires publics ou privés.

University of Limoges

ED 615 - Sciences Biologiques et Santé (SBS)

UMR CNRS 7276 – Inserm U1262

Contrôle de la Réponse Immune B et des Lymphoproliférations (CRIBL)

A thesis submitted to University of Limoges
in partial fulfillment of the requirements of the degree of

Doctor of Philosophy

Discipline: Biology Science Health

Specialty: Immunogenetics

Presented and defended by

Lina Zawil

On December 4, 2021

**Reproducing the complex development of BCL2
deregulation in mouse models**

Thesis directed by: Pr. Michel COGNE

JURY:

President of jury

M. Jean Feuillard, University Professor, University of Limoges

Reporters

M. Laurent Genestier, DR, University of Lyon

M. Thierry Fest, PU-PH, University of Rennes

Examiners

Mme. Karin Tarte, University Professor, Université de Rennes

M. Jean Feuillard, University Professor, University of Limoges

Mme. Yolla El Makhour, University Professor, Lebanese University





During the first three years of my thesis, I was partially funded by a scholarship from the Lebanese University. The second part of my funding was covered by the municipality of my hometown, Ebba, Lebanon. For the 4th year of my thesis I was funded by 'La ligue Contre Le Cancer'.

My work was carried out within the CRIBL Laboratory (UMR CNRS 7276, INSERM U1262) at the Faculty of Medicine and Pharmacy in the University of Limoges, FRANCE.



To my Mother ♥

To my Husband ♥

To my Family ♥

Strength does not come from winning. Your struggles develop your strengths. When you go through hardships and decide not to surrender, that is strength.
Mahatma Gandhi.

Table of Contents

Acknowledgements	11
List of Abbreviations	19
List of Figures.....	25
List of Tables.....	27
Abstract.....	29
Résumé.....	30
Preamble.....	31
Bibliographic Introduction	33
Chapter I. Normal B cell development	35
I.1. The different stages of B cell development.....	37
I.1.1. The antigen-independent early stage.....	37
I.1.1.1. From hematopoietic stem cells to common lymphoid progenitors.....	37
I.1.1.2. Pre-Pro-B stage: Definitive commitment to B cell lineage.....	38
I.1.1.3. Pro-B stage: IgH locus rearrangement	39
I.1.1.4. Pre-B stage: IgL locus rearrangement.....	39
I.1.1.5. Immature B cell stage: Tolerance and editing of the BCR:	40
I.1.2. Antigen dependent late stages: Transitional stage and “B cell fate”	41
I.1.2.1. Transitional stage.....	41
I.1.2.2. Signaling and B cell fate.....	42
I.1.2.3. Mature B cell stage and Germinal Center (GC) formation	44
I.1.2.4. Follicular B lymphocytes (FO) and the formation of Germinal centers	44
I.1.3. Final differentiation: antibody secretion and immune memory	46
I.1.4. Regulatory B lymphocytes (Bregs)	48
I.2. Mechanistic of Immunoglobulin (Ig) gene rearrangement.....	48
I.2.1. Early V(D)J recombination of heavy/light chain loci and Ig assembly.....	48
I.2.2. Secondary remodeling of Ig genes: SHM and CSR	54
I.2.2.1. AID : Structure and function	55
I.2.2.2. CSR versus SHM.....	56
I.2.2.2.1. SHM	56
I.2.2.2.2. CSR: Induction of double strand breaks and their repair.....	59
Chapter II. Introduction into B cell lymphomagenesis	65
II.1. The origin of lymphoproliferations	65
II.1.1. Oncogenic lesions	65
II.1.2. Cellular origin of lymphomas	68
II.1.3. Tumor heterogeneity	69
II.2. Oncogenic alterations during lymphomas.....	73
II.2.1. Translocations during VDJ recombination: Implications of the RAG complex	74
II.2.2. Translocations during secondary recombination.....	75
II.2.3. 3'RR during lymphomagenesis.....	77
II.2.4. BCR and lymphomagenesis	78
II.2.4.1. BCR signaling	79
II.2.4.1.1. BCR signaling in B-cell malignancies.....	82
II.2.4.2. Canonical structures of the BCR	83
II.2.4.3. Antigen or auto-antigen recognition during lymphomagenesis	85

II.2.4.4. BCR N-glycosylation	86
II.3. Secondary alterations/hits in lymphomas	89
II.3.1. Epigenetic alterations	89
Chapter III. Follicular lymphoma (FL).....	91
III.1. Introduction to Follicular lymphoma.....	91
III.2. Classification and prognosis of FL.....	91
III.3. Cellular origin and phenotype of FL.....	92
III.4. FL genetic alterations.....	94
III.4.1. t(14;18) translocation.....	95
III.4.2. Secondary genetic alterations.....	97
III.5. Transformation of FL.....	99
III.6. Role of the BCR during FL	102
III.7. FL murine models	102
III.7.1. E μ -Bcl2 transgenic mouse model	103
III.7.2. VavP-Bcl2 transgenic mouse model	104
III.7.3. IgH-3'E-bcl2 mouse model	104
Chapter IV. Follicular Lymphoma and the surrounding microenvironment	106
IV.1. B-cell/T-lymphocyte interaction during FL.....	107
IV.2. Myeloid cells.....	109
IV.3. FL niche in secondary lymphoid organs.....	111
IV.3.1. Stromal cells: In secondary lymphoid organs (lymph nodes) and the Bone marrow (BM)	111
Thesis Objectives	114
Results	116
Article 1: Diverse B-cell specific transcriptional contexts of the BCL2 oncogene in mouse models impacts pre-malignant development.....	118
Unpublished Data: BCL2 deregulation and secondary mutations.	155
Kappa-MOUSS mice.....	155
HVEM and KMT2D Conditional Knock-Outs (HVEM / KMT2D x 3'RR-Bcl2 x AID-Cre ERT2/LSL-Tomato).....	160
Discussion and Future perspectives	173
Conclusion	189
Bibliographic references	192
Appendices	225

Acknowledgements

Beginning to write this part makes everything suddenly feel so surreal! I genuinely cannot comprehend that it has been 4 years since I have joined this lab, it feels like yesterday! But like all things in life, everything has a beginning and an end, and I cannot think of a better ending than thanking everyone who has contributed, from near or far, to the realization of this work!

First and foremost, I would like to express my sincere acknowledgements to my directors for giving me the opportunity to finish my PhD. Thank you, Michel, as my director and the director of the CRIBL Laboratory at that time, for giving me this opportunity, though I came from a very different background. Thank you, Karin, for helping co-direct this project and thank you both for the scientific discussions and for being kind enough to welcome me into your home in Rennes. I would like to also thank Dr. Yolla Makhour for accepting to be my co-director on behalf of the Lebanese University which contributed to my funding during the first three years of my thesis. I truly appreciate your kindness.

I would like to extend my acknowledgments and profound respect to the jury reviewers, Dr. Laurent Genestier and Dr. Thierry Fest for giving me the honor by accepting to judge my work and be a part of this committee. A sincere thank you goes to Dr. Jean Feuillard for not only being the president of the committee but also for all your scientific discussions and valuable opinions that you have given during the Lab meetings that I have presented in our unit.

My biggest appreciation goes to ALL members of the CRIBL laboratory, it wouldn't have been possible without you!

I would like to begin first by thanking all the people who contribute directly to the FL project.

Tiffany, my dear friend and precious colleague. I believe a thank you would be an underestimation of what I feel, truly! You were a friend, the best mentor I could have in learning how to deal with mice and in SO MANY other things. Thank you for being the best colleague ANYONE can ever have. Thank you for all the good times and for always being there for me and NEVER getting tired of listening to me. Thank you for your support for 3 years out of 4, for the hugs that you gave me when I needed them and for calming me down when I was freaking out (which happened quite a lot I admit!!). This project wouldn't have been possible without you. Writing this just now made me realize that for three years and being in contact with you EVERY DAY, we never had any fights or any toxic drama! That just shows how much we got along and the amazing team that we are! Thank you for being sweet enough to invite me into your home and for the very yummy raclette that we shared! My sincerest thoughts also go to your precious family, Lea, Louic and Pierre.

Alexis, thank you for everything that you have taught me the first two years of my thesis and for everything that you have contributed to this project! Thank you for bearing with me at the beginning when I was still new and had SO much to learn. I truly appreciate everything and wish you success and happiness in your new work and life!

A very special thank you goes to Claire Carrion and Stephanie Durant Panteix. You have NO IDEA how much I truly appreciate everything you have done for me throughout these years and specially around the end!

Stephanie, first, I would like to thank you for creating the mice! Also, I would like to extend to you my “multitude” of ‘thank you’s (haha) for your great support. Thank you for taking the time to sit with me and help me write the story of this project when I really needed to, for always giving me the advice that I needed and for being so kind and sweet by always offering your help and asking me if I needed any!

Claire, thank you so much for all your help in flow cytometry and microscopy and for staying so late with me trying to solve all the gating issues, it wouldn’t have been possible without you. Thank you for always being there when I needed help with any trouble and for caring in general about everyone’s security in the lab and for always listening to any problem anyone in the unit might have and for always offering help. You are one of the sweetest people that I have met and I am sure everyone would agree.

I would like to express my sincere acknowledgment for the “Pinaud Team” for their help in Ion-Proton sequencing. After a blockade of two years with sequencing I was able to solve this problem thanks to your help. Thank you, Charlotte and Morgane, for teaching me the protocol and helping me with the analysis and I wish you both the best for the remainder of your theses. A special thank you here goes to Eric and Sandrine LN for the very useful scientific discussions that you have had with me and for always helping me. Thank you, Sandrine, for being the Master of Deminer because without you, it wouldn’t have been possible for me to resolve the issue that I had with it! And Eric, maybe you saw me cry too many times more than you should in the past year or so (haha) and for that I would like to express my gratitude for lending me your ear and for the comforting, sweet and very encouraging words that you told me in times of need!

Last but not least, thank you Christelle Oblet for your all your help in Western Blot and for teaching me everything about this technique. Thank you also for the very beautiful Blot of BCL2 at the end and for saving everyone from seeing my very ugly blots!!

Thank you, Sebastien Bender, for your help and guidance in repertoire analysis as well! And Thank you Paco Derouault for all the help you offered me with repertoire scripts and analysis in general.

I would like to thank, with no exceptions, ALL the remaining members of our unit, whether still with us or not. I hope I don't leave any one out, but in case I do, please excuse me.

First, I extend my sincere acknowledgments to Yves D, Jean-Claude A, Laurent D, Christophe S, Sophie P, Chantal V, Nathalie F, Danielle T, Ahmad N, Hussein A.... Thank you all for your contributions to this unit and for your valuable scientific discussions and opinions during our lab meetings. I would like to thank Julie G, who is no longer with us, for teaching me how to withdraw blood from living mice. Thank you also to Sandrine LC, who is also no longer with us, for teaching me all about the cryostat and for always being so sweet. A special thank you also goes to Jeannie for being so kind and for always checking if everything was going well! Thank you also for always listening to me and for all your help and compassion.

I would like to extend my kindest thoughts and wishes to all the PhD students in the lab, whether still with us, have already graduated, or joined us recently. Audrey, Lilian, Rasha, Omar, Jean-Marie, Victoria... I wish you all the best in your new journeys. Stecy, Lea, Quentin, Nader, Dina, Kenza, Mylene, Gemma, Catherine... I wish you all the best for the remainder of your theses.

Without mentioning names (as I am sure I don't know all), I would like to extend my acknowledgments to all the workers and members of our animal facilities for their work in maintaining our mice and for their help as well.

A special acknowledgement goes to my Lebanese colleagues and friends. Batoul, Zeinab, Iman, Tarek and Nour. Thank you all, first for any help you offered me when I first came to France and started in the lab and for the unforgettable times that we have shared. Though most of you are not with us today anymore, I do wish you happiness and success in your future endeavors.

This part wouldn't be complete without acknowledging some very special people to me who have had an outstanding impact in my life, whether friends or family.

I think two of you already know who they are by now. You are my colleagues in this unit as well but I did not mention your name in any of the previous sections on purpose. You are not only my colleagues, you are my sisters BY CHOICE and I already told you that several times. You are so very special to me that I want to thank you separately and, even that, would be an underestimation. When I was feeling down? You were by my side. When I needed comfort? You gave me that and more. When I was happy and all over the place? You were right there sharing my happiness and laughter. When my "étagère" fell on me? You were there helping me fix it (haha). Just writing this makes me too emotional that I will be leaving soon and that

we will no longer see each other on a daily basis. You guys showed me the true meaning of quality over quantity. I love you both so much and I hope we NEVER fall out of touch.

Jennifer, we may have met only 2 years ago, but you sure showed me that it is never about the amount of time you know someone but about who that person shows up to be! Thank you for being the strong, sweet, generous, and the kindest friend that you are. Thank you and your family for being so thoughtful and making our big day even more special in Lebanon by coming and blessing us with flowers! I wish nothing but the very best for you in life in any aspect possible!

Isso, I mean, where do I even begin? I have had friends in my life before that resemble me, but not like you. I have had people in my life that I truly get along with, but again, not as much as you! My very first neighbor here in France and the BEST friend and sister that I could EVER ask for. Thank you for always thinking about me and checking up on me. I don't think you realize how much that means to me. Thank you for being the most caring and the most thoughtful person that I have ever met in my entire life. Thank you for seeing me at my very worst (in Paris haha) and still loving me! Thank you for your honesty, strength, kindness, sincerity, spontaneity, loyalty... the list could go on. Just thank you for being there for me and what I wish for you in life is more than what I could express into words!

I would like to thank all my friends, not just outside of the lab here in France but also in Lebanon, for all their love and support.

I would like to heavily thank all my family members, my grandparents, my cousins, my aunts and uncles for their moral support and endless love and affection.

The biggest of 'Thank you's though, goes to the most valuable people in my life; my mother and father and my 3 siblings, Sarah, May and Bilal.

I love you all so much and I thank you for being there for me throughout these years, loving me and supporting me whenever I needed it. I wish you could be here to celebrate this day with me, but that's life I guess!

I have to admit though, I wouldn't be who I am today without your infinite support, Mama. If I am strong, independent, kind or any other good trait that I may be, it is only because I was raised by an extra-ordinary woman like you! I owe everything that I have done and everything that I am today to you, and ONLY YOU! Because without the infinite amount of trust you put in me and without your immense support and love, I wouldn't have been able to achieve anything. I love you more than words could ever describe and I am just going to leave it there.

Last but most certainly not least, I would like to express my sincerest love and my deepest gratitude to the love of my life, my ULTIMATE best friend and my husband (still feels weird saying it I have to admit!), Hussein Issaoui.

I wanted to thank you at the end because honestly, you are the sweetest ending I could have ever asked for, not just for this, but for everything in my life!

Thank you for coming into my life when I least expected it! Thank you for mending all my wounds and for making me believe I could love and trust again! Thank you for accepting me for the crazy, anxious, loud and extremely nervous person that I am. Thank you for NEVER making me feel that I should change in order for me to be loved!

Thank you for being by my side throughout these 4 years, for being my biggest supporter and for always cheering me up. Thank you for tolerating me when I was at my worst and for loving me when I was not even lovable! I don't think I can EVER put into words how much you mean to me, how much I love you and how much I appreciate this relationship. So, simply, THANK YOU for just being so effortlessly YOU and for loving me with every bit of that ♥

Finally, I would just like to express my eternal gratitude to God for giving me health, for granting me countless blessings and for giving me the patience and strength to accomplish this thesis. It wasn't easy, but I made it ♥

Rights

This creation is available under a Creative Commons contract:
« **Attribution-Non Commercial-No Derivatives 4.0 International** »
online at <https://creativecommons.org/licenses/by-nc-nd/4.0/>



List of Abbreviations

3'RR 3' Regulatory Region

γ gamma

μ mu

α alpha

δ delta

κ Kappa

λ lambda

ε Epsilon

A

Ab Antibody

ABC **Transporter** ATP-binding
Cassette Transporter

A-EJ Alternative End-Joining Pathway

Ag Antigen

AID Activation Induced cytidine
Deaminase

APOBEC Apolipoprotein B RNA-
Editing catalytic Component

APRIL A Proliferation-Inducing Ligand

ATM Ataxia-Telangiectasia Mutated

AVC Angiogenic Vascular cells

B

BAFF B Cell Activating Factor

BAFF-R BAFF Receptor

Bak BCL2 Antagonist/Killer

Bax BCL2-associated X

BCR B Cell Receptor

BCMA B-cell maturation antigen

BCL2 B-Cell Lymphoma 2

Bcl2-mbr Bcl2 major breakpoint

BCL6 B-Cell Lymphoma 6

BER Base Excision Repair

BL Burkitt Lymphoma

BM Bone Marrow

53BP1 p53 Binding Protein 1

BRIGHT B Cell Regulator of IgH
Transcription

BSAP B Cell Specific Activator Protein

Btk Bruton's tyrosine kinase

BTLA B- and T-Lymphocyte attenuator

C

CAF Cancer-Associated Fibroblastic
cells

CBs Centroblasts

CCs Centrocytes

CCL Chemokine Ligand

CCND1 Cyclin D1

CDK Cycling Dependant Kinase 4

CDKN2A/B Cyclin-Dependent Kinase
Inhibitor 2A/2B

CDR Complementary Determining
Region

ChIP Chromatine ImmunoPrecipitation

CHL Classical Hodgkin's Lymphoma
CLP Common Lymphoid Progenitor
CLL Chronic Lymphocytic Leukemia
CPC Common Progenitor Cell
CSR Class Switch Recombination
cRSS Cryptic Recombination Signal Sequence
CREB cAMP response element binding protein
CREBBP CREB binding protein
Csk C-terminal src tyrosine kinase
CXCR C-X-C type Chemokine Receptor
CXCL C-X-C-type Chemokine Ligand

D

D Diversity
DAMP Damage-Associated Molecular Patterns
DC Dendritic Cell
DC-SIGN Dendritic cell-specific intercellular adhesion molecule-3-grabbing non-integrin
DDR DNA Damage Repair pathway
DLBCL Diffuse Large B Cell Lymphoma
DLEU2 Deleted in Lymphocytic Leukemia 2
DM Double mutant
DNase I DeoxyriboNuclease I
DNA-PKcs DNA Dependant Protein Kinase catalytic subunit

DSB Double Strand Break
DZ Dark Zone

E

E2A E box protein binding 2 A
EBF1 Early B cell Factor-1
ER Endoplasmic Reticulum
ERK Extracellular-signal-Regulated Kinase
ESC Embryonic Stem Cell
EZH2 Enhancer of zeste homolog 2

F

FDC Follicular Dendritic Cell
FL Follicular Lymphoma
FL-CAF FL associated Fibroblasts
FLLC FL like cells
FOXO1 Forkhead box protein O1
FOXP3 forkhead box P3
FO Follicular
FR Framework Region
FRC Follicular Reticular Cells

G

GC Germinal Center
Gof Gain of Function

H

HCV Hepatitis C virus
HGF Hepatocyte Growth factor

Hh Hedgehog
HL Hodgkin's Lymphoma
HRS Hodgkin and Reed-Sternberg cells
HSC Hematopoietic Stem Cells
Hs Hypersensible
HT Histologic Transformation
HTM HVEM Triple Mutant
HVEM Herpes Virus Entry Mediator A

I

Ig Immunoglobulin
IgH Immunoglobulin Heavy chain
IgL Immunoglobulin Light chain
IL Interleukine
IFN Interferon
IIC Infiltrating Immune Cells
IRF4 Interferon Regulatory Factor 4

J

J Junction

K

Kb Kilobase
Ki Knock-in
KMT2D Histone-lysine N-methyltransferase 2D (other names: MLL4)
KTM KMT2D TM
KO Knock-Out

L

LAPTM5 lysosome associated protein transmembrane 5
LLPC Long-lived Plasma Cells
LN Lymph node
LPS Lipopolysaccharides
LT Lymphotoxin
LTA Lymphotoxin Alpha
LZ Light Zone

M

MALT Mucosa Associated Lymphoid Tissue
MARE MAf Recognition Element
MAPK Mitogen Activated Protein Kinase
MCL Mantle Cell Lymphoma
MDR1 multidrug resistance mutation 1
MEF2B Myocyte enhancer binding factor 2B
MLH MutL Homolog1
MMR Mismatch Repair
MRC Marginal Reticular Cells
MSH MutS Homolog
MSC Mesenchymal Stem Cells
mTOR Mammalian Target of Rapamycin
MZ Marginal Zone
MZL Marginal Zone Lymphoma

N

N Non-germline nucleotide

NF-κB Nuclear Factor Kappa B pathway

NHEJ Non-Homologous End Joining

NHL Non-Hodgkin Lymphoma

NK Natural Killer

O

OAEMZL ocular adnexal extranodal marginal zone lymphomas

P

P Palindromic nucleotide

PARP 1 poly ADP-ribose polymerase I

Pax-5 Paired box gene 5

PBs Plasmablasts

PCs Plasma cells

PCR Polymerase Chain Reaction

PI3K phosphatidylinositol-3-kinase

PMS2 Post Meiotic Segregation 2

P.P Peyer's Patches

PRDM1 PR domain zinc finger protein 1

PTK Protein Tyrosine Kinases

PU.1 Purine box factor 1

R

RPA Replication Associated Protein A

RAG Recombination Activating Gene

RSS Recombination Sequence Signal

REAL Revised European and American Lymphoma

S

SHM Somatic HyperMutation

SHP-1 Src homology phosphatase-1

SIRP Inhibitory receptor Signal Regulatory Protein

SLC Surrogate Light Chain

SLPC Short-Lived Plasma Cells

SMZL Splenic Marginal Zone Lymphoma

SNV Single Nucleotide Variation

SOCS3 Suppressor of Cytokine Signaling 3

SOPF Specific and Opportunistic Pathogen Free

SSB Single Strand Break

STAT5 Signal transducer and activator of transcription 5

SYK Spleen tyrosine kinase

T

TAM Tumor-Associated Macrophage

TACI Transmembrane Activator and CAML interactor

TdT Terminal deoxynucleotidyl Transferase

Teff Effector T cells

TNF Tumor Necrosis Factor

TNFAIP3 TNF Alpha Induced Protein 3

TGF-β Transforming Growth Factor β

TGM Tingible Body Macrophages

X

TFH T Follicular Helper

tFL Transformed Follicular Lymphoma

XRCC1 X-ray Repair Cross-
Complementing protein 1

Th Helper T cells

TLR Toll Like Receptor

XRCC4 X-ray Repair Cross-
Complementing protein 4

TNFRSF14 TNF Receptor Superfamily
Member 14

XLF XRCC4-like Factor

TM triple mutant

Tp53 Tumor protein 53

Treg Regulatory T cells

Z

TRAIL TNF-related apoptosis-inducing
ligand

ZAP-70 Zeta-chain-associated protein
kinase 70

U

UNG Uracil DNA Glycosylase

V

V Variability

VEGF vascular endothelial growth
factor

VH Variable regions of heavy chains

VL Variable regions of light chains

VSC Verstaile Stromal Cells

W

WES Whole exome sequencing

WT Wildtype

List of Figures

Figure 1 : Structure of an immunoglobulin, example of IgG1.	35
Figure 2 : Schematic representation of the recombination events during B cell lymphopoiesis.....	36
Figure 3 : Origin of B lymphocytes.....	38
Figure 4 : Schematic representation of early B cell ontogeny.	41
Figure 5 : Model of germinal center dynamics and compartmentalization.	45
Figure 6 : Models of GC B cell differentiation.....	47
Figure 7 : Schematic representation of RSS and the « 12/23 » rule.....	49
Figure 8 : Schematic representation of the RAG-mediated DNA cleavage.	54
Figure 9 : Hypermutation profile induced by AID in the Ig locus.....	57
Figure 10 : Schematic showing how the mismatches created during SHM are handled.....	59
Figure 11 : Generation of germline transcripts in the constant regions.	60
Figure 12 : Schematic representation of an R-loop.....	61
Figure 13 : Schematic representation of CSR mechanism.....	62
Figure 14 : DNA repair pathways implicated within CSR.	64
Figure 15 : Recurrent translocations in B cell lymphoproliferations.....	66
Figure 16 : Acquired cellular characteristics during cancerization.	67
Figure 17 : The cellular origin of B cell lymphomas.....	69
Figure 18 : Schematic representation of the clonal composition of tumors.....	71
Figure 19 : Representation of the Hodgkin Reed-sternberg (HRS) cells.	72
Figure 20 : Recurrent translocations within the IgH locus linked to Ig diversification mechanisms.....	74
Figure 21 : Genome-wide partners of c-myc and the IgH locus during translocations.....	77
Figure 22 : Schematic model representation of the BCR signaling crosstalk (example of CSR induction).....	82
Figure 23 : Schematic representation of the interactions of an N-glycosylated BCR.....	88
Figure 24 : Schematic representation of the molecular alterations and appearance of lymphomas.....	93
Figure 25 : The different steps that lead to FL development.	95
Figure 26 : Schematic representation of the mechanism of the t(14;18) during FL.	96
Figure 27 : Schematic representation showing the aberrant histone/chromatin modifications in FL.....	97
Figure 28 : Schematic representation showing the histologic transformation of FL.....	101



Figure 29: A model of B-cell/stromal cell interactions in normal and malignant follicles.	107
Figure 30: The cumulative effect of BCR N-glycosylation and BCL2 deregulation on splenocytes.	157
Figure 31: ROC <i>versus</i> WT compared to Kappa-MOUSS.	159
Figure 32: Triple mutant mouse induction and follow up.	162
Figure 33: Cumulative effect of HVEM deletion and BCL2 deregulation on peripheral B cells.	164
Figure 34 : Preliminary heavy chain (IgM and IgG) repertoire data in secondary lymphoid organs.	166
Figure 35 : Ion- Proton sequencing of the BCL2 promoter region in secondary lymphoid organs of Non-tumoral mice.	169
Figure 36: Ion-Proton sequencing of the BCL2 promoter region in the tumor tissue and secondary lymphoid organs of tumoral mice.....	170
Figure 37 : Cumulative effect of BCL2 deregulation and KMT2D deletion on peripheral B cells.....	172
Figure 38 : Schematic representation of the <i>BCL2 promoter region</i>	180
Figure 39: Summary of the most famous secondary genetic alterations and biologic pathways that lead to FL.	182

List of Tables

Table 1 : Summary of tumor development, or not, in the HVEM triple mutant cohort bred in the SOPF animal facility. 165

Table 2: Summary of tumor development, or not, in the HVEM triple mutant cohort bred in the conventional animal facility. 165

Tables 3 : Detailed Ig heavy chain repertoire analyses of the different tumor tissues obtained for both HVEM TM cohorts. 167

Table 4 : Summary of tumor development (or not) in the KMT2D triple mutant cohort bred in the pathogen free SOPF animal facility. 171

Table 5 : Modified peripheral B cell staining panel for Triple Mutant mice expressing tomato. 226

Abstract

Follicular lymphoma (FL) is the most common indolent form of non-Hodgkin lymphoma arising from malignant germinal center (GC) B-cells. The genetic hallmark that leads to the development of FL is the t(14:18) which occurs early in the bone marrow during B cell development, thereby placing the anti-apoptotic Bcl2 gene under the direct control of the transcriptional enhancers which stand in 3' of the immunoglobulin heavy chain locus (IgH 3'RR) and leading to the constitutive expression of the BCL2 protein. To assess the impact of the Bcl2 deregulation on B-cell fate and try to reproduce FL development in mice, two models were designed: the **Igκ-BCL2** (Knock in of the Bcl2 in the immunoglobulin light chain kappa locus) and the **3'RR-BCL2** (Transgene containing Bcl2 and a micro-3'RR), both containing the full BCL2 promoter region. Despite striking differences between both models, we showed that the 3'RR-BCL2 mouse model is the more pertinent for the study of FL. This model indeed leads to a much more GC-focused expression, and, accordingly, to more significant GC B cell expansion rather than plasma cell expansion. By contrary, pan-B expression of BCL2 in the Igκ-BCL2 models culminates with a strong overexpression in plasmablasts and plasma cells. However, and whatever the BCL2 configuration, in the absence of additional oncogenic hit, both of our models remained free of GC B cell tumors on the long run and rather ended developing plasmacytic lymphomas. Thus, to introduce secondary genetic alterations, we crossed our 3'RR-BCL2 mice with other models bringing anomalies known to occur in human FL (BCR N-glycosylation of the V domains, HVEM or KMT2D loss of function). We were able to show that with the addition of these secondary mutations, notably HVEM/KMT2D deletions, our mice developed GC hyperplasia and were eventually able to develop tumors of GC B cell phenotype. This part of our work is still preliminary and more work needs to be done but, all in all, our current study presents strong tools that can be used for further building pertinent FL models and better understanding the complex development of FL.

Key words:

Bcl2 deregulation, Follicular lymphoma, Transcriptional regulation, B-lymphocytes.

Résumé

Le lymphome folliculaire (FL) est le lymphome non-hodgkinien indolent émanant de cellules B du centre germinatif (GC) le plus courant. La translocation t(14 :18) ayant lieu tôt dans le processus du développement B est la marque génétique du FL. Cette translocation place le gène Bcl2 sous le contrôle direct des éléments régulateurs situés en 3' du locus des chaînes lourdes d'immunoglobulines (IgH 3'RR) et aboutit à l'expression constitutive de la protéine Bcl2. Afin d'étudier l'impact de la dérégulation de Bcl2 sur le développement B et dans le but de reproduire les mécanismes aboutissant au développement du lymphome folliculaire, deux nouveaux modèles murins ont été créés : le modèle **Igκ-BCL2** (*Knock-In* du gène Bcl2 inséré dans le locus kappa des chaînes légères d'immunoglobulines) et le modèle **3'RR-BCL2** (Transgène contenant Bcl2 et les éléments régulateurs minimum en 3' de la chaîne lourde des Ig, micro-3'RR), ces deux modèles comprenant le gène BCL2 et sa région promotrice complète. Nos études ont montré que le modèle 3'RR-BCL2 apparaît le plus pertinent pour l'étude du FL (avec une expression plus focalisée de l'oncogène dans les cellules du GC, et avec une plus nette expansion des cellules B du GC et une expansion des cellules plasmocytaires moindre). Cependant, avec pour seul hit la dérégulation de BCL2, nous avons observé qu'aucune tumeur issue du GC n'apparaissait sur le long terme dans aucun de nos deux modèles, mais éventuellement des tumeurs de type lymphome plasmablastique. Afin d'introduire un deuxième événement génétique potentiellement oncogénique, nous avons croisé nos modèles murins avec des modèles possédant d'autres anomalies génétiques connues pour être observées dans le FL (modèle avec un BCR N-glycosylé au niveau des régions variables, ou portant la perte de fonction de HVEM ou de KMT2D). L'ajout d'un second hit a permis d'observer le développement de tumeurs avec un phénotype de type GC, notamment dans le cas du modèle double-mutant 3'RR-BCL2 x HVEM/KMT2D. Cette deuxième partie est en cours d'étude mais nous présentons déjà les différents outils qui nous semblent conduire à de nouveaux modèles très pertinents du FL humain, propres à permettre de mieux comprendre le développement d'un lymphome folliculaire.

Mots clés :

Dérégulation de Bcl2, Lymphome Folliculaire, Régulation transcriptionnelle, lymphocytes B.

Preamble

Follicular lymphoma (FL) is an indolent form of non-Hodgkin's lymphoma (NHL), accounting for 30 to 40% of the cases, making the most common. It originates from germinal center (GC) B cells and is considered incurable. The genetic hallmark that leads to the development of FL is the t (14:18) that occurs early in the bone marrow during the development of B lymphocytes. This translocation places the anti-apoptotic gene Bcl2 under the direct control of the enhancers of the immunoglobulin heavy chain locus 3' regulatory region (IgH 3'RR), leading to a deregulated expression of its promoters and thereby a constitutive expression of the anti-apoptotic Bcl2 protein.

The complex natural history of FL spans years of evolution. Before transformation, cells go through several cycles of entry and exit (with likely defective exit) from the GC, where they accumulate various oncogenic alterations in contact with a microenvironment that is supporting their survival and growth. Faithful modeling of this complex natural history requires animal models reproducing *in vivo* the interaction between malignant B cells and the microenvironment. However, no mouse model to date has faithfully modeled this pathogenesis. An "original sin" of the published models is the deregulation of Bcl2 distinct from that of FL; meaning either with overexpression in all hematopoietic cells (vavP-Bcl2) (Egle et al. 2004), or restricted to B cells but under the control of an enhancer (E μ) without specificity for the activated GC B cell stage (E μ -Bcl2)(McDonnell et al. 1989a; Strasser, Harris, and Cory 1993).

The objective of my thesis project was thus to study the effect of this stage specificity by designing and comparing two new models:

- 1- Igk-Bcl2: Knock-in of human Bcl2 in the Igk light chain locus, ensuring "pan-B" deregulation, but with maximum activity in terminal B cell differentiation.
- 2- 3'RR-Bcl2: Transgene placing Bcl2 under the control of an enhancer which our laboratory has previously demonstrated the specificity of the GC stage and the capacity to stimulate both the transcription and the recruitment of the enzyme AID: the super enhancer IgH 3'RR.

It should be noted that the promoter region of Bcl2 has a characteristic structure including two promoters P1 and P2. In healthy cells, transcription is only issued from P1. In FL however, cells show a shift from P1 to P2. Unlike the Bcl2 transgenes previously described, our two models contain the complete Bcl2 promoter region and

allow us to study its involvement in the Bcl2 deregulation process. This region includes sites binding transcription factors, such as the repressor Bcl6 that limits the expression of Bcl2 in normal GC cells.

Deregulation of Bcl2 alone is not enough to induce the development of FL, secondary genetic mutations are necessary. For that reason, we crossed our Bcl2-deregulated mice with three other models carrying alterations frequently detected during FL:

- 1- The presence of N-glycosylation sites in the variable region of BCR is almost constant in LB of FL. We have developed a new mouse model carrying a pre-rearranged N-glycosylated IgK chain (Kappa-MOUSS mouse).
- 2- Mutations affecting KMT2D (or MLL4) which are detected in 90% of cases of FL. KMT2D is a histone methyltransferase. Its deletion disrupts the development of B cells in the GC and promotes lymphomagenesis in mice.
- 3- HVEM (Herpes Virus Entry Mediator, also referred to as TNFRSF14), frequently mutated during FL (in up to 40% of the cases). HVEM normally controls cell proliferation and its loss has been shown to disrupt cell-cell interactions, creating a tumor-supportive microenvironment. In other words, HVEM deletion

facilitates escape from the immune response and leads to increased B proliferation.

Our aim in this thesis project was to understand the earliest stage of FL development and the mechanism leading to its transformation into a more aggressive lymphoma. Such work could eventually lead to uncovering novel diagnostic and therapeutic strategies. We ran a multitude of experiments on all of our mice, including flow cytometry and immunohistochemistry ones to fully characterize our mice at the cellular level. In parallel various, high-throughput sequencing techniques were also conducted to help us better characterize our mice at the molecular level as well.

All the data we obtained showed that our mouse models were invaluable tools to recapitulate the early events of FL lymphomagenesis and could even be used for preclinical studies.

Bibliographic Introduction

Chapter I. Normal B cell development

Immunoglobulins (Ig) are glycoproteins produced by B lymphocytes that play a pivotal role in protective immunity. In mice as in humans, Igs are polymers of four protein chains, two identical heavy chains and two identical light chains (Fig. 1), encoded by three distinct loci, located on three different chromosomes. We distinguish two loci coding for the light chains: the Igk locus and the Ig λ locus, and one encoding the heavy chains, the IgH locus. Each type of chain has a variable region (denoted VH or VL), which forms the recognition site specific to the antigen, and a constant part (CH or CL), which determines the effector functions of immunoglobulin. In mammals, there are two types of light chain loci, termed Kappa and lambda (Igk and Ig λ respectively) and five classes of heavy chains denoted: μ , δ , γ , ϵ , α , giving IgM, IgD, IgG, IgE and IgA respectively.

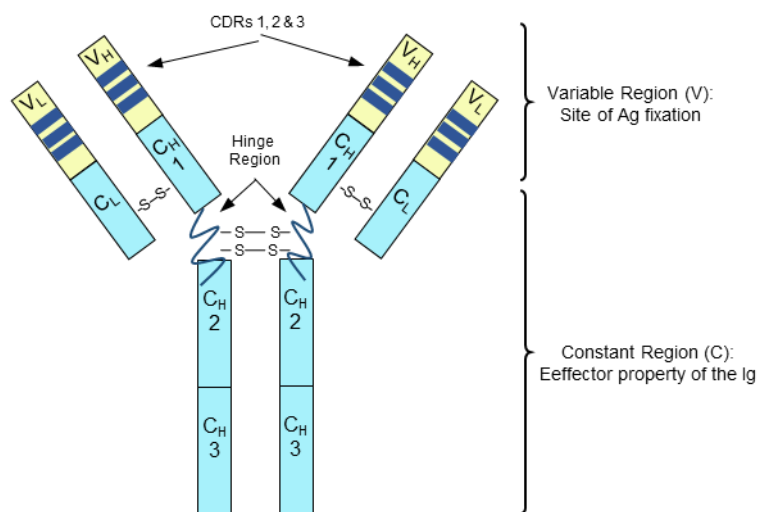

Figure 1 : Structure of an immunoglobulin, example of IgG1.

The variable domain (represented in light yellow) is composed of the variable regions of both the heavy and light chains (VH and VL respectively). Each of these domains contains three hypervariable regions, named CDR 1 to 3 (represented in dark blue), separating four less variable regions (FR 1 to 4). The constant domain (represented in light blue), is composed of the constant regions of both the heavy and light chains (CH and CL respectively). The hinge region, which confers flexibility is located in-between the CH1 and CH2.

In their germline configuration, these Ig loci are nonfunctional and composed of a succession of genes, forming different segments: from 5' to 3', we distinguish the segments of variability "V", the segments of diversity "D" (only on the IgH locus), the joining segments "J" and finally the constant segments "C". The V (D) J segments

encode the variable regions, while the C-segments encode the constant regions of the Ig chains. Despite the differences between different mammal species, both the murine and human loci have a very similar organization, making the mouse an ideal model for their analysis (Hirano et al., 2011). The efficient combination of a single light chain V and J segment along with heavy chain V, D and J segments occurs in a seemingly random fashion thereby resulting in the expression of a BCR on the cell surface, determining the further fate of the B cell. To be more specific, these loci must undergo several gene recombination events to allow the expression of functional Igs by B lymphocytes (Fig.2). These events punctuate lymphopoiesis. We distinguish the so-called "early", events which occur in the bone marrow and precede the encounter with the antigen, followed by the "late" events, which occur in the secondary lymphoid organs (such as the spleen, Peyer's patches and lymph nodes) after engaging with the antigen (Pieper et al., 2013).

These events help to diversify the antigenic repertoire to optimize the efficiency of the immune response, by increasing the affinity of the Ig for the antigen on one hand, and on the other hand by adapting its effector functions (explained in detail later on in this chapter).

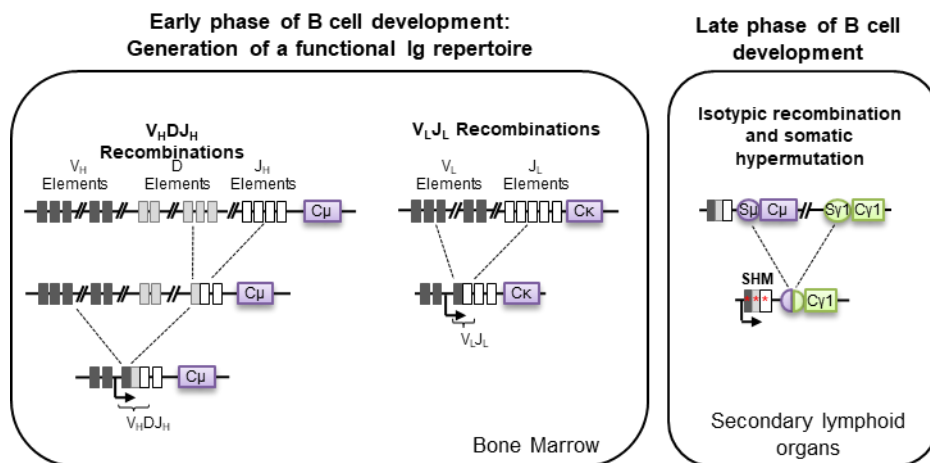

Figure 2 : Schematic representation of the recombination events during B cell lymphopoiesis. During the early phases of B cell development, before any encounter with an antigen, the V_HDJ_H et V_LJ_L (here V_kJ_k) assembly takes place, allowing expression of a functional BCR. During the late phases of B cell development, under an antigen-drive selection, the phenomena of SHM and CSR take place, optimizing BCR affinity for the antigen and modifying the expressed isotype.

I.1. The different stages of B cell development

The maturation of B cells is a sequential process, which progresses through a series of developmental stages to result in the generation of a functional antibody-producing B lymphocyte.

I.1.1. The antigen-independent early stage

I.1.1.1. From hematopoietic stem cells to common lymphoid progenitors

B cell ontogenesis begins in bone marrow (BM) and the fetal liver in the absence of an antigen (Ag). This journey is not clearly compartmentalized; meaning that we rather speak of a "continuum" during which the B lymphocytes come from hematopoietic stem cells (HSC for Hematopoietic Stem Cells) (Fig.3). The latter constitute the self-renewing multipotent progenitors capable of generating all blood cell lineages (Pieper et al., 2013; Tsuneto et al., 2014).

These hematopoietic stem cells will initially differentiate as multipotent progenitors, always capable of differentiating into cells of different lineages, but having lost their capacity for self-renewal. Then, the differentiation and commitment of HSCs into specific cell types involves the sequential activation of lineage-specific transcription factors. The most crucial of which is the E26 transforming sequence (ETS) purine box transcription factor 1 (PU.1), the action of which allows these cells to engage into different lineages, thus forming myeloid or early lymphoid progenitors (ELP). Then, the zinc finger transcription factor IKAROS synergizes with PU.1, and through its control of lineage priming, sets the stage for lymphoid cell development and reduced myeloid potential. Cells at this stage will gradually acquire the expression of IL7 and Rag1, forming the population of common lymphoid progenitors (CLP), which is at the origin of T and B lymphocytes, Natural Killer (NK) as well as plasmacytoid dendritic cells (pDC) (For review: (Dress et al., 2019; Hardy et al., 2007; Miyazaki et al., 2014; Nutt and Kee, 2007)).

Entry into B cell lineage is mainly influenced by four transcription factors: E2A, EBF1, Pax5 and FOXO1, which promote the differentiation of B cells while suppressing the T and NK lineages (For review: (Welinder et al., 2011; Zhang et al., 2013)). More specifically, stimulation of CLPs by IL-7 will induce the expression of Early B cell Factor (EBF1), which will limit the differentiation to B and T lymphocyte lineages. Finally, the expression of Pax5 (along with EBF1) will inhibit T and NK lymphocyte lineages,

allowing the expression of B220 (CD45 receptor), and the definitive engagement to the B lymphocyte line and differentiation into the pre-pro-B cell stage (Souabni et al., 2002; Treiber et al., 2010; Tsuneto et al., 2014). Studies have shown that inactivation of Pax-5 expression in mice blocks development B cells at the pre-pro B cell stage and leads to their return to the multipotent progenitor cell stage having the capacity to differentiate into macrophages or T cells (Cobaleda et al., 2007; Mikkola et al., 2002).

It is worthy to note that there is a subpopulation of particularly common lymphoid progenitors, capable of entering the B lymphocyte line in the absence of IL7, but not PU.1. This population, found in the fetal liver, is at the origin of B1 lymphocytes, a special class of B cells that play a role in innate immunity (For review: (Montecino-Rodriguez and Dorshkind, 2012)).

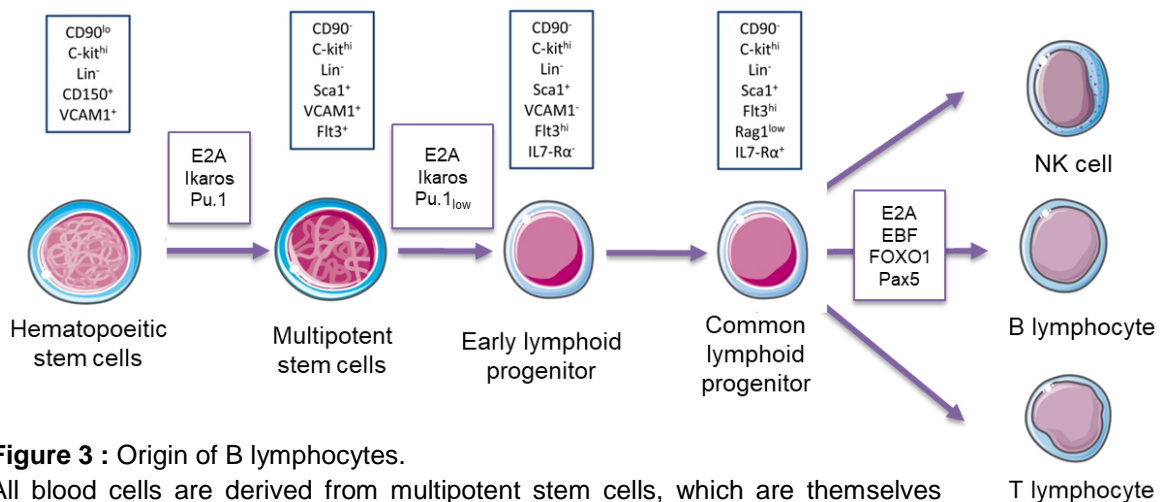

Figure 3 : Origin of B lymphocytes.

All blood cells are derived from multipotent stem cells, which are themselves derived from hematopoietic stem cells. These cells, under the influence of certain transcription factors, will gradually engage in the lymphoid line, forming precursors common to T and B lymphocytes, but also to NK cells, before differentiating into pre-pro B and thus begin their differentiation into B lymphocytes.

I.1.1.2. Pre-Pro-B stage: Definitive commitment to B cell lineage

The pre-pro-B cell stage is the most immature stage of the B cell lineage. These cells are distinguished from their progenitors only by the expression of markers specific for B cells. Thus, while still expressing the marker CD117 (c-kit), these cells express the surface marker B220 or CD45R specific of B cells as well as the signal transduction molecules CD79a (Ig α) and CD79b (Ig β) which are all characteristics of B lymphocytes (Hardy et al., 2007). Up to this point, the loci of the Ig chains are in germline conformation, therefore unable to express an Ig.

Again, the prolonged expression of Pax5 and EBF1 at this stage is necessary to acquire the expression of the marker CD19, thereby allowing these cells to reach the pro-B cell stage, where the VHDJH rearrangements take place on the heavy chain loci (Hardy et al., 2007).

I.1.1.3. Pro-B stage: IgH locus rearrangement

Up to this point, the immunoglobulin (Ig) chain loci are in a germline conformation, and therefore do not allow the expression of Ig. However, when B cells reach the pro-B stage, they begin to express the marker CD19. This is particularly marked by the initiation of the VHDJH rearrangement process. The latter is an ordered (in which the IgH locus rearrangements occur before those of the IgL loci) and sequential mechanism (in which the D-JH recombination precedes the VH-DJH) (Alt et al., 1984; Jung et al., 2006).

First, and simultaneously on both alleles of the IgH locus, a segment D combines with a JH segment to form a D-JH junction resulting in the deletion of the DNA between these segments. Secondly, the VH-DJH rearrangement, which combines a segment VH to the previously formed D-JH segment, takes place only on a single allele. It is the allelic exclusion mechanism that ensures the uniqueness of the Ig produced by a cell (Corcoran, 2005; Jung et al., 2006). The VHDJH exon thus formed is transcribed and then spliced on the first exon C μ resulting in the expression of a heavy chain μ .

The exact mechanism through which the VDJ recombination process occurs is detailed carefully in a later section in this chapter (see section I.2.1.).

I.1.1.4. Pre-B stage: IgL locus rearrangement

The expressed Ig heavy chain, will then associate with a pseudo light chain and with the CD79a and CD79b co-stimulatory molecules to form a pre-BCR. This constitutes the first control point during B cell development. This ensures that the cell expresses a single heavy chain, before initiating light chain recombination (For review: (Mårtensson et al., 2010)). The pre-B cells are separated into two sub-populations. We distinguish the large pre-B cells characterized by the expression of CD43 and the absence of CD25. These cells will undergo 2 to 5 division cycles (Rolink et al., 2000), before becoming small pre-B cells (small pre-B), expressing CD25 but no longer CD43. These cells do not divide anymore, but do undergo rearrangements on their light chains. It is necessary that proliferation and recombination phenomena are exclusive,

in order to ensure genome stability. This equilibrium is ensured by the balance between the receptor pathway to IL7 and the pre-BCR pathway (Clark et al., 2014). At the large pre-B cell stage, pre-BCR activation (signaling through the BCR is explained in details in chapter 2), activates the PI3K pathway via the SYK protein, which results in phosphorylation and degradation of FOXO proteins, thereby inducing proliferation and subexpression of RAG proteins. During the transition to the small pre-B stage, SYK activates the SLP65 protein which then represses the signaling of pre-BCR via PI3K, and inhibits the degradation of FOXO proteins, thus stopping proliferation and re-expression of RAG proteins (Herzog et al., 2009, 2008); For review: (Reth and Nielsen, 2014)). This repression of signaling by pre-BCR is amplified by a mechanism of negative feedback: signaling by pre-BCR induces the expression of the protein LAPTM5 (lysosome associated protein transmembrane 5) which causes degradation in intracellular pre-BCR lysosomes, limiting its expression to the membrane (Kawano et al., 2012). The inhibition of signaling via the pre-BCR leads to the inhibition of proliferation of cells and triggers rearrangements on light chain loci (detailed later in this chapter (see section I.2.1.)).

I.1.1.5. Immature B cell stage: Tolerance and editing of the BCR:

At this stage, after the various stages of maturation, the cells express a functional BCR and lose the expression of CD25 (Fig. 4). However, the expression of a BCR is not sufficient to allow the passage of B cells to the periphery: they must first undergo a new control checkpoint in order to eliminate the cells expressing self-reactive BCRs, i.e. recognizing an antigen of the organism itself. This second checkpoint ensures the immune tolerance, i.e. the ability of the body to withstand the presence of an antigen without triggering an immune response. For this, a negative selection mechanism occurs to eliminate cells expressing a self-reactive BCR by apoptosis, or to render them anergic (Pike et al., 1982; Russell et al., 1991). To escape apoptosis, cells can modify their BCR, by performing new rearrangements at their Ig loci: this is called BCR editing (Halverson et al., 2004; Tiegs et al., 1993). On the Igk locus, these rearrangements can easily take place between a Vk segment upstream of the exon VkJk and a Jk segment downstream. The locus can also undergo recombination that lead to k locus inactivation and triggers recombination on the Igλ locus (Luning Prak et al., 2011; Moore et al., 1985). On the heavy chain locus and without going into much

detail, the editing mechanism is significantly different from the initial VHDJH rearrangements and can lead to VH segment replacement.

At the end of this checkpoint, and after a possible modification of the receptor, the cells that do not recognize self-antigens are capable of moving forward with their development, and of leaving the bone marrow to reach the secondary lymphoid organs.

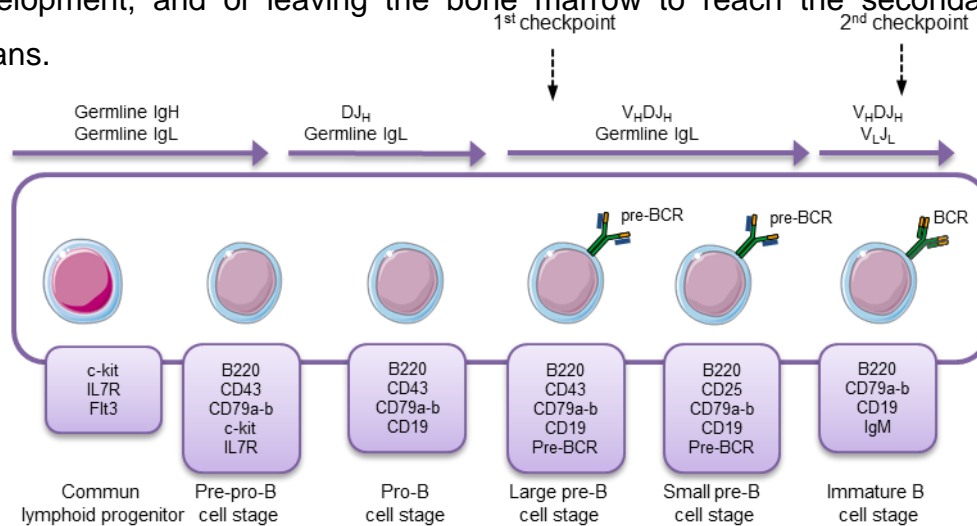

Figure 4: Schematic representation of early B cell ontogeny.

The purple boxes indicate the main transcription factors and cell surface markers that are expressed at each stage of early B cell development. The horizontal arrows represent the evolution of the configuration of the Ig loci, and the two vertical arrows represent the two checkpoints that occur during early B cell development.

1.1.2. Antigen dependent late stages: Transitional stage and “B cell fate”.

1.1.2.1. Transitional stage

When they exit the bone marrow, the B cells pass through the circulation to get to the spleen. However, these cells are not yet mature, and do not have the ability to respond to stimulation by an antigen. These functions are acquired gradually, during the so-called “transitional” stage (For review: (Chung et al., 2003)). This stage corresponds to a population of heterogeneous cells, divided into three subpopulations: T1, T2 and T3, each with specific surface markers and functions. Schematically, T1 corresponds to early transitional cells, and T2 corresponds to the late ones. T3, described more recently, constitutes a distinct population of anergic and frequently self-reactive cells (Liubchenko et al., 2012; Merrell et al., 2006; Teague et al., 2007).

The main difference between T1 and T2 cells is their response to BCR stimulation. In fact, at the T1 stage, the binding of an antigen to the BCR induces the apoptosis of the

cell. It is therefore an additional selection, in the continuity of the checkpoints taking place at the immature stage in the bone marrow. However, transitional cells no longer express the enzymes of the RAG complex; recognition of a self-antigen does not induce the edition of BCR, and therefore causes the apoptosis of the cell or its anergy (Sandel and Monroe, 1999). Several studies have demonstrated the importance of this selection in transitional cells, showing that deregulation at this stage is frequently associated with autoimmune diseases such as lupus erythematosus or Sjögren syndrome ((Teague et al., 2007); for review: (Vossenkämper et al., 2012)). At the T2 stage, cells will gradually acquire the characteristics of a mature B cell. Even though the different bibliographic sources differ significantly, it is well known that the T2 stage is marked by the progressive increase of resistance to apoptosis and proliferation capacity in response to stimulation via BCR.

It is the installation of signaling cascades upstream of the BCR that will regulate the continued lymphocyte development up to the mature stage, in combination in particular with the BAFF receptor pathway (B-cell Activating Factor, also called BLys) ((Sasaki et al., 2004; Schneider et al., 1999); For review: (Cancro, 2004; Jung et al., 2006; Khan, 2009)). In parallel with the installation of these signs, the BCR acquires, at the mature stage, the ability to respond to stimulation by relocating within lipid rafts and overexpressing CD86, a costimulatory protein, thus forming a "signalosome" to optimize the BCR signal transduction (Chung et al., 2001, 2002).

I.1.2.2. Signaling and B cell fate

The ability of B cells to respond to signals, acquired during the transitional stage has two functions: on one hand ensuring the survival and continuity of the development of cells having successfully passed the various checkpoints during early lymphopoiesis, and on the other hand regulating the fate of mature cells. Indeed, mature B cells are divided into several subpopulations, each with different features and functions. The two major sub-populations are so-called marginal zone cells (MZ B cells, for Marginal zone B cells) and follicular cells (FO) (Pillai and Cariappa, 2009).

There is also a population of so-called "B1" cells, from different precursors (Montecino-Rodriguez and Dorshkind, 2012). The importance of these signals has been demonstrated by numerous studies based on alteration of signaling cascades in response to BCR activation. According to targeted proteins, a disruption of this

signaling can lead to blockade at the transitional stage, or a bias in the distribution of marginal and follicular subpopulations (Allman et al., 2004; Chung et al., 2003). Activation of signaling by BCR can be divided into 3 stages:

- 1- Initiation of signaling by binding of an antigen to the receptor
- 2- Propagation signaling and activation of phosphorylation cascades via second messengers
- 3- Signal integration, leading to activation and translocation to the nucleus of transcription promoting the survival and differentiation of B cells (For review: (Dal Porto et al., 2004; Packard and Cambier, 2013)).

In parallel to the BCR track, the binding of BAFF and APRIL proteins, ligands of the TNF family, to their receptors (BAFF-R and TACI for BAFF, BCMA and TACI for APRIL), promote differentiation and survival of B cells by activating the canonical and alternative pathways of NF- κ B (For review: (Chung et al., 2003; Pieper et al., 2013; Pillai and Cariappa, 2009)). B cells also express, from the early stages of their development, TLR receptors (Toll Like Receptors), capable of recognizing specific patterns pathogens such as lipopolysaccharides or specific DNA sequences, grouped under the name of DAMPs (for Damage Associated Molecular Patterns). Studies showed that the activation of these TLRs during the transitional stage influences the fate of B-cells, and can cause their differentiation into plasma cells (Capolunghi et al., 2008) or memory B cells (Aranburu et al., 2010). The balance between the activation of these different pathways will affect B cell fate. The most widely accepted assumption is that a strong BCR signaling induces differentiation into follicular B cells, while a weak BCR signal favors differentiation into marginal zone B cells. Some studies tend to qualify this theory, however, and suggest a finer regulation of B cell fate. Indeed, most of the models used to study the impact of BCR signaling on differentiation involves eliminating or altering proteins involved in the signaling cascade induced by the BCR, in order to modulate the intensity of this signal. The main failure of these models is that signaling is disrupted from the earliest stages of lymphopoiesis, well before the differentiation into MZ or FO B cells. It has been suggested that such mutations could disrupt the establishment of the antigenic repertoire, in particular by affecting the negative and / or positive selection of the clones, thus favoring the maintenance of self-reactive cells, which would disrupt the distribution of MZ and FO B cells (For review: (Allman et al., 2004; Martin and Kearney, 2002; Pillai and Cariappa, 2009)).

I.1.2.3. Mature B cell stage and Germinal Center (GC) formation

Naive mature B lymphocytes, that is before their interaction with an antigen, are divided into 3 sub-populations which differ by their origin, their function, their localization within secondary lymphoid organs and their surface markers. We distinguish the marginal and follicular B cells, mentioned above, the latter forming the population of B2 lymphocytes, called the conventional B cell population, and B1 lymphocytes. The latter constitute a separate population of B-lymphocytes which is at the interface between innate and adaptive immunity, and therefore plays a crucial role, on one hand by ensuring a first line of defense against pathogens, and on the other hand by ensuring "maintenance" of the organism necessary to limit the risks of autoimmune pathologies (For review: (Baumgarth, 2011)).

I.1.2.4. Follicular B lymphocytes (FO) and the formation of Germinal centers

The FO B lymphocytes represent the majority of spleen B cells and are, like their name suggests, located in the follicles of secondary lymphoid organs (Allman and Pillai, 2008). The center of these follicles is occupied by a network of follicular dendritic cells (FDCs), and they are surrounded by areas rich in T lymphocytes (called "T zones").

B cell activation by an antigen will cause these cells to migrate into the inter-follicular area, where they will interact with T cells, which will lead to the formation of a germinal center (GC) (Batista and Harwood, 2009; Okada and Cyster, 2006; Qi et al., 2008).

Within this GC, the B lymphocytes will proliferate very quickly, and undergo the secondary gene remodeling events, somatic hypermutation and class switch recombination (SHM and CSR respectively, which are detailed later in this chapter), coupled with a selection to promote the development of cells expressing Ig of higher affinity for the antigen. Proliferation and selection of clones are more or less separated physically: proliferation mostly takes place in the "dark zone" of the GC, while selection mostly takes place in the "light zone", in the presence of T lymphocytes and the FDCs (Fig. 5). The B cells cycle back and forth between the two areas to select the clones with the highest affinity for the antigen. So, the B cells come out of the dark zone after a proliferation phase and compete in the light zone to interact with CD4 + T cells (Tfh, for Follicular Helper T lymphocytes) and FDCs (MacLennan, 1994; Victora and Nussenzweig, 2012). These cells provide the signals necessary for survival and proliferation in cells with a high affinity for the antigen presented. Conversely, cells with

a low affinity or self-reactive BCRs will go into apoptosis. Some cells are also selected for re-entry into the dark zone, where they will resume their proliferation and undergo another round of SHM to further increase their affinity. The reactions within the GC thus make it possible to favor the proliferation of B lymphocytes having receptors with the highest affinity for the antigen, before their differentiation into antibody-secreting or memory B cells, thanks to several cycles of proliferation / selection (For review: (De Silva and Klein, 2015) (Kennedy and Clark, 2021)).

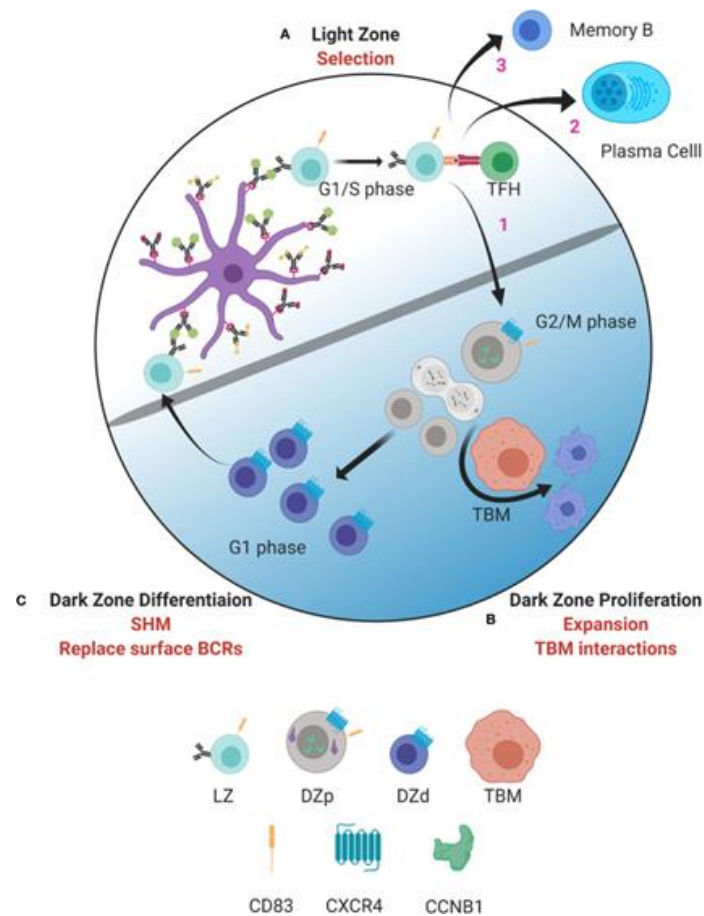

Figure 5: Model of germinal center dynamics and compartmentalization.

The progression of B cells in the GC occurs through a series of molecular states compartmentalizing key functions to distinct spatial niches. **(A)** Selection of GC B cells takes place in the LZ. B cells entering the LZ from the DZd first attempt to bind the antigen deposited on follicular dendritic cells (FDC). Antigen processing and presentation to T_{FH} cells in the context of MHC class II then follows. These interactions between LZ B cells and T_{FH} determine if B cells are fated to differentiate into memory B cells (MBCs) or plasmablasts (PBs). Cells then either undergo cyclic re-entry into the DZp, or initiate apoptosis. Cells selected for cyclic re-entry migrate to the DZp. **(B)** B cells that initiate apoptosis in the LZ are cleared by TBMs in the DZp niche. The cells that are successfully selected in the LZ however, and therefore are not cleared by TBMs, undergo mitosis. **(C)** Following one or several rounds of cell division, GC B cells transit to the DZd compartment where they undergo differentiative functions, including SHM and replacing old BCRs with newly mutated ones. B cells that have successfully completed the different processes in the DZd, then migrate to the LZ to undergo selection. Image taken from *Kennedy and Clark, 2021*.

I.1.3. Final differentiation: antibody secretion and immune memory

At some points of their differentiation, B lymphocytes have opportunities to exit the GC reactions and will have two main roles: first is the secretion of antibodies to fight against pathogens, and second, the establishment of an immune memory, which will allow for a faster and more effective response during a future encounter with the same antigen.

The secretion of antibodies is provided by plasma cells. We distinguish plasma cells as either short-lived predominantly expressing IgM and some IgG3, mainly from MZ B cells or B1 cells after T- independent activation, but also from extrafollicular foci at the beginning of classical B2-cell stimulation, and long-lived plasma cells expressing Ig from other isotypes, mainly originating from GC B cells after T-dependent activation. Short-lived plasma cells have little or no hyper mutation and have a limited affinity for the antigen. They are active during the early stages of the immune response. Conversely, long-lived plasma cells are derived from cells which have passed through the germinal center and produce antibodies with strong affinity for the antigen (For review: (Nutt et al., 2015)).

Humoral memory thus relies on two populations: We distinguish the constitutive humoral memory and the reactive humoral memory. The former corresponds to long-lived plasma cells, which are mainly located in the bone marrow, and will produce Abs on the long-term even in the absence of new antigen stimulation. The latter however is made up of long-lived B lymphocytes capable of reaching the germinal centers formed during an encounter with an antigen to optimize, again, the affinity of their receptor and eventually to undergo secondary CSR as known to occur for the IgG1 to IgE class switching. This memory, which is the basis of vaccination, allows the body to react much faster and more effectively to a pathogen if encountered for a second time (For review: (Kurosaki et al., 2015)). While it was claimed that only part of memory B cells reenter into GCs and herein compete with activated naïve cells, such reentering oligoclonal cells are however likely to provide the highest possible affinity, as well known to occur for generating broadly neutralizing antibodies after repetitive antigenic challenges (Mesin et al., 2020; Tian et al., 2016). It is worthy to note that efforts to develop vaccines that induce broadly protective memory B cells to rapidly mutating pathogens have not yet been successful. Hence, understanding the entry / exit into and from the GC reaction and the memory B cell development and function are

essential to overcome the current challenges hindering successful vaccine development. Recent reviews focus on discussing and better understanding the various signals and transcription factors that regulate this GC reaction (Fig.6) (For detailed review: (Laidlaw and Cyster, 2021)).

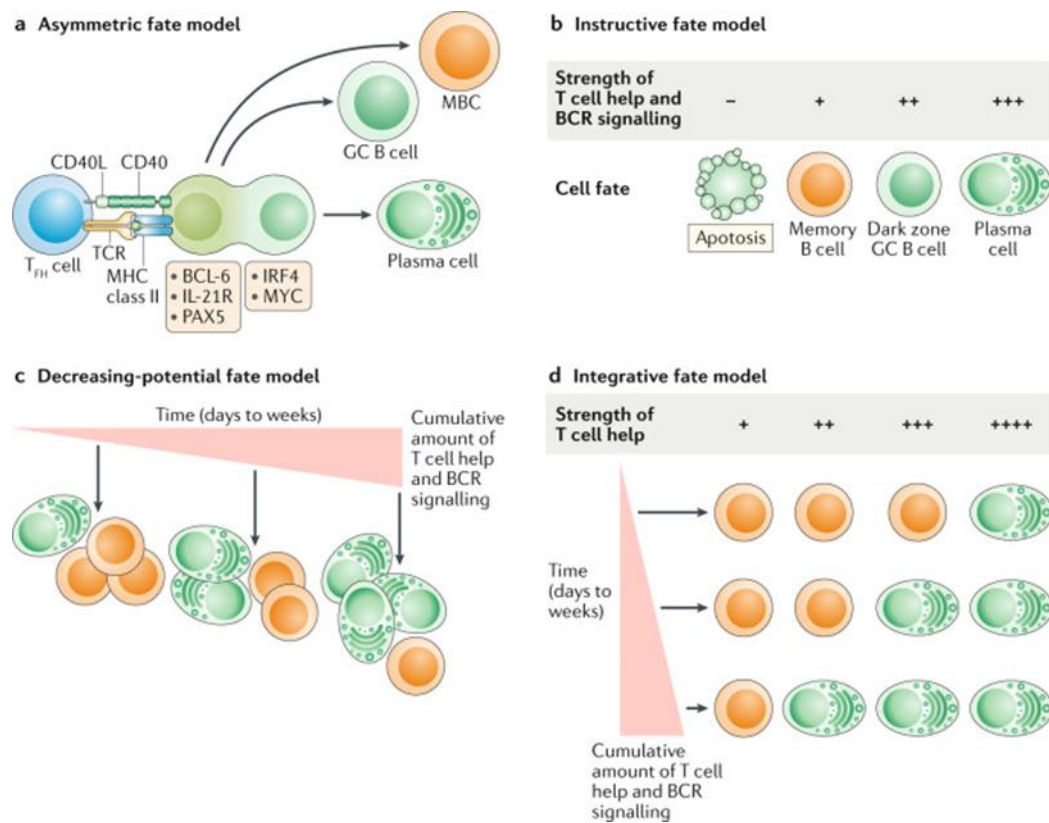

Figure 6: Models of GC B cell differentiation.

(a) Asymmetric fate model: GC B cells that interact with TFH cells undergo cellular polarization, resulting in unequal distribution of fate-altering molecules by daughter cells. The latter inheriting fate-altering molecules (that promote the expression of IRF4 and MYC preferentially) differentiate into PCs, whereas cells that inherit BCL-6, PAX5 and IL-21R either maintain GC B cell identity or differentiate into MBCs. (b) Instructive fate model: The strength of T cell help and BCR signaling received by GC B cells dictates cell fate. Strong T cell help favors PC differentiation and the dark zone state, whereas weak T cell help predisposes GC B cells to differentiate into MBCs or to undergo apoptosis. (c) Decreasing-potential fate model: GC B cell fate is determined by the cumulative strength of T cell help and BCR signaling, accrued over the length of duration in the GC (days to weeks). Upon repeated rounds of cyclic re-entry, GC B cells progressively lose their ability to differentiate into MBCs, resulting in a shift towards increased PC differentiation at late GC time points. (d) Integrative fate model: GC B cells integrate both the current quality and the cumulative amounts of received signals when making cell fate decisions. GC B cells that have received less cumulative T cell help and BCR signaling need a stronger signal to differentiate into PCs. By contrast, GC B cells that have been in the GC longer and received more cumulative signals require a weaker signal to induce PC differentiation. Image taken from *Laidlaw and Cyster, 2021*.

I.1.4. Regulatory B lymphocytes (Bregs)

Beyond their role as Ig secretors, B lymphocytes also play a role as modulators of the immune response. Their function as negative regulators has long been underestimated, as B lymphocytes are generally considered as activators for their capacities to produce antibodies and activate T lymphocytes by presenting them with antigens.

There are different populations of regulatory B cells, which can be derived from B lymphocytes at different stages of maturation (from T2 to plasmablasts). Their main mechanism of action is the secretion of IL-10, an immunosuppressive cytokine. They can also act by secreting IL-35 or TGF- β , or by interacting directly with CD4+ T lymphocytes via membrane proteins to limit their proliferation or induce their apoptosis (For review: (Mauri and Menon, 2015; Ray et al., 2015; Rincón-Arévalo et al., 2016)). A specific BREG population producing granzyme B was also reported in human grafted patients (Chesneau et al., 2015).

Various studies have demonstrated the importance of regulatory B cells. Therefore, a defect in these subpopulations is very frequently associated with inflammatory or autoimmune pathologies. Conversely, they are also involved in the mitigation of the anti-tumor immune response (For review: (Miyagaki et al., 2015; Zhang et al., 2015)).

I.2. Mechanistic of Immunoglobulin (Ig) gene rearrangement

I.2.1. Early V(D)J recombination of heavy/light chain loci and Ig assembly

As stated earlier in this chapter, V(D)J recombination is a highly ordered (rearrangements at the IgL locus begin only at the pre-B stage, after the end of rearrangements at the IgH locus), and sequential mechanism (D-JH recombination takes place before VH-DJH recombination). DJH rearrangement constitutes of the random association of a D segment with a JH segment, on both alleles simultaneously. In contrast, the VH-DJH rearrangements, which randomly associates a VH segment to a previously assembled DJH segment, only takes place on one allele, suggesting a stricter regulation of this second rearrangement and an allelic exclusion mechanism ((Reth and Alt, 1984) For review: (Jung et al., 2006)). This was confirmed by the discovery of DJH rearrangement, but not VH-DJH in T lymphocytes (Kurosawa et al.,

1981). This process of combinatorial assembly— choosing one segment of each type from several possibilities is the fundamental engine driving antigen receptor diversity in mammals.

From a mechanistic point of view, the V(D)J recombination can be divided into two phases: the induction of double strand breaks (DSB), and their repair.

The first vital component for this process is the RAG (Recombination-Activating Gene) endonuclease, or simply V(D)J recombinase which consists of two subunits RAG1 and RAG2. The latter works with non-lymphoid-specific DNA bending factors, HMG1A or HMG1B to carry out DNA cleavage. This enzyme is necessary *in vivo* (Mombaerts et al., 1992; Shinkai et al., 1992) and sufficient *in vitro* (McBlane et al., 1995; van Gent et al., 1995) to induce these double strand breaks.

These endonucleases will target DNA specifically on signal sequences located between the segments, called RSS (Recombination Sequence Signal), with a very particular structure (Fig.7). They are comprised of a heptameric (CACAGTG) and nonameric sequences (ACAAAAACC), both highly preserved during evolution, located adjacent to each of the coding segments and separated by either 12 or 23 nucleotides of less conserved “spacer” sequences.

The nucleotide sequences of the natural RSS vary considerably among one another, however the first three nucleotides of the heptamer, which are closest to the coding segment, show the highest level of conservation and have shown to be critical for the process of V(D)J recombination. The nonamer sequence on the other hand are less consensus with only a few highly conserved nucleotides particularly in the A/T tract.

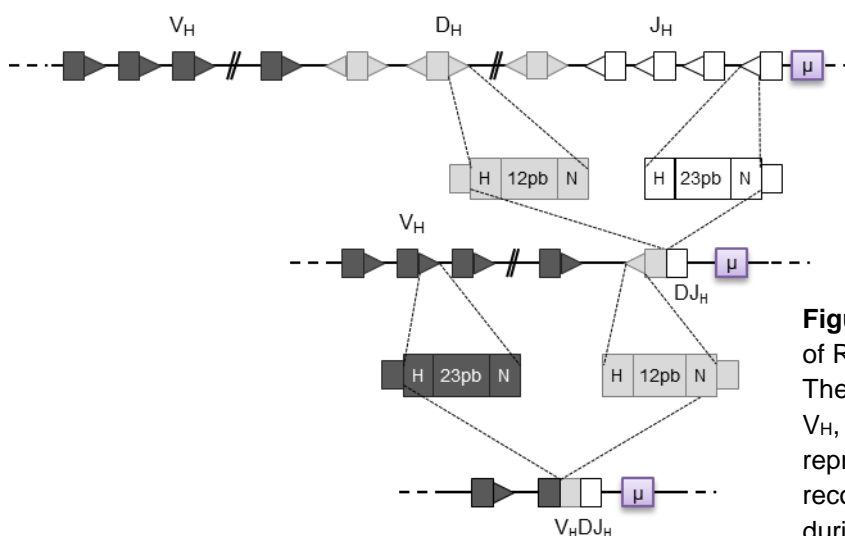

Figure 7: Schematic representation of RSS and the « 12/23 » rule. The rectangles represent the exons V_H, D, J_H and C_μ. The triangles represent the RSS sequences recognized by the RAG enzymes during VDJ recombination.

How does V(D)J recombination occur?

Efficient recombination occurs between spacer sequences of different lengths. In fact, different studies have shown that the DNA cleavage follows a sequential process (Fig.8): it begins with the recognition and fixation of the RAG complex on an appropriate RSS, then it captures a "partner" RSS and forms a synapse between two segments (Jones and Gellert, 2002; Mundy et al., 2002).

This is followed by DNA cleavage using the help of HMG1A/B in the presence of a divalent metal ion. The DNA cleavage then proceeds via a 2-step mechanism, where a nick is introduced, at first, between the RSS and the coding segment adjacent to it thereby resulting in a 3'OH group which is then used to attack the opposite strand by trans-esterification, forming a hairpin-coding end and a blunt signal end. The second step is similar to transesterification reactions catalyzed by the HIV integrase and by bacterial transposases.

Following the so-called 12/23 rule; In the presence of the physiological divalent metal ion (Mg^{2+}), trans-esterification requires assembly of a synaptic complex including both a 12- and a 23- RSS. After cleavage, the four DNA ends remain associated with the RAG proteins in a post-cleavage complex, thereby retaining the signal ends more stable than the coding ends. This complex is important for the proper rejoining of the broken DNA ends, which then proceeds following the classical non-homologous end joining (cNHEJ) pathway (Roth, 2014). Any errors in any of the key components of this repair mechanism (for example KU70/80, XRCC4, Artemis, DNA-PK) would result in severe impairment of the rejoining process.

One very important characteristic feature of the V(D)J recombination is the asymmetric processing of the coding and signal ends. In fact, while coding ends are joined with slight variations and imprecise repair (small deletions, short insertions), signal ends are generally joined with little or no end processing, so that the majority of the signal joints are perfect heptamer-to-heptamer fusions. One advantage behind that is the fact that the additional processing of coding ends provides additional so-called "junctional" diversity to the structure of antigen receptors. Despite the fact that V(D)J recombination is the founding mechanism by which the diversity of the antigen receptor is generated, this process could be considered as a dual ended sword (For review: (Brandt and Roth,

2009)). Any error during any of the steps mentioned above would yield hazardous genomic rearrangements that often lead to lymphoid neoplasms such as Follicular Lymphoma, which is the basis of the work during my thesis.

Since RSS are small sequences and since this recombination mechanism allows variations in the structure of RSS itself and the heptamer/nonamer sequence, it does not seem surprising at all that errors could occur after DNA breaks at off-target genomic positions.

V(D)J recombination errors fall into two broad categories; errors in target recognition and errors in joining: The first type consists of recognition of one authentic RSS and one DNA sequence fortuitously resembling an RSS, termed a “cryptic RSS” (cRSS). Such error could also occur between two cRSS sequences themselves. The latter could occur either in Trans, thereby generating a chromosome translocation, or in cis (meaning between two cRSS sequences on the same DNA molecule, thereby generating deletional “coding joint” and an excised “signal joint”.

The second type of errors involves events that join a RAG-mediated double strand break (DSB) to a broken DNA end generated by a non-RAG mediated mechanism. These can involve breaks resulting from an apparently normal V(D)J recombination event, which are then mistakenly joined with another break generated by a different mechanism. Another possibility could involve a combination of recognition and joining errors, meaning cleavage at a pair of cRSS followed by joining with a non-RAG mediated DSBs. It is worthy to note that joining errors may involve the normal cNHEJ mechanism; however, it is thought that such events may be favored by the use of error-prone alternative NHEJ (aNHEJ) mechanisms, which are often involved in the repair of long-distance breaks and translocations.

In conclusion, to limit the risks, breaks must be quickly detected, supported and repaired. The first protection is provided by RAG proteins, which require target sequences to be adequately joined into a synapsis before any DNA break can occur ((Eastman et al., 1996), and which remain attached to the generated ends (McBlane et al., 1995) until the detection of DSB by the DNA damage response sensors (DDR for DSB Dependent Response), dependent on the ATM protein kinase (ATM for Ataxia-Telangiectasia Mutated), which will allow their stabilization and recruitment of repair factors (For review: (Helmink and Sleckman, 2012)). Finally, the repair of breakages is ensured through NHEJ repair (for Non-Homologous End Joining), which mobilizes

several factors, including in particular Ku70 / Ku80, DNA-PKcs (DNA dependent on Protein Kinase catalytic subunit), XRCC4 (X-ray Repair Cross-Complementing protein 4), DNA ligase-IV, Artemis and Cernunnos (or XLF for XRCC4-like Factor) (For review: (Boboila et al., 2012)).

Although using the same remedy, the blunt ends of RSS are not repaired in the same way as the hairpin ends of the coding segments. The blunt ends are linked by direct junction, without modification of their sequence, which results in the formation of signal junctions. When located in inverted orientations, signal joints lead to the formation of episomes which are then eliminated by the cell. Contrary to signal ends, the coding ends undergo modifications before the repair. An asymmetrical break in the hairpin structure leads to the insertion of nucleotides on the shortest strand, homologous to the opposite strand, causing the appearance of short palindromic sequences called P nucleotides (for Palindromic Nucleotide). Of more, the TdT (Terminal deoxynucleotidyl Transferase) introduces nucleotides randomly at the ends of the coding regions and hereby increases junctional diversity (Alt and Baltimore, 1982; Desiderio et al., 1984; Kurosawa et al., 1981; Sakano et al., 1981); For review: (Schatz and Spanopoulou, 2005)).

These mechanisms ensure an almost unlimited diversity of the antigenic repertoire. Indeed, the CDR1 and 2 coding sequences are located in the VH segments. Each VH segment having a different sequence, we obtain a first so-called "germinal" diversity. The third CDR is coded by the junction region between the VHDJH segments, the diversity of junctions will therefore provide a second level of diversity, called "combinatorial". Finally, the diversity of the processing of the various V, D and JH segments before their imprecise repair, add a so-called "junctional" diversity during rearrangements, later amplified by the introduction of mutations during rearrangements, (Jung et al., 2006).

This great diversity of repertoire is necessary to optimize immune responses but the partly random mechanisms involved in its generation are responsible for the frequent formation of unproductive VHDJH rearrangements. Indeed, rearrangements lead in 2/3 of the cases to a reading frame shift due to the insertion of a number of random nucleotides, which can also cause a stop codon to appear. In addition, there is the possibility of using a non-functional VH or D segment (For review (Mostoslavsky et al., 2004)). In the event of an unproductive VHDJH rearrangement, another VH-DJH

rearrangement will take place on the second allele. This yields two possibilities: either the new VHDJH segment is functional, in which case the cell will continue its development, or it is not, and in this case, the cell will go into apoptosis due to the lack of an Ig heavy chain. A part of the B lymphocytes will therefore have two rearranged IgH alleles. It has been shown that in this case the two alleles are expressed throughout B cell development. Transcripts from the non-productive allele will then be taken care of and degraded by different RNA monitoring mechanisms, thus avoiding the synthesis of truncated heavy chains which are potentially cytotoxic (Daly et al., 2007; Tinguely et al., 2012). After a productive rearrangement, a heavy chain will be expressed, and will associate with a pseudo light chain formed by the proteins CD179a and CD179b, allowing the expression of a pre-BCR on the cell surface (Kudo and Melchers, 1987; Mårtensson et al., 2002; Sakaguchi and Melchers, 1986). This expression at the membrane marks the transition to the pre-B stage, on one hand by inhibiting a possible rearrangement on the second allele, if it has not already taken place, and on the other hand by inducing the rearrangements on light chain loci.

Regarding recombination on the light chain loci, they imply substantially the same mechanisms compared to recombination on heavy chains, the main difference being the absence of expression of TdT, which prevents the appearance of N-diversity. This process is ordered, and first affects the Igk locus, then the Igλ locus (Engel et al., 1999). As with the heavy chains, an allelic exclusion mechanism occurs. Indeed, the formation of a functional VLJL segment causes the recombination to stop and spare the other allele. We speak of allelic exclusion for stopping recombination on the second Igk allele after formation of a functional VkJk exon, and of isotypic exclusion for blocking recombination on the Igλ locus (Jung et al., 2006; Mostoslavsky et al., 2004). It is interesting to note that re-expression of RAG proteins does not induce VHDJH rearrangement on the second non-rearranged IgH allele; rather, the activity of these proteins during this pre-B stage is mainly limited to the IgL loci ((Constantinescu and Schlissel, 1997); For review: (Jung et al., 2006)). The formation of a productive VLJL exon allows the synthesis of an IgL, which then associates with the heavy chain already present, allowing the formation of a complete IgM. It is then exported to the membrane where it forms a BCR by associating with the CD79a / CD79b complex. The expression of a BCR characterizes the transition to the immature B stage.

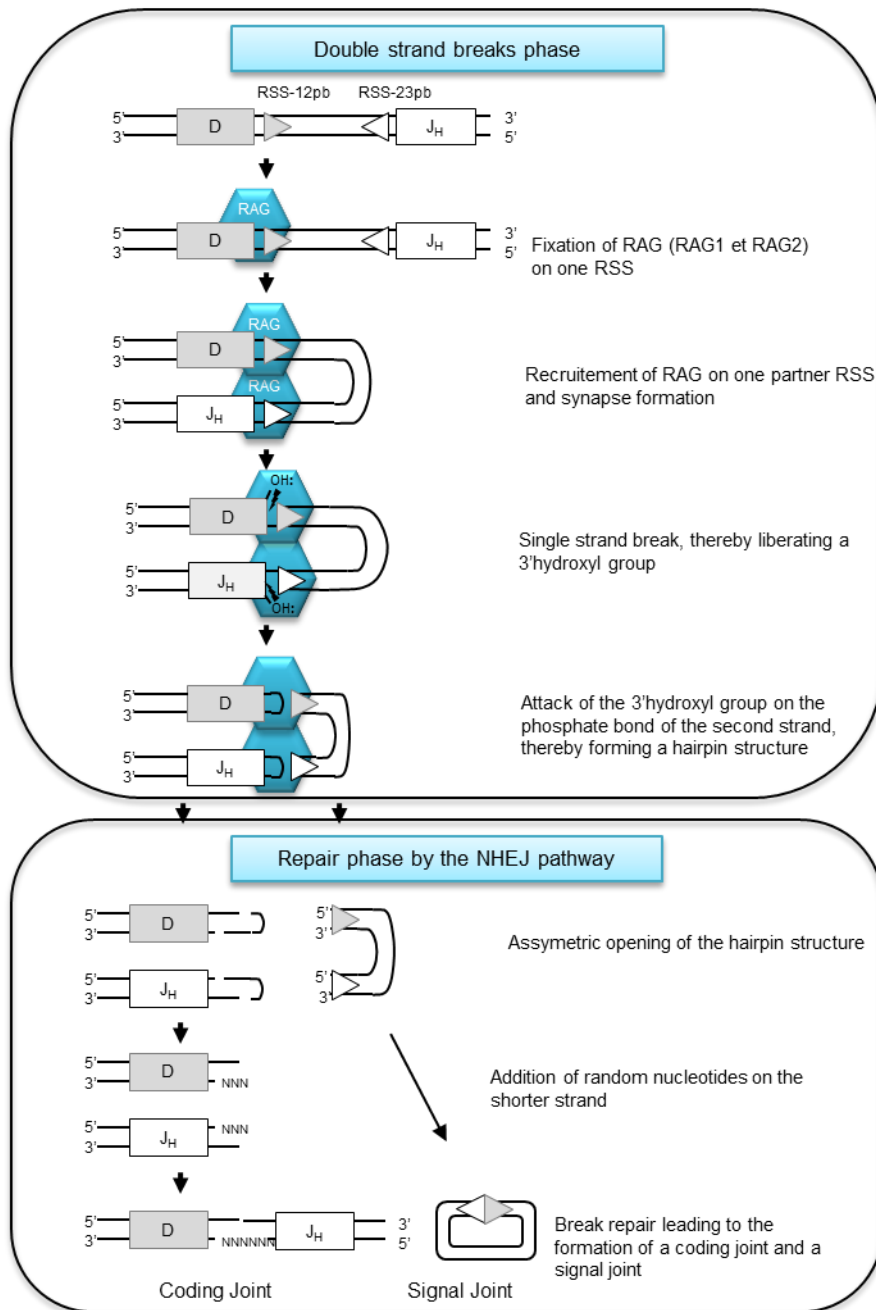

Figure 8: Schematic representation of the RAG-mediated DNA cleavage.

The light grey and white rectangles respectively represent the JH and D exons. The blue hexagon represents the RAG complex.

I.2.2. Secondary remodeling of Ig genes: SHM and CSR

During their maturation in the GC, the mature activated B lymphocytes undergo two so-called secondary recombination mechanisms:

1- SHM, which consists of introducing mutations in the variable regions of the Ig heavy and light chains, thereby increasing the affinity for the antigen.

2- CSR, which makes it possible to obtain an Ig isotype other than μ , by replacing the $C\mu$ gene with one of the other constant genes, without modifying the region variable.

Although these two mechanisms have different functions, they all require two the intervention of the enzyme AID (AID for Activation Induced Cytidine Deaminase) (Larijani and Martin, 2012; Wang, 2013).

I.2.2.1. AID : Structure and function

The AID enzyme and its role in CSR and SHM were discovered in 1999 by the Honjo team (Muramatsu et al., 1999). AID is a small protein (198 amino acids, 26kDa), encoded by the *Aicda* gene. It is a part of the BRIGT protein family (Apolipoprotein B RNA-Editing catalytic Component), which are RNA-editing enzymes that form a subgroup of a Zinc-dependent deaminase superfamily (Conticello et al., 2007).

The expression of AID is strictly regulated and almost exclusively restricted to activated (GC or non-GC) B cells. Its deletion in mice does not disturb early B cell development but blocks CSR and SHM (Muramatsu et al., 2000). Inactivation of the *Aicda* gene, in humans, causes an onset of hyper IgM syndrome which is marked by increased IgM levels, absence of SHM in variable regions of Ig, absence of CSR, hypertrophy of the GC in immunized individuals and high susceptibility to bacterial infections (Revy et al., 2000). While AID is predominantly located in the cytoplasm, it exerts its activity in after being adequately imported into the nucleus of activated B cells, and the balance between cytoplasmic retention, nuclear import/import and nuclear degradation after ubiquitinylation provides an additional level of regulation for AID activity, together with complex interactions with multiple co-factors (fo review: Cogné M, 2013, Biomedical Journal).

Due to its homology with the APOBEC proteins, it was first suggested that AID acts by altering RNA (RNA editing model). However, this model was later found to be incorrect and the DNA deamination model is now broadly accepted to explain the induction of DSB.

From a mechanistic point of view, AID induces a deamination of Cytosine (C) to Uracil (U) at particular DNA sites called “Hot spots” or “hotspots” (Pham et al., 2003). These sites have the WRCY (W = weak= dA / dT, R = purine = dA / dG and Y = pyrimidine = dT / dC). The dU: dG mismatch from AID's action forms the first joint step between the SHM and the CSR. This mismatch is then taken care of by different DNA repair

pathways, the consequence of which is the generation of point mutations in the Ig variable regions (case of SHM) or DSB in repetitive “switch” regions at the IgH locus (case of CSR) (Alt et al., 2013; Di Noia and Neuberger, 2007). A biochemical study has shown that AID's preference for DNA rather than RNA is due to the presence of the hydroxyl group in position β' on the deoxy-ribonucleotide sugar which is necessary for deamination (Nabel et al., 2013).

Deamination of a cytosine by AID creating a U: G mismatch constitutes the first step common to CSR and SHM. The differences between these two mechanisms are mainly due to the regions targeted by AID and the way in which these mismatches are handled. The specificities of each of these phenomena are detailed below

I.2.2.2. CSR versus SHM

Although the mechanisms used are significantly different, the first stages of CSR and SHM lead to the same point, which is the deamination of a cytosine and the creation a U:G mismatch, which is then handled by the MMR and BER pathways.

From this stage onward, the mechanisms involved differ, at least partially, to achieve either the introduction of mutations, or the recombination between two switch regions.

I.2.2.2.1. SHM

The SHM consists of the introduction of point mutations (in the order of 10 mutations per 1000 bp), in the variable region of the Ig heavy and light chains in order to increase the affinity of the BCR to the antigen. It occurs during the activation of a BCR by an antigen when mutations accumulate in the Ig hypervariable regions (CDRs) (Fig.9) (Di Noia and Neuberger, 2007; Peled et al., 2008).

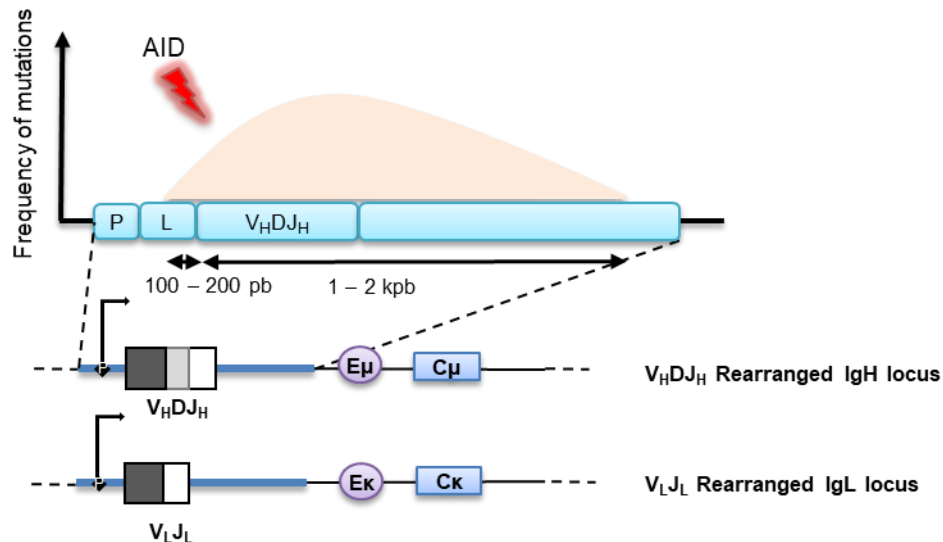

Figure 9: Hypermutation profile induced by AID in the Ig locus.

The profile and the frequency of mutation in the IgH and IgL loci are indicated on the schematic in light orange. These mutations range between 100-200 bp upstream of the transcription initiation site and can extend up to 2kb downstream of this site. The dark blue lines represent the target area of AID in the IgH and IgL loci (VDJ and VJ respectively). The « enhancers » E μ et E κ in addition to constant regions C μ et C κ are not included within this target area. L: Leader. Adapted from Peled et al., 2008.

Mechanically speaking, SHM is initiated by an increase in transcription in activated B cells, making the target DNA region accessible by forming small transcription loops with single stranded DNA (ssDNA) (Di Noia and Neuberger, 2007; Peled et al., 2008) (Chaudhuri et al., 2003 ; Pham et al., 2003; Ramiro et al., 2003; Ronai et al., 2007).

When the two strands of DNA are dissociated, the RPA protein (RPA for Replication Associated Protein A) will bind to ssDNA and stabilize the structures formed. Once AID is phosphorylated by the PKA protein (PKA for c-AMP dependent Protein Kinase A), its serine at position 38 will interact with RPA and fill its role in deamination (Basu et al., 2005; Chaudhuri et al., 2004). It has been shown that AID phosphorylation is essential for the SHM process (McBride et al., 2008). After being defused, AID will detach and RPA will remain linked to ssDNA during the implementation of the DNA repair machinery (Chaudhuri et al., 2004). AID-induced basic mismatch can be addressed by different repair mechanisms (Fig. 10) (Peled et al., 2008):

- 1- The DNA containing the mismatch can be simply replicated; the dU being ignored by the polymerase and considered as a dT. This yields therefore a transitional mutation of dC towards dT on the deaminized strand and therefore dG towards dA on the complementary strand.

- 2- AID-induced dU can be excised by a Uracil Glycosylase (UNG for Uracil DNA Glycosylase), thus creating an abasic site. The latter is then taken care of by the BER pathway (BER for Base Excision Repair) which sets up a machinery of infidel polymerases, who will randomly introduce a base in place of the dU, causing then transversion or transition type mutations (Pérez-Durán et al., 2012).
- 3- The mismatch can also be recognized by the MMR pathway (MMR for MisMatch Repair), which involves the heterodimer MSH2 / MSH6 (MSH for MutS Homolog 2 and 6), then the MARE1 / PMS2 protein complex (MLH1 for MutL Homolog 1; PMS2 for Post Meiotic Segregation 2) which will recruit the Exo1 exonuclease. The latter will excise the mismatch and potentially the surrounding bases over a length ranging from ten bases (short MMR patch) to several kilobases (long MMR patch) (Iyer et al., 2006). Unfaithful polymerases, notably Pol η , will then intervene and synthesize the excised strand, leading to transition or transversion mutations (Delbos et al., 2007).

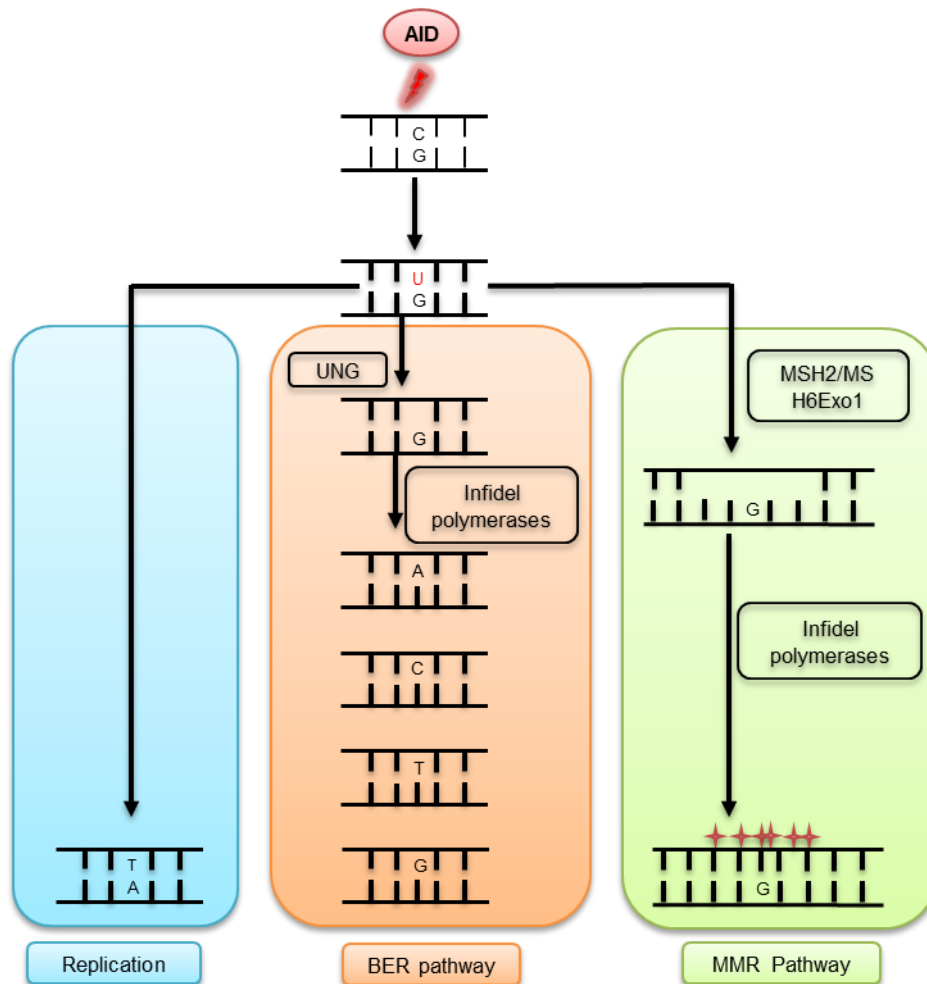

Figure 10: Schematic showing how the mismatches created during SHM are handled. AID initiates SHM by deaminating cytidine on a strand of DNA. The dU:dG mismatch created by AID can then be addressed by different pathways. DNA can be replicated without taking into account the mismatch (blue box). The created Uracil can be excised by UNG and the abasic site generated is then repaired by infidel polymerases of the BER pathway (BER for Base Excision Repair), which will randomly insert one of the four bases in place of the dU (orange box). Finally, the mismatch can be taken care of by the MMR pathway (MMR for MisMatch Repair), which will excise it along with the surrounding bases. The excised strand will be re-synthesized by unfaithful polymerases by inserting random nucleotides (green box). Adapted from Peled et al., 2008.

1.2.2.2.2. CSR: Induction of double strand breaks and their repair

Isotypic recombination is a mechanism for expressing an Ig isotype other than μ , thus modifying the effector function of the BCR while retaining its antigenic specificity (Chaudhuri et al., 2007). This process takes place in specific regions, called “switch” regions (S) (a donor region which is most often S_{μ} and a region S_x called acceptor region; x corresponding to the other isotypes), located upstream of each constant gene with the exception of C_{δ} . They are characterized by their GC rich sequences, ranging in size between 1kb and 10kb. They are the target of the mutations at the origin of the DSB of the CSR (Dunnick et al., 1993).

As with SHM, transcription in S regions is an essential prerequisite for the CSR. This is the germline transcription which does not lead to the production of a protein but which aims to make the region accessible (Chaudhuri and Alt, 2004; Manis et al., 2002; Nambu et al., 2003). Indeed, each of the genes encoding the different isotypes constitutes an independent transcriptional unit having, in order, a promoter, an exon "I" (I for Intervening), an S region and the CH exons (Chaudhuri and Alt, 2004). Primary transcripts thus generated are spliced to give germinal transcripts of type IxCx (Fig.11) (Chaudhuri and Alt, 2004). The transcription of exon I μ occurs in one constitutive way and is also non-specifically increased by B-cell activation. On the other hand, transcription of the other Ix exon requires adequate stimulation in the presence of cytokines (Li et al., 1994; Matthews et al., 2014). Thus, the choice of the synthesized isotype depends on the surrounding cytokines to which B cells are exposed. For example, stimulation of mouse B cells with LPS will activate transcription of I γ 3 and I γ 2b and consequently CSR to IgG3 and IgG2b. A combined stimulation of LPS and interleukin 4 (IL-4) promotes transcription of I γ 1 and I ϵ and therefore CSR to IgG1 and IgE. Finally, stimulation of B cells with LPS and TGF- β (TGF- β for Transforming Growth Factor) will activate transcription of I α and therefore CSR to IgA. The importance of transcription for the effectiveness of the "switch" has been demonstrated by several studies. Deletion of exon Ix (other than I μ) in mice results in loss of transcripts of the constant x gene, followed by a stop in CSR towards the x isotype (Bottaro et al., 1994; Zhang et al., 1993).

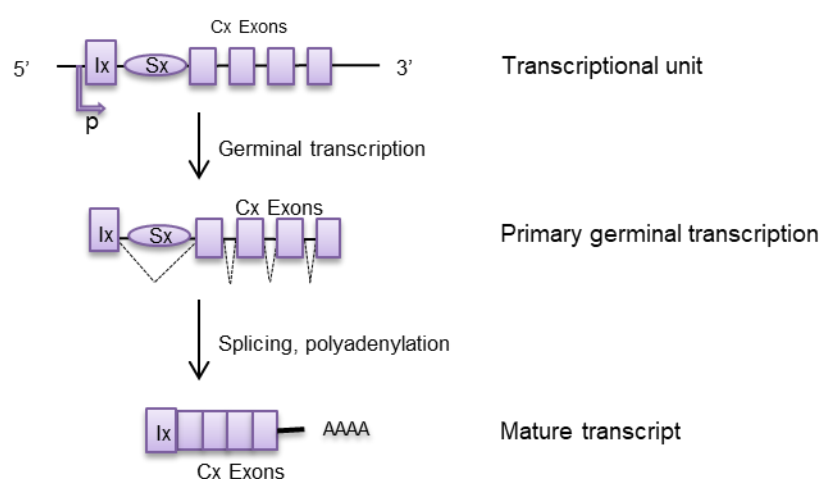

Figure 11: Generation of germline transcripts in the constant regions.

Each of the constant genes forms an independent transcriptional unit, which consists of a promoter (P), a sequence I, an S region and the Cx exons. The mature non-coding transcript is obtained after splicing and polyadenylation of the primary transcript. Adapted from *Chaudhuri and Alt, 2004*.

The germline transcription of the switch regions will lead to the formation of a particular DNA structure, referred to as the R-loop, which has been demonstrated in vitro by Lieber's team (Yu et al., 2003). In this study, the neo-synthesized RNA hybridizes with the strand of template DNA leaving the opposite unpaired strand exposed in single strand in order to improve AID activity (Fig.12) (Chaudhuri and Alt, 2004; Pavri, 2017). Studies have demonstrated that the effectiveness of an S region in inducing the "switch" depends on its ability to form R-Loops. These structures therefore constitute an important element in the regulation of the CSR machinery (Zhang et al., 2014).

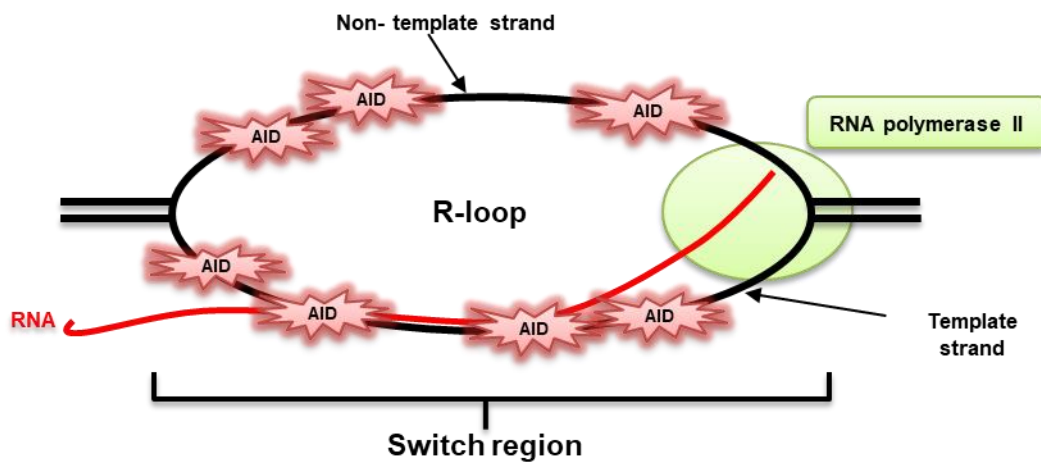

Figure 12: Schematic representation of an R-loop.

RNA polymerase II is represented in green, the neo synthesized RNA in red, and the red stars represent the AID attack sites. The germline transcription of the S regions leads to the formation of the R-loop. In this structure, the neo-synthesized RNA hybridizes with the template DNA strand leaving the opposite unpaired strand exposed in single strand form to facilitate AID activity. *Adapted from Pavri, 2017.*

From a molecular point of view, CSR can be divided into two stages:

- 1- The induction of DSB following AID's action in S regions and
- 2- The repair of these DSB by the ligation of the two S regions of interest together thereby replacing the $C\mu$ exon with Cx exons and therefore the expression of another Ig isotype.

DNA located between these two regions will be excised and circularized in the form of an episome in order to be eliminated (Fig. 13) (Xu et al., 2012).

The AID enzyme will induce the deamination of cytosines in the two donor and acceptor S regions. Similar to SHM, the basic mismatch dU:dG is excised by UNG. The abasic site created is then handled by the BER and MMR pathways, which will lead to a single strand break (SSB). Because of the high density of GC (AID targets) present in S regions, multiple SSBs can take place simultaneously on both strands of DNA, to generate DSBs (Hackney et al., 2009; Meng et al., 2015).

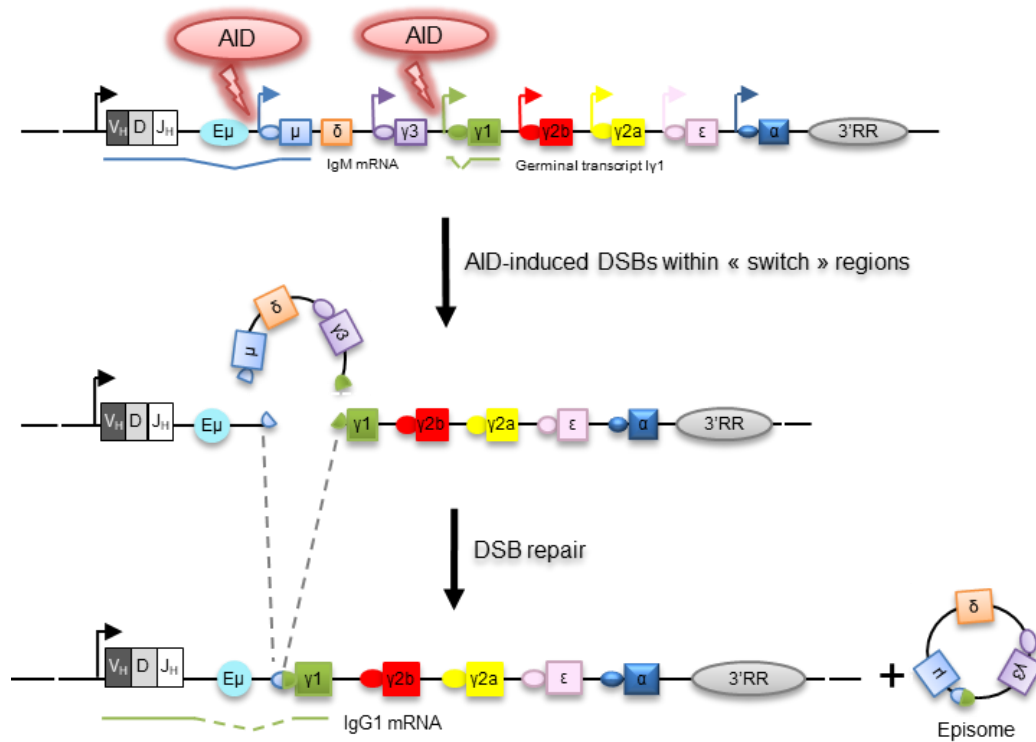

Figure 13: Schematic representation of CSR mechanism.

The rectangles represent the genes encoding the variable and constant regions of the IgH locus, the oval circles represent the S regions and the light blue circles represent the "enhancers" of the locus. The AID enzyme induces DSB in the donor (S_μ) and acceptor (here S_{γ1}) region. The two S regions are then ligated. The DNA in-between is circularized and then eliminated as an episome. After the CSR, an mRNA is initiated from the promoter V (mRNA IgG1), allowing the production of an IgG1. Adapted from *Chaudhuri and Alt, 2004*.

DSBs are then handled by DNA damage repair pathways (DDR for DNA Damage Repair pathway) (Fig.14). Therefore, the protein complex MRN (MRE11-RAD50-NBS1) will bind to these DSBs and recruit the ATM protein kinase. The latter then phosphorylates NBS1 in the MRN complex and recruits other proteins (facilitating DSB stabilization) including 53BP1 (53BP1 for p53 Binding Protein 1) and histone H2AX (Dinkelmann et al., 2009; Hwang et al., 2015; Petersen et al., 2001). The deletion of H2AX or 53BP1 protein causes a decrease in CSR, an increase in DSB frequency and genomic translocations (Franco et al., 2006; Manis et al., 2004; Xu et al., 2012). Finally, the DSB is repaired by factors of the NHEJ pathway (Non-homologous end joining pathway) (Boboila et al., 2012).

The impairment in one of the factors involved in this pathway decreases the effectiveness of CSR, but it does not abolish it completely. The existence of a residual CSR (20 to 40% of the normal rate) suggests that the NHEJ pathway can be replaced by a second alternative pathway called A-EJ (A-EJ for Alternative End Joining) (Matthews et al., 2014; Vaidyanathan et al., 2014; Yan et al., 2007).

While the NHEJ pathways applies to DNA broken ends protected by 53bp1, A-EJ applied to unprotected DNA ends first bound by RPA. The proteins present in the A-EJ pathway are still incompletely characterized. It would seem that the MRN complex, PARP-1 (PARP-1 for poly ADP-ribose polymerase I), XRCC1 as well as ligases I and III are involved in this pathway (Boboila et al., 2012; Hwang et al., 2015) (Saha et al., 2021).

The A-EJ pathway mainly uses micro-homology sequences between S regions in order to recombine them. Thus, the analysis of the S μ -S α junctions allows, to a certain extent, the identification of the remedy used.

The junctions generated by the NHEJ path are mainly direct junctions (a straightforward connection of the two S regions) or junctions with short microhomologies (presence of some bases (≤ 5 bp) homologous to the two regions S). On the other hand, the involvement of the A-EJ pathway results mainly in junctions with long microhomologies (presence of several bases (> 5 bp) homologous to the two regions S) with also possible insertions (Stavnezer et al., 2010; Stavnezer and Schrader, 2014; Yan et al., 2007).

Induction of DNA breaks, and their repair by more or less faithful pathways, are points in common with all of the gene events that take place throughout B cell development (early VHDJH rearrangements or late CSR and SHM rearrangements). Although at lower level than Ig genes, a number of other genes (and notably oncogenes such as bcl6, myc, bcl2...) are also sites for "off-target" cytidine deamination by AID, which can end with off-target mutation or DNA breaks. A "collateral effect" of all these distant but simultaneous DNA breaks is to transform the IgH locus into a "hot-spot" for different potentially oncogenic junctions and translocations. In order to avoid them, strict and fine-tuned regulation of these events is ensured by several cis-regulatory elements of the locus.

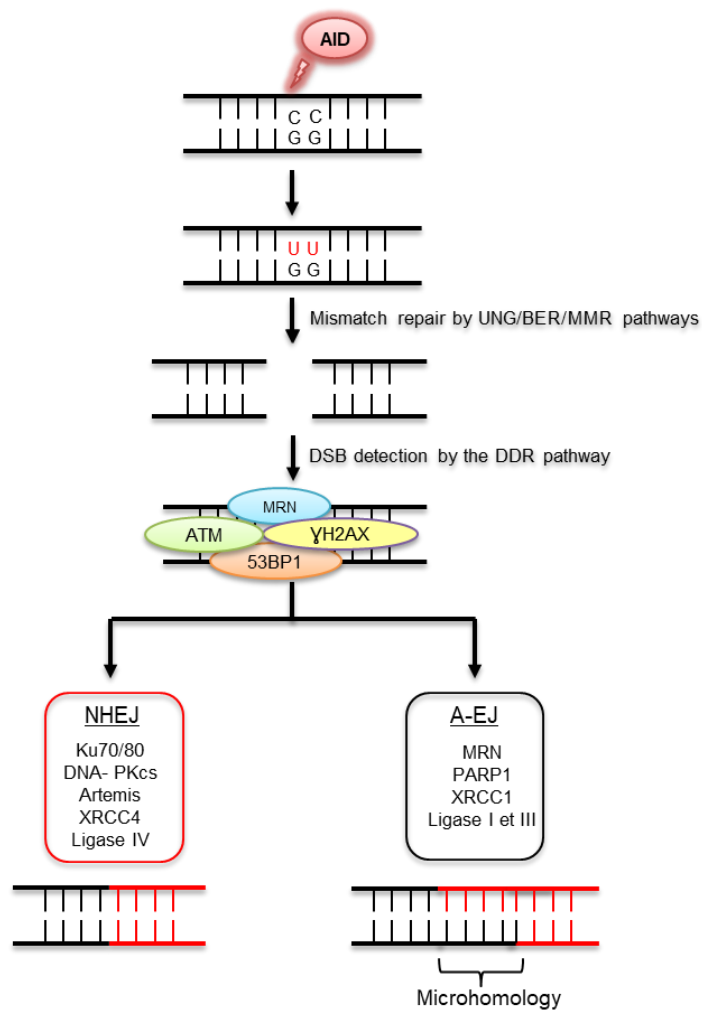

Figure 14: DNA repair pathways implicated within CSR.

The AID-induced mismatch is repaired by the BER and MMR pathways, thereby generating DSBs. The latter recognized and stabilized by the DDR pathway to allow the recruitment of either the NHEJ (red box) or the A-EJ (grey box) repair pathways. During the NHEJ pathway, the ends are repaired by Ku70, Ku80 and DNA-PKcs and then ligated by XRCC4 and DNA ligase IV. The A-EJ pathway, however, involves the proteins XRCC1 and PARP1 and the ligation is ensured by DNA ligases I or III.

Chapter II. Introduction into B cell lymphomagenesis

II.1. The origin of lymphoproliferations

II.1.1. Oncogenic lesions

The development and proliferation of B lymphocytes are tightly controlled phenomena. The imbalance between apoptosis and proliferation of these cells will cause leukemia or lymphoma. When a B cell undergoes a malignant transformation, it retains certain original phenotypic traits, allowing identifying and classifying the precursor that caused the lymphoma. Thus, B lymphomas represent a heterogeneous group comprising more than 40 subtypes, the majority of which are derived from mature B cells (Dalla-Favera and Pasqualucci, 2015).

To become malignant, a cell must undergo several oncogenic events, modifying the functions related to proliferation, apoptosis or even interaction with the environment. In the case of lymphomas, these events are, on one hand, mostly random genetic lesions, and on the other hand, lesions linked to the risks induced by the recombination events that punctuate B cell ontogeny (Robbiani and Nussenzweig, 2013).

The development of cytogenetic techniques in the 1970s made it possible to discover recurrent translocations in cancerous B cells (Rowley, 1973a, 1973b). More recently, the arrival of high-speed sequencing techniques and TC-seq (Translocation Capture - sequencing) allowed a more exhaustive study of translocations and mutations that cause many cancers, including lymphomas (Fig. 15) (Campbell et al., 2008; Cancer Genome Atlas Research Network et al., 2013; Greenman et al., 2007; Wartman et al., 2011); for review (Robbiani and Nussenzweig, 2013).

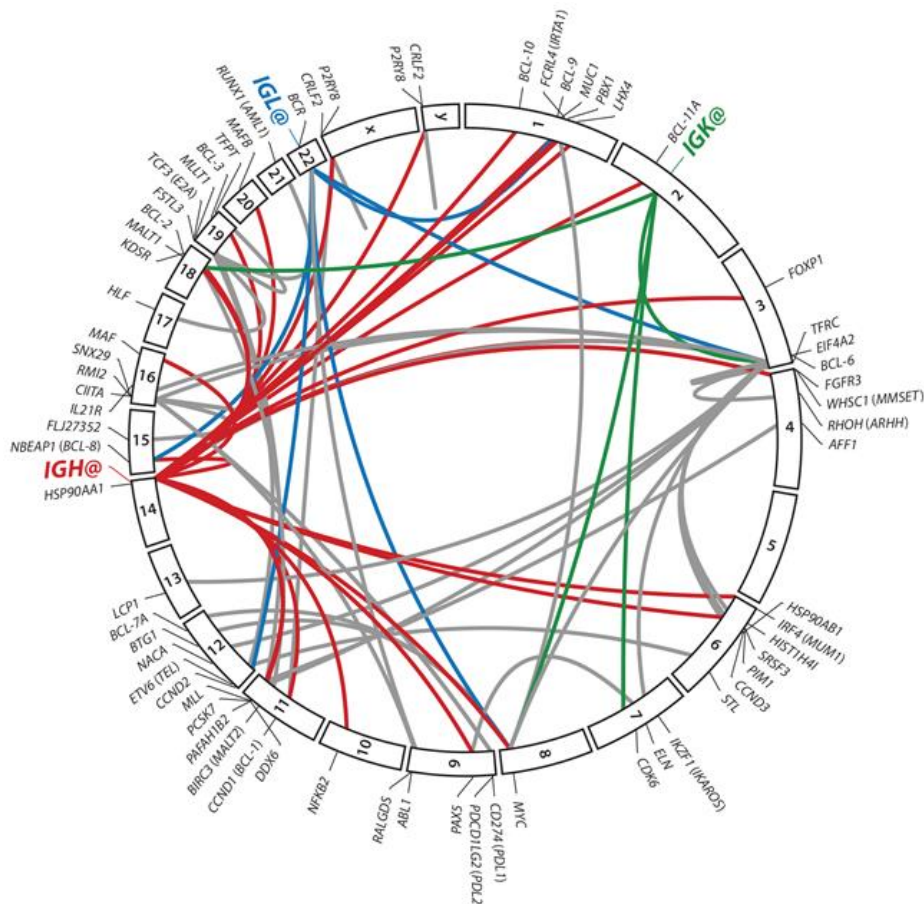

Figure 15: Recurrent translocations in B cell lymphoproliferations. The circular diagram represents the entire human genome. The arcs connect the partners involved in recurrent chromosomal rearrangements during malignant B cell pathologies. The colored lines indicate the translocations concerning the Ig genes. Taken from *Robbiani and Nussenzweig, 2014*.

Different types of translocations are found during B lymphoproliferations.

The more frequent ones cause the juxtaposition of a regulatory element to the intact coding sequence of an oncogene. The most common example is the translocation of the c-myc gene within of the IgH locus, under the transcriptional control of E μ and / or of the 3'RR during Burkitt lymphoma

It may also happen that the combination of two genes initially located on two different chromosomes, but brought together by a translocation, allows the synthesis of an oncogenic fusion protein. This is the case, for example, of the fusion of the BCR and ABL1 genes in chronic myeloid leukemia (CML for Chronic Myeloid Leukemia) or acute lymphocytic leukemia (B-ALL) (Küppers, 2005; Robbiani and Nussenzweig, 2013).

Finally, it also happens that a translocation disrupts the function or the transcription of an anti-oncogene or a miRNA, resulting in deregulation of the latter's target genes (Calin and Croce, 2007).

These translocations are generally one of the earliest events in malignant transformation, but are usually not enough to result in cancer. The cell should undergo several gene events (or so called "hits") to lead to complete cancerization. These mutations will make it possible to bypass the various "checkpoints" of the cellular homeostasis, by affecting the cell cycle, resistance to apoptosis, intracellular signaling, transcriptional program, interaction with the microenvironment and / or recognition by the immune system etc... (Fig. 16) (Hanahan and Weinberg, 2011; Vogelstein and Kinzler, 1993). These genetic alterations are not specific to lymphoproliferations, but are found in many types of cancer as well. It is the case for example of the TP53 gene, which codes for the tumor suppressor protein p53 that is found mutated in almost half of the tumors in humans. This transcription factor, sometimes called "Guardian of the genome" leads to the arrest of the cell cycle or apoptosis in response to stress (DNA damage, lack of replication etc...). Its mutation will therefore create an environment permissive to tumor development (Goh et al., 2011; Zilfou and Lowe, 2009).

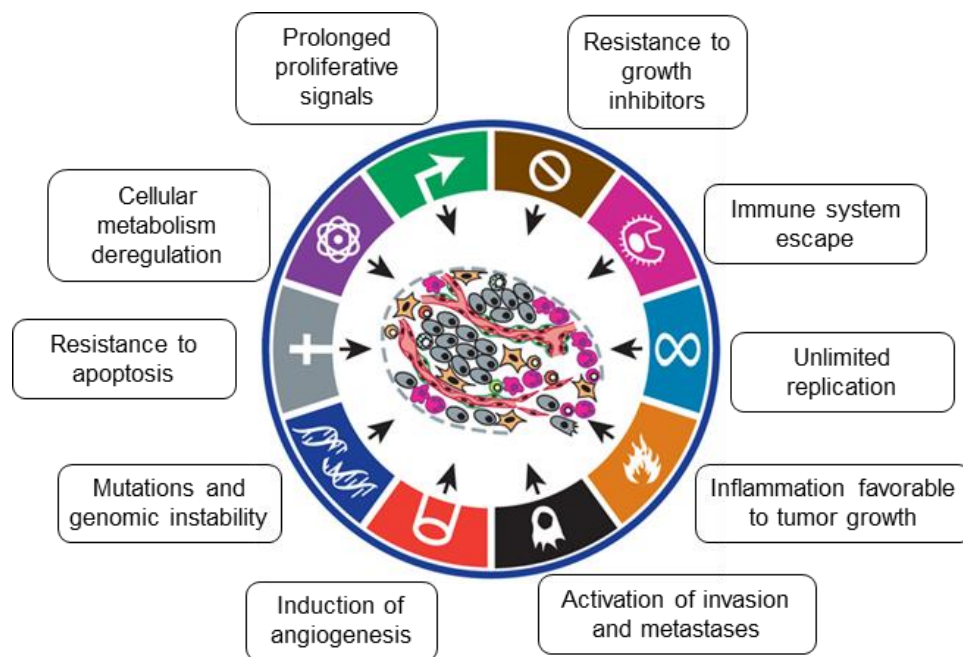

Figure 16: Acquired cellular characteristics during cancerization.

To become malignant, cells must accumulate several gene alterations leading to their deregulation. These mutations can affect different aspects of cell homeostasis and will condition the course of the tumor. Adapted from *Hanahan and Weinberg, 2011*.

II.1.2. Cellular origin of lymphomas

B cell lymphomas can involve more or less mature B cells, from the most undifferentiated cells during B-ALL to fully differentiated plasma cells in multiple myeloma (Campos-Sanchez et al., 2011; Robbiani and Nussenzweig, 2013).

As stated in the previous section, B cells, even after becoming malignant, have the tendency to retain key features of their cell of origin, including certain characteristics of the particular differentiation stage of the lymphoma precursor (Seifert et al., 2019).

Histological and immunohistochemical studies of lymphomas have hence become very crucial in classifying B cell malignancies and determining their cellular derivation.

In the case of follicular lymphoma for example, which is the heart of my thesis project, the malignant B cells morphologically resemble GC B cells, and express typical markers of these GC B cells. Not to mention, they grow in follicular structures that resemble the GC and that harbor GC T helper cells and FDC networks (Seifert et al., 2019). Taken together, all these features point to the fact that follicular lymphomas are derived from GC B cells.

These histopathological observations were further confirmed by polymerase chain reaction (PCR) and sequencing based studies of the Ig gene rearrangements. Such studies showed that malignant B cells in follicular lymphoma carry somatically mutated Ig V genes with intraclonal diversity as a sign of ongoing SHM throughout clonal expansion, further characteristic features of GC B cells (Seifert et al., 2019), thereby validating the GC B cell origin of follicular lymphomas.

Another example is Burkitt lymphoma, for which cells were shown to morphologically resemble centroblasts, and express key GC B cell markers, in addition to having somatically mutated Ig V genes with ongoing hypermutation in a fraction of the cases (Seifert et al., 2019), thus proving that Burkitt lymphomas derive from GC B cells, too.

To conclude, the majority of human lymphomas appear to originate from GC or post-GC B cells (Fig. 17). Even though this observation may seem surprising, since the B cells spend only a short time in the GC and only naive B cells represent more than half of the B cell pool, the intense proliferation of GC B cells along with the processes of SHM and CSR, which increase the risk of oncogenic mutations, explain this observation.

The notion of an original or precursor cell must be qualified; as mentioned previously, the cancerization of a cell is done in several stages, which can take place at different stages of development. It is therefore difficult to determine which stage represents the actual original cell. For example, in follicular lymphomas, the t(14;18) Bcl2/IgH chromosomal translocation, occurs at the pro-B cell stage as a result of a misguided V gene recombination, but does not become pathogenetically relevant until much later in B cell development; more specifically in GC B cells when BCL2 is normally downregulated and only in conjunction with additional oncogenic hits.

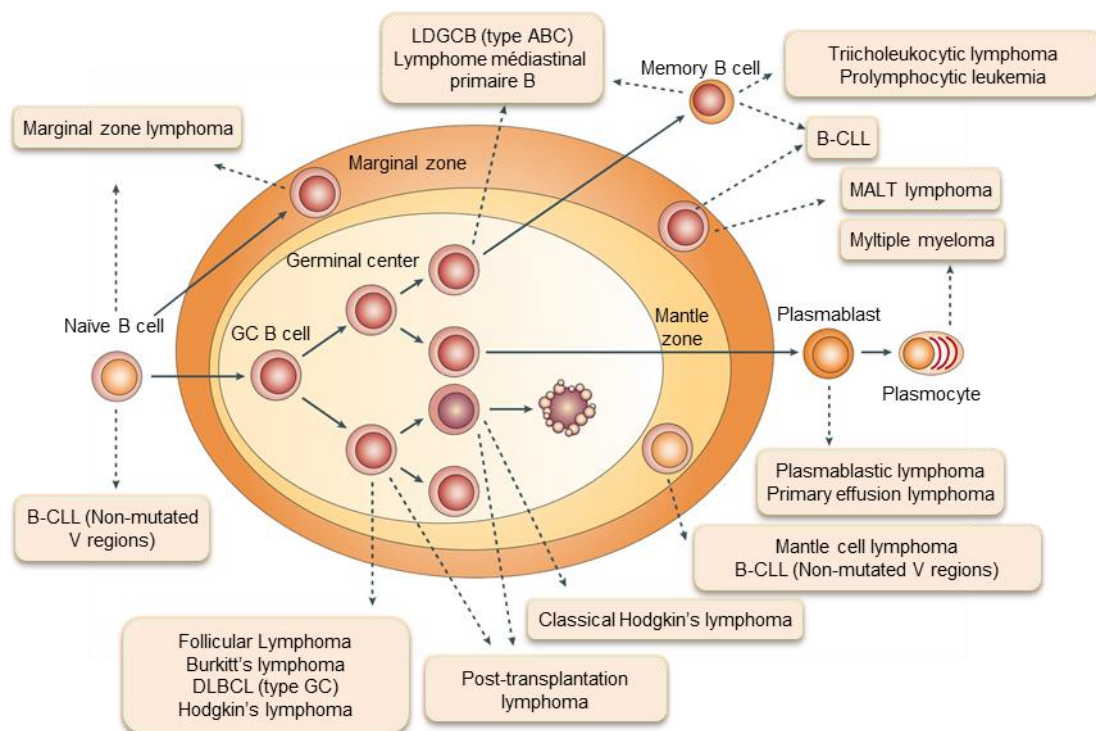

Figure 17: The cellular origin of B cell lymphomas. B cell lymphomas are named after the normal counterpart of the cancer cells. The majority of lymphomas originate from germinal center B cells. The continuous arrows represent normal cell maturation. The dashed arrows indicate the lymphomas originating from each cell type. Taken from *Küppers, 2005*

II.1.3. Tumor heterogeneity

During their malignant transformation, the cells eventually undergo hundreds of mutations, which will modify their genotype and/or their phenotype. Among these mutations, those called "drivers", contribute to giving a selective advantage to the cell and the so-called "passenger" mutations, which have a neutral effect (Pon and Marra, 2015). Driver mutations are identified by their highly frequent presence in the cells of

a given tumor (which is quantified after deep sequencing by a high “variant allele frequency” (VAF)) (citer par exemple Salichos et al, Nat Comm 2020). Therefore, a tumor, whether it is solid or hematological, is composed of several clones rather than a single one. These different clones are close, of common origin, but have different mutations: that is intracлонаl heterogeneity. This complexity of tumors must be taken into account, since it has influence on their evolution and eventual resistance to treatment (Fig. 18) (For review: (Brioli et al., 2014)). This heterogeneity makes cancer a system subject to evolution according to a Darwinian model. This theory was first proposed in 1976 and has since been confirmed by modern high-throughput sequencing techniques (Greaves and Maley, 2012; Nowell, 1976; Pepper et al., 2009). The surrounding environment, through resource limitation or immune response, limits tumor growth. A natural selection therefore takes place within the tumor, which will promote the emergence of a clone carrying advantageous mutations; meaning mutations that allow faster proliferation, resistance to apoptosis, better adaptation to the microenvironment, and exhaustion of the immune system ... (Greaves and Maley, 2012). This notion of natural selection is important, since it suggests that the progression of a tumor does not depend solely on the cell of origin nor of the initial oncogenic alteration, but also of the context in which it is located. Thus, the evolution of a tumor and the selection of certain clones carrying new mutations will depend on its environment; that is the presence of growth factors, cytokines, contact with neighboring cells, spatial constraints etc... This phenomenon of selection will be amplified by the ability of the tumor to modify its microenvironment to make it favorable for its development (Amé-Thomas and Tarte, 2014; Taylor and Gribben, 2015). In addition, certain mutations will facilitate the appearance of new alterations, either by inactivating proteins essential for chromatin remodeling or genome stability, or by weakening certain genome sites (Miron et al., 2015; Ozeri-Galai et al., 2014). Thus, the evolution of a tumor will depend on the initial oncogenic alteration and the cell in which it took place, but will also be influenced by its microenvironment, epigenetic alterations, activated signaling pathways, secondary mutations, therapy (notably when based on genotoxic treatments), etc ... Although with less diversity than in human, because with a much shorter evolution time-schedule, example of this complexity was also observed in various mouse models of myc-driven lymphomas, where the same deregulations of c-myc can end with a broad landscape of tumor phenotypes. One study demonstrated that two different mutations (affecting TP53 or CDK4) both induce

the appearance of tumors similar to mantle cell lymphomas (mantle cell lymphoma-like lymphomas) when they are coupled with the translocation of c-myc under the control of the 3'RR (Rouaud et al., 2012). Conversely, another study has shown that the genetic background of mice strongly influences their sensitivity to the development of tumors induced by the same mutation (Vincent-Fabert et al., 2009). Finally, the addition of a mutation affecting TP53 considerably modifies the spectrum of lymphomas developed by mice already carrying a c-myc / 3'RR cassette, confirming the influence of secondary mutations on the tumor phenotype (Pinaud et al., 2011). This heterogeneity also influences the response of a tumor during treatment. Thus, the removal of a tumor clone by treatment can promote the development of a second clone, which was previously kept quiescent by competition of the first (Brioli et al., 2014; Keats et al., 2012). In addition, therapy of cancer can eventually promote mutations and select or facilitate the emergence of new variants of an initial tumor.

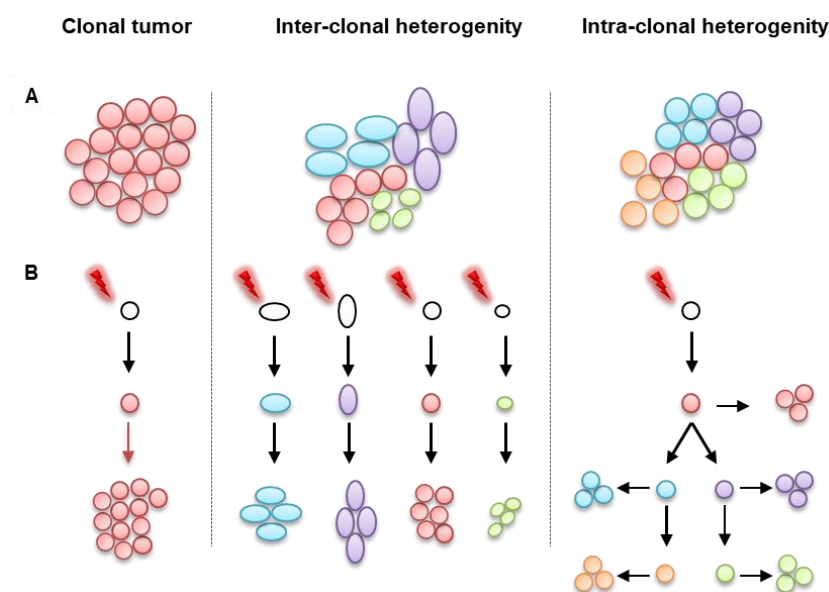

Figure 18: Schematic representation of the clonal composition of tumors.

(A) Represents the phenotype of the tumor, (B) its phylogenetic tree. The white circles represent healthy cells and the colored ones represent tumor cells. A tumor can be clonal, all cells carrying the same characteristics and mutations, or heterogeneous. 2 types of heterogeneity can be distinguished: inter-clonal and intra-clonal heterogeneity. Inter-clonal diversity is when the clones are derived from different cells which have acquired their phenotypes separately (and eventual common anomalies can then, rarely, be acquired through convergent evolution). Intra-clonal diversity however, is when the different cells all originate from a unique initial clone, but have evolved differently, with some subclones eventually acquiring a more aggressive phenotype. Adapted from *Brioli et al., 2014*

Regarding lymphomas, it is important to note that several types of B cell lymphomas can be distinguished. Generally speaking, lymphomas are classified into 2 broad categories: Hodgkin versus non-Hodgkin lymphomas.

Hodgkin lymphoma (HL) is a clonal B-cell neoplasm. Using microdissection and single-cell polymerase chain reaction (PCR) techniques, immunoglobulin (Ig) V-gene rearrangements in isolated tumor cells were detected confirming this notion. It is recognized by the current world health organization (WHO) classification as a malignant lymphoma with unique clinicopathologic features, which primarily involves lymph nodes commonly found in the supradiaphragmatic areas.

The classical Hodgkin's lymphoma (CHL), to be more specific, constitutes about 95% of all HL cases in the United States and Europe. CHL is a clonal B cell malignancy whose neoplastic tissue is comprised of a minor population of mononuclear Hodgkin and multinucleated Reed–Sternberg (so called HRS) cells admixed with an abundant reactive infiltrate including various inflammatory cells (Naeim et al., 2018) (Fig. 19).

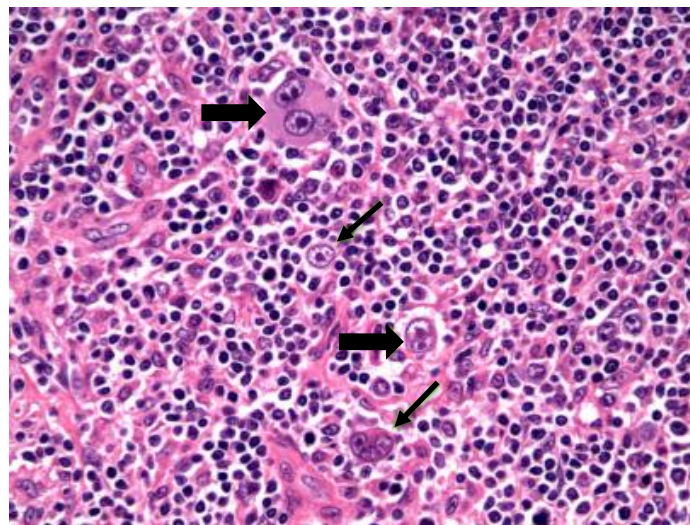

Figure 19: Representation of the Hodgkin Reed-sternberg (HRS) cells. Reed–Sternberg cells (thick arrows) and Hodgkin cells (thin arrows) in a background of lymphocytes, plasma cells, and histiocytes. Taken from *Naeim et al., 2018*.

More importantly in this scenario, Non-Hodgkin lymphomas (NHL) are defined as a heterogenous group of lymphoid tumors that arise by a complex process of malignant transformation of mature lymphocytes during various stages of lymphocyte differentiation and clonal expansion in secondary lymphoid organs. A striking feature that differentiates these types of lymphomas from one another is the absence of the

HRS cells in NHL. However, NHL are highly heterogeneous can includes multiple different entities, most of them related to the B-cell lineage and more-or-less similar to all the various stages of normal B cell differentiation.

The current Revised European and American Lymphoma (REAL) along with the related WHO classification subdivides NHL into B cell and T cell, or natural killer (NK)-cell types respectively accounting for 85% and 15% of cases, each having distinct pathophysiological and prognostic characteristics (Winkfield et al., 2016)

From a clinical point of view, these lymphomas comprise indolent, aggressive, or highly-aggressive malignancies that, not only differ in their etiology, pathogenesis, genetics, clinical manifestations and patterns of spread but also have different treatment and prognostic approaches (Isaacson, 2001, p.).

II.2. Oncogenic alterations during lymphomas

Most B cell lymphomas are characterized by the existence of a translocation displacing an oncogene within the Ig loci, where it will be constitutively transcribed under the control of the regulatory elements of these loci. The high frequency of these gene alterations is explained by the induction of DSBs during the rearrangements which punctuate the lymphopoiesis (VDJ, SHM and CSR processes), thereby making these Ig loci hotspots for such translocations (Fig.20) (Küppers, 2005; Seifert et al., 2019).

It is worthy to note that the nature of these so-called hits has diverse natures including viral infection, gene mutations, and epigenetic remodeling; all of which will be discussed in details below.

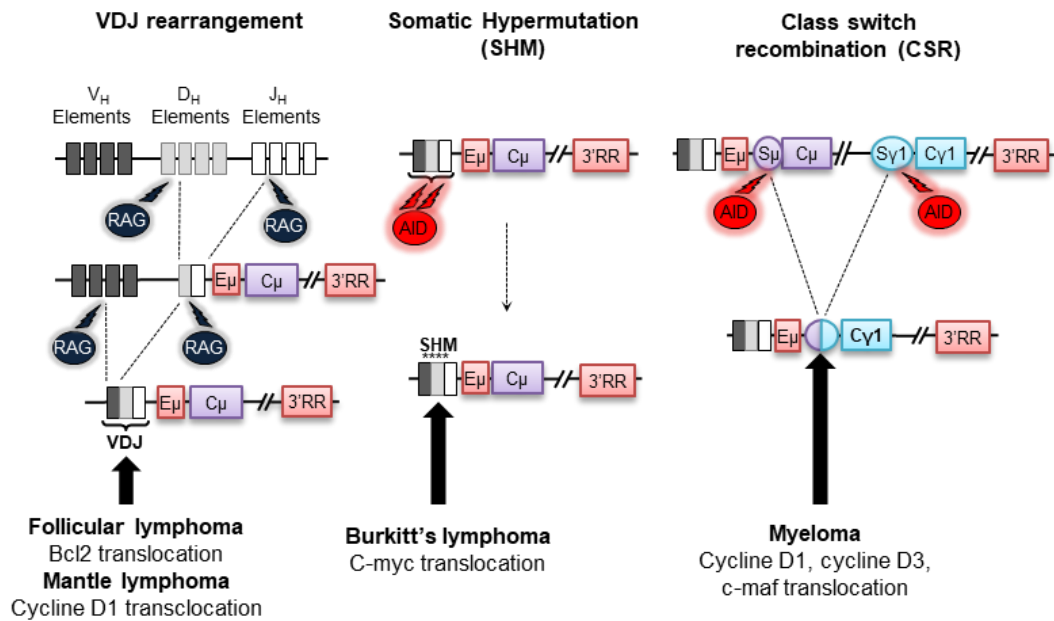

Figure 20: Recurrent translocations within the IgH locus linked to Ig diversification mechanisms. The various gene modifications that take place on the IgH locus during B cell development make it a hotspot for translocation. Depending on the mechanism involved, translocation can take place in the variable or constant regions and can involve different oncogenes.

II.2.1. Translocations during VDJ recombination: Implications of the RAG complex

During certain translocations, the breakpoint within the IgH locus may be adjacent to D or J segments, near an RSS. In this case, the translocation results in an error during V (D) J rearrangements. This is the case with the Bcl2-IgH translocations or the CCND1-IgH (Cyclin D1-IgH), associated respectively with follicular lymphoma and mantle cell lymphoma (Küppers, 2005; Robbiani and Nussenzweig, 2013).

These translocations require the induction of two DSBs, one at the Ig locus, and the other at close proximity to the oncogene. They are classified into two categories: those where the two DSBs are induced by RAG enzymes, and those where only the DSB in the Ig locus is dependent on RAG, while the second is due to other mechanisms (replicative or oxidative stress, radiation, chemical agent etc...) (Mani and Chinnaiyan, 2010).

In the case of one RAG dependent break, this "off target" activity may affect two types of targets: the so-called "cryptic" sites, sufficiently similar to RSS sites to be targeted by the RAG complex; or DNA fragments adopting a "non-B" structure, able to recruit the RAG complex. This last scenario is notably encountered during Bcl2 translocations

where a part of the sequence, named Bcl2-Mbr (for Bcl2 major breakpoint) is frequently exhibited in single strand form.

However, in the case where both breaks are RAG dependent, the translocation is due to an illegitimate VDJ rearrangement, involving the formation of a synapse between the two RAG complexes. Finally, in the case of an independent RAG break, the end of the oncogene will invade a synaptic complex formed during a legitimate VDJ recombination (Jankovic et al., 2007; Lieber et al., 2006; Marculescu et al., 2006).

II.2.2. Translocations during secondary recombination

General considerations: Implications of the AID enzyme and other genetic events

The breakpoints, during certain translocations, are located within or at a close proximity to the rearranged VDJ exon. This is for example the case of the c-myc-IgH translocation in endemic Burkitt's lymphoma. This type of translocation is characteristic of an error in the repair during SHM. Indeed, although they are not necessary, it often happens that a DSB is induced during this mechanism, thereby facilitating the appearance of translocations. On the other hand, some translocations take place within switch regions preceding the constant exons, and are due to illegitimate repairs during the CSR. It is the case for example of the c-myc-IgH or c-maf-IgH translocations, respectively observed in sporadic Burkitt lymphomas or multiple myelomas (Robbiani and Nussenzweig, 2013; Seifert et al., 2019).

As described above, a translocation requires the simultaneous induction of two DSBs. If the DSBs within the IgH locus are due to the physiological action of AID; the one situated in close proximity to the oncogene may be due to non-specific mechanisms of B cells, or AID's "off target" activity. Indeed, despite its very strict regulation, AID can target certain regions of the genome in a non-specific manner. As a matter of fact, ChIP-seq experiments have demonstrated that AID is able to link to several hundred of sites together (Yamane et al., 2011).

Even if it has been established that AID fixation is not always representative of a mutagenic activity, its involvement in lymphomagenesis and in the induction of DSBs around oncogenes has been widely demonstrated, in particular through the use of murine models (Jankovic et al., 2010; Matthews et al., 2014; Ramiro et al., 2004).

Two studies have identified AID's main "off target" targets. By using I-SceI-induced breaks in c-myc or within the IgH locus as targets, the authors identified the partners involved in translocations by TC-seq. The comparison of results in the presence or absence of AID made it possible to identify hotspots for AID-dependent mutations (Fig.21). Detection of numerous somatic mutations in the genes thus identified, confirmed their targeting by AID ((Chiarle et al., 2011; Klein et al., 2011) For review: (Robbiani and Nussenzweig, 2013)).

AID is strongly expressed in several human B lymphomas, in particular those originating from GC cells. This presence of AID is not always linked to the development of SHM, but is, in some cases, associated with a worse prognosis (Okazaki et al., 2007).

Many teams have been working to determine the factors explaining the preferential involvement of these genes in AID-dependent translocations. The idea is that targeting by AID is due to the presence of certain factors on these genes: transcription machinery, epigenetic marks, R-loops etc... (Duke et al., 2013; Wang et al., 2014). On the other hand, the nuclear space organization seems to play an important role, with translocations being more frequent between genes localized in cis or in proximity within the nucleus (Klein et al., 2011; Zhang et al., 2012). It has also been suggested that the localization of a gene near the IgH locus promotes its targeting by AID, but these results are controversial (Casellas et al., 2013; Gramlich et al., 2012; Hakim et al., 2012; pubmeddev and al, n.d.; Rocha et al., 2013).

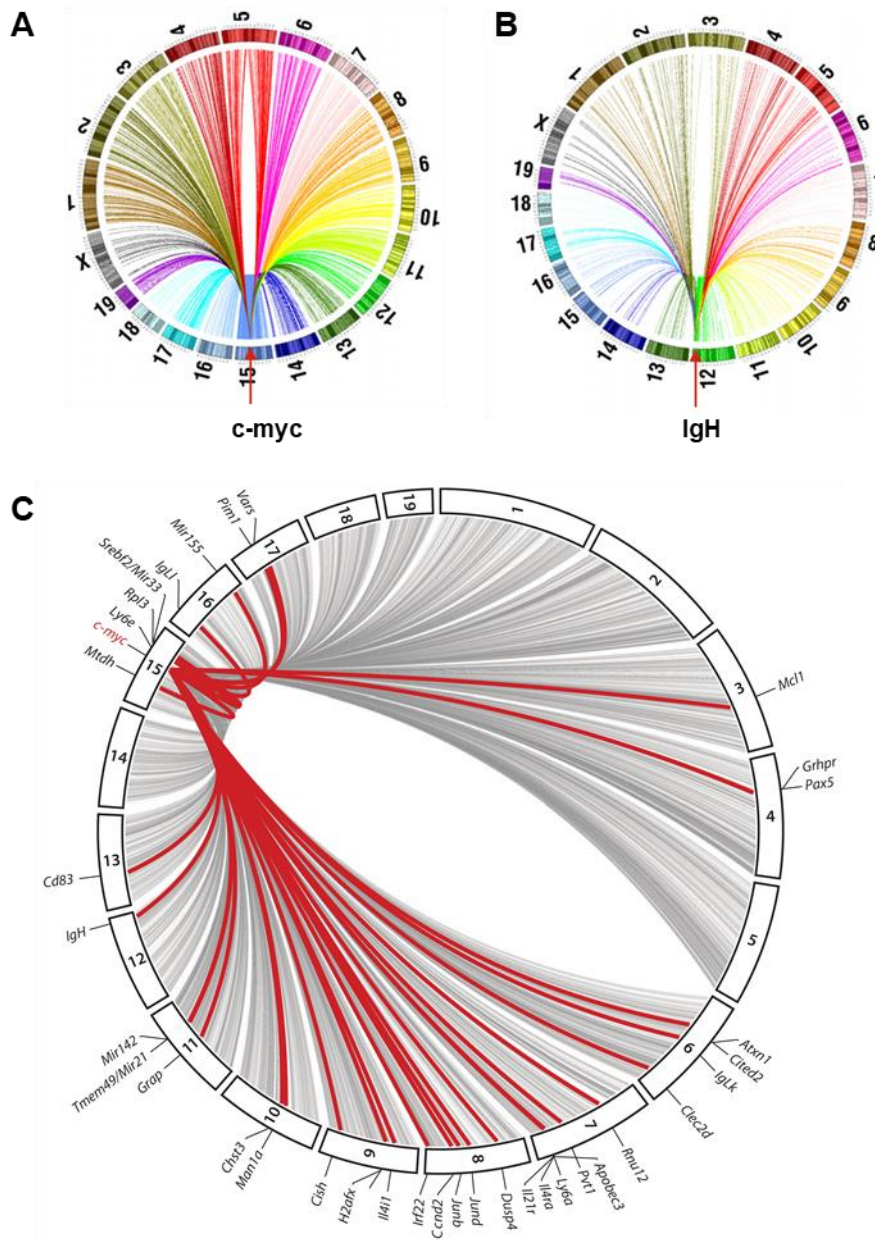

Figure 21: Genome-wide partners of c-myc and the IgH locus during translocations. The TC-seq technique made it possible to identify potential partners of c-myc (A) and the IgH locus (B) during translocations. This technique consists of inducing breaks via the endonuclease I-SceI in a determined sequence (called "target") and identifying by high-throughput sequencing the genes that will be translocated at this target. By comparing the data obtained in a background, deficient or not for AID (C), it is possible to identify which are the genes whose break allowing the translocation is dependent on AID (in red on the diagram). Taken from *Chiarles et al., 2011; Robbiani and Nussenzweig, 2014.*

II.2.3. 3'RR during lymphomagenesis

The translocation of an oncogene within the IgH locus leads to its overexpression, which suggests that it becomes under the transcriptional control of the regulatory elements of this locus (For review: (Pinaud et al., 2011; Vincent-Fabert et al., 2010)).

The intronic enhancer E μ was initially suggested as the critical player in this deregulation. However, the transgenic mice containing an E μ -c-myc cassette only develop tumors of immature phenotypes, different from the mature Burkitt lymphomas found in humans following a c-myc-IgH translocation (Janz, 2006; Schmidt et al., 1988). Likewise, the transfection of an E μ -CCND1 cassette does not cause the appearance of any lymphoid tumor (Lovec et al., 1994). These results and the fact that E μ can be deleted during c-myc-IgH translocations have led to the suggestion that the 3'RR is responsible for the deregulation of the translocated oncogene (Gostissa et al., 2009).

The involvement of the 3'RR has been confirmed by murine models: the transfection of c-myc-3'RR cassette or the knock-in of a 3'RR cassette 5' of endogenous c-myc induced the development of B cell lymphomas resembling human Burkitt lymphoma (Truffinet et al., 2007; Wang and Boxer, 2005).

The final definitive confirmation of the role of the 3'RR was brought about by the deletion of the enhancers hs3b and hs4 in mouse models favoring the development of lymphomas. The authors have demonstrated that the 3'RR is essential for the development of mature B cell lymphomas but not pro-B cell lymphomas (Gostissa et al., 2009). It is the case also for the deregulation of Bcl-2 in FL involving the Bcl-2-IgH translocation, which was confirmed through in vitro studies (Duan et al., 2007).

All of these studies have confirmed the importance of the 3'RR during lymphomagenesis, and the relevance of mouse models as tools for studying the development of these pathologies. This role of the 3'RR in oncogenic deregulation suggests that targeted inhibition may prove to be a promising therapeutic strategy in the case of mature lymphomas. In particular, histone deacetylase inhibitors seem to be an interesting track (Bose et al., 2014; Lu et al., 2005; Slingerland et al., 2014; Waibel et al., 2015).

II.2.4. BCR and lymphomagenesis

The essential contribution of the BCR in human pathology concerns mainly lymphomas. Despite the presence of numerous B cell lymphomas which differ in their clinical characteristics, their biological phenotypes as well as their predictions, all types of lymphoma share two common characteristics: 1- chromosomal translocations involving the immunoglobulin gene and another proto-oncogene and 2- BCR

expression. Ig translocations are generated by one of the three processes responsible for reshaping the Ig during B cell development (that is VDJ recombination, SHM or CSR). Regardless of this translocation, the expression of the BCR is ensured by the second allele, testifying for the cell's addiction to BCR expression despite the genetic defects that arise.

II.2.4.1. BCR signaling

In addition to the extracellular stimuli and their profound effect on B cell development, a paramount for the B cell's physiological fate are the BCR-mediated signals. The recognition of extracellular antigens through the BCR, activates the receptor and leads to the precise transduction of intracellular signals. Precision in such a system comes as no surprise because while it is extremely crucial to be able to detect infectious pathogens, this system should be robust and fail-safe in matters of avoiding autoimmunity yet overcoming undermining factors such as self-mimicking ligands and super antigens.

The BCR is a multi-protein structure consisting of two subunits; the antigen binding subunit referred to as the membrane immunoglobulin (mIg) and the signaling subunit, a heterodimer composed of two proteins, Ig α and Ig β that are non-covalently linked by a disulfide bond. Each of these proteins contain a single immunoreceptor tyrosine-based activation motif (ITAM which is a conserved motif composed of two precisely spaced tyrosine residues with surrounding consensus sequence that provide antigen receptors with specific binding sites for SH2 domain-containing effectors).

As mentioned earlier in chapter I, signaling through the BCR (Fig.22) can be divided into 3 stages explained in detail below:

- 1- Signal Initiation: Earliest step requiring the BCR complex itself: Antigen binding activates the BCR leading to its aggregation, which then results in the phosphorylation of the ITAM tyrosine residues by protein tyrosine kinases (PTK; primarily thought to be the src-family kinases such as Lyn, Fyn, Blk, or Lck). More preferentially, the double phosphorylation of both tyrosine residues for the Ig α and Ig β proteins will then recruit the cytosolic tyrosine kinase Syk which is crucial for facilitating the initiation of several different signaling pathways (Rowley et al., 1995). It is worthy to mention that signal initiation is also indirectly regulated by at least two other non-BCR associated molecules such as the

CD45 and the C-terminal src tyrosine kinase (Csk). The former, also known as B220 is a transmembrane tyrosine phosphatase which ensures that a proportion of associated src-family kinases, such as Lyn, are in a convenient state of phosphorylation and responsive to activation by BCR aggregation thereby establishing the required sensitivity for the BCR to stimulation as well as being involved in the following BCR signaling cascade.

- 2- Signal propagation: Key effector and adaptor molecules, culminating in activated downstream effectors and the production of second messenger molecules, mediate the amplification and diversification of BCR signals in this step: Following BCR aggregation, protein-protein or protein–lipid interactions as well as specific enzymatic activity lead to the formation of multi-protein complexes on the inner leaflet of the cell membrane to ensure the propagation of the signal initiated. The quality and the quantity of the latter is defined by the temporal and spatial regulation of these processes. To keep it brief and clear, proper BCR signal transduction is ensured by the ordered activation of three different non-receptor PTKs, prototypically represented by Lyn, Syk, and Bruton's tyrosine kinase (Btk, a TEC family PTK). The recruitment of Lyn and Syk, previously explained in the earlier section, is crucial for the activity of Btk. However, another limiting factor for that was found to be the generation of specific phospholipids by the action of phosphatidylinositol-3-kinase (PI3K). The latter is also activated post BCR aggregation, mainly through the BCR co-receptor molecule CD19, an integral transmembrane glycoprotein. Lyn mediated phosphorylation of the tyrosine in the Y-X-X-M sequences of the cytoplasmic tail of CD19 activates the PI3K, which then phosphorylates the ubiquitous plasma membrane lipid phosphatidylinositol 4,5-bisphosphate [PI(4,5)P₂] to create phosphatidylinositol 3,4,5-triphosphate [PI(3,4,5)P₃].

Progression of the signaling beyond this step is ensured by the tyrosine phosphorylation-dependent activation of a number of effector molecules such as the recruitment and activation of PLCY2 and elevation of calcium influx ([Ca²⁺]_i). Another important player in BCR signal propagation is the effector molecule BLNK. The latter has been shown to be essential for the recruitment of PLCY2 from the cytosol to the plasma membrane and for coupling BCR aggregation to [Ca²⁺]_i, thereby providing a major platform for effector molecule

assembly and transforming these initial BCR-proximal events into several divergent signaling pathways (for review: (Dal Porto et al., 2004, p. 101)).

- 3- Signal integration: This step is described as connection between the intracellular signaling pathways and the activation of transcription factors as well as the regulation of gene expression in the nucleus, which is, is a crucial aspect of BCR signaling: The key players in this step are the mitogen activated protein kinase family, consisting of three members: extracellular signal-regulated kinase (ERK), c-Jun NH2-terminal kinase (JNK/SAPK) and p38 MAPK. Following activation, these kinases phosphorylate different sets of transcription factors. Without going into infinite detail, multiple effector pathways can converge at this level and the BCR is connected to these “downstream” effectors by a “phospho-relay” system of cytoplasmic kinases which phosphorylate and regulate each other via a “checks and balance” system to ensure that the proper genes or processes are turned on or off at the proper time.

It is worthy to mention, at this point, that multiple receptor-associated accessory molecules and co-receptors can significantly influence the signal quality and quantity. Regardless of the fact that Ig α and Ig β are the primary BCR signal transducers, we have established previously that the co-receptor CD19 plays a pivotal role in BCR signaling. Other examples include CD22 and Fc γ RIIb as well as two surface accessory molecules MAIR-II/LMIR and PIR-B. TLR receptors also provide an alternative pathway of B-cell activation in an Ag-independent fashion (Chen and Wang, 2021) (Wen et al., 2019).

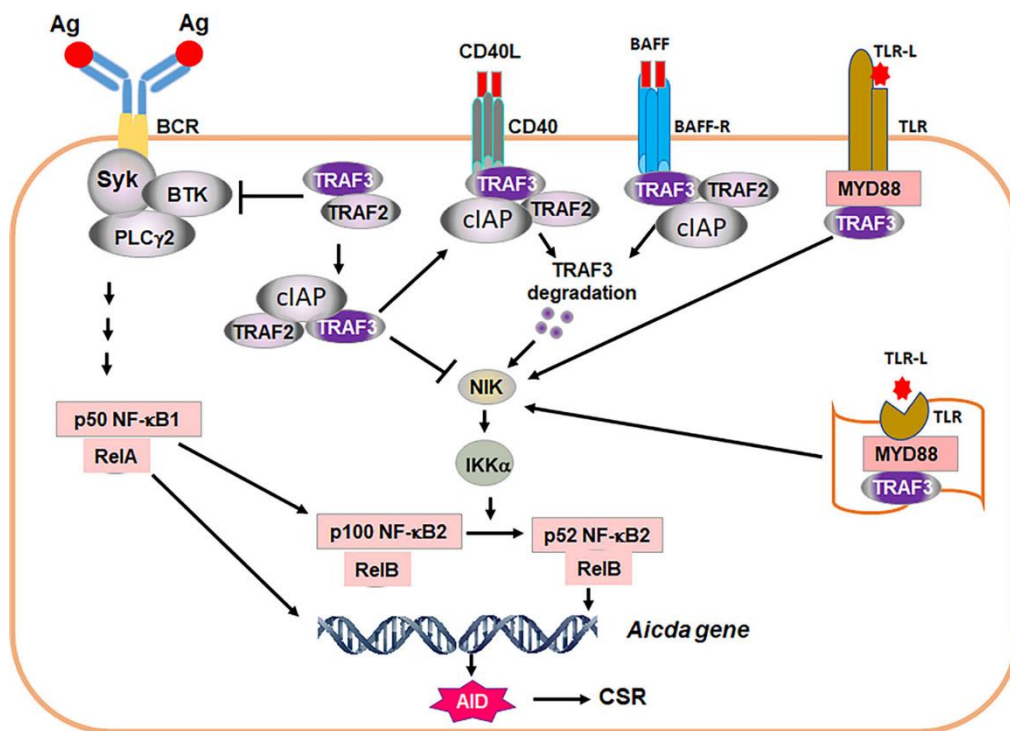

Figure 22: Schematic model representation of the BCR signaling crosstalk (example of CSR induction). Ag stimulation of BCR activates proximal signaling elements, Syk, BTK and PLC γ 2, leading to transcription factor NF- κ B1 activation. NF- κ B1 p50/RelA complex is required for AID transcription. NF- κ B1 p50/RelA also induces NF- κ B2 p100 transcription. TRAF2/3 restrict BCR proximal signaling strength. TRAF2 and TRAF3 also block NIK activity. Thus, Syk/BTK/PLC γ 2 complex cannot signal to generate transcription factor NF- κ B2 p52 that is required for AID expression. Removal of TRAF3 and/or TRAF2 leads to NIK accumulation, which activates IKK α pathway, resulting in NF- κ B2 p100 being processed into active NF- κ B2 p52. NF- κ B2 p52/RelB complex and NF- κ B1 p50/RelA together with additional factors initiate AID transcription. AID protein initiates CSR by targeting *Igh* locus. During humoral immune responses, CD40, BAFF-R as well as cell surface and intracellular TLRs are activated by corresponding ligands, CD40L, BAFF or TLR ligand (TLR-L), respectively. TRAF3/TRAF2 are recruited to cell membrane where TRAF3 is degraded by CD40 and BAFF-R signaling or sequestered by TLRs. As a consequence, NIK and NF- κ B2 complex can be activated. NF- κ B2 activation allows the BCR to induce CSR. Thus, the critical function of co-stimulatory signals is to degrade or sequester TRAF3 to permit NF- κ B2-dependent BCR-induced CSR essential for *in vivo* antibody responses. It is worthy of note that TRAF3 restricts Syk, BTK and PLC γ 2 hyper-activation upon Ag stimulation that may be especially important for maintaining autoreactive B-cell energy. Figure taken from *Chen and Wang, 2021*.

II.2.4.1.1. BCR signaling in B-cell malignancies

A number of B-cell malignancies feature BCR signaling, and it was notably shown *in vitro* in some such lymphoma cell lines that cell growth required BCR expression (Davis et al., 2010). Since the signals provided by the BCR are both constitutive (tonic signal) and mediated by interaction with ligands (activated signal), interpretation of BCR-dependence or BCR-addiction for malignant B-cell survival or proliferation is not

unequivocal. In ABC-type DLBCL, deregulation of the BCR signaling cascade is by contrary mediated by dominant positive mutations of various members of the cascade and then provide such malignant B-cells with apparent BCR-independent survival and growth. The same is true with EBV-transformed lymphomas expressing the viral protein LMP2a, which acts as a BCR surrogate and provides ongoing signaling.

II.2.4.2. Canonical structures of the BCR

Besides BCR-dependent growth of established tumors, another issue is the natural story of their development and their “past BCR dependence”, which can then be interpreted as a BCR ligand-dependence, i.e. the indication that initial Ag-driven B cell proliferation contributed to lymphomagenesis. The important role of antigen recognition through clonotypic BCR in various types of B cell malignancies has been extensively studied over the past years as an indirect indication of Ag-driven selection of the malignant B-cells. In some cases, direct proof that such clonotypic BCR or secreted monoclonal Ig indeed bound some antigens has also been obtained (notably for paratarg in multiple myeloma, MGUS and lympho-plasmocytic lymphoma (Grass et al., 2011a, 2011b)). Antigens and/or super antigens have thus been suggested to aid in the development of certain B cell malignancies by stimulating the proliferation of certain B cells expressing a “distinctive” BCR. In fact, several immuno-genetic studies have reported the presence of restricted repertoires in the variable regions of both the heavy and the light Ig genes.

From a clinical point of view, the importance of BCR stimulation has been emphasized by the therapeutic efficacy of small-molecule antagonists of effectors in the BCR signaling pathway explained earlier (such as Syk, Btk and PI3K) in certain types of B cell malignancies (such as CLL or mantle cell lymphoma) (O'Brien et al., 2011; Wang et al., 2011).

What paved the way in deciphering the notion of a distinctive or “stereotyped” BCRs were the studies done initially on CLL. These initial studies revealed that the CLL IGHV gene repertoire is nonrandom and distinct from that of normal B cells. In addition, differences in SHM status and heavy chain CDR3 (VH CDR3) composition and features were shown to be gene-related and provided evidence for the presence of IGHV subgroups (Chiorazzi and Ferrarini, 2011).

Further immuno-genetic studies on CLL have succeeded in proving the presence of sequence restrictions for the antigen binding sites (that is IGHV / IGHD / IGHJ genes) in the BCRs of the malignant cells in this disease. For example, a “stereotypic” IGHV1-69 BCR was found to be substantially un-mutated and used an IGHD3-3 gene and an IGHJ6 gene, thereby encoding for a long, tyrosine-rich, highly acidic VH CDR3 (Widhopf and Kipps, 2001). Later on, it was demonstrated that approximately half of CLL cases utilizing the IGHV3-21 gene display distinctive Igs with short and highly similar, if not identical, VH CDR3 along with a remarkable biased pairing with lambda light chains utilizing the IGLV3-21 gene (Tobin et al., 2003). These findings show that distinct prototypic BCRs could be repeated with minimum or no variation in different subsets of patients with CLL, thereby strongly suggesting the presence of an antigen driven pathway of CLL development and that a particular antigen-binding site could be critical in determining the clinical features and prognosis of CLL patient subsets. One study also claimed that the CLL BCR structure could eventually be somehow “self-specific” and thus providing cell-autonomous rather than Ag-driven activation (Dühren-von Minden et al., 2012).

Although initially thought to be exclusive only for CLL, the analyses of Ig gene repertoires of patient cohorts in other B cell malignancies like mantle cell lymphoma (MCL) and splenic marginal zone lymphoma (SMZL) have further proven the concept of BCR stereotypy.

In the case of MCL, the study of IgH gene rearrangements revealed a strong bias in the usage of certain IGHV genes, in particular, IGHV4-34, IGHV3-21 and IGHV3-23. Such studies however eventually occulted the fact that some VH genes notably predominate in the normal B-cell repertoire, as in the case of VH3-23, which has been reported as involved in up to 17% of all BCR rearrangement in normal B cells (Stewart et al., 1993). Further immuno-genetic studies of MCL cases confirmed the restricted associations of specific IGHV genes with certain IGHD or IGHJ genes. For instance, more than 30% of IGHV3-21 rearrangements utilized the IGHD3-3 gene. Similar yet less predominant biases were seen for IGHV1-8 and IGHV4-34 rearrangements, which were frequently recombined to the IGHD2-2 or the IGHD2-15 gene. Moreover, restricted patterns of associations with IGHJ genes were evident for certain IGHV genes; almost two-thirds of IGHV3-21 rearrangements utilized the IGHJ6 gene, compared to less than 10% of IGHV3-23 rearrangements. These restricted and biased

associations of IGHV, IGHD and IGHJ genes lead to the formation of distinctive antigen-binding sites with highly similar stereotyped VH CDR3 motifs, especially among subgroups of IGHV3-21 and IGHV4-34 -expressing MCL cases (Hadzidimitriou et al., 2011).

In the case of SMZL, it has been shown that over 30% of cases express biased Ig receptors that utilize a single polymorphic variant of the IGHV1-2 gene (denoted as IGHV1-2*04) as well as a low impact of SHM. Rearrangements in this variant gene in SMZL cases were shown to carry long, electropositive VH CDR3s with biased usage of the IGHD3-3 and IGHD3 – 10 genes, mostly in reading frame-3, resulting in VH CDR3s with common “IGHD-derived” motifs (Bikos et al., 2012).

As a conclusion, the above data confirm the importance of the BCR stereotypy study, not only in the mentioned malignancies, but also in a wide variety of different diseases and syndromes. In other words, such studies aid in elucidating the pathogenesis of these diseases thereby improving personalized therapeutic applications.

II.2.4.3. Antigen or auto-antigen recognition during lymphomagenesis

Activation of BCR has been shown to occur as a result to three distinct signals: 1- Autonomous signals at the pre-B cell stage due to the structural conformation of the pre-BCR (constituted of a heavy chain and a surrogate light chain (SLC)). Self-antigen recognizing BCRs of immature or mature B cells may selectively expand B cells by also inducing this autonomous signaling. 2- Antigen-dependent signals at the immature or mature B cell stage where the binding of an external antigen to the BCR results in the clustering and activation of a signaling complex transmitting the signal to the inside of the cell (explained in detail earlier) and 3- Tonic signals which are antigen-independent constitutive baseline signals that also occur at the immature or mature B cell stage and are essential for B cell survival and development.

The information above show that:

First, the functional similarity between self-reactive BCRs and pre-BCRs, in matters of autonomous signaling, suggests that self-antigen recognition could play a role in lymphomagenesis. One example on that were the studies on BCRs from mutated and un-mutated CLL cases which have revealed that they have signaling properties equivalent to those of the pre-BCR. In addition, autonomous BCR activity was demonstrated in 72% of non-germinal center DLBCL cases (Koning et al., 2016). Thus,

despite being structurally normal, this BCR autonomous signaling property provides strong evidence for the oncogenic role of the BCR in certain types of lymphomas.

Second, some role of BCR-mediated antigen recognition in lymphomagenesis has also been elucidated in several types of B cell lymphomas such as CLL, SMZL, and MZL of mucosa-associated lymphoid tissue (MALT). As explained in the previous section, the detection of an antigenic footprint in the BCR of the malignant cells in these lymphomas as well as the association of these malignancies with specific infections and auto-immune diseases have confirmed this notion. Another striking evidence is the response to specific foreign or auto-antigens and the induction of intracellular BCR signaling pathways in primary lymphoma cells. SMZL cases for example have been shown to be associated with hepatitis C virus (HCV) infections. Studies have shown that B cells that initially interact with the HCV-E2 protein could expand later on leading to the development of HCV-associated SMZL. The majority of HCV positive SMZL patients show complete response to anti-viral treatments thereby validating that antigen-dependent BCR activation is, indeed, a driver of lymphomagenesis. Without going into much detail, similar associations have been made for several types of lymphomas (for example: *Helicobacter pylori* infection in the case of gastric MZL of MALT-type, *Chlamydia psittaci* infection in the case of ocular adnexal extranodal marginal zone lymphomas (OAEMZLs), numerous viral and bacterial infections in the case of CLL etc...) (For review: (Sepulveda et al., 2017)). The possibility that antigenic stimulation might similarly contribute to some cases of FL has been proposed but remains debated.

Last but not least, evidence about the role of tonic BCR signaling in lymphomagenesis has also been reported in several B cell malignancies including BL and germinal center DLBCL. The signaling mediated through certain key players of this pathway (predominantly Syk and PI3K) was shown to activate of FOXO1 along with its target genes including Bcl2 (more specifically the member BCL2L11) and P27 (cell cycle inhibitor) ((Szydowski et al., 2016, p. 1).

II.2.4.4. BCR N-glycosylation

N-glycosylation is uncommon in the BCR variable domains of normal B-cells, in agreement with the less than 10% occurrence of the adequate motif “Asn-X-Ser/Thr” (Asn for asparagine; X for any amino acid except proline and Ser/Thr for serine or

threonine) in the germline sequence of V genes. Such glycosylation is by contrast frequent in lymphoma. Speaking exclusively of GC-associated lymphomas, there is no doubt that tumor cells are subjected to continuous rounds of SHM. This ongoing process can notably result in the introduction of N-glycosylation motifs most commonly in the Ig variable region genes of both heavy and light chains. These motifs are referred to as N-glycosylation sites, and, strikingly, the oligosaccharides added to these V region sites are usually “immature”, i.e. of the high-mannose type (Hollander and Haimovich, 2017).

Studies have shown that these acquired glycans are capable of interacting with mannose-specific lectins, especially the dendritic cell-specific intercellular adhesion molecule-3-grabbing non-integrin, referred to as DC-SIGN. This interaction triggers continuous activation of the BCR, as well as signaling pathways similar to those demonstrated for BCR engagement by antigen, which has been shown to be indispensable for the survival of several tumor cell types. Malignant cells have also been shown to be able to interact in a similar manner to bacterial lectins and the best example for this alteration is FL (Fig.23). Shockingly and while in normal B-lymphocytes, N-glycosylation of V regions barely reach 10%, in FL cells however, it is found in more than 90% of the cases, which is a strong indicative of its pathogenic function (Detailed more in the next chapter).

With lower frequency, N-glycosylation sites in Ig variable regions has been found in other GC lymphomas, such as diffuse large B-cell lymphomas and Burkitt's lymphomas. It is worthy to note that even though these malignancies often show continuous rates of SHM, no correlation was found between acquisition of novel glycosylation sites and levels of SHM activity. In other words, some of these lymphomas had low SHM activity but specifically “devoted” to acquiring novel sites. On the contrary, mucosa-associated lymphoid tissue lymphomas showed high mutational activity but a low frequency of these sites, as expected in the normal process of an Ag-driven selection. For all these reasons, the strong correlation observed between the tumor type and the occurrence of N-glycosylation suggests that it is a marker of a specific lymphomagenesis pathway in which tumor environmental factors are implicated in the positive selection of clones acquiring V-region glycans (for example, stromal lectins that interact with acquired oligosaccharides in the mutated BCR) (Hollander and Haimovich, 2017).

By contrast to FL, it was found that the BCR in CLL carries immature high-mannose oligosaccharides, but in the heavy chain constant rather than the variable region, thus rather relating to post-translational anomaly (this notion will be discussed in a separate section in Chapter 3 on the role of the BCR in FL).

Taken together, these data thereby confirm the involvement of altered glycans in the pathogenesis of these different malignancies. This could also be extremely beneficial for the development of novel therapeutic strategies for the different types of lymphomas in question; targeting the interaction that occurs between the lectins and the glycosylated BCR, via certain blocking reagents like antibodies for either of the involved parties could be an innovative therapeutic strategy. In addition, starting from the fact that BCR signaling is activated post this interaction, inhibitors for this signal transduction pathway come in handy as effective therapeutics for these lectin-driven malignancies. (Hollander and Haimovich, 2017).

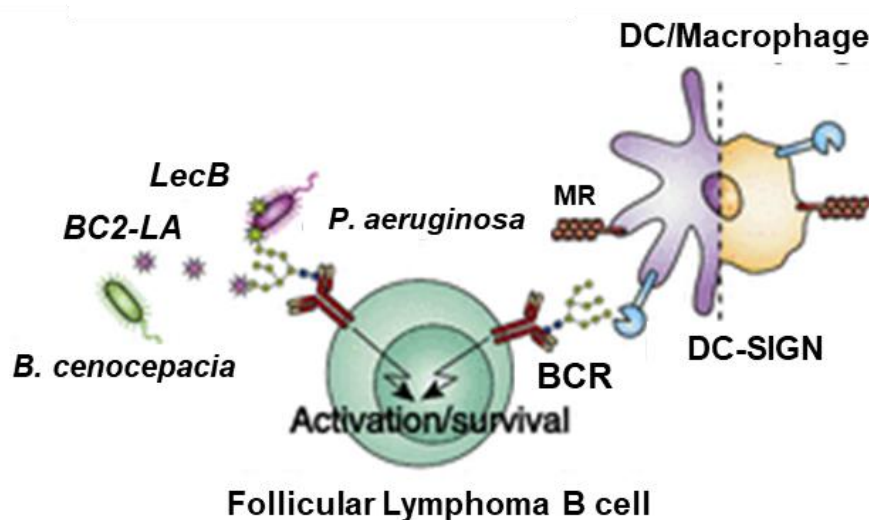

Figure 23: Schematic representation of the interactions of an N-glycosylated BCR.

In Follicular lymphoma, BCR-linked high-mannose glycans or simply N-glycosylated BCRs may interact with DC-SIGN, or bacterial lectins, thereby leading to BCR signaling and presumably enhancing tumor survival. Image edited from *Bovenkamp et al., 2016*.

II.3. Secondary alterations/hits in lymphomas

II.3.1. Epigenetic alterations

B cell lymphomas show substantial alterations in their epigenetics. The most widely analyzed epigenetic mark is their DNA methylation pattern, which is commonly found in a hypomethylated state throughout the genome but also in a hypermethylated state in particular regions.

In CLL for example, studies showed that three subgroups of CLL can be separated based on their DNA methylation pattern into 3 subgroups, each associated with distinct clinical behavior: the first is linked to CLL with unmutated IgV genes, the second with IgV-mutated genes, and the third is an intermediate group. With additional studies performed on CLL, it was shown that tumor cells show substantial intra-tumor heterogeneity in matters of DNA methylation, which could be linked to transcriptional variation and may affect genetic evolution and clinical outcome.

Similar studies were performed for mantle cell lymphomas, where, based on DNA methylation profiling, two subgroups of these lymphomas emerged: One associated with mainly pre-GC B cells and the other with post-GC B cells, which also fitted to the IgV gene mutation patterns of these subgroups.

An outstanding finding of an in-depth epigenetic analysis of Burkitt lymphomas revealed that several pathways, also affected by recurrent genetic lesions in this lymphoma, are indeed affected by alterations of the DNA methylation patterns of genes encoding critical factors of these signaling pathways. Hence, both genetic and epigenetic alterations cooperate in the pathogenesis of Burkitt lymphoma (Kretzmer et al. 2015).

In addition to everything mentioned above, a cellular function that is not completely understood but, nevertheless, found to be recurrently deregulated in several types of lymphomas is chromatin remodeling. Major examples validating this notion are the recurrent inactivation of KMT2D (MLL4), a histone methyltransferase, and CREBBP, a histone acetyltransferase in both Follicular lymphoma and DLBCL (Meyer et al., 2019). EP300, the paralogue of CREBBP is also eventually involved in the absence of CREBBP mutation. Since the loss of CREBP often occurs only on one allele, the alteration of CREBBP dosage appears sufficient for contributing to lymphomagenesis,

notably by deregulating the BCL6 pathway and genes downstream of BCL6 which are normally inhibited by CREBBP.

Studies whereby the artificially induced inhibition of these genes in cell lines has shown that their activity controls the chromatin state of a variety of genetic loci. Their lowered dosage in malignant cells notably silences tumor suppressor genes such as P53, and to reactivate epigenetically silenced oncogenes by editing histone marks or by directly acetylating BCL6. This is validated even further with the observation that many lymphomas show an abnormal pattern of histone marks and/or DNA methylation when compared to their nonmalignant counterparts.

Another frequently affected chromatin modifying gene in FL is the histone methyl transferase EZH2. Mutations of EZH2 usually occur only one one allele and are missense mutations of tyrosine 641, resulting in increased activity for catalyzing the addition of the third methyl group to H3K27me2, but with reduced activity for adding the first and second methyl groups. Wild-type and mutant EZH2 act thus likely cooperate in heterozygous mutant cells to promote H3K27me3, and then also cooperate with Bcl2 overexpression to promote lymphoma by repressing genes normally involved in GC exit and terminal differentiation (IRF4, PRDM1...), thus stalling B-cell differentiation at the GC stage (Green, 2018).

Advances in the understanding of micro- RNAs that have also emerged in recent years, it became obvious that this class of small noncoding RNAs is another frequent target of deregulation in lymphomas. For example, the microRNA cluster, comprising miR-15a and miR-16-1, was found to be recurrently deleted in CLL, mantle cell lymphoma and multiple myeloma. It was shown that this cluster along with the single protein-coding gene DLEU2 act as tumor suppressors thereby providing a selective advantage for tumor clones that have lost one or both copies of this region.

Chapter III. Follicular lymphoma (FL)

III.1. Introduction to Follicular lymphoma

Follicular lymphoma (FL) is the most frequent indolent NHL, representing 30 to 40% of B cell malignancies, with a median survival ranging from 8 to 12 years (Bastion et al. 1997).

To be more specific, FL is a germinal center B cell malignancy that results from the malignant transformation of a clone of centrocytes. FL is a disseminated disease characterized by a very complex development. The premalignant phase is long and the clinical course is slow and associated with multiple relapses, thereby making it increasingly resistant to therapy. FL affects both males and females equally with a median diagnostic age of 60 years. Over the course of time, approximately 30% of FL cases transform into aggressive DLBCL (de Jong 2005; Ott and Rosenwald 2008; Roulland et al. 2011).

III.2. Classification and prognosis of FL

The Ann Arbor classification, identifies four stages of FL, depending on the number and location of the organs affected by the disease:

Stage I: the disease is present in only one group of lymph nodes or rarely in a non-lymphoid organ.

Stage II: FL is present in two or more groups of lymph nodes, but located on the same side of the diaphragm. A non-lymphoid organ close to the affected lymph nodes can be reached.

Stage III: involvement of the lymph nodes on both sides of the diaphragm or involvement of an adjacent organ or spleen.

Stage IV: the liver, bone marrow, lungs or other organs far from the lymph nodes are also affected.

Response to treatment and survival depend on poor prognostic factors such as advanced age (over 60), disseminated disease (meaning if it is classified stage III to IV according to the Ann Arbor classification), involvement of four or more lymph node areas, an abnormal serum lactate dehydrogenase (LDH) level and a hemoglobin level

less than 10 g / L. These factors define what is referred to as the FLIPI score (Follicular Lymphoma International Prognostic Index). This score identifies three major risk groups as: the low risk group (factor 0-1), the intermediate risk group (factor 2) and the high-risk group (factor 3 to 5). Survival at 10 years being 71%, 51% and 36% respectively (Solal-Céligny et al. 2004).

Other factors have also been suggested such as an elevated level of β 2-microglobulin (greater than 3 mg / L), an albumin level less than 35 g / L and no response to treatment (Bastion et al. 1997).

It is worthy to note that the transformation into high-grade lymphoma is a part of the FL evolution with an incidence around 70%. More frequently, FL cases transform into DLBCL (with a centroblastic or immunoblastic variant) however less frequently into Burkitt or lymphoblastic type lymphomas.

The prognosis for transformed lymphomas remains grim with a survival rate of 36% at ten years. The factors of poor prognosis for transformation include: advanced age, diffuse lymph node involvement, spinal infiltration, the presence of extra-lymphatic localizations, impaired general condition, high LDH levels, high number of previously performed chemotherapy and the lack of response to treatment (Bernstein and Burack 2009).

III.3. Cellular origin and phenotype of FL

With the exception of certain subtypes of mantle cell lymphomas or rare lymphoblastic lymphomas, all NHLs have a somatic IgV gene mutation indicating that they are derived from B cells which are blocked at the GC B cell stage or which have transited there (R. Küppers et al. 1999; Stevenson et al. 1998). In addition, the genome of these malignant cells has chromosomal translocations and aberrant somatic hyper-mutations that represent errors or dysfunctions of the immunoglobulin gene remodeling mechanisms. These genetic lesions often affect the Ig gene but can also affect other genes like BCL6, PRDM1 and MYC. These genetic aberrations participate strongly in the appearance of lymphomas in the GC (Fig. 24).

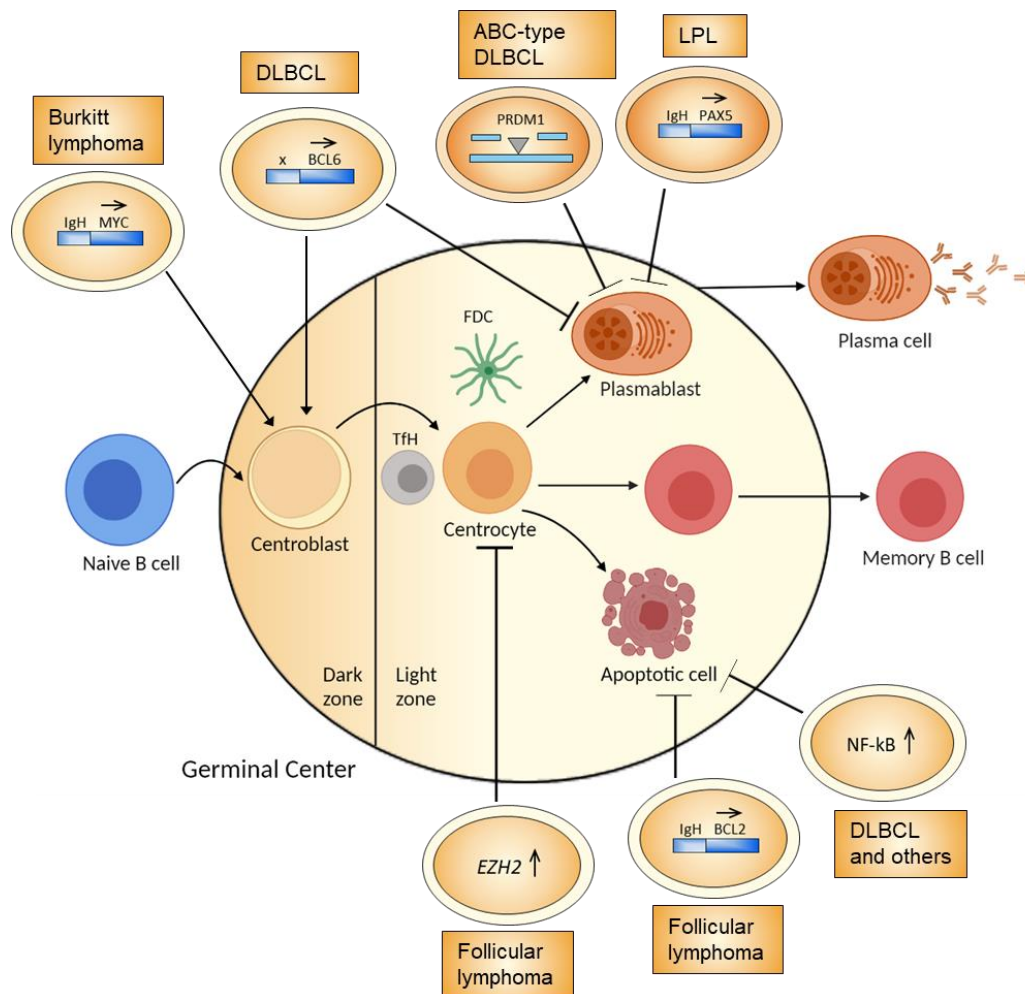

Figure 24: Schematic representation of the molecular alterations and appearance of lymphomas.

The molecular alterations that occur during the maturation of B cells sometimes form obstacles to the proper functioning of differentiation in the GC. For example, chromosomal translocations concerning the IgH, MYC or BCL-6 genes induce an increased proliferation of centrocytes leading to Burkitt's lymphoma or diffuse large cell B lymphoma (DLBCL). Genetic aberrations affecting the PRDM1 or PAX5 genes inhibit plasma cell differentiation and participate in the appearance of ABC-type DLBCL or LPL (lymphoplasmatic lymphoma). Overactivation of the NF κ B pathway, as well as chromosomal translocation affecting IgH and BCL-2 prevent apoptosis of centrocytes are defects involved in the development of follicular lymphoma or DLBCL. Gain of function mutations in EZH2 block the exit of centrocytes from the GC by disrupting the Tfh barrier as well as increasing interaction with FDCs. Edited from *Klein and Dalla-Favera, 2008*.

The architectural and cytological characteristics of FL cells evoke those of the GC, with 80% of FL cases displaying a "GCB-like" phenotype and the remaining 20% showing similarity to plasmablasts. The malignant follicles contain centroblasts but also tumor centrocytes, normal T cells, FDCs and some macrophages. Analysis of genes encoding the variable regions of heavy and light chains of the BCR of the FL cells confirms their GC origin. The Ig (V) genes of FL cells show somatic mutations similar

to those observed in normal cells that have encountered the antigen. FL cells can express the IgM isotype or the IgG isotype meaning that class switching is a phenomenon that can also touch FL cells. In fact, there have been a few cases of FL cells expressing both the IgM and the IgG isotype reflecting the clonal heterogeneity which can characterize some cases of FL (Aarts et al. 2000).

It is worthy to note, however, that the pattern of gene co-expression in single FL B cells is not compatible with the reference signatures of normal GC B cells. This was revealed by recent single-cell transcriptomic analyses of FL samples and indicates a major desynchronization of GC-specific gene expression programs in this disease. The mechanisms that underlie this desynchronization remain unknown, but it is plausible that FL-associated epigenetic alterations and/or interactions with the surrounding microenvironmental factors both have major influences (Pasqualucci 2019).

Immunophenotyping of lymph node, spinal or other samples revealed that the surface markers expressed in FL are: cell surface immunoglobulin (with a predominance for the IgM isotype followed by IgG and finally IgA), molecules such as CD10, CD19, CD20, CD38 and Bcl-6 with a defect in the expression of the markers CD5 and CD23. Again, the overexpression of the proto-oncogene BCL-2, following a chromosomal translocation, is a characteristic feature of FL cells. Many other genetic aberrations affecting the P53, MDM2, FCGR2B, REL, BCL6, P73 genes, CDK4... have been identified in FL, some of them have established prognostic value (discussed in further detail in the upcoming section) (Viardot et al. 2003).

III.4. FL genetic alterations

FL is considered as a multistep disease. In the natural history of FL, the hallmark for its development is comprised of a critical genetic event that occurs early during B cell development in the BM. Later on, this is accompanied with numerous entries and re-entries of the malignant cells into the GC where they undergo several rounds of SHM thereby allowing the introduction of secondary mutations or hits that are even more favorable for the development of FL (Fig.25). The section below aims to explain in detail these genetic alterations that occur during FL:

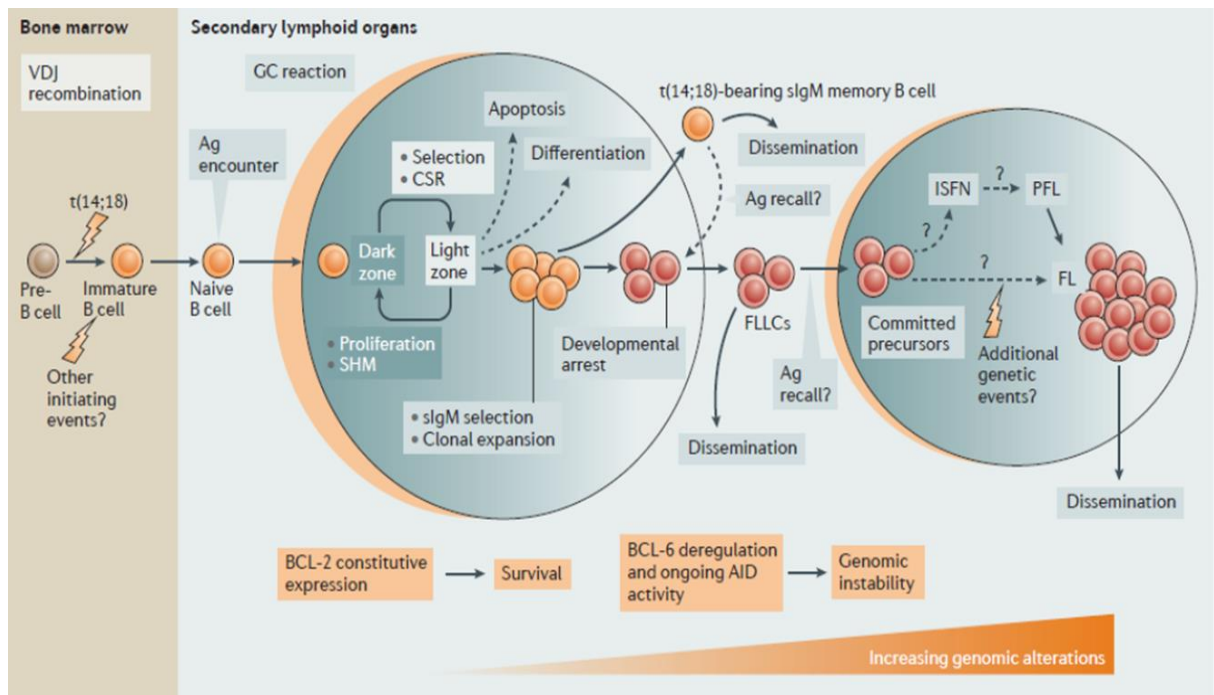

Figure 25: The different steps that lead to FL development.

Detailed schematic representation of the different events that occur in FL. From the earliest event comprising the t(14;18) that occurs during V(D)J recombination in the BM (accompanied or not with other secondary genetic alterations), to their entry into the GC and their exit as t(14;18)+ sIgM+ memory B cells (allelic paradox) or their developmental arrest at a centroblast/centrocyte like stage (follicular lymphoma (FL)-like cells or FLLCs) which could disseminate extensively and traffic between follicles, blood and BM compartments or potentially re-enter GCs following a second encounter with their cognate Ag (Ag recall) or following another yet unidentified signal. Together with a supportive microenvironment, these events gradually induce clonal expansion and acquisition of additional genomic alterations and evolve over decades through a putative committed precursor stage until progression to early malignant stages (in situ follicular neoplasia (ISFN) and FL with partial involvement (PFL)) and overt FL occurs. ISFN and PFL represent the putative earliest stages before full transformation to overt FL, but the sequence of oncogenic events linking those stages is still unclear — in particular, whether they are mandatory developmental steps before the appearance of overt FL. Image taken from *Huet et al., Nature reviews 2018*.

III.4.1. t(14;18) translocation

t(14; 18) (q32, q21) is the hallmark for the development of FL. It is the result of an error during the V(D)J recombination process in the BM.

Due to the DSBs induced by the RAG complex during the latter, this translocation juxtaposes the BCL2 oncogene located on chromosome 18q21 and the region coding for the immunoglobulin heavy chain locus located on chromosome 14q32 (IgH, segment JH) (Fig.26). This leads to overexpression of the gene and thereby the constitutive expression of the transcribed protein Bcl2 (Raghavan et al. 2004).

This translocation is found in 90% of FL cases, 20% to 30% of de novo DLBCL cases and 50% of other histological types of lymphomas (mantle and marginal zone

lymphomas, Hodgkin's disease), with no identified prognostic association. It is also preserved during the transformation of FL into high-grade lymphoma. The functional result of this translocation is the imbalance of the balance between cell survival and death. Bcl2 is a transmembrane mitochondrial protein, which intervenes in the regulation of cell death by inhibiting the apoptosis phenomenon. The overexpression of protein Bcl2 thus leads to a defect in cell death. As already mentioned above, the cells of the GC are normally characterized by an increased ability to respond to apoptotic signals in order to eliminate B cells whose BCR is not functional or auto-reactive. So, it is easy to imagine the deregulation yielded by t(14; 18) at this stage, where, normally, anti-apoptotic proteins are absent as a result of the action of pro-apoptotic proteins (such as Bak, Bax and Bad).

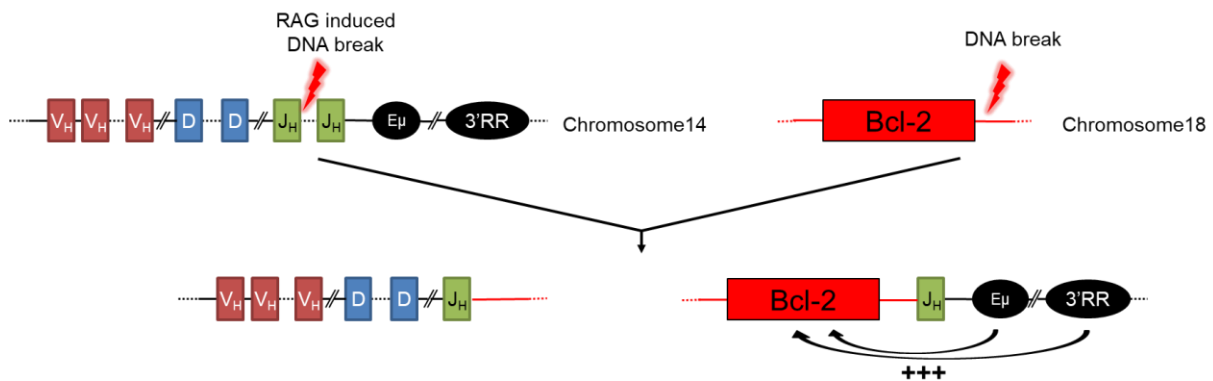

Figure 26: Schematic representation of the mechanism of the t(14;18) during FL.

During the V(D)J recombination process that occurs early during B cell development in the BM, the DSBs induced by the RAG complex during the latter, juxtapose the BCL2 oncogene located on chromosome 18q21 and the region coding for the immunoglobulin heavy chain locus located on chromosome 14q32 (IgH, segment JH). This Bcl2 gene then falls under control by the IgH locus enhancers (E μ and the 3'RR), hereby leading to the constitutive expression of the anti-apoptotic protein Bcl2.

When naive B cells leave the BM and migrate to reach the periphery, those harboring the t(14;18) translocation display a selective advantage during the GC reaction allowing them to recirculate as atypical memory B cells, referred to as FL like cells (FLLC), carrying some features of FL cells. Even though detected at a low frequency in the peripheral blood of most healthy individuals (around 70%), it has been shown that these FLLCs retain a functional surface IgM allele (sIgM) despite the fact that they have passed through the GC and have undergone a round of CSR. This retention of sIgM would allow these cells to reenter the GC upon future Ag encounter subjecting them to additional rounds of SHM, making them even more susceptible to the accumulation of additional mutations and thereby perhaps contributing to malignant transformation. This process is what we call the "allelic paradox". (Milpied, Nadel, et Roulland 2015; Tellier et al. 2014; Huet, Sujobert, et Salles 2018).

III.4.2. Secondary genetic alterations

As mentioned earlier, besides t(14;18) and the subsequent Bcl2 deregulation, additional secondary alterations and mutations, thanks to the recurrent subjecting of these cells to SHM in the GC, are mandatory for the development of FL.

It is worthy to note that in some cases, FL can also be derived from the cells which do not have t(14;18) translocation/Bcl2 overexpression. These cells have been shown to have undergone a different translocation called t(3;14), which results in BCL6 deregulation and FL progression (Ruminy et al. 2006).

The secondary alterations could involve mutations in epigenetic regulators (Fig.27) such as histone methyl transferase 2 (MLL4), CREBBP, EZH2 etc. It has been shown that mutations in the latter seem to drive early progression of FL and are thus considered as founder events as well.

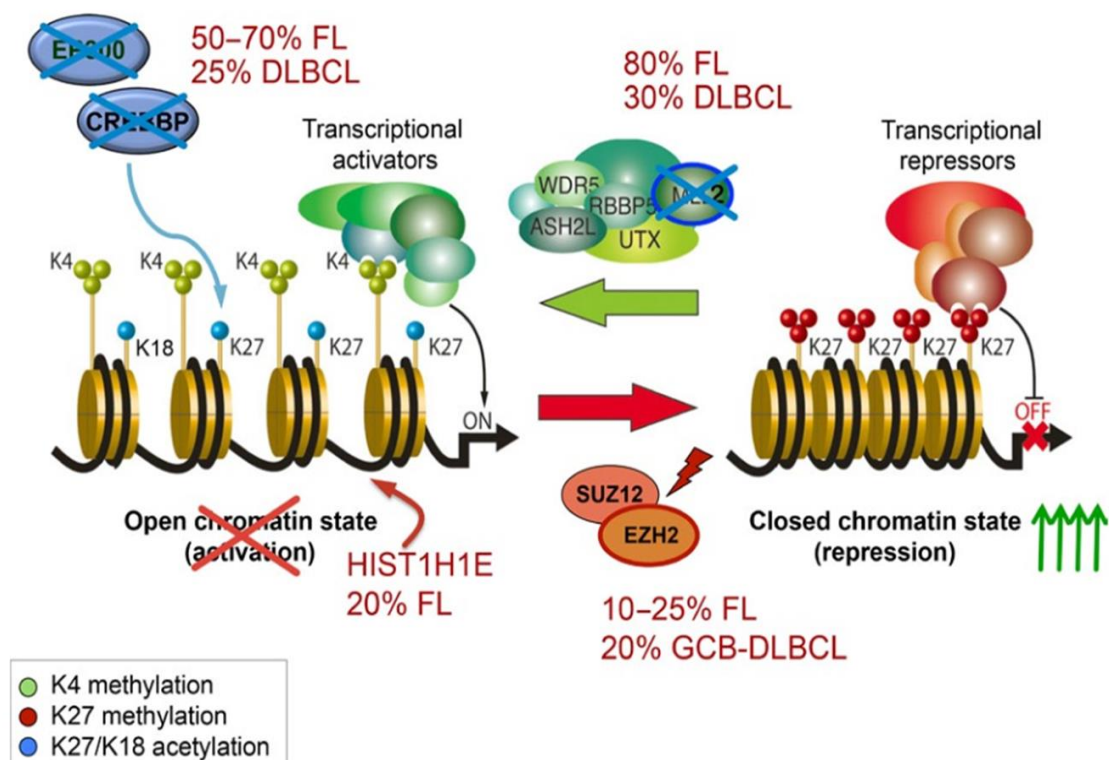

Figure 27: Schematic representation showing the aberrant histone/chromatin modifications in FL.

Post-translational modifications of histone tails modulate the degree of chromatin compaction and therefore accessibility of the underlying DNA to the transcriptional machinery. This tightly regulated program is rewired due to genetic lesions in most FLs due to somatic mutations of histone methyltransferases and acetyltransferases or histones themselves. Percentages denote the proportion of mutated cases in FL. Crosses, inactivating lesions; bolts, activating lesions. Edited from *Pasqualucci, 2019*.

To be more specific, MLL4 or KMT2D is a member of the SET1 family of histone methyltransferases. KMT2D acts predominantly through mono- and di-methylating the lysine 4 in histone 3 (H3K4), a mark of active enhancers. In normal cases, KMT2D acts as a tumor suppressor, however its deletion or inactivation has been detected in 90% of FL cases (and DLBCL). The mutations that affect this enzyme are mainly biallelic truncating events that disrupt the enzymatic function of the protein by eliminating the C-terminal cluster of conserved domains, including the SET domain. Studies using CD19-Cre conditional knock out models showed that KMT2D deletion accelerates lymphomagenesis through significant expansion of the GC B cell population as well as affecting B-cell physiology, including the positive regulation of apoptosis, CD40 signaling, and the control of cell migration and proliferation (Pasqualucci 2019). Additional targets of MLL4 such as TNFAIP3, SOCS3 and TNFRSF14/HVEM are genes that were found to be frequently mutated in FL as well. More importantly, the herpes virus entry mediator (HVEM) is a receptor encoded by the TNFRSF14 gene. It is a type I membrane protein that is expressed in both T and B cells. Depending on its interaction with multiple ligands, HVEM can deliver opposing signals controlling both inflammatory and inhibitory responses (including the canonical LIGHT and lymphotoxin α , and the immunoglobulin superfamily proteins BTLA (short for B and T lymphocyte attenuator)). HVEM can provide proliferation activating (that is inflammatory) or inhibiting signals. Nonsense, frameshift as well as missense mutations, frequently in biallelic configuration, in the exons encoding the ectodomain of HVEM have been found in a significant portion of FL cases (40% of FL cases).

Loss of HVEM is thought to disrupt cell-cell interactions via its ligand BTLA, thereby forming a tumor-supportive microenvironment characterized by exacerbated lymphoid stroma activation and increased recruitment of Tfh cells. Indeed, the deletion of HVEM in genetically modified mice carrying the Bcl2 transgene: 1- facilitated immune escape of the malignant B cells, 2- yielded cell autonomous activation of B cell proliferation with an increased incidence of GC-derived lymphomas, 3- amplified the follicular helper T cell population (Tfh) producing high amounts of Il-4, and tumor necrosis factor (TNF) and 4- activated the lymphoid stromal cell population (Lamaison and Tarte 2019; Pasqualucci 2019).

Finally, yet importantly, it is important to state that, thanks to the development of high throughput sequencing techniques, numerous additional genetic alterations have been

recently identified. Examples include: EBF1, regulators of NF- κ B signaling pathway (MYD88 and TNFAIP3), as well as defects in genes involved in cell cycle progression, DNA damage response (CDKN2A/B, MYC, TP53) and SHM.

III.5. Transformation of FL

Generally speaking, one of the characteristics of the natural history and the clinical course of B cell indolent lymphomas is the risk of histologic transformation (HT) to an aggressive lymphoma. HT is accompanied mainly by a change in the pace of the disease to a more aggressive clinical behavior, with clinical characteristics typical of aggressive lymphomas, such as a declining performance status, rapidly growing or asymmetric growth of lymphadenopathy, involvement of extra-nodal sites, hypercalcemia, and raised lactate dehydrogenase level. HT represents one of the main challenges in the management and treatment of patients with indolent lymphomas; the main reason being the lack of an answer to the question as to why only a fraction of the patients experience HT. Despite the fact that major advances have been made in the molecular understanding of this phenomenon, detailed information on its pathogenesis remain unclear and the body of evidence to either prevent HT or improve the outcome of patients with HT remains rather poor.

In the case of FL, HT (transformed FL or tFL) has been a well-known phenomenon that has been extensively studied in terms of the incidence, risk factors, and outcome in patients with this disease. More commonly, FL transforms into a diffuse large B-cell lymphoma (DLBCL) and, less commonly, to Burkitt lymphoma (BL) or other types of aggressive lymphomas. The exact definition of HT in FL varies considerably among the series based on either cytological or histological samples or, in certain cases, solely on clinical criteria (that is diagnosis of DLBCL or BL) (Montoto and Fitzgibbon 2011).

Even though a genetic consensus defining the transformation of FL into tFL has not yet been defined, a considerable improvement in defining the molecular events related to this transformation has been made over the years.

Reanalysis done on available FL and paired FL-tFL gene-expression profiles identified an embryonic stem cell (ESC) signature at diagnosis that predicts HT.

This does not mean that tFL arises from a hematopoietic stem cell per se, but rather from a GC B cell with enhanced stem cell expression features. This ESC signature may reflect early epigenetic remodeling within the B-cell population carrying the t(14;18). This means that a somewhat programmed global change in gene expression may be a prerequisite for onset of FL or tFL.

Clinical data have succeeded in further validating this idea, with evidence of recurrences after HT as the initial indolent histologic subtype. The current notion that tFL (and indeed relapsed FL) may arise from a more immature cell, denoted as common ancestor cell or common progenitor cell (CPC; Fig. 28) is based on several lines of genetic evidence tracing the genetic changes in sequential biopsy samples taken over the clinical course of a patient's disease. These data suggest that, in some patients, the transformed tumor originates from a more undifferentiated B cell population rather than reflecting its clonal evolution from a previous episode of the disease.

In addition, it is worthy to note that a more complete picture of the clonal patterns of FL evolution has been defined via more comprehensive whole exome sequencing (WES) studies of paired diagnosis, relapsed, and transformed FL as well as thorough SNV analyses. Again, these studies have showed that most tFL do not directly evolve from FL, but rather from the CPC that is also ancestral to the dominant FL clones at diagnosis and relapse. Another striking finding are the recurrent mutations of epigenetic regulators such as KMT2D, CREBBP and EZH2 that seem to facilitate the early progression of FL, which have been found to be present in this CPC as well.

As a conclusion, the detection of the ESC signature within the CPC pool in FL (if found in an appropriate quantity in the biopsy with a strong HT signal) may serve as a good marker for later transformation in patients. Not to mention that the observed patterns of clonal evolution as well as early and late acquisition of mutations in key additional driver genes suggest a protracted yet very dynamic process leading from FL-like or CPC to tFL

Although this CPC population has not been characterized, the development of multiplexed flow cytometry approaches has identified B-cell receptor insensitive cells that appear to increase in number at the time of tumor progression. This thrilling observation may offer a technical approach for sampling rare cell populations within FL biopsies, to try to formally characterize this proposed CPC population. High

throughput sequencing approaches in FL are indeed a powerful tool to identify many new mutational targets that are tightly linked with a risk of HT. It is practical also to monitor the genetic and microenvironmental characteristics of FL, both at initial diagnosis and during follow-up, in order to improve our understanding and management of relapsed FL and HT.

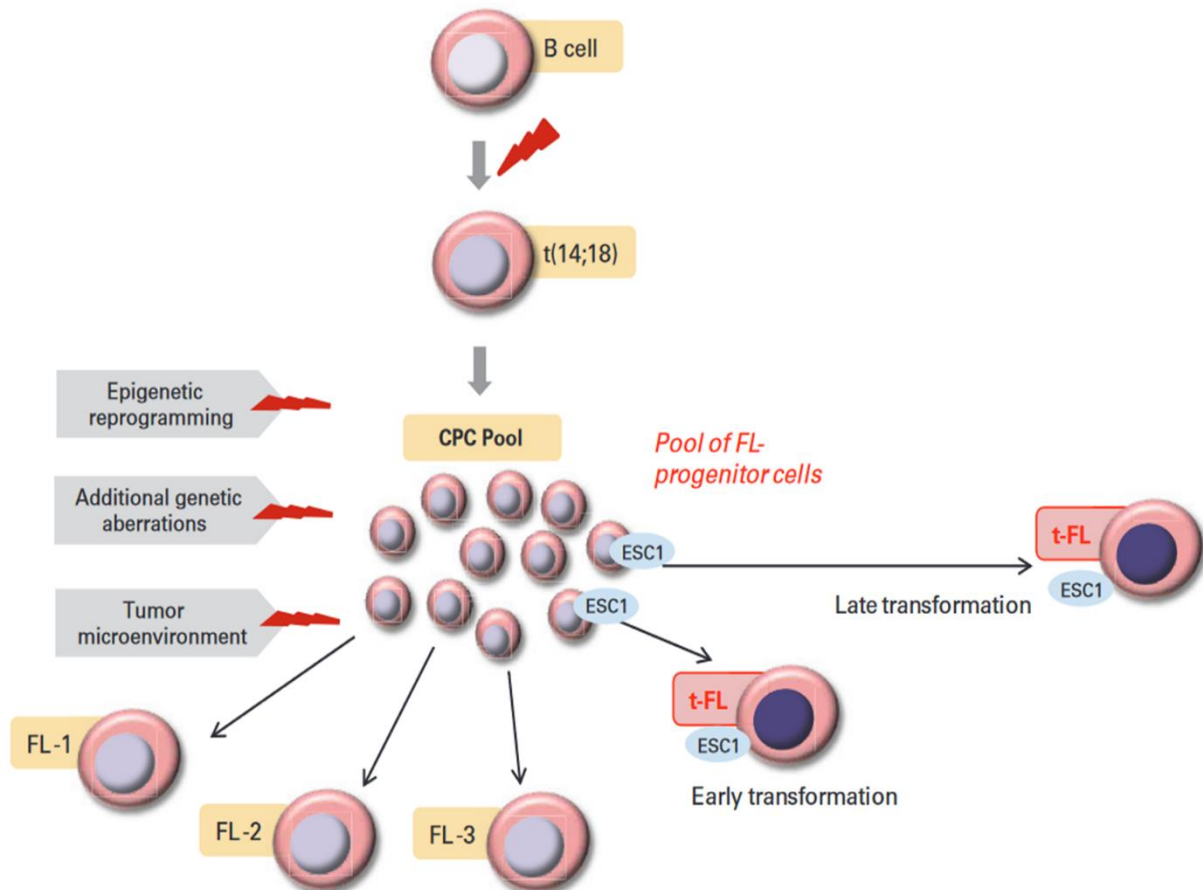

Figure 28: Schematic representation showing the histologic transformation of FL.

Epigenetic reprogramming in conjunction with the acquisition of additional genetic events in a t(14;18) positive B cell leads to the development of an FL-initiating pool of common progenitor cells (CPCs). The emergence of a particular FL-CPC clone at diagnosis (FL-1) or relapse (FL-2, FL-3) is dependent on the selective pressure of these acquired genetic mutations as well as the cellular microenvironment that may differ between CPCs. Modular expression profile rises to transformed FL (tFL) in cells that have acquired a particular embryonic stem cell 1 (ESC1). This model is distinct from a process of direct evolution where FL1, FL2, FL3, and tFL reflect the sequential acquisition of events from a prior episode of disease. Image taken from *Montoto and Fitzgibbon, 2011*.

III.6. Role of the BCR during FL

As stated earlier in Chapter 2, the introduction of an N-glycosylation site as a result of an error during SHM is a frequent secondary alteration that occurs during lymphomas in general. Indeed, this is the case for FL, where it has been shown that BCR N-glycosylation is, in fact, one of the most frequent genetic alterations that occur during this disease. To be more precise, 79% of FL cases carry the mutation in the IgVH region that generates the N-glycosylation sites. This mutation rate is significantly higher in FL compared to DLBCL (41%), CLL (13%), multiple myelomas (8%) or normal B (9%) (Zhu et al. 2002a).

This alteration on its own is not oncogenic per se and, conversely to DLBCL, is not associated with a constitutively active BCR signaling but is associated with an increased capacity to interact with lectin-expressing cells of the FL microenvironment (Fig. 23). Altogether, these data, that are further discussed in much more detail thereafter (see chapter 4), indicate that the microenvironment plays a key role in FL pathogenesis.

Deregulation of BCR signaling in FL has been demonstrated in various studies thus supporting the role that this receptor could play in the FL ontogeny. Several studies have demonstrated that: 1- BCR signaling in FL is more intense and longer lasting compared to normal B cells (Irish et al. 2006), 2- Syk tyrosine kinase is overexpressed in FL and the mTOR pathway is excessively activated leading to increased proliferation of FL cells (Leseux et al. 2006) and finally 3- the under-expression of phosphatase SHP-1 (a major protein for inhibiting the BCR signal and considered to be a tumor suppressor) during FL, which could be due to the hypermethylation of the promoter of its encoding gene (Chim et al. 2004, 1).

III.7. FL murine models

With a disease as complex as FL, it is virtually impossible to understand the mechanism of action of FL without reproducing it in a whole living organism to actually try to imitate the complexity of the numerous factors that aid in the development of this disease. Mice are the most commonly used model organisms in human disease research, the main reason being the 90% similarity between their immune system and ours.

With advances in recombinant DNA technologies and genetic engineering, it became feasible to create genetically modified mice carrying genetic alterations or mutations identical to those that occur in humans in a wide variety of diseases, in aims of, not only understanding the underlying mechanisms for the development of these diseases, but also of discovering novel potential therapeutical strategies for these diseases. The section below is dedicated to describing specifically the different FL murine models that have been described in the bibliography.

III.7.1. E μ -Bcl2 transgenic mouse model

E μ -Bcl2 is a transgenic mouse model that carries the human bcl-2 gene linked to the murine 5' IgH enhancer (E μ enhancer) to direct Bcl-2 expression to B lymphocytes.

Initial studies of this transgene showed that they uniformly develop atypical lymphoid hyperplasia manifesting as expanded splenic follicles that grow together into massive geographic regions of white pulp. These studies have also revealed that this transgene possesses a lymphoid pattern of expression and an expanded follicular center cell population. The expanded lymphoid compartment was shown to be composed primarily of polyclonal B220+ as well as IgM/IgD+ B cells that seemed to have an extended survival. Moreover, regional lymphadenopathy with abnormal cellular infiltrates was demonstrated in mice over 15 weeks of age. (McDonnell et al. 1989a).

Additional studies done on different strains of these mice showed that they have elevated levels of B cell counts in peripheral blood, lymph nodes, bone marrow, and spleen. It has been shown also that these mice exhibit high Bcl2 expression levels in the different subsets of the B cell population, including the Bcl2-negative counterparts (Secord, Edington, and Thorbecke 1995).

Taken together, these data show that this transgene succeeded in conferring a survival advantage for the B cells but not a strong proliferative signal, thereby resulting in an apparently immortalized, expanded population of polyclonal B cells.

The downfalls of this model would be that the advantages given were predominantly limited to mature B cells, in general, and not specifically to GC B cells, which is not really the case of FL as we have previously established. Moreover, it is well known that FL is a monoclonal disease; meaning that the t(14;18) is acquired in a single somatic cell that clonally expands later on. On the contrary, this transgene carries the Bcl2 deregulation in its germ line, hence in all of the cells, which explains why the expanded

mature B cells were polyclonal rather than monoclonal. Finally, mice developed follicular hyperplasia and, after prolonged latencies, high-grade lymphomas that were clearly not reminiscent of FL.

Therefore, even though this initial mouse model represented a significant leap in the study of FL and provided further evidence on the oncogenic effects of the t(14;18), however it was not completely relevant to the accurate study of this disease.

III.7.2. VavP-Bcl2 transgenic mouse model

This mouse model bears a Bcl2 transgene controlled by Vav gene regulatory sequences (VavP), which confer expression in multiple hemato-poietic lineages (Egle et al. 2004).

The study of this mouse model showed that mice older than 10 months developed FL. Young VavP- Bcl2 mice, however, exhibited overabundant enlarged germinal centers and greatly elevated numbers of cycling B cells that had undergone IgH class switching and V-gene hypermutation. In addition to the B cell compartment, the peripheral T cell compartment was found to be expanded in this mouse model as well (5-fold increase compared to normal). This notion suggested a potential role of T cells in the development of the enlarged germinal centers and the greatly increased pool of immunoglobulin class switched B cells observed.

While this mouse model conferred a bigger advantage compared to the previous E μ -Bcl2 model. To be more specific, the mice, after a certain amount of time, actually developed lymphomas that shared morphological features with FL. In addition, they had switched and hyper mutated B cells which are at the origin of the developed monoclonal FL. However, on the molecular level, the high expression of the Bcl2 transgene in the T cell compartment represents an artificial situation that is not found in FL and the fact that the deregulation of Bcl2 is present in all of the hematopoietic compartment is not quite relevant to FL.

III.7.3. IgH-3'E-bcl2 mouse model

This mouse model is a knock-in containing the Igh 3' enhancers (composed of four DNase I hypersensitive sites denoted HS 1234) located 3' of the Bcl2 gene (Xiang et al. 2011). Analyses of these mice revealed that they exhibit significantly increased expression levels of Bcl2 mRNA and protein, solely in B cells, which delayed their entry

and progression through the cell cycle. These mice also showed increased levels of pre-B, immature, and mature B cells, which, similarly to the previous Bcl2 mouse models, turned out to be polyclonal rather than monoclonal and had the ability to survive longer in cell culture compared to wild-type B cells. With age, these mice developed monoclonal B cell lymphomas, whose subsequent histological analyses showed that the tumors exhibit enlarged lymph nodes and spleens with extensive infiltrates of small lymphocytes having irregular nuclear outlines and hyperchromatic chromatin. The examination of the Bcl2 promoter usage by real-time PCR in these mice revealed the use of both promoters in malignant B cells with an increased activity of P2 compared to P1, which is similar but not completely relevant to human follicular lymphoma.

As a conclusion, even though this mouse model has a few advantages compared to the previously explained mouse models, it is still not accurately mimicking human FL development.

Based on everything mentioned above, it is quite clear that to this very day, there is no mouse model that has managed to accurately reproduce the complex development of FL, which makes the importance of such -model more evident to the study and the treatment of this disease.

Chapter IV. Follicular Lymphoma and the surrounding microenvironment

FL cells, on their own, are not capable of maintaining an infinite survival. The in-vitro culture studies of FL cells alone have proven the authenticity of this notion. This means that the in-vitro culture lacks certain factors or “helpers” that are found in-vivo and that seem to play a massive role in the development of the malignant B cells.

Up to this level, we have strongly established that the microenvironment plays an important role in the development of FL (Fig. 29). In other words, malignant B cells in FL seem to not only strongly rely on their interaction with the surrounding cell types, but also have the ability to modulate these cell types in their favor. This has been illustrated by the presence of numerous secondary genetic alterations in FL that seem to highlight the dysfunction that occurs in the cell-cell interactions during this disease. The best proof for this notion is the deletion of HVEM, previously explained in detail in chapter 2. This recurrent malfunction in FL provides solid evidence that the creation of a tumor-supporting microenvironment, by the extensive recruitment of stromal and helper T cells, is mandatory for the survival and the proliferation of malignant B cells. Another critical player in FL pathogenesis is the BCR. We have previously established a major role of the BCR in lymphomagenesis in general. It is the case also for FL, where the antigen-independent activation of the BCR along with positive selection of motifs for addition of glycans into the antigen-binding sites of the BCR, seem to be important pre and post-translational strategies to actively engage the microenvironment in the development of FL.

The different sections below are dedicated to explain in detail the role of each cell type within the microenvironment in supporting the survival and the development of malignant B cells during FL.

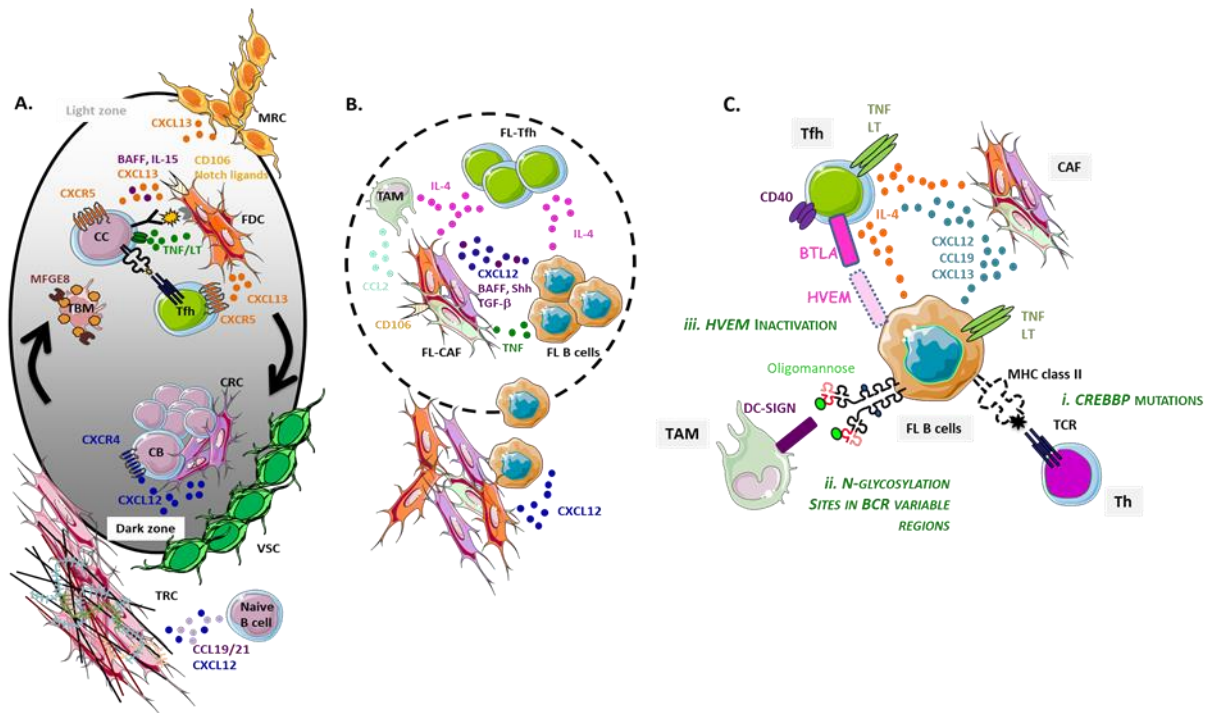

Figure 29: A model of B-cell/stromal cell interactions in normal and malignant follicles.

(A) In normal situations, the dark zone is characterized by the accumulation of CXCR4^{hi} proliferating CBs retained by CXCL12-expressing reticular cells (CRC). On the other hand, the light zone CCs exhibiting high affinity BCR interact with Tfh and FDCs which provide them with survival and differentiation signals. Low affinity CC are eliminated by tingible body macrophages (TBM). Subcapsular marginal reticular cells (MRC) also contribute to B-cell activation through delivery of antigens and as putative precursors of FDC. Versatile stromal cells (VSC) are localized at the border of B-cell follicles and are converted into CXCL13-secreting cells upon contact with activated B cells of the growing follicles. Finally, T-zone reticular cells (TRC) contribute to naïve B cell recruitment and guided trafficking outside the follicles. **(B)** In FL, FL associated fibroblasts (FL-CAF) form a heterogeneous compartment overexpressing factors involved in direct FL B-cell activation and in the recruitment or activation of other components of tumor supportive cell niche such as TAM. **(C)** Various additional mutations play a pivotal role in the interaction between malignant FL cells and the surrounding microenvironment, the most important of which is the deletion of HVEM which disrupts the inhibitory cell-cell interactions with BTLA on the surface of Tfh cells. This leads to cell autonomous activation of B cell proliferation and induces a tumor supportive microenvironment marked by the exacerbated lymphoid stroma activation and increased TFH recruitment. The presence of N-glycosylation sites in the variable BCR region is well known to increase the activation of B cells during FL upon interaction with with DC-SIGN, or bacterial lectins, thereby leading to BCR signaling and presumably enhancing tumor survival. Figure edited from *Lamaison and Tarte, 2019*.

IV.1. B-cell/T-lymphocyte interaction during FL

Irrespective of the biopsy site, studies have shown that FL cells reside and proliferate in follicular structures that are in close association with helper T cells (Th) and follicular dendritic cells (FDCs) (Carbone et al. 2009).

Flow cytometry-based studies on FL have revealed higher levels of CD4+ helper T cells compared to the CD8+ cytotoxic T cells along with higher CD4/CD8 ratios in these organs. This proves the fact that there is a vital stimulus for FL cells to increase the recruitment of CD4+ T cells while reducing that of CD8+ T cells due to their opposing roles in supporting versus killing the FL cells respectively (Wahlin et al. 2012).

Starting with CD4+ helper T cells, the pivotal role played by these cells in supporting the FL development is revealed by the fact that genes related to this subtype are prominently found in the FL prognostic signature at diagnosis. The follicular helper T cell compartment in FL (FL-Tfh) has been shown to display a specific gene expression profile mainly characterized by the overexpression of certain cytokines including IL4, IL2, IFN- γ , and TNF (P. Amé-Thomas et al. 2012). Briefly, the potential role of these Tfh cells in supporting FL growth is mainly highlighted by: 1- the action of CD40 ligand (CD40L) in inhibiting TRAIL-induced apoptosis (TRAIL being a TNF family member) in FL B cells (Travert et al. 2008, 40). 2- The expression of TNF and LTA which sustain the differentiation and maintenance of the FL B cell supportive lymphoid stroma network (Patricia Amé-Thomas et al. 2007). 3- The secretion of high amount of IFN- γ thereby affecting the action of the stromal cell population (Maby-EI Hajjami et al. 2009) and 4- The overexpression of IL-4 which then polarizes macrophages into the malignant cell niche (Gocheva et al. 2010).

In addition to Tfh cells, Tregs have been suggested to have an inhibitory role for the anti-tumor response to FL. Studies have shown that an excessive number of Foxp3+CXCR5hi follicular Treg (referred to as Tfr) has been reported in FL neoplastic follicles.

Another very important feature that highlights the modification in the T/B cell interaction that occurs in FL is that of CD8+ T cells. It is widely known that the latter are key players in the anti-tumor immunity (antigen-driven cytotoxicity), however in FL, it has been shown that a rich infiltrate of CD8+ granzyme-B+ cells is found in the interfollicular spaces. Moreover, these CD8+ cells were detected at the border of the FL follicle where they formed lytic synapse-like structures with FL B cells and with apoptotic cells (Laurent et al. 2011). Another very important observation during FL is that intratumoral Tregs inhibit in vitro degranulation and cytotoxic activity of infiltrating CD8+ T cells exposed to FL B cells.

Two other key players in anti-tumor immunity, more specifically the innate one, are natural killer cells (NK) and the $\gamma\delta$ T lymphocytes. While little is known on the NK cells, it has been shown that $\gamma\delta$ T lymphocytes predominantly have a perifollicular localization and are represented at a lower density in FL lymph node (LN) tissues, compared to reactive LN (Braza et al. 2010).

Based on everything mentioned above, it has become clear that Tfh and Treg cells seem to be strongly modulated, both quantitatively and qualitatively, during FL pathogenesis. As a conclusion, the above data not only highlight the role of various CD4+ T cell subsets in FL growth and immune escape, but also show that the antitumor immune response is actively counteracted by tumor escape mechanisms affecting immune cell recruitment and activation.

IV.2. Myeloid cells

Myeloid cells include monocytes, macrophages, neutrophils, basophils, eosinophils, erythrocytes, and megakaryocytes to platelets.

Focusing predominantly on macrophages; tumor-associated macrophages also known as TAM (see Fig. 29) have been shown to have dual roles in FL, meaning they could favor FL progression (through the release of tumor growth factors, proangiogenic molecules, and immunosuppressive mediators (described below)) as well as contributing to the clinical efficacy of antibody-based anti-lymphoma drugs.

The positive role that macrophages could play in FL progression is associated with the important role played by the BCR in this disease as well. We have already established that the majority of malignant B cells express mannosylated BCRs that have the ability to interact with c-type lectin DC-SIGN, also known as CD209, as well as mannose receptors, also known as CD206, which are also known to be upregulated in M2 macrophages and TAMs during FL. Therefore, even in the absence of an antigen, the interaction between CD209/CD206 and the mannosylated BCR leads to activation of the BCR and induction of the subsequent signaling cascade.

Immunohistochemical studies have revealed a strong relationship between malignant B cells, infiltrating macrophages and T cells. Briefly, it has been shown that FL-Tfh cells overexpress CD40L, which in turn increases the expression of IL-15 by monocytes/macrophages. The latter then trans-present IL-15 to the FL B cells thereby

promoting IL-15 dependent B cell proliferation (predominantly through the induction of STAT5, another player in the cytosolic BCR signaling pathway) (Epron et al. 2012).

Another interesting finding is that IFN- γ , also upregulated in FL microenvironment, has been shown to increase the migration and recruitment of macrophages, through an upregulation of STAT1 expression, in response to CCL2 (Hu et al. 2005). TAMs not only help FL B cells by increasing their activation and proliferation, they also seem to have a role in the escape of these malignant B cells from the local immune response, mainly by the secretion of immune suppressive molecules such as IL-41 (Carbannelle-Puscian et al. 2009). In parallel, these macrophages have been shown to have a role in angiogenesis as well, which in the case of FL, is related to poor prognosis. This was confirmed by the analysis of tissue microarrays of diagnostic biopsies from patients at the extremes of FL survival with respect to the number of formed angiogenic sprouts. The poor prognostic group revealed a higher angiogenic activity and demonstrated an association between increased sprouting and elevated numbers of infiltrating CD163+ macrophages within the immediate surrounding microenvironment of the neovascular sprout (Clear et al. 2010).

As supportive as these TAMs may appear to the progression of FL, several studies have shown that they are a highly plastic cell subset involved in antitumor immunity, in particular through Fc γ R-related antibody-dependent cellular phagocytosis (ADCP), a process actively inhibited by CD47-expressing malignant B cells. Briefly, the overexpression of certain cytokines in the FL microenvironment, predominantly IL-4 and IL-10, has the potential to modify the TAM phenotype, including expression levels of the receptors Fc γ Rs, thereby modulating their ADCP properties in the presence of certain therapeutic antibodies. Furthermore, it has been shown that FL B cells (alongside DLBCL B cells) overexpress CD47 which is a transmembrane protein that enables evasion of phagocytosis through binding to the inhibitory receptor signal regulatory protein (SIRP)- α located on macrophages (Chao et al. 2010).

IV.3. FL niche in secondary lymphoid organs

IV.3.1. Stromal cells: In secondary lymphoid organs (lymph nodes) and the Bone marrow (BM)

Over the past decade, strong focus has been dedicated to the study of the tumor microenvironment and its constituent stromal cell compartment. The contribution of the stromal cell compartment to cancer development is realized by three generic constituents: Angiogenic vascular cells (AVCs), infiltrating immune cells (IICs), and cancer-associated fibroblastic cells (CAFs).

All normal stromal cell subsets are derived from a common precursor in the BM, that is, the mesenchymal stem cell (MSC), which are multipotent stem cells capable of differentiating into several mesodermal lineages including adipocytes, chondrocytes, and osteoblasts. Even though they have been found in several other sites including adipose tissue, cartilage, and cord blood, their preferential localization remains the BM. Another common feature of these lymphoid stromal cells is that they require both the tumor necrosis factor (TNF)- α and lymphotoxin (LT)- α 1 β 2 for their maturation and maintenance as immunologically competent cells.

Focusing exclusively on FL, the CAFs have been shown to be different from their normal counterpart, both phenotypically and functionally, and to play a pivotal role in FL development and progression. As it is the case for normal secondary lymphoid organs, it has been shown that the lymph node (LN) and bone marrow (BM) CAF cell compartment in FL is heterogeneous and organized into three specialized cell niches (Patricia Amé-Thomas and Tarte 2014):

- 1- The fibroblastic reticular cells (FRC) forming the mesenchymal stromal network of the T-cell zone whose main role is to provide a foothold for antigen delivery, immune cell recruitment, motility, interaction, and homeostasis by releasing extracellular matrix components (including IL-7, VEGF, nitric oxide, and homeostatic chemokines such as CCL19, CCL21 and CXCL12).
- 2- The follicular dendritic cells (FDC) whose role is to attract, via CXCL13, B and Tfh cells into the GC where they promote the selection of high affinity B cells through the retention and presentation of antigens as immune complexes.

3- The marginal reticular cells (MRC) whose role is to deliver small antigens to cognate B cells.

The suggested mechanism of action for the involvement of these stromal cells in the development of FL is through the secretion of CXCL12 and CXCL13. Production of CXCL12 by FRCs has been shown to play a pivotal role in the recruitment of malignant GC B cells. CXCR4 blockade for example completely abrogated the migration of these cells towards BM MSCs (Patricia Amé-Thomas et al. 2007). Moreover, CCL2 has been described as a potent FL cell chemoattractant only in combination with CXCL12 (Husson et al. 2001) and high levels of CCL2 mRNA was detected in both LN- and BM-derived stromal cells (Patricia Amé-Thomas et al. 2007). In parallel, the production of CXCL13 by FDCs has been shown to synergistically direct the accumulation of CXCR4+CXCR5+ FL cells. Stromal cells have also been shown to produce paracrine supportive factors such as Hedgehog (Hh) ligands, B cell-activating factor of the TNF family (BAFF), IL-15, hepatocyte growth factor (HGF), and the adhesion molecule CD106. These factors have all been proposed to contribute to the anti-apoptotic effect of stromal cells on normal and malignant GC B cells (Patricia Amé-Thomas and Tarte 2014). In addition, the interaction of malignant B cells and FDCs was recently suggested to upregulate MDR1, an ABC transporter which triggers multidrug resistance in FL B cells (Yagi et al. 2013).

It is worthy to note at this point that the BM is one organ that has been found to be involved in up to 70% of FL cases at diagnosis. Comparisons of cultures between MSCs obtained from healthy donor BM (HD-MSC) and those obtained from invaded FL BM (FL-MSC) revealed that the latter support more efficiently the growth of malignant B cells (Guilloton et al. 2012).

This is further validated with the emergence of ectopic LN-like reticular (FRC-like) cells admixed with malignant B cells among nodular aggregates. These LN-like reticular cells revealed a heterogeneous phenotype where a few of them were shown to express the FDC-associated markers CD21 and CD35. This suggests that the interactions between FL cells and the medullar stromal cell compartment favor lymphoma development, meaning that the BM provides a preferred stromal microenvironment for FL cell growth. In agreement, in response to TNF- α and LT- α 1 β 2 priming, the FRC-like cells obtained from HD-MSC have been shown to be more powerful in driving

malignant B-cell survival compared to HD-MSc themselves (Patricia Amé-Thomas et al. 2007).

As a conclusion, the above information supports the hypothesis that MSCs in the BM could also be involved in the development of FL alongside FRCs, FDCs and MRCs in the secondary lymphoid organs.

Thesis Objectives

Broadly speaking, the main objective of my thesis was to study the complex development of Follicular lymphoma, which is the most common type of non-Hodgkin's lymphoma. Our work was primarily focused on the early stage of FL development in order to not only have a better understanding of the way this indolent disease develops, but also to try to identify new therapeutic strategies for the treatment.

Starting from the fact that a complex disease as FL would be virtually impossible to study without the help of living organisms, our work was focused on the analysis of several genetically modified mouse models, all carrying alterations or mutations which have been shown to be involved in the development of FL in the literature.

The pattern by which our project evolved was rather a sequential process, where we started with the analysis of the most general mouse models carrying a single mutation which is considered the hallmark for the development of FL, i.e. deregulation of the anti-apoptotic protein *BCL2* (mimicking the *BCL2* deregulation that occurs in FL human patients after the translocation $t(14;18)$). Two new mouse models were developed in our laboratory, named $Ig\kappa$ -*BCL2* and 3'RR-*BCL2*. The main objective was to monitor the development of tumors naturally in these mouse models, while also mimicking the entries and re-entries of B cells into the GC (a characteristic feature of FL), via iterative immunizations, to try to characterize the early stage of oligoclonal proliferation in both of these mouse models to see which is more relevant for the study of FL. Following that, we moved to studying other mouse models, bearing additional mutations that were famously known to occur in FL. First, we began by analyzing the effect of BCR N-glycosylation on B cell development. For that we used a mouse model, named Kappa-MOUSS, carrying a pre-rearranged N-glycosylated $Ig\kappa$ chain. The presence of N-glycosylation sites in the variable region of the BCR is a well-established event that occurs almost constantly in FL, so our goal was to really examine the effect of this N-glycosylation on B cell development and to see whether this modification has a cumulative effect along with *BCL2* deregulation or not. After that, our goal was to really mimic the involvement of the surrounding microenvironment in the complex development of FL. For that we chose to cross our mice carrying the *BCL2* deregulation with two additional mouse models carrying mutations in two proteins called *KMT2D* or *MLL4*, which is mutated in 90% of FL cases, and *HVEM*, Herpes Virus Entry Mediator,

also referred to as TNFRSF14, also frequently mutated during FL (in up to 40% of the cases). Both of these strains were crossed with AID-CreERT2/LSL-Tomato mice to induce the secondary hit in GC B cells. Again, our main objective was to carefully analyze and characterize the early stage of FL development to have a better understanding of how this complex disease progresses over time.

Results

Article 1: Diverse B-cell specific transcriptional contexts of the BCL2 oncogene in mouse models impacts pre-malignant development.

As explained earlier in the introduction, none of the previously created models in the literature succeeded in carefully recapitulating the development of FL. For that reason, two new models were created in our laboratory, both reproducing the deregulation of the anti-apoptotic BCL2 protein that occurs in FL. The first is a knock-in of the human *BCL2* in the Ig κ light chain locus named Ig κ -*BCL2*. The second is a transgene placing *BCL2* under the control of the super-enhancer IgH 3'RR named 3'RR-*BCL2*.

We were able to show, via the detailed analyses of these two mice models, that, indeed, the deregulation of BCL2, alone, was not sufficient for the development of FL. On their own, the mice developed plasma cell tumors at a very late stage which were rather polyclonal. It was evident, though, that we were indeed on the right path in our study, because the comparison of early oligoclonal proliferation (by performing iterative intra-peritoneal immunizations) through FACS analyses in both of our mouse models, confirmed that there is an initial increase of the germinal center B and T cell populations, more significant in the 3'RR-*BCL2* model compared to the Ig κ -*BCL2* one. We were also able to prove that the enlargement of this GC B cell population is indeed due to an increased differentiation in both models but more significantly in the 3'RR-*BCL2* model. This was not the case, however, for the plasma cell population, whose increased number (more significantly in the Ig κ -*BCL2* mouse model) is due to cells living longer rather than cells being newly differentiated. In parallel, we were also able to show that both of our mouse models are capable of mounting a specific and efficient immune response by producing antibodies with high affinity against a specific antigen. These data allowed us to conclude also that the transgenic 3'RR-*BCL2* mouse model is the more relevant model for the study of FL.

One remarkable feature of both our mice, which had never been done before, was the fact that both of them contained the full promoter region of *BCL2*. This region was of specific importance to our work and to the study of FL in general, due to its characteristic structure comprised of two distinct promoters named P1 and P2. Such

construction allowed us to dive deeper into the analysis of this region in specific, to try to unravel the reason behind the shift from the usage of P1 to the usage of P2 in FL. Sequencing of this region revealed that B cells in the secondary lymphoid organs of iteratively immunized mice (i.e. B cells that had undergone several rounds of GC reactions) indeed have a higher mutation rate. This was also validated in human lymphoma cell lines where mutations at the *BCL2* promoter region were detected at 50%. The analysis of primary transcripts of P1 and P2 promoters in our mice showed a higher P2/P1 ratio in both of our mouse models compared to wild-type. This was established even more by comparing class-switched versus non-class switched B cells in both of our models as well, where we showed that indeed the ratio of P2/P1 is higher in B cells that have undergone the GC reaction compared to those that have not. All together these data showed that the shift from P1 to P2 during FL is most probably due to mutations at the level of the P1 promoter.

Diverse B-cell specific transcriptional contexts of the BCL2 oncogene in mouse models impacts pre-malignant development

Lina Zawil¹, Tiffany Marchiol¹, Baptiste Brauge², Alexis Saint-Amand¹, Claire Carrion¹, Elise Dessauge², Christelle Oblet¹, Sandrine Le Noir¹, Frédéric Mourcin², Florence Jouan², Paco Derouault³, Mehdi Alizadeh², Mylène Brousse¹, Yolla Makhour⁴, Céline Monvoisin², Simon Léonard^{2,5}, Stéphanie Durand-Panteix¹, Karin Tarte^{2*}, Michel Cogné^{1,2*}

¹ Limoges University, CNRS UMR 7276, INSERM U1262, 2 rue du Dr Marcland, Limoges, France.

² Rennes1 University, INSERM U 1236, EFS, Rennes, France

³ CHU Dupuytren, Limoges, France

⁴ Lebanese University, Beirut, Lebanon

⁵ LabEx IGO “Immunotherapy, Graft, Oncology”, Nantes, France

Correspondance : michel.cogne@inserm.fr & karin.tarte@univ-rennes1.fr

Abstract:

Follicular lymphoma (FL) is the most common indolent form of non-Hodgkin lymphoma arising from malignant germinal center (GC) B-cells. The genetic hallmark that leads to the development of FL is the t(14:18) which occurs early in the bone marrow during B cell development, thereby placing the anti-apoptotic *BCL2* gene under the direct control of the transcriptional enhancers in 3' of immunoglobulin heavy chain locus (IgH 3'RR) and leading to the constitutive expression of the BCL2 protein. To assess the impact of the BCL2 deregulation on B-cell fate and try to reproduce FL development in mice, two models were designed: the Igk-BCL2 (Knock in of the BCL2 in the light chain Ig kappa locus) and the BCL2-3'RR (Transgene containing BCL2 and a micro-3'RR), both containing the full BCL2 promoter region.

Introduction

Follicular lymphoma (FL) is the most frequent indolent non-Hodgkin's lymphoma (NHL), representing about 25% of B-cell malignancies (Milpied et al. 2021). This germinal center (GC) B-cell malignancy results from the malignant and clonal accumulation of centrocytes and follows a multistep lymphomagenesis process evolving over decades before clinical manifestations. After a long premalignant phase, the clinical course is slow and associates with multiple relapses associated with increasing resistant to therapy. Over time, approximately 30% of FL cases transform into aggressive diffuse large B-cell lymphoma (DLBCL).

The FL genetic hallmark is the translocation t(14; 18) (q32, q21) found in 90% of FL cases and deregulating the anti-apoptotic factor BCL2 under the control of immunoglobulin (Ig) heavy chain promoter. A translocation less frequent in FL, t(3;14), involves BCL6 such, hereby indirectly deregulating BCL2 (Ruminy et al. 2006). Contrasting to MYC in Burkitt lymphoma, for which variant translocations onto Ig light chain loci are common, *BCL2* t(2;18) and t(18;22) translocations are rare in FL but found in 9% of chronic lymphocytic leukemia cases (Hillion et al. 1991; Lin et al. 2008). Beside translocations, chromosomal amplification of *BCL2* is also observed in DLBCL and in mantle cell lymphoma (Monni et al. 1997). The precise pattern of BCL2 deregulated expression is thus likely impacting the phenotype of *BCL2*-driven lymphoproliferative disorders. The t(14;18) translocation stands as an aberrant V(D)J recombination product, joining double-strand breaks (DSBs) induced by RAG both in the IgH JH region (at position 14q32) and close to *BCL2* oncogene (at position 18q21) and hereby imposing an IgH-like pattern on *BCL2* gene accessibility and transcription (Raghavan et al. 2004). The *BCL2* gene encodes a transmembrane mitochondrial protein with dual roles, both inhibiting apoptosis and cell cycle entry. In mature B cells, expression of the IgH-translocated *BCL2* is mostly under the control of the IgH transcriptional enhancers located at the 3' end of the IgH locus, which are the main IgH locus drivers at mature stages (Pinaud et al. 2011). These enhancers notably

ensure accessibility of the locus to class switch recombination (CSR), somatic hypermutation (SHM) and hyper-transcription in activated B cells or plasma cells (Cogné et al. 1994; Rouaud et al. 2013; Saintamand et al. 2015; Pinaud et al. 2011). The functional result of this translocation is the imbalance between cell survival and death at a stage where mature B cells are intensely exposed to affinity-based selection within the GC. Normal GC B cells are indeed prone to undergo cell death unless they are positively selected and induced to enter the memory B cell or the plasma cell compartments. (Mayer et al. 2017; Péron et al. 2012). *BCL2* is normally repressed in the GC while apoptosis is promoted by proteins such as Bak, Bax and Bad. *BCL2* deregulation yielded by t(14; 18) thus jeopardizes the GC B cell survival checkpoint and *BCL2* translocation stands as a driver genetic event initiating lymphomagenesis in FL.

Among naive B cells having left the BM and circulating in the periphery, those harboring the t(14;18) translocation display a selective advantage during the GC reaction allowing them to persist as atypical memory B cells already carrying some features of FL cells and considered as FL precursor cells. These premalignant cells are prone to re-enter the GC upon future Ag encounter, undergoing additional SHM and eventual additional oncogenic hits under the iterative exposure to AID activity (Milpied, Nadel, and Roulland 2015; Tellier et al. 2014; Huet, Sujobert, and Salles 2018). Although an early and crucial anomaly, the t(14;18) by itself is not sufficient for FL development since the prevalence of FL does not exceed 0.03%. Among the most frequent additional hits, alterations of histone/chromatin modifying enzymes, including KMT2D, and CREBBP, are collectively found in almost 100% of FL cases whereas mutations of HVEM/TNFRSF14 or introduction of N-glycosylation sites within Ig variable regions have been shown to affect the crosstalk between tumor B cells and their surrounding microenvironment (Boice et al. 2016; Amin et al. 2015; Huet, Sujobert, and Salles 2018).

Exploring the mechanisms of such a complex disease requires to study whole living organisms and has prompted the generation of several models in mice. Initial transgenic mouse models expressing *BCL2* driven by the E μ enhancer have mostly resulted in polyclonal expansion of all B-cell compartments overexpressing *BCL2*, from progenitors to plasma cells (McDonnell et al. 1989; Strasser et al. 1991). Lymphoma development was reported mostly when the *BCL2* deregulation was associated with other spontaneously selected or experimentally enforced genetic anomalies, notably involving *Myc* (Strasser et al. 1990; McDonnell and Korsmeyer 1991). However, lymphoproliferation observed in such conditions rather involved immature B cells and did not represent models for post-GC low-grade human lymphoma. Strikingly, the most widely used transgenic mice considered as a pertinent model of human FL and based on the tumorigenic potential of *BCL2* have been the *vavP-BCL2* transgenics, although they broadly overexpress *BCL2* in all hematopoietic lineages, including T-cells and thus cannot recapitulate the natural story of human FL where *BCL2* overexpression is strictly restricted to mature B cells (Ogilvy et al. 1999; Egle et al. 2004).

Therefore, in an aim to better understand the complex development of FL and the impact of *BCL2* deregulation, our current study explores two new mouse models, designed either for pan-B cell expression through a knock-in of *BCL2* in the Ig κ locus, or for a specific targeting of activated B-cells with a *BCL2* transgene driven by the IgH 3'RR enhancers. Since these elements are major drivers of Ig gene remodeling in the GC, the latter model is expected to more specifically mimic the *BCL2* deregulation associated with FL. The *BCL2* promoter region has a characteristic structure comprising the P1 and P2 promoters, with P1 dominating in healthy lymphocytes, while a shift from P1 to P2 is observed in FL. Contrary to previous *BCL2* transgenes in the literature, the full human *BCL2* promoter region was thus included in our *BCL2* gene cassettes. Indeed, this region includes transcription factor-binding sites, notably for the repressor BCL6, that limits *BCL2* expression in normal GC cells (Saito et al. 2009). The design of our constructs should thus allow to reproduce in mice the deregulation or the mutations of the *BCL2* promoter region documented in patients. On their own, both models develop B-cell expansion which differed in terms of stage-specificity according to the context of *BCL2* deregulation, 3'RR-*BCL2* mice showing the most "GC-restricted" phenotype. These models are pertinent for studying a pre-FL stage in young mice, notably showing the impact of GC B-cell expansion on the TFH counterparts. In the absence of other genetic abnormality, neither of these models however develop FL-like lymphoma at late ages, but rather plasma cell tumors with mutated Ig genes corresponding to post-GC cells.

Materials and methods:

1- Cell lines and mouse models:

DoHH2, SU-DHL-4, SU-DHL-6 and OCI-Ly3 cell lines (Germinal center or activated B cell type Diffuse large B cell lymphoma (DLBCL)) were grown in RPMI 1640 medium supplemented with 10% Fetal calf serum (Dominique Dutscher, Catalog number: S1810-500) at 37°C with 5% CO₂ atmosphere).

All in vivo experiments were performed in accordance with animal ethical rules, and all protocols were authorized by the French Ministry of Research according to European Union regulations (APAFiS 13900). All mice were bred in a specific and opportunistic free (SOPF) animal facility.

Two new mouse models were designed for this study (Fig 1A):

- 1- The "3'RR-*BCL2*" model, with random integration of a transgene which contains a human *BCL2* gene cassette driven by the *BCL2* P1/P2 promoter region, under the control of 3' IgH superenhancer (a "micro IgH 3'RR" combining the various enhancer elements from the Ig heavy chain locus 3' regulatory region)
- 2- The "Ig κ -*BCL2*" model which is a deletion (Δ) of the J κ region, replaced with the same *BCL2* cassette [P1/P2 promoter *BCL2* gene] described above, thus as a knock-in in the mouse Ig κ light chain locus, immediately upstream of the E κ enhancer.

Both of our models thus contain the full promoter region of *BCL2*, including its two alternative promoters P1 and P2, all in a mixed B6;129S genetic background.

2- Flow cytometry analysis of lymphoid compartment:

Single cell suspensions from the Bone marrow (BM), and secondary lymphoid organs (spleen and mesenteric lymph nodes) were taken from mice that were either resting or immunized with 3 iterative monthly SRBC injections. These cell suspensions were then labelled using various extracellular antibodies designed to see the different early and late B cell populations as well as the different T cell populations in each of the organs mentioned above. Following the extracellular staining step, cells were fixed and permeabilized using the eBioscience FXP3/transcription staining buffer set (Invitrogen, Reference: 00-5523-00) and then stained for the intracellular proteins (highlighted in grey in Supplementary Table1). The detailed list of antibodies used in each of these panels is summarized in Supplementary Table 1. Cells were then analyzed by flow cytometry using an LSR FORTRESSA cytometer (Beckton Dickinson) and data analysis was done using the <Flow Logic> system (the precise gating strategies for the different panels are listed in supplementary data 2 to 4).

Percentages were determined (for the different B cell sub-populations among CD19+ cells and for the different T cell sub-populations among CD4+ cells) as well as absolute cell numbers only in immunized mice (calculated based on the measured cell counts and lymphocyte percentages in organ analyzed).

The mice used for evaluating lymphoid compartments represented 2 cohorts:

- 1- Resting cohort: this cohort comprised of 6 wildtype, 13 hemizygous *Igκ-BCL2* $\Delta/+$ (*Igκ-BCL2* $\Delta/+$) and 7 *3'RR-BCL2* mice were analyzed to carry out full characterizations of our mice at the resting state.
- 2- Iteratively immunized cohort: 3 groups of 13 wildtype, 7 *Igκ-BCL2* $\Delta/+$ and 10 *3'RR-BCL2* mice were immunized with the following protocol: at 3 months of age, mice were immunized intra-peritoneally with 200 μ l of Sheep Red Blood Cells (SRBC) iteratively over 3 consecutive months and were sacrificed one month after the third immunization.

3- Western Blots:

For detection of human BCL2, we used a cohort of 2 wildtype mice (as a negative control), 2 *3'RR-BCL2*, 2 homozygous *Igκ-BCL2* (*Igκ-BCL2* Δ/Δ), 2 hemizygous *Igκ-BCL2* (*Igκ-BCL2* $\Delta/+$) and 1 DoHH2 cell line (as a positive control).

10 μ g of total proteins were extracted (using 2X Laemmli buffer, Biorad, Catalog number # 161-0737, Composition: 65.8 mM Tris-HCl PH 6.8, 26.3% (w/v) glycerol, 2.1% SDS, 0.01% bromophenol blue) and denatured / reduced using β -mercaptoethanol (2.5% final) at 95 °c for 5 mins.

After electrophoresis on a 12% polyacrylamide gel (Biorad), proteins were transferred onto PVDF membranes (GE Healthcare). The human BCL2 protein was detected using the same mouse anti-human BCL2 antibody we use for flow cytometry followed by an HRP-linked anti-mouse Ig antibody (eBioscience, #18-8817-30).

Actin was used as a housekeeping protein (Rabbit anti-Actin antibody (Sigma-Aldrich A2066) followed by Goat anti-Rabbit-HRP (Southern Biotech 4050-05)). Membranes were developed by enhanced chemiluminescence for high sensitivity detection system according to the manufacturer's instructions (Biorad).

4- Proliferation Test:

A separate cohort of 6 wildtype, 5 3'RR-*BCL2* and 4 Igκ-*BCL2* Δ/+ mice were injected intraperitoneally with 200 μl of SRBC at day 0, followed by another intraperitoneal injection with 200 μl of 5-ethynyl-2'-deoxyuridine (EdU) at Day 6 and their sacrifice at day 7.

Single cell suspensions were taken from the bone marrow, spleen and mesenteric lymph nodes and stained using the same panel described above but modified to be able to see the EDU+ cells. This was done following the "Click-iT EdU Flow Cytometry Assay Kit protocol" (Molecular probes by Life technologies, catalog numbers C10419, C10420). Cells were then analyzed by flow cytometry using the BD LSR FORTRESSA and data analysis was done using the <Flow Logic> system.

5- Quantification of Antibody affinity:

We followed the indirect enzyme-linked immunosorbent assay (ELISA) described by Zhang et al. to quantify the affinity of the produced antibodies (Notably IgG) in both of our mouse models compared to wildtype.

Mice were injected with Ovalbumin at 1ng/ml and Addavax (equal volume for both) at Day 0 and Day 14. Sera was taken at different time points to follow up the secretion of IgM and IgG (Day 0, 7, 14, 21 and 28). Only sera of day 28 were eventually studied. Quantification of total IgG in the serum was first done followed by the ELISA based affinity study.

96- well plates were coated with Ovalbumin at 2 μg/ml. In parallel, sera of Day 28 for each mouse model (at a fixed concentration of 5×10^{-10} M for IgG) was incubated overnight with Ovalbumin at different concentrations but always in large excess compared to IgG (4×10^{-7} to 6.25×10^{-9} M). The next day, the mix of serum IgG / Ovalbumin was incubated with the plate previously coated with Ovalbumin. Then, the alkaline phosphatase conjugated secondary antibody (anti-Mouse IgG) was added. After 45 minutes of incubation, P- Nitrophenyl phosphate (1 mg/ml) was added and alkaline-phosphatase activity was blocked with 3M Sodium hydroxide

(NaOH) and the optical density was measured at 405 nm using a Multiskan FC photometer.

Finally, the dissociation constant (K_D) was evaluated by measuring the slope of the linear dependence $A_0 / (A_0 - A)$ upon $1/a_0$ (Zhang et al. 2012).

6- Next-generation sequencing for repertoire analysis:

We performed repertoire sequencing analysis on RNA (500ng - 1.5mg) extracted from:

- 1- Primary cell suspensions of tumoral tissue, spleen and mesenteric LNs of 5 Ig κ -*BCL2* Δ/Δ tumoral mice, 3 Ig κ -*BCL2* $\Delta/+$ tumoral mice and only one 3'RR-*BCL2* tumoral mouse
- 2- Primary cell suspensions of bone marrow, spleen and mesenteric LNs of 5 Ig κ -*BCL2* $\Delta/+$ mice, 5 3'RR-*BCL2* mice and 9 wildtype mice from the iteratively immunized cohort.

Sequencing was done using the strategy described by Li et al. developed for T-cell repertoire diversity and clonotype. These experiments used a new generation methodology, which combines 5' RACE PCR; sequencing; and, for analysis, the international ImMunoGeneTics information system (IMGT), IMGT/HighV-QUEST Web portal, and IMGT-ONTOLOGY concepts. Briefly, we amplified transcripts with 5' RACE PCR using a reverse primer hybridizing within the Mu (μ) and gamma (γ). Sequencing adapter sequences was thus added by primer extension, and resulting amplicons were sequenced on a GS FLX 1 Sequencing system (Roche, Pleasanton, CA). Repertoire was done using IMGT/High-V-Quest and associated RStudio package scripts; associated tools are available on the IMGT Web site.

7- Single cell sequencing and analysis

Three sets of 10-day splenic B cells were magnetically sorted (StemCell B cell negative selection kit) from mice immunized once with SRBC. Single cells were captured and barcoded using the 10X 3' sequencing kit (Chromium Next Gem Single cell 3' reagent kit v3.1, 10X Genomics), and libraries were prepared following the manufacturer's instruction. Libraries were run using 2x75 paired end reads on the HiSeq4000 Illumina sequencer. Raw data were successively processed and analyzed with the 10X Cell Ranger (10XGenomics) and Seurat (v3.2.3) package (Stuart et al. 2019). Mean reads per cell was 40,766 for the WT sample, 66,971 for the *BCL2*-3'RR sample and 102,596 for the Ig κ -*BCL2* sample. Median genes per cell over 3 samples varied from 1767 to 1869. Cells expressing less than 800 or more than 4500 genes or with more than 20000 umi counts were filtered out. Cells with the frequency of mitochondrial genes more than 8% or with the frequency of ribosome genes less than 10% were also removed from the analysis. Contaminating T-cells and myeloid cells were detected based on canonical markers (Cd3 genes and C1q genes) and filtered out. Gene counts were normalized using the SCTransform package (v0.3.1) with a second non-regularized linear regression applied to percentage of mitochondrial and ribosomal genes (Hafemeister and

Satija 2019) . Canonical correlation analysis was used to integrate data from different batches by running the following steps as implemented in Seurat package (Butler et al. 2018): Selection of integration features; Removal of immunoglobulin genes from the features used for integration; Preparation for integration with the PrepSCTIntegration function. Data integration was then performed using the FindIntegrationAnchors and IntegrateData functions based on the first 30 correlation components. PCA analysis was performed on the integrated dataset and the first 12 principal components were used for UMAP computation and clustering (using 30 nearest neighbors and a resolution of 0.2). Cluster 1 was subclustered by executing the same steps previously described (PCA analysis on the subset and clustering computation with the first 10 principal components, 15 nearest neighbors and a resolution of 0.2). Using lognormalized expression values, marker genes for each cluster as well as differentially expressed genes between conditions were inferred by the Wilcoxon test as implemented in the FindAllMarkers function. Cell cycle score and classification were calculated by CellCycleScoring function based on the expression of G2/M and S phase markers (Kowalczyk et al. 2015).

8- Tumor Follow up:

A cohort of 12 $Ig\kappa$ -*BCL2* Δ/Δ , 7 $Ig\kappa$ -*BCL2* $\Delta/+$ and 8 3'RR-*BCL2* mice were monitored for the spontaneous development of tumors with time.

9- Study of BCL2 promoter mutations:

For this study, DNA was extracted following the classical phenol/chloroform protocol from:

- 1- The various cell lines listed in section 1 (DoHH2, SU-DHL-4, SU-DHL-6 and OCI-Ly3).
- 2- From our iteratively immunized cohort: total spleens of 4 $Ig\kappa$ -*BCL2* $\Delta/+$ and 4 3'RR-*BCL2* mice.
- 3- Class switched versus non- class switched B cells of a new cohort comprised of:
3 young (3 months old) $Ig\kappa$ -*BCL2* $\Delta/+$ and 3 3'RR-*BCL2* mice.
These mice were induced only once with SRBC and sacrificed at day7. Single cell suspensions from the spleen were stained with CD19 coupled to BV510 (BD Biosciences, Clone: 1D3) and IgM coupled to FITC (Southern Biotech, Cat number: 1020-02) antibodies. Cells were then sorted using the BD Aria III cell sorter to obtain class switched B cells ($CD19^+/IgM^-$) and non-class switched B cells ($CD19^+/IgM^+$).
- 4- From our tumoral cohort:
 - Tumoral tissues of 3 $Ig\kappa$ -*BCL2* $\Delta/+$ mice
 - Mesenteric LNs of one $Ig\kappa$ -*BCL2*, used as positive controls $\Delta/+$ and one 3'RR-*BCL2* tumoral mice

- Total spleen of two 3'RR-*BCL2* tumoral mice

The full promoter region of *BCL2* was then amplified by polymerase chain reaction (PCR) using specific forward (having the sequence 5' TGAATGAACCGTGTGACGTTACGC 3') and reverse (having the sequence 5' CTCAGCCCAGACTCACATCA 3') primers. The amplification of the PCR product (2,184 bp long) is verified by gel electrophoresis using agarose 2% gel in TBE. The amplified PCR product is then purified from gel using the "Nucleospin Gel and PCR Clean-up" kit (Macherey-Nagel, Reference: 740609.250).

Next-generation sequencing was performed according to the user guide of the Ion Xpress Plus gDNA Fragment Library Preparation (Life Technologies catalog no. 4471269;) from amplified products (1 µg), and libraries were sequenced on an Ion Proton System.

Two negative controls are mandatory for each library run. In this study, we our negative controls comprised of genomic DNA samples extracted from the tails of an Igκ-*BCL2* Δ/+ and a 3'RR-*BCL2* mouse respectively. Analysis was done using Deminer software developed by our laboratory in order to subtract the background level of mutations observed on the same sequence in a control experiment (Martin et al. 2018).

Results

Generation of mice carrying B-cell specific *BCL2* deregulation

Mice hemizygous for any of our 2 *BCL2* transgenic models were studied and produced high amounts of human BCL2 of normal size in B-lineage specific manner (Fig 1A-D). Both revealed overexpression of the human BCL2 protein in spleen follicular and GC B cells with a stronger BCL2 expression in the Igκ-*BCL2* than in the 3'RR-*BCL2* mice (Fig 1D). In addition, BCL2 expression patterns along B cell differentiation stages strongly differed (Fig 1D). The Igκ-locus driven deregulation consisted in very high and stable BCL2 overexpression throughout B-cell differentiation in the bone marrow from B cell progenitors to recirculating mature B cells, plasmablasts having migrated to the bone marrow and plasma cells. This architecture of the transgene also yielded a constitutively high expression in peripheral spleen and lymph node lymphoid tissues, homogeneously affecting all B-cell compartments, but strongly culminating in plasmablasts.

In striking contrast, the IgH 3'RR-*BCL2* drove low BCL2 expression in bone marrow B cell progenitors and plasma cells. In spleen and lymph nodes, it provided the highest expression in GC B cells, either centrocytes or centroblasts, with expression remaining high in plasmablasts but rapidly falling down in plasma cells.

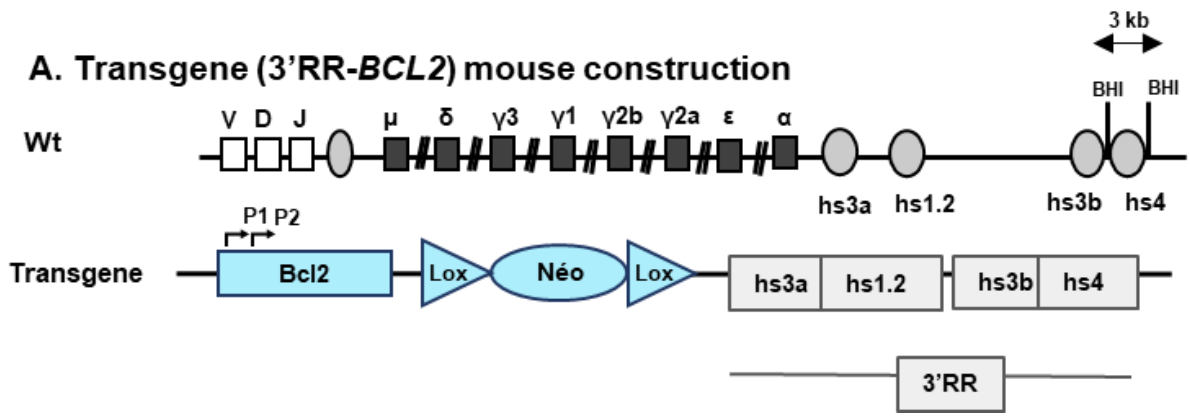

B. Knock-in (*Igκ-BCL2*) mouse construction

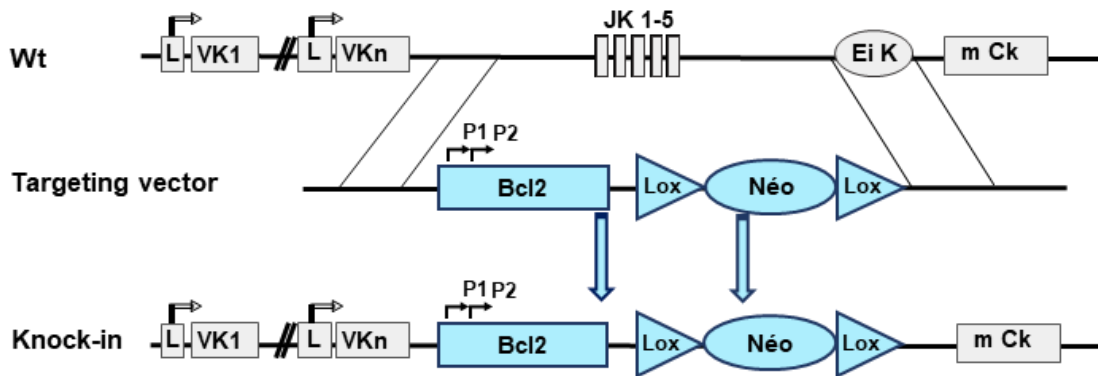

C. *BCL2* expression by Western blot

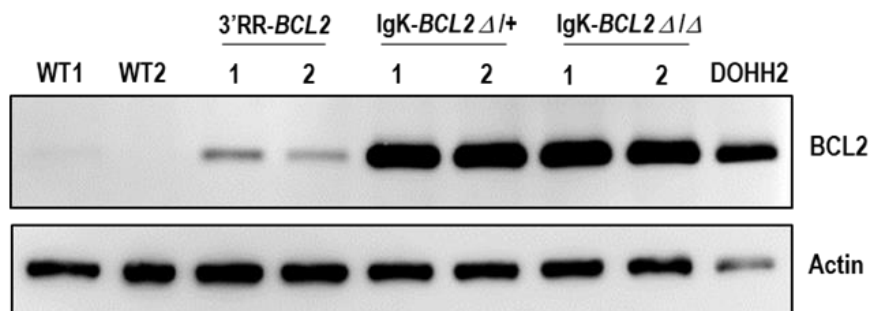

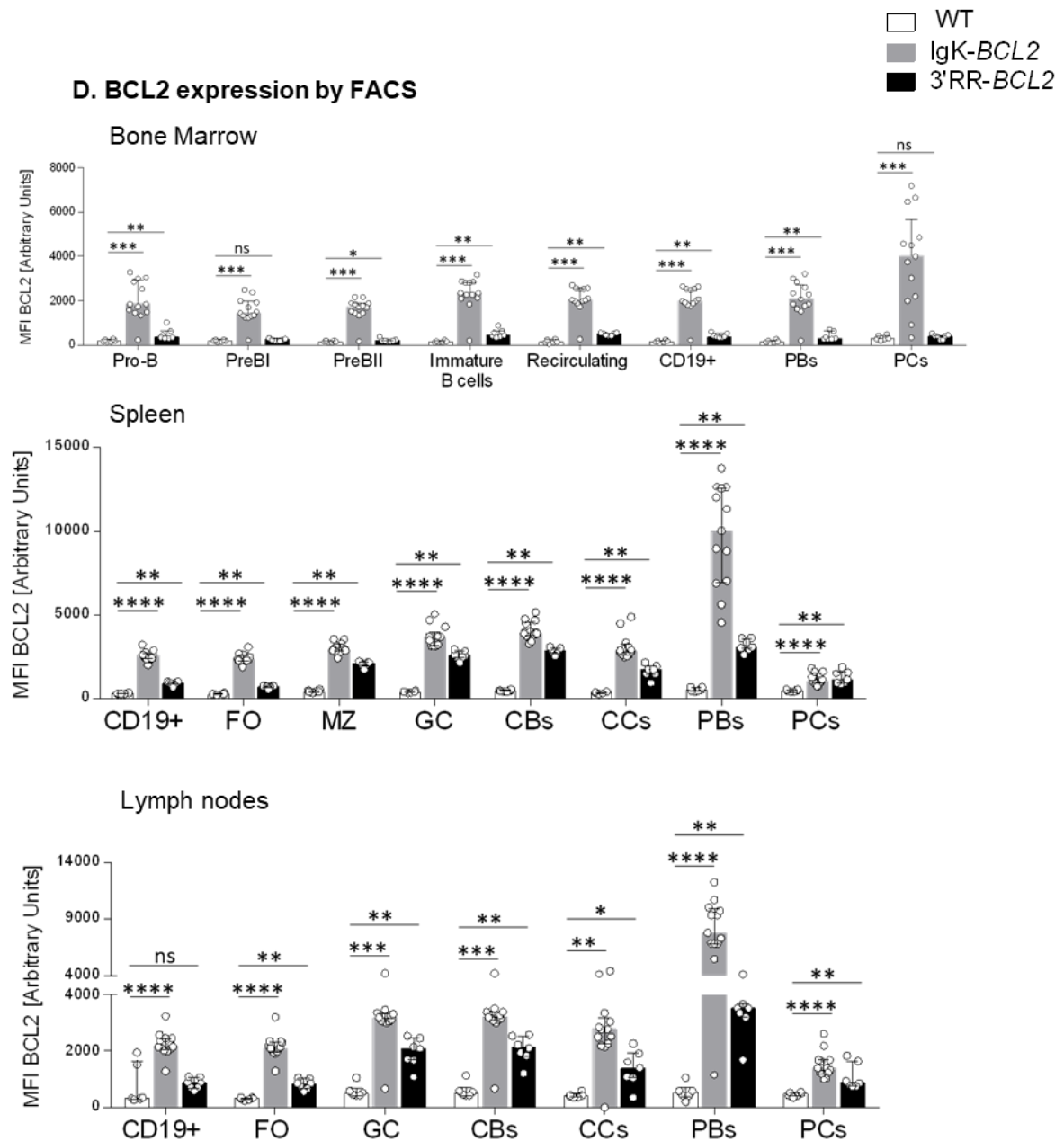

Figure 1: Mouse model construction schematics for (A) 3'RR-BCL2 transgenics and (B) Igκ-BCL2 knock-in mice. (C) Western-blot evaluation of human BCL2 protein expression in the spleen of WT (negative control), 3'RR-BCL2, Igκ-BCL2 Δ/+, Igκ-BCL2 Δ/Δ mice, and in the DoHH2 human cell line (positive control)

Impact of BCL2 deregulation on B and T cell differentiation.

We analyzed early B cell compartments by flow cytometry in non-immunized mice bred in an SOPF facility, comparing mutant mice to wildtype controls. Prior to any immunization, the percentage of bone marrow CD19+ cells was similar to that in WT controls and showed no amplification of any progenitor compartment, even with rather decreased percentages of pro-B and pre-B cells in Igκ-BCL2 mice (**Fig 2A**). By contrast, bone marrow plasmablasts and PCs were constitutively increased in the Igκ-BCL2 mice.

In the periphery of resting unimmunized Ig κ -*BCL2* mice, CD19⁺ cells were globally more abundant than in WT controls in both lymph nodes and spleen, while 3'RR-*BCL2* mice inconstantly showed such an increase. The difference between both strains was still more striking for plasmablasts and plasma cells, which were in normal amount in 3'RR-*BCL2* mice while increased in number by up to ten-fold in Ig κ -*BCL2* (**Fig 2B and 2C**). By contrast, marginal zone (MZ) cells were decreased in Ig κ -*BCL2* mice. The ratio of CD93⁺CD138⁺ vs CD93⁻CD138⁺ plasmablasts was rather increased in both strains, significantly in lymph nodes, suggesting increased amount of recently differentiating plasmablasts (Chevrier et al. 2009). In PCs, for which CD93 expression marks long-lived PCs having arisen from T-dependent responses, there was a tendency to an increased ratio of such cells in the BCL2-3'RR mice, but not reaching significance (Chevrier et al. 2009).

Regarding the GC B-cell compartments in spleen and lymph nodes (corresponding to background GCs in non-immunized mice), both strains showed a constitutive increase of both centroblasts and centrocytes and an increased ratio of centroblasts vs centrocytes.

Relatively to expanded B cell populations, the percentage of helper T cells appeared significant decreased in the periphery of Ig κ -*BCL2* mice only (**Fig 2D**), with a tendency for both BCL2 strains to have less naïve T cells but slightly increased effector (Teff) and follicular helper T (Tfh) cell populations, only showing statistical significance in the mesenteric LNs of the Ig κ -*BCL2* mice (**Fig 2E**).

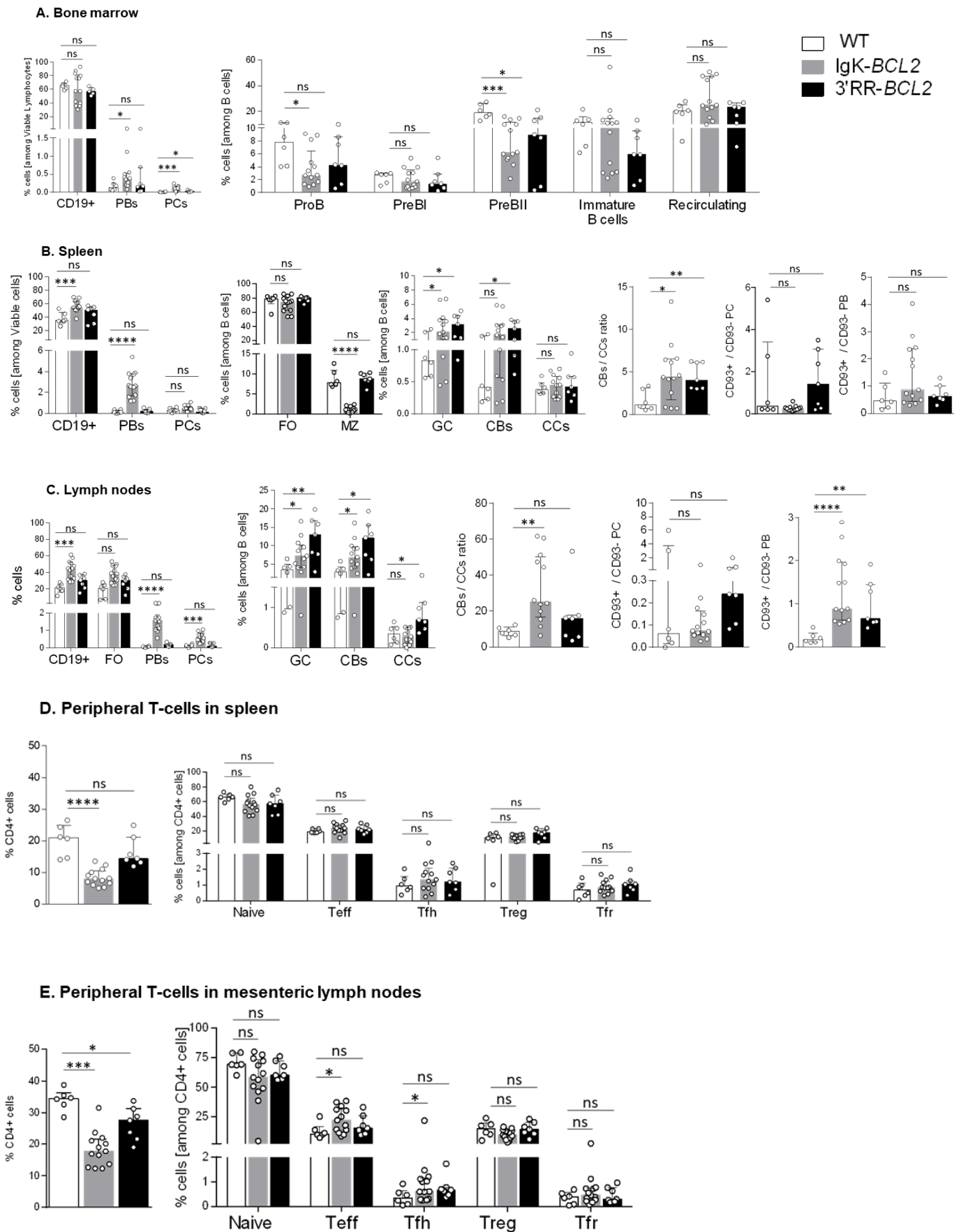

Figure 2: Flow cytometry data showing the impact of BCL2 deregulation alone, in both mouse models compared to wildtype mice at the resting non-immunized stage, on the different B cell compartments, in bone marrow (A), spleen (B) and mesenteric lymph nodes (C), as well as on the T cell compartment (D). Percentages of the different cell compartments are presented as medians with interquartile range and the statistical significance was determined by the Mann-Whitney *U* test. Ratios for the centroblasts to centrocytes, as well as CD93+ to CD93- plasma cell and plasmablastic cell populations are also presented. The full staining panel of both B and T cells in each of the organs is summarized as supplementary data 1.

Lymphoid compartments in immunized mice

Human lymphoid malignancies are often correlated with past chronic activation by viral Ag or auto-Ag, and we thus explored the behavior of BCL2 transgenic mice in conditions of 3 consecutive B-cell stimulations with the particulate Ag sheep red blood cells (SRBCs).

Such a repeated stimulation resulted in a strong global increase of the B-cell compartment in all lymphoid tissues from Ig κ -BCL2 mice, but not 3'RR-BCL2 mice (**Fig 3**). The Ig κ -BCL2 also confirmed an MZ B-cell decrease.

In bone marrow (**Fig 3A**), the B-cell increase corresponded to recirculating B-cells, whereas all B-cell progenitor compartments appeared to be decreased. Percentages and absolute number of bone marrow plasmablasts and plasma cells were also significantly increased in Ig κ -BCL2 mice.

In spleen and lymph nodes from Ig κ -BCL2 mice (**Fig 3B-C**), the global increase of CD19+ cells also associated with a strong persisting increase of plasmablasts and to a lower extent of plasma cells. Plasma cells quantified after immunization did not show the abovementioned increased ratio of CD93+ cells and not yet express the markers of LLPCs. By contrast for the burst of plasmablasts seen in Ig κ -BCL2 mice, a strongly increased ratio of CD93+CD138+ plasmablasts was seen in spleen, corresponding to a high amount of recently differentiated cells (Chevrier et al. 2009). In order to evaluate whether the plasmacytosis in Ig κ -BCL2 mice rather involves the ongoing entry of B-cells into the PC stage or the accumulation of long-lived PCs, we measured BrdU incorporation into PCs and GC B-cells one week after immunization (**Fig 3D**). This experiment revealed a decreased ratio of BrdU+/BrdU- PCs, indicating that accumulation of long-lived PCs predominantly contributed to the peripheral plasmacytosis. Parallel evaluation of BrdU incorporation in GC B cells showed a preserved ratio of recently divided vs lately divided cells.

By contrast to Ig κ -BCL2 mice, 3'RR-BCL2 mice showed a more specific relative increase of GC B-cells, involving both centrocytes and centroblasts, together with a higher ratio of centroblasts vs centrocytes, suggesting that BCL2 expression in these mice mostly impacted B-cell survival at the centroblast stage.

Anomalies of T-cell compartments after repetitive immunization remained similar to those in resting mice, with a significant decrease of the peripheral helper T cell population in the Ig κ -BCL2 mice, together with increased Teff and TFH cell populations in the LNs of both models (**Fig3E-F**).

A. Bone marrow

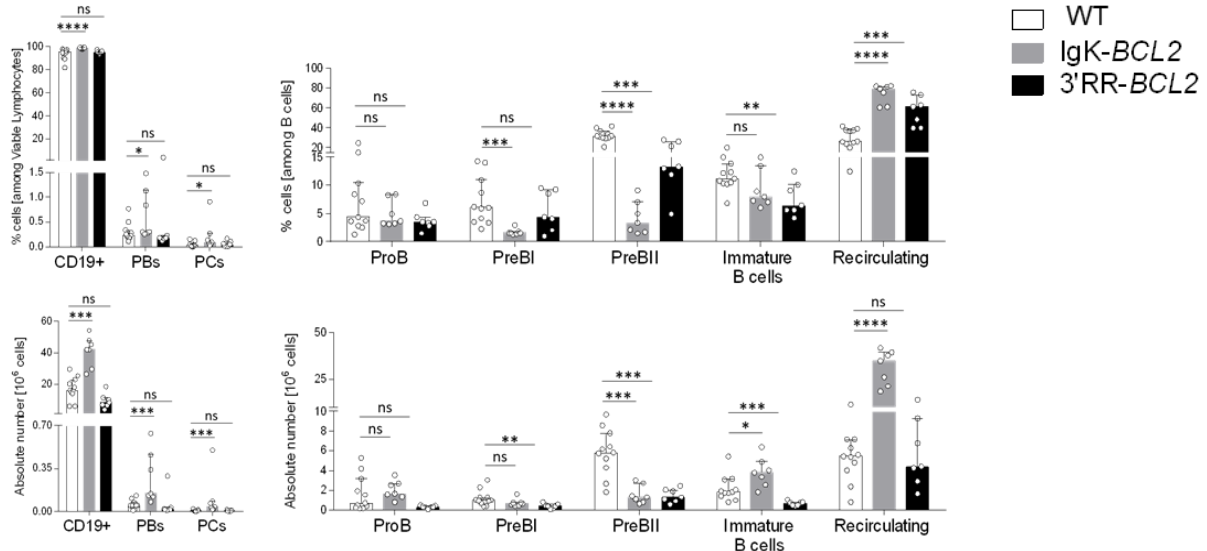

B. Spleen

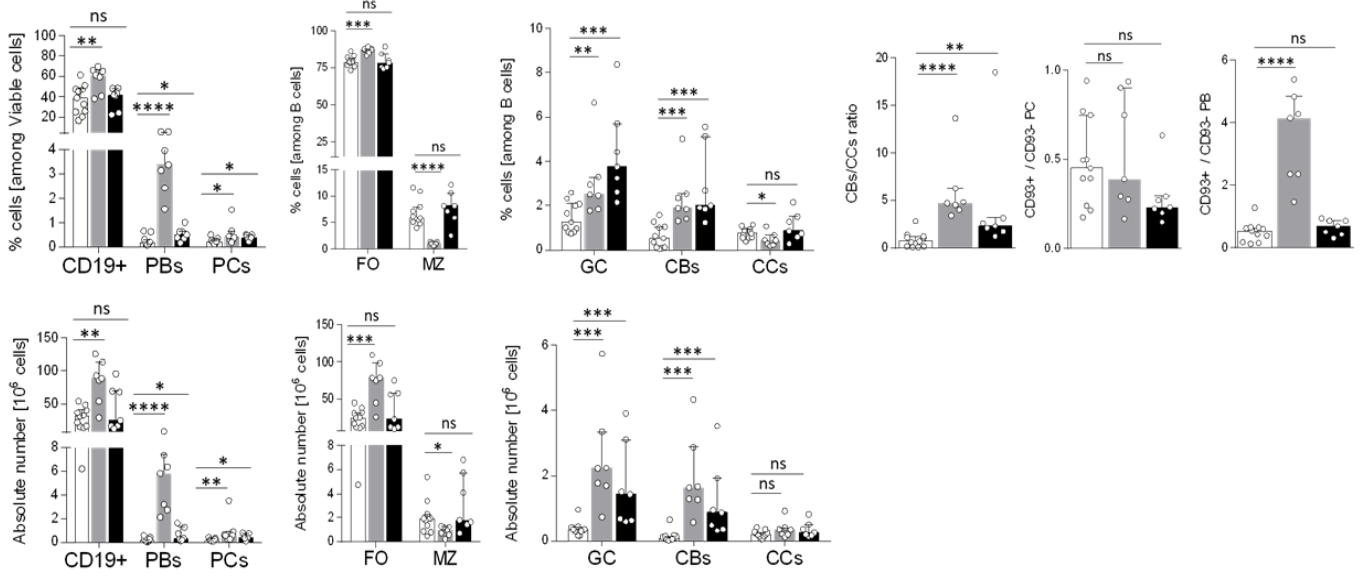

C. Lymph nodes

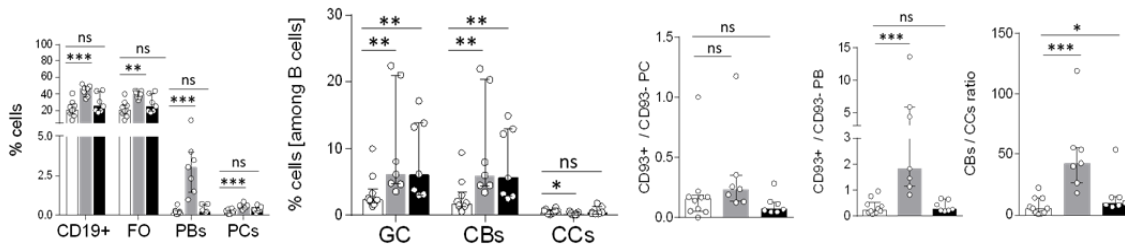

D. EdU assay in immunized mice

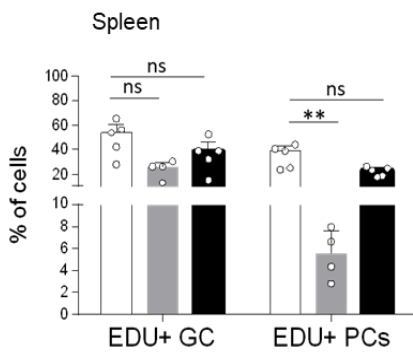

E: T cell compartments in spleen

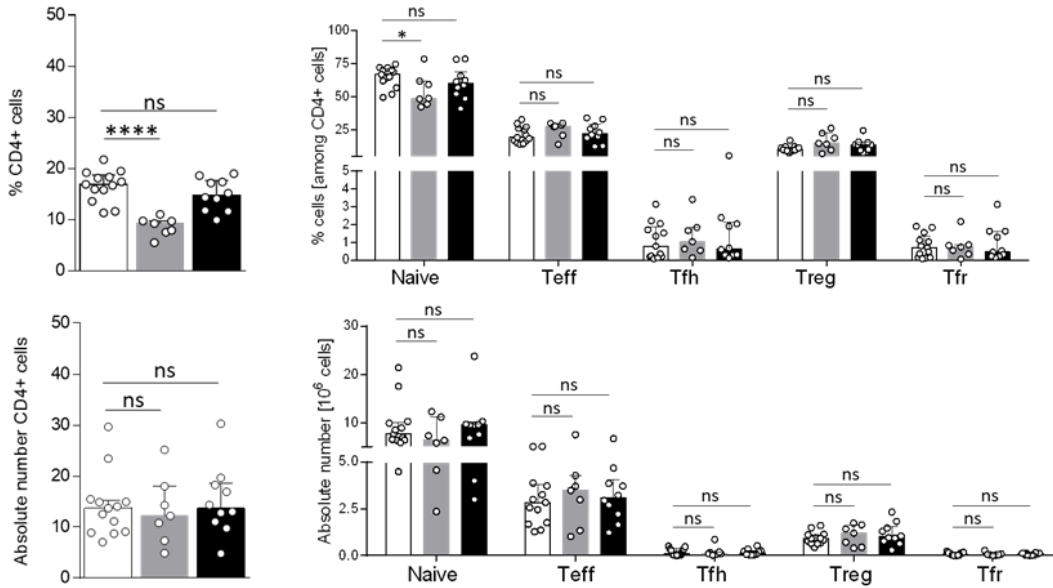

F: T cell compartments in LNs

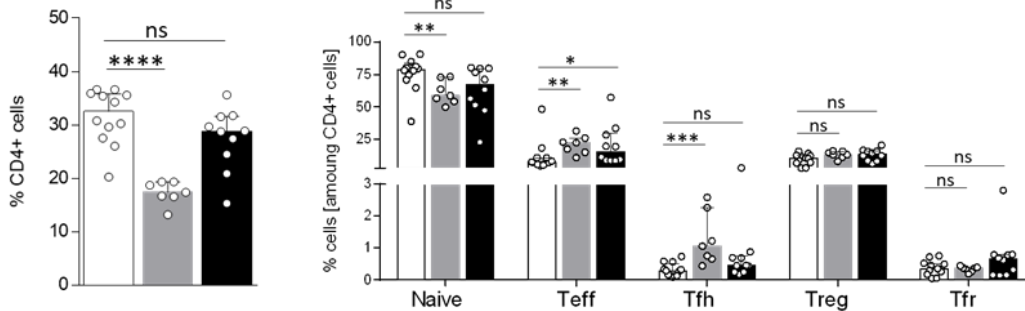

Figure 3: Flow cytometry data showing the impact of the BCL2 deregulation accompanied with 3 iterative intra-peritoneal SRBC injections (on a monthly basis) on the different B cell populations, in both BCL2 mouse models compared to WT, in the early stages of development in the bone marrow (A) and late ones in the secondary lymphoid organs, the spleen and mesenteric lymph nodes (B and C respectively). The ratios of centroblasts to centrocytes as well as CD93+ to CD93- plasma cells and plasmablasts was also realized. Percentages of the different cell populations as well as absolute cell numbers (calculated based on the percentages obtained by flow cytometry and the total percentage of lymphocytes in each corresponding organ) are presented as medians with interquartile range and the statistical significance was determined using the Mann-Whitney *U* test. The full staining panel for each organ is summarized in supplementary data 1. (D) Flow cytometry data showing the expression (or not) of EDU in splenocytes, 24 hours post its intraperitoneal injection into 5 WT, 4 IgK-*BCL2* $\Delta/+$ and 5 3'RR-*BCL2* mice (and 7 days after SRBC immunization). The percentages of EDU expressing plasma cells (EDU+ PC) and GC B cells (EDU+ GC) are presented as medians with interquartile range. Statistical significances were realized using Mann-Whitney *U* test. The EDU used for the staining panel was coupled to FITC (A488) along with markers specific for the plasma cell (CD138 BV786), GC B cells (GL7 coupled to APC and CD38 coupled to APC-R700) and cell viability (FVS 780). (E) Flow cytometry data showing the impact of the BCL2 deregulation accompanied with 3 iterative intra-peritoneal SRBC injections (on a monthly basis) on the different T cell populations, in both BCL2 mouse models compared to WT, in the periphery (spleen and LNs). Both percentages and absolute cell numbers each T cell population are presented as medians with interquartile range and the statistical significance is realized via the Mann-Whitney *U* test.

Antibody affinity

In parallel, we wanted to assess the ability of these mice to mount an efficient immune response against a T-dependent Ag despite their altered GC regulation. We quantified the affinity of anti-Ovalbumin IgG antibodies using the ELISA-based protocol. Analysis of the obtained dissociation constant (K_D) showed that both models are able to produce large amount of high affinity antibodies (the higher the affinity of the produced antibody the lower the K_D). With an ELISA-based evaluation of antibody affinity, both of our models produced high-affinity circulating IgG with dissociation constant similar to wildtype (or even with a tendency towards a lower value) (Fig 4). This finding is reminiscent from observations previously done for E μ -BCL2 mice, in which the selection of Ag-specific B-cells appeared to maintained (Smith et al. 2000).

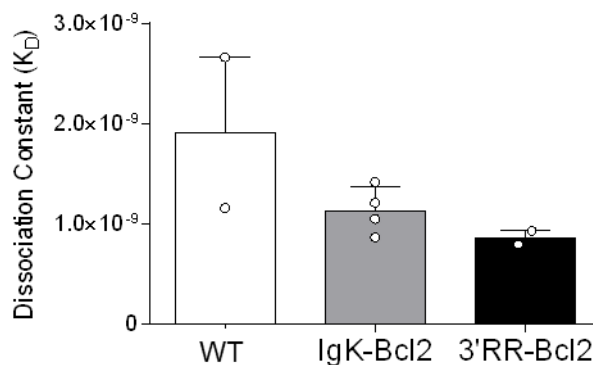

Figure 4: (A) Histogram showing the dissociation constant (K_D) of IgG to Ovalbumin, obtained by an ELISA-based assay (described in materials and methods), in the sera of both BCL2 mouse models compared to WT after 45 minutes of incubation with the secondary antibody. A lower K_D value indicated higher IgG affinity against Ovalbumin. K_D is reported here as medians with interquartile range and no statistical significance was determined due to the limited number of mice.

Single cell transcriptome analysis

In order to appreciate the impact of BCL2 deregulation on the B-cell transcriptome more precisely than by following surface expression of a limited set of membrane markers, we carried a single cell analysis of B-lineage splenocytes 10 days after immunization. This analysis allowed to identify 13 clusters and sub-clusters, from transitional cells, recirculating resting B-cells, extrafollicular and interfollicular cells, IFN-activated cells, marginal zone, pre-centroblastic, centroblasts, early centrocytes (AID+ BCL6+), late centrocytes (AID-, BCL6+), preplasmablasts, plasmablasts and plasma cells (**Fig 5A**). This analysis confirmed and extended the observations made by flow cytometry, but with much better precision. All compartments upstream of GC formation were rather decreased in BCL2 transgenics (from transitional cells to resting, extrafollicular, IFN-activated, marginal zone and pre-centroblastic cells... In the Igk-BCL2 model, the compartments amplified began with centrocytes but culminated with plasmablasts and plasma cells. By contrast in the BCL2-3'RR model, the amplified subclusters were more

focused on the GC including centroblasts, centrocytes, late centrocytes and plasmablasts (**Fig 5B**). This analysis also allowed to monitor the mean expression level of a number of highly expressed genes comparatively between WT, Ig κ -BCL2 and BCL2-Tg mice. With more precision than in flow cytometric measurements, this analysis showed a broad overexpression of BCL2 in all subclusters in the Ig κ -BCL2 model, compared with a lower and much more specific expression in BCL2-3'RR B cells, focused on centroblasts, centrocytes and plasma cells (**Fig 5C**).

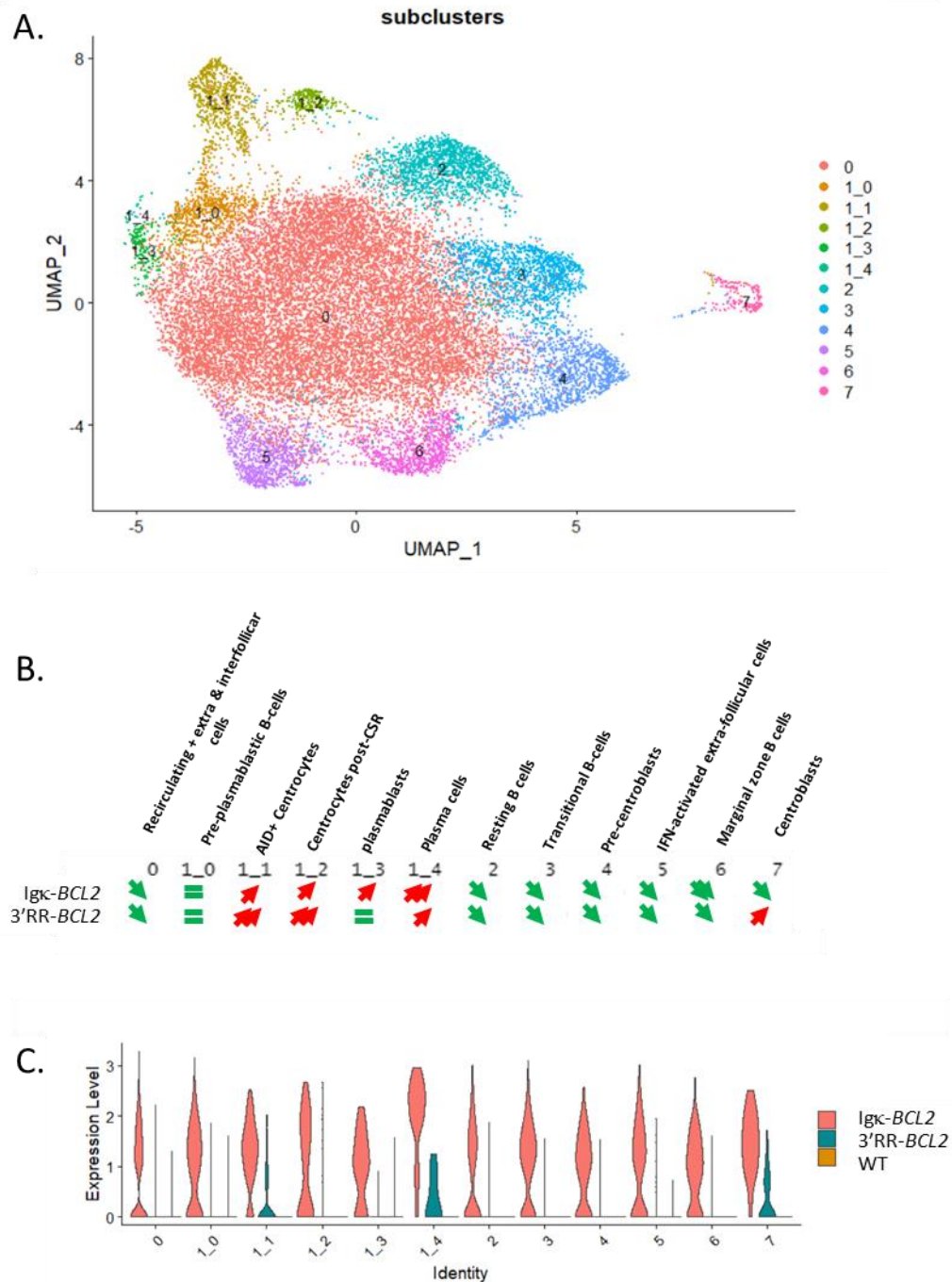

Figure 5 : (A) UMAP of the 10X single cell analysis of spleen B-cells 10 days after SRBC immunization, split into 12 clusters. (B) Quantitative variations of cell numbers in the various clusters in Ig κ -BCL2 and 3'RR-BCL2 mice compared to wildtype. (C) Human BCL2 expression level in the various cell clusters in Ig κ -BCL2 and 3'RR-BCL2.

B-cell diversity in immunized mice.

Repertoire of immunized mice only showed minor changes by comparison to normal mice (**Fig 6**), without significant increase of the Gini index in any of the Ig transcript category analyzed (μ or γ IgH transcripts from spleen or lymph nodes), thus indicating at this stage that no clonal amplification was detectable but that normally diversified repertoires were expressed after immunization. Usage of VH subgroups associated with IgH μ or IgH γ transcripts showed no significant variation compared to WT.

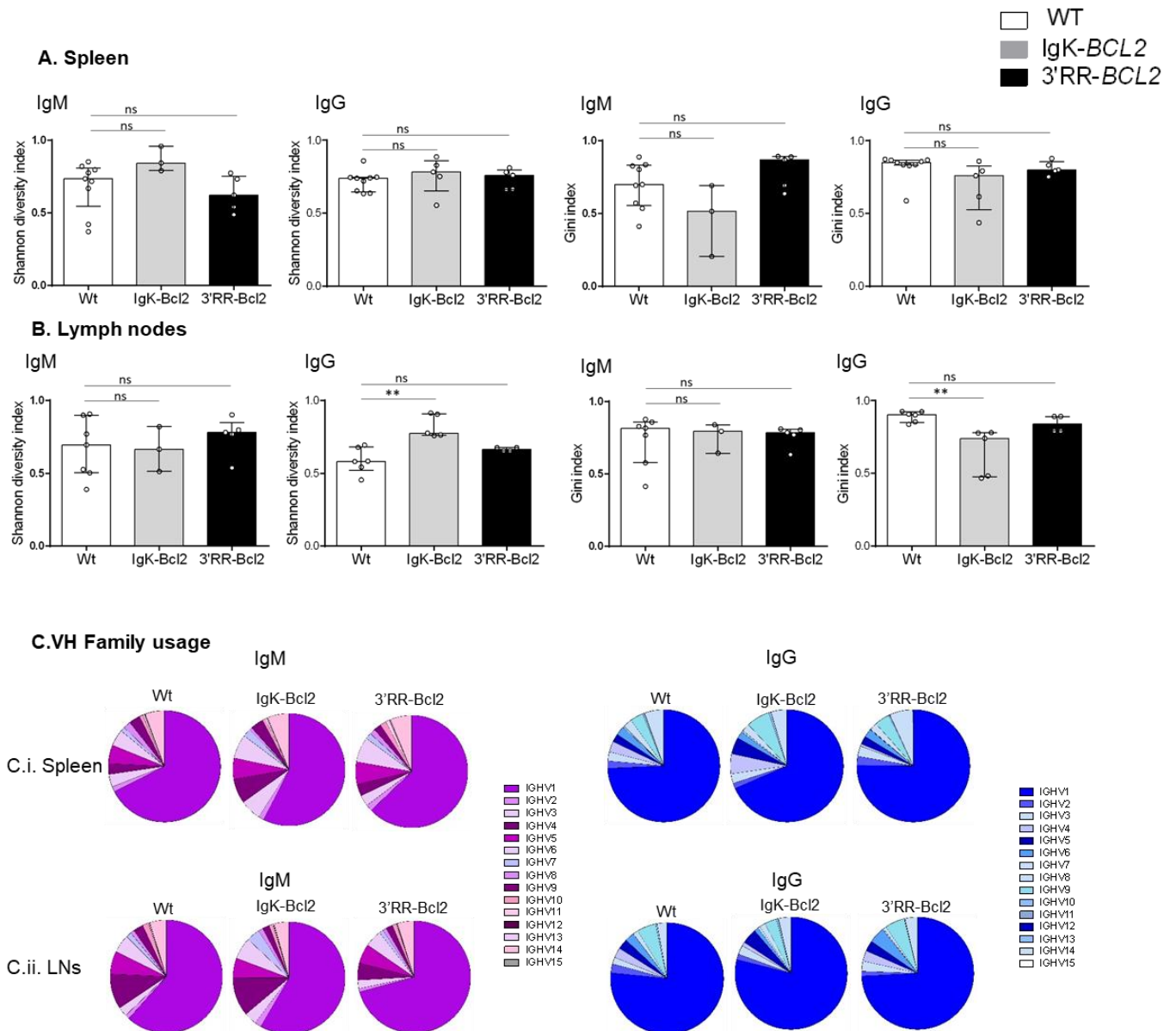

Figure 5: Histogram showing the Shannon diversity index and the Gini index of both IgM and IgG repertoires in the spleen (A) and mesenteric LNs (B) of both BCL2 mouse models compared to WT. Both indices are presented as medians with interquartile range and statistical significances are determined by Mann-Whitney U test. (C) Pie charts showing the mean for the percentage of each VH gene family usage of both IgM (in purple) and IgG (in blue) in the spleen and mesenteric LNs of both BCL2 mouse models compared to WT.

Immunohistochemical analysis and tumor development in *BCL2* transgenic mice.

We allowed cohorts of 40 mice for each genotype to grow older, in order to monitor the potential onset of spontaneous tumors. Aggressive tumors indeed started to appear after around 25 weeks of age in about 15% of mice with either configuration of the *BCL2* (**Table 1** and **Fig 7A**).

Representative immunohistochemistry analyses of tissues either from young mice (thus in the pre-lymphomatous stage) or old mice (affected with overt lymphoma, notably 3'RR-*BCL2* mouse Tg-6 and Igκ-*BCL2* Δ/Δ mouse KI-8 in Table 1) are shown in Fig 6B. At the pre-lymphoma stage, the organization of the spleen is respected showing large follicles densely occupied with CD19+ B-lymphocytes, mixed with less abundant plasma cells. In such young *BCL2*-3'RR mice, *BCL2* staining is mostly seen in B-cells within germinal centers. By the contrary in the Igκ-*BCL2* mice, abundant plasma cells populate the red pulp already at the early stage, and stain the most strongly for *BCL2*.

In mice carrying tumors from either genotype, the spleen red pulp later appeared heavily infiltrated by CD138+ *BCL2*+ plasma cells. These tumors affected mostly the mesenteric lymph nodes, spleen and liver. The tumors analyzed at other distant locations also consisted into CD138+ cells and the disease thus appears like a disseminated plasmablastic lymphoma. (**Fig 7B**).

Table 1 : Table describing in the mice that developed tumors in both *BCL2* models. This cohort comprised of 19 Igκ-*BCL2* (total) and 8 3'RR-*BCL2* mice was allowed to grow older and these tumors were monitored for tumor development over time. For each mouse, the age at which they developed the tumor (or pre-tumoral symptoms) along with detailed description of the location and the phenotype of each tumor is listed.

Genotype	Number	Age (weeks)	Ascitis	Tumor	Organs affected / Tumor description	Other observations
Igκ-Bcl2 Δ/Δ	KI- 1	85	✓	✓	Intestine, Mesenteric LNs, Cervical LNs, Splenomegaly (165 mg)	/
	KI- 2	50	X	✓	Intestine, Mesenteric LNs, Cervical LNs, Splenomegaly (650 mg)	/
	KI- 3	71	✓	✓	Intestine, Stomach, Splenomegaly (395 mg)	/
	KI- 4	90	X	✓	Intestine, LNs	occlusion
	KI- 5	71	X	✓	Mesenteric LNs, Liver, Splenomegaly (1580 mg)	/
	KI- 6	54	✓	✓	Stomach, Intestine, Mesenteric LNs, Liver, Pancreas, Splenomegaly (305 mg)	/
	KI- 7	54	✓	✓	Kidneys, LN atrophy, Splenomegaly (950 mg)	/
	KI- 8	105	X	✓	Mesentery, Liver, Kidneys, Splenomegaly	/
	KI- 9	109	✓	✓	Liver, Splenomegaly (397 mg)	/
	KI- 10	70	X	✓	Stomach, Liver, Splenomegaly (287 mg)	/
KI BCl2 Δ/+	KI- 11	92	✓	✓	Under lungs, Mesenteric LNs, Splenomegaly (145 mg)	Diffused and bloody cervical LNs
	KI- 12	84	X	✓	Splenomegaly, Liver, Kidneys	Swollen testicles
	KI-13	117	✓	✓	Intestine, Atrophy of all LNs, Splenomegaly (2500 mg)	/
	KI-14	52	X	✓	Atrophy of cervical LNs, Splenomegaly (300 mg)	Obese
	KI-15	52	X	✓	Splenomegaly (300 mg)	Obese
	KI-16	41	X	✓	Mesentery, Splenomegaly	/
	KI-17	81	X	✓	Mesentery, Splenomegaly	/
	KI-18	111	X	✓	Mesentery, Splenomegaly	/
	KI-19	79	✓	✓	Mesentery, splenomegaly (1350 mg)	Decolored liver
3'RR-Bcl2+	Tg-1	74	X	✓	Atrophy of inguinal and axillary LNs, Splenomegaly (380)	/
	Tg-2	74	X	✓	Splenomegaly (161 mg)	/
	Tg-3	60	X	✓	Splenomegaly (240 mg)	/
	Tg-4	60	X	✓	Splenomegaly (222 mg)	/
	Tg-5	64	X	✓	Atrophy of cervical LNs Splenomegaly (222 mg)	/
	Tg-6	64	✓	✓	Intestine, Liver, Atrophy of cervical LNs, Splenomegaly (730 mg)	/
	Tg-7	121	X	✓	Mesentery, Splenomegaly (1139 mg)	/

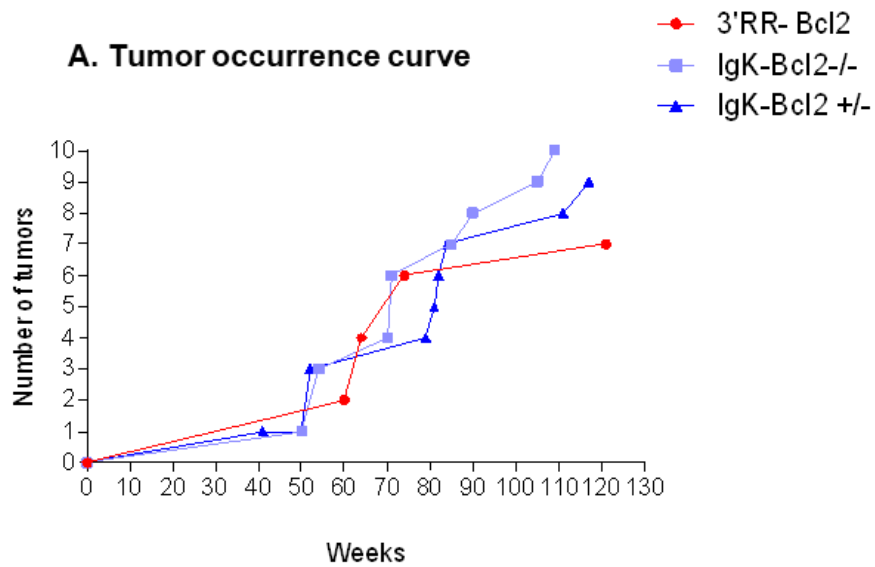

B. Immunohistochemistry in mice before and after plasmacytoma development

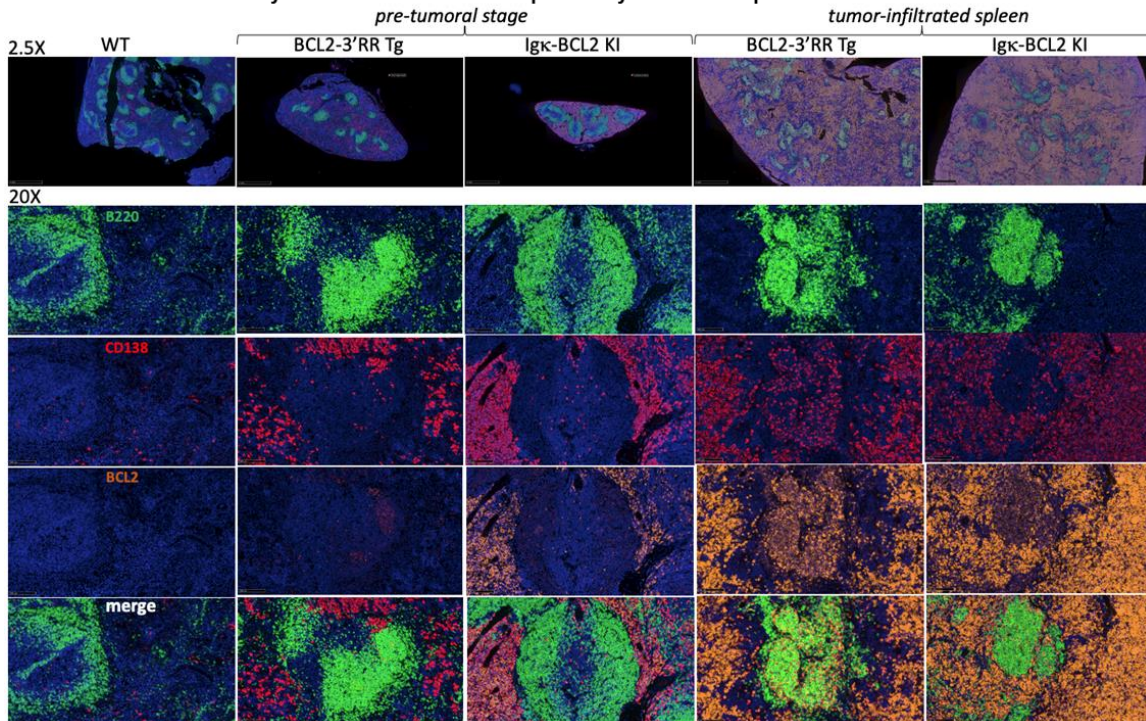

Figure 6: (A) Curve showing the evolution of tumor occurrence in both BCL2 models with respect to their age (in weeks). (B) Immunohistochemistry (IHC) analysis of the spleen at the pre-tumoral and tumor-infiltrated stage of both BCL2 models compared to WT. Staining was done for B cells (using B220 in Fitc → Green), plasma cells (CD138 in Tritc → Red), human BCL2 (in cyanine 5 → Yellow) and finally DAPI in blue.

Ig repertoire analysis by REPseq was done for tumors from 4 Igκ-*BCL2* Δ/Δ tumoral mice (KI-2, KI-3, KI-4 and KI-8, **Table 1**), 3 Igκ-*BCL2* Δ/+ tumoral mice numbers KI-16, KI-18 and KI-19 and one 3'RR-*BCL2* tumoral mouse number Tg-6. All tumors analyzed in both strains included one or eventually two strongly predominant clonal cell populations, each so-called “predominant clonotype” representing 30% to 98% of all Ig reads (**Table 2**).

Both IgM producing and IgG clones were found, 5 of them carrying no mutation of the expressed VDJ regions, while 7 had clearly accumulated somatic hypermutation (from 3.5 to 21 / Kbp), indicating that malignant clones could originate in some cases from an extra-follicular pathway or in other cases be GC-derived.

Table 2: Table showing the detailed IgM and IgG repertoire analyses of the tumor tissues only, of a few mice from both *BCL2* models. Total number of clones for each heavy chain, the corresponding number of productive reads are indicated. Based on the previous repertoire data obtained from WT mice, a certain threshold for the clone frequency was used and only the clones that were present at a frequency higher than or equal to 30% were selected. For each clone, the V and J gene used along with their corresponding V mutation frequency (without CDR3 as it is highly mutated) are also indicated.

Genotype	Mouse nb	Heavy chain	Total number of clones	Total number of productive reads	V_gene	J_gene	Frequency (Clones ≥ 30%)	V_mutation frequency (without CDR3) 0/00
Igκ- <i>BCL2</i> Δ/Δ	KI-2	IgG	234	1269	IGHV4-1	IGHJ2	42.2	1
	KI-3	IgM	248	9087	IGHV6-3	IGHJ2	95.2	2.1
		IgG	58	8308	IGHV10-3	IGHJ2	99.0	0.35
	KI-4	IgM	430	2104	IGHV4-1	IGHJ2	47.6	0
		IgG	1055	6274	IGHV1-5	IGHJ3	30.2	1.5
	KI-8	IgM	143	1560	IGHV3-6	IGHJ2	64.4	1.8
IgG		26	2835	IGHV4-1	IGHJ2	98.4	0.8	
Igκ- <i>BCL2</i> Δ/+	KI-16	IgG	15	871	IGHV10-1	IGHJ2	98.8	0
	KI-18	IgG	74	175	IGHV10-3	IGHJ2	41.1	0.35
	KI-19	IgM	494	2106	IGHV1-39	IGHJ2	53.4	0
		IgG	619	11924	IGHV1-26	IGHJ2	85.2	0
3'RR- <i>BCL2</i>	Tg-6	IgG	1157	12395	IGHV2-2	IGHJ4	51.1	0

(clones carrying a VDJ N-glycosylation site are in red)

The *BCL2* cassette is exposed to low SHM in both transgenic models.

Sequencing the promoter region of *BCL2* in both models revealed that SHM occurred all along a 1.5 kb sequence fragment, and globally appeared diversified in polyclonal cells (in agreement with the B-cell diversity indicated by Ig repertoire experiments) in mice not affected with tumors (**Fig 8**). The mutation rate at a given position thus never exceeded 0.6%. Sequences with the highest rate of SHM were rather obtained in class-switched B cells from immunized Igκ-*BCL2* mice, and the most often mutated positions were located around the P1 promoter.

In some but not all tumors, mutations were present at a higher level, eventually approaching 10% of the reads.

A: Mutation in Bcl2 promoter region of human lymphoma cell lines

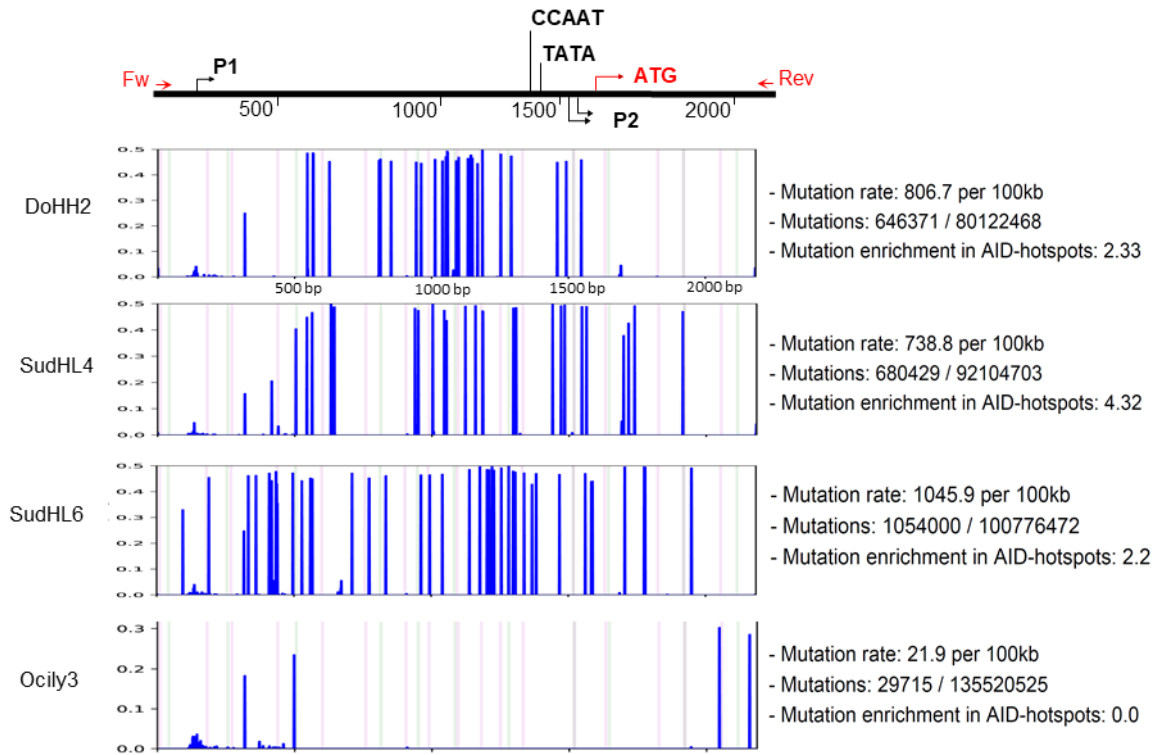

B: Mutation in Bcl2 promoter region in immunized BCL2 mice

Igκ-BCL2 Δ/+ mice

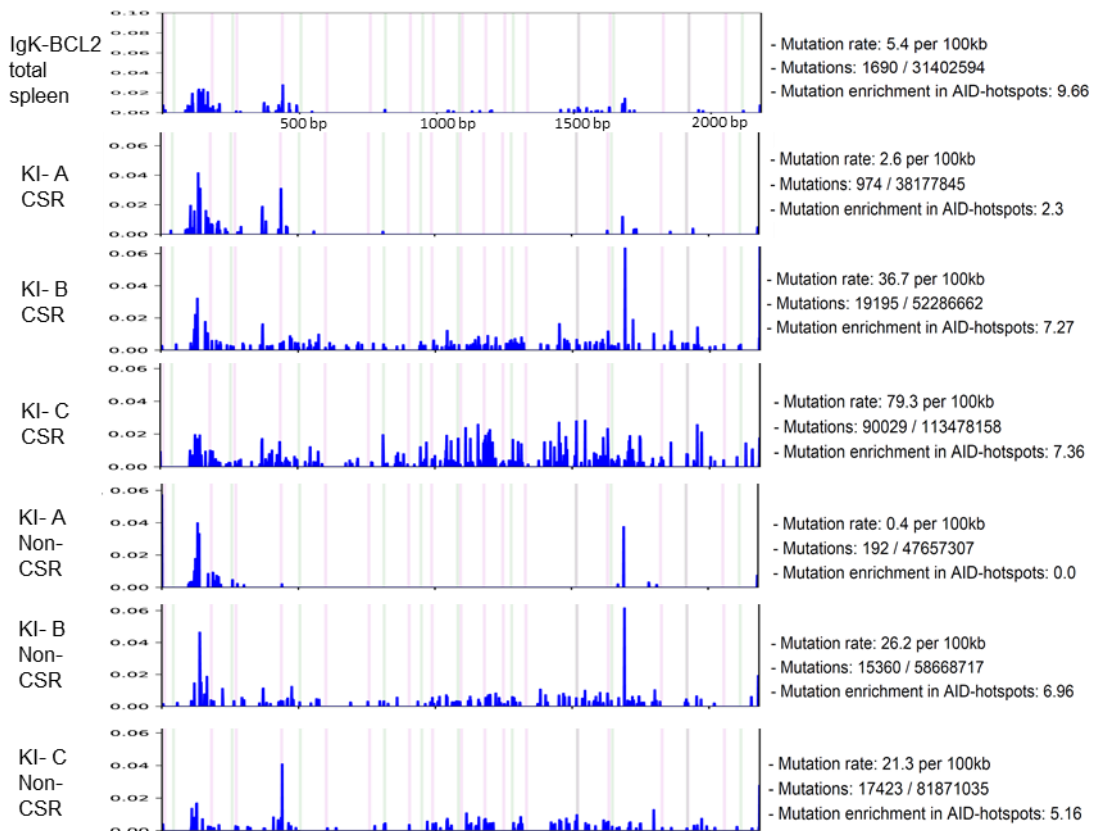

3'RR-*BCL2* mice

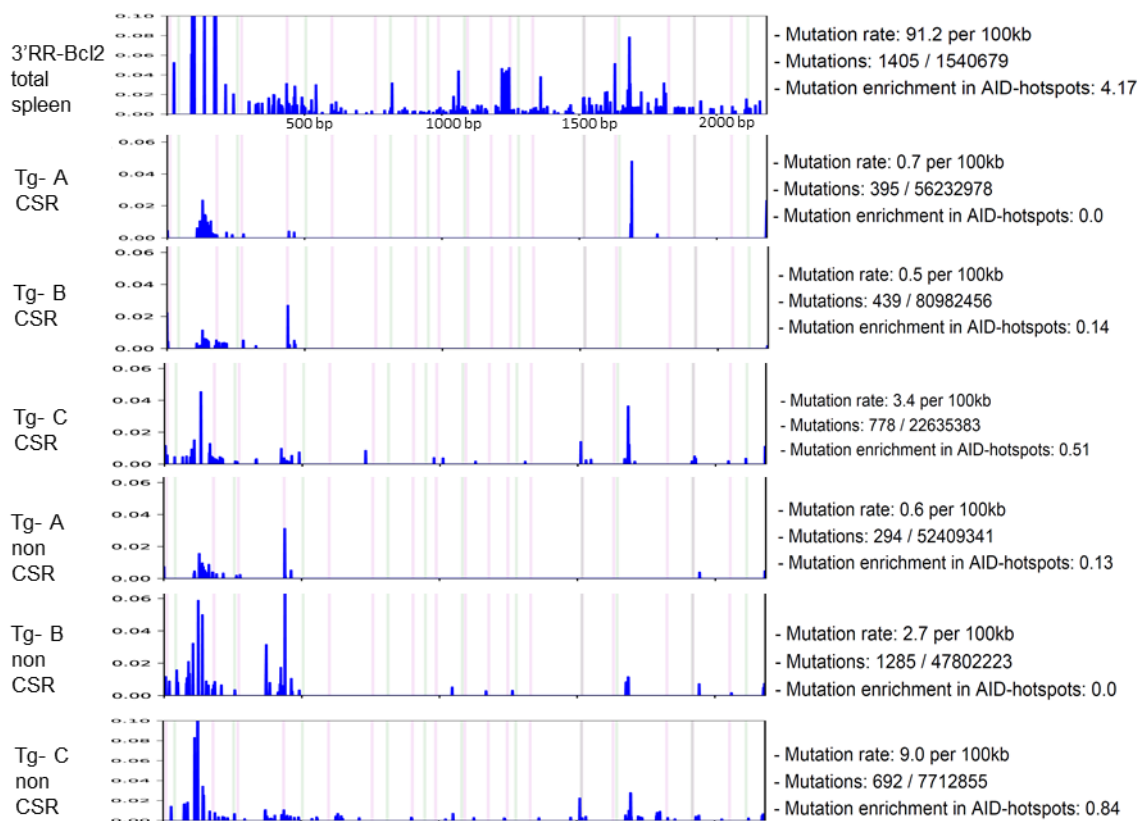

Total spleens are from mice immunized iteratively 3 times with SRBC however, CSR and non-CSR are mice who were immunized only once with SRBC for 7 days

C: Mutation in *Bcl2* promoter region in tumors

Igκ-*BCL2* tumors



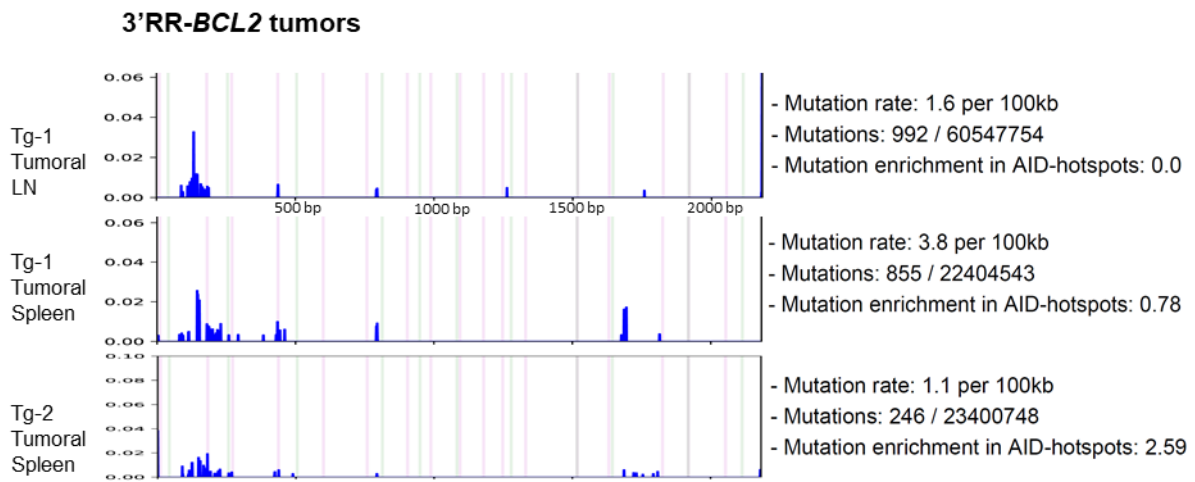

Figure 7: Graphs showing the frequency and the localization / distribution of mutations along the BCL2 promoter region (after high-throughput sequencing) as well as the global mutation rate and the mutation enrichment in AID-hotspots in several human DLBCL cell lines as positive controls (A), in total splenocytes or class-switched versus non-class-switched splenocytes of immunized mice (3 iterative immunizations or single 7-day immunization respectively) from both BCL2 models (B) and finally in various tissues / organs from several tumoral mice of both BCL2 models (C). Graphs are shown as generated by the system Deminer after correction with respect to two negative controls passed on the same run.

DISCUSSION

We herein report two new models of B-lineage specific BCL2 deregulation in mice. These models yield different patterns of expression, either with a global increase of BCL2 expression at all B-cell maturation stages in the Ig κ -BCL2 knock-in strain, but with a climax in plasma cells, or with a more restricted GC-specific expression in transgenics driven by the IgH locus 3'RR enhancers. Although both models roughly yield the same level of BCL2 expression in GC B cells, its higher "GC-specificity" makes the 3'RR-driven model a potentially attractive "first hit" platform for studying early events of FL lymphomagenesis. Indeed, FL is currently considered as evolving from FLLC cells carrying an initial t(14;18) translocation then followed by multiple additional driver mutations, the latter concurring to block plasma cell differentiation and exit of the transformed cells from the GC-stage. By contrast, the strongest and broadest deregulation observed after the knock-in of BCL2 within the Ig κ locus principally results into the expansion of the plasmablastic and plasma cell compartments even in young mice prior to any immunization. Finally, regarding the occurrence of spontaneous tumors in either of these BCL2 strains, both appear exposed to plasma cell tumors, whether or not this was preceded by overt polyclonal plasmacytosis. A similar situation is likely occurring for human cells deregulating only BCL2, which circulate and can be found in blood and lymphoid tissues of many healthy individuals and do not appear to be blocked in their differentiation (Roulland et al. 2011; Sungalee et al. 2014). By contrast, local amplification of a more aggressive B-cell clone, either in the early situation of *in situ* follicular neoplasia or of overt FL is always associated to mutations additional to the BCL2 deregulation (Vogelsberg et al. 2021). The most obvious roles of all such mutations, notably involving chromatin modifier genes such as CREBBP, EZH2 or TET2, is to reprogram B-cells towards an iterative GC reentry cycle by up-regulating BCL6 expression, and inhibiting genes either involved into B-cell egress from the GC and/or into PC differentiation and progress beyond the GC B-cell stage (Lu et al. 2018; Dominguez et al. 2018; "Mutant EZH2 Induces a Pre-Malignant Lymphoma Niche by Reprogramming the Immune Response - PubMed" n.d.; Rivas et al. 2021).

Although we have no indication about the eventual second hits supporting the growth of plasmacytoma in aged mice from this study, such acquired genetic or epigenetic anomalies are likely since no tumor arise in young mice and since, whatever the BCL2 expression dosage in both mouse strains, the clonotypic diversity of B-cells in younger tumor-free animals is normal and does not reveal the early expansion of a monoclonal population.

Contrary to our expectations, presence of a large P1/P2 BCL2 promoter fragment including the negative regulatory sites for BCL6 binding does not seem to repress expression in those mouse models, and is not affected by acquired mutations unleashing expression in some B-cell clones. It is thus likely that the spontaneous expression yielded by the BCL2 cassette in either model, is already sufficiently high by itself for initiating the clonal malignant development without the need of promoter mutations. Although the P1/P2 fragment is accessible to a significant amount of SHM, notably when inserted in the Ig κ locus, these mutations rather seem to randomly accumulate at low level.

Tumors occurring in both models are thus mostly made up of clonal plasma cells (with biclonal proliferations in some cases), either producing IgG or IgM with roughly similar frequencies, and revealing SHM of VH genes ranging from 3.5 to 21 per Kbp for 7 out of 12 malignant clones, thus with a clear indication of a "post-GC" origin of the malignant clones, but without any mutation for 5 of them, which could thus likely correspond to extra-follicular PCs or to PCs differentiated independently of T-cell help. Toellner et al previously characterized extrafollicular and classical GC-derived plasma cells respectively with means of 0.7/Kbp vs 5.6 Kbp (Toellner et al. 2002).

Although attributed to V(D)J recombination errors, which could potentially affect any Ig locus, BCL2 translocations associated with FL overwhelmingly involve the IgH locus on chromosome 14 and much more rarely Ig light chain loci (Szymanowska et al. 2008; Hillion et al. 1991, 2). Such translocations replace all the V constant gene cluster with BCL2 and thus associates the oncogene with regulatory elements for the constant gene cluster, *i.e.* predominantly under the influence of the IgH 3'RR in mature B-cells. Such conditions are thus likely to favor a strong expression in activated B-cells and at the GC-stage, as observed in our IgH-3'RR model.

Why both BCL2 strains explored in this study strongly differ for the polyclonal PC expansion developed in Ig κ -BCL2 mice reveals an unexpected impact of the level of BCL2 expression into B-cell differentiation. Such an effect could either be related to an imprinting of activated B-cells, more prone to enter into the PC-differentiation pathway when BCL2 is higher, but such a differentiation bias should then decrease entry into the alternate pathway of memory B cell differentiation, which is in fact not observed. By the contrary, BCL2 transgenic B-cells show a conserved ability to mount high-affinity Ag-dependent responses after immunization. The most likely explanation for PC accumulation is thus at this stage, that the high level of BCL2 expression reached by Ig κ -BCL2 cells, and to a lower extent in BCL2-3'RR mice, significantly impact first plasmablast, and secondarily PC survival. Initial steps of PC differentiation are indeed known to depend on endogenous BCL2 expression (Peperzak et al. 2013), and survival is thus initially increased when no decrease of BCL2 expression occurs in transgenic B cells. Later on, long-live PCs normally do not rely on BCL2 at all for their survival but rather on BCMA-dependent MCL1 expression (Peperzak et al. 2013). Since MCL1 and BCL2 share a similar pro-survival function, the knock-in Ig κ -BCL2 construction maintaining or even increasing constitutive BCL2 expression in all PCs necessarily ends with deregulated survival of these cells and hypertrophy of the LLPC compartment. PCs are also strongly exposed to endothelial reticulum (ER)-mediated stress, which triggers autophagy and mitophagy. BCL2-family members such as BCL2-L13

and BNIP3 are major actors of autophagy and mitophagy (Onnis et al. 2018; Onishi et al. 2021). These factors share interactions with some BCL2 partners, such as BECLIN-1 and their function in promoting mitophagy might likely be hampered by excessive amounts of BCL2. Noticeably, human myeloma often associates up-regulation of the BCL2 homolog MCL1 and silencing of BNIP3 (Murai et al. 2005). Altogether, either by reducing ER-stress induced apoptosis, autophagy or mitophagy, the BCL2 up-regulation triggered at the plasmablast/PC stage in Igκ-BCL2 mice appears to open up the gate for entry of more B cells into the plasma cell stage together with deregulated accumulation of non-dying long-lived PCs.

ACKNOWLEDGMENTS

This work was supported by grants from Fondation ARC pour la Recherche sur le Cancer (Grants PGA1 RF20170205386 / RF20180207070), the Institut National du cancer (INCA AAP PLBIO-17-06), the Agence Nationale de la Recherche (ANR, ANR-16-CE15-0019-01/03), the Leukemia Lymphoma Society (TRP 6593-20) and Rennes Métropole. SL was supported by a specific grant from the LabEx IGO program (n° ANR-11-LABX-0016) funded by the «Investment into the Future» French Government program, managed by the National Research Agency (ANR). The authors have no conflicting financial interests. We thank staff from the Limoges University core animal facility for animal care.

REFERENCES :

- Amin, Rada, Frédéric Mourcin, Fabrice Uhel, Céline Pangault, Philippe Ruminy, Loic Dupré, Marion Guirriec, et al. 2015. "DC-SIGN-Expressing Macrophages Trigger Activation of Mannosylated IgM B-Cell Receptor in Follicular Lymphoma." *Blood* 126 (16): 1911–20. <https://doi.org/10.1182/blood-2015-04-640912>.
- Boice, Michael, Darin Salloum, Frederic Mourcin, Viraj Sanghvi, Rada Amin, Elisa Oricchio, Man Jiang, et al. 2016. "Loss of the HVEM Tumor Suppressor in Lymphoma and Restoration by Modified CAR-T Cells." *Cell* 167 (2): 405-418.e13. <https://doi.org/10.1016/j.cell.2016.08.032>.
- Butler, Andrew, Paul Hoffman, Peter Smibert, Efthymia Papalexi, and Rahul Satija. 2018. "Integrating Single-Cell Transcriptomic Data across Different Conditions, Technologies, and Species." *Nature Biotechnology* 36 (5): 411–20. <https://doi.org/10.1038/nbt.4096>.
- Chevrier, Stéphane, Céline Genton, Axel Kallies, Alexander Karnowski, Luc A. Otten, Bernard Malissen, Marie Malissen, et al. 2009. "CD93 Is Required for Maintenance of Antibody Secretion and Persistence of Plasma Cells in the Bone Marrow Niche." *Proceedings of the National Academy of Sciences of the United States of America* 106 (10): 3895–3900. <https://doi.org/10.1073/pnas.0809736106>.
- Cogné, M, R Lansford, A Bottaro, J Zhang, J Gorman, F Young, H L Cheng, and F W Alt. 1994. "A Class Switch Control Region at the 3' End of the Immunoglobulin Heavy Chain Locus." *Cell* 77 (5): 737–47.
- Dominguez, Pilar M., Hussein Ghamlouch, Wojciech Rosikiewicz, Parveen Kumar, Wendy Béguelin, Lorena Fontán, Martín A. Rivas, et al. 2018. "TET2 Deficiency Causes Germinal Center Hyperplasia, Impairs Plasma Cell Differentiation, and Promotes B-Cell Lymphomagenesis." *Cancer Discovery* 8 (12): 1632–53. <https://doi.org/10.1158/2159-8290.CD-18-0657>.
- Egle, Alexander, Alan W. Harris, Mary L. Bath, Lorraine O'Reilly, and Suzanne Cory. 2004. "VavP-Bcl2 Transgenic Mice Develop Follicular Lymphoma Preceded by Germinal Center Hyperplasia." *Blood* 103

(6): 2276–83. <https://doi.org/10.1182/blood-2003-07-2469>.

Hafemeister, Christoph, and Rahul Satija. 2019. "Normalization and Variance Stabilization of Single-Cell RNA-Seq Data Using Regularized Negative Binomial Regression." *Genome Biology* 20 (1): 296. <https://doi.org/10.1186/s13059-019-1874-1>.

Hillion, J., C. Mecucci, A. Aventin, D. Leroux, I. Wlodarska, H. Van Den Berghe, and C. J. Larsen. 1991. "A Variant Translocation t(2;18) in Follicular Lymphoma Involves the 5' End of Bcl-2 and Ig Kappa Light Chain Gene." *Oncogene* 6 (1): 169–72.

Huet, Sarah, Pierre Sujobert, and Gilles Salles. 2018. "From Genetics to the Clinic: A Translational Perspective on Follicular Lymphoma." *Nature Reviews. Cancer* 18 (4): 224–39. <https://doi.org/10.1038/nrc.2017.127>.

Kowalczyk, Monika S., Itay Tirosh, Dirk Heckl, Tata Nageswara Rao, Atray Dixit, Brian J. Haas, Rebekka K. Schneider, Amy J. Wagers, Benjamin L. Ebert, and Aviv Regev. 2015. "Single-Cell RNA-Seq Reveals Changes in Cell Cycle and Differentiation Programs upon Aging of Hematopoietic Stem Cells." *Genome Research* 25 (12): 1860–72. <https://doi.org/10.1101/gr.192237.115>.

Lin, Pei, Rechna Jetly, Patrick A. Lennon, Lynne V. Abruzzo, Sapana Prajapati, and L. Jeffrey Medeiros. 2008. "Translocation (18;22)(Q21;Q11) in B-Cell Lymphomas: A Report of 4 Cases and Review of the Literature." *Human Pathology* 39 (11): 1664–72. <https://doi.org/10.1016/j.humpath.2008.04.007>.

Lu, Xiaoqing, Tharu M. Fernando, Chen Lossos, Nevin Yusufova, Fan Liu, Lorena Fontán, Matthew Durant, et al. 2018. "PRMT5 Interacts with the BCL6 Oncoprotein and Is Required for Germinal Center Formation and Lymphoma Cell Survival." *Blood* 132 (19): 2026–39. <https://doi.org/10.1182/blood-2018-02-831438>.

Martin, Ophélie Alyssa, Armand Garot, Sandrine Le Noir, Jean-Claude Aldigier, Michel Cogné, Eric Pinaud, and François Boyer. 2018. "Detecting Rare AID-Induced Mutations in B-Lineage Oncogenes from High-Throughput Sequencing Data Using the Detection of Minor Variants by Error Correction Method." *The Journal of Immunology* 201 (3): 950–56. <https://doi.org/10.4049/jimmunol.1800203>.

Mayer, Christian T., Anna Gazumyan, Ervin E. Kara, Alexander D. Gitlin, Jovana Golijanin, Charlotte Viant, Joy Pai, et al. 2017. "The Microanatomic Segregation of Selection by Apoptosis in the Germinal Center." *Science (New York, N.Y.)* 358 (6360). <https://doi.org/10.1126/science.aao2602>.

McDonnell, T. J., N. Deane, F. M. Platt, G. Nunez, U. Jaeger, J. P. McKearn, and S. J. Korsmeyer. 1989. "Bcl-2-Immunoglobulin Transgenic Mice Demonstrate Extended B Cell Survival and Follicular Lymphoproliferation." *Cell* 57 (1): 79–88. [https://doi.org/10.1016/0092-8674\(89\)90174-8](https://doi.org/10.1016/0092-8674(89)90174-8).

McDonnell, T. J., and S. J. Korsmeyer. 1991. "Progression from Lymphoid Hyperplasia to High-Grade Malignant Lymphoma in Mice Transgenic for the t(14; 18)." *Nature* 349 (6306): 254–56. <https://doi.org/10.1038/349254a0>.

Milpied, Pierre, Anita K. Gandhi, Guillaume Cartron, Laura Pasqualucci, Karin Tarte, Bertrand Nadel, and Sandrine Roulland. 2021. "Follicular Lymphoma Dynamics." *Advances in Immunology* 150: 43–103. <https://doi.org/10.1016/bs.ai.2021.05.002>.

Milpied, Pierre, Bertrand Nadel, and Sandrine Roulland. 2015. "Premalignant Cell Dynamics in Indolent B-Cell Malignancies." *Current Opinion in Hematology* 22 (4): 388–96. <https://doi.org/10.1097/MOH.000000000000159>.

Monni, O., H. Joensuu, K. Franssila, J. Klefstrom, K. Alitalo, and S. Knuutila. 1997. "BCL2 Overexpression Associated with Chromosomal Amplification in Diffuse Large B-Cell Lymphoma." *Blood* 90 (3): 1168–74.

Murai, M., M. Toyota, A. Satoh, H. Suzuki, K. Akino, H. Mita, Y. Sasaki, et al. 2005. "Aberrant DNA Methylation Associated with Silencing BNIP3 Gene Expression in Haematopoietic Tumours." *British*

Journal of Cancer 92 (6): 1165–72. <https://doi.org/10.1038/sj.bjc.6602422>.

“Mutant EZH2 Induces a Pre-Malignant Lymphoma Niche by Reprogramming the Immune Response - PubMed.” n.d. Accessed October 13, 2021. <https://pubmed-ncbi-nlm-nih-gov.proxy.insermbiblio.inist.fr/32396861/>.

Ogilvy, S., D. Metcalf, C. G. Print, M. L. Bath, A. W. Harris, and J. M. Adams. 1999. “Constitutive Bcl-2 Expression throughout the Hematopoietic Compartment Affects Multiple Lineages and Enhances Progenitor Cell Survival.” *Proceedings of the National Academy of Sciences of the United States of America* 96 (26): 14943–48. <https://doi.org/10.1073/pnas.96.26.14943>.

Onishi, Mashun, Koji Yamano, Miyuki Sato, Noriyuki Matsuda, and Koji Okamoto. 2021. “Molecular Mechanisms and Physiological Functions of Mitophagy.” *The EMBO Journal* 40 (3): e104705. <https://doi.org/10.15252/embj.2020104705>.

Onnis, Anna, Valentina Cianfanelli, Chiara Cassioli, Dijana Samardzic, Pier Giuseppe Pelicci, Francesco Cecconi, and Cosima T. Baldari. 2018. “The Pro-Oxidant Adaptor P66SHC Promotes B Cell Mitophagy by Disrupting Mitochondrial Integrity and Recruiting LC3-II.” *Autophagy* 14 (12): 2117–38. <https://doi.org/10.1080/15548627.2018.1505153>.

Peperzak, Victor, Ingela Vikström, Jennifer Walker, Stefan P. Glaser, Melanie LePage, Christine M. Coquery, Loren D. Erickson, et al. 2013. “Mcl-1 Is Essential for the Survival of Plasma Cells.” *Nature Immunology* 14 (3): 290–97. <https://doi.org/10.1038/ni.2527>.

Péron, Sophie, Brice Laffleur, Nicolas Denis-Lagache, Jeanne Cook-Moreau, Aurélien Tinguely, Laurent Delpy, Yves Denizot, Eric Pinaud, and Michel Cogné. 2012. “AID-Driven Deletion Causes Immunoglobulin Heavy Chain Locus Suicide Recombination in B Cells.” *Science (New York, N.Y.)* 336 (6083): 931–34. <https://doi.org/10.1126/science.1218692>.

Pinaud, Eric, Marie Marquet, Rémi Fiancette, Sophie Péron, Christelle Vincent-Fabert, Yves Denizot, and Michel Cogné. 2011. “The IgH Locus 3’ Regulatory Region: Pulling the Strings from Behind.” *Advances in Immunology* 110: 27–70. <https://doi.org/10.1016/B978-0-12-387663-8.00002-8>.

Raghavan, Sathees C., Patrick C. Swanson, Xiantuo Wu, Chih-Lin Hsieh, and Michael R. Lieber. 2004. “A Non-B-DNA Structure at the Bcl-2 Major Breakpoint Region Is Cleaved by the RAG Complex.” *Nature* 428 (6978): 88–93. <https://doi.org/10.1038/nature02355>.

Rivas, Martín A., Cem Meydan, Christopher R. Chin, Matt F. Challman, Daleum Kim, Bhavneet Bhinder, Andreas Kloetgen, et al. 2021. “Smc3 Dosage Regulates B Cell Transit through Germinal Centers and Restricts Their Malignant Transformation.” *Nature Immunology* 22 (2): 240–53. <https://doi.org/10.1038/s41590-020-00827-8>.

Rouaud, Pauline, Christelle Vincent-Fabert, Alexis Saintamand, Rémi Fiancette, Marie Marquet, Isabelle Robert, Bernardo Reina-San-Martin, Eric Pinaud, Michel Cogné, and Yves Denizot. 2013. “The IgH 3’ Regulatory Region Controls Somatic Hypermutation in Germinal Center B Cells.” *The Journal of Experimental Medicine* 210 (8): 1501–7. <https://doi.org/10.1084/jem.20130072>.

Roulland, Sandrine, Mustapha Faroudi, Emilie Mamessier, Stéphanie Sungalee, Gilles Salles, and Bertrand Nadel. 2011. “Early Steps of Follicular Lymphoma Pathogenesis.” *Advances in Immunology* 111: 1–46. <https://doi.org/10.1016/B978-0-12-385991-4.00001-5>.

Ruminy, P., F. Jardin, J. M. Picquenot, P. Gaulard, F. Parmentier, G. Buchonnet, C. Maisonneuve, H. Tilly, and C. Bastard. 2006. “Two Patterns of Chromosomal Breakpoint Locations on the Immunoglobulin Heavy-Chain Locus in B-Cell Lymphomas with t(3;14)(Q27;Q32): Relevance to Histology.” *Oncogene* 25 (35): 4947–54. <https://doi.org/10.1038/sj.onc.1209512>.

Saintamand, Alexis, Pauline Rouaud, Faten Saad, Géraldine Rios, Michel Cogné, and Yves Denizot. 2015. “Elucidation of IgH 3’ Region Regulatory Role during Class Switch Recombination via Germline

Deletion." *Nature Communications* 6: 7084. <https://doi.org/10.1038/ncomms8084>.

Saito, Masumichi, Urban Novak, Erich Piovan, Katia Basso, Pavel Sumazin, Christof Schneider, Marta Crespo, et al. 2009. "BCL6 Suppression of BCL2 via Miz1 and Its Disruption in Diffuse Large B Cell Lymphoma." *Proceedings of the National Academy of Sciences of the United States of America* 106 (27): 11294–99. <https://doi.org/10.1073/pnas.0903854106>.

Smith, K. G., A. Light, L. A. O'Reilly, S. M. Ang, A. Strasser, and D. Tarlinton. 2000. "Bcl-2 Transgene Expression Inhibits Apoptosis in the Germinal Center and Reveals Differences in the Selection of Memory B Cells and Bone Marrow Antibody-Forming Cells." *The Journal of Experimental Medicine* 191 (3): 475–84. <https://doi.org/10.1084/jem.191.3.475>.

Strasser, A., A. W. Harris, M. L. Bath, and S. Cory. 1990. "Novel Primitive Lymphoid Tumours Induced in Transgenic Mice by Cooperation between Myc and Bcl-2." *Nature* 348 (6299): 331–33. <https://doi.org/10.1038/348331a0>.

Strasser, A., S. Whittingham, D. L. Vaux, M. L. Bath, J. M. Adams, S. Cory, and A. W. Harris. 1991. "Enforced BCL2 Expression in B-Lymphoid Cells Prolongs Antibody Responses and Elicits Autoimmune Disease." *Proceedings of the National Academy of Sciences of the United States of America* 88 (19): 8661–65.

Stuart, Tim, Andrew Butler, Paul Hoffman, Christoph Hafemeister, Efthymia Papalexi, William M. Mauck, Yuhao Hao, Marlon Stoeckius, Peter Smibert, and Rahul Satija. 2019. "Comprehensive Integration of Single-Cell Data." *Cell* 177 (7): 1888-1902.e21. <https://doi.org/10.1016/j.cell.2019.05.031>.

Sungalee, Stéphanie, Emilie Mamessier, Ester Morgado, Emilie Grégoire, Philip Z. Brohawn, Christopher A. Morehouse, Nathalie Jouve, et al. 2014. "Germinal Center Reentries of BCL2-Overexpressing B Cells Drive Follicular Lymphoma Progression." *The Journal of Clinical Investigation* 124 (12): 5337–51. <https://doi.org/10.1172/JCI72415>.

Szymanowska, Natalia, Wolfram Klapper, Stefan Gesk, Ralf Küppers, José I. Martín-Subero, and Reiner Siebert. 2008. "BCL2 and BCL3 Are Recurrent Translocation Partners of the IGH Locus." *Cancer Genetics and Cytogenetics* 186 (2): 110–14. <https://doi.org/10.1016/j.cancergencyto.2008.06.007>.

Tellier, Julie, Cedric Menard, Sandrine Roulland, Nadine Martin, Céline Monvoisin, Lionel Chasson, Bertrand Nadel, Philippe Gaulard, Claudine Schiff, and Karin Tarte. 2014. "Human t(14;18) Positive Germinal Center B Cells: A New Step in Follicular Lymphoma Pathogenesis?" *Blood* 123 (22): 3462–65. <https://doi.org/10.1182/blood-2013-12-545954>.

Toellner, Kai-Michael, William E. Jenkinson, Dale R. Taylor, Mahmood Khan, Daniel M.-Y. Sze, David M. Sansom, Carola G. Vinuesa, and Ian C. M. MacLennan. 2002. "Low-Level Hypermutation in T Cell-Independent Germinal Centers Compared with High Mutation Rates Associated with T Cell-Dependent Germinal Centers." *The Journal of Experimental Medicine* 195 (3): 383–89. <https://doi.org/10.1084/jem.20011112>.

Vogelsberg, Antonio, Julia Steinhilber, Barbara Mankel, Birgit Federmann, Janine Schmidt, Ivonne A. Montes-Mojarro, Katrin Hüttl, et al. 2021. "Genetic Evolution of in Situ Follicular Neoplasia to Aggressive B-Cell Lymphoma of Germinal Center Subtype." *Haematologica* 106 (10): 2673–81. <https://doi.org/10.3324/haematol.2020.254854>.

Zhang, Chunmei, Rende Li, Yongming Li, Chaojun Song, Zhijia Liu, Yun Zhang, Zhuwei Xu, et al. 2012. "Establishment of Reverse Direct ELISA and Its Application in Screening High-Affinity Monoclonal Antibodies." *Hybridoma* 31 (4): 284–88. <https://doi.org/10.1089/hyb.2012.0010>.

Supplemental information

Supplementary Table 1 : Table summarizing the list of antibodies used for the staining Panel of B and T cells in the Bone Marrow and peripheral lymphoid organs (Spleen / mesenteric Lymph nodes). Antibodies used for intracellular staining of permeabilized cells are highlighted in grey

LB Moelle (BM)				Peripheral B cells (Spleen + mesenteric Lymph nodes)				T cells (Spleen + mesenteric Lymph nodes)			
Antibody	Reference	Supplier	Dilution	Antibody	Reference	Supplier	Dilution	Antibody	Reference	Supplier	Dilution
Bcl2 BV421	Bcl-2/100	BD Biosciences	1/50	Bcl2 BV421	Bcl-2/100	BD Biosciences	1/50	Ki-67 BV786	B56	BD Biosciences	1/50
CD19 BV510	1D3	BD Biosciences	1/200	CD19 BV510	1D3	BD Biosciences	1/200	Bcl6 FITC	K112-91	BD Biosciences	1/50
CD24 BV650	M1/69	BD Biosciences	1/400	CD93 BV650	AA4.1	BD Biosciences	1/200	fox P3 PE	FJK-16s	Invitrogen	1/100
CD23 BV711	B3B4	BD Biosciences	1/100	CD138 Biotin	281-2	Biologend	1/200	CD62L BV421	MEL-14	BD Biosciences	1/1000
B220Bv786	RA3-6B2	BD Biosciences	1/100	CD23 FITC/ A488	B3B4	Biologend	1/100	CD4 PE-CF594	RM4-5	BD Biosciences	1/400
CD2 FITC/A488	RM2-5	BD Biosciences	1/800	IgD PerCP-Cy5.5	11-26c.2a	BD Biosciences	1/100	Icos PerCP-Cy5.5	C398.4A	Biologend	1/100
CD117 PerCP-Cy5.5	2B8	Biologend	1/50	CXCR4 PE	551966	BD Biosciences	1/50	PD1 PE-Cy7	29F.1A12	Biologend	1/50
CD43 PE	S7	BD Biosciences	1/50	CD21 PE-CF594	7G6	BD Biosciences	1/400	CXCR5 APC	REA215	Milteny Biotech	1/50
BP1 Biotin	6C3	BD Biosciences	1/25	IgM PC7	eB121-15F9	Invitrogen	1/200	CD44 APC-cy7	IM7	BD Biosciences	1/100
IgM PE-Cy5	II/41	eBiosciences	1/100	GI7 APC	GL7	Invitrogen	1/100	FVS 510	564406	BD Biosciences	1/1000
CD25 PE-Cy7	PC61	Biologend	1/50	CD38 APC-R700	90	Invitrogen	1/100				
CD127 APC	564175	BD Biosciences	1/50	Streptavidin BV786	563858	BD Biosciences	1/400				
CD138 APC-R700	281-2	BD Biosciences	1/200	FVS 780 APC-H7	565388	BD Biosciences	1/1000				
Streptavidin PE-CF594	562318	BD Biosciences	1/400								
FVS 780 APC-H7	565388	BD Biosciences	1/1000								

Intracellular antibodies are highlighted in Grey

A. Gating strategy for B cells in the Bone marrow

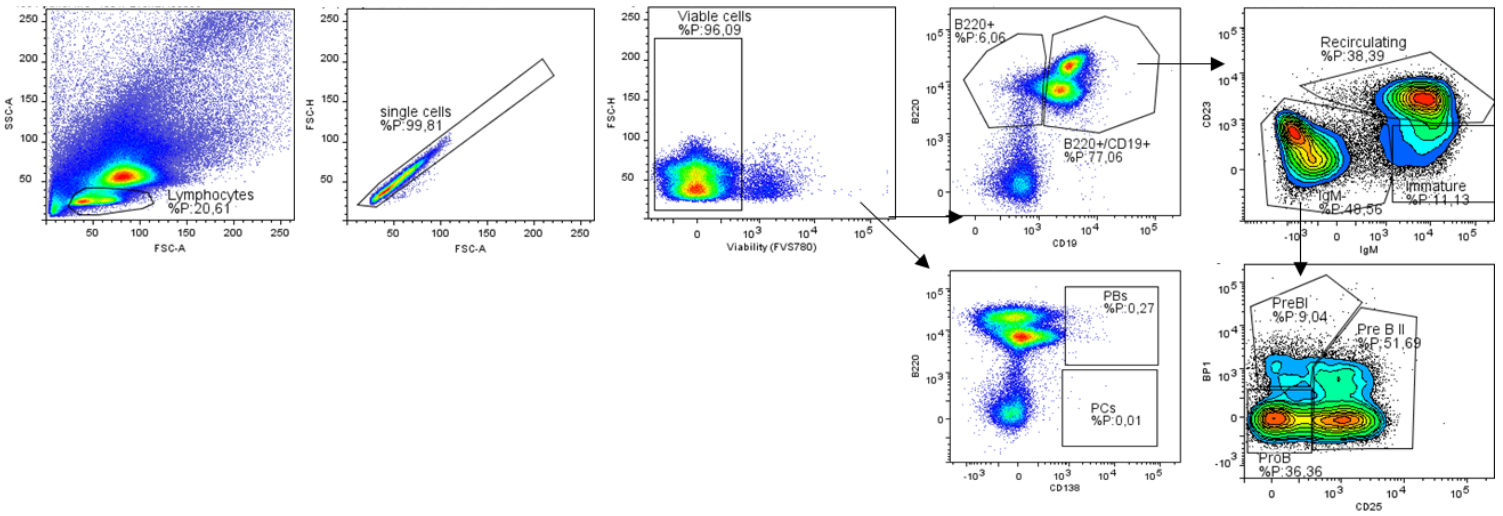

B. Gating strategy for peripheral B cells (spleen and mesenteric LNs)

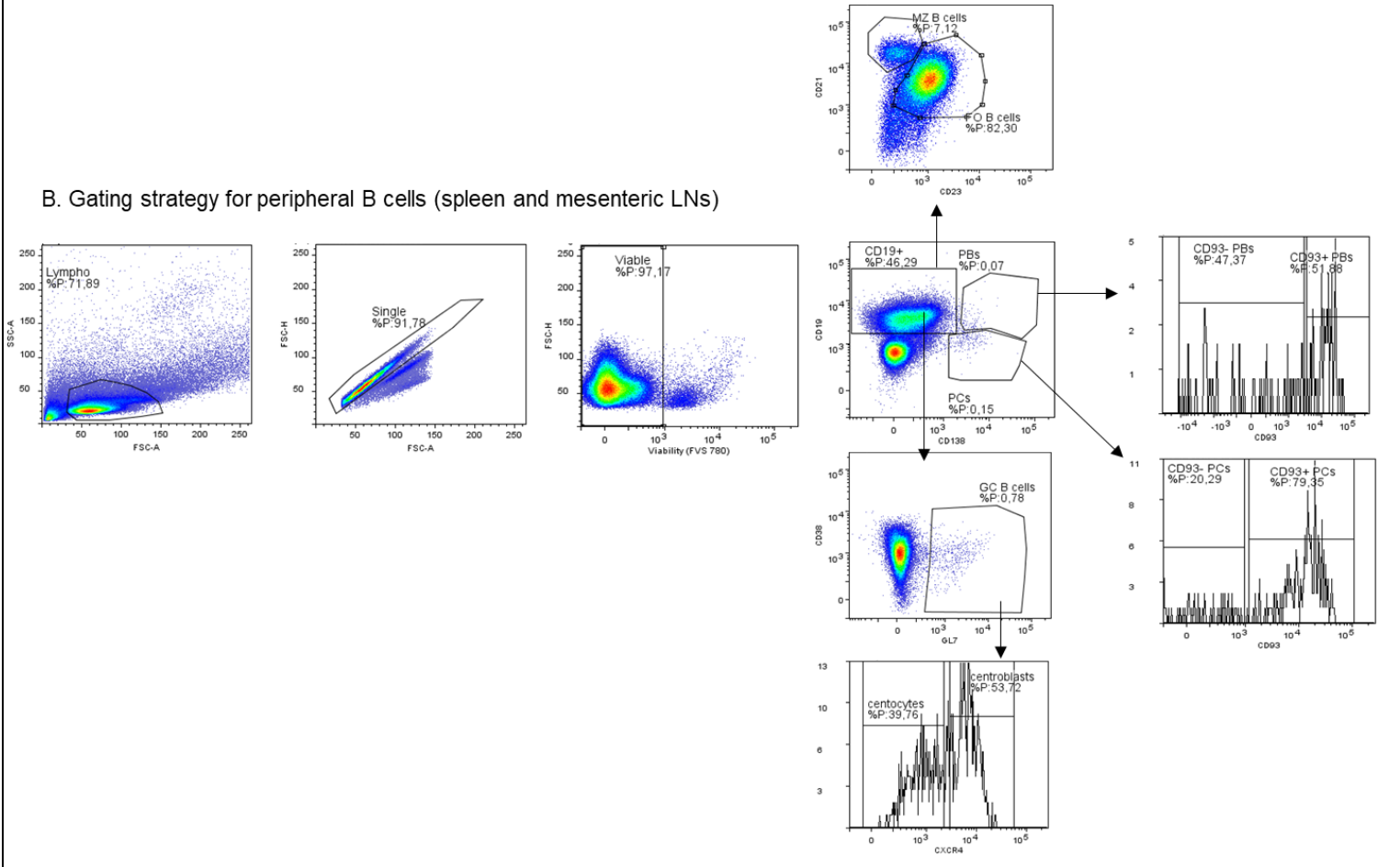

C. Gating strategy for peripheral T cells (in spleen and mesenteric LNs)

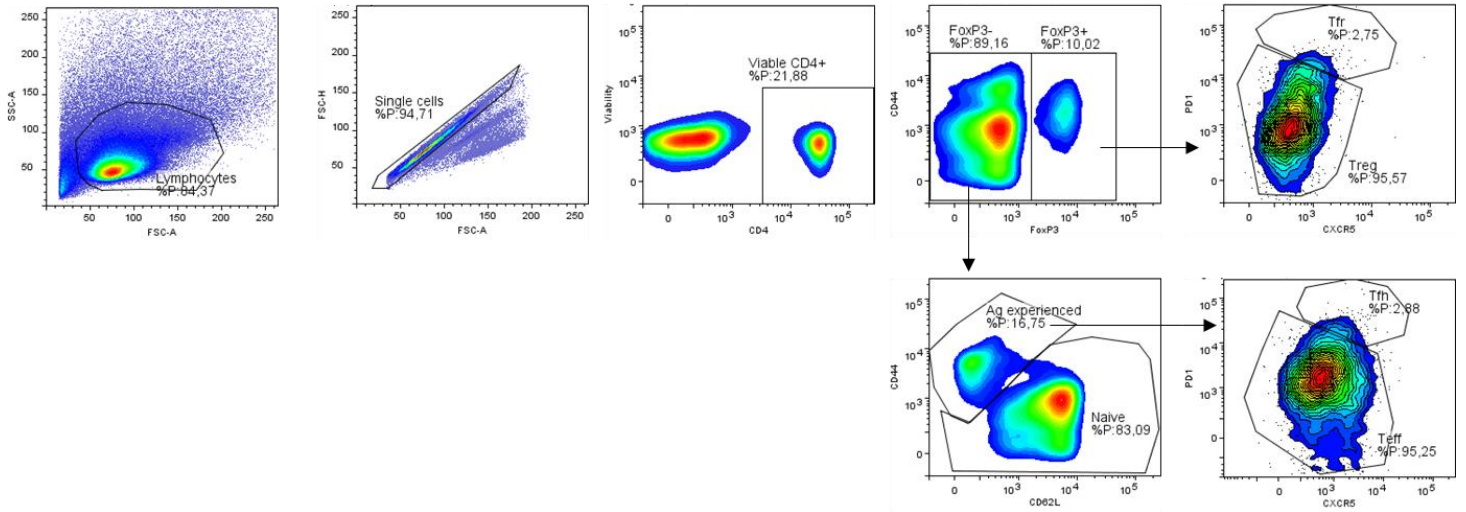

Supplementary Figure 2: (A). Gating strategy for staining of B cells in the bone marrow and periphery respectively. (B). Gating strategy for staining of B-lineage cells in the spleen or lymph nodes (C) Gating strategy for the staining of T cells in the periphery (staining examples are from a resting unimmunized WT mouse).

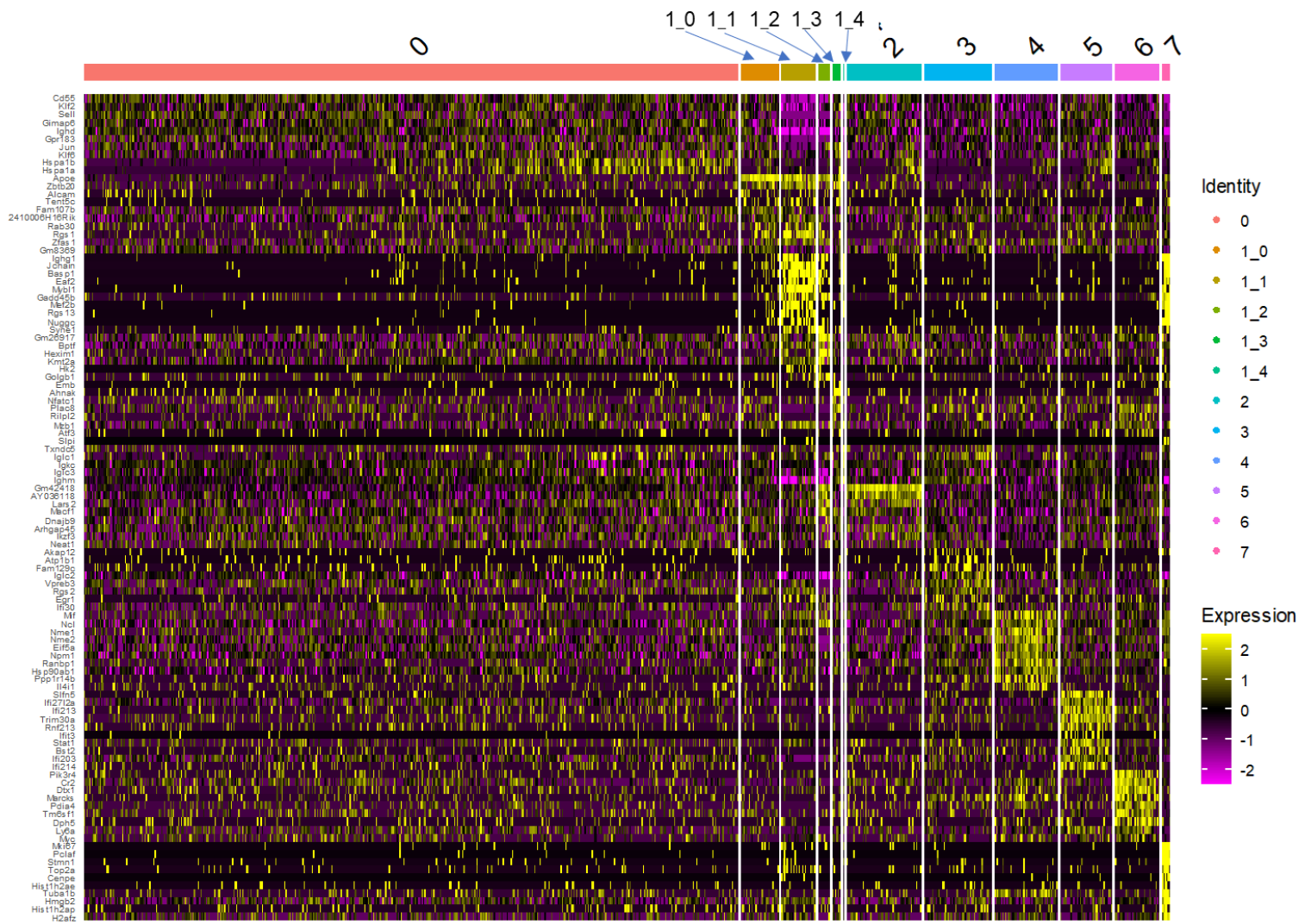

Supplementary Figure 2: Heatmap showing expression of the Top 10 differentially expressed genes defining the various B-cell clusters identified by single-cell transcriptome analysis.

Unpublished Data: BCL2 deregulation and secondary mutations.

It is well established that FL has a very complex development that spans over several years or decades. This means that the deregulation of BCL2 alone is never sufficient to induce FL. Over the course of the years, the malignant cells go through several cycles of entry and, most probably, a defective exit into and from the GC, making them highly susceptible for the accumulation of additional mutations that help facilitate the development of FL.

So, as mentioned in my thesis objective, our work progressed in a sequential manner. The upcoming part of my thesis focuses on the additional mouse models we used, that carry secondary mutations well known to occur in FL.

Based on the results obtained in article 1, we came to a conclusion that the 3'RR-*BCL2* model is the most pertinent mouse model for our study. The main reasons being the focused increase of BCL2 expression at the GC B cell stage rather than very early in B cell development, the less significant enlargement of the PC population compared to the Igκ-*BCL2* model and of course, the pertinent increase in the GC compartment in the periphery.

Kappa-MOUSS mice

The first mouse model that we chose is called Kappa-MOUSS. These mice are a Knock-in carrying a fixed Kappa light chain with the insertion of an N-glycosylation motif in the variable region. While extremely rare in normal B cells (occurring in less than 10%), V region N-glycosylation is quite frequent in FL (roughly 90% of cases, involving either IgH or IgL variable domain). Again, the continuous entry and exit of malignant cells into and from the GC, and their subjection to several rounds of SHM may lead to the introduction of N-glycosylation motifs in the variable regions of both the heavy and light Ig chains. A striking feature is that the oligosaccharides added to these V region N-glycosylated sites are usually expressed in malignant B-cells under an “immature” format, *i.e.* of the high-mannose type. Various studies have shown that such acquired high-mannose glycans are capable of interacting with mannose-specific lectins, especially the human DC-SIGN. The same interaction can (either during infections or experimentally) occur also with bacterial lectins, thereby triggering

continuous activation of the BCR, as well as signaling pathways similar to those demonstrated for BCR engagement by an antigen. Of note, constitutive BCR signaling has been shown to be indispensable for the survival of several lymphoma cell types.

Based on these data, we crossed our 3'RR-*BCL2* mice with hemizygous Kappa-MOUSS mice, thus bringing a “pre-rearranged Ig κ gene, which then mediates allelic exclusion and restricts all B-cells to the expression of this artificially monoclonal V κ J κ rearrangement. The work done on these mice can be divided into 3 sections which I will discuss below, each of which was dedicated to answering a certain question we had in mind:

1- Is there a cumulative a cumulative effect of both mutations on B cell development?

Method used: We ran a 7-day SRBC injection on a cohort of 7 WT, 3 3'RR-*BCL2*, 4 Kappa-MOUSS $\Delta/+$ and 4 3'RR-*BCL2* x MOUSS $\Delta/+$ (referred to as double mutant) mice. Mice were sacrificed at day 7 and splenocytes were primarily analyzed by flow cytometry using the same B-cell panel explained in article 1.

Results obtained: The preliminary data obtained (Fig. 30) showed that the presence of a fixed kappa light chain along with *BCL2* deregulation lead to a decrease in both B and Plasma cell levels compared to the 3'RR-*BCL2* mice that carry the *BCL2* deregulation only.

On the contrary, GC B cells and centroblasts increased in the double mutant mice compared to both WT and 3'RR-*BCL2* mice, thereby suggesting that there is indeed a cumulative effect of both mutations on the GC B cells compartment.

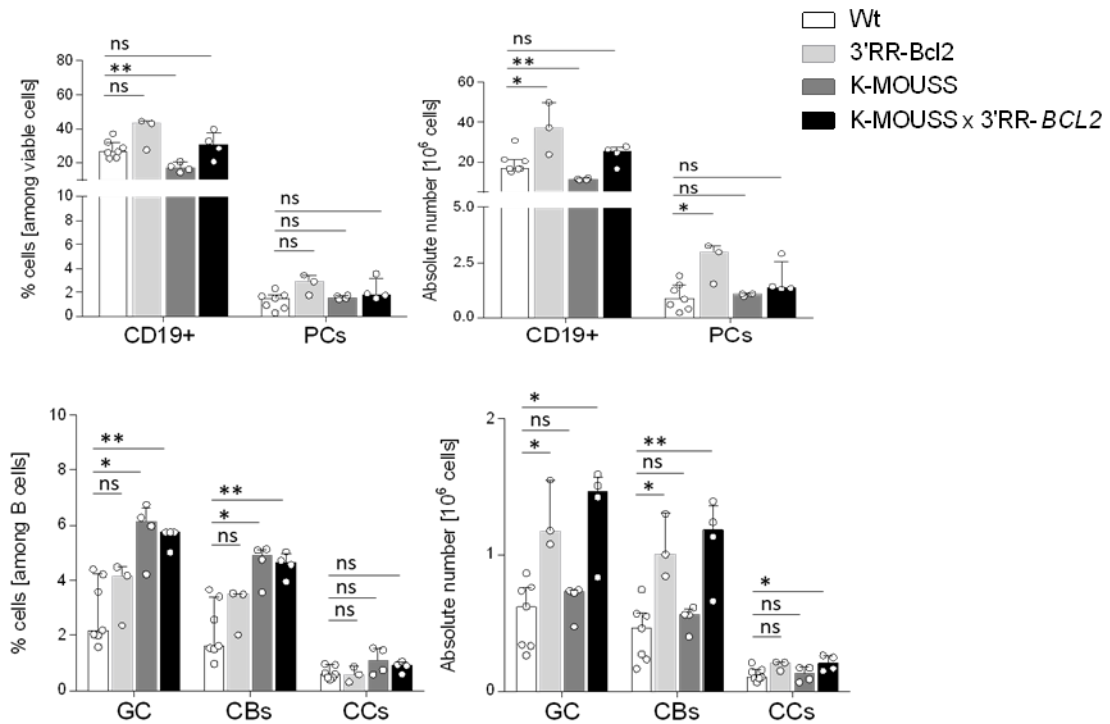

Figure 30: The cumulative effect of BCR N-glycosylation and BCL2 deregulation on splenocytes. Flow cytometry data on B cells in splenocytes realized 7 days after SRBC injection on WT, 3'RR-*BCL2*, Kappa-MOUSS and MOUSS x 3'RR-*BCL2* mice, to show the cumulative effect of both mutations on B peripheral B cells. Percentages of GC B cells were realized among that of CD19+ cells, and the absolute cells numbers were calculated based on the total percentage of lymphocytes in the spleen. Data are presented in bargraphs as medians with interquartile range and the statistical significance were done using the Mann-Whitney *U* test.

2- Does the presence of N-glycosylation site lead to BCR activation via interaction with lectins?

As mentioned earlier, the oligosaccharides added to the N-glycosylated sites are usually immature and are capable of interacting with various lectins leading to a continuous activation of the BCR. Starting from this fact, we wanted to further characterize our double mutant mice by trying to see if we can recapitulate this notion in-vitro.

Despite the countless efforts and the immense amount of time that were devoted to this section of our project, unfortunately, we were not able to yield good and reproducible data.

Method used: To briefly explain, we tried to do several in-vitro culture assays on splenocytes from 7-day immunized WT, Kappa-MOUSS, 3'RR-*BCL2* and double mutant mice in the presence of lipopolysaccharide (LPS, B4 ultrapure, as a positive

control), DC-SIGN or bacterial lectins (called LecB and BC2LA) that we got in collaboration with Dr Annabelle Varrot, director of research in CERMAV Laboratory, Grenoble, FRANCE.

Cultures were done under appropriate conditions, using culture media with calcium, for 24, 48 and 72 hrs followed by flow cytometry data analyses using the same lectins but coupled to a fluorescent label, as well as 2 fluorescently labelled proteins that are effectors in the BCR signaling pathways:

- 1- Phospho-p44/42 MAPK (Erk1/2) (Thr202/Tyr204) (197G2) Rabbit monoclonal antibody (A488 conjugate, #13214)
- 2- Phospho-Zap-70 (Tyr319) Syk (Tyr352) (65E4) Rabbit monoclonal antibody (Alexa Fluor 647 conjugate, #82975)

In parallel, we tried to run kinetics assays for 0, 2, 5 and 10 minutes of induction with either of the lectins as well as IgM as a positive control (Goat anti-mouse IgM unlabeled, southern biotech) as a positive control, followed by the same flow cytometry staining.

Our goal was to analyze B, GC B and plasma cells and see if we can detect their interaction with lectins and whether this interaction is leading to BCR activation (by detection of both cell-signaling proteins) or not.

Results obtained: Unfortunately, none of the results that we obtained were as we anticipated (data not shown).

With flow cytometry, we did not obtain a much-elevated level of neither GC B / plasma cells binding the lectins, nor the signaling proteins (ERK and SYK). Not to mention that we always seemed to have a lot of trouble with compensation of the fluorescent signals, especially for ERK and SYK.

After the countless trials with flow cytometry, we decided to switch to a less quantitative assay which was Western Blot, but even with that we could not yield good reproducible data.

3- Are WT mice were really the pertinent controls for this specific part of this study?

The answer was no, because we assumed that a control harboring the same conditions of “quasi-monoclonal” restriction of the Ig light chain repertoire as our Kappa-Mouss mice would be more ideal. So, we decided to switch to another, more

appropriate, mouse model, called ROC, that is also a knock-in carrying fixed kappa light chain (same Vk1 subgroup as for Kappa-MOUSS), but this time it was without any N-glycosylation motif.

Method used: We ran the same 7-day SRBC injection on another cohort comprised of 13 Kappa-MOUSS $\Delta/+$, 9 ROC $\Delta/+$ and 11 WT mice followed by the same flow cytometry analysis on splenocytes.

Results obtained: We saw that ROC mice were, figuratively speaking, “killing” the Kappa-MOUSS mice by having a higher amount of both GC B cells and centroblasts (Fig 31). Knowing that, it is important to consider both WT controls and “k-monoclonal” controls before taking any firm conclusions from all studies made with Kappa-MOUSS mice.

Therefore, based on such discouraging preliminary results and after devoting so much time on this part of our project, we thought it would be fit to press pause on experimenting with these double mutant MOUSS x 3'RR-*BCL2* mice in order to carry on with the analysis of other mice that we were developing in parallel.

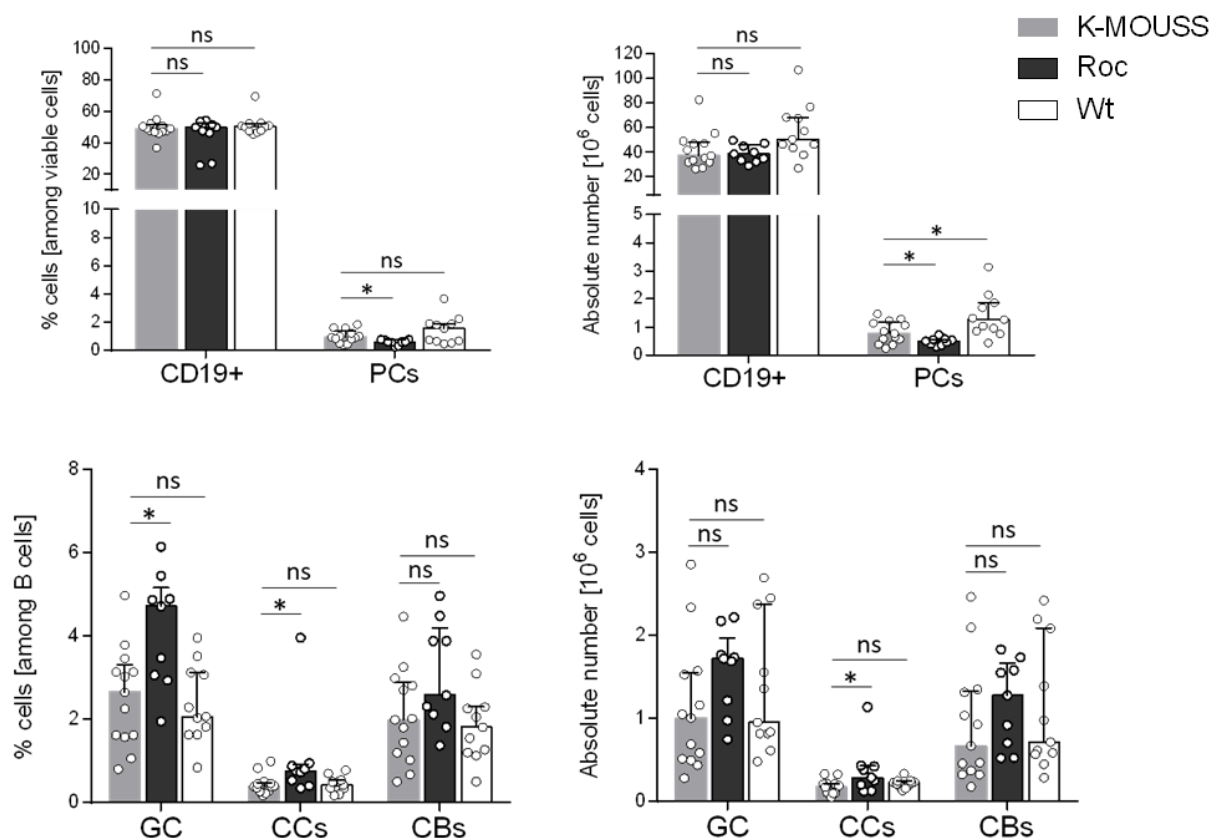

Figure 31: ROC versus WT compared to Kappa-MOUSS.

Flow cytometry data on B cells in splenocytes following a 7-day SRBC injection on WT and hemizygous ROC and K-MOUSS mice. Percentages of GC B cells were realized among that of CD19+ cells, and the absolute cells numbers were calculated based on the total percentage of lymphocytes in the spleen. Data are presented in bar graphs as medians with interquartile range and the statistical significances were done using the Mann-Whitney *U* test, either comparing Kappa-MOUSS mice to WT or to ROC mice.

HVEM and KMT2D Conditional Knock-Outs (HVEM / KMT2D x 3'RR-Bcl2 x AID-Cre ERT2/LSL-Tomato)

The other mouse models that we chose for our study involved proteins that were involved in the regulation of the microenvironment surrounding the malignant cells.

Two of the very famous secondary mutations known to occur in FL are the deletions of the proteins HVEM and KMT2D. A brief reminder, HVEM or the herpes virus entry mediator, is a receptor expressed in both T and B cells. Depending on its interaction with multiple ligands, HVEM can deliver opposing signals controlling both inflammatory and inhibitory responses. Nonsense, frameshift as well as missense mutations, frequently in the exons encoding the ectodomain of HVEM have been found in a significant portion of FL cases (40% of FL cases). As mentioned in Chapter 3 of my thesis introduction, loss of HVEM is thought to disrupt cell-cell interactions, thereby forming a tumor-supportive microenvironment characterized by exacerbated lymphoid stroma activation and increased recruitment of Tfh cells. It has been shown that the deletion of HVEM in genetically modified mice carrying the Bcl2 transgene facilitated immune escape of the malignant B cells, yielded cell autonomous activation of B cell proliferation with an increased incidence of GC-derived lymphomas.

KMT2D on the other hand, is a histone methyltransferase which, in normal cases, acts as a tumor suppressor. However, its deletion or inactivation has been detected in 90% of FL cases (and DLBCL). Again, studies using CD19-Cre conditional knock out models showed that KMT2D deletion not only accelerates lymphomagenesis through significant expansion of the GC B cell population but also affects B-cell physiology, including the positive regulation of apoptosis, CD40 signaling, and the control of cell migration and proliferation (Pasqualucci 2019).

Based on these data, we decided to cross our 3'RR-*BCL2* mice with mice that are conditional knock-outs for either HVEM or KMT2D. In order to induce this secondary mutation exclusively in GC B cells, these mice were also crossed with mice expressing the Cre recombinase under the control of an AID promoter (a knock-in of the cre-recombinase gene within the AICDA gene on mouse chromosome 6), in response to tamoxifen induction (AID-CreERT2/LSL-Tomato).

Mice that carried the 3'RR-*BCL2* deregulation, were homozygous for HVEM / KMT2D (HVEM / KMT2D^{fl/fl}) and were hemizygous for both AID and Tomato expression (AID-Cre Ert2^{-/+} x LSL-Tomato^{-/+}) were considered "Triple mutant (TM)". In order to generate

adequate animals for study (with one functional allele of AICDA left), we had to generate colonies of “perfect parents”, both with homozygous Floxed KMT2D or HVEM, one parent bringing the deregulated Bcl2 and the other homozygous for the AICDA replacement (AID-creERT2).

To really highlight the impact of BCL2 deregulation, we chose to compare these mice to a control group (which I will be referring to as double mutants) that harbored the exact same conditions but without the deregulation of BCL2 (*i.e.* double mutant controls were HVEM / KMT2D^{fl/fl} and AID-Cre Ert2^{-/+}, LSL-Tomato^{-/+}).

To activate the Cre-recombinase with tamoxifen in mice, we ran several tests and concluded that the optimal induction method is the oral introduction of tamoxifen (at a concentration of 40 mg/ml) at day 0, when mice turn 3 months of age, accompanied with an intra-peritoneal injection of SRBC. Tamoxifen administration is then repeated twice at days 2 and 4 (Fig 32 A).

To verify that indeed our system is functional, we verified the deletion of either gene by PCR (data not shown). In parallel, we withdrew blood from the submandibular vein of our living mice at day 10 (*i.e.* one week after the last tamoxifen introduction) and we verified the expression, by flow cytometry, of tomato (excitation and emission maxima at 554 nm and 581 nm, similar to PE) in the B cell population found in the blood. Markers for B cells (CD19 BV510 and IgM FITC) Though the percentage of lymphocytes is low in the blood, we were indeed able to see an elevated level of B cells expressing tomato, compared to the control mice (Fig 32 B).

After that, 5 SRBC injections were carried out on a monthly basis (*i.e.* from the 3rd to the 7th month).

In parallel, a monthly follow up of tomato expression in the blood was also carried out (even after the SRBC injections stopped). With that we showed that we were able to maintain and detect a stable expression of tomato in our mice for almost a year after the primary induction (Fig 32 C).

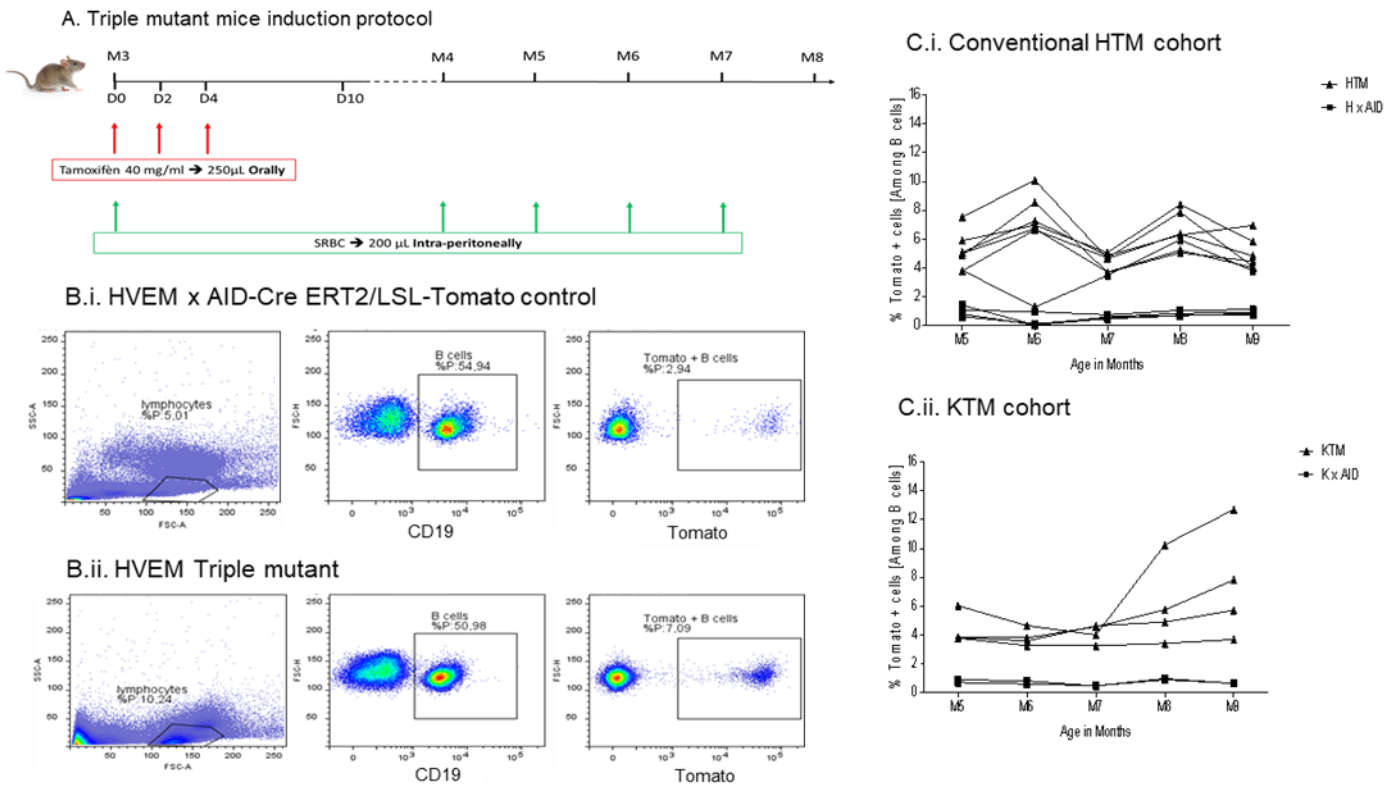

Figure 32: Triple mutant mouse induction and follow up.

(A) Triple mutant induction protocol followed to activate the activity of Cre-Recombinase enzyme to carry out the knock-out / deletion of HVEM or KMT2D (and thereby drive tomato expression) in GC B cells. 3 doses of tamoxifen (at 40 mg/ml) are administered orally at days 0, 2 and 4 when mice are 3 months of age (M3). In parallel an intra-peritoneal injection of SRBC is also administered at day 0 and repeated on a monthly basis 4 additional times. (B). Flow cytometry data to detect Tomato expressing B cells that are circulating in the blood of living mice (withdrawn from the submandibular vein), one week after the last tamoxifen administrations (*i.e.* at day 10). An example of one HVEM triple mutant mouse versus one control mouse is shown, but the exact same is obtained for KMT2D mice. (C) Graph showing the evolution of the tomato expressing B cell population (circulating in blood) in HVEM (C.i.) or KMT2D (C.ii.) triple mutant mice compared to their respective controls, 2 months post induction (*i.e.* M5) to up to 5 months (*i.e.* M9).

Mouse cohorts used:

1- HVEM Triple mutant (HTM) mouse cohorts:

Originally, the idea was to analyze one single cohort with both triple mutant and control mice. However, the crossings to obtain the mice in the appropriate genotype was quite challenging. So, we initially obtained a group of mice, in the specific and opportunistic free (SOPF) animal facility, comprised of 11 HVEM TM mice only (without controls). Then we obtained 7 additional triple mutant mice and 4 double mutant controls. Unfortunately, shortly after that, we had the covid-19 outbreak and our inability to follow up the work forced us to move these mice to the unprotected conventional animal facility, and to start their induction at a slightly older age than the first group of mice. That's why we were obliged to follow up and analyze these mice as two separate

cohorts which I will be referring to as the SOPF cohort and the conventional cohort respectively.

2- KMT2D Triple mutant (KTM) mouse cohorts:

For these mice we only obtained one cohort comprised of 4 KMT2D triple mutants and 2 double mutant controls. Again, we struggled with the breeding of these mice and were only capable of obtaining this initial cohort. Breeding is still ongoing however and we expect additional cohorts in the near future.

Results obtained:

I will begin first by describing the preliminary results obtained for the HVEM TM mice, as we were able to obtain bigger cohorts which we were able to analyze more carefully compared to KMT2D TM mice.

1- HVEM triple mutant mice:

To highlight the impact of BCL2 deregulation in our mice, we first began by analyzing the TM mice before they develop any tumor, compared to the double mutant controls. FACS data using the same staining panel described in article 1, but slightly modified to have the expression of tomato, were done.

Focusing primarily on the periphery (Spleen and mesenteric LNs), we were able to show that, while there was no significant effect on B cells in the TM mice compared to the controls, there was an expansion of the plasma cell population, only in the LNs. On the other hand, a significant increase was seen for the GC B cells (most of which are expressing tomato), centroblasts and centrocytes was seen in both peripheral organs as well.

Interestingly, the comparison of the ratio of GC to plasma cells (PCs) between Tomato+ cells (thus with HVEM deletion) and Tomato^{neg} cells (then HVEM proficient), showed that this ratio is more significantly higher in TM mice compared to their respective controls only in the Tomato+ population, in both spleen and LNs. These data confirmed the cumulative effect of both mutations on the GC compartment (Fig. 33).

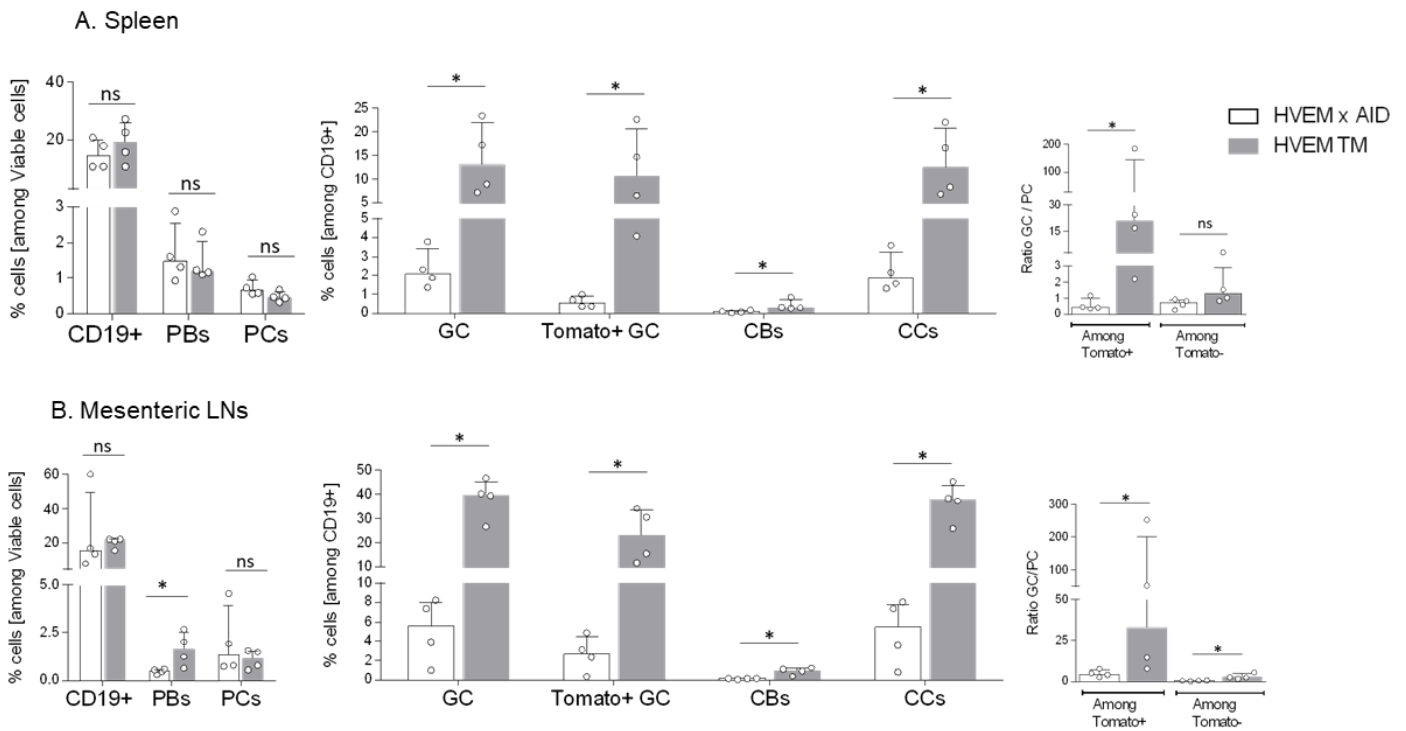

Figure 33: Cumulative effect of HVEM deletion and BCL2 deregulation on peripheral B cells.

Preliminary Flow cytometry data showing the cumulative effect of BCL2 deregulation and HVEM deletion on B cell compartments in secondary lymphoid organs (spleen in A and mesenteric LNs in B) only in the mice that did not develop tumors compared to their respective controls (*i.e.* only the non-tumoral mice of the conventional cohort are shown). Staining was done using our modified staining panel described in supplementary data.

Cells are shown as percentages only; absolute numbers could not be realized due to some experimental limitations. Data are presented as medians with interquartile range and the statistical significance is realized by the Mann-Whitney *U* test.

5 out of 11 mice for the SOPF cohort developed tumors and 3 out of 7 for the conventional cohort developed tumors at different ages and in different locations. All of the tumors developed revealed a GC / centrocyte phenotype, which is in contrast with the plasmacytic lymphomas developed in BCL2 single transgenic mice (article 1). In the majority of the cases, almost all of the malignant GC B cells expressed tomato (Tables 1 and 2). Only one case (HTM-5) however, showed no tomato expression but however carried the Cre-deletion of HVEM, this simply indicating that the Cre enzyme did a “partial job” in this clone during tamoxifen induction, only disrupting HVEM. This occurred as a result of Cre recombinase activity which we validated by the same PCR (data not shown).

Table 1 : Summary of tumor development, or not, in the HVEM triple mutant cohort bred in the SOPF animal facility. Full details are given for the mice that did develop tumors, indicating the corresponding age at which the tumor developed, the precise location of the tumor, whether, or not, there were any remarkable additional observations seen upon sacrifice in these tumoral mice and finally stating the phenotype obtained by flow cytometry data of each tumor.

Mouse Number	Age (weeks)	Tumor ?	If yes, where?	Other observations	Phenotype
HTM-1	88	✓	- Mesentric LNs - Kidney	- Weird Liver phenotype	- GC B (94,54%) / Centrocytes (97,45%) / Tomato+ (91,11%) - GC B (88,2%) / Centrocytes (98,94%) / Tomato+ (87,4%)
HTM-2	78	X	-	- Died of natural causes → Nothing weird	-
HTM-3	88	X	-	- Weird Liver phenotype	-
HTM-4	71	✓	- Mesentric LNs	-	- GC B (90,28%) / Centrocytes (97,14%) / Tomato+ (93,43%)
HTM-5	84	✓	- Mesentric LNs (4g weight)	- Splenomegaly	- GC B (99,04%) / Centrocytes (99,62%) / Tomato- (0,13%)
HTM-6	88	X	-	- Weird Liver phenotype - Mesenteric LNs fused together	-
HTM-7	88	X	-	- Huge spleen - Weird Liver phenotype	-
HTM-8	54	X	-	- Enlarged spleen with white dots - Greyish liver	-
HTM-9	88	X	-	- Extremely dark enlarged spleen - Weird Liver phenotype	-
HTM-10	88	✓	- Mesentric LNs	- Weird Liver phenotype	- GC B (81,03%) / Centrocytes (99,18%) / Tomato + (85,73%)
HTM-11	88	✓	- Mesentric LNs - Peyer's Patches	- Weird Liver phenotype	- GC B (62,11%) / Centrocytes (97,79%) / Tomato+ (23,77%) - GC B (38,25%) / Centrocytes (98,11%) / Tomato+ (73,81%)

Table 2: Summary of tumor development, or not, in the HVEM triple mutant cohort bred in the conventional animal facility. Full details are given for the mice that did develop tumors, indicating the corresponding age at which the tumor developed, the precise location of the tumor, whether, or not, there were any remarkable additional observations seen upon sacrifice in these tumoral mice and finally stating the phenotype obtained by flow cytometry data of each tumor.

Mouse Number	Age (Weeks)	Tumor ?	If yes, where?	Other observations	Phenotype
cHTM1	74	X	-	-	-
cHTM2	74	X	-	-	-
cHTM3	74	X	-	-	-
cHTM4	74	✓	- Mesentric LNs	-	- GC B (36,5 %) / Centrocytes (92,83 %) / Tomato+ (37,21 %)
cHTM5	74	✓	- Left and right kidneys - Liver - Splenomegaly	-	- Left: GC B (16,28 %) / Centrocytes (97,48 %) / Tomato+ (95,54 %) - Right: GC B (21,61 %) / Centrocytes (75,27 %) / Tomato+ (96,77 %) - Liver: GC B (10,19 %) / Centrocytes (94,62 %) / Tomato+ (83,61 %)
cHTM6	74	✓	- Mesenteric LNs	-	- GC B (42,71 %) / Centrocytes (89,79 %) / Tomato+ (95,31%)
cHTM7	74	X	-	- Weird testes phenotype	-

After that, we ran repertoire analyses using the exact same method described in article 1, but this time with UMIs to have a better quantification of the relative abundance of RNA templates, *i.e.* clearer identification of diversity and potential predominant clonotypes. IgM and IgG repertoires were evaluated in the periphery of TM mice carrying no tumor, and we saw no significant global effect on the clonality in our mice compared to the controls (Fig. 34).

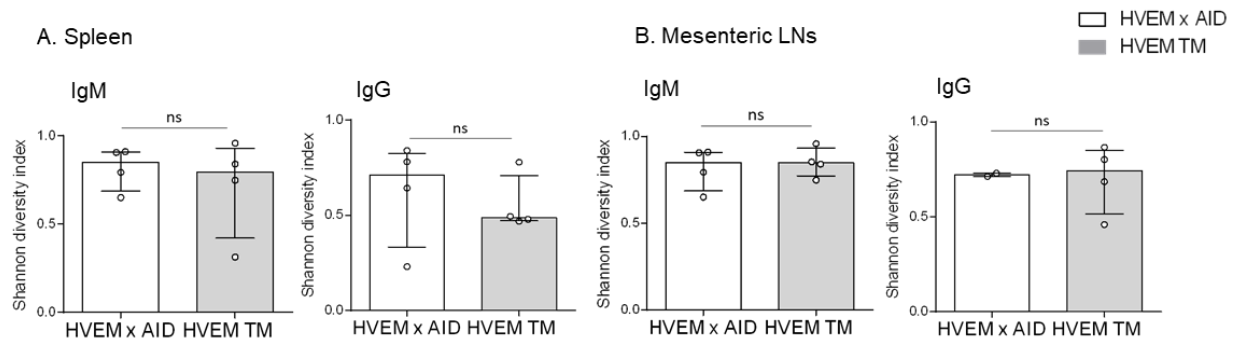

Figure 34 : Preliminary heavy chain (IgM and IgG) repertoire data in secondary lymphoid organs. Shannon diversity index for IgM and IgG in the triple mutant mice that did not develop tumors compared to their respective controls (*i.e.* only mice from the conventional cohort are shown) in the spleen (A) and mesenteric LNs in (B). The shannon diversity index is calculated via an R-studio script that analyzes the sequences of each heavy chain after high-throughput sequencing and a primary analysis step with IMGT High-V-Quest. The shannon diversity index is presented in bar graphs as medians with interquartile range and the statistical significance is realized via Mann-Whitney *U* test.

The same Ig repertoire sequencing analysis was run on the different tumors that were developed in both HVEM TM cohorts, this time with a more detailed description of each isotype in each tumor location (Tables 3). We observed that tumors obtained were rather oligoclonal than monoclonal, involving both IgM-producing and/or IgG-producing clones. Interestingly however, in some cases we saw that the same clone (as identified by its unique combination of VH, CDR3 length and JH) disseminated onto two different locations in the same mouse, sometimes with a different V mutation frequency between the 2 locations (such clones are highlighted in the same color (either red or blue) for identification).

Tables 3 : Detailed Ig heavy chain repertoire analyses of the different tumor tissues obtained for both HVEM TM cohorts.

The tumors obtained in the SOPF cohort are summarized in the table on top and conventional cohort ones are summarized in the table on the bottom). Data are obtained by an R-studio script after high-throughput sequencing of both IgM and IgG (when possible) and a primary analysis step with IMGT High-V-Quest tool. For each tumor, complete characterization of the most abundant clones is realized. A threshold of 10% was selected and only the clones having a frequency equal or higher to 10% are presented. For each tumor, in IgM and /or IgG, the total number of clones, the total number of productive reads is indicated and then for each most abundant clone, the used V and J gene along with the V mutation frequency (without CDR3) and the corresponding CDR3 length (in amino acids (AA)) is indicated. Clones that are found in different tumor locations in the same mouse are highlighted in the same color (Either red or Blue).

Genotype	Mouse nb	Tumor location	Heavy chain	Total number of clones	Total number of productive reads	V_gene	J_gene	Frequency (Clones ≥ 10%)	V_mutation frequency (without CDR3)	CDR3 length (AA)
HVEM triple mutant (SOPF cohort)	HTM-1	LN	IgM	1690	8414	IGHV4-1	IGHJ1	31,6	0,2	12
			IgG	270	10895	IGHV5-17	IGHJ4	80,7	0,3	13
		Kidney	IgM	933	3306	IGHV14-4	IGHJ3	22,5	0,6	12
				IGHV4-1	IGHJ1	10,1	0,2	12		
			IgG	211	7346	IGHV3-1	IGHJ4	51,6	6,9	16
						IGHV5-17	IGHJ4	23,4	0,7	13
	HTM-10	LN	IgM	142	221	IGHV4-1	IGHJ1	14,5	2,6	17
			IgG	80	14310	IGHV6-3	IGHJ2	96,8	7,8	8
	HTM-11	LN	IgM	774	5531	IGHV4-1	IGHJ1	53,6	2,3	17
						IGHV1-53	IGHJ2	12,9	6,5	11
Peyer's Patches		IgM	129	216	IGHV6-3	IGHJ1	26	0,1	17	

Genotype	Mouse nb	Tumor location	Heavy chain	Total number of clones	Total number of productive reads	V_gene	J_gene	Frequency (Clones ≥ 10%)	V_mutation frequency (without CDR3)	CDR3 length (AA)
HVEM triple mutant (Conventional cohort)	cHTM-4	LN	IgG	329	829	IGHV5-9-1	IGHJ4	21	1,4	9
	cHTM-5	Left Kidney	IgM	377	928	IGHV1-26	IGHJ2	30,2	6,4	10
						IGHV1-78	IGHJ4	11,4	5,6	13
		Right Kidney	IgM	279	574	IGHV1-26	IGHJ2	18,7	6,9	10
						IGHV1-78	IGHJ4	18,2	5,4	13
	Liver	IgM	385	489	IGHV1-26	IGHJ2	13	5,6	10	
					IGHV1-78	IGHJ4	14,8	5,3	13	
	cHTM-6	LN	IgM	428	650	IGHV2-6	IGHJ4	11,0	13,8	10
						IgG	185	6198	IGHV1-53	IGHJ2

Finally, we ran the same sequencing analysis of the BCL2 promoter region, as done in article 1, in the spleen and LNs of mice from the SOPF cohort only (Fig 35 A and B respectively), as well as some of the tumor tissues obtained in this cohort as well (Fig 36). Data revealed a much lower global rate of mutations across this region, with a low frequency, but with an overall similar phenotype, where most of the mutations seem to occur around P1 promoter. In some cases, however (spleen and LNs of mice HTM-6 and HTM-11) we could identify some mutations at a higher frequency (reaching 8 to 10%), then compatible with the size of a malignant subclone present within the tumoral tissue.

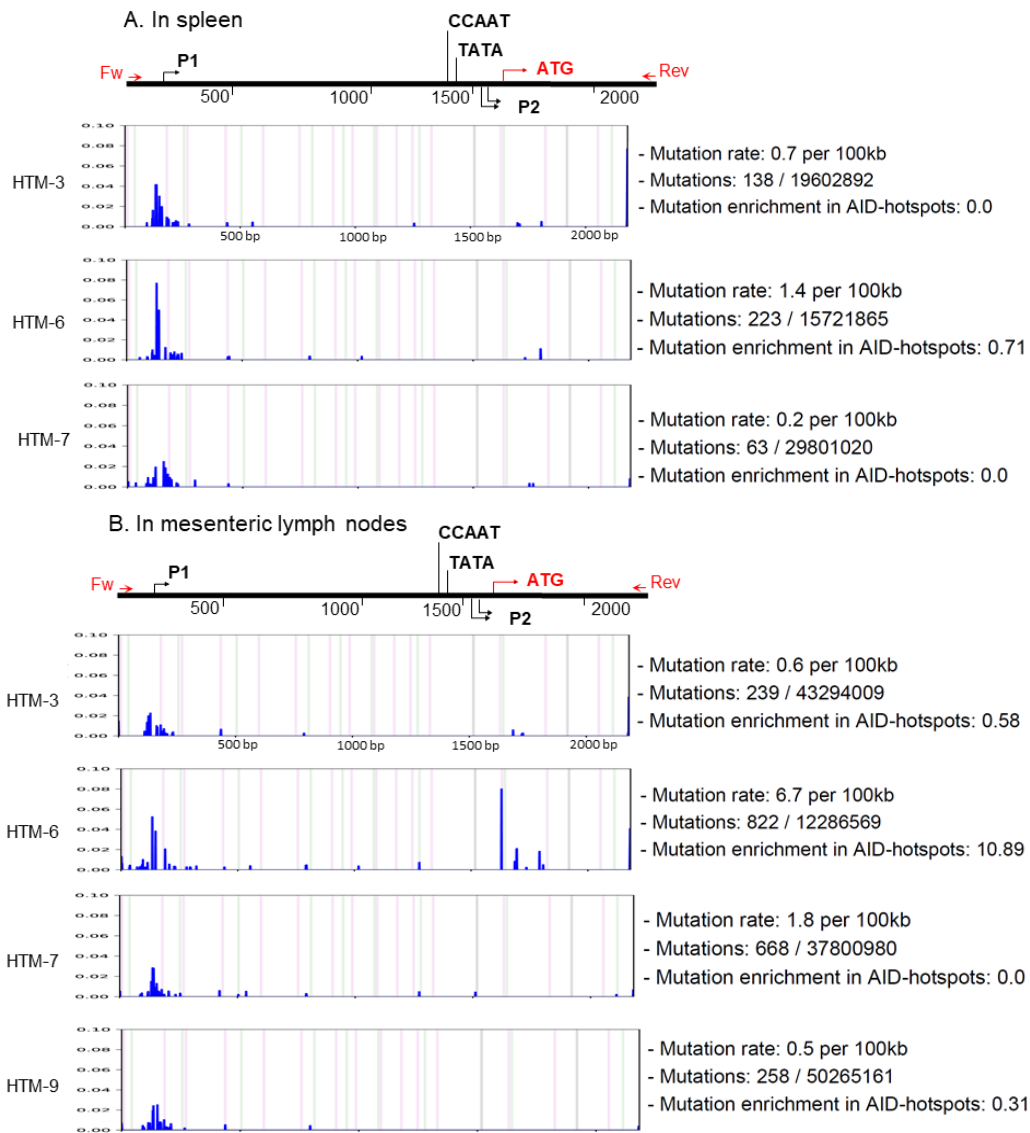

Figure 35 : Ion- Proton sequencing of the BCL2 promoter region in secondary lymphoid organs of Non-tumoral mice.

Graphs show the frequency (left Y axis) the localization of mutations (Blue lines) along the BCL2 promoter region, (after Ion-Proton high-throughput sequencing), the global mutation rate and the mutation enrichment in AID-hotspots in the secondary lymphoid organs (spleen in A and mesenteric LNs in B) of some of the HVEM TM mice that did not develop tumors (SOPF cohort only). Graphs are shown as generated by the system Deminer after correction with respect to two negative controls passed on the same Ion-Proton high through-put sequencing run (In this experiment the two negative controls were genomic tail DNA extracted from BCL2 mice).

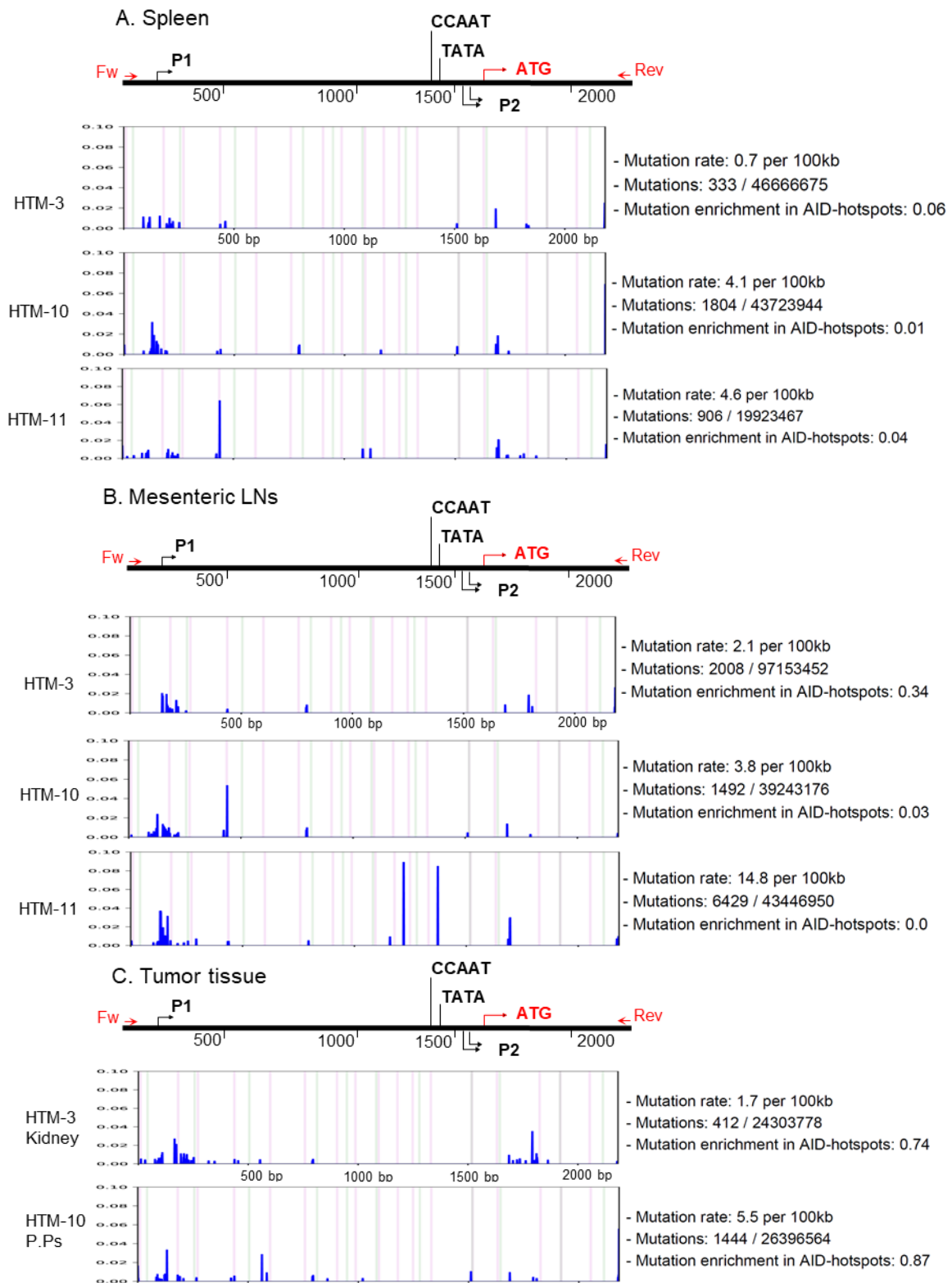

Figure 36: Ion-Proton sequencing of the BCL2 promoter region in the tumor tissue and secondary lymphoid organs of tumoral mice.

Graphs showing the frequency (on the left Y axis) and the localization of mutations along the BCL2 promoter region, the global mutation rate and the mutation enrichment in AID-hotspots in the spleen, mesenteric LNs (A and B respectively) of 3 HVEM TM mice (HTM-1, HTM-10, HTM-11) as well as the tumors of only 2 of the same mice (HTM-1 and HTM-10) (SOPF cohort only). Graphs are shown as generated by the system Deminer after correction with respect to two negative controls passed on the same Ion-Proton high through-put sequencing run (In this experiment the two negative controls were genomic tail DNA extracted from BCL2 mice).

2- KMT2D triple mutant mice:

The data obtained for these mice are preliminary and quite limited due to the limited number of mice we were able to obtain. Indeed, the work on these mice is yet to be finished and a lot of future experiments are to be done on them.

Out of 5 TM mice, only one developed a tumor which was, again of GC / centrocyte phenotype (Table 4).

Table 4 : Summary of tumor development (or not) in the KMT2D triple mutant cohort bred in the pathogen free SOPF animal facility.

Full details are given for the mice that did develop tumors (in this cohort only one), indicating the corresponding age at which the tumor developed, the precise location of the tumor, whether, or not, there were any remarkable additional observations seen upon sacrifice in these tumoral mice and finally stating the phenotype obtained by flow cytometry data of each tumor.

Mouse Number	Age (weeks)	Tumor ?	Tumor Location	Other observations	Phenotype
KTM1	66	✓	- Mesentric LNs - Splenomegaly (930 mg)	- Weird Liver phenotype - Tumor tissue entirely filled with feces (due to intestine occlusion)	- GC B (61,55%)/ Centrocytes (95,20 %) / Tomato+ (62,54 %)
KTM2	83	X	-	-	-
KTM3	80	X	-	-	-
KTM4	81	X	-	-	-
KTM5	89	X	-	-	-

Analysis by flow cytometry on B cells, using the same modified panel we used for the HVEM TM mice revealed that, while there was no strong effect on the B and plasma cell populations, there was the same increase in the GC and centrocyte cell populations in our TM mice compared to the control group (more significantly in LNs than spleen (Fig 37). Though the expansion of the GC / centrocyte population was overall less significant in the KMT2D TM mice compared the HVEM TM ones; both models shared the same feature, exclusively in the LNs (which is the more relevant secondary lymphoid organ to FL), where the ratio of GC to PC increased in the Tomato+ population only.

It is very hard to be conclusive on these data, due to the limitation in the number of mice and thus the lack of a statistical test but we are expecting to obtain more mice in the near future to run more flow cytometry analyses to verify what we initially obtained and also run analyses like the ones we did on HVEM mice. This part of our project is

ongoing and the remainder of the work is pursued in collaboration with MICMAC (UMR INSERM U1236) laboratory in Rennes, France, and I will stay in contact and continue this collaboration beyond the defense of my PhD.

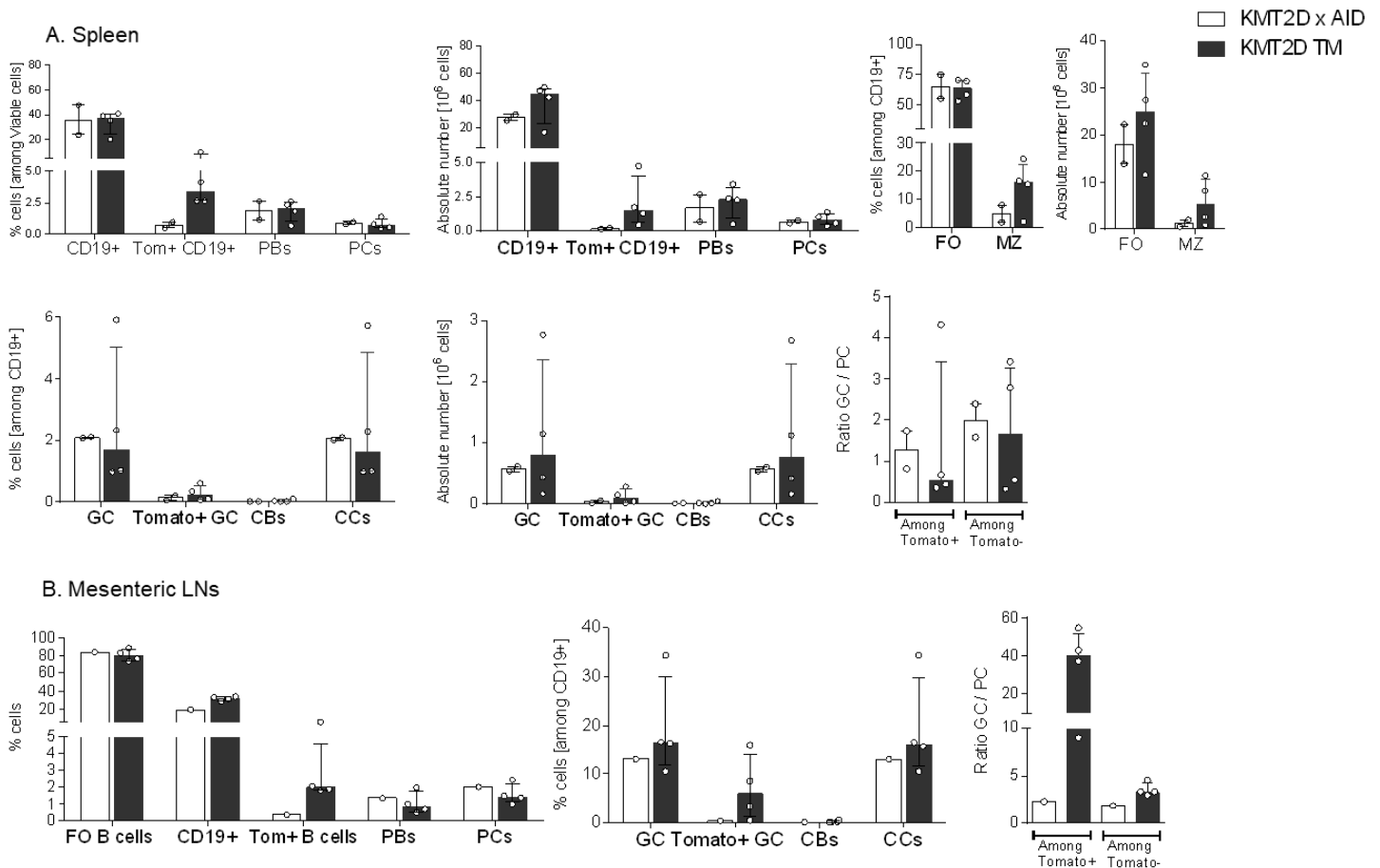

Figure 37 : Cumulative effect of BCL2 deregulation and KMT2D deletion on peripheral B cells.

Preliminary Flow cytometry data showing the cumulative effect of BCL2 deregulation and KMT2D deletion on B cell compartments in secondary lymphoid organs (spleen in A and mesenteric LNs in B) in the KMT2D TM mice that did not develop tumors only compared to their respective controls. Staining was done using our modified staining panel described in supplementary data. Cells are shown in percentages and absolute numbers (calculated based on the total percentage of lymphocytes in each organ). Data are presented in bar graphs as medians with interquartile range. Statistical significance could not be realized due to the limited number of control mice (2 in spleen and only one in LNs).

Discussion and Future Perspectives

BCL2 mouse models:

Recapping everything mentioned earlier, the primary goal of this thesis was to generate genetically modified mouse model(s) that could help recapitulate the complex development of Follicular Lymphoma. FL is an indolent B cell lymphoproliferative disorder of transformed germinal center B cells. It is characterized by diffuse lymphadenopathy, bone marrow involvement, and splenomegaly. Though this disease is marked with a long natural history and the survival rate could potentially extend to several years, or in some cases, several decades, this chronic disease is still considered incurable. Thus, revealing what happens in the early stages of FL development is not only crucial for understanding the complex development of FL but also indispensable for identifying better early diagnostic procedures and the “Achilles heel” of this malignancy to eventually develop novel therapeutic strategies for patients. Surely, we were not the first to think of generating such mouse models. Without going back into much details on each of the previously published mouse models (see introduction of article 1), unfortunately, none of these mouse models accurately reproduced the complex development of FL, potentially because they did not faithfully follow the pattern of BCL2 deregulation observed in patients and notably featured either very early BCL2 deregulation (under the control of E μ , which is the enhancer in charge of VDJ recombination in B cell progenitors, or driven by Vav-P regulatory elements which are active in all hematopoietic lineages). Our study explored two newly designed mouse models, conceived with the aim of the latest possible B-cell specific hyperexpression. This was obtained by physically linking the oncogene sequence with cis-regulatory elements that are 1- known as potent inducers of transcription and chromatin remodeling in mature activated and/or terminally differentiated B-cells and 2- known as BCL2 translocation partners in human lymphoid malignancies. The first model, named Ig κ -BCL2 (knock-in of BCL2 in the Ig κ locus, for pan-B cell expression) associates BCL2 with all the cis-regulatory context of a locus highly transcribed in mature B-cells, demethylated and exposed to AID deamination. Although highly active at mature stages and after B-cell activation, enhancers from this locus bound by PU.1, might transiently repress expression in GC-B cells after recruiting BCL6 (Bai et al. 2005; Wei et al. 2009). The second model, named 3'RR-BCL2, opted for specific targeting of activated B-cells with a BCL2 transgene driven by the IgH 3'RR enhancers, *i.e.* those enhancers inducing germline transcription of IgH switch regions, chromatin

remodeling and accessibility to AID in GC B-cells. Although both models (and both the IgH and Ig κ loci) are expected to finally be active beyond the plasma cell stage (notably in PCs), our expectation was that their expression might be uncoupled at the GC B-cell stage and that this might explain why in FL patients, translocation of BCL2 to an Ig κ J κ segment is exquisitely rare, while translocation to an IgH JH segment is overwhelmingly predominant.

Indeed, both of our models appeared to differ substantially in their patterns of BCL2 expression; While the Ig κ -BCL2 knock-in yielded a global increase of BCL2 expression in all B-cell maturation stages, with a climax in plasma cells, the effect of the IgH locus 3'RR enhancers in our second transgenic model, featured a more restricted GC-specific expression.

Starting from the fact that the hallmark for the development of FL is the translocation t(14;18), occurring as a result of an error during VDJ recombination (in turn placing the anti-apoptotic BCL2 protein under the effect of these IgH 3'RR enhancers).

Starting also from the fact that these enhancers are major drivers of Ig gene remodeling in the GC; our initial observations about BCL2 expression were in agreement with our speculation that the 3'RR-BCL2 model should more specifically mimic the BCL2 deregulation associated with FL.

Before diving deeper into explaining the differences between both models, one aspect we were able to validate is that both are able to mount efficient immune responses, by secreting high-affinity IgGs, after encounter with a specific antigen. However, the different flow cytometry data analyses that we ran on these mice, both at the resting / unimmunized and immunized states validated our previous speculation. By immunohistochemistry, while Ig κ -BCL2 plasma cells brightly stained for BCL2, this staining was barely visible in GCs. By contrast 3'RR-BCL2 immunized young mice showed BCL2 staining clearly localized to GCs. We observed a strong expansion of the plasmablastic and plasma cell compartments in the Ig κ -BCL2 mice both early in the bone marrow and in the secondary lymphoid organs. This was not only seen less significantly in our transgenic mouse model, but we also witnessed a more significant expansion of the GC B cell population in the periphery, which is more relevant to what is seen in human FL patients. Another striking difference that we saw between both models, is that plasma and GC B cells in the Ig κ -BCL2 models "differentiate" less upon antigen-encounter and simply live longer as a result of the BCL2 deregulation they

carry. This was again verified by our flow cytometry data which showed a higher ratio of CD93+ to CD93- plasma cells (CD93+ assumed to be long lived plasma cells).

These data confirmed our hypothesis that a model with BCL2 deregulation driven by IgH 3' enhancer was the most pertinent platform and starting point for the study of the natural story of FL lymphomagenesis, since the "first hit" leading to BCL2 deregulation seemed to recapitulate more carefully what occurs in humans.

However, BCL2 deregulation by itself is not sufficient for FL development, as obviously shown by the multiple genetic anomalies found in patients. Both of our mouse models thus remained healthy for months and when tumors lately developed in aged mice, we observed that they always lacked this characteristic feature of FL: retention of tumor cells within GCs. All of the tumors that we characterized in single transgenics were indeed made up of plasmablasts or plasma cells, without any differentiation blockade. Beside many such tumors in Igκ-*BCL2* mice, a single one was characterized in a 3'RR-*BCL2* mouse, but it also featured a plasma cell rather than a GC phenotype. Among the tumors analyzed in single transgenics, 7 out of 12 carried mutated Ig genes and stood as post-GC cells (whether involving IgM or IgG clones). 5 tumors were by contrast expressing germline VDJ regions and could correspond to extra-follicular plasma cells. Altogether, these late plasmacytic tumors thus rather appear as random malignant transformation of plasma cells, more likely to occur in the context of expanded PB/PC compartments whatever the origin of the accumulated PCs (GC or extrafollicular). Interestingly by immunocytochemistry, plasmacytic tumors seem to more strongly express BCL2 than the non-malignant PCs characterized in young transgenic mice. This upregulated expression could correspond to mutations of the BCL2 P1/P2 promoter (but we fail to identify such mutations) or more likely to epigenetic changes boosting expression from the transgenic oncogene (an aspect that remains to be explored in our models).

Globally, our findings confirm partly our starting hypotheses. Studies over the years have indeed shown that with a disease as complex and indolent in its development as FL, the t(14;18) alone is never sufficient and constantly requests additional genetic or epigenetic changes for malignant transformation to occur. Works from animal models comes in accordance to what has been seen in humans, where t(14;18)+ cells were detected in the blood and lymphoid tissues of rather healthy individuals (almost 70%). Moreover, it has been shown that even after having left the BM and circulating in the periphery, the t(14;18) confers a selective advantage for these cells during the GC

reaction thereby allowing them to persist as atypical memory B cells, referred to as FL like cells (FLLC), carrying some features of FL cells. In addition, the retention of surface IgM allele (sIgM) on these FLLCs, despite having passed through the GC and eventually undergone CSR-like recombination on the translocated allele, might expose them to re-enter the GC upon future Ag encounter, thereby subjecting them to additional rounds of SHM and eventually additional oncogenetic hits (the so-called Allelic paradox) (Roulland et al. 2011). In fact, the local amplification of a more aggressive B-cell clone in FL has been shown to always be associated with the accumulation of additional mutations. Therefore, in the absence of these secondary genetic “hits”, neither of our models actually developed FL-like lymphomas at late ages.

Last but not least, one very important feature of both of our mouse models, which has never been done in any of the previous models in the literature, was the inclusion of the full human BCL2 promoter region. The characteristic structure of this region comprising two distinct promoters P1 and P2, and the fact that in FL, a shift from the use of P1 to the use of P2 is always exclusively seen, suggests a major importance of this regulatory region for FL development. Indeed, this region includes transcription factor-binding sites, notably for the repressors Bcl6/Miz1 which limit BCL2 expression in normal GC cells (Saito et al. 2009). Thus, such design of our models allowed us to analyze the mutations of the BCL2 promoter region, also documented in human patients (Saito et al. 2009). In the near future, we will also check the DNA methylation status and histone marks of this region as soon as we have a larger collection of tumors available.

I chose to talk about this part of our project both separately and at the end for the sole reason of showing that this specific area of our project is still to be further explored in the future.

Although our data showed that this promoter region was accessible to a significant amount of SHM, notably when inserted in the Ig κ locus, these mutations rather seemed to randomly accumulate. Contrary to our expectations, neither the BCL6 binding site nor the acquired mutations seemed to repress expression in our models. We assumed that the spontaneous expression yielded by the BCL2 cassette in both models, is either already sufficiently high by itself for supporting an eventual malignant development without the need of promoter mutations, or that it is increased through epigenetic changes. Unfortunately, until now, we mostly were able to study tumors from single

transgenic animals, which were mostly plasmacytic, had little or no SHM of VDJ genes and were unlikely to have undergone multiple rounds of reentry into the GC. Since we now begin to accumulate tumor samples from triple mutant mice where malignant cells appear blocked with a GC phenotype, the landscape of the genomic mutations accumulated in such tumors might be different. Already and even if in low amount, one important observation in our sequencing data however, was the localization of the mutations detected: in the majority of the cases we saw that mutations were localized more at the beginning of the promoter, that is around P1 more than P2, thereby perhaps offering a possible reason / explanation for the shift from P1 to P2 in FL?

This is one area that we really need to work on in our mice, perhaps not only in the BCL2 mouse models but also in the other mouse models that I talked about in my results section.

We initially tried to validate by QPCR (data not shown) whether we can see an increased expression of P2 in our mice compared to P1. However, the high similarity between human and mouse genomes really restricted our abilities to design good primers for the amplification of these two promoters. Not to mention that the BCL2 promoter is a GC-rich region which created another limitation in the design of good-quality primers. With primers designed in different exons of P2 for example, we would obtain highly different data, in the same mouse even, which stopped us from definitively concluding whether there was a higher expression of P2 in our mice or not. So, more efforts need to be devoted in the future in trying to resolve this issue and validating the preferential use of P2. Future RNAseq data from tumors might instrumentally and definitely help answer this question.

Though I only showed data obtained from BCL2 promoter high-throughput sequencing of mutations, we initially attempted to study this area in much more detail. In fact, the primary goal and my initial thesis project were actually to analyze this region in both mouse models and try to understand what really happens at the BCL2 promoter level. Reminiscing, once again, on what has been well established in the literature, we highlighted several times that a shift from P1 to P2, for BCL2 expression, does occur in FL (though no one really knows why) and that the BCL2 promoter is indeed a “hotspot” for mutations (though not a lot of information exist in the literature on the nature and the outcome of such mutations). But in addition to that, it has also been well established that P1, the major promoter, contains multiple transcriptional start

sites and is positioned within a nuclease hypersensitive site. Very briefly recapping the major points that were important to us at the beginning of our project:

- 1- The 5'-end of this P1 promoter has been shown to be implicated in playing a major role in the regulation of BCL-2 transcription, via a 39-bp GC-rich element (located 57–19 base pairs upstream of P1). Multiple transcription factors such as, SP1, WT1, E2F and NGF have been reported to bind to and / or regulate BCL2 expression (Xiong et al. 2016).
- 2- The G-rich strand of the DNA in this region has been shown to form G-quadruplex structures (Agrawal et al. 2014). Other GC-rich regions, also susceptible for the formation of other G-quadruplexes have also been reported upstream of P1 (Onel et al. 2016) (Fig 38).
- 3- In parallel, several other studies in the literature also talk about methylation at the level of the BCL2 promoter. Usually these studies combine these methylation assays with genes other than just *BCL2* and sometimes on diseases other than FL (BAX is one example (Ahani-Nahayati et al. 2018) (Asadi et al. 2020)).



Figure 38 : Schematic representation of the *BCL2* promoter region.

The *BCL2* promoter region is comprised of two promoters P1 and P2, located at respectively at -1432 bp and -88 bp upstream of the transcription start site (ATG). Upstream of P1 is a GC-rich region that can form a G-quadruplex structure (stabilized by compound SYUIQ-FM05 with a resulting structure that leads to transcriptional arrest). Multiple transcription factors bind to this promoter region to regulate the expression of *BCL2* (in this case we only show the example of the transcription factor WT1 binding sites, whose binding leads to the activation of *BCL2* expression). Image edited from Xiong et al., 2016

Thus, it has never been done, to study the presence of methylation or R-loop formation in mice at the level of the *BCL2* promoter region. For that, we initially speculated that such mechanisms at the level of the P1 promoter exclusively, would explain why in FL, we have the shift from P1 to P2. So, we devoted an immense amount of time, once again, to set up assays that could detect such mechanisms. Very briefly and without much experimental details, our trials were comprised mainly of using Sodium Bisulfite-based assays to detect either methylation or R-loop formation. Bisulfite works only on single stranded DNA by converting Cytosine (C) to Uracil (U). We assumed that this is only the case when the DNA is indeed “accessible”. However, in cases of methylation and R-loop formations, DNA no longer becomes accessible and the conversion would no longer take place. So, by analyzing (after cloning and sequencing), the presence / absence of converted or non-converted stretches of DNA around P1 or P2, we could verify the occurrence (or not) of these two phenomena.

However unfortunately we were never able to obtain reproducible and informative data, again due to the complexity and the GC-rich nature of this region.

Based on everything mentioned above, I believe that we need to:

- 1- Set up better assays, by designing new primers, in order to evaluate comparatively the transcripts coming from these two promoters in both of our models, not just from RNA extracted from iteratively immunized mice, but also in the tumors that we obtained from both models and compare that to normal human cells.
- 2- Tackle the area of R-loop and methylation detection by trying to use other assays that don't just rely on the use of bisulfite.

Other mouse models:

1- Kappa-MOUSS

Moving on to the additional mouse models we used in this study; based on our previous data, we clearly showed that the deregulation of *BCL2* alone was clearly not sufficient in driving the formation of FL-like tumors. This notion has been heavily established in the literature and countless studies have shown that additional mutations affecting certain key point genes or biological pathways are required to trigger FL (Fig. 39).

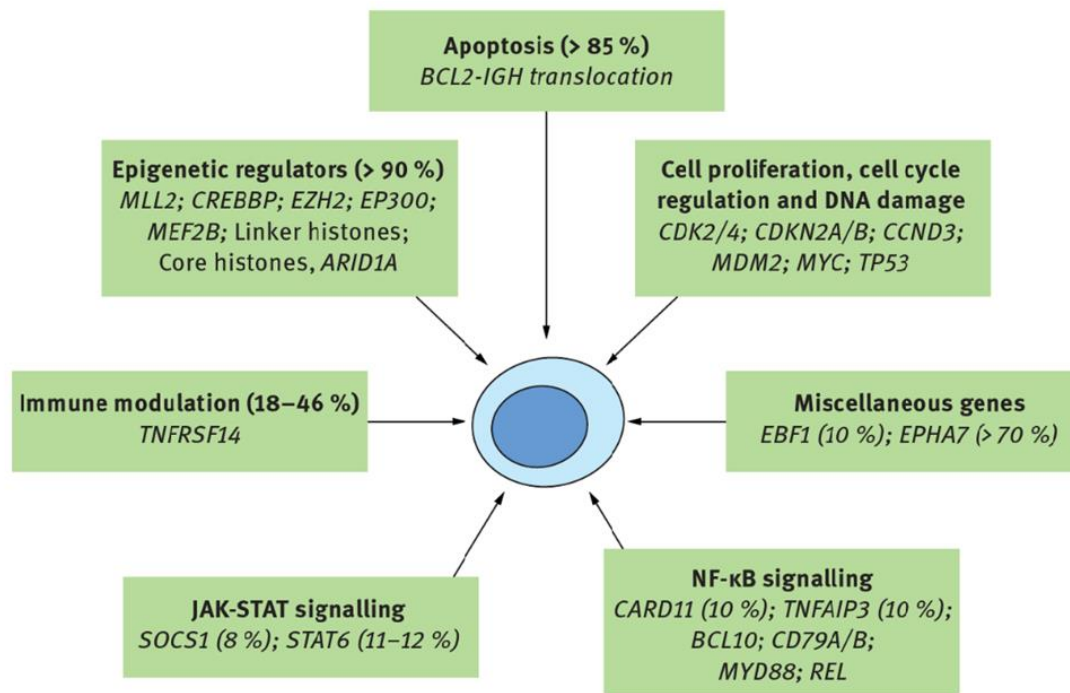

Figure 39: Summary of the most famous secondary genetic alterations and biologic pathways that lead to FL. Seven functional categories are listed, showing the most commonly identified gene mutations / alterations. Each FL tumor can harbor several mutations in the same or from different functional categories. Schema taken from *Lenz and Pasqualucci, 2016*.

Hence, to create conditions that resemble more accurately what occurs in humans, we wanted to breed our transgenic BCL2 mice with other mouse models carrying genetic alterations that are well known to occur in FL.

As I have stated earlier in my thesis introduction, the BCR plays a crucial role in lymphomagenesis. Particularly speaking, the introduction of N-glycosylation sites in the V region of Igs is famously known to occur in FL, though in normal cells, this situation is rather rare. Another fascinating feature that occurs in FL, is that the oligosaccharides added to these N-glycosylation sites are exclusively of the immature type, which, upon interaction with lectins (both endogenous and exogenous), lead to continuous activation of the BCR. It was also shown that such V region N-glycans, in humans, interact with lectins such as DC-SIGN and trigger signaling in B-cells (Amin et al. 2015).

For that, the first mouse model that we chose was the Kappa-MOUSS, having a fixed kappa light chain with an N-glycosylation motif in the V region. Recapping on what I had previously stated in the results part of my thesis; the preliminary analyses done by flow cytometry on these mice, after a 7-day injection with SRBC, were quite interesting. We could see the negative effect the fixed kappa light chain on the B and plasma cell

population in these mice, with or without the deregulation of BCL2. We also saw the cumulative effect that both of these mutations have on the expansion of the GC B cell compartment compared to mice with either of the mutations alone, and of course compared to wild-type.

Based on these data, we wanted to move forward and validate that we can indeed activate the N-glycosylated BCR in our mice upon interaction with various lectins. We tried doing that via flow cytometry either by detecting the B cells that express the lectins, after interaction, or by detecting the expression of two staple effectors of BCR cell-signaling pathways, ERK and SYK. These experiments began long before, but also after, we definitively concluded that the 3'RR-*BCL2* model is the more pertinent model to use. So, several in-vitro cell culture experiments with the endogenous lectin, DC-SIGN, and two exogenous bacterial lectins, LecB and BC2LA, were conducted on either of the BCL2 models, with and without N-glycosylated BCRs.

As I have previously mentioned, in details, in the results section, none of these experiments yielded high-quality reproducible data, that we eventually decided to press pause on this part of our project.

Our assumption is that it was very difficult maybe to capture the exact moment at which the interaction between the lectins and the BCRs in our mice occurs. Though in the literature it is well known that such interactions lead to continuous, or at least to longer and more intense, activation of the BCR, we were, unfortunately, not able to accurately validate that, even with less quantitative methods like western blot.

We do plan on re-conducting such experiments in the near future by focusing mainly on the detection of lectin expressing B cells (without that of cell signaling proteins as they were the most troublesome by flow cytometry). This time we plan to start from square 1, by obtaining new DC-SIGN and new lectins (at higher concentrations as recommended eventually by Dr. Annabelle Varrot) to try again the in-vitro assays. Moreover, the cell signaling experiments we tried to execute are usually very tricky and hard to establish, so we plan on collaborating with Laboratories specialized in cell signaling to guide us in carrying out such experiments in the future.

2- HVEM / KMT2D Triple mutants:

Last but not least, the other two mouse models we chose for our study are conditional knock-outs for two very famously known proteins in FL, HVEM and KMT2D. Deletions for either proteins have been recorded in 40% and 90% of FL cases respectively.

We created triple mutant mice, that not only carry the transgenic BCL2 deregulation but also lose the expression of either of these two proteins upon oral induction with tamoxifen, thanks to the AID-Cre LSL tomato system which we introduced into our mice as well.

These two proteins play major roles in regulating the microenvironment surrounding B cells. Briefly and without going back to the same details, several studies have highlighted that the loss of either proteins in FL has hazardous effects leading to increased lymphomagenesis and the enrichment of a tumor-supportive microenvironment.

Despite the fact that this project is far from being finished, the preliminary data we obtained during my thesis seem to be very intriguing.

We were able to set up an induction protocol for our mice that was indeed functional and allowed us to monitor the circulating population of tomato expressing B cells in our living mice for over one year, which was very useful for us to both follow up our mice in a very ethical way and also keep them living for as much as possible to monitor the development of tumors and thus decide on the optimal time for their sacrifice to visualize earlier stages of lymphomagenesis.

I will begin first by discussing the data we obtained on HVEM triple mutant mice, as it is more comprehensive and complete and then move to the very preliminary data of KMT2D mice which I will be discussing along with the future perspectives of this part of our project.

One cannot deny that it was quite challenging to breed these mice to obtain the ideal genotype and that we faced several obstacles on the way, including the outbreak of the covid-19 virus. But I believe that, at the end, what we obtained was rather beneficial. Instead of having one single cohort of mice bred in the same conditions; we obtained two separate cohorts that were bred either in the absence or presence of pathogens. I believe this was even closer to reality because it gave us an idea also of what happens under conditions that are more similar to human life, that is living in

conditions where it is highly probable to be subjected to incessant antigenic challenges (the case of our conventional cohort).

Regardless of the breeding conditions, our HVEM triple mutant mice had expanded GC B cell populations, the majority of which expressed tomato. This expansion of the GC B cell population occurred in our mice at the expense of the plasma cell population (verified by the ratio we previously discussed in the results section). This was not the case in the mice with BCL2 deregulation only, thereby proving that BCL2 alone cannot block the cells at the GC B cell stage, however the presence of a secondary genetic hit, whether it be the loss of HVEM or KMT2D, succeeded in doing that. Not to mention that again, unlike the BCL2 deregulated models, a significant number of our mice developed tumors that were indeed of the GC / centrocyte phenotype, which is more relevant to FL.

The detailed Ig heavy chain repertoire analysis of these tumors revealed that the majority were oligoclonal, with the exception of some that were rather monoclonal. While it might be a little bit early to definitively conclude, since we need to analyze a bigger number of mice in the future, we assume that these oligoclonal tumors are still at an earlier stage of the disease.

As I stated previously in the results section, a very interesting feature that we saw in the repertoire of these mice is the presence of the same “major” clones in different tumors in the same mouse, sometimes with different SHM frequencies, meaning that the same clone, not only disseminated from one location to another but also additional mutations were acquired along the way. This comes in accordance to what has already been published in the literature, since it has been shown that a typical feature of FL is the frequent widespread disease at diagnosis. In fact, studies have shown that 75% of FL patients showed peripheral and central lymphadenopathy as well as splenomegaly, and/or BM involvement (in 40–70% of the cases). Thus, the ability of FL clones to emigrate from the “founder” follicle, and invade other lymphoid organs in remote locations has been considered as the basis of clinical staging, where stages I/II include one or few relatively localized nodes and later stages include increasingly widespread ones. This staging has also been shown to be classically associated with FL progression, prognosis, and thus an important criterion for therapeutic decisions (Roulland et al. 2011).

Moreover, not only did we find the same clone in various locations within the same mouse, but in some cases also, we noticed the repetition of the same clone(s) amongst

different tumors of different mice. This is again consistent to what has been published in the literature regarding lymphomas in general and not just FL. In the introduction of my thesis (specifically Chapter II section 4.b.), I explained in details the canonical structures of the BCR and how in certain lymphomas, such as MCL and SMZL, studies of IgH gene rearrangements revealed a strong bias in the usage of certain IgHV genes. Several studies have discussed a similar aspect in FL human patients. It is true however, that these studies are more focused on the correlation between biased IgHV gene usage and prognosis (Berget et al. 2015) or the risk of FL transformation into a more aggressive lymphoma (García-Álvarez et al. 2019). Without going in much details, it is worthy to mention that other studies in the literature even demonstrate the biased usage of certain V genes in the Ig Kappa light chain in FL, thereby alluding to the important role of Ig Kappa light chain in antigen selection of the clonogenic B cells in this disease (Smilevska et al. 2008). Though we cannot entirely apply that to what we have shown in our data, and though this aspect needs to be tackled more in the future, it is safe to say that our HVEM triple mutant mice seem to be developing tumors that have strong relevance to FL.

Finally, we analyzed, in parallel, a primary cohort of KMT2D triple mutant mice (bred in a pathogen free environment). I will not elaborate much on this part of our project because the number of mice and data we obtained are very preliminary and cannot allow us to derive any functional conclusions. However, we did seem to obtain one tumor that was also of the GC / centrocyte phenotype, similarly to the HVEM TM tumors. In addition, very preliminary flow cytometry data (though with a very limited number of control mice), showed that there seems to be the same stronger expansion of the GC B cell population compared to their relevant controls. (verified as well by the increased ratio of GC/PB or PC in these mice).

As I have mentioned in the results section, the work concerning both triple mutant models is long from being done. We are currently in strong collaboration with the MICMAC laboratory in Rennes, run by my co-director Dr. Karin Tarte, where the majority of the work remaining will continue to be done there:

We are expecting more KMT2D and HVEM TM mice in the near future. These mice will be induced using the same protocol that we initially used. A more careful follow up of these mice will be conducted, in hopes of obtaining additional tumors that we can use along with the initial ones we obtained, to fully characterize these mice by:

- 1- Running the same IgH repertoire experiments. This is indeed more urgent for the KMT2D TM mice than the HVEM ones as we need more than the one tumor we obtained to really have an idea
- 2- IHC staining to have an idea of the histological organization of our tumors. For this part, we already have parts from all of the TM tumors that we obtained and we plan on conducting these experiments very soon.

Conclusion

All of the previous data, even the very preliminary ones, whether regarding our single, double or triple mutant mouse models, show that we are indeed on the right path in our study and that, not only our 3'RR-*BCL2* transgenic model, but also both of our triple mutant models are reliable assets and invaluable tools for the study of FL lymphomagenesis. Our mouse models should also constitute a robust platform for further investigating in the future the impact of additional genetic or epigenetic hits on the malignant B-cell phenotype and on the dialog between tumor cells and their micro environment. All these elements have major implications for understanding the natural story of pre-FL, FL, transformed FL (and also DLBCL cases with *BCL2* deregulation) and potential therapeutic implications.

Bibliographic References

- Aarts, W. M., R. J. Bende, E. J. Steenbergen, P. M. Kluin, E. C. Ooms, S. T. Pals, and C. J. van Noesel. 2000. "Variable Heavy Chain Gene Analysis of Follicular Lymphomas: Correlation between Heavy Chain Isotype Expression and Somatic Mutation Load." *Blood* 95 (9): 2922–29.
- Agrawal, Prashansa, Clement Lin, RaveendraI. Mathad, Megan Carver, and Danzhou Yang. 2014. "The Major G-Quadruplex Formed in the Human BCL-2 Proximal Promoter Adopts a Parallel Structure with a 13-Nt Loop in K⁺ Solution." *Journal of the American Chemical Society* 136 (5): 1750–53. <https://doi.org/10.1021/ja4118945>.
- Ahani-Nahayati, Milad, Saeed Solali, Karim Shams Asenjan, Ali Akbar Movassaghpour Akbari, Mehdi Talebi, Milad Zadi Heydarabad, Sina Baharaghdam, and Majid Farshdousti Hagh. 2018. "Promoter Methylation Status of Survival-Related Genes in MOLT- 4 Cells Co-Cultured with Bone Marrow Mesenchymal Stem Cells under Hypoxic Conditions." *Cell Journal (Yakhteh)* 20 (2): 188–94. <https://doi.org/10.22074/cellj.2018.5101>.
- Allman, David, and Shiv Pillai. 2008. "Peripheral B Cell Subsets." *Current Opinion in Immunology* 20 (2): 149–57. <https://doi.org/10.1016/j.coi.2008.03.014>.
- Allman, David, Bhaskar Srivastava, and R. Coleman Lindsley. 2004. "Alternative Routes to Maturity: Branch Points and Pathways for Generating Follicular and Marginal Zone B Cells." *Immunological Reviews* 197 (February): 147–60. <https://doi.org/10.1111/j.0105-2896.2004.0108.x>.
- Alt, F. W., and D. Baltimore. 1982. "Joining of Immunoglobulin Heavy Chain Gene Segments: Implications from a Chromosome with Evidence of Three D-JH Fusions." *Proceedings of the National Academy of Sciences of the United States of America* 79 (13): 4118–22. <https://doi.org/10.1073/pnas.79.13.4118>.
- Alt, F. W., G. D. Yancopoulos, T. K. Blackwell, C. Wood, E. Thomas, M. Boss, R. Coffman, N. Rosenberg, S. Tonegawa, and D. Baltimore. 1984. "Ordered Rearrangement of Immunoglobulin Heavy Chain Variable Region Segments." *The EMBO Journal* 3 (6): 1209–19.
- Alt, Frederick W., Yu Zhang, Fei-Long Meng, Chunguang Guo, and Bjoern Schwer. 2013. "Mechanisms of Programmed DNA Lesions and Genomic Instability in the Immune System." *Cell* 152 (3): 417–29. <https://doi.org/10.1016/j.cell.2013.01.007>.
- Amé-Thomas, P., J. Le Priol, H. Yssel, G. Caron, C. Pangault, R. Jean, N. Martin, et al. 2012. "Characterization of Intratumoral Follicular Helper T Cells in Follicular Lymphoma:

- Role in the Survival of Malignant B Cells.” *Leukemia* 26 (5): 1053–63. <https://doi.org/10.1038/leu.2011.301>.
- Amé-Thomas, Patricia, Hélène Maby-El Hajjami, Céline Monvoisin, Rachel Jean, Delphine Monnier, Sylvie Caulet-Maugendre, Thierry Guillaudeux, Thierry Lamy, Thierry Fest, and Karin Tarte. 2007. “Human Mesenchymal Stem Cells Isolated from Bone Marrow and Lymphoid Organs Support Tumor B-Cell Growth: Role of Stromal Cells in Follicular Lymphoma Pathogenesis.” *Blood* 109 (2): 693–702. <https://doi.org/10.1182/blood-2006-05-020800>.
- Amé-Thomas, Patricia, and Karin Tarte. 2014. “The Yin and the Yang of Follicular Lymphoma Cell Niches: Role of Microenvironment Heterogeneity and Plasticity.” *Seminars in Cancer Biology* 24 (February): 23–32. <https://doi.org/10.1016/j.semcancer.2013.08.001>.
- Amin, Rada, Frédéric Mourcin, Fabrice Uhel, Céline Pangault, Philippe Ruminy, Loic Dupré, Marion Guirriec, et al. 2015. “DC-SIGN-Expressing Macrophages Trigger Activation of Mannosylated IgM B-Cell Receptor in Follicular Lymphoma.” *Blood* 126 (16): 1911–20. <https://doi.org/10.1182/blood-2015-04-640912>.
- Aranburu, Alaitz, Sara Ceccarelli, Ezio Giorda, Rosa Lasorella, Giovanna Ballatore, and Rita Carsetti. 2010. “TLR Ligation Triggers Somatic Hypermutation in Transitional B Cells Inducing the Generation of IgM Memory B Cells.” *Journal of Immunology (Baltimore, Md.: 1950)* 185 (12): 7293–7301. <https://doi.org/10.4049/jimmunol.1002722>.
- Asadi, Shahin, Alireza Khabbazi, Shahriar Alipour, Somayeh Abolhasani, Jafar Haji, Hossein Amjadi, and Ebrahim Sakhinia. 2020. “Promoter Methylation of Bax and Bcl2 Genes and Their Expression in Patients with Behcet’s Disease.” *International Journal of Immunogenetics* 47 (3): 309–17. <https://doi.org/10.1111/iji.12473>.
- Bai, Yuchen, Lakshmi Srinivasan, Leslie Perkins, and Michael L. Atchison. 2005. “Protein Acetylation Regulates Both PU.1 Transactivation and Ig Kappa 3’ Enhancer Activity.” *Journal of Immunology (Baltimore, Md.: 1950)* 175 (8): 5160–69. <https://doi.org/10.4049/jimmunol.175.8.5160>.
- Bastion, Y., C. Sebban, F. Berger, P. Felman, G. Salles, C. Dumontet, P. A. Bryon, and B. Coiffier. 1997. “Incidence, Predictive Factors, and Outcome of Lymphoma Transformation in Follicular Lymphoma Patients.” *Journal of Clinical Oncology: Official Journal of the American Society of Clinical Oncology* 15 (4): 1587–94. <https://doi.org/10.1200/JCO.1997.15.4.1587>.

- Basu, Uttiya, Jayanta Chaudhuri, Craig Alpert, Shilpee Dutt, Sheila Ranganath, Gang Li, Jason Patrick Schrum, John P. Manis, and Frederick W. Alt. 2005. "The AID Antibody Diversification Enzyme Is Regulated by Protein Kinase A Phosphorylation." *Nature* 438 (7067): 508–11. <https://doi.org/10.1038/nature04255>.
- Batista, Facundo D., and Naomi E. Harwood. 2009. "The Who, How and Where of Antigen Presentation to B Cells." *Nature Reviews. Immunology* 9 (1): 15–27. <https://doi.org/10.1038/nri2454>.
- Baumgarth, Nicole. 2011. "The Double Life of a B-1 Cell: Self-Reactivity Selects for Protective Effector Functions." *Nature Reviews. Immunology* 11 (1): 34–46. <https://doi.org/10.1038/nri2901>.
- Berget, Ellen, Anders Molven, Turid Løkeland, Lars Helgeland, and Olav Karsten Vintermyr. 2015. "IGHV Gene Usage and Mutational Status in Follicular Lymphoma: Correlations with Prognosis and Patient Age." *Leukemia Research* 39 (7): 702–8. <https://doi.org/10.1016/j.leukres.2015.03.003>.
- Bernstein, Steven H., and W. Richard Burack. 2009. "The Incidence, Natural History, Biology, and Treatment of Transformed Lymphomas." *Hematology. American Society of Hematology. Education Program*, 532–41. <https://doi.org/10.1182/asheducation-2009.1.532>.
- Bikos, V., N. Darzentas, A. Hadzidimitriou, Z. Davis, S. Hockley, A. Traverse-Glehen, P. Algara, et al. 2012. "Over 30% of Patients with Splenic Marginal Zone Lymphoma Express the Same Immunoglobulin Heavy Variable Gene: Ontogenetic Implications." *Leukemia* 26 (7): 1638–46. <https://doi.org/10.1038/leu.2012.3>.
- Boboila, Cristian, Frederick W. Alt, and Bjoern Schwer. 2012. "Classical and Alternative End-Joining Pathways for Repair of Lymphocyte-Specific and General DNA Double-Strand Breaks." *Advances in Immunology* 116: 1–49. <https://doi.org/10.1016/B978-0-12-394300-2.00001-6>.
- Bose, Prithviraj, Yun Dai, and Steven Grant. 2014. "Histone Deacetylase Inhibitor (HDACI) Mechanisms of Action: Emerging Insights." *Pharmacology & Therapeutics* 143 (3): 323–36. <https://doi.org/10.1016/j.pharmthera.2014.04.004>.
- Bottaro, A., R. Lansford, L. Xu, J. Zhang, P. Rothman, and F. W. Alt. 1994. "S Region Transcription per Se Promotes Basal IgE Class Switch Recombination but Additional Factors Regulate the Efficiency of the Process." *The EMBO Journal* 13 (3): 665–74.

- Brandt, Vicky L., and David B. Roth. 2009. "Recent Insights into the Formation of RAG-Induced Chromosomal Translocations." *Advances in Experimental Medicine and Biology* 650: 32–45. https://doi.org/10.1007/978-1-4419-0296-2_3.
- Braza, Mounia Sabrina, Anouk Caraux, Thérèse Rousset, Sylvie Lafaye de Micheaux, Hélène Sicard, Patrick Squiban, Valérie Costes, Bernard Klein, and Jean-François Rossi. 2010. "Gammadelta T Lymphocytes Count Is Normal and Expandable in Peripheral Blood of Patients with Follicular Lymphoma, Whereas It Is Decreased in Tumor Lymph Nodes Compared with Inflammatory Lymph Nodes." *Journal of Immunology (Baltimore, Md.: 1950)* 184 (1): 134–40. <https://doi.org/10.4049/jimmunol.0901980>.
- Brioli, Annamaria, Lorenzo Melchor, Michele Cavo, and Gareth J. Morgan. 2014. "The Impact of Intra-Clonal Heterogeneity on the Treatment of Multiple Myeloma." *British Journal of Haematology* 165 (4): 441–54. <https://doi.org/10.1111/bjh.12805>.
- Calin, George A., and Carlo M. Croce. 2007. "Chromosomal Rearrangements and MicroRNAs: A New Cancer Link with Clinical Implications." *The Journal of Clinical Investigation* 117 (8): 2059–66. <https://doi.org/10.1172/JCI32577>.
- Campbell, Peter J., Philip J. Stephens, Erin D. Pleasance, Sarah O'Meara, Heng Li, Thomas Santarius, Lucy A. Stebbings, et al. 2008. "Identification of Somatic Acquired Rearrangements in Cancer Using Genome-Wide Massively Parallel Paired-End Sequencing." *Nature Genetics* 40 (6): 722–29. <https://doi.org/10.1038/ng.128>.
- Campos-Sanchez, Elena, Amparo Toboso-Navasa, Isabel Romero-Camarero, Marcos Barajas-Diego, Isidro Sanchez-García, and César Cobaleda. 2011. "Acute Lymphoblastic Leukemia and Developmental Biology: A Crucial Interrelationship." *Cell Cycle (Georgetown, Tex.)* 10 (20): 3473–86. <https://doi.org/10.4161/cc.10.20.17779>.
- Cancer Genome Atlas Research Network, John N. Weinstein, Eric A. Collisson, Gordon B. Mills, Kenna R. Mills Shaw, Brad A. Ozenberger, Kyle Ellrott, Ilya Shmulevich, Chris Sander, and Joshua M. Stuart. 2013. "The Cancer Genome Atlas Pan-Cancer Analysis Project." *Nature Genetics* 45 (10): 1113–20. <https://doi.org/10.1038/ng.2764>.
- Cancro, Michael P. 2004. "Peripheral B-Cell Maturation: The Intersection of Selection and Homeostasis." *Immunological Reviews* 197 (February): 89–101. <https://doi.org/10.1111/j.0105-2896.2004.0099.x>.
- Capolunghi, Federica, Simona Cascioli, Ezio Giorda, Maria Manuela Rosado, Alessandro Plebani, Cinzia Auriti, Giulio Seganti, et al. 2008. "CpG Drives Human Transitional B Cells to Terminal Differentiation and Production of Natural Antibodies." *Journal of*

- Immunology* (Baltimore, Md.: 1950) 180 (2): 800–808.
<https://doi.org/10.4049/jimmunol.180.2.800>.
- Carbone, Antonino, Annunziata Gloghini, Antonello Cabras, and Giuliano Elia. 2009. “The Germinal Centre-Derived Lymphomas Seen through Their Cellular Microenvironment.” *British Journal of Haematology* 145 (4): 468–80.
<https://doi.org/10.1111/j.1365-2141.2009.07651.x>.
- Carbonnelle-Puscian, A., C. Copie-Bergman, M. Baia, N. Martin-Garcia, Y. Allory, C. Haioun, A. Crémades, et al. 2009. “The Novel Immunosuppressive Enzyme IL411 Is Expressed by Neoplastic Cells of Several B-Cell Lymphomas and by Tumor-Associated Macrophages.” *Leukemia* 23 (5): 952–60. <https://doi.org/10.1038/leu.2008.380>.
- Casellas, Rafael, Wolfgang Resch, Ofir Hakim, and Michel C. Nussenzweig. 2013. “The Origin of B Cell Recurrent Chromosomal Translocations: Proximity versus DNA Damage.” *Molecular Cell* 51 (3): 275–76. <https://doi.org/10.1016/j.molcel.2013.07.020>.
- Chao, Mark P., Ash A. Alizadeh, Chad Tang, June H. Myklebust, Bindu Varghese, Saar Gill, Max Jan, et al. 2010. “Anti-CD47 Antibody Synergizes with Rituximab to Promote Phagocytosis and Eradicate Non-Hodgkin Lymphoma.” *Cell* 142 (5): 699–713.
<https://doi.org/10.1016/j.cell.2010.07.044>.
- Chaudhuri, Jayanta, and Frederick W. Alt. 2004. “Class-Switch Recombination: Interplay of Transcription, DNA Deamination and DNA Repair.” *Nature Reviews. Immunology* 4 (7): 541–52. <https://doi.org/10.1038/nri1395>.
- Chaudhuri, Jayanta, Uttiya Basu, Ali Zarrin, Catherine Yan, Sonia Franco, Thomas Perlot, Bao Vuong, et al. 2007. “Evolution of the Immunoglobulin Heavy Chain Class Switch Recombination Mechanism.” *Advances in Immunology* 94: 157–214.
[https://doi.org/10.1016/S0065-2776\(06\)94006-1](https://doi.org/10.1016/S0065-2776(06)94006-1).
- Chaudhuri, Jayanta, Chan Khuong, and Frederick W. Alt. 2004. “Replication Protein A Interacts with AID to Promote Deamination of Somatic Hypermutation Targets.” *Nature* 430 (7003): 992–98. <https://doi.org/10.1038/nature02821>.
- Chaudhuri, Jayanta, Ming Tian, Chan Khuong, Katrin Chua, Eric Pinaud, and Frederick W. Alt. 2003. “Transcription-Targeted DNA Deamination by the AID Antibody Diversification Enzyme.” *Nature* 422 (6933): 726–30. <https://doi.org/10.1038/nature01574>.
- Chen, Zhangguo, and Jing H. Wang. 2021. “How the Signaling Crosstalk of B Cell Receptor (BCR) and Co-Receptors Regulates Antibody Class Switch Recombination: A New Perspective of Checkpoints of BCR Signaling.” *Frontiers in Immunology* 12: 963.
<https://doi.org/10.3389/fimmu.2021.663443>.

- Chesneau, Mélanie, Laure Michel, Emilie Dugast, Alexis Chenouard, Daniel Baron, Annaïck Pallier, Justine Durand, et al. 2015. “Tolerant Kidney Transplant Patients Produce B Cells with Regulatory Properties.” *Journal of the American Society of Nephrology: JASN* 26 (10): 2588–98. <https://doi.org/10.1681/ASN.2014040404>.
- Chiarle, Roberto, Yu Zhang, Richard L. Frock, Susanna M. Lewis, Benoit Molinie, Yu-Jui Ho, Darienne R. Myers, et al. 2011. “Genome-Wide Translocation Sequencing Reveals Mechanisms of Chromosome Breaks and Rearrangements in B Cells.” *Cell* 147 (1): 107–19. <https://doi.org/10.1016/j.cell.2011.07.049>.
- Chim, C. S., K. Y. Wong, F. Loong, and G. Srivastava. 2004. “SOCS1 and SHP1 Hypermethylation in Mantle Cell Lymphoma and Follicular Lymphoma: Implications for Epigenetic Activation of the Jak/STAT Pathway.” *Leukemia* 18 (2): 356–58. <https://doi.org/10.1038/sj.leu.2403216>.
- Chiorazzi, Nicholas, and Manlio Ferrarini. 2011. “Cellular Origin(s) of Chronic Lymphocytic Leukemia: Cautionary Notes and Additional Considerations and Possibilities.” *Blood* 117 (6): 1781–91. <https://doi.org/10.1182/blood-2010-07-155663>.
- Chung, J. B., M. A. Baumeister, and J. G. Monroe. 2001. “Cutting Edge: Differential Sequestration of Plasma Membrane-Associated B Cell Antigen Receptor in Mature and Immature B Cells into Glycosphingolipid-Enriched Domains.” *Journal of Immunology (Baltimore, Md.: 1950)* 166 (2): 736–40. <https://doi.org/10.4049/jimmunol.166.2.736>.
- Chung, James B., Richard A. Sater, Michele L. Fields, Jan Erikson, and John G. Monroe. 2002. “CD23 Defines Two Distinct Subsets of Immature B Cells Which Differ in Their Responses to T Cell Help Signals.” *International Immunology* 14 (2): 157–66. <https://doi.org/10.1093/intimm/14.2.157>.
- Chung, James B., Michael Silverman, and John G. Monroe. 2003. “Transitional B Cells: Step by Step towards Immune Competence.” *Trends in Immunology* 24 (6): 343–49. [https://doi.org/10.1016/s1471-4906\(03\)00119-4](https://doi.org/10.1016/s1471-4906(03)00119-4).
- Clark, Marcus R., Malay Mandal, Kyoko Ochiai, and Harinder Singh. 2014. “Orchestrating B Cell Lymphopoiesis through Interplay of IL-7 Receptor and Pre-B Cell Receptor Signalling.” *Nature Reviews. Immunology* 14 (2): 69–80. <https://doi.org/10.1038/nri3570>.
- Clear, Andrew J., Abigail M. Lee, Maria Calaminici, Alan G. Ramsay, Kelly J. Morris, Simon Hallam, Gavin Kelly, Finlay Macdougall, T. Andrew Lister, and John G. Gribben. 2010. “Increased Angiogenic Sprouting in Poor Prognosis FL Is Associated with Elevated Numbers of CD163+ Macrophages within the Immediate Sprouting

- Microenvironment.” *Blood* 115 (24): 5053–56. <https://doi.org/10.1182/blood-2009-11-253260>.
- Cobaleda, César, Alexandra Schebesta, Alessio Delogu, and Meinrad Busslinger. 2007. “Pax5: The Guardian of B Cell Identity and Function.” *Nature Immunology* 8 (5): 463–70. <https://doi.org/10.1038/ni1454>.
- Constantinescu, A., and M. S. Schlissel. 1997. “Changes in Locus-Specific V(D)J Recombinase Activity Induced by Immunoglobulin Gene Products during B Cell Development.” *The Journal of Experimental Medicine* 185 (4): 609–20. <https://doi.org/10.1084/jem.185.4.609>.
- Conticello, Silvestro G., Marc-Andre Langlois, Zizhen Yang, and Michael S. Neuberger. 2007. “DNA Deamination in Immunity: AID in the Context of Its APOBEC Relatives.” *Advances in Immunology* 94: 37–73. [https://doi.org/10.1016/S0065-2776\(06\)94002-4](https://doi.org/10.1016/S0065-2776(06)94002-4).
- Corcoran, Anne E. 2005. “Immunoglobulin Locus Silencing and Allelic Exclusion.” *Seminars in Immunology* 17 (2): 141–54. <https://doi.org/10.1016/j.smim.2005.01.002>.
- Dal Porto, Joseph M., Stephen B. Gauld, Kevin T. Merrell, David Mills, Aimee E. Pugh-Bernard, and John Cambier. 2004. “B Cell Antigen Receptor Signaling 101.” *Molecular Immunology* 41 (6–7): 599–613. <https://doi.org/10.1016/j.molimm.2004.04.008>.
- Dalla-Favera, Riccardo, and Laura Pasqualucci. 2015. “Chapter 22 - Molecular Pathogenesis of B Cell Lymphomas.” In *Molecular Biology of B Cells (Second Edition)*, edited by Frederick W. Alt, Tasuku Honjo, Andreas Radbruch, and Michael Reth, 399–416. London: Academic Press. <https://doi.org/10.1016/B978-0-12-397933-9.00022-9>.
- Daly, Janssen, Steve Licence, Aikaterini Nanou, Geoff Morgan, and Inga-Lill Mårtensson. 2007. “Transcription of Productive and Nonproductive VDJ-Recombined Alleles after IgH Allelic Exclusion.” *The EMBO Journal* 26 (19): 4273–82. <https://doi.org/10.1038/sj.emboj.7601846>.
- Davis, R Eric, Vu N Ngo, Georg Lenz, Pavel Tolar, Ryan M Young, Paul B Romesser, Holger Kohlhammer, et al. 2010. “Chronic Active B-Cell-Receptor Signalling in Diffuse Large B-Cell Lymphoma.” *Nature* 463 (7277): 88–92. <https://doi.org/10.1038/nature08638>.
- De Silva, Nilushi S., and Ulf Klein. 2015. “Dynamics of B Cells in Germinal Centres.” *Nature Reviews. Immunology* 15 (3): 137–48. <https://doi.org/10.1038/nri3804>.
- Delbos, Frédéric, Said Aoufouchi, Ahmad Faili, Jean-Claude Weill, and Claude-Agnès Reynaud. 2007. “DNA Polymerase Eta Is the Sole Contributor of A/T Modifications during Immunoglobulin Gene Hypermutation in the Mouse.” *The Journal of Experimental Medicine* 204 (1): 17–23. <https://doi.org/10.1084/jem.20062131>.

- Desiderio, S. V., G. D. Yancopoulos, M. Paskind, E. Thomas, M. A. Boss, N. Landau, F. W. Alt, and D. Baltimore. 1984. "Insertion of N Regions into Heavy-Chain Genes Is Correlated with Expression of Terminal Deoxytransferase in B Cells." *Nature* 311 (5988): 752–55. <https://doi.org/10.1038/311752a0>.
- Di Noia, Javier M., and Michael S. Neuberger. 2007. "Molecular Mechanisms of Antibody Somatic Hypermutation." *Annual Review of Biochemistry* 76: 1–22. <https://doi.org/10.1146/annurev.biochem.76.061705.090740>.
- Dinkelmann, Maria, Elizabeth Spehalski, Trina Stoneham, Jeffrey Buis, Yipin Wu, JoAnn M. Sekiguchi, and David O. Ferguson. 2009. "Multiple Functions of MRN in End-Joining Pathways during Isotype Class Switching." *Nature Structural & Molecular Biology* 16 (8): 808–13. <https://doi.org/10.1038/nsmb.1639>.
- Dress, Regine J., Charles-Antoine Dutertre, Amir Giladi, Andreas Schlitzer, Ivy Low, Nurhidaya Binte Shadan, Alicia Tay, et al. 2019. "Plasmacytoid Dendritic Cells Develop from Ly6D+ Lymphoid Progenitors Distinct from the Myeloid Lineage." *Nature Immunology* 20 (7): 852–64. <https://doi.org/10.1038/s41590-019-0420-3>.
- Duan, H., C. A. Heckman, and L. M. Boxer. 2007. "The Immunoglobulin Heavy-Chain Gene 3' Enhancers Deregulate Bcl-2 Promoter Usage in t(14;18) Lymphoma Cells." *Oncogene* 26 (18): 2635–41. <https://doi.org/10.1038/sj.onc.1210061>.
- Dühren-von Minden, Marcus, Rudolf Übelhart, Dunja Schneider, Thomas Wossning, Martina P Bach, Maike Buchner, Daniel Hofmann, et al. 2012. "Chronic Lymphocytic Leukaemia Is Driven by Antigen-Independent Cell-Autonomous Signalling." *Nature* 489 (7415): 309–12. <https://doi.org/10.1038/nature11309>.
- Duke, Jamie L., Man Liu, Gur Yaari, Ashraf M. Khalil, Mary M. Tomayko, Mark J. Shlomchik, David G. Schatz, and Steven H. Kleinstein. 2013. "Multiple Transcription Factor Binding Sites Predict AID Targeting in Non-Ig Genes." *Journal of Immunology (Baltimore, Md.: 1950)* 190 (8): 3878–88. <https://doi.org/10.4049/jimmunol.1202547>.
- Dunnick, W., G. Z. Hertz, L. Scappino, and C. Gritzmacher. 1993. "DNA Sequences at Immunoglobulin Switch Region Recombination Sites." *Nucleic Acids Research* 21 (3): 365–72. <https://doi.org/10.1093/nar/21.3.365>.
- Eastman, Q. M., T. M. Leu, and D. G. Schatz. 1996. "Initiation of V(D)J Recombination in Vitro Obeying the 12/23 Rule." *Nature* 380 (6569): 85–88. <https://doi.org/10.1038/380085a0>.
- Egle, Alexander, Alan W. Harris, Mary L. Bath, Lorraine O'Reilly, and Suzanne Cory. 2004. "VavP-Bcl2 Transgenic Mice Develop Follicular Lymphoma Preceded by Germinal

- Center Hyperplasia.” *Blood* 103 (6): 2276–83. <https://doi.org/10.1182/blood-2003-07-2469>.
- Engel, H., A. Rolink, and S. Weiss. 1999. “B Cells Are Programmed to Activate Kappa and Lambda for Rearrangement at Consecutive Developmental Stages.” *European Journal of Immunology* 29 (7): 2167–76. [https://doi.org/10.1002/\(SICI\)1521-4141\(199907\)29:07<2167::AID-IMMU2167>3.0.CO;2-H](https://doi.org/10.1002/(SICI)1521-4141(199907)29:07<2167::AID-IMMU2167>3.0.CO;2-H).
- Epron, G., P. Ame-Thomas, J. Le Priol, C. Pangault, J. Dulong, T. Lamy, T. Fest, and K. Tarte. 2012. “Monocytes and T Cells Cooperate to Favor Normal and Follicular Lymphoma B-Cell Growth: Role of IL-15 and CD40L Signaling.” *Leukemia* 26 (1): 139–48. <https://doi.org/10.1038/leu.2011.179>.
- Franco, Sonia, Monica Gostissa, Shan Zha, David B. Lombard, Michael M. Murphy, Ali A. Zarrin, Catherine Yan, et al. 2006. “H2AX Prevents DNA Breaks from Progressing to Chromosome Breaks and Translocations.” *Molecular Cell* 21 (2): 201–14. <https://doi.org/10.1016/j.molcel.2006.01.005>.
- García-Álvarez, María, Sara Alonso-Álvarez, Isabel Prieto-Conde, Cristina Jiménez, M. Eugenia Sarasquete, M. Carmen Chillón, Alejandro Medina, et al. 2019. “Immunoglobulin Gene Rearrangement IGHV3-48 Is a Predictive Marker of Histological Transformation into Aggressive Lymphoma in Follicular Lymphomas.” *Blood Cancer Journal* 9 (7): 1–10. <https://doi.org/10.1038/s41408-019-0213-9>.
- Gocheva, Vasilena, Hao-Wei Wang, Bedrick B. Gadea, Tanaya Shree, Karen E. Hunter, Alfred L. Garfall, Tara Berman, and Johanna A. Joyce. 2010. “IL-4 Induces Cathepsin Protease Activity in Tumor-Associated Macrophages to Promote Cancer Growth and Invasion.” *Genes & Development* 24 (3): 241–55. <https://doi.org/10.1101/gad.1874010>.
- Goh, Amanda M., Cynthia R. Coffill, and David P. Lane. 2011. “The Role of Mutant P53 in Human Cancer.” *The Journal of Pathology* 223 (2): 116–26. <https://doi.org/10.1002/path.2784>.
- Gostissa, Monica, Catherine T. Yan, Julia M. Bianco, Michel Cogné, Eric Pinaud, and Frederick W. Alt. 2009. “Long-Range Oncogenic Activation of Igh-c-Myc Translocations by the Igh 3’ Regulatory Region.” *Nature* 462 (7274): 803–7. <https://doi.org/10.1038/nature08633>.
- Gramlich, Hillary Selle, Tara Reisbig, and David G. Schatz. 2012. “AID-Targeting and Hypermutation of Non-Immunoglobulin Genes Does Not Correlate with Proximity to Immunoglobulin Genes in Germinal Center B Cells.” *PloS One* 7 (6): e39601. <https://doi.org/10.1371/journal.pone.0039601>.

- Grass, Sandra, Klaus-Dieter Preuss, Stephan Thome, Dennis D. Weisenburger, Vinetta Witt, Jane Lynch, Florian Zettl, et al. 2011. "Paraproteins of Familial MGUS/Multiple Myeloma Target Family-Typical Antigens: Hyperphosphorylation of Autoantigens Is a Consistent Finding in Familial and Sporadic MGUS/MM." *Blood* 118 (3): 635–37. <https://doi.org/10.1182/blood-2011-01-331454>.
- Grass, Sandra, Klaus-Dieter Preuss, Alexandra Wikowicz, Evangelos Terpos, Marita Ziepert, Diana Nikolaus, Yin Yang, et al. 2011. "Hyperphosphorylated Paratarg-7: A New Molecularly Defined Risk Factor for Monoclonal Gammopathy of Undetermined Significance of the IgM Type and Waldenstrom Macroglobulinemia." *Blood* 117 (10): 2918–23. <https://doi.org/10.1182/blood-2010-09-306076>.
- Greaves, Mel, and Carlo C. Maley. 2012. "Clonal Evolution in Cancer." *Nature* 481 (7381): 306–13. <https://doi.org/10.1038/nature10762>.
- Green, Michael R. 2018. "Chromatin Modifying Gene Mutations in Follicular Lymphoma." *Blood* 131 (6): 595–604. <https://doi.org/10.1182/blood-2017-08-737361>.
- Greenman, Christopher, Philip Stephens, Raffaella Smith, Gillian L. Dalglish, Christopher Hunter, Graham Bignell, Helen Davies, et al. 2007. "Patterns of Somatic Mutation in Human Cancer Genomes." *Nature* 446 (7132): 153–58. <https://doi.org/10.1038/nature05610>.
- Guilloton, Fabien, Gersende Caron, Cédric Ménard, Céline Pangault, Patricia Amé-Thomas, Joëlle Dulong, John De Vos, et al. 2012. "Mesenchymal Stromal Cells Orchestrate Follicular Lymphoma Cell Niche through the CCL2-Dependent Recruitment and Polarization of Monocytes." *Blood* 119 (11): 2556–67. <https://doi.org/10.1182/blood-2011-08-370908>.
- Hackney, Jason A., Shahram Misaghi, Kate Senger, Christopher Garris, Yonglian Sun, Maria N. Lorenzo, and Ali A. Zarrin. 2009. "DNA Targets of AID Evolutionary Link between Antibody Somatic Hypermutation and Class Switch Recombination." *Advances in Immunology* 101: 163–89. [https://doi.org/10.1016/S0065-2776\(08\)01005-5](https://doi.org/10.1016/S0065-2776(08)01005-5).
- Hadzidimitriou, Anastasia, Andreas Agathangelidis, Nikos Darzentas, Fiona Murray, Marie-Helene Delfau-Larue, Lone Bredo Pedersen, Alba Navarro Lopez, et al. 2011. "Is There a Role for Antigen Selection in Mantle Cell Lymphoma? Immunogenetic Support from a Series of 807 Cases." *Blood* 118 (11): 3088–95. <https://doi.org/10.1182/blood-2011-03-343434>.
- Hakim, Ofir, Wolfgang Resch, Arito Yamane, Isaac Klein, Kyong-Rim Kieffer-Kwon, Mila Jankovic, Thiago Oliveira, et al. 2012. "DNA Damage Defines Sites of Recurrent

- Chromosomal Translocations in B Lymphocytes.” *Nature* 484 (7392): 69–74. <https://doi.org/10.1038/nature10909>.
- Halverson, Regina, Raul M. Torres, and Roberta Pelanda. 2004. “Receptor Editing Is the Main Mechanism of B Cell Tolerance toward Membrane Antigens.” *Nature Immunology* 5 (6): 645–50. <https://doi.org/10.1038/ni1076>.
- Hanahan, Douglas, and Robert A. Weinberg. 2011. “Hallmarks of Cancer: The next Generation.” *Cell* 144 (5): 646–74. <https://doi.org/10.1016/j.cell.2011.02.013>.
- Hardy, Richard R., Paul W. Kincade, and Kenneth Dorshkind. 2007. “The Protean Nature of Cells in the B Lymphocyte Lineage.” *Immunity* 26 (6): 703–14. <https://doi.org/10.1016/j.immuni.2007.05.013>.
- Helmink, Beth A., and Barry P. Sleckman. 2012. “The Response to and Repair of RAG-Mediated DNA Double-Strand Breaks.” *Annual Review of Immunology* 30: 175–202. <https://doi.org/10.1146/annurev-immunol-030409-101320>.
- Herzog, Sebastian, Eva Hug, Sonja Meixlsperger, Ji-Hye Paik, Ronald A. DePinho, Michael Reth, and Hassan Jumaa. 2008. “SLP-65 Regulates Immunoglobulin Light Chain Gene Recombination through the PI(3)K-PKB-Foxo Pathway.” *Nature Immunology* 9 (6): 623–31. <https://doi.org/10.1038/ni.1616>.
- Herzog, Sebastian, Michael Reth, and Hassan Jumaa. 2009. “Regulation of B-Cell Proliferation and Differentiation by Pre-B-Cell Receptor Signalling.” *Nature Reviews. Immunology* 9 (3): 195–205. <https://doi.org/10.1038/nri2491>.
- Hirano, Masayuki, Sabyasachi Das, Peng Guo, and Max D. Cooper. 2011. “The Evolution of Adaptive Immunity in Vertebrates.” *Advances in Immunology* 109: 125–57. <https://doi.org/10.1016/B978-0-12-387664-5.00004-2>.
- Hollander, Nurit, and Joseph Haimovich. 2017. “Altered N-Linked Glycosylation in Follicular Lymphoma and Chronic Lymphocytic Leukemia: Involvement in Pathogenesis and Potential Therapeutic Targeting.” *Frontiers in Immunology* 8: 912. <https://doi.org/10.3389/fimmu.2017.00912>.
- Hu, Xiaoyu, Kyung-Hyun Park-Min, Hao H. Ho, and Lionel B. Ivashkiv. 2005. “IFN-Gamma-Primed Macrophages Exhibit Increased CCR2-Dependent Migration and Altered IFN-Gamma Responses Mediated by Stat1.” *Journal of Immunology (Baltimore, Md.: 1950)* 175 (6): 3637–47. <https://doi.org/10.4049/jimmunol.175.6.3637>.
- Huet, Sarah, Pierre Sujobert, and Gilles Salles. 2018. “From Genetics to the Clinic: A Translational Perspective on Follicular Lymphoma.” *Nature Reviews. Cancer* 18 (4): 224–39. <https://doi.org/10.1038/nrc.2017.127>.

- Husson, H., E. G. Carideo, A. A. Cardoso, S. M. Lugli, D. Neuberg, O. Munoz, L. de Leval, J. Schultze, and A. S. Freedman. 2001. "MCP-1 Modulates Chemotaxis by Follicular Lymphoma Cells." *British Journal of Haematology* 115 (3): 554–62. <https://doi.org/10.1046/j.1365-2141.2001.03145.x>.
- Hwang, Joyce K., Frederick W. Alt, and Leng-Siew Yeap. 2015. "Related Mechanisms of Antibody Somatic Hypermutation and Class Switch Recombination." *Microbiology Spectrum* 3 (1): MDNA3-0037–2014. <https://doi.org/10.1128/microbiolspec.MDNA3-0037-2014>.
- Irish, Jonathan M., Debra K. Czerwinski, Garry P. Nolan, and Ronald Levy. 2006. "Altered B-Cell Receptor Signaling Kinetics Distinguish Human Follicular Lymphoma B Cells from Tumor-Infiltrating Nonmalignant B Cells." *Blood* 108 (9): 3135–42. <https://doi.org/10.1182/blood-2006-02-003921>.
- Isaacson, P. G. 2001. "Non-Hodgkin's Lymphoma." In *Encyclopedia of Genetics*, edited by Sydney Brenner and Jefferey H. Miller, 1347–49. New York: Academic Press. <https://doi.org/10.1006/rwgn.2001.1606>.
- Iyer, Ravi R., Anna Pluciennik, Vickers Burdett, and Paul L. Modrich. 2006. "DNA Mismatch Repair: Functions and Mechanisms." *Chemical Reviews* 106 (2): 302–23. <https://doi.org/10.1021/cr0404794>.
- Jankovic, Mila, André Nussenzweig, and Michel C. Nussenzweig. 2007. "Antigen Receptor Diversification and Chromosome Translocations." *Nature Immunology* 8 (8): 801–8. <https://doi.org/10.1038/ni1498>.
- Jankovic, Mila, Davide F. Robbiani, Yair Dorsett, Thomas Eisenreich, Yang Xu, Alexander Tarakhovsky, Andre Nussenzweig, and Michel C. Nussenzweig. 2010. "Role of the Translocation Partner in Protection against AID-Dependent Chromosomal Translocations." *Proceedings of the National Academy of Sciences of the United States of America* 107 (1): 187–92. <https://doi.org/10.1073/pnas.0908946107>.
- Janz, Siegfried. 2006. "Myc Translocations in B Cell and Plasma Cell Neoplasms." *DNA Repair* 5 (9–10): 1213–24. <https://doi.org/10.1016/j.dnarep.2006.05.017>.
- Jones, Jessica M., and Martin Gellert. 2002. "Ordered Assembly of the V(D)J Synaptic Complex Ensures Accurate Recombination." *The EMBO Journal* 21 (15): 4162–71. <https://doi.org/10.1093/emboj/cdf394>.
- Jong, Daphne de. 2005. "Molecular Pathogenesis of Follicular Lymphoma: A Cross Talk of Genetic and Immunologic Factors." *Journal of Clinical Oncology: Official Journal of*

- the American Society of Clinical Oncology* 23 (26): 6358–63.
<https://doi.org/10.1200/JCO.2005.26.856>.
- Jung, David, Cosmas Giallourakis, Raul Mostoslavsky, and Frederick W. Alt. 2006. “Mechanism and Control of V(D)J Recombination at the Immunoglobulin Heavy Chain Locus.” *Annual Review of Immunology* 24: 541–70.
<https://doi.org/10.1146/annurev.immunol.23.021704.115830>.
- Kawano, Yohei, Rika Ouchida, Ji-Yang Wang, Soichiro Yoshikawa, Mutsumi Yamamoto, Daisuke Kitamura, and Hajime Karasuyama. 2012. “A Novel Mechanism for the Autonomous Termination of Pre-B Cell Receptor Expression via Induction of Lysosome-Associated Protein Transmembrane 5.” *Molecular and Cellular Biology* 32 (21): 4462–71. <https://doi.org/10.1128/MCB.00531-12>.
- Keats, Jonathan J., Marta Chesi, Jan B. Egan, Victoria M. Garbitt, Stephen E. Palmer, Esteban Braggio, Scott Van Wier, et al. 2012. “Clonal Competition with Alternating Dominance in Multiple Myeloma.” *Blood* 120 (5): 1067–76. <https://doi.org/10.1182/blood-2012-01-405985>.
- Kennedy, Domenick E., and Marcus R. Clark. 2021. “Compartments and Connections Within the Germinal Center.” *Frontiers in Immunology* 12 (March): 659151.
<https://doi.org/10.3389/fimmu.2021.659151>.
- Khan, Wasif N. 2009. “B Cell Receptor and BAFF Receptor Signaling Regulation of B Cell Homeostasis.” *Journal of Immunology (Baltimore, Md.: 1950)* 183 (6): 3561–67.
<https://doi.org/10.4049/jimmunol.0800933>.
- Klein, Isaac A., Wolfgang Resch, Mila Jankovic, Thiago Oliveira, Arito Yamane, Hirotaka Nakahashi, Michela Di Virgilio, et al. 2011. “Translocation-Capture Sequencing Reveals the Extent and Nature of Chromosomal Rearrangements in B Lymphocytes.” *Cell* 147 (1): 95–106. <https://doi.org/10.1016/j.cell.2011.07.048>.
- Koning, Marvyn T., Rudolf Übelhart, Arjen H. G. Cleven, Willem H. Zoutman, Sander A. J. van der Zeeuw, Philip Kluin, Marieke Griffioen, et al. 2016. “Antigen-Independent, Autonomous B-Cell Receptor Signaling As a Dominant Candidate Oncogenic Mechanism in ABC DLBCL.” *Blood* 128 (22): 778–778.
<https://doi.org/10.1182/blood.V128.22.778.778>.
- Kretzmer, Helene, Stephan H. Bernhart, Wei Wang, Andrea Haake, Marc A. Weniger, Anke K. Bergmann, Matthew J. Betts, et al. 2015. “DNA-Methylome Analysis in Burkitt and Follicular Lymphomas Identifies Differentially Methylated Regions Linked to Somatic

- Mutation and Transcriptional Control.” *Nature Genetics* 47 (11): 1316–25. <https://doi.org/10.1038/ng.3413>.
- Kudo, A., and F. Melchers. 1987. “A Second Gene, VpreB in the Lambda 5 Locus of the Mouse, Which Appears to Be Selectively Expressed in Pre-B Lymphocytes.” *The EMBO Journal* 6 (8): 2267–72.
- Küppers, R., U. Klein, M. L. Hansmann, and K. Rajewsky. 1999. “Cellular Origin of Human B-Cell Lymphomas.” *The New England Journal of Medicine* 341 (20): 1520–29. <https://doi.org/10.1056/NEJM199911113412007>.
- Küppers, Ralf. 2005. “Mechanisms of B-Cell Lymphoma Pathogenesis.” *Nature Reviews. Cancer* 5 (4): 251–62. <https://doi.org/10.1038/nrc1589>.
- Kurosaki, Tomohiro, Kohei Kometani, and Wataru Ise. 2015. “Memory B Cells.” *Nature Reviews. Immunology* 15 (3): 149–59. <https://doi.org/10.1038/nri3802>.
- Kurosawa, Y., H. von Boehmer, W. Haas, H. Sakano, A. Trauneker, and S. Tonegawa. 1981. “Identification of D Segments of Immunoglobulin Heavy-Chain Genes and Their Rearrangement in T Lymphocytes.” *Nature* 290 (5807): 565–70. <https://doi.org/10.1038/290565a0>.
- Laidlaw, Brian J., and Jason G. Cyster. 2021. “Transcriptional Regulation of Memory B Cell Differentiation.” *Nature Reviews Immunology* 21 (4): 209–20. <https://doi.org/10.1038/s41577-020-00446-2>.
- Lamaison, Claire, and Karin Tarte. 2019. “Impact of B Cell/Lymphoid Stromal Cell Crosstalk in B-Cell Physiology and Malignancy.” *Immunology Letters* 215: 12–18. <https://doi.org/10.1016/j.imlet.2019.02.005>.
- Laurent, Camille, Sabina Müller, Catherine Do, Talal Al-Saati, Sophie Allart, Luigi Maria Larocca, Stefan Hohaus, et al. 2011. “Distribution, Function, and Prognostic Value of Cytotoxic T Lymphocytes in Follicular Lymphoma: A 3-D Tissue-Imaging Study.” *Blood* 118 (20): 5371–79. <https://doi.org/10.1182/blood-2011-04-345777>.
- Leseux, Ludivine, Safouane M. Hamdi, Talal Al Saati, Florence Capilla, Christian Recher, Guy Laurent, and Christine Bezombes. 2006. “Syk-Dependent MTOR Activation in Follicular Lymphoma Cells.” *Blood* 108 (13): 4156–62. <https://doi.org/10.1182/blood-2006-05-026203>.
- Li, S. C., P. B. Rothman, J. Zhang, C. Chan, D. Hirsh, and F. W. Alt. 1994. “Expression of I Mu-C Gamma Hybrid Germline Transcripts Subsequent to Immunoglobulin Heavy Chain Class Switching.” *International Immunology* 6 (4): 491–97. <https://doi.org/10.1093/intimm/6.4.491>.

- Lieber, Michael R., Kefei Yu, and Sathees C. Raghavan. 2006. "Roles of Nonhomologous DNA End Joining, V(D)J Recombination, and Class Switch Recombination in Chromosomal Translocations." *DNA Repair* 5 (9–10): 1234–45. <https://doi.org/10.1016/j.dnarep.2006.05.013>.
- Liubchenko, Ganna A., Holly C. Appleberry, V. Michael Holers, Nirmal K. Banda, Van C. Willis, and Taras Lyubchenko. 2012. "Potentially Autoreactive Naturally Occurring Transitional T3 B Lymphocytes Exhibit a Unique Signaling Profile." *Journal of Autoimmunity* 38 (4): 293–303. <https://doi.org/10.1016/j.jaut.2011.12.005>.
- Lovec, H., A. Grzeschiczek, M. B. Kowalski, and T. Möröy. 1994. "Cyclin D1/Bcl-1 Cooperates with Myc Genes in the Generation of B-Cell Lymphoma in Transgenic Mice." *The EMBO Journal* 13 (15): 3487–95.
- Lu, Zhong-Ping, Zhong-Liang Ju, Guang-Yin Shi, Jing-Wu Zhang, and Jian Sun. 2005. "Histone Deacetylase Inhibitor Trichostatin A Reduces Anti-DNA Autoantibody Production and Represses IgH Gene Transcription." *Biochemical and Biophysical Research Communications* 330 (1): 204–9. <https://doi.org/10.1016/j.bbrc.2005.02.147>.
- Luning Prak, Eline T., Marc Monestier, and Robert A. Eisenberg. 2011. "B Cell Receptor Editing in Tolerance and Autoimmunity." *Annals of the New York Academy of Sciences* 1217 (January): 96–121. <https://doi.org/10.1111/j.1749-6632.2010.05877.x>.
- Maby-El Hajjami, H el ene, Patricia Am e-Thomas, C eline Pangault, Olivier Tribut, John DeVos, Rachel Jean, Nad ege Bescher, et al. 2009. "Functional Alteration of the Lymphoma Stromal Cell Niche by the Cytokine Context: Role of Indoleamine-2,3 Dioxygenase." *Cancer Research* 69 (7): 3228–37. <https://doi.org/10.1158/0008-5472.CAN-08-3000>.
- MacLennan, I. C. 1994. "Germinal Centers." *Annual Review of Immunology* 12: 117–39. <https://doi.org/10.1146/annurev.iy.12.040194.001001>.
- Mani, Ram-Shankar, and Arul M. Chinnaiyan. 2010. "Triggers for Genomic Rearrangements: Insights into Genomic, Cellular and Environmental Influences." *Nature Reviews. Genetics* 11 (12): 819–29. <https://doi.org/10.1038/nrg2883>.
- Manis, John P., Julio C. Morales, Zhenfang Xia, Jeffery L. Kutok, Frederick W. Alt, and Phillip B. Carpenter. 2004. "53BP1 Links DNA Damage-Response Pathways to Immunoglobulin Heavy Chain Class-Switch Recombination." *Nature Immunology* 5 (5): 481–87. <https://doi.org/10.1038/ni1067>.
- Manis, John P., Ming Tian, and Frederick W. Alt. 2002. "Mechanism and Control of Class-Switch Recombination." *Trends in Immunology* 23 (1): 31–39. [https://doi.org/10.1016/s1471-4906\(01\)02111-1](https://doi.org/10.1016/s1471-4906(01)02111-1).

- Marculescu, Rodrig, Katrina Vanura, Bertrand Montpellier, Sandrine Roulland, Trang Le, Jean-Marc Navarro, Ulrich Jäger, Fraser McBlane, and Bertrand Nadel. 2006. “Recombinase, Chromosomal Translocations and Lymphoid Neoplasia: Targeting Mistakes and Repair Failures.” *DNA Repair* 5 (9–10): 1246–58. <https://doi.org/10.1016/j.dnarep.2006.05.015>.
- Mårtensson, Inga-Lill, Nina Almqvist, Ola Grimsholm, and Angelina I. Bernardi. 2010. “The Pre-B Cell Receptor Checkpoint.” *FEBS Letters* 584 (12): 2572–79. <https://doi.org/10.1016/j.febslet.2010.04.057>.
- Mårtensson, Inga-Lill, Antonius Rolink, Fritz Melchers, Cornelia Mundt, Steve Licence, and Takeyuki Shimizu. 2002. “The Pre-B Cell Receptor and Its Role in Proliferation and Ig Heavy Chain Allelic Exclusion.” *Seminars in Immunology* 14 (5): 335–42. [https://doi.org/10.1016/s1044-5323\(02\)00066-0](https://doi.org/10.1016/s1044-5323(02)00066-0).
- Martin, Flavius, and John F. Kearney. 2002. “Marginal-Zone B Cells.” *Nature Reviews. Immunology* 2 (5): 323–35. <https://doi.org/10.1038/nri799>.
- Matthews, Allysia J., Simin Zheng, Lauren J. DiMenna, and Jayanta Chaudhuri. 2014. “Regulation of Immunoglobulin Class-Switch Recombination: Choreography of Noncoding Transcription, Targeted DNA Deamination, and Long-Range DNA Repair.” *Advances in Immunology* 122: 1–57. <https://doi.org/10.1016/B978-0-12-800267-4.00001-8>.
- Mauri, Claudia, and Madhvi Menon. 2015. “The Expanding Family of Regulatory B Cells.” *International Immunology* 27 (10): 479–86. <https://doi.org/10.1093/intimm/dxv038>.
- McBlane, J. F., D. C. van Gent, D. A. Ramsden, C. Romeo, C. A. Cuomo, M. Gellert, and M. A. Oettinger. 1995. “Cleavage at a V(D)J Recombination Signal Requires Only RAG1 and RAG2 Proteins and Occurs in Two Steps.” *Cell* 83 (3): 387–95. [https://doi.org/10.1016/0092-8674\(95\)90116-7](https://doi.org/10.1016/0092-8674(95)90116-7).
- McBride, Kevin M., Anna Gazumyan, Eileen M. Woo, Tanja A. Schwickert, Brian T. Chait, and Michel C. Nussenzweig. 2008. “Regulation of Class Switch Recombination and Somatic Mutation by AID Phosphorylation.” *The Journal of Experimental Medicine* 205 (11): 2585–94. <https://doi.org/10.1084/jem.20081319>.
- McDonnell, T. J., N. Deane, F. M. Platt, G. Nunez, U. Jaeger, J. P. McKearn, and S. J. Korsmeyer. 1989. “Bcl-2-Immunoglobulin Transgenic Mice Demonstrate Extended B Cell Survival and Follicular Lymphoproliferation.” *Cell* 57 (1): 79–88. [https://doi.org/10.1016/0092-8674\(89\)90174-8](https://doi.org/10.1016/0092-8674(89)90174-8).

- Meng, Fei-Long, Frederick W. Alt, and Ming Tian. 2015. “Chapter 19 - The Mechanism of IgH Class Switch Recombination.” In *Molecular Biology of B Cells (Second Edition)*, edited by Frederick W. Alt, Tasuku Honjo, Andreas Radbruch, and Michael Reth, 345–62. London: Academic Press. <https://doi.org/10.1016/B978-0-12-397933-9.00019-9>.
- Merrell, Kevin T., Robert J. Benschop, Stephen B. Gauld, Katja Aviszus, Debora Decote-Ricardo, Lawrence J. Wasycki, and John C. Cambier. 2006. “Identification of Anergic B Cells within a Wild-Type Repertoire.” *Immunity* 25 (6): 953–62. <https://doi.org/10.1016/j.immuni.2006.10.017>.
- Mesin, Luka, Ariën Schiepers, Jonatan Ersching, Alexandru Barbulescu, Cecília B. Cavazzoni, Alessandro Angelini, Takaharu Okada, Tomohiro Kurosaki, and Gabriel D. Victora. 2020. “Restricted Clonality and Limited Germinal Center Reentry Characterize Memory B Cell Reactivation by Boosting.” *Cell* 180 (1): 92-106.e11. <https://doi.org/10.1016/j.cell.2019.11.032>.
- Meyer, Stefanie N., Claudio Scuppo, Sofija Vlasevska, Elodie Bal, Antony B. Holmes, Mara Holloman, Laura Garcia-Ibanez, et al. 2019. “Unique and Shared Epigenetic Programs of the CREBBP and EP300 Acetyltransferases in Germinal Center B Cells Reveal Targetable Dependencies in Lymphoma.” *Immunity* 51 (3): 535-547.e9. <https://doi.org/10.1016/j.immuni.2019.08.006>.
- Mikkola, Ingvild, Barry Heavey, Markus Horcher, and Meinrad Busslinger. 2002. “Reversion of B Cell Commitment upon Loss of Pax5 Expression.” *Science (New York, N.Y.)* 297 (5578): 110–13. <https://doi.org/10.1126/science.1067518>.
- Milpied, Pierre, Bertrand Nadel, and Sandrine Roulland. 2015. “Premalignant Cell Dynamics in Indolent B-Cell Malignancies.” *Current Opinion in Hematology* 22 (4): 388–96. <https://doi.org/10.1097/MOH.0000000000000159>.
- Miron, Karin, Tamar Golan-Lev, Raz Dvir, Eyal Ben-David, and Batsheva Kerem. 2015. “Oncogenes Create a Unique Landscape of Fragile Sites.” *Nature Communications* 6 (May): 7094. <https://doi.org/10.1038/ncomms8094>.
- Miyagaki, Tomomitsu, Manabu Fujimoto, and Shinichi Sato. 2015. “Regulatory B Cells in Human Inflammatory and Autoimmune Diseases: From Mouse Models to Clinical Research.” *International Immunology* 27 (10): 495–504. <https://doi.org/10.1093/intimm/dxv026>.
- Miyazaki, Kazuko, Masaki Miyazaki, and Cornelis Murre. 2014. “The Establishment of B versus T Cell Identity.” *Trends in Immunology* 35 (5): 205–10. <https://doi.org/10.1016/j.it.2014.02.009>.

- Mombaerts, P., J. Iacomini, R. S. Johnson, K. Herrup, S. Tonegawa, and V. E. Papaioannou. 1992. "RAG-1-Deficient Mice Have No Mature B and T Lymphocytes." *Cell* 68 (5): 869–77. [https://doi.org/10.1016/0092-8674\(92\)90030-g](https://doi.org/10.1016/0092-8674(92)90030-g).
- Montecino-Rodriguez, Encarnacion, and Kenneth Dorshkind. 2012. "B-1 B Cell Development in the Fetus and Adult." *Immunity* 36 (1): 13–21. <https://doi.org/10.1016/j.immuni.2011.11.017>.
- Montoto, Silvia, and Jude Fitzgibbon. 2011. "Transformation of Indolent B-Cell Lymphomas." *Journal of Clinical Oncology: Official Journal of the American Society of Clinical Oncology* 29 (14): 1827–34. <https://doi.org/10.1200/JCO.2010.32.7577>.
- Moore, M. W., J. Durdik, D. M. Persiani, and E. Selsing. 1985. "Deletions of Kappa Chain Constant Region Genes in Mouse Lambda Chain-Producing B Cells Involve Intrachromosomal DNA Recombinations Similar to V-J Joining." *Proceedings of the National Academy of Sciences of the United States of America* 82 (18): 6211–15. <https://doi.org/10.1073/pnas.82.18.6211>.
- Mostoslavsky, Raul, Frederick W. Alt, and Klaus Rajewsky. 2004. "The Lingering Enigma of the Allelic Exclusion Mechanism." *Cell* 118 (5): 539–44. <https://doi.org/10.1016/j.cell.2004.08.023>.
- Mundy, Cynthia L., Nadja Patenge, Adam G. W. Matthews, and Marjorie A. Oettinger. 2002. "Assembly of the RAG1/RAG2 Synaptic Complex." *Molecular and Cellular Biology* 22 (1): 69–77. <https://doi.org/10.1128/mcb.22.1.69-77.2002>.
- Muramatsu, M., K. Kinoshita, S. Fagarasan, S. Yamada, Y. Shinkai, and T. Honjo. 2000. "Class Switch Recombination and Hypermutation Require Activation-Induced Cytidine Deaminase (AID), a Potential RNA Editing Enzyme." *Cell* 102 (5): 553–63. [https://doi.org/10.1016/s0092-8674\(00\)00078-7](https://doi.org/10.1016/s0092-8674(00)00078-7).
- Muramatsu, M., V. S. Sankaranand, S. Anant, M. Sugai, K. Kinoshita, N. O. Davidson, and T. Honjo. 1999. "Specific Expression of Activation-Induced Cytidine Deaminase (AID), a Novel Member of the RNA-Editing Deaminase Family in Germinal Center B Cells." *The Journal of Biological Chemistry* 274 (26): 18470–76. <https://doi.org/10.1074/jbc.274.26.18470>.
- Nabel, Christopher S., Jae W. Lee, Laura C. Wang, and Rahul M. Kohli. 2013. "Nucleic Acid Determinants for Selective Deamination of DNA over RNA by Activation-Induced Deaminase." *Proceedings of the National Academy of Sciences of the United States of America* 110 (35): 14225–30. <https://doi.org/10.1073/pnas.1306345110>.

- Naeim, Faramarz, P. Nagesh Rao, Sophie X. Song, and Ryan T. Phan. 2018. "Chapter 57 - Classical Hodgkin Lymphoma." In *Atlas of Hematopathology (Second Edition)*, edited by Faramarz Naeim, P. Nagesh Rao, Sophie X. Song, and Ryan T. Phan, 789–801. Academic Press. <https://doi.org/10.1016/B978-0-12-809843-1.00057-7>.
- Nambu, Yukiko, Manabu Sugai, Hiroyuki Gonda, Chung-Gi Lee, Tomoya Katakai, Yasutoshi Agata, Yoshifumi Yokota, and Akira Shimizu. 2003. "Transcription-Coupled Events Associating with Immunoglobulin Switch Region Chromatin." *Science (New York, N.Y.)* 302 (5653): 2137–40. <https://doi.org/10.1126/science.1092481>.
- Nowell, P. C. 1976. "The Clonal Evolution of Tumor Cell Populations." *Science (New York, N.Y.)* 194 (4260): 23–28. <https://doi.org/10.1126/science.959840>.
- Nutt, Stephen L., Philip D. Hodgkin, David M. Tarlinton, and Lynn M. Corcoran. 2015. "The Generation of Antibody-Secreting Plasma Cells." *Nature Reviews. Immunology* 15 (3): 160–71. <https://doi.org/10.1038/nri3795>.
- Nutt, Stephen L., and Barbara L. Kee. 2007. "The Transcriptional Regulation of B Cell Lineage Commitment." *Immunity* 26 (6): 715–25. <https://doi.org/10.1016/j.immuni.2007.05.010>.
- O'Brien, Susan, Jan A. Burger, Kristie A. Blum, Richard R. Furman, Steven E. Coutre, Jeff Sharman, Ian W. Flinn, et al. 2011. "The Bruton's Tyrosine Kinase (BTK) Inhibitor PCI-32765 Induces Durable Responses in Relapsed or Refractory (R/R) Chronic Lymphocytic Leukemia/Small Lymphocytic Lymphoma (CLL/SLL): Follow-up of a Phase Ib/II Study." *Blood* 118 (21): 983–983. <https://doi.org/10.1182/blood.V118.21.983.983>.
- Okada, Takaharu, and Jason G. Cyster. 2006. "B Cell Migration and Interactions in the Early Phase of Antibody Responses." *Current Opinion in Immunology* 18 (3): 278–85. <https://doi.org/10.1016/j.coi.2006.02.005>.
- Okazaki, Il-mi, Ai Kotani, and Tasuku Honjo. 2007. "Role of AID in Tumorigenesis." *Advances in Immunology* 94: 245–73. [https://doi.org/10.1016/S0065-2776\(06\)94008-5](https://doi.org/10.1016/S0065-2776(06)94008-5).
- Onel, Buket, Megan Carver, Guanhui Wu, Daria Timonina, Salil Kalarn, Marti Larriva, and Danzhou Yang. 2016. "A New G Quadruplex with Hairpin Loop Immediately Upstream of the Human BCL2 P1 Promoter Modulates Transcription." *Journal of the American Chemical Society* 138 (8): 2563–70. <https://doi.org/10.1021/jacs.5b08596>.
- Ott, German, and Andreas Rosenwald. 2008. "Molecular Pathogenesis of Follicular Lymphoma." *Haematologica* 93 (12): 1773–76. <https://doi.org/10.3324/haematol.2008.001495>.

- Ozeri-Galai, Efrat, Michal Tur-Sinai, Assaf C. Bester, and Batsheva Kerem. 2014. “Interplay between Genetic and Epigenetic Factors Governs Common Fragile Site Instability in Cancer.” *Cellular and Molecular Life Sciences: CMLS* 71 (23): 4495–4506. <https://doi.org/10.1007/s00018-014-1719-8>.
- Packard, Thomas A., and John C. Cambier. 2013. “B Lymphocyte Antigen Receptor Signaling: Initiation, Amplification, and Regulation.” *F1000prime Reports* 5 (October): 40. <https://doi.org/10.12703/P5-40>.
- Pasqualucci, Laura. 2019. “Molecular Pathogenesis of Germinal Center-Derived B Cell Lymphomas.” *Immunological Reviews* 288 (1): 240–61. <https://doi.org/10.1111/imr.12745>.
- Pavri, Rushad. 2017. “R Loops in the Regulation of Antibody Gene Diversification.” *Genes* 8 (6). <https://doi.org/10.3390/genes8060154>.
- Peled, Jonathan U., Fei Li Kuang, Maria D. Iglesias-Ussel, Sergio Roa, Susan L. Kalis, Myron F. Goodman, and Matthew D. Scharff. 2008. “The Biochemistry of Somatic Hypermutation.” *Annual Review of Immunology* 26: 481–511. <https://doi.org/10.1146/annurev.immunol.26.021607.090236>.
- Pepper, John W., C. Scott Findlay, Rees Kassen, Sabrina L. Spencer, and Carlo C. Maley. 2009. “Cancer Research Meets Evolutionary Biology.” *Evolutionary Applications* 2 (1): 62–70. <https://doi.org/10.1111/j.1752-4571.2008.00063.x>.
- Pérez-Durán, Pablo, Laura Belver, Virginia G. de Yébenes, Pilar Delgado, David G. Pisano, and Almudena R. Ramiro. 2012. “UNG Shapes the Specificity of AID-Induced Somatic Hypermutation.” *The Journal of Experimental Medicine* 209 (7): 1379–89. <https://doi.org/10.1084/jem.20112253>.
- Petersen, Simone, Rafael Casellas, Bernardo Reina-San-Martin, Hua Tang Chen, Michael J. Difilippantonio, Patrick C. Wilson, Leif Hanitsch, et al. 2001. “AID Is Required to Initiate Nbs1/Gamma-H2AX Focus Formation and Mutations at Sites of Class Switching.” *Nature* 414 (6864): 660–65. <https://doi.org/10.1038/414660a>.
- Pham, Phuong, Ronda Bransteitter, John Petruska, and Myron F. Goodman. 2003. “Processive AID-Catalysed Cytosine Deamination on Single-Stranded DNA Simulates Somatic Hypermutation.” *Nature* 424 (6944): 103–7. <https://doi.org/10.1038/nature01760>.
- Pieper, Kathrin, Bodo Grimbacher, and Hermann Eibel. 2013. “B-Cell Biology and Development.” *The Journal of Allergy and Clinical Immunology* 131 (4): 959–71. <https://doi.org/10.1016/j.jaci.2013.01.046>.

- Pike, B. L., A. W. Boyd, and G. J. Nossal. 1982. "Clonal Anergy: The Universally Anergic B Lymphocyte." *Proceedings of the National Academy of Sciences of the United States of America* 79 (6): 2013–17. <https://doi.org/10.1073/pnas.79.6.2013>.
- Pillai, Shiv, and Annaiah Cariappa. 2009. "The Follicular versus Marginal Zone B Lymphocyte Cell Fate Decision." *Nature Reviews. Immunology* 9 (11): 767–77. <https://doi.org/10.1038/nri2656>.
- Pinaud, Eric, Marie Marquet, Rémi Fiancette, Sophie Péron, Christelle Vincent-Fabert, Yves Denizot, and Michel Cogné. 2011. "The IgH Locus 3' Regulatory Region: Pulling the Strings from Behind." *Advances in Immunology* 110: 27–70. <https://doi.org/10.1016/B978-0-12-387663-8.00002-8>.
- Pon, Julia R., and Marco A. Marra. 2015. "Driver and Passenger Mutations in Cancer." *Annual Review of Pathology* 10: 25–50. <https://doi.org/10.1146/annurev-pathol-012414-040312>.
- pubmeddev, and Rocha PP al et. n.d. "Close Proximity to Igh Is a Contributing Factor to AID-Mediated Translocations. - PubMed - NCBI." Accessed March 24, 2020. <https://www.ncbi.nlm.nih.gov/pubmed/?term=Close+proximity+to+Igh+is+a+contributing+factor+to+AID-mediated+translocations>.
- Qi, Hai, Jennifer L. Cannons, Frederick Klauschen, Pamela L. Schwartzberg, and Ronald N. Germain. 2008. "SAP-Controlled T-B Cell Interactions Underlie Germinal Centre Formation." *Nature* 455 (7214): 764–69. <https://doi.org/10.1038/nature07345>.
- Raghavan, Sathees C., Patrick C. Swanson, Xiantuo Wu, Chih-Lin Hsieh, and Michael R. Lieber. 2004. "A Non-B-DNA Structure at the Bcl-2 Major Breakpoint Region Is Cleaved by the RAG Complex." *Nature* 428 (6978): 88–93. <https://doi.org/10.1038/nature02355>.
- Ramiro, Almudena R., Mila Jankovic, Thomas Eisenreich, Simone Difilippantonio, Selina Chen-Kiang, Masamichi Muramatsu, Tasuku Honjo, André Nussenzweig, and Michel C. Nussenzweig. 2004. "AID Is Required for C-Myc/IgH Chromosome Translocations in Vivo." *Cell* 118 (4): 431–38. <https://doi.org/10.1016/j.cell.2004.08.006>.
- Ramiro, Almudena R., Pete Stavropoulos, Mila Jankovic, and Michel C. Nussenzweig. 2003. "Transcription Enhances AID-Mediated Cytidine Deamination by Exposing Single-Stranded DNA on the Nontemplate Strand." *Nature Immunology* 4 (5): 452–56. <https://doi.org/10.1038/ni920>.

- Ray, Avijit, Luman Wang, and Bonnie N. Dittel. 2015. "IL-10-Independent Regulatory B-Cell Subsets and Mechanisms of Action." *International Immunology* 27 (10): 531–36. <https://doi.org/10.1093/intimm/dxv033>.
- Reth, M. G., and F. W. Alt. 1984. "Novel Immunoglobulin Heavy Chains Are Produced from DJH Gene Segment Rearrangements in Lymphoid Cells." *Nature* 312 (5993): 418–23. <https://doi.org/10.1038/312418a0>.
- Reth, Michael, and Peter Nielsen. 2014. "Signaling Circuits in Early B-Cell Development." *Advances in Immunology* 122: 129–75. <https://doi.org/10.1016/B978-0-12-800267-4.00004-3>.
- Revy, P., T. Muto, Y. Levy, F. Geissmann, A. Plebani, O. Sanal, N. Catalan, et al. 2000. "Activation-Induced Cytidine Deaminase (AID) Deficiency Causes the Autosomal Recessive Form of the Hyper-IgM Syndrome (HIGM2)." *Cell* 102 (5): 565–75. [https://doi.org/10.1016/S0092-8674\(00\)00079-9](https://doi.org/10.1016/S0092-8674(00)00079-9).
- Rincón-Arévalo, Héctor, Claudia C. Sanchez-Parra, Diana Castaño, Lina Yassin, and Gloria Vásquez. 2016. "Regulatory B Cells and Mechanisms." *International Reviews of Immunology* 35 (2): 156–76. <https://doi.org/10.3109/08830185.2015.1015719>.
- Robbiani, Davide F., and Michel C. Nussenzweig. 2013. "Chromosome Translocation, B Cell Lymphoma, and Activation-Induced Cytidine Deaminase." *Annual Review of Pathology* 8 (January): 79–103. <https://doi.org/10.1146/annurev-pathol-020712-164004>.
- Rocha, Pedro P., Mariann Micsinai, Yuval Kluger, and Jane A. Skok. 2013. "Response to Casellas et Al." *Molecular Cell* 51 (3): 277–78. <https://doi.org/10.1016/j.molcel.2013.07.019>.
- Rolink, A. G., T. Winkler, F. Melchers, and J. Andersson. 2000. "Precursor B Cell Receptor-Dependent B Cell Proliferation and Differentiation Does Not Require the Bone Marrow or Fetal Liver Environment." *The Journal of Experimental Medicine* 191 (1): 23–32. <https://doi.org/10.1084/jem.191.1.23>.
- Ronai, Diana, Maria D. Iglesias-Ussel, Manxia Fan, Ziqiang Li, Alberto Martin, and Matthew D. Scharff. 2007. "Detection of Chromatin-Associated Single-Stranded DNA in Regions Targeted for Somatic Hypermutation." *The Journal of Experimental Medicine* 204 (1): 181–90. <https://doi.org/10.1084/jem.20062032>.
- Roth, David B. 2014. "V(D)J Recombination: Mechanism, Errors, and Fidelity." *Microbiology Spectrum* 2 (6). <https://doi.org/10.1128/microbiolspec.MDNA3-0041-2014>.

- Rouaud, Pauline, Rémi Fiancette, Christelle Vincent-Fabert, Virginie Magnone, Michel Cogné, Pierre Dubus, and Yves Denizot. 2012. “Mantle Cell Lymphoma-like Lymphomas in c-Myc-3’RR/P53+/- Mice and c-Myc-3’RR/Cdk4R24C Mice: Differential Oncogenic Mechanisms but Similar Cellular Origin.” *Oncotarget* 3 (5): 586–93. <https://doi.org/10.18632/oncotarget.474>.
- Roulland, Sandrine, Mustapha Faroudi, Emilie Mamessier, Stéphanie Sungalee, Gilles Salles, and Bertrand Nadel. 2011. “Early Steps of Follicular Lymphoma Pathogenesis.” *Advances in Immunology* 111: 1–46. <https://doi.org/10.1016/B978-0-12-385991-4.00001-5>.
- Rowley, J. D. 1973a. “Identificaton of a Translocation with Quinacrine Fluorescence in a Patient with Acute Leukemia.” *Annales De Genetique* 16 (2): 109–12.
- . 1973b. “Letter: A New Consistent Chromosomal Abnormality in Chronic Myelogenous Leukaemia Identified by Quinacrine Fluorescence and Giemsa Staining.” *Nature* 243 (5405): 290–93. <https://doi.org/10.1038/243290a0>.
- Rowley, R. B., A. L. Burkhardt, H. G. Chao, G. R. Matsueda, and J. B. Bolen. 1995. “Syk Protein-Tyrosine Kinase Is Regulated by Tyrosine-Phosphorylated Ig Alpha/Ig Beta Immunoreceptor Tyrosine Activation Motif Binding and Autophosphorylation.” *The Journal of Biological Chemistry* 270 (19): 11590–94. <https://doi.org/10.1074/jbc.270.19.11590>.
- Ruminy, P., F. Jardin, J. M. Picquenot, P. Gaulard, F. Parmentier, G. Buchonnet, C. Maisonneuve, H. Tilly, and C. Bastard. 2006. “Two Patterns of Chromosomal Breakpoint Locations on the Immunoglobulin Heavy-Chain Locus in B-Cell Lymphomas with t(3;14)(Q27;Q32): Relevance to Histology.” *Oncogene* 25 (35): 4947–54. <https://doi.org/10.1038/sj.onc.1209512>.
- Russell, D. M., Z. Dembić, G. Morahan, J. F. Miller, K. Bürki, and D. Nemazee. 1991. “Peripheral Deletion of Self-Reactive B Cells.” *Nature* 354 (6351): 308–11. <https://doi.org/10.1038/354308a0>.
- Saha, Tannishtha, Devakumar Sundaravinayagam, and Michela Di Virgilio. 2021. “Charting a DNA Repair Roadmap for Immunoglobulin Class Switch Recombination.” *Trends in Biochemical Sciences* 46 (3): 184–99. <https://doi.org/10.1016/j.tibs.2020.10.005>.
- Saito, Masumichi, Urban Novak, Erich Piovan, Katia Basso, Pavel Sumazin, Christof Schneider, Marta Crespo, et al. 2009. “BCL6 Suppression of BCL2 via Miz1 and Its Disruption in Diffuse Large B Cell Lymphoma.” *Proceedings of the National Academy*

- of Sciences of the United States of America* 106 (27): 11294–99.
<https://doi.org/10.1073/pnas.0903854106>.
- Sakaguchi, N., and F. Melchers. 1986. “Lambda 5, a New Light-Chain-Related Locus Selectively Expressed in Pre-B Lymphocytes.” *Nature* 324 (6097): 579–82.
<https://doi.org/10.1038/324579a0>.
- Sakano, H., Y. Kurosawa, M. Weigert, and S. Tonegawa. 1981. “Identification and Nucleotide Sequence of a Diversity DNA Segment (D) of Immunoglobulin Heavy-Chain Genes.” *Nature* 290 (5807): 562–65. <https://doi.org/10.1038/290562a0>.
- Sandel, P. C., and J. G. Monroe. 1999. “Negative Selection of Immature B Cells by Receptor Editing or Deletion Is Determined by Site of Antigen Encounter.” *Immunity* 10 (3): 289–99. [https://doi.org/10.1016/s1074-7613\(00\)80029-1](https://doi.org/10.1016/s1074-7613(00)80029-1).
- Sasaki, Yoshiteru, Stefano Casola, Jeffery L. Kutok, Klaus Rajewsky, and Marc Schmidt-Supprian. 2004. “TNF Family Member B Cell-Activating Factor (BAFF) Receptor-Dependent and -Independent Roles for BAFF in B Cell Physiology.” *Journal of Immunology (Baltimore, Md.: 1950)* 173 (4): 2245–52.
<https://doi.org/10.4049/jimmunol.173.4.2245>.
- Schatz, D. G., and E. Spanopoulou. 2005. “Biochemistry of V(D)J Recombination.” *Current Topics in Microbiology and Immunology* 290: 49–85. https://doi.org/10.1007/3-540-26363-2_4.
- Schmidt, E. V., P. K. Pattengale, L. Weir, and P. Leder. 1988. “Transgenic Mice Bearing the Human C-Myc Gene Activated by an Immunoglobulin Enhancer: A Pre-B-Cell Lymphoma Model.” *Proceedings of the National Academy of Sciences of the United States of America* 85 (16): 6047–51. <https://doi.org/10.1073/pnas.85.16.6047>.
- Schneider, P., F. MacKay, V. Steiner, K. Hofmann, J. L. Bodmer, N. Holler, C. Ambrose, et al. 1999. “BAFF, a Novel Ligand of the Tumor Necrosis Factor Family, Stimulates B Cell Growth.” *The Journal of Experimental Medicine* 189 (11): 1747–56.
<https://doi.org/10.1084/jem.189.11.1747>.
- Secord, E. A., J. M. Edington, and G. J. Thorbecke. 1995. “The Emu-Bcl-2 Transgene Enhances Antigen-Induced Germinal Center Formation in Both BALB/c and SJL Mice but Causes Age-Dependent Germinal Center Hyperplasia Only in the Lymphoma-Prone SJL Strain.” *The American Journal of Pathology* 147 (2): 422–33.
- Seifert, Marc, René Scholtysik, and Ralf Küppers. 2019. “Origin and Pathogenesis of B Cell Lymphomas.” *Methods in Molecular Biology (Clifton, N.J.)* 1956: 1–33.
https://doi.org/10.1007/978-1-4939-9151-8_1.

- Sepulveda, Julieta, Noé Seija, Pablo Opezzo, and Marcelo A. Navarrete. 2017. "The Antigen Receptor as a Driver of B-Cell Lymphoma Development and Evolution." *Hematology - Latest Research and Clinical Advances*, December. <https://doi.org/10.5772/intechopen.72122>.
- Shinkai, Y., G. Rathbun, K. P. Lam, E. M. Oltz, V. Stewart, M. Mendelsohn, J. Charron, M. Datta, F. Young, and A. M. Stall. 1992. "RAG-2-Deficient Mice Lack Mature Lymphocytes Owing to Inability to Initiate V(D)J Rearrangement." *Cell* 68 (5): 855–67. [https://doi.org/10.1016/0092-8674\(92\)90029-c](https://doi.org/10.1016/0092-8674(92)90029-c).
- Slingerland, Marije, Henk-Jan Guchelaar, and Hans Gelderblom. 2014. "Histone Deacetylase Inhibitors: An Overview of the Clinical Studies in Solid Tumors." *Anti-Cancer Drugs* 25 (2): 140–49. <https://doi.org/10.1097/CAD.0000000000000040>.
- Smilevska, Tatjana, Eugenia Tsakou, Anastasia Hadzidimitriou, Vasilis Bikos, Niki Stavroyianni, Nikolaos Laoutaris, Athanasios Fassas, et al. 2008. "Immunoglobulin Kappa Gene Repertoire and Somatic Hypermutation Patterns in Follicular Lymphoma." *Blood Cells, Molecules, and Diseases* 41 (2): 215–18. <https://doi.org/10.1016/j.bcmed.2008.06.002>.
- Solal-Céligny, Philippe, Pascal Roy, Philippe Colombat, Josephine White, Jim O. Armitage, Reyes Arranz-Saez, Wing Y. Au, et al. 2004. "Follicular Lymphoma International Prognostic Index." *Blood* 104 (5): 1258–65. <https://doi.org/10.1182/blood-2003-12-4434>.
- Souabni, Abdallah, Cesar Cobaleda, Michael Schebesta, and Meinrad Busslinger. 2002. "Pax5 Promotes B Lymphopoiesis and Blocks T Cell Development by Repressing Notch1." *Immunity* 17 (6): 781–93. [https://doi.org/10.1016/s1074-7613\(02\)00472-7](https://doi.org/10.1016/s1074-7613(02)00472-7).
- Stavnezer, Janet, Andrea Björkman, Likun Du, Alberto Cagigi, and Qiang Pan-Hammarström. 2010. "Mapping of Switch Recombination Junctions, a Tool for Studying DNA Repair Pathways during Immunoglobulin Class Switching." *Advances in Immunology* 108: 45–109. <https://doi.org/10.1016/B978-0-12-380995-7.00003-3>.
- Stavnezer, Janet, and Carol E. Schrader. 2014. "IgH Chain Class Switch Recombination: Mechanism and Regulation." *Journal of Immunology (Baltimore, Md.: 1950)* 193 (11): 5370–78. <https://doi.org/10.4049/jimmunol.1401849>.
- Stevenson, F., S. Sahota, D. Zhu, C. Ottensmeier, C. Chapman, D. Oscier, and T. Hamblin. 1998. "Insight into the Origin and Clonal History of B-Cell Tumors as Revealed by Analysis of Immunoglobulin Variable Region Genes." *Immunological Reviews* 162 (April): 247–59. <https://doi.org/10.1111/j.1600-065x.1998.tb01446.x>.

- Stewart, A. K., C. Huang, B. D. Stollar, and R. S. Schwartz. 1993. "High-Frequency Representation of a Single VH Gene in the Expressed Human B Cell Repertoire." *The Journal of Experimental Medicine* 177 (2): 409–18. <https://doi.org/10.1084/jem.177.2.409>.
- Strasser, A., A. W. Harris, and S. Cory. 1993. "E Mu-Bcl-2 Transgene Facilitates Spontaneous Transformation of Early Pre-B and Immunoglobulin-Secreting Cells but Not T Cells." *Oncogene* 8 (1): 1–9.
- Szydłowski, Maciej, Przemysław Kiliszek, Tomasz Sewastianik, Ewa Jabłonska, Emilia Białopiotrowicz, Patryk Gorniak, Anna Polak, et al. 2016. "FOXO1 Activation Is an Effector of SYK and AKT Inhibition in Tonic BCR Signal-Dependent Diffuse Large B-Cell Lymphomas." *Blood* 127 (6): 739–48. <https://doi.org/10.1182/blood-2015-06-654111>.
- Taylor, Joseph G., and John G. Gribben. 2015. "Microenvironment Abnormalities and Lymphomagenesis: Immunological Aspects." *Seminars in Cancer Biology* 34 (October): 36–45. <https://doi.org/10.1016/j.semcancer.2015.07.004>.
- Teague, Brittany N., Yujun Pan, Philip A. Mudd, Britt Nakken, Qingzhao Zhang, Peter Szodoray, Xana Kim-Howard, Patrick C. Wilson, and A. Darise Farris. 2007. "Cutting Edge: Transitional T3 B Cells Do Not Give Rise to Mature B Cells, Have Undergone Selection, and Are Reduced in Murine Lupus." *Journal of Immunology (Baltimore, Md.: 1950)* 178 (12): 7511–15. <https://doi.org/10.4049/jimmunol.178.12.7511>.
- Tellier, Julie, Cedric Menard, Sandrine Roulland, Nadine Martin, Céline Monvoisin, Lionel Chasson, Bertrand Nadel, Philippe Gaulard, Claudine Schiff, and Karin Tarte. 2014. "Human t(14;18)Positive Germinal Center B Cells: A New Step in Follicular Lymphoma Pathogenesis?" *Blood* 123 (22): 3462–65. <https://doi.org/10.1182/blood-2013-12-545954>.
- Tian, Ming, Cheng Cheng, Xuejun Chen, Hongying Duan, Hwei-Ling Cheng, Mai Dao, Zizhang Sheng, et al. 2016. "Induction of HIV Neutralizing Antibody Lineages in Mice with Diverse Precursor Repertoires." *Cell* 166 (6): 1471-1484.e18. <https://doi.org/10.1016/j.cell.2016.07.029>.
- Tiegs, S. L., D. M. Russell, and D. Nemazee. 1993. "Receptor Editing in Self-Reactive Bone Marrow B Cells." *The Journal of Experimental Medicine* 177 (4): 1009–20. <https://doi.org/10.1084/jem.177.4.1009>.
- Tinguely, Aurélien, Guillaume Chemin, Sophie Péron, Christophe Sirac, Stéphane Reynaud, Michel Cogné, and Laurent Delpy. 2012. "Cross Talk between Immunoglobulin Heavy-

- Chain Transcription and RNA Surveillance during B Cell Development.” *Molecular and Cellular Biology* 32 (1): 107–17. <https://doi.org/10.1128/MCB.06138-11>.
- Tobin, Gerard, Ulf Thunberg, Anna Johnson, Inger Eriksson, Ola Söderberg, Karin Karlsson, Mats Merup, et al. 2003. “Chronic Lymphocytic Leukemias Utilizing the VH3-21 Gene Display Highly Restricted Vlambda2-14 Gene Use and Homologous CDR3s: Implicating Recognition of a Common Antigen Epitope.” *Blood* 101 (12): 4952–57. <https://doi.org/10.1182/blood-2002-11-3485>.
- Travert, Marion, Patricia Ame-Thomas, Céline Pangault, Alexandre Morizot, Olivier Micheau, Gilbert Semana, Thierry Lamy, Thierry Fest, Karin Tarte, and Thierry Guillaudeux. 2008. “CD40 Ligand Protects from TRAIL-Induced Apoptosis in Follicular Lymphomas through NF-KappaB Activation and up-Regulation of c-FLIP and Bcl-XL.” *Journal of Immunology (Baltimore, Md.: 1950)* 181 (2): 1001–11. <https://doi.org/10.4049/jimmunol.181.2.1001>.
- Treiber, Thomas, Elizabeth M. Mandel, Sebastian Pott, Ildiko Györy, Sonja Firner, Edison T. Liu, and Rudolf Grosschedl. 2010. “Early B Cell Factor 1 Regulates B Cell Gene Networks by Activation, Repression, and Transcription- Independent Poising of Chromatin.” *Immunity* 32 (5): 714–25. <https://doi.org/10.1016/j.immuni.2010.04.013>.
- Truffinet, Véronique, Eric Pinaud, Nadine Cogné, Barbara Petit, Laurence Guglielmi, Michel Cogné, and Yves Denizot. 2007. “The 3’ IgH Locus Control Region Is Sufficient to Deregulate a c-Myc Transgene and Promote Mature B Cell Malignancies with a Predominant Burkitt-like Phenotype.” *Journal of Immunology (Baltimore, Md.: 1950)* 179 (9): 6033–42. <https://doi.org/10.4049/jimmunol.179.9.6033>.
- Tsuneto, Motokazu, Ekaterina Kajikhina, Katharina Seiler, Andreas Reimer, Julia Tornack, Corinne Bouquet, Szandor Simmons, et al. 2014. “Environments of B Cell Development.” *Immunology Letters* 157 (1–2): 60–63. <https://doi.org/10.1016/j.imlet.2013.11.011>.
- Vaidyanathan, Bharat, Wei-Feng Yen, Joseph N. Pucella, and Jayanta Chaudhuri. 2014. “AIDing Chromatin and Transcription-Coupled Orchestration of Immunoglobulin Class-Switch Recombination.” *Frontiers in Immunology* 5: 120. <https://doi.org/10.3389/fimmu.2014.00120>.
- Viardot, Andreas a, Thomas F. E. Barth, Peter Möller, Hartmut Döhner, and Martin Bentz. 2003. “Cytogenetic Evolution of Follicular Lymphoma.” *Seminars in Cancer Biology* 13 (3): 183–90. [https://doi.org/10.1016/s1044-579x\(03\)00014-2](https://doi.org/10.1016/s1044-579x(03)00014-2).

- Victora, Gabriel D., and Michel C. Nussenzweig. 2012. "Germinal Centers." *Annual Review of Immunology* 30: 429–57. <https://doi.org/10.1146/annurev-immunol-020711-075032>.
- Vincent-Fabert, Christelle, Rémi Fiancette, Michel Cogné, Eric Pinaud, and Yves Denizot. 2010. "The IgH 3' Regulatory Region and Its Implication in Lymphomagenesis." *European Journal of Immunology* 40 (12): 3306–11. <https://doi.org/10.1002/eji.201040778>.
- Vincent-Fabert, Christelle, Rémi Fiancette, Véronique Truffinet, Nadine Cogné, Michel Cogné, and Yves Denizot. 2009. "Genetic Background Modulates Susceptibility to Oncogen-Driven Proliferation and Lymphoma Occurrence in Mice Carrying a Deregulated c-Myc Transgene." *Leukemia Research* 33 (11): e203-206. <https://doi.org/10.1016/j.leukres.2009.05.018>.
- Vogelstein, B., and K. W. Kinzler. 1993. "The Multistep Nature of Cancer." *Trends in Genetics: TIG* 9 (4): 138–41. [https://doi.org/10.1016/0168-9525\(93\)90209-z](https://doi.org/10.1016/0168-9525(93)90209-z).
- Vossenkämper, A., P. M. K. Lutalo, and J. Spencer. 2012. "Translational Mini-Review Series on B Cell Subsets in Disease. Transitional B Cells in Systemic Lupus Erythematosus and Sjögren's Syndrome: Clinical Implications and Effects of B Cell-Targeted Therapies." *Clinical and Experimental Immunology* 167 (1): 7–14. <https://doi.org/10.1111/j.1365-2249.2011.04460.x>.
- Wahlin, B. E., B. Sander, B. Christensson, B. Ostenstad, H. Holte, P. D. Brown, C. Sundström, and E. Kimby. 2012. "Entourage: The Immune Microenvironment Following Follicular Lymphoma." *Blood Cancer Journal* 2 (1): e52. <https://doi.org/10.1038/bcj.2011.53>.
- Waibel, Michaela, Ailsa J. Christiansen, Margaret L. Hibbs, Jake Shortt, Sarah A. Jones, Ian Simpson, Amanda Light, et al. 2015. "Manipulation of B-Cell Responses with Histone Deacetylase Inhibitors." *Nature Communications* 6 (April): 6838. <https://doi.org/10.1038/ncomms7838>.
- Wang, Jinghong, and Linda M. Boxer. 2005. "Regulatory Elements in the Immunoglobulin Heavy Chain Gene 3'-Enhancers Induce c-Myc Deregulation and Lymphomagenesis in Murine B Cells." *The Journal of Biological Chemistry* 280 (13): 12766–73. <https://doi.org/10.1074/jbc.M412446200>.
- Wang, Luhua, Peter Martin, Kristie A. Blum, Brad S. Kahl, Lauren S. Maeda, Ranjana Advani, Michael E. Williams, et al. 2011. "The Bruton's Tyrosine Kinase Inhibitor PCI-32765 Is Highly Active As Single-Agent Therapy in Previously-Treated Mantle Cell Lymphoma (MCL): Preliminary Results of a Phase II Trial." *Blood* 118 (21): 442–442. <https://doi.org/10.1182/blood.V118.21.442.442>.

- Wang, Qiao, Thiago Oliveira, Mila Jankovic, Israel T. Silva, Ofir Hakim, Kaihui Yao, Anna Gazumyan, et al. 2014. “Epigenetic Targeting of Activation-Induced Cytidine Deaminase.” *Proceedings of the National Academy of Sciences of the United States of America* 111 (52): 18667–72. <https://doi.org/10.1073/pnas.1420575111>.
- Wartman, Lukas D., David E. Larson, Zhifu Xiang, Li Ding, Ken Chen, Ling Lin, Patrick Cahan, et al. 2011. “Sequencing a Mouse Acute Promyelocytic Leukemia Genome Reveals Genetic Events Relevant for Disease Progression.” *The Journal of Clinical Investigation* 121 (4): 1445–55. <https://doi.org/10.1172/JCI45284>.
- Wei, Fang, Kristina Zaprazna, Junwen Wang, and Michael L. Atchison. 2009. “PU.1 Can Recruit BCL6 to DNA to Repress Gene Expression in Germinal Center B Cells.” *Molecular and Cellular Biology* 29 (17): 4612–22. <https://doi.org/10.1128/MCB.00234-09>.
- Welinder, Eva, Josefine Ahsberg, and Mikael Sigvardsson. 2011. “B-Lymphocyte Commitment: Identifying the Point of No Return.” *Seminars in Immunology* 23 (5): 335–40. <https://doi.org/10.1016/j.smim.2011.08.005>.
- Wen, Yue, Yukai Jing, Lu Yang, Danqing Kang, Panpan Jiang, Na Li, Jiali Cheng, et al. 2019. “The Regulators of BCR Signaling during B Cell Activation.” *Blood Science* 1 (2): 119–29. <https://doi.org/10.1097/BS9.0000000000000026>.
- Widhopf, G. F., and T. J. Kipps. 2001. “Normal B Cells Express 51p1-Encoded Ig Heavy Chains That Are Distinct from Those Expressed by Chronic Lymphocytic Leukemia B Cells.” *Journal of Immunology (Baltimore, Md.: 1950)* 166 (1): 95–102. <https://doi.org/10.4049/jimmunol.166.1.95>.
- Winkfield, Karen M., Richard W. Tsang, and Mary K. Gospodarowicz. 2016. “Chapter 77 - Non-Hodgkin’s Lymphoma.” In *Clinical Radiation Oncology (Fourth Edition)*, edited by Leonard L. Gunderson and Joel E. Tepper, 1524-1546.e7. Philadelphia: Elsevier. <https://doi.org/10.1016/B978-0-323-24098-7.00077-0>.
- Xiang, Hong, Emily J. Noonan, Jinghong Wang, Hong Duan, Lawrence Ma, Sara Michie, and Linda M. Boxer. 2011. “The Immunoglobulin Heavy Chain Gene 3’ Enhancers Induce Bcl2 Deregulation and Lymphomagenesis in Murine B Cells.” *Leukemia* 25 (9): 1484–93. <https://doi.org/10.1038/leu.2011.115>.
- Xiong, Yun-Xia, Ai-Chun Chen, Pei-Fen Yao, De-Ying Zeng, Yu-Jing Lu, Jia-Heng Tan, Zhi-Shu Huang, and Tian-Miao Ou. 2016. “Blocking the Binding of WT1 to Bcl-2 Promoter by G-Quadruplex Ligand SYUIQ-FM05.” *Biochemistry and Biophysics Reports* 5 (March): 346–52. <https://doi.org/10.1016/j.bbrep.2015.12.014>.

- Xu, Zhenming, Hong Zan, Egest J. Pone, Thach Mai, and Paolo Casali. 2012. “Immunoglobulin Class-Switch DNA Recombination: Induction, Targeting and Beyond.” *Nature Reviews. Immunology* 12 (7): 517–31. <https://doi.org/10.1038/nri3216>.
- Yagi, Keiko, Kouhei Yamamoto, Shigeaki Umeda, Shinya Abe, Shiho Suzuki, Iichiroh Onishi, Susumu Kirimura, et al. 2013. “Expression of Multidrug Resistance 1 Gene in B-Cell Lymphomas: Association with Follicular Dendritic Cells.” *Histopathology* 62 (3): 414–20. <https://doi.org/10.1111/his.12035>.
- Yamane, Arito, Wolfgang Resch, Nan Kuo, Stefan Kuchen, Zhiyu Li, Hong-wei Sun, Davide F. Robbiani, Kevin McBride, Michel C. Nussenzweig, and Rafael Casellas. 2011. “Deep-Sequencing Identification of the Genomic Targets of the Cytidine Deaminase AID and Its Cofactor RPA in B Lymphocytes.” *Nature Immunology* 12 (1): 62–69. <https://doi.org/10.1038/ni.1964>.
- Yan, Catherine T., Cristian Boboila, Ellen Kris Souza, Sonia Franco, Thomas R. Hickernell, Michael Murphy, Sunil Gumaste, et al. 2007. “IgH Class Switching and Translocations Use a Robust Non-Classical End-Joining Pathway.” *Nature* 449 (7161): 478–82. <https://doi.org/10.1038/nature06020>.
- Yu, Kefei, Frederic Chedin, Chih-Lin Hsieh, Thomas E. Wilson, and Michael R. Lieber. 2003. “R-Loops at Immunoglobulin Class Switch Regions in the Chromosomes of Stimulated B Cells.” *Nature Immunology* 4 (5): 442–51. <https://doi.org/10.1038/ni919>.
- Zhang, J., A. Bottaro, S. Li, V. Stewart, and F. W. Alt. 1993. “A Selective Defect in IgG2b Switching as a Result of Targeted Mutation of the I Gamma 2b Promoter and Exon.” *The EMBO Journal* 12 (9): 3529–37.
- Zhang, Qingzhao, Ryuji Iida, Takafumi Yokota, and Paul W. Kincade. 2013. “Early Events in Lymphopoiesis: An Update.” *Current Opinion in Hematology* 20 (4): 265–72. <https://doi.org/10.1097/MOH.0b013e3283612628>.
- Zhang, Yu, Nicolas Gallastegui, and Joseph D. Rosenblatt. 2015. “Regulatory B Cells in Anti-Tumor Immunity.” *International Immunology* 27 (10): 521–30. <https://doi.org/10.1093/intimm/dxv034>.
- Zhang, Yu, Rachel Patton McCord, Yu-Jui Ho, Bryan R. Lajoie, Dominic G. Hildebrand, Aline C. Simon, Michael S. Becker, Frederick W. Alt, and Job Dekker. 2012. “Spatial Organization of the Mouse Genome and Its Role in Recurrent Chromosomal Translocations.” *Cell* 148 (5): 908–21. <https://doi.org/10.1016/j.cell.2012.02.002>.
- Zhang, Zheng Z., Nicholas R. Pannunzio, Li Han, Chih-Lin Hsieh, Kefei Yu, and Michael R. Lieber. 2014. “The Strength of an Ig Switch Region Is Determined by Its Ability to

Drive R Loop Formation and Its Number of WGCW Sites.” *Cell Reports* 8 (2): 557–69.
<https://doi.org/10.1016/j.celrep.2014.06.021>.

Zhu, Delin, Helen McCarthy, Christian H. Ottensmeier, Peter Johnson, Terry J. Hamblin, and Freda K. Stevenson. 2002. “Acquisition of Potential N-Glycosylation Sites in the Immunoglobulin Variable Region by Somatic Mutation Is a Distinctive Feature of Follicular Lymphoma.” *Blood* 99 (7): 2562–68.
<https://doi.org/10.1182/blood.v99.7.2562>.

Zilfou, Jack T., and Scott W. Lowe. 2009. “Tumor Suppressive Functions of P53.” *Cold Spring Harbor Perspectives in Biology* 1 (5): a001883.
<https://doi.org/10.1101/cshperspect.a001883>.

Appendices

Appendix 1. Modified staining panel for Triple Mutant mice with tomato.....226

Appendix 1. Modified staining panel for Triple Mutant mice with tomato

Table 5 : Modified peripheral B cell staining panel for Triple Mutant mice expressing tomato.

The same staining panel as the one described in article 1, except the antibody coupled to PE (which was originally CXCR4) was substituted with CXCR4 coupled to BV650 (highlighted in Bold) and the antibody CD93 which was coupled to BV650 in the original panel was removed.

Peripheral B cells (Spleen + mesenteric Lymph nodes)			
Antibody	Reference	Supplier	Dilution
Bcl2 BV421	Bcl-2/100	BD Biosciences	1/50
CD19 BV510	1D3	BD Biosciences	1/200
CXCR4 BV650	740526 (Clone: 2B11/CXCR4)	BD Biosciences	1/200
CD138 Biotin	281-2	Biolegend	1/200
CD23 FITC/ A488	B3B4	Biolegend	1/100
IgD PerCP-Cy5.5	11-26c.2a	BD Biosciences	1/100
CD21 PE-CF594	7G6	BD Biosciences	1/400
Tomato PE			
IgM PC7	eB121-15F9	Invitrogen	1/200
GL7 APC	GL7	Invitrogen	1/100
CD38 APC-R700	90	Invitrogen	1/100
Streptavidin BV786	563858	BD Biosciences	1/400
FVS 780 APC-H7	565388	BD Biosciences	1/1000

Reproducing the complex development of BCL2 deregulation in mouse models

Le lymphome folliculaire (FL) est le lymphome non-hodgkinien indolent émanant de cellules B du centre germinatif (GC) le plus courant. La translocation t(14 :18) ayant lieu tôt dans le processus du développement B est la marque génétique du FL. Cette translocation place le gène Bcl2 sous le contrôle direct des éléments régulateurs situés en 3' du locus des chaînes lourdes d'immunoglobulines (IgH 3'RR) et aboutit à l'expression constitutive de la protéine Bcl2. Afin d'étudier l'impact de la dérégulation de Bcl2 sur le développement B et dans le but de reproduire les mécanismes aboutissant au développement du lymphome folliculaire, deux nouveaux modèles murins ont été créés : le modèle **Igκ-BCL2** (*Knock-In* du gène Bcl2 inséré dans le locus kappa des chaînes légères d'immunoglobulines) et le modèle **3'RR-BCL2** (Transgène contenant Bcl2 et les éléments régulateurs minimum en 3' de la chaîne lourde des Ig, micro-3'RR), ces deux modèles comprenant le gène BCL2 et sa région promotrice complète. Nos études ont montré que le modèle 3'RR-BCL2 apparaît le plus pertinent pour l'étude du FL (avec une expression plus focalisée de l'oncogène dans les cellules du GC, et avec une plus nette expansion des cellules B du GC et une expansion des cellules plasmocytaires moindre). Cependant, avec pour seul hit la dérégulation de BCL2, nous avons observé qu'aucune tumeur issue du GC n'apparaissait sur le long terme dans aucun de nos deux modèles, mais éventuellement des tumeurs de type lymphome plasmablastique. Afin d'introduire un deuxième événement génétique potentiellement oncogénique, nous avons croisé nos modèles murins avec des modèles possédant d'autres anomalies génétiques connues pour être observées dans le FL (modèle avec un BCR N-glycosylé au niveau des régions variables, ou portant la perte de fonction de HVEM ou de KMT2D). L'ajout d'un second hit a permis d'observer le développement de tumeurs avec un phénotype de type GC, notamment dans le cas du modèle double-mutant 3'RR-BCL2 x HVEM/KMT2D. Cette deuxième partie est en cours d'étude mais nous présentons déjà les différents outils qui nous semblent conduire à de nouveaux modèles très pertinents du FL humain, propres à permettre de mieux comprendre le développement d'un lymphome folliculaire.

Mots-clés : Dérégulation de Bcl2, Lymphome Folliculaire, Régulation transcriptionnelle, lymphocytes B.

Abstract

Follicular lymphoma (FL) is the most common indolent form of non-Hodgkin lymphoma arising from malignant germinal center (GC) B-cells. The genetic hallmark that leads to the development of FL is the t(14:18) which occurs early in the bone marrow during B cell development, thereby placing the anti-apoptotic Bcl2 gene under the direct control of the transcriptional enhancers which stand in 3' of the immunoglobulin heavy chain locus (IgH 3'RR) and leading to the constitutive expression of the BCL2 protein. To assess the impact of the Bcl2 deregulation on B-cell fate and try to reproduce FL development in mice, two models were designed: the **Igκ-BCL2** (Knock in of the Bcl2 in the immunoglobulin light chain kappa locus) and the **3'RR-BCL2** (Transgene containing Bcl2 and a micro-3'RR), both containing the full BCL2 promoter region. Despite striking differences between both models, we showed that the 3'RR-BCL2 mouse model is the more pertinent for the study of FL. This model indeed leads to a much more GC-focused expression, and, accordingly, to more significant GC B cell expansion rather than plasma cell expansion. By contrary, pan-B expression of BCL2 in the Igκ-BCL2 models culminates with a strong overexpression in plasmablasts and plasma cells.

However, and whatever the BCL2 configuration, in the absence of additional oncogenic hit, both of our models remained free of GC B cell tumors on the long run and rather ended developing plasmacytic lymphomas. Thus, to introduce secondary genetic alterations, we crossed our 3'RR-BCL2 mice with other models bringing anomalies known to occur in human FL (BCR N-glycosylation of the V domains, HVEM or KMT2D loss of function). We were able to show that with the addition of these secondary mutations, notably HVEM/KMT2D deletions, our mice developed GC hyperplasia and were eventually able to develop tumors of GC B cell phenotype. This part of our work is still preliminary and more work needs to be done but, all in all, our current study presents strong tools that can be used for further building pertinent FL models and better understanding the complex development of FL.

Keywords: Bcl2 deregulation, Follicular lymphoma, Transcriptional regulation, B-lymphocytes.



