



HAL
open science

Physics-Informed Deterioration Modeling and Maintenance Optimization Using Stochastic Petri Nets: Application to Torrent Protection Structures

Nour Chahrour

► **To cite this version:**

Nour Chahrour. Physics-Informed Deterioration Modeling and Maintenance Optimization Using Stochastic Petri Nets: Application to Torrent Protection Structures. Automatic Control Engineering. Université Grenoble Alpes [2020-..], 2021. English. NNT: 2021GRALT071 . tel-03563893

HAL Id: tel-03563893

<https://theses.hal.science/tel-03563893>

Submitted on 10 Feb 2022

HAL is a multi-disciplinary open access archive for the deposit and dissemination of scientific research documents, whether they are published or not. The documents may come from teaching and research institutions in France or abroad, or from public or private research centers.

L'archive ouverte pluridisciplinaire **HAL**, est destinée au dépôt et à la diffusion de documents scientifiques de niveau recherche, publiés ou non, émanant des établissements d'enseignement et de recherche français ou étrangers, des laboratoires publics ou privés.

THÈSE

Pour obtenir le grade de

DOCTEUR DE L'UNIVERSITE GRENOBLE ALPES

Spécialité : Automatique - Productique

Arrêté ministériel : 25 mai 2016

Présentée par

Nour CHAHROUR

Thèse dirigée par **Christophe BÉRENGUER, Prof., Gipsa-lab**
Et co-dirigée par **Jean-Marc TACNET, Dr., INRAE**

préparée au sein du **Laboratoire Grenoble Images Parole Signal Automatique (Gipsa-lab)**, en collaboration avec **INRAE** dans l'**École Doctorale Electronique, Electrotechnique, Automatique, Traitement du Signal (EEATS)**

Modélisation de la détérioration et optimisation de la maintenance fondée sur la physique à l'aide de réseaux de Petri stochastiques : application aux ouvrages de protection en montagne

Physics-Informed Deterioration Modeling and Maintenance Optimization Using Stochastic Petri Nets: Application to Torrent Protection Structures

Thèse soutenue publiquement le **25 octobre 2021**,
devant le jury composé de :

John ANDREWS

Professeur, University of Nottingham, Rapporteur

David BIGAUD

Professeur des Universités, Université d'Angers, Rapporteur

François PÉRÈS

Professeur des Universités, Ecole Nationale d'Ingénieurs de Tarbes, Rapporteur

Johannes HÜBL

Professeur, University of Natural Resources and Life Sciences, Examineur

Didier GEORGES

Professeur des Universités, Université Grenoble Alpes, Président du jury

Auréliе TALON

Maitre de Conférences, Université Clermont Auvergne, Examineur

Christophe BÉRENGUER

Professeur des Universités, Université Grenoble Alpes, Directeur de thèse

Jean-Marc TACNET

Ingénieur des Ponts, Eaux et Forêts (ICPEF, Dr.), INRAE, Co-encadrant de thèse



“The will to win, the desire to succeed, the urge to reach your full potential... these are the keys that will unlock the door to personal excellence.”

— Eddie Robinson

Acknowledgements

Being enrolled in a PhD program is not like any other degree we have done before. It is a life changing experience and an opportunity to build our skills. This journey is not full of rainbows, and rather several obstacles might arise, those that require perseverance and determination to progress and succeed. In the end, success requires action, and it is about how much we are able to keep moving forward despite the complications and challenges we might face. It would always seem impossible until its done!

Most of all, I would like to heartily express my gratitude to my thesis director Professor Christophe BÉRENGUER for his continuous support and motivation during the past three years. His patience and immense knowledge, besides his valuable time spent in providing me with the relevant documents and guidance had helped me a lot in my research. His confidence and support in me for giving lectures, as well as participating in international conferences enabled me to acquire new experiences and to build more knowledge.

I am also genuinely grateful for my supervisor Doctor Jean-Marc TACNET for accepting to be a part of my PhD journey. His unwavering support, encouragements, patience and immense knowledge throughout this process allowed me to keep advancing in my thesis. Moreover, his endless involvement and judicious advises and remarks were major reasons behind the successful completion of this thesis.

Under their supervision, I was able to develop new knowledge and experiences that are essential for my future research career. I could have not imagined having better advisors for my PhD degree. It was my great honor to work under their guidance and I hope to continue our collaboration for a long time.

My appreciation and sincere gratitude are extended to Professor Eric BARTHÉLEMY, with whom I started my research career. I am grateful for his endless support and for his confidence in me to give lectures on his behalf at the university.

I am tremendously thankful for the members of the jury, Professors John ANDREWS, David BIGAUD, François PÉRÈS, Johannes HUBL, Aurélie TALON and Didier GEORGES for accepting to be part of my PhD Thesis Committee. I would like to thank them for spending their valuable time in evaluating this work. This is kindly appreciated, and it is a great honor for me.

My sincere thanks also go to Doctor Florence NAAIM-BOUVET, the director of the research unit *Erosion Torrentielle Neige et Avalanches* at INRAE. I would like to thank also Professor Sylvie CHARBONNIER, the adjoint director of the doctoral school EEATS.

My gratitude is also to the council board of the IDEX, for their confidence in funding this thesis. I am thankful for the French National Research Agency in the framework of the *Investissements d'Avenir program (ANR-15-IDEX-02)* for their support.

I am also grateful for the time spent with the CDP Risk members, as well as for all the seminars and valuable discussions we had. Indeed, I am thankful as well for the members of the ESReDA Project Group who I am honored to be a member of since 2018, for enriching my knowledge and experience.

My sincere thanks to my colleagues at INRAE especially Guillaume PITON, and the riskuers club members for the stimulating discussions and for all the moments that we have shared together. My friends in France, Lebanon and in the United Kingdom played also a crucial role in my motivation process. Thanks to Meryem BOUSEBATA, Hanan HAWI, Suha SHREIM, Adèle ABDALLA, Ana MAYO, Ghina TARHINI, Ghadir JALLOUL, Hussein YASSINE and Ismail AL-ARAB. All of them were important in this process more than they realize.

I further express my profound gratitude to Mohamad Hassan SHAHROUR. I thank him for his understanding, unconditional love and encouragement and for always being there for me. His emotional support has meant more to me than he could possibly imagine. I'm grateful to have him by my side.

Finally, my deep and sincere gratitude to my family for their continuous and unparalleled love, help and support throughout my PhD process and my life in general. Special thanks to my beloved mother and father for their faith in me and for providing me with great love and support in my determination to find and realize my potential. This accomplishment would have not been possible without them.

Contents

List of Acronyms	xix
Introduction	1
1 Background and Motivation	5
1.1 Risk Management Decision Process in Natural Hazard Context	5
1.1.1 Natural Phenomena in Mountains	7
1.1.1.1 Torrential Watersheds	7
1.1.1.2 Torrential Phenomena: Physics and Consequences	8
1.1.2 Natural Risk Preventive Management	13
1.1.2.1 Structural and Non-Structural Protection Measures	14
1.1.2.2 Integrated Structural Protection System in Torrential Water- sheds	15
1.2 Critical Protection Structures Management	18
1.2.1 Design and Failure Analysis of Torrent Protection Structures	19
1.2.2 Torrent Check Dams	20
1.2.2.1 Structural and Functional Design Analysis	20
1.2.2.2 Failure Modes and Maintenance Strategies	26
1.2.3 Retention Dams	30
1.2.3.1 Structural and Functional Design Analysis	30
1.2.3.2 Failure Modes and Maintenance Strategies	34
1.3 Conclusion	35
2 Technical and Scientific Issues Encountered while Managing Natural Risks and Torrent Protection Systems	39
2.1 Efficacy Assessment and Maintenance Optimization	40

2.1.1	Three Efficacy Components to be Assessed	40
2.1.2	Inspection, Maintenance and Decision-Making	42
2.2	Cascading Effect: Interactions and Dependencies	44
2.2.1	Dependencies Between Natural Phenomena	45
2.2.2	Interactions Between Failure Modes	46
2.2.3	Bi-directional Dependencies Between System's Components	46
2.2.4	Dependency Analysis and Decision Support	47
2.3	Decision-Making under Information Imperfection	49
2.3.1	Nature and Types of Information Imperfection	49
2.3.2	Information Imperfection Propagation within the Complex Risk Management Decision Process	50
2.4	Conclusion	52
3	Complex System's Reliability Analysis and Decision-Making Approaches: State of the Art and Beyond	55
3.1	Introduction to Reliability Modeling of Complex Systems	56
3.1.1	Reliability: An Attribute of Dependability	57
3.1.2	Useful Dependability Functions and Metrics	59
3.1.3	Common Probability Distributions used in Reliability Analysis	61
3.1.4	Conclusion	63
3.2	Basic and Static System's Reliability Modeling and Decision Aiding Approaches	64
3.2.1	Classical Methods used for Reliability Analysis and Quantification	64
3.2.1.1	Failure Mode and Effect Analysis	64
3.2.1.2	Reliability Block Diagram	67
3.2.1.3	Fault Tree Analysis	70
3.2.1.4	Event Tree Analysis	72
3.2.2	Classical Approaches used to Support Decision-making	74
3.2.2.1	Economic Approaches: Cost Benefit Analysis	74

3.2.2.2	Multi-Criteria Decision-Making	77
3.2.3	Conclusion	78
3.3	Dynamic Reliability and Maintenance Decision Aiding Approaches	79
3.3.1	Maintenance Optimization Policies	79
3.3.1.1	Time-Based Maintenance Policy	80
3.3.1.2	Condition-Based Maintenance Policy	81
3.3.2	Dynamic Approaches for System Deterioration and Maintenance Mod- eling	83
3.3.2.1	Markov Chains: Stochastic Markov Process	84
3.3.2.2	Stochastic Petri Nets	86
3.3.3	Conclusion	91
3.4	Information Imperfection Analysis and Traceability Techniques	92
3.4.1	Theoretical frameworks representing different types of information im- perfection	92
3.4.2	Hybrid Approaches for Uncertainty Analysis	94
3.4.3	Conclusion	95
3.5	Research Novelty: New Developments Beyond the State of the Art	96
3.5.1	Existing Gap	97
3.5.2	Thesis Objectives and Contributions	98
4	Methodology: Deterioration and Maintenance Models Development for Torrent Protection Structures	101
4.1	Global Framework Description	102
4.2	Physics-Based Model of Torrent Check Dam	106
4.2.1	Step 1: Geometry Characterization, Flood Scenario Definition and Ran- domness Generation	107
4.2.2	Step 2: Numerical Modeling via LOGICCHAR	108
4.2.3	Step 3: Local Scouring Estimation	109

4.2.4	Step 4: External stability verification	112
4.2.5	Step 5: States definition and transition laws	116
4.3	Physics-Based Model of Sediment Retention Systems	118
4.3.1	Step 1: Data Acquisition, Debris Flow Scenario Definition and Randomness Generation	119
4.3.2	Step 2: Hydraulic control of flows by a Retention dam	120
4.3.3	Step 3: Jamming Conditions and Stochastic Arrival of Boulders	121
4.3.4	Step 4: Retention Basin's Buffering Capacity	126
4.3.5	Step 5: Overall Computational Analysis	126
4.3.6	Step 6: States definition and transition laws	128
4.4	Stochastic Deterioration and Maintenance Modeling: SPN and CBM approach	129
4.4.1	Degradation Process	129
4.4.2	Inspection Process	130
4.4.3	Maintenance Process	130
4.4.4	Decision-making support for choosing maintenance strategies	131
4.5	Integrating Information Imperfection using HYRISK for Improved Decision-making	132
4.5.1	Functionality of HYRISK	133
4.5.2	Results produced with HYRISK	135
4.6	Conclusion	137
5	Application: Development and Evaluation of a Complete Check Dam Deterioration and Maintenance Model	139
5.1	Real Case Study: Check Dam Subjected to Clear Water Floods in the Manival Torrent	140
5.1.1	Manival Torrent Description	140
5.1.2	Numerical Modeling Inputs and Data Sources	141
5.1.3	SPN Model and Maintenance Strategies	144

5.1.4	Model Execution, Results and Discussions	146
5.1.5	Information Imperfection Analysis Within the Check Dam’s Model . .	151
5.1.5.1	Uncertainty Representation	151
5.1.5.2	Uncertainty Propagation and Sensitivity Analysis	153
5.2	Cascade Effect Analysis for Prioritizing Check Dams’ Maintenance strategies in a Multi-Component System	155
5.2.1	General Description of the Protection System	156
5.2.2	Physics-Based Modeling: Check Dams’ Stability Evolution	156
5.2.3	SPN Model and Maintenance Decision-Making	159
5.3	Conclusion	161
6	Application: Development and Evaluation of a Retention System Deterio- ration and Maintenance Model	163
6.1	Real Case Study: Retention System Subjected to Debris Flows in the Claret Torrent	164
6.1.1	Claret Torrent Description	164
6.1.2	Torrential Events’ History	165
6.1.3	Claret Retention System: Between the Past and the Present	166
6.2	Numerical Modeling Inputs and Data Sources	169
6.2.1	Generation of Random Debris Flow Events	169
6.2.2	Initial Configuration of the Retention System	175
6.2.3	SPN Model Inputs and Maintenance Strategies	177
6.3	Model Execution, Results and Discussions	179
6.3.1	Application to the Old Design	179
6.3.2	Application to New Design	186
6.4	Sensitivity Analysis Applied to the SPN Model	187
6.4.1	Inspection Frequency	190
6.4.2	Maintenance Duration	191

6.4.3	Maintenance Costs	196
6.5	Conclusion	199
Conclusion		201
6.6	Main Findings	201
6.6.1	Case of Check Dams	202
6.6.2	Case of Retention Systems	203
6.7	Achieved contributions Followed by General Discussions	204
6.8	Limitations and Future Work Insights	208
Bibliography		213

List of Figures

1.1	Risk definition.	6
1.2	Torrential watersheds in mountains.	8
1.3	Torrential phenomena characteristics: magnitude, physical consequences and intensity parameters.	9
1.4	Interactions between liquid and solid phases.	11
1.5	Damages resulted after torrential flood in <i>Bastan à Barèges (Hautes-Pyrénées)</i> , June 18, 2013.	12
1.6	Qualitative risk assessment matrix	13
1.7	Temporal steps involved within a risk management process.	14
1.8	Structural and non-structural prevention measures.	16
1.9	Different types of protection structures constructed along the torrential watershed to resist torrential phenomena.	17
1.10	Multi-disciplinarity involved in the theoretical design of protection structures in torrential watersheds.	18
1.11	Torrent check dams.	21
1.12	classical components of a cantilever check dam.	22
1.13	Structural analysis of torrent check dams.	22
1.14	Loading situations and loads considered during the design of torrent check dams.	24
1.15	Functional analysis of torrent check dams.	25
1.16	Joint expertise involved in the structural design analysis of a check dam.	26
1.17	Examples on the types of functional and structural failures failures check dams may be subjected to.	27
1.18	Multi-component retention system.	31
1.19	Common types of retention dams: slit and slot dams	33
2.1	Components involved when assessing the efficacy of a torrent protection structure.	41

2.2	Global efficacy assessment of protection structures considering the severity of failure modes.	42
2.3	Example of possible interactions and dependencies that exist between torrential phenomena, check dams' failure modes and check dams located in series. . . .	48
2.4	Multi-scale decision process for natural risk management.	51
2.5	Necessary information provided by different sources for protection structures' efficacy assessment.	52
2.6	Key issues encountered when assessing protection structure's efficacy and optimizing maintenance strategies.	54
3.1	Essential characteristic times in dependability analysis.	60
3.2	Failure rate "bathtub" curve.	60
3.3	Examples of different configurations of a RBD.	68
3.4	Basic symbols used in a FT.	70
3.5	FTA describing the causes behind the failure of torrent check dams by lateral bypass.	71
3.6	ETA concerning the consequences of clear water floods on check dam's stability. 74	
3.7	Principle and expected limitations of a CBA in torrential risk context.	75
3.8	MDCM process for prioritizing different alternatives.	78
3.9	Example of a TBM policy.	82
3.10	Example of a CBM policy.	83
3.11	Example of a simple Markov chain.	85
3.12	Elements involved within a PN model.	87
3.13	Transition firing rule - PN example.	89
3.14	Transition firing in the presence of an inhibitor arc.	89
3.15	System's degradation process represented by a simple PN.	90
3.16	Classical theories adopted in risk context for representing different types of information imperfection.	93
4.1	Key steps of a check dam modeling process.	104

4.2	Key steps of a retention system modeling process.	105
4.3	Principles of LOGICCHAR.	108
4.4	Main geometric parameters used for estimating the dimensions of a scour pit downstream a check dam in SOGREAH and Comiti et al. approaches.	111
4.5	Local scouring dimensions under a check dam's foundation to be considered in the developed approach of a scour pit geometry.	113
4.6	Data required for analyzing the external stability of a check dam.	114
4.7	Moment of inertia variables resulting in the normal stress diagram under a check dam's foundation after scouring.	116
4.8	Example showing the evolution of the global stability indicator S_g through the defined states over time.	117
4.9	Input data required for defining debris flow scenarios.	120
4.10	Hydraulic and geometric parameters describing different types of retention dams with different jamming configurations of their openings.	122
4.11	Conceptual schematic of boulder analysis used to calibrate the binomial distribution.	124
4.12	Example showing the evolution of the stored debris volume in the basin V_b through the defined states over time.	128
4.13	Degradation process involved within the SPN model.	130
4.14	Degradation and inspection processes involved within the SPN model.	131
4.15	Degradation, inspection and maintenance processes involved within the SPN model.	132
4.16	Complete SPN model developed for modeling stochastic deterioration and maintenance processes of a deteriorating system.	133
4.17	Integrated methodological framework of a check dam model considering uncertainty analysis.	134
4.18	Sub-models involved in the physics-based and the reliability-based models of a check dam.	136
5.1	Manival torrent.	141
5.2	Hydrograph required as an input to LOGICCHAR - Scenario 1.	143

5.3	Principal dimensions of the check dam under study.	144
5.4	SPN model incorporating restrictions on maintenance operations.	145
5.5	Variation in bed level along the entire studied reach after each flood event involved within the event series - Scenario 1.	147
5.6	Time-based variation of the six parameters resulting from LOGICCHAR simulation downstream the studied check dam - Scenario 1.	147
5.7	Time-based evolution of indicators corresponding to the maximum depth of the scour pit P , local scouring depth S_d , local scouring width S_w , bearing capacity stability ratio S_{BC} , overturning stability ratio S_{OT} , and sliding stability ratio S_{SL} - Scenario 1.	149
5.8	Time-dependent evolution of the global state indicator S_g of the dam under study.	150
5.9	Cumulative distribution functions of the stochastic transitions T_{1-2} , T_{2-3} , T_{2-4} and T_{3-4} involved in the degradation process of the SPN model.	151
5.10	Expected total cost of the four maintenance strategies considered in this study.	152
5.11	Representation of uncertain inputs used for scouring estimation.	153
5.12	Results of the hybrid uncertainty propagation representing the lower and upper CDFs related to the uncertainty on S_d and S_w	154
5.13	Lower and upper CDFs related to the uncertainty on S_d and S_w before and after pinching the parameters D_{90} , Z_{Fi} and θ	154
5.14	Description of the multi-component system under study.	157
5.15	Three different cases to be analyzed in the multi-component check dam system.	158
5.16	Evolution of the global stability index S_g of dam D_1 corresponding to three different scenarios.	159
5.17	Cumulative distribution functions of stochastic transitions of D_1 having high number of observation.	160
5.18	Total cost of maintenance strategies applied to check dam D_1	162
6.1	Claret torrent.	165
6.2	Claret retention system showing the old and the new design of the retention dam.	168
6.3	Monthly distribution of recorded torrential floods in the Claret.	170

6.4	CDF corresponding to the monthly distribution of recorded torrential floods in the Claret.	170
6.5	Available data concerning the time series of torrential floods and debris flow volumes in the Claret.	171
6.6	Claret' Frequency - Magnitude curve resulted after the adjustment of real observations of debris flow events using GPD distribution.	171
6.7	Time series of triggered debris flow events over a period of 50 years - Scenario 1.	173
6.8	Hydrographs corresponding to the first three debris flow events involved in scenarios 1.	173
6.9	Frequency - Magnitude curve resulted after the adjustment of randomly generated series of debris flow events using GPD distribution.	174
6.10	Claret's retention dam's detailed geometry and dimensions - Front view.	175
6.11	Claret's Stage - volume capacity curve for $S_{dep} = 6.1$	177
6.12	Variation of the outlet discharge depending on the flow level at the dam and on the rate of clogging of the dam's outlets - Old design.	180
6.13	Physics-based model's results showing the variation of several physical parameters. Event 1 in scenario 1 - Old design.	181
6.14	Physics-based model's results showing the variation of several physical parameters. Event 2 in scenario 1 - Old design.	182
6.15	Time-dependent evolution of the system's state indicator V_b for the 100 generated scenarios - Old design.	183
6.16	Cumulative distribution functions of the stochastic transitions involved in the degradation process of the SPN model.	184
6.17	Expected total cost of the four maintenance strategies considered in this study.	185
6.18	Variation of the outlet discharge depending on the flow level at the dam and on the rate of clogging of the dam's outlets - New design.	187
6.19	Physics-based model's results showing the variation of several physical parameters. Event 1 in scenario 1 - New design.	188
6.20	Physics-based model's results showing the variation of several physical parameters. Event 2 in scenario 1 - New design.	189
6.21	Time-dependent evolution of the system's state indicator V_b for the 100 generated scenarios - New design.	190

6.22 Expected total cost of the four defined maintenance strategies according to the adopted configuration. 198

List of Tables

1.1	Possible countermeasures and maintenance operations adopted for preventing structural and functional failures or repairing check dams after being subjected to such failures.	29
1.2	Possible countermeasures and maintenance operations adopted for preventing functional failures or repairing retention dams after being subjected to such failures.	36
3.1	Process FMEA applied to a check dam's foundation design process.	66
3.2	Design FMEA applied to a check dam's hydraulic weir.	67
5.1	General features of the studied reach in the Manival torrent.	142
5.2	Dates and peak water discharges of all flood events within an event series occurring over a period of 100 <i>years</i> - Scenario 1.	142
5.3	Data required for external stability verification of a check dam.	143
5.4	Deterministic transition times corresponding to the inspection and maintenance processes involved in the SPN model.	146
5.5	Mean sojourn time (years) of the studied check dam in each of its defined states based on the maintenance strategy adopted.	149
5.6	Statistics on the number of maintenance operations performed during the considered simulation period based on the maintenance strategy adopted. μ : average; σ : standard deviation.	150
5.7	Fixed inputs used for scouring calculation.	153
5.8	Epistemic uncertainty (%) and its percentage reduction between the one obtained from the uncertainty propagation and that obtained after pinching input parameters	155
5.9	Principle data of the torrential system and multi-components system under study.	156
5.10	Data concerning stochastic transitions of D_1 having few number of observations (in the absence of D_2).	160

5.11	Data concerning stochastic transitions of D_1 having few number of observations (in the presence of D_2).	160
5.12	Mean sojourn time (years) of D_1 in the absence of D_2 (case a) in each of its defined states based on the maintenance strategy adopted.	160
5.13	Mean sojourn time (years) of D_1 in the presence of D_2 (case b) in each of its defined states based on the maintenance strategy adopted.	161
5.14	Average number of maintenance operations performed to D_1 in the absence of D_2 (case a) during the considered simulation period based on the maintenance strategy adopted.	161
5.15	Average number of maintenance operations performed to D_1 in the presence of D_2 (case b) during the considered simulation period based on the maintenance strategy adopted.	161
6.1	Characteristics of the retention dam's outlets - Old design.	175
6.2	Characteristics of the retention dam's outlets - New design.	176
6.3	Number of boulders of different diameters that can be found in a reference volume of $30000 m^3$	176
6.4	Volume (* $10^3 m^3$) of debris material stored below a certain level at the level of the Claret's retention dam for several deposition slopes.	176
6.5	Deterministic transition times corresponding to the inspection and maintenance processes involved in the SPN model.	178
6.6	Costs of maintenance operations carried out for cleaning Claret's retention basin.	178
6.7	Mean sojourn time (years) of the studied retention system in each of its defined states based on the maintenance strategy adopted.	184
6.8	Statistics on the number of maintenance operations performed during the considered simulation period based on the maintenance strategy adopted.	185
6.9	Mean sojourn time (years) of the studied retention system in each of its defined states based on the maintenance strategy adopted - $T_5 = 0.5$ years.	191
6.10	Mean sojourn time (years) of the studied retention system in each of its defined states based on the maintenance strategy adopted - $T_5 = 2$ years.	192
6.11	Average number of maintenance operations performed on the system during the considered simulation period - $T_5 = 0.5$ years.	192

6.12	Average number of maintenance operations performed on the system during the considered simulation period - $T_5 = 2$ years.	192
6.13	Average total cost (k€) of each of the defined maintenance strategies - $T_5 = 0.5$ years.	193
6.14	Average total cost (k€) of each of the defined maintenance strategies - $T_5 = 2$ years.	193
6.15	Mean sojourn time (years) of the studied retention system in each of its defined states based on the maintenance strategy adopted - Case 1 maintenance. . . .	194
6.16	Mean sojourn time (years) of the studied retention system in each of its defined states based on the maintenance strategy adopted - Case 2 maintenance. . . .	195
6.17	Average number of maintenance operations performed on the system during the considered simulation period - Case 1 maintenance.	195
6.18	Average number of maintenance operations performed on the system during the considered simulation period - Case 2 maintenance.	195
6.19	Average total cost (k€) of each of the defined maintenance strategies - Case 1 maintenance.	196
6.20	Average total cost (k€) of each of the defined maintenance strategies - Case 2 maintenance.	196
6.21	Average total cost (k€) of each of the defined maintenance strategies - Maintenance configuration 1.	197
6.22	Average total cost (k€) of each of the defined maintenance strategies - Maintenance configuration 2.	198
6.23	Average total cost (k€) of each of the defined maintenance strategies - Maintenance configuration 3.	199
6.24	Average total cost (k€) of each of the defined maintenance strategies - Maintenance configuration 4.	199

List of Acronyms

CI	<i>Critical Infrastructure</i>
CBA	<i>Cost Benefit Analysis</i>
MCDM	<i>Multi-Criteria Decision-Making</i>
FMEA	<i>Failure Mode and Effect Analysis</i>
RTM	<i>Restauration des Terrains en Montagne</i>
ONF	<i>Office National des Forêts</i>
MEST	<i>Ministry of Ecological and Solidarity Transition</i>
PPRN	<i>Plan de Prévention des Risques Naturels</i>
ULS	<i>Ultimate Limit State</i>
SLS	<i>Serviceability Limit State</i>
MTTF	<i>Mean Time to Failure</i>
MTTR	<i>Mean Time to Repair</i>
MDT	<i>Mean Down Time</i>
MUT	<i>Mean Up Time</i>
MTBF	<i>Mean Time Between Failures</i>
TTF	<i>Time to Failure</i>
TTR	<i>Time to Repair</i>
DT	<i>Down Time</i>
UT	<i>Up Time</i>
TBF	<i>Time Between Failures</i>
RBD	<i>Reliability Block Diagram</i>
FTA	<i>Fault Tree Analysis</i>
FT	<i>Fault Tree</i>
ETA	<i>Event Tree Analysis</i>
ET	<i>Event Tree</i>

FMECA	<i>Failure Mode and Effect Criticality Analysis</i>
RBM	<i>Risk-Based Maintenance</i>
ABM	<i>Age-Based Maintenance</i>
TBM	<i>Time-Based Maintenance</i>
CBM	<i>Condition-Based Maintenance</i>
PN	<i>Petri Net</i>
DTPN	<i>Deterministic Timed Petri Net</i>
SPN	<i>Stochastic Petri Net</i>
CSPN	<i>Colored Stochastic Petri Net</i>
SAN	<i>Stochastic Activity Network</i>
AHP	<i>Analytic Hierarchy Process</i>
INRAE	<i>Institut National de Recherche pour L'agriculture, L'alimentation et L'environnement</i>
ETRM	<i>Eaux Torrents et Rivières de Montagne</i>
IPCC	<i>Intergovernmental Panel on Climate Change</i>

Introduction

This research project concerns the issue of deteriorating protection structures that are located in mountains in order to provide protection against natural phenomena. It is mainly dedicated to analyzing the behavior of the structures over their lifetime when subjected to several types of failures and to different maintenance operations. The PhD project is a part of the CDP-Risk project which is handled by University Grenoble Alpes and aims to develop a cross-disciplinary research and scientific innovation in the field of risk management, complex system and decision-making support.

Concerns about critical infrastructures (CIs) that provide vital resources necessary for a society's needs have increased among governments and citizens. Assessing the resilience of CIs and ensuring their availability and proper functioning have become an urgent priority. Nevertheless, the ease or struggle in achieving such challenges is highly dependent on interdependencies involved within the same system, potential uncertainties of collected data, and economic aspects. Possible existing internal or external interactions between the different components of a CI or between interdependent CIs might foster the induced risk due to cascading failures (Dueñas-Osorio and Vemuru, 2009). The complexity of these systems, arising especially from the dependencies between components and subsystems failures, lead to several possible maintenance strategies, composed of different types of operations to be carried out in various order. Therefore, it is essential to develop maintenance models, which are the basis for improved system resilience and maintenance decision-making.

Mountainous regions, e.g. French Alpes, are usually exposed to different types of natural phenomena such as torrential floods, debris flows, landslides, etc. These phenomena induce risk in downstream areas triggering casualties, injuries, and destruction. They pose a threat to vulnerable issues (people, houses, roads...) resulting in direct destruction and indirect economic damages. Such consequences prompt risk managers to acquire a comprehensive knowledge about the dynamics of all phenomena as well as the means and alternatives for protecting people and properties. Since the 19th century, engineers started implementing different types of protection structures (Check dams, retention dams, dykes) along watersheds seeking to reduce the risk level generated by torrential activities. Indeed, these structures aim in preventing or mitigating natural risk and thus in protecting exposed issues from the imposed danger. Each type of protection structures is designed to achieve specific essential functions, either acting on the causes of the hazards or on their consequences. Consequently, providing protection to people, properties, and other infrastructures is achieved within an integrated system composed of different types of protection structures grouped together so that they participate collaboratively in the same protection strategy.

In mountains, protection structures are constructed in order to fulfil essential functions that provide protection to people, properties and other infrastructures from the devastating consequences caused by natural hazards. These structures can be considered a sector of CIs since, as any other CI, their partial or total destruction, due to a triggering event, would

pose threat to the safety, security and economics of the society (kröger, 2008). During their lifetime, protection structures are exposed to a large number of potential dangerous phenomena (e.g. torrential floods) and damaging events. If not regularly inspected and maintained, their deterioration over time leads to their complete failure, which in turn may increase the risk induced by the natural phenomena themselves. Protection structures can be therefore classified as CIs and should be given deep attention.

Even though non-preventable, the consequences of accumulated damages can be limited, if both direct and indirect failures that protection structures may be subjected to are identified and the interdependencies between failure modes are recognized. A comprehensive understanding of failure mechanisms allows choosing the appropriate preventive maintenance operations to be applied. A properly defined and implemented maintenance policy can thus improve the resilience of these critical protection structures as shown in several works, which have emphasized the link between maintenance and resilience (Francis and Bekera, 2014; Okoh and Haugen, 2014). However, maintenance operations have high costs and require complex preparations, especially on these remote structures. Available budgets oblige risk managers and the owners of the structures to establish priorities between different maintenance strategies to be applied on structures that require maintenance. A comprehensive understanding of the possible failure mechanisms, allows modeling the structural and functional efficacy of the structures when monitored. This in turn allows decision-makers to choose effective preventive maintenance strategies to be applied to the deteriorating structures. Recent approaches have thus combined economic methods (e.g. cost-benefit analysis (CBA) and multi-criteria decision-making (MCDM)) and dependability methods (fault tree analysis (FTA), failure mode analysis and effect (FMEA), etc.) in order to assess the efficacy of structures at a given time (Carladous, 2017). However, such approaches provide only a static view of the condition of the structure at any given time and not over its entire lifespan. In other words, they do not consider the evolution of the structures efficacy over its lifetime period.

Stochastic models such as stochastic Petri nets (SPNs), stochastic activity networks (SANs) and colored stochastic Petri nets (CSPNs) are better adapted than other modeling techniques when dealing with degradation processes and predicting when the system fails. Approaches based on event-based stochastic models offer a flexible and efficient method to analyze the dynamic deterioration and maintenance processes of complex systems (Aubry et al., 2016). Compared to other modeling tools, SPNs permit modeling event-driven dynamic systems while integrating jointly deterioration, inspection and maintenance processes. Moreover, instead of performing maintenance at pre-scheduled times (predetermined maintenance), it is more reasonable to adopt a condition-based maintenance (CBM) strategy and to figure out the state of the structure at which applying maintenance increases the availability of the structure and saves money at the same time. Indeed SPN models implementing CBM decision policies have recently been used as a decision support tool for risk assessment especially in the domain of maintenance modeling for complex systems (Zille, 2009; Andrews and Fecarotti, 2017). In the context of protection structures, such tools enable (i) representing the dynamic behavior of a system when subjected to deterioration mechanisms and maintenance operations based on probabilistic transitions between the defined states of the structure and (ii) supporting maintenance decision-making by comparing and sorting maintenance strate-

gies taking into consideration economic aspects and the availability time of the system in each state.

Developing a stochastic deterioration and maintenance model using SPNs requires defining the structure's degradation states, probabilistic laws of transition times between these states and proposing several maintenance strategies to be compared. It is therefore necessary first to analyze the physical behavior of the structures when subjected to natural phenomena by modeling their evolution from one state to another. Such physics-based model permits building time-dependent state trajectories which in turn allows estimating probability laws of transition times to be used as an input information in the SPN model. In the present project, an integrated approach coupling physics-based model and stochastic deterioration and maintenance modeling using SPNs is adopted for optimizing maintenance strategies of different types of protection structures (check dams, retention dams) based on the dynamic behaviour of the structures when exposed to a series of natural phenomena (torrential floods, debris flows) over time. The developed multi-disciplinary approach fills the gap still present when dealing with the contexts of natural hazard, critical protection structures and dependability analysis by analyzing existing scientific and technical obstacles (transition times estimation, cascading effects analysis, information imperfection, etc.) and incorporating them within the model.

With the aim to thoroughly analyze and model the behavior of torrent protection structures when subjected to deterioration mechanisms due to high intensity natural phenomena, this project contributes in proposing a new methodology that enables modeling the dynamic deterioration of these structures and to support their maintenance decision-making taking into account economic constraints. The context, desired objectives, encountered challenges, developed approach and the performed applications are presented sequentially in this manuscript as described in the following paragraphs. Chapters 4, 5 and 6 represent the main contributions of the project.

Chapter 1 presents the general background and motivations concerning the addressed context. It provides information about torrential watershed (characteristics), phenomena (causes, consequences) and protection structures (functions, failures).

Chapter 2 identifies the major technical and scientific issues encountered while managing natural risks and protection systems. It reveals the difficulties in assessing the efficacy of protection structures, figuring out the dependencies between failure modes and between structures implemented within a multi-component system and in making decisions under the effect of information imperfection.

Chapter 3 explains the main methods and approaches adopted in the literature in order to tackle such problems and challenges. A detailed explanation of reliability analysis concept and methods (static, dynamic) is given. Classical decision-aiding techniques, maintenance policies, and uncertainty analysis theories are also presented. The chapter ends by revealing the gap in the literature and stating the direct objectives and contributions of the project.

Chapter 4: is one of the main contributions. It presents, comprehensively, the overall

developed methodology for the dynamic deterioration and maintenance modeling of two different types of protection systems (check dams, retention systems). First, an overview of the global methodological framework is presented. After, a detailed description of each sub-step involved in the methodology is provided.

Chapter 5: represents two applications to check dams. The first one corresponds to a real case study in which the deterioration and maintenance model is applied to a real check dam located in the Manival torrent in France. The second application considers a fictive multi-components system composed of two dams in which the bi-directional dependencies between the dams are analyzed.

Chapter 6 presents an application to another type of protection structure. A thorough analysis and modeling of a real case study retention system located in the Claret torrent in France is carried out.

Chapter 7 summarizes the main findings, achieved contributions and limitations of the presented work. It also provides a list of future work that can develop further what have already been done.

Background and Motivation

Contents

1.1 Risk Management Decision Process in Natural Hazard Context . . .	5
1.1.1 Natural Phenomena in Mountains	7
1.1.1.1 Torrential Watersheds	7
1.1.1.2 Torrential Phenomena: Physics and Consequences	8
1.1.2 Natural Risk Preventive Management	13
1.1.2.1 Structural and Non-Structural Protection Measures	14
1.1.2.2 Integrated Structural Protection System in Torrential Watersheds	15
1.2 Critical Protection Structures Management	18
1.2.1 Design and Failure Analysis of Torrent Protection Structures	19
1.2.2 Torrent Check Dams	20
1.2.2.1 Structural and Functional Design Analysis	20
1.2.2.2 Failure Modes and Maintenance Strategies	26
1.2.3 Retention Dams	30
1.2.3.1 Structural and Functional Design Analysis	30
1.2.3.2 Failure Modes and Maintenance Strategies	34
1.3 Conclusion	35

This chapter provides a general background concerning natural risks in mountains and torrent protection structures/systems. It also points out the motivation behind this project revealing explicitly the need of developing a decision-aiding model for assessing and managing protection structures due to their deterioration over time.

1.1 Risk Management Decision Process in Natural Hazard Context

The terms hazard and risk are often used interchangeably but actually have different meanings. Generally, hazard is defined as an undesirable event or situation considered as a potential source of harm in terms of deaths, injuries, damages or a combination of all (UNISDR, 2009). For example, natural hazards are physical environmental phenomena (floods, earthquakes,

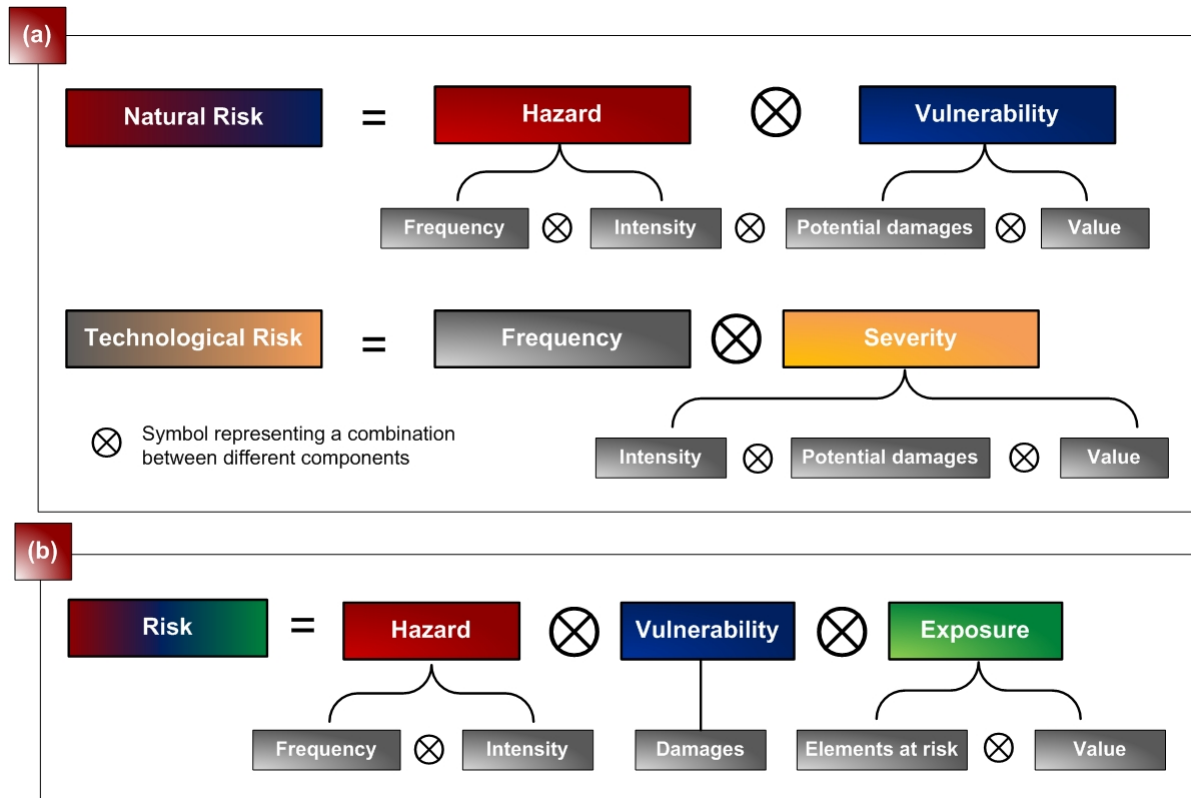

Figure 1.1: Risk definition: (a) in natural and technological hazards contexts (Adapted from (Tacnet, 2009)); (b) given by the IPCC.

avalanches...) that cause loss of life, property damage, and social and economic disruption. another example, technological hazards correspond to events originating from technological or industrial conditions such as the failure of infrastructures and they have similar consequences as natural hazards.

On the other hand, risk is the possibility that someone or something could be damaged by the hazard and how severely. It is therefore a combination of probability and consequences. Defining a risk level depends on the scientific discipline considered (e.g. social sciences, physical sciences, economics, geography, etc.) and on the field of application involved (e.g. natural context, industrial/technological context, etc.). Attaining a common terminology remains a challenge, in which there is still no common and unique adopted definition. It is widely acknowledged that risk induced by a natural hazard is defined as a combination between hazard and vulnerability (Leone et al., 2010). For each type of natural phenomenon, hazard is a combination of its frequency (probability of occurrence) and its intensity which reflects a physical quantity describing the phenomenon (e.g. volume). Moreover, vulnerability represents a combination between the resulted potential damages on all exposed elements (people, assets, infrastructures) and the value (e.g. in euros) of what might be lost. In the case of a technological hazard, risk is defined as a combination of frequency and severity which in turn constitutes intensity, potential damages, and value. Consequently, whatever the discipline or the field of application is, the components used to analyze or quantify the

risk are almost the same. The difference lies only in the terminology used in each context (fig. 1.1, a).

A recent definition of natural risk separates vulnerability and exposure, in which vulnerability refers only to potential damages and exposure refers to a combination between elements at risk that are exposed to the hazard and to their value as shown in fig. 1.1, b). This definition is provided by IPCC: The intergovernmental panel on climate change.

1.1.1 Natural Phenomena in Mountains

Natural phenomena can be categorized into five different groups including geophysical, hydrological, shallow earth processes, atmospheric, and biophysical (Gill and Malamud, 2014). Mountain regions are particularly concerned with two main groups: geophysical (e.g. snow avalanches, landslides, etc.) and hydrological hazards (e.g. torrential flows). These so-called torrential phenomena have the potential to induce severe damages to vulnerable exposed issues (people, houses, roads, infrastructures, etc.) located in the downstream alluvial fan, thus resulting in dramatic social and economic consequences.

1.1.1.1 Torrential Watersheds

The word “torrent”, derived from the Latin adjective “torrens”, is widely used in Europe and refers to a rushing, violent, and ephemeral fast flowing (Gaffiot, 1934). The characteristics of torrent are poorly known and they totally differ than those of rivers (Meunier, 1991). Rivers flow in wide valleys, have a large volume of water, and are characterized by a mild slope ($< 1\%$). On the other hand, torrents flow in shorter and narrower valleys, have less considerable volume of water, and are characterized by a rapidly variable steep slope ($> 6\%$) (Bernard, 1925). Compared to river flows, torrential flows are characterized by violent and sudden floods in addition to a high geomorphic activity due to sediment transport (Fabre, 1797).

A torrential watershed is physically composed of three parts (fig. 1.2) linked to the process of production, transfer, and deposition of materials (Surell, 1841).

1. *Upstream receiving basin*: a run-off production area and sediment supply source. It is exposed to violent and intensive rainfalls. The transport capacity of the flow varies according to the rain intensity and to the torrent’s bed slope.
2. *Flow channel*: a narrow path where materials flow between the banks. It is subjected to (longitudinal) bed incision and (lateral) banks erosion due to excess transport capacity or deposition caused by excess solid inputs.
3. *Downstream alluvial fan*: a flat cone fan where people live. It is characterized by a sudden decrease of slope and high deposition of sediments.

Different types of torrential phenomena occur at different time and spacial scales of the

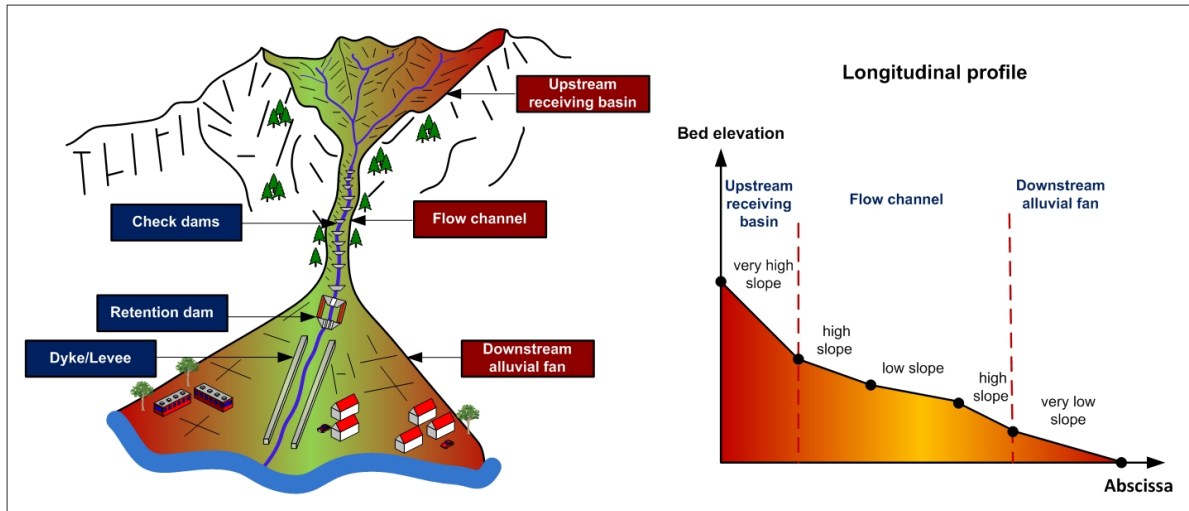

Figure 1.2: Torrential watersheds in mountains.

watershed. The most common and frequent phenomena (e.g. in French Alps) include torrential flows (e.g. clear water floods, bedload, debris flows) and landslides. They share some common characteristics due to the similar physical processes involved. They are all gravitational phenomena characterized by rapid movement of mass and are usually expressed in terms of magnitude, intensity, impact, and frequency (Thouret and D’Ercole, 1996).

The magnitude of a phenomenon corresponds to the volume or area of the localized slip. The intensity is a set of parameters providing measures related to the physical consequences of the phenomena. Exposed issues include inhabitants, houses, industries, ski resorts, agricultural activities, networks and infrastructures, etc. Therefore, the impact of a phenomenon, can be evaluated depending on the vulnerability of each exposed element. In fact, each element has a potential damage curve that reveals its level of degradation for a given intensity of the phenomenon (Papathoma-Köhle et al., 2011). Generally, the concept of vulnerability is limited to structural vulnerability. However, different forms of vulnerability exist depending on the type of consequences induced by the phenomenon (physical, human, material, economic, psychological, etc.). Concerning the frequency, it represents the probability (likelihood) of an event generating a given phenomena of a given intensity to occur in a specific area and time interval. For clarification, the magnitude, intensity, and effects of some torrential phenomena are illustrated in fig. 1.3.

1.1.1.2 Torrential Phenomena: Physics and Consequences

Torrential watersheds are subjected to violent and sudden precipitations, generally localized over a small area. The time difference between the precipitations and the raise of flow level is approximated by at most few hours and sometimes much less. Therefore, intense precipitations lead to fast-moving flows which may be very destructive (Mathys et al., 2013). Indeed, flows in mountain streams differ from those occurring in plain areas because of high geomor-

Phenomenon	Magnitude	Consequences	Intensity
Clear water flood (hydrogram only)	Hydrogram 	Submersion → Scouring →	Velocity (m) Flow height (m) Scouring depth (m) Scouring length (m)
	bed load (hydrogram + sedimentogram)	Sedimentogram 	Deposition → Earth pressure →
Debris flow		Submersion → Impact → Deposition → Earth pressure →	Velocity (m) Flow height (m) Kinetic energy (KJ) Height of deposition (m) Duration of deposition (h) Pressure (Kpa) Kinetic energy (KJ)

Figure 1.3: Torrential phenomena characteristics: magnitude, physical consequences and intensity parameters.

phological activity (e.g. sediment transport) causing both material erosion and deposition. Steep slopes, narrow streams, and short valleys in mountains boost gravitational forces thus triggering gravitational phenomena of various natures. Triggered by the harsh climate, the so-called gravity phenomena (more or less rapid) propagate from the upstream to the downstream of the watershed. The propagation and aggravation of torrential flows are governed by the geomorphological processes and the topographical characteristics of the torrential watershed. Their particularly steep slopes provide them with capacity to erode and destabilize banks, transport sediment, and deposit materials on fans and into downstream rivers.

The sediment production and its propagation varies in time (Fryirs, 2013). This depends on natural factors such as climate and land-use change (Gomez et al., 2003; Liébault et al., 2005) and on man-made aggravating factors especially those concerning vegetation covers (e.g. reforestation, deforestation, etc.) (Phillips et al., 2013). In addition, the discharge (flow rate) of transported solid materials is highly linked to the torrent’s bed slope and influenced by the geotechnical characteristic of the bed’s materials, in which sedimentary particles are dragged to the point that even large solid particles can be in motion and transported by torrential flows. The transported materials can generate up to several hundreds thousands cubic meters of deposits in the downstream alluvial fan where there is a sudden decrease in the slope. This leads to the disruption of infrastructures (transport network), damaging of houses and industrial structures, and generation of causalities. This natural process of

fluctuating sediment transport has been encountered for centuries by mountain inhabitants (Hughes and Thirgood, 1982).

While rivers carry mostly fine materials and suspended particles, torrents are able to drive blocks of up to several tons. In torrential hydraulics, flows can be either clear water, pure solid materials, or can be composed of complex mixtures of fluids (air, water) and solids (e.g. fine particles, gravel, blocks, trunks, plant debris, etc.). Whatever the material composition of the flow is, it may have the potential to trigger low or high geomorphological activities. Both the torrent's banks and the torrent's bed, interact strongly and are considered as potential sources of sediment supply to torrential flows. This can be interpreted by the fact that the variation in these two entities (e.g. erosion) depends respectively on two specific thresholds (Meunier, 1991):

- As long as the flow is less than the two thresholds, the water remains clear.
- If the flow exceeds the threshold corresponding to the banks, bank erosion occurs and solid materials will be transported.
- If the flow exceeds the threshold corresponding to the bed, bed incision occurs endangering the stability of the torrent.

The mobilization of sediments within a very short time span and a short distance between the top and the bottom of the watershed often involves a complex sequence of several torrential phenomena. Generally, two main types of phenomena can be distinguished (Meunier, 1991):

Besd load: It corresponds to the flow of particles and blocks whose maximum size corresponds to the height of the flow, quite comparable to those observed in rivers. They can however reach concentrations much higher in torrents than in rivers. It is a bi-phasic flow in which water and solid material move with different velocities. The solid moves by rolling on the bottom.

Debris flows A phenomena quite specific to torrents. It corresponds to a mass flow (large blocks with muddy fluid) propagating a few meters high with few m/s velocities. They are a mono-phasic flow in which all the mixture move with the same velocity. They are considered the most destructive torrential phenomena. Their considerable volume spread over the alluvial fan, close the roads, and ruin the assets. Yet, big events rarely occur (once every ten or thirty years in the Alps for a given torrent).

Generally, in torrents, the influence of solid transport on the liquid flow, and vice versa, is generally too strong for the two phenomena to be approached separately. Among the interactions between liquid phase and solid phase, those that result in geomorphological processes (erosion, deposition), thus varying the torrent's bed (fig. 1.4). For example, with intense solid transport, the morphology of the torrent can be quickly modified, either in terms of the longitudinal profile, or by rapid changes and displacements of the flow channels.

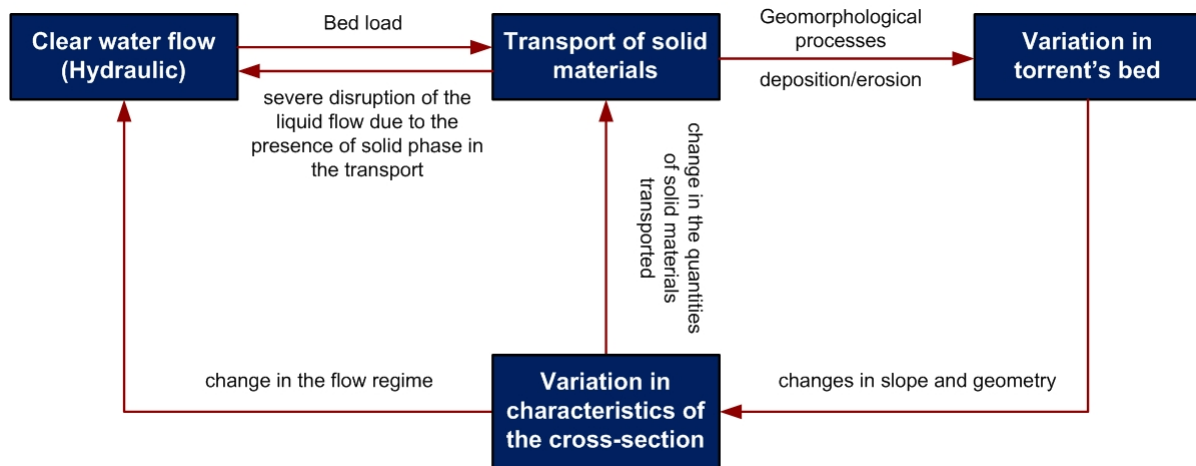

Figure 1.4: Interactions between liquid and solid phases. Modified after (Guide PPRn, 2008)

The sudden and rapid nature of most torrential flows, make it almost impossible to set up an alert system to ensure the safety of the population. In bedload, based on the volume of solid materials transported to areas downstream the watershed, a series of disorders and damages can result (fig. 1.5). On the other hand, intense and high liquid flow rates of bedload and the associated sedimentary dynamics generate also different types of disorders (e.g. scouring). The erosive capacity of torrential flows causes destabilization of torrent's bed and banks. Consequently, bedload phenomena result in the following disorders:

- Overflows due to deposition of sediments which in turn reduces the cross-section.
- Deviation of the watercourse to undesirable directions.
- Obstruction of roads and bridges.
- Invasion of downstream alluvial fan by solid materials of different sizes and types (fine materials, coarse materials, plant debris, etc.).

In case of debris flows, the only operational alert to date is based on early detection of the events. However, the time elapsing between their detection and their arrival to the downstream is very short (may be less than one minute). They can travel long distances and move several meters per second while maintaining their dynamic characteristics (Chambon and Laigle, 2013). They endanger human life and cause partial or total destruction of buildings, infrastructures, and equipment. Other gravitational phenomena have similar catastrophic consequences. For instance, snow avalanches (Barbolini et al., 2004) cause more or less large deposits depending on the volume of snow available and set in motion. The consequences of an avalanche depend on the pressure it exerts. Moreover, rapid gravitational ground movements such as landslides (Leone, 1996) and rockfalls (Mavrouli and Corominas, 2010) can have direct consequences on exposed elements.

All of the above mentioned phenomena are specific to mountain areas, such as those of the French massifs (Alps, Pyrénées, Cévennes, Massif Central, Jura, and Vosges). These massifs



Figure 1.5: Damages resulted after torrential flood in *Bastan à Barèges (Hautes-Pyrénées)*, June 18, 2013. (1) and (2) destruction; (3) deposition; (4) scouring. Source: ©INRAE/ETNA.

have been already subjected to several recognized historical events. Indeed, one of the most prominent events that happened recently is the flood in the Prénées that occurred between 17 and 19 of June 2013. Two people died and the damages were estimated to be around 500 million euros. Below are some examples of ancient disasters that illustrate the dramatic consequences of torrential phenomena (MEDDTL, 2011; Guide PPRn, 2008):

- Isère 14/06/1827: 50 to 60 victims in Goncelin.
- Ariège 23/06/1875: 91 victims in Verdun out of 792 inhabitants.
- Sainte Foy Tarentaise 20/08/1882 and 16/09/1883: 175 victims due to debris flows.
- Modane 27/08/1987: no victims but the damages were estimated as around 8 million euros.
- Pyrénées-Orientales 17/10/1940: 48 deaths in France and 300 in Catalonia.
- Pyrénées massif 15/08/1953: 6 victims in Ancizan.

In French Alps, statistical analysis have shown an increased frequency of natural hazards since 1970 (Einhorn et al., 2015). A considerable number of torrential events were recorded having significant direct (destruction) and indirect (economic) impacts on elements at risk and the society as a whole. This have drawn the attention of scientist, land use and natural hazard managers, and decision-makers for interventions onset.

1.1.2 Natural Risk Preventive Management

Risk assessment aims in identifying risk arising due to an undesirable event and analyzing its consequences(Rausand and Haugen, 2020). Developing and assessing risk scenarios in an early stage permit risk managers and decision-makers to predict risk levels and to consider proper risk prevention or mitigation strategies, thus contributing in the global risk management decision process. Particularly, in torrential watersheds, the quantification of risk components (frequency, intensity, potential damages) is an key scientific obstacle (Fuchs et al., 2007). Indeed, expertise is needed to describe torrential phenomena, which are difficult to fully understand. In practice, risk level often takes the form of qualitative classes (risk assessment matrix) based on experts’ judgments. Fig. 1.6 is an example of a risk assessment matrix used to classify the level of risk in industrial context where risk is a combination of frequency and severity. The objective of such classification is to support decision-makers in prioritizing different strategies involved within the risk management processes, thus adopting optimal decisions.

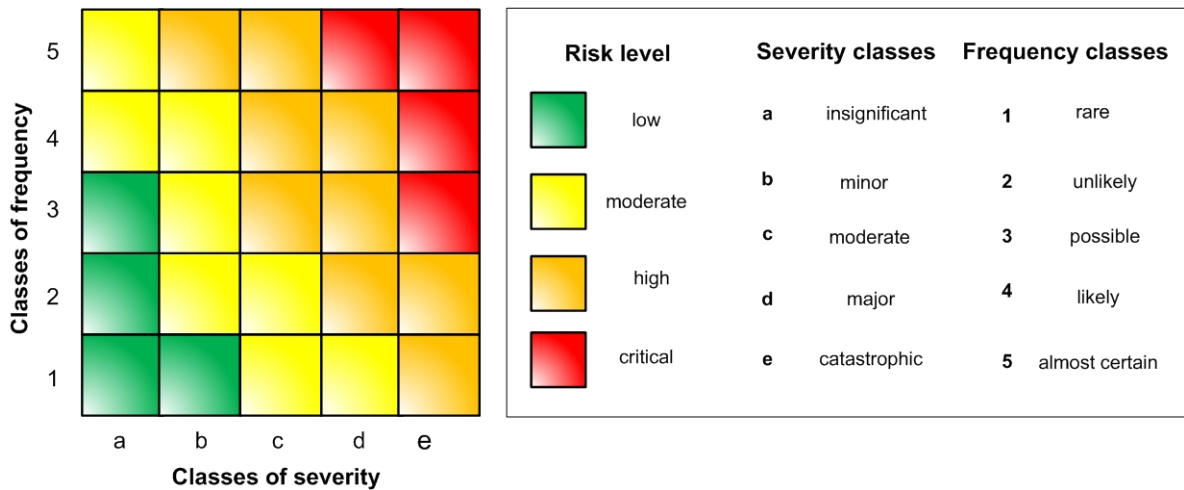

Figure 1.6: Qualitative risk assessment matrix

Risk management consists of changing the risk class by acting on its components. It is a multi-scale decision process consisting of a series of temporal steps at which decisions are taken before, during and after an event (crisis). Each step involves a set of actions to be carried out (Bourrelie et al., 2000) as shown in fig. 1.7). Going through all actions in the right sequence enhances continuously the decision-making process.

Since the 19th century, natural risk assessment and management became a priority for the

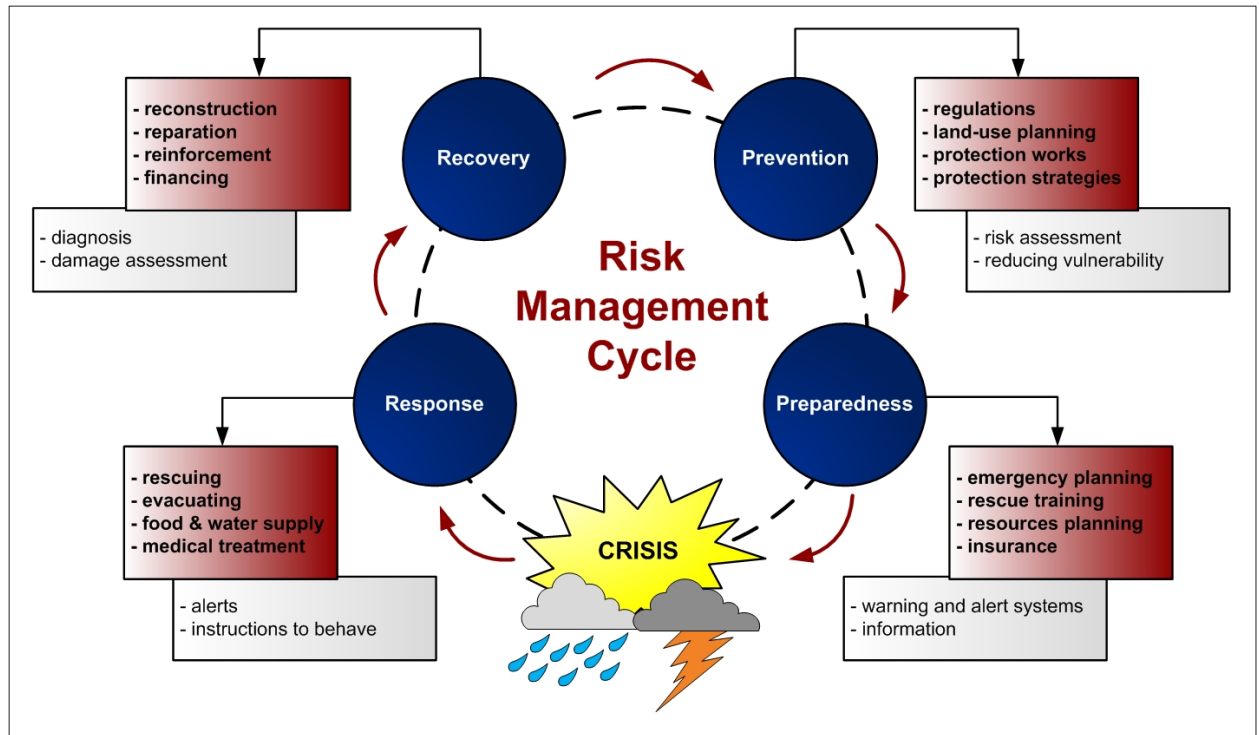

Figure 1.7: Temporal steps involved within a risk management process.

state and local authorities in order to ensure safety and to preserve economic life. To protect people and properties, the French state has initiated a policy known as RTM “*Restauration des terrains en montagne*”, responsible for the restoration and conservation of mountain lands. The objective of RTM is to provide assistance in the prevention step of the natural risk management cycle. Its main tasks are to propose mitigation measures (e.g. protection strategies), monitor their implementation on the national territory, and to maintain a high level of their efficacy in order to achieve more cost-effective solutions for the prevention of natural risks. In addition, the ONF that stands for “*Office national des forêts*” (National office of forests), is allocated to manage forests and torrential watersheds by establishing priorities in mitigation and protection strategies according to the limited public budgets. Furthermore, the Ministry of Ecological and Solidarity Transition (MEST), in charge of natural and technological risk prevention, has set up guidelines developing a natural risk prevention plan (PPRN), specifically to reduce the vulnerability of exposed issues.

1.1.2.1 Structural and Non-Structural Protection Measures

Indeed, since the 19th century, the French state has acquired more than 380 000 ha of public forests under the RTM policy in order to protect mountain areas against torrential phenomena. Generally, risk management involves identifying the risk level and then choosing the best strategy for prevention or mitigation. The preventive management of torrential risks is largely based on either structural or non-structural protection measures (fig. 1.8).

Structural measures are mainly civil engineering structures constructed along the torrential watershed aiming to resist natural hazards. About 100 000 torrential protection structures (e.g. check dams, retention dams, levees, etc.) are built in French mountains (Messines du Sourbier, 1964). Each type of structures has its own functions depending on the component of hazard it acts on. In general, there are two types of protection structures (Tacnet and Degoutte, 2013), one acting the causes (e.g. sediment production, erosion) of the hazard and the other acting on the consequences (e.g. deposition, overflowing) of the hazard. Structures acting on the causes of the hazard aim in preventing the occurrence of the phenomenon by reducing the probability of exceeding a certain magnitude that triggers it. They are located in the upstream part of the torrential watershed (receiving basin and flow channel) and progress from downstream to upstream (e.g. series of check dams). On the other hand, structures acting on the consequences of the hazard aim in protecting vulnerable exposed issues from the by limiting the potential damages resulting from the phenomenon. They are located in the downstream part of the torrential watershed (alluvial fan). Such structures include retention dams, dykes, levees, etc.

Non-structural measures such as natural risk prevention plans (PPRN), are based on the thorough knowledge of both the natural phenomena (frequency, intensity, potential damages) and on the level of protection provided by the structural protection measures (structure's efficacy) if they exist. The strategy adopted by non-structural measures is linked to risk zoning, in which the catchment area (downstream alluvial fan) is divided into zones where buildings are allowed, restricted, or forbidden. In addition, risk maps support risk assessment by providing information about different phenomena, vulnerabilities and risk levels in a particular area. This can help in prioritizing protection strategies and well-distributing the limited available budgetary resources. Further more, well managed forests reduces the frequency, intensity and the impact of natural phenomena by reducing the vulnerability of the land to climate change. For example, reforestation can ensure social, economic and environmental improvements. It also contributes to guarantee ecosystems services by controlling hydrological processes and land degradation. This can positively influence the components of torrential phenomena by decreasing their frequency, intensity (velocity), magnitude (volume) and impact (erosion, deposition) (Ladier et al., 2012). Hence, managing forests can be considered as an effective protection measure against torrential risks.

Nowadays, civil engineering protection structures are being highly adopted measures against natural risks in mountains. However, risk managers seek to implement an integrated protection strategy adopting both types of measures (structural and non-structural) in torrential watersheds in order to limit as much as possible the resulted damages.

1.1.2.2 Integrated Structural Protection System in Torrential Watersheds

The implementation of civil engineering structures in torrential watersheds has been an essential prevention strategy for natural risk management. Generally, structural protection measures do not function separately. The objectives of protection are only achieved within a protection system composed of several structures grouped together so that they participate

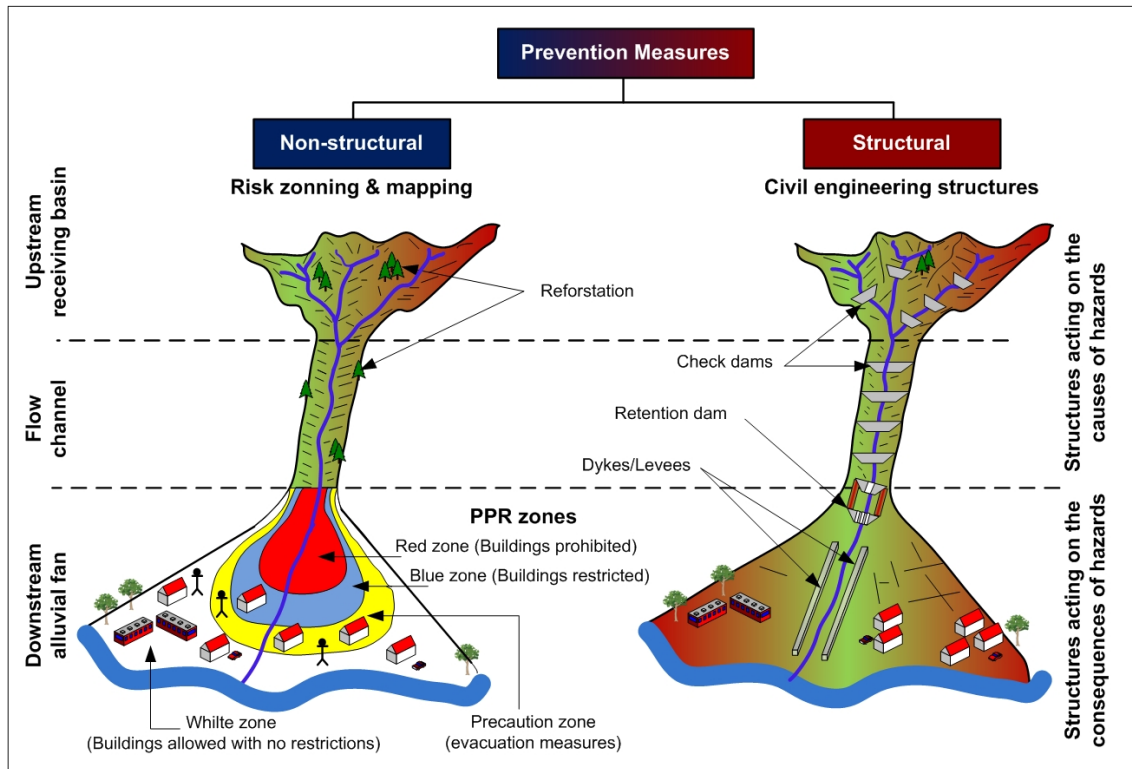

Figure 1.8: Structural and non-structural prevention measures.

collaboratively in resisting natural hazards in mountains and to protecting socio-economic issues. In the context of torrential risks, the analysis of protection systems is performed on several scales starting from upstream to the downstream of the watershed. It must achieve three main functions (Carladous, 2013):

1. stabilizing the longitudinal and transverse profiles of the torrential watershed and maintaining materials on slopes in order to limit the departure of materials in the triggering area.
2. storing materials before they reach vulnerable exposed issues in order to protect them from the destructive effects of deposits in the stopping area.
3. transferring the flow in a way to prevent overflows in order to protect exposed issues against submergence effects both in the the propagation and stopping zones.

The previously mentioned functions can be fulfilled by different types of protection structures constructed along torrential watersheds. A detailed description of protection structures adopted in French mountains is available in a data base developed by the RTM service (DTRTM, 2007). The most dominating types of protection structures are briefly presented below.

- **Check dams:** aim to limit the departure of materials from source areas by reducing

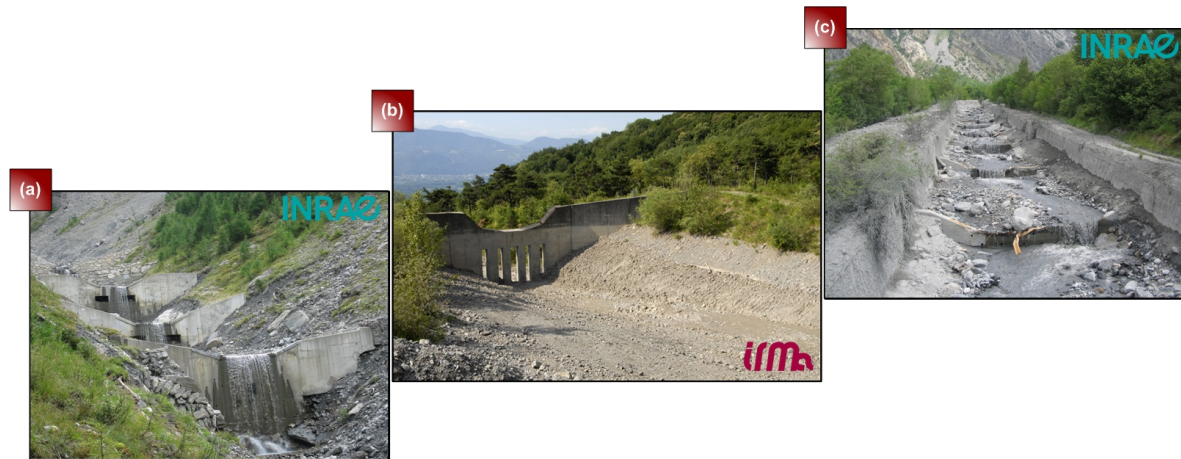

Figure 1.9: Different types of protection structures constructed along the torrential watershed to resist torrential phenomena. (a) series of check dams, Saint Antoine torrent, France, 2014, Source: ©INRAE/ETNA; (b) retention dam, Manival torrent, France, 2020, Source: ©IRMa/S. Gominey, <http://www.irma-grenoble.com>; and (c) levees, Saint Bernard torrent, France, 2005, Source: ©INRAE/ETNA.

the bed slope and stabilizing the longitudinal profile. They are usually implemented in series in the upstream part of the torrential watershed (receiving basin and flow channel) (fig. 1.9 (a)). Check dams act on reducing the causes of solid materials production.

- **Retention dams (Open check dams):** aim to store, the solid materials especially the big blocks carried by torrential flow. They are implemented in the top of the downstream alluvial fan, downstream a sediment retention basin 1.9 (b)). Retention dams act on reducing the consequences of the hazard by avoiding excessive sediment downstream, thus protecting vulnerable exposed issues avoiding.
- **Dykes/Levees:** aim to control the direction and transfer of the flow. They are implemented in areas of lower slope of the downstream alluvial fan, near people and assets (fig. 1.9 (c)). Dykes or levees act on reducing the consequences of the hazard by preventing overflows, thus protecting vulnerable exposed issues.

The choice and design of protection structures relies on skills linked to a variety of disciplines. They are designed, according to a risk reduction objective, in order to resist and to ensure specific functions. The theoretical design approach is based on the following main steps (Piton and Recking, 2015a; Tacnet and Degoutte, 2013):

1. **Step 1:** having knowledge about the characteristics of torrential catchment areas subjected to natural phenomena (topography, geotechnical data, analysis of the nature and cause of the phenomena, etc.);
2. **Step 2:** identifying risk levels, the need for protection, and the functions to be fulfilled;

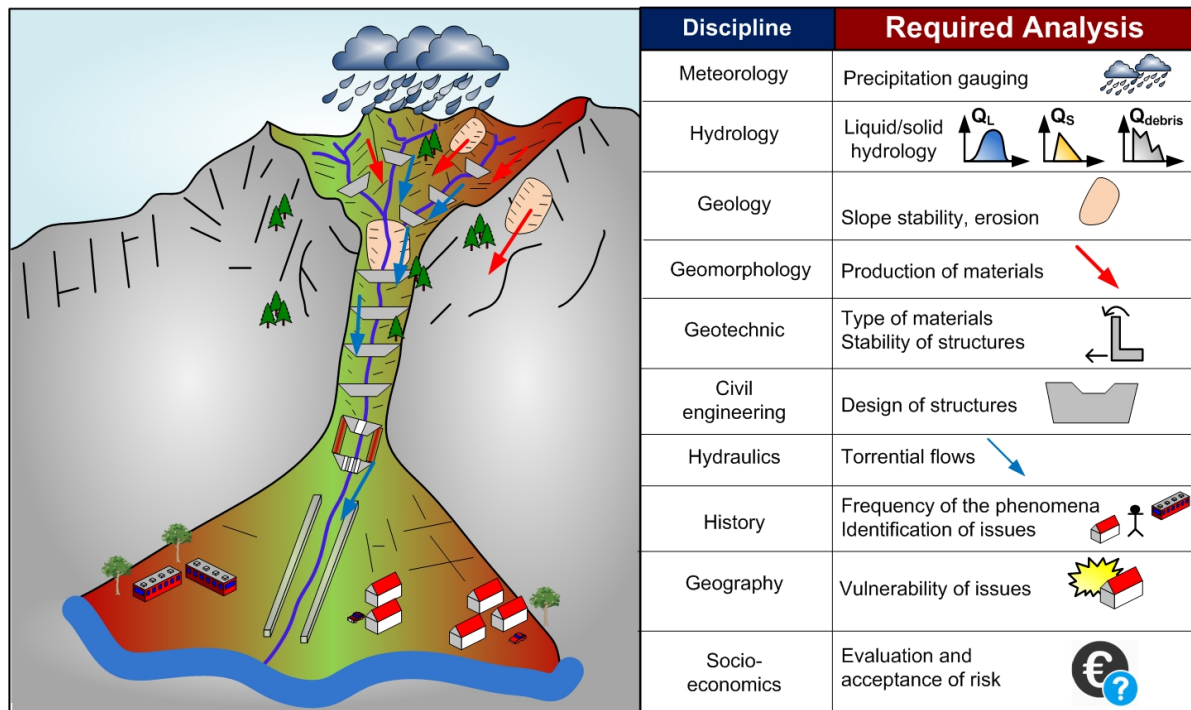

Figure 1.10: Multi-disciplinary involvement in the theoretical design of protection structures in torrential watersheds (Adapted from (Carladous, 2017)).

3. **Step 3:** choosing suitable (cost-effective) types of protection structures (check dam, retention dam, etc.);
4. **Step 4:** designing protection structures (shape, materials used, etc.) in a way that they are able to fulfill properly the required function;
5. **Step 5:** proper dimensioning of the structures in a way that justifies their internal and external stability; and
6. **Step 6:** readjusting with available budget and environmental constraints.

At each step, different but complementary disciplines are involved (Brochot, 1998). Therefore, several theoretical elements, represented in fig. 1.10, are required first to analyze hazards occurring in a given watershed and then to design and implement suitable protection structures (Carladous, 2017).

1.2 Critical Protection Structures Management

Recently, societies have become more and more reliant on infrastructures which constitute a network of man-made systems that deliver permanently and cooperatively major benefits, supplies, and services (e.g. electric power, telecommunication, transportation, water supply). Such systems are important for enhancing social environment and for economic prosperity.

However, dependencies within the same component and/or between the system's components have turned them into a critical system-of-systems (Eusgeld et al., 2009). Critical infrastructures (CIs) are usually exposed to various types of threats (technical, natural, man-made attacks, etc.) which cause them damage. The destruction or weakness in achieving their desired functions induces risk that might have an impact on the economy, safety, and the society as a whole (Kröger, 2008). Nevertheless, not all infrastructures are considered to be critical. They can be classified based on a criticality scale identified after assessing the possible consequences resulting after the infrastructure disruption (Clarke et al., 2015). As defined by the European Commission, CIs are “physical and information technology facilities, networks, services and assets that, if disrupted or destroyed, would have a serious impact on the health, safety, security or economic well-being of citizens or the effective functioning of governments in EU States”. The efficacy of CIs is influenced by the attained level of their structural damage or their level of malfunctioning. Because of the essential services they provide, assessing the resilience in addition to ensuring the availability and the proper functioning of CIs have become one of the state's priorities.

Since they insure safety to people and protect socio-economic issues, protection structures in torrential watersheds are considered as essential infrastructures that should always withstand and operate efficiently. As any other type of infrastructure, the partial or total destruction of protection structures, would pose threat to the safety, security, and economics of the society. Over their lifetime, protection structures are influenced by the direct impact of the hazards they resist on one hand and by the indirect consequences resulting from the geomorphic activity (erosion, deposition) that occurs after each torrential phenomenon on the other hand. As a consequence, torrent protection structures may be subjected to different types of failure modes that can have local or distant effects on their efficacy and performance level. If not regularly inspected and maintained, their deterioration over time leads to their complete failure, which in turns may increase the risk induced by natural phenomena themselves. Protection structures are therefore classified as critical infrastructures (CIs) and should be given deep attention.

1.2.1 Design and Failure Analysis of Torrent Protection Structures

Protection structures are designed to ensure specific functions related to the phenomenon whose effects are to be limited. Hence, they are designed to resist and operate over time, and to protect socio-economic issues. Structurally, they are designed in a way that enables them to resist the stresses to which they are subjected and to withstand over a specified period of time. As standardized by Euro-codes (AFNOR, 2003, 2005a,b, 2014), the design approach of a civil engineering structure is divided into two steps: functional design (objectives) and structural design (dimensioning). The designer must first define the desired objectives in order to choose the type, shape, and materials of the structure.

Due to the high intensity phenomena they must resist (direct impact), the unstable environment surrounding them (e.g. geomorphologic activity) and due to their aging over time, torrent protection structures may be subjected to different types of failures that may lead

to their partial or total destruction and malfunctioning. Protection structures' management requires having a comprehensive knowledge about the design of each type of structure and the possible failure modes that might occur. In general, a failure is characterized by its type, location, origin, consequences, and severity. The aggravation of failures may lead to a total destruction and/or malfunctioning of the structure. In fact, it is important to differentiate between two types of failures:

Structural failure: a structure can have a very bad structural properties such as concrete degradation, steel corrosion, or cracks but is still able to fulfill its assigned functions without guarantee of its durability. A structural failure can be analyzed in terms of the external stability (balance) and the internal stability (strength of materials) of the structure. Such types of failure result when one or more stability indicator exceeds equilibrium conditions justified during the design phase.

Functional failure: a structure can no longer accomplish its required functions although it is stable from a structural point of view. Such failures are mainly linked to the dynamic of the flows, instability of the surrounding environment, and the initial design of the structures.

In the late 19th century, a comprehensive classification of streams and a detailed description of the geomorphic processes related to torrents were provided by (Demontzey, 1882). Although they share many common characteristics, the choice and design of protection structures must adapt with the type of torrent. For torrents subjected to torrential flows such as clear water floods, bedload and debris flows, a series of check dams in the flow channel followed by a retention dam close to the downstream alluvial fan is recommended.

1.2.2 Torrent Check Dams

In France, among thousand of civil engineering protection structures constructed in mountains, check dams (92 873 check dam recorded in 1964) are the most adopted (Messines du Sourbier, 1964). Torrent check dams are transverse civil engineering structures built across stream beds in torrential watersheds in order to fulfill several functions. In the 19th century, check dams were made up of stones or masonry blocks (gravity dams). However, after the development of reinforced concrete in the middle of the 20th century, engineers started to build, in the 1950's, cantilever check dams (auto-stable dams) with a reinforced foundation (Poncet, 1968, 1995).

1.2.2.1 Structural and Functional Design Analysis

Generally, a series of check dams (fig. 1.11) is implemented in the flow channel of the torrential watershed aiming to work collaboratively and interdependantly on achieving specific functions. To be effective, each check dam involved within a series of check dams must fulfill



Figure 1.11: Torrent check dams: (a) Check dams series; (b) Single check dam. Saint Antoine torrent, France, 2014. Source: ©INRAE/ETNA.

all functional requirements and also, as any civil engineering structure, has to be stable from a mechanical point of view considering external and internal stability equilibrium justifications. Indeed, cantilever check dams are usually designed based on structural and torrential hydraulics functional analysis design criteria (Tacnet and Degoutte, 2013).

The structural analysis of a check dam is divided into four elements: central body, left wing, right wing, and foundation (fig. 1.12). The dimensioning of check dams is then relatively conventional. Their stability and hydraulic calculation first introduced by (Thiéry, 1891) then developed by (Deymier et al., 1995; García and Lenzi, 2013). Deymier et al. provided a technical reference document for the structural design of check dams adapting classical civil engineering stability justification to the specific context of torrent protection structures (geotechnical characteristics, loading conditions). Nevertheless, the design criteria may differ according to how old the dam is based on the standards that existed at that period. The document includes calculating all loads/actions exerted on a check dam and then justifying its stability by (i) ultimate limit state (ULS), which corresponds to the risk of its destruction and (ii) serviceability limit state (SLS), whose exceeding does not lead to destruction but compromises the durability or the operation of the structure. Usually, the structural design (fig. 1.13) of cantilever check dams is based on the following design principles:

- **Hydraulic design:** setting dimensions for the hydraulic weir of the dam depending on the total discharge allowed to pass through the weir (Meunier, 1991). Estimating the discharge capacity of the weir is based on extracting topographic data (longitudinal profile slope, channel's width, etc.) and hydraulic data (catchment basin area, Q_{10} , Q_{100} , debris flows height, etc.).
- **Loads/Actions calculation:** identifying and calculating all loads exerted on a check dam.
- **External stability justification:** verifying conditions that ensure stability against excessive foundation pressure overturning, sliding, etc.

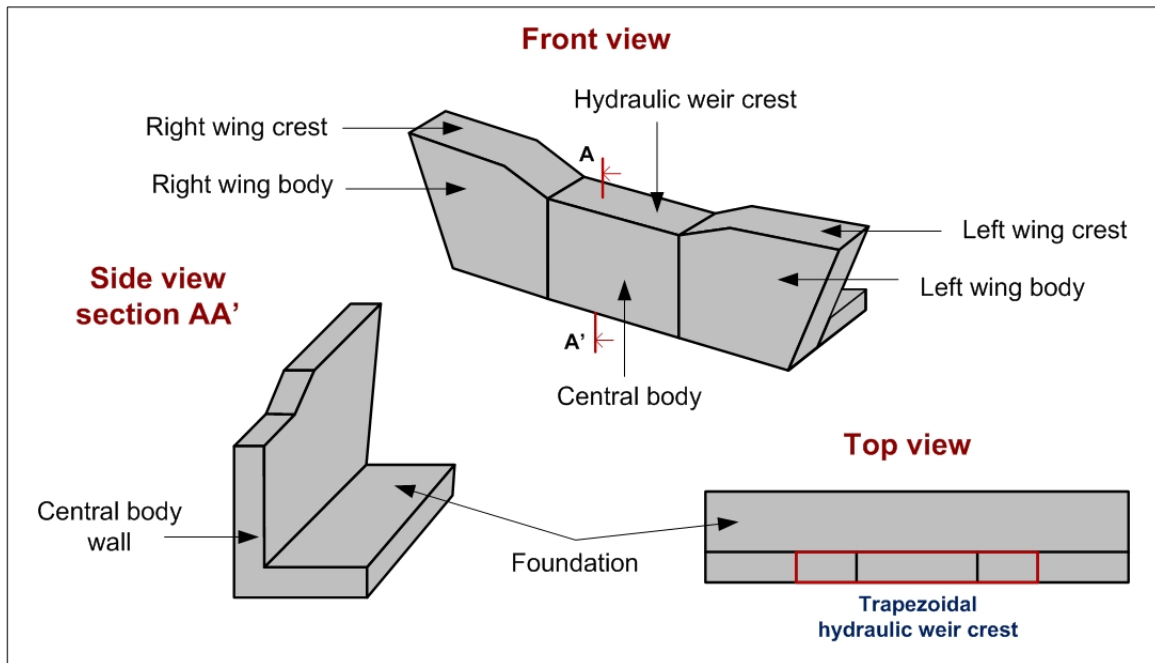

Figure 1.12: classical components of a cantilever check dam.

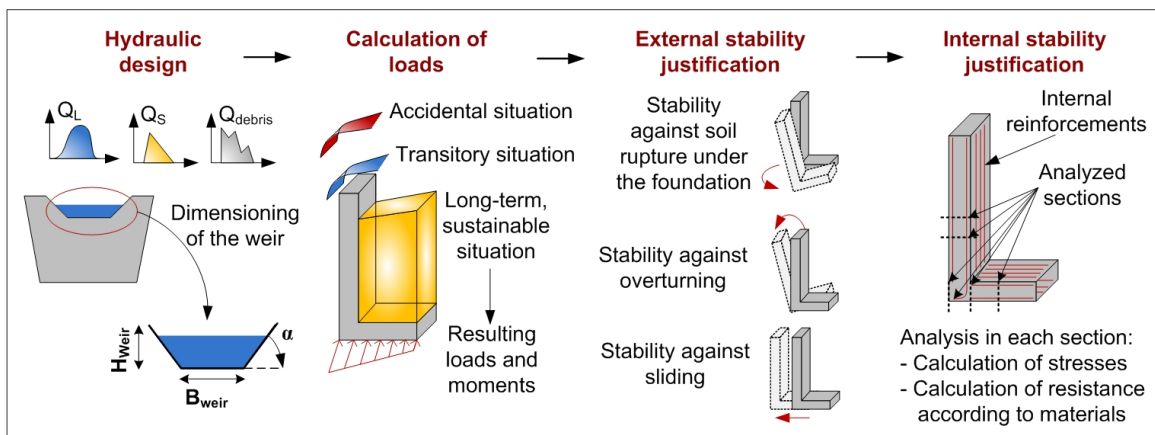

Figure 1.13: Structural analysis of torrent check dams.

- **internal stability justification:** verifying the maximum allowed stresses (steel and concrete) in different sections of the dam.

The structural dimensioning of a check dam is almost the same as that of a retaining structure. However, the determination of loading situations (nature and characteristics) applicable to structures subjected to torrential phenomena is often an initial difficulty even for engineers and technicians specialized in classical civil engineering but not familiar to the context of torrential risks. Once the loading situation and the loads to be considered have been identified, the traditional design calculations in civil engineering takes place for stability justification. Indeed, the check dams designers have to choose between three loading situations:

sustainable, transitory, and accidental. For each loading situations, several loads that can be either permanent, variable, or accidental should be computed (fig. 1.14). The definition of loading situations must also take into account the lifetime period of the structure (Tacnet and Degoutte, 2013).

Sustainable loading situation: duration of the loading is of the same order of magnitude as the service lifetime of the structure. This situation corresponds, for example, to the permanent presence of earth pressure upstream the dam. The loads to be considered in this situation include the concrete dead weight, sediment deposit weight and the earth pressure load.

Transitory loading situation: duration of the loading is much less than the service lifetime of the structure. This situation corresponds, for example, to the passage of a frequent flood. The loads to be considered in this situation include those considered in the sustainable loading situation in addition to the pressure due to liquid, excess weight due to liquid flow and the liquid dynamic impact on the dam wall.

Accidental loading situation: duration of the loading compared to the service lifetime of the structure cannot be defined. Accidental modifications occurs due to seismic events or due to the occurrence of accidental actions. This situation corresponds, for example, to the passage of rare flood (e.g. debris flows). The return periods of the events can be used as indicators. However, in the case of debris flows, the definition of the return period is not always easy. The loads to be considered in this situation include those considered in the sustainable loading situation in addition to the excess weight load due to debris flows, dynamic pressure due to debris flows impact and the dynamic load due to debris flows impact.

On the other hand, the functional analysis of a check dam aims in verifying whether the structure is able to achieve each of its expected functions related to hydraulics and erosion control. The main functional elements of a check dam are the central hydraulic weir which controls the flow direction and the side wings that prevent the lateral bypass of the flow during extreme flood events. Check dams are usually built in torrents that necessitates bed stabilization, slope reduction, and bed widening in order to prevent bed incision and destabilization of banks (Poncet, 1995). They aim to limit the departure of solid materials by stabilizing the longitudinal and transverse profiles, thus reducing the risk of lateral landslides. In other words, check dams act as kinds of retaining walls for materials (preventing from longitudinal erosion) but with hydraulic functions (centering flows and preventing lateral erosion). Since decades, researchers working on torrent protection structures have reported lists of check dams' functions (Armanini et al., 1991; Poncet, 1995; Hübl and Suda, 2008; Zeng et al., 2009). Recent work, describes, in more details, the different functions of check dams and their positions within the torrential watershed depending on the function to be fulfilled (Piton et al., 2017). The main functions of a check dam series are illustrated in fig. 1.15 and briefly described below:

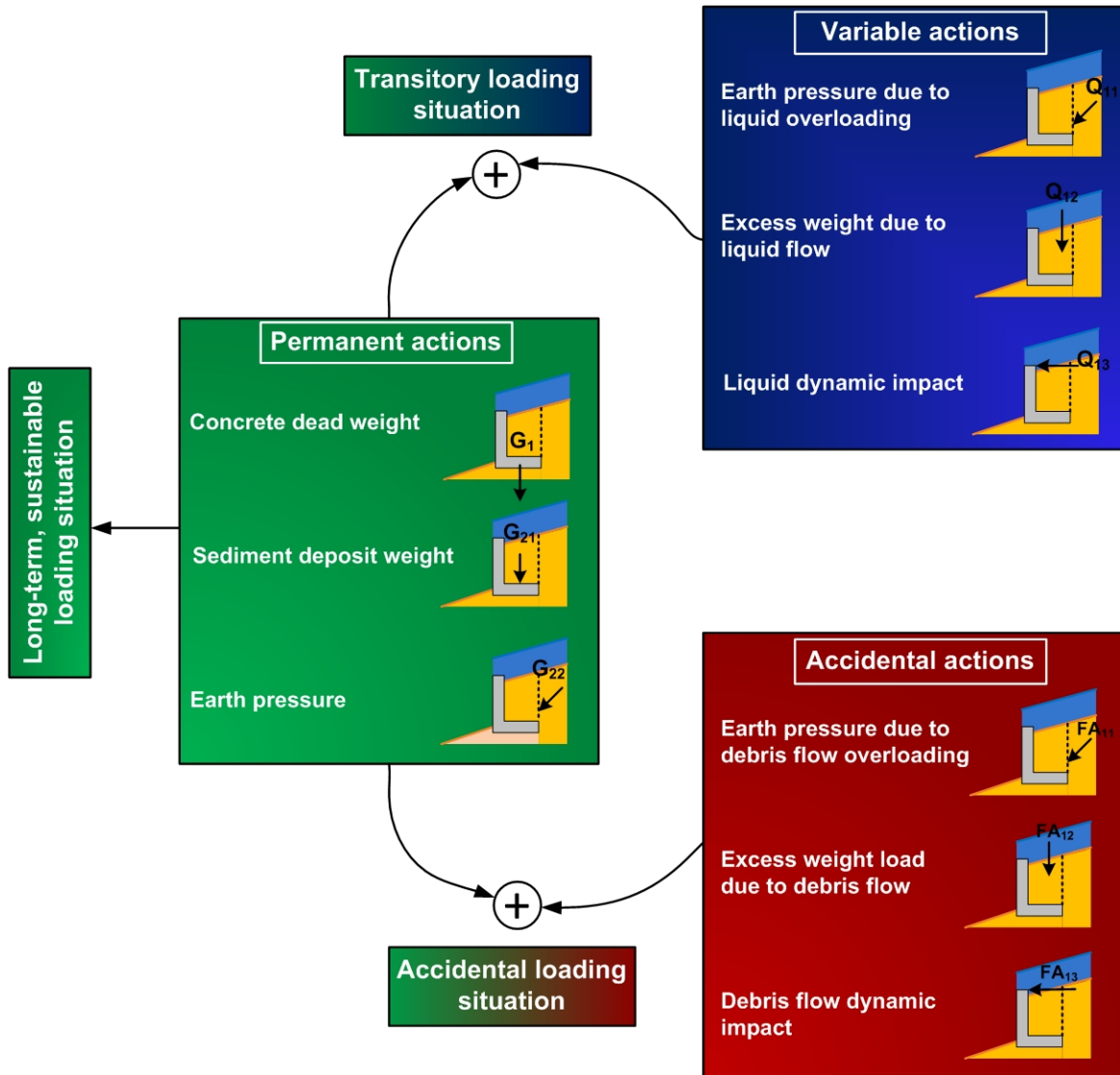

Figure 1.14: Loading situations and loads considered during the design of torrent check dams.

Bed stabilization: The implementation of a series of check dams create fixed points on the longitudinal profile of the torrent thus stabilizing the bed. This stabilization limit sediment production and transport which in turn prevent bed incision and destabilization of banks (Piton et al., 2017).

Hill-slope consolidation: Check dams significantly elevate the torrent's bed level and consolidate the lateral hill-slope where sediments are produced. This slow down the activity of the sediment sources such as landslides and debris flows (Kronfellner-Kraus, 1983). The difference between bed stabilization and hill-slope consolidation may be confusing. In fact, even if the check dams are built on the same level as that of the existing torrent bed, they stabilize the bed. However, if they are built above the bed level by few meters, the incised valley will be refilled and the activity of important

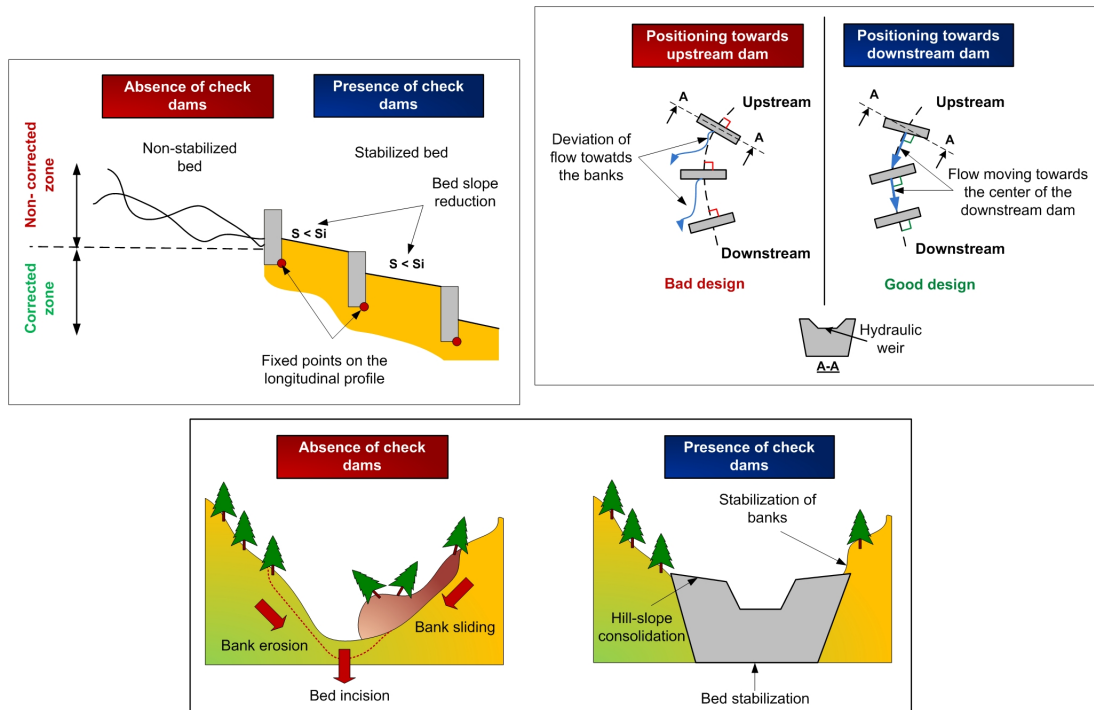

Figure 1.15: Functional analysis of torrent check dams (Adapted from (Deymier et al., 1995; Tacnet and Richard, 2010)).

sediment sources will be reduced (Piton et al., 2017).

Slope reduction: The upstream reaches of check dams are usually filled by sediments and solid materials transported by torrential flows (Piton and Recking, 2017). This results in a bed slope milder than the initial one. Slope reduction reduces the intensity (e.g. velocity) of the flow, the transported volume of sediments (Liu, 1992), the displacement of large boulders and thus the longitudinal and lateral erosion.

Sediment retention: It is a secondary function of check dams. Due to the fact that the crest of the dam's hydraulic weir is set above the initial bed, solid materials are trapped in the upstream reach of the dam. This can be defined as a long-term trapping of solid materials (Liu, 1992). A series of check dams should be implemented close to each others in order to trap a maximum amount of materials. However, retention dams (another type of prote are build particularly to store the transported solid materials.

Sediment transport regulation: The fixed points created by check dams on the longitudinal profile of the torrent make the upstream reach of the dam independent of its downstream reach. This independence helps in regulating the storage and the release of sediments (Recking, 2014). Check dams thus release in small portions what a torrential flow would suddenly transport in a single massive portion (Poncet, 1995).

Flow centering: The hydraulic weir (central part) of a check dam aim to direct the flow towards the center of the downstream dam so that the flow doesn't deviate towards the

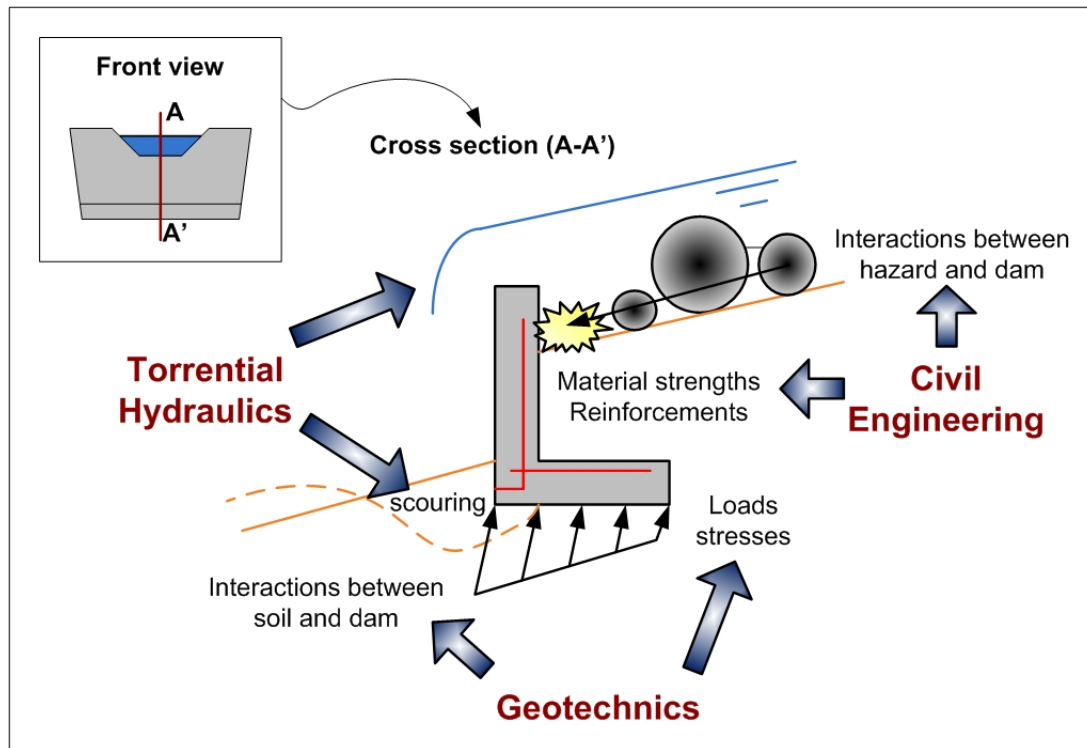

Figure 1.16: Joint expertise involved in the structural design analysis of a check dam (Modified after (Tacnet et al., 2000)).

banks (Deymier et al., 1995; Tacnet and Degoutte, 2013). In addition, the wings of the dam are extended to the banks in order to prevent lateral bypass and thus to reduce lateral erosion.

A well structurally designed check dam series enables it to achieve efficiently the assigned functions related to hydraulics and erosion control. Therefore, during the structural design phase, engineers should take into account, the functional requirements that should be fulfilled by the system (series of check dams). Furthermore, due to the different constraints in the context of natural hazards and torrents, both functional and structural designs of check dams require more expertise compared to conventional civil engineering applications (Hübl et al., 2005). The design of check dams is therefore based on joint expertise (fig. 1.16) in torrential hydraulics (dynamics of solid transport), geomorphology (e.g. scouring), civil engineering (stability verification considering the dynamic impact of flows) and geotechnical engineering (physical and mechanical characteristics of the soil, loads, etc.).

1.2.2.2 Failure Modes and Maintenance Strategies

Having a comprehensive knowledge about check dams' functional and structural requirements makes it possible to identify both functional and structural failure modes these structures

may be possibly subjected to. All types of check dam's failures are described in an inclusive technical report provided by (Tacnet et al., 1999d). Below are the most frequent types of failures (fig. 1.17):

Functional Failures

- **Local scouring:** removal of materials (soil) under the dam's foundation caused by intense clear water flows passing through the center of the dam. It is an unavoidable phenomenon because it is directly related to the geomorphic activity (change in bed level) resulted after each torrential phenomenon. This type of failure has been known since the first constructions (Bernard, 1925) and is considered to be the most critical since it is one of the main causes that results in the total destruction of the structure (Comiti et al., 2013; Dell'Agnese et al., 2013).
- **Lateral bypass:** failure in directing the flow towards the center of the downstream structure. The flow is released behind the dam wings due to high intensity torrential event, improper sizing of the dam's hydraulic weir responsible for centering the flow, or due to the reduction of the hydraulic section by large boulders.

Structural Failures

Failure by external stability

- **Sliding:** horizontal movement of the structure caused by extreme event or due to large horizontal applied forces.
- **Overturning:** rotation of the structure around its horizontal axis due to an exceeding moment resulting from overturning forces compared to the resisting moment resulting from stabilizing forces.
- **Settlement:** vertical drop of the structure due to weak bearing soil or due to poor compaction of soil (presence of voids).
- **Uplift:** vertical upward movement of the structure due to the effect of any upward pressure (e.g. water pressure due to water stored in the pores of the dam's foundation).
- **Soil rupture:** occurs when the resultant vertical force exerted on the soil exceeds the bearing capacity of the soil. This results in the total destruction of the structure.

Failure by internal stability

- **Material failure:** strength of materials is overpassed. For example, cracks refer to a mechanical discontinuity affecting a structural element due to high stress, swelling, differential settlement, creep, bank slip, earthquake, etc. It



Figure 1.17: Examples on the types of functional and structural failures check dams may be subjected to: (1) scouring under dam's foundation; (2) erosion of banks due to lateral bypass; (3) presence of cracks; (4) concrete corrosion; (5) steel corrosion; (6) total destruction. Saint Antoine torrent, France, 2014. Source: ©INRAE/ETNA.

can appear in several shapes and directions (longitudinal, oblique, transverse, etc.).

- **Ageing:** resistance of materials is reduced over time. For example, concrete corrosion refers to the disintegration of concrete materials due to the action of water or wind, formation of salt (ettringite) or due to the effect of freezing. Moreover, steel corrosion refers to electrolysis or chemical attack (e.g. direct oxidation) that causes rust of steel due to poor porous structure, insufficient coating, penetration of aggressive agents or due to Penetration of moisture.
- **Material breakage: resistance of materials is overpassed.**

Upon the initiation of any type of failure, a check dam may result in an abnormal structural and/or functional behavior. The accumulation of damage intensifies the failure thus increasing its severity and consequences. In other words, if not regularly maintained, the structural and functional degradation levels of a deteriorating check dam evolve over time. Due to the considerable role of check dams in preventing the triggering of torrential phenomena, reducing their intensities and protecting vulnerable exposed issues from their devastating consequences, engineers have proposed several countermeasures that can be carried out depending on the confronted type of failure. The objectives of these measures are to monitor, control, delay, minimize or prevent different types of failures thus extending the availability time of check dams. Some structural measures can be implemented during the design stage of check dams while others are carried out after the occurrence of failures for maintenance (reparation). Table 1.1 summarizes some countermeasures and maintenance operations corresponding to the previously mentioned types of failures check dams are frequently subjected to (Tacnet et al., 1999c).

1.2.3 Retention Dams

Retention dams, also called open check dams, sediment traps, sabo dams, torrential barriers or debris detention basins, are widely used as torrent protection structures across Europe (e.g. Alps) and Asia (e.g. Japan) (Zollinger, 1985; Ikeya, 1989). In France, most retention dams were implemented by the French torrent control service ONF-RTM since the beginning of the 20th century (1980s and 1990s). Indeed, the number of retention dams increased from 21 in 1970 to 176 in 1996 (Gruffaz, 1996). These structures are mainly adopted in torrents highly exposed to debris flows. They are generally built in downstream alluvial fans in order to provide protection for exposed issues. However, some also exist in the upstream areas of torrents with steep slopes in order to reduce the energy and the erosive power of debris flows (Mizuyama et al., 1996; Rudolf-Miklau and Suda, 2013). A recent study reflects the French experience with retention dams, in which it provides a thorough review concerning their design, functions, malfunctions and maintenance (Carladous et al., 2021).

Type of failure	Countermeasures and maintenance operations
Local scouring	<ul style="list-style-type: none"> - Refilling of the scour hole (e.g. riprap, pre-cast concrete, etc.) - Reinforcing the soil layer (e.g. piles, micropiles, anti-scouring beam, etc.)
Lateral bypass	<ul style="list-style-type: none"> - Resizing of the dam's hydraulic weir. - Centering the flow by adding rockfill close to the banks. - Extending the wings more toward the banks.
Sliding	<ul style="list-style-type: none"> - Adding a shear key under the dam's foundation in order to increase passive resistance. - Stabilizing the dam by an upstream gravity dam.
Overturning	<ul style="list-style-type: none"> - Reinforcing by tie rods and anchor bolts. - Adding counterforts in order to join the dam's wall and foundation thus reducing bending moments.
Settlement	Reinforcing the foundation (e.g. jet grouting, concrete underpinning, micropiles etc.).
Uplift	<ul style="list-style-type: none"> - Increasing the self weight of the dam (e.g. adding counterforts). - Reinforcing by ground anchors or piles. - Creating drainage system (e.g. drain holes).
Soil rupture	<ul style="list-style-type: none"> - Increasing the depth of the dam's foundation. - Increasing the soil bearing capacity (e.g. drainage, grouting, compaction, etc.)
Cracks	<ul style="list-style-type: none"> - Providing sufficient concrete cover (e.g. polyethylene sheeting, plastic, etc.). - Reinforcing the concrete (e.g. chemical admixtures, micro-fibers, external beams, etc.).
Corrosion	<ul style="list-style-type: none"> - Adding anti-corrosive protective coatings (e.g. paint or powder coatings). - Inhibiting corrosion (passivation, chloride extraction, etc.)

Table 1.1: Possible countermeasures and maintenance operations adopted for preventing structural and functional failures or repairing check dams after being subjected to such failures.

1.2.3.1 Structural and Functional Design Analysis

Retention dams are involved within multi-component systems composed of separate components, each having its own functions but yet all working collaboratively on increasing the efficacy of the overall system and providing a high level of protection to downstream exposed issues. The type, shape and size of the system's components may differ from one torrent to

another depending on its characteristics and on the desired functional requirements (Hübl and Suda, 2008). The basic components that must at least be present are a sediment basin, retention dam, and a maintenance access track. These components in addition to other supplementary components usually implemented in most torrents (fig. 1.18) are detailed by (Zollinger, 1985; Deymier et al., 1995; Carlados et al., 2021) and briefly described below.

Upstream inlet structure: An upstream earth or reinforced concrete check dam that aims in directing torrential flows to the sediment basin entrance and stabilizing the upstream torrent's bed against incision.

Sediment basin: A deposition area where solid materials (sediments) and large elements (boulders, woody debris, etc.) are stored. It is characterized by its storage capacity defined during the design phase.

Outlet structure: A retention dam (open check dam) that aims in regulating torrential flows at the outlet of the sediment basin, by filtering and trapping solid materials.

Lateral dykes: aims in preventing lateral erosion of banks by guiding torrential flows to the downstream outlet structure. They are usually constructed using earth materials (backfill, riprap).

Access track: allows trucks to access the sediment basin in order to dredge the stored materials and to carry out maintenance operations on the different components.

Downstream structure: A counter dam that aims in stabilizing the bed and well-directing the flow exiting the retention dam.

Scour protection: Earth ripraps or concrete raft foundations placed at different positions of the overall system (downstream the dams) in order to prevent or limit scouring under the foundations of the dams.

For the first constructions, both structural and functional design criteria of retention systems were based on experts perception adopting trial and error strategy. However, the crucial need for effective protection systems have pushed researchers, since the 1980s, to develop a basic design criteria adopting scientific and technical assessments and analysis. Indeed, several studies concerning the design of retention systems in torrents have been published, focusing on several aspects such storage capacity of the sediment basin, type of the retention dam and the adequate dimensions of its openings (Van Effenterre, 1982; Senoo and Mizuyama, 1984; Ikeya, 1985; Mizuyama et al., 1988; Johnson and McCuen, 1989; Ikeya, 1989). A complementary design criteria involving a functional analysis of the system was then developed (Armanini et al., 1991; Poncet, 1995; Deymier et al., 1995; VanDine, 1996; Mizuyama et al., 1996; Hübl and Suda, 2008). Recently, standards concerning the structural design of retention dams have been proposed. Some of which focuses on the design from a civil engineering point of view (Osanai et al., 2010; Rudolf-Miklau and Suda, 2011, 2013). Others, achieved further developments by accounting the hydraulic and deposition processes associated with sediment transport (Piton and Recking, 2015a) and by adapting the design (type, shape) considering different types of debris (Piton and Recking, 2015b).

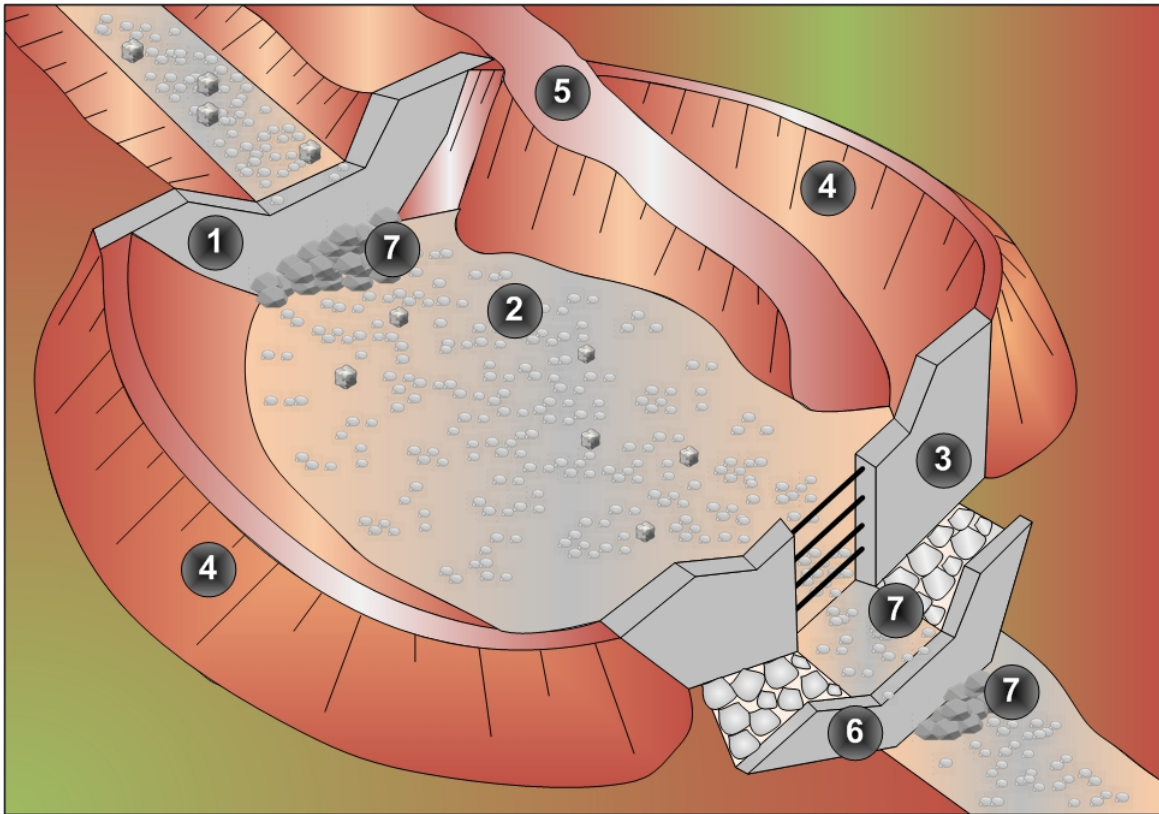

Figure 1.18: Multi-component retention system: (1) upstream inlet structure; (2) sediment basin; (3) outlet structure; (4) lateral dykes; (5) access track; (6) downstream structure; (7) scour protection (Adapted from (Zollinger, 1985; Piton and Recking, 2015a)).

The components of a retention system are usually designed taking into consideration the entire range of events that are likely to occur. Indeed, some old structures have experienced several events of events with different frequency (return period), magnitudes (volumes), intensities (discharge) and features (grain size). Each component is designed based on the event's magnitude (Royet et al., 2010; Rudolf-Miklau and Suda, 2013; Camiré et al., 2019; Carladous et al., 2021). Generally, events are categorized as follows:

- **Routine events (return period 2-10 years):** involve fluvial processes (floods with bedload transport) that do not threaten exposed issues. Consequently, the maximum of the transported volume should be transferred to the downstream in order to limit as much as possible maintenance actions. These events are used to design the bottom opening of the retention dam and the guiding channel of the sediment basin. Both water and solid discharges are considered in the design.
- **Design events (return period 100-300 years):** include debris flows that would trigger damage to exposed issues. They should be partially or totally trapped in the sediment basin. The central body part of the retention (openings) designed based on these events in order to control the trapping capacity.

- **Safety-check events (return period 500-1000 years):** have higher magnitudes than design events. They may overtop the retention dam and reach downstream issues. The dam may suffer from some damages due to such events but would not totally fail. These events are used to design the hydraulic weir (spillway), crest and the wings of the retention dam in a way that prevents overtopping the dam and lateral bypass of the flow. They are also used to design lateral dykes.
- **Danger events (return period 1000-10000 years):** represent extreme events that threaten the stability of the retention dam. Excess scouring and lateral bypass are more likely to occur.

Retention dams have different shapes depending on the objectives they are intended to fulfill. Generally, the hydraulic weir has a trapezoidal shape. However, the type and the dimensions of the openings may differ from one dam to another resulting in different crest shapes. A comprehensive classification of retention dams depending on their crest shape and opening dimensions is proposed by (Wehrmann et al., 2006). Two common types of retention dams are the slot and slit dams. They can be differentiated depending on the shape and position of the opening as illustrated in fig. 1.19.

Slot retention dam: has a continuous crest (no gap), in which the openings does not intersect with the dam's crest. In addition, to be considered as a slot dam, one of these two conditions concerning the opening dimensions should be verified:

- The longest side is smaller than twice the shortest side and is larger than half the height of the dam.
- The longest side is smaller or equal than half the height of the dam.

Such dam can either contain several small slot openings (small slot dams) that allow the passage of water only, or large slot openings (large slit dams) that permit the passage of solid materials.

Slit retention dam: can either have:

- A continuous crest with the longest dimension of its opening greater than twice its shortest dimension.
- A non-continuous crest (presence of gap) with the longest dimension of its opening greater than half the height of the dam.

Such dam can have several slits (multiple-slit dam). The slit openings can either have vertical long sides or horizontal long sides. Grills (beams, bars) can also be added between the vertical slit aiming to control the trapping capacity and the filtering of the debris (grill slit dam). It can be also advantageous to add a bottom slot which is able to transfer routine events with a minimum trapping effect (Piton and Recking, 2015a).

From a functional point of view, retention systems can ensure same functions fulfilled by check dams concerning bed stabilization, hill slope consolidation, upstream slope reduction

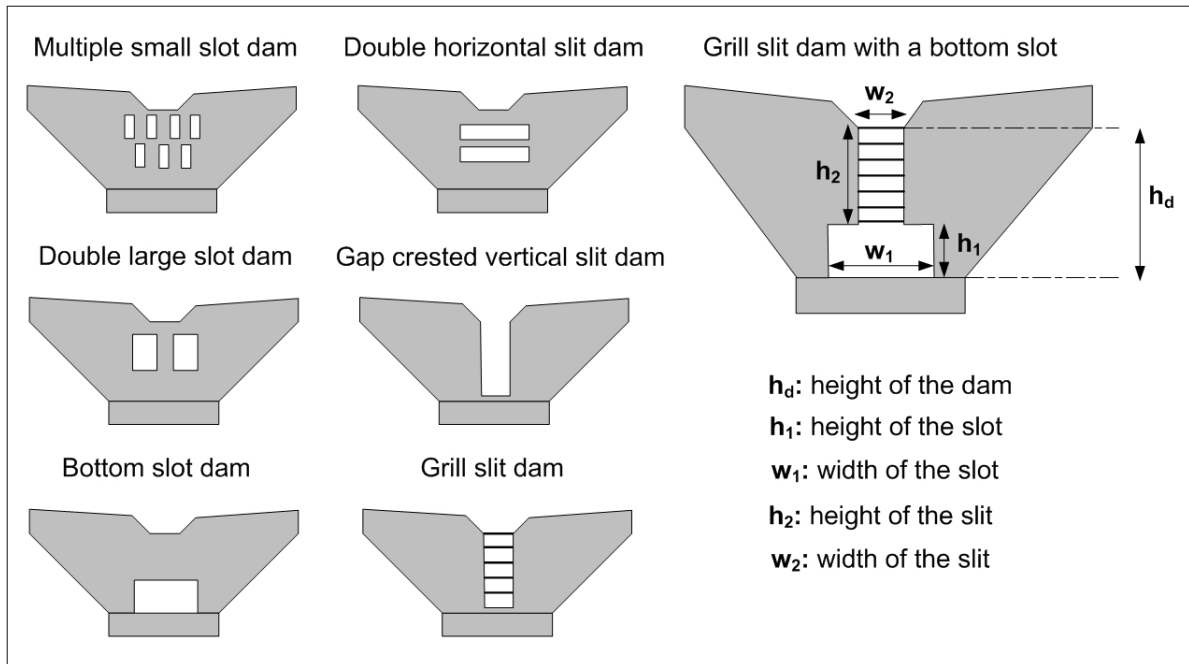

Figure 1.19: Common types of retention dams: slit and slot dams

and sediment retention (Bernard, 1925). Additional functions that can be only achieved by retention dams, specifically by the openings, are the following (Zollinger, 1985; Armanini et al., 1991; Hübl et al., 2005):

- **Filtration of solid material:** sorting and storing solid materials based on their size and severity (e.g. boulders, large woods, etc.).
- **Dosing of solid transport:** buffering (temporal storage/self cleaning) of water and solid discharges.
- **Debris flow breaking:** reducing the energy level of a debris flows (energy dissipation) by storing big boulders and woody debris that would probably clog downstream narrow sections.

In order to fulfill efficiently the mentioned functions, retention systems must be designed following the following steps (Rudolf-Miklau and Suda, 2013; Piton and Recking, 2015a,b; Hübl et al., 2017; Carladous et al., 2021): (1) identifying the types of events (routine, design, safety-check and danger) that are likely to occur on the studied watershed, (2) identifying assets to be protected (elements at risk), (3) choosing an appropriate location for implementing the system, (4) assigning functions to be fulfilled by the system's components, (5) determining the shape and the dimensions of the sediment basin (width, length, bottom slope, etc.), (6) estimating the probable deposition slope in order to compute the maximum height of deposition, (7) dimensioning of the retention dam's openings in a way that that prevents exceeding the maximum admissible height of deposition, (8) dimensioning the retention dam (total height, hydraulic weir and side wings), (9) choosing the type of the retention dam (earth, cantilever)

and verifying its internal and external stabilises, (10) design of the inlet structure (functional and structural design of check dam), (11) designing lateral dykes (height, crest slope, length) in addition to scouring protections downstream the inlet and the outlet structures and finally (12) verifying the consistency of the over all system.

Note that the first step involved in the design process is the most important, in which all other steps rely on. Indeed, knowledge concerning the types of events that are likely to occur is highly essential for selecting suitable hydraulic models, accurate approaches for solid transport assessment and precise dimensioning procedures (Rudolf-Miklau and Suda, 2013). Similar to the case of check dams, the design of retention dams necessitates experts in different domains (torrential hydraulics, fluid dynamics, geomorphology and civil engineering).

1.2.3.2 Failure Modes and Maintenance Strategies

Understanding the structural design of retention systems in addition to the desired functional objectives that must be fulfilled facilitates identifying possible failure modes that lead to the partial or total destruction or malfunctioning of the entire system. A list of failure modes that have already been observed or are expected to occur was reported by the ONF-RTM services based on past experiences with 115 retention systems implemented in French massifs (Carladous et al., 2021). Below is brief description of the most frequent observed types of failures:

Functional Failures

- **Excess trapping:** failure in transferring routine events to the downstream thus storing more solid materials than expected. This can happen due to undersized bottom slot, clogged openings and/or wide sediment basins which break of the material transport. Trapping of routine events causes downstream incision and reduces the storage capacity of the basin prior to upcoming events with higher magnitudes.
- **Lateral bypass (outflanking):** the flow is released behind the wings of the retention dam due to high level of deposition near the basin's inlet, low level of lateral dykes' crests, mild slopes of the dam's wings and/or undersized hydraulic weir. This might cause failure in trapping solid materials.
- **Insufficient storage capacity:** the storage capacity of the basin is reduced due to frequent bedload transport, undersizing of the basin limited available space because of land constraints and/or limited available construction budget.
- **Transfer of deris flows to the downstream:** debris flows are transported to the downstream due to miss-locating the retention system. In the case where the system is located too much upstream, far from elements at risk, the incision or eosion occuring in the intermediate area will be transporter downstream with no protection.

Type of failure	Countermeasures and maintenance operations
Excess trapping	<ul style="list-style-type: none"> - Adding bottom slot opening in order to transfer flows with low magnitudes. - Adding check dams in the downstream for protecting against incision. - Dredging (partial or total cleaning of stored solid materials).
Lateral bypass	<ul style="list-style-type: none"> - Resizing of the retention dam's hydraulic weir. - Re-designing the wings of the retention dam. - Adding lateral dykes if not present. - Re-designing the dykes if present.
Insufficient storage capacity	<ul style="list-style-type: none"> - Enlarging the openings of the retention dam. - Increasing the storage capacity of the sediment basin. - Increasing the bottom slope of the sediment basin. - Dredging (partial or total cleaning of stored solid materials).
Scouring	<ul style="list-style-type: none"> - Refilling of the scour hole (e.g. riprap, pre-cast concrete, etc.). - Reinforcing the soil layer (e.g. piles, micro-piles, anti-scouring beam, etc.).

Table 1.2: Possible countermeasures and maintenance operations adopted for preventing functional failures or repairing retention dams after being subjected to such failures.

- **Scouring:** removal of materials downstream the dam's foundations. This threatens the stability of the structures in the long term.

Structural Failures

Failure by external and/or internal stability: the system loses its stability and/or durability due to displacement of the retention dam, erosion of lateral dykes, soil compaction, steel/concrete corrosion, etc. (Same as check dam's structural failures explained in section 1.2.2.2).

Not all retention systems require regular maintenance. Some systems are subjected to any type of failure due to their good design or if no major events have occurred since their construction. Others may have minor damages which will not influence their efficacy level. Nonetheless, for systems that experience different types of failures, maintenance will be essential in order to retrieve a sufficient efficacy level. The structural failures can be prevented or resolved using the same operations carried out for maintaining structurally sound check dams (table 1.1). Concerning the functional failures that retention systems are subjected to, table 1.2 presents the common countermeasures and maintenance operations adopted.

1.3 Conclusion

The particular features of torrential watersheds trigger destructive phenomena. A huge volume of transported solid materials may reach the downstream where elements at risk are located. This can possibly disrupt infrastructures (transport network), damage houses and industrial structures, and generate casualties. Therefore, sediment production and transport capacity in mountain streams are key issues of torrent control interventions that aim to reduce negative consequences of sediment release. Natural risk management involves a complex decision process concerning protection measures and strategies. In order to provide a high level of protection, the chosen protection strategy should act on all the levels of propagation of torrential phenomena starting from the upstream area until reaching the downstream area of the watershed. Consequently, providing protection to people, properties, and other infrastructures is achieved within an integrated system composed of different types of protection structures grouped together so that they participate collaboratively in the same protection strategy. Yet, the decision to implement such protection system depends, in advance, on the analyzing and assessing the induced risk.

Since their construction, protection structures have proven their ability to reduce the risk level and to protect socio-economic issues either by limiting the causes that triggers torrential phenomena or by limiting the resulted consequences. Their efficacy level depends on their functional and structural design conditions. However, these structures are considered to be critical due to the fact that they constitute a complex system that age, deteriorate, and may be totally damaged over time. Although they are designed to withstand and operate efficiently, their exposure to high intensity phenomena during their lifetime makes them suffer from different types of failures. Depending on the type of failure and on the attained level of degradation, their efficacy level would be influenced from a functional and structural point of views. In this case, the risk level will not be reduced as much as it should be compared to the initial situation. Analyzing possible failure modes and assessing their consequences is not an easy task. It requires a comprehensive knowledge regarding structural and functional design principles. However, identifying the causes and the consequences of the different types of failures helps in assessing the structure's efficacy and in proposing suitable maintenance operations.

In France, an integrated protection system is often implemented along the longitudinal profile of torrential watersheds aiming to prevent or mitigate the resulted damaged. The system is a combination of active measures (e.g. check dams) located in the upper part of the watershed and passive measures (e.g. retention dams, dykes) implemented in the lower part of the watershed. This project focuses on torrent check dams and retention dams because they are the most adopted protection structures in French mountains. They both have a recognized efficacy whose assessment remains however challenging.

This chapter emphasizes the need of making decisions concerning the efficacy and the maintenance of deteriorating protection structures. The only routes to support-decision making is through modeling. Consequently, there is a need for developing a decision-aiding model for assessing and managing these structures. However, developing such a model is not an

easy task. There are some challenges encountered due to the specific features associated with these structure and the phenomena they are exposed to. Such challenges add complexities to the model thus necessitating further studies and analysis. This highlights the importance of identifying these challenges and incorporating them in the modeling. All the technical and scientific challenges that could be confronted while dealing with protection structures are described in the next chapter.

Technical and Scientific Issues Encountered while Managing Natural Risks and Torrent Protection Systems

Contents

2.1 Efficacy Assessment and Maintenance Optimization	40
2.1.1 Three Efficacy Components to be Assessed	40
2.1.2 Inspection, Maintenance and Decision-Making	42
2.2 Cascading Effect: Interactions and Dependencies	44
2.2.1 Dependencies Between Natural Phenomena	45
2.2.2 Interactions Between Failure Modes	46
2.2.3 Bi-directional Dependencies Between System's Components	46
2.2.4 Dependency Analysis and Decision Support	47
2.3 Decision-Making under Information Imperfection	49
2.3.1 Nature and Types of Information Imperfection	49
2.3.2 Information Imperfection Propagation within the Complex Risk Management Decision Process	50
2.4 Conclusion	52

As revealed from the previous chapter, there is a need to develop a decision-aiding model that permits assessing the efficacy of protection structures and supports their maintenance decision-making taking into account possible encountered challenges. In this chapter, the main scientific and technical difficulties experienced while dealing with torrent protection structures and their surrounding environment are described. The chapter identifies all the specifications that the model, to be developed, should integrate.

2.1 Efficacy Assessment and Maintenance Optimization

Protection structures are built in order to provide sufficient protection to people and socio-economic issues. It is therefore expected that they maintain a high level of efficacy during their lifetime. Consequently, their aging and deterioration over time point out the importance monitoring them, diagnosing level of performance and rehabilitating them when needed. In response, natural risk managers, and experts who support them, seek to assess the efficacy of protection structures at different time slots. This assessment appears to be essential to the risk-management process and several decision problems are associated with it. One of the common decision problems is the prioritization of maintenance strategies based on available budgets.

2.1.1 Three Efficacy Components to be Assessed

Protection structures' efficacy reflects the level of protection they provide and therefore the reduced level of risk. It is linked to the performance level of the structure expected at the design phase, after construction and in service (Carladous, 2017). Its assessment involves evaluating three different components (fig. 2.1):

Structural efficacy: To be effective, the structure should be in a state where it is able to resist, from a structural point of view, both the torrential phenomena and the surrounding environmental changes. The structural efficacy level varies depending on the the level of stability of the structure (internal and external stability). At a certain level, the structure totally collapse (e.g overturning, concrete crash).

Functional efficacy: To be effective, the structure (if one structure) or the system (if multi-component) must fulfill efficiently the required functions (e.g. bed stabilization, sediment retention, etc.). The functional efficacy level varies depending on whether the functional requirements are totally, partially or not at all achieved.

Economic efficacy: To be effective, their should be a balance between the level of protection provided by the structure to downstream exposed issues and the expenses spent on them. The economic efficacy level can be evaluating by comparing the total cost of interventions (inspection, maintenance, construction) spent on the structure with the the economic losses (people, houses, infrastructures) resulted after a torrential phenomenon. In fact, each element at risk (people, houses, infrastructures) is given an economic value.

The assessment of these efficacy components consists in estimating the deviation from a defined theoretical objective by taking into account specific indicators (DI Ciocco, Geoffray, 2015). In order to define indicators, assess the efficacy of the structure, and to end up with a decision concerning interventions (no maintenance, maintenance is needed, destruction, reconstruction, etc.), three aspects should be considered: (1) understanding the structural

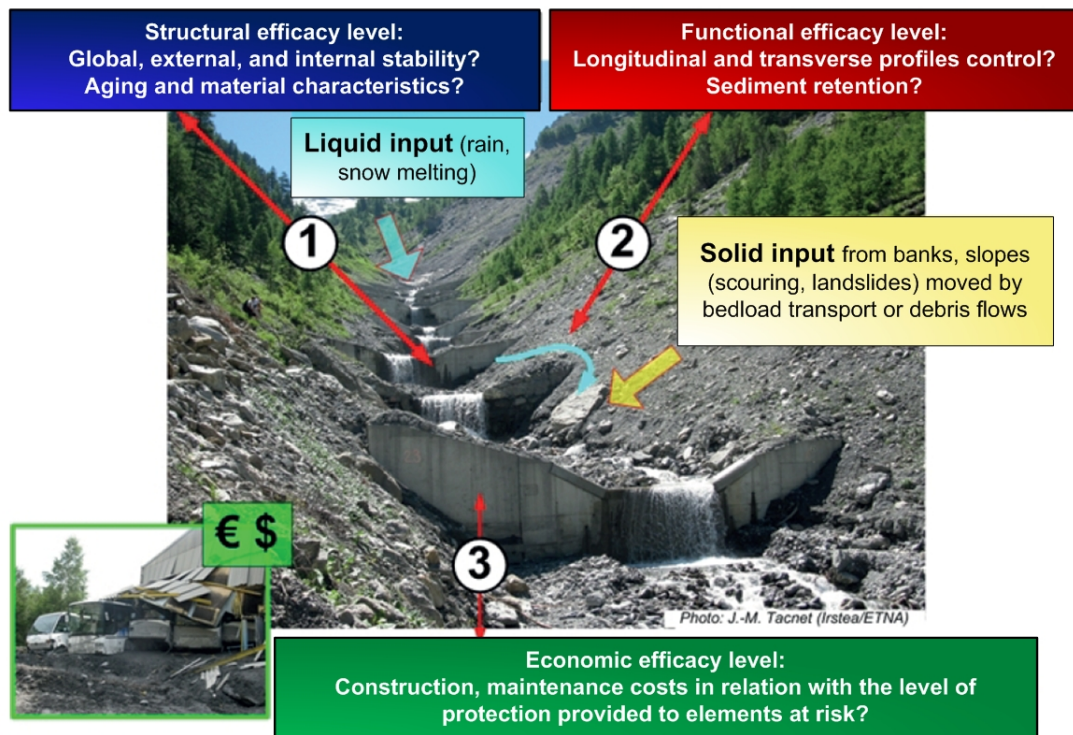

Figure 2.1: Components involved when assessing the efficacy of a torrent protection structure (Adapted from (Tacnet et al., 2016)).

design of protection structures, (2) determining their functions, and (3) identifying possible failure modes that they may be subjected to.

After identifying the different types of failures that might occur, the global technical (structural and functional) efficacy level of the structure can be assessed (fig. 2.2). This assessment can be described by a procedure of four different stages (Tacnet et al., 1999b):

1. Define six characterization models of each identified type of failure:

- Geometric model: type, depth, orientation, etc.
- Temporal model: failure initiation date, age of the structure upon observing the failure, future evolution of the failure, etc.
- Geographical model: sensitivity of each component of the structure to the failure (e.g. wings, central body, hydraulic weir, and foundation when considering a check dam).
- Technical difficulties for repair operations: materials availability, access to the site, and conditions of implementation.
- Economic model: products cost, need for manpower, comparison between the repair cost and the reconstruction of the structure.

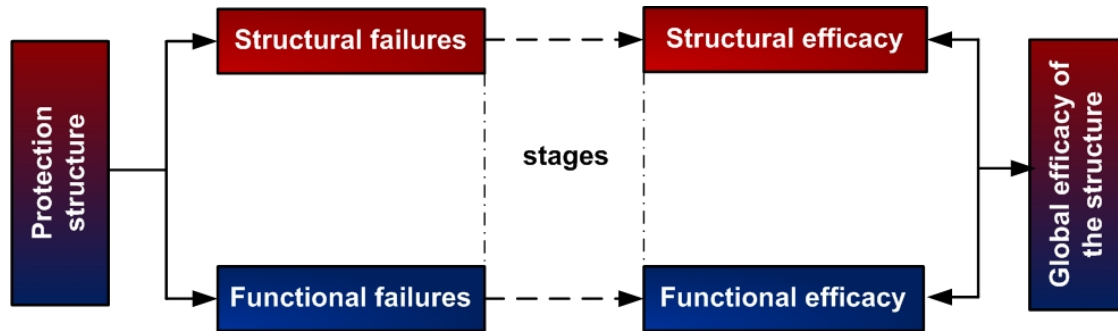

Figure 2.2: Global efficacy assessment of protection structures considering the severity of failure modes.

- Aggravating factors: depending on the identifies failure (e.g. water flow, bad coating of steel, rust traces, visible steels, etc.).
2. Classify the failures according to their type: functional or structural and order them according to the level of danger they induce.
 3. Assess the severity of each type of failure.
 4. Asses the global efficacy of the structure when exposed to different types of failures.

2.1.2 Inspection, Maintenance and Decision-Making

Based on the previous steps, field inspection should take place in order to diagnose failures. In addition to characterizing the failure, it is important to figure out whether it has occurred because of a poor design of the structure or because of an accidental or unexpected impacts in which it was not prepared to. Four different levels of inspection exist, each with specific constraints (Tacnet et al., 1999b):

Level 1: highest level of inspection. It requires high financial means (sampling, instrumentation, etc.). It is only adopted for structures of high costs and of significant importance.

Level 2: intermediate level of inspection. It involves a survey analysis of the structure and a detailed visual diagnosis. It permits to evaluate the severity of damage in a relatively safe way.

Level 3: in this level, only visual but detailed diagnosis is performed. Its results remain to be appreciated and are linked to experts skills.

Level 4: quick expert assessment. It is possible to avoid inspection and to rely instead on experts judgement.

Each type of failure should have a corresponding quantitative degradation indicator (e.g. length or width of crack, degree of tilting, amount of scouring, etc.). This indicator reflects objectively the state (condition) of the structure. Specifying degradation indicators makes it possible for inspectors, analysts or experts, depending on the adopted level of inspection, to identify whether the structure is stable, able to fulfill its functions and insure the required conditions (e.g. sustainability) or not. Hence, inspection permits to assess quantitatively or qualitatively at a given time, the global efficacy of the structure. Usually, inspections take place regularly at defined time intervals according to the importance of each structure. Depending on the results of inspection, the state of the structure, revealing its efficacy level, can be one of the following:

- The structure is in a good condition and it is fulfilling its functions.
- The structure is slightly degraded and does not require maintenance.
- The structure is degraded and minor maintenance is needed.
- The structure is very degraded and major maintenance is needed.
- The structure is in a critical state close to rupture and may have to be reconstructed.
- The structure is completely destroyed and can be either reconstructed or ignored.

Regular inspection followed by maintenance is a primary necessity in order for the structure to preserve a high level of efficacy for a longer period of time. Generally, maintenance operations are chosen according to the state of the system revealed after the diagnosis. In order to restore the structure back to its initial state, the following aspects are necessary and have to be accomplished (Tacnet et al., 1999a):

- having comprehensive knowledge concerning the context of implementation, design methods, and stability justification of the structure;
- identifying the functions and the type of the structure (based on the materials used);
- reviewing conditions, specifications, and recommendations that exist in the field of civil engineering;
- characterizing and diagnosing different types of failures that torrent protection structures are subjected to;
- analyzing possible causes of failures;
- assessing the severity of failures;
- proposing possible rehabilitation methods and maintenance operations according to the failures identified; and
- choosing the most appropriate maintenance strategy based on certain conditions and constraints.

Notably, field inspections of torrential protection structures are difficult due to the particular constraints in mountain regions (number of protection structures, isolation, extreme

weather, high altitudes and rough terrain). Hence, in winter it is impossible to make field visits. In other seasons, where it is possible to have access to areas where protection structures are located, inspection must be carried out within a limited time, for safety reasons, often limited to visual observation with few measurements (Carladous, 2017). Consequently, when inspection is delayed for a long time, the deterioration of the structure may keep on evolving until reaching critical states where there will be no avail to perform minor maintenance (no more effective) and major maintenance is needed instead.

On the other hand, both inspection visits and maintenance operations cost much. Indeed, available budgets, provided by the state for protection structures' management, oblige risk managers and the owners of the structures to establish priorities between different maintenance strategies to be applied to deteriorating structures. Due to the fact that the structure can be repaired following different maintenance strategies, several questions arise in this case: How often should the structure be inspected? What degradation indicators are the most important to diagnose? when should maintenance be applied? At what level of degradation should the structure be repaired? Should maintenance be carried out or can the structure withstand and resist more without maintenance? Which maintenance operation should be adopted according on the actual level of degradation of the structure (minor? major?)? Reasonable answers to these questions can be only found by developing decision-aiding models that help to choose optimal strategies.

2.2 Cascading Effect: Interactions and Dependencies

Due to the crucial need of protection structures in mountain areas risk managers and researchers in the domain, seek in predicting scenarios (failures, hazards, etc.), evaluating their consequences, and choosing between several maintenance strategies based on the technical and imposed budgetary constraints. In the context of risk assessment, a risk scenario is identified by reviewing potential events that may occur and then predicting alternative possible outcomes. In other words, it is a representation of single-risk or multi-risk situation and the paths to possible consequences. Scenario building is mainly based on experiences from the past. However, it should also consider events and impacts which have not been analyzed or encountered so far. Indeed, defining risk scenarios provides a qualitative risk assessment which is an introductory procedure prior to any quantitative assessment tackled afterward by quantitatively analyzing the scenarios. For achieving a robust risk assessment, the following aspects are to be identified within a scenario analysis:

1. **Multi-hazard scenarios:** start by a given top event (primary event) and predict the potential triggering of other events (secondary events).
2. **Possible consequences:** study the effect of each event (primary consequences), including domino effects (secondary consequences).
3. **Modeling indicators:** define indicators that characterize the consequences.

4. **Software/tools:** run the defined scenarios in order to analyze quantitatively the consequences, model the evolution of the associated indicators and therefore to visualize and facilitate the decision-making process.

As a part of natural risk assessment, the efficacy of protection structures should be assessed taking into consideration scenario analysis. Even if it is not completely preventable, the accumulation of damage can be limited if the occurrence of direct (primary) and indirect (secondary) events and consequences and their dependencies are identified early enough. Indeed, modeling the evolution of degradation indicators as a function of time considering possible interactions and dependencies result definitively in a more explicit and accurate assessment of protection structures' efficacy. These interactions and dependencies are the crucial elements for analyzing the real behavior of the structures thus being more closer to reality.

Cascade effect, sometimes referred to as domino effect, consists of a sequence of interdependent events that can result in disastrous damages. It happens when a primary/initial event propagate and cause secondary events which may exacerbate the consequences of the primary event. Four principal aspects characterize cascade effect (Kadri et al., 2011):

1. Initiating event.
2. Primary consequences on certain targets resulting from the initiating event (deterioration of assets and harm to people during cascading progression).
3. Secondary events propagating on same or other target units.
4. Intensification of primary event's consequences due to the effects of secondary events and/or triggering of new secondary consequences.

The particular aspects necessary to study cascade effects are: time influence, space influence, dependencies between elements, and uncertainties (Zuccaro et al., 2018). Indeed, cascade effect is a major scientific obstacle that have recently caught the attention of researchers in different domains. It shed the light on how important is to analyze the inevitable and sometimes the unforeseen chain of events that light occur due to an initial event. In the context of natural risk analysis and protection structures' efficacy assessment, interactions may exist between natural phenomena (torrential flood triggering landslides), failure modes (functional failure triggering structural failure) and between the components of a multi-component protection system (failure of one dam triggering failure in other consecutive dams). Such interactions and dependencies that have the potential to generate serious cascade effect are briefly described in the following sections.

2.2.1 Dependencies Between Natural Phenomena

Identifying and understanding interactions between natural phenomena makes it easier to reflect the real series of continuous disaster events, better quantify the overall risk, and to

support risk management decision by better prioritizing mitigation and risk reduction measures.

It is true that sometimes, phenomena may coincide spatially and temporally while not being dependent on one another. However, some hazards are interdependent, in which they occur one after another due to interactions between them. In this case, natural phenomena are triggered one after another. A primary phenomenon can trigger a secondary phenomenon and then the secondary phenomenon will be considered as next primary phenomenon which have the potential to trigger further a tertiary phenomenon. Furthermore, three types of interactions between phenomena can be distinguished (Gill and Malamud, 2016):

1. **Triggering:** A phenomenon is triggered when a particular threshold associated to its probability of occurrence is reached or over-passed.
2. **Increasing probability:** The probability of occurrence of a phenomenon is increased when some environmental parameters change and move towards a particular threshold but do not reach it.
3. **Catalyzing:** If a phenomenon can trigger another phenomenon, the triggering can be catalyzed by some other process (e.g. human activities).

2.2.2 Interactions Between Failure Modes

As mentioned before, protection structures may be subjected to structural and functional failure modes due to improper design or due to external accidents. Among the different types of failures in each mode (structural or functional), some interact with one another, in which the occurrence of one failure may trigger, increase the probability of occurrence or catalyze the occurrence of other types of failures that could either belong to the same failure mode or to the other.

It is essential to figure out and analyze interactions between failures in order to (i) better model the aging and the deterioration of protection structures over time, (ii) have a robust assessment of their structural and functional efficacy levels and (iii) end up with the most appropriate maintenance strategies that have the efficiency to increase the availability time of the structures as much as possible.

2.2.3 Bi-directional Dependencies Between System's Components

Critical infrastructures (CIs) represent either an interdependent multi-component systems, system of systems or complex network. A failure or disruption in one infrastructure CI_1 may affect the behaviour of other infrastructure CI_2 , which in turn leads to the partial or total failure of CI_2 . Dependencies between CIs could be physical, cyber, geographic, logical and/or social (Kotzanikolaou et al., 2013). In the context of critical protection structures that are civil engineering structures only physical, geographic and social dependencies may exist.

Physical dependencies: in which the state of a CI depends on the material outputs of another CI (e.g. released volume of sediments).

Geographic dependencies: in which the state of a CI depends on an environmental event related to another CI due to location (e.g. failure propagation due to small distance separating two structures).

Social dependencies: it is related to human activities (e.g. land use around the structures).

Since they are located in series, check dams constitute an interdependent multi-component system that interacts with lateral banks and slopes. The partial or total damage of a specific element of a check dam (one component) may trigger a total failure of the structure, which in turn may trigger failure of consecutive upstream and downstream structures (other components of the same system) under different mechanisms such as regressive upstream erosion and excess downstream deposition. In fact, the presence of one check dam can affect positively the evolution of other consecutive check dams. On the other hand, the partial or total failure of one check dam may negatively influence the behavior (e.g. deterioration rate) of other consecutive check dams. Similarly for the case of retention systems, composed of several components. It must be stressed that the failures observed or foreseeable on a retention dam can affect other structures or system's components. For instance, if a check dam is implemented downstream the retention dam, it may be impacted by the materials escaping from the latter. In addition, if the openings of the retention dam are partially or totally clogged, this will lead to insufficient storage capacity or excess trapping in the sediment basin because it will be filled by materials that were supposed to be transferred downstream through the openings.

Analyzing dependencies between structures supports the maintenance decision-making not only those applied to failed structures but also to the dependent ones.

2.2.4 Dependency Analysis and Decision Support

Fig. 2.3 provides an example cascade effect with the different types of interactions and dependencies that may exist in the studied context. It presents a multi-component system composed of two check dams (D_1 and D_2) separated by a specific distance. The system is subjected initially to a clear water flood, which causes primary consequences (e.g. scouring, deposition) and also triggers landslide in one of the banks (e.g. due to saturation of bank materials with water). The primary consequences then trigger secondary consequences (e.g. loss in stability due to scouring) which in turn trigger tertiary consequences (e.g. loss in stability due to overload caused by excess deposition). Moreover, the secondary phenomenon (landslide) have the potential to intensify the consequences resulted from the primary phenomenon (e.g. increasing the volume of deposition) or to trigger new consequences (e.g. destruction of the dam underneath). Consequently, the figure illustrates the possibility of (1) a torrential phenomenon to trigger another phenomenon (flood triggering landslide), (2) a functional

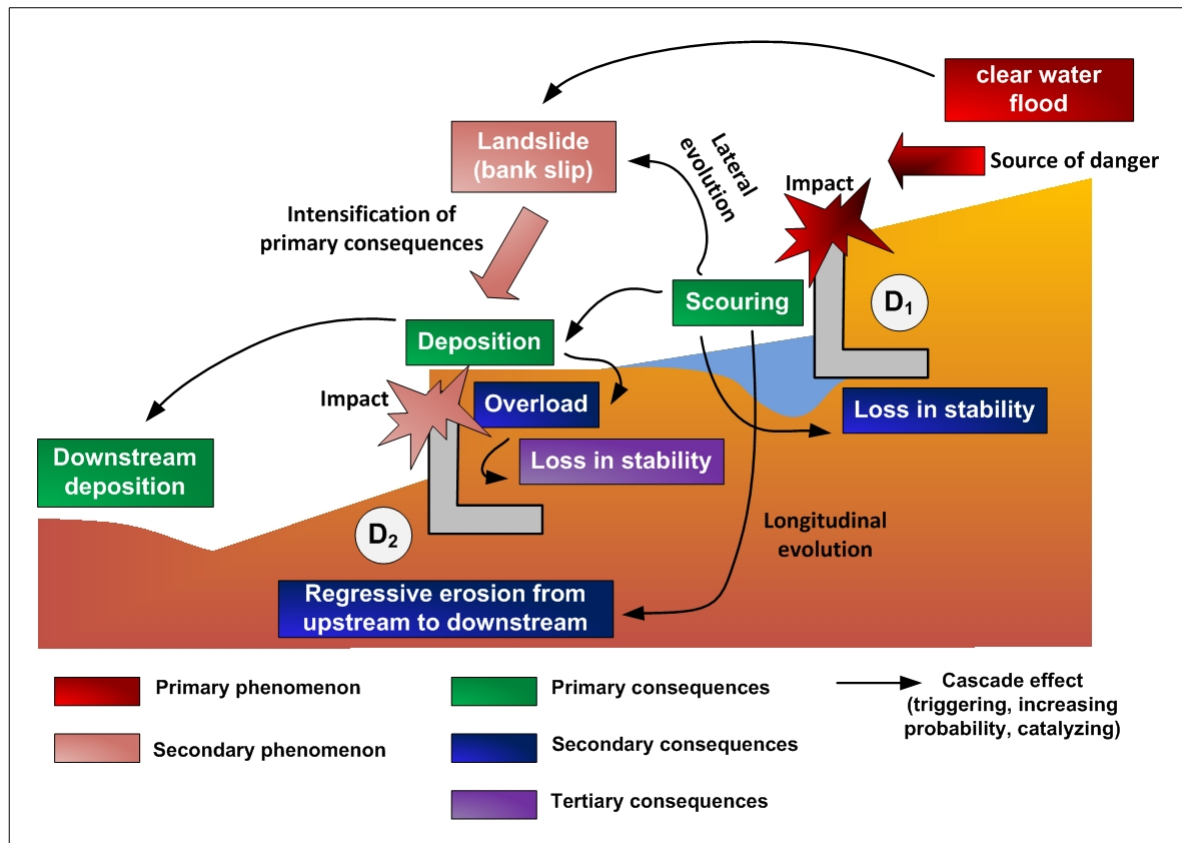

Figure 2.3: Example of possible interactions and dependencies that exist between torrential phenomena, check dams' failure modes and check dams located in series.

failure to trigger a structural failure (e.g. scouring triggering loss in dam's stability) and (3) a failure in D_1 to trigger a failure in D_2 due to either the total collapse of D_1 or due to the propagation of its failure (e.g. scoured material behind D_1 deposits next or over to D_2).

Examining all types of interactions and dependencies between torrential phenomena, failure modes and structures is of paramount importance for supporting risk management decisions, increasing the technical efficacy of protection structures (structural and functional) and enhancing economic efficacy. For the latter, the study of cascade effect results in a more efficient distribution of budget. However, the complexity here lies in: How to figure out such dependencies and interactions? Providing answer to this question opens a set of scientific questions: What type of torrential phenomenon is the most dangerous and have the potential to trigger other phenomena? What are the best protection measures that can efficiently resist such phenomenon? Which types of failures have a high probability to trigger other failures? What maintenance operations could limit the propagation of such failures? Which structure fails before the other? To what extent does the presence or absence of one structure affects the evolution of the others? Which structures have the priority to be maintained first? Finding answers to these questions requires developing multi-hazard approaches and physical models that enable analyzing interactions between failures and structures.

2.3 Decision-Making under Information Imperfection

Ideal decisions are expected to be made when real (actual, accurate, precise, certain) data related to natural events and structures' behaviors are available. In the addressed context, these data are often missing or imperfect (incomplete, imprecise...). Available information as well, may be affected by the precision of the design data of the structures (e.g. dimensions, materials' properties, soil characteristics), events data (e.g. intensity, frequency), and also by the validity of the assumptions made based on experts' knowledge and skills. Risk management decisions are therefore influenced by the quality of the heterogeneous information coming from more or less reliable sources such historical data, expert assessments, and numerical simulations. Taking this imperfection into account through the diagnosis and decision-making process is therefore essential and challenging (Carladous et al., 2019).

2.3.1 Nature and Types of Information Imperfection

Generally, information can be described according to several features and characteristics. The type, content and quality of information significantly influence any decision (Dubois and Prade, 2006). Information can be either (i) subjective, based on personal opinions and points of view or (ii) objective, based on facts, measurements and observations. Obviously, subjective information are not always suitable for decision-making especially in critical fields related to risk and safety analysis, business, politics, etc. Its content can be either (i) quantitative, expressed by numerical values (e.g. physical quantities) or (ii) qualitative, categorized according to different references (e.g. low, medium, high). Information quality refers to imperfection, which is related to the notion of uncertainty.

Uncertainty is always present in the design phase of any engineering system and has the potential to significantly affect its efficacy throughout its lifetime period. It is the relation between the real state and the assessment of a specific situation (Helton, 1997, 2008). Small variations in environmental (e.g. torrential phenomena characteristic, soil properties) or design variables (e.g. loading situation, geometric dimensions, materials properties) may lead to a considerable loss of quality and performance. Although there exist several sources of uncertainty, they are generally classified as random or epistemic (Guo and Du, 2007; Kiureghian and Ditlevsen, 2009; Tacnet et al., 2014). Aleatory uncertainty, also referred to as irreducible, objective, stochastic or type A uncertainty, represents the variability associated with a physical quantity related to a system or to the environment (Oberkampf et al., 2001; Helton et al., 2004). Uncertainties categorized as aleatory, are those whose possibility to be reduced cannot be foreseen. Epistemic uncertainty, also referred as reducible, subjective, knowledge, ignorance or type B uncertainty, results from a lack of knowledge of the system or the surrounding environment (Oberkampf et al., 2004). Uncertainties categorized as epistemic, are those whose level is possible to be reduced by gathering additional information (data) and increasing knowledge. Epistemic uncertainty can also derive from the reliability of information sources (e.g. non-confident source). Generally, it corresponds to three different types of information imperfection (Tacnet, 2009):

1. *Inconsistency* concerns the conflict between several sources of information. For example, for the same structure and the same visual observation of an indicator, experts may propose different evaluations without being able to explain the evidences.
2. *Imprecision* relates to the insufficiency of information. For example, a range of values can correspond to a physical quantity, in which the correct value is bounded by a lower and an upper interval values.
3. *Incompleteness* corresponds to the partial availability or total lack of information. For example, the volume of a specific debris flow event could be missing.

2.3.2 Information Imperfection Propagation within the Complex Risk Management Decision Process

In watersheds, natural risk management reflects a complex decision process that involves several decisions made depending on multi spatial and temporal scales (fig. 2.4, (a) and (b)). Risk management decisions often result from a combination of several expert assessments depending on the temporal step (before, during, or after the event) and on the geographical zone (triggering, propagation, or stopping zone). These experts are in charge of describing the phenomenon, assessing vulnerability, identifying the risk level, supporting the choice of suitable protection measures and prioritizing prevention strategies. Fig. 2.4, (c) illustrates the conflicting positions of experts distributed spatially (geographical zone in the watershed) and temporary (temporal step in risk management process). They all contribute in the final risk management decision. Indeed, final decisions often result by combining multi-scale assessments concerning the (i) phenomena characteristics, (ii) protection system's design and efficacy (iii) risk level imposed on downstream elements and (iv) available budgets. The final objective behind all decisions is to reduce the risk level imposed downstream and thus to provide sufficient protection to exposed elements.

Like any other simplification of reality, the definition of a risk scenario involves a set of logical, reasonable, and consistent subjective assumptions. Therefore, all the information needed for defining a scenario has to be explained and clarified intelligibly so that they can be reviewed, assessed, and improved. Furthermore, expert opinions are important throughout scenario analysis. They can identify new risks, analyze impacts and likelihoods, and can assess the efficacy of protection measures. Some conceptual aspects are difficult to evaluate in practice. For example, assessing vulnerability, probability of occurrence and resulted damages are important scientific barriers (Fuchs et al., 2007). Hence, the selection of experts and their decisions should be carefully considered.

Besides, assessing protection structures' efficacy is a fundamental task in the risk management decision process. It is based on a multidisciplinary expertise that remains empirical supported by quantitative approaches and involves confusion between its multiple components (structural, functional and economic). Its evaluation relies on a huge number of information produced by heterogeneous sources which can have unequal reliability and thus can be conflicting when providing contradictory evaluations (Shafer, 1976a). This multi-dimensional

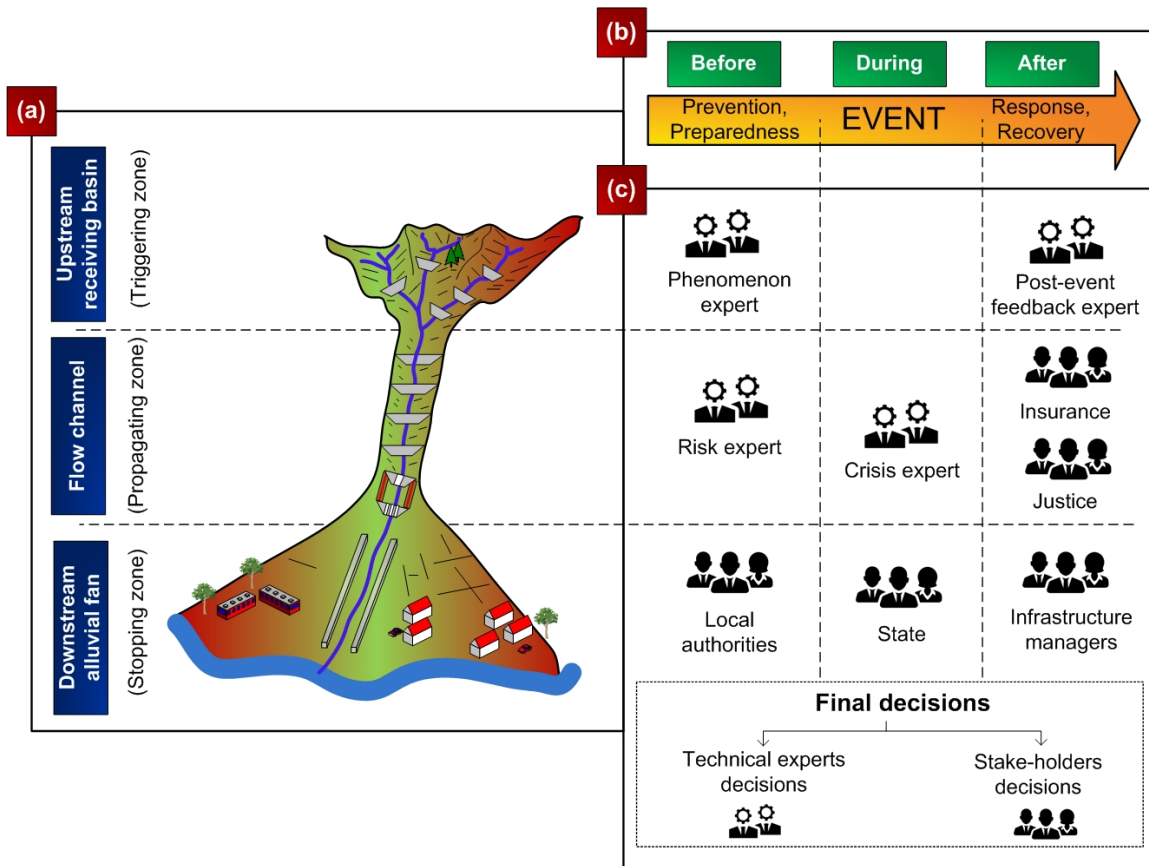

Figure 2.4: Multi-scale decision process for natural risk management. (a) spatial partitioning of torrential watersheds; (b) time partitioning of risk management cycle; (c) Multidisciplinary expertise distribution (Adapted from (Tacnet et al., 2014)).

evaluation is based on limited knowledge. The expected effect of reducing risk and the functions to be fulfilled are not completely obvious. Besides, the requisite knowledge on topographical, geotechnical and hydraulic data is imperfect and the lifetime period of the structure is rarely identified (Carladous, 2017). Furthermore, the analysis necessitates a huge amount of data. Commonly, the information needed to evaluate the efficacy of protection structures are presented in fig. 2.5. In practice, access to all data is limited. Some are obtained from historical archives (databases), geographic information systems, visual observations, expert assessment, measurements and numerical models.

Notably, information imperfection propagates in the different stages of the risk management decision process. Wrong, improper or inaccurate decisions may result in uneconomic ad/or inefficient design or in a partial or total (functional or structural) failure of torrent protection structures, which in turn lead to negative consequences for the protected area. Questions that arise while dealing with information imperfection are the following: To what extent is the final risk management decision affected by such imperfection? How to incorporate both aleatory and epistemic uncertainties in the developed risk management model ((physical model, decision-aiding model,...)? How to propagate uncertainties in all the stages

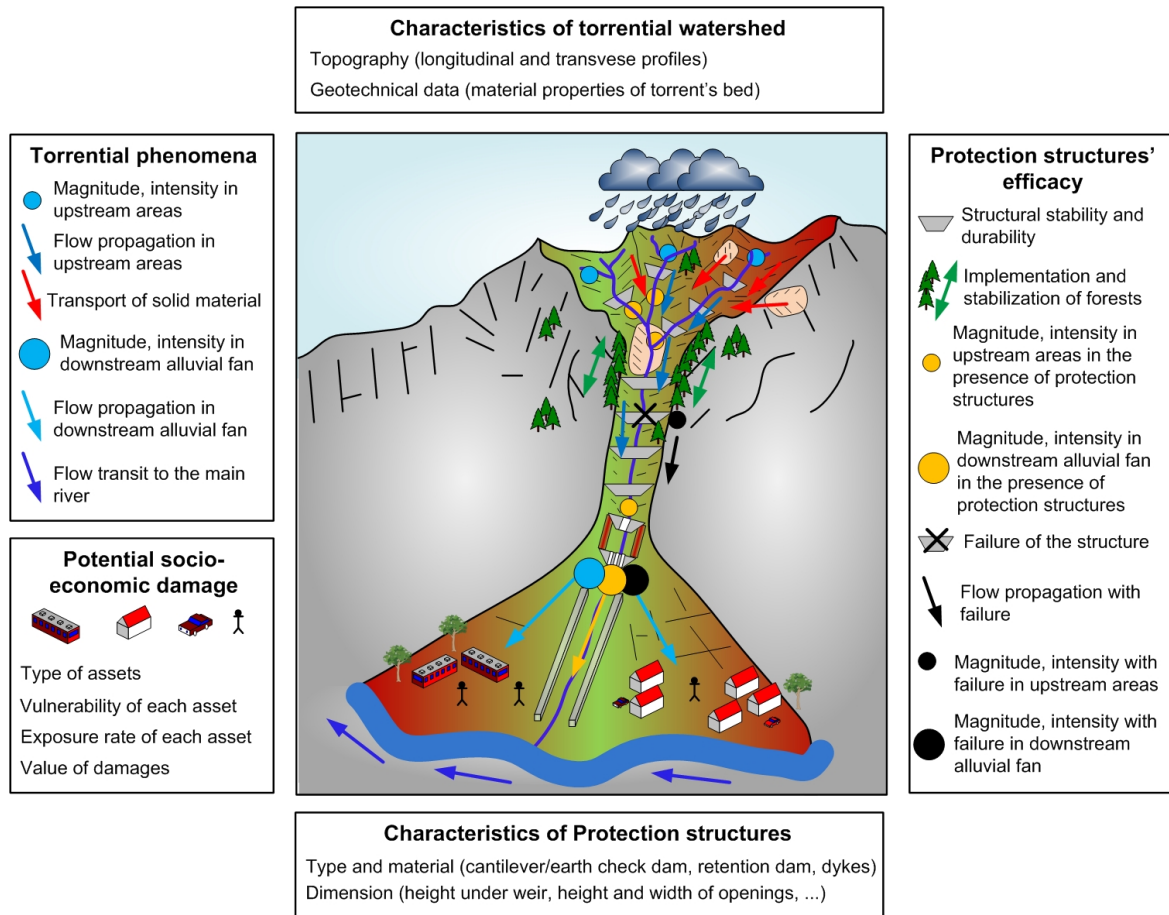

Figure 2.5: Necessary information provided by different sources for protection structures' efficacy assessment (Modified after (Carladous, 2017)).

involved in the model until reaching the final decision? To which inputs (parameters, indicators) are the model's outputs most sensitive?

2.4 Conclusion

In mountains, natural risk managers, and the experts who support them, seek to assess the efficacy of protection structures. Their efficacy is linked to the reduced level of risk they provide. This assessment appears to be essential in the risk management process and several decision problems are associated with it.

Protection structures' efficacy assessment integrates assessing technical (structural and functional) components as well as the economic component. The analysis must take into account the level stability of the structure (structural state), its performance level (functional state) and the reduced level of risk imposed on exposed issues (people, asset) to be protected. Analyzing structural and functional failure modes is not an easy task. It requires a compre-

hensive knowledge regarding the principles (design, functions) of the structure for being able to monitor and diagnose degradation indicators. This necessitates inspection visits conducted regularly at defined time intervals. The results of inspection, based on indicators extracted from failures characteristics and evaluated by visual observations, make it possible to make decisions on further operations (nothing to do, reparation, reconstruction, etc.). However, physics-based approaches, make it possible for the modelers to predict numerically the evolution of degradation indicators as a function of time when a structure/system is subjected to deterioration mechanisms due to external events (e.g. torrential phenomena). This supports decision-makers to make decisions at early stages.

Yet, dependencies between torrential phenomena, failures and structures of a multi-component system triggers cascade effect that may intensify the damage, result in disastrous proportions across the whole system, and thus reduce more the structure's efficacy. Consequently, such dependencies should be taken into account in the risk management process in order to have more precise efficacy assessments. Interactions and dependencies that are already encountered or may be encountered highlights how critical protection structures are and how complex their efficacy assessment is. Dependability approaches that involves safety and reliability analysis are adequate in such case, in which they provide qualitative and quantitative techniques that models the deterioration of complex systems considering different complexities (e.g. causes, consequences, interactions, etc.).

All protection structures should be regularly inspected so that maintenance is carried out when needed (Mazzorana et al., 2014). However, in France, only 14 000 check dams (among tens of thousand dams) and 115 retention dams (among 164 dams with a retention capacity $> 1000m^3$) are regularly diagnosed and maintained by the ONF-RTM services in the Pyrenees and the Alps due to limited available budgets. In fact, several maintenance strategies can be carried out on a degraded structure/system. In order to decide between the different choices, several aspects must be taken into account such as the reparation cost, reconstruction cost, the efficacy of the structure, etc. Consequently, risk management requires decision-aiding models that permit decision-makers to justify rigorously the choice of which maintenance strategy to follow.

Fig. 2.6 presents, concisely, the complexities confronted while assessing the efficacy of protection structures and making decisions concerning their rehabilitation. It also points out some of the scientific and technical questions, mentioned in previous sections, that have to be answered in order to end up by high level of protection and cost-effective decisions.

Additional complexity is present when making decisions. Whatever is needed to be assessed (costs, efficacy,...), the assessment is based on imperfect information that could be uncertain, imprecise, inconsistent or totally vague. Therefore, the issue of decision-making is not straightforward. Decisions are closely related to information availability, nature, content and quality. Although acquired information are used as they are when making risk management decisions, imperfection cannot be ignored. It is, therefore, important to use or develop methods that combine the different types of information imperfection, propagate this imperfection in dependability and physics-based models and incorporate it within the decision-aiding approach so that final decisions are made while being aware of uncertainties.

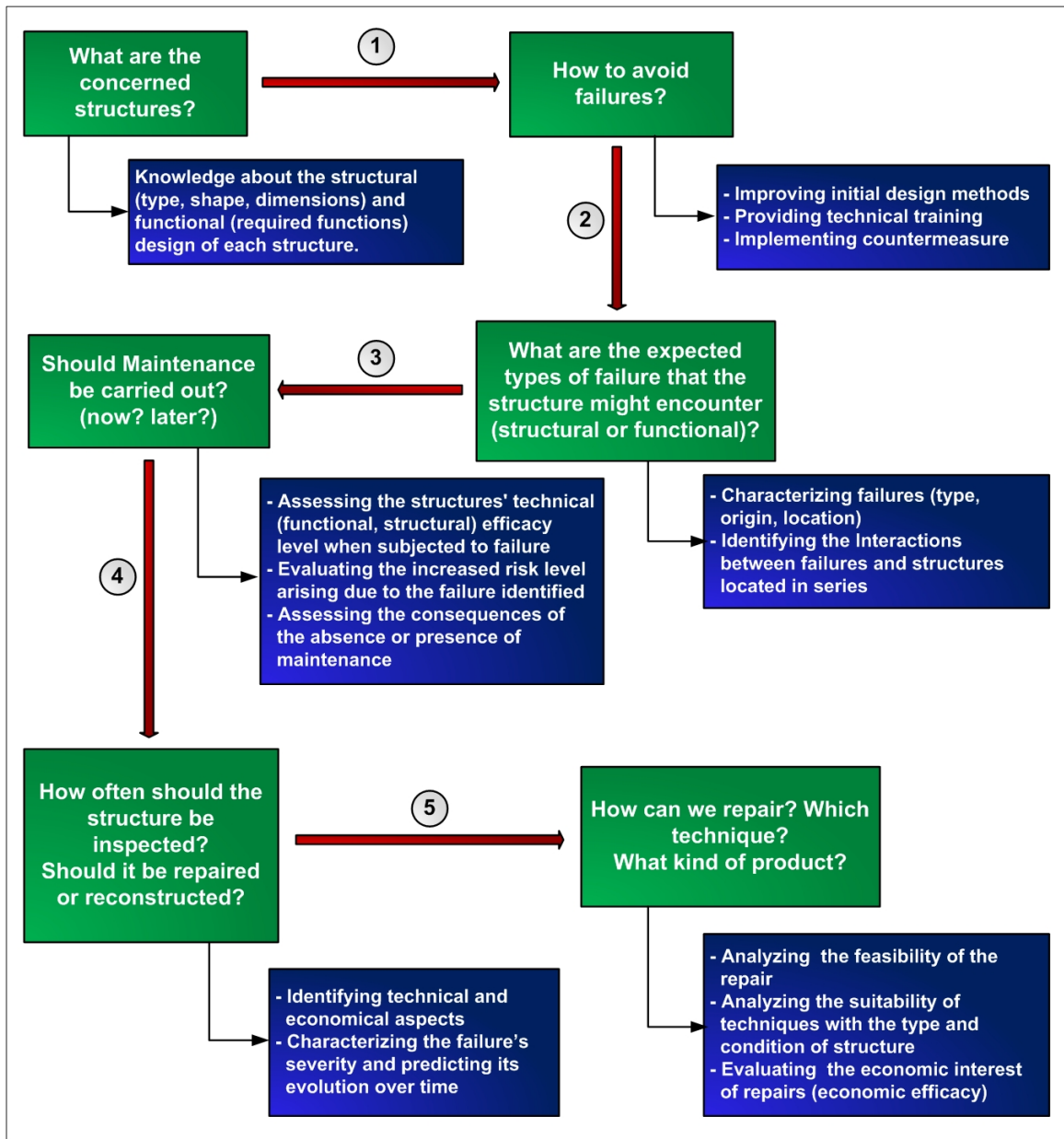

Figure 2.6: Key issues encountered when assessing protection structure’s efficacy and optimizing maintenance strategies (Modified after (Tacnet et al., 1999a)).

This chapter identifies all the scientific and technical issues that should be analyzed and incorporated in the model to be developed. Therefore, a dynamic decision-aiding model that integrates together the time-dependent evolution of the structure/system, possible dependencies and interactions, economic constraints in addition to information imperfection must be developed. The next chapter provides a summary about the existing modeling tools and methods adopted in the literature when dealing with similar complexities. It shows whether or not each of these tools and methods well suits the needs identified in the current chapter, states its limitations and explicitly claims the contributions behind this research project.

Complex System's Reliability Analysis and Decision-Making Approaches: State of the Art and Beyond

Contents

3.1	Introduction to Reliability Modeling of Complex Systems	56
3.1.1	Reliability: An Attribute of Dependability	57
3.1.2	Useful Dependability Functions and Metrics	59
3.1.3	Common Probability Distributions used in Reliability Analysis	61
3.1.4	Conclusion	63
3.2	Basic and Static System's Reliability Modeling and Decision Aiding Approaches	64
3.2.1	Classical Methods used for Reliability Analysis and Quantification	64
3.2.1.1	Failure Mode and Effect Analysis	64
3.2.1.2	Reliability Block Diagram	67
3.2.1.3	Fault Tree Analysis	70
3.2.1.4	Event Tree Analysis	72
3.2.2	Classical Approaches used to Support Decision-making	74
3.2.2.1	Economic Approaches: Cost Benefit Analysis	74
3.2.2.2	Multi-Criteria Decision-Making	77
3.2.3	Conclusion	78
3.3	Dynamic Reliability and Maintenance Decision Aiding Approaches	79
3.3.1	Maintenance Optimization Policies	79
3.3.1.1	Time-Based Maintenance Policy	80
3.3.1.2	Condition-Based Maintenance Policy	81
3.3.2	Dynamic Approaches for System Deterioration and Maintenance Modeling	83
3.3.2.1	Markov Chains: Stochastic Markov Process	84
3.3.2.2	Stochastic Petri Nets	86
3.3.3	Conclusion	91
3.4	Information Imperfection Analysis and Traceability Techniques	92

3.4.1	Theoretical frameworks representing different types of information imperfection	92
3.4.2	Hybrid Approaches for Uncertainty Analysis	94
3.4.3	Conclusion	95
3.5	Research Novelty: New Developments Beyond the State of the Art .	96
3.5.1	Existing Gap	97
3.5.2	Thesis Objectives and Contributions	98

As clarified in the previous chapter, the main objective behind this project is to develop a model for maintenance decision-making of deteriorating protection structures. This pushes us naturally into the field of reliability and maintenance modeling. In this chapter a summary of the main approaches that exist in the literature concerning the field of complex system’s reliability and maintenance modeling is presented. The chapter aims (i) to show how can each of the listed approaches be used for the own purpose of this project to choose a well adapted one (e.g. SPN), (ii) to explain its limitations (e.g. transitions are not linked to a physical modeling) and (iii) to extend it (e.g. determining the transition laws using physics based-modeling). In other words, the objective is to identify a well adapted existing tool which is not necessarily the best or the only one that could make it possible to develop the desired model. The chapter ends by explicitly stating the thesis objectives and all of the intended contributions that differentiates it from what already exists in the literature.

3.1 Introduction to Reliability Modeling of Complex Systems

Critical infrastructures (CIs) represent complex systems of interdependent components that provide vital resources necessary for a society’s needs. They ensure production, transport, communication, health, safety, and many other activities that enhance economic prosperity and quality of life (Bruijne and Eeten, 2007). The failure of some components in the system can trigger other failures within the same component and/or can result in the disruptions of other components via cascade effect. Identifying, understanding and analyzing dependencies and interactions between failures and system’s components are still remarkable challenges, which catch the attention of many researchers and scientists (Rinaldi et al., 2001). Specifically, with increased complexities, estimating system’s efficacy becomes a prominent challenge and a complicated task. Infrastructures that are considered to be critical are those, whose failure due to a triggering event (natural, technical, etc.), poses a threat to life, well-being, structures, and the society as a whole (Adetoye et al., 2013).

Critical protection structures has recently become a major concern worldwide. The complex and hidden dependencies between their failure modes and the bi-directional interactions between structures involved within the same protection system make it difficult to have a good estimate of structure’s/system’s efficacy, which in turn generate doubts on undertaken decisions. Some researchers focus on developing methods and tools that allow them to inves-

tigate the current state of the system. Others, are interested in understanding and describing the dynamic behavior of the structure/system (Bagheri and Ghorbani, 2008).

Recently, reliability analysis has become the main approach adopted by most researchers for acquiring knowledge required for the design and development of critical infrastructures in variety of fields (Johansson et al., 2013).

3.1.1 Reliability: An Attribute of Dependability

A system is an entity that interacts with other entities (e.g. other systems) that constitute its surrounding environment. The functional specifications of the system refers to what it is intended to do whereas its structural specifications refer to what enables it to fulfill the its intended functions (Avizienis et al., 2004).

Generally, a system is composed of a set of components and each component can be considered as another system thus constituting a complex system of systems. Each components has its own functions but also interact with other components in order to achieve common functions. The disrupt in one or more of the components may leave the system in a degraded state suffering from a partial functional and/or structural failure, and not necessarily in a total failed state (still able to withstand and perform some functions). Therefore, the level of damage of a failing component, provides an estimate of the efficacy level of the overall system (Bagheri and Ghorbani, 2008). The better the performance of a component, the more effective it is. Consequently, assessing the efficacy of the different components that constitute the system and analyzing the relationship between them enable determining the overall system's efficacy.

Dependability analysis has become increasingly important as modern critical systems become more heterogeneous and complex (Sharvia et al., 2016). It concerns the study of a system and its corresponding functions in order to distinguish between possible failures and consequences and finally to propose measures for reducing the associated risk. It demonstrates a confidence level of the functioning of a system. In other words, dependability is defined as “ the ability of an entity to perform one or several required functions” (Villemeur, 1992). It is an integrating concept that involves four different attributes: safety, reliability, availability and maintainability.

- **Safety:** the ability of the system to operate under designated conditions, without causing any damages and non-desirable outcomes (catastrophic consequences) on the user(s) and the surrounding environment.
- **Reliability:** the ability of the system to perform a required function, under given environmental and operational conditions over a specified period of time (ISO8402, 1986). It can be represented by $R(t)$, the probability that the system has not failed since the start of its service. In other words, it is the probability that the system performs the desired function throughout a time interval $[0, t]$. It is a measure of continuous

serviceability. While interventions (repairs) after individual component failures are allowed, interventions after a system failure is not admitted when estimating system's reliability. Therefore, one or more state, involved in the state space of the reliability model, should be an absorbing state, a state that, once reached, cannot be escaped.

- **Maintainability:** the ability of the system, under specific conditions of use, to be retained in, or restored to, a state where it can perform its required functions (BS4778, 1991). It reflects the flexibility of the system to be modified or repaired. It can be represented by $M(t)$, the probability that the system fulfills its functions at a given time t knowing that at $t = 0$ the system was at a failed state.
- **Availability:** the ability of the system, under combined aspects of its reliability and maintainability, to perform its function at a specified instant of time or over a specified period of time (BS4778, 1991). It can be presented by $A(t)$, the probability that the system will be operating at a given time t . Unavailability, corresponds to the time where the system is out of service. Since interventions are allowed without restrictions in an availability model, there will be no absorbing state within its state space.

Reliability as a concept has been known since the 1800s. In the early 1900s, it has been developed to be an internationally active field of research (e.g. complex system's and networks reliability engineering, software reliability engineering, etc.). Reliability is a basic attribute for the safety and effective operation of any technological system. Its analysis aims at studying the failure mechanisms of a system and quantifying the associated likelihoods. It plays a significant role in system's risk analysis. A fundamental issue in reliability analysis is the incorporation of uncertainty analysis (randomness) when studying the occurrences and consequences of failures. This offers a theoretical framework that takes into consideration uncertainties involved in engineering problems and decisions (Bastidas-Arteaga and Soubra, 2014). Indeed, the outcomes of such analysis are used to (i) identify design solutions for avoiding the occurrence of failures and (ii) to propose mitigation measures for limiting the consequences of failures (Zio, 2016).

Reliability analysis has a wide range of applications in several domains. However, the analysis varies depending on the different fields of engineering and sciences. Commonly, the concept of reliability is widely used in the fields of risk analysis, environmental protection, quality management, maintenance and operation optimization and engineering design (Rausand and Høyland, 2004) to be applied to nano-technology, computer communication network, distributed systems, tele-communication, network reliability optimization and many other applications (Khandelwal, 2011). In engineering context, reliability aims in figuring out design and actions strategies that increase the availability (lifetime) period of a system by controlling the possible causes of its failure. Such actions include, designing stronger elements, recognizing dangerous events, reducing the loads and stresses applied on the system during its use, and setting up a maintenance strategy that prevent the occurrence of failures or mitigate their consequences. Indeed, a high quality design, production, manufacturing and operation program leads to less failures, effective maintenance and eventually high performance.

3.1.2 Useful Dependability Functions and Metrics

Generally, at the component level, the three functions $R(t)$ (reliability function), $A(t)$ (availability function) and $M(t)$ (maintainability function) are defined in terms of some essential dependability metrics illustrated in fig. 3.1 (Rausand and Høyland, 2004; Hilt et al., 2016). It is considered that the component starts operating at $t = 0$ and fails at time a random time $t = T$ characterized by its pdf $f(t)$.

Mean time to failure (MTTF) is the mean expected time before the first failure of a system.

$$MTTF = \int_0^{\infty} R(t)dt \quad (3.1)$$

and

$$R(t) = 1 - F(t) = \int_t^{\infty} f(u)du \quad \text{for } t \geq 0 \quad (3.2)$$

where $F(t)$ is the time to failure cumulative distribution function (cdf) and $f(t)$ is the time to failure probability density function (pdf). $F(t)$ (unreliability function) is represented by the following equation

$$F(t) = \int_0^t f(u)du, \quad \text{for } t \geq 0 \quad (3.3)$$

The reliability of a system can be analyzed through two different approaches (Modarres, 1992). Deterministic approach aims in understanding the physics/mechanisms of failures (why and how the system fails) and the way the system can be designed, inspected, repaired or redesigned. These aspects are important in order to prevent failures from occurrence or re-occurrence. On the other hand, probabilistic approaches aims in quantifying system's reliability represented by $R(t) = P(T > t)$, the probability that the system performs the desired function during the time interval $[0, t]$ before reaching the failure time T .

Mean time to repair (MTTR) is the mean expected time needed to restore/repair a failed system.

$$MTTR = \int_0^{\infty} (1 - M(t)) \quad (3.4)$$

and

$$M(t) = \int_0^t g(u)du \quad (3.5)$$

where $g(t)$ is the time to repair probability density function (pdf).

Mean down time (MDT) is the mean expected time during which a system is in a filed state and cannot fulfill its function (non-operational time). In other words, it is the time needed to detect and repair the problem

Mean up time (MUT) is the mean expected time of functioning of a system after a repairing action and before reaching a second failure (continuous operational time).

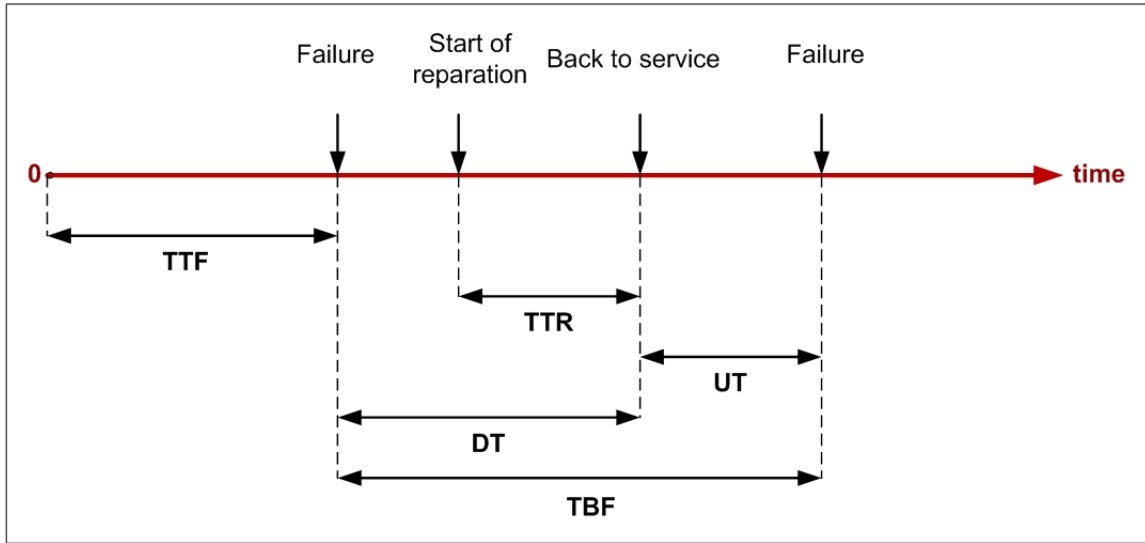

Figure 3.1: Essential characteristic times in dependability analysis: time to failure (TTF), time to repair (TTR), time between failures (TBF), down time (DT) and up time (UT).

Mean time between failures (MTBF) is the mean expected time between two consecutive failures.

$$MTBF = MDT + MUT \tag{3.6}$$

Note that the average availability can be defined as following:

$$\bar{A} = \frac{MUT}{MUT + MDT} \tag{3.7}$$

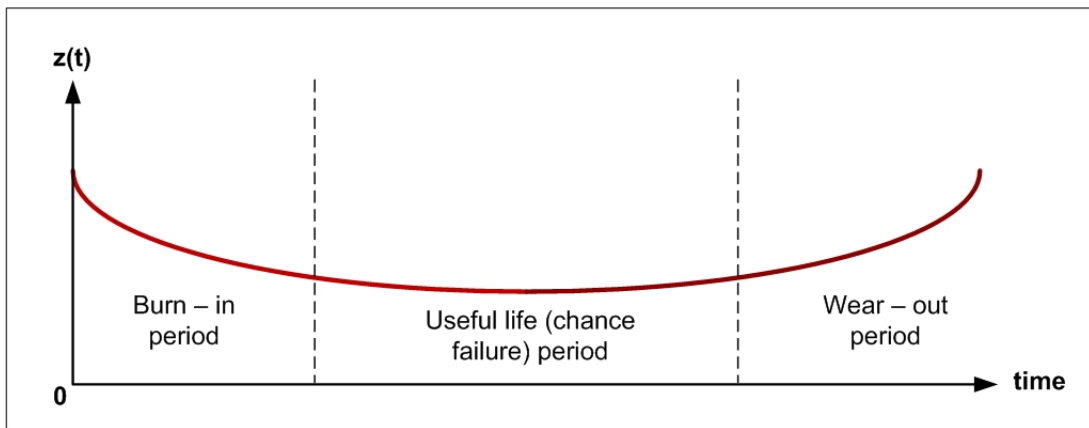

Figure 3.2: Failure rate “bathtub” curve.

The failure rate $z(t)$ (rate of occurrence of failure) is defined in terms of the system's failure probability in the time interval $[t, t + \Delta t]$ knowing that no failure has occurred before time t (the system is functioning at time t).

$$z(t) = \lim_{\Delta t \rightarrow 0} \frac{1}{\Delta t} P(t \leq T \leq t + \Delta t | T > t) = \lim_{\Delta t \rightarrow 0} \frac{1}{\Delta t} \frac{F(t + \Delta t) - F(t)}{R(t)} = \frac{dF(t)/dt}{R(t)} = \frac{f(t)}{R(t)} \quad (3.8)$$

The failure rate is a fundamental function in reliability analysis that aims in revealing the variation in the conditional failure probability of the system over its lifetime. In practice, $z(t)$ is often displayed as a curve having a bathtub shape. This curve is generally divided into three regions described below and illustrated in fig. 3.2.

1. **Burn-in period:** early failure region with a decreasing failure rate. The initial failure rate is high due to the fact that some defects may remain unrevealed until the system is activated.
2. **Useful life (chance failure) period:** shows a quasi-constant failure rate characterized by random failures of the system.
3. **Wear-out period:** represents an increasing failure rate characterized by complex aging phenomena (deterioration of components).

The range of these regions differs from one system to another (electrical system, mechanical system, etc.). Moreover, as the stress level on the system increases, the useful life (chance failure) region decreases and an early wear-out occurs. Hence, maximizing reliability is linked to minimizing stress factors (e.g. severe operating environment).

3.1.3 Common Probability Distributions used in Reliability Analysis

Several probability distributions are used in reliability analysis (O'Connor, 2011). The most common distributions are:

Exponential distribution: the most common used distribution in applied reliability analysis. This is due to its mathematical simplicity (constant failure rate). It is adequate for specific types of systems in which it reflects their realistic behavior over time.

Weibull distribution: one of the widely used distributions in reliability analysis and has a wide range of applications. This is due to its flexibility in which it can, through an appropriate choice of parameters, model many types of failure rate behaviors. It is suitable for complex systems (Multi-component systems) whose failures are influenced by the most severe defect of their components.

Poisson distribution: used to model the occurrences of a specific event (e.g. failure or an accident) over a given time interval.

Gamma distribution: used when a system is subjected to a series of events and the time intervals between the events are independent and exponentially distributed with constant failure rate λ .

Normal distribution: most common distribution in statistics. It is appropriate for modelling many physical phenomena. However, its use is limited to applications that necessitate the estimation of time to failure.

Lognormal distribution: very used in reliability analysis. It is suitable for analyzing failure processes that result due to several small multiplicative errors.

Binomial distribution: one of the most widely used discrete distributions in reliability engineering.

Since exponential distribution is the most adopted in reliability analysis, a short description concerning this distribution is presented in this section. Within the bathtub curve, this distribution corresponds to the useful life (chance failure) region. In fact, the use of exponential distribution in models that represent complex systems with components consisting of many interacting parts is still a reasonable option. More specifically, for components whose chance failure region is long in comparison with the other regions, exponential distribution is considered to be a valid choice (Modarres, 1992).

Consider a system which is put into operation at time $t = 0$. The probability density function of time to failure following an exponential distribution is given as follows:

$$f(t) = \lambda \exp(-\lambda t) \quad \text{for } \lambda, t > 0, \quad (3.9)$$

The failure process represented by an exponential distribution has no memory meaning that it cannot model the aging of the system (future development does not depend on what happened before). Therefore, it has a constant failure rate. Below are the equations representing the reliability function, mean time to failure and the failure rate function of a system following an exponential distribution.

$$R(t) = \exp(-\lambda t), \quad \lambda, t > 0 \quad (3.10)$$

$$MTTF = \int_0^{\infty} R(t) dt = \frac{1}{\lambda} \quad (3.11)$$

$$z(t) = \frac{f(t)}{R(t)} = \lambda = \text{constant} \quad (3.12)$$

One key issue concerns the estimation of the parameters associated with each probability distribution. Due to the fact that a limited amount of information is available (e.g. times

to failure), it is difficult to be certain about the estimations. The estimation process is always influenced by the amount of data available, diverse sources of data, assumptions, etc. This highlights the importance of considering a confidence interval in the estimation process. Sometimes, due to lack of observed data, the use of generic failure data is required. This is accomplished by taking into consideration several factors that affect the failure rate of the system under study. The most considered factors include:

- **Environmental factors:** they influence the failure rate due to, for example, extreme mechanical, electrical and chemical environments.
- **Design factors:** they influence the failure rate according to the quality and the composition of the materials used, functional requirements and human skills.
- **Operating factors:** they influence the failure rate due to the applied stresses resulting from operation, testing and maintenance actions.

3.1.4 Conclusion

For about 60 years, researchers in the field of reliability engineering have developed several methods and tools to satisfy different need. Until now, continuous researches aim in improving these methods more and more so that they adapt with the increase in the complexity of critical infrastructures and complex industrial systems. Due to the crucial need for such infrastructures and systems, a high level of their efficacy should be guaranteed. Consequently, risk managers seek to predict scenarios (hazards, failures, etc.), assess and evaluate their causes and consequences and to end up by choosing between several possible intervention strategies (e.g. maintenance) considering technical and budgetary constraints.

Reliability analysis tools integrating or followed by decision aiding models are often adopted to tackle these objectives. Generally, these approaches can be classified into three different categories (Signoret, 2009) to be discussed in next sections:

Basic qualitative approaches: used to understand how the system operates, identify related risks and perform a primary basic reliability analysis.

Static models: used to identify failure scenarios and their consequences on the functioning of the system by performing basic calculations. They are often based on boolean models that shows how the system logically fails as a function of the states of its components.

Dynamic models: used to model the time-dependent behavior of a system when subjected to deterioration mechanisms or to maintenance operations.

3.2 Basic and Static System's Reliability Modeling and Decision Aiding Approaches

In order to guarantee the efficacy of a system within its later phases of its life cycle, reliability analysis should begin early in the design phase in which potential problems are identified and resolved (Sharvia et al., 2016). One of the most important aspects of this analysis is to start from the basic components of the system. In other words, it is important to assess the efficacy of individual components and to model the logical interactions between them in order to determine the efficacy of the system as a whole. In some cases, the failure of one component may lead to the failure of the system. In other cases, the system may still be functioning while other components function properly. The main concern in reliability analysis is to identify potential failures and to prevent them from occurring by different means.

Reliability analysis starts by defining all the functions of the system, analyzing all the possible failure modes and proposing several alternatives to reduce the associated risk. Researchers have focused on finding out techniques and methods to address such problems and challenges (Zio, 2009; Sabaei et al., 2015).

3.2.1 Classical Methods used for Reliability Analysis and Quantification

Traditional methods in reliability analysis are widely used during the design phase of critical systems in order to figure out the interactions between system's components, checking their behaviour at a specific period of time and finally assessing the efficacy of the overall system (Zio, 2016). Failure modes, their causes and their consequences can be presented and described using different failure classification frameworks. In this section, an introduction of some classical basic and static methods used for system's reliability analysis is presented (Modarres, 1992; Rausand and Høyland, 2004; Zio, 2007; Rausand, 2014).

3.2.1.1 Failure Mode and Effect Analysis

Failure Mode and Effect Analysis (FMEA) was developed by the US army (reliability engineers) in the late 1950s in order to study problems that might arise from defects of military systems. It is one of the best techniques used to analyze potential reliability problems from the earliest design and development stages, making it easier for engineers to take decisions and mitigate possible failures. FMEA is a qualitative and inductive method usually created by a spreadsheet which may have a different format depending on the domain of application. It is an iterative analysis that should be performed at all stages of system's development and it often comes as a first step in reliability analysis. FMEA consists of four steps (Mortureux, 2001):

Step 1: identifying the different components constituting the system.

Step 2: identifying the potential failures each component may be subjected to.

Step 3: assessing the consequences of each type of failure.

Step 4: prioritizing failure modes according to their severity (seriousness of failure consequences), frequency (how often failure can occur) and detectability (degree of difficulty of detecting the failure).

FMEA has several applications in civil engineering domain especially for hydraulic structures. In such domains, it is essential first to represent and describe the system using a functional block diagram. This diagram illustrates the operation, interrelationship and correlation of the functional components of the system. The aim of this step is to analyze functional requirements in order to identify all types of failure. Later on, two stages of FMEA can be differentiated:

Process FMEA: is applied at a process level. It takes into account failures that may exist in the different steps (operations) involved in the design process of the system. Note that one failure can be a result of one or more reasons. Finally, the consequences of each failure should be examined and recorded. Process FMEA ends up by a description of the structure at the end of its construction. It enables discovering the reasons behind a bad or inaccurate design of the system. Its key characteristics are the inputs used in the design phase.

Design FMEA: is applied for each component of the system. It is represented by a table including the different functions of the component, the failure modes associated to each function, the causes of these failures and their consequences on the overall system. It helps identifying several indicators related to the causes of failures which in turn enables assessing the system's efficacy. Design FMEA ends up by a description of how a component can fail in fulfilling its functions. Its key characteristics are the outputs expected after the design phase (during operation). Note that it is very recommended to carry out a FMEA before the implementation of a FT and/or ET where the possible failure modes and their causes are mentioned.

An example of process FMEA applied to the design process of a check dam's foundation is given in table. 3.1. Another example of design FMEA applied to the hydraulic weir of a check dam is presented in table. 3.2. Both examples are adapted, respectively, from the work of (Carladous, 2017) and (Tacnet et al., 2011). Moreover, Peyras et al. has developed an aging functional model based on FMEA (process and design FMEA) in order to support engineers, risk managers and decision-makers in performing diagnosis, analyzing risks and proposing maintenance strategies concerning operational hydraulic dams (Peyras et al., 2006). The authors used historical database collected from dams that have already experienced deterioration and provided information about dams' aging mechanisms. The study resulted in describing dams' aging historical data, failure mechanisms and the corresponding trends of performance loss. Yet, it has been revealed that FMEA does not produce a detailed analysis of

Process	Operations	Failure modes	Consequences
Conception	geotechnical study	limited study	insufficient resistance in external stability
	- geological study of the downstream bed hydraulic conditions	- limited study	- functional failure due to scouring downstream the dam's foundation
	- implementation of downstream structures	- not high enough	- functional failure due to flows overtopping the dams
	sizing of the foundation taking into account the phenomenon of scouring (lateral anchors, anti-scouring beam)	insufficient sizing	structural failure by external stability
Implementation	- implementation of the reinforced concrete foundation	- insufficient reinforcement - insufficient concrete quality	structural failure by internal stability
	- implementation of anchors and injections	- insufficient density - insufficient concrete quality	
	- implementation of the concrete anti scouring beam	- insufficient lateral support - insufficient concrete quality	

Table 3.1: Process FMEA applied to a check dam's foundation design process (Adapted from (Carladous, 2017))

the variation in the dams' performance and their reliability/efficacy over time. For this reason, a criticality analysis is carried out in order to identify the most critical dams, components and scenarios in addition to the available time to perform and schedule maintenance operations. A continuation of this work, has introduced a hybrid approach combining physical risk analysis (civil engineering, hydraulics and hydrology) with reliability methods (FMEA, ETA) in order to assess quantitatively the safety of dams (Peyras et al., 2010, 2012).

Failure Mode and Effect Criticality Analysis (FMECA) is an extension of FMEA that provide more quantitative treatment of failures. It has the same procedure as the FMEA in all aspects except for one additional step. This step is the criticality analysis in which the probability of occurrence of each failure is determined and the impact of each type of failure on the reliability of the system is described. Therefore, this extension to FMEA enables prioritizing prevention measures of failures.

FMEA is considered to be a comprehensive method which takes time and requires people with specialized skills. During the analysis, each failure is considered individually, independent to other failures in the system. Thus, FMEA may be very effective when applied to a system where failures are most likely linked to a single component. However, it is not suitable

Function	Failure modes	Possible causes of failures	Possible failures' consequences	Indicators
Centering torrential flows	unsuitable orientation of the flow (non-centered flow)	<ul style="list-style-type: none"> - Wrong implementation of downstream dams - Insufficient hydraulic calibration - Clogging of the hydraulic section by large deposited materials 	<ul style="list-style-type: none"> - Deviation of the flow - Erosion of banks - Erosion of the dam's wings - Bypassing the dam's wings 	<ul style="list-style-type: none"> - Angle of deviation of the flow ($^{\circ}$) - Volume of eroded banks' materials (m^3) - Percentage of clogging of the hydraulic section (%) - Submerged length of the dam's wing (m) - Length of erosion on the edge of the dam's wings (m)

Table 3.2: Design FMEA applied to a check dam's hydraulic weir (Adapted from (Tacnet et al., 2011)).

for complex systems with several interacting components and interacting failures. Besides, FMEA provides very limited vision of a probabilistic representation of system's reliability (presents a totally static view of the system). Hence, FMEA studies are very powerful for non-probabilistic analysis of a system's design and operation. However, they should be followed by other methods which can fulfill its limitations. Regardless of its limitations, in many industrial applications, engineers request for a FMEA to be integrated in the design process of technical systems.

3.2.1.2 Reliability Block Diagram

A Reliability Block Diagram (RBD) is a graphical representation of system components showing how the state of each component affect the overall system's state. It illustrates how the components are interconnected when they have to achieve a specified system's function. The diagram consists of functional blocks, represented as rectangles or squares and connected by lines. A functional block could represent either a component or a specific function of a component and could have either a functioning state or a failed state. Consequently, the diagram reflects the state of the system in terms of the states of its components. Moreover, RBD has a single starting point a and a single end point b . The possibility to pass through a series of functional blocks to move from a to b , reveals that the system is in a functioning state.

When the reliability of each component is identified, it will be possible to calculate the reliability function for the entire system, identify critical components and propose an optimum reliability allocation strategy that allows the analysts to meet a system's reliability target. The reliability of the system depends on the type of the system's functional configuration.

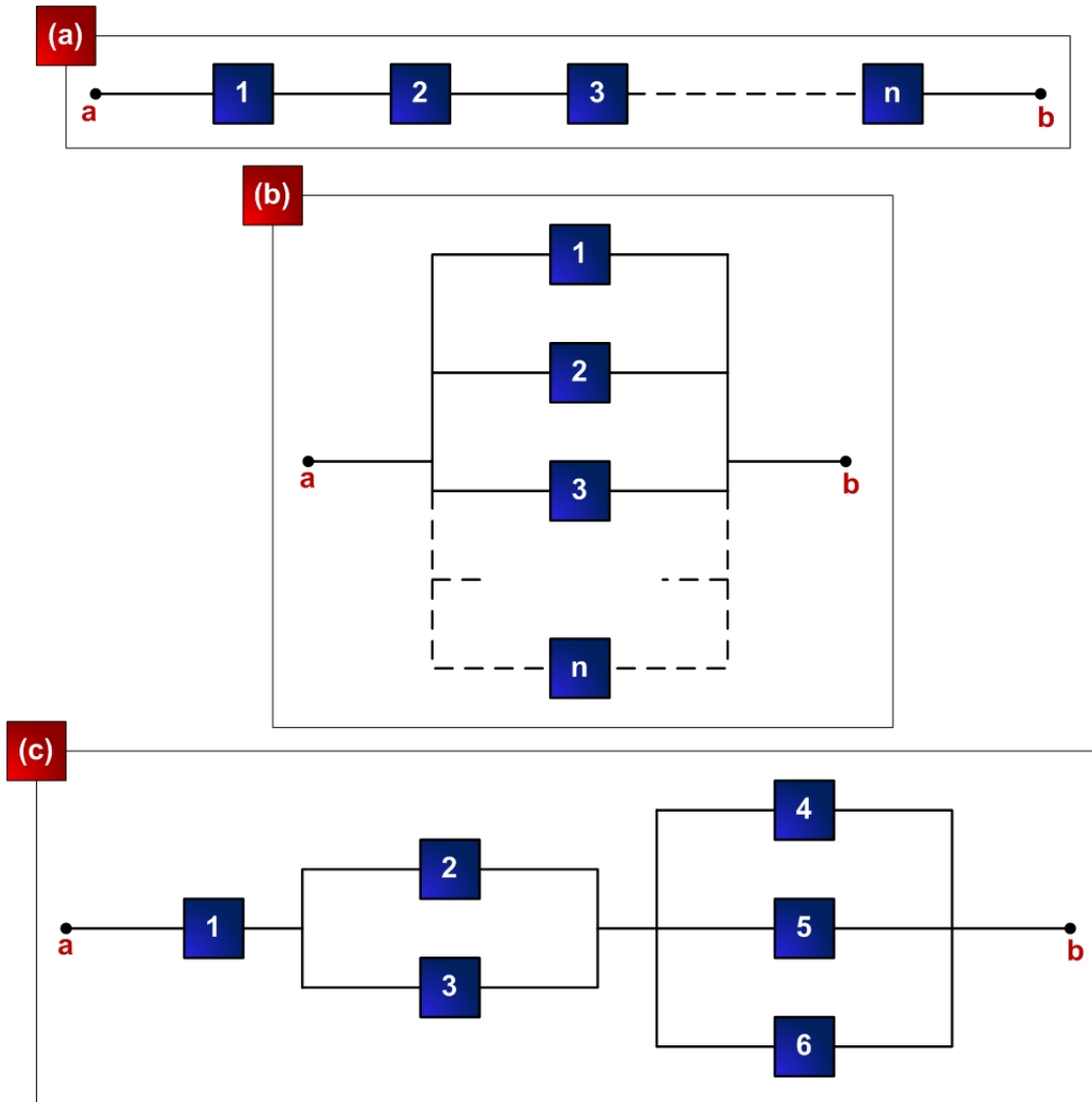

Figure 3.3: Examples of different configurations of a RBD: (a) series configuration n components; (b) parallel configuration of n components; (c) parallel-series configuration of 6 components.

Usually, the logical layout (arrangement of blocks) in a RBD can be either represented as a series system, parallel system or a combination of both.

Series configuration: A RBD is considered to be in a series configuration when the failure of one of the components results in a failure of the overall system. Hence, if the system is functioning, all the components constituting the system should be in their functioning state. Fig. 3.3, (a) shows an example of a system's RBD with a series configuration, composed of n components. The reliability of the system is equal to the probability that all the components in the system are in a functioning state during the time interval $[0, t]$.

The reliability and the instantaneous failure rate of a system with series configuration are given respectively by Eq. 3.13 and Eq. 3.14

$$R_s(t) = \prod_{i=1}^n R_i(t) \quad (3.13)$$

where $R_i(t)$ represents the reliability of the i^{th} component.

$$z_s(t) = z_s(t) = \frac{-d \ln R_s(t)}{dt} = \sum_{i=1}^n z_i(t) \quad (3.14)$$

Parallel configuration: A RBD is considered to be in a parallel configuration when the failure of all the components results in a failure of the overall system. Hence, if only one component is in a functioning state, the system will remain in a functioning state. Fig. 3.3, (b) represents an example of a system's RBD with a parallel configuration, composed of n components. The unreliability of the system ($F_s(t)$) is equal to the probability that all the components in the system are in a functioning state during the time interval $[0, t]$.

The unreliability, reliability and the failure rate functions of a system with parallel configuration, composed of n components are given respectively by Eq. 3.15, 3.16, and Eq. 3.17.

$$F_s(t) = \prod_{i=1}^n F_i(t) \quad (3.15)$$

where $F_i(t) = 1 - R_i(t)$ represents the unreliability of the i^{th} component.

$$R_s(t) = 1 - F_s(t) = 1 - \prod_{i=1}^n [1 - R_i(t)] \quad (3.16)$$

$$z_s(t) = \frac{-d \ln R_s(t)}{dt} \quad (3.17)$$

Parallel-series configuration: Most complex systems do not neither have parallel nor series configuration of components. Instead, they exhibit a hybrid combination of both configurations as shown in fig. 3.3, (c). In order to determine the reliability function of the whole system, the system should be divided into basic parallel and series modules and the reliability of each module should be determined.

RBD is a practical and applicable technique used in determining industrial and commercial powers system's reliability and availability (Wang et al., 2004). This technique has been used in different applications concerning large systems and infrastructures (Bodi, 1999; Rocha et al., 2017; Boussahoua and Elmaouhab, 2019). Its advantages is that it is easy to construct, understand, modify and to incorporate any additions. However, two main limitations of

Events	Gates
<div style="display: flex; flex-direction: column; gap: 10px;"> <div style="display: flex; align-items: center;"> <div style="background-color: #1a3d4d; color: white; padding: 5px; margin-right: 10px;">TE</div> <div> <p>Top event: critical event triggered due to one event or more</p> </div> </div> <div style="display: flex; align-items: center;"> <div style="background-color: #c00000; color: white; padding: 5px; margin-right: 10px;">IE</div> <div> <p>Intermediate event: event triggered due to other intermediate or basic event and leads to other events</p> </div> </div> <div style="display: flex; align-items: center;"> <div style="background-color: #0056b3; color: white; border-radius: 50%; width: 30px; height: 30px; display: flex; align-items: center; justify-content: center; margin-right: 10px;">BE</div> <div> <p>Basic event: a basic initiating event which requires no more development</p> </div> </div> </div>	<div style="display: flex; flex-direction: column; gap: 20px;"> <div style="display: flex; align-items: center;"> <div style="background-color: #cccccc; border: 1px solid black; border-radius: 50% 50% 50% 50%; width: 40px; height: 40px; margin-right: 10px;"></div> <div> <p>OR gate: output event occurs if at least one of the input events occur</p> </div> </div> <div style="display: flex; align-items: center;"> <div style="background-color: #cccccc; border: 1px solid black; border-radius: 50% 50% 0% 0%; width: 40px; height: 40px; margin-right: 10px;"></div> <div> <p>AND gate: output event occurs if all input events occur</p> </div> </div> </div>

Figure 3.4: Basic symbols used in a FT.

using RBD for calculation are the assumption of independent components and the absence of modeling the time-dependent behavior of each (static modeling). Moreover, in the case of very complex systems with complex physical and operational interacting components (each having multiple failure modes), the use of RBD will be complicated. Fault tree analysis is more convenient in such situations.

3.2.1.3 Fault Tree Analysis

Fault Tree Analysis (FTA) is a deductive process that starts by a critical event and aims to link different original events that lead to the occurrence of the critical event. The main idea is to represent graphically the logic of the dysfunctioning of a system. Fault trees (FTs) are presented in a vertical way starting by the top event (final event e.g. complete failure) and then predicting the causes behind this event. The postulated events should demonstrate the immediate, necessary and sufficient causes for the occurrence of the top event. The events are linked to their corresponding causes by means of logical gates (and, or) meaning that the occurrence of an event can be caused due to one or more different reasons. Fig. 3.4 represents the most common and basic symbols used in a FTA (more complicated symbols exist). Note that the symbols may differ from one standard to another but their meanings remain almost the same. The procedure ends when a suitable level of details is reached and the lowest level in the FT constitutes the basic events.

The quantitative evaluation of FTs is based on computing the probability of occurrence of the top event taking into account the type of the gate (and, or) in order to apply the suitable probability equation. The reliability associated with the top event will then be determined. Besides, FTA is a binary analysis in which all events are assumed either to occur or not to occur (no intermediate option). The results of such analysis involve a list of the possible combinations of different causes (components' failures, environmental factors, human errors and normal events expected to occur during the lifetime period of the system) that may result in a critical event in the system and the probability that the critical event will occur during a specified time interval.

Fig. 3.5 is an example of a FT showing the possible reasons behind the failure of a torrent

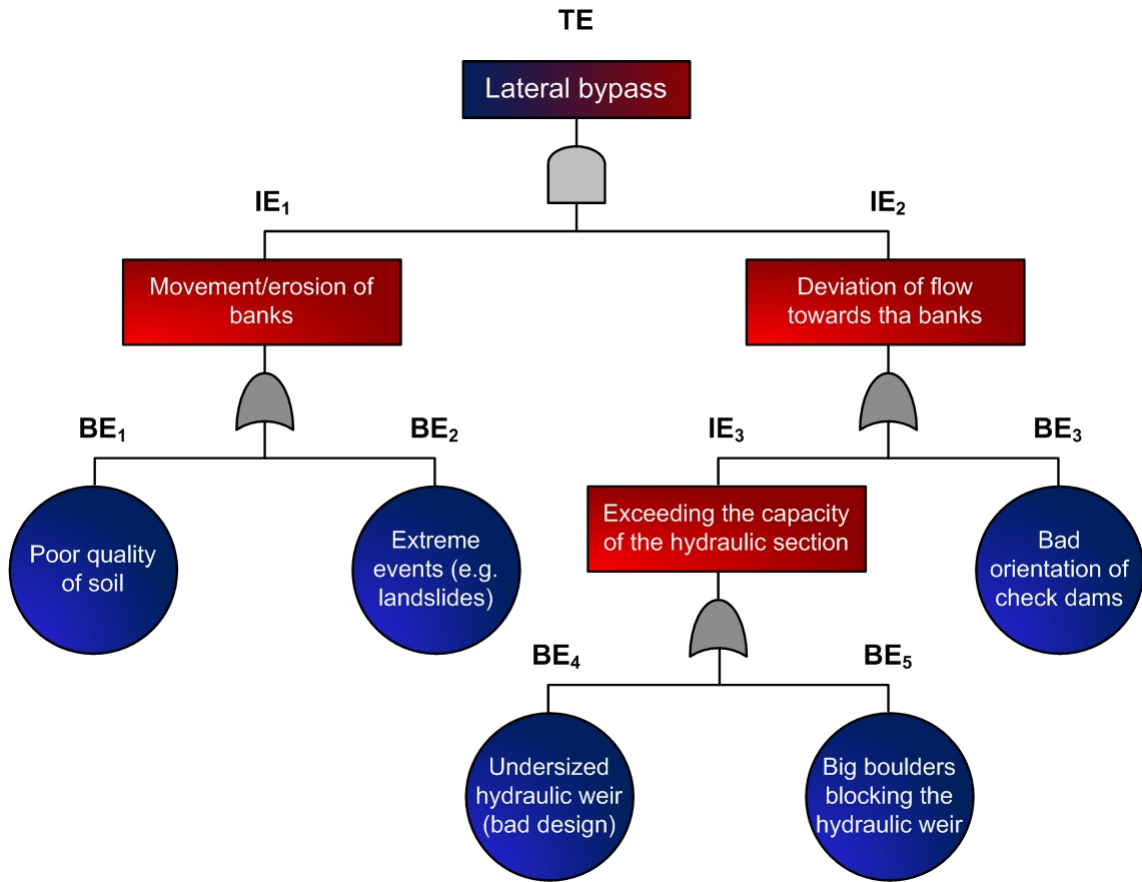

Figure 3.5: FTA describing the causes behind the failure of torrent check dams by lateral bypass.

check dam due to lateral bypass (functional failure). It also illustrates the way the likelihood (probability of occurrence) of each event is calculated depending on the gate symbol used. Based on the given example, the occurrence of one of the basic events BE_1 or BE_2 leads to intermediate event IE_1 . In addition, the occurrence of either the intermediate event IE_3 or the basic event BE_3 results in the intermediate event IE_2 . However, IE_3 is also a result of basic events BE_4 or BE_5 . Considering that each basic BE is given as a boolean variable (Eq. 3.18), Eqs. 3.19 to 3.23 provide boolean expressions that explain how the intermediate events and the top event TE can be realized as a function of the realization of basic events.

$$BE_i = \begin{cases} 0 \text{ (False)} & \text{if event } i \text{ is not realized} \\ 1 \text{ (True)} & \text{if event } i \text{ is realized} \end{cases} \quad (3.18)$$

$$IE_1 = BE_1 + BE_2 \quad (3.19)$$

$$IE_2 = IE_3 + BE_3 \quad (3.20)$$

$$IE_3 = BE_4 + BE_5 \quad (3.21)$$

$$TE = IE_1 * IE_2 \quad (3.22)$$

Combining Equations 3.19, 3.20 and 3.21, results in:

$$TE = (BE_1 + BE_2) * (BE_4 + BE_5 + BE_3) \quad (3.23)$$

Consequently, if the probabilities of all the basic events ($P(BE_i)$) are known, the probability of occurrence of the top event ($P(TE) = True$) can be estimated as follows:

$$P(TE) = P((BE_1 + BE_2) * (BE_4 + BE_5 + BE_3) = 1) \quad (3.24)$$

The FT technique was introduced in 1962 by Bell Labs. Today, it is one of the most common techniques used for risk and reliability studies in different fields. For example, in the context of civil engineering and critical infrastructures, a methodology for reliability assessment of bridge piers against local scouring considering parameter uncertainties and duration of floods has been recently developed (Salamatian and Zarrati, 2019). The authors use FTA in order to consider the interactions between the complex processes of scouring around unprotected and protected bridge piers and to compute the over all probability of bridge failure in both cases. Besides, a FT-based approach is derived in order to quantify the decrease in the level of performance of railway sub-networks (Weik and Nieben, 2019). It was revealed that FT techniques are suitable when intended to identify critical elements, relevant failure scenarios and resilience of railway systems. Another FT-based approach was carried out in order to introduce the failure modes and the failure probabilities of high arch dams (Ren et al., 2012). It has been revealed that the deterioration of the dam's foundation is a major risk source for high dam's. The research focuses on the phenomenon of cracking (the main pattern of local failure of high concrete dam) and provides preventive measures for this local failure.

Many others publications that consider FT technique exist in the previous mentioned fields and in many other domains. In fact, FT analysis is an important tool for identifying weaknesses in the system design and for estimating the probability of occurrence of undesired events. However, FTA is limited because of the binary assumption (the event either occurs or not) in which the degraded states of the system cannot be considered. Beside, it has the same limitations as the RBD concerning the assumption of independent components and the static modeling. In spite the limitations of FTA, it is still considered a suitable approach for a large number of systems analysis problems encountered in practice (Fussell, 1975).

3.2.1.4 Event Tree Analysis

Event Tree analysis (ETA) is an inductive process that starts by an initiating event and then provide a systematic coverage of its potential consequences triggered over time. The initiating event is usually defined as the first significant deviation from the initial normal situation that may lead to a system failure. It may occur either due to either a technical failure or due to human error and must result in a sequence of consequences. Hence, an event tree (ET) displays the chronological development of an events' chain (cascade effect). ETs are presented in a horizontal way, drawn from left to the right, starting by the initiating event. Each event in the tree is conditional on the occurrence of the previous events in the event chain. The outcomes of each event are often assumed to be binary (true or false, yes or no). The outputs from one event trigger other events and the development of the tree continues until, eventually, critical consequences are reached. At each node, the tree splits into two branches. The upper branch signifies that the event above the node is true, and the lower branch signifies that the event below the node is false. This allows to explore all the possible event sequences and their consequences.

Depending on the desired objectives, ETA may be either qualitative, quantitative or both. The quantitative evaluation of ETs requires computing the probability of occurrence of each event of the tree. Since the events are considered to be statistically independent, the probability of the chosen scenario is equal to the product of the conditional probabilities corresponding to all events involved in the scenario. Such tree provides a very clear and understandable description of the resulting consequences. The results of ETA permit the analyst to rank the consequences according to their severity. They also supports decision makers to prioritize prevention and mitigation measures depending on their efficiency in protecting against these events.

Fig. 3.6 is an example of an ET showing the possible chain of consequences a check dam may be subjected to after a high intensity clear water flood event. In fact, intense waterfall passing through the hydraulic weir of the check dam results in the phenomenon of scouring downstream the dam which then leads to dam's failure by external stability (e.g. overturning). Each chain of events represents a scenario S_i . The probability of occurrence of each scenario is equal to the product of the occurrence probability of each event involved in the scenario.

ETA has been used for risk and reliability analysis in a wide range of technological systems. For example, in the context of critical infrastructures, a quantitative risk analysis approach applied to railway tunnels based on ETA and Monte-Carlo simulation was proposed by (Vanorio and Mera, 2012). Both techniques were adopted in order to analyze undesired events (accidents such as collision) that may occur in a railway tunnel, assess multiple scenarios (triggered consequences on people, goods and the environment) considering uncertain likelihoods and different types of railway tunnel systems and finally choosing the best type to be implemented. ETs were also used in order to assess quantitatively the consequences of 272 NaTech events (technological accidents caused by natural events) triggered by flood events (Cozzani et al., 2010). Moreover, in the context of civil engineering structures, a quantitative (probabilistic) ETA has been applied on a bridge that has collapsed due to structural failures

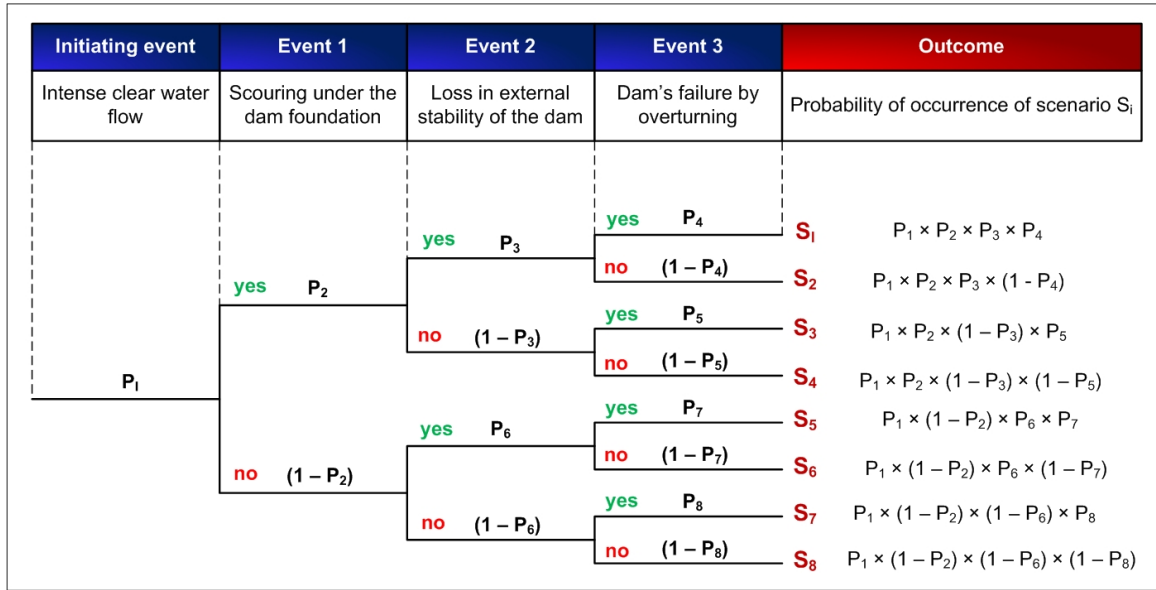

Figure 3.6: ETA concerning the consequences of clear water floods on check dam's stability.

in order to rank failure scenarios, identify the most critical scenario and to find the main reason behind the bridge collapse (Choi et al., 2006).

ETs are clear, logical and easy to understand. They are suitable tools for quantitative risk analysis of several consequences arising from a sequence of successive failures. Yet, in ETA, events are assumed to be independent in which the analysis fails to model events with joint probabilities occurring at the same time. In addition, it is only limited to one initiating event and cannot consider the consequences resulting from a combination of events. Still, ETs are widely used for failure analysis of complex systems even though they consider binary events in which the failure of the system is not linked to physical modeling.

3.2.2 Classical Approaches used to Support Decision-making

A decision consists in choosing between several alternatives/strategies (solutions, actions, etc.) proposed by experts and technical managers and discussed by public authorities, economic managers and citizens. Hence, to support decision-makers, the decision problem should be first formalized and the strategies to be compared should be defined. After, optimization makes it possible to choose the optimal strategy considering single or multiple criteria. Different decision aiding tools allow comparing several strategies through optimization. In the following sections, the two main classical approaches are presented.

3.2.2.1 Economic Approaches: Cost Benefit Analysis

Cost Benefit Analysis (CBA) has been established primarily as a tool supporting the government in making social and economic decisions. It helps people who are concerned about the decision problem to have an idea about the economic cost of each strategy and allows them to debate whether they are for or against each of the proposed strategy. CBA is considered as a mono-criterion method in which a single economic indicator is evaluated. It is a technique that evaluate positive (benefits) and negative (costs) consequences of a specific strategy in terms of money. The outcomes of such evaluation permits decision-makers to compare different possible strategies. In fact, for a planned strategy to be considered successful, it must produce more benefits compared to its cost. Hence, the analysis relies on adding positive factors and subtracting negative ones to determine a net result (subtracting costs from benefits). The results of CBA are used to develop reasonable conclusions around the feasibility of decisions.

In France, CBA applications are highly remarkable in the field of natural hazards (Grelot, 2004) and risk prevention (Treich, 2005). However, limited applications of CBA concerning torrential risks and protection structures in mountains have been carried out (Brochot et al., 2003; Carladous, 2013, 2017). Protection structures reduce the initial risk $R_w(0)$ to a residual risk $R_w(d)$ (Bründl et al., 2009). The economic efficacy of these structures is assessed by comparing the cost of construction and maintenance operations with the actual reduced level of risk ($R_w(0) - R_w(d)$). The result of the CBA is then given by two indicators: the actual net value ANV which represent the difference between the benefit (profit) and the cost and the ratio B/C which represent the ratio of benefit to cost. Consequently, if $ANV > 0$ and if the ratio $B/C > 1$, the proposed strategy is economically profitable. Among several alternatives, the one with the best ANV and the maximum ratio is the optimal decision to make.

CBA is the most widely adopted method to decide which protection strategy should be implemented. Evaluating the reduced level of risk (benefits) provided by each protection measure requires assessing the reduction of risk level on each exposed element. Therefore, based on the type of exposed element (people, assets, etc.) and according to the intensity level of the torrential phenomenon, vulnerability curves (potential damage rate) and monetary values must be respectively established and assessed. Fig. 3.7 shows the general principles of a CBA concerning the choice of an optimal protection strategy to be implemented in torrential watersheds. The figure also recalls some of the existing limitations when dealing with natural risks in mountains.

Carladous et al. have provided a theoretical example where torrential floods threaten roads and houses (Carladous et al., 2014). The authors suggest three strategies for protecting both types of exposed elements: implementing torrent check dams, retention dam or dykes. As a first step, the costs of the situation without protection and the costs of each of the three protection measures are evaluated. Then, flood scenarios having different return period scenarios ($T = 10, 30, 100, \text{ and } 300$), different intensity classes are defined (low, medium, and high) and different consequences on exposed issues are analyzed. compared to the initial situation. Damages, in each situation, are estimated based on several hypothesis. The initial

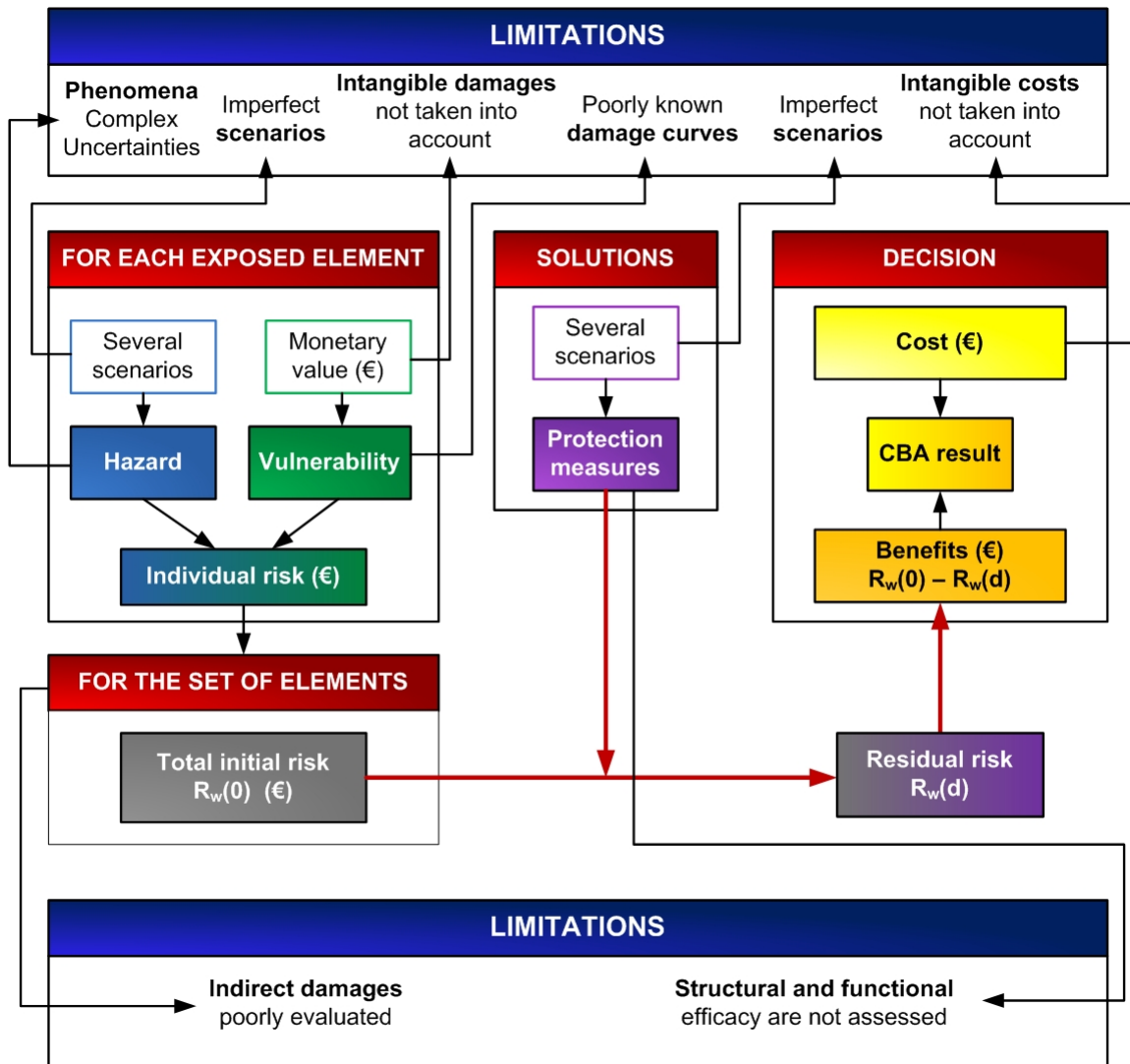

Figure 3.7: Principle and expected limitations of a CBA in torrential risk context (Adapted from and modified after (Carladous et al., 2014)).

risk $R_w(0)$ and the risk associated to each solution $R_w(d)$ are then evaluated. Finally, the CBA indicators (ANV and B/C) are calculated revealing that implementing a retention dam is the most cost-effective solution. However, results were based on adopted assumptions (lifetime period, initial potential damage, monetary value of human life, etc.). Considering alternative assumptions (varying parameters) will probably have a big influence on the economic relevance of each strategy.

Indeed, based on a thorough bibliographic analysis, limitations of a CBA encountered when dealing with multiple decision-making problems related to torrential risk and torrent protection structures are presented below (Carladous, 2013):

- Uncertainties coming from unreliable sources, assumptions and experts opinions.

- Ignorance of intangible damages (e.g. human mortality, impacts on the environment, deterioration of the architectural heritage, impacts on touristic areas, etc.).
- Ignorance of intangible costs (e.g. impacts of a construction on the environment, on landscapes, etc.).
- Lack of comprehensiveness while considering tangible damages due to difficulties in evaluating the rate of damage (e.g. damaged networks, the cost of the dysfunction of public services, etc.).
- Ignorance of non-structural protection measure (e.g. quantifying their efficacy in reducing risk).
- Complexities encountered while assessing the different components of protection structures' efficacy (e.g. stability, functioning).
- Static analysis which assumes that the studied territory, considered hazard scenarios and the efficacy of protection structures will be fixed (no evolution) over several decades (at least 50 years in France).

CBA deals with assessing the economic component of efficacy. It considers only the costs of structures and their efficiency in reducing risk. In order to provide a robust support to decision-makers responsible for managing structural protection measures, experts and engineers must use or develop tools that permit them to evaluate other efficacy components. Multi-criteria decision-making methods are adequate to cope with difficult and complex decision contexts and could help to overcome some of the previously mentioned limitations (Figueira et al., 2005).

3.2.2.2 Multi-Criteria Decision-Making

Decision-Making Problems depend often on several criteria. Multi Criteria Decision Making (MCDM) is a technique used to select, depending on the desired objective, the most optimal strategy with respect to multiple criteria. It aims to sort and compare several proposed strategies according to predefined criteria in the decision-making process. MCDM process consists in:

- Identifying decision context, objectives and decision-makers.
- Defining possible alternatives (strategies) A_i and identifying the criteria C_j that are relevant to the decision problem.
- Assigning scores to measure the efficiency of the alternatives against each criteria.
- Standardizing the scores S_{ij} to end up with a priority score matrix (fig. 3.8).
- Determining a weight for each criterion w_j that reveals how important the criterion is to the overall decision.

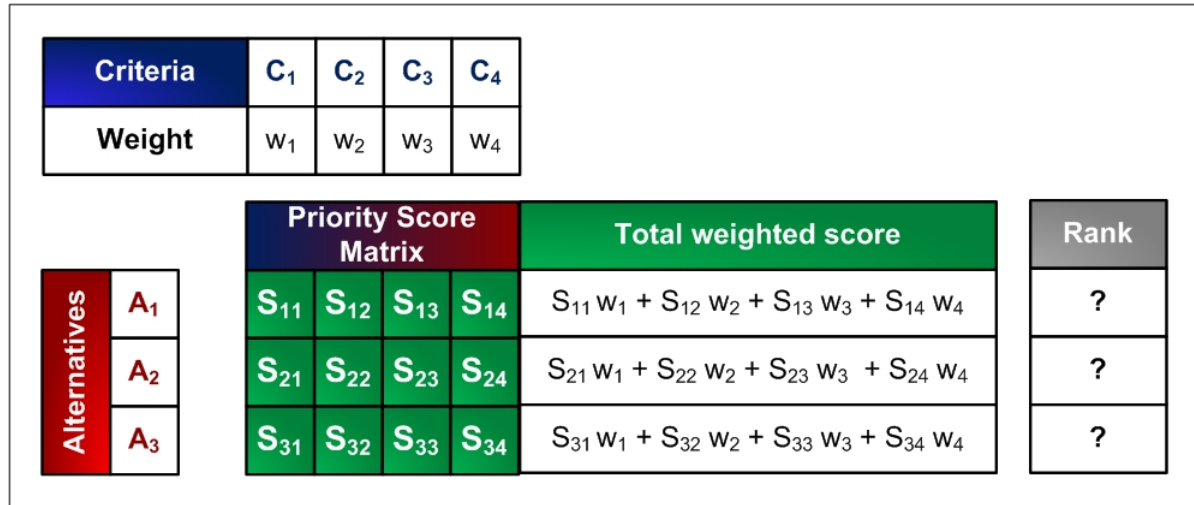

Figure 3.8: MDCM process for prioritizing different alternatives.

- Ranking the alternatives based on corresponding weights and priority scores.
- Performing a sensitivity analysis (varying scores and assigned weights) in order to assess the robustness of the resulted ranking.

MCDM techniques are nowadays widely used for solving decision-making, optimization and predictive problems (Figueira et al., 2005; Tacnet, 2009). In mountains areas, choosing the best strategies for risk prevention or mitigation in addition to protection structures' efficacy assessment and maintenance is a multi-scale decision-making problem involved in the risk management process. Therefore, adopted decision support techniques should have the ability to analyze, at different, scales both the technical (structural and functional) and economic efficacy of protection structures. In this context, a MCDM model was developed (Carladous, 2013; Carladous et al., 2014, 2015, 2016; Carladous, 2017).

3.2.3 Conclusion

Most classical reliability analysis and decision aiding methods are generic in nature but applicable to many fields. One major limitation of these techniques is that they are basic (functional analysis, FMEA) or static (RBD, FTA, ETA, CBA, MCDM) in which they do not take into consideration dependencies between events (hazards, failures), in which only one event can be analyzed at a time and only binary events (either working or failed) can be handled. In other words, such models cannot analyze its evolution with time in which they provide a static vision of the system's efficacy. The main purpose behind these methods is to represent graphically the logic of a dysfunction of a system due to an occurring event, assess qualitatively or quantitatively the system's efficacy and provide useful support to decision-makers concerning the choice of prevention and maintenance strategies. However, they do not account for the time-dependent (dynamic) behavior of the system.

The time-dependent behavior of complex systems remains to be quite challenging in practical cases. To cope with this issue, dynamic reliability analysis and decision aiding approaches should be used, instead of static ones, in order to capture the dynamic response of the system when subjected to deterioration mechanisms or to maintenance operations (Dekker, 1996; Zio, 2009).

3.3 Dynamic Reliability and Maintenance Decision Aiding Approaches

Achieving improvements in the field of system's reliability is strongly linked to the maintenance of the system. In the domain of maintenance management, (i) maintenance strategies are of paramount importance for increasing the efficacy of infrastructures and complex industrial systems and (ii) decision-making is essential for enhancing maintenance budget (Sabaei et al., 2015). Maintenance decisions are mostly made on the basis of qualitative information provided by experts and feedback data resulted after a functional and dysfunctional analysis of the system using classical reliability analysis models. However, optimal decisions are made based on quantitative analysis that assesses the time-dependent evolution of the systems, its dynamic efficacy and the performance (in terms of technical and economic efficiency) of maintenance programs (Zille et al., 2007). Hence, to obtain a complete representation and analysis of a multi-component system, dynamic approach integrating both the complex time-dependent evolution (degradation and failure processes) and the maintenance decision problem should be built.

3.3.1 Maintenance Optimization Policies

In the 1960s, numerous publications propose mathematical models that permit defining the optimal maintenance policy to be adopted (Barlow and Proschan, 1965; McCall, 1965). The first developed maintenance models consider single-component systems and maintenance policies for simple structures (Valdez-Flores and Feldman, 1989). Due to the strong adopted modeling assumptions, results of such approaches were far from reflecting the real behaviour of the system and thus did not support industrial managers and stakeholders concerned about complex and critical systems. Until recently, research on maintenance optimization continues to progress further by improving existing models and developing new ones taking into account multi-component system and complex maintenance strategies (Cho and Parlar, 1991; Scarf, 1997; Bérenguer et al., 2000). More recent publications, develop models that consider the behavior of the maintained system as well as the nature of the implemented maintenance operations by predicting the evolution of the system after different phenomena based on stochastic simulations (Castanier, 2002; Bérenguer et al., 2003, 2004; De Jonge and Scarf, 2020).

Maintenance policies no longer consist of pure replacement strategies but also considers the state of the system. Two types of maintenance operations exist:

Preventive maintenance: applied prior to the complete failure of the system (repair). It aims in reducing the failure probability and to increase the performance level of the system. Besides, this type of maintenance can be either perfect (totally effective) in which it returns the system back to its initial state or imperfect (partially effective) in which it does not necessarily allow the system to return back to its new initial state (Pham and Wang, 1996).

Corrective maintenance: applied after the complete failure of the system (replacement). It aims in restoring the system back to its initial state by replacement of failed components or the system itself.

Within the class of preventive maintenance, several policies such as age-based maintenance (ABM) (Huynh et al., 2012), time-based maintenance (TBM) (Rosmaini and Shahrul, 2012), condition-based maintenance (CBM) (Alaswad and Xiang, 2017), predictive maintenance and prescriptive maintenance can be used. The latter two are more adapted to technological advanced systems. The choice of either one of these policies depends on the depends on the level of information available on the system. In the following, two well adopted maintenance policies are briefly introduced (Rosmaini and Shahrul, 2012).

3.3.1.1 Time-Based Maintenance Policy

Time-based maintenance (TBM), also referred to as periodic maintenance, corresponds to regular maintenance actions carried out on a repairable system at fixed time intervals, regardless of its condition (fig. 3.9). It aims in slowing down the deterioration process by carrying out operations such as inspection, reparation and equipment replacement on a regularly scheduled basis. The main objective of TBM is to maintain the proper functioning of a system and to prevent severe failures from occurring. The chosen time intervals at which maintenance is schedules is based on a reliability analysis, applied prior to maintenance analysis in order to gain knowledge concerning the system's failure data. TBM policy assumes that the deterioration process is predictable based on statistical information and expert knowledge (Gertsbakh, 1977). A TBM policy consists of:

- Gathering failure data (types of failures, severity of each, etc.).
- Analyzing failure data through reliability or statistical models in order to figure out failure characteristics (failure rate trends (bathtub curves), MTTF and MTBF).
- Maintenance decision-making in order to select the optimal maintenance strategy (schedule, repair or replacement) that has the efficiency to provide, at the lowest possible maintenance cost, optimum system's dependability attributes (reliability, availability and safety). Note that this step concerns only systems having an increasing failure rate (wear-out period in the bathtub curve).

TBM is a traditional method, well adopted in the field of maintenance decision-making due to its efficiency in reducing the failure probability of the system. It is also characterized by its simplicity in which it has a low long-term cost and is easy to implement when compared to other maintenance policies (e.g. condition-based maintenance). It does not require additional equipment (e.g. sensors) that reveals whether the system requires maintenance or not. In the contrary, maintenance schedules are consistent and predictable.

Regardless the advantages of TBM, its use is not so suitable for complex systems surrounded by unstable environment. It cannot handle with random catastrophic events in which it do not deal with the actual behavior (e.g. operation) of the system. In other words, it assumes that failures are age-related only and does not consider other causes of failures. Decisions are made on the basis of past experiences, manufacturers recommendations, history of reported failures in addition to maintenance staff and technicians' judgments. Moreover, adopted maintenance schedules could be either too frequent leading to excessive maintenance (non cost-effective) or too infrequent leading to excessive failures. A TBM policy is essentially static.

3.3.1.2 Condition-Based Maintenance Policy

Condition-based maintenance (CBM) is the most modern and popular maintenance policy discussed in literature (Grall et al., 2002). It is based on real-time information about the current state of the system through inspection process. Its main objective is to eliminate unnecessary maintenance operations in which maintenance operation are only carried out when needed. According to the current state of the system, CBM recommends suitable maintenance strategies in order to avoid unnecessary maintenance costs.

It is important to differentiate between a CBM policy and a model of the CBM policy. The policy refers to what is actually done on site (inspecting, measuring the level of deterioration, comparing this level with a given threshold, making decision, etc.). On the other hand, a model associated with a CBM policy is a mathematical tool that makes it possible to assess the cost and the performance of the policy given its variables (inspection frequency, states' thresholds, etc.). Therefore, in order to optimize CBM decisions, a model is required. A CBM model consists of:

- Modeling the dynamic deterioration process in order to represent the state evolution of the system.
- Periodic or continuous inspection of the system in order to detect the degraded state of the system. Periodic inspections are performed at fixed time intervals by visual observations (humans). Continuous inspections are performed continuously using specific measuring devices (e.g. sensors).
- Maintenance decision-making in order to plan and schedule appropriate maintenance strategies (No maintenance needed, repair or replacement is needed).

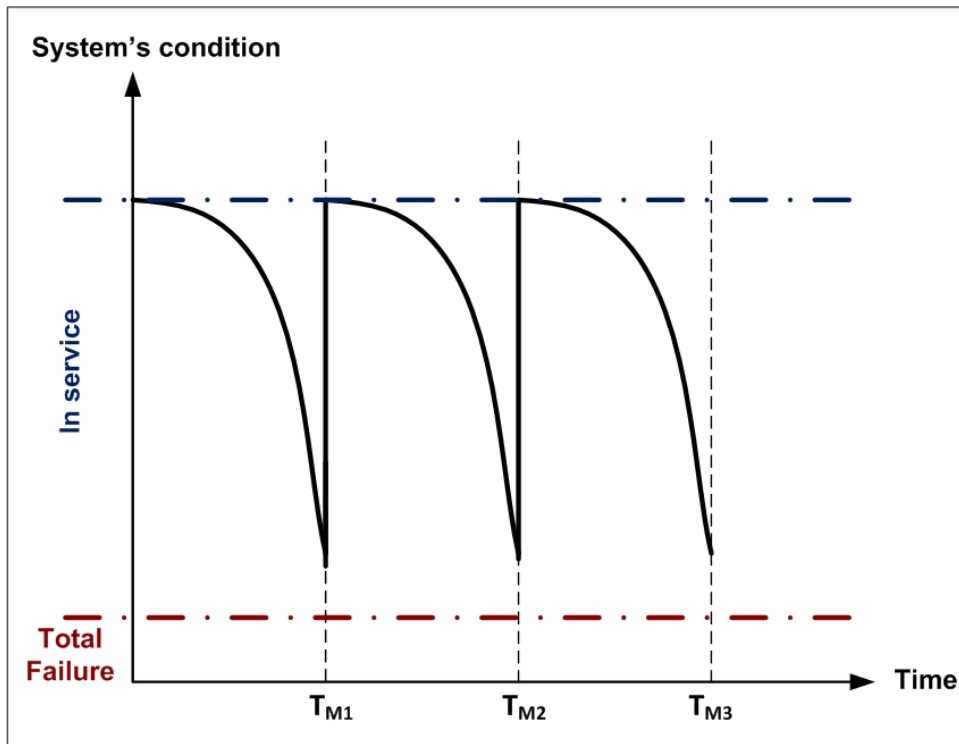

Figure 3.9: Example of a TBM policy.

Modeling and assessing a CBM policy involve representing the state evolution of the system (Alaswad and Xiang, 2017). Depending on the state detected after inspection, the decision may be either a preventive, or a corrective maintenance, or neither any. The degradation level is linked to a degradation indicator (e.g. width of cracks), whose evolution is modeled over time (fig. 3.10). Based on this indicator, experts can specify thresholds or critical values and associate them to intervals. Each interval corresponds to a degraded state of the system. Consequently, the system is replaced (corrective maintenance) if inspection reveals that the degradation indicator corresponds to a totally failed state or repaired if the degradation indicator lies in states where reparation (preventive maintenance) can still be applied to extend the lifetime period of the system.

In order to implement a CBM policy, three types of decisions must be taken (Tsang, 1995):

- Identifying the indicators to be monitored. Note that several degradation indicators may correspond to one type of failure.
- Determining the inspection frequency (how often should inspection take place).
- Figuring out triggering limits (thresholds).

The inspection frequency and the thresholds represent the decision variables of the CBM policy. They have to be optimized using a maintenance model assessing the cost and the performance of the decision as a function of these variables.

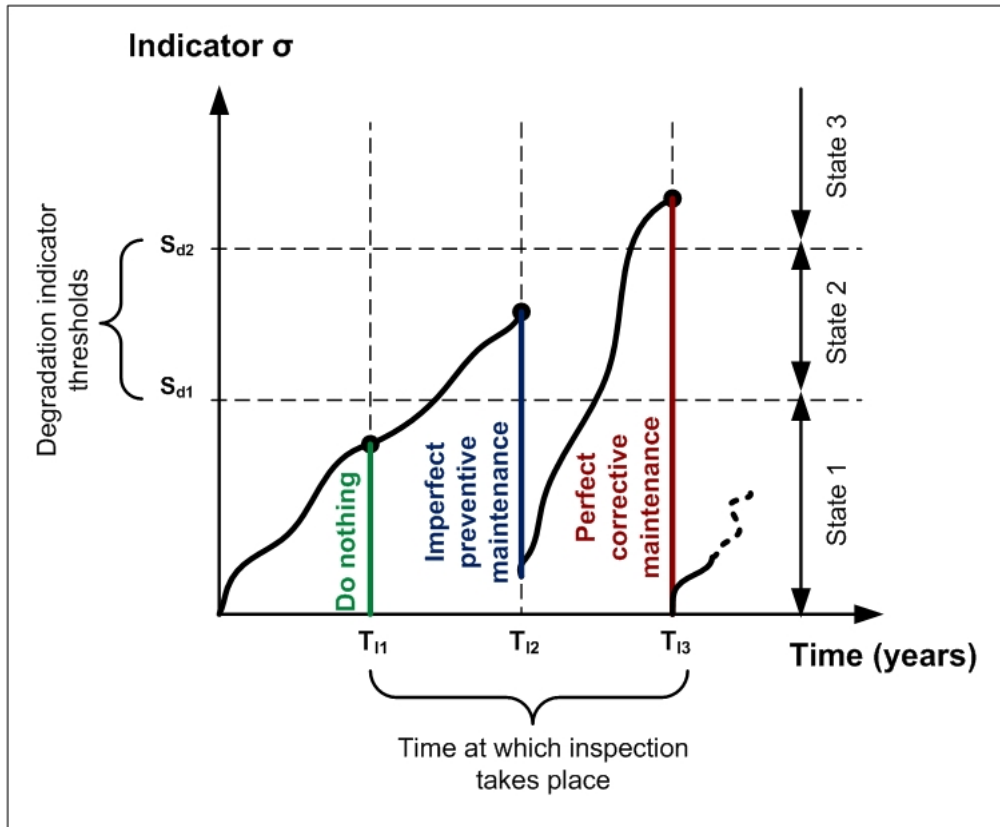

Figure 3.10: Example of a CBM policy.

Fig. 3.10 is an example of a CBM applied to a system considering a specific indicator σ . It illustrates the inspection process, critical values (thresholds) upon which preventive or corrective maintenance is carried out and the evolution of the deterioration rate after each maintenance operation. The example reveals that:

- Inspection is carried out periodically over an interval $[T_{I_i}, T_{I_{i+1}}]$ where the index i corresponds to the i^{th} inspection.
- Two maintenance thresholds are identified (σ_1 and σ_2)
 - if $0 \leq \sigma \leq \sigma_1$, no maintenance is required.
 - if $\sigma_1 \leq \sigma \leq \sigma_2$, preventive maintenance is required.
 - if $\sigma \geq \sigma_2$, corrective maintenance is required.
- Both perfect and imperfect preventive maintenance operations can be applied.

CBM has been used in several engineering domains especially for mechanical, electrical, transportation, and industrial applications (Oke, 2004). Nowadays, there is a strong direction towards the use of CBM policy for maintenance modeling of civil engineering infrastructures

(Arismendi et al., 2021; Sancho et al., 2021). Its main goal is to perform a real-time assessment concerning the condition of the system in order to make appropriate maintenance decisions, thus reducing unnecessary maintenance and related costs (Gupta and Lawsirirat, 2006). Nonetheless, optimizing the decision variables of a CBM policy requires a maintenance cost model associated to this policy.

3.3.2 Dynamic Approaches for System Deterioration and Maintenance Modeling

Dynamic reliability models are partially or totally free from the limitations of basic and static models. They often rely on the use of stochastic processes (Dutuit et al., 1997; Signoret, 2009). These models are partially or totally free from the limitations of basic and static models in the sense that can explicitly model the evolution of the system's deterioration until failure and they can integrate the effect of maintenance actions on this deterioration. Stochastic models (Markov-based models or semi-Markov models) allow proceeding to time-random experiments and analyzing systems behavior, being therefore superior to other modeling techniques while dealing with deterioration processes (Frangopol et al., 2004). They are statistical techniques that considers the variability through the use of probability. They are used to understand the distribution of times within a deterioration process and thus to predict system's efficacy.

The deterioration process of a system can be either modeled by continuous or discrete stochastic processes (Alaswad and Xiang, 2017). Continuous-space stochastic process is used to model the time-dependent deterioration of systems which do not have a finite number of states. This type of process is adopted when it is difficult to classify the multiple states of a system due to its gradual evolution over time (Grall et al., 2002; Bérenguer et al., 2003; Hao et al., 2020; Guo et al., 2020). On the other hand, discrete-space stochastic process is used to model the time-dependent deterioration of systems which have a finite number of states. In some applications it is more reasonable to classify the conditions of the system by a finite set of deterioration states. Indeed, discrete-space stochastic approaches are recently well adopted for dynamic reliability analysis of critical civil infrastructures (Le et al., 2017; Arismendi et al., 2021).

In the case of discrete-space stochastic modeling, the deterioration process is modeled according to the transitions between the discrete deterioration states. Transition times are considered to be random because it is difficult to predict them without uncertainty. The deterioration process of the system can be then modeled using a continuous-time discrete-space stochastic process. Moreover, in addition to the deterioration mechanisms, the state of the system changes according to the scheduled maintenance operation. In the following sections, two well known discrete-space modeling approaches that can handle such problems are presented.

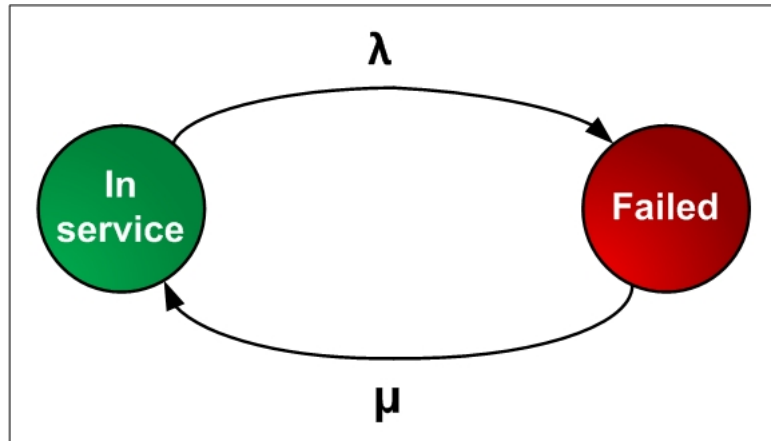

Figure 3.11: Example of a simple Markov chain.

3.3.2.1 Markov Chains: Stochastic Markov Process

Markov chains, named after the Russian mathematician Andrey Markov (Markov, 1951), are discrete-space Markov process that represent the set of states (state space) that a system can reside in. At each time step, the system can be only found in one of the states. Graphically, a discrete Markov chain consists of finite number of states represented by circles in addition to transition arcs that connect the state to each others. Each arc is associated with a value representing the probability (for discrete-time Markov process) or a rate (for continuous-time Markov process) that the system moves from one state to another during a given time.

In order to support maintenance decision-making, Markov chain must involve both stochastic deterioration and maintenance processes. For a continuous time discrete Markov chain with a maintenance process, an arc can either be associated to a failure rate (λ) or to a repair rate (μ). Fig. 3.11 provides an example of a simple Markov chain describing the random process concerning the operation of a system. In the case of an exponential distribution, λ and μ are constant with:

$$\lambda = \frac{1}{MTTF} \quad (3.25)$$

$$\mu = \frac{1}{MTTR} \quad (3.26)$$

In the case of complex systems, interactions between functional and dysfunctional behaviors increases, the complexity of the model increases. The objective of Markov chains is to assess the probability of the system to be in each of the involved states or conditions and thus supports maintenance decision-making depending on the efficiency of the maintenance actions on increasing the availability time of the system depending on their frequency. Markov decision processes are used across a wide range of application for modeling stochastic deterioration processes and optimizing maintenance strategies. They have been applied considerably

to critical infrastructures in civil engineering (e.g. bridges) or in oil and gas industry (e.g. gas networks) (Kallen, 2007; Compare et al., 2020; Tao et al., 2021; Arismendi et al., 2021).

Markov chains or Markov processes represent a memoryless stochastic process. They follow a Markov property which states that the probability of being in a state during the next step does not depend what happened in prior steps but only on the information present in the current state. In other words, within a pure discrete-state Markov process, the ageing within a state cannot be modeled. Moreover, a continuous-time Markov process assumes that the transition times between states follows an exponential distribution. However, constant failure rates are not always appropriate for modeling a system's deterioration process (Le and Andrews, 2016b). Although these assumptions are adopted in order to reduce the model's complexities, they may not reflect the real behavior of the system and thus may significantly influence the reliability of the results (Morcoux, 2006; Thomas and Sobanjo, 2013). In order to have a vision closer to reality, models that allow to have any continuous-time probability distribution (e.g. Weibull, Gamma, etc.) are used. These models refer to semi-Markov process (Howard, 1971).

3.3.2.2 Stochastic Petri Nets

Petri nets (PNs) are graphical and mathematical tools used to describe and analyze existing processes (e.g. failure, repair, etc.) arising in systems with different components (Signoret, 2009). Carl Adam Petri was the German who invented the graphics and the rules of PNs in the 1962 to be used in automation systems (Petri, 1962). PN models were then implemented to analyze dependability attributes of production systems (Dutuit et al., 1997). Since then, PNs have passed through many developments and improvements so that they were applied in several domains. This development has been accomplished by using stochastic Petri nets (SPNs) and by moving from analytical calculations to Monte-Carlo simulations which is generally used for reliability analysis of complex systems (Zio, 2013).

PNs are capable of representing discrete states and transitions between these states. A PN model mainly consists of four different elements (fig.3.12):

Places: finite set $P = \{P_1, P_2, \dots, P_n\}$ symbolized by circles. They correspond either to states that reflect specific conditions of the system conditions or to resources that need to be met or to be available before an action can be carried out.

Tokens: finite set $M = M(P_1), M(P_2), \dots, M(P_n)$ where $M(P_i)$ is the number of tokens in place P_i . Tokens are symbolized by small solid (black) circles. Their presence in a given place means that the corresponding condition is fulfilled or that a resource is available.

Transitions: finite set $T = \{T_1, T_2, \dots, T_n\}$ symbolized by rectangles. They correspond to events/actions that occur after a specified time. They are responsible for the movement of tokens from one place to another

Arcs: symbolized by arrows. They link places to transitions and vice versa. Each arc in the model should be associated with a multiplicity/weight w (natural number). If the



Figure 3.12: Elements involved within a PN model.

multiplicity is not shown above the arc, this means that it is by default equals to one. Below are the features describing the links between places and transitions:

- Set of input places of T_j :

$$I(T_j) = \{P_i \in P | w^-(P_i, T_j) > 0\} \quad (3.27)$$

- Set of output places of T_j :

$$O(T_j) = \{P_i \in P | w^+(P_i, T_j) > 0\} \quad (3.28)$$

- Set of input transitions of P_i :

$$I(P_i) = \{T_j \in T | w^+(P_i, T_j) > 0\} \quad (3.29)$$

- set of output transitions of P_i :

$$O(P_i) = \{T_j \in T | w^-(P_i, T_j) > 0\} \quad (3.30)$$

The operation of PNs concerning the movement of tokens is governed by the following rules (Aubry et al., 2016):

1. **Transition enabling:** a transition T_j is enabled if:

- (i) each of its input places is marked by a number of tokens $M(P_i)$ at least equal to the multiplicity of the arc connecting it to T_j . This can be given by:

$$M(P_i) \geq w^-(P_i, T_j) \quad \forall P_i \in I(T_j). \quad (3.31)$$

- (ii) T_j under the action of an inhibitor arc. Inhibitor arcs are special type of arcs usually represented by dashed arrows and can be only directed from a place to a transition. If the transition is connected to an inhibitor arc and the input place attached to this arc has a number of tokens equals to the multiplicity of the arc, the transition will be inhibited from being enabled.

2. **Transition firing time:** each transition is associated with a specific firing time which represents the sojourn time of a token in a given place. It is a necessary data that control the simulation of the PN model. Firing delay times can be either be deterministic (deterministic timed Petri nets DTPNs) or probabilistic (stochastic Petri nets SPNs). SPNs are more often used due to some limitations of DTPNs in modeling the behavior of complex systems.

3. **Transition firing:** it is considered as an elementary event describing the evolution of the system. When the transition time associated to the enabled T_j is reached, T_j fires removing tokens from the input places $I(T_j)$ and depositing tokens in the output places $O(T_j)$ according to their arc multiplicities. Suppose that M_b is the number of tokens before firing of T_j and M_a is the number of tokens after firing of T_j , then:

$$\forall P_i \notin I(T_j) \cup O(T_j) \Rightarrow M_a(P_i) = M_b(P_i) \quad (3.32)$$

$$\forall P_i \in I(T_j) - (I(T_j) \cap O(T_j)) \Rightarrow M_a(P_i) = M_b(P_i) - w^-(P_i, T_j) \quad (3.33)$$

$$\forall P_i \in O(T_j) - (I(T_j) \cap O(T_j)) \Rightarrow M_a(P_i) = M_b(P_i) + w^+(P_i, T_j) \quad (3.34)$$

$$\forall P_i \in I(T_j) \cap O(T_j) \Rightarrow M_a(P_i) = M_b(P_i) - w^-(P_i, T_j) + w^+(P_i, T_j) \quad (3.35)$$

For an easier calculation of the number of tokens marking each place, one can use a transition matrix, equal to the difference between the forward matrix and the backward matrix. These matrices are defined as follows:

Backward Matrix

$$W^- = \begin{pmatrix} W^-(P_1, T_1) & \cdot & \cdot & \cdot & W^-(P_1, T_m) \\ \cdot & \cdot & \cdot & \cdot & \cdot \\ \cdot & \cdot & W^-(P_i, T_j) & \cdot & \cdot \\ W^-(P_n, T_1) & \cdot & \cdot & \cdot & W^-(P_n, T_m) \end{pmatrix} \quad (3.36)$$

Forward Matrix

$$W^+ = \begin{pmatrix} W^+(P_1, T_1) & \cdot & \cdot & \cdot & W^+(P_1, T_m) \\ \cdot & \cdot & \cdot & \cdot & \cdot \\ \cdot & \cdot & W^+(P_i, T_j) & \cdot & \cdot \\ W^+(P_n, T_1) & \cdot & \cdot & \cdot & W^+(P_n, T_m) \end{pmatrix} \quad (3.37)$$

Transition Matrix

$$W = W^+ - W^- \quad (3.38)$$

Note that the j^{th} column of W corresponds to the firing of T_j .

Fig. 3.13 is an example of a simple PN with two transitions. Based on the initial distribution of tokens, transition T_1 is enabled. Upon its firing, the number of tokens in each place is calculated according to Eq. 3.36, 3.37 and 3.38. Fig. 3.14 is an example of a PN containing an inhibitor arc. As seen in the figure, T_1 is disabled and will not fire as long as there is a token in P_4 . This means that over the life time period of the components/system represented by this PN, only T_2 can be fired. Thus the system can only moves to P_3 but never to P_2 .

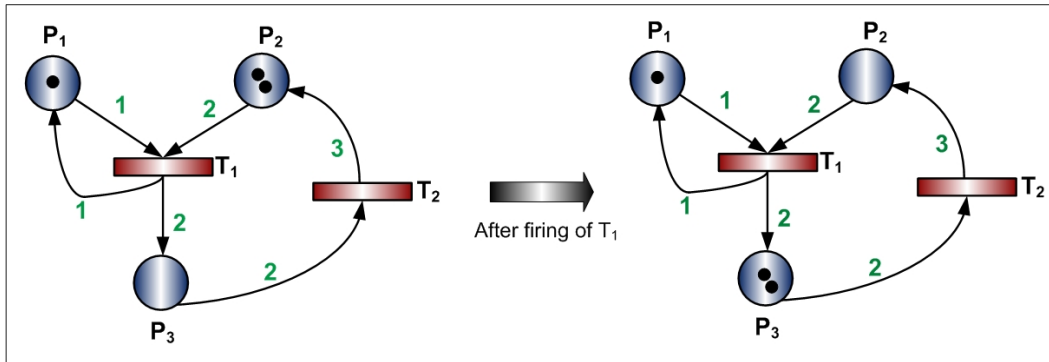

Figure 3.13: Transition firing rule - PN example (Aubry et al., 2016).

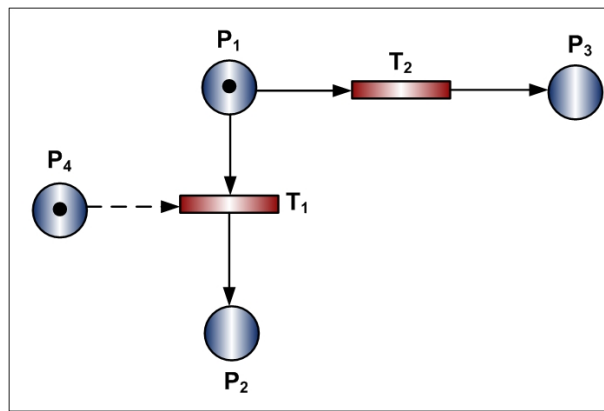

Figure 3.14: Transition firing in the presence of an inhibitor arc.

Note that if no token is present in P_4 , there will be a conflict between transitions T_1 and T_2 in which only one transition should be enabled. However, the transition whose associated event occurs first (depending on its deterministic time or probabilistic rate) will fire first. In the case when both transitions have the same transition time, firing priorities should be assigned to each transition.

SPNs, are an extension of PNs that take into account stochastic variables, in which the transitions are associated to probabilistic distributed firing times. Generally, for the evaluation of SPN based-model, the principle of Monte-Carlo simulation is used. Monte-Carlo simulations are a wide category algorithm that depend on repeated random sampling in order to obtain numerical results. In principle, they are used to solve issues having a probabilistic interpretation and make it possible to estimate the solutions of a mathematical problem starting from random numbers. They represent a technique which aims to understand mainly risk, uncertainty and forecasting models. Monte-Carlo simulations were named based on the gambling games in Monaco, due to the fact that the drawing of random numbers is similar to the principle of roulette, dice and slot machines (Dubi, 2000). They have been used in several dependability studies (Billinton and Pan, 2000; Barata et al., 2002). Once the SPN model is constructed and the lifetime period t_f of the system (duration of simulation) is identified, Monte-Carlo simulation starts and the tokens keep on moving around the model until t_f is

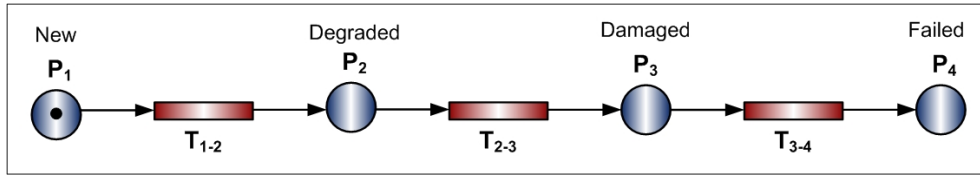

Figure 3.15: System's degradation process represented by a simple PN.

reached. Applying this type of simulation to SPN models and repeating the draw of a random value several times (simulating different stories), provide statistical estimates of specific quantities of interest such as the mean residing time of tokens in each place and the average number of firing of each transition.

Models based on SPNs are able to represent the dynamic behavior of a system subjected to discrete events depending on probabilistic transitions between the states of the system. Fig. 3.15 provides an example of a deterioration process of a system. In this example, it is assumed that the system can reside in four different states reflecting four different conditions: new, degraded, damaged and failed. The states are represented respectively by places $P_1 - P_4$. T_{i-j} corresponds to the transition from state i to state j . In a SPN model, transitions are stochastic in which they are associated to specific probability laws.

In reliability engineering, the combination of SPN with maintenance decision policies has recently been used as a decision support tool for risk assessment, reliability analysis and maintenance optimization of complex systems (Zille, 2009; Andrews and Fecarotti, 2017). In the context of critical civil infrastructures, railway networks and railway bridges are multi-component systems that may be subjected to several types of failures. Therefore, railway assets need to be regularly inspected and maintained in order to ensure safety and prevent accidents. However, their maintenance costs much and leads to traffic stop. This necessitates a maintenance decision-making model that compares different maintenance strategies depending on their efficiency in increasing system's availability, costs, and maintenance scheduling times. A research work by (Andrews, 2013), has proposed a modeling approach using SPNs in order to assess the efficacy of different maintenance strategies applied on a deteriorating railway track geometry. Besides, Le and Andrews have developed a complete bridge model using SPN (Le and Andrews, 2016b). The deterioration, inspection and maintenance processes for each component (deck, girder and abutment) of the bridge was explained separately using a sub-Petri net. The complete bridge SPN model has also represented dependencies and interactions between the deterioration of the different components of a bridge. Moreover, Le et al. has also described in details the development of a bridge maintenance model based on SPN (Le et al., 2017). A more Recent study has revealed that SPNs are the most suitable techniques that permit having an effective degradation modeling and maintenance optimization for railway assets (Litherland, 2019).

Furthermore, some researchers have adopted the used of colored stochastic Petri nets (CSPNs), an extension of SPNs for similar modeling objectives (Shang, 2015; Yianni et al., 2017). The specific feature of CPNs is that they allow differentiating between tokens of different values depending on their color (Zimmermann, 2008). Other extensions of SPNs,

such as stochastic activity networks (SANs) could be also used for reliability analysis (Sanders and Meyer, 2001). Available studies in the field of deterioration modeling and maintenance optimization highlight the crucial issues that should be given deep attention in order to reach a high quality model adequate to solve industrial and economic problems in an effective way.

A hybrid approach integrating stochastic process via Monte-Carlo simulation such as SPNs for system's reliability analysis in addition to maintenance decision policies such as CBM policy have drawn the attention of the specialists in dependability fields. It offer a flexible and efficient technique to model the dynamic deterioration and maintenance processes of complex systems.

On the other hand, SPNs are based on defining both system's states and probabilistic transition laws between the states. This reveals that these stochastic transitions are crucial elements in representing the behavior of the system. Indeed, one main difficulty confronted while modeling the dynamic deterioration process of a system using SPNs lies in estimating transitions' probability laws. Figuring out these laws is not an easy task, especially when no or few monitoring data are available. Therefore, most researchers assume an exponential distribution as a starting point because of the simplicity in considering a constant failure rate. However, others consider that constant failure rates corresponding to exponential distribution are rarely appropriate for deterioration modeling because they cannot model properly the aging of the system. Generally, stochastic processes involving specific statistical distributions are used to model the degradation process in order to estimate transition laws between different degradation levels of deteriorating systems or components (Shafiee and Sørensen, 2019). For example, Weibull distributed state transition times (Le and Andrews, 2016a,b; Le et al., 2017; Ferreira et al., 2019; Litherland, 2019; Ferreira et al., 2020), Gamma processes (Shang, 2015; Tao et al., 2021), Markov processes (Bressi et al., 2021) and compound Poisson processes (Yang and Frangopol, 2019) have been adopted for modeling the time-dependent evolution of degradation indicators (e.g. scour, corrosion, etc.) of civil engineering infrastructures (e.g. building facades, railway networks, bridges, wind turbines, etc.). The choice of the degradation process model relies either on available failure data (e.g. recorded times-to-failure), degradation indicators classified or measured during periodic inspections, or on experts' judgments. Yet, a mathematical description of the physical mechanism underlying this process is often not available (Biondini and Frangopol, 2016). Therefore, determining or justifying the choice of transition laws remains an issue while designing and implementing SPN models.

3.3.3 Conclusion

In order to make optimal economic and risk management decisions regarding when and how to maintain a deteriorating system, knowledge concerning the deterioration process should be gained first. For this purpose, dynamic modeling approaches should be adopted. Dynamic reliability tools and decision-making methods complement each other so that are able to model cooperatively deterioration, inspection and maintenance processes.

SPNs extend and complement existing methods that provide only static efficacy assessment. The application of SPNs in most previous studies focus on industrial systems and/or mechanical components (Lee and Mitici, 2020). Their use for assessing civil engineering infrastructures is a recent research field. At the same time, there is a strong direction towards the use of CBM decision policy in the asset management and maintenance research community. Instead of maintenance based on fixed intervals, CBM analyzes and monitors the state of an asset in order to decide which maintenance strategy should be implemented. Indeed SPN models implementing CBM decision policies have recently been used as a decision support tool for risk assessment and management especially in the domain of complex systems' maintenance optimization. Yet, describing the real behavior of a deteriorating system is not so easy. It requires identifying all types of failures the system may be subjected to, understanding interactions between failures and the different components of the system in addition to analyzing the degradation mechanisms due to failures and existing dependencies. Such detailed description and analysis support risk managers and decision-makers to easily define conditional maintenance strategies. Therefore, a hybrid approach can be a result of coupling a physics-based model that models, physically, the deterioration process with a dynamic reliability-based approach (CBM, SPNs, Monte-Carlo) that supports maintenance decision-making (Vasilyev, 2019).

To sum up, given the analysis made on the different modeling options, SPN is revealed to be an adequate tool that adapts to the project's needs. Yet, modeling through SPNs still show a significant limitation. The transition probability laws corresponding to the transition times between the states involved in the deterioration process are not based on physical modeling. On this basis, the present research project contributes to fill this gap and to propose a comprehensive modeling framework in which the transition laws used in the SPN model are learnt from a prior physics-based model that makes it possible to estimate these laws.

Although such integrated approach seems to be the best, one should be aware about the validity of model's outputs which in turn affects the adequacy of undertaken decisions. Whatever the type of system, events and failures to be analyzed, the maintenance decision process starts by data acquisition. Apparently, all decisions are influenced by the quality of the used data, the credibility of sources (database, experts) from which these data were acquired and by the reasonability of adopted scenarios and assumptions. The fact that information imperfection propagates between the different stages of the process puts risk managers, stakeholders and decision-makers in a doubt whether the the final adopted decisions are optimal or not. Consequently, propagating information imperfection involved in each stage in sequence, enables continual improvement in decision-making.

3.4 Information Imperfection Analysis and Traceability Techniques

Improper decision-making could result due to the ignorance of information imperfection. Not considering the uncertainty of the model's outputs due to imperfection of input data and/or due to errors in computational simulation may cause low robust and reliable decisions, costly warranty, low satisfaction and dramatic consequences due to totally inappropriate decisions (Du and Chen, 1999; Huang, 1995). Due to the complexity of critical infrastructures and the necessity to attain high efficacy, identifying, and managing existing uncertainties have become compulsory. Therefore, achieving wise decisions requires theoretical frameworks that enables representing and combining all types of information imperfection presented in section 2.3.1. This section presents, briefly, some classical theories and approaches used to represent and propagate uncertainty in natural risk context.

3.4.1 Theoretical frameworks representing different types of information imperfection

Natural risk assessment and management correspond to situations where there is low availability of data. In such cases, experts' judgements are required to compensate for this lack of data. Several theories already exist in order to cope with information imperfection and decision-making processes. Those mainly adopted in natural risk context are briefly reviewed below and illustrated in fig. 3.16.

Probability theory is a classical approach, widely used in natural hazard context to characterize and propagate aleatory uncertainty in the model by assuming probability distributions (e.g. normal, log-normal, Weibull, Gamma, Poisson, etc.) for uncertain variables estimated by experts (fig. 3.16, a). The Monte-Carlo method is the most to propagate aleatory uncertainty. Probability theory is practical but has some limitations. On the one hand, in the absence of sufficient data, the analysis will be subjective rather than objective. In this case, the used probability distributions and their associated parameters will depend on expert knowledge and not on statistical analysis based on real data. On the other hand, it only deals with stochastic processes of uncertainty and do not allow representing all forms of information imperfection (e.g. epistemic uncertainty).

Possibility theory (Dubois, 1989) extends probability theory by being able to model imprecise information (one feature of epistemic uncertainty) using possibility distributions. It deals with intervals instead of single evaluations (fig. 3.16, b). Indeed, it better reflects the imprecision that prevails expert judgment. Considering a given parameter Q (e.g. discharge of a flood event), the expert proposes intervals with a specific confidence level. For example, he could propose $Q \in [2.5m^3/s, 4.5m^3/s]$ with 75% level of confidence while he could be certain (100% level of confidence) that $Q \in [2m^3/s, 5m^3/s]$. Consequently, the wider the interval is, the more confident the expert is.

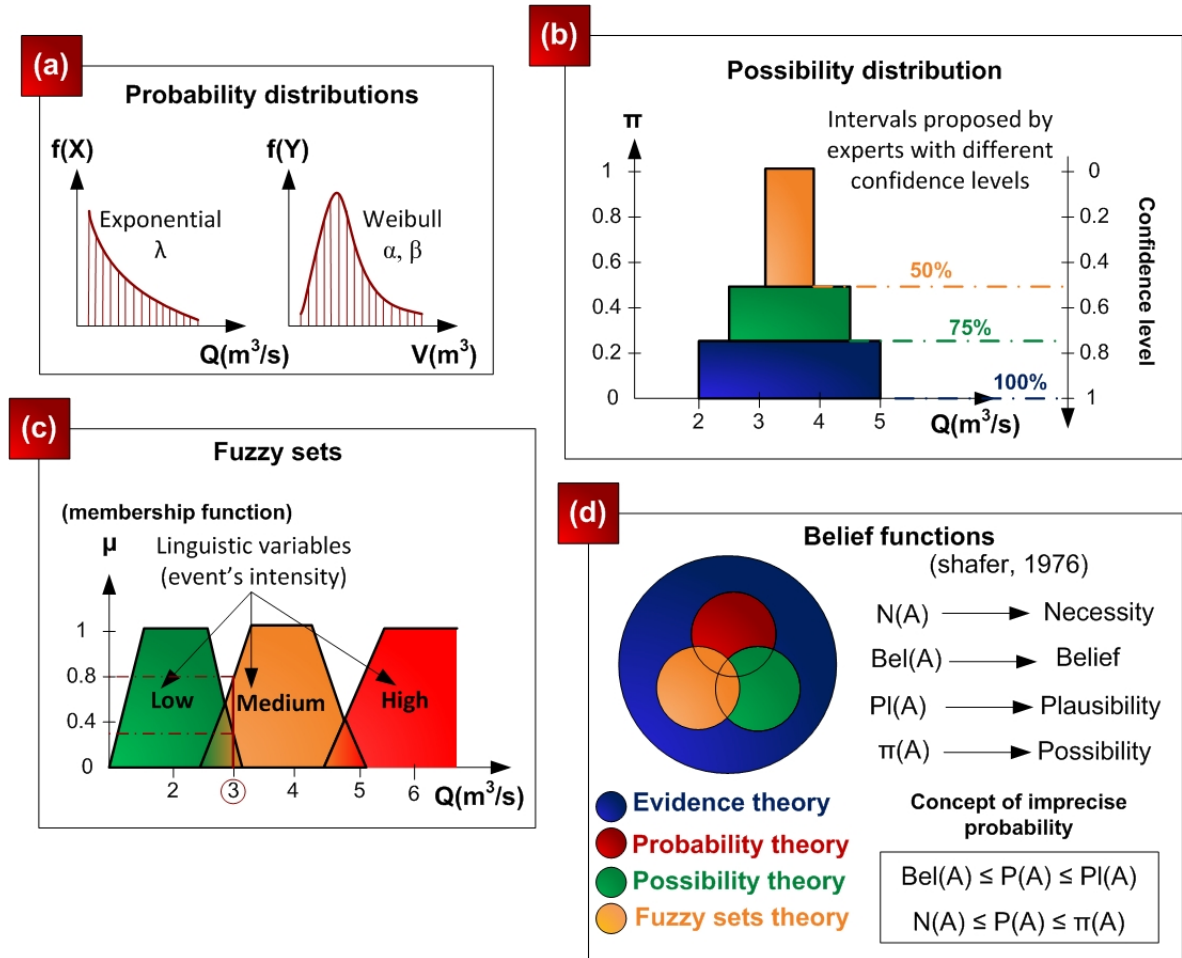

Figure 3.16: Classical theories adopted in risk context for representing different types of information imperfection.

Fuzzy sets theory (Zadeh, 1965) deals with ambiguous information and imprecise evaluations. Fuzzy numbers allow incorporating randomness on parameters. They also relates ambiguous (e.g. linguistic) variables to numerical (quantitative) values. In the example given in fig. 3.16, c, a discharge $Q = 3m^3/s$ belongs with a high membership level (0.8) to the category of medium intensity event whereas it belongs with a low membership level (0.35) to the category of low intensity event.

Evidence theory (Shafer, 1976b) (also called belief function theory) provides a powerful mathematical formalism that combines information or evidences acquired from conflicting sources (information fusion) in order to reach a degree of belief represented by a mathematical belief function. It represents imprecision, randomness, inconsistency and incompleteness in the provided information. It is a mix between probability, possibility and fuzzy theories which is therefore able to quantify both aleatory and epistemic uncertainty (fig. 3.16, d). Generally, it is well adopted for decision-making under the effect of information imperfection. However, for large sets (e.g. several sources, evidences,

possible events, etc.), the evidence theory requires high computational efforts.

In the context of natural risk analysis, the different types of imperfection are encountered. Separately, classical theories fail to cope with all aspects of imperfection. Therefore, it is essential to seek for other alternatives that consider the heterogeneous, ambiguous, imprecise and conflicting information actually accessible by risk managers, decision-makers and stakeholders.

3.4.2 Hybrid Approaches for Uncertainty Analysis

Numerical analyses are widely used for analyzing the behavior of protection structures. These models depend on variables whose determination is often imperfect. The quality and the validity of the model's results varies depending on the initial adopted hypotheses.

Probabilistic models and Monte-Carlo simulation are most often used for representing aleatory uncertainties and propagating them through the models. However, uncertainty analysts agreed on the fact that probabilistic approaches are not adequate for modeling epistemic uncertainties (Walley, 1991). Indeed, recent approaches differentiate between aleatory and epistemic uncertainty and model them by means of different theories but still within an integrated framework (Helton and Oberkampf, 2004). For example, in risk context, aleatory uncertainty is usually modeled by conventional probability distributions and epistemic uncertainty by possibility distributions or fuzzy calculus (Chojnacki et al., 2010; Dupouy et al., 2012).

Combining the theories of probabilities, possibilities, fuzzy sets and belief functions makes it possible to represent both variability (randomness) and imprecision, related to the imperfect knowledge provided by experts regarding different variables involved in the model. Such integrated frameworks, often referred to as 'hybrid' approaches, have been highly appreciated for addressing different aspects of information imperfection, especially in risk assessments.

Concerning protection structures' management, there are different tools and methods for assessing their efficacy. The approaches are known but still based on assumptions that are not always formalized or accessible. Carladous proposed a methodology to improve the assessment of protection works efficacy based on MCDM which considers both, the technical (structural and functional) and the economic components of efficacy taking into account information imperfection (Carladous, 2017). The developed approach has coupled dependability analysis tools with evidential reasoning based-decision-aiding methods (ER-DAMs). Static dependability tools (e.g. FMEA) were used in order to describe several decision-making problem. After, fuzzy sets and possibility theories, has been adopted in order to assess structures' efficacy and to support decision-making under the effect of information imperfection. Tacnet et al. have proposed approaches for natural risk assessment also adopting ER-DAMs methods. The approaches combines analytic hierarchy process (AHP) (Saaty, 1980), an analysis based on multi-criteria decision making (MCDM) in addition to fuzzy sets, possibility and belief function theories in order to consider information imperfection, source reliability, and conflicts

(Tacnet, 2009; Tacnet et al., 2010, 2014; Tacnet et al., 2017). Until recently, approaches based on ER-DAMs are adopted in the specific context of natural risks and protection structures management. However, the application of ER-DAMs to debris flows revealed that a hybrid approach that uses possibility distributions is a flexible tool able to formulate and assess expert knowledge (Dupouy et al., 2012).

A very recent hybrid approach has been developed and implemented within an R package called "HYRISK" (Rohmer et al., 2018). It is dedicated to handle information imperfection and its propagation in applications dealing with quantitative risk assessments. The R package uses hybrid representations of uncertainty, providing functions that jointly handle aleatory (represented by probabilities) and epistemic (represented by possibility distributions, intervals, fuzzy numbers or parametric probability categories, p-boxes) uncertainty. Therefore, HYRISK fills the gap previously identified by treating, altogether, different types of imperfection encountered while quantitatively assessing risk. However, this approach has not been yet applied to models that concern protection structures' efficacy assessment.

3.4.3 Conclusion

Several research works have dealt rigorously with information imperfection in a wide range of risk and engineering fields. The reason behind this is that the quality of decisions rely on the outputs of the developed decision-making models which in turn rely on the used input data, assumptions and expert judgments which may not be completely valid. Aleatory (randomness) and epistemic (imprecise, incomplete, inconsistent) uncertainty are therefore such models. They can be viewed as the difference between the actual state of knowledge and the real complete knowledge. From a realistic point of view, decision-makers should be aware that, at every stage of the decision-making process, they should not rely on information acquired from methods that do not incorporate uncertainty analysis.

Information imperfection can be represented and propagated using different theories depending on its type. Random variables or stochastic processes are used to model aleatory uncertainty using probability theory when sufficient statistical data are available for estimating probability distributions. On the other hand, possibility theory was revealed to be very adequate to model epistemic uncertainty. It is therefore necessary to categorize uncertainties involved within a model so that each category can be modeled separately (Kiureghian and Ditlevsen, 2009). Consequently, hybrid approaches such as HYRISK that integrate both probability and possibility theories should be adopted for a thorough uncertainty analysis.

In the context natural risk management in mountains, the quality of information, reliability of sources, credibility in assumptions and conflicts between experts could result in all types of information imperfection. The assessment of protection structures' efficacy necessitates a huge amount of information. The outcomes of the developed physical, reliability and decision-aiding models that supports protection structure's maintenance decision-making depends on the adopted hypothesis, principals and assumptions. Consequently, there is a need for a multi-disciplinary approach that combines these models with uncertainty theories and

approaches in order to have a reliable assessment of protection structures' efficacy and thus reasonable maintenance decisions.

Given the different modeling options available in the literature, SPN is found to be the most adequate dynamic tool that allows the stochastic modeling of both deterioration and maintenance processes of a complex system. However, in order to integrate all the scientific and technical challenges that are still missed in the literature, some extensions and new developments are required. These developments highlights the novelty of this research work and its main contributions, presented in the next section.

3.5 Research Novelty: New Developments Beyond the State of the Art

Our lives, society and economy depend on a group of interconnected critical infrastructures (CIs), which provide essential products and services. Protection structures/systems in mountains are so critical. Their structural and operational safety must be always ensured so that they keep on providing a sufficient protection to exposed issues against torrential phenomena. The danger exposed to people, economy, and the society as a whole due to the deterioration of these systems highlights the importance of developing approaches for modeling their deterioration, assessing their efficacy and supporting their maintenance decision-making. Existing methods have not addressed yet the complexities associated with protection structures (failures, dependencies, time-dependent behavior, efficacy, maintenance decision-making, information imperfection) for an improved maintenance decision-making. This research project aims in developing an integrated model that covers the gap by overcoming existing limitations.

3.5.1 Existing Gap

Reliability analysis of complex systems has become a priority in order to acquire a comprehensive knowledge about the functional and structural design of the system, identifying links between events (e.g. failures), causes (e.g. torrential phenomena, geomorphic activities) and consequences (e.g. chain of triggered events, structure's behavior or efficacy evolution). Decision aiding approaches are then adopted in order to prioritize prevention and maintenance strategies based on single or multi-criteria. Several reliability and decision-aiding methods have been proposed in the literature. Their application to critical civil infrastructures (e.g. bridges, railway networks, protection structures) is a recent field of study, which is developing progressively and providing effective results that support maintenance-decision-making. Yet, these applications still suffer from some limitations that could highly influence the adequacy of adopted decisions. These limitations are already discussed in details in previous sections involved within this chapter. However, below is a summary of the main limitations and drawbacks concerning the application of reliability and decision-aiding approaches to critical civil infrastructures.

From reliability and preventive maintenance points of view:

- Basic or statics methods (e.g. FMEA) are used to assess the technical efficacy (structural, functional) of protection structures. These methods provide only a static assessment of the structure's efficacy considering its actual state instead of a its structural and functional state evolution over time.
- Dynamic methods (e.g. SPNs) are used to model stochastic deterioration and maintenance process of bridges and railway networks. The stochastic transition times between the discrete states are always assumed to follow a specific probability distribution (e.g. Weibull, Gamma, Poisson, exponential, etc.) based on available monitoring data concerning times to failures and on expert judgments. However, the deterioration mechanisms (failures, dependencies) are never physically modeled over time in order to verify the choice of transitions' probability laws. In addition, these methods have never been applied to torrential protection structures.

From a civil engineering and torrential hydraulics points of view:

- Recent approaches focus on the phenomena of scouring under bridges' foundations due to flooding (Tubaldi et al., 2017; Argyroudis et al., 2019). However, available frameworks do not account for real time-dependent evolution of scouring, scour pit geometry, and the accumulation of damage due to scour (e.g. soil-structure interaction).
- No developments have been made to analyze dependencies between protection structure's failure modes (e.g. local scouring triggering failure by external stability) and to consider bi-directional dependencies between structures located in series within an integrated protection system.
- Uncertainty and sensitivity analyses have never been carried out on models related to protection structures failure mechanisms such as scouring and stability calculations.

3.5.2 Thesis Objectives and Contributions

Stochastic models are better adapted than other modeling techniques when dealing with degradation processes and predicting when the system fails. Approaches based on event-based stochastic models like SPNs implementing CBM policy offer a flexible and efficient method to analyze the dynamic deterioration and maintenance processes of complex systems. In industrial and technological systems, monitoring is common. However, protection structures in mountains are not instrumented. Therefore, there is a lack of enough sufficient deterioration data to build time-dependent deterioration trajectories. Hence, one major potential difficulty in using SPNs is to figure out transitions' probability laws in an effective and realistic way.

Following the common classical approach, simple SPN models, with stochastic transitions following an exponential law, have been applied, as a starting point, on torrent check dams (Chahrour et al., 2019b,a). However, because of the criticality of these structures, it is

essential to improve such introductory models by moving to something closer to reality. To compensate for the lack of data, it is proposed in this study to resort to simulations based on the physics-based modeling of specific deterioration processes (e.g. stability evolution of a check dam, gradual filling of a sediment retention basin, etc.) triggered by torrential phenomena. This permits estimating probability distributions of transition times between defined states of the structure to be used in the SPN model. Finally, the results of the SPN model enable comparing and sorting different proposed maintenance based on multi-criteria hence contributing to better comparative and informed choices and to an improved resilience through the analysis of a large range of possible adverse scenarios. The main objective and interest of such a holistic approach, is to show how coupling both numerical physics-based and reliability-based models offers a more effective and realistic reliability analysis to be used for risk management decision-making.

From a dependability point of view concerning system's safety and reliability, the modeling approach presented in this research project develops a contribution in order to cope with the poor knowledge about degradation transition laws. The proposed methodology aims to choose and justify probability laws for the transition times between the defined degraded states of different types of protection structure (check dams and retention systems), considering their real time-dependent deterioration mechanisms while being subjected to a time-series scenarios of torrential events (clear water floods, debris flows). As it is not possible to access extended and complete data sets, the principle is to explore failure scenarios through physics-based modeling. The information provided by these models are then used as an input to the SPN model which helps comparing the different maintenance strategies and choosing the best one in terms of cost and efficiency.

Concerning the failure mechanisms of civil infrastructures subjected to natural hazards (e.g. floods, the originality in the presented approach concerning the phenomena of scouring lies in (1) estimating the scour pit geometry considering the real behavior of the torrent's bed using physics-based modeling and (2) performing structural analysis in order to analyze the effect of scouring on the stability of check dams. Indeed, the developed approach couples multi-scale hydraulic (from global bed evolution to local scouring analysis) and civil engineering approaches (check dam's stability analysis). The developed approach incorporates also uncertainty analysis on scouring and stability models in order to propagate different types of information imperfection propagate within a check dam's deterioration model and to quantify the sensitivity of the proposed model's outputs to all possible uncertainties. In addition, the model is used for assessing the evolution of a multi-component system (composed of several check dams) while being exposed to a series of treating events (natural hazards, failures) in order to check which dam fails before the other and how will the absence of the failed dam affect the behavior of the surviving dam.

To sum up, in the context of protection structures' time-dependent deterioration modeling and maintenance optimization, the direct contributions of the presented research project are the following:

1. Defining new degradation indicators that synthesize functional and/or structural de-

terioration mechanisms of protection structures/systems taking into consideration the dynamic interactions between failure modes.

2. Proposing a physics-based deterioration model that analyzes the time-dependent evolution of a check dam's global stability indicator by moving from multi-scale physical and analytical hydraulic models to external stability analysis. Then taking advantage of this model for (i) propagating uncertainties and figuring out which parameters greatly influence the final results involved in different stages of the model (ii) analyzing the bi-directional dependencies between check dams located in series.
3. Proposing a physics-based deterioration model that analyzes the time-dependent evolution of debris volume filling a sediment retention basin considering functional failures of a downstream retention dam (jamming of openings).
4. Providing a stochastic model related to the studied deterioration processes using SPNs and taking advantage of this model to assess the efficiency of preventive/corrective maintenance policies to be applied to the deteriorating structure/system.

The path followed in order to achieve the desired objectives and to develop the identified contributions is presented sequentially in this manuscript as follows:

- # 1, # 2, # 3 and # 4 represent the main methodological contributions and are presented in Chapter 4.
- Application to # 1, # 2 and # 4 dedicated to check dams is presented in Chapter 5.
- Application to # 1, # 3 and # 4 dedicated to check dams is presented in Chapter 6.

Methodology: Deterioration and Maintenance Models Development for Torrent Protection Structures

Contents

4.1	Global Framework Description	102
4.2	Physics-Based Model of Torrent Check Dam	106
4.2.1	Step 1: Geometry Characterization, Flood Scenario Definition and Randomness Generation	107
4.2.2	Step 2: Numerical Modeling via LOGICCHAR	108
4.2.3	Step 3: Local Scouring Estimation	109
4.2.4	Step 4: External stability verification	112
4.2.5	Step 5: States definition and transition laws	116
4.3	Physics-Based Model of Sediment Retention Systems	118
4.3.1	Step 1: Data Acquisition, Debris Flow Scenario Definition and Randomness Generation	119
4.3.2	Step 2: Hydraulic control of flows by a Retention dam	120
4.3.3	Step 3: Jamming Conditions and Stochastic Arrival of Boulders	121
4.3.4	Step 4: Retention Basin's Buffering Capacity	126
4.3.5	Step 5: Overall Computational Analysis	126
4.3.6	Step 6: States definition and transition laws	128
4.4	Stochastic Deterioration and Maintenance Modeling: SPN and CBM approach	129
4.4.1	Degradation Process	129
4.4.2	Inspection Process	130
4.4.3	Maintenance Process	130
4.4.4	Decision-making support for choosing maintenance strategies	131
4.5	Integrating Information Imperfection using HYRISK for Improved Decision-making	132
4.5.1	Functionality of HYRISK	133
4.5.2	Results produced with HYRISK	135
4.6	Conclusion	137

This chapter represents the core methodological contribution of this research project. It provides an exhaustively description of the integrated approach used to tackle the identified scientific and technical obstacles. The global frameworks for modeling both systems are first explained. After, a physics-based model (Hydraulic, civil engineering) that analyzes the time-dependent deterioration of each system when subjected to different types of torrential phenomena is described. Both systems share the same reliability-based model (Stochastic Petri net, condition-based maintenance), but with different inputs, for assessing their stochastic behavior when subjected to deterioration mechanisms and to maintenance strategies. At the end, a simple hybrid approach (HYRISK) is proposed to be adopted for handling information imperfection and analyzing the sensitivity of the developed model to uncertain inputs. The developed model is applied on two different types of protection structures.

4.1 Global Framework Description

In order to assess different maintenance strategies, the goal is to analyze the degraded states at which a system is likely to be found during its lifetime (roughly between 50 and 100 years). The ideal situation consists in using real data related to torrential events and to the behavior of the system when exposed to these events. Unfortunately, these data are often missing or imperfect (incomplete, imprecise . . .). Defining a modeling hypothesis requires to make assumptions and to combine several sources of information coming from past experiences, historical data but also expert assumptions and assessments. Coping with information imperfection in natural risk assessment process cannot be avoided. The principle of the developed approach is therefore to (i) create fictive series of torrential events occurring over a specified lifetime period and to check the time-dependent evolution of a chosen degradation indicator that describes the deterioration process of the system, (ii) propose different maintenance operations to be carried out on the system depending on its degraded state that will be revealed after inspection and (iii) model the stochastic behavior of the system when subjected to stochastic deterioration mechanisms and to maintenance operations.

In this chapter, the approach is developed on two different types of protection structures/systems: check dams and retention systems. Each of them has a specific physics-based model presented, respectively, in sections 4.2 and 4.3. The models differ depending on the structural and functional designs of the structure/system and on the failure modes it may be subjected to. However, they both share the same framework of the reliability-based model, presented in section 4.4, which analyzes the stochastic deterioration, inspection and maintenance processes.

In practice, the overall modeling approach of both types of structures are summarized by the following steps, which are detailed in the following sections. detailed in the following subsections and illustrated in figs. 4.1 and 4.2.

Torrent Check Dams

1. **Torrential system features' definition (fig. 4.1, (a)):** defining the torrent's geometry, its characteristics and its location in addition to describing the protection system (series of check dams).
2. **Flood series generation (fig. 4.1, (b)):** assuming a series of clear water flood events with defined dates and peak discharges over a specified period of time (use of real events time series if available).
3. **Events' consequences and resulting functional and structural failures analysis (fig. 4.1, (c)):** modeling the time-dependent evolution of the torrent's bed, estimating the dimensions of the scour pit generated under the dams' foundations depending on the global and local hydraulic conditions and assessing the external stability of the dams after each flood event involved within the series of events.
4. **Stochastic deterioration and maintenance modeling (fig. 4.1, (d)):** proposing a stability state indicator, defining degradation states at which the dams may reside, estimating empirical non-parametric probability laws corresponding to transition times between those states, and analyzing the behavior of the dam when subjected to deterioration mechanisms and to maintenance operations.

Retention systems

1. **Retention system and torrential events features' definition (fig. 4.2, (a)):** describing the dam's, its openings, the basin's storage capacity in addition to defining the frequent occurring debris flows (hydrographs) and their features (e.g. transported boulders).
2. **Debris flow series generation (fig. 4.2, (b)):** assuming a series of debris flow events with defined dates and volumes over a specified period of time (use of real events time series if available).
3. **Events' consequences and resulting functional and structural failures analysis:** modeling the time-dependent evolution of the (i) discharge ($Q_{out}(t)$) passing through the outlets/openings of the retention dam, (ii) flow height ($h(t)$) at the level of the retention dam and (iii) debris volume stored in the sediment retention basin after the whole event series. The analysis should take into consideration the time-dependent evolution of the blockage (jamming) rate of the retention dam's outlets/openings due to transported boulders.
4. **Stochastic deterioration and maintenance modeling:** proposing a state indicator (e.g. stored debris volume in the basin), defining degradation states at which the system may reside, estimating empirical non-parametric probability laws corresponding to transition times between those states and analyzing the behavior of the system when subjected to deterioration mechanisms and to maintenance operations.

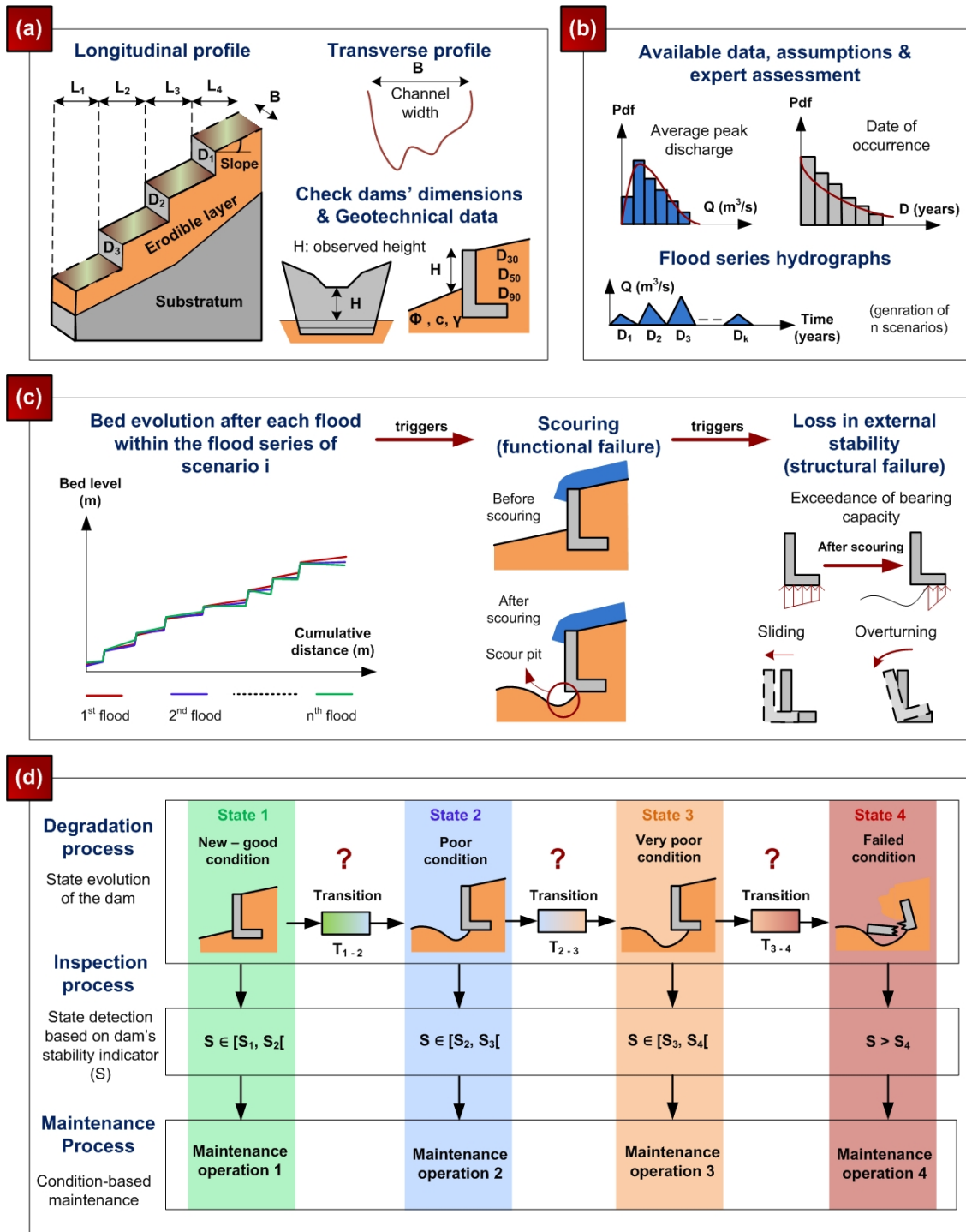

Figure 4.1: Key steps of a check dam modeling process: (a) torrential system geometry; (b) events series scenario; (c) resulting failures analysis; and (d) stochastic deterioration and maintenance analysis.

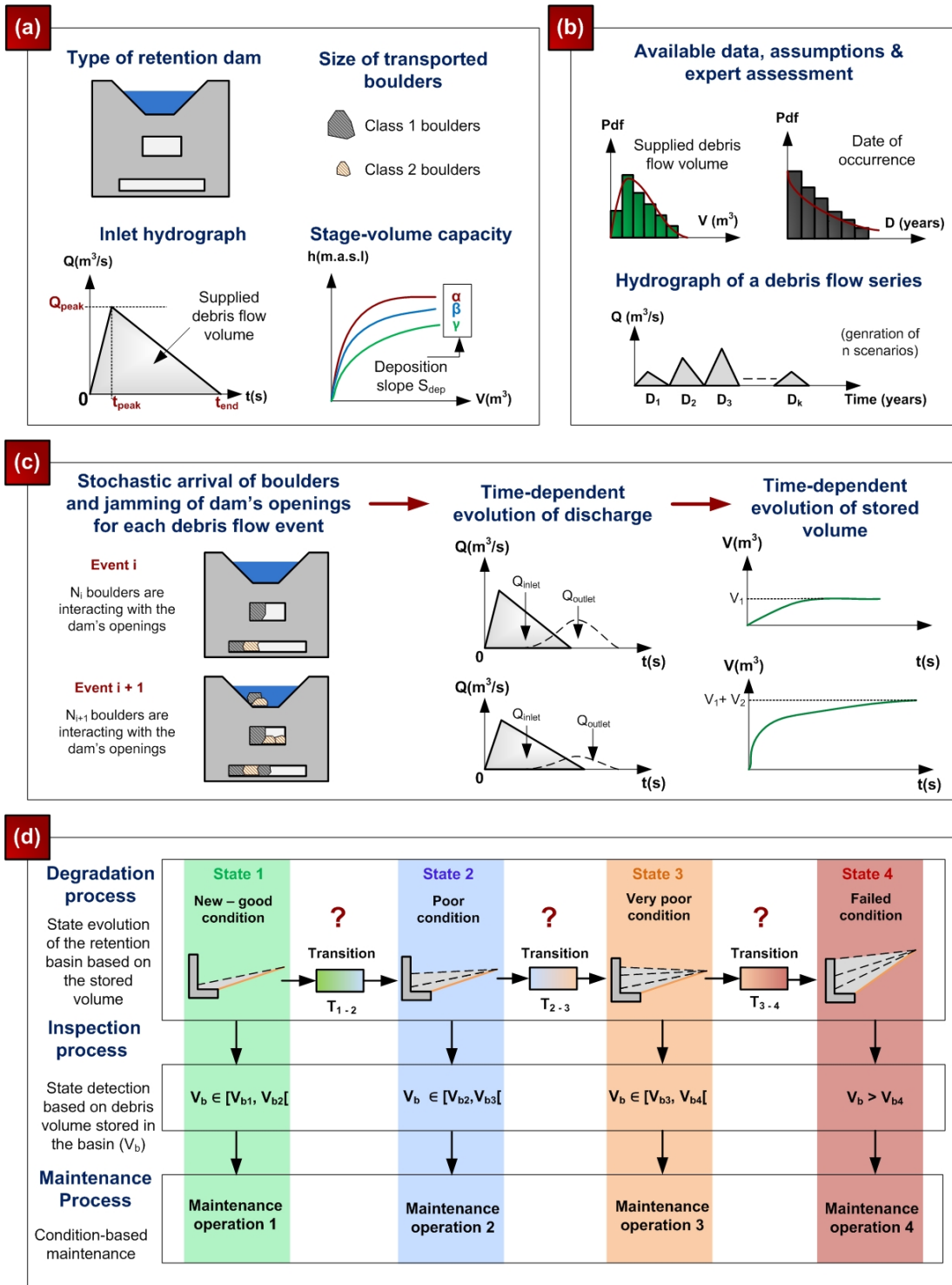

Figure 4.2: Key steps of a retention system modeling process: (a) system's geometry and debris flows features; (b) events series scenario; (c) resulting failures and flow routing analysis; and (d) stochastic deterioration and maintenance analysis.

4.2 Physics-Based Model of Torrent Check Dam: From Torrential Hydraulics Numerical Modeling to Check Dam's Stability Assessment (Chahrour et al., 2021a)

The content of this section has been published in the journal of Reliability Engineering and System Safety (Chahrour et al., 2021a).

For classical water floods, the only parameters of interest are linked to water (i.e., height, speed, extension area). In mountain rivers, sediment transport becomes indeed considerable and impacts the morphology of the torrent's bed and therefore the hydraulics of water, which was the origin of this transport. Sediment transport assessment is indeed a key issue in torrential hydraulics characterized by steep slopes and relative shallow depths corresponding to a small ratio between water height and the grain size of bed (Recking et al., 2008). Contrary to river plains characterized by a gentle slope and little deformable beds, hydraulics and sediment transport can hardly be dissociated in mountain rivers (Recking et al., 2013).

Physical laws of torrential hydraulics differ from classical hydraulics and require to use specific modeling tools able to simulate both water flows and sediment transport. Spatialized analysis of both water hydraulics and sediment transport is needed since during the flood event, some parts of the torrent will be eroded while some others will be filled by sediment deposition. Longitudinal and lateral erosion in the bed and banks can also generate destabilization of lateral slopes. In addition to the global bed's slope evolution, local scouring will be observed as soon as a water acceleration occurs such as in the case of check dam waterfalls. A scouring pit will be formed inducing a possible destabilization of the structures' foundations because of soil removal. Moreover, the large volume of transported sediments will be deposited somewhere raising the bed level and thus causing overflows.

Improving scientific knowledge of the phenomena linked to torrential hydraulics is still under progress. In addition, developing methods and tools, combining modeling and expert assessments, for this type of natural risk, is a paramount issue to manage those risks (Meunier, 1991; Rickenmann, 2001; Recking, 2009). Several software have been released to study those kinds of phenomena (IBER, 2010). LOGICCHAR (Laigle, 2008) is a simplified (finite differences) numerical 1D model, developed by INRAE (ETNA team), in order to predetermine the evolution of the torrent's bed during torrential floods on the basis of hypotheses and scientific knowledge related to torrential hydraulics and existing sediment transport laws.

The geometry of the torrent is represented by a series of reaches with a given slope, grain size distribution and rectangular or trapezoidal sections. Water and sediment hydrographs are injected at the top of torrent. The hydraulics and sediment transport are coupled and calculated continuously in successive loops for any point of the simulated torrent's bed: water induces sediment transport, which changes the slope modifying the hydraulics.

The basic data required as inputs to LOGICCHAR (fig. 4.3, (a)) concern the:

- **Torrent's geometry:** the longitudinal profile is defined by a series of nodes with an

abscissa x measured from downstream as well as the slope $\frac{dx}{dy}$ of the reach. Each node corresponds either to a border between two reaches with different characteristics or to the presence of a protection structure. Between two consecutive nodes, the cross section (rectangular or trapezoidal), channel width and the heights and slopes of the banks are defined.

- **Protection structures:** a check dam can be added as a hydraulic singularity on the longitudinal profile characterized by the height observed under the weir of the dam.
- **Torrent's bed characteristics:** for each specified node, it is necessary to define the thickness of the erodible layer above the substratum. Then, for each reach, the grain size distribution (D_{30} , D_{50} , D_{90} , and d_m) of the erodible layer should be defined. Note that the D_i value reveals that $i\%$ of solid materials have a diameter which is less than this value.
- **Flood's water and solid hydrographs:** For a simple (triangular) flood, the liquid and solid hydrographs are constructed based on the peak water and solid discharges respectively, duration of flood, and the time at which the peak discharges are reached.
- **Simulation settings:** these settings are related to the discretization of the longitudinal profile, the time step of calculation, and to the choice of sediment transport formulas (Rickenmann, Meunier, Lefort, or Recking).

4.2.1 Step 1: Geometry Characterization, Flood Scenario Definition and Randomness Generation

A simplified geometry and sediment characteristics are considered in the model in which the torrent's longitudinal and transverse profiles, the implemented check dams' structural design, and the grain size of the torrent's materials are given (fig. 4.1, (a)). Regarding the flood scenario, the objective is to re-create a time series of realistic floods which will occur randomly during the check dams' lifetime. In this context, the evolution and the level of failures that check dams are subjected to, should be analyzed. This enables fitting probability laws for transition times between different check dam's states of degradation.

Consequently, n scenarios must be generated by choosing random variables of X , Y , ... corresponding to uncertain parameters involved in the model. In this study, randomness is applied to create a scenario (series) of successive flood events, each of them being randomly characterized by the peak water Q and solid Q_s discharges and its date of occurrence D . The choice of probability laws and their associated parameters used to create those specified random variables is based on available data and expert assumption. Using n drawn realizations from these probability distributions (using Matlab, R, etc.), n scenarios are generated noting that in each scenario, different numbers of flood events can probably occur during the specified lifetime period.

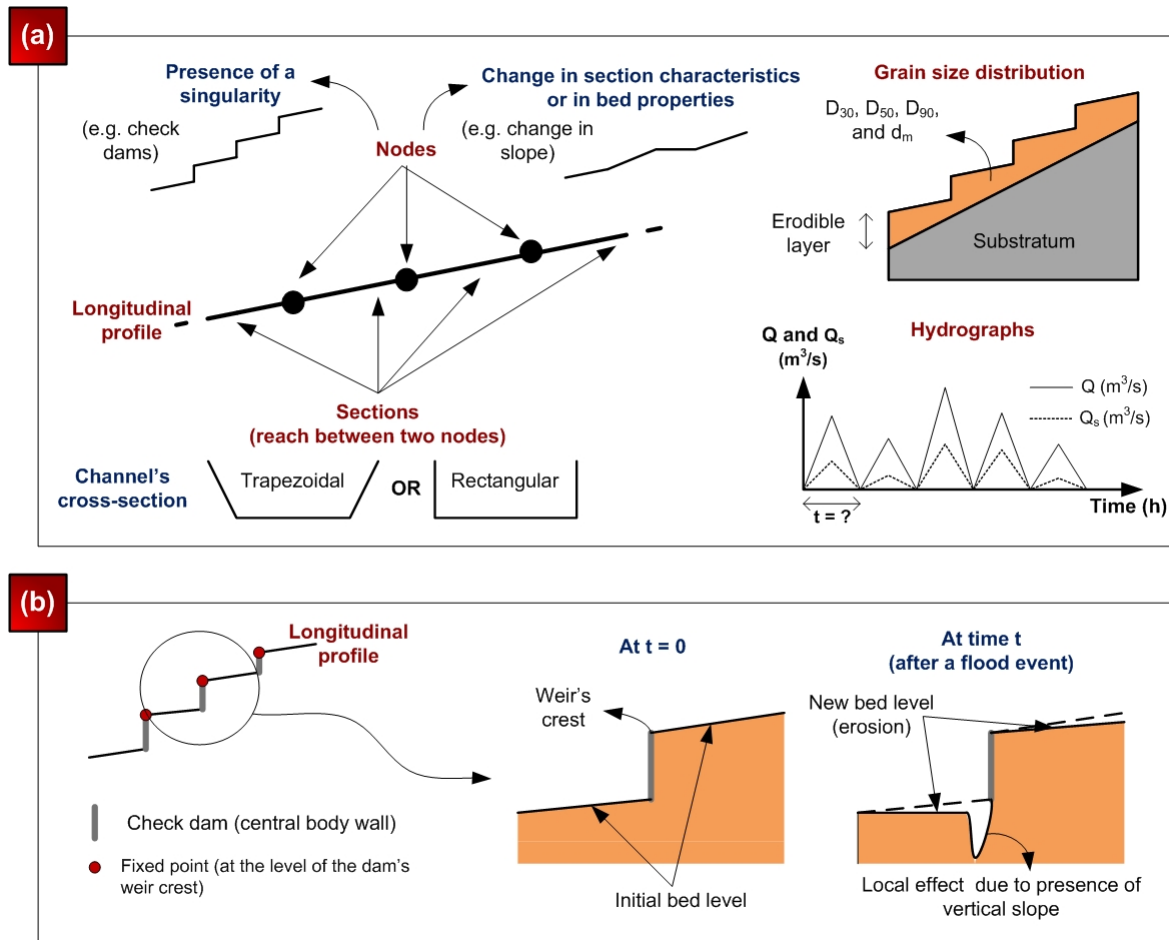

Figure 4.3: Principles of LOGICCHAR: (a) main terms and data used; (b) software assumptions.

4.2.2 Step 2: Numerical Modeling via LOGICCHAR

The defined scenario makes it possible to launch a numerical simulation via LOGICCHAR. Each event series scenario, defined over a specified period of time (e.g. 100 years), is modeled separately. However, a single water and solid hydrographs include the series of flood events considered within the same scenario as shown in fig. 4.1, (b). It is true that each flood event within the series of events has an associated date of occurrence. Yet, in LOGICCHAR, there is no need of a time separation between two consecutive events due to the fact that the torrential system remains stable during this period of time. However, it is very important to specify the duration of each flood event and the time needed until reaching the peak discharge. Concerning the choice of sediment transport formula, it depends on the studied case and should be assessed by experts. After each simulation, the results of the corresponding scenario are obtained.

After inserting the inputs, one can choose scan points (spatial and temporal) at which the operator wants to see the outputs. Once the simulation is executed, results appear in the form of graphs and tables. For each chosen temporal scan point, the outputs include the

water height (m), water velocity (m/s), slope (m/m), initial bed level (m), actual bed level (m) and solid discharge (m^3/s) along the whole torrent. Besides, for each chosen spatial scan point, the same previous mentioned outputs are also given over the whole flood duration.

As many other tools, this software has some limitations due to the adopted assumptions (fig. 4.3, (b)). Being a 1D model, LOGICCHAR represents check dams as simple vertical walls, not taking into consideration the lateral dimensions of the hydraulic weir by which the flow is supposed to pass. In addition, check dams are considered as local hydraulic singularities and a cautious interpretation of the results close to the dams is needed. The model is able to represent the global bed evolution but very local effects may not be fully relevant especially in scan points that are too close from these singularities. Consequently, the results corresponding to abscissas that are very close to the dams show a local artefact due to the sudden variation in the slope caused by the presence of the dam (vertical slope). To get a realistic and usable outputs, spatial scan points should therefore be chosen far enough from the dam. Moreover, the bed level upstream the dam is fixed to the level of the dam's weir crest. Hence, deposition and erosion, do not occur at the level of the dam from the upstream unless the dam is totally buried by sediments. One last remark concerns the discretization settings, in which if not properly adjusted, the software diverges.

4.2.3 Step 3: Local Scouring Estimation

Local scouring corresponds to soil erosion downstream or under a structure's foundation, in which the soil is removed by the flow, creating a scour pit whose dimensions depend on the flow energy, solid transport, and bed grain size distribution. In fact, clear water condition leads to larger ultimate scouring depths than other flow conditions (Prendergast and Gavin, 2014). Different approaches exist to consider scouring in the design phase of check dams (Deymier et al., 1995). The most secure approach (but possibly costly) is to set the foundation as least as deep as the maximum expected depth (vertical dimension) of the scour hole (Comiti et al., 2013). Consequently, predicting the maximum scour depth is required to design adequate foundations of check dams. The scour pit develops itself with a slope which can lead to soil removal under the check dam's foundation, inducing a possible external stability failure.

Several approaches and tools based on complex relationships among hydraulic, geometric, and sediment variables have been developed in order to estimate the size of the scour pit. Two reliable methods, commonly used in torrent protection structures context, are those developed by VAWE and SOGREAH (Couvert, B. et al., 1991). More recent tools, based on laboratory experiments and field measurements have been proposed by Comiti et al. (Comiti et al., 2013). The empirical equations and a simple description of each of these methods is presented below:

VAWE method (1967 - 1970): this bi-dimensional model calculates the depth P_{vawe} and the length L_{vawe} of the scour pit. With no sediment transport, the two dimensions are given in terms of the unit discharge q , hydraulic drop h_c , and the grain size of the bed D_{95} . In the presence of sediment transport, the depth of the scour depth P'_{vawe} can be

computed as a function of P_{vawe} as represented by Eq. 4.3.

$$P_{vawe} = 0.88 \frac{(q\sqrt{h_c})^{0.686}}{D_{95}^{0.372}} \quad (m) \quad (4.1)$$

$$L_{vawe} = 0.879 \frac{(q\sqrt{h_c})^{0.914}}{D_{95}^{0.828}} \quad (m) \quad (4.2)$$

$$P'_{vawe} = 0.69P_{vawe} + 0.79D_{95} \quad (m) \quad (4.3)$$

SOGREAH method (1989): this three dimensional model calculates the depth $P_{sogreah}$, length $L_{sogreah}$, and the width $l_{sogreah}$ of the scour pit. The tests were carried out on bed slopes between 2 and 10 %. An initial analysis of the results made it possible to validate the VAWE formula in the absence of sediment transport. However, the results diverge from those obtained by VAWE in the presence of sediment transport. Consequently, this approach starts from the VAWE formula with no sediment transport and incorporate correction coefficients (R , R' , and R'') in order to take into account the additional dimension and three-dimensional effects related to the flow contraction. The correction coefficients are extracted from an abacus (Couvert, B. et al., 1991) depending on a dimensionless contraction coefficient C given by Eq. 4.4.

$$C = \frac{H_s * h_c}{L_s^2} \quad (4.4)$$

where H_s is the hydraulic head, $L_s = b + H_s$ is the width of the weir at the level of the water, and b is the width of the weir's base. Hence, the three dimensions of the scour pit can be obtained by the following equations:

$$P_{sogreah} = P_{vawe} * R \quad (m); \quad R = f(C) \quad (4.5)$$

$$l_{sogreah} = P_{vawe} * R' \quad (m); \quad R' = f(C) \quad (4.6)$$

$$L_{sogreah} = P_{vawe} * R'' \quad (m); \quad R'' = f(C) \quad (4.7)$$

Comiti method (2013): D'Agostino and Ferro proposed an equation that estimates the scour width calibrated on laboratory data on single structures with null bed slope downstream (Ferro and D'Agostino, 2004). Comiti et al. developed further this equation by taking into consideration the case of a sloping bed. In contrary to VAWE and SOGREAH approaches, the scour pit depth S_{comiti} is measured from the level of the bed and not from the level of water downstream the structure. The simplified equation of S_{comiti} is given by Eq. 4.8.

$$S_{comiti} = 2.Z \left(\frac{H_s}{Z} \right)^{0.59} \left(\frac{b}{B} \right)^{2.34} \left(\frac{\Delta D_{90}}{Z} \right)^{-0.09} \quad (m) \quad (4.8)$$

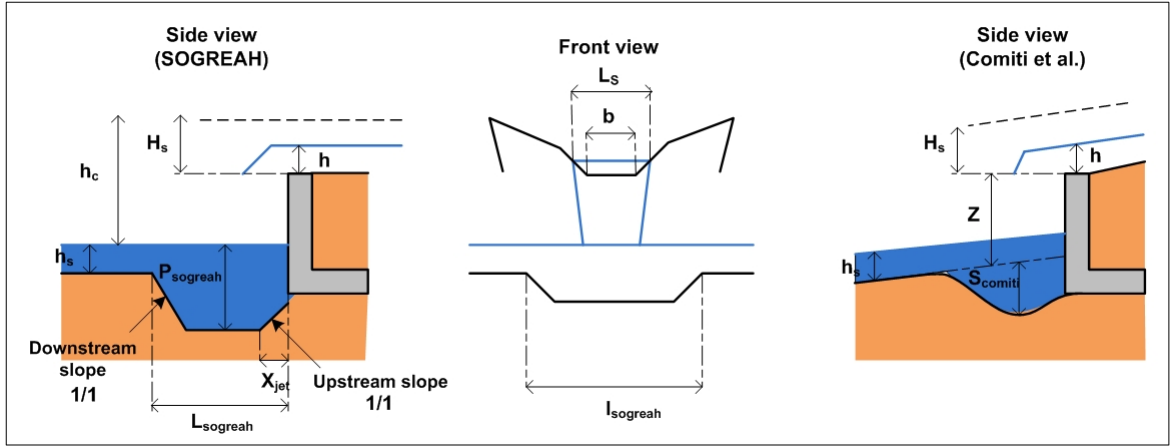

Figure 4.4: Main geometric parameters used for estimating the dimensions of a scour pit downstream a check dam in SOGREAH and Comiti et al. approaches.

where Z is the drop height, B is the channel width, D_{90} is the grain size for which 90% of the sediment in weight is finer, and Δ is the sediment relative submerged density ($\Delta = \frac{\rho_s - \rho}{\rho}$).

Fig. 4.4 illustrates the scour pit geometry and the main parameters used for estimating its dimensions in SOGREAH and Comiti approaches. The plots are extracted from the work of Tacnet and Vecchio (Tacnet, 2009) and of Comiti et al. (Comiti et al., 2013). However, simple modifications in the parameter's names used in each of the plots are performed in order to unify the names for the sake of simplicity.

In fact, SOGREAH method overestimates the scour pit depth when compared to Comiti approach. Yet, only SOGREAH permits calculating the three dimensions of the scour pit. In the present study, the dimensions of the scouring pit are estimated by combining both approaches of SOGREAH and Comiti et al. in which $P_{sogreah}$ is updated by using P_{comiti} instead of P_{vawe} . Note that P_{comiti} is the sum of the maximum depth of the scour pit estimated by Comiti et al. approach and the downstream water level ($P_{comiti} = S_{comiti} + h_s$).

The key parameters necessary for checking the stability of the dam are the depth S_d (horizontal dimension) and the width S_w of local scouring (material removed) under its foundation. S_w is equal to $l_{sogreah}$ which can be calculated using Eq. 4.6. On the other hand, the estimation of S_d highly depends on the depth and the observed (or assumed) upstream slope of the scour pit which can vary depending on the soil properties. SOGREAH assumes a trapezoidal scour pit with sides of slope 1/1 as shown in fig. 4.4. With an upstream slope of 1/1 and using the hydraulic formulas given by Eq. 4.9, 4.10 and 4.11, the calculation of S_d is based on simple geometry calculation as follows:

$$X_{jet} = \sqrt{\frac{4}{3} H_s (h_c + P_{comiti})} \quad (4.9)$$

$$H_s = h + \frac{v^2}{2g} \quad (4.10)$$

$$h_c = (H_w + H_s) - Z_F - h_s \quad (4.11)$$

where X_{jet} is the distance between the base of scour pit and the edge of the dam's wall, h_s is the downstream water level, h is the upstream water level, v is the water velocity, H_w is the height of the dam under the weir, $Z_F = Z_{FI} + d_z$ is the bed level after event i , Z_{FI} is the initial bed level, and d_z is the drop between the bed levels. S_d is then computed by the following set of equations:

$$P_s = \begin{cases} h_s & \text{if } (P_{comiti} - X_{jet}) < h_s \\ P_{comiti} - X_{jet} & \text{otherwise} \end{cases} \quad (4.12)$$

$$Z_{af} = \begin{cases} Z_F & \text{if } (P_{comiti} - X_{jet}) < h_s \\ Z_F + h_s - P_s & \text{otherwise} \end{cases} \quad (4.13)$$

$$S_d = \begin{cases} Z_{af} & \text{if } Z_{af} < 0 \\ 0 & \text{otherwise} \end{cases} \quad (4.14)$$

where P_s is the water height in the scour pit at the level of the dam, and Z_{af} is the scour pit height under the dam's foundation at the edge of the dam's wall.

Fig. 4.5. represents the scour pit geometry of the developed approach and it illustrates all the previously mentioned parameters required for the calculation of local scouring dimensions S_d and S_w .

4.2.4 Step 4: External stability verification

The generated scour pit reduces the length of soil supporting the foundation and induces an increase in constraints which can cause a structural failure of the dam. For the calculation of check dam's stability, the maximum scour pit depth attained during a flood event is considered. In other words, the values of the variables required in the computations are extracted at the time at which maximum scour pit depth occurs (scouring critical state). In addition, based on the the peak discharge of each flood event within a series of floods, the dimensions of local scouring attained after a specific event could be lower or higher than those attained in the previous event. In this study, it is also assumed that the torrent's bed is stable between events and that the refilling of materials in the scour pit caused by sediment transport does not have a positive influence on the stability of the structure. In other words, even if the scour pit looks as having been refilled, the refilled materials may be loosely compacted.

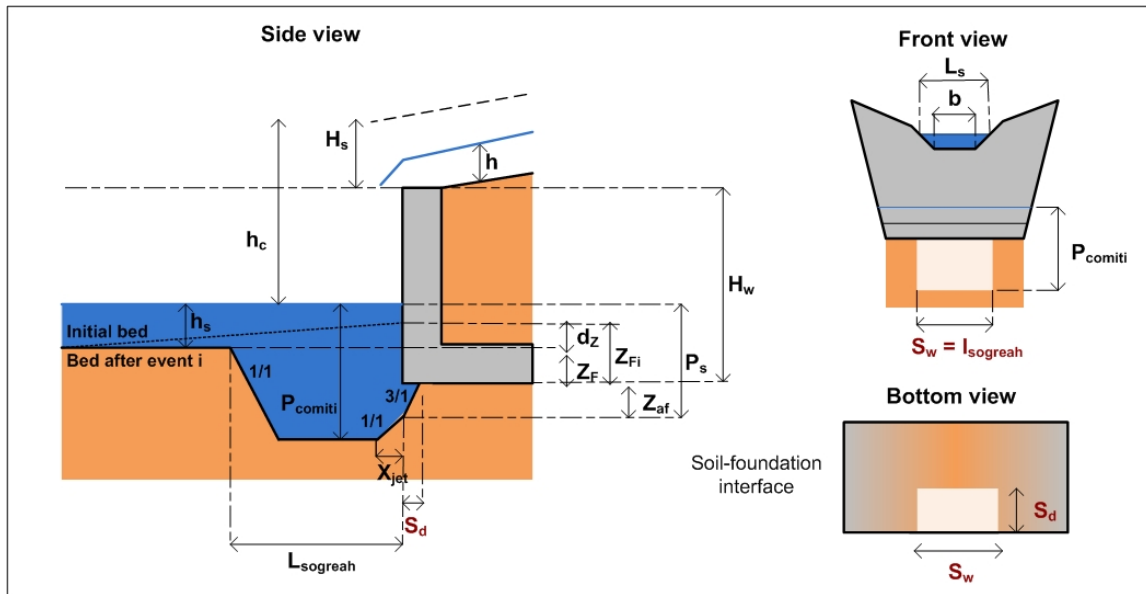

Figure 4.5: Local scouring dimensions under a check dam's foundation to be considered in the developed approach of a scour pit geometry.

Therefore, S_w and S_d are assumed to be monotonically increasing after each event meaning that the maximum values of S_w and/or S_d attained among all the past events are considered in stability calculation.

In this study, the internal stability of the dam is not analyzed. For studying the external stability of a check dam, the dam is classically considered as a fully rigid structure with no internal deformation of its body. Rules and parameters for stability justification depend on national or international standards such as Eurocode and may differ through the choice of security factors, weights of loads depending on considered combinations. In the present study, the calculation principles and the safety factors used are based on a French standard (Groupe de travail, 1993) and should be considered as a methodological example (not representing totally new Eurocode formulas). The principle of justification is described as follows (fig. 4.6):

1. Collecting (or assuming) geotechnical data (e.g. soil bearing capacity, internal friction angle) and design data (e.g. structure's dimensions);
2. Defining loading situations and computing related actions for each of them;
3. Computing the stabilizing M_S and overturning M_O moments with respect to the point of application chosen at the downstream base of the foundation;
4. Computing the horizontal R_H and vertical R_V components of the resulting force R , its eccentricity e , and its vertical inclination angle δ ;
5. Evaluating the soil permissible stress σ_{adm} and determining the diagram of normal stresses applied on the soil which results in the soil reference stress q'_{ref} .

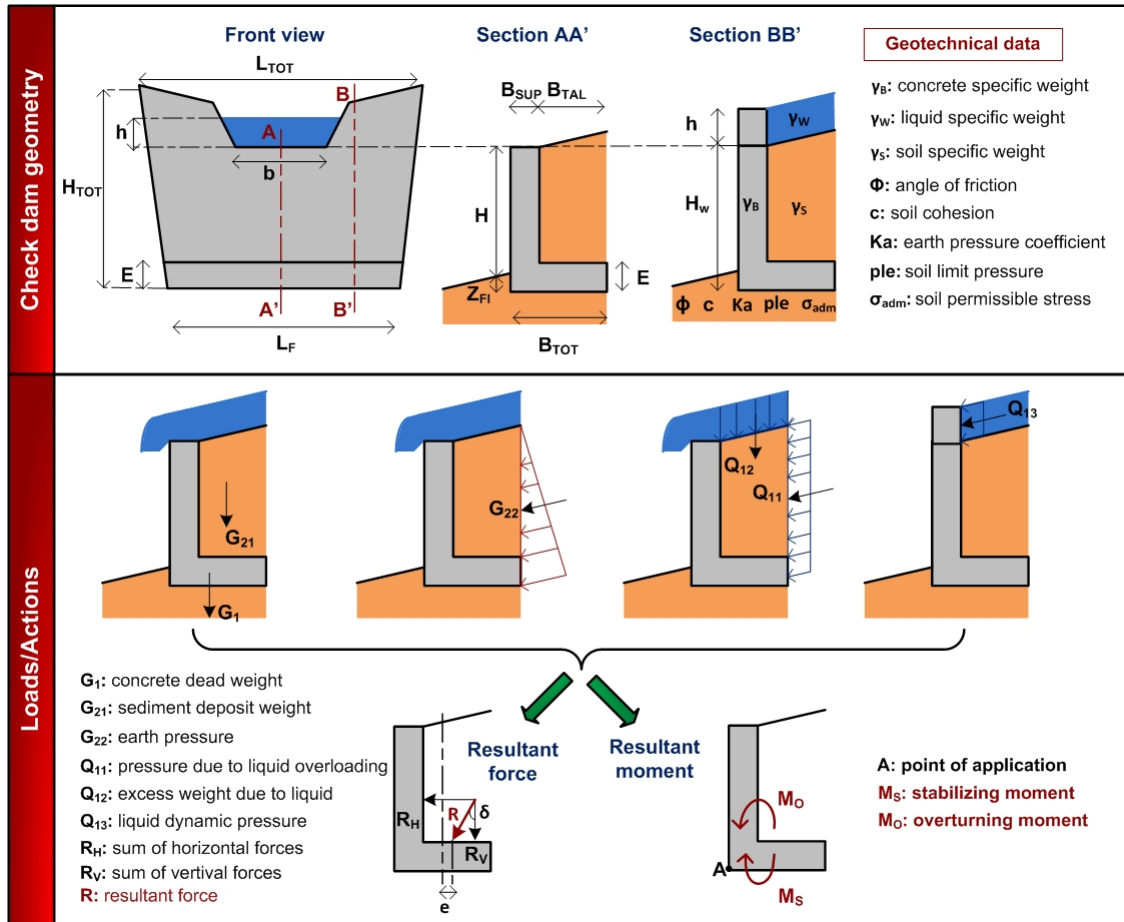

Figure 4.6: Data required for analyzing the external stability of a check dam.

After that, the three equilibriums below must be verified in order to justify the external stability of a torrent check dam (Deymier et al., 1995).

Soil bearing capacity: this stability corresponds to the ability of the soil below the foundation to withstand the stress caused by the vertical loads above it. To avoid soil rupture, the following condition should be verified:

$$\sigma_{adm} > q'_{ref} \quad (4.15)$$

For simplification, external stability is generally justified according to a 2D hypothesis. Stability is checked for cross sections chosen (e.g.) in the central part of the weir, at the edge of the weir or at the end of lateral wings. For each of these sections, the calculation of q'_{ref} is based on a normal stress diagram depending on the vertical resultant force R_V and its eccentricity e , considering somewhere the soil as a beam submitted to simple bending with compression. However, in the case of local scouring, the 2D hypothesis is not valid since soil is removed in the central part of the foundation. Another method is proposed to calculate and redistribute the constraints on the part of

the foundation remaining in contact with the soil. The stress is therefore redistributed on the non-scoured soil and is estimated using the moment of inertia of the reduced area of foundation as shown in fig. 4.7. The moment of inertia I (Eq. 4.16) around the vertical axis depends on the abscissa of the center of gravity C_x (Eq. 4.18) and the area A' (Eq. 4.17) of the foundation which is still in contact with soil after scouring. Note that for each flood event, C_x , A' , and I have different values depending on the variation of S_d and S_w .

$$I = \frac{1}{3}[B_{TOT}^3(L_F - S_w) + S_w(B_{TOT} - S_d)^3] - A'.C_x^2 \quad (4.16)$$

$$A' = L_F(B_{TOT} - S_d) + S_d(L_F - S_w) \quad (4.17)$$

$$C_x = \frac{1}{2A'}[B_{TOT}^2(L_F - S_w) + S_w(B_{TOT} - S_d)^2] \quad (4.18)$$

Having calculated I , the maximum σ_{max} and minimum σ_{min} stresses can be estimated using Eq. 4.19. If $\sigma_{min} > 0$, the soil under the foundation is totally compressed. On the other hand, if $\sigma_{min} < 0$, the soil under the foundation is partially compressed and σ_{min} is considered equals to zero since it is assumed that no tension exist in the soil. Finally, q'_{ref} is given by Eq. 4.20.

$$\begin{cases} \sigma_{max} = \frac{R_v}{A'} + \frac{M_x(B_{TOT}-C_x)}{I} \\ \sigma_{min} = \frac{R_v}{A'} - \frac{M_x.C_x}{I} \end{cases} \quad (4.19)$$

where $M_x = R_v.e$ is the moment around the centroidal axis.

$$q'_{ref} = \frac{1}{4}[3\sigma_{max} + \sigma_{min}] \quad (4.20)$$

Check dam overturning: Failure by overturning occurs when the overturning moment M_O exceeds the stabilizing moment M_S . To avoid overturning of a check dam, a factor of safety of at least 1.5 is considered and the following *ULS* condition should be verified:

$$\frac{M_S}{M_O} \geq 1.5 \quad (4.21)$$

In case of local scouring, stability against overturning is affected only if the scouring width is equal to the total length of the foundation ($S_w = L_F$) which confirms that this justification is a bit theoretical. In such case, the axis of rotation is shifted inward as shown in fig. 4.7 reducing significantly the stabilizing moment. In practice, the reduction of compressed length will first induce a failure because the applied stress will exceed the permissible constraint.

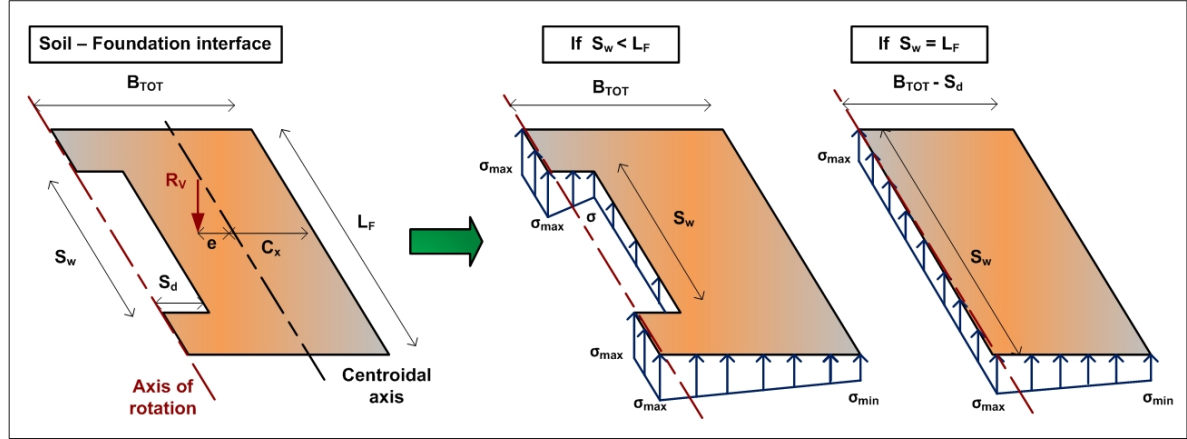

Figure 4.7: Moment of inertia variables resulting in the normal stress diagram under a check dam's foundation after scouring.

Check dam sliding: Failure by sliding occurs when the horizontal force R_H exceeds the maximum resisting friction force that opposes sliding R_{SL} , at the contact between foundation and soil. R_{SL} is estimated based on *ULS* load combination as given in Eq. 4.22.

$$R_{SL} = \frac{R_V \cdot \tan \delta}{\gamma_{g1}} + \frac{c \cdot B'}{\gamma_{g2}} \quad (4.22)$$

To avoid sliding of a check dam, the following condition should be verified:

$$R_H \leq R_{SL} \quad (4.23)$$

where B' is the compressed width of the foundation. c is the soil cohesion. δ is the friction angle of the soil-foundation interface. δ is set equal to the friction angle ϕ of the soil for cast-in-place concrete foundations and maximally set to $\frac{2}{3}\phi$ for pre-cast foundations. γ_{g1} and γ_{g2} are *ULS* safety factors set to 1.2 and 1.5 respectively.

4.2.5 Step 5: States definition and transition laws

A check dam is evolving progressively from initial state to states with single or multiple failures. Knowing the condition of each failure, it is required to define a state indicator for each type of failure transforming continuous values (e.g. safety factor) into discrete states. The principle is therefore to link an interval of measured values with the different states. Moreover, the global indicator of the check dam should combine all possible causes of failure. For example, a check dam may fail by overturning while having no problem in soil bearing capacity. Consequently, all types of failure should be considered together while analyzing the stability of a check dam. To aggregate and consider all possible causes of failure, a global state indicator S_g is proposed. It is based on normalizing the state indicators of all the failure mechanisms mentioned in section 4.2.4 as follows:

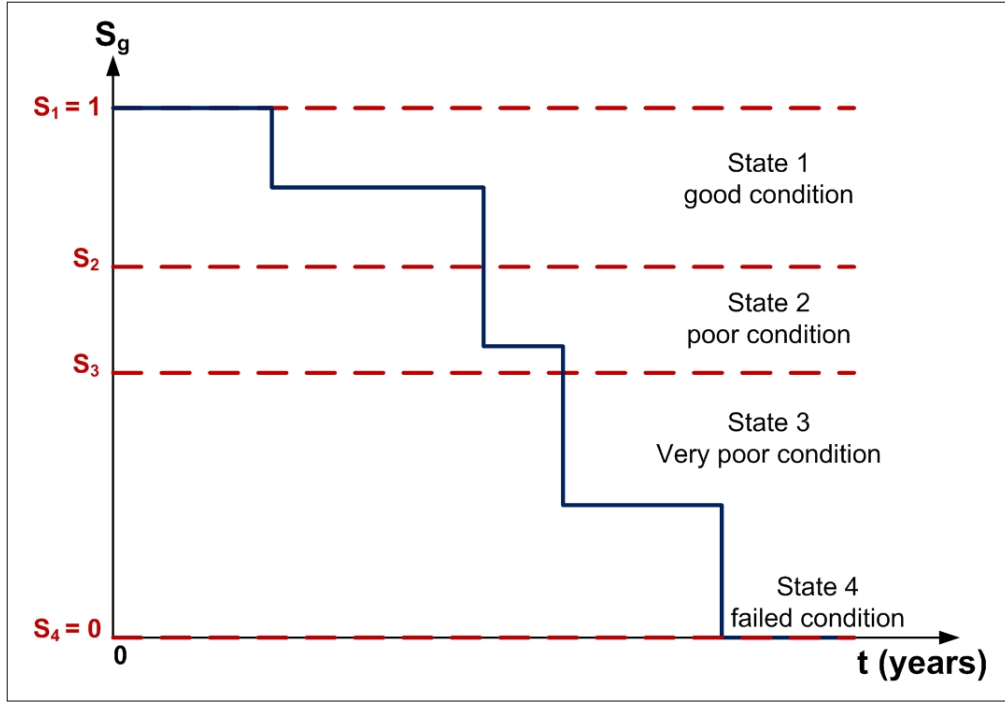

Figure 4.8: Example showing the evolution of the global stability indicator S_g through the defined states over time.

$$\left\{ \begin{array}{l} S_{BC} = \frac{\sigma_{adm} - q_r \cdot e f}{\sigma_{adm}} \\ S_{OT} = \frac{M_S - M_O}{M_S} \\ S_{SL} = \frac{R_{SL} - R_H}{R_{SL}} \end{array} \right. \quad (4.24)$$

where S_{BC} is the bearing capacity stability ratio, S_{OT} is the overturning stability ratio, and S_{SL} is the sliding stability ratio. The normalization is performed so that all the state indicators fit in the same interval $[0, 1]$ in which 0 corresponds to a failed state and 1 corresponds to a state with maximal stability level (initial new state). The global non-dimensional state indicator is assumed as:

$$S_g = \sqrt[3]{S_{BC}^\alpha \cdot S_{OT}^\beta \cdot S_{SL}^\gamma} \quad (4.25)$$

Due to the fact that the stability indicators S_{BC} , S_{OT} and S_{SL} have different degrees of influence on S_g , they are weighted by coefficients α , β and γ respectively. These coefficients are given as powers to the stability components depending on the extent of their dependency with scouring phenomenon.

Eq. 4.25 reveals that the structure is in a failed state when at least one of the state

indicators of the considered failure mechanisms reaches a failed state. In the present study, four different states are considered and described below. These intervals are resulting from an expert choice and could of course be discussed and modified:

State 1: initial to good condition with $S_2 < S_g \leq S_1$

State 2: poor condition with $S_3 < S_g \leq S_2$

State 3: very poor condition with $S_4 < S_g \leq S_3$

State 4: failed condition with $S_g = S_4$

where $S_1 = 1$, S_2 , S_3 , and $S_4 = 0$ are the global state indicator thresholds. The intermediate thresholds S_2 and S_3 are to be defined later (fig. 4.12).

Due to the fact that the scenarios are generated based on stochastic inputs of the floods, transitions between these states will therefore be stochastic. Therefore, the next step consists in modeling the evolution of the maintained system from one state to another through this stochastic process using SPNs.

4.3 Physics-Based Model of Sediment Retention Systems: Debris Flows Routing in the Presence of Retention Dams

Retention systems are designed to mitigate risk by trapping a specific volume of solid materials transported mainly by debris flows. On one hand, the trapping of low magnitude events (routine events) increases the stored volume and thus reduces the capacity of the sediment basin. On the other hand, the passage of large volumes of debris corresponding to high magnitude events (design, safety-check and danger events) through the retention dam may pose threat to downstream exposed issues. Consequently, a better understanding of the trapping process is essential in order to optimize their efficacy and to avoid unnecessary dredging costs. In fact, the regulation of debris flows (routing, deposition, storage) depends on four different factors presented below (Zollinger, 1983; Piton and Recking, 2015a). The first two factors depend on the geometry of the sediment retention basin (slope, width) and the other two depend on the geometry of the retention dam (shape and size of openings, dam's dimensions, etc.).

- **Deposition slope:** a mild deposition slope in the sediment retention basin decelerates the flow and thus decreases the transport capacity which in turn leads to higher deposition.
- **Basin width:** a wide sediment retention basin, compared to the upstream flow channel, forces the flow to spread in the lateral upstream areas of the basin thus reducing the transport capacity which in turn leads to higher deposition.

- **Deposit level:** a high level of deposition upstream the retention dam could force the flow to overtop the retention dam thus releasing large volume of debris to the downstream.
- **Openings' jamming:** large boulders or woody debris may partially or totally block the openings of the retention dam thus reducing the their discharge capacity which in turn increases the stored volume in the basin.

In order to analyze the mechanisms of debris flows, specifically how the flow is routed through a retention system, a physics-based model is developed and coded by INRAE (Piton G. and Chahrour N.), as a numerical model using R tool (coding language). The model adopts classical hydraulic capacity equations that permit estimating the outlet discharge taking into consideration the jamming of the retention dam's openings. Its end purpose is to model the evolution of the stored volume in the retention basin until reaching the maximum basin's storage capacity. A detailed explanation of the developed model is presented in the following sections and is already illustrated in fig. 4.2.

4.3.1 Step 1: Data Acquisition, Debris Flow Scenario Definition and Randomness Generation

Several inputs are required before launching simulations. Indeed, the model requires knowledge concerning the (i) geometry of the retention dam (shape, dimensions, openings), (ii) characteristics of the retention basin (storage capacity, deposition slope, stage-volume capacity curve) and (iii) Debris flows characteristics (return periods, inlet hydrographs, size of transported boulders). Some of these data can be extracted from historical database and topographical surveys while others could be missing and have to be assumed or obtained by modeling.

In debris basins, deposition does not occur horizontally. The deposition slope depends on the sediment concentration and on the type of sediment transport. The stage-volume capacity curve depends on the deposition slope and provides an estimate of the volume stored for different deposition levels upstream the retention dam (fig.4.9, (a)). In addition, the inlet hydrograph represent the inlet discharge as a function of time over the duration of the debris flow event. In case the data is limited, triangular hydrographs can be assumed. In this case, the hydrograph can be described by three parameters: volume, peak discharge and peak lag (fig.4.9, (b)). The peak lag depends on the total duration of the event (t_{end}) and on the time to peak discharge (t_{peak}) as shown in the following equation:

$$Peak\ lag = \frac{t_{peak}}{t_{end}} \quad (4.26)$$

In case the peak discharge and the duration of the debris flow event are missing but the volume of the event is known, the peak discharge (Q_{peak}) can be estimated based on the equation proposed by (Mizuyama et al., 1992) as follows:

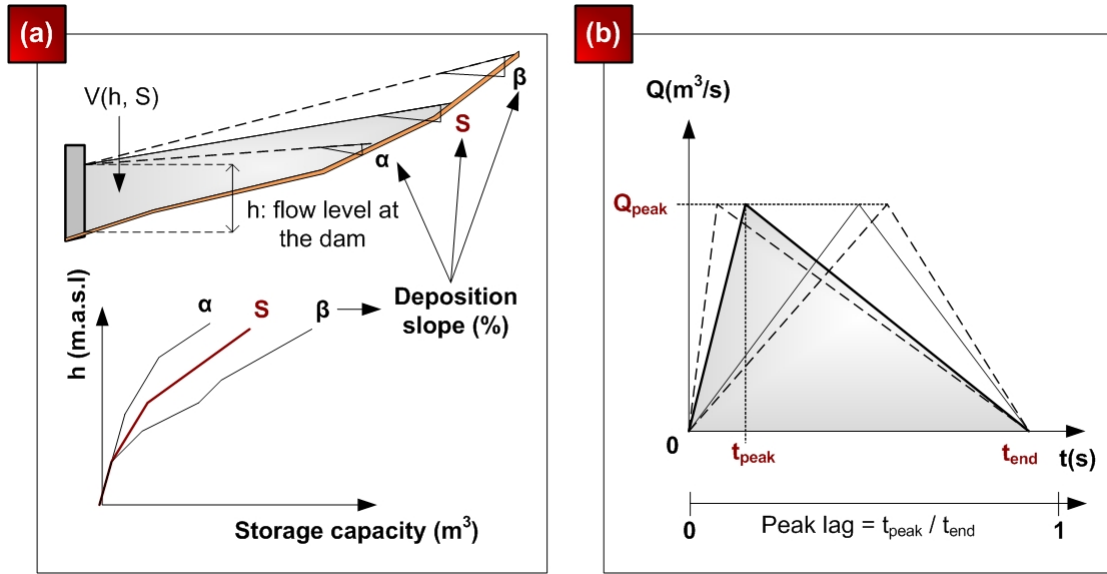

Figure 4.9: Input data required for defining debris flow scenarios: (a) volume of debris stored in the retention basin below a specific level at the dam for several deposition slopes; (b) shape and parameters of inlet hydrographs.

$$Q_{peak} = 0.0188 * V^{0.79} \quad (m^3/s) \quad (4.27)$$

The event's duration can be then computed by:

$$t_{end} = 2 \left(\frac{V}{Q_{peak}} \right) \quad (s) \quad (4.28)$$

Concerning debris flow scenarios, the objective is to re-create a time series of realistic events which will occur randomly during a specified simulation duration, usually considered as 50 years. In this context, the time-dependent evolution of the stored volume in the retention basin should be analyzed taking into consideration the clogging rate of the retention dam due to large boulders arriving and interacting with the openings of the dam. This analysis enables fitting probability laws for transition times between different states of degradation each corresponding to a specific volume of stored debris in the basin. Events are generated in the same way as presented in section 4.2.1. In this case, randomness is applied to create a scenario (series) of successive debris flow events, each of them being randomly characterized by a volume V and a date of occurrence D .

4.3.2 Step 2: Hydraulic control of flows by a Retention dam

Retention dams control the flow by their openings which allow a specific volume of the flow to be transferred to the downstream. Analysis concerning debris flows has not yet been covered

thoroughly in the literature. Consequently, equations dedicated to pure water hydraulics are adopted and applied to debris flows. This section provides the stage-discharge equations used in order to estimate the discharge capacity through the openings/outlets of a retention dam (Piton and Recking, 2015a).

Discharge capacity through the dam's weir (Deymier et al., 1995):

$$Q_i = 0.385 * w_i(t) * \sqrt{2 * g * (h(t) - y_i(t))^3} + 0.308 \frac{\sqrt{2 * g * (h(t) - y_i(t))^5}}{\tan(\phi)} \quad (4.29)$$

Discharge capacity through the dam's slit (Zollinger, 1983):

$$Q_i = \mu * w_i(t) * \frac{2}{3} \sqrt{2 * g * (h(t) - y_i(t))^3} \quad (4.30)$$

Discharge capacity through the dam's slot (Zollinger, 1983):

$$Q_i = \mu * w_i(t) * \frac{2}{3} \sqrt{2 * g * ((h(t) - y_i(t))^{3/2} - (h(t) - y_i(t) - a_i)^{3/2})} \quad (4.31)$$

where Q (m^3/s) is the discharge capacity through opening i , t is the time, $w_i(t)$ (m) is the opening free width (full width of the opening if it is not jammed by boulders), g (9.81 m/s^2) is the gravitational acceleration, $h(t)$ (m) is the flow depth over the dam's base level, $y_i(t)$ (m) is the base level of the flow (base level of the opening if it is not jammed by boulders), ϕ ($^\circ$) is the angle between the weir's wing and the horizontal, μ is a dimensionless opening coefficient usually assumed as 0.65 (Zollinger, 1983) and a_i is the slot's height (m). All of these parameters are illustrated in fig. 4.10.

in order to estimate $w_i(t)$ and $y_i(t)$, the progressive jamming of the dam's openings should be analyzed at different time steps during a debris flow event. The total discharge capacity of a retention dam is the sum of the discharge capacities through all its openings.

4.3.3 Step 3: Jamming Conditions and Stochastic Arrival of Boulders

The content of this section is adapted from the work done by (Piton and Goodwin, 2021).

In order to assess possible interactions between transported boulders and the retention dam's openings, simple hydraulic approaches that provide the spatio-temporal distribution of boulders approaching the dam and predict whether or not the boulders are blocked and jam the dam's outlets should be developed. Piton G., has recently proposed a new model that analyzes the (i) conditions of jamming based on granule dynamics and (ii) the stochastic arrival of boulders to the dam. This model is summarized and presented below.

The jamming process of a retention dam's openings is governed based on the size of boulders relative to the size of the openings. The dam's openings can be jammed based on the following boulders' arrangements:

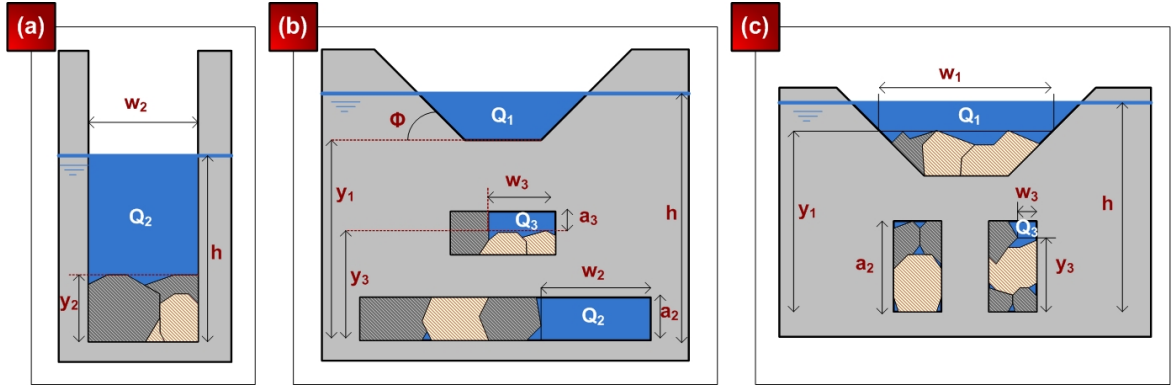

Figure 4.10: Hydraulic and geometric parameters describing different types of retention dams with different jamming configurations of their openings: (a) slit dam; (b) horizontal slot dam; (c) vertical slot dam (Adapted from (Piton and Goodwin, 2021)).

Lateral jamming: It is the most common jamming process and can be applied to all types of openings: slits (fig. 4.10, (a)), slots (e.g. central slot in fig. 4.10, (b)) and dam's weir (fig. 4.10, (c)). This type of boulders arrangement occurs only when the following condition is satisfied:

$$D_A + D_B > \omega_i(t) \quad (4.32)$$

where D_A and D_B are the diameters of the two largest boulders passing together at time t through the opening number i and $\omega_i(t)$ is the free width of opening i at time t . For trapezoidal sections (e.g. weir), $\omega_i(t)$ widens progressively depending on the free height of the section. Lateral jamming elevates the flow level in which the base level of all openings will be incremented by a height equals to the diameter of the largest blocked boulder. In the case where several boulders are approaching towards the dam at the same time, they are all assumed to move either ahead or behind the two largest ones. In other words, boulders will not accumulate above each others as illustrated in fig. 4.11.

Vertical jamming: It occurs only when the diameter of a boulder is greater than the height of the opening. This type of boulders arrangement can be more probably seen on bottom slots (e.g. bottom slot in fig. 4.10, (b)). Any boulder can vertically jam an opening if it satisfies the following condition:

$$D > a_i - y_i(t) \quad (4.33)$$

where D is the boulder's diameter, a_i is the height of opening number i and $y_i(t)$ is the level of boulder jamming the base. Vertical jamming reduces the width of the opening thus posing a lateral constraint on the flow. The opening width is reduced by the sum of diameters of all boulders approaching toward the dam at the same time and satisfying Eq. 4.33.

Combined jamming: This type of jamming occurs after sequential phases of lateral or vertical jamming. On one hand, after successive vertical jamming of wide and short slots, they become sufficiently narrow to be laterally jammed (e.g. the central slot in fig. 4.10, (b)). On the other hand, after successive lateral jamming of narrow and tall slots, they become sufficiently short to be vertically jammed (e.g. vertical slots in fig. 4.10, (c)).

In order to numerically implement these jamming conditions, information about the number and size of boulders transported by a debris flow event and passing, at the same time, through a retention dam's openings should be acquired. Usually, the stochastic arrival of boulders to the dam is assumed to follow a binomial distribution. Such stochastic modeling provides statistical data about the number of boulders that are transported by a given debris flow volume and reaches the dam at a specific time. The procedure starts by classifying the boulders according to their size in which class j corresponds to boulders larger than those of class $j + 1$. The number of adopted classes J and the diameters of boulders involved in a given class j ranging within the interval $[D_{j,min}, D_{j,max}]$ and should be adjusted depending on the available data provided for the analysis.

Briefly, the binomial distribution is a common discrete distribution that account only for two states, typically represented as 1 for a success or 0 for a failure given an independent number of trials N in the data. It, therefore, represents the probability for x successes in N trials, given a success probability p or a failure probability $p - 1$ for each trial. In the studied context, the binomial distribution is used in order to assess the number of boulders n_j of class j transported within a debris flow volume V and approaching towards the retention dam. For each class j , the average diameter D_j and volume of the associated boulders are computed as follows:

$$D_j = \frac{1}{2}(D_{j,min} + D_{j,max}) \quad (4.34)$$

$$V_j = \pi D_j^3 / 6 \quad (4.35)$$

where $D_{j,min}$ and $D_{j,max}$ are the minimum and the maximum boulders' diameters involved in class j . For adopting a binomial distribution, the number of trials N_j required for a class j of boulders per time step should be provided. Let N_j represent the number of elementary volumes V_j constituting the over all debris flow volume V which will pass through an opening. Hence:

$$N_j = \frac{V}{V_j} = \frac{V}{\pi D_j^3 / 6} \quad (4.36)$$

At each time step, the the binomial distribution gives probability that an elementary volume V_j close to the retention dam includes a boulder of class j . Finally, the number of

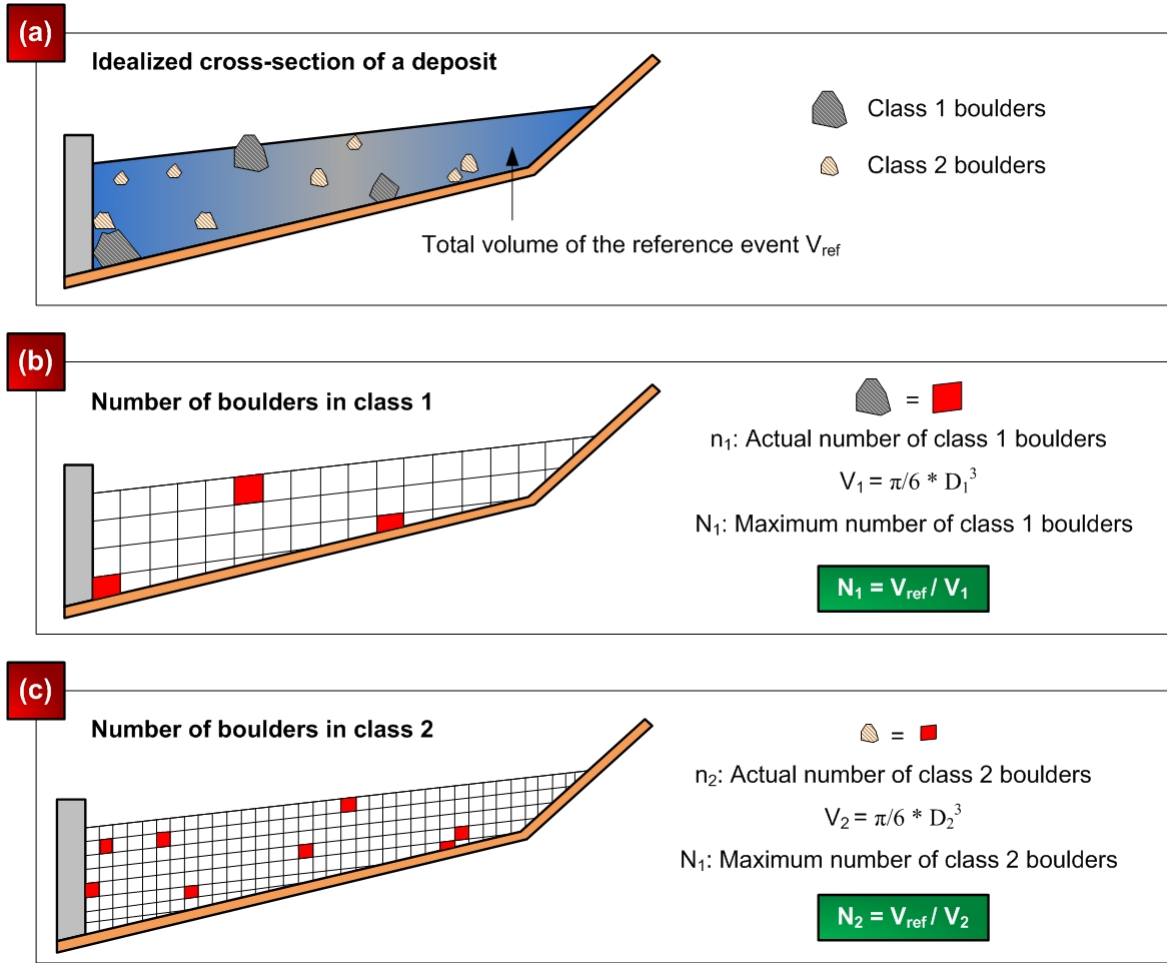

Figure 4.11: Conceptual schematic of boulder analysis used to calibrate the binomial distribution: (a) an idealised cross-section of a debris flow deposit with a given volume V_{ref} and a certain number of boulders belonging to two different size classes in a retention basin; (b) a more idealised version of the same deposit, where only the boulders of class 1 are represented: true boulders (red polygons) and false boulders (white polygons); (c) same concept but for boulders of class 2 (Adapted from (Piton and Goodwin, 2021)).

successes reveals the number of boulders n_j of class j in a given debris flow volume. The number of failed trials $(N_j - n_j)$ corresponds to elementary volumes containing boulders of other classes. The end purpose of such analysis is to compute the number of boulders n_j of a given class j involved in a given debris flow volume and passing through the dam's opening at different time steps, covering the entire duration of the flow. This is achieved by carrying out N_j random samples following the binomial distribution of known probability p_j . The mean of the binomial distribution is then given as:

$$\langle n_j \rangle = N_j * p_j \quad (4.37)$$

A reference deposit of a debris flow whose volume V_{ref} is high enough to involve a considerable number of boulders N_j of each class j must be collected from field data in order to estimate p_j . The number of boulder classes in V_{ref} is equivalent to physically measuring $\langle n_j \rangle$. Consequently, the probability that an elementary reference volume contains a class j boulder close to the retention dam is:

$$p = \langle n_j \rangle / N_j \quad (4.38)$$

It is important to note that V_{ref} differs from the volume V of debris flow approaching and interacting with the dam's opening (fig. 4.11, (a)). In addition, the estimation of p must be performed for each class separately since N_j depends on the average boulder diameter D_j of each class (fig. 4.11, (b) and (c)). This allows estimating p_j associated with each class of boulders. Assuming that the frequencies of boulder classes are homogeneous in average across the entire flow, p_j can be adopted for any debris flow volume V , interacting with an opening and inferior to the considered V_{ref} . The number of boulders of each class n_j involved with a volume V at a specific time can be obtained by simulating N_j trials using a binomial distribution of parameter p . The probability mass function P providing the probability that n_j is exactly equal to a given value k is defined by:

$$P(n_j = k) = \binom{N_j}{k} * p^k * (1 - p)^{N_j - k} \quad (4.39)$$

$$= \frac{N_j!}{k!(N_j - k)!} * p^k * (1 - p)^{N_j - k} \quad (4.40)$$

Furthermore, if boulders of class j are revealed to be involved within a specific volume V of debris flow, V cannot include boulders of other classes at the same time. Therefore, when randomly sampling the number of boulders of the J classes, V must be progressively reduced by the volume of boulders of larger classes that have already been identified at a given time step ($k = 1, 2, \dots, \sum n_{j-1}$). In this case, Eq. (4.36) is modified as:

$$N_j = \frac{V - \sum_{k=1}^{\sum n_{j-1}} V_k}{V_j} \quad (4.41)$$

$$= \frac{V - \sum_{k=1}^{\sum n_{j-1}} \pi * D_k^3 / 6}{\pi * D_j^3 / 6} \quad (4.42)$$

In conclusion, the stochastic arrival of boulders to a retention dam can be summarized by the following process:

- Assessing the number of boulders involved within a reference volume V_{ref} based on a field study.

- Estimating, using Eq. (4.38), the probability p_j of a binomial distribution for each boulder class.
- Randomly sampling the number of boulders in a given volume V of a debris flow interacting with an opening taking into consideration mass conservation (Eq. 4.42) in order to define the number of trials for each class of boulders.

4.3.4 Step 4: Retention Basin's Buffering Capacity

The presence of a sediment retention basin upstream a retention dam regulates debris flows by reducing their peak discharges (dosing effect). In other words, solid materials are stored in the basin and are later on expected to escape gradually through the retention dam. The clogging of the dam's openings by boulders, reduces their discharge capacities and thus the volume stored in the basin will significantly increase which in turn reduces the buffering capacity of the basin. In such cases, the dam will no more be able to self-clean a filled basin which will have to be dredged manually by carrying out maintenance operations.

Having information concerning the characteristics of the retention basin (storage capacity, deposition slope, stage-volume capacity curve) in addition to input hydrographs of debris flow events, the buffering of input flows in the basin can be estimated using the following mass conservation equation:

$$(Q_{inlet}(t) - Q_{outlet}(h(t))) * \Delta t = \Delta V_b(h(t)) \quad (4.43)$$

where Q_{inlet} (m^3/s) is the inlet discharge provided by the input hydrograph, Q_{outlet} (m^3/s) is the outlet discharge which is equal to the total discharge capacity of the retention dam, Δt (s) is the time step, h (m) is the flow level, and ΔV_b the variation in the basin storage. The basin volume V_b for a specific flow level h can be extracted from the stage-volume capacity curve corresponding the considered deposition slope.

4.3.5 Step 5: Overall Computational Analysis

A code for solving all previous steps is written in R in order to model the time-dependent evolution of the stored debris volume in the retention basin. The developed model can be applied to retention dams with different types of openings. The R code goes through the following main steps:

- **Step 1:** Defining an input vector that involves: volume (m^3) of the event, peak inlet discharge (m^3/s) based on Eq. 4.27, peak lag (s), deposition slope (%), initial volume (m^3) of deposit in the basin and initial lateral and vertical clogging of the dam's openings.

- **Step 2:** Creating a discharge (m^3/s) - time (s) curve (inlet hydrograph) using Eqs. 4.26 and 4.28.
- **Step 3:** Uploading the available stage (m) - volume (m^3) capacity curves for different deposition slopes and interpolating in order to have the curve corresponding to the associated deposition slope.
- **Step 4:** Reading data concerning the boulders classes, diameters and possible triggered number in a reference debris flow volume.
- **Step 5:** Estimating the elementary volume (m^3) of each boulder class (Eq. 4.35), maximum number of boulder that could theoretically be observed in the reference volume (Eq. 4.36) and the probability of having a boulder each time a volume of debris flow is equal to volume triggering a boulder to pass (Eq. 4.38).
- **Step 6:** Describing the geometry of the retention dam and all of its openings (width (m), height (m)) taking into consideration the initial lateral and vertical clogging.
- **Step 7:** Randomly sampling the number of boulders of each class that try to pass through each opening using the binomial distribution approach presented in section 4.3.3.
- **Step 8:** Checking the lateral and vertical jamming conditions (Eqs. 4.32 and 4.33) in each opening and updating the dimensions of the dam's openings.
- **Step 9:** Estimating the initial level (m) of deposit depending on the initial volume (m^3) in the basin using the obtained stage (m) - volume (m^3) capacity curve.
- **Step 10:** Computing the total discharge capacity (outlet discharge) through the retention dam taking into account only the free height (m) and width (m) of its openings.
- **Step 11:** Estimating final volume (m^3) stored in the basin using Eq. 4.43.

In order to model the evolution of indicators over time, the previous steps 7, 8 and 9 are performed at different time steps over the whole duration of a debris flow event. Concerning the passage of boulders, at each time step, if at least one boulder may pass ($N_j > 1$), a random number of boulder of size D are picked up according to a binomial law with N_j random sampling (Eq. 4.36). After, the diameter value of the randomly sampled positive values is added and the debris flow volume is reduced by the volume of detected boulders.

The results obtained after running the code are the evolution of the inlet discharge $Q_{inlet}(t)$ (m^3/s), outlet discharge $Q_{outlet}(t)$ (m^3/s), rate of lateral and horizontal clogging by boulders (%) at each opening of the retention dam, flow level $Z(t)$ (m) at the dam and the cumulative volume $V_b(t)$ (m^3) stored in the basin. Moreover, several important indicators can be extracted for analysis: maximum flow level at the dam (Z_{max}), maximum volume stored in the basin (V_{max}), duration of flow when overtopping the dam (T_{over}) and the total volume (V_{out}) released out of the dam's openings/outlets.

Since the objective of the approach is to analyze the behavior of the retention system over 50 years, the generated events involved within the series of debris flow events occurring over the specified period of time should be modeled one after another. In other words, the outputs

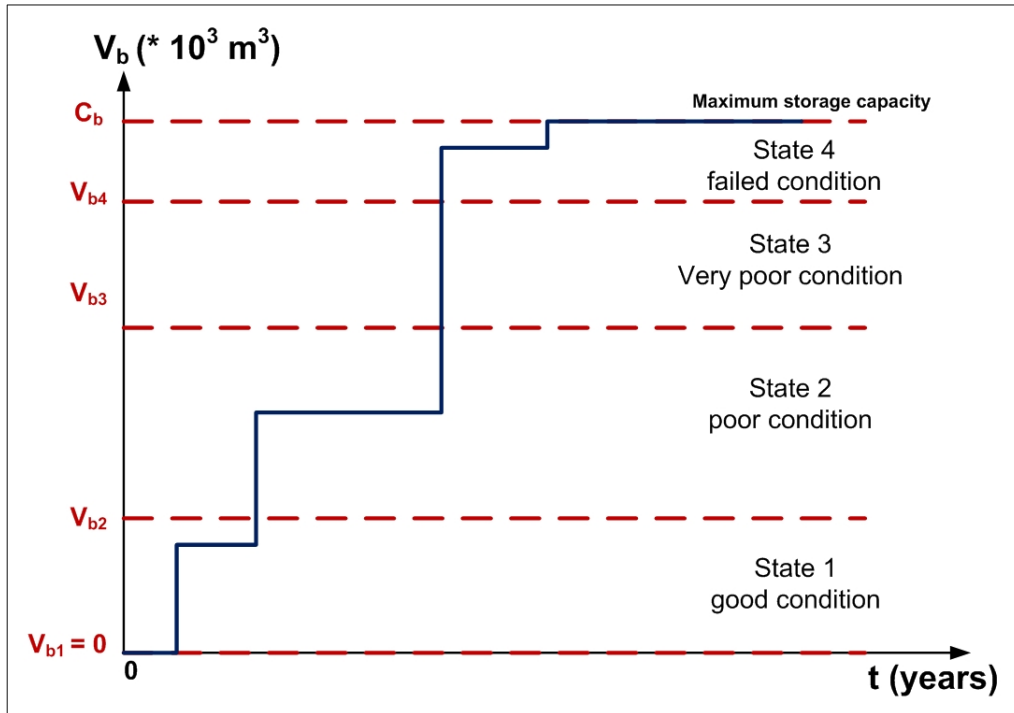

Figure 4.12: Example showing the evolution of the stored debris volume in the basin V_b through the defined states over time.

provided after running event i will be the inputs provided for analyzing event $i + 1$ involved within the series of debris flow events. This results in progressive and cumulative evolution of the studied indicators (e.g. rate of clogging of the openings; stored volume in the basin).

4.3.6 Step 6: States definition and transition laws

Using the framework presented in section 4.3.5, the analyst (modeler), can start the analysis considering an empty or partially filled basin and then assess how the retention dam and the basin moderate (dose) debris flow events.

The stored volume in a retention basin evolves progressively from an initial state (e.g. empty basin) to degraded states (e.g. partially filled basin) until reaching a completely failed state (e.g. fully filled basin). As explained in section 4.2.5, a state indicator that links intervals of measured values with the different states should be defined. The chosen stored volume indicator (V_b) in turn incorporates several indicators such as the rate of clogging of the dam's openings and the outlet discharge capacity of the retention dam. V_b (m^3) ranges between the initial volume stored in the basin and the maximum storage capacity of the basin (C_b).

In the present study, four different states are considered and described below. The chosen intervals result based on expert judgement and could of course be discussed and modified:

State 1: initial to good condition with $V_{b1} < V_b \leq V_{b2}$

State 2: poor condition with $V_{b2} < V_b \leq V_{b3}$

State 3: very poor condition with $V_{b3} < V_b \leq V_{b4}$

State 4: failed condition with $V_{b4} < V_b \leq C_b$

where V_{b1} , V_{b2} , V_{b3} and V_{b4} are the states' indicator thresholds.

Due to the fact that the scenarios are generated based on stochastic inputs of the debris flows, transitions between these states will therefore be stochastic. Therefore, the next step consists in modeling the evolution of the maintained system from one state to another through this stochastic process using SPNs.

4.4 Stochastic Deterioration and Maintenance Modeling: SPN and CBM approach

In the present study, the end purpose of the developed physics-based models is to support maintenance decision-making of protection systems. Strategies may differ depending on several aspects such as inspecting less often, waiting the degradation to be more severe and then repairing, or detecting and repairing at early stages. For infrastructures' managers, the issue is to choose the best economic solution, having in mind also that the longer is the default period, the higher is the risk on protected assets and people downstream. Stochastic Petri nets (SPNs) incorporating condition-based maintenance (CBM) aim in representing how the system moves from a low to a high degraded state considering possible deterioration mechanisms and maintenance actions. Indeed, regular inspections are performed in order to detect the state of the system based on the specified degradation indicator (e.g. S_g or V_b) whose evolution is modeled as a function of time. This permits making choices based on quantitative criteria describing the performance of several maintenance strategies proposed.

In this section, an example of a deterioration and maintenance model using SPN is presented. Several variations around this model could have been easily considered. For example, the structure of the model could be different if more deterioration states are considered. The main objective is to show the principle of the general methodology that integrates a degradation process with transition laws learnt from the physics-based model in addition to inspection and maintenance processes. However, this does not mean that the used SPN model is the only one that can be built in the sense that different extensions are possible. Indeed, the developed SPN model provides a stochastic deterioration and maintenance modeling of any deteriorating system. Its global framework involves degradation, inspection and maintenance processes.

4.4.1 Degradation Process

The states describing the evolution of the system are represented in fig. 4.13 by places P_1 - P_4 . These places correspond to the four states defined in section 4.2.5 and 4.3.6 in which P_1 , P_2 , P_3 , and P_4 correspond respectively to a good, poor, very poor, and failed condition of the system. At $t = 0$, the system is in its initial-new state. Hence, as a starting point, a token is added to P_1 revealing that the system is initially in a good condition. The stochastic transitions T_{i-j} (T_{1-2} , T_{1-3} , T_{1-4} , T_{2-3} , T_{2-4} and T_{3-4}) link between states i and j . The firing delay times corresponding to these transitions should be given as probability distributions. The probability laws of these transitions can be built, based on the system's deterioration trajectories across its defined states, using non-parametric estimations (Kaplan and Meier, 1958). The physics-based models presented in sections 4.2 and 4.3, provides, respectively, observations of a check dam's and retention system's deterioration trajectories.

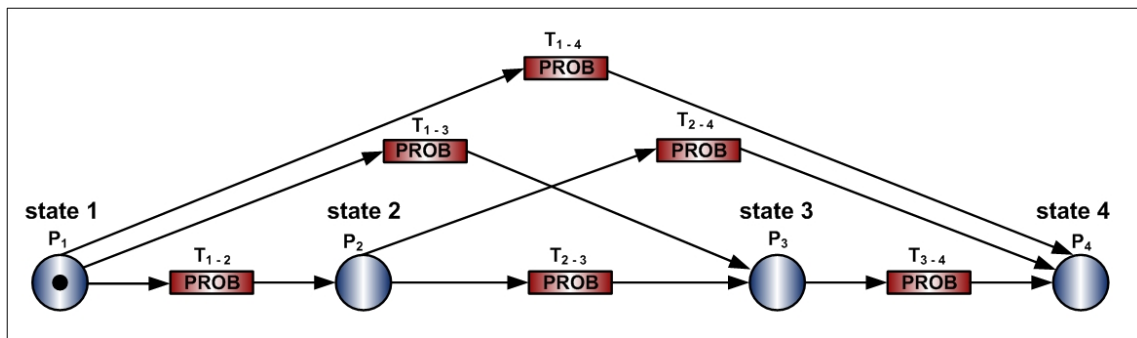

Figure 4.13: Degradation process involved within the SPN model.

4.4.2 Inspection Process

In order to detect the state of the system, inspection must be carried out periodically over a specified period of time (fig. 4.14). T_{insp} is the firing delay time of transition T_5 linked to places P_5 and P_6 which correspond to the inspection process. At $t = 0$, a token is added to P_5 . When T_{insp} is reached, T_5 is fired and the token in P_5 travels to P_6 in which inspection takes place. Consequently, depending on the current state of the system, one of the immediate transitions T_6 , T_7 or T_8 will immediately fire. Moreover, after the immediate firing of T_6 , T_7 or T_8 , T_4 fires immediately so that the token in P_6 returns to P_5 waiting for another inspection to take place after another T_{insp} years. For avoiding the conflict between the firing of T_4 with T_6 , T_7 or T_8 , priorities should be assigned to transitions. Hence, a lower priority is given to T_4 in order to ensure the firing of T_6 , T_7 or T_8 first.

4.4.3 Maintenance Process

Depending on the state of the system, different maintenance operations can be performed in order to restore the system to its initial state (fig. 4.15). A condition-based maintenance

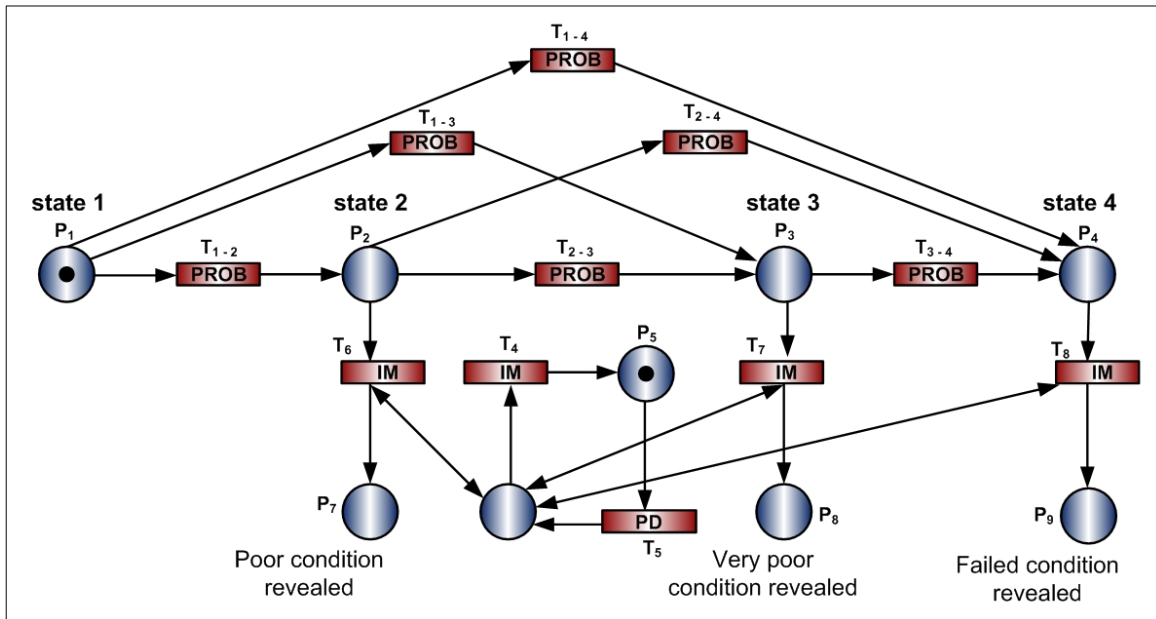

Figure 4.14: Degradation and inspection processes involved within the SPN model.

policy is applied in this model in which each degraded state corresponds to a maintenance operation. Places $P_7 - P_9$ represent the states revealed after inspection. If a token is present in P_7 , P_8 or in P_9 , maintenance operation 1, 2 or 3 is required respectively. Following maintenance, transition T_9 , T_{10} or T_{11} fires and returns the token back to P_1 . The firing delay times associated to Transitions $T_9 - T_{11}$ represent the time needed to schedule and carry out the work. Note that all maintenance operations presented in this model are considered to be perfect in which, after their application, the system is restored to the initial new state.

From state 1, the system can move either to state 2, 3 or 4 depending on which of the associated transitions (T_{1-2} , T_{1-3} and T_{1-4}) fires first. While the system resides in state 1, no maintenance operation is required. If the system is in state 2, a token is present in P_2 and three possible pathways exist. If transition T_6 fires first, the token in P_2 moves to P_7 meaning that the system is inspected and maintenance operation 1 will be carried out. However, if transition T_{2-3} or T_{2-4} fires first, the token travels to P_3 or to P_4 respectively, meaning that the system has degraded to state 3 or to state 4 before being inspected. Similarly, if the system is in state 3, a token is present in P_3 and may either move to P_8 (maintenance operation 2 to be scheduled) if T_7 fires first or to P_4 (failed state) if T_{3-4} fires first. Finally, if the system is in state 4, a token is present in P_4 and only T_8 can be fired. The system waits for inspection to occur and maintenance operation 3 will be applied.

4.4.4 Decision-making support for choosing maintenance strategies

In order to make a decision and to choose between several proposed maintenance strategies, inhibitor arcs may be added to the model (fig. 4.16). One could for instance decide to

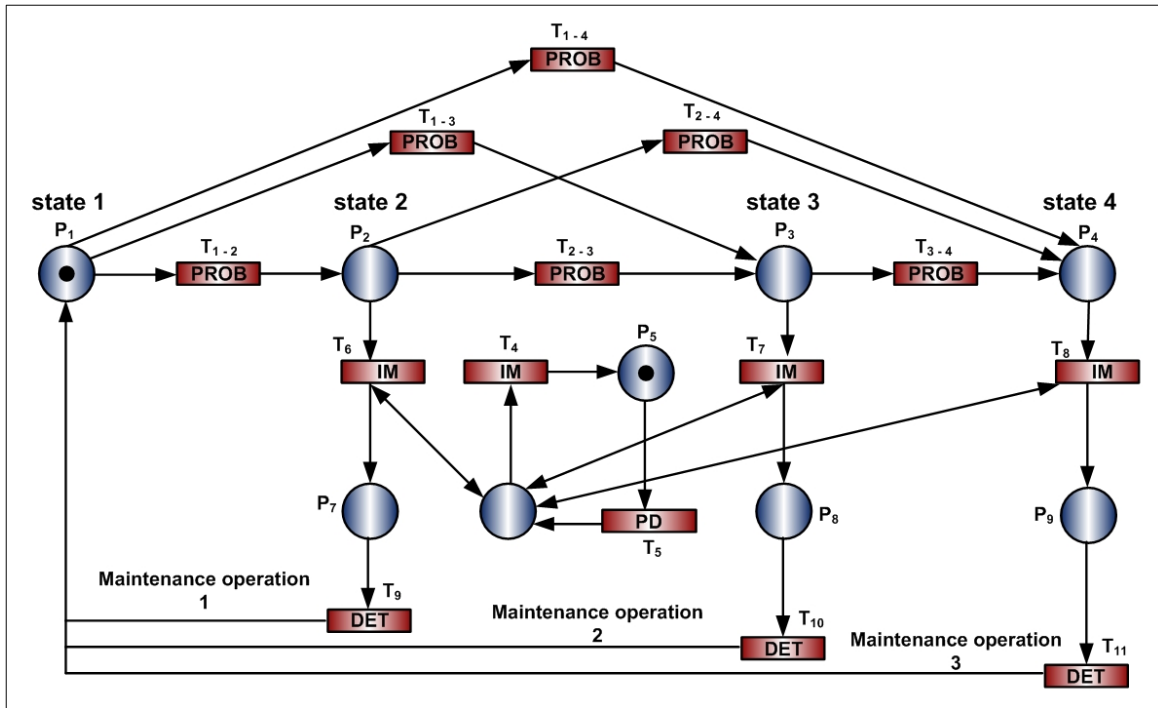

Figure 4.15: Degradation, inspection and maintenance processes involved within the SPN model.

compare strategies without intermediate maintenance operations, waiting for the system to be completely out of order to proceed to a corrective maintenance. The addition of places P_{10} and P_{11} , linked to inhibitor arcs, permits simulating different maintenance strategies. The presence of a token in P_{10} inhibits the firing of transition T_6 . Consequently, maintenance operation 1 is not permitted and the system is allowed to degrade further to state 3 with no prior maintenance. Similarly, if a token is added to P_{11} , T_7 is inhibited and maintenance operation 2 will not be allowed.

Based on Monte-Carlo simulations, the model provides for each maintenance strategy and over the specified duration of simulation:

- The time spent by the system in each of the defined states.
- The number of maintenance operations performed for each type of maintenance.

Such outcomes can be adequate for making a decision regarding the most suitable maintenance strategy to be applied to a system depending on available resources. In fact, knowing the cost of each maintenance operation, the total cost of each maintenance strategy can be computed. Hence, the strategies can be sorted in terms of cost and maximum availability (total time spent in non-failed state).

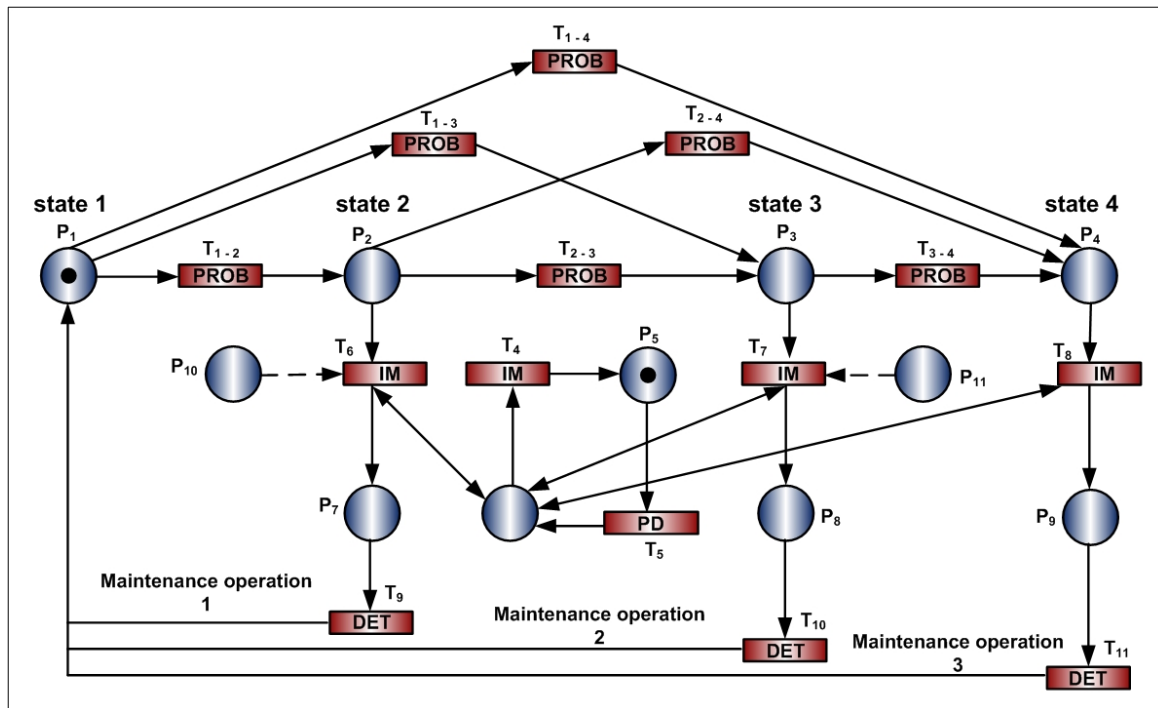

Figure 4.16: Complete SPN model developed for modeling stochastic deterioration and maintenance processes of a deteriorating system. PROB: probabilistic; IM: immediate, PD: periodic; and DET: deterministic transition times.

4.5 Integrating Information Imperfection using HYRISK for Improved Decision-making (Chahrour et al., 2021c)

The content of this section has been published within the proceedings of the 31st European Safety and Reliability Conference (ESREL 2021) (Chahrour et al., 2021c).

Obtained results from the SPN model permit assessing (compare, sort...) several maintenance strategies taking into account the total cost of each strategy. Yet, due to the partial knowledge and imprecise information, input parameters remain imperfect. In other words, different choices for the same input variable may lead to different outputs, and thus influence the decision. Hence, results must be analyzed with caution considering the subjectivity or the quality of the information provided. It is also worthwhile to quantify and propagate the uncertainty (e.g., using HYRISK) through the deterioration and maintenance model so as to gain further information on the confidence that the decision-maker can have in the model outputs. Accordingly, an integrated approach that incorporates uncertainty analysis in the maintenance decision process of deteriorating systems should be developed. Fig. 4.17 provides an example of an integrated approach corresponding to a check dam deterioration and maintenance model. Similar framework can be obtained for any other system (e.g. retention system).

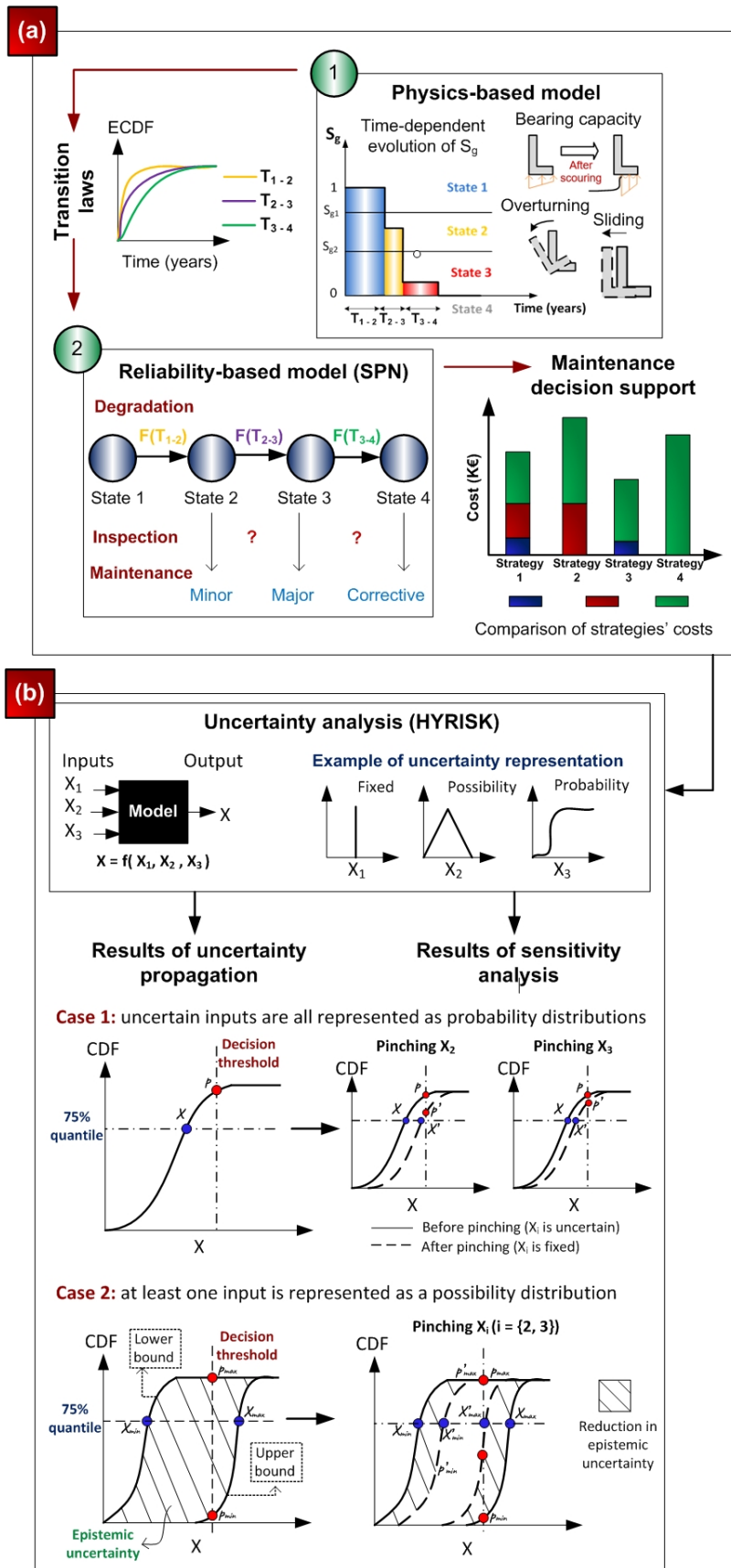

Figure 4.17: Integrated methodological framework of a check dam model considering uncertainty analysis. (a) Check dam's deterioration and maintenance coupled model; (b) Uncertainty analysis using HYRISK.

4.5.1 Functionality of HYRISK

HYRISK is a R package developed by BRGM (French Geological Survey) in order to propagate information imperfection through a model allowing to represent both aleatory and epistemic uncertainty using probability and possibility distributions. HYRISK package provides functions at each step of the uncertainty quantification process (Rohmer et al., 2018). These steps and the associated functions are summarized below.

- **Uncertainty representation:** In this step, input variables (imprecise, random or fixed) are first defined using `CREATE_INPUT` function. Then, the `CREATE_DISTR` function is used to assign probability (normal, uniform, Gumbel, etc...) for random input variables and possibility distributions (trapezoidal or triangular) for imprecise ones. The graphical representation forms of all input parameters can be finally be implemented using `PLOT_INPUT` function.
- **Uncertainty propagation:** The `PROPAG` function evaluates impact of the uncertainty that invades the inputs on the outcome of the risk assessment model. It combines random sampling using Monte-Carlo method with fuzzy interval analysis for jointly handling possibility, probability distributions and p-boxes.
- **Sensitivity analysis:** This step is dedicated for analyzing how uncertainty in the model's output is influenced by each model's input separately. The pinching method (Ferson and Tucker, 2006) implemented using `PINCHING_fun` and `SENSI_PINCHING` functions is used in this analysis.

4.5.2 Results produced with HYRISK

Both uncertainty propagation and sensitivity analysis via HYRISK result in a pair of upper and lower cumulative probability distributions (CDFs), which defines the p-box related to the uncertainty on the output variable X (fig. 4.17, (b)). Three statistical quantities that support the decision-making process can be extracted from the resulted p-boxes using the following HYRISK functions:

- **PROBA_INTERVAL** provides the upper and lower bound on the probability of X being below a decision threshold.
- **QUAN_INTERVAL** provides the upper and lower bound corresponding to a quantile at a given level (e.g. 75%).
- **UNCERTAINTY** estimates the area within the lower and upper probability distribution thus providing a global measure of epistemic uncertainty.

The analysis of information imperfection should be carried out considering its propagation through the different stages of the deterioration and maintenance model. Indeed, the

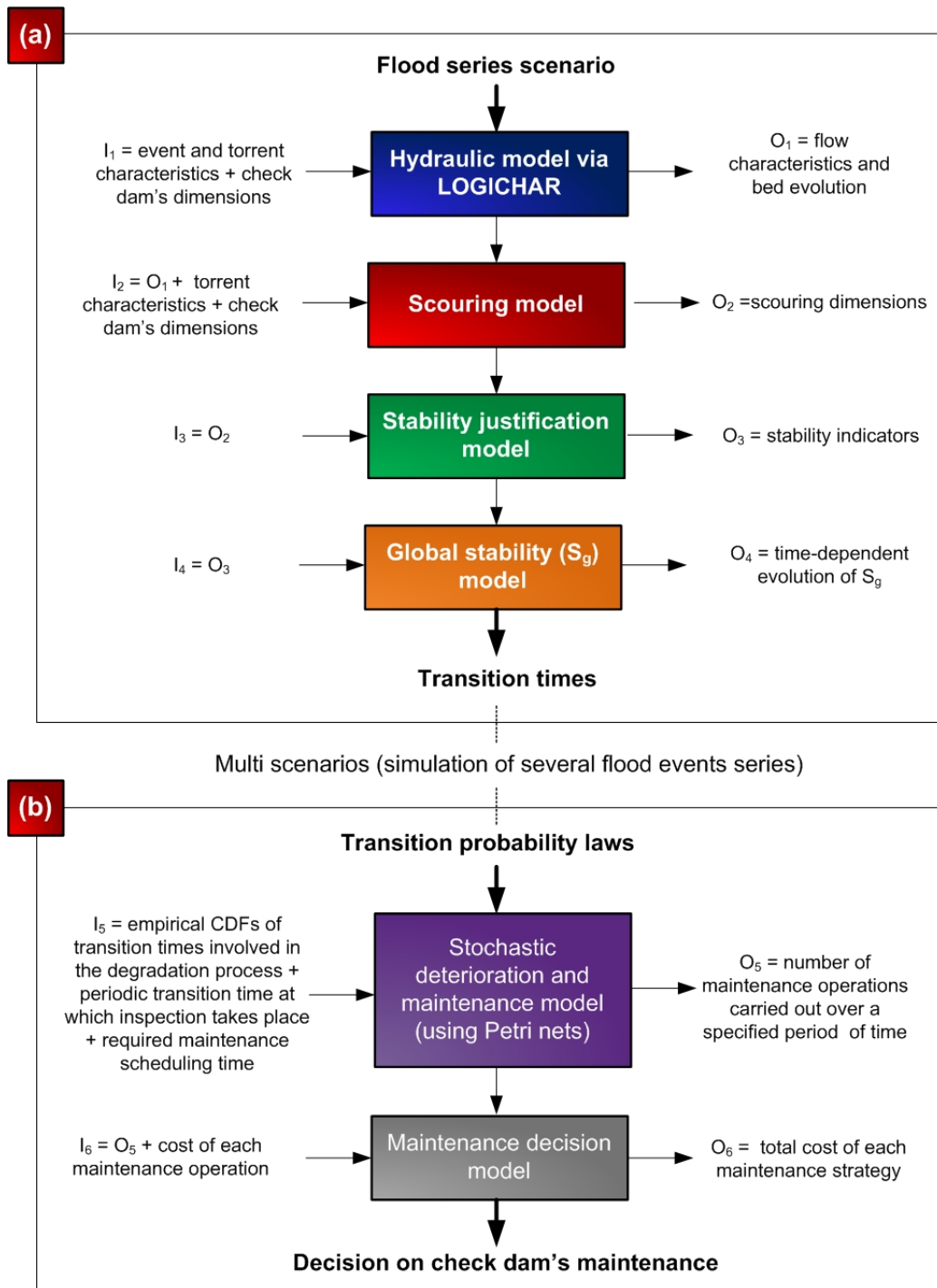

Figure 4.18: Sub-models involved in the (a) physics-based model and the (b) reliability-based model of a check dam. I_i : list of inputs to sub-model i . O_i : list of outputs provided by sub-model i .

integrated model can be divided into sub-models (fig. 4.18) at which uncertainty analysis can be implemented.

4.6 Conclusion

In this chapter, a holistic approach that allows modeling the behavior of protection structures when exposed to deterioration mechanisms and to maintenance operations over their lifetime. The approach integrates (i) a physic-based model that results in trajectories showing the time-dependent deterioration of the structure which in turn allows to estimate transition laws and (ii) a reliability-based model using SPN, which uses the information provided by the previous model in order to model the stochastic deterioration and maintenance processes of the structure and to support its maintenance decision-making. It is also shown in this chapter, how uncertainty could propagate within the proposed modeling approach and how to consider this issue within the model.

The objective now is to show how the proposed methodology can be implemented on real case studies. For this reason, the overall approach is applied to two different types of protection structures which will in turn contribute to prove the model genericity. Chapters 5 and 6 present, respectively, the applications to check dams and retention systems.

Application: Development and Evaluation of a Complete Check Dam Deterioration and Maintenance Model

Contents

5.1	Real Case Study: Check Dam Subjected to Clear Water Floods in the Manival Torrent	140
5.1.1	Manival Torrent Description	140
5.1.2	Numerical Modeling Inputs and Data Sources	141
5.1.3	SPN Model and Maintenance Strategies	144
5.1.4	Model Execution, Results and Discussions	146
5.1.5	Information Imperfection Analysis Within the Check Dam's Model	151
	5.1.5.1 Uncertainty Representation	151
	5.1.5.2 Uncertainty Propagation and Sensitivity Analysis	153
5.2	Cascade Effect Analysis for Prioritizing Check Dams' Maintenance strategies in a Multi-Component System	155
5.2.1	General Description of the Protection System	156
5.2.2	Physics-Based Modeling: Check Dams' Stability Evolution	156
5.2.3	SPN Model and Maintenance Decision-Making	159
5.3	Conclusion	161

This chapter aims to show how the proposed methodology can be implemented on check dams. This will also be an opportunity to clarify, in particular, how the transition laws involved in the deterioration process are estimated, how this can be implemented on a real case study, what are the encountered difficulties and what kind of conclusion or decision can be made from the model. In other words, the chapter does not only involve a simple application of the model. The objective is to show how risk managers and decision-makers can leverage this model to get a better insight into the best maintenance decision for deteriorating check dams.

Two different applications to check dams. The first one corresponds to a real case study in which the time-dependent evolution of a check dam located in the Manival torrent in France when subjected to scouring phenomena and loss in external stability due to intense clear water floods is modeled over a period of 100 years. After, four different maintenance strategies are modeled using the SPN model in which the total cost of each is estimated making it possible to choose the best cost-effective strategy to be applied to the dam. The application ends by a simple model analyzing uncertainty propagation within the scouring calculation approach using HYRISK. The second application considers a fictive multi-components system composed of two dams in which the bi-directional dependencies between the dams are analyzed. The time-dependent evolution of each dam in the presence or absence of the other dam is modeled when being subjected to a series of clear water floods over a period of 50 years.

5.1 Real Case Study: Check Dam Subjected to Clear Water Floods in the Manival Torrent (Chahrour et al., 2021a)

The content of this section has been published in the journal of Reliability Engineering and System Safety (Chahrour et al., 2021a).

In order to illustrate the abilities of the developed model and to achieve results with relevant order of magnitudes, it is essential to apply it to a real case study. The Manival torrent, located at 45.263° N, 5.837° E in Saint-Ismier and Saint-Nazaire-les-Eymes, close to the city of Grenoble in the Chartreuse Mountains of the Northern French Prealps, is chosen for this purpose.

5.1.1 Manival Torrent Description

The Manival flows intermittently into the Isère River in the Grésivaudan valley. It is a very active torrent characterized by a steep slope and high sediment potential, highly prone to bedload transport and to debris flows (Theule et al., 2012; ONF-RTM, 2016; Bel, 2017). Frequent debris floods events (once every one year since 2008) flow throughout the main channel and deposit into the 25000 m^3 sediment retention basin which was built in 1926 in order to protect the urbanized alluvial fan against debris flows. The solid materials related to bedload transport can be defined as gravel wedges with well sorted grain size distributions. The entire torrent extends to more than 7 km and is fortified by an integrated protection system composed of approximately 180 check dams constructed since the 1890s, a retention dam constructed in the 1992 as a completion of the sediment retention basin and several lateral earth or concrete dykes. All protection structures are monitored and managed by the French national forest office in charge of torrent control in the Isère department (ONF-RTM(38)).

In the present application, the reach downstream the sediment retention basin is considered. It starts from the open check dam and extends about 1 km downstream towards the alluvial fan as shown in fig. 5.1. It contains 39 transverse check dams having different

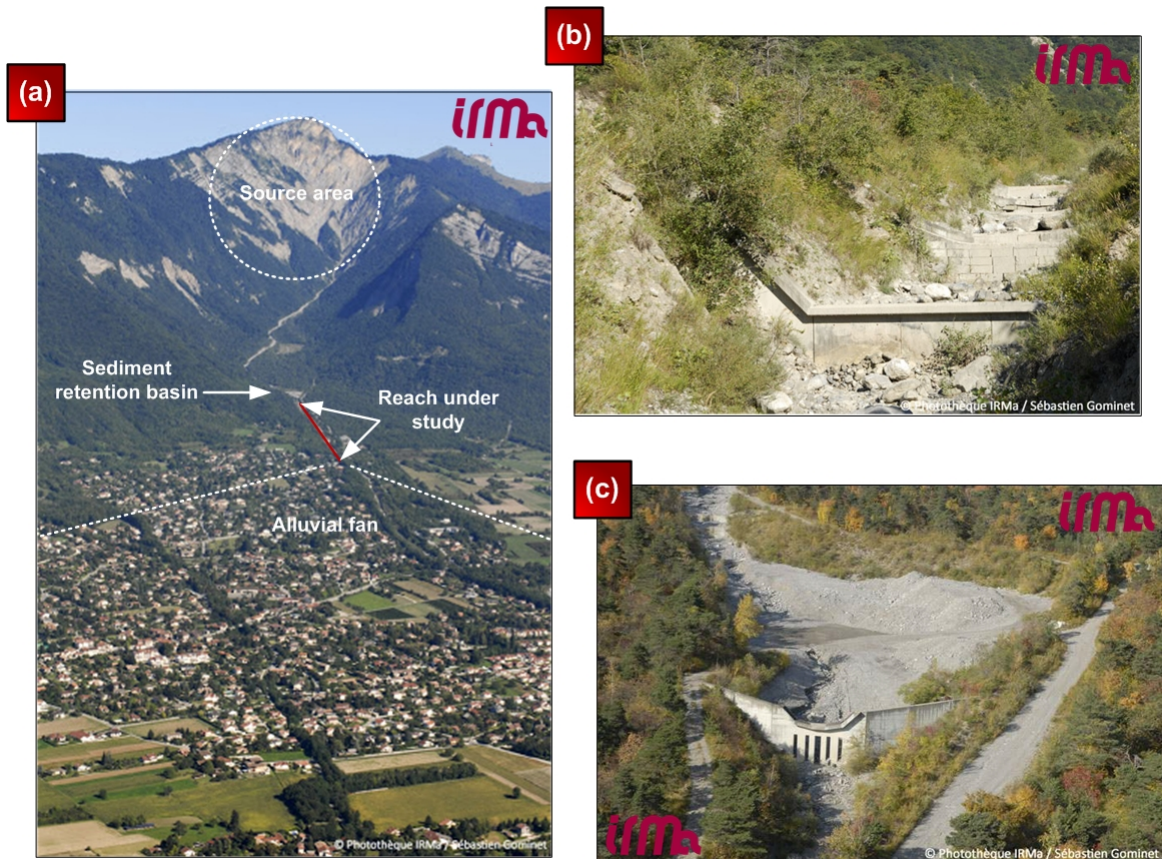

Figure 5.1: Manival torrent: (a) Torrential watershed; (b) series of check dams; (c) retention system. Source: ©IRMa/S. Gominey, <http://www.irma-grenoble.com>.

dimensions and made up of built in place or prefabricated reinforced concrete. In addition, 2 lateral dykes, made up of reinforced concrete and earth materials are implemented directly downstream the sediment retention basin.

5.1.2 Numerical Modeling Inputs and Data Sources

The entire reach under study is modeled using LOGICAR software. The data in table 5.1 are extracted from the ONF-RTM database that contains information regarding the longitudinal profile, channel section, and grain size distribution of the Manival (ONF-RTM, 2016). Moreover, the RTM GIS survey performed in 2009, allows to locate the 39 check dams along the longitudinal profile and to estimate the observed height of each dam. The erodible layer under each dam is assumed to be equals to 2 m. However, local scouring can go beyond this value. Regarding sediment transport, Rickenmann equation is considered (Rickenmann, 1991).

Besides, it has been found, based on the RTM study of 2009, that the average discharge in the studied reach corresponding to 10 years return period is $Q_{10} = 5 \text{ m}^3/\text{s}$. For choosing

Longitudinal profile		Slope (%)		11
Channel cross section (trapezoidal)		Width B (m)		6
		Slope (m/m)		1/1
		Height (m)		5.5
Grain size distribution		D_{30} (cm)		2.6
		D_{50} (cm)		3.7
		D_{90} (cm)		9
		D_m (cm)		4.6

Table 5.1: General features of the studied reach in the Manival torrent (ONF-RTM, 2016).

Discharge (m^3/s)		4.46	3.93	4.60	4.70	3.89	7.28	3.41	2.90
Date (<i>years</i>)		10.34	15.54	25.88	52.84	72.99	87.20	88.28	99.00

Table 5.2: Dates and peak water discharges of all flood events within an event series occurring over a period of 100 *years* - Scenario 1.

the scenario corresponding to a series of events, it is considered that the studied reach is subjected only to clear water floods. This is justified by the fact that the solid materials flowing from the upstream are trapped in the sediment retention basin while assuming that the retention dam is totally blocked by large sediments. Consequently, upstream sediment inputs in all flood events are neglected. The hydrographs are assumed to have a triangular shape with a peak discharge attained at half time of the flood event. Each flood event within the event series is assumed to last 1 *hour*. Over a period of 100 *years*, only events of return period 10 *years* are considered in the modeling. The dates of the events and the value of the peak discharge corresponding to each event are obtained by random draws using a Poisson law ($\lambda = \frac{1}{returnperiod} = \frac{1}{10}$) and Gamma law ($\alpha = 5, \beta = 1, \alpha * \beta = Q_{10}$) respectively. The number of scenarios to be considered was chosen on the basis of (i) observing convergence in the estimated empirical distribution laws of the stochastic transitions and (ii) keeping a reasonable size of data. Indeed, the generation of 50 scenarios fulfills both mentioned conditions. Therefore, 50 different scenarios, corresponding to 50 different event series, are obtained. As an example, the data obtained by random draw, corresponding to the first scenario is given in table 5.2. In fact, the dates of the events are not necessary input to LOGICCHAR since the variation in the torrent's bed only occurs during a flood event while it remains constant between two consecutive events. Hence, it is relevant to simulate a fictive series (events one after another) taking into consideration only the duration of the flood as shown in fig. 5.2. However, the dates of the events are still required in order to estimate the time spent by the dams in each of the defined states over the 100 *years* lifetime period.

All the previously mentioned data are used as inputs into LOGICCHAR in order to execute simulations. The results of the LOGICCHAR modeling will be the input for scouring and stability calculations.

Concerning the calculation of local scouring under check dams, up to now, only the ge-

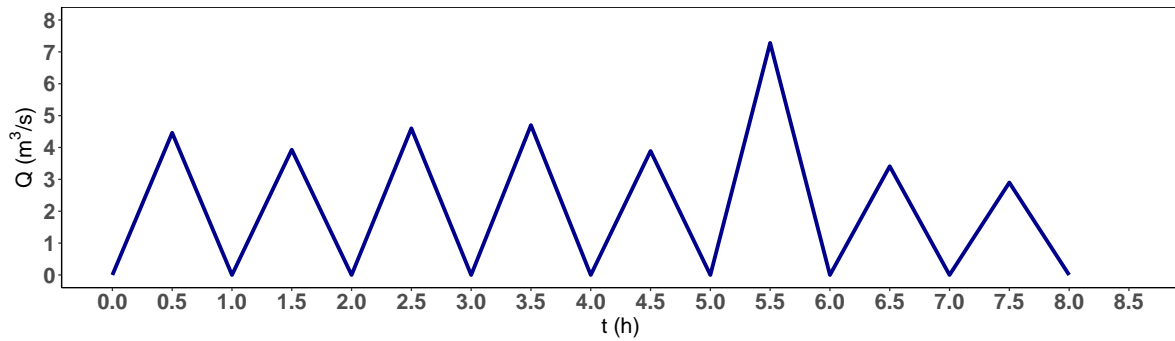

Figure 5.2: Hydrograph required as an input to LOGICCHAR - Scenario 1.

Data	Parameter	Value	reference	
Check dam #54 dimensions	H_{TOT} (m)	3.3	ONF-RTM(38) database	
	H_w (m)	2.3		
	b (m)	4.4		
	L_F (m)	5		
	L_{TOT} (m)	13.7		
		B_{TAL} (m)	2	Assumptions
		B_{SUP} (m)	0.3	
		E (m)	0.3	
		H (m)	2	RTM 2009 GIS survey
		Z_{FI} (m)	0.3	
Geotechnical and soil properties	γ_B (KN/m ³)	25	(Deymier et al., 1995)	
	γ_S (KN/m ³)	18		
	γ_W (KN/m ³)	10		
	ϕ (ř)	30		
	c (Kpa)	0		
	Ka	0.33		
	ple (Mpa)	2		
	Liquid impact factor	5	Assumption	

Table 5.3: Data required for external stability verification of a check dam.

ometry of the scour pit downstream the wall of the dam is analyzed by researchers since it is not recommended to allow scouring under foundation while designing a check dam. The extension of scouring under the dam and its local effect does not exist in the literature. The objective in this study is somehow different since it deals with failure analysis requiring to propose specific assumptions for the scour pit geometry under the foundation. As shown in fig. 4.5, the slope of local scour under the dam is assumed to be 3/1, considered to be steeper than the scour pit slope which is given and proved to be 1/1 based on the non-dimensional

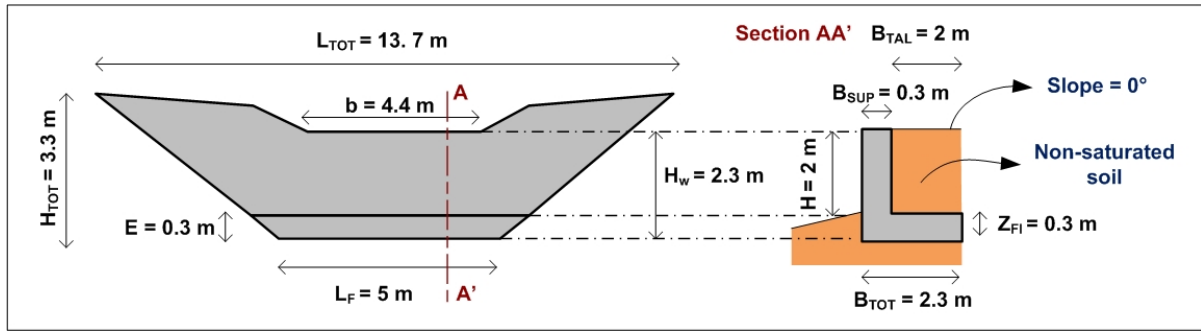

Figure 5.3: Principal dimensions of the check dam under study (check dam #54 in Manival).

scour pit profile resulting from the experimental work of (Gaudio et al., 2000). In addition, the maximum value, corresponding to the most intense flood event among all the defined scenarios, of the contraction coefficient C (Eq. 4.4) is computed and used in all scenarios. Hence, for simplicity, same values of C , R , R' , and R'' are used in the modeling.

In the studied reach, 3 large reinforced concrete check dams ($H_{TOT} > 2.5$ m) exist. All the other structures are considered as small check dams constructed close to each others in order to limit the incision of the torrent's bed. In this paper, the external stability of one of the large reinforced concrete check dams is analyzed (#54 in the Manival torrent). The dam under study is located about 70 m downstream the retention dam. The analysis of stability is done on the entire check dam body. For more safety, the dam is assumed to be completely filled by sediments from the upstream, with no angle of inclination between the soil and the dam (fig. 5.3). In addition, the soil is assumed to be not saturated (drained condition). The dimensions of the dam and the soil properties are summarized in table 5.3.

Note that all the assumptions made regarding the missing data or for the sake of simplicity, are assessed by experts in the field.

5.1.3 SPN Model and Maintenance Strategies

The SPN model is implemented and evaluated using GRIF-Workshop (GRIF, 2018) developed by TOTAL and SATODEV. The GRIF package, related to the Petri module, uses the MOCA-RP computation engine (Monte-Carlo and Petri nets). The SPN model presented in fig. 4.16 has been used for representing the evolution of the check dam under study. Regarding the three maintenance operations 1, 2, and 3, described in section 4.4.3, which correspond to states 2, 3, and 4 respectively, the following types of operations are chosen:

- **Maintenance operation 1:** minor preventive maintenance in which the scoured area can be refilled by earth material (e.g. rock or concrete riprap);
- **Maintenance operation 2:** major preventive maintenance in which anchor ties (steel beams mortared at the end) can be installed. In addition, cantilever supports made of reinforced concrete can be constructed in the worst case (more expensive);

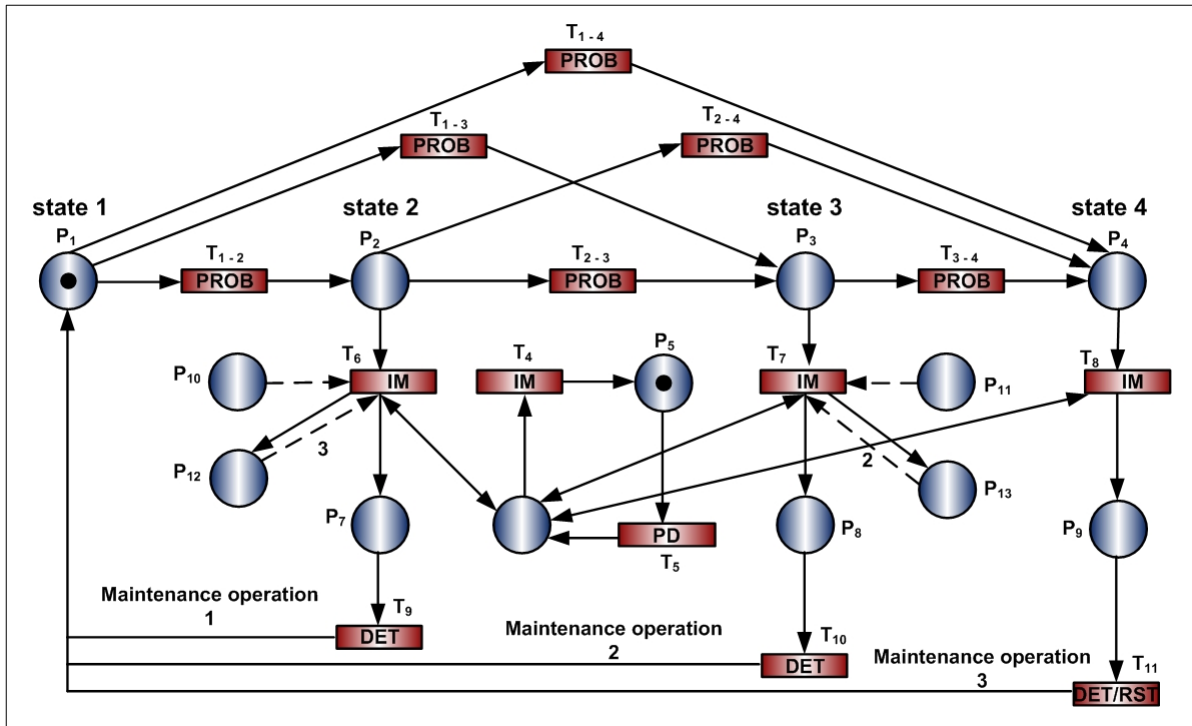

Figure 5.4: SPN model incorporating restrictions on maintenance operations.

- **Maintenance operation 3:** corrective maintenance in which the system should be reconstructed.

In the current application, it is assumed that only three minor operations and two major operations can be performed prior to a corrective operation. In other words, after carrying out three minor operations and two major operations on the check dam, minor and major maintenance will be inhibited. However, as soon as a corrective maintenance is performed, minor and major operations will be allowed again. These constraints are incorporated into the SPN model presented in fig. 4.16 by the addition of P_{12} and P_{13} as shown in fig. 5.4. As soon as three tokens are present in P_{12} , T_6 will be inhibited from firing and thus no minor operation can take place. Similarly, if P_{13} already contains two tokens, T_7 will be inhibited from firing and major operations are prevented. In addition, transition T_{11} also acts as a reset transition, in which upon its firing, the tokens in P_{12} and P_{13} are removed so that minor and major operations can again be performed after carrying out a corrective operation. Reconstruction of the dam is estimated to cost around 150,000. Minor and major operations are estimated respectively as 5% and 50% from the cost of reconstruction. The deterministic transition times of fig. 5.4, corresponding to the inspection frequency (T_5) and the scheduling and work time of each maintenance operation (T_9 , T_{10} , and T_{11}), are assessed and presented in table 5.4.

In order to achieve the objective of supporting decision-making for check dam's maintenance, four different maintenance strategies are defined to be compared and sorted. The

Intervention	Transition	Constant firing time (years)
Inspection	Inspection frequency T_5	1
	Immediate transitions $T_4 T_6$ $T_7 T_8$	0
Maintenance	Minor T_9	0.0138
	Major T_{10}	0.083
	Corrective T_{11}	0.333

Table 5.4: Deterministic transition times corresponding to the inspection and maintenance processes involved in the SPN model.

strategies are analyzed during a period of 100 *years*.

1. **Strategy 1:** all maintenance operations are allowed.
2. **Strategy 2:** minor maintenance is inhibited.
3. **Strategy 3:** major maintenance is inhibited.
4. **Strategy 4:** only corrective maintenance is allowed.

5.1.4 Model Execution, Results and Discussions

While modeling the evolution of the torrent's bed over 100 *years* via LOGICCHAR, the duration of simulation depends on the total duration of all flood events involved within the event series of each scenario. Hence, the duration of simulation varies from one scenario to another depending on the number of flood events in the scenario. However, the simulations are controlled by three parameters. The calculation time step is set up to 0.2 *s*, the longitudinal profile is divided into 2000 cells, and 10 observations per hour are resulted as an output (result every 0.1 *h*). These parameters are chosen in a way that limits the duration of simulation for each scenario but still provides sufficient temporal and spatial calculation steps.

The 50 generated scenarios, having 50 different series of flood events are simulated via LOGICCHAR. Figures 5.5 and 5.6 are examples of the major outputs corresponding to scenario 1. Fig. 5.5 illustrates the variation in the torrent's bed level along the entire reach as a function of time after being subjected to 8 flood events. It can be noticed that between $X = 550$ *m* and $X = 830$ *m*, the torrent confronts less variation in bed level than in the other zones. This is due to the existence of 25 small check dams separated by short distances aiming to limit bed incision. Fig. 5.6 represents all the results obtained at a specific chosen abscissa. It shows the variation of the water level, water velocity, slope, bed level, evolution in bed level, and solid discharge over time occurring downstream of the check dam under study. Similar outcomes are obtained for the other simulated scenarios.

These outputs enable modeling the evolution of the degradation indicator corresponding to the amount of scouring downstream and under the dam and the dam's stability level

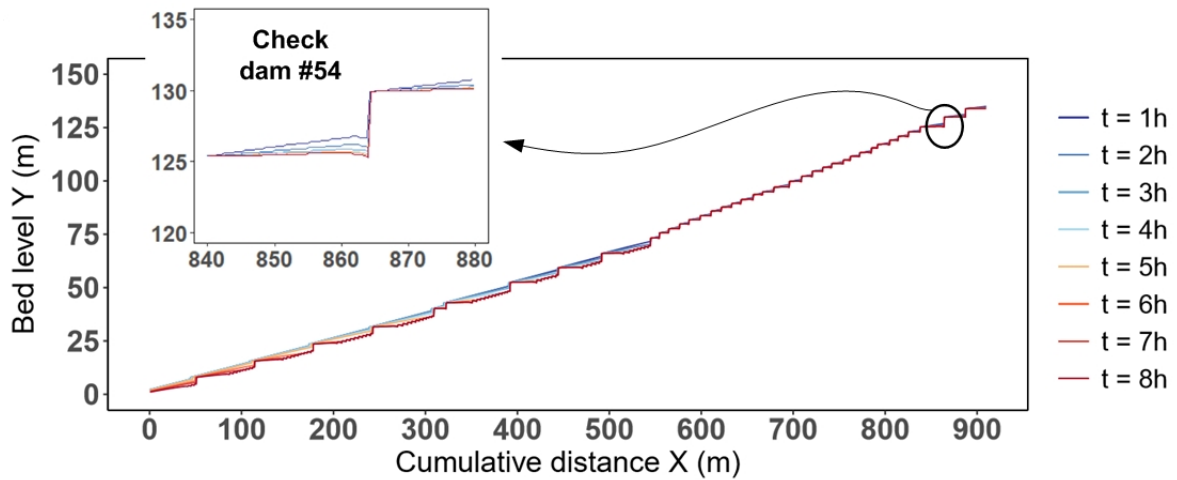

Figure 5.5: Variation in bed level along the entire studied reach after each flood event involved within the event series - Scenario 1.

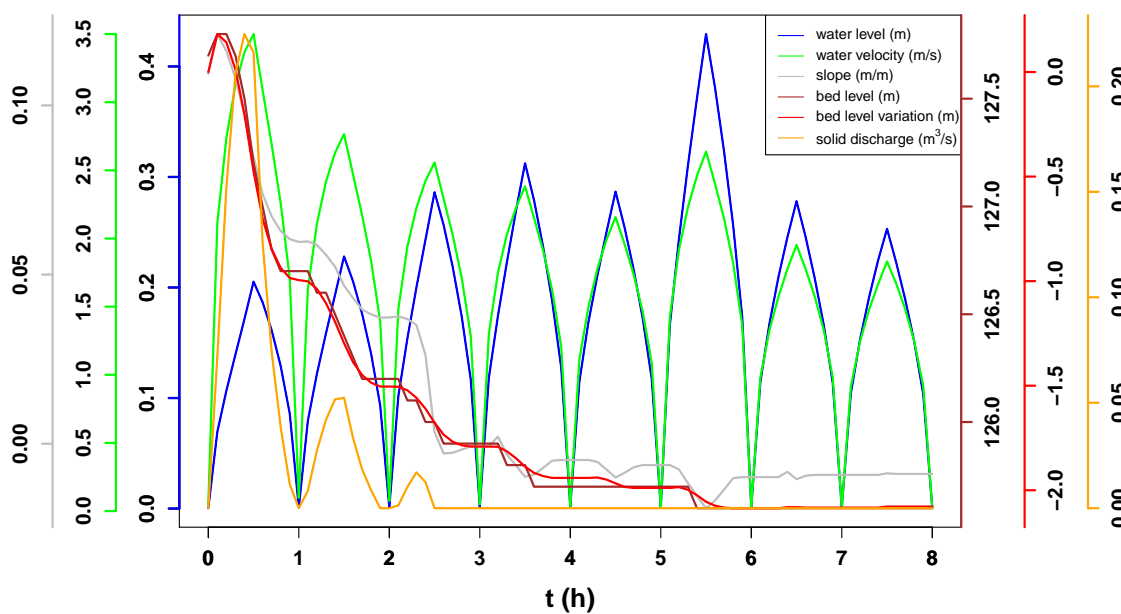

Figure 5.6: Time-based variation of the six parameters resulting from LOGICCHAR simulation downstream the studied check dam - Scenario 1. Blue: water level (m); green: water velocity (m^2/s); grey: slope (m/m); brown: bed level (m); red: variation in bed level (m); orange: solid discharge (m^3/s).

against bearing capacity problem, overturning, and sliding (fig. 5.7). The maximum depth P of the scour pit downstream of the dam varies depending on the peak discharge of each flood event and on the amount of sediment transported. In other words the evolution of P

as a function of time is not necessarily monotonic. On the other hand, the local scour depth S_d and scour width S_w are assumed to evolve monotonically for the reasons mentioned in section 4.2.4. The indicators corresponding to the external stability justification also shows non-monotonic evolution over time. This is interpreted by the fact that these indicators are not only dependent on the local scouring dimensions, but also on the intensity of the flood event (e.g. impact load) that varies from one event to another and its dynamic effect vanishes by the end of the event.

In this application, the influence of the stability components S_{BC} , S_{OT} , and S_{SL} on the global state indicator S_g is assumed to be the same. Hence, combining the three indicators S_{BC} , S_{OT} , and S_{SL} using Eq. 4.25 given that $\alpha = 1$, $\beta = 1$ and $\gamma = 1$ results in S_g . Fig. 5.8, shows the time-dependent evolution of S_g for all of the generated scenarios. The dispersion in fig. 5.8, (b) reveals that the behavior of the dam varies depending on the flood events involved in each scenario. This in turn proves the necessity of stochastic modeling in order to integrate possible behaviors of the dam in the analysis. The intermediate states' thresholds are chosen taking into consideration the results of all the scenarios. Based on the rapid and gradual variation of the S_g as a function of time, the global states of the check dam under study are defined: state 1: $1 \leq S_g < 0.7$; state 2: $0.7 \leq S_g < 0.5$; state 3: $0.5 \leq S_g < 0$; state 4: $S_g = 0$.

The estimation of the time spent in each of the defined states, for all the simulated scenarios, provides a data set for each of the stochastic transitions that links between the states of the dam. From the obtained results, it was revealed that transitions from state 1 to state 3 or from state 1 to state 4 occurred only in few scenarios. In fact, T_{1-3} attained six values and T_{1-4} attained only three values. Because of their short data sets, it is assumed that each of T_{1-3} and T_{1-4} follows a log-normal law with a defined log mean μ and log standard deviation σ ($T_{1-3} \sim \text{Log-normal}(\mu = 3.11, \sigma^2 = 0.17)$; $T_{1-4} \sim \text{Log-normal}(\mu = 2.68, \sigma^2 = 0.15)$). On the other hand, for transitions attaining high number of observations (data sets with more than 20 values), an empirical cumulative distribution function (CDF) is obtained for each. Indeed, the CDFs of transitions T_{1-2} , T_{2-3} , T_{2-4} and T_{3-4} are estimated using Kaplan-Meier estimator (Kaplan and Meier, 1958). The obtained distributions of all stochastic transitions involved in the degradation process are used as an input to the SPN model. Each of these transitions has a probability of firing based on its attained number of observations. Moreover, in some scenarios, the dam reaches a specific state i and do not evolve to a more degraded state j over the duration of simulation (100 years). In such cases, there exist no transition between states i and j but an information that the dam stopped evolving after reaching state i is revealed. These censored information are taken into account while estimating the CDFs presented in fig. 5.9). In the cases where censored information exist, the probability of moving from state i to state j does not reach the value 1.

Since the model integrates a stochastic process, the number of simulations to be held is considered to be sufficient when convergence in results occurs. In this study, convergence is reached after 200 simulations for all of the defined strategies. Tables 5.5 and 5.6 summarize the results obtained for each maintenance strategy modeled over a period of 100 years.

Table 5.5 reveals the influence of each maintenance strategy on the mean sojourn time in

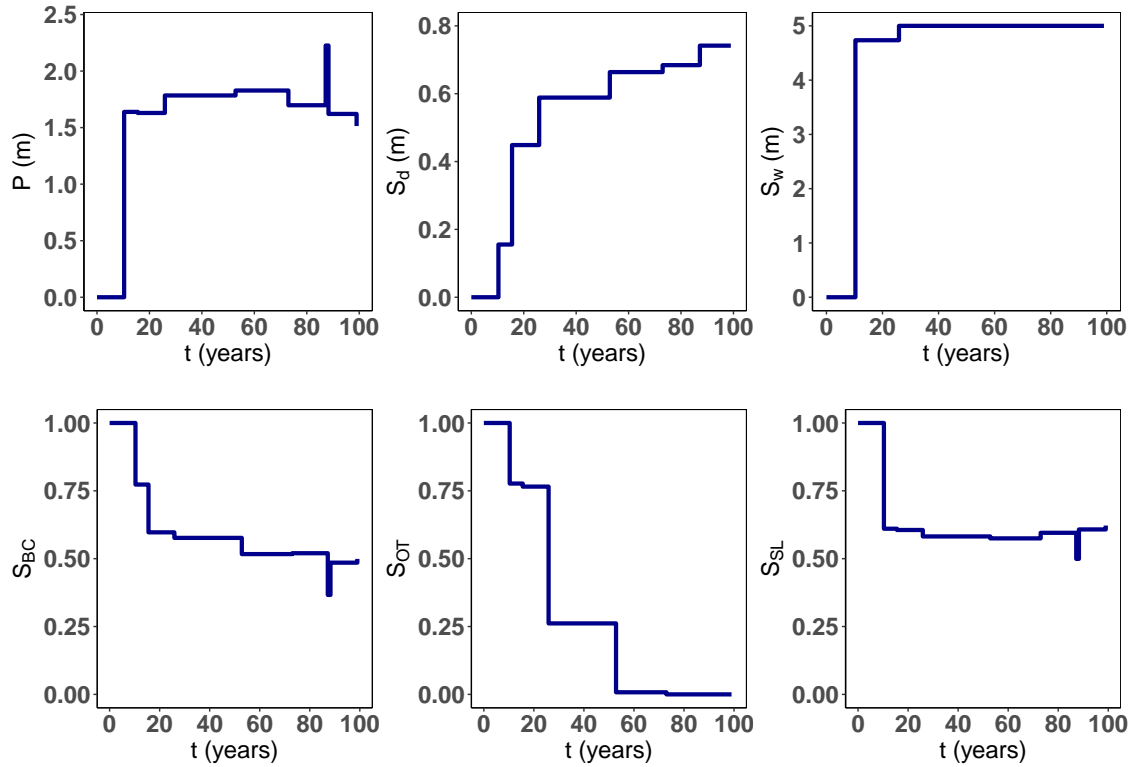

Figure 5.7: Time-based evolution of indicators corresponding to the maximum depth of the scour pit P , local scouring depth S_d , local scouring width S_w , bearing capacity stability ratio S_{BC} , overturning stability ratio S_{OT} , and sliding stability ratio S_{SL} - Scenario 1.

Strategy	State 1	State 2	State 3	State 4
1	86.01	10.49	2.55	0.87
2	56.62	37.27	4.20	1.77
3	73.04	6.73	19.02	1.21
4	44.43	25.89	27.45	2.23

Table 5.5: Mean sojourn time (years) of the studied check dam in each of its defined states based on the maintenance strategy adopted.

the four defined states of the check dam. In strategies 1 and 3, the dam resides in the initial state (state 1) for a longer period of time when compared to strategies 2 and 4. This is due to the fact that in strategies 1 and 3, maintenance is applied as soon as the dam is no more in a good condition using minor operations. On the other hand, for strategies 2 and 4, where minor maintenance is prevented, the check dam remains in a poor condition (state 2) for a longer time. In strategy 3, since major maintenance is inhibited, the dam resides in a very poor condition (state 3) for a long time in comparison to the strategies where major operations are allowed. Concerning strategy 4 in which only corrective operations are authorized, the dam spends more time in the degraded states 2 and 3 compared to other strategies. The reason behind this is that the dam continues to deteriorate without any reparation until it

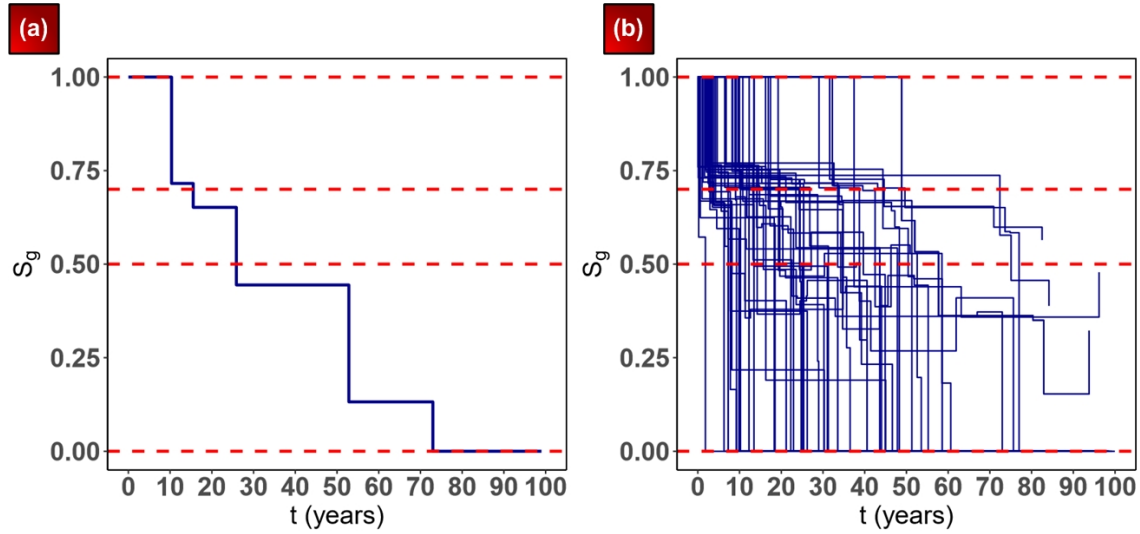

Figure 5.8: Time-dependent evolution of the global state indicator S_g of the dam under study obtained after modeling (a) scenario 1 and (b) the 50 generated scenarios. Blue curve: indicator evolution over time; red dashed lines: indicator thresholds ($S_1 = 1$, $S_2 = 0.7$, $S_3 = 0.5$, $S_4 = 0$).

Strategy	Minor		Major		Corrective	
	μ	σ	μ	σ	μ	σ
1	3.85	1.40	1.13	0.97	1.04	0.85
2	0.00	0.00	1.57	1.09	2.04	1.15
3	3.49	1.35	0.00	0.00	1.48	1.03
4	0.00	0.00	0.00	0.00	2.62	1.23

Table 5.6: Statistics on the number of maintenance operations performed during the considered simulation period based on the maintenance strategy adopted. μ : average; σ : standard deviation.

completely fails and then it is replaced by a new dam.

The statistics on the number of applied maintenance operations, provided in table 5.6, allow computing the total expected cost of each maintenance strategy. Fig. 5.10, (a) represents the box plots depicting data sets of the total cost of each strategy, obtained after the 200 simulations of the SPN model, through their quartiles. Fig. 5.10, (b) makes it easy to sort, compare, and to choose the best maintenance strategy based on the average expected cost of each maintenance strategy. The results obtained reveal that strategy 3 is the most cost-effective.

This can be interpreted by the fact that the system is not allowed to deteriorate to states where expensive maintenance operations are required and it is directly repaired by minor operations which are less expensive than major ones. Strategy 2 is the most expensive

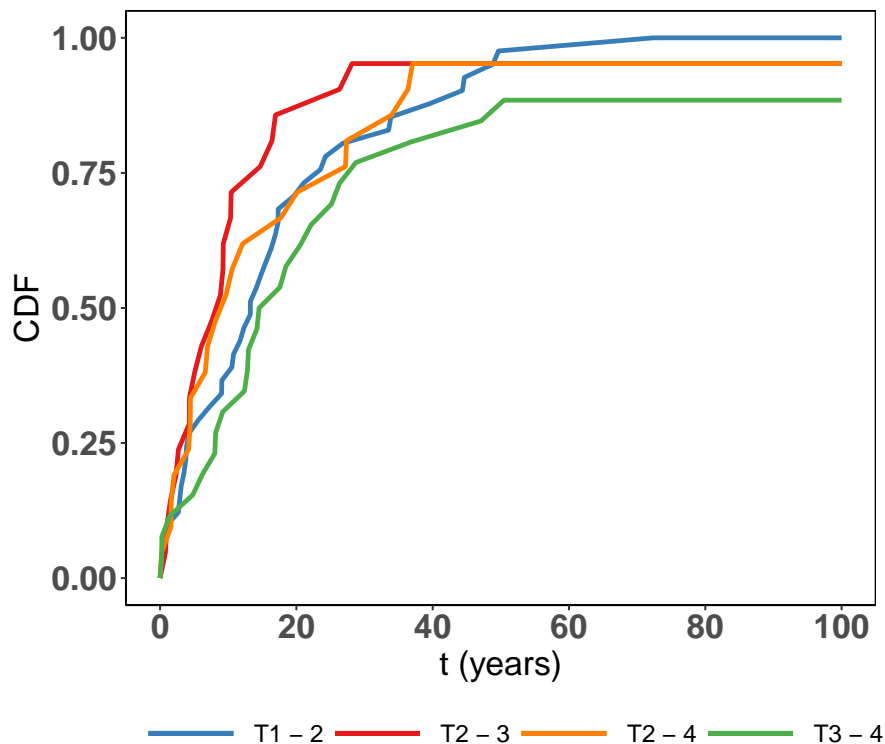

Figure 5.9: Cumulative distribution functions of the stochastic transitions T_{1-2} , T_{2-3} , T_{2-4} and T_{3-4} involved in the degradation process of the SPN model.

because maintenance is applied only when the system reaches critical states (states 3 and 4) where expensive operations are required.

5.1.5 Information Information Analysis Within the Check Dam’s Model (Chahrour et al., 2021c)

The content of this section has been published within the proceedings of the 31st European Safety and Reliability Conference (ESREL 2021) (Chahrour et al., 2021c).

In this section, a simple application involving uncertainty estimation and sensitivity analysis is performed. HYRISK functions, explained in section 4.5, are executed on one sub-model of the physics-based model related to local scouring estimation (fig.4.18).

5.1.5.1 Uncertainty Representation

As a reminder, the phenomenon of scouring corresponds to soil erosion downstream and under a structures foundation. The dimensions of the generated scour pit depend on specific characteristics related to the flow, the torrent and the dam. The main dimensions that have

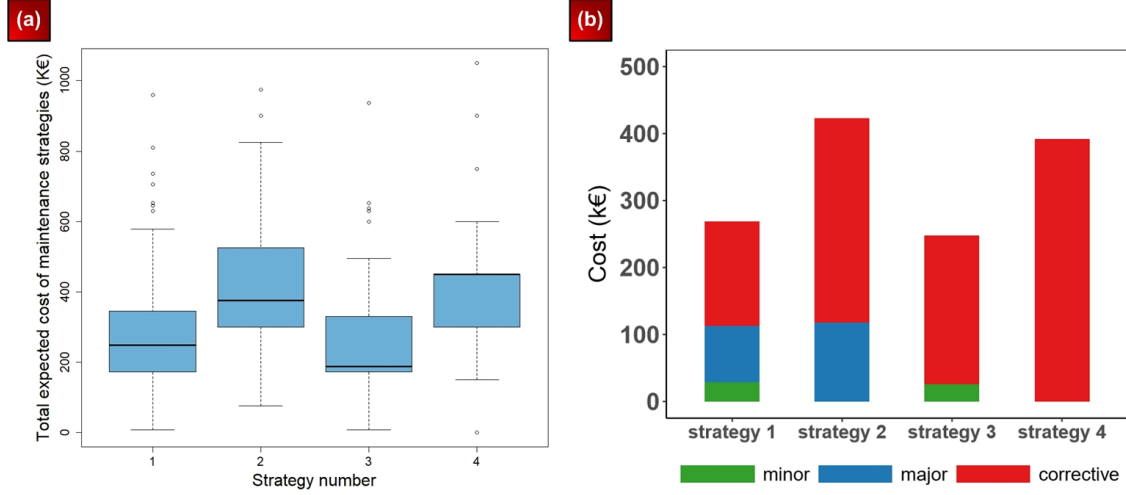

Figure 5.10: Expected total cost of the four maintenance strategies considered in this study: (a) box plots corresponding to the data sets (200 histories) of costs. The black line in the boxplot indicates the median. The upper and lower edges of the boxplot indicate, respectively, the 75th and 25th percentiles. The upper and lower edges of the whisker provide, respectively, the maximum and the minimum values involved in the data excluding outliers; (b) average cost. Green: minor maintenance; blue: major maintenance; red: corrective maintenance.

an influence on the external stability of the dam are the scouring depth (S_d) and the scouring width (S_w) illustrated previously in fig. 4.5. Based on the scouring approach developed in section 4.2.3 the estimation of S_d and S_w requires the following inputs:

$$S_d = f(H_s, h_s, B, D_{90}, Z_{Fi}, d_z, \Delta, H_w, b, \theta) \quad (5.1)$$

$$S_w = f(H_s, h_s, B, D_{90}, Z_{Fi}, d_z, \Delta, H_w, b) \quad (5.2)$$

where H_s is the hydraulic head, h_s is the downstream water level, B is the torrent's channel width, D_{90} is the grain size for which 90% of the sediment in weight is finer, Z_{Fi} is the initial bed level downstream the dam, d_z is the drop in bed level, Δ is the sediment relative submerged density, H_w is the dam's height below the weir's base, b is width of the weirs base and θ is the downstream slope of the scour pit under the foundation.

In the present application, D_{90} , Z_{Fi} and θ are considered as epistemic uncertain parameters following a possibility distribution as represented in fig. 5.11. All other parameters are fixed to values given in table 5.7.

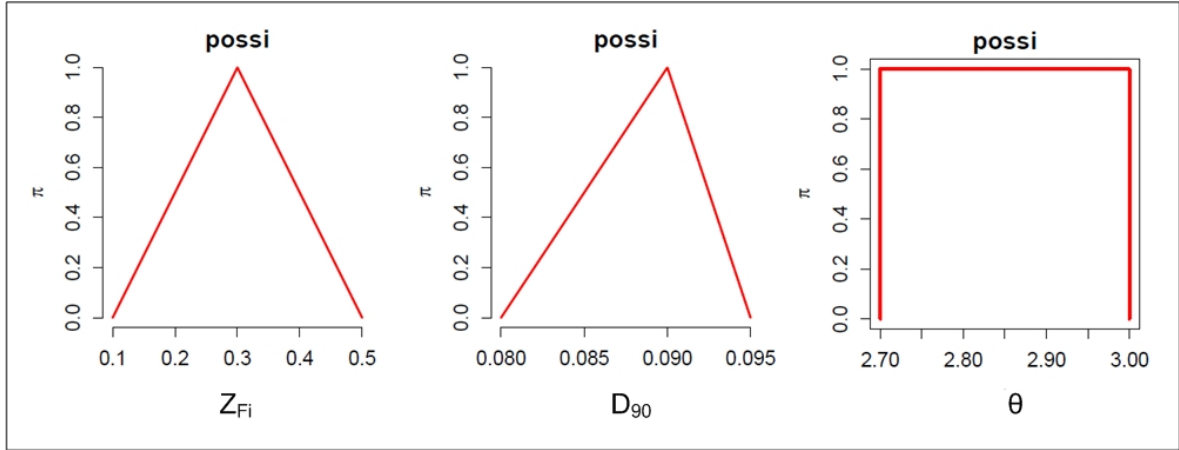

Figure 5.11: Representation of uncertain inputs used for scouring estimation. $Z_{Fi}(m)$, $D_{90}(m)$: possibility distribution (triangular) and $\theta(m/m)$ possibility distribution (interval).

Input	H_s (m)	h_s (m)	B (m)	d_z (m)	Δ	H_w (m)	b (m)
Value	0.737	0.229	6	0.873	1.65	2.3	4.4

Table 5.7: Fixed inputs used for scouring calculation.

5.1.5.2 Uncertainty Propagation and Sensitivity Analysis

Uncertainty analysis is performed in order to assess the uncertainty associated with estimating the dimensions of scouring under the dam's foundation. To do this, the uncertainty represented in fig. 5.11 is propagated with the IRS algorithm of (Baudrit et al., 2007) and 1000 random samples. Such propagation results in a pair of upper and lower cumulative probability distributions (CDFs) for each of S_d and S_w , presented in fig. 5.12. The area bounded between the lower and the upper curves represents the epistemic uncertainty.

Due to the fact that there exist more than one imprecise or missing parameter, a sensitivity analysis based on pinching approach is carried out. It consists of assessing how the imprecision on S_d and S_w may be reduced if additional information on the input parameters D_{90} , Z_{Fi} and θ were available. In the present application, the pinching function is used in order to transform the triangular possibility distributions of D_{90} and Z_{Fi} and the interval associated to the parameter θ into fixed values of: $0.09m$, $0.3m$ and $3m/m$. Figure 5.13 shows the evolution of the lower and upper CDFs corresponding to S_d and S_w after pinching D_{90} , Z_{Fi} and θ .

The impact of pinching D_{90} , Z_{Fi} and θ on reducing the epistemic uncertainty (quantity of interest) can be summarized in terms of the reduction of the area between both the lower and the upper CDFs. Results, provided in table 5.8, reveal that S_d and S_w are more sensitive to the epistemic parameter Z_{Fi} . It can be also seen that D_{90} does not have a great influence on

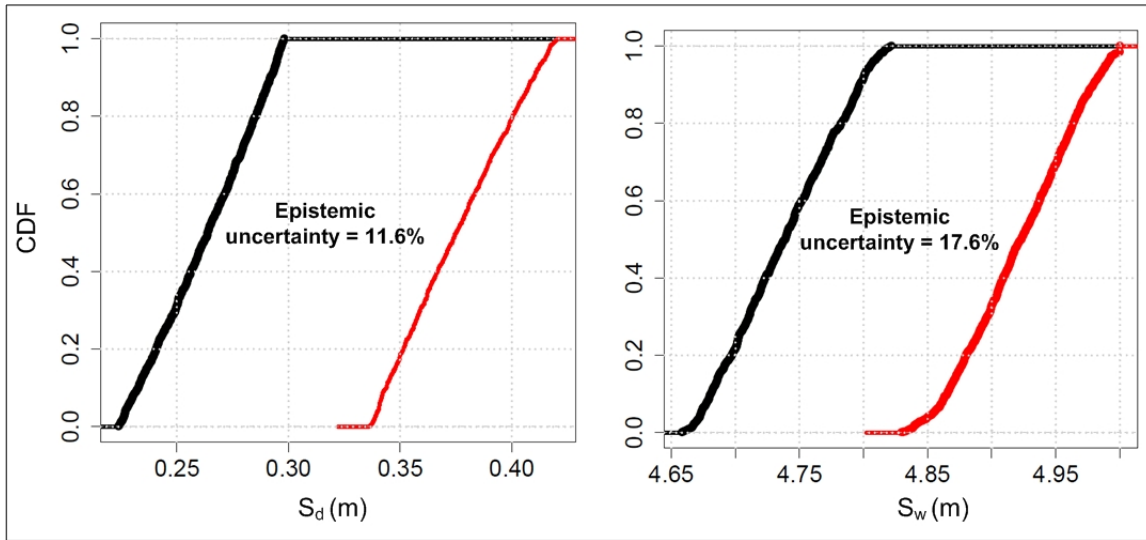

Figure 5.12: Results of the hybrid uncertainty propagation representing the lower (black curve) and upper (red curve) CDFs related to the uncertainty on S_d and S_w .

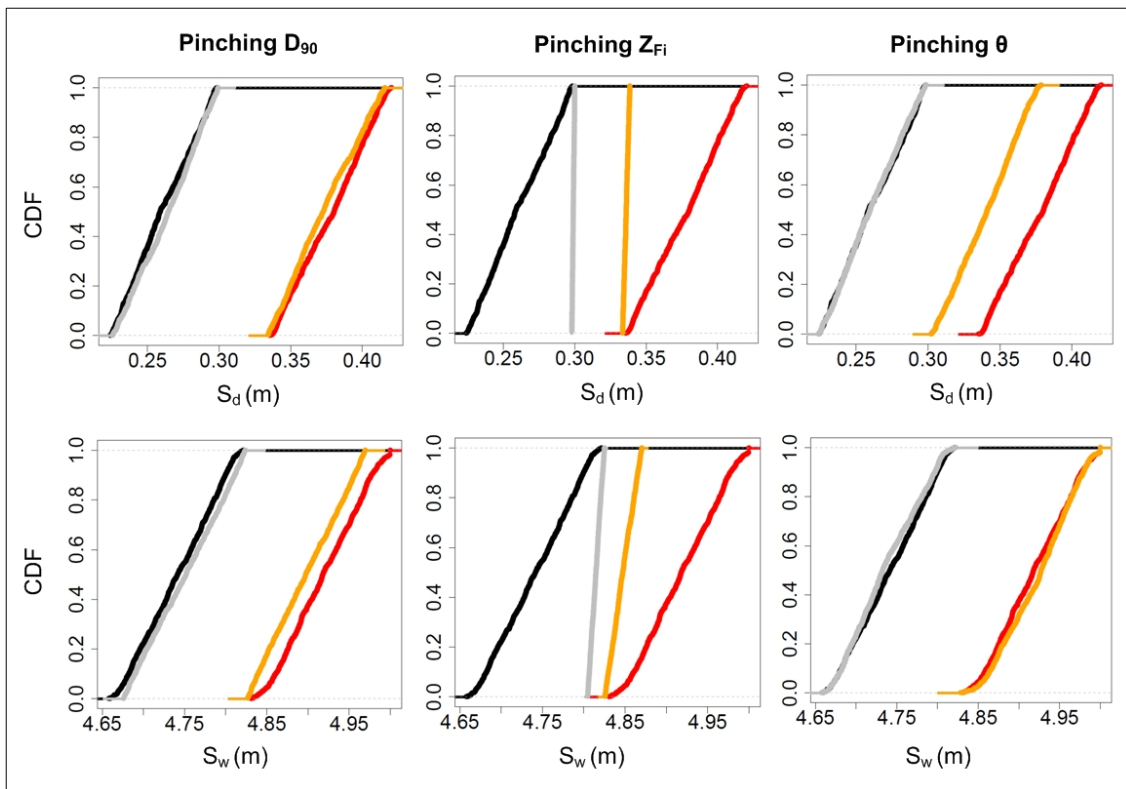

Figure 5.13: Lower and upper CDFs related to the uncertainty on S_d and S_w before (black and red curves) and after (grey and orange curves) pinching the parameters D_{90} , Z_{Fi} and θ respectively to the values of $0.09m$, $0.3m$ and $3m/m$.

Output	Uncertainty propagation	Pinched input parameter		
		D_{90}	Z_{Fi}	θ
S_d	11.60	10.84 <i>6.55%</i>	3.67 <i>68.36%</i>	7.93 <i>31.63%</i>
S_w	17.60	14.56 <i>17.27%</i>	3.36 <i>80.90%</i>	17.60 <i>0%</i>

Table 5.8: Epistemic uncertainty (%) and its percentage reduction between the one obtained from the uncertainty propagation and that obtained after pinching input parameters

S_d . Note that S_w is not sensitive to the parameter θ since it is independent of it. In terms of decisions, such sensitivity analysis, provides information to risk managers and decision-makers concerning critical indicators that should be given deep attention. For example, in this case, as it is revealed that Z_{Fi} has a big influence on S_d , countermeasures and maintenance decisions must consider limiting the evolution of the bed level behind the dam (e.g. adding earth or concrete riprap).

5.2 Cascade Effect Analysis for Prioritizing Check Dams Maintenance strategies in a Multi-Component System (Chahrour et al., 2021b)

The content of this section has been published within the proceedings of the Annual Symposium on Reliability and Maintainability (RAMS 2021) (Chahrour et al., 2021b).

In the previous application, the developed integrated approach was applied on a single check dam and not on a global scale, which covers the whole system of dams. In other words, the application involved analyzing one-direction dependencies occurring between failures modes that a check dam may be subjected to but did not consider the effect of the presence of consecutive dams on the evolution of the dam under study. In fact, there exist bi-directional interactions between the dams located in series in which the presence of a dam can affect positively the evolution of other dams. On the other hand, the failure (partial or complete destruction) of one dam can have a negative influence on other dams involved in the multi-component system, which in turn increases the risk induced.

Until now, no study has been performed in the context of protection structure for tackling this issue and hence no clear vision regarding these cascading effects is yet provided. However, due to the criticality of protection structures and their important role on protecting people and the society as a whole, it is essential to assess the evolution of a multi-component system (composed of several check dams) while being exposed to a series of threatening events (natural hazards, failures). For this reason, the developed approach is applied on a simple protection system composed of two check dams. The main objective is to address: Which dam fails before the other? To what extent does the presence or absence of one dam affects the evolution of the others? Which dam should be maintained first? Providing answers to

Longitudinal profile	Length L (m)	80
	Slope S (%)	6
Channel cross section (trapezoidal)	Width B (m)	6
	Slope (m/m)	1/1
	Height (m)	5.5
Grain size distribution	D_{30} (cm)	2.6
	D_{50} (cm)	3.7
	D_{90} (cm)	9
Check dams' dimensions	H_{TOT} (m)	4.5
	H_w (m)	3
	L_F (m)	6
	L_{TOT} (m)	9
	B_{TAL} (m)	1.9
	B_{SUP} (m)	0.4
	E (m)	0.4

Table 5.9: Principle data of the torrential system and multi-components system under study.

these questions and obtaining results from the SPN model participate in the maintenance management process by optimizing maintenance strategies and respecting available budgets.

5.2.1 General Description of the Protection System

As a first trial, a simple application on a system composed of two identical check dams is carried out. The reach under study is 80 m in length. The dams are separated by a distance of 40 m. All other data regarding the longitudinal and transverse profiles, grain size distribution and the dimensions of the dam are given in table 5.9 and illustrated in fig. 5.14. Initially, the foundation is totally covered by earth materials (sand and gravel). Consequently, the initial downstream bed level (Z_{FI}) is 0.4 m and the initial observed height under the weir of the dam H is 2.6 m. Similar to the previous application, it is assumed that 2 m of the torrents bed materials can be eroded. Concerning the clear water flood events, the average peak discharge corresponding to 10 years return period is $Q_{10} = 5m^3/s$. Gamma (for peak discharge) and Poisson (for event dates) laws are considered for generating 50 flood series scenarios over a period of 50 years. Each flood event has a triangular shaped hydrograph and lasts for 1 hour. The peak discharge is attained at the middle of the event. Note that this application does not correspond to a real case study and all the data are assumed and assessed by experts.

5.2.2 Physics-Based Modeling: Check Dams' Stability Evolution

In order to analyze the dependencies that exist between the two dams and to assess the influence of the presence or absence of one dam on the behavior of the other, three cases, presented in fig 5.15, are to be considered in the modeling:

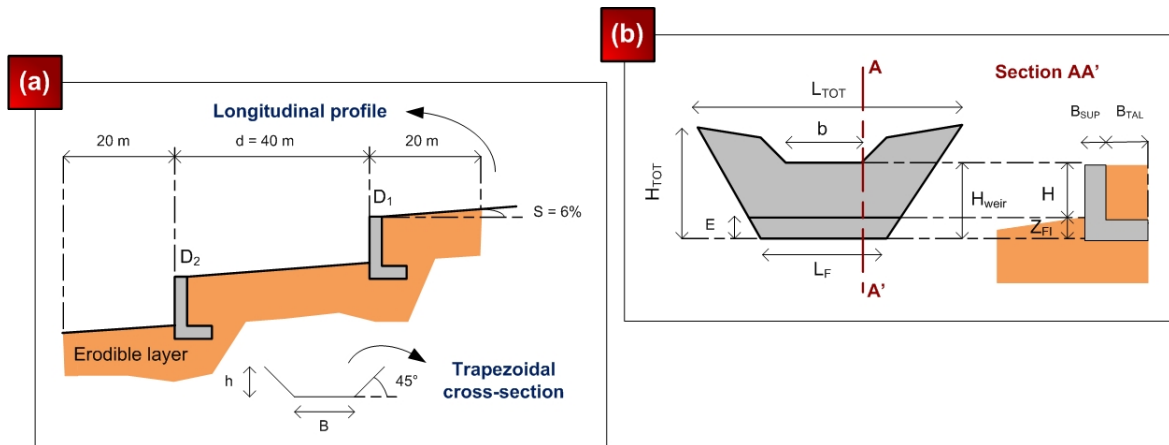

Figure 5.14: Description of the multi-component system under study: (a) series of check dams; (b) check dams' geometry.

- **Case a:** two systems with single dams are modeled in which the behavior of each dam in the absence of the other is analyzed.
- **Case b:** the system of two dams is modeled and the behavior of each dam in the permanent presence of the other is analyzed.
- **Case c:** the system of two dams is modeled and the behavior of each dam in the temporary presence of the other dam is analyzed. In other words, if one of the dam fails during the duration of simulation, the surviving dam will continue to be modeled in the absence of the failed dam starting from the instant of its failure.

After the simulation of the 50 generated flood series scenarios for each of the three considered cases, several conclusions are to be discussed. Note that in this application, the global stability indicator S_g is computed in a different way than in the previous application in which the degree of influence of each stability component on S_g is considered. Hence, it is assumed that $\alpha = 1.5$, $\beta = 1$ and $\gamma = 0.5$.

Regarding case a, in the absence of D_2 , it is noticed that D_1 evolves gradually from a good state (state 1) to a failed state (state 4) in most of the scenarios. Yet, in some scenarios, the deterioration is rapid in which D_1 directly moves from a new state (state 1) to a very poor state (state 3) or from a poor state (state 2) to a failed state (state 4). This is the case when there exist events with high peak discharges ($> 10 \text{ m}^3/\text{s}$) in the beginning or the end of the flood series or when two or more consecutive events involved within the series attain a peak discharge greater than the average one ($7 - 9 \text{ m}^3/\text{s}$). On the other hand, in the absence of D_1 , D_2 never fails over the duration of simulation. It slightly deteriorates and evolves maximum to a poor state (state 2). This can be interpreted by the fact that the distance between the start of the reach (upstream) and D_2 is quite long (60 m). The absence of a fixed point in between leads to extreme erosion in the upstream. Consequently, when events with high peak discharge occur, the eroded materials will be transported downstream D_2 . Downstream deposition supports the dam by lifting the bed level thus limiting local scouring

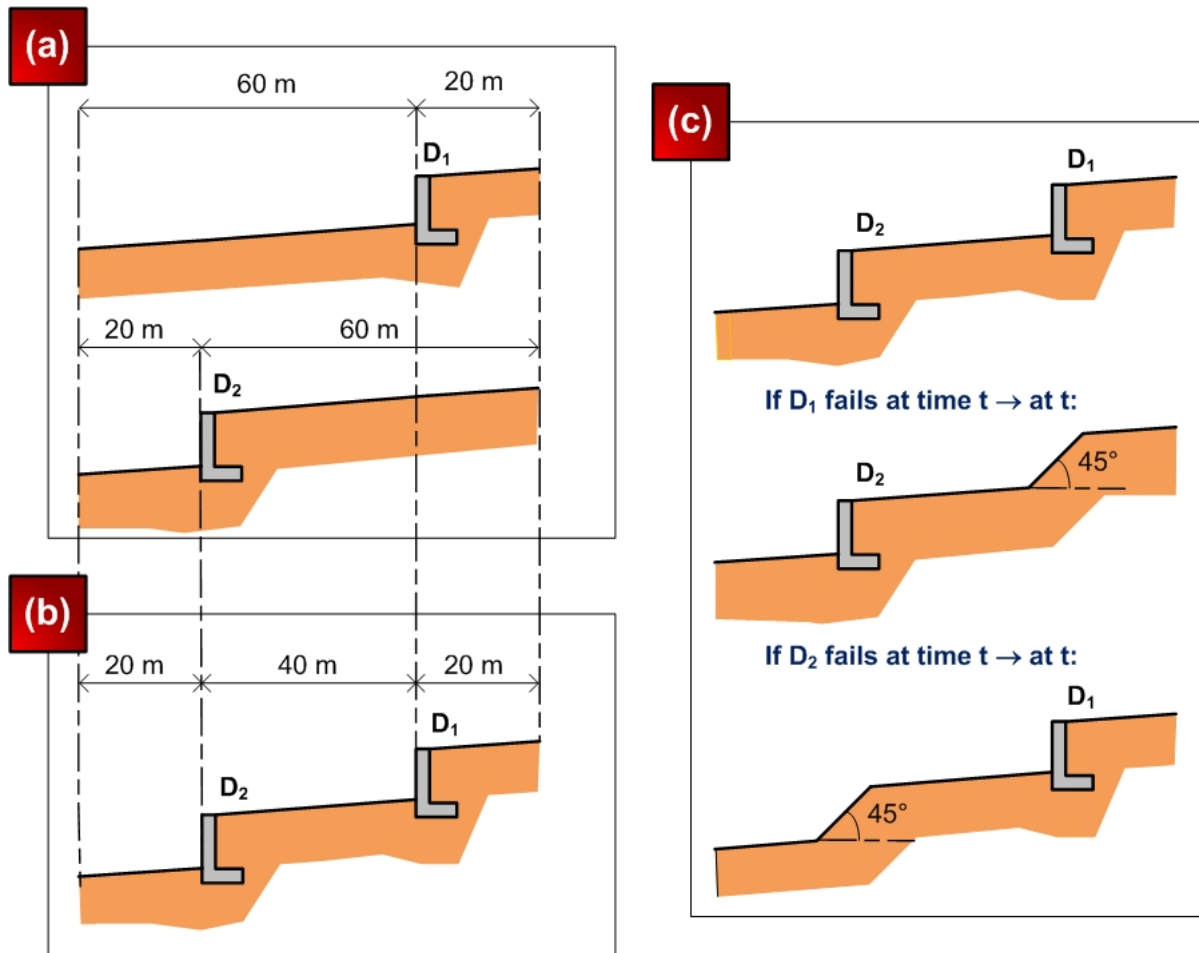

Figure 5.15: Three different cases to be analyzed in the multi-component check dam system: (a) case a; (b) case b; and (c) caase c.

and loss in stability.

Concerning case b, although D_1 deteriorates and reaches a failed state in most scenarios, it shows a lower deterioration rate than that attained in the absence of D_2 (fig. 5.16). On the other hand, D_2 shows quite the same response (slight deterioration) as that attained in the absence of D_1 . However, in the presence of D_1 , there is no problem of excessive erosion upstream and thus no deposition occurs downstream D_2 . To sum up, the behavior of D_1 is dependent on the presence or absence of D_2 . In the contrary, in the absence or presence of D_1 , the global bed evolution is effected but not the behavior of D_2 .

In case c, upon the failure of D_1 , D_2 continues to be modeled in the absence of D_1 . In reality, the collapsed dam will trigger the beds materials that where initially supported by the dam to fall with a specific slope. Hence, in order to consider the effect of the failed dam D_1 on the behavior of the surviving dam D_2 , D_1 is replaced by a 45° slope. After simulations, it is revealed that the stability of D_2 continues to evolve until D_1 fails. The reason behind this is that the materials in the slope replacing D_1 , will be eroded and deposited downstream

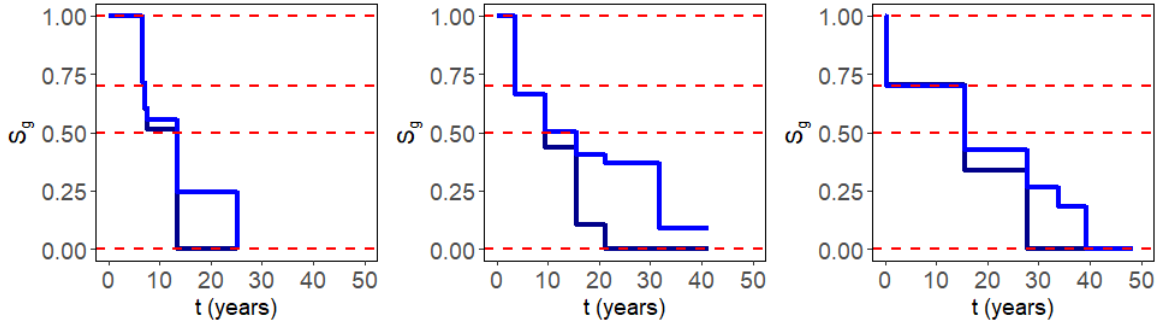

Figure 5.16: Evolution of the global stability index S_g of dam D_1 corresponding to three different scenarios (as an example). Dark blue: absence of D_2 ; blue: presence of D_2 ; red dashed lines: S_g thresholds ($S_1 = 1$, $S_2 = 0.7$, $S_3 = 0.5$ and $S_4 = 0$).

D_2 thus acting as a stability support. Over the duration of simulation, the stability level of D_2 remains constant after the failure of D_1 . However, if simulations have been performed for a longer period of time, D_2 will continue to deteriorate when the upstream slope again reaches equilibrium where no more materials are deposited downstream. Due to the fact that the dependencies between the two dams upon the failure of one dam is not clear in this application, the focus in next steps will be on case a and case b.

5.2.3 SPN Model and Maintenance Decision-Making

Since D_1 is the dam that deteriorates faster and reaches eventually a failed state, only the maintenance of D_1 will be modeled using the SPN model presented in section 4.4 incorporating the restrictions concerning the minor and major maintenance operations (fig. 5.4). As previously mentioned, the simulation of the generated flood scenarios results in assigning a probability distribution for each of the stochastic transitions involved within the degradation process of the SPN model. Non of the scenarios provides results for transition T_{1-4} . Few scenarios provide results for transitions T_{1-3} and T_{2-4} respectively. Hence, it is assumed that T_{1-3} and T_{2-4} follow an exponential distribution with a constant firing rate λ equals to the inverse of the average of their obtained values (tables 5.10 and 5.11). The cumulative distribution functions of T_{1-2} , T_{2-3} and T_{3-4} are presented in fig. 5.17. Regarding deterministic transitions, inspection (T_5) is scheduled every year. Minor (T_9), major (T_{10}) and corrective (T_{11}) maintenance operations require respectively 5 days, 1 month and 4 months to be carried out.

The simulation of the SPN model revealed that the behavior of D_1 in the presence or the absence of D_2 is more-less the same. In other words, the applied maintenance strategies have more or less the same efficacy in both situations. The average sojourn times of D_1 in the different states and the number of maintenance operations applied to D_1 show a very slight difference in both cases (tables 5.12 - 5.15).

Transition	T_{1-3}	T_{2-4}
Firing probability	0.083	0.211
Firing rate λ	0.056	0.075

Table 5.10: Data concerning stochastic transitions of D_1 having few number of observations (in the absence of D_2).

Transition	T_{1-3}	T_{2-4}
Firing probability	0.063	0.083
Firing rate λ	0.098	0.044

Table 5.11: Data concerning stochastic transitions of D_1 having few number of observations (in the presence of D_2).

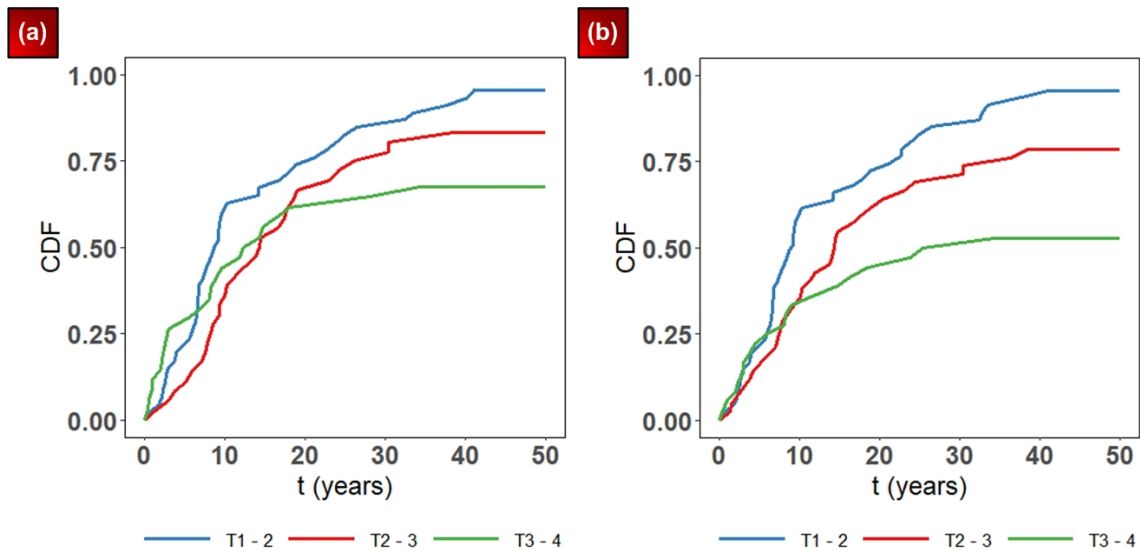

Figure 5.17: Cumulative distribution functions of stochastic transitions of D_1 having high number of observation: (a) absence of D_2 ; (b) presence of D_2 .

Strategy	State 1	State 2	State 3	State 4
1	44.65	4.95	0.27	0.04
2	26.02	23.00	0.63	0.15
3	41.20	4.13	4.42	0.13
4	20.82	19.37	9.18	0.39

Table 5.12: Mean sojourn time (years) of D_1 in the absence of D_2 (case a) in each of its defined states based on the maintenance strategy adopted.

The information provided after the simulation of SPN model permits to sort, compare and to choose the best maintenance strategy considering the total cost of each strategy. Fig. 5.18 reveals that strategy 3 is the cheapest among the other. In strategy 3, the dam is not

Strategy	State 1	State 2	State 3	State 4
1	44.06	5.59	0.26	0.02
2	24.03	24.44	1.35	0.06
3	40.11	4.72	4.96	0.11
4	18.43	18.69	12.45	0.26

Table 5.13: Mean sojourn time (years) of D_1 in the presence of D_2 (case b) in each of its defined states based on the maintenance strategy adopted.

Strategy	Minor	Major	Corrective
1	2.37	0.45	0.09
2	0	0.96	0.34
3	2.31	0	0.27
4	0	0	0.72

Table 5.14: Average number of maintenance operations performed to D_1 in the absence of D_2 (case a) during the considered simulation period based on the maintenance strategy adopted.

Strategy	Minor	Major	Corrective
1	2.51	0.36	0.05
2	0	1.10	0.12
3	2.37	0	0.21
4	0	0	0.52

Table 5.15: Average number of maintenance operations performed to D_1 in the presence of D_2 (case b) during the considered simulation period based on the maintenance strategy adopted.

allowed to deteriorate to states where expensive operations are to be carried out. Strategy 2 is the most expensive since maintenance is applied only when the dam reaches critical states requiring expensive operations.

5.3 Conclusion

In this chapter, the developed modeling approach is applied on two different case studies.

The first application aims to analyze the behavior of a real check dam located in the Manival torrent in France and exposed to clear water floods. The interactions between local scouring under the dam's foundation and the external stability of the dam makes it possible to define a global degradation indicator S_g of the dam that synthesizes the sub-indicators related to scouring and external stability. The simulation of 50 generated flood scenarios using the physics-based model makes it possible to model the evolution of S_g over a period of 100 years

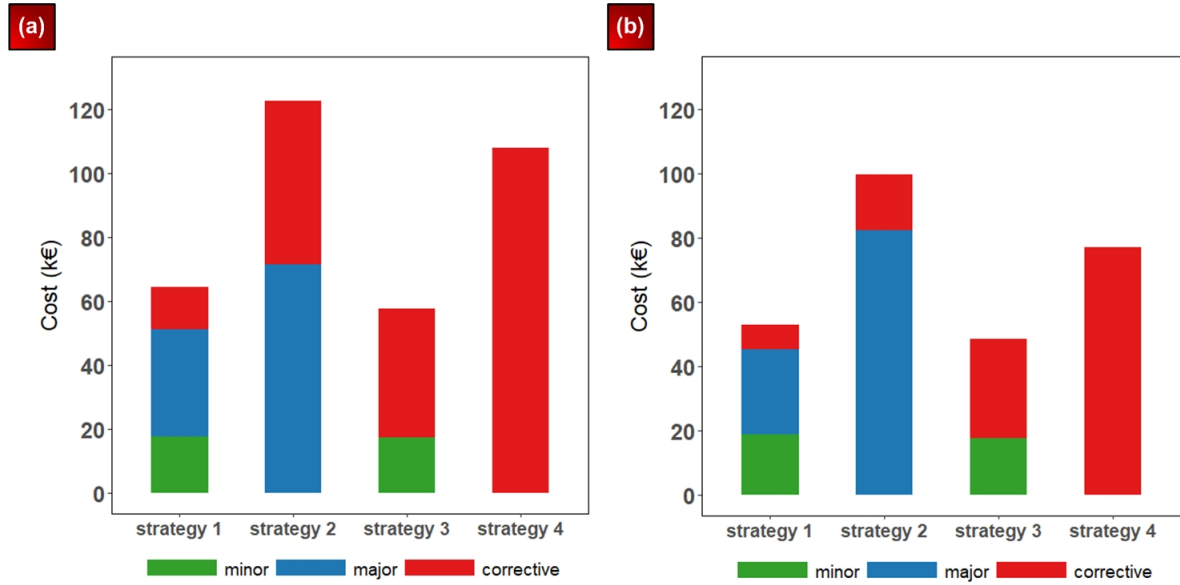

Figure 5.18: Total cost of maintenance strategies applied to check dam D_1 : (a) absence of D_2 ; (b) presence of D_2 .

and therefore to estimate transition laws to be used in the SPN model. Results provided by the SPN model show that applying maintenance operations only when the dam is in a poor state or in a failed state (strategy 3) is the most cost-effective. In addition, strategies which allow carrying out maintenance operations (strategies 1 and 3) as soon as the the system reaches a poor state allow the system to reside more time in the good state when compared to other strategies. Besides, uncertainty and sensitivity analyses performed on the scouring approach reveal that the scouring depth and width under the dam's foundation are very sensitive to the epistemic parameter Z_F which represents the bed level downstream the dam.

The second application aims to model the bi-directional dependencies between two check dams located in series. The state evolution of each dam is modeled over a period of 50 years using the physics-based model in the absence and in the presence of the other dam. Results show that the upstream dam (D_1) is highly dependent on the downstream dam (D_2) in which in the absence of D_2 , D_1 attains a higher deterioration rate than in the presence of D_2 . On the other hand, D_1 shows quite the same response (slight deterioration) in the absence and in the presence of D_1 . However, in the absence of D_1 , excessive erosion occurs upstream and materials are deposited downstream D_2 . The presence of D_1 creates a fixed point in the longitudinal profile which helps stabilizing the torrent's bed and therefore limit upstream erosion. Therefore, the absence or presence of D_1 affects the global bed evolution but not the behavior of D_2 . Applying the SPN model to D_1 in both the presence and the absence of D_2 provides the same results as in the previous application concerning maintenance strategies (strategy 3 is the best).

Application: Development and Evaluation of a Retention System Deterioration and Maintenance Model

Contents

6.1	Real Case Study: Retention System Subjected to Debris Flows in the Claret Torrent	164
6.1.1	Claret Torrent Description	164
6.1.2	Torrential Events' History	165
6.1.3	Claret Retention System: Between the Past and the Present	166
6.2	Numerical Modeling Inputs and Data Sources	169
6.2.1	Generation of Random Debris Flow Events	169
6.2.2	Initial Configuration of the Retention System	175
6.2.3	SPN Model Inputs and Maintenance Strategies	177
6.3	Model Execution, Results and Discussions	179
6.3.1	Application to the Old Design	179
6.3.2	Application to New Design	186
6.4	Sensitivity Analysis Applied to the SPN Model	187
6.4.1	Inspection Frequency	190
6.4.2	Maintenance Duration	191
6.4.3	Maintenance Costs	196
6.5	Conclusion	199

In this chapter, the developed modeling approach is applied to another type of protection structure. The objective is to show the genericity of the proposed methodology and what kind of study can be done adopting the developed model. In addition, despite of its interest, the case of check dams is limited by the availability of real data (e.g. maintenance duration and costs). consequently, another added value of this application is that a lot of data concerning the physical characteristics of torrential events and maintenance data related to the studied torrent are available.

The chapter presents a thorough analysis and modeling of a real case study retention system located in the Claret torrent in France. The time-dependent evolution of the stored volume of debris in the retention basin taking into consideration the blockage of the retention dam's outlets by boulders is modeled over a period of 50 years. After that, four different maintenance strategies are modeled using the SPN model in which the total cost of each is estimated making it possible to choose the best cost-effective strategy to be applied to the system. The chapter ends by performing a sensitivity analysis considering some of the SPN model's inputs (inspection frequency, maintenance duration) and the costs of maintenance operations. The objective is to check which parameter affects more the maintenance decision.

6.1 Real Case Study: Retention System Subjected to Debris Flows in the Claret Torrent

The developed stochastic deterioration and maintenance model is applied to a real case that studies a retention system subjected to debris flows in the Claret torrent in France (French Alps). In this application, the functional model is simpler than in the previous application but still corresponds to another important issue for protection infrastructure managers.

6.1.1 Claret Torrent Description

The Claret torrent is located at 44.689° N, 6.009° E. It is a tributary on the right bank of the Arc river. Its confluence with the Arc is in the town of Saint Julien Montdenis in the Maurienne valley (Savoie). It is a very active torrent characterized by a steep slope and high sediment potential thus experiencing active erosion on 41% of its surface (Piton et al., 2018). Frequent debris flow events flow throughout the main channel and deposit into the 22000 m^3 sediment retention basin that was built in 1991 in order to protect downstream exposed issues (EDF channel, roads, railway, etc.) from the very large boulders that contributes in the geomorphic activity of the torrent. The sediment supply provided by the geological formation of the 2.63 km^2 Claret's catchment area constitutes gypsum, black schists and cargneules on the right bank and jurassic limestones on the left bank.

The torrent extends to 4.49 km upstream the retention basin which is located at 45.250° N, 6.418° E (fig. 6.1, (a)). It was initially composed of 260 small check dams and one large check dam built at the beginning of the 20th century. However, almost all small check dams implemented on very steep slopes of actively eroding valleys did not withstand the passage of debris flows and were completely destroyed. In 1960, it was revealed after a field visit that only 20 small check dams in addition to the large check dam were still in place (ONF-RTM, 2013; Hugerot, 2015). The reason behind this was the total absence of preventive maintenance after 1925. Other protection structures that include large check dams and a retention system were built later in the 20th century (between 1956 and 2004). Indeed, after the 1960, only major (large) check dams, the retention basin which is closed by a reinforced concrete retention dam and downstream lateral dykes (fig. 6.1, (c), (d) and (e)) still function providing effective

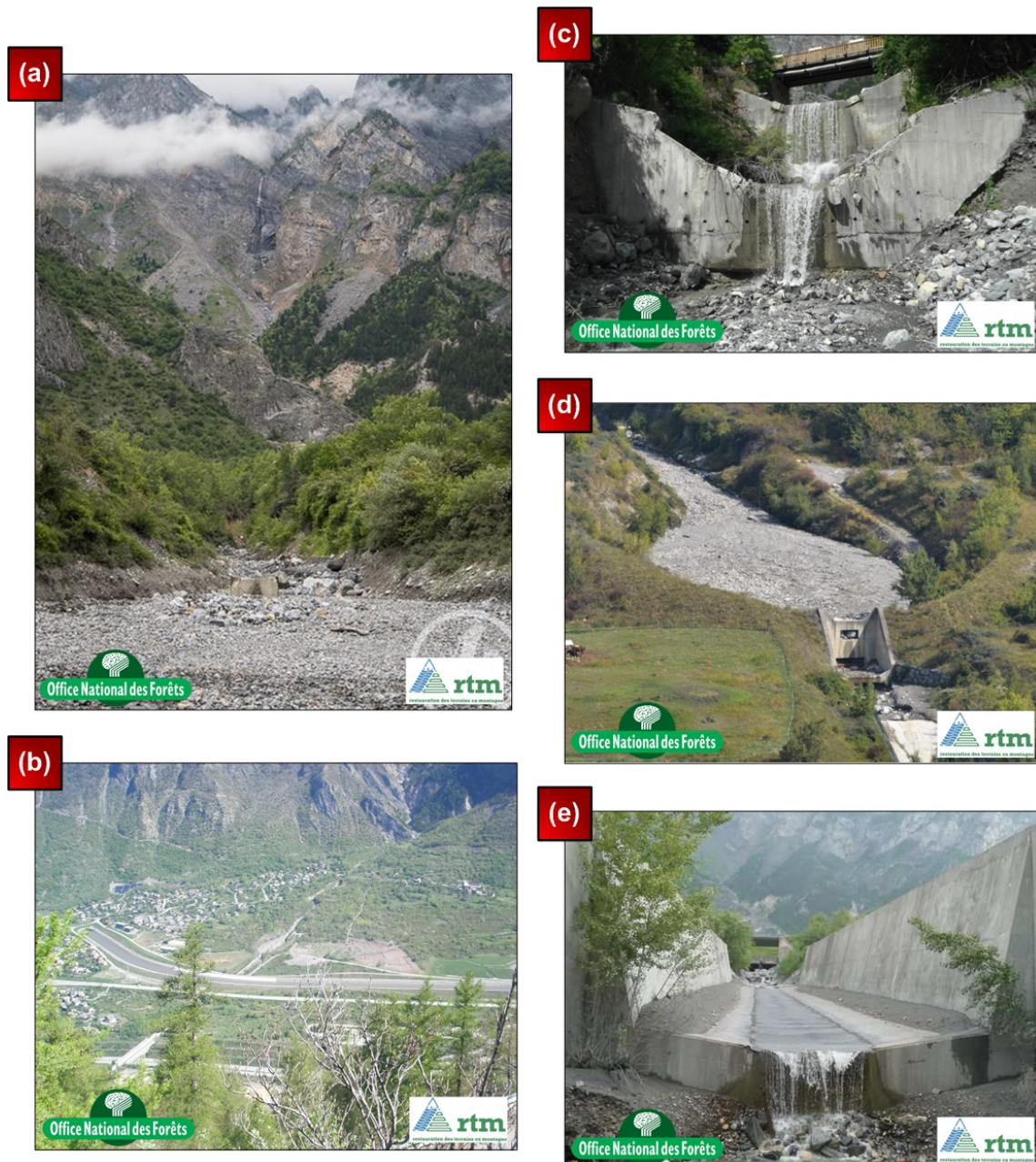

Figure 6.1: Claret torrent: (a) Upper part of the torrential watershed; (b) downstream alluvial fan; (c) check dams; (d) retention system; (e) lateral dykes. Source: ©ONF-RTM.

protection to the downstream alluvial fan (fig. 6.1, (b)).

6.1.2 Torrential Events' History

According to the events' history, the Claret torrent has a frequent tendency to produce muddy debris flows. These events can contain a significant volume of materials and can carry large

blocks sometimes up to its confluence with the Arc. These materials are very quickly mobilized by the flows of intense stormy episodes which are very quickly concentrated due to the small size of the watershed. Historical archives of torrential floods show that they occur with a very high frequency during intense summer storms (up to 3 events per year), with an average frequency of significant debris flow events per decade (Piton et al., 2018). From available sources (BD events of the RTM service, the Mougins monograph (1914) on the torrents of Savoy and the RTM archives), it is possible to group together the main known damaging floods that have occurred in the Claret watershed since 1971 until recently (ONF-RTM, 2013). It is revealed that the torrent contains a variable frequency of occurring torrential floods. For damaging flood (e.g. debris flows), four different categories can be differentiated (ONF-RTM, 2018):

- **1791 - 1802:** production of a flood every 3.6 years.
- **1802 - 1812:** production of flood every 1 to 2 years in average.
- **1812 - 1940:** the frequency has decreased to approximately one flood every 4 years.
- **1940 - present:** the frequency has increased slightly to 1 flood every 2.6 years.

The changes in the flooding dynamics could result due to the geomorphological changes (variation in the erodible land). All recorded damaging events have almost caused the same damages such as bridge collapsing, roads and railways blockage by large boulders and alluvial fan incision. Protection structures were put in place (dykes in 1825 and check dams between 1897 and 1902) but were quickly destroyed due to the high intensity of occurring events. This has implied the need to regularly inspect and maintain the new installed structures. Since 1957, new check dams (some of which are large reinforced concrete dams) were built in order to stop torrential floods, reduce their intensities and to stabilize the longitudinal profile. Nonetheless, the violent debris flow event which has occurred in July 2, 1987 caused severe damages to exposed issues located in the downstream due to the transfer of very large blocks. This debris flow is considered as a reference event that urged risk managers to implement a retention system which was indeed built in 1991.

6.1.3 Claret Retention System: Between the Past and the Present

The retention system is located at a place called “Clapotière” just upstream the EDF channel at an altitude of 700 *m* and in an area with a bed slope of 12 %. The system aims in retaining the materials transported by debris flow events and in stopping blocks with a diameter larger than 1.5 *m*. It is composed of several structures previously illustrated in section 1.2.3.1 and represented in fig. 6.2. A small check dam made up of earth materials is located at the entrance to the retention basin aiming to stabilize the longitudinal profile by creating a fixed point. The sediment/debris retention basin is of 120 *m* long with a capacity of 22000 *m*³. The basin is closed by lateral dykes and by a 9.2 *m* high reinforced concrete retention dam with a 2 *m* high trapezoidal weir that directs extreme flows over the dam when the deposit is more than 7 *m* high. Just downstream of the retention dam, a counter dam is implemented

with a reinforced concrete raft and concrete rip-rap protections present on both sides on the upstream face of this raft. A rip-rap is also placed at the bottom of the dykes at the entrance to the retention basin. In addition, six debris flow breakers are located at the entrance to the basin in order to slow the flow and to promote deposits upstream of the deposit range. They are made up of reinforced concrete blocks having a triangular shape and are organized in a triangular pattern. It was revealed over time that these debris breakers are not effective. They quickly deteriorate when subjected to debris flows. However, their installation made it possible to improve knowledge concerning the operation of a deposit beach (ONF-RTM, 2013).

Initially, the retention dam was built with two separate rectangular openings as shown in fig. 6.2, (a). The lower opening was a slot of dimensions 5 m x 1 m (width x height) located at the bottom of the dam. Its main objectives were to allow low flows (routine events) to pass through the dam towards the downstream and to stop blocks with diameters greater than 1.5 m. The upper opening was a 3 m x 1.5 m slot and was only activated when the deposit level upstream the dam reaches 4 m of sediment or debris. The flood on the 7th of May 1993 completely filled the retention basin and blocked the lower opening by a large boulder (104 m³ block) in which there was no self cleaning of materials. Similar situation happened during the recent debris flow in 2017 (June 14th) in which the lower slot was blocked and the flow reached its maximum deposition in less than 6 minutes and then was progressively partially self-cleaned through the upper slot.

These observations made it possible to better understand the functioning of retention dam. When subjected to debris flows transporting large boulders that are likely to obstruct the lower slot, the structure operates as a closed check dam (retaining wall) storing a large volume of materials. In such cases, all materials will be retained in the basin, even those carried by minor floods, which could have passed smoothly to the downstream. Consequently, the dam's lower opening was not sufficient in relation to the maximum diameter of the blocks which are transported during frequent debris flows. This issue necessitates regular cleaning operations in order to dredge the retained materials and thus to ensure the functional efficacy of the retention system. However, frequent cleaning operations require high monetary budgets (very expensive). In addition, the scheduling time required to carry out cleaning operations is quite long. During this time, the system will not be fully effective from a functional point of view. Compared to the frequency of debris flows reaching the basin (2 to 3 years), the system will be only fully functional 75 % of the time (Paulhe et al., 2018).

In 1995, the RTM service thought about modifying the retention system but the suggested project was refused due to financial reasons. After a considerable period of time, progressive studies confirmed the feasibility and interest of the project that proposes to expand the the slot by merging together the two slots. Hence, the proposition was finally accepted in 2011. The scheduling procedure have lasted for several years in which it started in December 2012 and ended in September 2018. The dimensions chosen for the opening of the retention dam 4 x 5 m (width x height). The edges of the new slot are protected by anti-corrosion plates, type Hardox 500 and 20mm thick as shown in fig. 6.2, (b). In addition, the management decision involved also eliminating the six reinforced concrete debris flow breakers made at the entrance



Figure 6.2: Claret retention system showing the old and the new design of the retention dam: (a) old design ©ONF-RTM/S. Carladou 23/05/2018; (b) new design ©INRAE/J.-M. Tacnet 05/07/2021. (1) upstream inlet check dam (2) retention basin, (3) retention dam, (4) downstream counter dam, (5) lateral dykes, (6) access track and (7) debris flow breaker.

of the retention basin in order to reduce deposition in the upstream part of the basin. The cost of the carried work was estimated as 25000 € excluding tax (Paulhe et al., 2018).

The Claret's retention basin is now monitored by INRAE (*l'Institut national de recherche pour l'agriculture, l'alimentation et l'environnement*). It is equipped with a camera and geophones for filming debris flows. This monitoring makes it possible to observe and analyze the functioning of the new designed retention system. In the present application, the progressive filling of the retention basin when subjected to debris flows over a specified period of time will be studied considering the initial and the new design of the retention dam.

6.2 Numerical Modeling Inputs and Data Sources

The developed model concerns analyzing the time-dependent evolution of the debris volume deposited in the retention basin in addition to the progressive jamming of the retention dam's openings when subjected to a series of debris flow events and to cleaning operations over a period of 50 years. The R code explained in section 4.3.5 and the SPN model represented in section 4.4 is used to tackle this analysis. In order to execute simulations, several numerical inputs should be collected and identified.

6.2.1 Generation of Random Debris Flow Events

In order to generate random debris flow series scenarios, random volumes and dates of occurrence of the events must be generated. Data concerning the average number of events that occurs during every month of the year is extracted from RTM database. Fig. 6.3 shows the monthly distribution of all recorded torrential floods in the Claret (ONF-RTM, 2013). Fig. 6.4 represents the corresponding cumulative distribution function. It can be noticed that almost all of the floods (87 %) occur between June and September. The predominant phenomena responsible for torrential floods are summer thunderstorms, which are often very intense.

Data concerning the volumes of events that have already taken place in the Claret have been collected from different sources. In 2012, a thorough study was carried out by ETRM (*Eaux Torrents et Rivières de Montagne*) while proposing the management plan for the Claret retention system (ETRM, 0112). Debris flow events' volumes were estimated using different methods adopted by different sources:

Deposit volume estimating by cleaning: It is assumed that the deposited volume after each event corresponds to the debris flow volume. This assumption is justified by two facts: On one hand, part of the flow is transported to the downstream, and the flow's volume is therefore underestimated. On the other hand, part of the dredged volume corresponds to ordinary loads in bedload, which are deposited in the retention basin, and the flow's volume is overestimated in this case. In some torrent, it is better to consider the whole event's volume since the basin may be not fully dredged and a considerable amount of materials may be deposited upstream the basin or downstream the retention dam. Otherwise, if only the dredged volume, part of the event's volume will be missed.

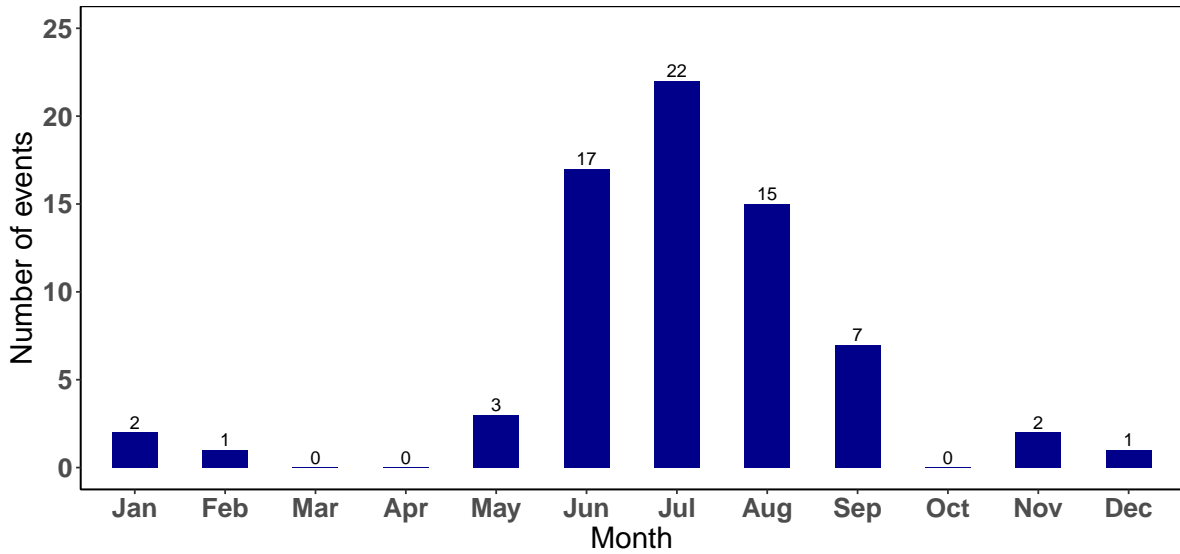

Figure 6.3: Monthly distribution of recorded torrential floods in the Claret (data extracted from (ONF-RTM, 2013)).

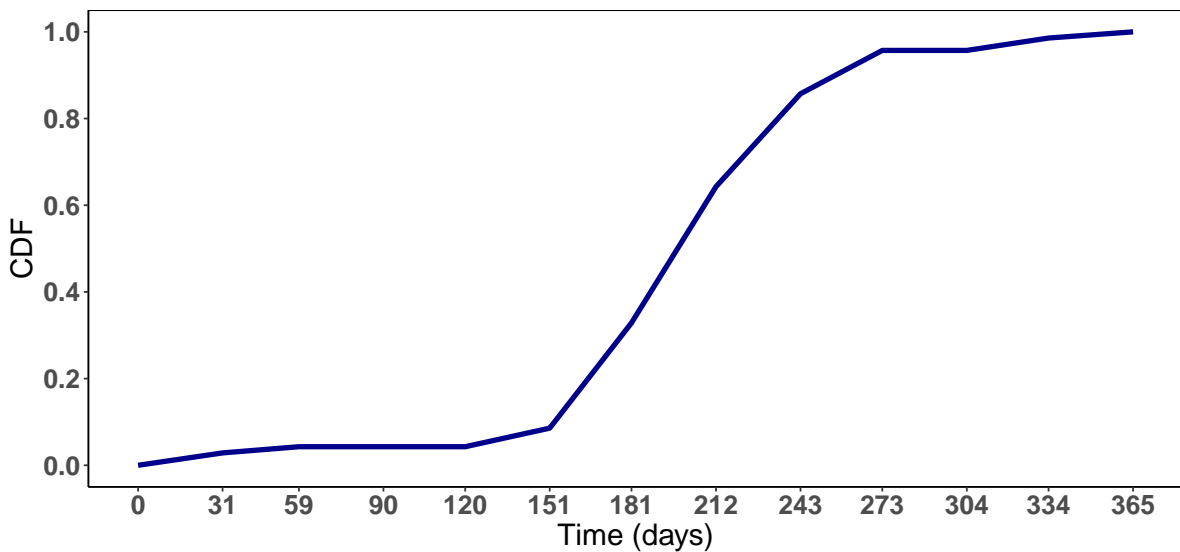

Figure 6.4: CDF corresponding to the monthly distribution of recorded torrential floods in the Claret.

However, this is not the case in Claret. Since the construction of the Claret retention basin in 1991, available data reveal that overflowing the retention dam was very rare and that the dam, as it was initially designed, stops almost all materials. Hence, the possible overestimation or underestimation of the debris flow is negligible.

Event’s volume estimated by physical formulations: The volume of materials is esti-

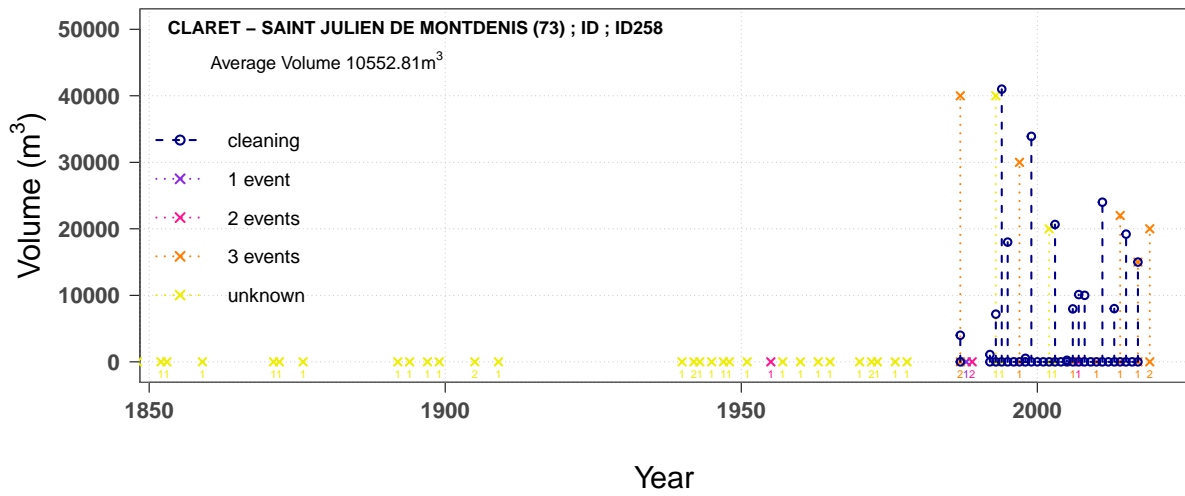

Figure 6.5: Available data concerning the time series of torrential floods and debris flow volumes in the Claret (Adapted from an R code written by Maxime MOREL (INRAE)).

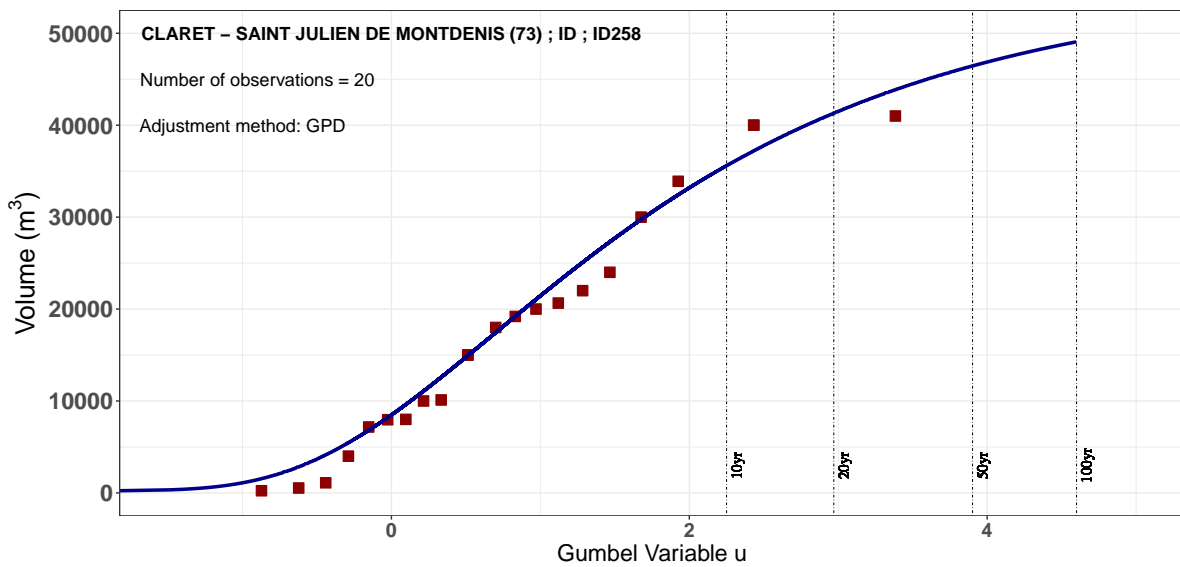

Figure 6.6: Claret’s Frequency - Magnitude curve resulted after the adjustment of real observations of debris flow events using GPD distribution (Adapted from an R code written by Maxime MOREL (INRAE)). Blue line: GPD fitting; red points: real observations.

mated using several formulations from the European research center (formula by Zeller, D’Agostino, Rickenmann or Brochot). These methods allow, using descriptive parameters of the watershed (area, slope, length, etc.), to calculate an order of magnitude of the debris flow events’ volumes. An additional estimate is performed using a method (by ETRM) known as the “rain method”, which converts the volume of water precipitated on a non-vegetated surface into a volume of debris flow. It requires knowledge about the hourly precipitation in the area.

In the Claret, the two sources of information were aggregated and used in order to build a “Frequency - Magnitude” curve of the catchment. It is very important to do a fusion of information in the studied case due to the fact that the analysis will involve the initial and the new design of the retention dam in which the deposited volumes in the case of the previous design is different than those in the case of the new design. The available data were then subjected to a Gumbel adjustment (ONF-RTM, 2013). A more recent study involved in the HYDRODEMO project (www6.inrae.fr/hydrodemo) has been carried out in which additional data corresponding to more recent events (until events of 2019) were added to the previous ETRM study and a new adjustment using the generalized Pareto distribution (GPD) was performed.

Fig. 6.5 incorporates sufficient data concerning some torrential floods that have already occurred in the Claret torrent. It reveals that the number of flood events occurring in one year ranges between 1 and 3 events. However, not all events trigger debris flows. In addition, it can be noticed that the data is incomplete in which information about debris flow volumes are became available after 1991. In previous years, no volumes were recorded but there were information about the number of events that have took place per year. This complementary information is essential because it helps to have a more robust computation of the rate (average number of events per year), which is used when fitting a GPD distribution. Besides, the figure also reveals the years at which cleaning operations have taken place.

The GPD adjustment (fig. 6.6) is characterized by a shape ($\xi = -0.49$) and a scale parameter ($\beta = 27172.8$). It is very satisfactory for an observation period of barely 27 years (1992 - 2019). Using this adjustment, it is easy to extract the debris flow volumes of events with different return periods. For example the volumes corresponding to return periods 10, 20, 50 and 100 years are respectively 35457.50, 41255.73, 46436.27 and 49066.00 m^3 . The main objective of this “Frequency - Magnitude” fitting is to make it possible to generate random volumes of debris flow events based on real empirical data.

In order to achieve the desired objective of this project, it is relevant to generate 100 fictive series of debris flow events over a period of 50 years and to simulate each event after the other. It is considered that 3 torrential floods, triggered by storms, occur per year but not all triggering debris flows meaning that a total of 150 events occur over the studied period (50 years). For figuring out whether each of the 3 events trigger or not a debris flow, a binomial distribution is adopted. This distribution provides the number of successes in a sequence of n independent runs (experiments), each of which yields success with probability p . In this application, 3 runs corresponding to the 3 events that occur each year should be performed. The success probability of each events within the 3 possible events is $p = \frac{1}{6}$ since the claret experiences, in average, 1 debris flow each 2 years and therefore 1 debris flow every 6 events. If a debris flow is triggered (result of binomial run is 1), a random volume is picked up from the GPD fitting of fig. 6.6. Otherwise (result of binomial run is 0), the debris flow volume is set to 0 m^3 . The syntax used in the developed R code for randomly running the binomial and the GPD distributions is given respectively by Eqs. 6.1 and 6.2.

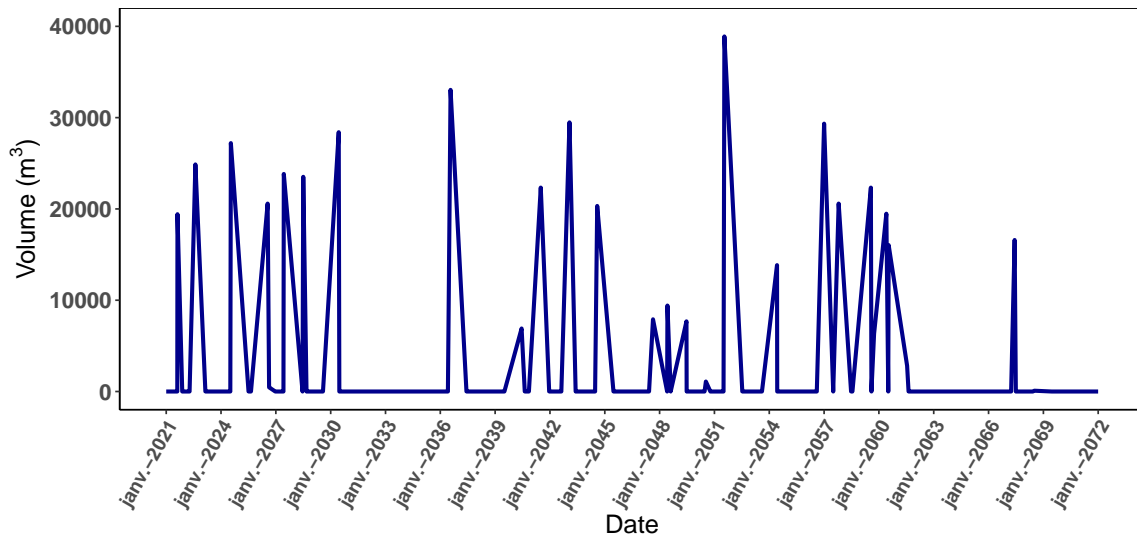

Figure 6.7: Time series of triggered debris flow events over a period of 50 years - Scenario 1.

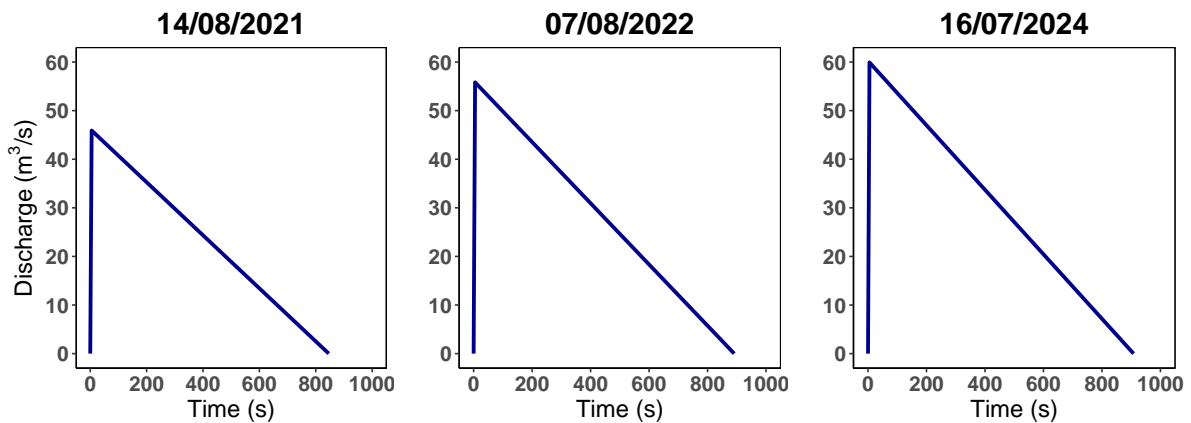

Figure 6.8: Hydrographs corresponding to the first three debris flow events involved in scenarios 1.

$$\text{rbinom}(50, 3, \frac{1}{6}) = \begin{cases} 1 & \text{Debris flow is triggered,} \\ 0 & \text{debris flow is not triggered} \end{cases} \quad (6.1)$$

$$\text{rgpd}(1, \text{loc} = 0, \text{scale} = 27172.8, \text{shape} = -0.49) = \text{Debris flow volume} \quad (6.2)$$

With regards to the dates of the 150 torrential flood events that take place over a period of 50 years, the objective is to generate, for each year, 150 random dates starting from the 1st of January 2021 until the 31st of December 2071. Consequently, for each year, 3 probabilities are generated using a uniform law (ranging between 0 and 1) using the following syntax in R:

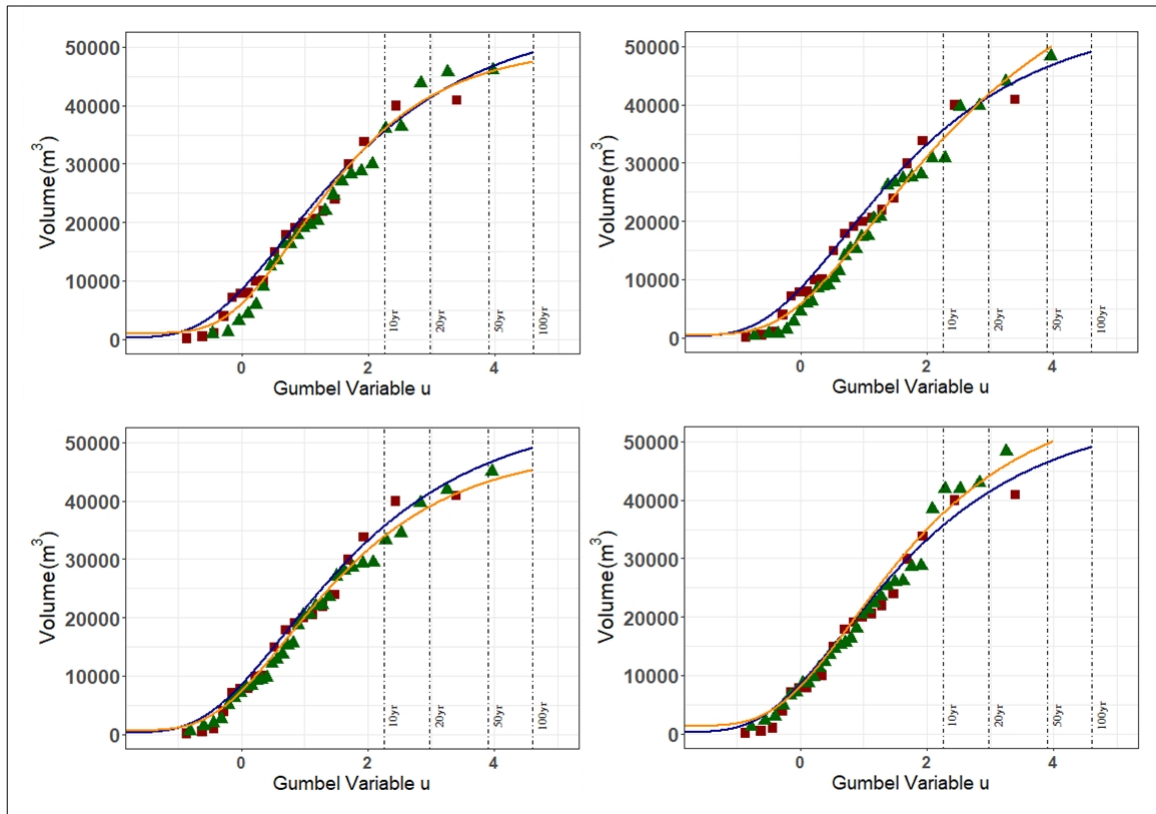

Figure 6.9: Frequency - Magnitude curves resulted after the adjustment of randomly generated series of debris flow events using GPD distribution (example of four different scenarios). Blue line: GPD fitting of real events; orange line: GPD fitting of generated events; red points: real observations, green points: generated observations.

$$\text{runif}(3, \text{min} = 0, \text{max} = 1) \tag{6.3}$$

Afterward, 3 dates corresponding to the 3 generated probabilities are extracted from the CDF that belongs to the real empirical data presented in fig. 6.4. The procedure is performed 50 times in order to generate 150 dates. All generated dates are then sorted in ascending order and associated to the 150 generated volumes. In the same way, 100 different scenarios with different series of events are generated. Fig. 6.7 represents the time series of events corresponding to scenario 1 (first generated scenario). The hydrographs are assumed to have a triangular shape with a peak discharge attained after 5 s of the event's starting time. The events' peak discharges and duration are estimated, respectively, according to Eqs. 4.27 and 4.28. Fig. 6.8 shows three different hydrographs corresponding to the first three debris flow events involved in the events' series of scenario 1.

In order to prove the reasonability of the generated scenarios in comparison with the historical empirical data, a GPD adjustment is carried out and compared with that of fig. 6.6. Fig. 6.9 presents the resulted GPD fitting of 4 different scenarios showing little variation

that can be justified by the random generation using the binomial law. The variability would be much less if the considered time window is higher (e.g. 1000 years).

6.2.2 Initial Configuration of the Retention System

Fig. 6.10 provides a detailed illustration of both the old and the new geometrical design of the retention dam. However, the principle data required to execute simulations are mainly those linked to the outlets' types, dimensions, altitude and other characteristics. In the case of the old design, there exist four functioning outlets: 2 openings, weir and crest. Whereas, in the case of the new design, three outlets are present: 1 opening, weir and crest. All related information are involved within tables 6.1 and 6.2.

All outlets are assumed to be initially empty from boulders. In other words, the vertical and lateral clogging dimension are both set to 0 m in the first simulation. In order to estimate the number of boulders that could be transported by a given debris flow volume and could interact with the dam's outlets, data concerning the class and the number of boulders observed in a reference volume should be acquired. Indeed, information concerning the number of boulders of different diameter classes for a reference volume of 30000 m³ are collected and presented in table 6.3. The first column is the representative diameter D of the boulder class in meters. The second column is the typical number N of such boulders that can be found in the chosen reference volume.

One more necessary information concerns the deposition slope in the retention basin. Available topographic data, collected after the 2017 debris flow, made it possible to build using 3D analysis the stage (m.a.s.l) - volume (m³) capacity curves corresponding to different deposition slopes (work done by Piton G. (INRAE)). The numerical data associated to these curves are provided in table 6.4). Moreover, the actual deposition slope was measured and estimated to be $S_{dep} = 6.1 \%$. From the data provided in table 6.4, it is possible to interpolate

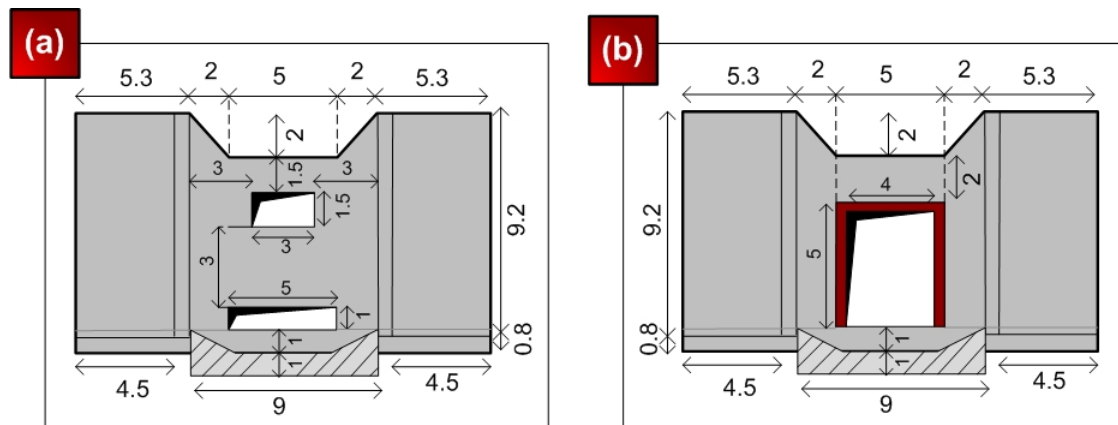

Figure 6.10: Claret's retention dam's detailed geometry and dimensions (in m) - Front view. (a) old design; (b) new design.

**Chapter 6. Application: Development and Evaluation of a Retention System
176 Deterioration and Maintenance Model**

Number	Type	Width (m)	Base level (m.a.s.l)	Top level (m.a.s.l)	Inclination angle with horizontal (°)
1	Slot (Bottom)	5	690	691	-
2	Slot (Upper)	3	694	695.5	-
3	Weir	5	697	-	45
4	Crest	50	699	-	90

Table 6.1: Characteristics of the retention dam's outlets - Old design.

Number	Type	Width (m)	Base level (m.a.s.l)	Top level (m.a.s.l)	Inclination angle with horizontal (°)
1	Slot (Bottom)	4	690	695	-
2	Weir	5	697	-	45
3	Crest	50	699	-	90

Table 6.2: Characteristics of the retention dam's outlets - New design.

Diameter (m)	Number
3	2
2	10
1	200

Table 6.3: Number of boulders with different diameters that can be found in a reference volume of $30000 m^3$.

on the actual deposition slope in order to have the corresponding stage (m.a.s.l) - volume (m^3) capacity curve to be used in the modeling (fig. 6.11). Note that initially (before the first event involved in a scenario), the retention basin is considered to be empty of materials ($V_b(t = 0) = 0 m^3$) and the initial level at the retention dam is also $Z(t = 0) = 0 m.a.s.l.$

The stored volume of deposits V_b in the retention basin evolves after each debris flow event. As mentioned in section 4.3.6, the system resides in four different states defined depending on the value of V_b . Based on experts judgment, the states' thresholds are chosen as follows:

State 1: $0 m^3 < V_b \leq 2200 m^3$ (until 10% of the basin's capacity)

State 2: $2200 m^3 < V_b \leq 10000 m^3$ (before reaching half the basin's capacity)

State 3: $10000 m^3 < V_b \leq 20000 m^3$ (before reaching the basin's total capacity)

State 4: $20000 m^3 < V_b \leq 22000 m^3$ (until the basin is completely filled)

Z (m.a.s.l)	$S_{dep} = 5.1 \%$	$S_{dep} = 6.1 \%$	$S_{dep} = 7.1 \%$
705	53.024	66.277	79.523
799	25.628	32.035	38.441
698	21.062	26.328	31.594
697	16.916	21.145	25.374
696	13.256	16.570	19.884
695	9.953	12.441	14.930
694	6.907	8.633	10.360
693	4.110	5.138	6.165
692	1.688	2.110	2.532
691	0.353	0.442	0.530
650	0	0	0

Table 6.4: Volume ($\times 10^3 \text{ m}^3$) of debris material stored below a certain level at the level of the Claret's retention dam for several deposition slopes.

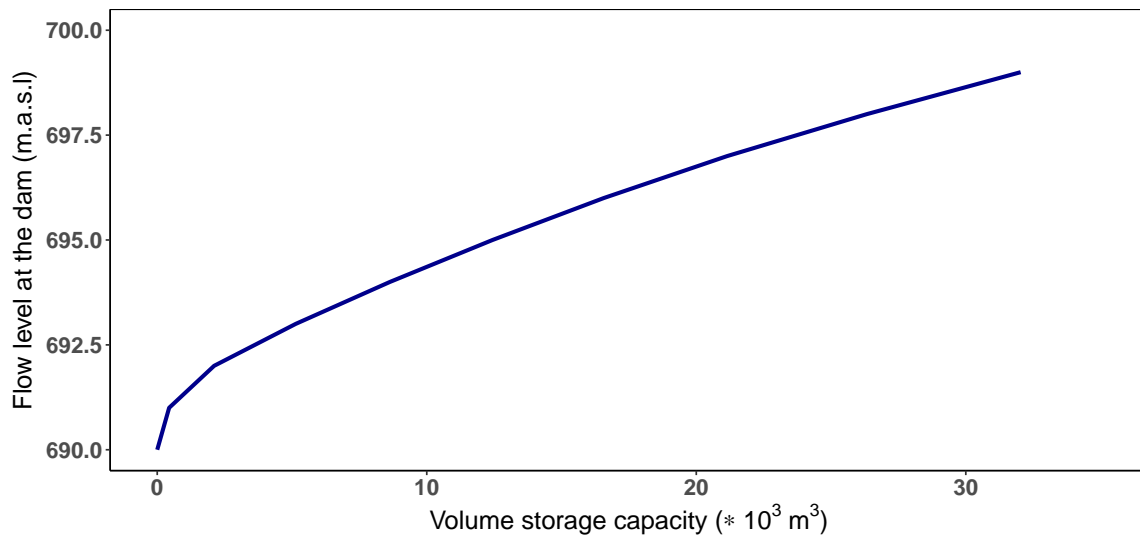

Figure 6.11: Claret's Stage - volume capacity curve for $S_{dep} = 6.1$.

6.2.3 SPN Model Inputs and Maintenance Strategies

The SPN model presented in fig. 4.16 has been used for representing the evolution of the stored volume in the Claret's retention basin. In section 4.4.3, three maintenance operations 1, 2, and 3 corresponding, respectively, to states 2, 3, and 4 are defined. However, in this application, whatever the state of the system, the same maintenance policy is carried out. In other words, after inspection, whatever the detected stored volume is, the decision is to dredge (clean) all the deposited materials in the basin. The difference in maintenance operations lies

**Chapter 6. Application: Development and Evaluation of a Retention System
178 Deterioration and Maintenance Model**

Intervention	Transition	Constant firing time (years)
Inspection	Inspection frequency T_5	1
	Immediate transitions $T_4 T_6 T_7 T_8$	0
Maintenance	Minor T_9	0.291
	Major T_{10}	0.375
	Corrective T_{11}	0.458

Table 6.5: Deterministic transition times corresponding to the inspection and maintenance processes involved in the SPN model.

only in the amount of materials to be dredged which affects the time needed to carry out maintenance. The deterministic transition times of fig. 4.16, corresponding to the inspection frequency (T_5) and the scheduling and work time of each maintenance operation (T_9 , T_{10} , and T_{11}), are assessed and presented in table 6.5. The time required for carrying out cleaning operations ranges between 3 to 12 months (Paulhe et al., 2018). On June 14th 2017, a debris flow with $V_b \approx 8000 m^3$ (a typical State 2 maintenance) has occurred. The cleaning maintenance operation took about one month (Sept. 3rd - Oct. 11th) but it was launched 2.5 months after the event (scheduling time). Consequently, it is assumed that the launching time is fixed to 2.5 months in addition to a dredging period proportional to the volume to be dredged:

- **Maintenance operation 1:** 2.5 months + 1 month for state 2 (minor maintenance)
- **Maintenance operation 2:** 2.5 months + 2 months for state 3 (major maintenance)
- **Maintenance operation 3:** 2.5 months + 3 months for state 4 (corrective maintenance)

Since the creation of the deposit range (1991), the average cost of cleaning operations has been 17000 €/year for average extracted volume of 6000 $m^3/year$. and therefore 2.83 €/m³ (ONF-RTM, 2013; Paulhe et al., 2018). Assuming mean dredging operations, the costs of the defined maintenance operations are estimated and presented in table 6.6. As a cross control, it is equivalent to dredging costs of:

$$17000 \text{ €}/[2200,10000] m^3: [1.7,7.7] \text{ €/}m^3$$

$$42000 \text{ €}/[10000,20000] m^3: [2.1,4.2] \text{ €/}m^3$$

$$59000 \text{ €}/[20000,22000] m^3: [2.7,2.95] \text{ €/}m^3$$

These costs are consistent with the variation of dredging costs presented in the literature (Carladous et al., 2021).

In order to achieve the objective of supporting decision-making for check dam's maintenance, four different maintenance strategies are defined to be compared and sorted. The strategies are analyzed during a period of 50 years.

Maintenance operation	Mean dredged volume (m^3)	Cost (€)
Minor	$(2200 + 10000)/2 = 6100$	$6100 m^3 * 2.83 \text{ €/}m^3 \approx 17000$
Major	$(10000 + 20000)/2 = 15000$	$15000 m^3 * 2.83 \text{ €/}m^3 \approx 42000$
Corrective	$(20000 + 22000)/2 = 21000$	$21000 m^3 * 2.83 \text{ €/}m^3 \approx 59000$

Table 6.6: Costs of maintenance operations carried out for cleaning Claret's retention basin.

1. **Strategy 1:** all maintenance operations are allowed.
2. **Strategy 2:** minor maintenance is inhibited.
3. **Strategy 3:** major maintenance is inhibited.
4. **Strategy 4:** only corrective maintenance is allowed.

6.3 Model Execution, Results and Discussions

The 100 generated scenarios, each having 150 torrential flood events (3 events per year) involving different number of debris flow events are simulated using the physics-based model incorporated in the developed R codes. The duration of simulation depends on the number of scenarios (100 generated scenarios), number of debris flows involved within each scenario (events with non-zero volume) and on the chosen time step. The calculation time step is set up to 2 s so that it captures the events' peak discharges ($t_{peak} = 5s$). Simulations are carried out considering both the old and the new design of the retention dam. The only different input to the codes when differentiating between both dams is the data concerning the dam's outlets which are already provided by tables 6.1 and 6.2. The achieved results and their interpretations are presented in the following sections.

6.3.1 Application to the Old Design

In the physics-based model, all events involved in each of the generated scenarios are simulated consecutively one after another so that the outputs of event i are used as inputs to event $i + 1$. The main outputs of event i to be considered when simulating event $i + 1$ are the rate (%) of clogging of the dam's outlets, the final stored volume in the basin ($V_b m^3$) and the final level of deposits at the dam ($Z m.a.s.l$).

Fig. 6.12 provides the outlet discharge for a given flow level at the barrier depending on the rate of clogging of the dam's outlets. The flow level is set to vary starting from the base level of the lower slot until 5 m above the dam's crest level. These 5 m are added in order to consider the whole volume of debris flows that overtop the crest. The discharge escaping the dam is calculated based on the hydraulic equations presented in section 4.3.2. The figure involves two curves: one corresponding to the case where the rate of clogging of all outlets is 0 % (e.g. first event) and the other corresponding to the case where there is an initial clogging

in one or more of the outlets (e.g. second event in scenario 1). As noticed in the figure, the outlet discharge in the case of partial clogging of the outlets is less than that in the case of no clogging. This reveals the fact that as the rate of clogging increases, the dam will be retaining more materials and thus the volume of debris stored in the basin will increase compared to the case where the outlets are free of any obstruction.

Figures 6.13 and 6.14 represent the buffering model’s results obtained for the first two consecutive debris flow events involved in scenario 1 (event 1: $V = 19422 \text{ m}^3$, date = 14/08/2021 ; event 2: $V = 24873 \text{ m}^3$, date = 07/08/2022). During the first event (buffering of 42 %), the dam was able to release the flow with a rate higher than that recorded during the second event (buffering = 69 %). This results due to partial blockage (80 % horizontally and vertically 100 %) of the dam’s lower slot after the end of event 1. It can be also noticed that during the second event, the flow level at the dam has reached and has exceeded the weir’s base level. The final stored volume attained after the second event is $V_b = 21900 \text{ m}^3$ which is approximately equals to the maximum storage capacity of the basin $C_b = 22000 \text{ m}^3$. It is important to differentiate between the maximum stored volume during the event and the final stored volume attained at the end of the event. In fact, the maximum stored volume is usually higher than the final stored volume due to self cleaning. Indeed, both debris flows have reached their maximum deposition in less than 12 minutes and then have progressively self-cleaned a specific volume through the upper slot. At the end of event 2, the lower slot was horizontally and vertically totally blocked (100 %) and the upper slot was partially blocked (80 % horizontally and vertically 100 %).

Similar outcomes can be obtained for other events and scenarios. Note that in addition to the stochastic model developed for generating random events, stochasticity is also present in another stage of the physics-based model in which the presence and transport of boulders in a given debris flow volume are modeled via a binomial law as mentioned in section 4.3.3. Consequently, results obtained after the simulation of a specific event differs when simulating

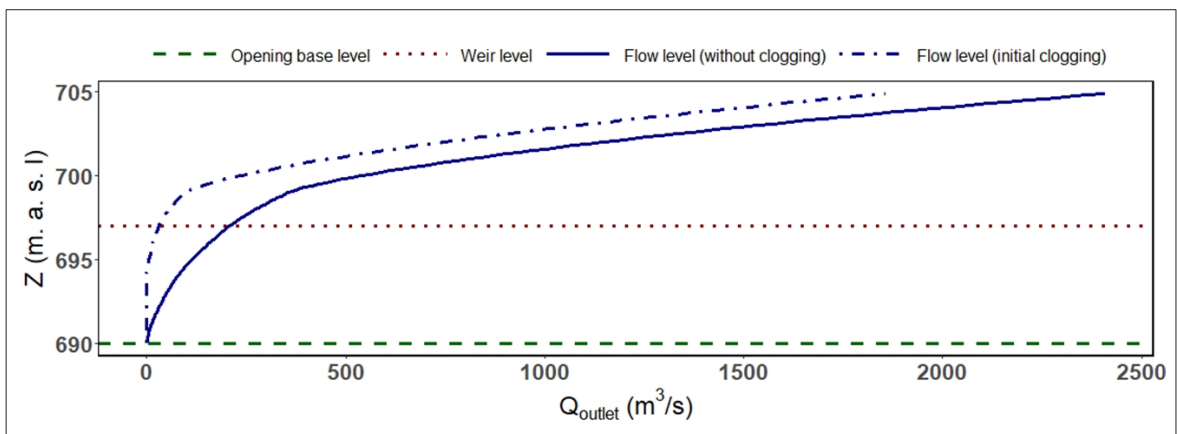

Figure 6.12: Variation of the outlet discharge depending on the flow level at the dam and on the rate of clogging of the dam’s outlets. Example corresponding to the first two events in scenario 1 - Old design.

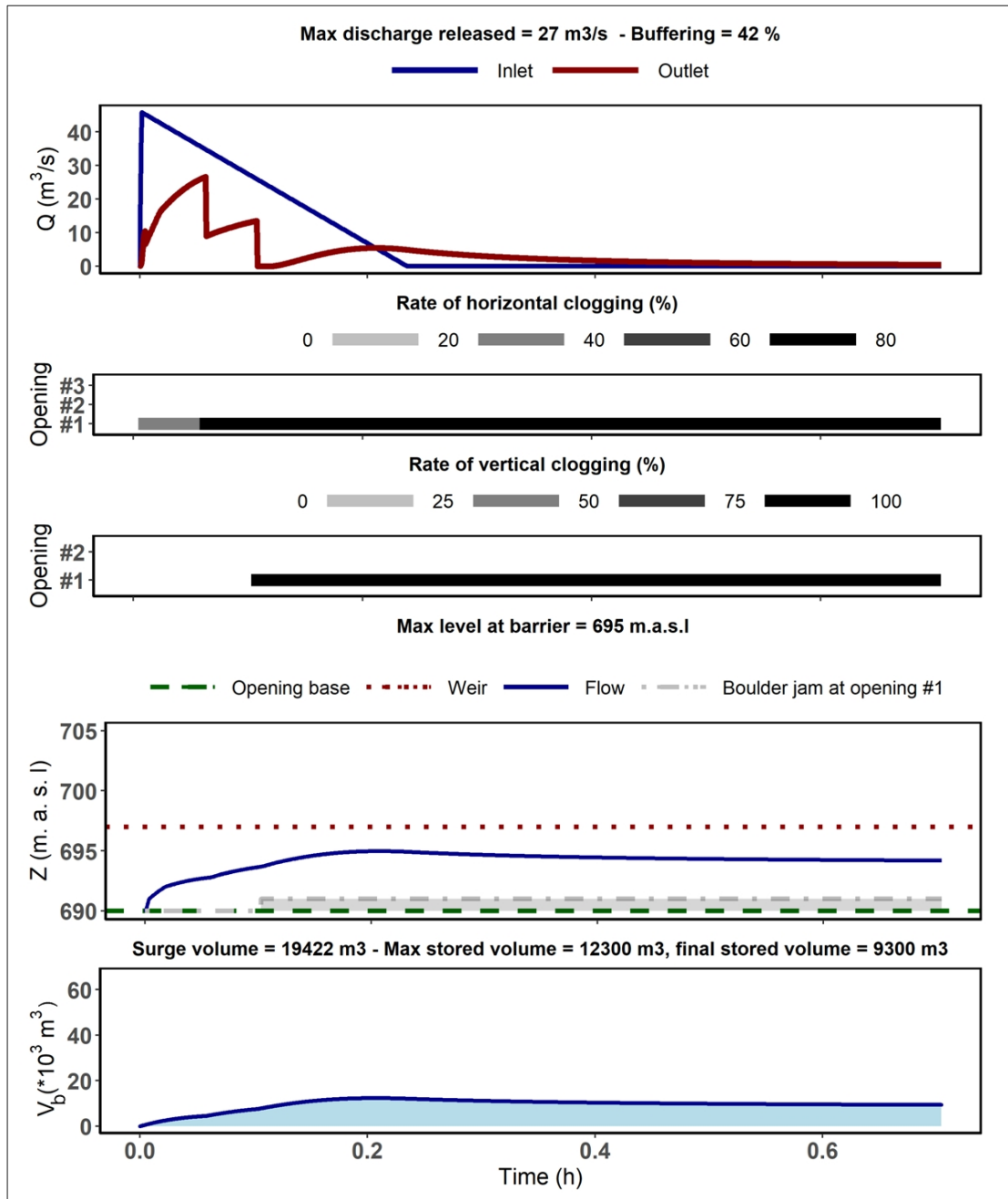

Figure 6.13: Physics-based model's results showing the variation of several physical parameters. Event 1 in scenario 1 - Old design. Q (m³/s) is the discharge, Z (m.a.s.l) is the flow level at the dam and V_b (*10³ m³) is the stored volume in the basin.

again the same event due to the randomness in the number of boulders passing and jamming the dam's outlets.

These outputs enable modeling the evolution of the volume stored in the retention basin V_b (degradation indicator) taking into account dependencies with the rate of clogging of the

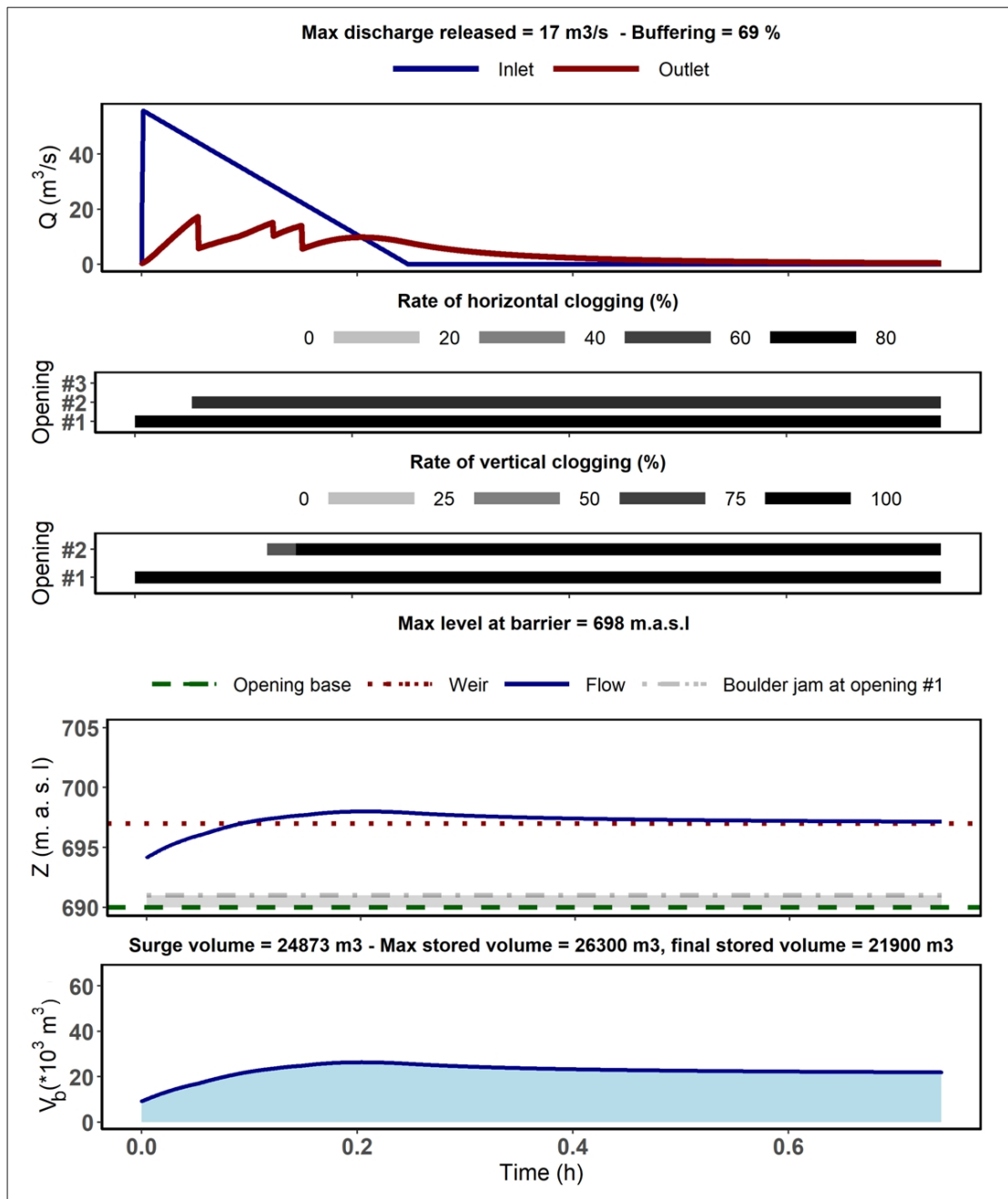

Figure 6.14: Physics-based model's results showing the variation of several physical parameters. Event 2 in scenario 1 - Old design. Q (m³/s) is the discharge, Z (m.a.s.l) is the flow level at the dam and V_b (*10³ m³) is the stored volume in the basin.

dam's outlets (sub degradation indicator). Fig. 6.15, shows the time-dependent evolution of V_b for all of the 100 generated scenarios. The dispersion seen in the figure reveals that the evolution of V_b varies depending on the generated scenario. The variation is mainly controlled by the magnitude of the events involved in each scenario in addition to the number and class

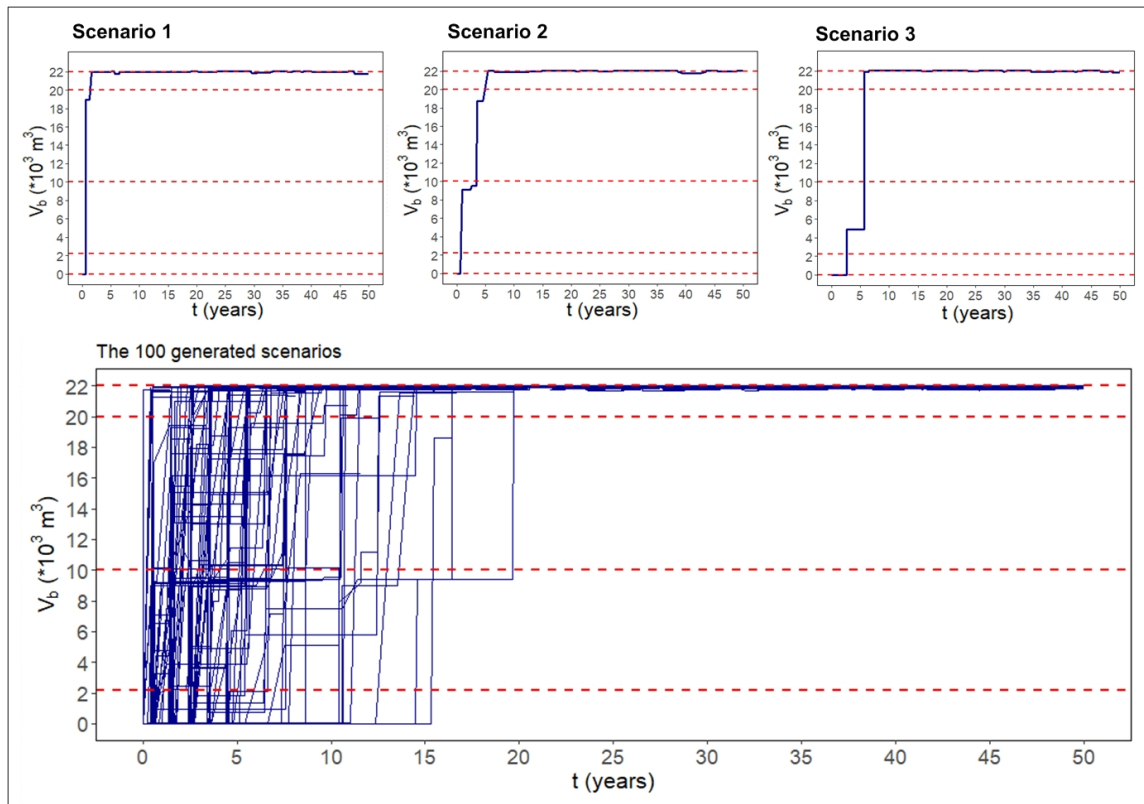

Figure 6.15: Time-dependent evolution of the system's state indicator V_b for the 100 generated scenarios - Old design. Blue curve: indicator evolution over time; red dashed lines: indicator thresholds ($V_{b1} = 0 * 10^3 m^3$, $V_{b2} = 2.2 * 10^3 m^3$, $V_{b3} = 10 * 10^3 m^3$, $V_{b4} = 20 * 10^3 m^3$ and $C_b = 22 * 10^3 m^3$).

of boulders interacting with the dam's outlets. This, again, proves the necessity of stochastic modeling in order to integrate possible behaviors of the system in the analysis. In most scenarios, the basin is completely filled within 5 years (others within 20 years). Therefore, maintenance is required at very early stages.

The estimation of the time spent in each of the defined states, for all the simulated scenarios, provides a data set for each of the stochastic transitions that links between the states of the system. From the obtained results, it was revealed that all transitions have a considerable number of observations in which T_{1-2} , T_{1-3} , T_{1-4} , T_{2-3} , T_{2-4} and T_{3-4} have attained, respectively, 46, 29, 25, 21, 25 and 50 values out of 100 values. An empirical cumulative distribution function (CDF) is estimated for each transition using Kaplan-Meier estimator (fig. 6.16). The obtained distributions of all stochastic transitions involved in the degradation process are used as an input to the SPN model of figure 4.16 presented in section 4.4. Each of these transitions has a probability of firing based on its attained number of observations. In this application, the system reaches a complete failed state in all scenarios. Therefore, there are no censored information and that is why all the CDF curves reach a probability value equals to 1.

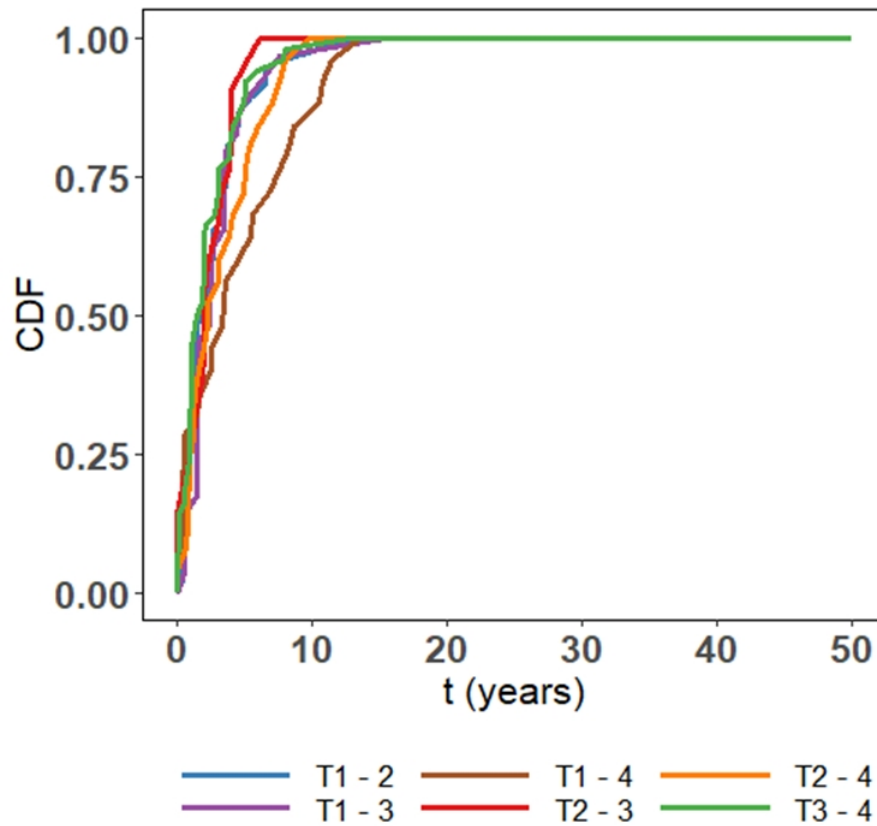

Figure 6.16: Cumulative distribution functions of the stochastic transitions involved in the degradation process of the SPN model.

Strategy	State 1	State 2	State 3	State 4
1	40.49	3.36	2.67	3.48
2	31.05	10.94	3.19	4.82
3	33.55	2.93	7.77	5.74
4	25.32	9.42	8.19	7.07

Table 6.7: Mean sojourn time (years) of the studied retention system in each of its defined states based on the maintenance strategy adopted.

Since the model follows a stochastic process, the number of simulations to be held is considered to be sufficient when convergence in results occurs. In this application, convergence is reached after 200 simulations for all of the defined strategies. Tables 6.7 and 6.8 summarize the results obtained for each maintenance strategy modeled over a period of 50 years.

Table 6.7 reveals the influence of each maintenance strategy on the mean sojourn time in the four defined states of the retention system. In strategies 1 and 3, the system resides in the initial state (state 1) for a longer period of time when compared to strategies 2 and 4. This is

Strategy	Minor		Major		Corrective	
	μ	σ	μ	σ	μ	σ
1	4.84	2.15	3.66	1.87	4.14	1.64
2	0.00	0.00	4.09	1.75	5.29	1.65
3	4.09	2.16	0.00	0.00	6.44	1.71
4	0.00	0.00	0.00	0.00	7.48	1.70

Table 6.8: Statistics on the number of maintenance operations performed during the considered simulation period based on the maintenance strategy adopted. μ : average; σ : standard deviation.

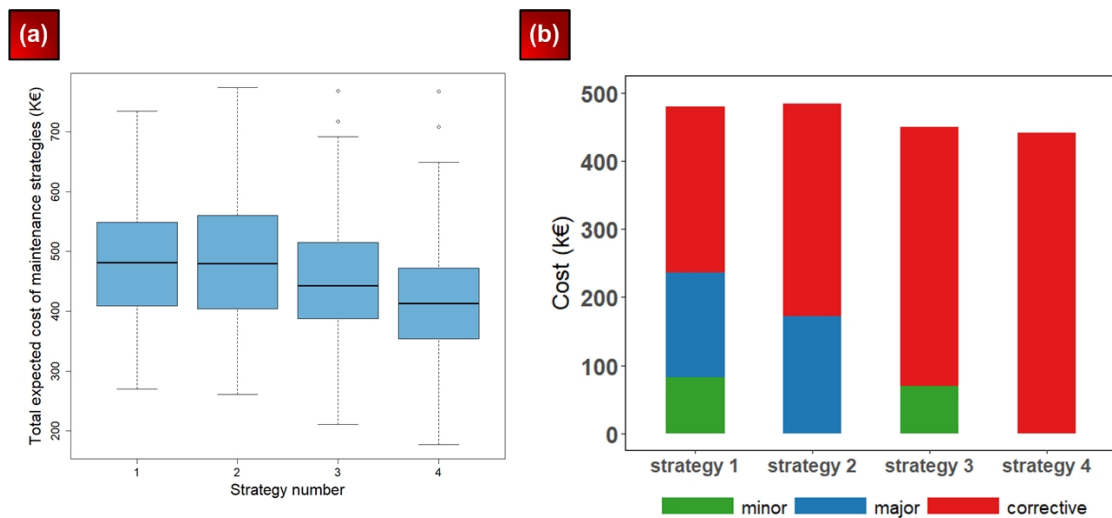

Figure 6.17: Expected total cost of the four maintenance strategies considered in this study: (a) box plots corresponding to the data sets (200 histories) of costs. The black line in the boxplot indicates the median. The upper and lower edges of the boxplot indicate, respectively, the 75th and 25th percentiles. The upper and lower edges of the whisker provide, respectively, the maximum and the minimum values involved in the data excluding outliers; (b) average cost. Green: minor maintenance; blue: major maintenance; red: corrective maintenance.

due to the fact that in strategies 1 and 3, maintenance is applied as soon as the dam is no more in a good condition using minor operations. On the other hand, for strategies 2 and 4, where minor maintenance is prevented, the system remains in a poor condition (state 2) for a longer time. In strategy 3, since major maintenance is inhibited, the system resides in a very poor condition (state 3) for a long time in comparison to the strategies where major operations are allowed (strategies 1 and 2). Concerning strategy 4 in which only corrective operations are authorized, the system spends more time in the degraded states 2 and 3 compared to other strategies. The reason behind this is that the system continues to deteriorate without any reparation (e.g. cleaning the basin, removing boulders from the dam's outlets) until it completely fails (filled basin, total blockage of dam's outlets).

The statistics on the number of applied maintenance operations, provided in table 6.8, allow computing the total expected cost of each maintenance strategy. Fig. 6.17, (a) represents the box plots depicting data sets of the total cost of each strategy, obtained after the 200 simulations of the SPN model, through their quartiles. It can be interpreted that the medians of box plots corresponding to strategies 1 and 2 are on the same level meaning that both strategies have the same average cost. Besides, the medians of boxplots corresponding to strategies 3 and 4 are on levels not so much lower than the level of those corresponding to strategies 1 and 2. This in turn reveals that, for the old design of the Claret retention system and according to the data provided, all of the defined maintenance strategies have more or less the same total cost. This can be seen from fig. 6.17, (b) which makes it easy to sort, compare, and to choose the best maintenance strategy based on the average expected cost of each strategy.

Regardless the rapprochement of strategies costs, strategy 4 is the most the cheapest. In other words, waiting until the basin is more than 90% filled ($V_b \geq 20000 m^3$) and dredging the whole volume of deposits seems to be the most cost-effective strategy. Strategies 1 and 2, where cleaning operations are applied when the basin is 10% to 90% filled, are the most expensive. This can be interpreted according to the results of the physics-based model which shows that the retention basin is rapidly filled by debris materials. Consequently, dredging each time an amount of deposits which is much less than the capacity of the basin will not serve, from an economic point of view, in the long term in which the basin will be rapidly filled again and similar cleaning operations will have to be carried out several times within a short duration.

6.3.2 Application to New Design

Considering the new design of the retention dam where the openings were modified, the simulation of the 100 generated scenarios using the physics-based model has resulted in completely different outputs concerning the clogging of the outlets and the evolution of the stored volume in the basin.

Fig. 6.18 provides the outlet discharge for a given flow level at the barrier depending on the rate of clogging of the dam's outlets. Similar to the previous case, this curve is obtained after simulating the first two debris flow events involved in scenario 1. Both events provided the same output stage - discharge curve revealing that after the first event, there was no clogging of the dam's outlets (clogging rate = 0 %). It can be also realized that the discharge capacity of the old design of the dam is somehow higher than that of the new design, approximately by $200 m^3/s$.

Figures 6.19 and 6.20 represent the buffering model's results obtained for the first two consecutive debris flow events involved in scenario 1 (event 1: $V = 19422 m^3$, date = 14/08/2021 ; event 2: $V = 24873 m^3$, date = 07/08/2022). During the first event (buffering of 32 %), the dam was able to release the flow more or less with the same as that recorded during the second event (buffering = 31 %). This is due to the 0% blockage of the dam's slot after the

end of event 1. The final stored volume attained after the second event is $V_b = 0 \text{ m}^3$ meaning that the basin was still empty before the occurrence of event 2. At the end of event 2, the slot was still not jammed by any boulder (clogging rate = 0% and the dam was still able to self clean and to evacuate all the flow leaving the basin empty again ($V_b = 0 \text{ m}^3$)). Similar outcomes are obtained for other events and scenarios.

Indeed, after simulating the 100 generated scenarios, it was revealed that new design of the dam with its big slot is able to, progressively, self clean and evacuate the whole volume of the debris flow events in most of the scenarios. In other words, most of the scenarios have resulted in a 0% clogging rate and an empty basin ($V_{b1} = 0 \text{ m}^3$). Fig. 6.21, shows the time-dependent evolution of V_b for all of the 100 generated scenarios. It can be seen that in all scenarios, the system resides, at the end, either in state 1 or in state 2. Only in two scenarios, the system has reached state 4. Concerning the scenarios where the system has reached state 2 (e.g. scenarios 17), the slot was vertically clogged by 3 m during one of the involved debris flow events. For the two where the system has reached state 4 (e.g. scenarios 37), the slot was totally vertically clogged.

The considerable difference between the results obtained for both designs of the retention system, assure the necessity of redesigning the old dam and verify the efficiency of the new design. Since, the system has not reached critical states in the presence of the big slot of the new designed dam, there is no need to think about a cost-effective maintenance policy, in which cleaning is rarely required. Consequently, the stochastic deterioration and maintenance model using SPN will not be applied to this case.

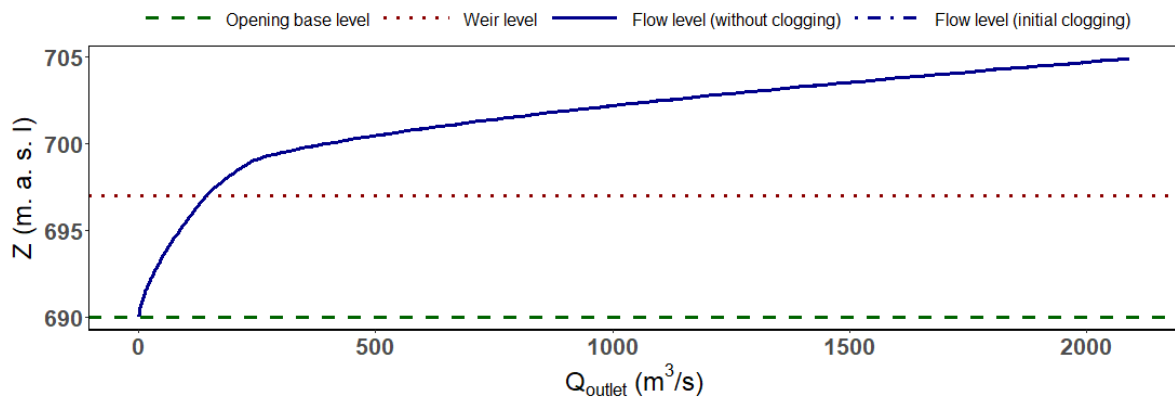

Figure 6.18: Variation of the outlet discharge depending on the flow level at the dam and on the rate of clogging of the dam's outlets. Example corresponding to the first two events in scenario 1 - New design.

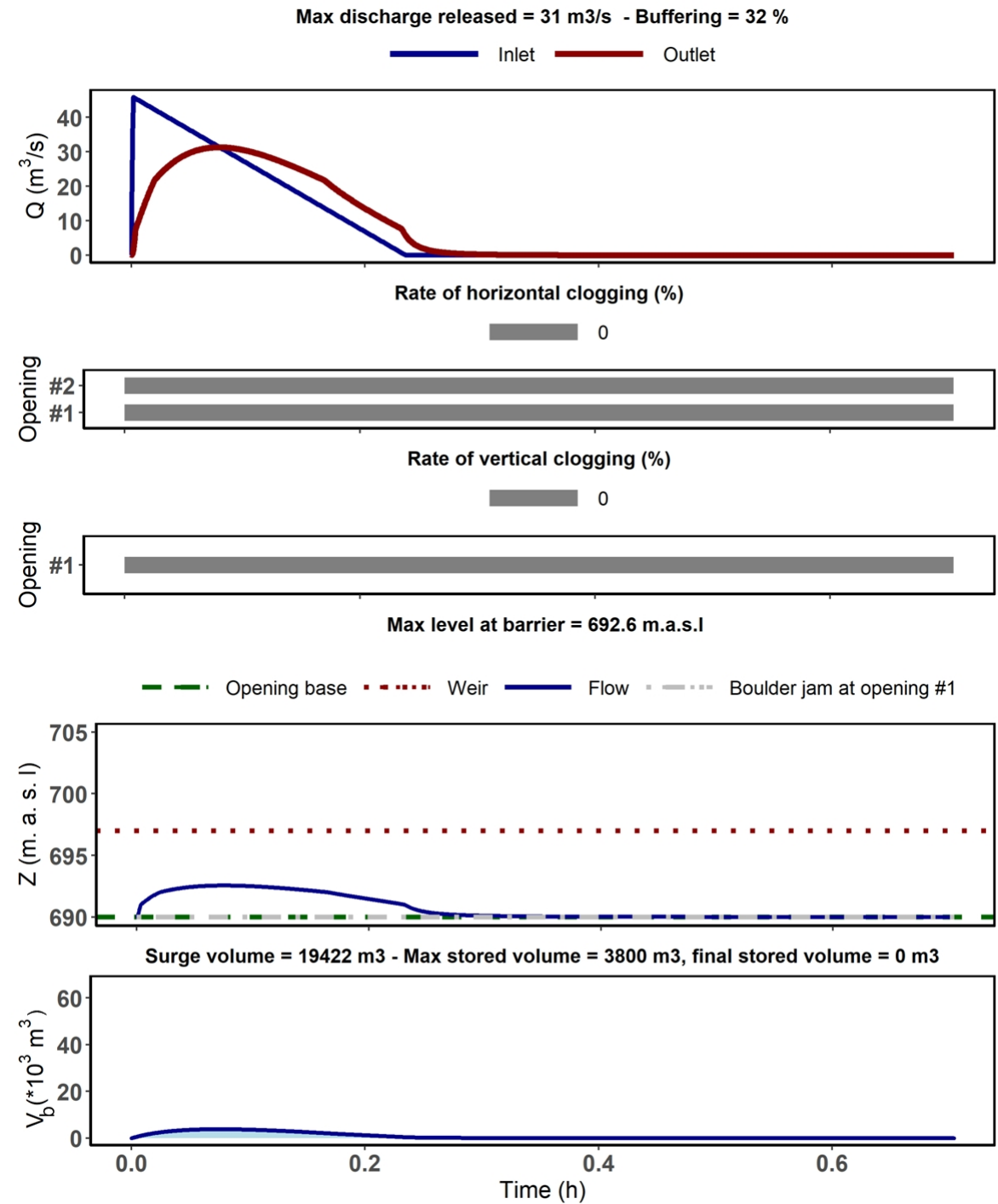

Figure 6.19: Physics-based model's results showing the variation of several physical parameters. Event 1 in scenario 1 - New design. Q (m^3/s) is the discharge, Z ($m.a.s.l$) is the flow level at the dam and V_b ($*10^3 m^3$) is the stored volume in the basin.

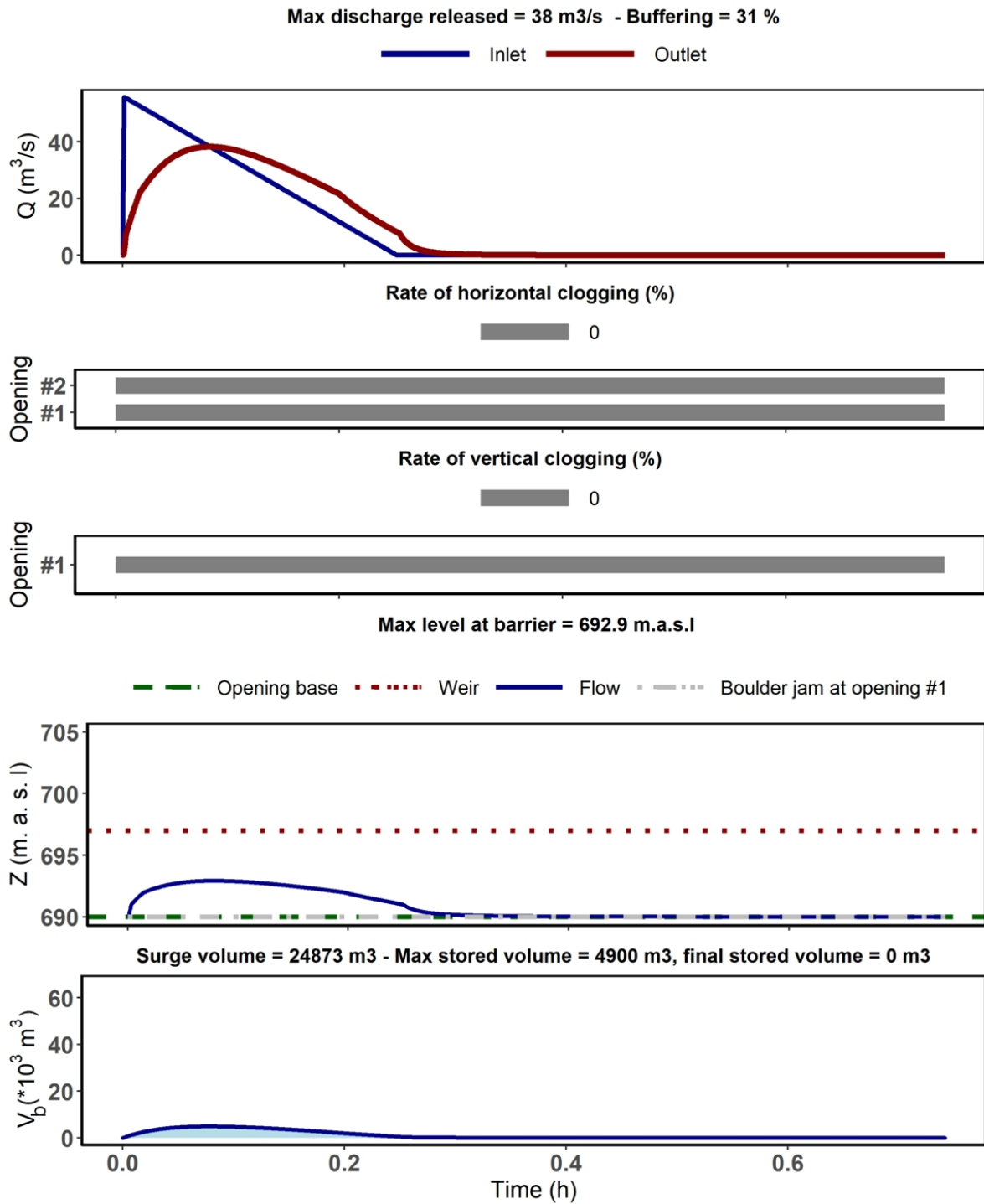

Figure 6.20: Physics-based model's results showing the variation of several physical parameters. Event 2 in scenario 1 - New design. Q (m^3/s) is the discharge, Z ($m.a.s.l$) is the flow level at the dam and V_b ($*10^3 m^3$) is the stored volume in the basin.

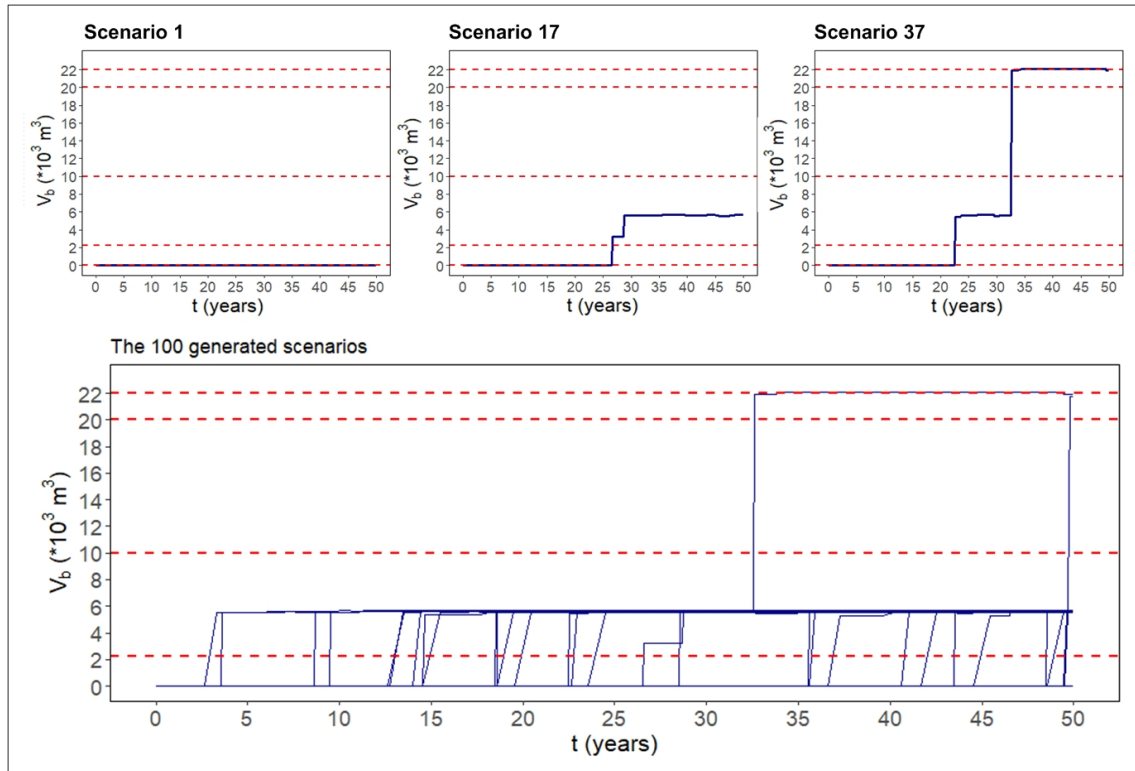

Figure 6.21: Time-dependent evolution of the system's state indicator V_b for the 100 generated scenarios - New design. Blue curve: indicator evolution over time; red dashed lines: indicator thresholds ($V_{b1} = 0 *10^3 m^3$, $V_{b2} = 2.2 *10^3 m^3$, $V_{b3} = 10 *10^3 m^3$, $V_{b4} = 20 *10^3 m^3$ and $C_b = 22 *10^3 m^3$).

6.4 Sensitivity Analysis Applied to the SPN Model

Although the SPN model applied to the old design of the retention dam is based on real data and has provided logical results, it is still worth it to explore different situations under a given set of assumptions.

In this section, a sensitivity analysis is performed on different parameters involved in the SPN model in order to (i) check the influence of each parameter on the results of the model and to (ii) improve decision-making in case something changes in the future (e.g. easier maintenance operations, more expensive operations, etc.). Three different parameters are chosen for this purpose: frequency of inspection, maintenance duration and maintenance costs.

6.4.1 Inspection Frequency

In the developed model, it was assumed that inspection takes place once per year ($T_5 = 1$ year). In other words, the state of the system is considered only one time per year whatever

the number of events that have already occurred within the year. Therefore, a decision concerning maintenance is only taken once per year. Simulations using SPN are carried out again considering two other inspection times ($T_5 = 6 \text{ months}$ and $T_5 = 2 \text{ years}$). Results concerning the mean sojourn time, the average number of maintenance operations and the total average cost of each maintenance strategy are provided in tables 6.9 - 6.14. Note that each table involves also the percentage difference with the values corresponding to the initial case where the inspection time was $T_5 = 1 \text{ year}$.

For $T_5 = 0.5 \text{ years}$, the times spent by the system in the different states did not differ much ($< 14 \%$ difference) than those corresponding to $T_5 = 1 \text{ year}$. Similarly for the number of maintenance operations carried out over a duration of 50 years ($< 8 \%$ difference). However, for $T_5 = 2 \text{ years}$, the percentage difference was higher for both the mean sojourn time (up to 70%) and for the applied maintenance operations (up to 25%). This can be justified by the fact that, in the Claret, debris flows are triggered maximum once per year and more probably once every 2 years. Hence, inspecting every 6 months has quite the same efficiency as inspecting once per year. On the other hand, inspecting once every 2 years may not be so efficient as inspecting once per year since 1 triggered debris flow may be missed and thus the system will spend more time in the same state or will evolve to a more degraded state without doing any preventive maintenance.

Although, in some cases, there is a considerable difference between the results provided according to the different inspection times, the total costs of the defined maintenance strategies have not shown a big difference (up to 3% for $T_5 = 0.5 \text{ years}$ and up to 10% for $T_5 = 2 \text{ years}$). Nonetheless, for all the considered times of inspection, maintenance strategy 4 remains the most cost-effective regardless that the costs of all strategies are not so different.

Strategy	State 1	State 2	State 3	State 4
1	41.24 1.86%	3.12 7.31%	2.57 3.93%	3.08 11.52%
2	31.28 0.73%	11.68 6.72%	2.90 9.10%	4.14 13.98%
3	34.51 2.85%	2.63 10.44%	7.88 1.42%	4.98 13.24%
4	25.76 1.73%	9.91 5.20%	8.52 4.06%	5.81 1.96%

Table 6.9: Mean sojourn time (years) of the studied retention system in each of its defined states based on the maintenance strategy adopted - $T_5 = 0.5 \text{ years}$. The given percentages correspond to the differences with the values provided when considering $T_5 = 1 \text{ year}$.

Chapter 6. Application: Development and Evaluation of a Retention System
192 Deterioration and Maintenance Model

Strategy	State 1	State 2	State 3	State 4
1	35.92 <i>11.29%</i>	4.77 <i>41.72%</i>	3.41 <i>27.79%</i>	5.90 <i>69.72%</i>
2	27.58 <i>11.19%</i>	10.80 <i>1.31%</i>	3.98 <i>24.78%</i>	7.64 <i>58.69%</i>
3	30.29 <i>9.72%</i>	4.11 <i>40.38%</i>	7.11 <i>8.49%</i>	8.48 <i>47.64%</i>
4	23.18 <i>8.48%</i>	9.16 <i>2.76%</i>	7.45 <i>9.04%</i>	10.22 <i>44.51%</i>

Table 6.10: Mean sojourn time (years) of the studied retention system in each of its defined states based on the maintenance strategy adopted - $T_5 = 2$ years. The given percentages correspond to the differences with the values provided when considering $T_5 = 1$ year.

Strategy	Minor	Major	Corrective
1	5.09 <i>5.27%</i>	3.72 <i>1.50%</i>	4.05 <i>2.17%</i>
2	0 <i>0%</i>	4.12 <i>0.61%</i>	5.54 <i>4.63%</i>
3	4.39 <i>7.21%</i>	0 <i>0%</i>	6.50 <i>1.01%</i>
4	0 <i>0%</i>	0 <i>0%</i>	7.62 <i>1.94%</i>

Table 6.11: Average number of maintenance operations performed on the system during the considered simulation period - $T_5 = 0.5$ years. The given percentages correspond to the differences with the values provided when considering $T_5 = 1$ year.

Strategy	Minor	Major	Corrective
1	3.76 <i>22.34%</i>	2.76 <i>24.59%</i>	4.32 <i>4.35%</i>
2	0 <i>0%</i>	2.89 <i>29.46%</i>	5.44 <i>2.74%</i>
3	3.21 <i>21.52%</i>	0 <i>0%</i>	5.87 <i>8.86%</i>
4	0 <i>0%</i>	0 <i>0%</i>	6.72 <i>10.10%</i>

Table 6.12: Average number of maintenance operations performed on the system during the considered simulation period - $T_5 = 2$ years. The given percentages correspond to the differences with the values provided when considering $T_5 = 1$ year.

Strategy	Minor	Major	Corrective	Total
1	86.530 <i>5.27%</i>	156.030 <i>1.50%</i>	238.950 <i>2.17%</i>	481.510 <i>0.28%</i>
2	0 <i>0%</i>	172.830 <i>0.61%</i>	326.565 <i>4.63%</i>	499.396 <i>3.20%</i>
3	74.545 <i>7.21%</i>	0 <i>0%</i>	385.500 <i>1.01%</i>	458.045 <i>1.97%</i>
4	0 <i>0%</i>	0 <i>0%</i>	449.580 <i>1.94%</i>	449.580 <i>1.94%</i>

Table 6.13: Average total cost (k€) of each of the defined maintenance strategies - $T_5 = 0.5$ years. The given percentages correspond to the differences with the values provided when considering $T_5 = 1$ year.

Strategy	Minor	Major	Corrective	Total
1	63.835 <i>22.34%</i>	115.920 <i>24.59%</i>	254.880 <i>4.35%</i>	434.635 <i>9.48%</i>
2	0 <i>0%</i>	121.170 <i>29.46%</i>	320.665 <i>2.74%</i>	441.835 <i>8.69%</i>
3	54.570 <i>21.52%</i>	0 <i>0%</i>	346.035 <i>8.86%</i>	400.605 <i>10.82%</i>
4	0 <i>0%</i>	0 <i>0%</i>	396.480 <i>10.10%</i>	396.480 <i>10.10%</i>

Table 6.14: Average total cost (k€) of each of the defined maintenance strategies - $T_5 = 2$ years. The given percentages correspond to the differences with the values provided when considering $T_5 = 1$ year.

6.4.2 Maintenance Duration

As mentioned in section 6.2.3, the scheduling time of maintenance is assumed fixed (2.5 months) for all the considered operations and the time to carry out the maintenance depends on the debris volume to be dredged (1 month for minor operations, 2 months for major operations and 3 months for corrective operations). The chosen duration may vary depending on different situations. For example, in the case where enough funds are available, maintenance contracts can be made with companies in concern with these systems. In such case, the scheduling time of maintenance will be much less than the one considered since there is no need to search, ask and wait for a funding to apply the maintenance operation. Instead, maintenance is applied as soon as it is requested. In addition, in the case where large boulders are deposited in the basin, the time to carry out maintenance may vary depending on the capacity of the engines and on the distance traveled to reach the location where the deposits are evacuated. Therefore, the duration needed to perform the maintenance operation is not only dependent on the volume to be dredged.

The two mentioned cases with different (assumed) maintenance duration are considered as follows. The first duration corresponds to the scheduling time and the other corresponds to the time needed to carry out the maintenance operation.

Case 1: maintenance contract:

- Minor operations: 1 week + 1 month
- Major operations: 1 week + 2 months
- Corrective operations: 1 week + 3 months

Case 2: large boulders are present and the distance to evacuation is quite long:

- Minor operations: 2.5 weeks + 2 month
- Major operations: 2.5 weeks + 3 months
- Corrective operations: 2.5 weeks + 4 months

Simulations using SPN are performed for each case and the results are compared with those obtained for the initial analyzed case. Results concerning the mean sojourn time, the average number of maintenance operations and the total average cost of each maintenance strategy are provided in tables 6.15 - 6.20.

In case 1, the times spent by the system in the different states show a significant difference (up to 30 % difference) when compared to those corresponding to the initial case. Concerning the number of maintenance operations carried out over a duration of 50 years, the difference was low (< 8 % difference). In case 2, the percentage difference was also high for the mean sojourn time (up to 20 %) but less than those attained in case 1. This can be justified by the fact that, in the initial case, maintenance operations need about *2.5 months* more time than in case 1 to be launched but only 1 month less time than in case 2. Consequently, results corresponding to case 2 will be closer to those of the initial case than those of case

Strategy	State 1	State 2	State 3	State 4
1	42.22 <i>4.28%</i>	2.62 <i>22.18%</i>	2.17 <i>18.93%</i>	3.00 <i>13.80%</i>
2	31.67 <i>2.01%</i>	11.91 <i>8.81%</i>	2.49 <i>21.95%</i>	3.93 <i>18.40%</i>
3	35.19 <i>4.86%</i>	2.04 <i>30.35%</i>	8.10 <i>4.20%</i>	4.67 <i>18.61%</i>
4	25.87 <i>2.16%</i>	9.93 <i>5.42%</i>	8.69 <i>6.20%</i>	5.51 <i>22.11%</i>

Table 6.15: Mean sojourn time (years) of the studied retention system in each of its defined states based on the maintenance strategy adopted - Case 1 maintenance. The given percentages correspond to the differences with the values provided when considering the initial maintenance duration.

Strategy	State 1	State 2	State 3	State 4
1	38.98 <i>3.73%</i>	3.96 <i>17.65%</i>	3.07 <i>15.06%</i>	3.99 <i>14.76%</i>
2	29.85 <i>3.86%</i>	10.77 <i>1.59%</i>	3.87 <i>21.24%</i>	5.51 <i>14.46%</i>
3	32.75 <i>2.39%</i>	3.53 <i>20.48%</i>	7.29 <i>6.22%</i>	6.43 <i>11.91%</i>
4	24.45 <i>3.47%</i>	9.59 <i>1.86%</i>	7.98 <i>2.53%</i>	7.98 <i>12.88%</i>

Table 6.16: Mean sojourn time (years) of the studied retention system in each of its defined states based on the maintenance strategy adopted - Case 2 maintenance.. The given percentages correspond to the differences with the values provided when considering the initial maintenance duration.

Strategy	Minor	Major	Corrective
1	5.18 <i>7.03%</i>	3.76 <i>2.60%</i>	4.28 <i>3.38%</i>
2	0 <i>0%</i>	4.10 <i>0.12%</i>	5.65 <i>6.71%</i>
3	4.34 <i>5.99%</i>	0 <i>0%</i>	6.61 <i>2.64%</i>
4	0 <i>0%</i>	0 <i>0%</i>	7.73 <i>3.34%</i>

Table 6.17: Average number of maintenance operations performed on the system during the considered simulation period - Case 1 maintenance. The given percentages correspond to the differences with the values provided when considering the initial maintenance duration.

Strategy	Minor	Major	Corrective
1	4.64 <i>4.03%</i>	3.38 <i>7.65%</i>	4.09 <i>1.21%</i>
2	0 <i>0%</i>	3.82 <i>6.72%</i>	5.26 <i>0.66%</i>
3	3.85 <i>5.87%</i>	0 <i>0%</i>	6.18 <i>3.96%</i>
4	0 <i>0%</i>	0 <i>0%</i>	7.24 <i>3.14%</i>

Table 6.18: Average number of maintenance operations performed on the system during the considered simulation period - Case 2 maintenance. The given percentages correspond to the differences with the values provided when considering the initial maintenance duration.

Strategy	Minor	Major	Corrective	Total
1	87.975 <i>7.03%</i>	157.710 <i>2.60%</i>	252.520 <i>3.38%</i>	498.205 <i>3.75%</i>
2	0 <i>0%</i>	171.990 <i>0.12%</i>	333.055 <i>6.71%</i>	505.045 <i>4.37%</i>
3	73.695 <i>5.99%</i>	0 <i>0%</i>	389.695 <i>2.64%</i>	463.390 <i>3.16%</i>
4	0 <i>0%</i>	0 <i>0%</i>	455.775 <i>3.34%</i>	455.775 <i>3.34%</i>

Table 6.19: Average total cost (k€) of each of the defined maintenance strategies - Case 1 maintenance. The given percentages correspond to the differences with the values provided when considering - Case 1 maintenance.

Strategy	Minor	Major	Corrective	Total
1	78.880 <i>4.03%</i>	141.960 <i>7.65%</i>	241.310 <i>1.21%</i>	462.150 <i>3.75%</i>
2	0 <i>0%</i>	160.230 <i>6.72%</i>	310.045 <i>0.66%</i>	470.275 <i>2.81%</i>
3	65.450 <i>5.87%</i>	0 <i>0%</i>	364.620 <i>3.96%</i>	430.070 <i>4.26%</i>
4	0 <i>0%</i>	0 <i>0%</i>	427.160 <i>3.14%</i>	427.160 <i>3.14%</i>

Table 6.20: Average total cost (k€) of each of the defined maintenance strategies - Case 2 maintenance. The given percentages correspond to the differences with the values provided when considering - Case 2 maintenance.

1. Moreover it can be noticed that in case 1, the time spent by the system in state 1 is higher than that when applying case 2 or the initial case in all strategies. This is due to the fast maintenance operations that return the systems back to its new state. For the number of applied maintenance operations, case 2 did not result in a big difference when compared to the initial case (up to 8 %). Total maintenance costs did not differ much in both cases as they are proportional to the number of performed operations. Still, maintenance strategy 4 remains the most cost-effective.

It is also important to note that during maintenance, the system is taken out from the deterioration chain. This is a limitation of the model which necessitates assuming short maintenance duration so that it is not possible for the system to degrade to another state while applying any of the maintenance operations.

6.4.3 Maintenance Costs

The maintenance costs already used in the model were estimated depending on the debris volume to be dredged (2.83 €/m³). The debris volume corresponding to each state of the system is assumed equal to the average of the two threshold volumes defining the state. As given in table 6.6, the average costs of minor, major and corrective operations are, respectively, 17 k€, 42 k€ and 59 k€. In order to check the influence of varying the costs of maintenance operations on the total cost of the defined maintenance strategies, a simple example that accounts for this variation is presented in this section.

Instead of considering only the average volume of the interval defining a states, three different volumes (minimum, average and maximum values) are considered. Below are the equations used to estimate the costs of considered operations depending on the volume to be dredged.

Minor maintenance applied when the system is in state 2: $V_b \in [2200, 10000[$

- V_{2200} : $C_{2200} = 2200 \text{ m}^3 * 2.83 / \text{m}^3 \approx 6 \text{ k€}$
- V_{6100} : $C_{6100} = 6100 \text{ m}^3 * 2.83 / \text{m}^3 \approx 17 \text{ k€}$

Major maintenance applied when the system is in state 3: $V_b \in [10000, 20000[$

- V_{10000} : $C_{10000} = 10000 \text{ m}^3 * 2.83 / \text{m}^3 \approx 28 \text{ k€}$
- V_{15000} : $C_{15000} = 15000 \text{ m}^3 * 2.83 / \text{m}^3 \approx 42 \text{ k€}$

Corrective maintenance applied when the system is in state 3: $V_b \in [20000, 22000]$

- V_{20000} : $C_{20000} = 20000 \text{ m}^3 * 2.83 / \text{m}^3 \approx 57 \text{ k€}$
- V_{21000} : $C_{21000} = 21000 \text{ m}^3 * 2.83 / \text{m}^3 + 14318.18 \text{ €} \approx 59 \text{ k€}$
- V_{22000} : $C_{22000} = 220000 \text{ m}^3 * 2.83 / \text{m}^3 + 15000 \text{ €} \approx 62 \text{ k€}$

The main objective is to create several configurations and to check the total cost of the defined maintenance strategies based on the number of applied maintenance operations carried out over a period of 50 years. The results of the SPN modeled presented table 6.8 are used for this purpose. For simplicity, only four different configurations are chosen:

- **Configuration 1:** Minor, major and corrective operations are applied, respectively, for $V_b = V_{2200}$, $V_b = V_{10000}$ and $V_b = V_{20000}$.
- **Configuration 2:** Minor, major and corrective operations are applied, respectively, for $V_b = V_{2200}$, $V_b = V_{10000}$ and $V_b = V_{22000}$.
- **Configuration 3:** Minor, major and corrective operations are applied, respectively, for $V_b = V_{6100}$, $V_b = V_{15000}$ and $V_b = V_{21000}$.
- **Configuration 4:** Minor, major and corrective operations are applied, respectively, for $V_b = V_{2200}$, $V_b = V_{15000}$ and $V_b = V_{22000}$.

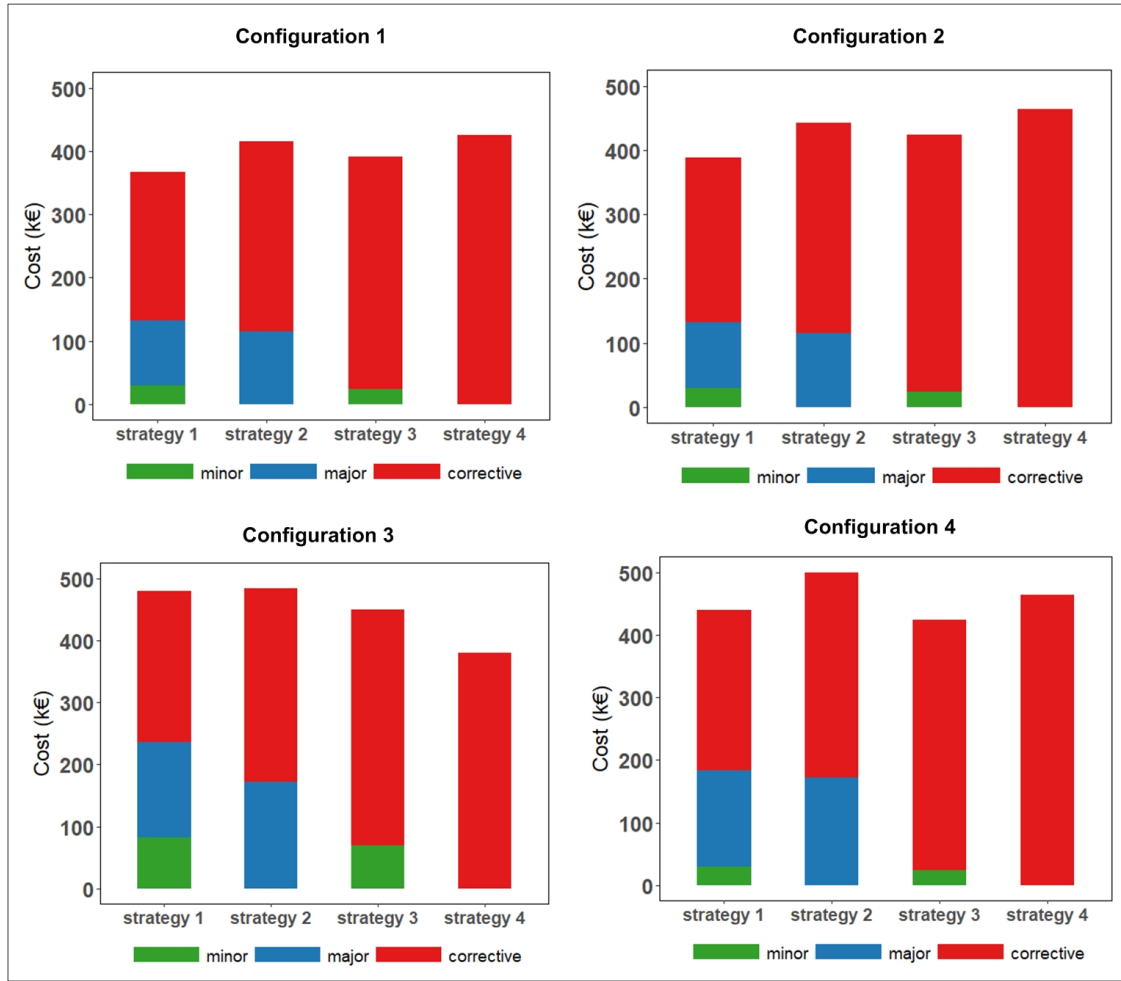

Figure 6.22: Expected total cost of the four defined maintenance strategies according to the adopted configuration.

Strategy	Minor	Major	Corrective	Total
1	29.010	102.480	235.980	367.470
2	0	114.520	301.530	416.050
3	24.540	0	366.795	391.335
4	0	0	426.075	426.075

Table 6.21: Average total cost (k€) of each of the defined maintenance strategies - Maintenance configuration 1.

For each configuration, multiplying the costs corresponding to each operation with the number of performed operations (table 6.8, provides the results given by tables 6.21 - 6.24 and illustrated in fig. 6.22.

From the obtained results, it can realized that the total costs of maintenance strategies

Strategy	Minor	Major	Corrective	Total
1	29.010	102.480	256.680	388.170
2	0	114.520	327.980	442.500
3	24.540	0	398.970	423.510
4	0	0	463.450	463.450

Table 6.22: Average total cost (k€) of each of the defined maintenance strategies - Maintenance configuration 2.

Strategy	Minor	Major	Corrective	Total
1	82.195	153.720	244.260	480.175
2	0	171.780	312.110	483.890
3	69.530	0	379.665	449.195
4	0	0	441.025	441.025

Table 6.23: Average total cost (k€) of each of the defined maintenance strategies - Maintenance configuration 3.

Strategy	Minor	Major	Corrective	Total
1	29.010	153.720	256.680	439.410
2	0	171.780	327.980	499.760
3	24.540	0	398.970	423.510
4	0	0	463.450	463.450

Table 6.24: Average total cost (k€) of each of the defined maintenance strategies - Maintenance configuration 4.

differ depending on the adopted configuration. For configurations 1 and 2, strategy 1 is the cheapest and strategy 4 is the most expensive. In the contrary, for configuration 3, strategy 4 is the cheapest and strategies 1 and 2 are the most expensive. With regards to configuration 4, strategy 3 is the cheapest and strategy 2 is the most expensive. The variability in the results, highlights the importance of considering the cost of cleaning operations depending on the actual stored volume instead of considering an average volume. Indeed, the overall decision-making model seems to be very sensible to the costs of maintenance operations. Consequently, deep attention should be given when collecting this information in order to support decision-makers to undertake optimal decisions.

6.5 Conclusion

In this chapter, the developed modeling approach is applied to a real case study retention system located in the Claret torrent in France. Real data concerning torrential events characteristics, maintenance duration and maintenance costs related to the studied torrent and the studied retention system are available. The physics-based modeling is carried out considering both the old and the new design of the retention dam being exposed to a series of debris flow events carrying different number of boulders that can block the dam's outlets. The stored volume in the basin V_b is considered to be the degradation indicator that describes the behavior of the system. The simulation of 100 generated debris flow scenarios using the physics-based model makes it possible to model the evolution of V_b over a period of 50 years and therefore to estimate transition laws to be used in the SPN model. For the old design, results shows that the system evolves gradually or rapidly from a good state to a failed state where as for the new design, the system resides either in a good or in a poor state. Consequently, the SPN model is only applied to the old design of the retention dam. Results provided by the SPN model show that applying maintenance operations only when the basin is completely filled by debris materials (strategy 4) is the most cost-effective. However, strategies which allow carrying out maintenance operations (strategies 1 and 3) as soon as the the system reaches a poor state allow the system to reside more time in the good state when compared to other strategies.

A sensitivity analysis considering the inputs to SPN model (inspection frequency, maintenance duration) and the cost model (cost of each operation) is also carried out in this application. Results show that varying the inspection frequency and the time required to schedule and to apply maintenance operations does not affect the total cost of the proposed maintenance strategies but influence the sojourn time of the system in each state. In contrary, the estimated cost of each maintenance operation highly affects the total cost of the proposed maintenance strategies and thus influence the maintenance decision.

Conclusions and Perspectives

Protection structures' management is a paramount issue. They must always ensure high structural and functional efficacy in order to provide sufficient protection to exposed elements (people, infrastructures, assets, etc.) against torrential phenomena. Due to possible dangers encountered while accessing mountain sites and due to budgetary constraints, the type of maintenance and the time at which its application is cost-effective must be carefully identified. Indeed, defining and optimizing maintenance strategies of torrent protection structures is associated to several research and technical issues. Failure modes, dependencies and cascading events, efficacy reduction, time-dependent deterioration, high maintenance costs and information imperfection shed the light on the necessity of developing approaches that make it possible to support maintenance decision-making while considering these obstacles.

Although there is a strong direction nowadays towards the use of dynamic tools (stochastic Petri nets) and policies (condition-based maintenance) developed in the field of reliability engineering for addressing such problems and challenges, they still necessitate in prior numerical models that capture the physical behavior of the system and its evolution over time while being subjected to progressive deterioration. Existing approaches developed in the context of torrent protection structures remain to be static, in the sense that they do not take into account the time-dependent behavior of the structure/system and therefore cannot compare maintenance strategies over its lifetime.

The aim from this thesis project is to fill existing gaps and voids in literature. In the following, a summary of the main findings and achieved contributions followed by a general discussion on the aforementioned studies besides their limitations and a list of further research insights are presented.

6.6 Main Findings

This project presents a thorough analysis concerning the dynamic behavior of protection structures when exposed to torrential events. The objective is to analyze different behavioral scenarios of a structure subject to both deterioration mechanisms and maintenance operations in order to make cost-effective decisions about inspection plannings and repair actions. The desired objectives are achieved throughout an integrated modeling approach that involves several stages. The developed model is divided into two models:

Physics-based model: which starts by describing the structural and functional design principles of the structure, the physics behind the torrential events it is subjected to (e.g. intensity, magnitude, sediment/debris transport, etc.) in addition to the failure modes, their mechanisms and interactions that exist between them. The next step is to model the time-dependent evolution of the structure when exposed to a series of events

over a specified period of time. This evolution makes it possible to finally estimate transition times between a finite set of states corresponding to the level of degradation of the structure.

Reliability-based model: which starts by constructing a SPN model that integrates the degradation process (moving between a good, poor, very poor and a failed state), inspection process (detecting the state of the system) and the maintenance process (implementing condition-based maintenance policy). It uses the information provided by the previous model concerning transition times in order to allow stochastic modeling of the degradation process. The next step is to simulate several maintenance strategies and to compute the total cost of each in order to be able to make cost-effective decisions.

Due to the fact that in natural hazard and protection structures context decisions are made under the effect of information imperfection, uncertainty and sensitivity analyses are also considered part of both models in order to check the influence of this imperfection on final decisions. The developed model has been applied to two different types of structures/systems: check dams and retention systems. Each type has its own physics-based model (chapter 5, sections 4.2 and 4.3) due to different structural and functional designs. However, they both share the same SPN model (4.4) except for the defined maintenance strategies.

6.6.1 Case of Check Dams

In the case of check dams, two applications are performed (chapter 5). The first one aims to analyze the behavior of a real check dam located within a series of check dams in the Manival torrent in France. The dam is assumed to be subjected only to clear water floods which trigger the phenomena of local scouring (functional failure) downstream the dam's foundations which in turn triggers failure of the dam by external stability (structural failure). The interaction between the two failure modes makes it possible to define a global degradation indicator S_g of the dam that combines indicators related to its external stability (exceedance of bearing capacity, overturning and sliding), which already incorporate indicators related to scouring (width and depth of scour pit under the foundation). The evolution of S_g is modeled over a period of 100 years. 50 fictive scenarios, each having a different series of flood events are generated. Each event is characterized by a specific peak discharge and a date at which it occurs. Simulating the 50 generated flood scenarios using the physics-based model permits computing transition times between the four defined degradation states of the dam. It is revealed that the probabilities of moving from one state to another are very different. The dam moves from a good to poor, poor to very poor, poor to failed and from very poor to failed state most often but it rarely moves from good to very poor state and from good to failed state. It is also noticed that in few scenarios that dam does not reach a failed state over 100 years.

The obtained transition laws are then incorporated in the developed SPN model where the stochastic deterioration and maintenance model is implemented. The simulation of 4 different maintenance strategies allows to compare, sort and to choose the best maintenance

strategy considering its total cost and its efficiency in increasing the time spent by the dam in non critical states (e.g. good state). Results show that, if maintenance decision is taken once per year (inspection every one year), applying maintenance operations only when the dam is detected to be either in a poor state or in a failed state is the most cost-effective. Besides, the strategies which allow carrying out maintenance operations as soon as the the system reaches a poor state allow the system to reside more time in the good state when compared to other strategies. The application ends by performing a simple uncertainty and sensitivity analyses using HYRISK. The analyses takes into account epistemic uncertain parameters, which permit estimating local scouring indicators (scour width and depth) involved in the scouring sub-model. Results reveal that both indicators are very sensitive to the uncertain parameter Z_F which represents the bed level downstream the dam.

In the second application, the objective is to analyze the bi-directional dependencies between check dams located in series. A simple multi-component system involving two check dams is studied. The state evolution of each dam is modeled over a period of 50 years using the physics-based model in the absence and in the presence of the other dam. The modeling technique, assumptions and data are considered the same as in the previous application. Results show that according to the considered distance between the dams (40 m), the upstream dam (D_1) is highly dependent on the downstream dam (D_2) in which in the absence of D_2 , D_1 attains a higher deterioration rate than in the presence of D_2 . On the other hand, D_1 shows quite the same response (slight deterioration) in the absence and in the presence of D_1 . However, in the absence of D_1 , excessive erosion occurs upstream and materials are deposited downstream D_2 . The presence of D_1 creates a fixed point in the longitudinal profile which helps stabilizing the torrent's bed and therefore limit upstream erosion. Therefore, the absence or presence of D_1 affects the global bed evolution but not the behavior of D_2 .

6.6.2 Case of Retention Systems

In the case of retention systems, a real case study is performed (chapter 6). The objective is to analyze the behavior of the retention system located in the Claret torrent in France. The system is composed of a retention dam, basin of volume capacity equals to 22000 m^3 built since 1991. Since 2018, the retention dam has a new design than the one initially constructed. Analysis is made considering both the old and the new design of the dam. The system is assumed to be subjected to debris flows carrying different sizes of boulders that can block the dam's outlets (functional failure) which in turn increases the stored debris volume in the basin and therefore reduces its storage capacity (functional failure). The degradation indicator of interest is the stored volume in the basin V_b . The evolution of V_b is modeled over a period of 50 years taking into account the volume of each debris flow event, the rate of clogging of the dam's openings based on the transported boulders by the event and the outlet discharge capacity of the dam during the event. A simple model coded by INRAE is developed in order to route debris flows through the retention system.

100 different scenarios, each having a different series of torrential events are generated. A binomial law is adopted in order to check whether each torrential event trigger a debris flow

or not. In the case where a debris flow is triggered, its volume and its date of occurrence are picked randomly from real adjusted data extracted from RTM historical database and representing the series of debris flows that have occurred in the Claret. In addition, for each debris flow event, the passage of boulders and their interaction with the dam's outlets are modeled via a binomial law. Simulating the 100 generated scenarios using the physics-based model permits computing transition times between the four defined degradation states of both the old and the new design of the dam.

For the old design, all possible transitions between the defined states have attained a considerable number of observations. It is also revealed that reaching the final state is rapid in which, in most scenarios, the basin is completely filled after the first 2 or 3 debris flow events. The obtained transitions are then incorporated in the developed SPN model where 4 different maintenance strategies are simulated. Results show that, if maintenance decision is taken once per year (inspection every one year), applying only corrective operations is the most-cost effective. In other words, waiting until the basin is completely filled (failed state) and then dredging all the volume is less expensive than dredging when the stored volume reaches a specific limit. However, the strategies which allow carrying out maintenance operations as soon as the stored volume reaches a specific limit (poor state) allow the system to reside more time in the good state when compared to other strategies. In this application, a sensitivity analysis regarding the inputs to SPN model (inspection frequency, maintenance duration) and the cost model (cost of each operation) is carried out. In the case of Claret, varying the inspection frequency and the time required to schedule and to apply maintenance operations does not have a big influence on the number of performed maintenance operations over a period 50 years. However, it cause some variation in the time spent by the system in each state but still does not change the maintenance decision. In contrary, the estimated cost of each maintenance operation highly affects the total cost of each maintenance strategy, which in turn changes the decision to be made. Therefore, it is better to consider the exact stored volume to be dredged when estimating the cost of maintenance instead of adopting the average volume corresponding to each state.

Modeling the physical behavior of the new dam's design, reveals that the dam has become able to self clean most of the event's volume by its slot in which it does no more retain high volumes of debris in the basin. Indeed, the evolution of V_b for the 100 generated scenarios show that, after 50 years, the system is found to be either in a good or in a poor state. It does not degrade further to critical states. Consequently, the decision that have been made to modify the old design of the dam is proved to be effective. No maintenance policy is studied for this case.

6.7 Achieved contributions Followed by General Discussions

The contributions of this work can be analyzed according to:

- **Two domains:** (i) civil and hydraulic engineering and (ii) safety/ reliability analysis

and preventive maintenance.

- **Two point of views:** (i) research and (ii) operational.

From a thematic point of view related to protection structures engineering, while classical and existing methods focus on static assessment of the state/efficacy of the structures, the presented approach proposes a new dynamic vision of these infrastructures management during their lifetime, which is completely new in the domain. In the case of check dams, some recent works (Carladous, 2017) have addressed the issue of protection works' efficacy from a static point of view. However, no developments have been made to couple multi-scale hydraulic analysis (from global bed evolution to check dams' local scouring analysis) and civil engineering approaches (stability analysis). In this project, a way to define and quantify the different stability levels of check dams is proposed. This is also not so common since classical design methodologies aim to design structures in a way that comply with regulations and standards requirements. Exploring the domain where structures are about to collapse is poorly done and this work proposes a new methodology for dealing with this issue. In the case of retention systems, very recent work has addressed the routing of debris flows through the system (Piton and Goodwin, 2021). However, the model has been applied to a case study considering single debris flow event resulting in a static view of the system's state. In this project, the model is developed further so that it considers a series of debris flows and models the dynamic evolution of the parameters related to the routing analysis (flow level at dam, stored volume in basin, outlet discharge capacity of the dam, dam's outlets' blockage rate, etc.) over a specified period of time when subjected to those events.

From a safety, reliability analysis and preventive maintenance perspective, the main interest of the presented work is to prove the capabilities of the established methodology to integrate in a multidisciplinary approach numerical modeling (physics of torrential phenomena, sediment/debris transport, and structural stability calculation) and reliability-based modeling (SPN, CBM, and Monte-Carlo evaluation) in order to support decision-making based on raw data and expert knowledge. The proposed combination of hydraulics, civil engineering, SPNs, CBM and Monte-Carlo simulation has indeed proven to be adequate for dependability analysis and for the provision of new results in comparison to traditional safety and reliability techniques and decision-making methods. In particular, the proposed approach contributes in the domain of dependability analysis with an indirect physics-based approach to determine transition laws of a SPN reliability and maintenance model. Starting with the context of missing data, a series of probabilistic events is injected in a chain of deterministic tools and models in order to assess the time spent by the studied structure/system in each state and also to justify the inputs used in the SPN modeling approach.

Designing an effective protection structure is of course a basic objective for risk managers but considering the time-dependent evolution of the efficacy of these structures during their lifetime is also essential and less classically addressed.

Consequently, from a research point of view, the developed approach opens the way to better understanding the real system behaviour by coupling between physics-based modeling of the deterioration process and the stochastic modeling for maintenance assessment merg-

ing together MCDM, CBA and reliability analysis. It proposes a global methodology for implementing SPNs with an original contribution that aims at determining and indirectly justifying the probability laws corresponding to the transition times between the degraded states of a system. As deterministic approach does not systematically take into account any information on the uncertainties encountered when analyzing the deterioration of structures, the presented work make it possible to describe stochastic deterioration processes using physics-based modeling. This is achieved mainly by estimating stochastic transition laws, considered to be crucial elements in representing the behavior of the system. Further more, the combination and adaptation of safety, reliability approaches and decision-aiding methods is quite innovative and contributes to assessing protection structures' resilience. It is indeed necessary to accept and consider that these structures will progressively deteriorate over time.

Besides, in the particular context of natural risks, appraisal processes often have to deal with imperfect information (incomplete, imprecise, uncertain, etc.) resulting from more or less reliable sources such as historical data, expert opinions and numerical simulations. The developed approach makes it possible to make the description of the scenarios more objective and to outline their assumptions and conditions. Moreover, information imperfection propagates also within within protection structures' deterioration and maintenance model. The functional design and structural justification of the structures are known but are based on hypotheses that are not always formalized or available. Indeed, topographic, geotechnical and hydraulic data may be missing or imprecise. When confronted with epistemic uncertainty, conventional probability theory tools frequently appear too restrictive. The HYRISK package, adopted in this project, propagates and uses random and epistemic uncertainties together thus providing a hybrid approach sufficient for dealing with different forms of imperfection. Further more, the developed SPN model is based on stochastic modeling via Monte-Carlo simulation and therefore it makes it possible to overcome lack of knowledge and monitoring data related to system degradation states.

The monitoring of structures is currently largely based either on field inspection or on expert appraisal processes during which technicians imagine the evolution of the condition of a protection structure in the short, medium and long term according to the scenarios of combination of physical phenomena. On these bases, maintenance decisions are made.

Consequently, from an operational/technical point of view, the developed approach contributes to a better and more resilient management: knowing what can happen and being somehow better prepared to unavoidable evolution of protection structures, risk managers can better anticipate and take optimal decisions. It indeed provides more realistic and informative approach than existing ones and thus permit predicting the evolution of the system under realistic assumptions which in turn support risk managers and decision-makers to make optimal management decisions.

Certainly, SPNs offer a flexible and efficient method to model the deterioration and maintenance process of structures. They have the capacity to capture more complex features (e.g. interactions and dependencies) compared to other developed models. In the context of protection structures, such tool enables (i) representing the dynamic behavior of a system when subjected to events (deterioration, maintenance) based on stochastic transitions between the

states of the system and (ii) supporting maintenance decision-making by comparing and sorting maintenance strategies taking into consideration economic aspects and the availability time of the system in each state. Undoubtedly, the use of other models (extensions of SPNs) such as stochastic activity networks (SANs, (Sanders and Meyer, 2001)) and colored stochastic Petri nets (CSPNs, (Zimmermann, 2008)) could have been also possible. However, this would have not affect the target behind this project, which is rather to reveal how this class of models can be connected with physics-based models than to show the performance of a given reliability and maintenance stochastic modeling approach. In addition, the SPN model developed and adopted in this research project is just an example that makes it possible to integrate together the dynamic degradation, inspection and maintenance processes. However, several extensions and variations around this model could have been also considered. Eventually, the choice of SPN tools and the developed SPN model is not claimed to be the optimum but is assured to be good for reaching the desired objectives.

Excessive maintenance costs can also be seen as a malfunction, sometimes leading to an operational failure. Therefore, a properly defined and implemented maintenance policy can absolutely improve the resilience of critical protection structures. For example, concerning the Claret retention system, managers have used to adopt a specific maintenance policy. Each time a debris flow occurs, they ask for scheduling maintenance where all the stored volume should be cleaned. At the moment (in real) the maintenance policy is: after each event, all the stored volume despite its amount. In the application presented in this project (chapter 6), the aim is to explore a different maintenance policy. Instead of event-based maintenance, condition-based maintenance is adopted in which maintenance decision depends on the state of the system detected after inspection. Consequently, knowledge concerning the thresholds defining the states at which different maintenance operations are applied, is required. Experts that manage these structures should provide information about when it is acceptable to let the structure reside in a given state without any preventive maintenance and when the stored volume is no longer acceptable and maintenance should be carried out.

Typically in France, the design of protection structures are analyzed over a period period of 50 years. It is important to carefully address the inspection frequency and to differentiate between different maintenance decision-making scenarios. One scenario could be that each time an event happen, they go to the field and they do maintenance. Let's imagine now that because of yearly budget, they must only decide on the 1st of January which maintenance operation they will do regardless the level of degradation attained during the year. Another scenario could be to consider the state of the structure once a year and then to decide whether or not to apply maintenance. In other words, it is not necessary that they will take decision to do maintenance upon inspection. The latter scenario is the one adopted in this project in which inspection is scheduled once per year and thus decision whether to apply maintenance or not and which maintenance operation to apply based on the detected state is only made once per year.

However, it is also essential to explore different situations by trying different assumptions (e.g. inspection frequencies, maintenance duration, maintenance costs, etc.) though it could be possible that results regarding maintenance decisions would be the same. For example,

in the Claret application, obtained results reflect more or less what is implemented in reality. This is due to the fact that real data concerning historical events, retention system's characteristic and maintenance costs are available. However, different situations have been also explored to check whether the maintenance decision differs or not. On the other hand, for the Manival application, some data are missing and thus results depend on the quality of the considered assumptions and on the information provided by experts. Consequently, the aim of this project is not only to prove that the application of the model has provided sensitive results but also to show that with the developed modeling approach and in different situations, the model can end up by making different maintenance decisions depending on the configuration of the site under study. Indeed, one of the added values of this approach is to explore possible pathways where different situations that may require different solutions can be explored.

Last but not least, the developed approach is totally generic in which it can be applied to any civil engineering structure exposed to any undesirable phenomena. One more thing which is important to mention is that based on the frequently confronted types of failures and the applied maintenance operation for each, it is important to think about what should have been done before in order to prevent the failure to occur. For example, if it is a matter of material quality, one should think about how to make durable materials and how to assess its quality. If it is a matter of scouring and stability, one should propose countermeasures that reinforce the structure and the soil underneath. Indeed, maintenance experience sheds light on several problems that can be taken into account when reconstructing a failed structure or when designing other new structures. This will in turn prevent making the same errors in the design phase and will prevent some failures to occur in the short or long terms.

6.8 Limitations and Future Work Insights

Despite the attempt of this project to provide complementary work to what have been tackled in literature in the studied context, more research is required in order to cover some limitations. This section summarizes the issues that have not been covered in each of the studied applications and proposes a further research agenda.

Case of Check dams

The Manival check dam application does not completely reflect the state of the dam in real life. In order to limit the scope of the study, other failure modes (e.g. internal stability) and the aging aspects of the dam are not incorporated into the deterioration modeling. In addition, the bi-directional dependencies between the studied dam and other consecutive dams are not taken into consideration. In other words, the evolution of the dam is modeled assuming that other dams do not fail and are always present. Furthermore, the reliability of results may be influenced by the information imperfection resulting from uncertain, imprecise or incomplete data used in the analysis. The propagation of information imperfection within the model and its effect on the final risk management decision is not fully assessed in the current study. In the application

uncertainty analysis is performed only on the scouring sub-model in order to describe technically the functionalities of HYRISK as a first stage. Undoubtedly, such work can be developed further by:

- Developing the global state indicator by considering aging aspects and more types of failures and assigning a power coefficient for each failure depending on its power in affecting the overall structural state of the dam (e.g. $S_g = \sqrt[3]{S_{BC}^\alpha \cdot S_{OT}^\beta \cdot S_{SL}^\gamma}$);
- Analyzing the bi-directional interactions between check dams constructed in series (cascading failure) by studying the influence of the partial or complete failure of one dam on other consecutive dams.
- Propagating uncertainty using HYRISK within the whole model in order to be aware of how it may eventually affect the maintenance decision.
- Performing a sensitivity analysis on uncertain parameters (e.g. grain size distribution, longitudinal profile slope, etc.) in order to identify the parameters that the model's outputs are sensitive to.

Concerning the application analyzing the bi-directional dependencies between dams located in series. A fictive multi-component system composed only of two dams is analyze. All the used data used are assumed and assessed by experts. Moreover, the achieved results are not generic and correspond to the proposed case study. Several features (e.g. longitudinal slope, distance separating the dams, etc.) could have resulted in different types of dependencies. Such analysis can be developed by:

- Applying the model to a real case study where real data is available in order to improve the results by driving them closer to reality.
- Considering more dams within the same system so that the interactions with an upstream dam and a downstream dam can be analyzed at a time.
- Assuming a different bed slope in the case of the absence of a dam than in the case when it is present. In the absence of a dam the longitudinal profile is missing a fixed point and thus it may not be stabilized as in the case of the presence of the dam and the bed slope could be higher.

Case of Retention Systems

The application is based on real data extracted from RTM database. However, some information are still missing especially those related to the size and number of large boulders that are transported in a given debris volume and have the potential to block the retention dam's outlets. Although in the present study, a stochastic approach for modeling the passage of boulders and their interaction with the dam's outlets, it may still does not reflect the real situation. Actually, considering the size of the debris flows occurring in the Claret, it can always transform boulders. So it is really a matter of random process whether a big boulder is transported and not deposited in the basin but have reached the slot. Similar to the Manival application, some data could be imperfect even though acquired from reliable sources. However, information imperfection is not analyzed in this application. The developments that can be made in this case involve:

- Checking the validity of the developed stochastic model that estimates the number and the size of transported boulders in a given debris volume. This can be performed by acquiring more data about the type of boulders transported in a number of past events.
- Propagating uncertainty within the whole model using HYRISK in order to be aware of how it may eventually affect the maintenance decision.
- Performing a sensitivity analysis on uncertain parameters (e.g. grain size distribution, longitudinal profile slope, etc.) in order to identify the parameters that the model's outputs are sensitive to. Parameters that could be uncertain involve the volume of events (based of empirical data), the discharge (calculated using the model developed by (Mizuyama et al., 1992)

Additional limitations that are common between all the studied applications also exist. One of these is considering perfect preventive maintenance operations that return the structure/system back to an as-good-as new state. Besides, the thresholds corresponding to the defined degraded states are chosen more or less randomly. However, these thresholds are crucial elements and should be carefully selected. Another crucial elements are the transition times. In order to have a good estimate of their probability laws, a considerable number of scenarios should be generated. Note that in the retention dam application the number of generated scenarios is 100 whereas in the check dams applications it is 50. The reason behind this is that the computational time spent when simulating each scenario using the physics based model is much less in the retention dam application. Moreover, the consequences identified after a torrential event are the direct consequences without an analysis of the real consequences on downstream elements at risk (residual risk analysis including the occurrence of the malfunction). In addition, maintenance decision-making is done on the basis of economic aspects and the time spent by the dam in a good state, not taking into consideration its efficiency reducing the deterioration rate of the structure/system after its application. Also, the variation of the torrential events' characteristics due to climate change (change in frequency and magnitude of floods) as well as the variation of the topography where the dams are located caused by the destruction of existing dams or the construction of new dams are not taken into consideration while modeling deterioration processes over time.

Furthermore, as any other task, maintenance operations necessitates labor, engines and other tools. Therefore, their costs depend on the number of workers, the number and size of engines in addition to the duration required to perform the maintenance. Moreover, in the case where there is a maintenance contract with a company for example, operations will be more expensive. In such cases, maintenance operations are carried out as soon as they are requested for with no scheduling time which in turn necessitates paying more (trade-off). Consequently, it is highly essential to not consider a fixed cost for maintenance operations and to vary them instead depending on the situation. Besides, the inflation rate of prices is not accounted for in this project in which maintenance costs are assumed to be constant over time. To sum up, the cost model adopted in this research work is not sophisticated enough.

Accordingly, future work can involve;

- Considering partial renewal maintenance actions instead of perfect ones.
- Carrying out more research and technical analysis in order to better choose the degradation states' thresholds. Experts judgment could also help in this case.
- Generating more torrential event scenarios in order to have a better estimate of transition laws representing the time needed to move from a state to another.
- Estimating the risk imposed on downstream elements by collecting data concerning the type of exposed elements and assessing their vulnerability.
- Analyzing the efficiency of adopted maintenance strategies on the maintained structure itself by comparing the variation in the failure rate before and after the application of maintenance.
- Re-estimating transition laws taking into account (i) climate change in which peak discharges or volumes can be varied (+10 %, +20 %, etc.) and (ii) topographical changes by, for example, modifying the bed slope after the destruction or construction of a dam.
- Dividing maintenance costs into (i) a fixed price C_1 corresponding to the cost of the operation itself (e.g. dredging, adding an anti-scouring beam, etc.) (ii) an additional price C_2 that varies depending on the situation (e.g. number of workers, number of engines, duration, etc.).
- Taking into account the monetary evolution over time instead of constant maintenance costs. This can be done by incorporating in the cost model either an inflation rate or a discount rate.

In all of the listed tasks, the objective is to check whether the total costs of maintenance strategies will significantly differ when compared to what is already done in this project. To conclude, although the achieved results seem to be realistic, more developments are still required in order to make it more obvious whether or not the developed model could really support risk managers and decision-makers.

Bibliography

- Adetoye, A. O., Goldsmith, M., and Creese, S. (2013). Analysis of Dependencies in Critical Infrastructures. In Bologna, S., Hämmerli, B., Gritzalis, D., and Wolthusen, S., editors, *Critical Information Infrastructure Security*, pages 18–29, Berlin, Heidelberg. Springer Berlin Heidelberg.
- AFNOR (2003). *NF EN 1990 - Base de calcul des structures*. 72 p. [In French].
- AFNOR (2005a). *NF EN 1992-1-1 - Calcul des structures en béton - Partie 1-1 : règles générales et règles pour les bâtiment*. 204 p. [In French].
- AFNOR (2005b). *NF EN 1997-1-1 - Calcul géotechnique*. 168 p. [In French].
- AFNOR (2014). *NF P 94-281 - Justification des ouvrages géotechnique - Normes d'application nationale de l'Eurocode 7 - Ouvrages de soutènement - Murs*. 168 p. [In French].
- Alaswad, S. and Xiang, Y. (2017). A review on condition-based maintenance optimization models for stochastically deteriorating system. *Reliability Engineering & System Safety*, 157:54 – 63.
- Andrews, J. (2013). A modelling approach to railway track asset management. *Proceedings of the Institution of Mechanical Engineers, Part F: Journal of Rail and Rapid Transit*, 227(1):56–73.
- Andrews, J. and Fecarotti, C. (2017). System design and maintenance modelling for safety in extended life operation. *Reliability Engineering & System Safety*, 163:95 – 108.
- Argyroudis, S.-A., Mitoulis, S.-A., Winter, M.-G., and Kaynia, A.-M. (2019). Fragility of transport assets exposed to multiple hazards: State-of-the-art review toward infrastructural resilience. *Reliability Engineering & System Safety*, 191:106567.
- Arismendi, R., Barros, A., and Grall, A. (2021). Piecewise deterministic markov process for condition-based maintenance models application to critical infrastructures with discrete-state deterioration. *Reliability Engineering and System Safety*, 212.
- Armanini, A., Dellagiacomma, F., and Ferrari, L. (1991). From the check dam to the development of functional check dams. In Armanini, A. and Di Silvio, G., editors, *Fluvial Hydraulics of Mountain Regions*, pages 331–344, Berlin, Heidelberg. Springer Berlin Heidelberg.
- Aubry, J.-F., Brinzei, N., and Mazouni, M. H. (2016). *Systems Dependability Assessment: Benefits of Petri Net Models*, volume 1 of *Systems and Industrial Engineering Series. Systems Dependability Assessment Set*. ISTE Ltd and John Wiley & Sons Inc.
- Avizienis, A., Laprie, J.-C., Randell, B., and Landwehr, C. (2004). Basic concepts and taxonomy of dependable and secure computing. *IEEE Transactions on Dependable and Secure Computing*, 1(1):11–33.

- Bagheri, E. and Ghorbani, A.-A. (2008). The state of the art in critical infrastructure protection: A framework for convergence. *International Journal of Critical Infrastructures*, 4(3):215–244.
- Barata, J., Guedes Soares, C., Marseguerra, M., and Zio, E. (2002). Simulation modelling of repairable multi-component deteriorating systems for on condition maintenance optimisation. *Reliability Engineering & System Safety*, 76(3):255 – 264.
- Barbolini, M., Cappabianca, F., and Sailer, R. (2004). Empirical estimate of vulnerability relations for use in snow avalanche risk assessment. *Management Information Systems*, 9.
- Barlow, R.-E. and Proschan, F. (1965). *Mathematical Theory of Reliability*. . Wiley, New-York,.
- Bastidas-Arteaga, E. and Soubra, A.-H. (2014). In *Stochastic Analysis and Inverse Modelling - M. A. Hicks and C. Jommi (Eds), ALERT Doctoral School 2014, Grenoble.*, chapter Reliability Analysis Methods., pages 53 – 77.
- Baudrit, C., Guyonnet, D., and Dubois, D. (2007). Joint propagation of variability and imprecision in assessing the risk of groundwater contamination. *Journal of Contaminant Hydrology*, 93(1):72–84.
- Bel, C. (2017). *Analysis of debris-flow occurrence in active catchments of the French Alps using monitoring stations*. PhD thesis, Université Grenoble Alpes, France.
- Bérenguer, C., Châtelet, E., Langeron, Y., and Despujols, A. (2004). Modeling and Simulation of Maintenance Strategies using Stochastic Petri Nets. In *Proceedings of MMR 2004 Mathematical Methods in Reliability, Santa Fe, USA*.
- Bérenguer, C., Grall, A., and Castanier, B. (2000). Simulation and evaluation of condition-based maintenance policies for multi-component continuous-state deteriorating systems. In *Proceedings of the European Safety and Reliability Conference*.
- Bérenguer, C., Grall, A., Dieulle, L., and Roussignol, M. (2003). Maintenance policy for a continuously monitored deteriorating system. *Probability in the Engineering and Informational Sciences*, 17:235 – 250.
- Bernard (1925). *Cours de Restauration des Montagnes*. Ecole Nationale des Eaux et Forêts Nancy.
- Billinton, R. and Pan, J. (2000). Application of Monte Carlo simulation to optimal maintenance scheduling in a parallel-redundant system. *IEE Proceedings: Generation, Transmission and Distribution*, 147(5):274–278.
- Biondini, F. and Frangopol, D. M. (2016). Life-cycle performance of deteriorating structural systems under uncertainty: Review. *Journal of Structural Engineering*, 142(9):F4016001.
- Bodi, F. (1999). Development of power system reliability modelling technology. In *21st International Telecommunications Energy Conference. INTELEC '99 (Cat. No.99CH37007)*, pages 28–.

- Bourelrier, P.-H., Deneufbourg, G., and deVanssay, B. (2000). *Les catastrophes naturelles : le grand caffouillage*. Série Santé et Société.
- Boussahoua, B. and Elmaouhab, A. (2019). Reliability Analysis of Electrical Power System Using Graph Theory and Reliability Block Diagram. In *Algerian Large Electrical Network Conference (CAGRE)*, pages 1–6.
- Bressi, S., Santos, J., and Losa, M. (2021). Optimization of maintenance strategies for railway track-bed considering probabilistic degradation models and different reliability levels. *Reliability Engineering & System Safety*, 207:107359.
- Brochot, S. (1998). Approches globales pour l'estimation de l'érosion torrentielle - Apports des versants et production de sédiments. *Ingénieries eau-agriculture-territoires*, (15):p. 61 – p. 78.
- Brochot, S., Duclos, P., and Bouzit, M. (2003). L'évaluation économique des risques torrentiels : intérêts et limites pour les choix collectifs de prévention. *Ingénieries eau-agriculture-territoires*, (spécial Risques naturels et aménagement du territoire):53–68.
- Bruijne, M. and Eeten, M. (2007). Systems that Should Have Failed: Critical Infrastructure Protection in an Institutionally Fragmented Environment. *Journal of Contingencies and Crisis Management*, 15:18 – 29.
- Bründl, M., Romang, H.-E., Bischof, N., and Rheinberger, C.-M. (2009). The risk concept and its application in natural hazard risk management in Switzerland. *Natural Hazards and Earth System Sciences*, 9(3):801–813.
- BS4778 (1991). British Standard: Glossary of Terms Used in Quality Assurance Including Reliability and Maintainability Terms.
- Camiré, F., Piton, G., and Schwindt, S. (2019). Hydrogeomorphology and steep creek hazard mitigation lexicon: French, English and German. In *International Conference on Debris-Flow Hazards Mitigation: Mechanics, Prediction, and Assessment*, Proc. 7th Int. Conf. on Debris-Flow Hazards Mitigation, pages 589–596, Golden, United States.
- Carladous, S. (2013). Analyse critique des méthodes d'évaluation de l'efficacité économique des mesures de protection contre les risques naturels en montagne. Master's thesis, Université Paul Valéry Montpellier III.
- Carladous, S. (2017). *Approche intégrée d'aide à la décision basée sur la propagation de l'imperfection de l'information—application à l'efficacité des mesures de protection torrentielle*. Phd. theses, l'Ecole des Mines de Sait-Etienne.
- Carladous, S., Piton, G., Kuss, D., Charvet, G., Paulhe, R., Morel, M., and Quefféléan, Y. (2021). *Check Dam Construction for Sustainable Watershed Management and Planning*, chapter 13: French Experience with Open Check Dams: Inventory and Lessons Learnt Through Adaptive Management. Wiley Online Library (under review).

- Carladous, S., Tacnet, J.-M., and Batton-Hubert, M. (2016). Protection structures against natural hazards: from failure analysis to effectiveness assessment. In *13th Congress INTERPRAEVENT Conference, Lucerne*.
- Carladous, S., Tacnet, J.-M., Batton-Hubert, M., Dezert, J., and Marco, O. (2019). Managing protection in torrential mountain watersheds: A new conceptual integrated decision-aiding framework. *Land Use Policy*, 80:464–479.
- Carladous, S., Tacnet, J.-M., Curt, C., and Batton-Hubert, M. (2015). Évaluation intégrée de l'efficacité des ouvrages de protection contre les risques naturels en montagne. In *Congrès Lambda Mu 19 de Maîtrise des Risques et Sécurité de Fonctionnement, Dijon*. [In French].
- Carladous, S., Tacnet, J.-M., ECKERT, N. N., Curt, C., and Batton-Hubert, M. (2014). Vers une analyse intégrée de l'efficacité des ouvrages de protection contre les risques naturels en montagne. In *8èmes Journées Fiabilité des Matériaux et des Structures, Aix-en-Provence, France*. [In French].
- Castanier, B. (2002). *Modélisation stochastique et optimisation de la maintenance conditionnelle des systèmes à dégradation graduelle*. PhD thesis, Thèse de doctorat, Université de Technologie de Troyes. [In French].
- Chahrouh, N., Hariri, S., Tacnet, J.-M., and Bérenguer, C. (2019a). A Modeling Framework for Efficacy Assessment and Preventive Maintenance of Torrential Protection Works. In Beer, M. and Zio, E., editors, *Proc. of 29th European Safety and Reliability Conference - ESREL 2019*, Proceedings of 29th European Safety and Reliability Conference - ESREL 2019, pages 444–451, Hannover, Germany.
- Chahrouh, N., Hariri, S., Tacnet, J.-M., and Bérenguer, C. (2019b). Degradation Analysis and Preventive Maintenance Modelling and Assessment for Improved Resilience of Critical Infrastructures - Application to Torrent Checkdams. In *56th ESReDA Seminar On Critical Services continuity, Resilience and Security*, Proc. of 56th ESReDA Seminar On Critical Services continuity, Resilience and Security, Linz, Austria.
- Chahrouh, N., Nasr, M., Tacnet, J.-M., and Bérenguer, C. (2021a). Deterioration modeling and maintenance assessment using physics-informed stochastic petri nets: Application to torrent protection structures. *Reliability Engineering System Safety*, 210:107524.
- Chahrouh, N., Tacnet, J.-M., and Bérenguer, C. (2021b). Cascade Effect Analysis in Torrential Context for Prioritizing Check Dams Maintenance Strategies. In *Annual Reliability and Maintenance Symposium - RAMS 2021*, Proc. Annual Reliability and Maintainability Symposium, pages 02E1–047, Orlando, FL, United States. IEEE.
- Chahrouh, N., Tacnet, J.-M., and Bérenguer, C. (2021c). Integrating Imperfect Information in the Deterioration Modeling of Torrent Protection Measures for Maintenance and Reliability Assessment. In *Proc. of 31th European Safety and Reliability Conference - ESREL 2021*, Proceedings of 31th European Safety and Reliability Conference - ESREL 2021, Angers, France.

- Chambon, G. and Laigle, D. (2013). *Torrents et rivières de montagne : Dynamique et aménagement.*, chapter Les Laves torrentielles. A. Recking, D. Richard, G. Degoutte. Paris, France : Quae. Chap. 4, p. 200 - 266.
- Cho, D. I. and Parlar, M. (1991). A survey of maintenance models for multi-unit systems. *European Journal of Operational Research*, 51(1):1 – 23.
- Choi, H.-H., Lee, S.-Y., Choi, I.-Y., Cho, H.-N., and Mahadevan, S. (2006). Reliability-based failure cause assessment of collapsed bridge during construction. *Reliability Engineering and System Safety*, 91(6):674–688.
- Chojnacki, E., Baccou, J., and Destercke, S. (2010). Numerical accuracy and efficiency in the propagation of epistemic and aleatory uncertainties. *International Journal of General Systems*, 39(7):683–704.
- Clarke, J., Coaffee, J., Rowlands, R., Finger, J., Hasenstein, S., and Siebold, U. (2015). Resilience evaluation and sota summary report. Technical report, Horizon 2020 Programme.
- Comiti, F., Lenzi, M., and Mao, L. (2013). *Check Dams, Morphological Adjustments and Erosion Control in Torrential Streams*, chapter Local scouring at check-dams in mountain rivers. Pages 263-282.
- Compare, M., Baraldi, P., Marelli, P., and Zio, E. (2020). Partially observable markov decision processes for optimal operations of gas transmission networks. *Reliability Engineering System Safety*, 199:106893.
- Couvert, B., Lefebvre, B., Lefort, Ph., and Morin, E. (1991). Études générale sur les seuils de correction torrentielle et les plages de dépôts. *La Houille Blanche*, 6(6):449–456. [In French].
- Cozzani, V., Campedel, M., Renni, E., and Krausmann, E. (2010). Industrial accidents triggered by flood events: Analysis of past accidents. *Journal of Hazardous Materials*, 175(1-3):501–509.
- De Jonge, B. and Scarf, P. A. (2020). A review on maintenance optimization. *European Journal of Operational Research*, 285(3):805–824.
- Dekker, R. (1996). Applications of maintenance optimization models: a review and analysis. *Reliability Engineering & System Safety*, 51(3):229 – 240. Maintenance and reliability.
- Dell’Agnese, A., Mazzorana, B., Comiti, F., Von Maravic, P., and D’Agostino, V. (2013). Assessing the physical vulnerability of check dams through an empirical damage index. *Journal of Agricultural Engineering*, 44(1):9–16.
- Demontzey, P. (1882). *Traité pratique du reboisement et du gazonnement des montagnes*. Ministères de l’agriculture et du commerce et des travaux publiques. [In French].
- Deymier, C., Tacnet, J.-M., and Mathys, N. (1995). *Conception et calcul de barrages de correction torrentielle*. Grenoble, France: Cemagref Editions, 287p. [In French].

- DI Ciocco, Geoffray (2015). Conception et réalisation d'un environnement d'évaluation de l'efficacité fonctionnelle et structurelle d'ouvrages de protection contre les risques torrentiels. Master's thesis, Polytech'Clermont Ferrand. [In French].
- DTRTM (2007). *Observatoire des Risques Naturels en Montagne, Notice Générale, Tome 1, Définition et descripteurs.*, base de données rtm, 2 édition. 120 p. edition.
- Du, X. and Chen, W. (1999). Towards a better understanding of modeling feasibility robustness in engineering design. *ASME Journal of Mechanical Design*, 122:385–394.
- Dubi (2000). *Monte Carlo Applications in Systems Engineering*.
- Dubois, D. and Prade, H. (2006). *Concepts et méthodes pour l'aide à la décision 1: Outils de modélisation*, chapter Chap 3 - Représentations formelles de l'incertain et de l'imprécis. HermèsLavoisier, Paris. [In French].
- Dubois, D et Prade, H. (1989). *Possibility Theory: an approach to computerized processing of uncertainty*. Plenum Press, New York.
- Dueñas-Osorio, L. and Vemuru, S. M. (2009). Cascading failures in complex infrastructure systems. *Structural Safety*, 31(2):157–167. Risk Acceptance and Risk Communication.
- Dupouy, G., Tacnet, J., Laigle, D., and Chojnacki, E. (2012). Uncertainty in natural hazards numerical modeling: application of an hybrid approach to debris-flows simulation. In *12th international conference Interpraevent*, pages 95–106, Grenoble, France.
- Dutuit, Y., Châtelet, E., Signoret, J.-P., and Thomas, P. (1997). Dependability modelling and evaluation by using stochastic Petri nets: Application to two test cases. *Reliability Engineering and System Safety*, 55(2):117–124.
- Einhorn, B., Eckert, N., Chaix, C., Ravanel, L., Deline, P., Gardent, M., Boudieres, V., Richard, D., Vengeon, J.-M., Giraud, G., and Schoeneich, P. (2015). Climate change and natural hazards in the Alps. *Revue de Géographie Alpine.*, 103.
- ETRM (20112). Proposition d'aménagement de la plage de dépôt du Claret. Technical report, Eaux Torrents et Rivières de Montagne.
- Eusgeld, I., Kröger, W., Sansavini, G., Schläpfer, M., and Zio, E. (2009). The role of network theory and object-oriented modeling within a framework for the vulnerability analysis of critical infrastructures. *Reliability Engineering System Safety*, 94(5):954–963.
- Fabre, J.-A. (1797). *Essai sur la théorie des torrens et des rivières*. Chez Bidault, Libraire.
- Ferreira, C., Canhoto Neves, L., Silva, A., and de Brito, J. (2019). Stochastic Petri-net models to predict the degradation of ceramic claddings. *Building Research & Information*, 47(6):697–715.
- Ferreira, C., Canhoto Neves, L., Silva, A., and de Brito, J. (2020). Stochastic maintenance models for ceramic claddings. *Structure and Infrastructure Engineering*, 16(2):247–265.

- Ferro, V. and D'Agostino, V. (2004). Scour on alluvial bed downstream of grade-control structures. *Journal of Hydraulic Engineering*, 130:24–37.
- Ferson, S. and Tucker, W. (2006). Sensitivity analysis using probability bounding. *Reliability Engineering & System Safety*, 91:1435–1442.
- Figueira, J., Greco, S., and Ehrogott, M., editors (2005). *Multiple criteria decision analysis: state of the art surveys.*, volume 78 of *International series in operations research & management science*. Springer, 78 edition.
- Francis, R. and Bekera, B. (2014). A metric and frameworks for resilience analysis of engineered and infrastructure systems. *Reliability Engineering System Safety*, 121:90–103.
- Frangopol, D.-M., Kallen, M., and Noortwijk, J.-M. (2004). Probabilistic models for life-cycle performance of deteriorating structures: review and future directions. *Progress in Structural Engineering and Materials*, 6(4):197–212.
- Fryirs, K. (2013). (Dis)Connectivity in catchment sediment cascades: a fresh look at the sediment delivery problem. *Earth Surface Processes and Landforms*, 38(1):30–46.
- Fuchs, S., Heiss, K., and Hübl, J. (2007). Towards an empirical vulnerability function for use in debris flow risk assessment. *Natural Hazards and Earth System Sciences*, 7(5):495–506.
- Fussell, J.-B. (1975). A Review of Fault Tree Analysis with Emphasis on Limitations. *IFAC Proceedings Volumes*, 8(1, Part 3):552 – 557. 6th IFAC World Congress (IFAC 1975) - Part 3: Systems, Economics, Management, and Social Effects, Boston/Cambridge, MA, USA, August 24-30, 1975.
- Gaffiot, F. (1934). *Dictionnaire Latin-Français*. Hachette.
- García, C. and Lenzi, M. (2013). *Check Dams, Morphological Adjustments Erosion Control in Torrential Streams*. Nova Science Publishers Inc.
- Gaudio, R., Marion, A., and Bovolín, V. (2000). Morphological effects of bed sills in degrading rivers. *Journal of Hydraulic Research*, 38(2):89–96.
- Gertsbakh, I. B. (1977). *Models of preventive maintenance*. North-Holland Publishing Co Amsterdam [etc.] ; Oxford.
- Gill, J. C. and Malamud, B. D. (2014). Reviewing and visualizing the interactions of natural hazards. *Reviews of Geophysics*, 52(4):680–722.
- Gill, J. C. and Malamud, B. D. (2016). Hazard interactions and interaction networks (cascades) within multi-hazard methodologies. *Earth System Dynamics*, 7(3):659–679.
- Gomez, B., Banbury, K., Marden, M., Trustrum, N. A., Peacock, D. H., and Hoskin, P. J. (2003). Gully erosion and sediment production: Te Weraroa Stream, New Zealand. *Water Resources Research*, 39(7).

- Grall, A., Dieulle, L., Berenguer, C., and Roussignol, M. (2002). Continuous-time predictive-maintenance scheduling for a deteriorating system. *IEEE Transactions on Reliability*, 51(2):141–150.
- Grelot, F. (2004). *Gestion collective des inondations - Peut-on tenir compte de l'avis de la population dans la phase d'évaluation économique a priori ?* PhD thesis, Thèse de doctorat, Ecole doctorale de IENSAM (ED 432). Spécialité Sciences économiques. [In French].
- GRIF (2018). *GRIF-Workshop*. TOTAL and SATODEV.
- Groupe de travail (1993). *N° 93 - 3 TO. Fascicule 62 titre V. Règles techniques de conception et de calcul des fondations des ouvrages de génie civil*. Bulletin officiel du Ministère de l'Équipement, Paris, France. [In French].
- Gruffaz, F. (1996). Études de description et analyse des plages de dépôt torrentielles réalisées dans les alpes et pyrénées françaises. Technical report, Rep. No. Bilan détape, RTM, Grenoble, France.
- Guide PPRn (2008). Plan de prévention des risques naturels: Les risques d'inondation, les crues des torrents de montagne - version 6-october 2008. Technical report, Ministère de l'Écologie, de l'Énergie, du Développement Durable et de l'Aménagement du Territoire - Service des risques naturels et hydrauliques.
- Guo, H.-Y., Dong, Y., and Gu, X.-L. (2020). Two-step translation method for time-dependent reliability of structures subject to both continuous deterioration and sudden events. *Engineering Structures*, 225.
- Guo, J. and Du, X. (2007). Sensitivity analysis with mixture of epistemic and aleatory uncertainties. *AIAA Journal*, 45(9):2337–2349.
- Gupta, A. and Lawsirirat, C. (2006). Strategically optimum maintenance of monitoring-enabled multi-component systems using continuous-time jump deterioration models. *Journal of Quality in Maintenance Engineering*, 12:306–329.
- Hao, S., Yang, J., and Berenguer, C. (2020). Condition-based maintenance with imperfect inspections for continuous degradation processes. *Applied Mathematical Modelling*, 86:311–334.
- Helton, J. (1997). Uncertainty and sensitivity analysis in the presence of stochastic and subjective uncertainty. *Journal of Statistical Computation and Simulation*, 57(1-4):3–76.
- Helton, J., Johnson, J., and Oberkampf, W. (2004). An exploration of alternative approaches to the representation of uncertainty in model predictions. *Reliability Engineering System Safety*, 85(1):39–71. Alternative Representations of Epistemic Uncertainty.
- Helton, J. and Oberkampf, W. (2004). Alternative representations of epistemic uncertainty. *Reliability Engineering & System Safety*, 85:110.

- Helton, J. C. (2008). Uncertainty and sensitivity analysis for models of complex systems. In Graziani, F., editor, *Computational Methods in Transport: Verification and Validation*, pages 207–228, Berlin, Heidelberg. Springer Berlin Heidelberg.
- Hilt, A., Járó, G., and Bakos, I. (2016). Availability prediction of telecommunication application servers deployed on cloud. *Periodica Polytechnica Electrical Engineering and Computer Science*, 60(1):72–81.
- Howard, R. A. (1971). *Dynamic probabilistic systems. Volume II: Semi-Markov and decision processes*. Wiley, Toronto, ON, Canada.
- Huang, H.-Z. (1995). Reliability analysis method in the presence of fuzziness attached to operating time. *Microelectronics Reliability*, 35(12):1483–1487.
- Hübl, J., Strauss, A., Holub, M., and Suda, J. (2005). Structural Mitigation Measures. In *Proceedings zum 3rd Probabilistic Workshop: Technical Systems + Natural Hazards, 24/25 November, Wien*.
- Hugerot, T. (2015). Études des trajectoires paysagères et des dynamiques anthropoclimatiques des cônes de déjection torrentiels dans les alpes du nord: lexemple du cône de déjection du claret en maurienne. Master’s thesis, Université Savoie Mont Blanc. [In French].
- Hughes, J. D. and Thirgood, J. V. (1982). Deforestation, Erosion, and Forest Management in Ancient Greece and Rome. *Journal of Forest History*, 26(2):60–75.
- Huynh, K.-T., Castro, I.-T., Barros, A., and Bérenguer, C. (2012). Modeling age-based maintenance strategies with minimal repairs for systems subject to competing failure modes due to degradation and shocks. *European Journal of Operational Research*, 218(1):140 – 151.
- Hübl, J., Nagl, G., Suda, J., and Rudolf-Miklau, F. (2017). Standardized stress model for design of torrential barriers under impact by debris flow (according to austrian standard regulation 24801). *International Journal of Erosion Control Engineering*, 10.
- Hübl, J. and Suda, J. (2008). Debris flow mitigation measures in Austria. In *Debris Flows: Disaster, Risk, Forecast, Protection. Pyatigorsk, Russia*.
- IBER (2010). GEAMA, Flumen Institute and CIMNE.
- Ikeya, H. (1985). Study on sediment control effect of open dams. In *Int. Symp. on Erosion, Débris Flow and Disaster Prevention, Japan Erosion Control Engineering Society, Tokyo*, page 401406.
- Ikeya, H. (1989). Debris flow and its countermeasures in japan. *Bulletin - International Association of Engineering Geology* 40(1): 1533.
- ISO8402 (1986). Quality Vocabulary.
- Johansson, J., Hassel, H., and Zio, E. (2013). Reliability and vulnerability analyses of critical infrastructures: Comparing two approaches in the context of power systems. *Reliability Engineering System Safety*, 120:27–38.

- Johnson, P. and McCuen, R. (1989). Slit dam design for debris flow mitigation. *Journal of Hydraulic Engineering*, 115(9):1293–1298.
- Kadri, F., Chatelet, E., and Birregah, B. (2011). Analyse d’Effet Domino : Méthodes et Outils. *Workshop interdisciplinaire sur la sécurité globale*, pages 1–15. [In French].
- Kallen, M. J. (2007). *Markov processes for maintenance optimization of civil infrastructure in the Netherlands*. PhD thesis, Delft University of Technology, Delft, Netherlands.
- Kaplan, E. L. and Meier, P. (1958). Nonparametric estimation from incomplete observations. *Journal of the American Statistical Association*, 53(282):457–481.
- Khandelwal, D. A. S. (2011). Application of reliability analysis : A technical survey. *International Journal of Scientific & Engineering Research*, 2.
- Kiureghian, A. D. and Ditlevsen, O. (2009). Aleatory or epistemic? does it matter? *Structural Safety*, 31(2):105–112. Risk Acceptance and Risk Communication.
- Kotzanikolaou, P., Theoharidou, M., and Gritzalis, D. (2013). Interdependencies between critical infrastructures: Analyzing the risk of cascading effects. In Bologna, S., Hämmerli, B., Gritzalis, D., and Wolthusen, S., editors, *Critical Information Infrastructure Security*, pages 104–115, Berlin, Heidelberg. Springer Berlin Heidelberg.
- Kronfellner-Kraus, G. (1983). Torrent Erosion and its Control in Europe and some Research Activities in this Field in Austria: Sabo Gakkaiishi . *Journal of the Japan Society of Erosion Control Engineering.*, 35(3):33–44.
- kröger, W. (2008). Critical infrastructures at risk: A need for a new conceptual approach and extended analytical tools. *Reliability Engineering System Safety*, 93(12):1781–1787. 17th European Safety and Reliability Conference.
- Ladier, J., Rey, F., and Dreyfus, P. (2012). *Guide de Sylvicultures de Montagne Alpes du Sud françaises*. CRPF - INRA - irstea - ONF. 302 p.
- Laigle, D. (2008). Logichar. <https://forge.irstea.fr/projects/logichar>.
- Le, B. and Andrews, J. (2016a). Modelling wind turbine degradation and maintenance. *Wind Energy*, 19(4):571–591.
- Le, B. and Andrews, J. (2016b). Petri net modelling of bridge asset management using maintenance-related state conditions. *Structure and Infrastructure Engineering*, 12(6):730–751.
- Le, B., Andrews, J., and Fecarotti, C. (2017). A petri net model for railway bridge maintenance. *Proceedings of the Institution of Mechanical Engineers, Part O: Journal of Risk and Reliability*, 231(3):306–323.
- Lee, J. and Mitici, M. (2020). An integrated assessment of safety and efficiency of aircraft maintenance strategies using agent-based modelling and stochastic Petri nets. *Reliability Engineering & System Safety*, 202:107052.

- Leone, F. (1996). *The concept of vulnerability applied to the assessment of mass movements risk*. Theses, Université de Grenoble. Thèse réalisée à l'Institut de Géographie Alpine de Grenoble (université Grenoble 1) et financée par le Bureau de Recherches Géologiques et Minières (BRGM, projet Risques Naturels, Marseille). Reçue avec la mention très honorable et les félicitations du jury.
- Leone, F., Meschinet de Richemond, N., Vinet, F., and Nancy (2010). *Aléas naturels et gestion des risques*. Presses universitaires de France. 288 p.
- Liébault, F., Gomez, B., Page, M., Marden, M., Peacock, D., Richard, D., and Trotter, C. M. (2005). Land-use change, sediment production and channel response in upland regions. *River Research and Applications*, 21(7):739–756.
- Litherland, J. (2019). *Whole System Approaches to Railway Asset Management*. Phd. theses, University of Nottingham.
- Liu, C.-M. (1992). The effectiveness of check dams in controlling upstream channel stability in north-eastern taiwan. *Erosion, Debris Flows and Environment in Mountain Regions. IAHS Publication*, 209:423-428.
- Markov, A. (1951). *Izbrannye Trudy (Selected Works)*. A.N.S.S.S.R, Leningrad. [In Russian].
- Mathys, N., Lang, M., Sauquet, E., Cipriani, T., and Peteuil, C. (2013). *Torrents et rivières de montagne : Dynamique et aménagement.*, chapter Hydrologie. A. Recking, D. Richard, G. Degoutte. Paris, France : Quae. Chap. 2, p. 90 - 132.
- Mavrouli, O. and Corominas, J. (2010). Rockfall vulnerability assessment for reinforced concrete buildings. *Natural Hazards and Earth System Sciences*, 10.
- Mazzorana, B., Trenkwalder-Platzer, H., Fuchs, S., and H'ubl, J. (2014). The susceptibility of consolidation check dams as a key factor for maintenance planning. *Österreichische Wasser- und Abfallwirtschaft*, 66:214–216.
- McCall, J. J. (1965). Maintenance Policies for Stochastically Failing Equipment: A Survey. *Management Science*, 11(5):493–524.
- MEDDTL (2011). Construire en montagne - La prise en compte du risque torrentiel. Technical report, Guide technique, Ministère de l'Écologie du Développement Durable des Transports et du Logement - DGPR, Direction Générale de la Prévention des Risques & DGALN, Direction Générale de l'Aménagement, du Logement et de la Nature. 125 p.
- Messines du Sourbier, J. (1964). Enquête sur la conservation et la restauration des terrains en montagne. Technical report, Grenoble, France : Administration des Eaux et Forêts.
- Meunier, M. (1991). *Éléments d'hydraulique torrentielle. Études Montagne n°1*. Cemagref-DICOVA.
- Mizuyama, T., Abe, S., and Ido, K. (1988). Sediment control by sabo dams with slits and/or large drainage conduits. In *6th Congress Asian and Pacific Regional Division*. Int. Association for Hydraulic Research, Dept. of Civil Engineering, Kyoto Univ., Kyoto, Japan.

- Mizuyama, T., Kobashi, S., and Mizuno, H. (1996). Development and improvement of open dams. In *INTERPRAEVENT, Vol. 5*, page 5965. International Research Society INTERPRAEVENT, Klagenfurt, Austria.
- Mizuyama, T., Kobashi, S., and Ou, G. (1992). Prediction of debris flow peak discharge. In *INTERPRAEVENT, Vol. 4*, page 99108. International Research Society INTERPRAEVENT, Bern, Switzerland.
- Modarres, M. (1992). *What Every Engineer Should Know about Reliability and Risk Analysis*. CRC Press.
- Morcous, G. (2006). Performance prediction of bridge deck systems using markov chains. *Journal of Performance of Constructed Facilities*, 20(2):146–155.
- Mortureux, Y. (2001). La sûreté de fonctionnement : méthodes pour maîtriser les risques. *Techniques de l'ingénieur Méthodes d'analyse des risques*, base documentaire : TIB155DUO.(ref. article : ag4670). [In French].
- Oberkampf, W., Helton, J., Joslyn, C., Wojtkiewicz, S., and Ferson, S. (2004). Challenge problems: Uncertainty in system response given uncertain parameters. *Reliability Engineering System Safety*, 85:11–19.
- Oberkampf, W., Helton, J., and Sentz, K. (2001). Mathematical representation of uncertainty.
- O'Connor, A.-N. (2011). *Probability Distributions Used in Reliability Engineering*. Reliability Information Analysis Center (RIAC).
- Oke, S.-A. (2004). Condition based maintenance: status and future directions. *The South African Journal of Industrial Engineering*, 15(2).
- Okoh, P. and Haugen, S. (2014). Improving the robustness and resilience properties of maintenance. *Process Safety and Environmental Protection*, 94.
- ONF-RTM (2013). Études de bassin versant: Torrent du Claret. Research report, Office National des Forêts, Service de Restauration des Terrains en Montagne du Département de l'Isère, Grenoble.
- ONF-RTM (2016). Études de Bassin de Risques Division domaniale RTM du Manival versant contre les crues. Research report, Office National des Forêts, Service de Restauration des Terrains en Montagne du Département de l'Isère, Grenoble.
- ONF-RTM (2018). Comptes-rendus des retours d'expériences approfondis du Saint-Martin et du Claret (73). Research report, Office National des Forêts, Service de Restauration des Terrains en Montagne du Département de l'Isère, Grenoble.
- Osanai, N., Mizuno, H., and Mizuyama, T. (2010). Design standard of control structures against debris flow in japan. *Journal of Disaster Research*, 5.
- Papathoma-Köhle, M., Kappes, M., Keiler, M., and Glade, T. (2011). Physical vulnerability assessment for alpine hazards: state of the art and future needs. *Natural Hazards*, 58(2):645–680.

- Paulhe, R., Kuss, D., Lamy, O., Etcheverry, D., Carladou, S., and Martin, R. (2018). Retour d'expérience sur les travaux de modification de la plage de dépôt du Claret (73). Research report, Office National des Forêts, Service de Restauration des Terrains en Montagne du Département de l'Isère, Grenoble, ONF-RTM Agence Rhône Alpes.
- Petri, C.-A. (1962). *Kommunikation mit Automaten*. Bonn: Mathematisches Institut der Universität Bonn. [In German].
- Peyras, L., Boissier, D., Carvajal, C., Bacconnet, C., Royet, P., Bécue, J., Gaillard, T., Talon, A., Peyras, L., Boissier, D., and Carvajal, C. (2010). *Analyse de risque et fiabilité des barrages - Application aux barrages-poids en béton*. Éditions Universitaires Européennes. [In French].
- Peyras, L., Carvajal, C., Felix, H., Bacconnet, C., Royet, P., Bécue, J.-P., and Boissier, D. (2012). Probability-based assessment of dam safety using combined risk analysis and reliability methods application to hazards studies. *European Journal of Environmental and Civil Engineering*, 16(7):795–817.
- Peyras, L., Royet, P., and Boissier, D. (2006). Dam ageing diagnosis and risk analysis: Development of methods to support expert judgment. *Canadian Geotechnical Journal*, 43(2):169–186.
- Pham, H. and Wang, H. (1996). Imperfect maintenance. *European Journal of Operational Research*, 94(3):425–438.
- Phillips, C. J., Rey, F., Marden, M., and Liébault, F. (2013). Revegetation of steeplands in France and New Zealand: geomorphic and policy responses. *New Zealand Journal of Forestry Science*, 43(1):14.
- Piton, G., Carladou, S., Recking, A., Tacnet, J. M., Liébault, F., Kuss, D., Quefféléan, Y., and Marco, O. (2017). Why do we build check dams in Alpine streams? An historical perspective from the French experience. *Earth Surface Processes and Landforms*, 42(1):91–108.
- Piton, G., Fontaine, F., Bellot, H., Liébault, F., Bel, C., Recking, A., and Hugerot, T. (2018). Direct field observations of massive bedload and debris-flow depositions in open check dams. *E3S Web of Conferences*, 40:8 p.
- Piton, G. and Goodwin, G. (2021). Cheeky barrier detailed design - functional design analysis of the opening and spillway. Research report, INRAE - Center. V1.
- Piton, G. and Recking, A. (2015a). Design of Sediment Traps with Open Check Dams. I: Hydraulic and Deposition Processes. *Journal of Hydraulic Engineering*, 142:1–16.
- Piton, G. and Recking, A. (2015b). Design of sediment traps with open check dams. ii: Woody debris. *Journal of Hydraulic Engineering*, 142:1–13.
- Piton, G. and Recking, A. (2017). Effects of check dams on bed-load transport and steep-slope stream morphodynamics. *Geomorphology*, 291:94–105.

- Poncet, A. (1968). Cours de restauration et conservation des terrains en montagne. *Paris, France: Ecole Nationale des Ingénieurs des Travaux, des Eaux et Forêts*. [In French].
- Poncet, A. (1995). *Restauration et conservation des terrains en montagne*. Office National des Forêts-Service RTM. Paris, 1000p. [In French].
- Prendergast, L.-J. and Gavin, K. (2014). A review of bridge scour monitoring techniques. *Journal of Rock Mechanics and Geotechnical Engineering*, 6(2):138 – 149.
- Rausand, M. (2014). *Reliability of Safety-Critical Systems: Theory and Applications.*, chapter 5, pages 91 - 164. John Wiley & Sons, Ltd.
- Rausand, M. and Haugen, S. (2020). *Risk Assessment: Theory, Methods, and Applications*. Statistics in Practice. Wiley.
- Rausand, M. and Høyland, A. (2004). *System reliability theory: models, statistical methods, and applications*. John Wiley & Sons.
- Recking, A. (2009). Theoretical development on the effects of changing flow hydraulics on incipient bed load motion. *Water Resources Research*, 45(4):W04401.
- Recking, A. (2014). Relations between bed recharge and magnitude of mountain streams erosions. *Journal of Hydro-environment Research*, 8(2):143 – 152. Moveable Bed Models.
- Recking, A., Degoutte, G., Camenen, B., and Frey, P. (2013). Hydraulique et transport solide. In Recking, A., Richard, D., and Degoutte, G., editors, *Torrents et rivières de montagne : Dynamique et aménagement*. Editions Quae, Paris, France. [In French].
- Recking, A., Frey, P., Paquier, A., Belleudy, P., and Champagne, J. Y. (2008). Feedback between bed load transport and flow resistance in gravel and cobble bed rivers. *Water Resources Research*, 44(5):W05412.
- Ren, Q.-W., Li, Q., and Liu, S. (2012). Research advance in failure risk and local strength failure for high arch dams. *Chinese Science Bulletin*, 57(36):4672–4682.
- Rickenmann, D. (1991). Hyperconcentrated Flow and Sediment Transport at Steep Slopes. *Journal of Hydraulic Engineering*, 117(11):1419–1439.
- Rickenmann, D. (2001). Comparison of bed load transport in torrents and gravel bed streams. *Water Resources Research*, 37(12):3295–3305.
- Rinaldi, S.-M., Peerenboom, J.-P., and Kelly, T.-K. (2001). Identifying, understanding, and analyzing critical infrastructure interdependencies. *IEEE Control Systems Magazine*, 21(6):11–25.
- Rocha, E., Endo, P., Leoni, G., Braga, J., and Lynn, T. (2017). Analyzing the impact of power infrastructure failures on cloud application availability. In *IEEE International Conference on Systems, Man and Cybernetics (SMC)*, pages 1746–1751.

- Rohmer, J., Manceau, J.-C., Guyonnet, D., Boulahya, F., and Dubois, D. (2018). An R package for hybrid uncertainty analysis in natural and environmental risk assessments using probability, imprecise probability and possibility distributions. In *EGU 2018 - European Geosciences Union General Assembly 2018*, Vienne, France.
- Rosmaini, A. and Shahrul, K. (2012). An overview of time-based and condition-based maintenance in industrial application. *Computers Industrial Engineering*, 63(1):135–149.
- Royet, P., Degoutte, G., Peyras, L., Lavabre, J., and Lemperrière, F. (2010). Cotes et crues de protection, de sûreté et de danger de rupture. *La Houille Blanche*, 96(2):51–57.
- Rudolf-Miklau, F. and Suda, J. (2011). Technical standards for debris flow barriers and breakers. pages 1083–1091.
- Rudolf-Miklau, F. and Suda, J. (2013). *Design Criteria for Torrential Barriers*, volume 47, pages 375–389.
- Saaty, T. L. (1980). *The analytic hierarchy proces*. McGraw-Hill, New York.
- Sabaei, D., Erkoyuncu, J., and Roy, R. (2015). A review of multi-criteria decision making methods for enhanced maintenance delivery. *Procedia CIRP*, 37:30–35. CIRPe 2015 - Understanding the life cycle implications of manufacturing.
- Salamatian, S.-A. and Zarrati, A.-R. (2019). Reliability study on uncertainty parameters and flood duration on scouring around unprotected and protected bridge piers. *ISH Journal of Hydraulic Engineering*.
- Sancho, L., Braga, J., and Andrade, A. (2021). Optimizing maintenance decision in rails: A markov decision process approach. *ASCE-ASME Journal of Risk and Uncertainty in Engineering Systems, Part A: Civil Engineering*, 7(1).
- Sanders, W. H. and Meyer, J. F. (2001). Stochastic activity networks: Formal definitions and concepts. In Brinksmas, E., Hermanns, H., and Katoen, J.-P., editors, *Lectures on Formal Methods and Performance Analysis: First EEF/Euro Summer School on Trends in Computer Science, Bergen Dal, The Netherlands, July 3–7, 2000 - Revised Lectures*, pages 315–343. Springer, Berlin, Heidelberg.
- Scarf, P. (1997). On the application of mathematical models in maintenance. *European Journal of Operational Research*, 99:493–506.
- Senoo, K. and Mizuyama, T. (1984). Function of structures against debris flow. In *INTER-PRAEVENT, Vol. 3*, page 113120. International Research Society INTERPRAEVENT, Klagenfurt, Austria.
- Shafer, G. (1976a). *A Mathematical Theory of Evidence*. Princeton University Press.
- Shafer, G. (1976b). *A Mathematical Theory of Evidence*. Princeton University Press.
- Shafiee, M. and Sørensen, J.-D. (2019). Maintenance optimization and inspection planning of wind energy assets: Models, methods and strategies. *Reliability Engineering and System Safety*, 192:105993.

- Shang, H. (2015). *Maintenance modelling, simulation and performance assessment for railway asset management*. PhD thesis, Université de Technologie de Troyes. Thèse de doctorat dirigée par Andrews, John et Bérenguer, Christophe Optimisation et Sûreté des Systèmes Troyes 2015.
- Sharvia, S., Kabir, S., Walker, M., and Papadopoulos, Y. (2016). Chapter 12 - Model-based dependability analysis: State-of-the-art, challenges, and future outlook. In Mistrik, I., Soley, R., Ali, N., Grundy, J., and Tekinerdogan, B., editors, *Software Quality Assurance*, pages 251 – 278. Morgan Kaufmann, Boston.
- Signoret, J.-P. (2009). Dependability & safety modeling and calculation: Petri nets. *IFAC Proceedings Volumes*, 42(5):203 – 208. 2nd IFAC Workshop on Dependable Control of Discrete Systems.
- Surell, A. (1841). *Étude sur les torrents des Hautes-Alpes*. Carilian-Goeury.
- Tacnet, J., Garin, L., and Cheruy, O. (2000). Calcul global des barrages de correction torrentielle : prise en compte des interactions sol-structure. In *Internationales Symposium Interpraevent 2000, Villach, AUT, 26 juin 2000*, pages 295–306, Austria.
- Tacnet, J. and Richard, D. (2010). De la conception à la sûreté des barrages de correction torrentielle. *Sciences Eaux Territoires*, (2):p. 164 – p. 175. [In French].
- Tacnet, J.-M. (2009). *Prise en compte de l'incertitude dans l'expertise des risques naturels en montagne par analyse multicritères et fusion d'information*. PhD thesis, Ecole Nationale Supérieure des Mines de Saint-Etienne. [In French].
- Tacnet, J.-M., Batton-Hubert, M., and Dezert, J. (2010). A two-step fusion process for multi-criteria decision applied to natural hazards in mountains. In *Workshop on the Theory of Belief Functions, April 1- 2, 2010 Brest, France*, page Paper no 125, Brest, France.
- Tacnet, J.-M., Carladous, S., Curt, C., Legat, Y., Rulleau, B., and Wery, C. (2016). Combiner les modèles d'aide à la décision pour la gestion patrimoniale des infrastructures. *Sciences Eaux and Territoires : la Revue du IRSTEA*, (20):90–97. [In French].
- Tacnet, J.-M., Carladous, S., Dezert, J., Han, D., and Batton-Hubert, M. (2017). New MCDM methods under uncertainty applied to integrated natural risks management. In *IEEE International Conference on Computational Intelligence and Virtual Environments for Measurement Systems and Applications (CIVEMSA)*, pages 193–198.
- Tacnet, J.-M., Curt, C., Richard, D., and Rey, B. (2011). Efficacité des ouvrages de correction torrentielle Indicateurs basés sur la sûreté de fonctionnement. In *Annales du Bâtiment et des Travaux Publics*, number 4/5, page 78. Editions ESKA. [In French].
- Tacnet, J.-M. and Degoutte, G. (2013). *Torrents et rivières de montagne : Dynamique et aménagement*, chapter Principes de conception des ouvrages de protection contre les risque torrentiels. Paris, France : Quae.

- Tacnet, J.-M., Dezert, J., Curt, C., Batton-Hubert, M., and Chojnacki, E. (2014). How to manage natural risks in mountain areas in a context of imperfect information? New frameworks and paradigms for expert assessments and decision-making. *Environment Systems and Decisions*, Volume 34(Issue 2):pp 288–311.
- Tacnet, J.-M., Poymiro, N., and Mathieu, G. (1999a). Elément d'aide à la décision pour la gestion d'ouvrages de protection contre les risques naturels. Pathologie - diagnostic - réparation. Application aux ouvrages de correction torrentielle et de protection contre les avalanches. Fascicule n° 1: Rapport de synthèse. Technical report, Ministère de l'aménagement du territoire et de l'environnement, Direction de la prévention des pollutions et des risques, Sous-direction de la prévention des risques majeurs. (Cemagref). France. [In French].
- Tacnet, J.-M., Poymiro, N., and Mathieu, G. (1999b). Elément d'aide à la décision pour la gestion d'ouvrages de protection contre les risques naturels. Pathologie - diagnostic - réparation. Application aux ouvrages de correction torrentielle. Fascicule n° 2: Méthodologie et éléments d'analyse d'un ouvrage. Technical report, Ministère de l'aménagement du territoire et de l'environnement, Direction de la prévention des pollutions et des risques, Sous-direction de la prévention des risques majeurs. (Cemagref). France. [In French].
- Tacnet, J.-M., Poymiro, N., and Mathieu, G. (1999c). Elément d'aide à la décision pour la gestion d'ouvrages de protection contre les risques naturels. Pathologie - diagnostic - réparation. Application aux ouvrages de correction torrentielle. Fascicule n° 4: Glossaire des pathologies. Technical report, Ministère de l'aménagement du territoire et de l'environnement, Direction de la prévention des pollutions et des risques, Sous-direction de la prévention des risques majeurs. (Cemagref). France. [In French].
- Tacnet, J.-M., Poymiro, N., and Mathieu, G. (1999d). Elément d'aide à la décision pour la gestion d'ouvrages de protection contre les risques naturels. Pathologie - diagnostic - réparation. Application aux ouvrages de correction torrentielle. Fascicule n° 5: Catalogue des pathologies. Technical report, Ministère de l'aménagement du territoire et de l'environnement, Direction de la prévention des pollutions et des risques, Sous-direction de la prévention des risques majeurs. (Cemagref). France. [In French].
- Tao, W., Lin, P., and Wang, N. (2021). Optimum life-cycle maintenance strategies of deteriorating highway bridges subject to seismic hazard by a hybrid markov decision process model. *Structural Safety*, 89:102042.
- Theule, J., Liébault, F., Loye, A., Laigle, D., and Jaboyedoff, M. (2012). Sediment budget monitoring of debris-flow and bedload transport in the Manival Torrent, SE France. *Natural Hazards and Earth System Sciences*, 12:731–749.
- Thiéry, E. (1891). *Restauration des montagnes, correction des torrents, reboisement*. Librairie Polytechnique: Paris, 443 p. [In French].
- Thomas, O. and Sobanjo, J. (2013). Comparison of markov chain and semi-markov models for crack deterioration on flexible pavements. *Journal of Infrastructure Systems*, 19:186–195.

- Thouret, J.-C. and D'Ercole, R. (1996). Vulnérabilité aux risques naturels en milieu urbain : effets, facteurs et réponses sociales. *Cahiers des Sciences Humaines*, 32:407–422.
- Treich, N. (2005). L'analyse Coût-Bénéfice de la Prévention des Risques. Technical report, LERNA INRA, Université de Toulouse. [In French].
- Tsang, H.-A. (1995). Condition-based maintenance: tools and decision making. *Quality in Maintenance Engineering*.
- Tubaldi, E., Macorini, L., Izzuddin, B.-A., Manes, C., and Laio, F. (2017). A framework for probabilistic assessment of clear-water scour around bridge piers. *Structural Safety*, 69:11–22.
- UNISDR (2009). *Terminology on disaster risk reduction*. United Nations Office for Disaster Risk Reduction.
- Valdez-Flores, C. and Feldman, R. M. (1989). A survey of preventive maintenance models for stochastically deteriorating single-unit systems. *Naval Research Logistics (NRL)*, 36(4):419–446.
- Van Effenterre, C. (1982). *Revue Forestière Française*, Vol. 34, N° 5, chapter Les barrage perméables de sédimentation, pages 87–93. [In French].
- VanDine, D. (1996). *Debris flow control structures for forest engineering*. Ministry of Forests, British Columbia, VIC, Australia.
- Vanorio, G. and Mera, J. (2012). Methodology for risk analysis in railway tunnels using Monte Carlo simulation. In *Proceedings of the 3rd International Forum on Risk Analysis, Dam Safety Dam Security and Critical Infrastructure Management, 3IWRDD-FORUM2012, Pages 159-164.*, pages 673–683.
- Vasilyev, A. (2019). *Modelling Polymer Electrolyte Membrane Fuel Cells for Dynamic Reliability Assessment*. PhD thesis, Loughborough University.
- Villemeur, A. (1992). *Reliability, Availability, Maintainability and Safety Assessment, Assessment, Hardware, Software and Human Factors*. Reliability, Availability, Maintainability and Safety Assessment. Wiley.
- Walley, P. (1991). *Statistical Reasoning with Imprecise Probabilities*. Chapman & Hall.
- Wang, W., Loman, J.-M., Arno, R.-G., Vassiliou, P., Furlong, E.-R., and Ogden, D. (2004). Reliability block diagram simulation techniques applied to the IEEE Std. 493 standard network. *IEEE Transactions on Industry Applications*, 40(3):887–895.
- Wehrmann, H., Hübl, J., and Holzinger, G. (2006). Classification of dams in torrential watersheds. In *INTERPRAEVENT: Disaster Mitigation of Debris Flows, Slope Failures and Landslides*, page 829838. Universal Academy Press, Tokyo.
- Weik, N. and Nieben, N. (2019). Performability Analysis of Railway Systems. In *International Conference on Intelligent Rail Transportation, ICIRT*.

- Yang, D.-Y. and Frangopol, D. M. (2019). Life-cycle management of deteriorating civil infrastructure considering resilience to lifetime hazards: A general approach based on renewal-reward processes. *Reliability Engineering & System Safety*, 183:197–212.
- Yianni, P. C., Rama, D., Neves, L. C., Andrews, J. D., and Castlo, D. (2017). A Petri-Net-based modelling approach to railway bridge asset management. *Structure and Infrastructure Engineering*, 13(2):287–297.
- Zadeh, L. (1965). Fuzzy sets. *Information and Control*, 8(3):338–353.
- Zeng, Q.-L., Yue, Z., Yang, Z., and Zhang, X. (2009). A Case Study of Long-Term Field Performance of Check-Dams in Mitigation of Soil Erosion in Jiangjia Stream, China. *Environmental Geology*, 58:897–911.
- Zille, V. (2009). *Modélisation et évaluation des stratégies de maintenance complexes sur des systèmes multi-composants*. PhD thesis, Université de Technologie de Troyes, France. [In French].
- Zille, V., Bérenguer, C., Grall, A., Despujols, A., and Lonchamp, J. (2007). Modelling and performance assessment of complex maintenance programs for multi-component systems. In *In ESREDA 32nd Seminar proceedings, Alghero, Mai 2007*.
- Zimmermann, A. (2008). *Stochastic Discrete Event Systems: Modeling, Evaluation, Applications*, chapter Colored Petri Nets, pages 99–124. Springer, Berlin, Heidelberg.
- Zio, E. (2007). *An Introduction to the Basics of Reliability and Risk Analysis*. World Scientific Publishing Company.
- Zio, E. (2009). Reliability engineering: Old problems and new challenges. *Reliability Engineering & System Safety*, 94(2):125 – 141.
- Zio, E. (2013). *The Monte Carlo Simulation Method for System Reliability and Risk Analysis*. Springer. ISBN 978-1-4471-4588-2.
- Zio, E. (2016). Reliability Analysis of Systems of Systems. *IEEE Reliability Society*.
- Zollinger, F. (1983). *Die Vorgänge in einem Geschiebeablagungsplatz (ihre Morphologie und die Möglichkeiten einer Steuerung)*. Phd. theses, ETH Zürich. [In German].
- Zollinger, F. (1985). Debris detention basins in the European Alps. In *International symposium on Erosion, Debris Flow and Disaster Prevention. Tsukuba, Japan: Japan Erosion Control Engineering Society.*, pages 433–438.
- Zuccaro, G., De Gregorio, D., and Leone, M. (2018). Theoretical model for cascading effects analyses. *International Journal of Disaster Risk Reduction*, 30.

Résumé — Les risques naturels en montagne constituent une menace pour les habitants, les propriétés et les infrastructures. Plusieurs structures de protection sont construites dans ces zones afin de réduire le risque induit et de protéger les éléments vulnérables exposés. Ces structures constituent des systèmes critiques interdépendants à composants multiples qui se détériorent avec le temps en raison des phénomènes violents auxquels ils sont soumis depuis leur construction. La propagation des dommages est influencée par les dépendances entre les différents modes de défaillance et entre les structures elles-mêmes. Ces événements en cascade réduisent l'efficacité du système global en matière de protection. Par conséquent, s'ils ne sont pas entretenus régulièrement, le niveau de protection offert par ces structures sera réduit. En raison des ressources budgétaires limitées, il est essentiel d'identifier les types de défaillances les plus critiques et les dépendances existantes afin de définir l'état de dégradation à partir duquel la maintenance préventive doit être effectuée. Par conséquent, il est très important d'effectuer une analyse de fiabilité de ces systèmes. Cela nécessite d'analyser la détérioration dynamique de chaque structure et les effets locaux ou distants de son indisponibilité partielle ou totale sur les autres structures impliquées dans un système multi-composants. La méthodologie présentée dans ce projet intègre des modèles basés sur la physique et sur la fiabilité pour suivre l'évolution de l'état des structures de protection et améliorer les processus de décision en matière de maintenance. L'approche de modélisation proposée est basée sur (1) une modélisation basée sur la physique pour identifier les lois probabilistes des temps de transition entre les états définis de la structure en fonction de son comportement dans le temps et (2) une méthode d'aide à la décision basée sur les réseaux de Petri, qui aide à choisir la meilleure stratégie de maintenance tout en considérant les contraintes budgétaires. Dans ce contexte, les décisions entreprises dépendent toujours de la quantité de données disponibles, de sources diverses, d'hypothèses, etc. Par conséquent, cette étude se concentre également sur l'évaluation de l'influence des entrées incertaines sur les sorties obtenues à partir des modèles de détérioration et de maintenance. Les modèles développés sont appliqués à deux structures de protection différentes (barrages de correction et systèmes de rétention) soumises à différents types de phénomènes naturels (crues d'eau claire et laves torrentielles). Les résultats obtenus permettent d'analyser le comportement d'une structure en fonction du temps et de prioriser plusieurs stratégies de maintenance proposées en tenant compte des contraintes économiques et de l'efficacité de chaque stratégie pour augmenter le temps de disponibilité de la structure dans des états non critiques.

Mots clés : risques naturels; ouvrages de protection; modélisation des détériorations, temps de transition ; réseaux de Petri stochastiques; optimisation de la maintenance; imperfection de l'information

Abstract — Natural hazards in mountains pose threat to people, properties and infrastructures. Several protection structures are implemented in such areas aiming to reduce the induced risk and to protect vulnerable exposed issues. These structures constitute critical interdependent multi-component systems that deteriorate over time due to the harsh phenomena they are subjected to since their construction. The propagation of damage is influenced by the dependencies between different failure modes and between the structures themselves. Such cascading events reduce the efficacy of the overall system in providing protection. Hence, if not regularly maintained, the level of protection offered by these structures will be reduced. Due to limited budgetary resources, it is essential to identify the most critical types of failures and existing dependencies in order to capture the state of degradation at which preventive maintenance should be carried out. Consequently, performing a reliability analysis of such systems is highly important. This requires analyzing the dynamic deterioration of each structure and the local or distant effects of its partial or total unavailability on other structures involved in a multi-component system. The methodology presented in this project integrates physics-based and reliability-based models for monitoring the state evolution of protection structures and improving maintenance decision-making processes. The modeling approach proposed is based on (1) physics-based modeling for identifying the probabilistic laws of the transition times between the defined states of the structure depending on its behavior over time and (2) a decision aiding method based on Petri nets, which helps in choosing the best maintenance strategy while considering budgetary constraints. In this context, undertaken decisions always depend on the amount of available data, diverse sources, assumptions, etc. Consequently, this study also focuses on assessing the influence of uncertain inputs on the outputs obtained from deterioration and maintenance models. The developed models are applied on two different protection structures (check dams and retention systems) subjected to different types of natural phenomena (clear water floods and debris flows). The achieved results permit to analyze the time-dependent behavior of a structure and to prioritize several proposed maintenance strategies taking into consideration economic constraints and the efficiency of each strategy in increasing the availability time of the structure in non-critical states.

Keywords: Natural risk; protection structures; deterioration modeling, transition times; stochastic Petri nets; maintenance optimization; information imperfection

Gipsa-lab, 11 Rue des Mathématiques
38400 Saint-Martin-d'Hères

INRAE, 2 Rue de la Papeterie
38402 Saint-Martin-d'Hères

*“Imagination means
nothing without doing.”*

— **Charlie Chaplin**