



HAL
open science

Algorithms on closure systems and their representations

Simon Vilmin

► **To cite this version:**

Simon Vilmin. Algorithms on closure systems and their representations. Combinatorics [math.CO]. Université Clermont Auvergne, 2021. English. NNT: . tel-03565674v1

HAL Id: tel-03565674

<https://theses.hal.science/tel-03565674v1>

Submitted on 11 Feb 2022 (v1), last revised 10 May 2022 (v2)

HAL is a multi-disciplinary open access archive for the deposit and dissemination of scientific research documents, whether they are published or not. The documents may come from teaching and research institutions in France or abroad, or from public or private research centers.

L'archive ouverte pluridisciplinaire **HAL**, est destinée au dépôt et à la diffusion de documents scientifiques de niveau recherche, publiés ou non, émanant des établissements d'enseignement et de recherche français ou étrangers, des laboratoires publics ou privés.

Université Clermont Auvergne

École Doctorale Sciences pour l'Ingénieur, Clermont-Ferrand

Thèse présentée par
Simon VILMIN

Pour obtenir le grade de
DOCTEUR D'UNIVERSITÉ

Spécialité INFORMATIQUE

Algorithms on closure systems and their representations

Soutenue publiquement le 13 Décembre 2021 devant le jury constitué de :

| | | | |
|------------------|------------------------------------|---|-------------|
| Kira ADARICHEVA | <i>Professeur</i> | <i>Hofstra University, Hempstead</i> | RAPPORTEUR |
| Karell BERTET | <i>Maître de conférences (HDR)</i> | <i>Université de la Rochelle</i> | RAPPORTEUR |
| Sergeï KUZNETSOV | <i>Professeur</i> | <i>Higher School of Economics, Moscow</i> | RAPPORTEUR |
| Arnaud MARY | <i>Maître de conférences</i> | <i>Université de Lyon</i> | EXAMINATEUR |
| Jean-Marc PETIT | <i>Professeur</i> | <i>Université de Lyon</i> | EXAMINATEUR |
| Lhouari NOURINE | <i>Professeur</i> | <i>Université Clermont Auvergne</i> | DIRECTEUR |

Remerciements

Cette thèse fût une belle et longue journée, sur laquelle le soleil se couche à présent. Avant qu'il ne se retire, j'aimerais profiter de ses derniers rayons pour faire la lumière sur celles et ceux qui m'ont accompagné tout au long de ce voyage¹.

Mes premiers remerciements vont naturellement à Lhouari Nourine, mon directeur de thèse. D'abord, il y a ces trois années de thèse où tu as été un directeur patient, passionné et présent, distillant conseils et intuitions issus de cette inépuisable connaissance des nombreux dialectes de l'informatique. À tout ça, il faut bien sur ajouter ce fameux cours de méthodes discrètes, il y a maintenant sept ans de ça, où tu nous as montré les treillis pour la toute première fois. Ces derniers, tout aussi omniprésents que poétiques, ont dès lors fait brûler ma curiosité, et la font brûler encore. Pour tout cela Lhouari, merci.

This paragraph is written in English for it is devoted to the members of my jury. First, I would like to thank Kira Adaricheva, Karell Bertet and Sergeï Kuznetsov for having accepted to review my manuscript. It is truly an honour for me that you agreed to read this thesis, knowing that your research works hugely impacted my understanding of lattices. Also, I would like to thank you, along with Jean-Marc Petit and Arnaud Mary, for having attended my PhD defense. Thanks to your remarks and questions, there is no doubt that I have plenty of problems to investigate in the near future.

Je voudrais également remercier Oscar Defrain et Jean-Marc Petit pour les collaborations. Celles-ci ont donné lieu à des discussions scientifiques riches et passionnantes. Merci aussi à Jean-Marc de m'avoir invité au LIRIS, et de m'offrir à la suite de cette thèse un post-doctorat que je me languis de commencer. D'ailleurs, Alexandre, Caroline, j'espère que votre emploi du temps n'est pas plein, nous avons à Lyon des discussions à finir, d'autres à commencer, des musées à visiter. Je suis par ailleurs profondément reconnaissant envers les personnes qui m'ont entourées au LIMOS, à Lyon, au Japon, et qui ont contribué à faire de cette thèse un espace de rencontres. Merci d'abord à Béatrice et Cristine, sans qui la vie serait beaucoup plus compliquée. Ensuite, merci à Élodie, Aurélie, Caroline, Oscar, Olivier, Alexandre, Vincent, Lucas, Jean-Marc, Arnaud, Laurent, Yannick, Florent, Jean-Florent, Alexey (my favorite spoon thief), et à tous les malheureux·euses oublié·e·s du LIMOS ou d'ailleurs, pour m'avoir fait une place de choix parmi vous, malgré ma froideur de bernard l'hermite. Merci pour toutes ces soirées, ces apéros, ces restos, ces nuits reposantes passées au Japon. Élodie, merci de m'avoir tenu compagnie (i.e. supporté) ce dernier été, non loin du potager, alors que j'entamais sans aucun doute la partie la plus rude de mon périple. Oublions donc cette sombre histoire de

¹Les pages de ce manuscrit impose un ordre total (donc un treillis) sur les mots et les noms. Cependant, trouver un ordre adéquat, même partiel, sur les personnes envers lesquelles je suis reconnaissant me semble complexe voire impossible. À vue de nez, c'est déjà plus dur que les transversaux...

frisbee coincé. Olivier, une thèse doit être le terrain d'un épanouissement intellectuel dépassant la lumière blafarde de la salle A002, d'un épanouissement contribuant à approfondir, revoir et corriger sa vision du monde à tous les égards. Tu as été l'un des moteurs principaux de ce mouvement. Comment te remercier pour ces toiles, ces discussions, en fait ces soirées où j'ai bu trop vite les minutes qui remplissaient mon verre. Enfin, Oscar, sache que je regrette de n'avoir pu rembourser en brioches la patience, la pédagogie et l'incroyable optimisme dont tu as fait preuve avec moi pendant deux ans, et pour lesquels je te suis infiniment reconnaissant.

Au delà des frontières du LIMOS et de la recherche, il y a des ami-e-s sur qui j'ai pu compter. Merci à Betty et Irina, d'avoir motivé mon entrée en thèse, d'avoir été là jusqu'à la toute fin. À Rémi et Wendy, nos diverses retrouvailles au cours de ce voyage m'ont permis de ne pas oublier qu'être un adulte, c'est aussi être un enfant. Je ne saurais vous dire à quel point ça a été important, et vous remercier ici n'est peut-être qu'un bien maigre paiement à cet égard. Enfin, -1 + 12 mercis à Yann, Johann, et Mathieu. Les discussions scientifiques et les questions sur le monde ont cotoyé de très (très) près l'invention de monnaies prometteuses (le coauteuro), les randonnées au parcours douteux, les croix, les montages, les photos du roi René (béni soit-il), et plus généralement, une myriade d'instantanés hors du temps, hors de la thèse, passés à rigoler.

Bien sur, je remercie toute ma famille, mes parents, mon frère, mes grands-parents, pour leur indéfectible support pendant ces trois années qui ont du en paraître six à mon contact. À mon père, je crois que cette thèse t'es un peu dédiée au final. En me montrant la voie du doctorat, paré de ses atours épistémologiques et philosophiques sur la science et le monde qui nous entoure, tu as entretenu chez moi une pensée finalement assez enfantine : « *Quand je serai grand, je veux faire comme mon père !* ». Pour ça, merci.

Enfin, merci à toi, toi dont le regard espiègle a su illuminer les jours les plus sombres, toi, à qui je dédie ce dernier rayon de soleil.

Résumé

La théorie des espaces de connaissances est un domaine de la psychologie mathématique dont l'objectif est d'évaluer et représenter les connaissances des étudiant·e·s. Au cœur de cette théorie se trouvent les *espaces de connaissances* et les *espaces d'apprentissage*. Ces structures sont équivalentes à des objets combinatoires bien connus : les *systèmes de fermeture* (ou *treillis*) et les *géométries convexes*, respectivement. Un système de fermeture est une famille de sous-ensembles d'un ensemble de base V qui est fermée par intersection et qui contient V . Ses éléments sont appelés fermés. Outre la théorie des espaces de connaissance, les systèmes de fermeture se cachent dans de nombreux domaines de l'informatique parmi lesquels l'analyse formelle de concepts, la logique propositionnelle, la théorie des bases de données, l'optimisation combinatoire ou encore la théorie de l'argumentation. Cela étant, les systèmes de fermeture souffrent de leur taille. À ce titre, ils sont souvent codés avec des représentations compactes et implicites telles que des *implications* ou leurs éléments *inf-irréductibles*. Les implications sont des règles $A \rightarrow B$ exprimant des dépendances au sein du système de fermeture : un fermé incluant A doit inclure B . Les inf-irréductibles sont, quant à eux, des fermés à partir desquels le système entier peut être reconstruit par intersections successives.

Dans cette thèse, nous étudions deux problèmes concernant les systèmes de fermeture et ces deux représentations, à commencer par le problème de la *traduction* entre celles-ci. Cette question ouverte bien connue généralise le problème d'énumération des stables maximaux d'un hypergraphe, souvent appelé dualisation des hypergraphes. Notre approche ici est de décomposer hiérarchiquement, si possible, un ensemble d'implications par le prisme de partitions appelées splits (acycliques). Nous déduisons ainsi une caractérisation récursive des éléments inf-irréductibles du système de fermeture associé. En conséquence, nous obtenons de nouveaux types de systèmes de fermeture (et de géométries convexes) pour lesquels la traduction peut être effectuée en temps total quasi-polynomial au moyen d'un algorithme reposant sur la dualisation des hypergraphes.

Ensuite, nous considérons les *sous-ensembles* et *sur-ensembles interdits* dans les systèmes de fermeture. En premier lieu, les *sur-ensembles* interdits. Un fermé qui n'est le sous-ensemble d'aucun sur-ensemble interdit est *sur-admissible*. Il est *sur-préfér*é s'il est de surcroît minimal par inclusion. En utilisant des résultats sur l'argumentation, nous montrons que l'énumération des fermés sur-admissibles est impossible en temps total polynomial (à moins que $\mathbf{P} = \mathbf{NP}$) à partir d'un ensemble d'implications, même si les sur-ensembles interdits sont des co-paires (complémentaires de paires d'éléments). Nous donnons une procédure énumérant les fermés sur-admissibles en temps polynomial à partir des inf-irréductibles, ou à partir d'implications pour certains types de systèmes de fermeture. L'énumération des fermés sur-préférés généralise la *dualisation dans les treillis*, étant une tâche difficile. Ainsi, nous limitons notre attention

aux co-paires interdites. Le problème reste difficile pour les bases d'implications. Pour les inf-irréductibles, nous montrons que le problème peut être résolu avec un délai polynomial. Ensuite, nous passons aux sous-ensembles interdits. Nous appelons *sous-admissible* un fermé qui ne contient aucun sous-ensemble interdit. Un fermé sous-admissible maximal par inclusion est *sous-préféréré*. Via la dualisation dans les treillis, nous montrons que l'énumération des fermés sous-préférérés est un problème difficile, indépendamment de la représentation choisie. En fait, le problème devient équivalent à la dualisation dans plusieurs classes de systèmes de fermeture généralisant la distributivité, contrastant ainsi avec certains résultats antérieurs sur les semi-treillis médians et modulaires. D'un autre côté, nous utilisons un algorithme paramétré par le *nombre de Carathéodory* pour identifier des classes de géométries convexes où le problème d'énumération des fermés sous-préférérés (par rapport à des paires) peut-être résolu en temps total polynomial. Avec le même algorithme, nous démontrons que cette tâche peut être réalisée en temps total quasi-polynomial dans les treillis modulaires atomiques.

Nous concluons cette thèse par un éventail de pistes et questions ouvertes pour de futures recherches.

Financement de la thèse *Cette thèse est financée par le projet **ProFan**, CNRS, France.*

Abstract

Knowledge Space Theory (KST) is a field of mathematical psychology which aims to assess and represent students knowledge. Its core structures, *knowledge spaces* and *learning spaces* are equivalent to well-known combinatorial objects: *closure systems* (or *lattices*) and *convex geometries* respectively. Given a ground set, a closure system is a family of sets closed under intersection and containing the ground set. Its elements are called closed sets. Apart from KST, closure systems are used in numerous fields of computer science such as Formal Concept Analysis, propositional logic, database theory, combinatorial optimization or argumentation theory for instance. Because of their size, closure systems are often encoded with compact representations such as *implications* or *meet-irreducible elements*. The former are rules $A \rightarrow B$ depicting a dependence relation within the closure system: a set including A must include B . The latter is a subfamily of closed sets from which the whole system can be recovered.

In this thesis, we focus on two problems regarding closure systems and their representations. We begin with the problem of *translating between the two representations of a closure system*. This famous open problem generalizes the task of enumerating maximal independent sets of a hypergraph, known as hypergraph dualization. Our approach here is to give an algorithm which hierarchically decomposes, if possible, a set of implications with partitioning operations called (*acyclic*) *splits*. We deduce a recursive characterization of the meet-irreducible elements of the associated closure system. As a consequence, we obtain new types of closure systems (and convex geometries) for which the translation can be done with an output-quasipolynomial time algorithm relying on hypergraph dualization.

Next, we study *forbidden subsets* and *forbidden supersets* in closure systems. First, we consider families of forbidden *supersets*. A closed set not included in any forbidden set is *upper-admissible*. An inclusion-wise minimal upper-admissible closed set is *upper-preferred*. Using results on argumentation frameworks, we show that listing upper-admissible is intractable from a set of implications, even when forbidden supersets are co-pairs (complements of pairs). We hint a procedure to list the upper-admissible closed sets which can be applied in output-polynomial time from meet-irreducible elements, or from implications in particular classes of closure systems. The problem of enumerating upper-preferred closed sets generalizes the *dualization in lattices*, being a hard task. Thus, we restrict our attention to forbidden co-pairs (complements of pairs). The problem remains hard for implicational bases. For meet-irreducible elements, we show that the problem can be solved with polynomial delay. Then, we move to forbidden subsets. We call *lower-admissible* a closed set which does not contain any forbidden subset. A maximal lower-admissible closed set is *lower-preferred*. Connecting with the dualization in lattices, we show that enumerating lower-preferred closed sets with respect to a set of forbidden pairs is impossible in output-polynomial time unless $\mathbf{P} = \mathbf{NP}$, independently

of the input representation. In fact, the problem becomes equivalent to the dualization in lattices in several generalizations of distributivity, thus contrasting with previous known results on modular and median-semilattices. On the positive side, we use an algorithm parametrized by the *Carathéodory number* to identify classes of convex geometries where the problem of listing lower-preferred closed sets with respect to a set of forbidden pairs is tractable for every representation of the closure system. Applying the same procedure, we finally prove that this task can be conducted in output-quasipolynomial time in atomistic modular lattices.

We conclude the dissertation with possible directions for further research.

Funding *This thesis is funded by the **ProFan project**, CNRS, France.*

Contents

| | |
|---|------------|
| Remerciements | i |
| Résumé | iii |
| Abstract | v |
| Contents | vii |
| Introduction | 1 |
| 1 Closure systems and their representations | 5 |
| 1.1 Preliminary notions: hypergraphs, posets | 5 |
| 1.2 Lattices and closure systems | 7 |
| 1.3 Representations of a closure system | 10 |
| 1.4 Classes of closure systems and lattices | 13 |
| 1.5 Enumeration complexity, dualization in hypergraphs and lattices | 23 |
| 1.6 Knowledge Space Theory: an application of closure systems | 27 |
| 2 Translating between the representations of a closure system | 31 |
| 2.1 Introduction | 31 |
| 2.2 Preliminaries | 34 |
| 2.3 Splits and hierarchical decomposition of implicational bases | 35 |
| 2.4 Closure systems with acyclic splits | 46 |
| 2.5 Discussions and open problems | 57 |
| 3 Closure systems with forbidden sets | 61 |
| 3.1 Introduction | 61 |
| 3.2 Preliminaries | 63 |
| 3.3 Closure systems with forbidden supersets | 64 |
| 3.4 Closure systems with forbidden subsets | 71 |
| 3.5 Discussions and open problems | 95 |
| Conclusion and perspectives | 97 |
| Bibliography | ix |

Introduction

Over the last decades, computer science has become prominent in countless aspects of our lives. Education and pedagogical processes are no exceptions to this trend. Integrating the tools provided by computer science into these domains leads to exciting theoretical and practical challenges. This constitutes the main purpose of the **ProFan project**, under which this thesis has been conducted. In particular, the motivation for our work initially originates from Knowledge Space Theory (KST), at the crossroad of computer science and mathematical psychology.

This theory has been developed in the 1980s by Doignon and Falmagne in their seminal paper [DF85] and later detailed in the books [DF12, FD10]. It aims at automatically assessing and representing students' knowledge by means of combinatorial structures named *knowledge spaces* and *learning spaces*. The key ideas of the framework are the following. A topic at school (math, chemistry, ...) is divided into *items*, or *problems*, that students should master. The items that the students are able to solve represent their current *knowledge state* about the topic. The empty knowledge state is feasible, as none of the items to be learned should be a prerequisite. With the further assumption that the combination of two states is also a state, the family of all knowledge states becomes a *knowledge space*. If moreover, the students can improve their knowledge state by mastering the missing items one by one, the knowledge space becomes a *learning space*. To estimate the knowledge state of students, and the items they are ready to learn, they pass through a test on a computer which prompts questions relating to the appropriate problems. This framework is already implemented in the ALEKS system [ALE]. From a mathematical perspective, it appears that knowledge spaces—and in particular learning spaces—are yet another name for well-known mathematical objects: *closure systems* and *lattices*.

Lattices and closure systems are rather old structures. The latter first appear in disguise in the mid XIXth century, with the work of Boole in his “*laws of thoughts*” [Boo54]. Still, the true beginning of lattice theory lies in the two landmark papers of Dedekind [Ded97, Ded00] on number theory. At that time, lattices were called “*Verband*” or “*Dualgruppe*”. Remark that nowadays, the term “*lattice*” has become the standard German name. As mentioned by Rota in his note [Rot97], the reception of this new mathematical object was mitigated. In fact, lattices did not receive much care until the 1930s, when mathematicians such as Ore, Klein, Von Neumann and most prominently Birkhoff undertook the construction of a whole theory of lattices and their applications in mathematics. The famous book “*lattice theory*” of Birkhoff [Bir40] is the very first text on lattices and summarizes all these works. It also formally states the equivalence between closure systems and lattices. Note that the latter notion was apparently introduced in the early XXth by Moore [Moo09] along with closure operators. Later in the 1960's, and aside from the numerous versions of “*lattice theory*”, Grätzer began the writing of his text-

book [Grä02] gathering most of the knowledge on lattices, and which has now become standard in the field. Since then, closure systems and lattices have spread in plenty of fields in computer science and mathematics. Apart from Knowledge Space Theory, they show up in database theory [Mai83, MR92], propositional logic [Kha95, KKS93], matroid theory [Whi92], combinatorial optimization [KLS12, Die87, BC93, HO18, HN20], Formal Concept Analysis (FCA) [GW12], argumentation frameworks [Dun95, DDLW15], social choice theory [Kos99, MR01], geometry [HPR94, Ste99, EJ85] or graph and hypergraph theory [JYP88, FK96, FJ86, KLS12] for example.

Albeit ubiquitous and central in computer science, closure systems suffer from their size. Indeed, if an n -element set is given, the size of a closure system grows up to 2^n . Therefore, despite the memory available on nowadays' computers, storing a whole closure system is unaffordable or inefficient. For this reason, numerous research works have been conducted over the last decades to construct space efficient representations of lattices, see *e.g.* [Kha95, GW12, GD86, HN18, ADS86, MR92, Wil94, Mar75, BM10]. The surveys [Wil17, BDVG18] as well as the Dagstuhl Seminar [AIKBT14] are also recent witnesses of the importance and the relevance of compactly representing closure systems.

This thesis focuses on two prominent representations for closure systems, their structural and algorithmic properties, their mutual relationship. These two representations are *implications* and *meet-irreducible elements*. An implication is a mathematical expression $A \rightarrow B$ and models a causality relation between A and B in the closure system: “*If a set includes A, it must also include B*”. Every closure system can be represented by a set of implications called an *implicational base*. Dually, every set of implications gives birth to a closure system [Wil94]. As several implicational bases can represent the same closure system, numerous bases with “*good*” properties have been studied. Among them, the Duquenne-Guigues base [GD86] being minimum or the canonical direct base [BM10], also known as the proper premises base [GW12, GWBP17], have attracted much attention. More recently, Adaricheva et al. [ANR13, AN14, AN17] have proposed refinements of the canonical direct base such as the D -base and the E -base. Because of their simple nature, implications have been used under different shapes and names in computer science. For instance in KST, they are used to querying experts in order to uncover the hidden structure of a knowledge space: “*If students fail the items in A, will they also fail the items in B?*”. There is also a strong relationship between implications and functional dependencies in databases [Mai80, Mai83], Horn functions [KKS93, Kha95], attribute implications in FCA [GW12, GD86] or circuits of matroid and anti-matroids [KLS12, Die87, Whi92] for instance. A second way to compactly represent a closure system is its family of meet-irreducible elements. It is the unique minimal collection of sets from which the whole closure system can be recovered by taking set-intersection. In Knowledge Space Theory, they are known as the atoms as they form the building blocks of a knowledge space: each state is an assembly of these blocks. Similarly in Horn logic, meet-irreducible elements are called *characteristic models* [Kha95, KKS93] for they completely identify a given Horn function. Moreover, they appear in the poset of irreducibles in [Mar75, HN18, BM70], in the Armstrong relations in databases [MR92, BB79] or in the reduced context of FCA [GW12].

The organization of the manuscript reads as follows. In Chapter 1, we give a brief overview of closure systems and their representations. Moreover, we draw a connection between closure

systems and Knowledge Space Theory, for it has been the starting point of this thesis.

Chapter 2 deals with the problem of translating between the representations of a closure system. Using a hierarchical decomposition of sets of implications, we derive new algorithms applicable to particular cases of acyclic convex geometries in output-quasipolynomial time.

Chapter 3 is devoted to the study of closure systems where some sets are forbidden as supersets or subsets. Here, the tasks we handle is the enumeration of the closed sets (the sets in the closure system) that are admissible and preferred (minimal or maximal admissible) with respect to a family of forbidden sets. With the help of dualization in lattices, we obtain several intractability results. On the positive side, we derive output-polynomial time algorithms under various restrictions concerning the Carathéodory number, forbidden pairs and forbidden co-pairs of elements. The two last chapters end with a list of open questions, some of which are recalled in the general conclusion of the manuscript.

CHAPTER 1. *Closure systems and their representations*

“Il faut reprendre le langage en son milieu
Équilibrer l'écho la question la réponse
Et que l'image transparente se reflète
En un point confluent cœur du panorama.”

Poésie Ininterrompue, Paul Éluard.

Summary: *In this chapter, we introduce the scientific background in which the thesis takes place. We define closure systems, lattices, and two of their representations: implications and meet-irreducible elements. Then, we study a couple of classes of lattices which we will encounter all along the dissertation. They are summarized in the hierarchy of Figure 1.20. Afterwards, we discuss the dualization in hypergraph and lattices, for it will have a key role in this thesis. We conclude with a brief introduction to Knowledge Space Theory, and we show how this framework connects to closure systems.*

We assume the reader to be familiar with basic set-theoretic and complexity notations. In this manuscript, we mostly manipulate elements, sets, or families of sets. *All the structures we consider are finite.* We denote elements by number or letters (e.g. $1, 2, u, v$), sets by capital letters (e.g. V, C, F) and families of sets by calligraphic capital letters (e.g. $\mathcal{C}, \mathcal{M}, \mathcal{F}$). We refer to \mathbb{N} (resp. \mathbb{R}) as the set of integers (resp. real numbers). Sometimes, and mostly in examples, we shall write a set $\{u_1, u_2, \dots, u_k\}$ as the concatenation of its elements, that is $u_1 u_2 \dots u_k$. Let V be a set. The size of a subset X of V , that is the number of elements in X , is written $|X|$. The family of all subsets of V , the *powerset* of V , is written 2^V .

1.1. Preliminary notions: hypergraphs, posets

In this section, we introduce some terminology for graphs and hypergraphs (or set systems) [Ber84, GLPN93], partially ordered sets [DP02].

1.1.1. Graphs and hypergraphs

A *hypergraph* \mathcal{H} or *set system* is a pair $(V(\mathcal{H}), \mathcal{E}(\mathcal{H}))$ where $V(\mathcal{H})$ is the *ground set* and $\mathcal{E}(\mathcal{H}) \subseteq 2^V$ a collection of (*hyper*)edges. When clear from the context, we simply write V and \mathcal{E} instead of $V(\mathcal{H})$ and $\mathcal{E}(\mathcal{H})$. Moreover, we sometimes use \mathcal{H} to directly denote the edges of \mathcal{H} . A hypergraph \mathcal{H} is *simple* if for every pair of distinct edges $E_1, E_2 \in \mathcal{E}$, $E_1 \not\subseteq E_2$ and $E_2 \not\subseteq E_1$.

A *graph* G is a hypergraph where all edges have size exactly two. A graph is *bipartite* if there exists a non-trivial bipartition V_1, V_2 of V such that every edge $\{u, v\}$ of G satisfies (w.l.o.g.) $u \in V_1$ and $v \in V_2$. An *independent set* of a hypergraph \mathcal{H} is a subset I of V which does not include any edge of \mathcal{E} , that is $E \not\subseteq I$ for every $E \in \mathcal{E}$. It is (inclusion-wise) *maximal* if $I \cup \{u\}$ includes an edge of \mathcal{H} for every $u \in V \setminus I$. We denote by $\text{IS}(\mathcal{H})$ the family of independent sets of \mathcal{H} . The collection of all the maximal independent sets is called $\text{MIS}(\mathcal{H})$. Dually, a subset T of V is a *transversal* of \mathcal{H} if it intersects every edge of \mathcal{E} , i.e., if $T \cap E \neq \emptyset$ for each $E \in \mathcal{E}$. It is (inclusion-wise) *minimal* if $T \setminus \{u\}$ is no longer a transversal of \mathcal{H} , for every $u \in T$. We write $\text{Tr}(\mathcal{H})$ for the family of all transversals of \mathcal{H} . The set of all minimal transversals of \mathcal{H} is written $\text{MTr}(\mathcal{H})$. Observe that for a given hypergraph \mathcal{H} , $\text{IS}(\mathcal{H}) = \{V \setminus T \mid T \in \text{Tr}(\mathcal{H})\}$. Consequently, the complement of a maximum independent set of \mathcal{H} is a minimal transversal, and vice versa.

Example 1. Let $V = \{1, 2, 3, 4, 5\}$. In Figure 1.1, we represent a graph G on the left and a hypergraph \mathcal{H} on the right. Edges of G are 24, 23, 35 and 34. Edges of \mathcal{H} are 12, 234 and 135 (\mathcal{H} is simple). The set 12 is an independent set of G , but not of \mathcal{H} . We have:

- $\text{MIS}(G) = \{145, 125, 13\}$ and
- $\text{MIS}(\mathcal{H}) = \{345, 245, 235, 145, 134\}$



Figure 1.1 – A graph (left), and a hypergraph (right).

Hypergraphs can also be *directed*. A *directed hypergraph* \mathcal{D} is a pair $(V(\mathcal{D}), \mathcal{A}(\mathcal{D}))$ where $\mathcal{A}(\mathcal{D})$ is a set of (hyper)arcs. A hyperarc is a pair (A, b) where $A \cup \{b\} \subseteq V$, A is the *body* and b the *head* of the arc. A *directed graph* D is a directed hypergraph where the body of each arc is a singleton element.

Example 2. Again, let $V = \{1, 2, 3, 4, 5\}$. On the left of Figure 1.2 we give an example of a directed graph D with arcs $\{(4, 2), (4, 1), (3, 4), (3, 1), (5, 3), (1, 5)\}$. On the right of the same figure, we have a directed hypergraph \mathcal{D} with hyperarcs $\{(1, 4), (24, 1), (135, 2)\}$.



Figure 1.2 – A directed graph (left), and a directed hypergraph (right).

1.1.2. Partially ordered sets

We move to definitions from order theory. A *partially ordered set* or *poset* P is a pair (V, \leq) where \leq is a binary relation on V which is reflexive ($u \leq u$), transitive ($u \leq v$ and $v \leq w$ imply

$u \leq w$) and antisymmetric ($u \leq v$ and $v \leq u$ entail $u = v$). When clear from the context, we shall write $u \in P$ rather than $u \in V$. Two elements u, v are *comparable* in P if $u \leq v$ or $v \leq u$. They are *incomparable* otherwise. If $u \leq v$ but $u \neq v$, we write $u < v$. We say that v *covers* u and write $u \prec v$ when $u < v$ and there is no distinct element w in V such that $u < w < v$. In this case, v is a *successor* of u , and u a *predecessor* of v . For a given element u in V , we denote by $\text{Pred}(u)$ (resp. $\text{Succ}(u)$) its set of predecessors (resp. successors). A poset P is conveniently represented by its *Hasse diagram*. It is the graph of its covering relation (V, \prec) , where $u \prec v$ implies that u is drawn below v in the plane.

Let $v \in P$. The *ideal* of v in P , denoted $\downarrow_P v$ gathers the elements of P that are below v , that is $\downarrow_P v = \{u \in P \mid u \leq v\}$. The *filter* $\uparrow_P v$ of v is defined dually: $\uparrow_P v = \{u \in P \mid v \leq u\}$. The definition of ideal and filter naturally extend to subsets of P . More precisely, for a given subset X of P , the ideal $\downarrow_P X$ of X is the union of the ideals of the elements in X , i.e. $\downarrow_P X = \bigcup_{u \in X} \downarrow u$. The filter $\uparrow_P X$ of X is defined accordingly. When clear from the context, we shall drop the subscript P and simply write $\downarrow v$ and $\uparrow v$. A *chain* of P is a subset C of P in which every pair of elements are comparable. The size of a chain is the number of elements it contains minus one. Dually, an *antichain* A is a set of pairwise incomparable elements of P . The *height* $h(P)$ of a poset P is the size of its longest chain.

Example 3. Let $V = \{1, 2, 3, 4, 5, 6\}$ and consider the relation \leq given by $1 \leq 2 \leq 4, 1 \leq 3 \leq 5, 3 \leq 4$ and $2 \leq 5$. Let P be the poset (V, \leq) . Its Hasse diagram is represented in Figure 1.3. We have for instance $1 \prec 2, 2 \parallel 3, \text{Pred}(2) = \{1\}$ and $\text{Succ}(2) = \{4, 5\}$. Moreover, we have $\uparrow 2 = \{2, 4, 5\}, \downarrow 2 = \{1, 2\}$. The subset $\{1, 3, 5\}$ is a chain, while $\{2, 3, 6\}$ is an antichain of P .

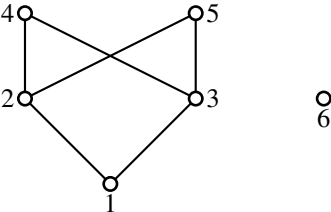

Figure 1.3 – A poset P .

Let P, Q be two posets and $\varphi: P \rightarrow Q$ be a map. We say that φ is *order-embedding* if $u \leq v$ implies that $\varphi(u) \leq \varphi(v)$ for every $u, v \in P$. The map φ is *order-preserving* when $u \leq v$ if and only if $\varphi(u) \leq \varphi(v)$. Finally, φ is an *(order) isomorphism* if it is a bijective order-preserving map between P and Q . We say that P and Q are *isomorphic* if there is an isomorphism from P to Q . Intuitively, P and Q are isomorphic when they can be represented by the same Hasse diagram, up to the labels of elements. The poset *dual* to P is the poset $P' = (V, \leq')$ where $u \leq' v$ if and only if $v \leq u$.

1.2. Lattices and closure systems

In this section we introduce *lattices* and *closure systems*, and discuss the one-to-one correspondence between the two objects. Most of the definitions given here originates from [Grä11, DP02, Bir40].

We begin with further definitions on ordered sets. Let $P = (V, \leq)$ be a poset and u, v be two distinct elements of V . The *meet* (or *greatest lower bound*) of u and v , denoted by $u \wedge v$ if it exists, is the unique maximal element belonging to both $\downarrow u$ and $\downarrow v$. The *join* (or *least upper bound*) $u \vee v$ of u and v is defined dually as the unique minimal element above u and v , and may not exist in general. These notions allow introducing the order-theoretic version of lattices.

DEFINITION 1. *Let L be a poset (V, \leq) . We say that L is a lattice if $u \wedge v$ and $u \vee v$ exist for every pair of elements u, v in V .*

The \wedge operation is commutative ($u \wedge v = v \wedge u$), associative ($u \wedge (v \wedge w) = (u \wedge v) \wedge w$), idempotent ($u \wedge u = u$) and absorbing ($u \wedge (u \vee v) = u$). The join operation similarly enjoys these properties, where the absorption law reads as $u \vee (u \wedge v) = u$. Using commutativity and associativity, we can extend the meet operation to subsets of V as follows. For $X = \{u_1, \dots, u_k\}$, $k \leq |V|$, we have $\bigwedge X = u_1 \wedge u_2 \wedge \dots \wedge u_k$. The join $\bigvee X$ is defined dually.

Since in a lattice L , every pair of elements has both a meet and a join, it follows by finiteness that L admits a unique minimal element \perp satisfying $\perp \leq u$ for every $u \in L$, called the *bot* or *bottom*. Similarly, L possesses a unique maximal element \top , called the *top*, such that $u \leq \top$ for every $u \in L$. It is customary to put $\perp = \bigvee \emptyset$ and $\top = \bigwedge \emptyset$. An element $j \in L$ is *join-irreducible* in L if it is different from \perp and for every $u, v \in L$, $j = u \vee v$ implies that $u = j$ or $v = j$. *Meet-irreducible elements* are defined similarly using the \wedge operation. The top element of L is not meet-irreducible. We call $\mathcal{J}(L)$ and $\mathcal{M}(L)$ the set of join-irreducible elements and meet-irreducible elements of L , respectively. Let $u \in L$. We denote $\mathcal{J}(u)$ the set of join-irreducible elements below u in L , i.e. $\mathcal{J}(u) = \{j \in \mathcal{J}(L) \mid j \leq u\}$. A *join-representation* of u is a subset J_u of $\mathcal{J}(u)$ such that $\bigvee J_u = u$. A join representation J_u of u is *minimal* or *irredundant* if for every $j \in J_u$, $\bigvee (J_u \setminus \{j\}) \neq u$. The set $\mathcal{M}(u)$ is defined dually for meet-irreducible elements above u , and we have $u = \bigwedge \mathcal{M}(u) = \bigvee \mathcal{J}(u)$. *Meet-representations* and their *minimal* (or *irredundant*) version are defined accordingly. Irreducible elements are characterized by their covers: a meet-irreducible element m has a unique successor, and a join-irreducible element j a unique predecessor. The *atoms* of a lattice L are the elements covering its bottom, and *co-atoms* are predecessors of the top. We denote by $\text{At}(L)$ the atoms of L , and $\text{coAt}(L)$ its co-atoms. Observe that $\text{At}(L) \subseteq \mathcal{J}(L)$ and $\text{coAt}(L) \subseteq \mathcal{M}(L)$. A lattice L is *atomistic* (resp. *co-atomistic*) when $\text{At}(L) = \mathcal{J}(L)$ (resp. $\mathcal{M}(L) = \text{coAt}(L)$).

Example 4. In Example 3, the meet of 4 and 5 is undefined as 2 and 3 are both maximal elements below 4 and 5. On the other hand, we have $2 \wedge 3 = 1$. Similarly, the join of 4 and 5 is undefined, as there is no element in $\{1, 2, 3, 4, 5\}$ above 4 and 5 at the same time. Finally, we have $2 \vee 5 = 5$ as $2 \leq 5$. Thus, P is not a lattice.

Consider instead $V = \{\perp, 1, \dots, 10, \top\}$ and the poset $L = (V, \leq)$ given in Figure 1.4. Here, we have for instance $2 \vee 9 = \top$ and $2 \wedge 9 = 1$. The poset L is a lattice. We have $\mathcal{J}(L) = \{1, 2, 3, 4, 5\}$ and $\text{At}(L) = \{1, 3\}$. On the other hand, $\mathcal{M}(L) = \{2, 4, 7, 8, 9, 10\}$ and $\text{coAt}(L) = \{8, 10\}$.

The definition of a lattice can be weakened to *semilattice*. A *meet-semilattice* is a poset in which the \wedge operation is well-defined. A *join-semilattice* is defined accordingly with the \vee operation. Thus, a lattice is both a meet-semilattice and a join-semilattice. Note that a join-semilattice with a top element automatically becomes a lattice (see [DP02]). Let $L = (V, \leq)$ be

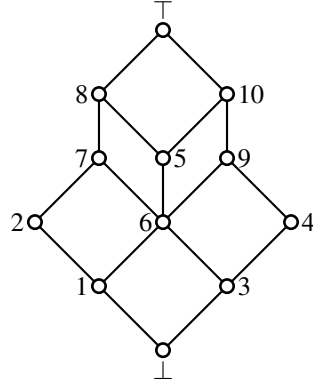

Figure 1.4 – A lattice (the knight lattice).

a lattice with meet \wedge and join \vee . A *sublattice* of L is a lattice $L' = (X, \leq)$ with $X \subseteq V$ which is closed under \wedge and \vee , that is $u, v \in X$ implies that $u \vee v$ and $u \wedge v$ also belong to X . In the fashion of semilattices, a \wedge -sublattice of L is a lattice L' defined over a subset of V and closed by the \wedge operation of L . A \vee -sublattice of L is defined likewise with the join of L .

Going back to families of sets, we introduce *closure systems* and *closure operators* and we relate them to lattices.

DEFINITION 2. Let $\mathcal{C} \subseteq 2^V$ be a set system over V . We say that \mathcal{C} is a *closure system* (over V) if $V \in \mathcal{C}$ and $C_1 \cap C_2 \in \mathcal{C}$ for every C_1 and C_2 in \mathcal{C} .

If \mathcal{C} is a closure system, we say that a set C in \mathcal{C} is *closed* or a *closed set*. Closure systems are strongly connected to closure operators.

DEFINITION 3. A mapping $\phi: 2^V \rightarrow 2^V$ is a *closure operator* if for every $X, Y \subseteq V$, it satisfies the following properties:

- $X \subseteq \phi(X)$ (*extensive*),
- $X \subseteq Y$ implies $\phi(X) \subseteq \phi(Y)$ (*monotone*),
- $\phi(X) = \phi(\phi(X))$ (*idempotent*).

Each closure system \mathcal{C} induces a closure operator $\phi_{\mathcal{C}}$ defined by $\phi(X) = \bigcap \{C \in \mathcal{C} \mid X \subseteq C\}$, for every $X \subseteq V$. Similarly, a closure operator $\phi_{\mathcal{C}}$ is associated to the closure system \mathcal{C}_{ϕ} of its fixed points, that is $\mathcal{C}_{\phi} = \{C \subseteq V \mid \phi(C) = C\} = \{\phi(X) \mid X \subseteq V\}$. Moreover, this relationship between closure operators and closure systems is one-to-one. Therefore, when no confusion can arise, we shall drop the subscripts and write ϕ and \mathcal{C} for a closure operator and its associated closure system.

DEFINITION 4 (Standard closure system). A closure system \mathcal{C} over V with associated closure operator ϕ is *standard* if for every $u \in V$, $\phi(u) \setminus \{u\}$ is closed.

We move to the connection between closure systems and lattices. When ordered by inclusion, a closure system \mathcal{C} is a poset where the \wedge operation is set intersection \cap . Since \mathcal{C} has a top element, it follows that (\mathcal{C}, \subseteq) is a (closure) lattice. The join operation $C_1 \vee C_2$ is given by $\phi(C_1 \cup C_2)$, for every $C_1, C_2 \in \mathcal{C}$. Dually, if $L = (V, \leq)$ is a lattice, the set system

$\{\mathcal{F}(u) \mid u \in V\}$ ordered by inclusion is a closure system isomorphic to L with ground set $\mathcal{F}(L)$. As a consequence, we have that lattices and closure systems are equivalent notions. Thus, we will interchangeably use the two terms. Notice that the closure system we associate to a lattice through the mapping $u \mapsto \mathcal{F}(u)$ is always standard. On the other hand, $\mathcal{F}(\mathcal{C})$ and V coincide in a standard closure system \mathcal{C} , *i.e.* if $\mathcal{F}(\mathcal{C}) = \{\phi(u) \mid u \in V\}$ and for every distinct $u, v \in V$, $\phi(u) \neq \phi(v)$.

Example 5. In Figure 1.5 we give the closure system \mathcal{C} associated to the lattice of Figure 1.4 where $\mathcal{F}(L) = \{1, 2, 3, 4, 5\}$. If ϕ is the closure operator associated to \mathcal{C} we have for instance $\phi(24) = 12345$.

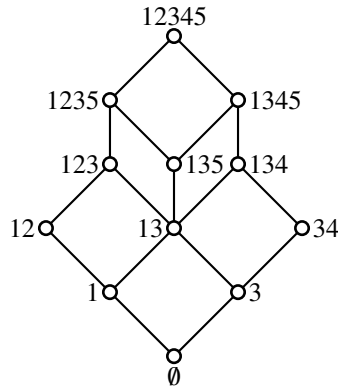

Figure 1.5 – A closure system \mathcal{C} over $\{1, 2, 3, 4, 5\}$.

Using the link with lattices, we introduce further notions on closure systems. Let \mathcal{C} be a closure system over V . A *key* of \mathcal{C} is a subset K of V such that $\phi(K) = V$ and for every $u \in K$, $\phi(K \setminus \{u\}) \neq V$. We denote by $\mathcal{K}(\mathcal{C})$ or simply \mathcal{K} the set of all keys of \mathcal{C} . It is known (see e.g., [Thi86, BM10]) that when we see \mathcal{K} as a hypergraph, we have $\text{MIS}(\mathcal{K}) = \text{coAt}(\mathcal{C})$. More generally, if C is a closed set, a *spanning set* of C is a subset S of V such that $\phi(S) = C$. A spanning set S of C is *minimal* if for every $u \in S$, $\phi(S \setminus \{u\}) \neq C$. A related notion is the one of a *minimal generator*. Let $u \in V$. A *minimal generator* of u is a subset A_u of V such that $u \in \phi(A_u)$ but $u \notin \phi(A_u \setminus \{v\})$ for every $v \in A_u$. Observe that a minimal generator is always a minimal spanning set, while the converse is not true.

1.3. Representations of a closure system

In this section we present with more details the two possible representations for closure systems we hinted in the introduction: implications and meet-irreducible elements.

1.3.1. Meet-irreducible elements

We give more insight about the meet-irreducible elements of lattices and closure systems. We define the arrow relations, borrowed from [GW12]. Let L be a lattice and $u, v \in L$. We write $u \uparrow v$ if $v \in \max_{\leq}(\{w \in L \mid u \not\leq w\})$. Note that $u \uparrow v$ implies $v \in \mathcal{M}(L)$. Dually, we write $v \downarrow u$ if $v \in \min_{\leq}(\{w \in L \mid w \not\leq u\})$ and $v \downarrow u$ entails that $v \in \mathcal{F}(L)$. Finally, we write $u \updownarrow v$ if $u \uparrow v \downarrow u$.

Arrow relations play a key role in understanding the structure of lattices and closure systems. Some example of use will be given in future subsections. Here, we simply mention for instance the D -relation, a must-have in the study of free and bounded lattices [FJN95, Day70]. Let $j_1, j_2 \in \mathcal{J}(L)$ with $j_1 \neq j_2$. We write $j_1 D j_2$ if there exists $m \in \mathcal{M}(L)$ such that $j_1 \uparrow m \downarrow j_2$. A D -cycle is a sequence j_1, \dots, j_k of join-irreducible elements such that $j_1 D j_2 D \dots D j_k D j_1$.

Example 6. We use the lattice of Example 4. We have $\mathcal{M}(L) = \{2, 7, 8, 4, 9, 10\}$ and $5 \uparrow 7$ as $5 \uparrow 7 \downarrow 5$. Moreover, $5D2$ holds as $5 \uparrow 9 \downarrow 2$ and $5D4$ as $5 \uparrow 7 \downarrow 4$.

There are several ways to represent the set of meet-irreducible elements of a lattice. The aim of these equivalent representations is to highlight different structural properties of lattices. We cite three have been well-studied:

- (i) the binary incidence matrix $\mathfrak{K}(L) = (\mathcal{J}(L), \mathcal{M}(L), \leq)$ where we put 1 or \times in the value indexed by (j, m) if and only if $j \leq m$, for some $j \in \mathcal{J}(L)$ and $m \in \mathcal{M}(L)$. This representation is mostly used in Formal Concept Analysis where it is known as the (*reduced context*) of the lattice L [GW12].
- (ii) Dually to $\mathfrak{K}(L)$, the *bipartite of irreducible* (or *poset of irreducible*) is the bipartite graph $\text{Bip}(L) = (\mathcal{J}(L), \mathcal{M}(L), \not\leq)$. It has been introduced by Markowsky in [Mar75, Mar92].
- (iii) Using the arrow relations, the authors in [HN18] define the *set-colored poset* of a lattice. The set-colored poset $P(L)$ of L is the tuple $(\mathcal{J}(L), \leq, \gamma, \mathcal{M}(L))$ where $(\mathcal{J}(L), \leq)$ is the order of L restricted to its join-irreducible elements, and $\gamma: \mathcal{J}(L) \rightarrow \mathbf{2}^{\mathcal{M}(L)}$ maps each $j \in \mathcal{J}(L)$ to the set $\{m \in \mathcal{M} \mid m \downarrow j\}$.

To conclude this subsection, we give the expression of meet-irreducible elements in closure systems. In a closure system \mathcal{C} over V , a closed set M is meet-irreducible if it cannot be obtained as the intersection of distinct closed sets of \mathcal{C} . Moreover, for each $C \in \mathcal{C}$, $\mathcal{M}(C) = \{M \in \mathcal{M}(\mathcal{C}) \mid C \subseteq M\}$ and $C = \bigcap \mathcal{M}(C)$.

Remark 1. The expression $\mathcal{M}(C)$ translates into the language of closure systems the usual representation of an element in a lattice by meet-irreducible elements.

Thus, $\mathcal{M}(\mathcal{C})$ is the unique minimum subset of \mathcal{C} from which the whole closure system can be reconstructed by taking set-intersections.

Example 7. In the closure system of Figure 5, we have $\mathcal{M}(\mathcal{C}) = \{12, 34, 123, 134, 1235, 1345\}$. Every closed set can be recovered from $\mathcal{M}(\mathcal{C})$, for instance, $13 = 123 \cap 1345$.

1.3.2. Representing a closure system with implications

In this part we give a glimpse of the theory of *implications*. An implication is a simple mathematical model for an “if ... then ...” expression such as “if it rains, (then) the dog will have muddy paws.”. As such it can express a causality relation, a dependence, antecedence, deduction systems, and so forth.

DEFINITION 5. An implication over V is an expression of the form $A \rightarrow B$ where A, B are subsets of V . In $A \rightarrow B$, A is called the premise and B the conclusion. An implicational base Σ over V is a collection of implications over V .

An implication of the form $A \rightarrow b$ is called *right-unit*, while an implication like $a \rightarrow B$ is *left-unit*. Let Σ be an implicational base over V . We denote by $|\Sigma|$ the *size* of Σ , *i.e.* the number of implications it contains. The *total size* $\|\Sigma\|$ of Σ is $\sum_{A \rightarrow B \in \Sigma} |A| + |B|$. Let $C \subseteq V$. We say that C *satisfies, models or is closed for* Σ if for every $A \rightarrow B \in \Sigma$, $A \subseteq C$ implies $B \subseteq C$. Let us denote by \mathcal{C}_Σ the family of models of Σ . It is well-known (see e.g. [Wil17, BDVG18, CM03]) that \mathcal{C}_Σ is in fact a closure system.

Example 8. Let $V = \{1, 2, 3, 4, 5\}$ and let $\Sigma = \{2 \rightarrow 1, 4 \rightarrow 3, 5 \rightarrow 13, 24 \rightarrow 5\}$ be an implicational base. On the one hand, 235 is not closed in Σ since it fails the implication $2 \rightarrow 1$: $2 \in 235$ but $1 \notin 235$. On the other hand, 1235 is closed for Σ . The closure system associated to Σ is the one of Example 5 (see also Figure 1.5). The implication $5 \rightarrow 13$ is left-unit, and $24 \rightarrow 5$ is right-unit. Finally, $2 \rightarrow 1$ is both left and right-unit.

As a consequence, an implicational base Σ encodes a closure operator ϕ_Σ . For every $X \subseteq V$, the closure $\phi_\Sigma(X)$ of X can be computed in polynomial time in the size of Σ and V by using the well-known closure algorithm, also known as the forward-chaining procedure. This procedure starts from X and constructs a sequence $X = X_0 \subseteq \dots \subseteq X_k = \phi_\Sigma(X)$ of subsets of V such that for every $1 \leq i \leq k$, $X_i = X_{i-1} \cup \bigcup \{B \mid \exists A \rightarrow B \in \Sigma \text{ such that } A \subseteq X_{i-1}\}$. The routine stops when $X_{i-1} = X_i$. Several algorithms for computing the closure of a set from a set implications have been implemented. The article [BO14] surveys and compares these different approaches.

We have seen that an implicational base is always associated to a closure system. It turns out the other way around also holds true: if \mathcal{C} is a closure system over V with induced closure operator ϕ , the set of models of the implicational base $\{A \rightarrow \phi(A) \mid A \subseteq V\}$ is exactly \mathcal{C} . In fact, a closure system can be represented by several implicational bases. Two implicational bases with the same closure system are *equivalent*. For instance, any implicational base Σ has a *right-unit expansion* Σ_u , equivalent to Σ , obtained by replacing every implication $A \rightarrow B$ in Σ by the set $\{A \rightarrow b \mid b \in B\}$ of right-unit implications. We say that an implication $A \rightarrow B$ holds in Σ if every model of Σ is a model of $A \rightarrow B$. Equivalently, $A \rightarrow B$ holds in Σ if and only if $B \subseteq \phi(A)$.

To conclude this section, we highlight particular implicational bases that have been well studied in the literature. First, much effort have been put on finding an implicational base Σ which is as short as possible, leading to different minimality criteria for Σ [Wil17, ADS86, Mai83]. Computing an implicational base which is *minimum*, *i.e.* with the least possible number of implications among equivalent bases, can be done in polynomial time, see e.g. [Sho86, GD86, Wil95, Day92, Mai80]. Among minimum implicational bases, the Duquenne-Guigues base (or canonical base) [GD86] plays a prominent role for it is uniquely defined for each closure system. It relies on the notion of pseudo-closed set. These are defined recursively: $P \subseteq V$ is pseudo-closed if it is not closed and $\phi(P') \subset P$ for every pseudo-closed set $P' \subset P$. The canonical base is then $\{P \rightarrow \phi(P) \mid P \text{ is pseudo-closed}\}$. Other minimality criteria such as optimality (minimizing $\|\cdot\|$), left-optimality and right-optimality have been studied in depth, see for instance [ADS86, AL17, Mai80, ?, Wil00, HK95] and [Wil17, AL17] for surveys about the topic. Unlike minimality however, all these three measures are hard to optimize [ADS86].

Another parameter of interest is the time spent in the computation of the closure of a set, thus motivating works on *direct* implicational bases. An implicational base is direct when the closure algorithm stops after a single iteration independently of its input set. For example, the implicational base $\{A \rightarrow \phi(A) \mid A \subseteq V\}$ is direct, for every closure operator ϕ over V . In the

fashion of the canonical base, there exists a *canonical direct base* being minimum among all direct bases. It has been rediscovered and characterized several times in different settings, for instance with the base of proper premises in [GW12, GWBP17]. In [BM10], Bertet and Monjardet survey and unify all of these characterizations. One of its definitions relies on minimal generators. The canonical direct base Σ_{cd} of a closure system \mathcal{C} is the set of all implications $A_v \rightarrow v$, where A_v is a non-trivial minimal generator of v . Remark that the size of Σ_{cd} is in general exponential in the size of a minimum implicational base.

Remark 2. Directed hypergraphs are a convenient graphical representation for implications [ADS86, AL17, Mai80]. If Σ is an implicational base, we can associate to Σ a directed hypergraph $\mathcal{D}_\Sigma = (V \cup \{\varepsilon\}, \mathcal{A})$ where $\mathcal{A} = \{(A, b) \mid A \rightarrow b \in \Sigma_u\} \cup \{(\varepsilon, b) \mid \emptyset \rightarrow b \in \Sigma_u\}$. When \emptyset is closed, ε can be omitted.

Example 9. Let $V = \{u_1, \dots, u_k, v_1, \dots, v_k, w_1, \dots, w_k, x\}$ for some $k \in \mathbb{N}$. Consider the following set Σ of implications $\{u_i v_i \rightarrow w_i \mid 1 \leq i \leq k\} \cup \{w_1 \dots w_k \rightarrow x\}$. We give the associated directed hypergraph in Figure 1.6.

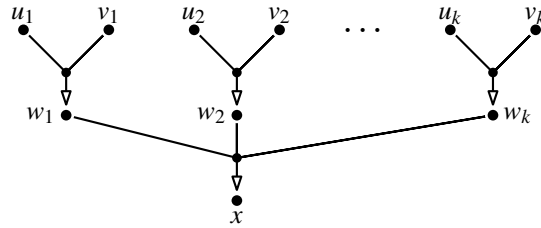

Figure 1.6 – The directed hypergraph associated to Σ .

Quite clearly, Σ is minimum. A minimal generator of x is any element from the Cartesian product $\prod_{1 \leq i \leq k} \{u_i v_i, w_i\}$. Hence, the number of minimal generators of x is exponential in k , so that the size of the canonical direct base is exponential in the size of Σ .

We finish by mentioning works of Adaricheva et al. [ANR13, AN14, AN17] on the D -base Σ_D of a closure system. It is a refinement of the canonical direct base, designed from the D -relation, which has the property of being *ordered direct*. It means that when the implications in Σ_D are suitably ordered, this implicational base becomes direct. As compared to Σ_{cd} , Σ_D has the advantage of being shorter in the case where \mathcal{C} is not atomistic. If \mathcal{C} is atomistic however, $\Sigma_{cd} = \Sigma_D$ and their size can also be exponential in the size of a minimum implicational base. This is the case for instance in Example 9.

1.4. Classes of closure systems and lattices

We now introduce most of the classes of closure systems we will encounter throughout the manuscript. In general, these classes are given in lattice-theoretic terms. In these cases, the class of a closure system is the class of its associated lattice. We conclude this subsection by a hierarchy of these classes.

Boolean lattices

Boolean lattices are easier to describe from the closure system point of view. Let L be a lattice and let \mathcal{C} be the associated standard closure system over $\mathcal{F}(L)$. We say that L is *Boolean* if $\mathcal{C} = \mathbf{2}^{\mathcal{F}(L)}$. Put another way, a lattice with n join-irreducible elements is Boolean if it is isomorphic to the n -dimensional hypercube. If \mathcal{C} is a standard Boolean closure system over V , the simplest implicational base Σ describing \mathcal{C} has no implications, *i.e.* $\Sigma = \emptyset$, as every subset of V is closed. The meet-irreducible elements of \mathcal{C} are exactly its co-atoms, and we have $\mathcal{M}(\mathcal{C}) = \{V \setminus \{v\} \mid v \in V\}$. In Figure 1.7 we give examples of Boolean closure systems.

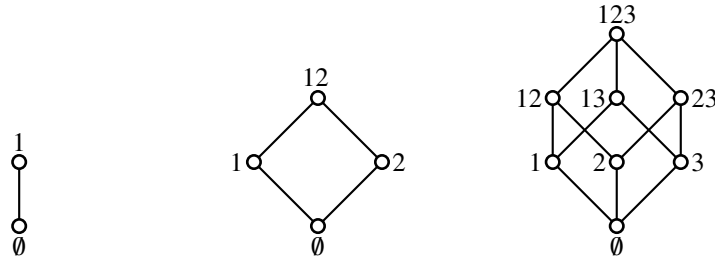

Figure 1.7 – Boolean closure systems on $\{1\}$, $\{1,2\}$ and $\{1,2,3\}$ respectively.

Distributivity

A lattice L is *distributive* when the two operations \wedge and \vee are distributive over each other, *i.e.* when for every $u, v, w \in L$, $u \wedge (v \vee w) = (u \wedge v) \vee (u \wedge w)$ and $u \vee (v \wedge w) = (u \vee v) \wedge (u \vee w)$. We mention two famous characterizations of distributive lattices. First, they are identified by two forbidden sublattices known as the diamond M_3 and the pentagon N_5 , represented in Figure 1.8. More precisely we have

THEOREM 1 (See e.g. [DP02, Grä11]). *A lattice is distributive if and only if it does not contain the diamond or the pentagon as sublattices.*

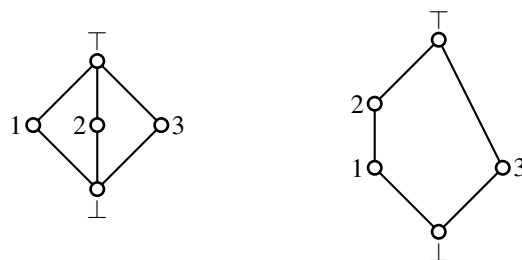

Figure 1.8 – The diamond and the pentagon on $V = \{\perp, 1, 2, 3, \top\}$.

The second characterization is the one of Birkhoff [Bir37] which says that a distributive lattice coincide with the set of ideals of a poset.

THEOREM 2 ([Bir37]). *A lattice is distributive if and only if it is isomorphic to the family of ideals of a poset, ordered by inclusion.*

This theorem allows connecting with closure systems. If L is a distributive lattice, its associated closure system is exactly the family of ideals of its poset of join-irreducible elements $(\mathcal{J}(L), \leq)$. On the other hand, if $P = (V, \leq)$ is a poset, the collection of all of its ideals is both closed by intersection and union, and yields a standard closure system. In particular, a standard closure system is distributive if and only if it is closed by union. The description of distributivity with posets also permits to identify standard distributive closure systems by particular implicational bases. A standard closure system \mathcal{C} is distributive if and only if it admits a left-unit implicational base. This is because such an implicational base encodes a poset where $v \leq u$ precisely when $u \rightarrow v$ holds. Finally, we mention the bijection between $\mathcal{J}(\mathcal{C})$ and $\mathcal{M}(\mathcal{C})$ given by the \uparrow relation. For every $u \in V$, the unique $M \in \mathcal{M}(\mathcal{C})$ such that $\phi(u) \uparrow M$ is given by $M = V \setminus \{v \in V \mid v \rightarrow u \text{ holds}\}$.

Example 10. Let $V = \{1, 2, 3, 4, 5\}$ and consider the poset P given on the left of Figure 1.9. The closure system \mathcal{C} of its ideal is represented on the right of the same figure. An implicational base for \mathcal{C} is $\{5 \rightarrow 34, 3 \rightarrow 1, 4 \rightarrow 1\}$. It coincides with the cover relation of P .

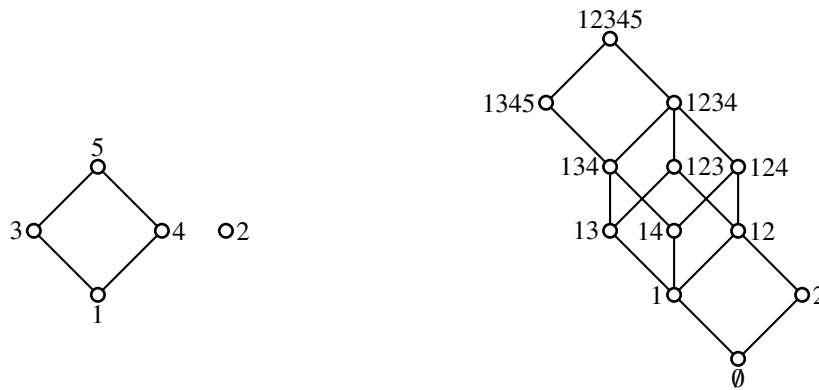

Figure 1.9 – A poset and the corresponding distributive closure system of its ideals.

Modular lattices

Perhaps the most famous generalization of distributivity is modularity. A lattice L is modular if for every $u, v, w \in L$ with $u \leq v$, $(u \vee w) \wedge v = u \vee (v \wedge w)$ holds. Modular lattices also enjoy a characterization by forbidden sublattices similar to distributive lattices. In fact, it is even a weaker version of Theorem 1.

THEOREM 3 (See e.g. [DP02, Grä11]). *A lattice is modular if and only if it does not contain the pentagon as a sublattice.*

Modular lattices are also present in projective geometry and matroid theory [HPR94, Whi92, Ste99]. It is known that there is a bijection between $\mathcal{J}(L)$ and $\mathcal{M}(L)$. Moreover, there exists a bijection $f: \mathcal{J}(L) \rightarrow \mathcal{M}(L)$ such that $j \leq f(j)$ in L [Kun85]. In [Wil00, HW96], the authors show that a standard modular closure system can always be represented by a set of implications with binary premises.

Example 11. Let $V = \{1, 2, 3, 4, 5\}$ and consider the closure system \mathcal{C} given in Figure 1.10. It is modular. Observe that it contains the diamond as a sublattice. An implicational base for \mathcal{C} is

for instance $\Sigma = \{5 \rightarrow 1, 12 \rightarrow 3, 13 \rightarrow 2, 23 \rightarrow 1\}$. We have $\mathcal{M} = \{24, 34, 1235, 145, 1234\}$ and a bijection between V and $\mathcal{M}(\mathcal{C})$ is for instance $2 \in 24, 3 \in 34, 1 \in 1235, 5 \in 145$ and $4 \in 1234$.

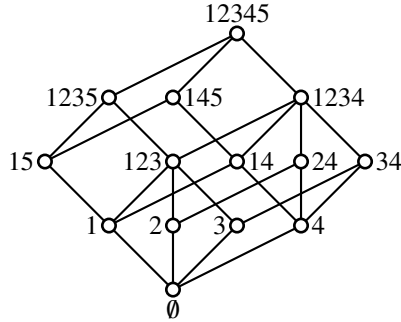

Figure 1.10 – A modular closure system over $V = \{1, 2, 3, 4, 5\}$.

Bounded lattices

In his work on the word problem and free lattices [Day70], A. Day introduced the *doubling construction* in lattices. The main idea behind this operation is to select a part of a lattice L and duplicate it to obtain a new lattice L' . We first need some more definitions about lattices. Let L be a lattice and $\ell, u \in L$ with $\ell \leq u$. The *interval* defined by ℓ and u is the set of elements in L that are above ℓ but below u . We denote this interval by $[\ell, u]$. We say that ℓ is the *lower bound* of the interval, and u its *upper-bound*.

DEFINITION 6. Let L be a lattice, $I = [\ell, u]$ an interval of L and let $(\{0, 1\}, \leq)$ be the two elements chain. Then $L[I] = ((L \setminus I) \cup (I \times \{0, 1\}), \leq')$ is the lattice obtained by duplication of I where:

$$u' \leq' v' \iff \begin{cases} u', v' \in L \text{ and } u' \leq v' \text{ in } L \\ u' \in L \setminus I, v' = vi \in I \times \{0, 1\} \text{ and } u' \leq v \\ u' = ui \in I \times \{0, 1\}, v' \in L \setminus I \text{ and } u \leq v' \\ u = ui, v = vj \in I \times \{0, 1\}, u \leq v \text{ and } i \leq j \end{cases}$$

The previous definition can be adapted to lower-pseudo intervals and upper-pseudo intervals. Let ℓ, u_1, \dots, u_k be elements of L such that $\ell \leq u_i$ for every $1 \leq i \leq k$. Putting $U = \{u_1, \dots, u_k\}$, the *lower-pseudo interval* $[\ell, U]$ is defined by $[\ell, U] = \bigcup_{u_i \in U} [\ell, u_i]$. *Upper-pseudo intervals* are defined dually. The duplication of lower and upper-pseudo interval follows. We can now introduce bounded lattices. A lattice L is *bounded* if it is obtained from a Boolean lattice by repeated duplications of intervals. *Lower-bounded* and *upper-bounded* lattices are defined accordingly with pseudo-intervals. A lattice is bounded if and only if it is both lower and upper-bounded. Bounded lattices and duplications have been at the core of an extensive study [BC02] using the perspective of meet-irreducible elements. A useful characterization of lower-bounded lattices can be given using the D -relation:

LEMMA 1 ([FJN95]). A finite lattice is lower-bounded if and only if it has no D -cycles.

Example 12. In Figure 1.11 we consider from left to right a series of duplications starting from the Boolean closure system $\{1, 2\}$. The last step is a duplication of a lower-pseudo interval. The resulting closure system is lower-bounded but not bounded. An implicational base for this last closure lattice is $\{5 \rightarrow 1, 3 \rightarrow 1, 34 \rightarrow 5, 2 \rightarrow 4, 12 \rightarrow 345\}$ and its meet-irreducible elements are the closed sets 13, 14, 24, 135, 145, and 1345. We highlight parts to duplicate with filled dots and dashed lines.

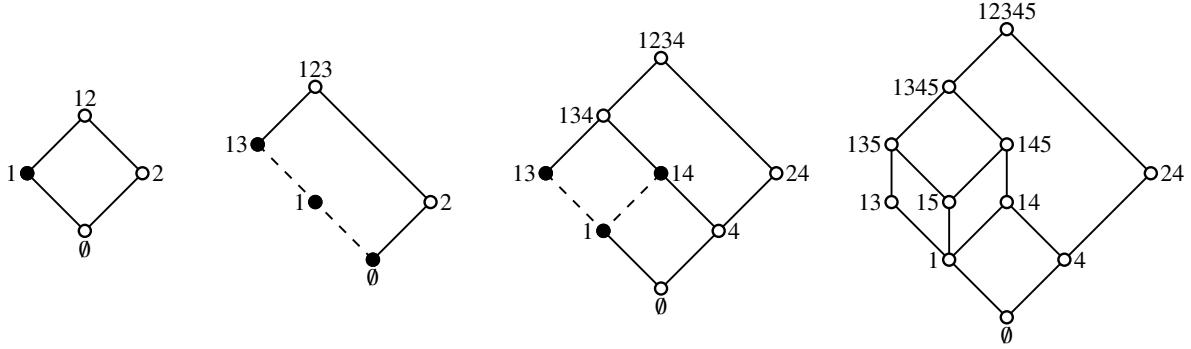

Figure 1.11 – Duplications of (lower pseudo-)intervals.

Semidistributivity

We now introduce yet another generalization of distributivity called semidistributivity [GN81, AGT03, FJN95, Nat00]. A lattice L is meet-semidistributive if for every $u, v, w \in L$, $u \wedge v = u \wedge w$ implies that $u \wedge (v \vee w) = (u \wedge v) \vee (u \wedge w)$. It is *join-semidistributive* when it satisfies the dual law with \vee . If L is both join and meet-semidistributive, it is *semidistributive*. Semidistributive lattices enjoy a nice characterization by the mean of arrow relations.

THEOREM 4 (See e.g. [Nat00]). *Let L be a lattice. Then:*

- L is join-semidistributive if and only if for every $m \in \mathcal{M}(L)$, there exists a unique $j \in \mathcal{J}(L)$ such that $j \uparrow m$;
- L is meet-semidistributive if and only if for every $j \in \mathcal{J}(L)$, there exists a unique $m \in \mathcal{M}(L)$ such that $j \uparrow m$;
- L is semidistributive if and only if the \uparrow relation is a bijection between $\mathcal{J}(\mathcal{C})$ and $\mathcal{M}(\mathcal{C})$.

Thus, semidistributivity is the generalization of distributivity which preserves the bijection between $\mathcal{M}(L)$ and $\mathcal{J}(L)$ given by \uparrow .

Example 13. In Figure 1.12, we give four closure systems along with their arrow relations. We proceed from left to right. The first closure system is semidistributive. The second is join-semidistributive but not meet-semidistributive as the join-irreducible element 3 satisfies $3 \uparrow 1$ and $3 \uparrow 2$. Dually, the third closure system is meet-semidistributive but not join-semidistributive. Finally, the last closure system is neither meet nor join-semidistributive as we have $1 \uparrow 2$, $1 \uparrow 3$ on the one hand, and $1 \uparrow 2$ and $3 \uparrow 2$ on the other hand.

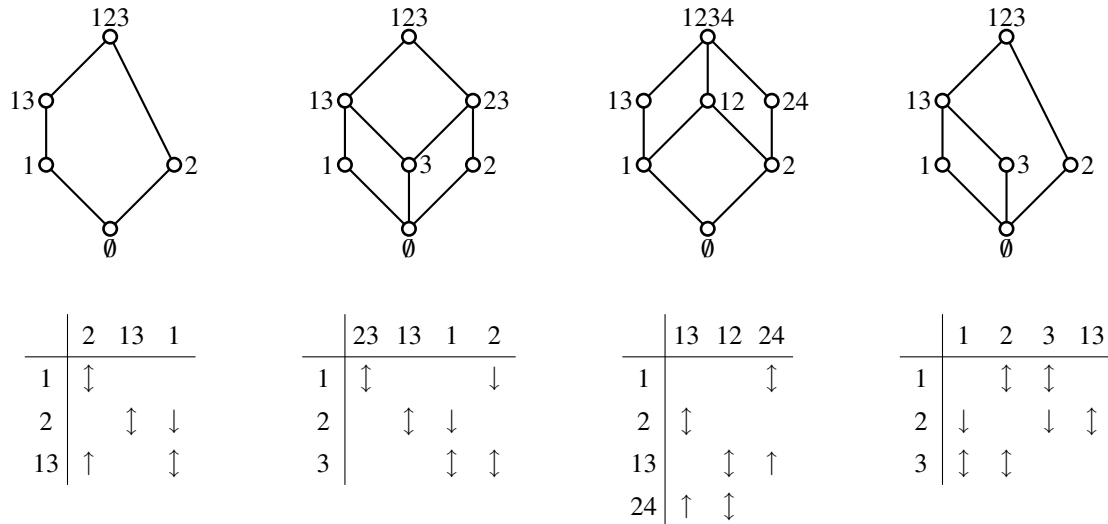

Figure 1.12 – Illustrating semidistributivity on closure systems with their arrow tables.

Semimodularity

We now turn to a generalization of modularity called *semimodularity* which acts on the covering relation of a lattice. We follow the monograph of Stern [Ste99] as it is a standard textbook about semimodular lattices and their properties. A lattice L is *upper-semimodular* if for every $u, v \in L$, $u \wedge v \prec u$ implies that $v \prec v \vee u$. In the finite case, this condition is equivalent to the Birkhoff condition which reads as follows: $u \wedge v \prec u, v$ implies that $u, v \prec u \vee v$. If L satisfies the dual law, it is *lower-semimodular*. Semimodularity provides another definition of modularity: L is modular if and only if it is both upper and lower-semimodular.

Example 14. In Figure 1.13, we give four closure systems. We proceed from left to right. The first is both upper and lower-semimodular. It is then modular. The second closure system is upper-semimodular but not lower-semimodular: $12, 34 \prec 1234$ but $12 \cap 34 = \emptyset \not\prec 12, 34$. On the contrary, the third closure system is lower-semimodular and not upper-semimodular. Indeed, we have for instance $1 \cap 3 = \emptyset \prec 1, 3$ but $1, 3 \not\prec 123$. The last closure system is neither upper nor lower-semimodular: the pair $1, 3$ fails upper-semimodularity and the pair $12, 3$ fails lower-semimodularity.

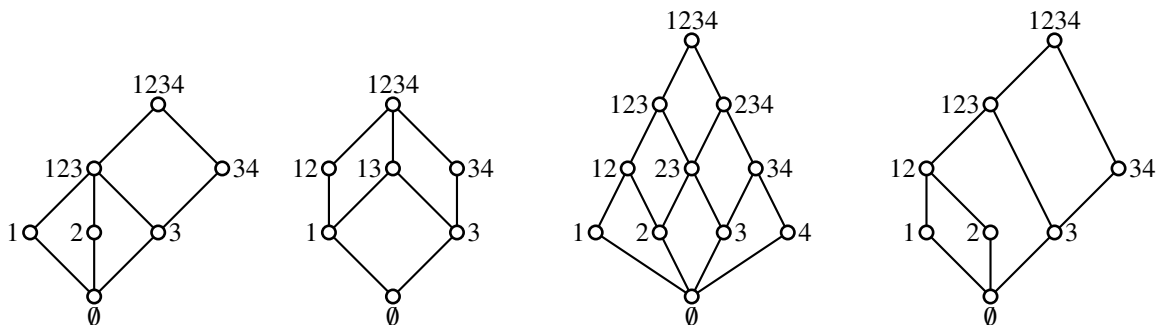

Figure 1.13 – Illustrating semimodularity on closure systems.

Antimatroids and Convex geometries

We introduce the class of *convex geometries* and their dual counterpart *antimatroids*. Convex geometries are essential in Knowledge Space Theory, as we will see in Section 1.6. Moreover, the second and third chapter will refer to different classes of convex geometries. For these reasons, we spend slightly more time on this class. For a detailed exposition about these closure systems and their use, see e.g. [Mon85, KLS12, Ste99]. Unlike the previous classes, convex geometries are usually defined from closure systems and closure operators rather than from lattices.

Let ϕ be a closure operator over V such that $\phi(\emptyset) = \emptyset$. We say that ϕ is *anti-exchange* (AEX) if for every $X \subseteq V$ and every $u, v \in V$ such that $u \neq v$ and $u, v \notin \phi(X)$, $u \in \phi(X \cup \{v\})$ implies that $v \notin \phi(X \cup \{u\})$. The closure system associated to an anti-exchange closure operator is a *convex geometry*. The family $\{V \setminus C \mid C \in \mathcal{C}\}$ of complements of closed sets of \mathcal{C} is an *antimatroid*. Let ϕ be a closure operator over V , $A \subseteq V$ and $v \in A$. We say that v is an *extreme point* for X if $v \notin \phi(X \setminus \{v\})$. We put $\text{ex}(X)$ as the set of extreme points of X . Note that in general, $\text{ex}(A)$ may be empty. Convex geometries are subject to the following characterization: [EJ85]:

THEOREM 5 ([EJ85]). *Let ϕ be a closure operator over V with induced closure system \mathcal{C} . The following conditions are equivalent:*

- (i) \mathcal{C} is a convex geometry,
- (ii) for every $C \in \mathcal{C}$ different from V , there exists $v \notin C$ such that $C \cup \{v\}$ is closed,
- (iii) for every $M \in \mathcal{M}(\mathcal{C})$, there exists a unique $v \in V$ such that $\phi(v) \uparrow M$. Moreover, $M \cup \{v\}$ is closed,
- (iv) every closed set C has a unique minimal spanning set being $\text{ex}(C)$,
- (v) for every $C \in \mathcal{C}$, $C = \phi(\text{ex}(C))$,
- (vi) for every $C \in \mathcal{C}$ and $v \notin C$, $v \in \text{ex}(\phi(C \cup \{v\}))$.

Observe that a convex geometry must be standard. The closure lattice of a convex geometry has also been studied from the lattice theoretic point of view, see e.g. [AGT03, EJ85, DC60, Ava61]. A lattice L whose associated (standard) closure system is a convex geometry is called *meet-distributive*. Their dual counterpart is called *join-distributive*.

THEOREM 6 (see [Ste99, AGT03]). *Let L be lattice. The following statements are equivalent:*

- (i) L is meet-distributive,
- (ii) L is lower-semimodular and join-semidistributive,
- (iii) each element of L admits a unique irredundant join-representation,
- (iv) L is isomorphic to the closure lattice of some convex geometry.

As pointed in the survey of [Mon85], convex geometries (or antimatroids) have been rediscovered several times all along the XXth century. They are used in different fields of mathematics and computer science. For instance, antimatroids are well-known in combinatorial optimization [KLS12] because they match shelling processes. They also appear in social choice theory

[Kos99, MR01] as path-independent choice operators are in a one-to-one correspondence with anti-exchange closure operators. In Knowledge Space Theory [DF12, FD10], a convex geometry is the counterpart of a *learning space*. Convex geometries arise from numerous combinatorial structures such as posets, graphs, hypergraphs, lattices, points in the euclidean space, etc. Numerous examples and classes of convex geometries can be found in [KLS12]. We highlight some examples here.

Affine convex geometry We follow [EJ85]. We consider V as a finite set of points in \mathbb{R}^d for some $d \in \mathbb{N}$. The *convex hull* of a subset $X = \{v_1, \dots, v_k\}$ of V is defined by $\phi(X) = \{u \in V \mid u = \sum_{i=1}^k \lambda_i v_i, \lambda_i \geq 0, \sum_{i=1}^k \lambda_i = 1\}$. In words, $\phi(X)$ is the smallest (discrete) convex set containing X . The convex hull operation is a closure operator, and its associated closure system is usually called an *affine convex geometry*. Note that the term convex geometry originates from this particular example. Figure 1.14 illustrates points in \mathbb{R}^2 and the associated convex geometry. We highlighted the convex hull of 124, containing 3.

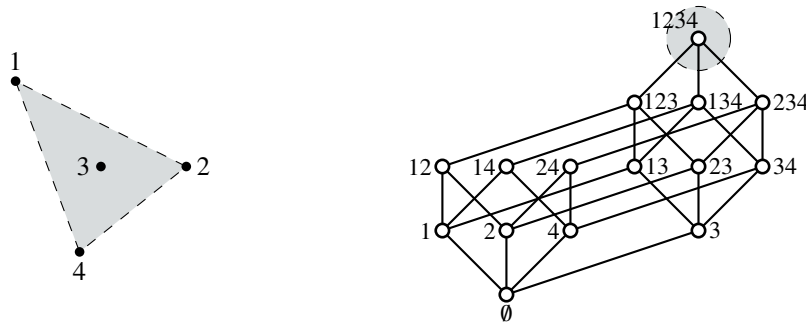

Figure 1.14 – An example of affine convex geometry.

Poset related convex geometries One can also devise convex geometries from posets. We give two examples. Let $P = (V, \leq)$ be a poset. First, consider the family of all ideals of P . As we mentioned earlier it forms a distributive lattice, which turns out to be a convex geometry. Thus, all (standard) distributive closure systems are convex geometries. An example is illustrated in Figure 1.15.

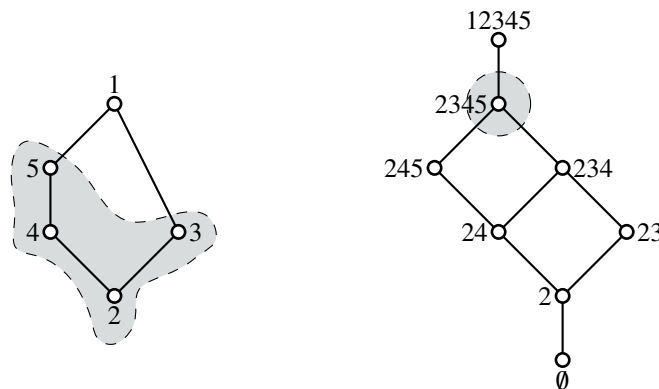

Figure 1.15 – A convex geometry of ideals of a poset.

Rather than ideals, one can take the *convex subsets* of the poset P . A subset X of V is convex in P if for every triple $u \leq v \leq w$ in P , $u \in X$ and $w \in X$ imply that $v \in X$ too. The family of all convex subsets of P yields an anti-exchange closure system usually called *double shelling of a poset*. The authors in [KN10] study this class of convex geometries. We give an example in Figure 1.16.

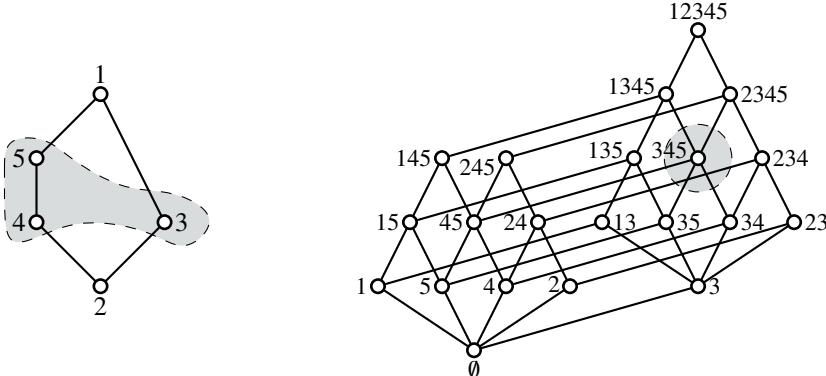

Figure 1.16 – A convex geometry of convex subsets of a poset.

Acyclic convex geometries We can also devise convex geometries directly from implicational bases. Let Σ be an implicational base over V . A *path* in Σ is a sequence v_1, \dots, v_k of elements of V such that for every $1 \leq i < k$ there exists an implication $A_i \rightarrow B_i$ with $v_i \in A_i$ and $v_{i+1} \in B_i$. The path is a *cycle* when $v_1 = v_k$.

Example 15. Let $V = \{1, 2, 3, 4\}$ and $\Sigma = \{12 \rightarrow 3, 23 \rightarrow 4, 4 \rightarrow 1\}$. The sequence 1, 3, 4 is a cycle in Σ .

An implicational base without cycles is called *acyclic*. The closure operator associated to an acyclic implicational base is anti-exchange. Hence, a closure system which admits an acyclic implicational base is an *acyclic convex geometry*. An example is illustrated in Figure 1.17. Acyclic convex geometries are also known as *G-geometries* [Wil94] or *poset type convex geometries* [AN14]. The term acyclic comes from Horn logic and acyclic Horn formulas [HK95, Zan15]. Acyclicity will play a key role in the second chapter of this thesis.

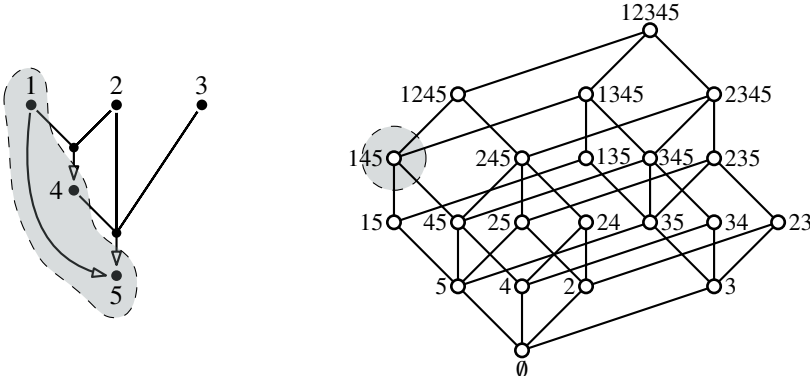

Figure 1.17 – An acyclic convex geometry.

Monophonic convexity on chordal graphs Finally, we mention a kind of convex geometry arising from graph theory. Let $G = (V, \mathcal{E})$ be a graph. A *path* in G is a sequence u_1, \dots, u_k of vertices such that $u_i u_{i+1} \in \mathcal{E}$ for every $1 \leq i < k$. A path is *induced* if for every u_i, u_j with $1 \leq i < k - 1$ and $j > i + 1$, $u_i u_j$ is not an edge of \mathcal{E} . The path is a *cycle* if $u_1 = u_k$. A graph G is *chordal* if it contains no induced cycle of length greater or equal than 4. Let G be a chordal graph. We say that a subset X of V is *monophonically convex* if for every distinct u, v in X , X contains all the vertices on an induced path between u and v . The family of all monophonically convex subsets of V is the *monophonic convex geometry* associated to the chordal graph G . These convex geometries have been studied for instance in [EJ85, FJ86]. Again, we give an example in Figure 1.18.

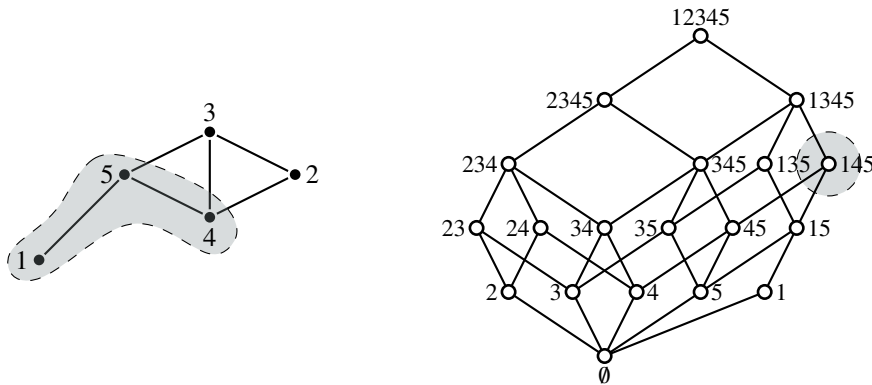

Figure 1.18 – A chordal graph and the associated monophonic convex geometry.

Extremal lattices

We conclude with a last generalization of distributivity, based on the fact that in a distributive lattice L , $h(L) = |\mathcal{J}(L)| = |\mathcal{M}(L)|$. A lattice L is *join-extremal* if $h(L) = |\mathcal{J}(L)|$ and *meet-extremal* if $h(L) = |\mathcal{M}(L)|$. It is *extremal* if it both join and meet-extremal. Extremal lattices are introduced and studied by Markowsky in [Mar92]. In particular, it is shown that every lattice is the sublattice of some extremal lattice. Remark that convex geometries are join-extremal due to Theorem 5.

Example 16. In Figure 1.19, we give four examples of closure systems. The first one (on the left) is both join and meet-extremal as it has 3 join-irreducible elements, 3 meet-irreducible elements and its longest chain $\emptyset \subset 1 \subset 13 \subset 123$ has size 3. The second closure system is meet-extremal but not join-extremal: it has dimension 3 but 4 join-irreducible elements. Dually, the third lattice is join-extremal but not meet-extremal. Finally, the last closure system is neither meet nor join-extremal as it has dimension 3, 4 meet-irreducible elements and 4 join-irreducible elements.

A hierarchy of lattices

We conclude this section with an inclusion chart (see Figure 1.20) of the classes of lattices we introduced so far. Each class is given a name written in bold font. For instance, \mathbf{SD}_\wedge refers to the class of all meet-semidistributive closure systems. The index of the classes is detailed on

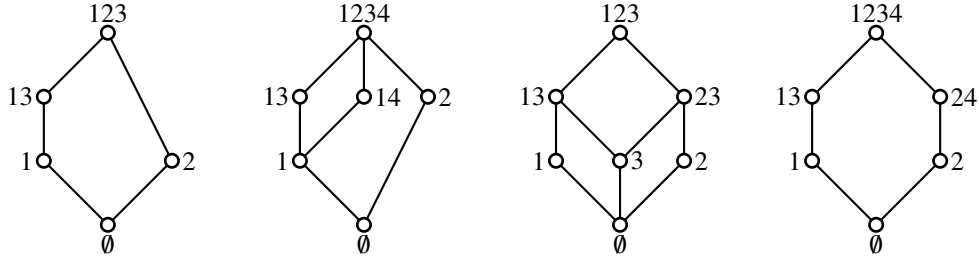

Figure 1.19 – Illustrating extremality on closure systems.

the right of the figure. We mention the class **ACG** of acyclic convex geometries since it plays an important role in this thesis. Most of the relationships can be found in [Grä11, Ste99]. Still, we discuss them briefly and highlight further references.

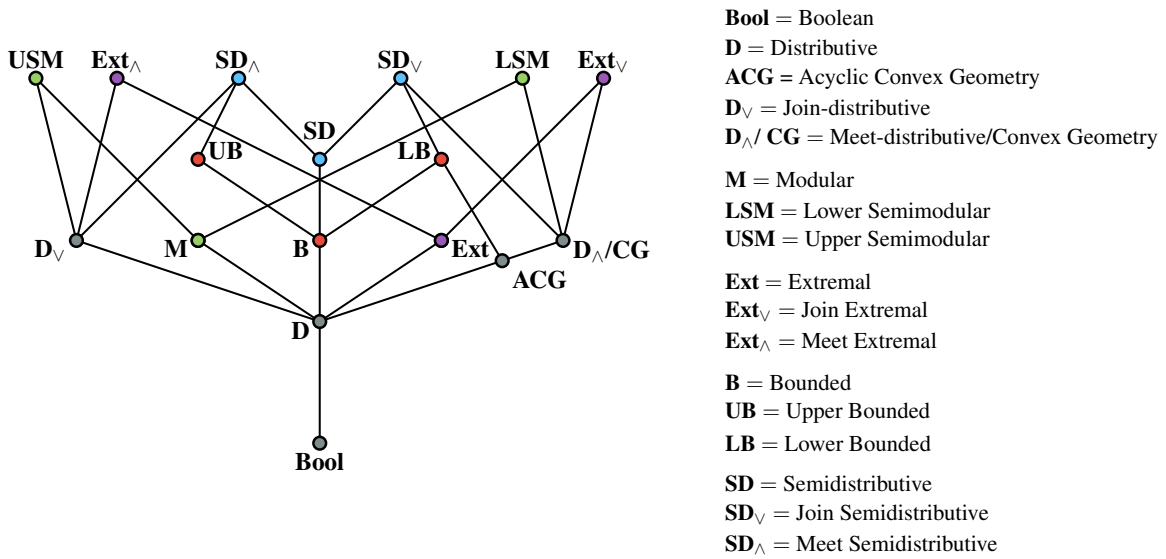

Figure 1.20 – Partial hierarchy of closure systems.

It is well-known that Boolean lattices are distributive, and that distributive lattices are modular [Grä11]. The connection between modular and both form of semimodularity is developed in [Ste99]. Extremal lattices and their connections with other classes are given in [Mar92]. The relationship between, distributivity, convex geometries and semimodularity is investigated for instance in [EJ85, Ava61, Ste99]. Convex geometries and their link with semidistributivity can be found in [AGT03]. Finally, bounded lattices and their upper/lower counterparts have been the topic of numerous works, among which we quote [FJN95, Day70, BC02].

We briefly introduced closure systems, their representations and some of their properties. The next section is devoted to some definitions on enumeration complexity and two enumeration problems playing an important role in this thesis.

1.5. Enumeration complexity, dualization in hypergraphs and lattices

In this section, we introduce few notions about enumeration complexity and algorithms. This exposition draws inspiration from [Str19, JYP88]. Then, we introduce *dualization* problems

on hypergraphs and lattices. These problems play a prominent role in this thesis, and we will encounter both of them in the two chapters of this dissertation.

1.5.1. Enumeration complexity

An *enumeration problem* or *generation problem* takes as input a finite structure and asks to list a set of solutions with prescribed properties. An algorithm solving an enumeration problem is an *enumeration algorithm*. For instance in the POWERSET problem, one is given a set V and has to generate all the subsets of V . However, there may be cases where the number of solutions is exponential in the size of the input (POWERSET is an example). For this reason, the time complexity of an enumeration algorithm is given in terms of the combined size of its input, n , and the number m of solutions to enumerate. This is *output-sensitive* complexity.

Remark 3. We assume that the size of an element in the solutions to an enumeration task is polynomial in the size of its input. For instance with POWERSET, a solution is a subset of V and hence has size polynomial in $|V|$.

We now give a couple of definitions regarding enumeration complexity. Let A be an enumeration algorithm with input size n and output size m .

DEFINITION 7. *An enumeration algorithm A is running in output-polynomial time if it has complexity $O(\text{poly}(n+m))$.*

If the time complexity of A is bounded by $2^{\text{polylog}(n+m)}$ rather than $\text{poly}(n+m)$, we say that A is running in *output-quasipolynomial time*. We call *tractable* an enumeration problem which admits an output-polynomial time algorithm. Observe however that no restriction is given on the time delay between two outputs of an output-polynomial algorithm. In fact, there could be cases where the time spent between the i -th and the $(i+1)$ -th outputs is not polynomial in n , provided m is not polynomial in n . As a consequence, we are led to a more severe notion of tractability.

DEFINITION 8. *An enumeration algorithm A is running in incremental-polynomial time if, for every $0 \leq i \leq m$, the time spent by the algorithm between the i -th and $(i+1)$ -th outputs is bounded by $\text{poly}(n+i)$.*

In other words, an algorithm is incremental-polynomial if the time before the next output is bounded by a polynomial in n and the number of solutions already output. Remark that the time before the first output, and after the last output are also subject to these time bounds. Still, incremental-polynomiality may be further restricted if one requires the delay between two solutions to be polynomial in n only. This lays the ground for the last definition of tractability we will encounter in this dissertation.

DEFINITION 9. *An enumeration algorithm A is running with polynomial delay if, for every $0 \leq i \leq m$, the time spent by the algorithm between the i -th and $(i+1)$ -th outputs is bounded by $\text{poly}(n)$.*

Finally, we say that an enumeration problem P_1 is (*polynomially*) *harder* than an enumeration problem P_2 if there exists an output-polynomial time algorithm for P_2 whenever there is one for P_1 . We write it $P_1 \geq P_2$. The two problems are (*polynomially*) *equivalent* if they are both harder than each other.

1.5.2. Dualization in hypergraphs and lattices

We now define *dualization* problems on hypergraph and lattices. Let $\mathcal{H} = (V, \mathcal{E})$ be a simple hypergraph. We begin with the task of listing all the maximal independent sets of \mathcal{H} :

MAXIMAL INDEPENDENT SETS ENUMERATION (MISENUM)

Input: A simple hypergraph $\mathcal{H} = (V, \mathcal{E})$.

Output: The family $\text{MIS}(\mathcal{H})$.

Since $\text{MIS}(\mathcal{H}) = \{V \setminus T \mid T \in \text{MTr}(\mathcal{H})\}$, the problem MISENUM is equivalent to the problem of listing the minimal transversals of \mathcal{H} :

MINIMAL TRANSVERSAL ENUMERATION (MTRENUM)

Input: A simple hypergraph $\mathcal{H} = (V, \mathcal{E})$.

Output: The family $\text{MTr}(\mathcal{H})$.

The family $\text{MTr}(\mathcal{H})$ is the hypergraph *dual* to \mathcal{H} . Hence, both MISENUM and MTRENUM relate to the decision problem which consists in testing that two hypergraphs are dual. This problem is called *hypergraph dualization*.

HYPERGRAPH DUALIZATION

Input: Two simple hypergraphs \mathcal{H}_1 and \mathcal{H}_2 over V .

Output: Yes if $\mathcal{H}_2 = \text{MTr}(\mathcal{H}_1)$, no otherwise.

These problems are crucial in theoretical computer science [EG95, FK96, EMG08, DNU21, KLMN14], and are sometimes known as *monotone Boolean dualization*. It is known from [BI95] that all the three problems are equivalent. In this thesis, we will mostly use the generation problem MISENUM.

Whether MISENUM is tractable or not is unknown. Actually, the best known algorithm is due to Fredman and Khachiyan [FK96], and has output-quasipolynomial time complexity. On the other hand, numerous particular cases have been studied [BEGK04, KBEG07, EGM03, KKP18, JYP88, EG95]. Among these, we quote two cases. First, if \mathcal{H} is a graph, the problem can be solved with polynomial delay, as shown for instance in [JYP88, TIAS77]. Second, and slightly more general than graphs, if edges of \mathcal{H} have constant size, the problem MISENUM is tractable in incremental-polynomial time. This is a result of [EG95, KBEG07]. In fact, MISENUM has two roles in enumeration. Either it is used as an intractability measure or, when dealing with a problem already harder than MISENUM, showing the equivalence with MISENUM is the best possible complexity result. We will use the both sides of the coin.

We now turn our attention to dualization in lattices. In MISENUM, the input hypergraph \mathcal{H} (in fact, its edges) is an antichain of the Boolean closure system 2^V and $\text{MIS}(\mathcal{H})$ is the unique antichain of 2^V such that $\downarrow \text{MIS}(\mathcal{H}) \cup \uparrow \mathcal{H} = 2^V$ and $\downarrow \text{MIS}(\mathcal{H}) \cap \uparrow \mathcal{H} = \emptyset$. We can generalize these properties to every pair of antichains in every closure system as follows. Let \mathcal{C} be a closure system and $\mathcal{B}^+, \mathcal{B}^-$ two antichains of \mathcal{C} . We say that \mathcal{B}^+ and \mathcal{B}^- are *dual* in \mathcal{C} when

$$\downarrow \mathcal{B}^+ \cup \uparrow \mathcal{B}^- = \mathcal{C} \text{ and } \downarrow \mathcal{B}^+ \cap \uparrow \mathcal{B}^- = \emptyset.$$

Note that \mathcal{B}^- and \mathcal{B}^+ are dual if either $\mathcal{B}^+ = \max_{\subseteq} \{C \in \mathcal{C} \mid C \notin \uparrow \mathcal{B}^-\}$ or $\mathcal{B}^- = \min_{\subseteq} \{C \in \mathcal{C} \mid C \notin \downarrow \mathcal{B}^+\}$. This leads to introduce *dualization in closure systems and lattices*.

LOWER DUALIZATION IN LATTICES AND CLOSURE SYSTEMS (LDUAL(α))

Input: A representation α for a closure system \mathcal{C} over V , an antichain \mathcal{B}^- of \mathcal{C} .

Output: The family $\mathcal{B}^+ = \max_{\subseteq} (\{C \in \mathcal{C} \mid C \notin \uparrow \mathcal{B}^-\})$.

UPPER DUALIZATION IN LATTICES AND CLOSURE SYSTEMS (UDUAL(α))

Input: A representation for a closure system \mathcal{C} over V , an antichain \mathcal{B}^+ of \mathcal{C} .

Output: The family $\mathcal{B}^- = \min_{\subseteq} (\{C \in \mathcal{C} \mid C \notin \downarrow \mathcal{B}^+\})$.

DUALIZATION IN LATTICES AND CLOSURE SYSTEMS (DUAL(α))

Input: A representation α for a closure system \mathcal{C} over V , two antichains \mathcal{B}^- , \mathcal{B}^+ of \mathcal{C} .

Output: *Yes* if \mathcal{B}^- and \mathcal{B}^+ are dual, *no* otherwise.

Remark 4. In this manuscript, α can be an implicational base, a set of meet-irreducible elements, or both. In this section, we also briefly mention the case where α is the closure system \mathcal{C} itself.

If there exists an output-polynomial time algorithm for LDUAL(α) or UDUAL(α), then DUAL(α) can be solved in polynomial time. However, unlike hypergraph dualization, whether a polynomial time algorithm for DUAL(α) implies that there exists output-polynomial time procedures for LDUAL(α) or UDUAL(α) is unknown. Here we principally rely on the enumeration problems LDUAL(α) and UDUAL(α).

In the case where $\mathcal{C} = \mathbf{2}^V$, we have that $\mathcal{M} = \{V \setminus \{v\} \mid v \in V\}$ and $\Sigma = \emptyset$ is a valid implicational base. Consequently, MISENUM, TRENUM and HYPERGRAPH DUALIZATION are particular cases of LDUAL(α), UDUAL(α) and DUAL(α) respectively.

We review the principal results on these problems. We mention first that if α is the whole closure system \mathcal{C} , the three problems can easily be solved in (output-)polynomial time by running over \mathcal{C} and checking the desired properties. They become much harder when the closure system is represented by an implicational base or its meet-irreducible elements:

- α is an implicational base Σ . In [KSS00, DN20], the authors show that DUAL(Σ) is coNP-complete. It follows that neither LDUAL(Σ) nor UDUAL(Σ) can be solved in output-polynomial time unless $\mathbf{P} = \mathbf{NP}$.
- α is a set of meet-irreducible elements \mathcal{M} . Babin and Kuznetsov [BK17] prove that DUAL(\mathcal{M}) is also an NP-complete problem. Hence, neither LDUAL(\mathcal{M}) nor UDUAL(\mathcal{M}) can be solved in output-polynomial time unless $\mathbf{P} = \mathbf{NP}$.
- α is a pair Σ, \mathcal{M} . Again, Babin and Kuznetsov [BK17] show that DUAL(Σ, \mathcal{M}) is not harder than deciding whether a given (minimum) implicational base represents the same

closure system as a given set of meet-irreducible elements. This former problem will be developed in Chapter 2.

On the positive side, Elbassioni proves in [Elb20] that $\text{DUAL}(\alpha)$ can be solved in quasipolynomial time in distributive closure systems, independently of the representation chosen for \mathcal{C} . Indeed, in distributive closure systems, going from the meet-irreducible elements to an implicational base (and vice-versa) can be done in polynomial time. This result motivates the problem of finding the class of lattices and closure systems where the problems $\text{DUAL}(\alpha)$, $\text{LDUAL}(\alpha)$ and $\text{UDUAL}(\alpha)$ can be solved in (output-)quasipolynomial time.

1.6. Knowledge Space Theory: an application of closure systems

This section is dedicated to Knowledge Space Theory (KST) as it constitutes the initial motivation for this thesis. It has been developed in the late 1980s by Jean-Paul Doignon and Jean-Claude Falgout in their seminal paper [DF85]. In a few words, KST wishes to use the tools provided by computer science to improve pedagogical processes. Our exposition follows the standard textbooks [DF12, FD10].

Remark 5. We only introduce parts of the whole framework of knowledge spaces. In fact, we restrict ourselves to the essential definitions to avoid a profusion of notations.

The fundamental motivation for KST is the following: to assess the knowledge of a student, a teacher will ask questions relating to particular items or problems of the appropriate topic. The questions the students are able to answer correctly defines their state of knowledge regarding the topic. Now, what if we could use the power of computers to improve the process ? That is, a student is sat in front of a machine which prompts questions selected in a database. With the knowledge of feasible (or reasonable) knowledge states in its memory, the computer will eventually discover the appropriate knowledge state of the student.

The purpose of Knowledge Space Theory is to provide a mathematical background for this automated assessment routine. We consider a field of knowledge that can be represented by a set of *items* or *problems*, the mastering of which reflects a strong enough understanding of the topic at hand. The set of all items is the *domain* of the field. The *knowledge state* of the students represents all the items they can solve. In general, not all groups of items will define a feasible knowledge state as, for instance, some items may be mutually dependent. The collection of all (feasible) knowledge state is called a *knowledge space* if it enjoys the following properties:

- the empty set of items and the whole domain are both knowledge states, as it should be possible to learn all the items from scratch;
- the union of two knowledge states remains a knowledge state. The reason for this hypothesis is mostly practical. In general, the number of possible knowledge state is exponential in the number of items in the domain. In spite of their capacity, storing all knowledge state in computer's memory is intractable. This second property allows the knowledge space to be recovered from a few number of states, and greatly reduces the total amount of memory required for storing the whole space. These essential states altogether form the *base* of the knowledge space.

Example 17. We illustrate these definitions on an example. Let us say the following questions are presented to students during a math course:

1. Graphically solve the equation $4x^2 - 3x + 2 = 0$.
2. Compute $\frac{\sqrt{4 \times \sqrt{9}}}{3} - \frac{6 \times 7}{\sqrt{144}}$.
3. Give the discriminant of $3x^2 - x + 8$.
4. Study the polynomial $7x^2 + 11x - 5$.

All of these questions are instances of the following *problems* or *items*:

1. Graphic resolution.
2. Arithmetic.
3. Knowledge about the discriminant.
4. Analysis of a second degree polynomial.

By a happy coincidence, we have at hand five students who answered the test in a representative way: Wolf, Lil, Lazuli, Folavril and Dupont. Their answers are represented in the table of Figure 1.21. For instance, the *knowledge state* of Lil contains the items 2 and 3. On the right of Figure 1.21, we represent a *knowledge space* which contains all the knowledge states of the five students. The *base* of this knowledge space contains the states 1, 2, 23, 234 and 124. As an example, the state 12 is obtained by combining the states 1 and 2.

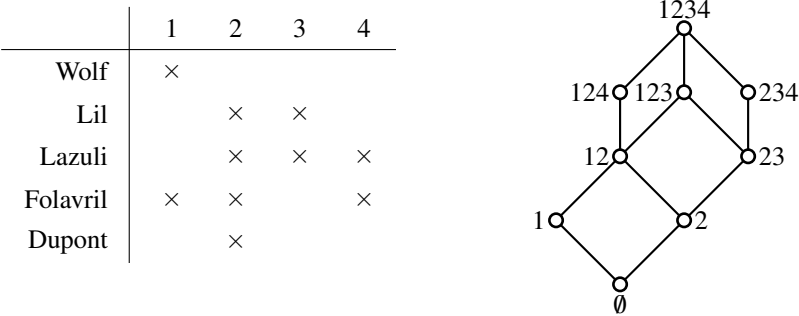

Figure 1.21 – An example of knowledge space.

If we apply some more restrictions to knowledge spaces, they can be used to facilitate the learning of students, and identify items that a student is ready to master. These restrictions are two reasonable assumptions:

- Q0 Items should be learnable step-by-step: if a state is strictly included in another, there should be a way to learn the missing items one by one.
- Q1 An item available for mastering remains available until it is learnt.

A knowledge space which satisfies these two properties is a *learning space*.

Example 18. The knowledge space of Figure 1.21 is a learning space. We illustrate the two properties of learning spaces in Figure 1.22. For Q0, it is possible to start from the empty knowledge state and learn all the items in the order 1, 2, 4, 3. As for the property Q1, observe that 1 is an item learnable from the beginning. If a student chooses not to learn 1 at first, it is always possible to learn it later, as every knowledge state can be augmented with 1.

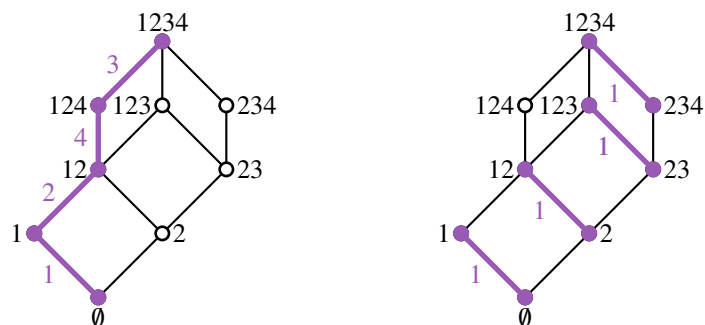

Figure 1.22 – The properties Q0 (left) and Q1 (right) of a learning space.

For a given field of knowledge, there may be for instance dependencies or prerequisites between items. Thus, all group of items will not form knowledge states. Experienced teachers might be able to provide such information on the problems of the domain, but probably not the list of feasible states. It appears that knowledge spaces can be represented by *queries* of the form “If the students fail the items u_1, \dots, u_k , they will also fail the item v .” These queries are questions that can be asked to teachers to uncover the structure of some knowledge space.

Example 19. In our running example, it seems reasonable to say that if a student fails items 1 and 3, he will also fail item 4. In view of the connection with closure systems and implications, we can write $13 \rightarrow 4$ this relationship. Similarly, computing the discriminant (item 1) or studying a polynomial (item 4) cannot be done without little knowledge about arithmetic (item 2), which we can write $2 \rightarrow 34$.

Mathematical formulation and connection with closure systems We now give a mathematical ground for our explanations. As a warning, we mention that some notations and notions on knowledge spaces overlap with previous definitions on closure systems. In the contributions of this thesis, we use closure systems. Thus, this overlap should cause no confusion.

Let V be a finite set called the *domain*. Its elements are the *items* or *problems*. A set system \mathcal{K} over V is called a *knowledge structure* if it contains V . Elements of \mathcal{K} are its *knowledge states*. We say that \mathcal{K} is a *knowledge space* if $\emptyset, V \in \mathcal{K}$, and for every $S_1, S_2 \in \mathcal{K}$, $S_1 \cup S_2 \in \mathcal{K}$. The former property is called *union-closure*.

Let \mathcal{K} be a knowledge space over V . The *base* of \mathcal{K} is the unique minimum subset \mathcal{B} of \mathcal{K} such that $\mathcal{K} = \{\cup \mathcal{B}' \mid \mathcal{B}' \subseteq \mathcal{B}\}$. Since \mathcal{K} is finite and union-closed, \mathcal{B} must exist. In particular, a state S belongs to \mathcal{B} if and only if $S = S_1 \cup S_2$ for some $S_1, S_2 \in \mathcal{K}$ implies that $S = S_1$ or $S = S_2$. Let $A \in \mathcal{K}$, $v \in V$. We say that A is an *atom* at v if it is an inclusion wise minimal state containing v . It is shown for instance in [FD10] that a state S is an atom at some $v \in V$ if and only if it belongs to the base of \mathcal{K} .

A knowledge space \mathcal{K} is a *learning space* when it satisfies the following two conditions. They are a mathematical expression of the statements Q0 and Q1 given above:

- Q0 If S, S' are knowledge states such that $S \subset S'$, there exists a sequence $S = S_0 \subset S_1 \subset \dots \subset S_k = S'$ such that $|S_i \setminus S_{i-1}| = 1$ for every $1 \leq i \leq k$.
- Q1 Let S be a knowledge state and $v \notin S$. If $S \cup \{v\}$ is a knowledge state, then for every $S' \in \mathcal{K}$ such that $S \subseteq S'$, $S' \cup \{v\}$ is also a knowledge state.

It remains to model the queries of the form “is it true that if a student fails items u_1, \dots, u_k , he will also fail item u_{k+1} ?”. Still following [FD10], we write $\{u_1, \dots, u_k\} \mathcal{P} u_{k+1}$ whenever the answer to the corresponding query is positive. The relation \mathcal{P} thus defined over $2^V \times V$ is called an *entailment*. Let \mathcal{K} be a knowledge space, $X \subseteq V$ and $v \in V$. We write $X \mathcal{P} v$ if for every $S \in \mathcal{K}$, $X \cap S = \emptyset$ implies that $v \notin S$.

We are now in position to relate knowledge spaces to closure systems. Let \mathcal{K} be a knowledge space over V and set $\mathcal{C} = \{V \setminus S \mid S \in \mathcal{K}\}$. As \mathcal{K} is closed under union and $\emptyset \in \mathcal{K}$, it follows that $V \in \mathcal{C}$ and \mathcal{C} is intersection-closed. Hence, \mathcal{C} is a closure system. The complement of an atom of \mathcal{K} is a maximal closed set not containing some element $v \in V$. Thus, we conclude that atoms of \mathcal{K} are in a one-to-one correspondence with the meet-irreducible elements of \mathcal{C} , that is $\mathcal{M}(\mathcal{C}) = \{V \setminus S \mid S \in \mathcal{B}\}$. Moreover, \mathcal{K} is a learning space if and only if it is an antimatroid, as proved in [FD10]. Therefore, the closure system \mathcal{C} is a convex geometry, and more generally, learning spaces are yet another name for convex geometries. Finally, consider some $X \subset V$ and $v \in V$ such that $X \mathcal{P} v$ holds in \mathcal{K} . Let S be a state such that $X \cap S = \emptyset$, or equivalently, such that $X \subseteq V \setminus S$. Then by definition of \mathcal{P} , $v \in V \setminus S$, which entails that the implication $X \rightarrow v$ holds in \mathcal{C} . Consequently, the relation \mathcal{P} describes all the implications that are true in \mathcal{C} . It follows that entailment relations coincide with implicational bases.

Example 20. In Figure 1.23, we give the closure system (in fact the convex geometry) associated to the learning space of Example 17. This closure system can be described by the implicational base $\Sigma = \{13 \rightarrow 4, 2 \rightarrow 34\}$, which connects to the queries of Example 19.

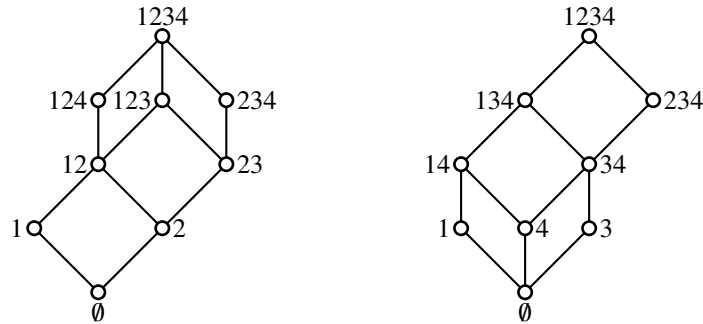

Figure 1.23 – A knowledge space and its associated closure system.

As a conclusion, it follows from our discussion that whenever we deal with closure systems or one of their representations, the properties or algorithms we highlight can be translated to knowledge spaces in a straightforward manner.

CHAPTER 2. *Translating between the representations of a closure system*

*“Les fenêtres plus larges que notre vue découpent le ciel en
compartiments salutaires.”*

Les Champs Magnétiques, André Breton & Philippe Soupault.

Summary: *We are interested in the problem of translating between two representations of closure systems, namely implicational bases and meet-irreducible elements. Albeit its importance, the problem is open. In our contribution, we introduce (acyclic) splits of an implicational base. It is a partitioning operation of the implications which we apply recursively to obtain a binary tree representing a decomposition of the implicational base. Focusing on the case of acyclic splits, we obtain new results for the translation problem.*

2.1. Introduction

In this chapter we study the problem of translating between two representations of a closure system: implicational bases and meet-irreducible elements. This problem is twofold. Either it asks to list the meet-irreducible elements of a closure system given by an implicational base, or vice-versa, to construct an implicational base from a set of meet-irreducible elements.

The choice of the representation impacts the complexity of several problems, thus making the translation a crucial task. For example, it is **NP**-complete to decide whether an element belongs to a minimal generator of a closure system if the latter is given by an implicational base [LO78]. When the closure system is represented by its meet-irreducible elements, we can answer the question in polynomial time [BDVG18]. The complexity of recognizing a class of closure system also depends on the representation. In fact, all the classes and properties we introduced in the previous chapter can be identified in polynomial time from a family of meet-irreducible elements: distributivity [Bir37], both forms of semimodularity [Ste99], every kind of semidistributivity and join and meet-distributivity [Nat00, EJ85, BMN17, HN18] (see also Theorem 4), extremality [Mar92], boundedness [BC02]. Whether we can recognize all of these properties from an implicational base is open, especially for convex geometries and join-semidistributive lattices. Another example where the representation matters comes from propositional logic [KKS93], where abductive reasoning can be conducted in polynomial time from meet-irreducible elements, while it is **NP**-complete with implications.

Translating is also important to enjoy the most compact representation for a given closure system. Indeed, implicational bases and meet-irreducible elements are generally much shorter than the closure systems they represent. However, when we compare the two representations, there are cases where an implicational base has size exponential in the number of meet-irreducible elements, or dually, where the number of meet-irreducible elements can be exponential in the size of an implicational base. Example 21, drawn from [MR94, Kuz04, Thi86], illustrates these two possibilities.

Example 21. Let $V = \{u_1, \dots, u_k\} \cup \{v_1, \dots, v_k\} \cup \{x\}$ for some $k \in \mathbb{N}$. We first construct an implicational base Σ_1 over V as follows: $\Sigma_1 = \{u_i v_i \rightarrow x \mid 1 \leq i \leq k\}$ (see Figure 2.1). We have $|\Sigma_1| = k$ and hence $|\Sigma_1| \leq |V|$. The family \mathcal{M}_1 of meet-irreducible elements associated to Σ_1 equals $\{V \setminus \{w_i\} \mid w_i \in \{u_i, v_i\}, 1 \leq i \leq k\} \cup \prod_{1 \leq i \leq k} \{u_i, v_i\}$. Hence, we have that $|\mathcal{M}_1| = 2^k + |V| - 1$ being exponential in the size of Σ_1 .

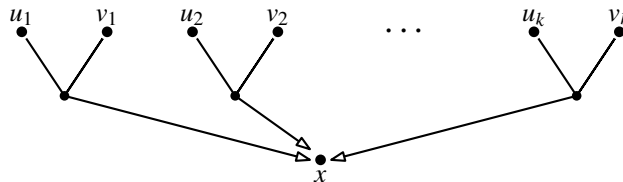

Figure 2.1 – The implicational base Σ_1 .

Dually, we build a family of meet-irreducible elements \mathcal{M}_2 over V . We set $\mathcal{M}_2 = \{V \setminus \{w_i\} \mid w_i \in \{u_i, v_i\}, 1 \leq i \leq k\} \cup \{V \setminus \{u_i, v_i, x\} \mid 1 \leq i \leq k\}$. We have $|\mathcal{M}_2| = k + |V| - 1$. A minimum implicational base associated to \mathcal{M}_2 is $\Sigma_2 = \{A \rightarrow x \mid A \in \prod_{1 \leq i \leq k} \{u_i, v_i\}\}$. However, we have $|\Sigma_2| = 2^k$, which is exponential in the size of \mathcal{M}_2 . Note that Σ_2 is at the same time the canonical direct basis and the canonical basis associated to \mathcal{M}_2 .

The translation task has attracted much attention during the last decades [Kha95, BK13, BMN17, Wil95, AN17, MR92]. A detailed account of all the results can be found in the surveys [Wil17, BDVG18].

We discuss four representations for a closure system: implications, meet-irreducible elements, the closure system itself or the closure operator. In our context, we consider the closure operator as a black-box oracle with input a set and returning its closure. We explain each direction of Figure 2.2, which summarizes hardness results about the translation task. Numbers in the Figure refers to the following explanations.

(1). *From any representation to the closure operator.* The closure operation can be simulated in polynomial-time from any other representation of the closure system, using intersections or the closure algorithm (forward chaining).

(2). *From any representation to the closure system.* The whole closure system can be constructed in output-polynomial time from any other representation, with the help of well-known algorithms such as NextClosure [GW12].

(3). *From the closure operator to meet-irreducible elements and implications.* Lawler et al. prove in [LLRK80] that meet-irreducible elements or implications cannot be enumerated in output-polynomial time unless $\mathbf{P} = \mathbf{NP}$ from a closure oracle.

(4). *From the closure system to its meet-irreducible elements.* It is sufficient to perform

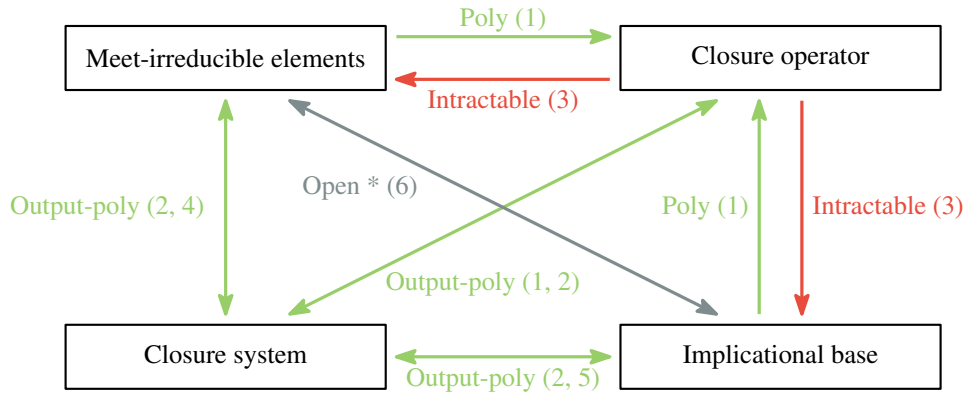

* Harder than MISENUM

Figure 2.2 – The complexity of translating between the representations of a closure system.

a traversal of the closed sets, and check for the meet-irreducible property. This is done in (output)-polynomial time.

(5). *From the closure system to an implicational base.* To find a (minimum) implicational base, it is for instance possible to use the attribute-incremental approach of Duquenne and Obiedkov [OD07] in output-polynomial time.

(6). *From an implicational base to meet-irreducible elements and vice-versa.* Remark that undertaking the construction of the whole closure system as an intermediate will necessarily produce output-exponential time algorithms in the worst case. In the landmark paper [Kha95], written in the framework of Horn logic, these problems are called CCM for *Computing Characteristic Models* and SID for *Structure Identification*. We keep these names for historicity.

MEET-IRREDUCIBLE ELEMENTS ENUMERATION (CCM)

Input: An implicational base Σ of a closure system \mathcal{C} over V .

Output: The meet-irreducible elements \mathcal{M} of \mathcal{C} .

MINIMUM IMPLICATIONAL BASE IDENTIFICATION (SID)

Input: The family \mathcal{M} of meet-irreducible elements of a closure system \mathcal{C} over V .

Output: A minimum implicational base Σ corresponding to \mathcal{C} .

In [Kha95] the author consider right-optimum implicational bases and shows that both directions of the translation (CCM and SID) are equivalent. Whether this equivalence also holds for minimum implicational bases is not clear as going from right-optimum to minimum is much easier than the other way around [Sho86, ADS86]. In any case, the task is already harder than hypergraph dualization [Kha95]. Remind that the best known algorithm solving MISENUM is the one of Fredman and Khachiyan [FK96], running in output quasi-polynomial time. Babin and Kuznetsov prove in [BK10, BK13] that it is coNP-complete to decide whether an implication belongs to a minimum implicational base from the meet-irreducible elements. In [KSS00], the authors state that co-atoms of a closure system cannot be enumerated in output-polynomial time unless $\mathbf{P} = \mathbf{NP}$. In [DS11], it is shown that the minimal pseudo-closed sets of the Duquenne-Guigues basis cannot be enumerated in output-polynomial time unless $\mathbf{P} = \mathbf{NP}$ either. In spite

of these negative hardness results, the complexity of translating between meet-irreducible elements and implications remains unsettled.

On the positive side, finding the canonical direct base from the meet-irreducible elements (and vice-versa) is equivalent to hypergraph dualization [Kha95, BM10, BDVG18]. The authors in [AN17] obtain similar results for the D -base. More generally, exponential time algorithms have been designed, see *e.g.* [MR92, Wil95, GW12, OD07]. In [Wil00], Wild shows that SID can be solved in polynomial time in modular lattices. Finally, the authors in [BMN17] devise output-polynomial time algorithms for both CCM and SID in k -meet-semidistributive lattices.

We are mostly interested in the problem CCM in the class of acyclic convex geometries. It is a well-studied class of convex geometries [ANR13, HK95, Wil94, Zan15] lying in the intersection of convex geometries and lower-bounded closure systems [AN14, FJN95]. They also contain distributive closure systems, in which the translation can be solved efficiently. Yet, much like convex geometries and the general case, the complexity of translating in this particular class is unknown.

Contributions and outline. In a first paper [DNV21], we show that CCM and SID are harder than MISENUM, even in acyclic convex geometries. Then, we focus on *ranked convex geometries*, and demonstrate that both CCM and SID become polynomially equivalent to MISENUM. These results are not detailed in the dissertation.

Let Σ be an implicational base for some (standard) closure system \mathcal{C} over V . We begin the chapter with some preliminary definitions in Section 2.2. Then, we give the following results:

- (i) We introduce a partitioning operation of an implicational base called a *split*, inspired by [Lib93, Das16]. We use this operation to hierarchically decompose Σ and its associated closure system \mathcal{C} . This part is detailed in Section 2.3.
- (ii) Section 2.4 is devoted to *acyclic splits*:
 - (1) We characterize \mathcal{C} with respect to this partitioning operation, see Subsection 2.4.1.
 - (2) We derive a recursive characterization of the set of meet-irreducible elements \mathcal{M} associated to \mathcal{C} , see Subsection 2.4.2.
 - (3) We devise an algorithm solving CCM in the presence of acyclic splits. We highlight cases where this procedure performs in output-quasipolynomial time using the algorithm of Fredman and Khachiyan [FK96] for hypergraph dualization. This result includes ranked convex geometries as a particular case. This is Subsection 2.4.3.

Similar results for SID are currently under writing. The chapter ends in Section 2.5 with some perspectives and open problems for further research. Most of the results presented in this chapter can be found in the contributions [NV20b] (for part (i)) and [NV20a] (for part(ii)) The new results are marked by a star (*).

2.2. Preliminaries

In [NV20a, NV20b], we have been adopting the language of directed hypergraphs because the decomposition we introduce does only depend on the syntax of implicational bases, rather than

their semantic. Yet, to avoid juggling with notations and since we are ultimately interested in the semantic of implicational bases, we rewrite our results in terms of implications. Consequently, we will often implicitly jump between an implicational base and its unit-expansion, without loss of generality (see Chapter 1, Section 1.3). We also assume that implicational bases do not contain implications like $A \rightarrow B$ where $B \subseteq A$ for some $A, B \subseteq V$, as they can be trivially removed without loss of information.

Most of the definitions we give here can be found in [Grä11, KLS12]. Let $\mathcal{S} \subseteq 2^V$, and $X \subseteq V$. The *trace* of \mathcal{S} on V , denoted by $\mathcal{S} : X$, results from the intersection of the sets in \mathcal{S} with X . Formally, $\mathcal{S} : X = \{S \cap X \mid S \in \mathcal{S}\}$. Let \mathcal{C} be a closure system over V with closure operator ϕ . Recall that we consider \mathcal{C} ordered by set-inclusion. Therefore, the definitions of partially ordered sets (see Chapter 1, Section 1.1) apply to \mathcal{C} . In particular, $C_1 \prec C_2$ for some $C_1, C_2 \in \mathcal{C}$ means that C_2 covers C_1 , that is $C_1 \subseteq C \subseteq C_2$ and $C \in \mathcal{C}$ implies that $C = C_1$ or $C = C_2$. Remind that \mathcal{C} is *standard* if for every $v \in V$, $\phi(v) \setminus \{v\} \in \mathcal{C}$. In particular, \emptyset is closed when \mathcal{C} is standard. Let $\mathcal{C}_1, \mathcal{C}_2$ be two closure systems over disjoint V_1, V_2 (resp.). The *direct product* of \mathcal{C}_1 and \mathcal{C}_2 is denoted $\mathcal{C}_1 \times \mathcal{C}_2$ and equals $\{C_1 \cup C_2 \mid C_1 \in \mathcal{C}_1, C_2 \in \mathcal{C}_2\}$. Let Σ an implicational base over V . An implicational base Σ' included in Σ is a *sub implicational base* (or sub-base) of Σ . Let $X \subseteq V$. The *restriction* $\Sigma[X]$ of Σ to X is the implicational base $\{A \rightarrow b \mid A \rightarrow b \in \Sigma, A \cup \{b\} \subseteq X\}$. Let V_1, V_2 be a non-trivial bipartition of V . A *bipartite implicational base* $\Sigma[V_1, V_2]$ is a collection of implications $A \rightarrow b$ satisfying $A \subseteq V_1$ and $b \in V_2$ or $A \subseteq V_2$ and $b \in V_1$.

Let $\mathcal{D} = (V, \mathcal{A})$ be a directed graph. A *directed path* is a sequence u_1, \dots, u_k of vertices such that $(u_i, u_{i+1}) \in \mathcal{A}$ for each $1 \leq i < k$. A directed path is a *directed cycle* if $u_1 = u_k$. A *strongly connected component* of \mathcal{D} is an inclusion-wise maximal subset C of V such that for every pair $u, v \in C$, there exists directed paths from u to v and from v to u . Note that these components can be computed in polynomial time in the size of \mathcal{D} . It is sufficient to interpret \mathcal{D} as a set of left-unit implications and apply the forward chaining procedure. Elements with the same closure belong to the same component.

In this chapter, we assume that all closure systems are standard, a common assumption [AN14, Wil94]. In particular, no implicational base Σ will contain implications of the form $\emptyset \rightarrow B$ for some $B \subseteq V$.

2.3. Splits and hierarchical decomposition of implicational bases

Inspired by [Lib93, Das16], we define the *split* operation for an implicational base Σ over V . A split is a bipartition (V_1, V_2) of the groundset V which *completely* partitions the implications of Σ in three sub-bases:

- $\Sigma[V_1]$: the implications of Σ fully contained in V_1 ,
- $\Sigma[V_2]$: the implications of Σ fully contained in V_2 ,
- $\Sigma[V_1, V_2]$: the implications of Σ whose premises are included in V_1 and their conclusions in V_2 , or vice-versa.

This partitioning operation can be conducted recursively and leads to a *hierarchical decomposition* (*H-decomposition*) of Σ , represented by a full rooted binary tree. The root of the tree is

labelled by $\Sigma[V_1, V_2]$, its left-child corresponds to a decomposition of $\Sigma[V_1]$, its right-child to a decomposition of $\Sigma[V_2]$. This tree is called a Σ -tree. We illustrate the structure of a Σ -tree in Figure 2.3.

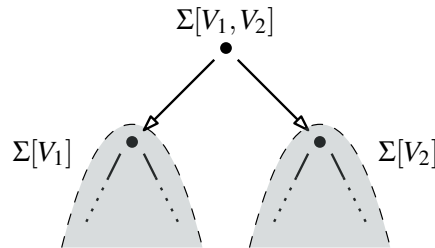

Figure 2.3 – A part of a tree resulting from a decomposition of Σ by splits.

We show that not all implicational bases can have such a H-decomposition into trivial bases, and give a polynomial time and space algorithm, `BuildTree`, which takes an implicational base Σ as an input, and outputs a Σ -tree if it exists. Afterwards, we relax the requirement of the H-decomposition into trivial bases to H-factors, which are indecomposable sub-bases of Σ .

Finally, we consider the decomposition of \mathcal{C} , when a split (V_1, V_2) of Σ is given. We show that \mathcal{C} is obtained by combining closed sets of \mathcal{C}_1 , the closure system of $\Sigma[V_1]$, with closed sets of \mathcal{C}_2 , the closure system of $\Sigma[V_2]$. The way \mathcal{C}_1 and \mathcal{C}_2 are combined depends on the implications in $\Sigma[V_1, V_2]$.

2.3.1. Split operation

Our first step is to define the split operation.

DEFINITION 10. *Let Σ be an implicational base over V . A split of Σ is a non-trivial bipartition (V_1, V_2) of V such that for every $A \rightarrow b \in \Sigma$, $A \subseteq V_1$ or $A \subseteq V_2$.*

A split (V_1, V_2) induces three sub-bases $\Sigma[V_1]$, $\Sigma[V_2]$ and a bipartite base $\Sigma[V_1, V_2]$. Moreover, every implication of Σ belongs to exactly one of $\Sigma[V_1]$, $\Sigma[V_2]$ or $\Sigma[V_1, V_2]$ (recall that Σ has no implications $\emptyset \rightarrow b$). Intuitively, the split shows that Σ is fully described by two smaller distinct bases $\Sigma[V_1]$ and $\Sigma[V_2]$ acting on each other through the bipartite implicational base $\Sigma[V_1, V_2]$.

Example 22. Let $V = \{1, 2, 3, 4, 5, 6, 7\}$ and consider the implicational base Σ with implications $12 \rightarrow 3, 3 \rightarrow 1, 56 \rightarrow 2, 23 \rightarrow 7, 45 \rightarrow 6$ and $5 \rightarrow 7$. Figure 2.4 represents Σ (in fact its associated directed hypergraph).

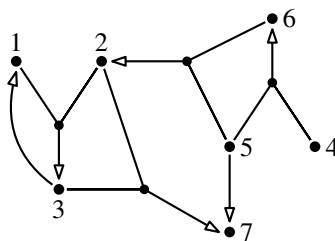

Figure 2.4 – The implicational base of Example 22.

In Figure 2.5 we consider two possible bipartitions of V . The bipartition illustrated on the left separates V in two sets $V_1 = \{1, 3\}$ and $V_2 = \{2, 4, 5, 6, 7\}$. It is not a split since the premises of $12 \rightarrow 3$ and $23 \rightarrow 7$ intersect both V_1 and V_2 . The bipartition on the right puts $V_1 = \{1, 2, 3\}$ and $V_2 = \{4, 5, 6, 7\}$. It is a split with $\Sigma[V_1] = \{12 \rightarrow 3, 3 \rightarrow 1\}$, $\Sigma[V_2] = \{45 \rightarrow 6, 5 \rightarrow 7\}$, and $\Sigma[V_1, V_2] = \{56 \rightarrow 2, 23 \rightarrow 7\}$.

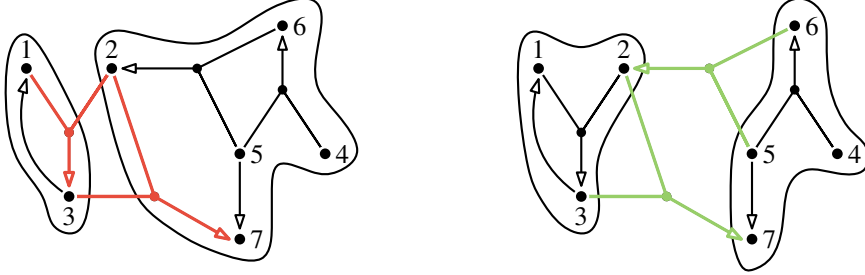

Figure 2.5 – Two bipartitions of V , the left one is not a split of Σ , the right one is.

Before giving a characterization of implicational bases having a split, we make two observations. First, if Σ is empty or contains only implications of the form $a \rightarrow b$. In this case, every non-trivial bipartition of V —every cut of the directed graph \mathcal{D}_Σ —is a split. In fact, an implication of the form $a \rightarrow b$ always satisfies the condition of Definition 10. Thus, these implications have no impact on the existence of a split. Second, there may be implicational bases where no bipartition corresponds to a split, as shown by the next example.

Example 23. Consider $V = \{1, 2, 3\}$ and the implicational base $\Sigma = \{12 \rightarrow 3, 13 \rightarrow 2\}$. Here, none of the three possible bipartitions is a split:

- $V_1 = \{1, 2\}$ and $V_2 = \{3\}$ fails to separate the implication $13 \rightarrow 2$;
- $V_1 = \{1, 3\}$, $V_2 = \{2\}$ omits the implication $12 \rightarrow 3$; and
- $V_1 = \{2, 3\}$, $V_2 = \{1\}$ breaks the two implications of Σ .

In the following, we show that the implicational base's connectivity is important for the notion of a split. Let Σ be an implicational base over V . A *premise-path* in Σ is a sequence v_1, \dots, v_k of (distinct) elements of V such that for every $1 \leq i < k$ there exists an implication $A_i \rightarrow b_i$ in Σ such that $\{v_i, v_{i+1}\} \subseteq A_i$. Two vertices $u, v \in V$ are said to be *premise-connected* in Σ if there exists a premise-path from u to v . We say that Σ is *premise-connected* when every pair of vertices in V is premise-connected. A subset C of V is a *premise-connected component* of Σ if there exists a body-path between each pair of vertices of C , and if C is inclusion-wise maximal for this property. A singleton premise-connected component of Σ is *trivial*.

Example 24. We study the premise-connectivity of the implicational base Σ given in Example 22. For instance, $6, 5, 4$ is a premise-path and hence 4 and 6 are premise-connected. Here Σ is not premise-connected as there is no premise-path between 2 and 6. The premise-connected components of Σ are $\{1, 2, 3\}$, $\{4, 5, 6\}$ and $\{7\}$ being trivial.

Using premise-connectivity, we are now in position to identify whether a given implicational base admits a split or not.

PROPOSITION 1. *An implicational base Σ over V has a split if and only if it is not premise-connected.*

Proof. We begin with the only if part. Suppose that Σ has a split (V_1, V_2) , and let $u \in V_1$ and $v \in V_2$. Since a split is a non-trivial bipartition of V , such u and v must exist. Now let us assume for contradiction there exists a premise-path $u = v_1, \dots, v_k = v$ for some $k \in \mathbb{N}$. Such a premise-path exists if there is some j with $1 \leq j \leq k$ such that $A_j \rightarrow b_j$ is an implication of Σ , $A_j \cap V_1 \neq \emptyset$ and $A_j \cap V_2 \neq \emptyset$. However, the implication $A_j \rightarrow b_j$ does not satisfy Definition 10. This contradicts the assumption that (V_1, V_2) is a split of Σ . Hence, u, v cannot be premise-connected and Σ is not premise-connected either.

We move to the if part. Suppose that Σ is not premise-connected and let C be a premise-connected component of Σ . We show that $(C, V \setminus C)$ is a split of Σ . Let $A \rightarrow b$ be an implication in Σ . If $A \subseteq C$ or A is a singleton element, it is clear that it satisfies Definition 10. Assume that $A \not\subseteq C$ and that A is not a singleton element. Recall that no implication of the form $\emptyset \rightarrow b$ lies in Σ . Let u, v be distinct elements in A and assume for contradiction $u \in C$ and $v \notin C$. Clearly, u, v is a premise path between u and v . Let w be any element of C . Since $u \in C$, u and w are premise connected. Consider any premise-path from w to u and append v to its end. The new path is a premise-path connecting w and v . Hence, $C \cup \{v\}$ is premise-connected, a contradiction with the fact that C is maximal. We deduce that $A \not\subseteq C$ implies that $A \cap C = \emptyset$. So $(C, V \setminus C)$ is indeed a split of Σ . \square

It is important to note that premise-connectivity is not inherited. That is, a sub-base induced by a premise-connected component need not be premise-connected in general.

Example 25. Consider the implicational base of Example 22 with the split $V_1 = \{1, 2, 3\}$, $V_2 = \{4, 5, 6, 7\}$. The elements 5 and 6 are premise-connected in Σ but not in $\Sigma[V_2] = \{5 \rightarrow 7, 45 \rightarrow 6\}$. This happens because the implication $56 \rightarrow 2$ is in $\Sigma[V_1, V_2]$.

Henceforth, premise-connected components of an implicational base may be further decomposed. Consequently, the split operation can be conducted in a recursive manner, leading to a hierarchical decomposition of implicational bases, up to trivial cases.

2.3.2. The decomposition tree of an implicational base

Based on the split operation, we define a hierarchical decomposition of an implicational base Σ . We call it a *H-decomposition* of Σ . The strategy is to recursively split Σ into smaller implicational bases until we reach trivial cases. This recursive decomposition can be conveniently represented by a full rooted binary tree T (full means that each node has precisely two children). An interior node of the tree corresponds to a split (V_1, V_2) of Σ whose children are H-decompositions of $\Sigma[V_1]$ and $\Sigma[V_2]$. The leaves of the tree represent the ground set V . Since the splits (V_1, V_2) and (V_2, V_1) are equivalent, the children of a node are unordered.

DEFINITION 11 (Σ -tree and H-decomposition). *Let Σ be an implicational base over V and T be a full rooted binary tree. Then (T, λ) is a Σ -tree of Σ if there exists a labelling map $\lambda: T \rightarrow V \cup 2^\Sigma$ satisfying the following conditions:*

- (i) $\lambda(t)$ equals v for some $v \in V$ if t is a leaf of T ;
- (ii) $\lambda(t) \subseteq \Sigma$ if t is an interior node (possibly $\lambda(t) = \emptyset$);
- (iii) for every $A \rightarrow b \in \lambda(t)$, elements of A are labels of leaves in the subtree of one child of t and b is the label of a leaf in the subtree of the other child.

(iv) the set $\{\lambda(t) \mid t \in T\}$ is a full partition of $V \cup \Sigma$ and may contain the empty set.

If such labelling exists, we say that Σ is hierarchically decomposable (H-decomposable for short), and H-indecomposable otherwise.

In the particular case where $V = \emptyset$, we must have that $\Sigma = \emptyset$. If it happens, we say for convenience that Σ is trivially H-decomposable and that its Σ -tree is empty.

Example 26. The implicational base Σ from Example 22 is H-decomposable. In Figure 2.6, we represent a possible Σ -tree for Σ .

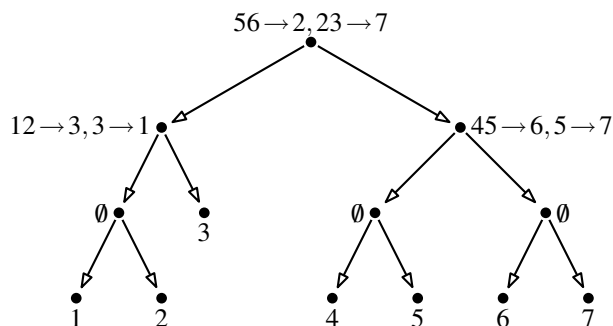

Figure 2.6 – An Σ -tree for the implicational base of Example 22.

There are cases where a H-decomposition can be computed easily. For instance, if Σ is empty, every full rooted binary tree whose leaves are labelled by a permutation of V and every interior node by \emptyset is a Σ -tree. We illustrate this on the left of Figure 2.7, with $V = \{1, 2, 3, 4\}$ and $\Sigma = \emptyset$. The case where Σ only contains implications of the form $a \rightarrow b$ for some $a, b \in V$ behaves similarly, except that the interior nodes of the tree contain the implications of Σ . We give an example on the right of Figure 2.7, with $V = \{1, 2, 3, 4\}$ and $\Sigma = \{1 \rightarrow 2, 2 \rightarrow 3, 3 \rightarrow 4\}$.

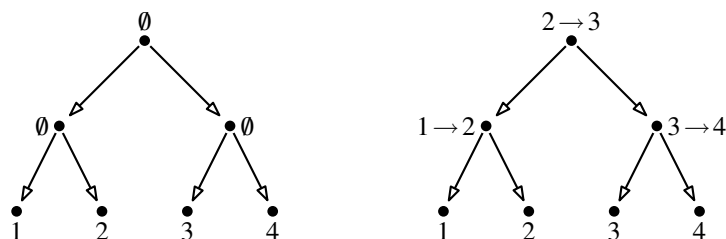

Figure 2.7 – Trees for $\Sigma_1 = \emptyset$ (left) and $\Sigma_2 = \{1 \rightarrow 2, 2 \rightarrow 3, 3 \rightarrow 4\}$ (right).

However, there are also some implicational bases that cannot be H-decomposed, for example when they admit no split at all. Next, our objective is to characterize H-decomposable implicational bases and devise a polynomial-time algorithm to build decomposition trees whenever possible. We first need two preparatory propositions.

PROPOSITION 2. *An H-decomposable implicational base Σ is not premise-connected.*

Proof. Suppose that Σ is H-decomposable, and let (T, λ) be a Σ -tree with root r . Let (V_1, V_2) be the split of V corresponding to r , i.e. V_1 corresponds to the leaves of the left subtree of r and V_2 to those of the right subtree. Then, according to Proposition 1, Σ is not premise-connected. \square

Remark that the converse of Proposition 2 does not hold in general. We exhibit a counter-example. The main idea is to hide a premise-connected implicational base into a sub-base of a non premise-connected one.

Example 27. Let $V = \{1, 2, 3, 4\}$ and $\Sigma = \{12 \rightarrow 3, 13 \rightarrow 2, 23 \rightarrow 4\}$. The implicational base Σ has a unique split, $V_1 = \{1, 2, 3\}$ and $V_2 = \{4\}$. Thus it is not premise-connected and any possible Σ -tree must have the split (V_1, V_2) in the label of its root. After splitting, we are left with the sub-bases $\Sigma[V_2] = \emptyset$, $\Sigma[V_1, V_2] = \{23 \rightarrow 4\}$ and $\Sigma[V_1] = \{12 \rightarrow 3, 13 \rightarrow 2\}$. Observe that $\Sigma[V_1]$ is exactly the implicational base of Example 23. Hence, it is premise-connected and using Proposition 2, it cannot be H-decomposed. It follows that Σ admits no H-decomposition either.

Inspired by the previous example, we show that H-decomposability is hereditary, *i.e.* if an implicational base Σ has a Σ -tree then each of its sub-bases has a H-decomposition too.

PROPOSITION 3. *Let Σ be an implicational base over V and let $X \subseteq V$. Then Σ has a H-decomposition only if $\Sigma[X]$ is H-decomposable.*

Proof. Let Σ be an implicational base over V , $X \subseteq V$, and let (T, λ) be a Σ -tree. If $X = \emptyset$, then the result trivially holds. We construct a subtree not necessarily induced by T which corresponds to a $\Sigma[X]$ -tree. We start from the root r of T and apply the following operation for each interior node t : if the sets of leaves of the left child and those of the right one both intersect X , keep t with label $\lambda(t) = \lambda(t) \cap \Sigma[X]$. Otherwise, there is a child of t whose set of leaves do not intersect X . In this case replace t by the child whose set of leaves intersects X . The obtained subtree has X as the set of label of its leaves, and the set of labels of the internal nodes are exactly $\Sigma[X]$. \square

The following theorem characterizes H-decomposability and gives the strategy of an algorithm computing a H-decomposition.

THEOREM 7. *Let Σ be a non premise-connected implicational base and let C be a premise-connected component of Σ . Then Σ is H-decomposable if and only if $\Sigma[C]$ and $\Sigma[V \setminus C]$ are H-decomposable.*

Proof. The only if part directly follows from Proposition 3. Let us show the if part. Let C be a premise-connected component of Σ , (T_1, λ_1) be a $\Sigma[C]$ -tree and (T_2, λ_2) be a $\Sigma[V \setminus C]$ -tree. We consider a new tree (T, λ) such that T has root r with left subtree T_1 and right subtree T_2 . As for λ , we put $\lambda(t_1) = \lambda_1(t_1)$ if $t_1 \in T_1$, $\lambda(t_2) = \lambda_2(t_2)$ if $t_2 \in T_2$ and $\lambda(r) = \Sigma \setminus (\Sigma[C] \cup \Sigma[V \setminus C])$. In words, $\lambda(r)$ contains each implication whose premise is not fully contained in C or $V \setminus C$. It is clear that conditions (i), (ii), (iv) of Definition 11 are fulfilled for (T, λ) as they are for (T_1, λ_1) , (T_2, λ_2) and $C \cup V \setminus C = V$. Hence, we have to check (iii). Let $A \rightarrow b$ be an implication in $\lambda(v)$. If $A \cap C \neq \emptyset$, then $A \subseteq C$ since C is a premise-connected component of Σ . As $A \rightarrow b$ is not an implication of $\Sigma[C]$, it follows that $b \in V \setminus C$. Dually, if $A \cap C = \emptyset$, then $b \in C$ since $A \rightarrow b$ is not in $\Sigma[V \setminus C]$. Consequently, condition (iii) is satisfied and (T, λ) is a Σ -tree as required. \square

Theorem 7 suggests a recursive algorithm which returns a Σ -tree for an implicational base Σ if it is H-decomposable. If $V = \emptyset$, we simply output \emptyset . If V is a singleton element v , we output a leaf with label v . Otherwise, we compute a premise-connected component C of Σ if Σ is not

premise-connected. We label the corresponding node by the implications of $\Sigma[C, V \setminus C]$, and we recursively call the algorithm on $\Sigma[C]$ and $\Sigma[V \setminus C]$. This strategy is formalized in Algorithm 1, whose correctness and complexity are studied in Theorem 8.

Algorithm 1: BuildTree.

Input: An implicational base Σ over V
Output: A Σ -tree, if it exists, FAIL otherwise

```

1 if  $V = \emptyset$  then
2    $\lfloor$  return  $\emptyset$  ;
3 if  $V$  has one vertex  $v$  then
4    $\lfloor$  create a new leaf  $r$  with appropriated  $\lambda(r)$ ;
5    $\lfloor$  return  $r$  ;
6 else
7    $\lfloor$  compute a premise-connected component  $C$  of  $\Sigma$  ;
8   if  $|C| = |V|$  then
9      $\lfloor$  stop and return FAIL ;
10  else
11     $\lfloor$  let  $r$  be a new node with  $\lambda(r) = \Sigma \setminus (\Sigma[C] \cup \Sigma[V \setminus C])$  ;
12     $\lfloor$  left( $r$ ) = BuildTree( $\Sigma[C]$ ) ;
13     $\lfloor$  right( $r$ ) = BuildTree( $\Sigma[V \setminus C]$ ) ;
14     $\lfloor$  return  $r$  ;

```

THEOREM 8. *Given an implicational base Σ over V , the Algorithm BuildTree computes a Σ -tree if it exists and returns FAIL otherwise in polynomial time and space in the size of Σ and V .*

Proof. First, we show by induction on $|V|$ that the algorithm returns a Σ -tree if and only if Σ is H-decomposable. Clearly if $V = \emptyset$, the algorithm returns \emptyset . In the case where V is reduced to a vertex v , the algorithm returns a Σ -tree corresponding to a leaf with label v .

Now, assume that the algorithm is correct for implicational bases with $|V| < n$, $n \in \mathbb{N}$, and consider a base Σ over V with $|V| = n$. Suppose Σ is H-decomposable. By Proposition 1, Σ is not premise-connected. Let C be a premise-connected component of Σ . Inductively, the algorithm is correct for $\Sigma[C]$ and $\Sigma[V \setminus C]$ since $1 \leq |C| < n$. From Theorem 7, we have that both $\Sigma[C]$ and $\Sigma[V \setminus C]$ are H-decomposable. By induction, the algorithm computes a $\Sigma[C]$ -tree (T_1, λ_1) and a $\Sigma[V \setminus C]$ -tree (T_2, λ_2) . Hence, the algorithm returns a labelled tree (T, λ) with root r whose label is $\lambda(r) = \Sigma \setminus (\Sigma[C] \cup \Sigma[V \setminus C])$ and children T_1 and T_2 . This tree satisfies all conditions to be a Σ -tree. Thus, the algorithm computes a Σ -tree for every H-decomposable implicational base.

Now suppose Σ is not H-decomposable. We have two cases:

- (i) Σ is premise-connected and the algorithm returns FAIL in Line 7.
- (ii) Σ is not premise-connected. The algorithm chooses a premise-connected component C with $1 \leq |C| < n$. By Theorem 7, either $\Sigma[C]$ or $\Sigma[V \setminus C]$ is H-indecomposable. Thus,

by induction, the algorithm will return FAIL for the input $\Sigma[C]$ or $\Sigma[V \setminus C]$ in lines **11-12**. Since the algorithm stops, the output of the algorithm is FAIL.

Hence, the algorithm fails if the input Σ is H-indecomposable. We conclude that the algorithm returns a Σ -tree if and only if the input Σ is H-decomposable.

Finally, we show that the total time and space complexity of the algorithm are polynomial. The space required for the algorithm is bounded by the size of the implicational base Σ , the ground set V and the size of the Σ -tree. As the size of the Σ -tree is bounded by $O(|\Sigma| \times |V|)$, the overall space is bounded by $O(|\Sigma| \times |V|)$.

The time complexity is bounded by the sum of the costs of all nodes (or calls) of the search tree. The number of calls is bounded by $O(|V|)$, the size of the search tree. The cost of a call is dominated by the computation of a premise-connected component of the input Σ . For this, we use union-find data structure of [TVL84], which runs in almost linear time, *i.e.* $O(|\Sigma| \times |V| \times \alpha(|\Sigma| \times |V|, |V|))$ where $\alpha(.,.)$ is the inverse Ackermann function. The almost linear comes from the fact that $\alpha(|V|) \leq 4$ for every practical implicational base (see [TVL84]). Thus, the total time complexity is $O(|V| \times (|\Sigma| \times |V| \times \alpha(|\Sigma| \times |V|, |V|)))$. \square

It is worth noticing, that the Σ -tree we obtain by the end of Algorithm 1 depends on the choice of a premise-connected component in line **5**. As shown by the following example, the structure of the resulting Σ -tree is impacted by this choice.

Example 28. Let $V = \{1, 2, 3, 4, 5, 6, 7, 8\}$ and let Σ be the implicational base $\{12 \rightarrow 3, 3 \rightarrow 1, 23 \rightarrow 4, 34 \rightarrow 5, 56 \rightarrow 7, 67 \rightarrow 8\}$. For convenience, we represent Σ in Figure 2.8.

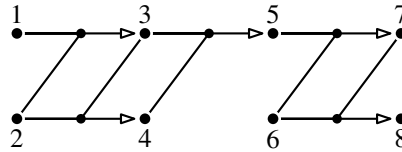

Figure 2.8 – The implicational base of Example 28.

The premise-connected components of Σ are $\{1, 2, 3, 4\}$, $\{5, 6, 7\}$ and $\{8\}$. Thus, we can devise at least three distinct Σ -trees for Σ . In Figure 2.9, we give two of them. Observe that the first one (on the left) balances the size of labels of its interior nodes. On the other hand, the second one is a balanced tree.

Following the previous example, a natural question arises: are all Σ -trees *equivalently interesting*? In particular, a balanced Σ -tree is a good candidate as the balancing is a common desirable property for decomposition trees to obtain efficient algorithms. This question, which uniquely depends on the syntax of the implicational base, is left open for further research.

2.3.3. Extension of the H-decomposition

As seen before, there are implicational bases that cannot have a split and thus a H-decomposition into trivial sub-bases. Such implicational bases are premise-connected, and will be called *irreducible H-factors* (H-factors for short). Now we describe a slight modification of Algorithm 1 to obtain a H-decomposition of implicational bases into H-factors. Instead of returning FAIL at line **7** in Algorithm BuildTree, we replace it by the following:

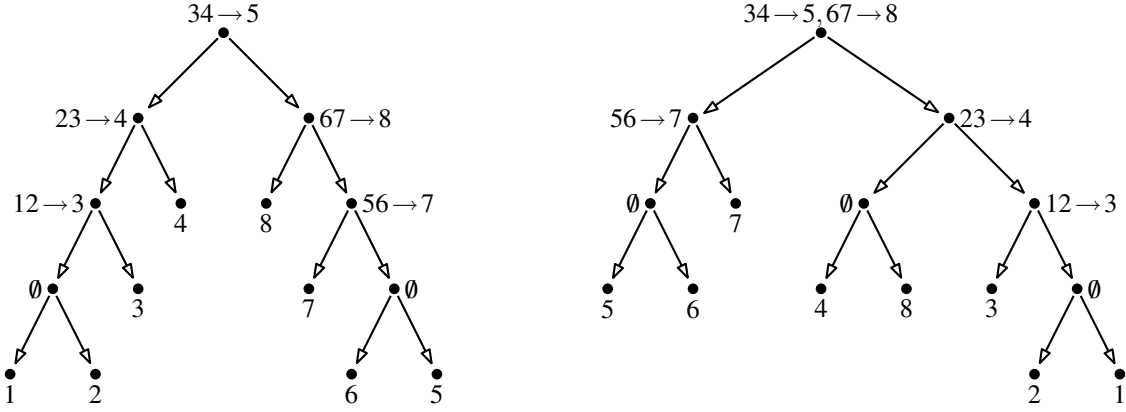

Figure 2.9 – Two Σ -trees for the implicational base of Example 28.

7' create a new leaf r with $\lambda(r) = \Sigma$ and return r ;

Example 29. Consider $V = \{1, 2, 3, 4, 5, 6\}$ and let $\Sigma = \{45 \rightarrow 1, 12 \rightarrow 3, 23 \rightarrow 1, 13 \rightarrow 2, 3 \rightarrow 6\}$. We represent Σ on the left of Figure 2.10. Clearly, Σ is not premise-connected and its premise-connected components are $\{4, 5\}$, $\{1, 2, 3\}$ and $\{3\}$. On the right of Figure 2.10, we present a H-decomposition of Σ into H-factors.

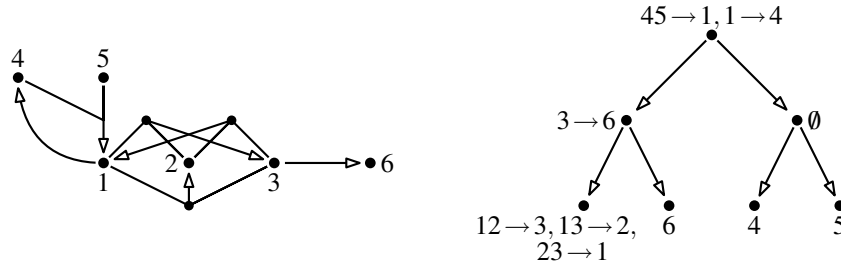

Figure 2.10 – H-decomposition into H-factors.

With this modification, each possible implicational base has now a H-decomposition where leaves can be H-factors. To conclude this subsection, we show that H-factors are independent of the choice of the Σ -tree.

PROPOSITION 4 (*). *Let Σ be an implicational base over V and let (T_1, λ_1) and (T_2, λ_2) be two Σ -trees. Then, T_1 and T_2 have the same number of leaves and $\{\lambda_1(t_1) \mid t_1 \text{ is a leaf of } T_1\} = \{\lambda_2(t_2) \mid t_2 \text{ is a leaf of } T_2\}$.*

Proof. If Σ is H-decomposable or $(T_1, \lambda_1) = (T_2, \lambda_2)$, the result is clear due to Theorem 8. Assume that Σ is not H-decomposable and that the trees are different. Let t_1 be a leaf of T_1 such that $\lambda(t_1) = \Sigma_H$ is a H-factor of Σ . Let V_H be the set of elements spanned by Σ_H and let t_2 be the lowest node of T_2 such that $\Sigma_H \subseteq \bigcup \{\lambda(t'_2) \mid t_2 \text{ is an ancestor of } t'_2 \text{ in } T_2\}$. In other words, t_2 is the ancestor of all the elements in V_H . If t_2 is not a leaf, there exists a split in the sub-base induced by t_2 which separates the elements of V_H , a contradiction with Σ_H being a H-factor of Σ in (T_1, λ_1) . Hence, t_2 is also a leaf, and $\lambda_2(t_2) = \Sigma_H$ follows by applying the same reasoning in T_1 , which concludes the proof. \square

2.3.4. Splits and decomposition of a closure system

Naturally, the H-decomposition of an implicational base Σ induces a decomposition of the closure system \mathcal{C} defined by Σ . We also call the decomposition of \mathcal{C} a H-decomposition. The H-decomposition of \mathcal{C} is obtained from the H-decomposition of Σ , where the label of a node of its Σ -tree is replaced by the closure system associated to the implicational base induced by its subtree. The closure systems in leaves are the irreducible H-factors of the input closure system. Figure 2.11 illustrates the H-decomposition of the closure system associated to the H-decomposition of Example 29.

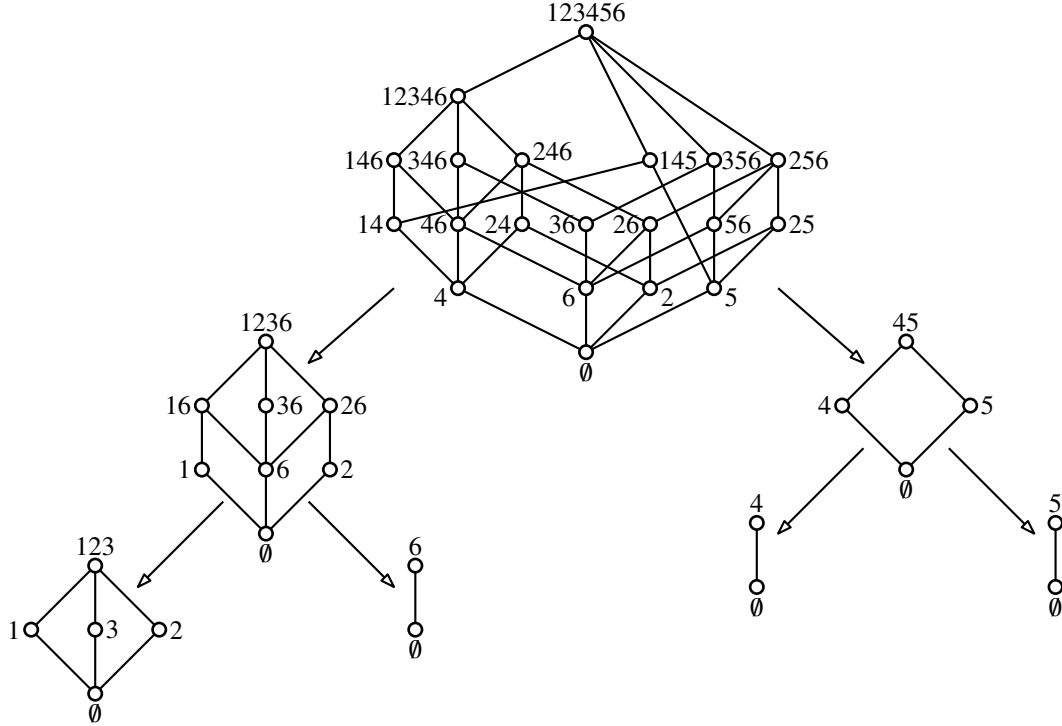

Figure 2.11 – H-decomposition of the closure system corresponding to Example 29.

THEOREM 9. *Let Σ be an implicational base over V with closure system \mathcal{C} , and let (V_1, V_2) be a split of Σ . Let \mathcal{C}_1 and \mathcal{C}_2 be closure systems associated to $\Sigma[V_1]$ and $\Sigma[V_2]$ (resp.). Then:*

- (i) $C \in \mathcal{C}$ implies that $C \cap V_1 \in \mathcal{C}_1$ and $C \cap V_2 \in \mathcal{C}_2$. Hence, $\mathcal{C} \subseteq \mathcal{C}_1 \times \mathcal{C}_2$;
- (ii) $\mathcal{C} = \mathcal{C}_1 \times \mathcal{C}_2$ holds whenever $\Sigma[V_1, V_2] = \emptyset$ (i.e. \mathcal{C} is the direct product of \mathcal{C}_1 and \mathcal{C}_2);
- (iii) if for every implication $A \rightarrow b$ in $\Sigma[V_1, V_2]$, we have $A \subseteq V_1$, then $\mathcal{C} : V_1 = \mathcal{C}_1$ and $\mathcal{C} : V_2 = \mathcal{C}_2$; and
- (iv) dually, if $A \subseteq V_2$ for every $A \rightarrow b$ in $\Sigma[V_1, V_2]$, we have $\mathcal{C} : V_1 = \mathcal{C}_1$ and $\mathcal{C} : V_2 = \mathcal{C}_2$.

Proof. Consider a split (V_1, V_2) of Σ , \mathcal{C}_1 and \mathcal{C}_2 the closure systems corresponding to $\Sigma[V_1]$ and $\Sigma[V_2]$. Their respective closure operators are ϕ_1, ϕ_2 . We prove items (i), (ii) and (iii). Items (iii) and (iv) are similar.

Item (i). Let $C \in \mathcal{C}$, $C_1 = C \cap V_1$ and let $A \rightarrow b$ be an implication of $\Sigma[V_1]$. Suppose $A \subseteq C_1$ and $b \notin C_1$. Then we also have $A \subseteq C$ and $b \notin C$ which contradicts $C \in \mathcal{C}$ as $A \rightarrow b \in \Sigma$. Thus $C_1 \in \mathcal{C}_1$. A similar reasoning applies to \mathcal{C}_2 , and $\mathcal{C} \subseteq \mathcal{C}_1 \times \mathcal{C}_2$ holds.

Item (ii). We readily have that $\mathcal{C} \subseteq \mathcal{C}_1 \times \mathcal{C}_2$ by item (i). For the other inclusion, let $C_1 \in \mathcal{C}_1$ and $C_2 \in \mathcal{C}_2$. We show that $C_1 \cup C_2 \in \mathcal{C}$. Let $A \rightarrow b$ be an implication of Σ with $A \subseteq C_1 \cup C_2$. As $\Sigma[V_1, V_2]$ is empty, $A \rightarrow b$ is either an implication of $\Sigma[V_1]$ or $\Sigma[V_2]$. As C_1, C_2 are closed for $\Sigma[V_1], \Sigma[V_2]$ (resp.), it follows that $C_1 \cup C_2 \in \mathcal{C}$.

Item (iii). Let $C_1 \in \mathcal{C}_1$. We show that $\phi(C_1)$ satisfies $\phi(C_1) \cap V_1 = C_1$. We readily have that $C_1 \subseteq \phi(C_1) \cap V_1$. Let $C_1 = X_0 \subset X_1 \subset \dots \subset X_k = \phi(C_1)$ be the sequence of sets obtained by applying the forward chaining algorithm on C_1 with Σ . We show by induction on $0 \leq i \leq k$ that $X_i \cap V_1 = C_1$. For the initial case $X_0 = C_1$, the result is clear. Now assume that the results holds true for any $0 \leq i < k$ and consider X_{i+1} . Let $A \rightarrow b$ be an implication such that $A \subseteq X_i$. Since (V_1, V_2) is a split of Σ , either $A \subseteq V_1$ or $A \subseteq V_2$. We have three cases

- (1) $A \subseteq V_2$. Then $A \rightarrow b \in \Sigma[V_2]$ and $b \in V_2$ so that $b \notin X_{i+1} \cap V_1$.
- (2) $A \rightarrow b$ is in $\Sigma[V_1]$. Then, $A \subseteq X_i \cap V_1$ which equals C_1 by inductive hypothesis. Since C_1 models $\Sigma[V_1]$ we have that $b \in X_i \cap V_1 = C_1$.
- (3) $A \rightarrow b$ is an implication of $\Sigma[V_1, V_2]$. Then $A \subseteq V_1$ and $b \in V_2$ since we assumed that every implication of $\Sigma[V_1, V_2]$ has its premise in V_1 and its conclusion in V_2 . Therefore, $b \notin X_{i+1} \cap V_1$.

Consequently $X_{i+1} \setminus X_i \subseteq V_2$, from which we deduce that $X_{i+1} \cap V_1 = C_1$, finishing the induction. Applying the result on $X_k = \phi(C_1)$, $\phi(C_1) \cap V_1 = C_1$ follows. So $C_1 \in \mathcal{C} : V_1$ and $\mathcal{C}_1 \subseteq \mathcal{C} : V_1$. The reverse inclusion holds by item (i). As for \mathcal{C}_2 , we have $\mathcal{C}_2 \subseteq \mathcal{C}$ as $A \subseteq V_1$ for every implication $A \rightarrow b$ of $\Sigma[V_1, V_2]$. \square

According to Theorem 9 item (i), every closure system is a subset of the product of its H-factors closure systems. So the idea is to compute in parallel \mathcal{C}_1 and \mathcal{C}_2 for every split (V_1, V_2) in the Σ -tree, and then use the bipartite implicational base $\Sigma[V_1, V_2]$ to compute \mathcal{C} . But this strategy is expensive, since the size of \mathcal{C}_1 and \mathcal{C}_2 may be exponential in the size of \mathcal{C} .

Example 30. Let $V = \{u_1, \dots, u_k, x, y\}$ for some $k \in \mathbb{N}$ and let $\Sigma = \bigcup \{ \{u_i u_j \rightarrow x, u_i u_j \rightarrow y\} \mid 1 \leq i, j, \leq k, i \neq j \} \cup \{xy \rightarrow u_i \mid 1 \leq i \leq k\}$. Clearly, the unique possible split is $(V \setminus \{x, y\}, \{x, y\})$. Since $\Sigma[V \setminus \{x, y\}]$ is empty, its associated closure system is Boolean and has 2^k elements. However, $\mathcal{C} = \{v \mid v \in V\} \cup \{ \{u, v\} \mid \{u, v\} \in (V \setminus \{x, y\}) \times \{x, y\} \} \cup \{\emptyset, V\}$ so that $|\mathcal{C}| = 3k + 4$.

However, this exponential reduction cannot occur when the sub-closure systems \mathcal{C}_1 and \mathcal{C}_2 appear as traces of \mathcal{C} .

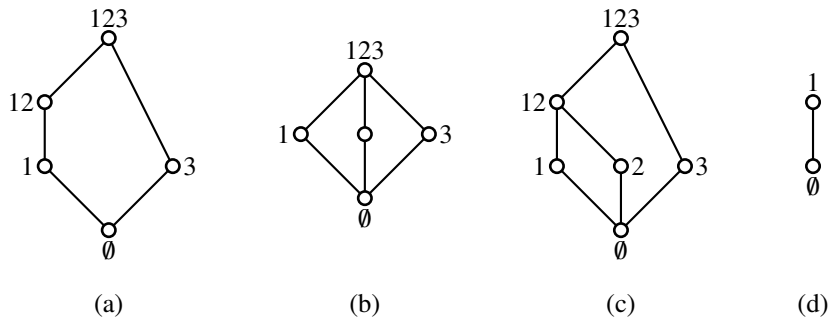

Figure 2.12 – Possible H-indecomposable factors.

To conclude this section, we relate H-decomposition to the subdirect product decomposition [GW12, Grä11]. Consider the closure system \mathcal{C} over $V = \{1, 2, 3\}$ in Figure 2.12(a) encoded by the implicational base $\{2 \rightarrow 1, 13 \rightarrow 2\}$. It is known that it cannot be decomposed using the subdirect product. Clearly Σ is not premise-connected and $V_1 = \{1, 3\}$ et $V_2 = \{2\}$ is the unique split where $\mathcal{C}_1 = \{\emptyset, 1, 3, 13\}$ and $\mathcal{C}_2 = \{\emptyset, 2\}$ are traces. Yet, \mathcal{C} is not a sublattice of $\mathcal{C}_1 \times \mathcal{C}_2$, since $\{1, 3\}$, the upper bound of 1 and 3 in $\mathcal{C}_1 \times \mathcal{C}_2$ is not preserved in \mathcal{C} . However, systems of Figure 2.12(b), (c) and (d) are both subdirectly irreducible and irreducible H-factors. Hence, we end the section with the following.

COROLLARY 1. *The closure system associated to an implicational base Σ is a meet-sublattice of the direct product of its H-factors.*

Proof. This follows from Theorem 9, item (i) and the fact that a closure system is closed under intersection. \square

In the next section, we pay more attention to particular splits called *acyclic*. We show how they can be applied to the problem of translating between the representations of a closure system.

2.4. Closure systems with acyclic splits

We introduce *acyclic split* of an implicational base Σ . They are a restriction of a split (V_1, V_2) where all implications of $\Sigma[V_1, V_2]$ have to go from V_1 to V_2 , *i.e.* they satisfy condition (iii) or (iv) of Theorem 9. The definition of acyclic split for implicational bases extend to closure systems.

DEFINITION 12 (Acyclic split). *Let Σ be an implicational base over V and (V_1, V_2) a split of Σ . The split (V_1, V_2) is acyclic if for every $A \rightarrow b \in \Sigma[V_1, V_2]$, $A \subseteq V_1$.*

DEFINITION 13 (Acyclic split of a closure system). *Let \mathcal{C} be a closure system over V and let (V_1, V_2) be a non-trivial bipartition of V such that $V_2 \in \mathcal{C}$. Then, (V_1, V_2) is an acyclic split of \mathcal{C} if there exists an implicational base Σ for \mathcal{C} with acyclic split (V_1, V_2) .*

In this section, we give a characterization of closure systems with acyclic splits. Then, we derive a recursive expression of their meet-irreducible elements. Finally, we devise an algorithm solving CCM in the presence of acyclic splits. To illustrate our results, we will use the following running example all along the section.

Example 31 (Running example). Let $V = \{1, 2, 3, 4, 5, 6\}$ and $\Sigma = \{12 \rightarrow 3, 13 \rightarrow 4, 23 \rightarrow 5, 2 \rightarrow 4, 1 \rightarrow 5, 5 \rightarrow 6, 4 \rightarrow 6\}$. We represent Σ and its associated closure system \mathcal{C} in Figure 2.13.

The bipartition $V_1 = \{1, 2, 3\}$ and $V_2 = \{4, 5, 6\}$ is an acyclic split of Σ and \mathcal{C} . We have $\Sigma[V_1] = \{12 \rightarrow 3\}$, $\Sigma[V_2] = \{4 \rightarrow 6, 5 \rightarrow 6\}$ and $\Sigma[V_1, V_2] = \{13 \rightarrow 4, 2 \rightarrow 4, 23 \rightarrow 5, 1 \rightarrow 5\}$.

2.4.1. Acyclic split of a closure system

Let Σ be an implicational base over V with acyclic split (V_1, V_2) . Let \mathcal{C} be its corresponding closure system. We first show how to construct \mathcal{C} from \mathcal{C}_1 , the closure system associated to $\Sigma[V_1]$, \mathcal{C}_2 , the closure system of $\Sigma[V_2]$ and the implications $\Sigma[V_1, V_2]$.

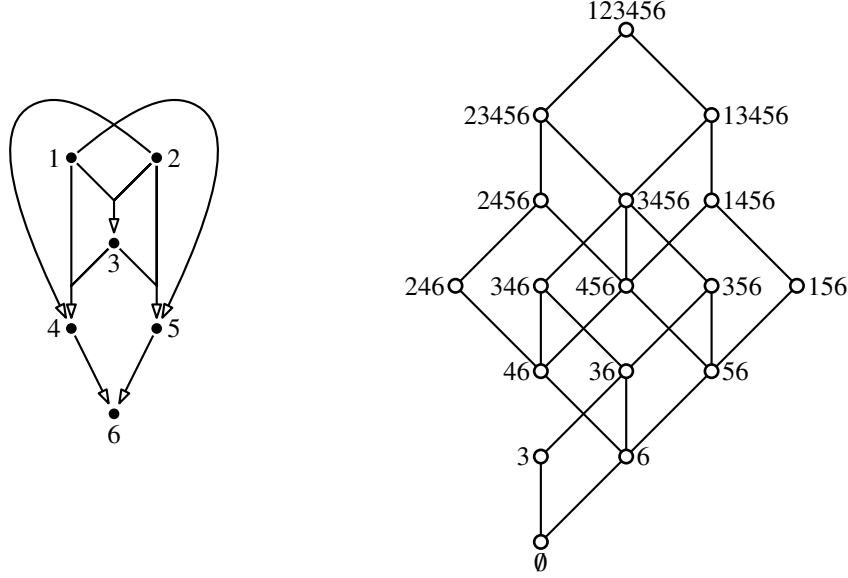

Figure 2.13 – An implicational base and its associated closure system.

We draw intuition from the particular case where $\Sigma[V_1, V_2] = \emptyset$. According to Theorem 9, \mathcal{C} is the direct product of \mathcal{C}_1 and \mathcal{C}_2 , that is $\mathcal{C} = \{C_1 \cup C_2 \mid C_1 \in \mathcal{C}_1, C_2 \in \mathcal{C}_2\}$. Intuitively, \mathcal{C} is obtained by “*extending*” each closed set of \mathcal{C}_2 with a copy of \mathcal{C}_1 (see the left part of Figure 2.14). This point of view will be particularly well-suited for us, and naturally leads to the following definition.

DEFINITION 14. *Let \mathcal{C} be a closure system over V , (V_1, V_2) be a non-trivial bipartition of V such that $V_2 \in \mathcal{C}$. Let $C_2 \in \mathcal{C}$, $C_2 \subseteq V_2$ and $C \in \mathcal{C}$. We say that C is an extension of C_2 with respect to V_2 if $C \cap V_2 = C_2$. We denote by $\text{Ext}(C_2)$ the extensions of C_2 in \mathcal{C} . The trace $\text{Ext}(C_2)$ on V_1 is written $\text{Ext}(C_2) : V_1$.*

In our definition, V_2 is closed. Therefore, for every $C \in \mathcal{C}$, $C \cap V_2$ is also closed. We deduce that C belongs to the extension of a unique closed set C_2 included in V_2 . As a consequence, we can write \mathcal{C} as the (disjoint) union of its extensions with respect to V_2 , *i.e.*

$$\mathcal{C} = \bigcup_{C_2 \in \mathcal{C}, C_2 \subseteq V_2} \text{Ext}(C_2)$$

This definition of extensions allows to formally express the intuition that the direct product of \mathcal{C}_1 and \mathcal{C}_2 (when $\Sigma[V_1, V_2] = \emptyset$) is obtained by extending each closed set of \mathcal{C}_2 with a copy \mathcal{C}_1 . Indeed, we have $\mathcal{C} = \bigcup_{C_2 \in \mathcal{C}_2} \text{Ext}(C_2)$ with the particularity that the trace of $\text{Ext}(C_2)$ on V_1 is exactly \mathcal{C}_1 for every $C_2 \in \mathcal{C}_2$. This construction is illustrated on the left of Figure 2.14.

In the more general case where $\Sigma[V_1, V_2]$ is not-empty, we show that the extensions of \mathcal{C}_2 are no longer full copies of \mathcal{C}_1 , but increasing copies of ideals of \mathcal{C}_1 , as illustrated on the right side of Figure 2.14. We begin with the following proposition, which characterizes extensions with the bipartite set of implications $\Sigma[V_1, V_2]$.

PROPOSITION 5. *Let $C_2 \in \mathcal{C}_2$ and $C_1 \subseteq V_1$. Then, $C = C_1 \cup C_2$ is an extension of C_2 if and only if $C_1 \in \mathcal{C}_1$ and for each implication $A \rightarrow b$ in $\Sigma[V_1, V_2]$, $A \subseteq C_1$ implies $b \in C_2$.*

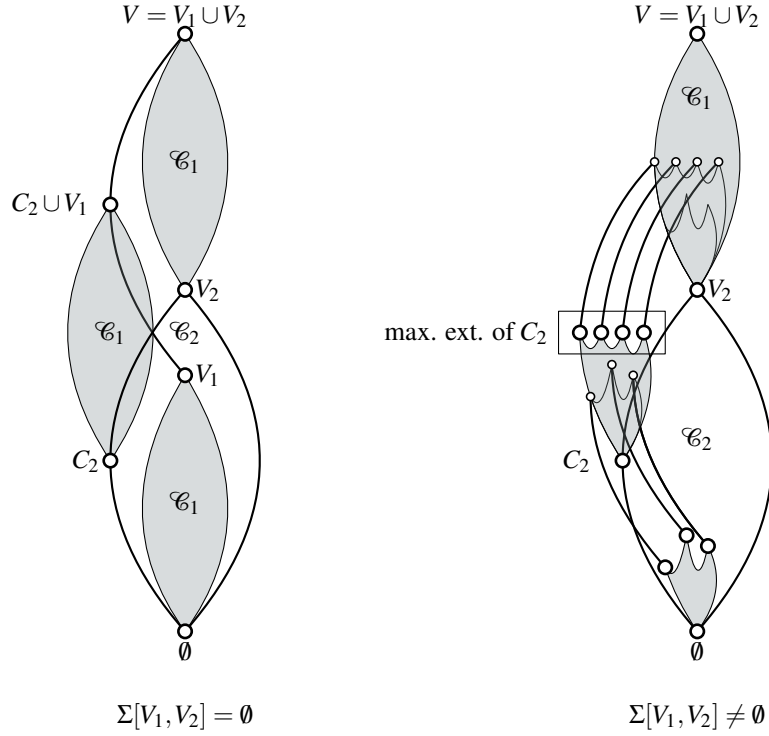

Figure 2.14 – Building of \mathcal{C} with an acyclic split: on the left, the case where $\Sigma[V_1, V_2] = \emptyset$ (direct product). On the right, the more general case where $\Sigma[V_1, V_2] \neq \emptyset$ (increasing extensions).

Proof. We begin with the only if part. Let C_1 be a subset of V_1 such that let C_1 be a closed set of \mathcal{C}_1 such that $C_1 \cup C_2$ is an extension of C_2 . By Theorem 9, $\mathcal{C} \subseteq \mathcal{C}_1 \times \mathcal{C}_2$ so that for every $C_1 \subseteq V_1$ such that $C_1 \cup C_2 \in \mathcal{C}$, $C_1 \in \mathcal{C}_1$ holds. Now let $A \rightarrow b \in \Sigma[V_1, V_2]$. If $A \subseteq C_1$, it must be that $b \in C_2$ since we would contradict $C_1 \cup C_2 \in \mathcal{C}$ otherwise.

We move to the if part. Let C_1 be a closed set of \mathcal{C}_1 and C_2 a closed set of \mathcal{C}_2 such that for each implication $A \rightarrow b$ in $\Sigma[V_1, V_2]$, $A \subseteq C_1$ implies $b \in C_2$. We have to show that $C_1 \cup C_2$ is closed. Let $A \rightarrow b$ be an implication of Σ with $A \subseteq C_1 \cup C_2$. As (V_1, V_2) is an acyclic split of V , we have two cases: either $A \rightarrow b$ is in $\Sigma[V_1, V_2]$ or it is not. In the second case, assume $A \rightarrow b$ belongs to $\Sigma[V_1]$. As $A \subseteq C_1 \cup C_2$, we have $A \subseteq C_1$. Furthermore, C_1 is closed for $\Sigma[V_1]$. Hence, $b \in C_1 \subseteq C_1 \cup C_2$. The same reasoning can be applied if $A \rightarrow b$ is in $\Sigma[V_2]$. Now assume $A \rightarrow b$ is in $\Sigma[V_1, V_2]$. We have that $A \subseteq V_1$ by definition of an acyclic split. In particular, we have $A \subseteq C_1$ which entails $b \in C_2$ by assumption. In any case, $C_1 \cup C_2$ already contains b for every implication $A \rightarrow b$ in Σ such that $A \subseteq C_1 \cup C_2$. Hence, $C_1 \cup C_2$ is closed. \square

We readily deduce from Proposition 5 that $\text{Ext}(V_2): V_1$ is equal to \mathcal{C}_1 . Proposition 5 is also a step towards the next proposition. It settles the fact that in an acyclic split, extensions coincide with ideals of \mathcal{C}_1 .

PROPOSITION 6. *Let $C_1 \in \mathcal{C}_1$, $C_2 \in \mathcal{C}_2$. If $C_1 \cup C_2$ is an extension of C_2 , then for every $C'_1 \in \mathcal{C}_1$ such that $C'_1 \subseteq C_1$, $C'_1 \cup C_2$ is also an extension of C_2 .*

Proof. Let $C_1 \in \mathcal{C}_1, C_2 \in \mathcal{C}_2$ such that $C_1 \cup C_2 \in \mathcal{C}$. Let $C'_1 \in \mathcal{C}_1$ such that $C'_1 \subseteq C_1$. As $C_1 \cup C_2$ is an extension of C_2 , for each $A \rightarrow b$ in $\Sigma[V_1, V_2]$ such that $A \subseteq C_1$, we have $b \in C_2$ by Proposition

5. Since $C'_1 \subseteq C_1$, this condition holds in particular if $A \subseteq C'_1$. Applying Proposition 5, we deduce that $C'_1 \cup C_2$ is closed. \square

In fact, the preceding proposition can be further strengthened. Not only extensions of \mathcal{C}_2 correspond to ideals of \mathcal{C}_1 , but they are increasing. That is, if C_1 contributes to an extension of C_2 , it will also contribute to an extension of any closed set $C'_2 \in \mathcal{C}_2$ including C_2 .

LEMMA 2. *Let $C_2, C'_2 \in \mathcal{C}_2$ such that $C_2 \subseteq C'_2$. Then $\text{Ext}(C_2): V_1 \subseteq \text{Ext}(C'_2): V_1$.*

Proof. We need to show that for every $C_2, C'_2 \in \mathcal{C}_2$ such that $C_2 \subseteq C'_2$, if $C_1 \cup C_2 \in \mathcal{C}$ for some $C_1 \subseteq V_1$, we also have $C_1 \cup C'_2 \in \mathcal{C}$. Observe that due to Proposition 5, $C_1 \in \mathcal{C}_1$. As $C_1 \cup C_2$ is an extension of C_2 , for every implication $A \rightarrow b$ of $\Sigma[V_1, V_2]$ such that $A \subseteq C_1$, we have $b \in C_2 \subseteq C'_2$ by Proposition 5. Therefore, $C_1 \cup C'_2$ is indeed an extension of C'_2 . \square

COROLLARY 2. *Let $C_2, C'_2 \in \mathcal{C}_2$ such that $C_2 \prec C'_2$ and let $C_1 \in \mathcal{C}_1$ such that $C_1 \cup C_2 \in \mathcal{C}$. Then $C_1 \cup C'_2 \in \mathcal{C}$ and $C_1 \cup C_2 \prec C_1 \cup C'_2$.*

Proof. The fact that $C_1 \cup C'_2$ is closed follows from Lemma 3. By Theorem 9, $\mathcal{C} \subseteq \mathcal{C}_1 \times \mathcal{C}_2$ so that any closed set C such that $C_1 \cup C_2 \subset C \subseteq C_1 \cup C'_2$ satisfies $C \cap V_2 \in \mathcal{C}_2$. Since $C_2 \prec C'_2$ in \mathcal{C}_2 , $C = C_1 \cup C'_2$ follows. \square

Thus, we have shown that if (V_1, V_2) is an acyclic split of Σ , \mathcal{C} can be constructed by extending each closed set C_2 of \mathcal{C}_2 , with an ideal of \mathcal{C}_1 , in an increasing fashion. This construction is illustrated in Figure 2.14 and in Figure 2.16 on an example. In the next theorem, we demonstrate that this construction by increasing extensions is in fact a characterization of acyclic splits.

THEOREM 10 (*). *Let \mathcal{C} be a closure system over V and (V_1, V_2) be a non-trivial bipartition of V such that $V_2 \in \mathcal{C}$. Let $\mathcal{C}_1 = \uparrow V_2: V_1$ and $\mathcal{C}_2 = \downarrow V_2$. Then, (V_1, V_2) is an acyclic split for \mathcal{C} if and only if for every $C_2, C'_2 \in \mathcal{C}_2$ such that $C_2 \subseteq C'_2$, we have $\text{Ext}(C_2): V_1 \subseteq \text{Ext}(C'_2): V_1$.*

Proof. The only if part follows from Lemma 2. To show the if part, we build an implicational base Σ with the acyclic split (V_1, V_2) . Beforehand, we outline the main ideas:

- Σ should contain an implicational base for \mathcal{C}_2 as it is an ideal of \mathcal{C} ;
- Σ should also include an implicational base for \mathcal{C}_1 since it is a filter of \mathcal{C} and Σ must respect the split (V_1, V_2) ;
- Σ must describe, for each $C_2 \in \mathcal{C}_2$, which closed sets of \mathcal{C}_1 contribute to extensions of C_2 or not. The most direct way to express this relationship is to explicitly write it in Σ by putting implications $C_1 \rightarrow \phi(C_1) \cap V_2$, if C_1 does not participate in an extension of C_2 .

Actually, we can readily optimize the last item. Indeed, since the property of not contributing to an extension is monotone, it is sufficient to put an implication $C_1 \rightarrow \phi(C_1) \cap V_2$ if C_1 is a minimal closed set of \mathcal{C}_1 which does not yield an extension of C_2 .

With these ideas in mind, we proceed now to the proof. Let $\mathcal{C}_1 = \uparrow V_2: V_1$ and $\mathcal{C}_2 = \downarrow V_2$. Observe that both \mathcal{C}_1 and \mathcal{C}_2 are closure systems, as they are intervals of \mathcal{C} . We aim to construct an implicational base Σ representing \mathcal{C} with acyclic split (V_1, V_2) .

First, we prove that $\mathcal{C} \subseteq \mathcal{C}_1 \times \mathcal{C}_2$. Let $C \in \mathcal{C}$ and let $C_1 = C \cap V_1$ and $C_2 = C \cap V_2$. As C and V_2 are closed in \mathcal{C} we deduce that $C_2 \in \mathcal{C}_2$ and hence that $C \in \text{Ext}(C_2)$. As $C_2 \subseteq V_2$, we have

$\text{Ext}(C_2): V_1 \subseteq \text{Ext}(V_2): V_1$ with $\text{Ext}(V_2): V_1 = \mathcal{C}_1$ by assumption. Hence $C_1 \in \mathcal{C}_1$. We deduce that $\mathcal{C} \subseteq \mathcal{C}_1 \times \mathcal{C}_2$.

Now, let $\Sigma[V_1]$ be an implicational base for \mathcal{C}_1 , $\Sigma[V_2]$ an implicational base for \mathcal{C}_2 and let

$$\Sigma[V_1, V_2] = \{C_1 \rightarrow \phi(C_1) \cap V_2 \mid C_1 \in \min_{\subseteq}(\mathcal{C}_1 \setminus \text{Ext}(C_2): V_1) \text{ for some } C_2 \in \mathcal{C}_2\}$$

Finally we put $\Sigma = \Sigma[V_1, V_2] \cup \Sigma[V_1] \cup \Sigma[V_2]$. Clearly (V_1, V_2) is an acyclic split for Σ . We prove that Σ is an implicational base for \mathcal{C} . Let \mathcal{C}_Σ be the closure system associated to Σ .

To show that $\mathcal{C}_\Sigma \subseteq \mathcal{C}$, we prove that $C \notin \mathcal{C}$ entails $C \notin \mathcal{C}_\Sigma$, for every $C \subseteq V$. Let $C \subseteq V$ such that $C \notin \mathcal{C}$ and put $C_1 = C \cap V_1$ and $C_2 = C \cap V_2$. First, assume that $C \notin \mathcal{C}_1 \times \mathcal{C}_2$. Since $\mathcal{C} \subseteq \mathcal{C}_1 \times \mathcal{C}_2$, $C \notin \mathcal{C}$ readily holds. Then, $C_1 \notin \mathcal{C}_1$ or $C_2 \notin \mathcal{C}_2$ so that C fails $\Sigma[V_1]$ or $\Sigma[V_2]$ and $C \notin \mathcal{C}_\Sigma$ holds. Now assume that $C \in \mathcal{C}_1 \times \mathcal{C}_2$ but $C \notin \mathcal{C}$. By construction of \mathcal{C} , we have that $C \notin \text{Ext}(C_2)$, or equivalently, $C_1 \notin \text{Ext}(C_2): V_1$. Let $C'_1 \in \mathcal{C}_1$ with $C'_1 \subseteq C_1$ and $C'_1 \in \min_{\subseteq}(\mathcal{C}_1 \setminus \text{Ext}(C_2): V_1)$. We show that C fails the implication $C'_1 \rightarrow \phi(C'_1) \cap V_2$ of $\Sigma[V_1, V_2]$. We have $\phi(C'_1) \in \mathcal{C}$ so that $\phi(C'_1) \cap V_2 \in \mathcal{C}_2$ and $C'_1 \in \text{Ext}(\phi(C'_1) \cap V_2): V_1$. By assumption, for every closed set $C''_2 \in \mathcal{C}_2$ such that $\phi(C'_1) \cap V_2 \subseteq C''_2$, $\text{Ext}(\phi(C_1) \cap V_2): V_1 \subseteq \text{Ext}(C''_2): V_1$. Therefore, $C'_1 \notin \text{Ext}(C_2): V_1$ implies that $\phi(C'_1) \cap V_2 \not\subseteq C_2$. Consequently, $C'_1 \subseteq C_1 \subseteq C$ but $\phi(C'_1) \cap V_2 \not\subseteq C \cap V_2 = C_2$. We deduce that $C \notin \mathcal{C}_\Sigma$, and hence that $\mathcal{C}_\Sigma \subseteq \mathcal{C}$.

Now we demonstrate that $\mathcal{C} \subseteq \mathcal{C}_\Sigma$. Let $C \in \mathcal{C}$ and put $C_1 = C \cap V_1$, $C_2 = C \cap V_2$. Recall that $\mathcal{C}_2 = \downarrow V_2$ and that $\Sigma[V_2]$ is an implicational base for \mathcal{C}_2 . Therefore, $C_2 \in \mathcal{C}_2$ and C is a model of $\Sigma[V_2]$ since $C_2 \subseteq C$. Now, because $C_2 \subseteq V_2$, we have $\text{Ext}(C_2): V_1 \subseteq \text{Ext}(V_2): V_1 = \mathcal{C}_1$ by assumption. Moreover, $\Sigma[V_1]$ is an implicational base for \mathcal{C}_1 . Consequently, we obtain that $C_1 \in \mathcal{C}_1$ and hence that C is a model for $\Sigma[V_1]$. It remains to show that C also models $\Sigma[V_1, V_2]$. But this is clear as $C = \phi(C)$ and each implication $C_1 \rightarrow \phi(C'_1) \cap V_2$ of $\Sigma[V_1, V_2]$ satisfies $\phi(C'_1) \cap V_2 \subseteq \phi(C_1)$. Hence, $C'_1 \subseteq C_1$ implies that $\phi(C'_1) \subseteq C$. Consequently, $\mathcal{C} \subseteq \mathcal{C}_\Sigma$ and $\mathcal{C} = \mathcal{C}_\Sigma$ holds, concluding the proof. \square

Example 32 (Running example). The closure system \mathcal{C}_1 associated to $\Sigma[V_1] = \{12 \rightarrow 3\}$ is given on the left of Figure 2.15. On the right, we give \mathcal{C}_2 , the closure system of $\Sigma[V_2] = \{4 \rightarrow 6, 5 \rightarrow 6\}$.

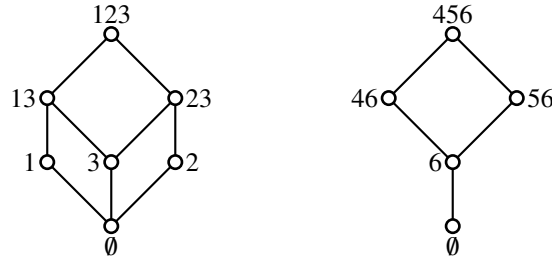

Figure 2.15 – The closure systems \mathcal{C}_1 and \mathcal{C}_2 .

The construction of \mathcal{C} using extensions with respect to \mathcal{C}_1 and \mathcal{C}_2 suggested by Theorem 10 is highlighted in Figure 2.16. For instance, the extensions of 6 are \emptyset and 36. Remark that \emptyset and 3 also contribute to the extensions 46, 346 of 46. Moreover, 346 is a maximal extension of 46, along with 246. Finally, the extensions of 456 (that is, V_2) coincide with \mathcal{C}_1 .

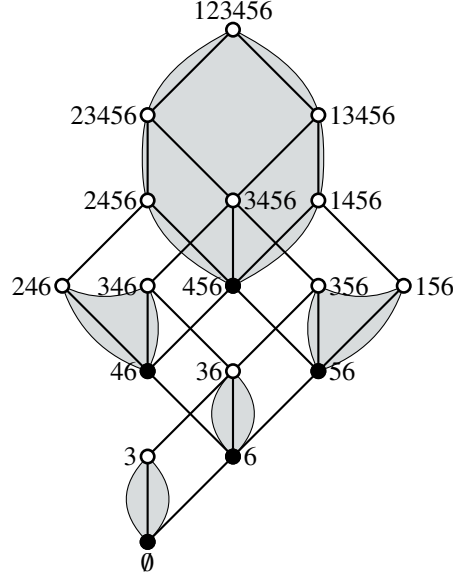

Figure 2.16 – The closure \mathcal{C} constructed from \mathcal{C}_1 and \mathcal{C}_2 (black dots are closed set of \mathcal{C}_2).

In the particular case where \mathcal{C} is a direct product of $\mathcal{C}_1, \mathcal{C}_2$, the pair (V_1, V_2) becomes a strong decomposition pair of [Lib93]. It is worth noticing that Theorem 10 hints a strategy to recursively compute the meet-irreducible elements of \mathcal{C} . This is the aim of the next subsection.

2.4.2. The meet-irreducible elements of a closure system with acyclic split

Now we use Theorem 10 to obtain a recursive expression of \mathcal{M} , the meet-irreducible elements of \mathcal{C} in terms of \mathcal{M}_1 and \mathcal{M}_2 , the meet-irreducible elements of \mathcal{C}_1 and \mathcal{C}_2 respectively. We prove that the decomposition of \mathcal{C} with extensions captures the structure of \mathcal{M} . Again, we start from the case of the direct product. This result has already been formulated in lattice theory, for instance in [DP02]. We give a proof in our framework for self-containment.

PROPOSITION 7. *Let \mathcal{C}_1 and \mathcal{C}_2 be two closure systems over V_1 and V_2 (resp.) where V_1 and V_2 are disjoint. Let $\mathcal{C} = \mathcal{C}_1 \times \mathcal{C}_2$. Then $\mathcal{M} = \{M_1 \cup V_2 \mid M_1 \in \mathcal{M}_1\} \cup \{M_2 \cup V_1 \mid M_2 \in \mathcal{M}_2\}$.*

Proof. Let $M \in \mathcal{M}$, $M_1 = M \cap V_1$ and $M_2 = M \cap V_2$. Since $\mathcal{C} = \mathcal{C}_1 \times \mathcal{C}_2$, we have $M_1 \in \mathcal{C}_1$ and $M_2 \in \mathcal{C}_2$. As $M \neq V_1 \cup V_2$, either $V_1 \not\subseteq M$ or $V_2 \not\subseteq M$. Suppose both statements hold. Then, there exists $C_1 \in \mathcal{C}_1$ such that $M_1 \prec C_1$ in \mathcal{C}_1 . Similarly, there exists $C_2 \in \mathcal{C}_2$ such that $M_2 \prec C_2$ in \mathcal{C}_2 . However $\mathcal{C} = \mathcal{C}_1 \times \mathcal{C}_2$. Hence, $M_1 \cup C_2$ and $C_1 \cup M_2$ belong to \mathcal{C} . Furthermore, they are incomparable and we have $M \prec M_1 \cup C_2$ and $M \prec C_1 \cup M_2$ which contradicts $M \in \mathcal{M}$. Therefore, either $V_1 \subseteq M$ or $V_2 \subseteq M$. Assume without loss of generality that $V_1 \subseteq M$. Let M' be the unique cover of M in \mathcal{C} . Then, $V_1 \subseteq M'$ and it follows that $M_2 \prec M' \cap V_2$ in \mathcal{C}_2 . As M' is the unique cover of M in \mathcal{C} , we conclude that $M' \cap V_2$ is the unique cover of M_2 in \mathcal{C}_2 and $M_2 \in \mathcal{C}_2$.

Let $M_1 \in \mathcal{M}_1$ and consider $M_1 \cup V_2 \in \mathcal{C}_2$. Let M'_1 be the unique cover of M_1 in \mathcal{C}_1 . As $\mathcal{C} = \mathcal{C}_1 \times \mathcal{C}_2$, we have that $M_1 \cup V_2 \prec M'_1 \cup V_2$ is in \mathcal{C} . Let C be any closed set such that $M_1 \cup V_2 \subset C$. We have $C \cap V_2 = V_2$ and hence $M_1 \subset C \cap V_1$. Since $\mathcal{C} = \mathcal{C}_1 \times \mathcal{C}_2$, we get $C \cap V_1 \in \mathcal{C}_1$. As $M_1 \prec M'_1$ in \mathcal{C}_1 and $M_1 \in \mathcal{M}_1$, we conclude that $M'_1 \subseteq C \cap V_1$ and hence that $M'_1 \cap V_2 \subseteq C$. Therefore, $M_1 \cup V_2 \in \mathcal{M}$. Similarly, we obtain $M_2 \cup V_1 \in \mathcal{M}$, for $M_2 \in \mathcal{M}_2$. \square

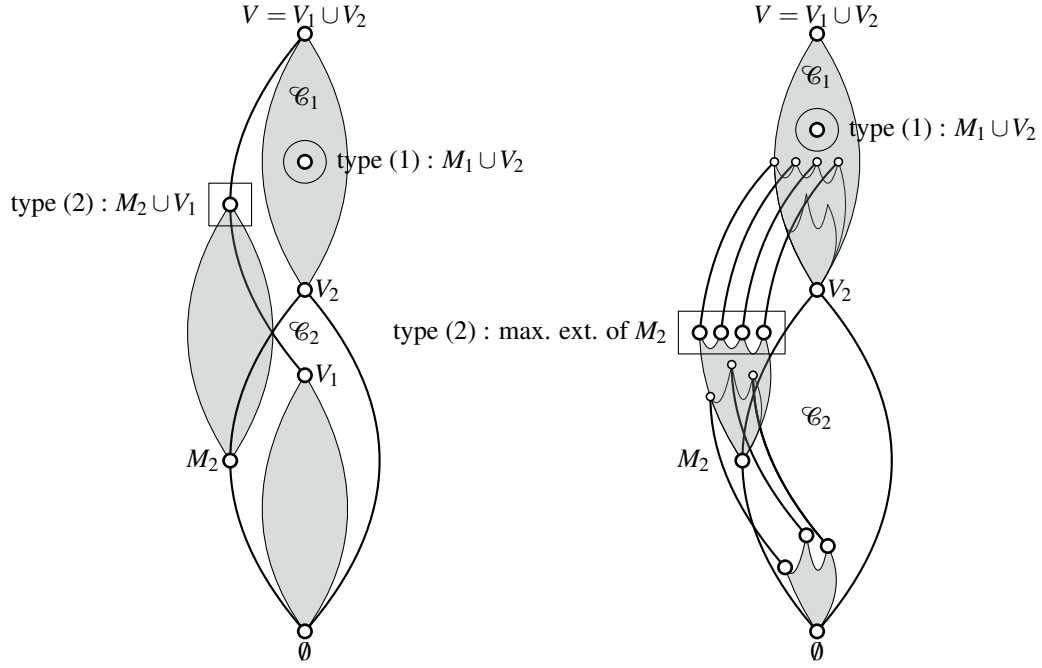

Figure 2.17 – Meet-irreducible elements of \mathcal{C} with an acyclic split: on the left, the direct product. On the right, the case of acyclic splits in general.

If we adopt the point of view of extensions with respect to \mathcal{C}_2 , as in the previous subsection, the meet-irreducible elements of $\mathcal{C}_1 \times \mathcal{C}_2$ can be partitioned into two classes:

- (1) those belonging to extensions of V_2 , that is $\{M_1 \cup V_2 \mid M_1 \in \mathcal{M}_1\}$;
- (2) meet-irreducible elements of \mathcal{M}_2 which we extended with V_1 , that is $\{M_2 \cup V_1 \mid M_2 \in \mathcal{M}_2\}$.

Observe that V_1 is the unique inclusion-wise maximal extension of M_2 , for each $M_2 \in \mathcal{M}_2$.

This construction is illustrated on the left part of Figure 2.17.

We show next that when \mathcal{C} has an acyclic split (V_1, V_2) but it is not the direct product of \mathcal{C}_1 and \mathcal{C}_2 , the structure of \mathcal{M} preserves this partitioning:

- (1) $\{M_1 \cup V_2 \mid M_1 \in \mathcal{M}_1\}$ remains unchanged;
- (2) $\{M_2 \cup V_1 \mid M_2 \in \mathcal{M}_2\}$ is adapted to replace V_1 by the possible maximal extensions of elements of \mathcal{M}_2 .

This construction is represented on the right of Figure 2.17. Let \mathcal{C} be a closure system with acyclic split (V_1, V_2) . Again, let $\mathcal{C}_1 = \uparrow V_2 : V_1$ and $\mathcal{C}_2 = \downarrow V_2$. We begin with the following two lemmas.

LEMMA 3. *Let $C_2 \in \mathcal{C}_2, C_2 \neq V_2$ and $C_1 \in \mathcal{C}_1$ such that $C_1 \cup C_2$ is a non-maximal extension of C_2 . Then $C_1 \cup C_2 \notin \mathcal{M}$.*

Proof. Let $C_2 \in \mathcal{C}_2, C_2 \neq V_2$ and $C_1 \in \mathcal{C}_1$ such that $C_1 \cup C_2$ is a non-maximal extension of C_2 . As $C_2 \neq V_2$, there exists at least one closed set $C'_2 \in \mathcal{C}_2$ such that $C_2 \prec C'_2$. By Corollary 2 we have that $C_1 \cup C_2 \prec C_1 \cup C'_2$ in \mathcal{C} . Furthermore, $C_1 \cup C_2$ is not a maximal extension of C_2 . Therefore, there exists a closed set C'_1 in \mathcal{C}_1 such that $C_1 \prec C'_1$ and $C'_1 \cup C_2 \in \mathcal{C}$. As $\mathcal{C} \subseteq \mathcal{C}_1 \times \mathcal{C}_2$ by Theorem 10 and extensions are increasing by Lemma 2, it follows that $C_1 \cup C_2 \prec C'_1 \cup C_2$ in

\mathcal{C} with $C_1 \cup C_2' \neq C_1' \cup C_2$. Therefore, $C_1 \cup C_2$ is not a meet-irreducible element of \mathcal{C} . \square

LEMMA 4. Let $C_2 \in \mathcal{C}_2$ such that $C_2 \neq V_2$ and $C_2 \notin \mathcal{M}_2$. Then $C \notin \mathcal{M}$ for every $C \in \text{Ext}(C_2)$.

Proof. Let $C_2 \in \mathcal{C}_2$ such that $C_2 \neq V_2$ and $C_2 \notin \mathcal{M}_2$. Let $C \in \text{Ext}(C_2)$ and $C_1 = C \cap V_1$. As $C_2 \notin \mathcal{M}_2$, it has at least two covers C_2', C_2'' in \mathcal{C}_2 . By Corollary 2, it follows that both $C_2' \cup C_1$ and $C_2'' \cup C_1$ are covers of C in \mathcal{C} . Hence $C \notin \mathcal{M}$. \square

These lemmas suggest that meet-irreducible elements of \mathcal{C} arise from maximal extensions of meet-irreducible elements of \mathcal{C}_2 . They might also come from meet-irreducible extensions of V_2 since $\text{Ext}(V_2): V_1 = \mathcal{C}_1$. These ideas are proved in the following theorem, which characterize the meet-irreducible elements \mathcal{M} of \mathcal{C} according to the two types we described.

THEOREM 11. Let \mathcal{C} be a closure system over V with acyclic split (V_1, V_2) . Let $\mathcal{C}_1 = \uparrow V_2: V_1$ and $\mathcal{C}_2 = \downarrow V_2$. Meet-irreducible elements \mathcal{M} of \mathcal{C} satisfy $|\mathcal{M}| \geq |\mathcal{M}_1| + |\mathcal{M}_2|$ and are subject to the following equality:

$$\mathcal{M} = \{M_1 \cup V_2 \mid M_1 \in \mathcal{M}_1\} \cup \{C \in \max_{\subseteq}(\text{Ext}(M_2)) \mid M_2 \in \mathcal{M}_2\}$$

Proof. First, $\{M_1 \cup V_2 \mid M_1 \in \mathcal{M}_1\} \subseteq \mathcal{M}$ follows from the fact that $\mathcal{C}_1 = \uparrow V_2: V_1$. We prove that $\max_{\subseteq}(\text{Ext}(M_2)) \subseteq \mathcal{M}$ for every $M_2 \in \mathcal{M}_2$. Let $M_2 \in \mathcal{M}_2$ and let C be a maximal extension of M_2 with $C = C_1 \cup M_2$. Since $M_2 \in \mathcal{C}_2$, it has a unique cover M_2' in \mathcal{C}_2 . By Corollary 2, we get $C \prec M_2' \cup C_1$ in \mathcal{C} . Let $C' \in \mathcal{C}$ such that $C \subset C'$. Recall that $\mathcal{C} \subseteq \mathcal{C}_1 \times \mathcal{C}_2$ follows from Theorem 10, so that $C' \cap V_1 \in \mathcal{C}_1$ and $C' \cap V_2 \in \mathcal{C}_2$. Furthermore, $C \in \max_{\subseteq}(\text{Ext}(M_2))$, therefore $C \subset C'$ implies that $M_2 \subset C' \cap V_2$ and hence that $M_2' \subseteq C' \cap V_2$ as $M_2 \in \mathcal{C}_2$. Since $C_1 \subseteq C' \cap V_1$, we get $C \prec M_2' \cup C_1 \subseteq C'$ and $C \in \mathcal{M}$ as it has a unique cover.

Now we prove the other side of the equation. Let $M \in \mathcal{M}$. As $\mathcal{C} \subseteq \mathcal{C}_1 \times \mathcal{C}_2$ since (V_1, V_2) is an acyclic split of \mathcal{C} , $M \cap V_2 \in \mathcal{C}_2$ and we can distinguish two cases. Either $M \cap V_2 = V_2$ or $M \cap V_2 \subset V_2$. If $M \cap V_2 = V_2$ then M is a meet-irreducible element of the closure system $\uparrow V_2$. Since $\uparrow V_2: V_1 = \mathcal{C}_1$, we obtain that $M \cap V_1 = M_1 \in \mathcal{M}_1$. Now assume that $M \cap V_2 \subset V_2$. Let $M_1 = M \cap V_1$ and $M_2 = M \cap V_2$. Then by contrapositive of Lemma 3 we have that $M \in \max_{\subseteq}(\text{Ext}(M_2))$ as $M_2 \neq V_2$. Similarly, we get $M_2 \in \mathcal{M}_2$ by Lemma 4. The inequality $|\mathcal{M}| \geq |\mathcal{M}_1| + |\mathcal{M}_2|$ follows from the description of \mathcal{M} . \square

Example 33 (Running example). The meet-irreducible elements \mathcal{M}_1 of \mathcal{C}_1 are 1, 13, 2 and 23. Similarly, the meet-irreducible elements of \mathcal{C}_2 are \emptyset , 46 and 56. In Figure 2.18 we highlight the two types of meet-irreducible elements of \mathcal{C} , based on Theorem 11. For instance 23456 is of type (1) as it is obtained from the meet-irreducible element 23 of \mathcal{C}_1 and V_2 . Dually, 356 is of type (2) because it is a maximal meet-irreducible element 56 of \mathcal{C}_2 .

To conclude this section, we briefly discuss another characterization of acyclic splits based on Theorem 10 and Theorem 11. Because extensions are hereditary, the extensions of \mathcal{M}_2 completely capture extensions of \mathcal{C}_2 . In other words, if $C_2 \in \mathcal{C}_2$ and C_1 contributes to an extension of C_2 , then $C_1 \cup M_2$ is also an extension of M_2 , for every $M_2 \in \mathcal{M}_2(C_2)$. Therefore, $C_1 \cup C_2$ results from the intersection of the closed sets $M_2 \cup C_1$, $M_2 \in \mathcal{M}_2(C_2)$. We illustrate this idea in Figure 2.19.

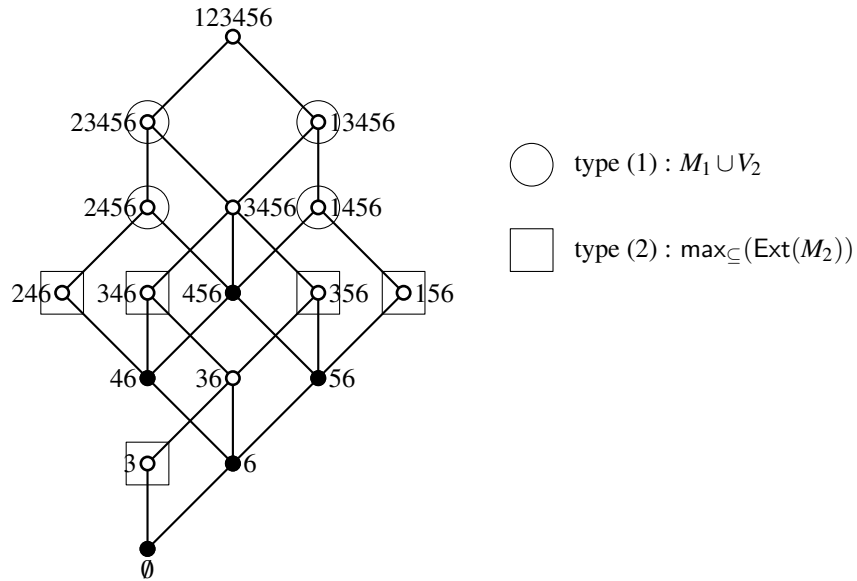

Figure 2.18 – The two types of meet-irreducible elements in \mathcal{C} (black dots are closed sets of \mathcal{C}_2).

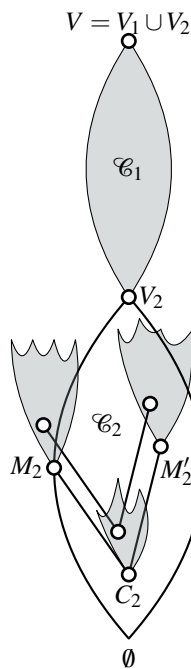

Figure 2.19 – Computing extensions of a closed set using extensions of meet-irreducible elements of \mathcal{C}_2 .

COROLLARY 3 (*). *Let \mathcal{C} be a closure system over V and (V_1, V_2) a non-trivial bipartition of V with $V_2 \in \mathcal{C}$. Let $\mathcal{C}_1 = \uparrow V_2 : V_1$ and $\mathcal{C}_2 = \downarrow V_2$. The pair (V_1, V_2) is an acyclic split for \mathcal{C} if and only if for every $C_2 \in \mathcal{C}_2$ and $C'_2 \in \mathcal{M}_2(C_2) \cup \{V_2\}$, $\text{Ext}(C_2) : V_1 \subseteq \text{Ext}(C'_2) : V_1$.*

Proof. The only if part follows from Theorem 10. Let $C_2, C'_2 \in \mathcal{C}_2$ with $C_2 \subseteq C'_2$. If $C_2 = V_2$ or $C'_2 = V_2$, the fact that $\text{Ext}(C_2) : V_1 \subseteq \text{Ext}(C'_2) : V_1$ is clear. Assume that $C_2 \subseteq C'_2 \subset V_2$ so that $\mathcal{M}_2(C_2)$ and $\mathcal{M}_2(C'_2)$ are not empty. From $C_2 \subseteq C'_2$, we deduce $\mathcal{M}_2(C'_2) \subseteq \mathcal{M}_2(C_2)$. Let $C \in \text{Ext}(C_2)$ with $C_1 = C \cap V_1$. Remark that $C_1 \in \mathcal{C}_1$ holds by assumption. Moreover, for every

$M_2 \in \mathcal{M}_2(C_2)$, we have $C_1 \cup M_2 \in \text{Ext}(M_2)$. This holds in particular for every $M_2 \in \mathcal{M}_2(C'_2)$ so that $\bigcap_{M_2 \in \mathcal{M}_2(C'_2)} (M_2 \cup C_1) = (\bigcap_{M_2 \in \mathcal{M}_2(C'_2)} M_2) \cup C_1 = C'_2 \cup C_1 \in \mathcal{C}$. Consequently, $C_1 \cup C'_2 \in \text{Ext}(C'_2)$ holds, concluding the proof. \square

2.4.3. Acyclic splits and CCM

We apply Theorem 11 to the problem CCM. Let \mathcal{C} be a closure system over V and Σ be an implicational base for \mathcal{C} . We assume that Σ has an acyclic split (V_1, V_2) . According to Theorem 11, computing \mathcal{M} from \mathcal{M}_1 and \mathcal{M}_2 requires finding maximal extensions of every meet-irreducible element $M_2 \in \mathcal{M}_2$. We will show that finding maximal extensions of a closed set is equivalent to a version of dualization in closure systems. First, we state the extension problem:

FIND MAXIMAL EXTENSIONS (MAXEXT)

Input: A triple $\Sigma[V_1], \Sigma[V_2], \Sigma[V_1, V_2]$ given by an acyclic split of an implicational base Σ , meet-irreducible elements $\mathcal{M}_1, \mathcal{M}_2$, and a closed set C_2 of $\Sigma[V_2]$.

Output: The maximal extensions of C_2 in \mathcal{C} , i.e. $\max_{\subseteq}(\text{Ext}(C_2))$.

We use the version of LDUAL where both \mathcal{M} and Σ are given, that is LDUAL(Σ, \mathcal{M}) (see Chapter 1, Section 1.5).

We show that MAXEXT and LDUAL(Σ, \mathcal{M}) are equivalent under polynomial-time reduction. First, we relate maximal extensions of a closed set with dualization. Let $C_2 \in \mathcal{C}_2$. Since $\text{Ext}(C_2): V_1$ is an ideal of \mathcal{C}_1 , the antichain $\max_{\subseteq}(\text{Ext}(C_2): V_1)$, we call it \mathcal{B}^+ , has a dual antichain \mathcal{B}^- in \mathcal{C}_1 . We have $\mathcal{B}^- = \min_{\subseteq}(\mathcal{C}_1 \setminus \text{Ext}(C_2): V_1)$. In words, \mathcal{B}^- is the family of minimal closed sets of C_1 that are not participating in extensions of C_2 .

PROPOSITION 8. *Let $C_2 \in \mathcal{C}_2$, and $C_1 \in \mathcal{C}_1$. Then, $C_1 \in \mathcal{B}^-$ if and only if $C_1 \in \min_{\subseteq}\{\phi_1(A) \mid A \rightarrow b \in \Sigma[V_1, V_2], b \notin C_2\}$.*

Proof. We show the if part. We denote by ϕ_1 the closure operator associated to $\Sigma[V_1]$. Let $C_1 \in \min_{\subseteq}\{\phi_1(A) \mid A \rightarrow b \in \Sigma[V_1, V_2], b \notin C_2\}$. We show that for any closed set $C'_1 \subseteq C_1$ in \mathcal{C}_1 , C'_1 contributes to an extension of C_2 . It is sufficient to show this property to the case where $C'_1 \prec C_1$ as $\text{Ext}(C_2): V_1$ is an ideal of \mathcal{C}_1 by Proposition 6. Hence, consider a closed set C'_1 in \mathcal{C}_1 such that $C'_1 \prec C_1$. Note that such C'_1 exists since $\emptyset \in \mathcal{C}_1$ and no implication $A \rightarrow b$ in Σ has $A = \emptyset$ so that $\emptyset \subset \phi_1(A)$ for any implication $A \rightarrow b$ of $\Sigma[V_1, V_2]$ such that $b \notin C_2$. Then, by construction of C'_1 , for any $A \rightarrow b$ in $\Sigma[V_1, V_2]$ such that $b \notin C_2$, we have $\phi_1(A) \not\subseteq C'_1$. As ϕ_1 is a closure operator, it is monotone and $\phi_1(A) \not\subseteq \phi_1(C'_1) = C'_1$ entails $A \not\subseteq C'_1$ for any such implication $A \rightarrow b$. Therefore $C'_1 \in \text{Ext}(C_2): V_1$ and $C_1 \in \mathcal{B}^-$.

We prove the only if part using contrapositive. Assume $C_1 \notin \min_{\subseteq}\{\phi_1(A) \mid A \rightarrow b \in \Sigma[V_1, V_2], b \notin C_2\}$. We have two cases. First, for any implication $A \rightarrow b$ in $\Sigma[V_1, V_2]$ such that $b \notin C_2$, $\phi_1(A) \not\subseteq C_1$. Since ϕ_1 is monotone and C_1 is closed in \mathcal{C}_1 , we have $A \not\subseteq C_1$ and $C_1 \in \text{Ext}(C_2): V_1$ by Lemma 2. Hence $C_1 \notin \mathcal{B}^-(C_2)$. In the second case, there is an implication $A \rightarrow b$ with $b \notin C_2$ in $\Sigma[V_1, V_2]$ such that $\phi_1(A) \subseteq C_1$ which implies $C_1 \notin \text{Ext}(C_2): V_1$. If $\phi_1(A) \subset C_1$, then clearly $C_1 \notin \mathcal{B}^-$ as $\phi_1(A) \in \mathcal{C}_1$ and $\phi_1(A) \notin \text{Ext}(C_2): V_1$. Hence, assume that $C = \phi_1(A)$. Since

$C_1 \notin \min_{\subseteq} \{\phi_1(A) \mid A \rightarrow b \in \Sigma[V_1, V_2], b \notin C_2\}$ by hypothesis, there exists another implication $A' \rightarrow b' \in \Sigma[V_1, V_2]$ such that $b' \notin C_2$ and $\phi_1(A') \subset C_1$. Hence $\phi_1(A') \notin \text{Ext}(C_2): V_1$ and $C_1 \notin \mathcal{B}^-$ as it is not an inclusion-wise minimum closed set which does not belong to $\text{Ext}(C_2): V_1$. \square

We can build \mathcal{B}^- in polynomial time from Σ using Proposition 5 and $\Sigma[V_1, V_2]$: we compute $\phi_1(A)$ for every implication $A \rightarrow b$ in $\Sigma[V_1, V_2]$ and we keep the closed sets (in \mathcal{C}_1) that are inclusion-wise minimal. Therefore, we prove the following theorem.

THEOREM 12. *MAXEXT and LDUAL(Σ, \mathcal{M}) are equivalent under polynomial-time reduction.*

Proof. First, we show that LDUAL(Σ, \mathcal{M}) is harder than MAXEXT. Let Σ be an implicational base over V , and $(\Sigma[V_1], \Sigma[V_2], \Sigma[V_1, V_2], \mathcal{M}_1, \mathcal{M}_2, C_2)$ be an instance of MAXEXT. By Proposition 8, $\max_{\subseteq}(\text{Ext}(C_2)): V_1$ is the dual antichain of $\mathcal{B}^- = \min_{\subseteq}(\{\phi_1(A) \mid A \rightarrow b \in \Sigma[V_1, V_2], b \notin C_2\})$ in \mathcal{C}_1 . Note that \mathcal{B}^- can be computed in polynomial time in the size of $\Sigma[V_1]$ and $|\mathcal{B}^-| \leq |\Sigma[V_1, V_2]|$. Therefore, the instance of MAXEXT reduces to the instance $(\Sigma[V_1], \mathcal{M}_1, \mathcal{B}^-)$ of LDUAL(Σ, \mathcal{M}).

Now we show that MAXEXT is harder than LDUAL(Σ, \mathcal{M}). Let $(\Sigma, \mathcal{M}, \mathcal{B}^-)$ be an instance of LDUAL(Σ, \mathcal{M}). Let z be a new gadget vertex and consider the bipartite implicational base $\Sigma[V, \{z\}] = \{B \rightarrow z \mid B \in \mathcal{B}^-\}$. Let $\Sigma_{new} = \Sigma \cup \Sigma[V, \{z\}]$. Clearly, Σ_{new} has an acyclic split $(V, \{z\})$ such that $\Sigma_{new}[V] = \Sigma$, $\Sigma_{new}[\{z\}] = (\{z\}, \emptyset)$ and $\Sigma_{new}[V, \{z\}] = \Sigma[V, \{z\}]$. The closure system associated to $\Sigma_{new}[\{z\}]$ has only 2 elements: its unique meet-irreducible element \emptyset and $\{z\}$. We obtain an instance MAXEXT where the input is $\Sigma, \Sigma_{new}[\{z\}], \Sigma[V, \{z\}], \mathcal{M}, \{\emptyset\}$ and where the closed set of interest is \emptyset . Moreover, this reduction is polynomial in the size of $(\Sigma, \mathcal{M}, \mathcal{B}^-)$ as we create a unique new element and $|\mathcal{B}^-|$ implications. According to Proposition 8, maximal extensions of \emptyset are given by the antichain dual to $\min_{\subseteq} \{\phi(A) \mid A \rightarrow z \in \Sigma[V, \{z\}]\}$. However, we have $\min_{\subseteq} \{\phi(A) \mid A \rightarrow z \in \Sigma[V, \{z\}]\} = \mathcal{B}^-$, so that maximal extensions of \emptyset are precisely elements of the dual antichain \mathcal{B}^+ of \mathcal{B}^- . \square

Now, we describe an algorithm for solving CCM in the presence of acyclic splits. First, we have $|\mathcal{M}| \geq |\mathcal{M}_1| + |\mathcal{M}_2|$ due to Theorem 11. Furthermore, each $M \in \mathcal{M}$ arise from a unique element of $M' \in \mathcal{M}_1 \cup \mathcal{M}_2$, and each $M' \in \mathcal{M}_1 \cup \mathcal{M}_2$ is used to construct at least one new meet-irreducible element $M \in \mathcal{M}$. Therefore, the algorithm will output every meet-irreducible element only once. Furthermore, the space needed to store intermediate solutions is bounded by the size of the output \mathcal{M} which prevents an exponential blow up during the execution.

The algorithm proceeds as follows. If Σ has no acyclic split, we use routines such as in [MR92, BMN17] to compute \mathcal{M} . When V is a singleton, the unique meet-irreducible to find is \emptyset and hence no call to other algorithm is required. Otherwise, we find an acyclic split (V_1, V_2) of Σ and we recursively call the algorithm on $\Sigma[V_1]$ and $\Sigma[V_2]$. Then, we compute \mathcal{M} using $\Sigma, \mathcal{M}_1, \mathcal{M}_2$ and MAXEXT. Observe that it takes polynomial time in the size of Σ and V to compute an acyclic split, if it exists:

- compute the premise-connected components of Σ ;
- construct a directed graph on these components, with an arc from a component C_1 to C_2 if there is an implication $A \rightarrow b$ in Σ such that $A \subseteq C_1$ and $b \in C_2$;

- then, an acyclic split exists if and only if there are at least two strongly connected components, and each non-trivial bipartition of the strongly connected components will represent an acyclic split.

Thus, the algorithm `BuildTree` can be adapted to find a decomposition with acyclic splits or return `FAIL` if not possible in polynomial time.

Example 34 (Running example). First, we compute a decomposition of Σ in terms of acyclic splits. We obtain the Σ -tree illustrated in Figure 2.20.

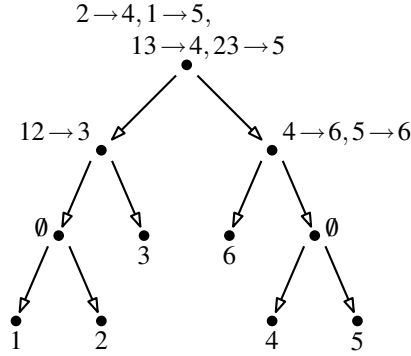

Figure 2.20 – The Σ -tree of Σ .

Then, we apply Theorem 11 bottom-up to construct the set \mathcal{M} of meet-irreducible elements of \mathcal{C} . This part is shown in Figure 2.21. For readability, we highlighted at each step which closed sets are part of \mathcal{C}_2 and also the two types of meet-irreducible elements of Theorem 11.

To conclude, we derive a class of implicational bases where our strategy can be applied to obtain the meet-irreducible elements in output quasi-polynomial time.

COROLLARY 4. *Let Σ be an implicational base over V . Assume there exists a full partition V_1, \dots, V_k of V such that for every implication $A \rightarrow b \in \Sigma$, $A \subseteq V_i$ and $b \in V_j$ for some $1 \leq i < j \leq k$. Then CCM can be solved in output-quasipolynomial time.*

Proof. Observe that Σ is acyclic in this case. Then, Σ can be hierarchically decomposed by $k - 1$ acyclic splits such that the implicational base on the left of the i -th split is $\Sigma[V_i] = \emptyset$ and the right-one $\Sigma[\bigcup_{j>i} V_j]$. Then, `MAXEXT` reduces to hypergraph dualization, and we can compute \mathcal{M} from Σ in output-quasipolynomial time using the algorithm of Fredman and Khachiyan [FK96]. \square

The class of closure systems associated to these implicational bases generalizes the ranked convex geometries of [DNV21] since an implicational base is ranked when it further satisfies the condition that $A \subseteq V_i$ implies $b \in V_{i+1}$.

2.5. Discussions and open problems

We conclude the chapter with some discussions and open questions for future work. Splits and more notably acyclic splits are decomposition methods based on the syntax of implications.

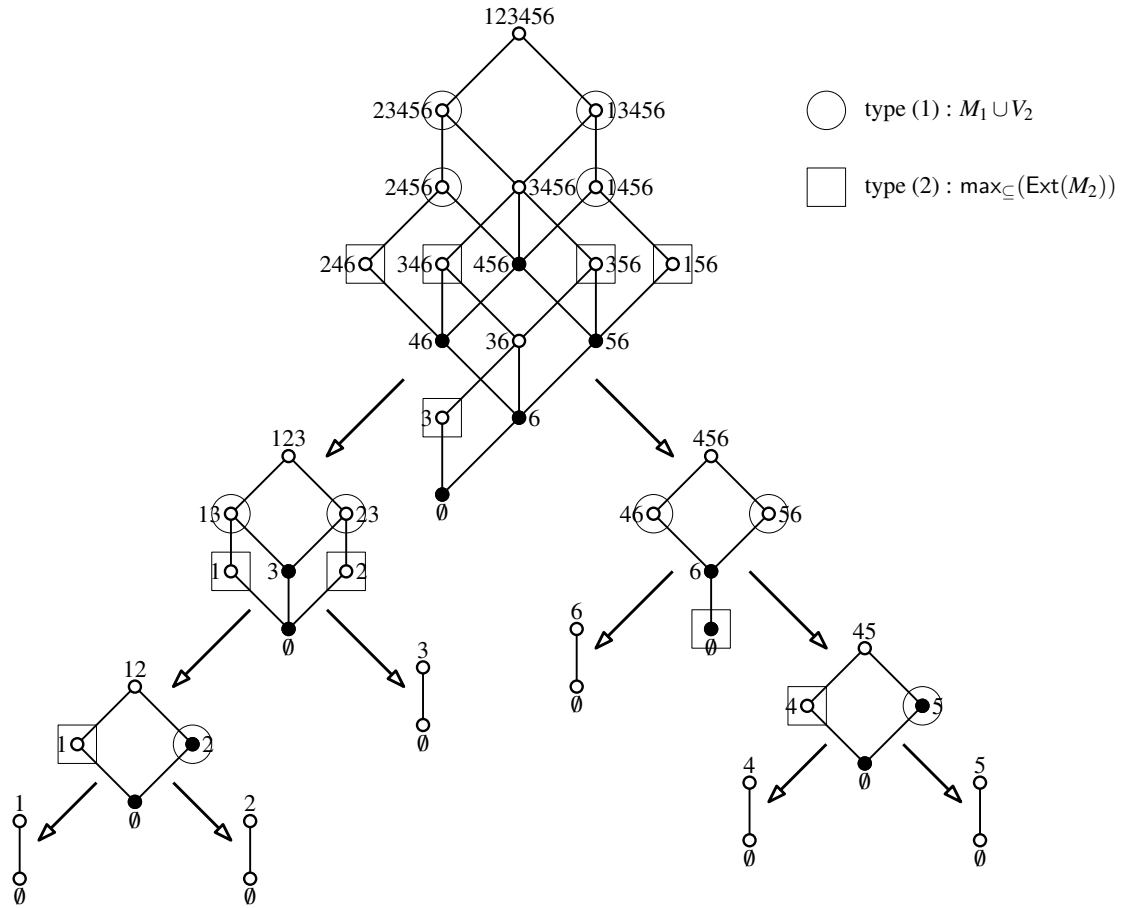

Figure 2.21 – Recursive computation of \mathcal{M} using a decomposition by acyclic splits.

However, two equivalent implicational bases may not share the same (acyclic) splits. In fact, it is even possible to find two equivalent implicational bases where one has an acyclic split, and not the other. This is demonstrated by the following example.

Example 35. Let $V = \{1, 2, 3, 4\}$ and $\Sigma = \{1 \rightarrow 4, 124 \rightarrow 3, 3 \rightarrow 4\}$. The unique possible split is $(124, 3)$ which is not acyclic. However, the implicational base $\Sigma' = \{1 \rightarrow 4, 12 \rightarrow 3, 3 \rightarrow 4\}$, which is clearly equivalent to Σ has an acyclic split being $(12, 34)$.

The previous example suggests considering only minimum implicational bases whose left-sides are as small as possible. However, several such bases may exist and finding the right-one might be an expensive task, whence the following question.

Question 1. *Is it possible to decide whether a closure system has an acyclic split in polynomial time from an implicational base?*

A similar question holds for the case of meet-irreducible elements:

Question 2. *Is it possible to recognize an acyclic split in polynomial time from a set of meet-irreducible elements?*

In Corollary 3, we give a first step towards a characterization of acyclic splits from meet-irreducible elements. The statement in the corollary does consider the representation of closed sets by meet-irreducible elements. Nonetheless, this characterization needs to be checked on

every closed set of \mathcal{C}_2 . In order to recognize an acyclic split from a set of meet-irreducible elements only, an idea would be to replace the statement by this one:

for every $M_2, M'_2 \in \mathcal{M}_2$ such that $M_2 \subseteq M'_2$, $\text{Ext}(M_2) : V_1 \subseteq \text{Ext}(M'_2) : V_1$.

Unfortunately, this latter condition is not sufficient, as demonstrated by the next example.

Example 36. Let $V_1 = \{4, 5\}$, $V_2 = \{1, 2, 3\}$ and consider the closure systems \mathcal{C}_1 and \mathcal{C}_2 given in Figure 2.22.

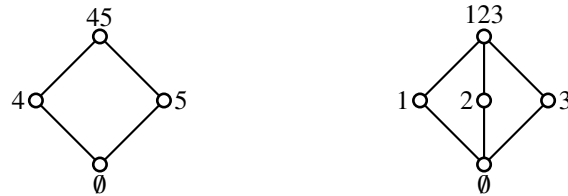

Figure 2.22 – The closure systems \mathcal{C}_1 and \mathcal{C}_2 .

An implicational base for \mathcal{C}_1 is $\Sigma_1 = \emptyset$ and $\Sigma_2 = \{12 \rightarrow 3, 13 \rightarrow 2, 23 \rightarrow 1\}$ is an implicational base for \mathcal{C}_2 . We have $\mathcal{M}_1 = \{4, 5\}$ and $\mathcal{M}_2 = \{1, 2, 3\}$. Now let $V = V_1 \cup V_2$ and consider the closure system \mathcal{C} of Figure 2.23 and the pair (V_1, V_2) .

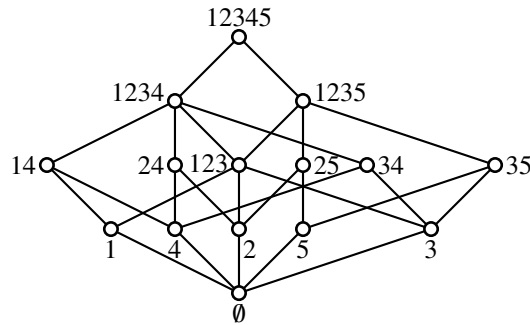

Figure 2.23 – The closure system \mathcal{C} , failing Corollary 3.

We have $\mathcal{M} = \{1234, 1235\} \cup \{14, 24, 25, 34, 35\}$. As \mathcal{M}_2 is an antichain, the condition given above is satisfied. However, Corollary 3 fails because $\max_{\subseteq}(\text{Ext}(\emptyset) : V_1) \not\subseteq \text{Ext}(1) : V_1$. Hence, (V_1, V_2) is not an acyclic split for \mathcal{C} .

When (V_1, V_2) is an acyclic split of \mathcal{C} and V_2 is a singleton element, the construction of \mathcal{C} can be interpreted as the duplication of an ideal of \mathcal{C}_1 . This puts the light on a possible link between (acyclic) splits and lower-bounded lattices [FJN95, ANR13]. In particular, we know from [ANR13] that the non-left-unit part of the D -base of a lower bounded lattice is acyclic. As left-unit implications play no role in the existence of splits, there should exist a H -decomposition of the D -base by “almost acyclic” splits.

Example 37. Let $V = \{1, 2, 3\}$ and $\Sigma = \{12 \rightarrow 3, 3 \rightarrow 1\}$. The associated closure system is the pentagon N_5 and is (lower) bounded. Its D -base is precisely Σ . It has no acyclic split when we consider $3 \rightarrow 1$, but it has a split $(12, 3)$ which becomes acyclic once $3 \rightarrow 1$ is removed.

Thus, we are naturally lead to the next question.

Question 3. *Can implicational bases of lower-bounded closure systems be characterized by the existence of a particular Σ -tree?*

Answering this question would allow extending Theorem 11 to take into account unitary implications creating cycles.

Finally, we showed the strong relationship between dualization and translation with acyclic splits by the mean of Theorem 12. We used this connection to go beyond our previous results on acyclic convex geometries [DNV21]. Still, not every acyclic convex geometry can be decomposed in this suitable way, whence the last more general question:

Question 4. *Can SID and CCM be solved in output-quasipolynomial time in (acyclic) convex geometries ?*

CHAPTER 3. *Closure systems with forbidden sets*

“J’ai procédé au recensement des pierres, elles sont au nombre de mes doigts et quelques autres; j’ai distribué des prospectus aux plantes, mais toutes n’ont pas voulu les accepter.”

Poisson Soluble, André Breton.

Summary: *Given a representation for a closure system, the objective is to list the closed sets that are allowed with respect to a family of forbidden sets. Inspired by argumentation, we will call them admissible closed sets. Depending on the intended meaning of forbidden sets, as subsets or supersets, we will also pay much attention to the problem of enumerating maximal or minimal admissible closed sets. They will be named preferred closed sets. By studying these objects, we connect several fields and problems of computer science such as argumentation frameworks, dualization in lattices or median-semilattices.*

3.1. Introduction

In this chapter, we are concerned with forbidden sets in closure systems. In our case, the term forbidden refers to set-inclusion, and hence sets are forbidden either as subsets or as supersets. As in the previous chapter, the knowledge of the closure system is provided by implications or meet-irreducible elements. Our first objective is to list the closed sets that are allowed or *admissible* with respect to a family of forbidden sets. Since the property of being forbidden is monotonic (or anti-monotonic), the family of admissible closed sets is compactly represented by its minimal (or maximal) elements. These are called *preferred* closed sets. This naturally leads to our second objective, being the enumeration of preferred closed sets.

Forbidding structures is common in computer science [Sch97, SU05, DPR75, DDLW15, MRS02, Che12]. Forbidden sets are not less frequent, and the problems we study appear under various shapes in different domains. Independently of the meaning of forbidden sets (supersets or subsets), the task of listing admissible closed sets generalizes the enumeration of closed sets of a closure system. This latter question has been widely studied in the literature, see *e.g.* [Bor86, NR99, Kuz96, GW12, DBF⁺20, KO02]. Listing the preferred closed sets connects on the other hand with dualization in lattices [BK17, DN20] and hypergraph dualization [FK96, EG95, EMG08], which we already introduced in Chapter 1.

Apart from these general aspects, several restrictions and particular types of forbidden sets arise from different fields of computer science. When considering forbidden supersets, the

tasks of enumerating admissible closed sets generalizes the enumeration of semi-kernels in directed graphs [DT96] and the enumeration of admissible sets in argumentation theory [Dun95, DDLW15], from which we borrowed the terms admissible and preferred. In these contexts, forbidden supersets are in fact co-pairs for they represent complements of edges in (directed) graphs. Similarly, the enumeration of preferred closed sets with respect to forbidden co-pairs generalizes the problem of listing the preferred sets of arguments in argumentation frameworks.

As for forbidden subsets, implications and forbidden pairs form a compact representation for median and modular-semilattices. More precisely, the authors of [BC93] show that any median-semilattice can be represented by a set of forbidden pairs along with a poset. This representation is also used for event structures [NPW81, Che12] or cubical complexes [AOS12] in which the term “*inconsistency*” is adopted. Based on this representation of median-semilattices [BC93] and projective ordered spaces [HPR94], the authors in [HO18, HN20] devise a compact encoding for modular semilattices also based on implications and forbidden pairs of elements. They use this encoding to compactly represent minimizers of a submodular functions on modular-semilattices or Pott’s k -submodular functions. As an application, they deduce that the preferred closed sets of the underlying closure system are precisely the maximal minimizers of k -submodular functions.

We now review the principal results on these problems. For those connected to dualization, we refer the reader to Chapter 1, Section 1.5.

For the case of forbidden supersets, the authors in [DT96] show that deciding whether there exists an admissible closed sets with respect to a set of forbidden co-pairs is **NP**-complete. However, the input to their problem is different from ours. Indeed, they consider as input a directed graph which encodes both a closure system and a family of forbidden co-pairs. On the positive side, [DDLW15, ENR21] mention classes of directed graphs where the problem can be solved in output-polynomial time. In these works, the closure system is intimately connected to the forbidden co-pairs. Here, we consider the more general case where the closure system is independent of the input family of forbidden sets. Finally, enumerating admissible closed sets has been studied in [BK17] as the problem of “*generating positive hypotheses*”. It is shown that the problem can be solved in output-polynomial time when the closure system is represented by its meet-irreducible elements.

For forbidden subsets, it is proved in [KSS00] that when the closure system is distributive and forbidden sets are pairs of elements, the preferred closed sets can be enumerated with polynomial delay using the algorithm in [JYP88, TIAS77] for listing the maximal independent sets of a graph. This result connects with the representation of median-semilattices by a poset and a family of forbidden pairs [BC93, AOS12, Che12]. Recently in [HO18, HN20], the authors characterize the cases where given an implicational base and a family of forbidden pairs, the preferred closed sets coincide with the maximal independent sets of a graph.

Contributions and outline The contributions are divided into two parts:

- (i) Closure systems with forbidden supersets (Section 3.3). Here, a closed set is *upper-admissible* if it is not included in any of the forbidden supersets. An inclusion wise minimal upper-admissible closed set is *upper-preferred*. We introduce two problems:

- enumerating upper-admissible closed sets (EUA(α)),
- enumerating upper-preferred closed sets *w.r.t.* forbidden co-pairs (EUP-CP(α)).

These problems take as input a family of forbidden sets and a representation α for a closure system. This representation is either an implicational base Σ , or a set of meet-irreducible elements \mathcal{M} . We show the following results:

- EUA(Σ) is intractable [ENR21,DDLW15], but it can be solved in output-polynomial time for meet and join-semidistributive closure systems.
- EUP-CP(Σ) is intractable while EUP-CP(\mathcal{M}) can be solved with polynomial delay.

(ii) Closure systems with forbidden subsets (Section 3.4). A closed set is called *lower-admissible* when it includes none of the forbidden subsets. An inclusion-wise maximal lower-admissible closed set is *upper-preferred*. Again, we consider two problems:

- enumerating lower-admissible closed sets (ELA(α)),
- enumerating lower-preferred closed sets *w.r.t.* forbidden pairs (ELP-P(α)).

Both problems have the same input as EUA(α) and EUP-CP(α). We obtain the following results:

- ELA(α) can be solved with polynomial delay from any representation.
- ELP-P(α) is hard in general. In particular, it is intractable in lower bounded and join-semidistributive closure systems represented by implicational bases. It can be solved with polynomial delay in standard Boolean and distributive closure systems [KSS00,JYP88].
- ELP-P(α) is equivalent to LDUAL(α) in various classes of closure systems generalizing distributivity.
- We develop an incremental-polynomial time algorithm to solve ELP-P(α) for closure systems with bounded Carathéodory number. It runs in output-quasipolynomial time if the Carathéodory number is logarithmic in the size of the groundset.

The chapter ends in Section 3.5 with some discussions and open problems for future works. This chapter is an extended version of our contribution in [NV21]. Several results are new. As in the previous chapter, we mark them by a star (*).

3.2. Preliminaries

Let \mathcal{C} be a closure system over V with induced closure operator ϕ . Let \mathcal{M} be its meet-irreducible elements, and \mathcal{J} its join-irreducible elements. Recall that for a subset X of V , $\mathcal{M}(X)$ denotes the set of meet-irreducible elements including X , that is $\mathcal{M}(X) = \{M \in \mathcal{M} \mid X \subseteq M\}$. Remind also that a closure system \mathcal{C} is *standard* if for every $v \in V$, $\phi(v) \setminus \{v\} \in \mathcal{C}$. The closure system \mathcal{C} is considered ordered by set inclusion. Consequently, all the definitions on posets (see Chapter 1, Section 1.1) apply. In particular, the ideal of a closed set C in \mathcal{C} is denoted by $\downarrow_{\mathcal{C}} C$, or $\downarrow C$ when \mathcal{C} is clear from the context. Similarly, the filter of C is denoted $\uparrow_{\mathcal{C}} C$ or simply $\uparrow C$. These

notations extend to subsets of \mathcal{C} .

We also recall the definitions of arrow relations (see Chapter 1, Section 1.3). Let $C \in \mathcal{C}$, $J \in \mathcal{J}$ and $M \in \mathcal{M}$. We write $C \uparrow M$ when $M \in \max_{\subseteq}(\{C' \in \mathcal{C} \mid C \not\subseteq C'\})$. Dually, we write $J \downarrow C$ when $J \in \min_{\subseteq}(\{C' \in \mathcal{C} \mid C' \not\subseteq C\})$. Moreover, we put $J \downarrow M$ when $J \uparrow M \downarrow J$ holds. Finally, we rewrite in terms of closed sets the definition of the D -relation [Day70, FJN95]. It is a binary relation D over \mathcal{J} , and we write $J_1 D J_2$ when there exists some $M \in \mathcal{M}$ such that $J_1 \uparrow M \downarrow J_2$.

Let $v \in V$. A *minimal generator* of v is a subset A_v of V such that $v \in \phi(A_v)$ but $v \notin \phi(A')$ for every $A' \subset A_v$. Following [KLS12], the *Carathéodory number* $cc(\mathcal{C})$ of \mathcal{C} is the least integer k such that for any $X \subseteq V$ and any $v \in V$, $v \in \phi(X)$ implies the existence of some $X' \subseteq X$ with $|X'| \leq k$ such that $x \in \phi(X')$. At first, this notion was used for (affine) convex geometries, but its definition applies to any closure system. Moreover, the Carathéodory number of \mathcal{C} is the maximal possible size of a minimal generator (see Proposition 4.1 in [KLS12], which can be applied to any closure system).

3.3. Closure systems with forbidden supersets

We consider a closure system \mathcal{C} over V with a simple family \mathcal{F} over V . We say that \mathcal{F} is a family of *forbidden supersets* for \mathcal{C} .

Remark 6. In this chapter, a representation α for a closure system is either an implicational base or a set of meet-irreducible elements.

DEFINITION 15 (Upper-admissible closed set). *Let \mathcal{C} be a closure system over V and let \mathcal{F} be a family of forbidden supersets over V . A closed set C is upper-admissible (w.r.t. \mathcal{F}) if $C \not\subseteq F$ for every $F \in \mathcal{F}$. The collection of all upper-admissible closed sets of \mathcal{C} w.r.t. \mathcal{F} is denoted $\text{Adm}_u(\mathcal{C}, \mathcal{F})$.*

ENUMERATION OF UPPER-ADMISSIBLE CLOSED SETS (EUA(α))

Input: A representation α for a closure system \mathcal{C} over V , a family $\mathcal{F} \subseteq 2^V$ of forbidden supersets.
Output: The family $\text{Adm}_u(\mathcal{C}, \mathcal{F})$.

Quite clearly, if C is upper-admissible, every closed set C' such that $C \subseteq C'$ is also upper-admissible. Thus, $\text{Adm}_u(\mathcal{C}, \mathcal{F})$ is completely characterized by its minimal elements. We obtain a second definition, *upper-preferred closed sets*, and the associated generation problem.

DEFINITION 16 (Upper-preferred closed sets). *Let \mathcal{C} be a closure system over V and \mathcal{F} a family of forbidden supersets over V . A closed set C is upper-preferred (w.r.t. \mathcal{F}) if it is an inclusion-wise minimal upper-admissible closed set of \mathcal{C} . The family of upper-preferred closed sets of \mathcal{C} (w.r.t. \mathcal{F}) is called $\text{Pref}_u(\mathcal{C}, \mathcal{F})$.*

ENUMERATION OF UPPER-PREFERRED CLOSED SETS (EUP(α))

Input: A representation α for a closure system \mathcal{C} over V , a family $\mathcal{F} \subseteq 2^V$ of forbidden supersets.
Output: The family $\text{Pref}_u(\mathcal{C}, \mathcal{F})$.

The problem $\text{EUP}(\alpha)$ is a generalization of $\text{UDUAL}(\alpha)$. Indeed, the antichain in the input of $\text{UDUAL}(\alpha)$ can be seen as a family of forbidden supersets. Therefore, $\text{EUP}(\alpha)$ inherits all the hardness results of $\text{UDUAL}(\alpha)$. In this section, we consider instead the restriction to forbidden co-pairs (complements of pairs):

EUP WITH FORBIDDEN CO-PAIRS ($\text{EUP-CP}(\alpha)$)

Input: A representation α for a closure system \mathcal{C} over V , a family $\mathcal{F} \subseteq 2^V$ of forbidden co-pairs.
Output: The family $\text{Pref}_u(\mathcal{C}, \mathcal{F})$.

When $\mathcal{F} = \{V\}$, $\text{Adm}_u(\mathcal{C}, \mathcal{F})$ is empty. To avoid this trivial case, we consider that $\mathcal{F} \neq \{V\}$. Dually, the case $\mathcal{F} = \emptyset$ is trivial to solve as $\text{Adm}_u(\mathcal{C}, \mathcal{F}) = \mathcal{C}$ and $\text{Pref}_u(\mathcal{C}, \mathcal{F}) = \{\emptyset(\emptyset)\}$. We also assume that $\mathcal{F} \neq \emptyset$. In particular, V is always a (trivial) upper-admissible closed set.

Example 38. We illustrate the definitions on an example. Let $V = \{1, 2, 3, 4, 5\}$ and let \mathcal{C} be the closure system represented in Figure 3.1. Let $\mathcal{F} = \{124, 235\}$ be a family of forbidden supersets. Observe that the sets in \mathcal{F} are co-pairs. We have:

- $\text{Adm}_u(\mathcal{C}, \mathcal{F}) = \{123, 15, 1234, 145, 1235\}$ (white dots in the figure),
- $\text{Pref}_u(\mathcal{C}, \mathcal{F}) = \{123, 15\}$ (boxed white dots).

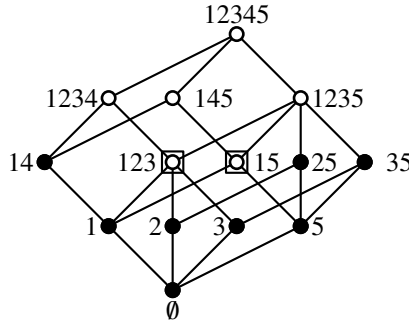

Figure 3.1 – A closure system \mathcal{C} with a family of forbidden supersets \mathcal{F} .

Results of the section. We show that $\text{EUA}(\Sigma)$ is intractable while $\text{EUA}(\mathcal{M})$ can be solved in output-polynomial time [BK17]. We prove that $\text{EUA}(\Sigma)$ can be solved in output-polynomial time for meet-semidistributive and join-semidistributive closure systems. Then, we consider the problem $\text{EUP-CP}(\alpha)$. We show that $\text{EUP-CP}(\Sigma)$ cannot be solved in output-polynomial time unless $\mathbf{P} = \mathbf{NP}$ while $\text{EUP-CP}(\mathcal{M})$ can be solved with polynomial delay.

3.3.1. Enumeration of upper-admissible closed sets

We start with the problem $\text{EUA}(\Sigma)$. We use a result of Dimopoulos and Torres [DT96], written in the language of directed graphs. Let $\mathcal{D} = (V, \mathcal{A})$ be a directed graph. For a subset X of V , we denote by $\Gamma^+(X)$ the set of all vertices v of V that are the head of an arc (x, v) in \mathcal{A} with $x \in X$. Dually, we set $\Gamma^-(X) = \{v \in V \mid \exists x \in X \text{ s.t. } (v, x) \in \mathcal{A}\}$. A set X of vertices is *semi-dominant* if $\Gamma^-(X) \subseteq \Gamma^+(X)$. We call $\text{sDom}(\mathcal{D})$ the family of semi-dominating sets of \mathcal{D} . The authors of [DT96] study the following problem

SEMI-KERNEL (SK)

Input: A directed graph $\mathcal{D} = (V, \mathcal{A})$.

Output: Yes if \mathcal{D} admits a non-trivial ($\neq \emptyset$) semi-kernel, no otherwise.

THEOREM 13 ([DT96]). *The problem SK is NP-complete.*

In the language of abstract argumentation, Dung [Dun95] proves that the family $\text{sDom}(\mathcal{D})$ is closed under union. As \emptyset is also semi-dominant, it follows that the set system $\mathcal{C}_{\mathcal{D}} = \{V \setminus X \mid X \in \text{sDom}(\mathcal{D})\}$ is a closure system over V . Now, semi-kernels of \mathcal{D} are precisely the sets in $\text{sDom}(\mathcal{D})$ that are also independent with respect to \mathcal{D} . Moreover, a subset X of V is independent in \mathcal{D} if and only if $V \setminus X \not\subseteq V \setminus \{u, v\}$ for every $(u, v) \in \mathcal{A}$. Hence, it follows that X is a semi-kernel of \mathcal{D} exactly when $V \setminus X$ is an upper-admissible closed set of $\mathcal{C}_{\mathcal{D}}$ with respect to the family $\mathcal{F}_{\mathcal{D}} = \{V \setminus \{u, v\} \mid (u, v) \in \mathcal{A}\}$ of forbidden co-pairs. Since SK is NP-complete, we deduce

THEOREM 14 (*). *The problem $\text{EUA}(\Sigma)$ cannot be solved in output-polynomial unless $\mathbf{P} = \mathbf{NP}$ even if \mathcal{F} is a set of co-pairs.*

Proof. Assume for contradiction that there exists an output-polynomial time algorithm A for $\text{EUA}(\Sigma)$, but $\mathbf{P} \neq \mathbf{NP}$. Let $\mathcal{D} = (V, \mathcal{A})$ be a directed graph. In [ENR21], the authors identify an implicational base $\Sigma_{\mathcal{D}}$ for the closure system $\mathcal{C}_{\mathcal{D}}$ which can be constructed in polynomial time in the size of \mathcal{D} . Thus, we can run A on $\Sigma_{\mathcal{D}}$ and $\mathcal{F}_{\mathcal{D}}$ for a time polynomial in the size of \mathcal{D} . If the algorithm stops within this time bound without non-trivial solutions, the answer to SK is *no*. Otherwise, the answer is *yes*. Since the whole procedure has taken a time polynomial in the size of \mathcal{D} , we have been solving an NP-complete problem in polynomial time. This contradicts the assumption that $\mathbf{P} \neq \mathbf{NP}$ and concludes the proof. \square

Now, we give a strategy to solve $\text{EUA}(\alpha)$. We use the related problem of computing the predecessors of a closed set. We prove that if the predecessors of a closed set can be computed in polynomial time, $\text{EUA}(\alpha)$ can be solved in output-polynomial time.

LEMMA 5 (*). *The problem $\text{EUA}(\alpha)$ can be solved in output-polynomial time whenever it is possible to compute the predecessors of a closed set in polynomial time.*

Proof. By assumption, it is possible to compute the predecessors of a closed set in polynomial time in the size of the input to $\text{EUA}(\alpha)$. Since checking that a closed set is upper-admissible can also be done in polynomial time, we can use the algorithm of Bordat [Bor86] to compute all the upper-admissible closed sets in output-polynomial time level-wise. To avoid repetitions, we use the lexicographic ordering. More precisely, when giving an upper-admissible predecessor C' of a closed set C , we check whether C is the lexicographically first parent of C' . If this is the case, we recursively call the algorithm on C' . If not, C' will be obtained as the predecessor of another upper-admissible closed set. \square

For every closed set C we have: $\text{Pred}(C) = \max_{\subseteq}(\{C \cap M \mid M \in \mathcal{M} \setminus \mathcal{M}(C)\})$ (see e.g., [Bor86]). Hence, the predecessors of C can be computed in polynomial time from \mathcal{M} . As a consequence we obtain the following result, stated in [BK17]

THEOREM 15 ([BK17]). *The problem $\text{EUA}(\mathcal{M})$ can be solved in output-polynomial.*

Now, we consider that the representation for \mathcal{C} is an implicational base Σ . In [BMN17] the authors give an algorithm to enumerate the meet-irreducible elements of a meet-semidistributive closure system in polynomial time from an implicational base. We deduce

COROLLARY 5 (*). *The problem $\text{EUA}(\Sigma)$ can be solved in output-polynomial time when \mathcal{C} is meet-semidistributive.*

There are also classes of closure systems where computing meet-irreducible elements from an implicational base is a hard task (see Chapter 2) but listing the predecessors of a closed set is tractable. For example in convex geometries, the predecessors of a closed set C are all of the form $C \setminus \{v\}$ for some $v \in C$. Therefore, $\text{Pred}(C)$ can be identified in polynomial time from any representation of the closure system, while computing meet-irreducible elements is at least as hard as the enumeration of maximal independent sets of a hypergraph.

In fact, we can extend this observation beyond convex geometries to join-semidistributive closure systems. To this aim, we use a result of Gaskill and Nation in [GN81]. Beforehand, we define prime elements in lattices.

DEFINITION 17 (Prime elements). *Let L be a lattice and $u \in L$. We say that u is prime if for every $v, w \in L$, $u \leq v \vee w$ implies that $u \leq v$ or $u \leq w$. Dually, u is co-prime if for every $u, v \in L$, $u \geq v \wedge w$ entails $u \geq v$ or $u \geq w$.*

Remark that a prime (resp. co-prime) element is join-irreducible (resp. meet-irreducible). In particular, a prime element j is uniquely associated to a co-prime m and m is the unique meet-irreducible satisfying $j \uparrow m$. Similarly, j is the unique join-irreducible element satisfying $j \downarrow m$. Primes and co-primes have been studied in depth by Markowsky in [Mar92].

LEMMA 6 ([GN81]). *The atoms of a semidistributive lattice are prime.*

The proof in [GN81] only makes use of the meet-semidistributivity condition. Furthermore, the dual of a meet-semidistributive lattice is join-semidistributive. Therefore, we can rewrite Lemma 6 in a more suitable way:

LEMMA 7 (*). *The co-atoms of a join-semidistributive lattice are co-prime.*

Hence, the number of co-atoms in a join-semidistributive closure system over V is bounded by $|V|$. Since join-semidistributive lattices are characterized by forbidden sublattices [DPR75], any sublattice of a join-semidistributive lattice is also join-semidistributive and we get:

COROLLARY 6 (*). *Let \mathcal{C} be a join-semidistributive closure system over V and let $C \in \mathcal{C}$. Then $|\text{Pred}(C)| \leq |V|$.*

Even though the number of predecessors of a closed set in a join-semidistributive closure system is linear, we do not have a polynomial time procedure to compute them from an implicational base yet. We describe such a subroutine on a join-semidistributive closure system \mathcal{C} . Let C be a closed set and consider the ideal $\downarrow C$. All sublattices of a join-semidistributive lattice are join-semidistributive. So, $\downarrow C$ is a join-semidistributive sublattice of \mathcal{C} with $\text{coAt}(\downarrow C) = \text{Pred}(C)$. Hence, $\text{Pred}(C)$ are co-prime elements in $\downarrow C$. Relying on the relationship between primes and co-prime elements, we first identify prime elements in \mathcal{C} and their associated co-prime closed set.

PROPOSITION 9 (*). *Let \mathcal{C} be a closure system over V and $v \in V$. Let $M_v = V \setminus \{u \in V \mid v \in \phi(u)\}$. Then $\phi(v)$ is prime if and only if $M_v \in \mathcal{C}$. If $\phi(v)$ is prime, M_v is the unique co-prime element associated to $\phi(v)$.*

Proof. We begin with the only if part. Let $v \in V$ such that $\phi(v)$ is a prime. Let $M_v = V \setminus \{u \in V \mid v \in \phi(u)\}$. Assume for contradiction that M_v is not closed. Then, $v \in \phi(M_v)$ and M_v contains a minimal generator A_v of v . Moreover, $|A_v| \geq 2$ by definition of M_v . Consider a non-trivial bipartition A_1, A_2 of A_v . Since A_v is a minimal generator of v , $v \notin \phi(A_1), \phi(A_2)$, and $\phi(A_1), \phi(A_2) \subset M_v$ while $\phi(\phi(A_1) \cup \phi(A_2)) = \phi(A_1 \cup A_2) = \phi(A_v)$ and $v \in \phi(A_v)$. This contradicts v being a prime element of \mathcal{C} . We deduce that M_v is closed as expected.

As for the if part, observe that if M_v is closed, then for every C_1, C_2 such that $v \notin C_1, C_2$ we have $C_1, C_2 \subseteq M_v$. Since M_v is closed, $\phi(C_1 \cup C_2) \subseteq M_v$ and $v \notin \phi(C_1 \cup C_2)$ follows.

Now, by definition of M_v , $\phi(v) \uparrow M_v$ must hold in case M_v is closed. We deduce that M_v is the unique co-prime associated to $\phi(v)$. \square

We use Proposition 9 to compute the predecessors of a closed set in a join-semidistributive closure system in polynomial time from an implicational base.

LEMMA 8 (*). *Let \mathcal{C} be a join-semidistributive closure system over V given by an implicational base Σ . For every $C \in \mathcal{C}$, $\text{Pred}(C)$ can be computed in polynomial time in the size of V and Σ .*

Proof. Let C be a closed set of \mathcal{C} . Since \mathcal{C} is join-semidistributive and $\downarrow C$ is a sublattice of \mathcal{C} , $\downarrow C$ is a join-semidistributive closure system. The co-atoms of $\downarrow C$ are exactly the predecessors of C in \mathcal{C} . By Lemma 7, the co-atoms of $\downarrow C$ are co-prime in $\downarrow C$. We show how to compute these elements in polynomial time in the size of Σ and V .

We construct an implicational base for $\downarrow C$. Let $\Sigma[C] = \{A \rightarrow B \in \Sigma \mid A \cup B \subseteq C\}$. Remark that $\Sigma[C]$ can be computed in polynomial time from Σ and V . We denote by ϕ_C the corresponding closure operator. We show that $\Sigma[C]$ is an implicational base for $\downarrow C$. Let $C' \in \downarrow C$. Then C' is a model of Σ . In particular, it is a model of $\Sigma[C] \subseteq \Sigma$. Now let C' be a model of $\Sigma[C]$ and let $A \rightarrow B$ be an implication of Σ such that $A \subseteq C'$. Then $A \subseteq C$ and $A \rightarrow B \in \Sigma[C]$ as $C \in \mathcal{C}$. Since C' models $\Sigma[C]$, $B \subseteq C'$ follows. We deduce that $\Sigma[C]$ is an implicational base for $\downarrow C$.

We compute prime and co-prime elements of $\downarrow C$. Remind that prime elements are join-irreducible and that join-irreducible elements are of the form $\phi_C(v)$ for some $v \in C$. Therefore, we can compute all the prime and co-prime elements of $\downarrow C$ in polynomial time by checking the condition of Proposition 9 for every $v \in C$. Among the co-prime elements, we discard those that are no co-atoms in polynomial time, concluding the proof. \square

COROLLARY 7 (*). *The problem $\text{EUA}(\Sigma)$ can be solved in output-polynomial time if the closure system is join-semidistributive.*

Remark 7. Using *canonical join representation* in join-semidistributive lattices (see [GW16], Chapter 3, Theorem 3-1.4.) is an equivalent way to derive these results.

3.3.2. Upper-preferred closed sets

We show first that $\text{EUP-CP}(\Sigma)$ is intractable. Then, we prove that $\text{EUP-CP}(\mathcal{M})$ can be solved with polynomial delay.

THEOREM 16 (*). *The problem EUP-CP(Σ) cannot be solved in output-polynomial time unless $P = NP$.*

Proof. Suppose that there exists an algorithm which solves EUP-CP(Σ) in output-polynomial time when \mathcal{F} is a set of co-pairs, but $P \neq NP$. Recall that $\text{Pref}_u(\mathcal{C}, \mathcal{F}) \subseteq \text{Adm}_u(\mathcal{C}, \mathcal{F})$ and $\text{Adm}_u(\mathcal{C}, \mathcal{F})$ is a filter in \mathcal{C} . Thus, one can enumerate $\text{Adm}_u(\mathcal{C}, \mathcal{F})$ in output polynomial time by applying on each upper-preferred closed set of $\text{Pref}_u(\mathcal{C}, \mathcal{F})$ an algorithm which enumerates the closed sets in a bottom-up fashion, such as `NextClosure` [GW12]. Remark that since $\text{Pref}_u(\mathcal{C}, \mathcal{F}) \subseteq \text{Adm}_u(\mathcal{C}, \mathcal{F})$, each upper-admissible closed set is obtained at most a polynomial number of times. However, we know from Theorem 14 that an output-polynomial time listing all elements of $\text{Adm}_u(\mathcal{C}, \mathcal{F})$ does not exist unless $P = NP$. This contradicts the assumption that $P \neq NP$, and concludes the proof. \square

We show that we can solve EUP-CP(\mathcal{M}) with polynomial delay. First, we use \mathcal{M} to characterize upper-admissible closed sets of \mathcal{C} .

PROPOSITION 10. *Let \mathcal{C} be a closure system over V and \mathcal{F} a family of forbidden co-pairs. Let $C \in \mathcal{C}$. Then $C \notin \text{Adm}_u(\mathcal{C}, \mathcal{F})$ if and only if there exists $M_1, M_2 \in \mathcal{M}(C)$ such that $M_1 \cap M_2 \notin \text{Adm}_u(\mathcal{C}, \mathcal{F})$.*

Proof. The if part is clear. Let $C \in \mathcal{C}$ such that $C \notin \text{Adm}_u(\mathcal{C}, \mathcal{F})$. By definition, there exists a forbidden co-pair $F = V \setminus \{u, v\}$ such that $C \subseteq F$. Since $C = \bigcap \mathcal{M}(C)$, we deduce that there exists $M_1, M_2 \in \mathcal{M}(C)$ such that $u \notin M_1$ and $v \notin M_2$ (possibly $M_1 = M_2$). Consequently, $M_1 \cap M_2 \notin \text{Adm}_u(\mathcal{C}, \mathcal{F})$, concluding the proof. \square

We construct a graph G on a subset of \mathcal{M} based on Proposition 10. We prove that the maximal independent sets of G coincide with the upper-preferred closed sets of \mathcal{C} .

LEMMA 9 (*). *Let $\mathcal{M}_{\text{Adm}} = \{M \in \mathcal{M} \mid M \in \text{Adm}_u(\mathcal{C}, \mathcal{F})\}$ and let $\mathcal{E} = \{\{M_1, M_2\} \mid M_1, M_2 \in \mathcal{M}_{\text{Adm}}, M_1 \cap M_2 \notin \text{Adm}_u(\mathcal{C}, \mathcal{F})\}$. Let G be the graph $(\mathcal{M}_{\text{Adm}}, \mathcal{E})$. Then*

$$\text{MIS}(G) = \{\mathcal{M}(C) \mid C \in \text{Pref}_u(\mathcal{C}, \mathcal{F})\}$$

Proof. Let G be the graph defined in the lemma. First, we handle the case where $\mathcal{M}_{\text{Adm}} = \emptyset$, which implies that V is the unique possible upper-admissible closed set. Then, \mathcal{M}_{Adm} is the unique maximal independent set of G , and since $\mathcal{M}(V) = \emptyset$, the result follows. From now on, we assume that $\mathcal{M}_{\text{Adm}} \neq \emptyset$.

We begin with the \supseteq part. Let $C \in \text{Pref}_u(\mathcal{C}, \mathcal{F})$ and consider $\mathcal{M}(C)$. Since C is upper-admissible, $\mathcal{M}(C)$ is an independent set of G by Proposition 10 and by construction of G . If $\mathcal{M}_{\text{Adm}} = \mathcal{M}(C)$, then $\mathcal{E} = \emptyset$, and $\mathcal{M}(C)$ is the unique maximal independent set of G . Suppose now there exists at least one closed set $M' \in \mathcal{M}_{\text{Adm}}$ such that $M' \notin \mathcal{M}(C)$. Since \mathcal{C} is closed by intersection, there exists a closed set $C' \in \mathcal{C}$ such that $C' = M' \cap \bigcap \mathcal{M}(C)$. In particular, we must have $C' \subset C$ by definition of $\mathcal{M}(C)$. Moreover, $C \in \text{Pref}_u(\mathcal{C}, \mathcal{F})$ implies that C' is not upper-admissible. Thus, there exists a forbidden co-pair $V \setminus \{u, v\}$ such that $C' \not\subseteq V \setminus \{u, v\}$ but $C' \subseteq V \setminus \{u, v\}$. As C is upper-admissible and $C' = M' \cap C$, we deduce that either $u \notin M'$ or $v \notin M'$. Let us assume without loss of generality that $u \notin M'$. Then, $v \in M'$ as $M' \in \mathcal{M}_{\text{Adm}}$.

Moreover, $C \in \text{Adm}_u(\mathcal{C}, \mathcal{F})$ and $u \notin C'$ imply that $u \in C$ and $v \notin C$, as otherwise, $C \cap M'$ would not be included in $V \setminus \{u, v\}$. Because $C = \bigcap \mathcal{M}(C)$ and $v \notin C$, we deduce that there exists $M \in \mathcal{M}(C)$ such that $v \notin M$. Consequently, $M \cap M' \subseteq V \setminus \{u, v\}$ which entails that $\{M, M'\}$ is an edge of G . Therefore, for every $M' \in \mathcal{M}_{\text{Adm}} \setminus \mathcal{M}(C)$, we have that $\mathcal{M}(C) \cup \{M'\}$ is no longer an independent set of G . We conclude that $\mathcal{M}(C)$ is a maximal independent set of G as expected.

We move to the \subseteq part. Let $\mathcal{M}'' \subseteq \mathcal{M}_{\text{Adm}}$ be a maximal independent set of G . Let $C = \bigcap \mathcal{M}''$ be the closed set associated to \mathcal{M}'' and assume for contradiction it is not upper-admissible. Then there exists a forbidden co-pair $V \setminus \{u, v\}$ in \mathcal{F} such that $C \subseteq V \setminus \{u, v\}$ for some distinct u and v . Hence, there must exist distinct M_1, M_2 in \mathcal{M}'' such that $u \notin M_1$ and $v \notin M_2$. However, it follows that $M_1 \cap M_2$ is not upper-admissible, so that $\{M_1, M_2\}$ is an edge of G , a contradiction with \mathcal{M}'' being independent. Thus, C is upper-admissible. Now consider any $M \in \mathcal{M} \setminus \mathcal{M}''$. In case such a M does not exist, the result is clear. Assuming $M \notin \mathcal{M}_{\text{Adm}}$, $M \cap \bigcap \mathcal{M}''$ is not upper-admissible and hence $M \cap \bigcap \mathcal{M}'' \subset C$ as C is in turn upper-admissible. If $M \in \mathcal{M}_{\text{Adm}}$, then $\mathcal{M}'' \cup \{M\}$ is no longer an independent set of G so that, $M \cap \mathcal{M}'' \subset C$ also holds. We deduce that $\mathcal{M}'' = \mathcal{M}(C)$ and that $C \in \text{Pref}_u(\mathcal{C}, \mathcal{F})$ as for each $M \in \mathcal{M} \setminus \mathcal{M}(C)$, $M \cap \bigcap \mathcal{M}(C) \subset C$ and $M \cap \bigcap \mathcal{M}(C)$ is not upper-admissible. It concludes the proof. \square

Example 39. Let $V = \{1, 2, 3, 4, 5\}$ and let \mathcal{C} be the closure system on the left of Figure 3.2. We have $\mathcal{M} = \{23, 24, 1, 234, 345, 135, 145, 2345, 1345\}$. Let $\mathcal{F} = \{235, 124, 123\}$ be a family of forbidden co-pairs. In Figure 3.2 we represent the upper-admissible closed sets of \mathcal{C} (*w.r.t.* \mathcal{F}) with white dots. Boxed ones are the upper-preferred closed sets. We have $\text{Pref}_u(\mathcal{C}, \mathcal{F}) = \{34, 45, 15\}$.

According to Lemma 9, we have $\mathcal{M}_{\text{Adm}} = \{2345, 135, 1345, 145, 234\}$. The graph G is illustrated on the right of Figure 3.2. The maximal independent sets of G are $\{1345, 2345, 234\}$, $\{1345, 2345, 145\}$ and $\{1345, 145, 135\}$ (highlighted in the figure). As mentioned by Lemma 9, they coincide with the upper-preferred closed sets of \mathcal{C} . For instance, $15 = 135 \cap 145 \cap 1345$.

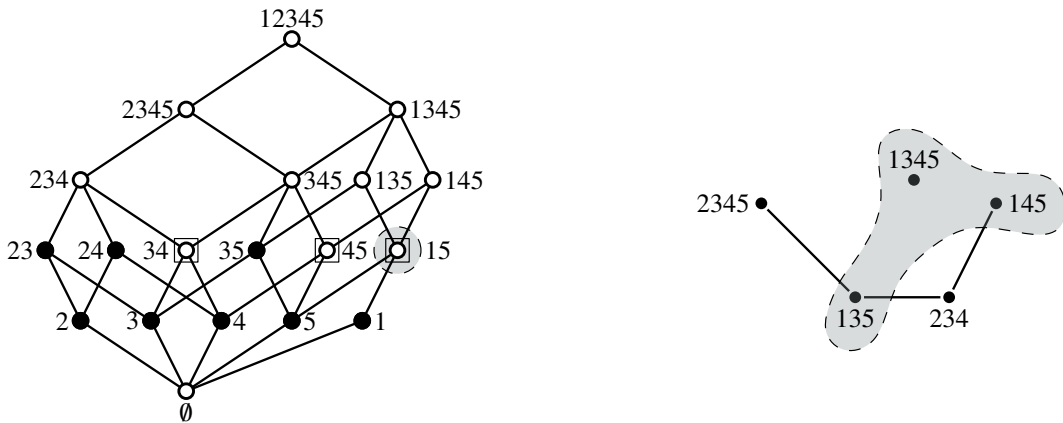

Figure 3.2 – On the left, the closure system \mathcal{C} (white dots are upper-admissible, boxed ones are upper-preferred *w.r.t.* \mathcal{F}). On the right, the graph $G = (\mathcal{M}_{\text{Adm}}, \mathcal{C})$.

We now use Lemma 9 to solve the problem EUP-CP(α). If \mathcal{C} is given by \mathcal{M} , the graph G can be computed in polynomial time. Applying the algorithm of [JYP88] for enumerating maximal independent sets of a graph, we derive

THEOREM 17 (*). *The problem EUP-CP(\mathcal{M}) can be solved with polynomial delay.*

Proof. We describe the algorithm. First, we construct the graph $G = (\mathcal{M}_{\text{Adm}}, \mathcal{C})$ in polynomial time in the size of \mathcal{M} , V and \mathcal{F} . Then, we use the algorithm of Johnson et al. [JYP88] to list all maximal independent sets of G with polynomial delay. But, instead of outputting a subset \mathcal{M}'' of \mathcal{M}_{Adm} found by the algorithm, we compute the closed set $C = \bigcap_{M \in \mathcal{M}''} M$ which belongs to $\text{Pref}_u(\mathcal{C}, \mathcal{F})$ according to Lemma 9. We obtain no repetition as $\mathcal{M}(C)$ is uniquely defined for every $C \in \mathcal{C}$. This operation is done in polynomial time in the size of \mathcal{M} and V , and the polynomial-delay of the whole algorithm follows. \square

If Σ is given instead of \mathcal{M} , computing the graph G is intractable in polynomial time in general. This is demonstrated by the following example.

Example 40. Let $V = \{u_1, v_1, \dots, u_n, v_n, x, y\}$ for some $n \in \mathbb{N}$ and let $\Sigma = \{u_i v_i \rightarrow x \mid 1 \leq i \leq n\}$, with associated closure system \mathcal{C} . We only consider one forbidden co-pair $F = V \setminus \{x, y\}$, and put $\mathcal{F} = \{F\}$. Here, $\text{Pref}_u(\mathcal{C}, \mathcal{F})$ has only two elements: $\{x\}$ and $\{y\}$. On the other hand, \mathcal{M} can be written as $\mathcal{M}_x \cup \mathcal{M}_{\bar{x}}$ where:

- $\mathcal{M}_x = \{V \setminus \{u\} \mid u \in V \setminus \{x\}\}$,
- $\mathcal{M}_{\bar{x}} = \{V \setminus \{x, w_1, \dots, w_n\} \mid w_i \in \{u_i, v_i\}, 1 \leq i \leq n\}$.

Hence $|\mathcal{M}_x| = 2^n$, so that $|\mathcal{M}| = 1 + n + 2^n$ is exponential in the size of Σ , V and G . In fact, the size of \mathcal{M} is even exponential in the number of solutions to find in $\text{Pref}_u(\mathcal{C}, \mathcal{F})$.

However, if \mathcal{M} can be computed in time polynomial in the size of V and Σ , the strategy of computing G becomes affordable. Again, this occurs when the closure system \mathcal{C} is meet-semidistributive [BMN17].

COROLLARY 8 (*). *The problem EUP-CP(Σ) can be solved with polynomial delay in meet-semidistributive closure systems.*

In the next section, we will use \mathcal{F} as a family of forbidden subsets for \mathcal{C} , with a focus on forbidden pairs, the counterpart of forbidden co-pairs.

3.4. Closure systems with forbidden subsets

In this section, we consider a closure system \mathcal{C} over V with a simple family \mathcal{F} over V where \mathcal{F} is a collection of *forbidden supersets* for \mathcal{C} .

DEFINITION 18 (Lower-admissible closed set). *Let \mathcal{C} be a closure system over V and let \mathcal{F} be a family of forbidden subsets over V . A closed set C is lower-admissible (w.r.t. \mathcal{F}) if $F \not\subseteq C$ for every $F \in \mathcal{F}$. The collection of all upper-admissible closed sets of \mathcal{C} w.r.t. \mathcal{F} is denoted $\text{Adm}_\ell(\mathcal{C}, \mathcal{F})$.*

ENUMERATION OF LOWER-ADMISSIBLE CLOSED SETS (ELA(α))

Input: A representation α for a closure system \mathcal{C} over V , a family $\mathcal{F} \subseteq 2^V$ of forbidden subsets.

Output: The family $\text{Adm}_\ell(\mathcal{C}, \mathcal{F})$.

Dually to upper-admissible closed sets, $\text{Adm}_\ell(\mathcal{C}, \mathcal{F})$ is identified by its maximal elements. Whence the second definition.

DEFINITION 19 (Lower-preferred closed sets). *Let \mathcal{C} be a closure system over V and \mathcal{F} a family of forbidden subsets over V . A closed set C is lower-preferred (w.r.t. \mathcal{F}) if it is an inclusion-wise maximal lower-admissible closed set of \mathcal{C} . The family of lower-preferred closed sets of \mathcal{C} (w.r.t. \mathcal{F}) is called $\text{Pref}_\ell(\mathcal{C}, \mathcal{F})$.*

ENUMERATION OF LOWER-PREFERRED CLOSED SETS (ELP(α))

Input: A representation α for a closure system \mathcal{C} over V , a family $\mathcal{F} \subseteq 2^V$ of forbidden subsets.

Output: The family $\text{Pref}_\ell(\mathcal{C}, \mathcal{F})$.

When $\mathcal{F} = \{\emptyset\}$ (equivalently $\{\phi(\emptyset)\}$), $\text{Adm}_\ell(\mathcal{C}, \mathcal{F})$ is empty. Similarly, the case $\mathcal{F} = \emptyset$ is easy to handle as $\text{Adm}_\ell(\mathcal{C}, \mathcal{F}) = \mathcal{C}$ and $\text{Pref}_\ell(\mathcal{C}, \mathcal{F}) = \{V\}$. Hence, we assume that $\mathcal{F} \neq \{\phi(\emptyset)\}$ and $\mathcal{F} \neq \emptyset$.

The problem ELP(α) is equivalent to LDUAL(α). Indeed, the antichain in the input of LDUAL(α) can be seen as a family of forbidden subsets. To reduce ELP(α) to LDUAL(α), we compute the closure of the forbidden subsets, and we keep those that are inclusion-wise minimal. Thus, ELP(α) inherits the intractability of LDUAL(α). Instead, we will consider the restriction of ELP(α) to forbidden pairs:

ELP WITH FORBIDDEN PAIRS (ELP-P(α))

Input: A representation for a closure system \mathcal{C} over V , a family \mathcal{F} of forbidden pairs.

Output: The family $\text{Pref}_\ell(\mathcal{C}, \mathcal{F})$.

Example 41. We illustrate the definitions on an example. Let $V = \{1, 2, 3, 4, 5\}$ and let \mathcal{C} be the closure system represented in Figure 3.1. Let $\mathcal{F} = \{124, 235\}$ be a family of forbidden subsets. We have:

- $\text{Adm}_\ell(\mathcal{C}, \mathcal{F}) = \{\emptyset, 1, 2, 3, 14, 123, 5, 15, 25, 35, 145\}$ (white dots in the figure),
- $\text{Pref}_\ell(\mathcal{C}, \mathcal{F}) = \{123, 145, 25, 35\}$ (boxed white dots).

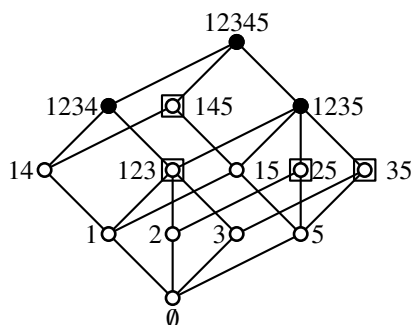

Figure 3.3 – A closure system \mathcal{C} with a family of forbidden subsets \mathcal{F} .

Results of the section In this section, we show that $\text{ELA}(\alpha)$ can be solved with polynomial delay. Then, we investigate the complexity of $\text{ELP-P}(\alpha)$. We prove that it is intractable in general, and we study its complexity in some classes of closure systems, including the distributive ones. In the last part of the section, we develop an algorithm for solving $\text{ELP-P}(\alpha)$. We show that the algorithm runs in incremental or output-quasipolynomial time when we bound the Carathéodory number of the input closure system. First, we settle the complexity of $\text{ELP-P}(\alpha)$.

THEOREM 18 (*). *The problem $\text{ELA}(\alpha)$ can be solved with polynomial-delay.*

Proof. Let \mathcal{C} be a closure system over V and $\mathcal{F} \subseteq 2^V$ be a family of forbidden subsets. Consider the closure operator $\phi_{\mathcal{F}}$ on V such that for every $X \subseteq V$,

$$\phi_{\mathcal{F}}(X) = \begin{cases} V & \text{if there exists } F \in \mathcal{F} \text{ s.t. } F \subseteq \phi(X) \\ \phi(X) & \text{otherwise.} \end{cases}$$

Let $\mathcal{C}_{\mathcal{F}}$ be the closure system associated to $\phi_{\mathcal{F}}$. Clearly, we have $\mathcal{C}_{\mathcal{F}} = \text{Adm}_{\ell}(\mathcal{C}, \mathcal{F}) \cup \{V\}$. Moreover, for each $X \subseteq V$, The closure operation $\phi_{\mathcal{F}}(X)$ can be computed in polynomial time in the size of \mathcal{F} and α with the following two steps: (i) compute $\phi(X)$, and (ii) check whether $F \subseteq \phi(X)$ for some $F \in \mathcal{F}$. If such an F exists, return V , and $\phi(X)$ otherwise. Thus, using an algorithm listing the closed sets of a closure system, e.g. `NextClosure` [GW12], we can solve $\text{ELA}(\alpha)$ with polynomial-delay, concluding the proof. \square

In the next subsection, we prove that $\text{ELP-P}(\alpha)$ is intractable in general. Then, we investigate its complexity for different classes of lattices around distributivity.

3.4.1. Hardness results for $\text{ELP-P}(\alpha)$

Observe first that $\text{ELP-P}(\alpha)$ easily reduces to $\text{LDUAL}(\alpha)$ by closing each forbidden pair, and discarding the non-minimal resulting closed sets. However, when choosing an antichain \mathcal{B}^- in \mathcal{C} there may be closed sets that cannot be represented by pairs of elements of V . Thus, a straightforward identification with $\text{ELP-P}(\alpha)$ is not possible.

Example 42. Assume that $\mathcal{C} = 2^V$ and let $\mathcal{B}^- = \{V \setminus \{v\} \mid v \in V\}$. We assume that $|V| \geq 4$. We have $\mathcal{M} = \mathcal{B}^-$, an implicational base for \mathcal{C} is $\Sigma = \emptyset$. However, there are no pairs $\{u, v\}$ of elements in V such that $\phi(\{u, v\}) \in \mathcal{B}^-$. Thus, an instance of $\text{LDUAL}(\alpha)$ with \mathcal{B}^- cannot be trivially reduced to an instance of $\text{ELP-P}(\alpha)$ within the same closure system.

Remark 8. We give reductions from $\text{ELP-P}(\alpha)$ to $\text{LDUAL}(\beta)$. We use α and β to denote that, the input representations to the two problems may be different. Some reductions do not preserve the underlying class of lattice. Therefore, “ $\text{ELP-P}(\alpha)$ is harder than $\text{LDUAL}(\beta)$ even when restricted to Π ,” means that when there exists an output-polynomial time algorithm for the instances of $\text{ELP-P}(\alpha)$ satisfying the property Π , there also exists an output-polynomial time algorithm for the instances of $\text{LDUAL}(\beta)$ satisfying Π .

We know from [KSS00, HO18, JYP88] that in small classes such as standard Boolean and distributive closure systems, the problem $\text{ELP-P}(\alpha)$ can be solved with polynomial delay, while an algorithm for $\text{LDUAL}(\alpha)$ runs at least in output-quasipolynomial time. Hence, the objective

is to identify the smallest classes of closure systems, including distributivity, for which $\text{ELP-P}(\alpha)$ becomes equivalent to $\text{LDUAL}(\alpha)$. The complexity results on $\text{ELP-P}(\alpha)$ are summarized in the hierarchy of Figure 3.4. More precisely, we have:

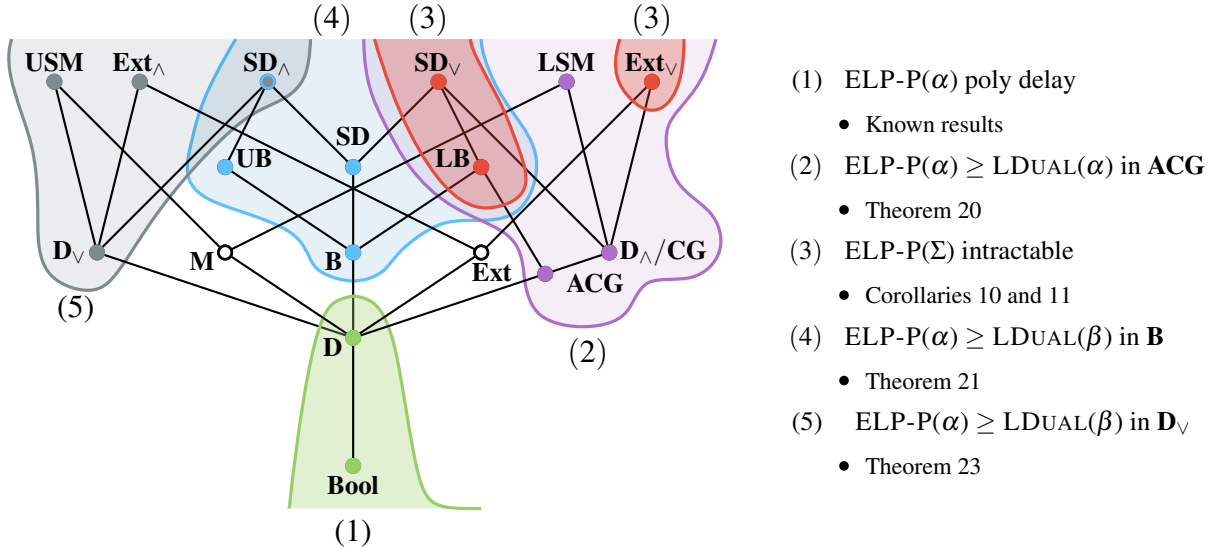

Figure 3.4 – The complexity of $\text{ELP-P}(\alpha)$ when restricted to standard closure systems.

- (0) $\text{ELP-P}(\alpha)$ and $\text{LDUAL}(\alpha)$ are equivalent. This equivalence holds independently of the underlying class of lattice, provided the problems are not restricted to standard closure systems, see Theorem 19.
- (1) It is known that $\text{ELP-P}(\alpha)$ is tractable in standard Boolean (**Bool**) and distributive closure systems (**D**) [JYP88, KSS00].
- (2) When restricted to standard closure systems, $\text{ELP-P}(\alpha)$ and $\text{LDUAL}(\alpha)$ remain equivalent. This equivalence holds even when restricted to acyclic convex geometries (**ACG**), see Theorem 20. It follows that in standard closure systems, $\text{ELP-P}(\alpha)$ restricted to **C** is harder than $\text{LDUAL}(\alpha)$ restricted to **ACG**, where **C** is one of the following classes of closure systems: **CG** (convex geometry), **LB** (lower-bounded), **LSM** (lower-semimodular), **SD_v** (join-semidistributive) and **Ext_v** (join-extremal).
- (3) We deduce in Corollaries 10, Corollary 11 that $\text{ELP-P}(\Sigma)$ is intractable in standard lower-bounded and join-extremal closure systems. It follows that $\text{ELP-P}(\Sigma)$ is intractable in standard join-semidistributive closure systems.
- (4) When restricted to standard bounded closure systems (**B**), $\text{ELP-P}(\alpha)$ and $\text{LDUAL}(\beta)$ are equivalent, see Theorem 21. It follows that in standard closure systems, $\text{ELP-P}(\alpha)$ restricted to **C** is harder than $\text{LDUAL}(\beta)$ restricted to **B**, where **C** is one of the following classes: **UB** (upper-bounded), **SD_{wedge}** (meet-semidistributive), **SD** (semidistributive), **LB** and **SD_v**.
- (5) When restricted to standard join-distributive closure systems (**D_v**), $\text{ELP-P}(\alpha)$ and $\text{LDUAL}(\beta)$ are equivalent, see Theorem 23. It follows that in standard closure systems, $\text{ELP-P}(\alpha)$ restricted to **C** is harder than $\text{LDUAL}(\beta)$ restricted to **D_v**, where **C** is one of the following classes: **USM** (upper-semimodular) and **Ext_{wedge}** (meet-extremal).

- (6) The classes of standard modular (**M**) and extremal closure systems (**Ext**) are left open for further research.

For all the reductions, we consider an instance of $\text{LDUAL}(\alpha)$ with $V = \{v_1, \dots, v_n\}$ for some $n \in \mathbb{N}$, \mathcal{C} a closure system over V with induced closure operator ϕ and $\mathcal{B}^- = \{B_1, \dots, B_m\}$ an antichain of \mathcal{C} . We assume that \mathcal{C} is standard, as it loses no generality for $\text{LDUAL}(\alpha)$. Moreover, we suppose that $\mathcal{B}^- \neq \emptyset$ and $\mathcal{B}^- \neq \{\emptyset\}$ as these are trivial cases. Let Σ be an implicational base for \mathcal{C} and \mathcal{M} its meet-irreducible elements. Moreover, let $R_{\mathcal{B}^-} = \{b_1, \dots, b_m\}$ be a set of labels for the sets of \mathcal{B}^- . For a given subset X of V , we put $R_{\mathcal{B}^-}(X) = \{b_i \in R_{\mathcal{B}^-} \mid B_i \subseteq X\}$. We consider the following example to illustrate all reductions.

Example 43. Let $V = \{1, 2, 3, 4\}$ and \mathcal{C} be the closure system given in Figure 3.5. An implicational base for \mathcal{C} is $\Sigma = \{3 \rightarrow 1, 4 \rightarrow 2, 14 \rightarrow 3, 23 \rightarrow 4\}$ and its meet-irreducible elements \mathcal{M} are 13, 12 and 24. We consider the antichain $\mathcal{B}^- = \{12, 13\}$. We have $\mathcal{B}^+ = \text{Pref}_\ell(\mathcal{C}, \mathcal{B}^-) = \{1, 24\}$.

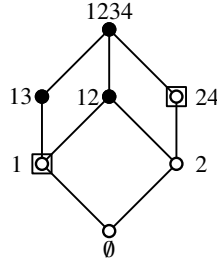

Figure 3.5 – The closure system \mathcal{C} with $\mathcal{B}^- = \{13, 12\}$ and $\mathcal{B}^+ = \{1, 24\}$.

ELP-P(α) and LDUAL(α) are equivalent in non-standard closure systems

We show that $\text{ELP-P}(\alpha)$ is equivalent to $\text{LDUAL}(\alpha)$ in general non-standard closure systems. This equivalence holds in every class of lattice.

Remark 9. For this reduction only, the difference between closure systems and lattices matters. If \mathcal{C}_1 and \mathcal{C}_2 have meet-distributive underlying lattices, \mathcal{C}_1 can be a convex geometry, while \mathcal{C}_2 may not.

Reduction. We reduce an instance of $\text{LDUAL}(\alpha)$ to an instance of $\text{ELP-P}(\alpha)$. The strategy is to apply the labelling process to each closed set of \mathcal{B}^- , using the set $R_{\mathcal{B}^-}$. Formally, we put:

- $V_r = V \cup R_{\mathcal{B}^-}$.
- $\Sigma_r = \Sigma \cup \bigcup_{i=1}^m \{b_i \rightarrow B_i, B_i \rightarrow b_i\}$;
- $\mathcal{M}_r = \{M \cup R_{\mathcal{B}^-}(M) \mid M \in \mathcal{M}\}$.
- $\mathcal{F}_r = \{\{b_i, v_j\} \mid b_i \in R_{\mathcal{B}^-}, v_j \in V\} \cup \{\{b_i, b_j\} \mid b_i, b_j \in R_{\mathcal{B}^-}, b_i \neq b_j\}$

The closure system associated to Σ_r and \mathcal{M}_r is \mathcal{C}_r . We have $\mathcal{C}_r = \{C \cup R_{\mathcal{B}^-}(C) \mid C \in \mathcal{C}\}$. Its associated closure operator is ϕ_r . In particular, we have that $\phi_r(B_i) = \phi_r(b_i) = B_i \cup \{b_i\}$ as \mathcal{B}^- is an antichain. The reduction from $\text{LDUAL}(\alpha)$ to $\text{ELP-P}(\alpha)$ can be conducted in polynomial time for the two possible representations.

Example 44 (Continued). We associate an element b_1 to 13 and b_2 to 12 so that $R_{\mathcal{B}^-} = \{b_1, b_2\}$. The implicational base Σ_r is $\Sigma \cup \{b_1 \rightarrow 13, 13 \rightarrow b_1, 12 \rightarrow b_2, b_2 \rightarrow 12\}$. The family of forbidden pairs \mathcal{F}_r is defined by $\mathcal{F}_r = \{b_1 b_2, b_1 1, b_1 2, b_1 3, b_1 4, b_2 1, b_2 2, b_2 3, b_2 4\}$. For convenience, we represent \mathcal{F}_r as a graph on the left of Figure 3.6. On the right, we also give the closure system \mathcal{C}_r along with $\text{Pref}_\ell(\mathcal{C}_r, \mathcal{F}_r)$. Observe that $\text{Pref}_\ell(\mathcal{C}_r, \mathcal{F}_r) = \mathcal{B}^+$.

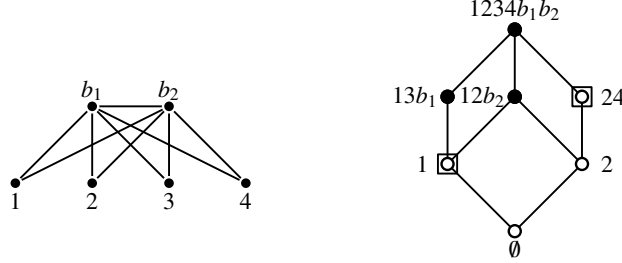

Figure 3.6 – The family \mathcal{F}_r on the left. On the right, the closure system \mathcal{C}_r obtained from \mathcal{C} by applying the non-standard reduction. Boxed elements are lower-preferred closed sets of \mathcal{C}_r with respect to \mathcal{F}_r .

We first identify the relationship between \mathcal{B}^+ and $\text{Pref}_\ell(\mathcal{C}_r, \mathcal{F}_r)$. In fact, we show that the two families are equal.

LEMMA 10 (*). *The equality $\mathcal{B}^+ = \text{Pref}_\ell(\mathcal{C}_r, \mathcal{F}_r)$ holds.*

Proof. It is sufficient to show that $\downarrow_{\mathcal{C}} \mathcal{B}^+ = \text{Adm}_\ell(\mathcal{C}_r, \mathcal{F}_r)$. Let $C \in \downarrow_{\mathcal{C}} \mathcal{B}^+$ in \mathcal{C} . For each $B_i \in \mathcal{B}^-$ we have $B_i \not\subseteq C$ by assumption. Thus, $R_{\mathcal{B}^-}(C) = \emptyset$ and $C \in \mathcal{C}_r$ by construction of Σ_r . Moreover, every forbidden pair of \mathcal{F}_r contains at least an element of $R_{\mathcal{B}^-}$. As $C \cap R_{\mathcal{B}^-} = \emptyset$, we obtain that C is also lower-admissible in \mathcal{C}_r with respect to \mathcal{F}_r .

Now, let C' be a lower-admissible closed set of \mathcal{C}_r (w.r.t. \mathcal{F}_r). We show that $C' \subseteq V$. Assume for contradiction there exists $b_i \in R_{\mathcal{B}^-}$ such that $b_i \in C'$. Then, $B_i \subseteq C'$ by definition of Σ_r . Since $B_i \neq \emptyset$ by assumption, we have that $C' \cap V \neq \emptyset$ and there must exist a forbidden pair $\{v_j, b_i\}$ in \mathcal{F}_r such that $\{v_j, b_i\} \subseteq C'$. This contradicts $C' \in \text{Adm}_\ell(\mathcal{C}_r, \mathcal{F}_r)$ and $C' \subseteq V$ must hold. Moreover, $C' \in \mathcal{C}$ as it is a model of Σ_r and $\Sigma \subseteq \Sigma_r$. We deduce from $C' \subseteq V$ and C' being closed for Σ_r that $B_i \not\subseteq C'$ for each $B_i \in \mathcal{B}^-$. In other words, $C' \in \downarrow_{\mathcal{C}} \mathcal{B}^+$ in \mathcal{C} as required. \square

Based on Lemma 10, we show that $\text{LDUAL}(\alpha)$ and $\text{ELP-P}(\alpha)$ are equivalent in non-standard closure systems.

THEOREM 19 (*). *The problems $\text{LDUAL}(\alpha)$ and $\text{ELP-P}(\alpha)$ are equivalent for non-standard closure systems. This equivalence holds in every class of lattices.*

Proof. Starting from an instance of $\text{LDUAL}(\alpha)$, we build the corresponding instance of $\text{ELP-P}(\alpha)$. Clearly, V_r and \mathcal{F}_r have size polynomial in the size of V and \mathcal{B}^- . We can compute the implicational base Σ_r in polynomial time in the size of Σ and \mathcal{B}^- . Similarly, we can compute the meet-irreducible elements of \mathcal{C}_r in polynomial time in the size of \mathcal{M} , $R_{\mathcal{B}^-}$ and \mathcal{B}^- . By Lemma 10, $\mathcal{B}^+ = \text{Pref}_\ell(\mathcal{C}_r, \mathcal{F}_r)$. Therefore, an algorithm solving $\text{ELP-P}(\alpha)$ solves $\text{LDUAL}(\alpha)$ at the same time. As \mathcal{C} and \mathcal{C}_r are isomorphic, the underlying class of lattices has no impact on the reduction. The theorem follows. \square

Having in mind hardness results about $\text{LDUAL}(\alpha)$, Theorem 19 suggests that $\text{ELP-P}(\alpha)$ becomes hopeless whenever we allow non-standard closure systems. Hence, from now on, we study $\text{ELP-P}(\alpha)$ in standard closure systems. Our strategy is to slightly modify Σ_r (or \mathcal{M}_r) and stay as close as possible to Lemma 10.

ELP-P(α) and LDUAL(α) are equivalent in acyclic convex geometries

We demonstrate that $\text{LDUAL}(\alpha)$ is equivalent to $\text{ELP-P}(\alpha)$ even in standard closure systems. We deduce that $\text{ELP-P}(\alpha)$ is intractable in general. In fact, we show that this equivalence already holds in the class **ACG** of acyclic convex geometries. As a corollary, we prove that $\text{ELP-P}(\Sigma)$ cannot be solved in output-polynomial time unless $\mathbf{P} = \mathbf{NP}$ in standard lower-bounded, join-semidistributive and join-extremal closure systems.

Reduction. We reduce $\text{LDUAL}(\Sigma)$ to $\text{ELP-P}(\Sigma)$. The reduction is based on the previous reduction for non-standard closure systems. In fact, V_r and \mathcal{F}_r are unchanged:

- $V_r = V \cup R_{\mathcal{B}^-}$.
- $\Sigma_r = \Sigma \cup \{B_i \rightarrow b_i \mid 1 \leq i \leq m\}$.
- $\mathcal{F}_r = \{\{b_i, v_j\} \mid b_i \in R_{\mathcal{B}^-}, v_j \in V\} \cup \{\{b_i, b_j\} \mid b_i, b_j \in R_{\mathcal{B}^-}, b_i \neq b_j\}$.

The closure system associated to Σ_r is \mathcal{C}_r . Its associated closure operator is ϕ_r . Moreover, the reduction is conducted in polynomial time.

Example 45 (Continued). The implicational base Σ_r is now $\Sigma \cup \{13 \rightarrow b_1, 12 \rightarrow b_2\}$. The associated closure system \mathcal{C}_r is given in Figure 3.7. The elements of \mathcal{B}^+ are lower-preferred closed sets of \mathcal{C}_r w.r.t. \mathcal{F}_r . However, the construction of Σ_r introduces new lower-preferred closed sets b_1 and b_2 that must be discarded to obtain \mathcal{B}^+ . Still, only a few solutions from $\text{Pref}_\ell(\mathcal{C}_r, \mathcal{F}_r)$ must be removed thanks to the structure of \mathcal{F}_r . Indeed, all possible pairs containing b_1 or b_2 are forbidden, which bounds lower-admissible closed sets of \mathcal{C}_r to $2^V \cup \{\{b_1\}, \{b_2\}\}$.

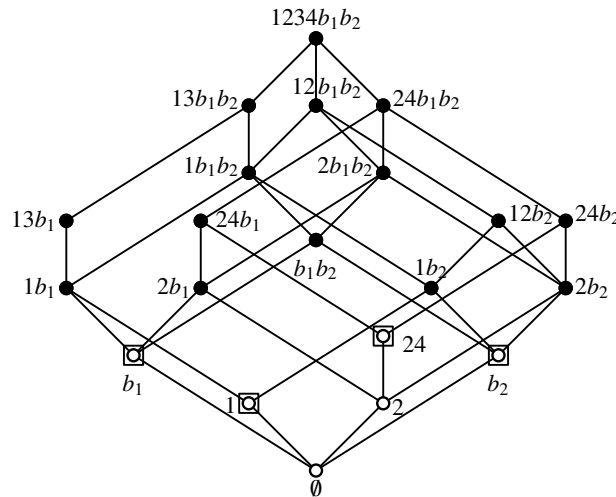

Figure 3.7 – The closure system \mathcal{C}_r derived from \mathcal{C} in Example 45.

We begin by showing that \mathcal{C}_r is standard as required. Recall that \mathcal{C} is standard by assumption.

PROPOSITION 11 (*). *The closure system \mathcal{C}_r is standard.*

Proof. Because \mathcal{C} is standard, $\emptyset \in \mathcal{C}$ and no premise of Σ is empty. As $\mathcal{B}^- \neq \{\emptyset\}$ by assumption, every premise of an implication Σ_r contains at least one element. Hence $\emptyset \in \mathcal{C}_r$ also holds. We prove now that every element of V_r satisfies the standard property. First, we consider $b_i \in R_{\mathcal{B}^-}$. Since b_i never appears in a premise of Σ_r , we have that $\phi_r(b_i) = \{b_i\}$ and $\{b_i\} \setminus \{b_i\} = \emptyset$ is closed. We handle the case $v_j \in V$. We have $\phi_r(v_j) = \phi(v_j) \cup R_{\mathcal{B}^-}(\phi(v_j))$ by definition of Σ_r , so that $\phi_r(v_j) \setminus \{v_j\} = (\phi(v_j) \setminus \{v_j\}) \cup R_{\mathcal{B}^-}(\phi(v_j))$ as $R_{\mathcal{B}^-} \cap V = \emptyset$. However, $\phi(v_j) \setminus \{v_j\}$ is in \mathcal{C} by assumption, and hence $\phi_r(v_j) \setminus \{v_j\}$ satisfies Σ . Moreover, $\phi_r(v_j) \setminus \{v_j\} \subseteq \phi_r(v_j)$ and $\phi_r(v_j) \cap R_{\mathcal{B}^-} = (\phi_r(v_j) \setminus \{v_j\}) \cap R_{\mathcal{B}^-}$. Hence, for every implication $B_i \rightarrow b_i$ of $\Sigma_r \setminus \Sigma$ such that $B_i \subseteq \phi_r(v_j) \setminus \{v_j\}$, $b_i \in (\phi_r(v_j) \setminus \{v_j\}) \cap R_{\mathcal{B}^-}$. Consequently $\phi_r(v_j) \setminus \{v_j\} \in \mathcal{C}_r$, concluding the proof. \square

In the definition of Σ_r , the implications $B_i \rightarrow b_i$ do not create new cycles in Σ_r . We deduce

LEMMA 11 (*). *If \mathcal{C} is an acyclic convex geometry, \mathcal{C}_r is an acyclic convex geometry.*

Proof. Suppose that \mathcal{C} is an acyclic convex geometry and let Σ be an acyclic implicational base for \mathcal{C} . The conclusions of the new implications of Σ_r are included in $R_{\mathcal{B}^-}$. Since elements of $R_{\mathcal{B}^-}$ are not in Σ , it follows that Σ_r is acyclic. Hence \mathcal{C}_r is also an acyclic convex geometry. \square

The next step is to characterize the meet-irreducible elements \mathcal{M}_r of \mathcal{C}_r in terms of the meet-irreducible elements \mathcal{M} of \mathcal{C} . Remark that the reduction from Σ to Σ_r produces an acyclic split of V_r being $(V, R_{\mathcal{B}^-})$. Hence, we can apply Theorem 11 from Chapter 2.

PROPOSITION 12 (*). *The set of meet-irreducible elements \mathcal{M}_r of \mathcal{C}_r satisfies the following equality:*

$$\mathcal{M}_r = \{M \cup R_{\mathcal{B}^-} \mid M \in \mathcal{M}\} \cup \{(R_{\mathcal{B}^-} \setminus \{b_i\}) \cup M \mid B_i \uparrow M \text{ in } \mathcal{C}\}$$

Proof. Recall that by assumption $\mathcal{B}^- \neq \emptyset$ so that $R_{\mathcal{B}^-} \neq \emptyset$. Thus, $(V, R_{\mathcal{B}^-})$ is a non-trivial bipartition of V . Moreover, it is an acyclic split of Σ_r with $\Sigma_r[V] = \Sigma$, $\Sigma_r[R_{\mathcal{B}^-}] = \emptyset$ and $\Sigma_r[V, R_{\mathcal{B}^-}] = \{B_i \rightarrow b_i \mid 1 \leq i \leq m\}$. Therefore, the closure system $\mathcal{C}_{R_{\mathcal{B}^-}}$ associated to $\Sigma[R_{\mathcal{B}^-}]$ is $\mathbf{2}^{R_{\mathcal{B}^-}}$ and its meet-irreducible elements set is $\{R_{\mathcal{B}^-} \setminus \{b_i\} \mid 1 \leq i \leq m\}$. On the other hand, the closure system associated to $\Sigma[V] = \Sigma$ is simply \mathcal{C} . According to Theorem 11, we have

$$\mathcal{M}_r = \{M \cup R_{\mathcal{B}^-} \mid M \in \mathcal{M}\} \cup \{(R_{\mathcal{B}^-} \setminus \{b_i\}) \cup C \mid C \in \max_{\subseteq}(\text{Ext}(R_{\mathcal{B}^-} \setminus \{b_i\}): V)\}$$

However, for each $1 \leq i \leq m$, there exists a unique implication in $\Sigma[V, R_{\mathcal{B}^-}] = \{B_i \rightarrow b_i \mid 1 \leq i \leq m\}$ with b_i as a conclusion. Plus, $B_i \in \mathcal{C}$ as $\mathcal{B}^- \subseteq \mathcal{C}$ by assumption. Therefore, for each $1 \leq i \leq m$, B_i is the unique minimal closed set of \mathcal{C} which does not contribute to an extension of $R_{\mathcal{B}^-} \setminus \{b_i\}$. Hence, $\max_{\subseteq}(\text{Ext}(R_{\mathcal{B}^-} \setminus \{b_i\}): V) = \max_{\subseteq}(\{C \in \mathcal{C} \mid B_i \not\subseteq C\}) = \{M \in \mathcal{M} \mid B_i \uparrow M \text{ in } \mathcal{C}\}$. Consequently, we obtain:

$$\mathcal{M}_r = \{M \cup R_{\mathcal{B}^-} \mid M \in \mathcal{M}\} \cup \{(R_{\mathcal{B}^-} \setminus \{b_i\}) \cup M \mid B_i \uparrow M \text{ in } \mathcal{C}\}$$

Concluding the proof. \square

As a consequence of Proposition 12, \mathcal{M}_r can be computed in polynomial time in the size of V , \mathcal{M} and \mathcal{B}^- . Therefore, the reduction from $\text{LDUAL}(\mathcal{M})$ to $\text{ELP-P}(\mathcal{M})$ can be also be achieved in polynomial time. Now, we show that \mathcal{B}^+ can be recovered in polynomial time in the size of \mathcal{B}^+ and \mathcal{B}^- from $\text{Pref}_\ell(\mathcal{C}_r, \mathcal{F}_r)$.

LEMMA 12 (*). *Exactly one of the following statements hold:*

- if $\mathcal{B}^+ = \{\emptyset\}$, then $\text{Pref}_\ell(\mathcal{C}_r, \mathcal{F}_r) = \{\{b_i\} \mid b_i \in R_{\mathcal{B}^-}\}$;
- if $\mathcal{B}^+ \neq \{\emptyset\}$, then $\text{Pref}_\ell(\mathcal{C}_r, \mathcal{F}_r) = \mathcal{B}^+ \cup \{\{b_i\} \mid b_i \in R_{\mathcal{B}^-}\}$.

Proof. As in Lemma 10, we first characterize lower-admissible closed sets. More precisely, we show that $\text{Adm}_\ell(\mathcal{C}_r, \mathcal{F}_r) = \downarrow_{\mathcal{C}} \mathcal{B}^+ \cup \{\{b_i\} \mid b_i \in R_{\mathcal{B}^-}\}$. The lemma follows from this equality, as the singleton elements $\{b_i\}$ are incomparable to every non-empty closed set in $\downarrow_{\mathcal{C}} \mathcal{B}^+$.

We begin with the \supseteq part. Recall that Σ_r is an implicational base for \mathcal{C}_r . Let $C \in \downarrow_{\mathcal{C}} \mathcal{B}^+$. By definition C satisfies Σ and for each $B_i \in \mathcal{B}^+$, we have $B_i \not\subseteq C$. Hence, C vacuously satisfies every implication $B_i \rightarrow b_i$, $1 \leq i \leq m$. Thus, C models Σ_r and $C \in \mathcal{C}_r$ holds. Now, every forbidden pair of \mathcal{F}_r contains at least one element of $R_{\mathcal{B}^-}$. Since $C \subseteq V$, we conclude that C cannot include a forbidden pair from \mathcal{F}_r . Thus, $C \in \text{Adm}_\ell(\mathcal{C}_r, \mathcal{F}_r)$. Now, consider the singleton elements $\{b_i\}$, for each $b_i \in R_{\mathcal{B}^-}$. Because \mathcal{F}_r is a set of pairs, it is sufficient to show that the singletons $\{b_i\}$ are closed. This is the case, as for each b_i in $R_{\mathcal{B}^-}$, no implication in Σ_r contains b_i in its premise. Thus, we obtain that $\{b_i\} \in \text{Adm}_\ell(\mathcal{C}_r, \mathcal{F}_r)$ and $\text{Adm}_\ell(\mathcal{C}_r, \mathcal{F}_r) \supseteq \downarrow_{\mathcal{C}} \mathcal{B}^+ \cup \{\{b_i\} \mid b_i \in R_{\mathcal{B}^-}\}$.

We move to the \subseteq part. Let us consider an upper-admissible closed set C of \mathcal{C}_r with respect to \mathcal{F}_r . We have two cases, either $C \cap R_{\mathcal{B}^-} \neq \emptyset$ or $C \subseteq V$. Because $C \in \text{Adm}_\ell(\mathcal{C}_r, \mathcal{F}_r)$, $C \cap R_{\mathcal{B}^-} \neq \emptyset$ entails that $C \subseteq R_{\mathcal{B}^-}$ by construction of \mathcal{F}_r . Moreover, for every distinct b_i and b_j in $R_{\mathcal{B}^-}$, the pair $\{b_i, b_j\}$ is forbidden. Since every singleton of the form $\{b_i\}$, $b_i \in R_{\mathcal{B}^-}$ is closed in \mathcal{C}_r , it must be that $C = \{b_i\}$ for some $b_i \in R_{\mathcal{B}^-}$. On the other hand, suppose now that $C \subseteq V$. As C is lower-admissible, $C \in \mathcal{C}_r$. But, we deduce from $C \subseteq V$ and $C \in \mathcal{C}_r$ two points. First, C satisfies Σ and hence $C \in \mathcal{C}$. Second, it must be that for each $B_i \in \mathcal{B}^-$, $B_i \not\subseteq C$ since otherwise, C would fail the implication $B_i \rightarrow b_i$ as $C \subseteq V$. Combining these two observations, we obtain that $C \in \downarrow_{\mathcal{C}} \mathcal{B}^+$. Thus, we have proved that $\text{Adm}_\ell(\mathcal{C}_r, \mathcal{F}_r) = \downarrow_{\mathcal{C}} \mathcal{B}^+ \cup \{\{b_i\} \mid b_i \in R_{\mathcal{B}^-}\}$ as expected. \square

We are ready to show that $\text{ELP-P}(\alpha)$ and $\text{LDUAL}(\alpha)$ are equivalent, even in standard closure systems.

THEOREM 20 (*). *The problems $\text{LDUAL}(\alpha)$ and $\text{ELP-P}(\alpha)$ are equivalent when restricted to standard closure systems. This equivalence holds in particular for acyclic convex geometries.*

Proof. The problem $\text{ELP-P}(\alpha)$ clearly reduces to $\text{LDUAL}(\alpha)$ in polynomial time. hence, assume there exists an output-polynomial time algorithm A solving $\text{ELP-P}(\alpha)$. We devise an output-polynomial time algorithm for $\text{LDUAL}(\alpha)$.

First, we construct the corresponding instance of $\text{ELP-P}(\alpha)$ in polynomial time:

- if α is an implicational base Σ , we simply compute Σ_r in polynomial time in the size of Σ , \mathcal{B}^- and V ;
- if α is the set \mathcal{M} of meet-irreducible elements of \mathcal{C} , we use Proposition 12 to compute \mathcal{M}_r in polynomial time.

Then, we use A to find $\text{Pref}_\ell(\mathcal{C}_r, \mathcal{F}_r)$. According to Lemma 12, the size of $\text{Pref}_\ell(\mathcal{C}, \mathcal{F})$ is bounded by $|\mathcal{B}^-| + |\mathcal{B}^+|$. Therefore, this step is conducted in output-polynomial time. To recover \mathcal{B}^+ from $\text{Pref}_\ell(\mathcal{C}, \mathcal{F})$, we discard the $|\mathcal{B}^-|$ singletons $\{\{b_i\} \mid b_i \in R_{\mathcal{B}^-}\}$ in polynomial time in the size of \mathcal{B}^- , being part of the input to $\text{LDUAL}(\alpha)$. Note that if $\text{Pref}_\ell(\mathcal{C}_r, \mathcal{F}_r)$ only contains these singletons, $\{\emptyset\}$ must be returned instead of \emptyset , due to Lemma 12. As a result, we obtain \mathcal{B}^+ . The whole procedure runs in output-polynomial time. The restriction to acyclic convex geometries follows from Lemma 11. \square

We now apply the previous results on $\text{LDUAL}(\alpha)$ to $\text{ELP-P}(\alpha)$.

COROLLARY 9 (*). [*KSS00, BK17*] $\text{ELP-P}(\alpha)$ cannot be solved in output polynomial-time unless $\mathbf{P} = \mathbf{NP}$, even when restricted to standard closure systems.

Proof. The hardness of $\text{LDUAL}(\Sigma)$ is shown in [*KSS00*]. The intractability of $\text{LDUAL}(\mathcal{M})$ is proven in [*BK17*]. Since $\text{ELP-P}(\alpha)$ is equivalent to $\text{LDUAL}(\alpha)$ by Theorem 20, the corollary follows. \square

In fact, we can further refine Corollary 9 by analysing the reduction of [*KSS00, DN20*] showing the hardness of $\text{LDUAL}(\Sigma)$. More precisely, we prove that their reduction is based on a lower-bounded and join-extremal closure system, which leads to the following statements.

COROLLARY 10. *The problem $\text{ELP-P}(\Sigma)$ cannot be solved in output-polynomial time unless $\mathbf{P} = \mathbf{NP}$ in standard lower-bounded closure systems.*

Proof. We start from the implicational base of [*DN20*], where the authors show that $\text{LDUAL}(\Sigma)$ cannot be solved in output-polynomial time unless $\mathbf{P} = \mathbf{NP}$ even if Σ has premises of size at most two.

Following [*DN20*], consider a positive 3-CNF over n variables and m clauses

$$\Psi(x_1, \dots, x_n) = \bigwedge_{i=1}^m C_i = \bigwedge_{i=1}^m (x_{i,1} \vee x_{i,2} \vee x_{i,3})$$

Let $V = \{x_1, \dots, x_n, y_1, \dots, y_m, z\}$ and consider the following sets of implications:

- $\Sigma_1 = \{x_{i,k}x_{i,\ell} \rightarrow z \mid 1 \leq i \leq m \text{ and } 1 \leq k, \ell \leq 3, k \neq \ell\}$,
- $\Sigma_2 = \{y_i \rightarrow z \mid 1 \leq i \leq m\}$,
- $\Sigma_3 = \{x_{i,k}z \rightarrow y_i \mid 1 \leq i \leq m, 1 \leq k \leq 3\}$.

And let $\Sigma = \Sigma_1 \cup \Sigma_2 \cup \Sigma_3$. In [*DN20*] the authors show that $\text{LDUAL}(\Sigma)$ is already intractable for these instances with a singleton antichain $\mathcal{B}^- = \{B_1\}$ where $B_1 = \{y_1 \dots y_m, z\}$. Observe that in general, the closure system \mathcal{C} may not coincide with a family of lower-admissible closed sets with respect to a family of forbidden pairs, so that a straightforward identification with ELP-P is not possible.

Applying our reduction, we obtain that $\text{ELP-P}(\Sigma)$ cannot be solved in output-polynomial time in the following case: $V_r = V \cup \{b_1\}$, $\Sigma_r = \Sigma \cup \{B_1 \rightarrow u_1\}$ and $\mathcal{F}_r = \{\{b_1, v\} \mid v \in V\}$.

We show that \mathcal{C}_r is lower-bounded. We use Lemma 1, which we recall here.

LEMMA 13 ([*FJN95*]). *A closure system is lower-bounded if and only if it has no D-cycles.*

We proceed by analysing the D -relation. Remark first that no D -cycle can contain $\phi_r(b_i)$ as no element of V depends on $\phi_r(b_i)$. Therefore, it is sufficient to show that \mathcal{C} is lower bounded. Observe that \mathcal{C} is standard. Therefore, $\mathcal{F}(\mathcal{C}) = \{\phi(v) \mid v \in V\}$. Let $x_i \in \{x_1, \dots, x_n\}$, $1 \leq i \leq n$. As x_i is the conclusion of no implication in Σ , we have that the unique element M_i in \mathcal{M} satisfying $\phi(x_i) \uparrow M_i$ is $V \setminus \{x_i\}$. Therefore, there is no element in $V \setminus \{x_i\}$ on which $\phi(x_i)$ depends, so that no D -cycle can contain $\phi(x_i)$, for each $1 \leq i \leq n$.

Let us move to z . As $y_j \rightarrow z \in \Sigma$ for every $1 \leq j \leq m$, we have $\phi(y_j) \setminus \{y_j\} = \{z\}$. Hence, $\phi(z)D\phi(y_j)$ cannot hold since $M \downarrow \phi(y_j)$ implies $z \in M$, for all $M \in \mathcal{M}$. Thus, $\phi(z)$ only depends on some of the $\phi(x_i)$'s, $1 \leq i \leq n$, and no D -cycle can contain $\phi(z)$ either.

Henceforth, the only possible D -cycles must be included in $\{\phi(y_1), \dots, \phi(y_m)\}$. We show that for every distinct $1 \leq i, k \leq m$, $\phi(y_i)D\phi(y_k)$ does not hold. For each y_i , we have $\phi(y_j) \setminus \{y_j\} = \{z\}$ as $y_i \rightarrow z \in \Sigma$. Hence, an element M_i of \mathcal{M} such that $\phi(y_i) \uparrow M_i \downarrow \phi(y_k)$ must contain z . Let $C \in \mathcal{C}$ be any closed set satisfying $y_i \notin C$ but $z \in C$. Assume there exists some y_k such that $y_k \notin C$. Then $C \cup \{y_k\} \in \mathcal{C}$, as $y_k \rightarrow z$ is the only implication having y_k in its premise, and $z \in C$. Therefore, it must be that for any $M_i \in \mathcal{M}$ such that $z \in M_i$ and $y_i \notin M_i$, $\{y_1, \dots, y_m\} \setminus \{y_i\} \subseteq M_i$ is verified, so that $\phi(y_i) \uparrow M_i \downarrow \phi(y_k)$ is not possible. As a consequence, $\phi(y_i)D\phi(y_k)$ cannot hold, for every $1 \leq i, k \leq m$. We conclude that \mathcal{C} has no D -cycles and that it is lower bounded by Lemma 13. \square

COROLLARY 11 (*). *The problem ELP-P(Σ) cannot be solved in output-polynomial time unless $P = NP$ even when restricted to standard join-extremal closure systems.*

Proof. We use the reduction from the previous corollary. We show that \mathcal{C}_r is also join-extremal. We have to show that the height $h(\mathcal{C}_r)$ of \mathcal{C}_r equals $|V_r|$. Recall that the height of \mathcal{C}_r is the size of its longest chain. Observe that $h(\mathcal{C}_r) \leq |V_r|$ always holds as the sets in \mathcal{C}_r are subsets of V_r . Recall that $\emptyset \in \mathcal{C}$ as \mathcal{C}_r is standard by Proposition 11. We construct a chain $\emptyset = C_0 \prec C_1 \prec \dots \prec C_{|V_r|} = V_r$ of distinct closed sets:

- $C_1 = \{b_1\}$ which is closed by construction of Σ_r ,
- $C_2 = \{b_1, z\}$ being closed by definition of Σ ,
- $C_{2+i} = C_2 \cup \{y_1, \dots, y_i\}$, $1 \leq i \leq m$. For each i , C_{2+i} must be closed as $\{b_1, z\} = C_2 \subseteq C_{2+i}$ and $C_{2+i} \cap \{x_1, \dots, x_n\} = \emptyset$.
- $C_{m+2+k} = C_{2+m} \cup \{x_1, \dots, x_k\}$, with $1 \leq k \leq n$. Again, C_{m+k+2} is closed for each k as C_{m+2} contains all the conclusions of Σ_r .

Clearly, $C_{m+n+2} = V_r$ and for every $1 < i \leq |V_r|$, $|C_i \setminus C_{i-1}| = 1$. Consequently, the chain $C_0 \prec C_1 \prec \dots \prec C_{|V_r|}$ has size $|V_r|$, which concludes the proof. \square

COROLLARY 12 (*). *The problem LDUAL(α) cannot be solved in output-polynomial time unless $P = NP$, even when restricted to standard lower bounded or join-extremal closure systems.*

In the next part, we study another reduction in order to settle the complexity of ELP-P(α) in bounded closure systems.

ELP-P(α) and LDUAL(β) are equivalent in standard bounded closure systems

We prove that ELP-P(α) is equivalent to LDUAL(β) in standard bounded closure systems. It is convenient to translate the construction of doubling intervals in a lattice in terms of closed sets in a closure system. Let \mathcal{C} be a closure system over V . Let $L, U \in \mathcal{C}$ such that $L \subseteq U$. The *interval* $[L, U]$ defined by L and U is the subfamily of closed sets containing L and included in U , that is $[L, U] = \{C \in \mathcal{C} \mid L \subseteq C \subseteq U\}$. We say that L is the *lower bound* of the interval $[L, U]$ while U is its *upper bound*. The *duplication* of $[L, U]$ in \mathcal{C} is the closure system $\mathcal{C}[L, U, \ell]$ defined on $V \cup \{\ell\}$ where ℓ is a new element and

$$\mathcal{C}[L, U, \ell] = \{C \in \mathcal{C} \mid L \not\subseteq C \text{ or } C \subseteq U\} \cup \{C \cup \{\ell\} \mid C \in \mathcal{C}, L \subseteq C\}$$

Now, if $L_{\mathcal{C}}$ is the lattice associated to \mathcal{C} , then $L_{\mathcal{C}[L, U, \ell]}$ is isomorphic to $\mathcal{C}[U, L, \ell]$ (see Chapter 1 Section 1.4).

Reduction. We reduce LDUAL(Σ) to ELP-P(Σ). The groundset and the family of forbidden pairs are unchanged as compared to previous reductions:

- $V_r = V \cup R_{\mathcal{B}^-}$.
- $\Sigma_r = \Sigma_r = \Sigma \cup \{b_i \rightarrow B_i \mid 1 \leq i \leq m\} \cup \{B_i \cup \{v_j\} \rightarrow b_i \mid 1 \leq i \leq m, v_j \in V \setminus B_i\}$.
- $\mathcal{F}_r = \{\{b_i, v_j\} \mid b_i \in R_{\mathcal{B}^-}, v_j \in V\} \cup \{\{b_i, b_j\} \mid b_i, b_j \in R_{\mathcal{B}^-}, b_i \neq b_j\}$.

The closure system associated to Σ_r is \mathcal{C}_r . Its associated closure operator is ϕ_r . The reduction can be conducted in polynomial time in the size of V , \mathcal{B}^- and Σ .

Example 46 (Continued). We have $\Sigma_r = \Sigma \cup \{123 \rightarrow b_1, 134 \rightarrow b_1, 123 \rightarrow b_2, 124 \rightarrow b_2, b_1 \rightarrow 13, b_2 \rightarrow 13\}$. The closure system \mathcal{C}_r is represented in Figure 3.8. Notice the difference with \mathcal{C} (Figure 3.5): the minimal forbidden subsets 13 and 12 have been duplicated. Our construction of \mathcal{F}_r makes the new closed sets $\phi_r(b_1)$ and $\phi_r(b_2)$ non lower-admissible. Observe that 1 is a closed set of \mathcal{B}^+ that is not in $\text{Pref}_{\ell}(\mathcal{C}_r, \mathcal{F}_r)$. This is due to the fact that elements of \mathcal{B}^- becomes lower-admissible, and in fact lower-preferred, in \mathcal{C}_r .

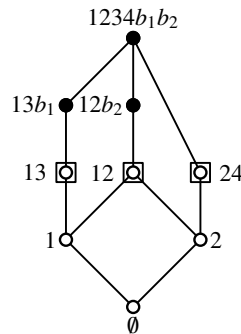

Figure 3.8 – The closure system \mathcal{C}_r derived from \mathcal{C} in Example 46.

Our first step is to characterize the closed sets of \mathcal{C}_r .

PROPOSITION 13 (*). *The following equality holds: $\mathcal{C}_r = \mathcal{B}^- \cup \downarrow_{\mathcal{C}} \mathcal{B}^+ \cup \{C \cup R_{\mathcal{B}^-}(C) \mid C \in \uparrow_{\mathcal{C}} \mathcal{B}^-\}$.*

Proof. We begin with the \subseteq part. Let $C \in \mathcal{B}^- \cup \downarrow_{\mathcal{C}} \mathcal{B}^+$. We have that C satisfies Σ by construction, and since $B_i \not\subseteq C$ for every $B_i \in \mathcal{B}^-$ and $C \cap R_{\mathcal{B}^-} = \emptyset$, C vacuously satisfies $\Sigma_r \setminus \Sigma$. Hence, $\mathcal{B}^- \cup \downarrow_{\mathcal{C}} \mathcal{B}^+ \subseteq \mathcal{C}_r$. Let $C \in \uparrow_{\mathcal{C}} \mathcal{B}^-$ and consider $C \cup R_{\mathcal{B}^-}(C)$. Again, $C \cup R_{\mathcal{B}^-}(C)$ models Σ as C does and $R_{\mathcal{B}^-} \cap V = \emptyset$. As $C \cup R_{\mathcal{B}^-}(C)$ contains some b_i if and only if $B_i \subseteq C$, it also follows that $C \cup R_{\mathcal{B}^-}(C)$ models $\Sigma_r \setminus \Sigma$. Hence, $\{C \cup R_{\mathcal{B}^-}(C) \mid C \in \uparrow_{\mathcal{C}} \mathcal{B}^-\} \subseteq \mathcal{C}_r$.

We now prove the \supseteq part. Let $C \in \mathcal{C}_r$. As $\Sigma \subseteq \Sigma_r$, $C \cap V \in \mathcal{C}$. If $C \cap R_{\mathcal{B}^-} = \emptyset$, then necessarily, $B_i \not\subseteq C$ for every $B_i \in \mathcal{B}^-$, by definition of Σ_r . Hence, $C \in \mathcal{B}^- \cup \downarrow_{\mathcal{C}} \mathcal{B}^+$ in this case. Now assume that $C \cap R_{\mathcal{B}^-} \neq \emptyset$. By construction of Σ_r , $b_i \in C$ implies that $B_i \subseteq C \cap V$, so that $C \cap R_{\mathcal{B}^-} \subseteq R_{\mathcal{B}^-}(C \cap V)$. Let $b_i \in R_{\mathcal{B}^-}(C \cap V)$. By definition of $R_{\mathcal{B}^-}(C \cap V)$, we have that $B_i \subseteq C \cap V$. If $B_i \subset C \cap V$, then $b_i \in C$ as C models Σ_r . If $C \cap V = B_i$, then $R_{\mathcal{B}^-}(C \cap V) = \{b_i\}$ as \mathcal{B}^- is simple. Moreover, $C \cap R_{\mathcal{B}^-} = \{b_i\}$ as otherwise, we would contradict $C \cap V = B_i$ or $C \cap R_{\mathcal{B}^-} \neq \emptyset$. \square

Then, we prove that \mathcal{C}_r is a standard closure system. Recall that by assumption, \mathcal{C} is standard.

PROPOSITION 14 (*). *The closure system \mathcal{C}_r is standard.*

Proof. We begin with $b_i \in R_{\mathcal{B}^-}$. We have $\phi_r(b_i) = B_i \cup \{b_i\}$ by definition of Σ_r and since \mathcal{B}^- is an antichain of \mathcal{C} . By Proposition 13, we have that $B_i \in \mathcal{C}_r$ so that $\phi_r(b_i) \setminus \{b_i\} \in \mathcal{C}_r$. Let $v_j \in V$. If $\phi(v_j) \in \mathcal{B}^- \cup \downarrow_{\mathcal{C}} \mathcal{B}^+$, then $\phi_r(v_j) = \phi(v_j)$ so that $\phi_r(v_j) \setminus \{v_j\}$ readily holds as \mathcal{C} is standard and $\mathcal{B}^- \cup \downarrow_{\mathcal{C}} \mathcal{B}^+ \subseteq \mathcal{C}_r$ by Proposition 13. Assume now that $\phi(v_j) \in (\uparrow_{\mathcal{C}} \mathcal{B}^-) \setminus \mathcal{B}^-$. From Proposition 13, it follows that $\phi_r(v_j) = \phi(v_j) \cup R_{\mathcal{B}^-}(\phi(v_j))$. As $\phi(v_j) \setminus \{v_j\}$ models Σ and $V \cap R_{\mathcal{B}^-} = \emptyset$, we have that $\phi_r(v_j) \setminus \{v_j\} = (\phi(v_j) \setminus \{v_j\}) \cup R_{\mathcal{B}^-}(\phi(v_j))$ also satisfies Σ . Thus, the only implications that may not be satisfied by $\phi_r(v_j) \setminus \{v_j\}$ are those of the form $b_i \rightarrow B_i$ for some $1 \leq i \leq m$. However, $b_i \in \phi_r(v_j)$ implies that $B_i \subset \phi(v_j)$ and hence, $v_j \notin B_i$. Thus, $B_i \subseteq \phi_r(v_j) \setminus \{v_j\}$ from which we deduce that the implication $b_i \rightarrow B_i$ is satisfied by $\phi_r(v_j) \setminus \{v_j\}$, for each $1 \leq i \leq m$. \square

We prove that \mathcal{C}_r is bounded if \mathcal{C} is bounded. To see this result, we show that \mathcal{C}_r is obtained from \mathcal{C} by iteratively duplicating each closed set of B_i in \mathcal{B}^- , interpreted as a unit interval $[B_i, B_i]$. If the initial closure system \mathcal{C} is bounded itself, it must be that \mathcal{C}_r remains bounded. The next lemma proves that Σ_r exactly translates these duplications in terms of implications.

LEMMA 14 (*). *The closure system \mathcal{C}_r is bounded when \mathcal{C} is bounded.*

Proof. Let us assume that \mathcal{C} is bounded and standard. We show by induction that \mathcal{C}_r remains bounded. First, define $\mathcal{C}_0 = \mathcal{C}$ and $\Sigma_0 = \Sigma$ over $V_0 = V$. Then, for each $1 \leq i \leq m$, we put $V_i = V_{i-1} \cup \{b_i\}$, $\Sigma_i = \Sigma_{i-1} \cup \{b_i \rightarrow B_i\} \cup \{B_i \cup \{v_j\} \rightarrow b_i \mid v_j \in V \setminus B_i\}$. Finally, we let \mathcal{C}_i be the closure system associated to Σ_i . Clearly, $\mathcal{C}_m = \mathcal{C}_r$ and $\Sigma_m = \Sigma_r$. Let $1 \leq i \leq m$, we show that $\mathcal{C}_i = \mathcal{C}_{i-1}[B_i, B_i, b_i]$.

We make two preliminary observations. Let $1 \leq i \leq m$. First, at each step $j < i$, adding the implications $u_j \rightarrow B_j$ and $\{B_j \cup \{v_k\} \rightarrow u_j \mid v_k \in V \setminus B_j\}$ does not change the closure of B_i as $B_j \not\subseteq B_i$ by definition of \mathcal{B}^- . Thus, B_i is always a closed set of \mathcal{C}_{i-1} and the closure system $\mathcal{C}_{i-1}[B_i, B_i, b_i]$ is well-defined. Second, in the definition of $\mathcal{C}_{i-1}[B_i, B_i, b_i]$, the set $\{C \in \mathcal{C}_{i-1} \mid B_i \not\subseteq C \text{ or } C \subseteq B_i\}$ can be simplified to $\{C \in \mathcal{C}_{i-1} \mid B_i \not\subseteq C\}$.

We are now in position to prove that $\mathcal{C}_i = \mathcal{C}_{i-1}[B_i, B_i, b_i]$. We begin with the \subseteq part. Let C be a closed set of \mathcal{C}_i . Suppose that $b_i \notin C$. We have two cases. Either $B_i = V$, or $B_i \subset V$. In the first case, observe that $i = 1$ must hold as \mathcal{B}^- is simple. Hence, $C \subseteq V$ and $B_i \not\subseteq C$ is true, whence $C \in \mathcal{C}_{i-1}[B_i, B_i, b_i]$. On the other hand, $B_i \subset V$ implies that for every $v_j \in V \setminus B_i$, $B_i \cup \{v_j\} \not\subseteq C$, and hence $B_i \not\subseteq C$ (possibly $B_i = C$). Furthermore, we have that $C \in \mathcal{C}_{i-1}$ as $C \subseteq V_{i-1}$ by assumption, and it is a closed set of Σ_i with $\Sigma_{i-1} \subseteq \Sigma_i$. Therefore, $C \in \{C' \in \mathcal{C}_{i-1} \mid B_i \not\subseteq C'\}$ too. Suppose now that $b_i \in C$. Because C satisfies Σ_i and $b_i \rightarrow B_i$ belongs to Σ_i , we have that $B_i \subseteq C$. Moreover, C models Σ_{i-1} as $\Sigma_{i-1} \subseteq \Sigma_i$. As no implication of Σ_{i-1} contains the element b_i , we deduce that $C \setminus \{b_i\}$ is a closed set of \mathcal{C}_{i-1} . Hence, $C \in \{C' \cup \{b_i\} \mid C' \in \mathcal{C}_{i-1}, B_i \subseteq C'\}$ as expected. We have proved $\mathcal{C}_i \subseteq \mathcal{C}_{i-1}[B_i, B_i, b_i]$.

We move to the \supseteq part. Let $C \in \mathcal{C}_{i-1}[B_i, B_i, b_i]$. Suppose first that $b_i \notin C$. By definition of $\mathcal{C}_{i-1}[B_i, B_i, b_i]$, we have that $C \in \mathcal{C}_{i-1}$ and $B_i \not\subseteq C$. Thus, C is a closed set of Σ_i which entails $C \in \mathcal{C}_i$. Assume now that $b_i \in C$. Again by construction of $\mathcal{C}_{i-1}[B_i, B_i, b_i]$, $C \setminus \{b_i\}$ is in \mathcal{C}_{i-1} so that C already satisfies Σ_{i-1} . Moreover, $b_i \in C$ implies that $B_i \subseteq C$ in $\mathcal{C}_{i-1}[B_i, B_i, b_i]$. Hence, C includes the conclusion of each implication in $\Sigma_i \setminus \Sigma_{i-1}$. We deduce that C is a closed set of Σ_i , and hence that $\mathcal{C}_i = \mathcal{C}_{i-1}[B_i, B_i, b_i]$.

Eventually, assuming that \mathcal{C}_0 is bounded, we obtain by induction on $1 \leq i \leq m$ that $\mathcal{C}_m = \mathcal{C}_r$ is also bounded, thus concluding the proof. \square

Then, we show how to recover \mathcal{B}^+ in polynomial time in the size of \mathcal{B}^+ and \mathcal{B}^- from the lower-preferred closed sets of \mathcal{C}_r (w.r.t. \mathcal{F}_r). We divide our result in two statements. First, we identify a relationship between the lower-admissible closed sets of \mathcal{C}_r and the closed sets of \mathcal{C} .

PROPOSITION 15 (*). *The following equality holds: $\text{Adm}_\ell(\mathcal{C}_r, \mathcal{F}_r) = \downarrow_{\mathcal{C}} \mathcal{B}^+ \cup \mathcal{B}^-$.*

Proof. In \mathcal{F}_r , each forbidden pair intersects $R_{\mathcal{B}^-}$. Since $\mathcal{B}^- \neq \{\emptyset\}$ by assumption, it follows from the construction of Σ_r that a closed set C of \mathcal{C}_r is lower-admissible if and only if $C \cap R_{\mathcal{B}^-} = \emptyset$. From Proposition 13, $C \cap R_{\mathcal{B}^-} = \emptyset$ if and only if $C \in \downarrow_{\mathcal{C}} \mathcal{B}^+ \cup \mathcal{B}^-$, which ends the proof. \square

According to Proposition 15, a closed set of \mathcal{B}^+ which is not included in a closed set of \mathcal{B}^- is a lower-preferred in \mathcal{C}_r . However, a closed set of \mathcal{B}^+ can be a predecessor of some $B_i \in \mathcal{B}^-$, as we observed in Example 46. In the next lemma, we formally state the differences between \mathcal{B}^+ and $\text{Pref}_\ell(\mathcal{C}_r, \mathcal{F}_r)$.

LEMMA 15 (*). *The next statements hold true:*

- (i) $\text{Pref}_\ell(\mathcal{C}_r, \mathcal{F}_r) \setminus \mathcal{B}^+ = \mathcal{B}^-$;
- (ii) $\mathcal{B}^+ \setminus \text{Pref}_\ell(\mathcal{C}_r, \mathcal{F}_r) \subseteq \{C \in \mathcal{C} \mid C \prec B_i \text{ in } \mathcal{C}, \text{ for some } B_i \in \mathcal{B}^-\}$.

Proof. We prove the items in order.

(i). By Proposition 15, we have that $\text{Adm}_\ell(\mathcal{C}_r, \mathcal{F}_r) \setminus \downarrow_{\mathcal{C}} \mathcal{B}^+ = \mathcal{B}^-$ as $\downarrow_{\mathcal{C}} \mathcal{B}^+$ and \mathcal{B}^- are disjoint. Moreover, $B_i \not\subseteq B_j$ for every $B_i, B_j \in \mathcal{B}^-$ such that $B_i \neq B_j$. Hence, there is no closed set $C \in \mathcal{C}_r$ such that $B_i \subset C$ and $C \in \text{Adm}_\ell(\mathcal{C}_r, \mathcal{F}_r)$ as moreover $\downarrow_{\mathcal{C}} \mathcal{B}^+ \cap \uparrow \mathcal{B}^- = \emptyset$. We deduce that $\mathcal{B}^- \subseteq \text{Pref}_\ell(\mathcal{C}_r, \mathcal{F}_r)$ and hence $\mathcal{B}^- \subseteq \text{Pref}_\ell(\mathcal{C}_r, \mathcal{F}_r) \setminus \mathcal{B}^+$.

We show that $\text{Pref}_\ell(\mathcal{C}_r, \mathcal{F}_r) \setminus \mathcal{B}^+ \subseteq \mathcal{B}^-$. We have that $\text{Pref}_\ell(\mathcal{C}_r, \mathcal{F}_r) \setminus \mathcal{B}^+ \subseteq \mathcal{B}^-$ if and only if $\text{Pref}_\ell(\mathcal{C}_r, \mathcal{F}_r) \subseteq \mathcal{B}^- \cup \mathcal{B}^+$ as $\mathcal{B}^- \subseteq \text{Pref}_\ell(\mathcal{C}_r, \mathcal{F}_r)$ by previous discussion. Again using

Proposition 15 and the fact that $\downarrow_{\mathcal{C}} \mathcal{B}^+$ and \mathcal{B}^- are disjoint, we have that $\text{Adm}_{\ell}(\mathcal{C}_r, \mathcal{F}_r) \setminus \mathcal{B}^- = \downarrow_{\mathcal{C}} \mathcal{B}^+$. As an ideal is characterized by its maximal elements and \mathcal{B}^+ is an antichain, $\max_{\subseteq}(\text{Adm}_{\ell}(\mathcal{C}_r, \mathcal{F}_r) \setminus \mathcal{B}^-) = \mathcal{B}^+$ holds. Consequently, $\text{Pref}_{\ell}(\mathcal{C}_r, \mathcal{F}_r) \subseteq \max_{\subseteq}(\text{Adm}_{\ell}(\mathcal{C}_r, \mathcal{F}_r) \setminus \mathcal{B}^-) \cup \mathcal{B}^- = \mathcal{B}^+ \cup \mathcal{B}^-$ and $\text{Pref}_{\ell}(\mathcal{C}_r, \mathcal{F}_r) \setminus \mathcal{B}^- \subseteq \mathcal{B}^+$ follows.

(ii). Remark that the result is clear if $\mathcal{B}^+ \setminus \text{Pref}_{\ell}(\mathcal{C}_r, \mathcal{F}_r)$ is empty. Hence, let us assume there exists at least one C in $\mathcal{B}^+ \setminus \text{Pref}_{\ell}(\mathcal{C}_r, \mathcal{F}_r)$. Due to Proposition 13, we have $C \in \mathcal{C}_r$. Moreover, $C \in \text{Adm}_{\ell}(\mathcal{C}_r, \mathcal{F}_r)$ by Proposition 15. Since $C \notin \text{Pref}_{\ell}(\mathcal{C}_r, \mathcal{F}_r)$, there exists $C' \in \mathcal{C}_r$ such that $C \subset C'$ and $C' \in \text{Adm}_{\ell}(\mathcal{C}_r, \mathcal{F}_r)$. However, \mathcal{B}^+ is an antichain of \mathcal{C} , so $C' \in \downarrow_{\mathcal{C}} \mathcal{B}^+$ is not possible. Thus, by Proposition 15, it must be that $C' = B_i$ for some $B_i \in \mathcal{B}^-$. Since $\mathcal{B}^+ = \max_{\subseteq}(\{C \in \mathcal{C} \mid C \not\subseteq \uparrow_{\mathcal{C}} \mathcal{B}^-\})$ and $\downarrow_{\mathcal{C}} \mathcal{B}^+ \cup \mathcal{B}^- \subseteq \mathcal{C}_r$ by Proposition 13, $C \prec B_i$ follows. \square

We are ready to prove the equivalence of $\text{LDUAL}(\alpha)$ and $\text{ELP-P}(\beta)$ in standard bounded closure systems.

THEOREM 21 (*). *The problems $\text{LDUAL}(\alpha)$ and $\text{ELP-P}(\beta)$ are equivalent, even when restricted to standard bounded closure systems.*

Proof. As bounded closure systems are meet-semidistributive, we can reduce $\text{ELP-P}(\beta)$ to $\text{LDUAL}(\alpha)$ in polynomial time using the algorithm of [BMN17] to find the appropriate representation.

let us assume there exists an output-polynomial time algorithm A for $\text{ELP-P}(\beta)$ in standard bounded closure systems. We construct an output-polynomial time algorithm for $\text{LDUAL}(\alpha)$ in the same class.

Since bounded closure systems are meet-semidistributive, it is possible to compute an implicational base from the meet-irreducible elements and vice-versa in polynomial time [BMN17]. We can reduce $\text{LDUAL}(\Sigma)$ to $\text{ELP-P}(\Sigma)$ in polynomial time using Σ_r . For $\text{LDUAL}(\mathcal{M})$, we use the algorithm in [BMN17] to compute an implicational base Σ in polynomial time. Then, we apply the reduction to Σ_r . Since the closure system \mathcal{C}_r is bounded by Lemma 14, we use again [BMN17] to compute \mathcal{M}_r in polynomial time. Consequently, we can reduce an instance of $\text{LDUAL}(\alpha)$ to $\text{ELP-P}(\beta)$ in polynomial time.

According to Proposition 14 and Lemma 14, \mathcal{C}_r is standard and bounded. Thus, we can run the algorithm A to find $\text{Pref}_{\ell}(\mathcal{C}_r, \mathcal{F}_r)$. By Lemma 15, the size of $\text{Pref}_{\ell}(\mathcal{C}_r, \mathcal{F}_r)$ is bounded by $|\mathcal{B}^-| + |\mathcal{B}^+|$. Therefore, this step is conducted in output-polynomial time. Moreover, again using Lemma 15, we just have to discard \mathcal{B}^- from $\text{Pref}_{\ell}(\mathcal{C}_r, \mathcal{F}_r)$, which is done in polynomial time in the size of \mathcal{B}^- , being part of the input to $\text{LDUAL}(\alpha)$.

According to Lemma 15, the missing elements of \mathcal{B}^+ are among the predecessors of \mathcal{B}^- . To find them, we use the fact that \mathcal{C} is bounded and hence meet-semidistributive. Therefore, each closed set of \mathcal{C} has at most $|\mathcal{M}| \leq |V|$ predecessors (see Theorem 4). Moreover, for a given closed set C , computing $\text{Pred}(C)$ can be achieved in polynomial time in the size of V and the representation for \mathcal{C} , using the algorithm in [BMN17] and the characterization of $\text{Pred}(C)$ of Bordat [Bor86]. Thus, we can compute $\{C \in \mathcal{C} \mid C \prec B_i \text{ in } \mathcal{C}, \text{ for some } B_i \in \mathcal{B}^-\}$ in polynomial time in the size of the representation for \mathcal{C} , V and \mathcal{B}^- . We identify the missing solutions of \mathcal{B}^+ by running over $\{C \in \mathcal{C} \mid C \prec B_i \text{ for some } B_i \in \mathcal{B}^-\}$ and checking for the desired property in polynomial time in the size of V , \mathcal{B}^- and the representation for \mathcal{C} .

By Lemma 15, we obtain \mathfrak{B}^+ as a result. Since the whole procedure runs in output-polynomial time, the theorem follows. \square

ELP-P(α) and LDUAL(β) are equivalent in standard join-distributive closure systems

The last reduction is about standard join-distributive closure systems. We show that LDUAL(α) and ELP-P(β) are equivalent in standard join-distributive closure systems.

Reduction. We modify the reduction from the non-standard case. First, we introduce two new gadget elements v_{n+1} and b_{m+1} . For simplicity, let $B_{m+1} = \{v_{n+1}\}$. Let $V_{\text{int}} = V \cup \{v_{n+1}\}$ be an intermediate groundset and $R_{\mathfrak{B}^-}^{\text{int}} = R_{\mathfrak{B}^-} \cup \{b_{m+1}\}$. For every subset X of V_{int} , we put $R_{\mathfrak{B}^-}^{\text{int}}(X) = \{b_i \in R_{\mathfrak{B}^-}^{\text{int}} \mid B_i \subseteq X\}$. Let \mathcal{C}_{int} be the intermediate closure system $\mathcal{C} \cup \{C \cup \{v_{n+1}\} \mid C \in \mathcal{C}\}$. Remark that since \mathcal{C} is assumed standard, $\{v_{n+1}\} \in \mathcal{C}_{\text{int}}$. We call ϕ_{int} the closure operator associated to \mathcal{C}_{int} . The meet-irreducible elements \mathcal{M}_{int} of \mathcal{C}_{int} are subject to the equality $\mathcal{M}_{\text{int}} = \{V\} \cup \{M \cup \{v_{n+1}\} \mid M \in \mathcal{M}\}$ and Σ is also an implicational base of \mathcal{C}_{int} . Moreover, $\mathfrak{B}^- \cup \{B_{m+1}\}$ is an antichain of \mathcal{C}_{int} whose dual antichain is exactly \mathfrak{B}^+ . We are now in position to define our reduction:

- $V_r = V \cup R_{\mathfrak{B}^-}^{\text{int}}$,
- $\Sigma_r = \Sigma \cup \{b_i \rightarrow B_i \mid 1 \leq i \leq m+1\} \cup \{B_i \cup \{b_j\} \rightarrow b_i \mid 1 \leq i, j \leq m+1, i \neq j\}$,
- $\mathcal{F}_r = \{\{b_i, v_j\} \mid b_i \in R_{\mathfrak{B}^-}, v_j \in V\} \cup \{\{b_i, u_j\} \mid 1 \leq i, j \leq m+1, b_i \neq b_j\}$.

Note that v_{m+1} is not in any forbidden pair of \mathcal{F}_r . Moreover, no pair of the form $\{b_{m+1}, v_j\}$ is forbidden. We denote by \mathcal{C}_r closure system associated to Σ_r . Its closure operator is called ϕ_r . The reduction can be conducted in polynomial time in the size of V , Σ and \mathfrak{B}^- .

Example 47. Unlike previous reductions, we first extend V to $V_r = \{1, 2, 3, 4, 5, b_1, b_2, b_3\}$. As for Σ_r we have

$$\Sigma_r = \Sigma \cup \left\{ \begin{array}{lll} b_1 \rightarrow 13, & b_2 \rightarrow 12, & b_3 \rightarrow 5 \\ 13b_2 \rightarrow b_1, & 12b_1 \rightarrow b_2, & 5b_1 \rightarrow b_3 \\ 13b_3 \rightarrow b_2, & 12b_3 \rightarrow b_2, & 5b_2 \rightarrow b_3 \end{array} \right\}$$

The corresponding closure system is \mathcal{C}_r . And the family \mathcal{F}_r is given by $\mathcal{F}_r = \{b_1 1, b_1 2, b_1 3, b_1 4, b_2 1, b_2 2, b_2 3, b_2 4, b_1 b_2, b_1 b_3, b_2 b_3\}$. For clarity, we represent \mathcal{F}_r as a graph on the left of Figure 3.9. On the right we give \mathcal{C}_r in which we highlight $\text{Pref}_\ell(\mathcal{C}_r, \mathcal{F}_r)$. Notice the one-to-one correspondence between the closed sets of $\text{Pref}_\ell(\mathcal{C}_r, \mathcal{F}_r)$ including $\{b_3, 5\}$, namely $15b_3$ and $245b_3$, and the closed sets $1, 24$ of \mathfrak{B}^+ . The lower-preferred closed set 12345 is a side-product of the construction of \mathcal{F}_r .

first, we characterize the closed sets of \mathcal{C}_r .

PROPOSITION 16 (*). *We have the following equality: $\mathcal{C}_r = \mathcal{C}_{\text{int}} \cup \{C \cup R_{\mathfrak{B}^-}^{\text{int}}(C) \mid C \in \mathcal{C}_{\text{int}}\}$.*

Proof. We begin with the \supseteq part. First, $\mathcal{C}_{\text{int}} \subseteq \mathcal{C}_r$ follows from the facts that $\Sigma \subseteq \Sigma_r$ and the premise of each implication in $\Sigma_r \setminus \Sigma$ intersects $R_{\mathfrak{B}^-}^{\text{int}}$. Thus, necessarily, a subset of V_{int} vacuously satisfies $\Sigma_r \setminus \Sigma$. Now let $C \in \mathcal{C}_{\text{int}}$ and consider the set $C \cup R_{\mathfrak{B}^-}^{\text{int}}(C)$. As $C \in \mathcal{C}_{\text{int}}$ and $R_{\mathfrak{B}^-}^{\text{int}} \cap V_{\text{int}} = \emptyset$, $C \cup R_{\mathfrak{B}^-}^{\text{int}}(C)$ readily satisfies Σ . Let $1 \leq i \leq m+1$. By construction, we have that $b_i \in C \cup R_{\mathfrak{B}^-}^{\text{int}}(C)$ if and only if $B_i \subseteq C$. Thus, whenever $C \cup R_{\mathfrak{B}^-}^{\text{int}}(C)$ contains the premise of the

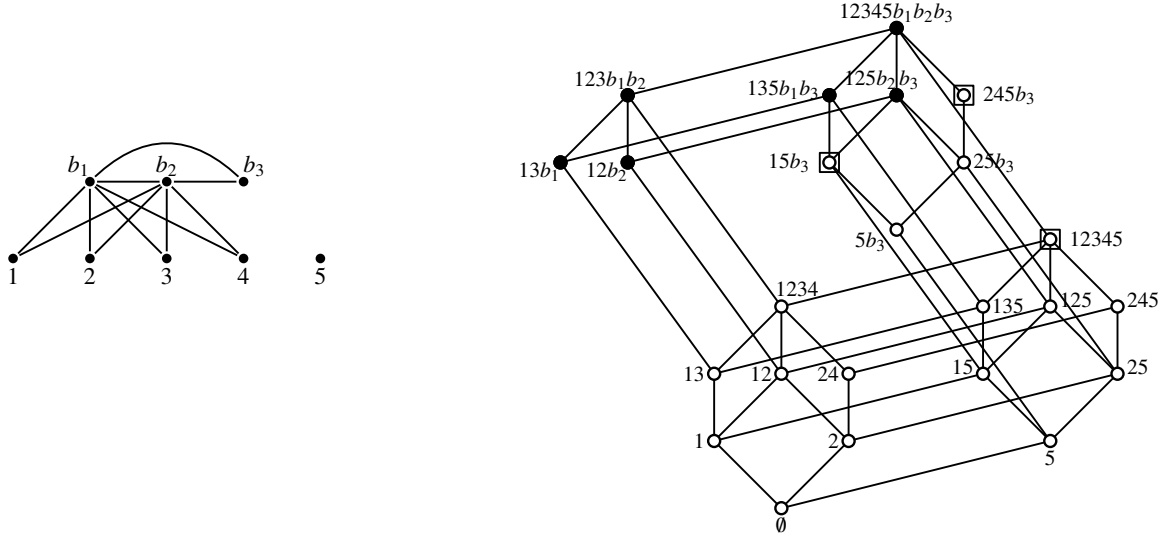

Figure 3.9 – The closure system \mathcal{C}_r derived from \mathcal{C} in Example 47.

implications $b_i \rightarrow B_i$ and $B_j \cup \{b_i\} \rightarrow b_j$, it also contains its conclusion, for each $1 \leq j \leq m+1$. Consequently, $C \cup R_{\mathcal{B}^-}^{\text{int}}(C)$ satisfies Σ_r and $\{C \cup R_{\mathcal{B}^-}^{\text{int}}(C) \mid C \in \mathcal{C}_{\text{int}}\} \subseteq \mathcal{C}_r$ as required.

We move to the \subseteq part. Let $C' \in \mathcal{C}_r$ and let $C = C' \cap R_{\mathcal{B}^-}^{\text{int}}$. Since $\Sigma \subseteq \Sigma_r$ and C' satisfies Σ_r , it must be that $C \in \mathcal{C}_{\text{int}}$. In particular, if $C' = C$, $C' \in \mathcal{C}_{\text{int}}$ holds. Suppose on the other hand that $C' \cap R_{\mathcal{B}^-}^{\text{int}} \neq \emptyset$. As $C \in \mathcal{C}_{\text{int}}$, we have to show that $C' = C \cup R_{\mathcal{B}^-}^{\text{int}}(C)$. First, observe that C' contains b_i only if it includes B_i , because C' models Σ_r and $b_i \rightarrow B_i, B_i \cup \{b_j\} \rightarrow b_i \in \Sigma_r$. Therefore, $C' \subseteq C \cup R_{\mathcal{B}^-}^{\text{int}}(C)$ readily holds. We now prove that if $b_i \in R_{\mathcal{B}^-}^{\text{int}}(C)$ for some $b_i \in R_{\mathcal{B}^-}^{\text{int}}$, then $b_i \in C'$. Hence, assume that $B_i \subseteq C \subseteq C'$ for some $1 \leq i \leq m+1$, and let $b_j \in R_{\mathcal{B}^-}^{\text{int}}$ such that $b_j \in C'$. By assumption on C' , such a b_j exists. If $b_j = b_i$ then $b_i \in C'$ trivially holds. Now, if $b_j \neq b_i$, then $b_i \in C'$ follows from the fact that C' satisfies Σ_r and includes the premise of the implication $B_i \cup \{b_j\} \rightarrow b_i$. Thus, $b_i \in C'$. We deduce that $C' = C \cup R_{\mathcal{B}^-}^{\text{int}}(C)$ for some $C \in \mathcal{C}_{\text{int}}$, concluding the proof. \square

Then, we prove that \mathcal{C}_r is standard. On this purpose we use Proposition 16 and the fact that \mathcal{C}_{int} is itself standard.

PROPOSITION 17 (*). *The closure system \mathcal{C}_r is standard.*

Proof. Let $v_j \in V_{\text{int}}$. Since $\mathcal{C}_{\text{int}} \subseteq \mathcal{C}_r$ by Proposition 16, we deduce that $\phi_r(v_j) \setminus \{v_j\} = \phi_{\text{int}}(v_j) \setminus \{v_j\}$. Because \mathcal{C} is standard by assumption, \mathcal{C}_{int} is too, and hence $\phi_r(v_j) \setminus \{v_j\} \in \mathcal{C}_r$ follows.

Consider now $b_i \in R_{\mathcal{B}^-}^{\text{int}}$, for some $1 \leq i \leq m+1$. We show that $\phi_r(b_i) = B_i \cup \{b_i\}$. Since $b_i \rightarrow B_i \in \Sigma_r$, $B_i \cup \{b_i\} \subseteq \phi_r(b_i)$ already holds. As $B_i \in \mathcal{C}_{\text{int}}$, B_i satisfies Σ and hence $B_i \cup \{b_i\}$ also does. Moreover, $\mathcal{B}^- \cup \{B_{m+1}\}$ is simple, so that for every $B_j \in \mathcal{B}^- \cup \{B_{m+1}\}$, distinct from B_i , $B_j \not\subseteq B_i$. Consequently, $B_i \cup \{b_i\}$ also satisfies every implication of the form $B_j \cup \{b_i\} \rightarrow b_j$ in Σ_r for every $j \neq i$. Thus, $B_i \cup \{b_i\}$ satisfies Σ_r and is closed in \mathcal{C}_r . Since $B_i \cup \{b_i\} \subseteq \phi_r(b_i)$ and $B_i \cup \{b_i\} \in \mathcal{C}_r$, we obtain that $\phi_r(b_i) = B_i \cup \{b_i\}$. Knowing that B_i is closed in \mathcal{C}_r , $\phi_r(b_i) \setminus \{b_i\} \in \mathcal{C}_r$ follows. \square

To demonstrate that our reduction preserves join-distributivity, we use a characterization of Ganter [GW12]:

THEOREM 22 ([GW12]). *A closure system \mathcal{C} is join-distributive if and only if for every $J \in \mathcal{J}$, there exists a unique $M \in \mathcal{M}$ such that $J \downarrow M$.*

Beforehand, we characterize the meet-irreducible elements of \mathcal{M}_r .

PROPOSITION 18 (*). *The following equality holds: $\mathcal{M}_r = \{V_{\text{int}}\} \cup \{M \cup R_{\mathcal{B}^-}^{\text{int}}(M) \mid M \in \mathcal{M}_{\text{int}}\}$.*

Proof. We begin with the \supseteq part. First, observe that V_{int} is a co-atom of \mathcal{C}_r by construction of Σ_r . Now let $M \in \mathcal{M}_{\text{int}}$ and consider $M \cup R_{\mathcal{B}^-}^{\text{int}}(M)$. By Proposition 16, $M \cup R_{\mathcal{B}^-}^{\text{int}}(M) \in \mathcal{C}_r$. Let v be an element of V_{int} such that $\phi_{\text{int}}(v) \uparrow M$ in \mathcal{C}_{int} . We show that $\phi_r(v) \uparrow M \cup R_{\mathcal{B}^-}^{\text{int}}(M)$ in \mathcal{C}_r . Let $v' \in V_{\text{int}} \setminus M$. Since $\Sigma \subseteq \Sigma_r$, we have $\phi_{\text{int}}(M \cup \{v'\}) \subseteq \phi_r(M \cup \{v'\})$ and because $\phi_{\text{int}}(v) \uparrow M$ in \mathcal{C}_{int} , $v \in \phi_r(M \cup \{v'\}) \subseteq \phi_r(M \cup R_{\mathcal{B}^-}^{\text{int}}(M) \cup \{v'\})$ follows. Now let $b_i \in R_{\mathcal{B}^-}^{\text{int}} \setminus R_{\mathcal{B}^-}^{\text{int}}(M)$. If it does not exist, $\phi_r(v) \uparrow M \cup R_{\mathcal{B}^-}^{\text{int}}(M)$ in \mathcal{C}_r is clear. Since $b_i \notin R_{\mathcal{B}^-}^{\text{int}}(M)$, we have $B_i \not\subseteq M$ in \mathcal{C}_r . As $\phi_{\text{int}}(v) \uparrow M$ in \mathcal{C}_{int} , it follows that $v \in \phi_{\text{int}}(B_i \cup M)$. From $b_i \rightarrow B_i \in \Sigma_r$, we deduce that $v \in \phi_r(B_i \cup M \cup R_{\mathcal{B}^-}^{\text{int}}(M)) \subseteq \phi_r(\{b_i\} \cup M \cup R_{\mathcal{B}^-}^{\text{int}}(M))$. We conclude that $\phi_r(v) \uparrow M \cup R_{\mathcal{B}^-}^{\text{int}}(M)$ in \mathcal{C}_r . Consequently, $\mathcal{M}_r \supseteq \{V_{\text{int}}\} \cup \{M \cup R_{\mathcal{B}^-}^{\text{int}}(M) \mid M \in \mathcal{M}_{\text{int}}\}$ holds.

We move to the \subseteq part which we show using contrapositive. Let $C' \in \mathcal{C}_r$ such that $C' \notin \{V_{\text{int}}\} \cup \{M \cup R_{\mathcal{B}^-}^{\text{int}}(M) \mid M \in \mathcal{M}_{\text{int}}\}$. If $C' = V_r$, then $C' \notin \mathcal{M}_r$ is clear. hence, assume that $C' \subset V_r$. According to Proposition 16, we have two cases. Assume first that $C' \in \mathcal{C}_{\text{int}}$. Again, we have two possible cases:

- (i) $R_{\mathcal{B}^-}^{\text{int}}(C') \neq \emptyset$. Then, by Proposition 16, $C' \cup R_{\mathcal{B}^-}^{\text{int}}(C') \in \mathcal{C}_r$. Hence, $C' = V_{\text{int}} \cap (C' \cup R_{\mathcal{B}^-}^{\text{int}}(C'))$ from which we deduce $C' \notin \mathcal{M}_r$ as $C' \neq V_{\text{int}}$ by assumption.
- (ii) $R_{\mathcal{B}^-}^{\text{int}}(C') = \emptyset$. Then, $v_{n+1} \notin C'$ by definition of $R_{\mathcal{B}^-}^{\text{int}}(C')$. Since $C' \cup \{v_{n+1}\} \in \mathcal{C}_{\text{int}}$ and $\mathcal{C}_{\text{int}} \subseteq \mathcal{C}_r$ by Proposition 16, we deduce that $C' = (V \cup R_{\mathcal{B}^-}^{\text{int}}(V)) \cap (C' \cup \{v_{n+1}\})$. As $V \in \mathcal{M}_{\text{int}}$, we have that $C' \neq V \cup R_{\mathcal{B}^-}^{\text{int}}(V)$ by assumption and hence $C' \notin \mathcal{M}_r$.

Now suppose $C' = C \cup R_{\mathcal{B}^-}(C)$ for some $C \in \mathcal{C}_{\text{int}}$. Again, it must be that $C \notin \mathcal{M}_{\text{int}}$ by assumption, and since $C \neq V_{\text{int}}$, we have that $\mathcal{M}_{\text{int}}(C) \neq \emptyset$. Therefore, $C' = \bigcap_{M \in \mathcal{M}_{\text{int}}(C)} (M \cup R_{\mathcal{B}^-}^{\text{int}}(M))$ and $C' \notin \mathcal{M}_r$ holds since $C' \notin \{M \cup R_{\mathcal{B}^-}^{\text{int}}(M) \mid M \in \mathcal{M}_{\text{int}}\}$ by assumption. \square

We can now show that the reduction from \mathcal{C} to \mathcal{C}_r preserves join-distributivity.

PROPOSITION 19 (*). *The closure system \mathcal{C}_r is join-distributive when \mathcal{C} is.*

Proof. Let us assume that \mathcal{C} is a (standard) join-distributive closure system. Observe that \mathcal{C}_{int} is also join-distributive. We show that \mathcal{C}_r also enjoys this property. By Proposition 17, \mathcal{C}_r is standard. We use Proposition 18 and Theorem 22.

For every $b_i \in R_{\mathcal{B}^-}^{\text{int}}$, we have $\phi_r(b_i) = B_i \cup \{b_i\}$. By Proposition 18, we obtain that the unique meet-irreducible element M' of \mathcal{M}_r satisfying $\phi(b_i) \downarrow M'$ is V_{int} as for any other $M'' \in \mathcal{M}_r$, $B_i \subseteq M''$ implies that $b_i \in M''$. For each $v_j \in V_{\text{int}}$, there is a unique meet-irreducible element $M \in \mathcal{M}_{\text{int}}$ such that $\phi(v_j) \downarrow M$ in \mathcal{C}_{int} by join-distributivity of \mathcal{C}_{int} . By Proposition 16, we have that $\phi_r(v_j) \setminus \{v_j\} = \phi_{\text{int}}(v_j) \setminus \{v_j\}$. We deduce from Proposition 18 that the unique meet-irreducible element M' of \mathcal{M}_r satisfying $\phi_r(v_j) \downarrow M'$ is $M \cup R_{\mathcal{B}^-}^{\text{int}}(M)$. Now, the fact that \mathcal{C}_r is join-distributive follows from Theorem 22. \square

It remains to express the relationship between \mathcal{B}^+ and $\text{Pref}_\ell(\mathcal{C}_r, \mathcal{F}_r)$.

LEMMA 16 (*). *We have $\text{Pref}_\ell(\mathcal{C}_r, \mathcal{F}_r) = \{V_{\text{int}}\} \cup \{C \cup \{v_{n+1}, b_{m+1}\} \mid C \in \mathcal{B}^+\}$.*

Proof. It is sufficient to show that $\text{Adm}_\ell(\mathcal{C}_r, \mathcal{F}_r) = \mathcal{C}_{\text{int}} \cup \{C \cup \{v_{n+1}, b_{m+1}\} \mid C \in \downarrow_{\mathcal{C}} \mathcal{B}^+\}$. We begin with the \supseteq part. By Proposition 16, $\mathcal{C}_{\text{int}} \subseteq \mathcal{C}_r$. Moreover, no forbidden pair of \mathcal{F}_r is included in V_{int} . Hence, $\mathcal{C}_{\text{int}} \subseteq \text{Adm}_\ell(\mathcal{C}_r, \mathcal{F}_r)$ holds. Now let $C \in \downarrow_{\mathcal{C}} \mathcal{B}^+$ in \mathcal{C}_{int} and consider $C \cup \{v_{n+1}, b_{m+1}\}$. Such a C must exist as $\mathcal{B}^- \neq \{\emptyset\}$. By assumption, $B_i \not\subseteq C$ for every $B_i \in \mathcal{B}^-$. As \mathcal{B}^- is defined over V , $B_i \not\subseteq C \cup \{v_{n+1}, b_{m+1}\}$ for every $B_i \in \mathcal{B}^-$. Hence, $C \cup \{v_{n+1}, b_{m+1}\} \in \mathcal{C}_r$ by construction of Σ_r . As it does not contain any element of $R_{\mathcal{B}^-}$, it is lower-admissible by definition of \mathcal{F}_r .

We move to the \subseteq part. Let C be a lower-admissible closed set of \mathcal{C}_r w.r.t. \mathcal{F}_r . We have two cases. First, $C \subseteq V_{\text{int}}$ in which case $C \in \mathcal{C}_{\text{int}}$ by Proposition 16. Second, $C \not\subseteq V_{\text{int}}$. Since $\mathcal{B}^- \neq \{\emptyset\}$ by assumption, it must be that $B_i \not\subseteq C$ for every $B_i \in \mathcal{B}^-$, by definition of Σ_r and \mathcal{F}_r . Hence $C \cap R_{\mathcal{B}^-}^{\text{int}} = \{b_{m+1}\}$. Again by Proposition 16, we have that $C = C' \cup R_{\mathcal{B}^-}^{\text{int}}(C')$ for some closed set $C' \in \mathcal{C}_{\text{int}}$. Thus, $C \cap R_{\mathcal{B}^-}^{\text{int}} = \{b_{m+1}\}$ implies that $R_{\mathcal{B}^-}^{\text{int}}(C') = \{b_{m+1}\}$. Consequently, $C' \setminus \{v_{n+1}\} \in \downarrow_{\mathcal{C}} \mathcal{B}^+$ in \mathcal{C} as expected. \square

We are in position to demonstrate that $\text{ELP-P}(\alpha)$ and $\text{LDUAL}(\beta)$ are equivalent in standard join-distributive closure systems.

THEOREM 23 (*). *The problems $\text{LDUAL}(\alpha)$ and $\text{ELP-P}(\beta)$ are equivalent, even when restricted to standard join-distributive closure systems.*

Proof. As join-distributive closure systems are meet-semidistributive, we can reduce $\text{ELP-P}(\beta)$ to $\text{LDUAL}(\alpha)$ in polynomial time using the algorithm of [BMN17] to find the appropriate representation.

Let us assume there exists an output-polynomial time algorithm A for $\text{ELP-P}(\beta)$ in standard join-distributive closure systems. We devise an output-polynomial time algorithm for $\text{LDUAL}(\alpha)$ in the same class.

By Lemma 19, \mathcal{C}_r is join-distributive. Hence, we can use the algorithm of [BMN17] and our reduction with Σ_r to reduce $\text{LDUAL}(\alpha)$ to $\text{ELP-P}(\beta)$ in polynomial time (see also Theorem 21).

Since \mathcal{C}_r is standard and join-distributive by Lemmas 17 and 19, we can run the algorithm A to find $\text{Pref}_\ell(\mathcal{C}_r, \mathcal{F}_r)$. According to Lemma 16, the size of $\text{Pref}_\ell(\mathcal{C}_r, \mathcal{F}_r)$ is bounded by $|\mathcal{B}^+| + 1$. Hence, this step is achieved in output-polynomial time. Moreover, \mathcal{B}^+ can be recovered from $\text{Pref}_\ell(\mathcal{C}_r, \mathcal{F}_r)$ in polynomial time in the size of \mathcal{B}^+ by discarding V_{int} and removing $\{v_{n+1}, u_{m+1}\}$ from every other solution. Since the whole procedure runs in output-polynomial time, the result follows. \square

To conclude this subsection, we remind the different results we have shown for $\text{ELP-P}(\alpha)$ in the hierarchy of Figure 3.10. It is a reminder of Figure 3.4. In the next subsection, we will suggest an algorithm to solve $\text{ELP-P}(\alpha)$. In contrast with the previous negative results, we will identify classes where this algorithm runs in output-polynomial time.

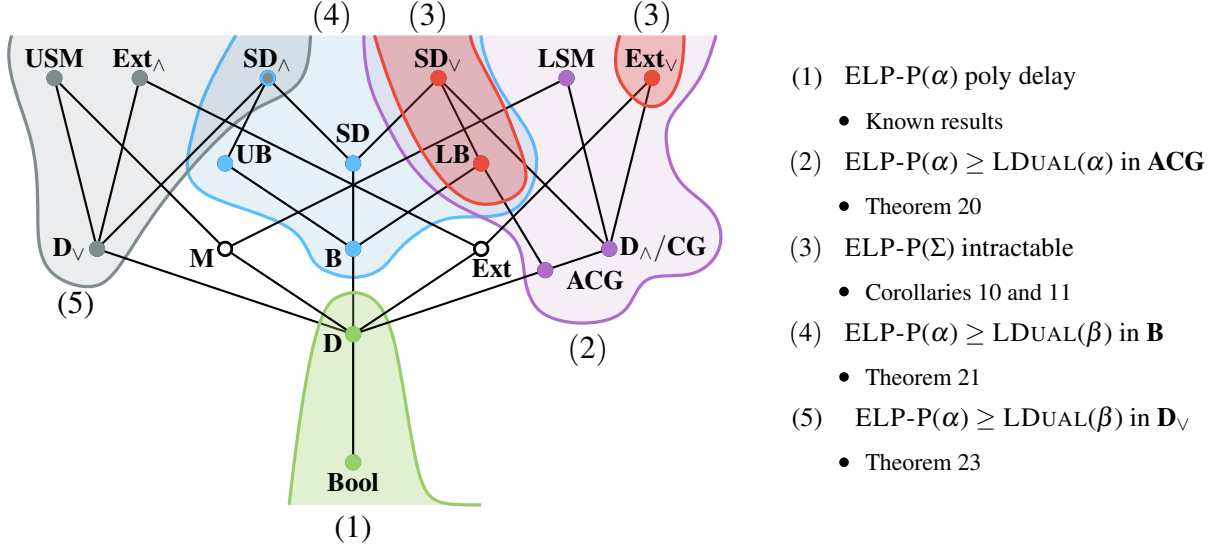

Figure 3.10 – The complexity of ELP-P in the hierarchy of (standard) closure systems.

3.4.2. Forbidden pairs and the Carathéodory number of a closure system

We give a procedure to solve the problem ELP-P(α) based on keys of a standard closure system. Using the Carathéodory number $cc(\cdot)$ as a parameter, we identify classes of closure systems where the algorithm runs in incremental-polynomial time or output-quasipolynomial time, independently of the input representation for \mathcal{C} .

Let \mathcal{C} be a standard closure system over V , with induced closure operator ϕ . Let \mathcal{F} be a family of forbidden pairs over V . Remind that $\mathcal{F} \neq \emptyset$ by assumption, which avoids the simple case where $\text{Pref}_\ell(\mathcal{C}, \mathcal{F}) = \{V\}$. We use the closure operator $\phi_{\mathcal{F}}$ which is defined as follows, for every $X \subseteq V$:

$$\phi_{\mathcal{F}}(X) = \begin{cases} V & \text{if there exists } F \in \mathcal{F} \text{ s.t. } F \subseteq \phi(X) \\ \phi(X) & \text{otherwise.} \end{cases}$$

Its associated closure system is $\mathcal{C}_{\mathcal{F}}$. Since $\mathcal{C}_{\mathcal{F}} = \text{Adm}_\ell(\mathcal{C}, \mathcal{F}) \cup \{V\}$, it must be that the co-atoms of $\mathcal{C}_{\mathcal{F}}$ are exactly the elements of $\text{Pref}_\ell(\mathcal{C}, \mathcal{F})$.

Remark 10. In general, $\mathcal{C}_{\mathcal{F}}$ does not belong to the same class as \mathcal{C} (distributive, modular, lower bounded, ...). Hence, for a given class of closure system, ELP-P(α) differs from the task of enumerating co-atoms. For instance if \mathcal{C} is a convex geometry, every co-atom is of the form $V \setminus \{v\}$ for some $v \in V$. Thus, enumerating co-atoms can be done in polynomial time in the size of V and the representation for \mathcal{C} while ELP-P(Σ) is harder than hypergraph dualization, see Theorem 20.

It is known (see e.g., [Thi86]) that co-atoms of a closure system are exactly the maximal independent sets of its keys, viewed as a hypergraph. Recall that a subset K of V is a key for the closure system \mathcal{C} if $\phi(K) = V$ and for any $K' \subset K$, $\phi(K') \subset V$. Therefore, we can use the following two-step procedure to compute $\text{Pref}_\ell(\mathcal{C}, \mathcal{F})$:

- (i) identify the set $\mathcal{K}(\mathcal{C}_{\mathcal{F}})$ of keys of the closure system $\mathcal{C}_{\mathcal{F}}$,
- (ii) compute $\text{MIS}(\mathcal{K}(\mathcal{C}_{\mathcal{F}})) = \text{Pref}_\ell(\mathcal{C}, \mathcal{F})$.

To see whether this strategy can be used in output-polynomial time, we first characterize elements of \mathcal{K} . To do so, we have to guarantee that a set $X \subset V$ contains a key of $\mathcal{C}_{\mathcal{F}}$ whenever X or $\phi(X)$ contains a forbidden pair of \mathcal{F} . Looking at \mathcal{F} is sufficient to identify lower-admissible closed sets of \mathcal{C} . But, there may be non-closed sets X not including any forbidden pair of \mathcal{F} whose closure $\phi(X)$ is however not lower-admissible. These will not be seen by just considering \mathcal{F} . Thus, if $\{u, v\}$ is a forbidden pair of \mathcal{F} included in $\phi(X)$, we deduce that there must be a minimal generator A_u of u included in X , possibly $A_u = \{u\}$. Similarly, X includes a minimal generator A_v of v . The fact that \mathcal{F} is a set of pairs plays an important role here, as it guarantees that X can be identified by combining only two minimal generators, one for each element of some forbidden pair. In particular, keys in $\mathcal{K}(\mathcal{C}_{\mathcal{F}})$ will share the following property.

PROPOSITION 20. *Let $K \in \mathcal{K}(\mathcal{C}_{\mathcal{F}})$. Then there exists $\{u, v\} \in \mathcal{F}$, a minimal generator A_u of u , and a minimal generator A_v of v such that $K = A_u \cup A_v$.*

Proof. Let $K \in \mathcal{K}(\mathcal{C}_{\mathcal{F}})$. As $\phi_{\mathcal{F}}(K) = V$ by definition and \mathcal{F} is non-empty by assumption, there exists a forbidden pair $\{u, v\} \in \mathcal{F}$ such that $\{u, v\}$ is in the closure $\phi(K)$ of \mathcal{K} in \mathcal{C} . Thus, there exists minimal generators A_u of u and A_v of v such that $A_u \cup A_v \subseteq K$. Assume that $A_u \cup A_v \subset K$ and let $w \in K \setminus (A_u \cup A_v)$. As $u \in \phi(A_u)$ and $v \in \phi(A_v)$, we get $\{u, v\} \subseteq \phi(K \setminus \{w\})$, a contradiction with the minimality of K . \square

Remark that $\mathcal{F} \not\subseteq \mathcal{K}(\mathcal{C}_{\mathcal{F}})$ in the general case, as there may be cases $u \in \phi(v)$ for some forbidden pair $\{u, v\} \in \mathcal{F}$. Thus, u is a key which satisfies Proposition 20 with $A_u = A_v = \{u\}$. It also follows from Proposition 20 that $\text{cc}(\mathcal{C})$ is a key parameter of the two-steps procedure we described. When no restriction on $\text{cc}(\mathcal{C})$ holds, $\mathcal{K}(\mathcal{C}_{\mathcal{F}})$ can have exponential size with respect to V and the representation for \mathcal{C} . The next example inspired from [KSS00] illustrates this exponential growth.

Example 48. Let $V = \{u_1, \dots, u_n, v_1, \dots, v_n, x, y\}$ for some $n \in \mathbb{N}$. We consider an implicational base Σ consisting of the implications $\{u_i \rightarrow v_i \mid 1 \leq i \leq n\}$ and $v_1 \dots v_n \rightarrow y$. Finally, let $F = \{x, y\}$ be a forbidden pair. We consider the singleton family $\mathcal{F} = \{F\}$. The elements of \mathcal{M} can be partitioned as follows:

$$\mathcal{M} = \{V \setminus \{x, u_i, v_i\} \cup \{V \setminus \{u_i\}\} \cup \{V \setminus \{u_i, v_i\}\} \cup \{V \setminus \{v\}\} \quad \text{for every } 1 \leq i \leq n$$

Hence \mathcal{M} has size polynomial in n . The family $\text{Pref}_{\ell}(\mathcal{C}, \mathcal{F})$ contains $n + 1$ solutions of the form $V \setminus \{x, u_i, v_i\}$ or $V \setminus \{v\}$ where i ranges from 1 to n . However, x has 2^n minimal generators of the form $w_1 \dots w_n$ with $w_i \in \{u_i, v_i\}$, $1 \leq i \leq n$. Using Proposition 20, we deduce that $\mathcal{K}(\mathcal{C}_{\mathcal{F}})$ has at least 2^n keys of dimension $n + 1$, which is exponential in the size of V, Σ, \mathcal{M} and $\text{Pref}_{\ell}(\mathcal{C}, \mathcal{F})$.

Thinking of Example 48, it appears that computing $\text{Pref}_{\ell}(\mathcal{C}, \mathcal{F})$ through the intermediary of $\mathcal{K}(\mathcal{C}_{\mathcal{F}})$ is in general impossible in output-polynomial time. In fact, this exponential blow up occurs even for small classes of closure systems where the Carathéodory number is unbounded. In Example 48 for instance, the closure system induced by Σ is acyclic.

On the other hand, let us assume now that $\text{cc}(\mathcal{C})$ is bounded by some constant $k \in \mathbb{N}$. Then, by Proposition 20, every key in $\mathcal{K}(\mathcal{C}_{\mathcal{F}})$ has at most $2 \times k$ elements. Since the size of $\mathcal{K}(\mathcal{C}_{\mathcal{F}})$ is bounded by $|V|^{2k}$, we deduce that it can be greedily computed in polynomial time from any representation of \mathcal{C} , by checking each subset of size at most $2 \times k$ for the desired property.

Remark 11. In fact, this greedy algorithm can be improved if an implicational base Σ is given. Let $\Sigma_{\mathcal{F}}$ be the implicational base $\Sigma_{\mathcal{F}} = \Sigma \cup \{F \rightarrow V \mid F \in \mathcal{F}\}$. Observe that $\Sigma_{\mathcal{F}}$ is an implicational base for $\mathcal{C}_{\mathcal{F}}$ which can be computed in polynomial-time in the size of Σ and \mathcal{F} . Then, one can apply the algorithm of [LO78] to compute the keys $\mathcal{K}(\mathcal{C}_{\mathcal{F}})$ of $\mathcal{C}_{\mathcal{F}}$ with polynomial-delay.

As a consequence we show in the next theorem that our two-steps algorithm can be conducted in incremental-polynomial time, independently of the input representation.

THEOREM 24. *if \mathcal{C} is standard and $cc(\mathcal{C}) \leq k$ for some constant $k \in \mathbb{N}$, the problems ELP-P(α) can be solved in incremental-polynomial time.*

Proof. Let \mathcal{C} be a standard closure system with $cc(\mathcal{C}) \leq k$ for some constant k . By Proposition 20, the keys of the closure system $\mathcal{C}_{\mathcal{F}}$ have size at most $2 \times \mathcal{K}$. Thus, to compute $\mathcal{K}(\mathcal{C}_{\mathcal{F}})$ one can check the all subsets of V of size at most $2 \times k$ for the desired properties, in polynomial time in the size of the input. Then, we apply the algorithm of Eiter and Gottlob [EG95] to compute $MIS(\mathcal{K}(\mathcal{C}_{\mathcal{F}})) = \text{Pref}_{\ell}(\mathcal{C}, \mathcal{F})$ which runs in incremental polynomial time. Since $\mathcal{K}(\mathcal{C}_{\mathcal{F}})$ has polynomial size with respect to $|V|$, the delay between the i -th and $(i+1)$ -th solution of $\text{Pref}_{\ell}(\mathcal{C}, \mathcal{F})$ output is bounded by $\text{poly}(|V|^{2k} + i)$, that is $\text{poly}(|V| + i)$. Furthermore, the delay after the last output is also bounded by $\text{poly}(|V|^{2k}) = \text{poly}(|V|)$. As the time spent before the first solution output is bounded by a polynomial in $|V|$, $|\mathcal{F}|$ and the size of the representation for \mathcal{C} , the whole algorithm has incremental delay as expected. \square

Theorem 24 applies to various classes of convex geometries which we introduced in Chapter 1 Section 1.4.

COROLLARY 13. *The problem ELP-P(α) admits an incremental-polynomial algorithm in the following cases:*

- \mathcal{C} is distributive,
- \mathcal{C} is the family of convex subsets of a poset,
- \mathcal{C} is the family of monophonically convex subsets of a chordal graph,
- \mathcal{C} is an affine convex geometry in \mathbb{R}^k for a fixed constant k .

Proof. Distributive lattices have Carathéodory number 1 as they can be represented by implicational bases with singleton premises. The family of convex subsets of a poset has Carathéodory number 2 [KN10] (Corollary 13). The family of monophonically convex subsets of a chordal graph has Carathéodory number at most 2 [FJ86] (Corollary 3.4). The Carathéodory number of an affine convex geometry in \mathbb{R}^k is $k+1$ (see for instance [KLS12], p. 32). \square

In the distributive case, the algorithm can perform in polynomial delay using the algorithm of [JYP88] since $\mathcal{K}(\mathcal{C}_{\mathcal{F}})$ will be a graph by Proposition 20. This connects with previous results on distributive closure systems by Kavvadias et al. [KSS00].

Now, let us assume $cc(\mathcal{C})$ is bounded by $\log_2(|V|)$ instead of a constant. Then, the size of a key is bounded by $2 \times \log_2(|V|)$ so that \mathcal{K} has size quasipolynomial with respect to the input. Hence, if we apply the same strategy as in Theorem 24, we obtain:

THEOREM 25. *There is an output-quasipolynomial time algorithm solving ELP-P(α) if \mathcal{C} is standard and $cc(\mathcal{C}) \leq \log_2(|V|)$.*

Proof. For clarity, we put $n = |V|$ and k as the size of the output $\text{MIS}(\mathcal{K}(\mathcal{C}_{\mathcal{F}})) = \text{Pref}_{\ell}(\mathcal{C}, \mathcal{F})$. $\mathcal{K}(\mathcal{C}_{\mathcal{F}})$ can be computed in quasi-polynomial time by checking every subset of V of size at most $2 \times \log_2(n)$, in virtue of Proposition 20. Moreover, $\mathcal{K}(\mathcal{C}_{\mathcal{F}})$ has at most $2^{2\log_2(n)}$ elements and total size bounded by $n^{2\log_2(n)}$. Thus the total time required by this first step is bounded by a polynomial in the size of the representation of \mathcal{C} , $|\mathcal{F}|$, n and $2^{\log_2(n)}$ being quasipolynomial in the size of the input and $\mathcal{K}(\mathcal{C}_{\mathcal{F}})$. To compute $\text{MIS}(\mathcal{K}) = \text{Pref}_{\ell}(\mathcal{C}, \mathcal{F})$ we use the algorithm of Fredman and Khachiyan [FK96] whose running time is bounded by $(n^{2\log_2(n)} + k)^{o(\log_2(n^{2\log_2(n)} + k))}$. In our case, we can derive the following upper bounds:

$$\begin{aligned} (n^{2\log_2(n)} + k)^{o(\log_2(n^{2\log_2(n)} + k))} &\leq (k+n)^{2\log_2(n) \times o(\log_2((k+n)^{2\log_2(n)}))} \\ &\leq (k+n)^{O(4\log_2^3(k+n))} \end{aligned}$$

Thus, the time needed to compute $\text{mis}(\mathcal{K}(\mathcal{C}_{\mathcal{F}}))$ from $\mathcal{K}(\mathcal{C}_{\mathcal{F}})$ is output-quasipolynomial in the size of V and $\text{Pref}_{\ell}(\mathcal{C}, \mathcal{F})$. Consequently, the running time of the whole algorithm is bounded by

$$\text{poly}(|\phi|, |\mathcal{F}|, n)^{\log_2(n)} + (k+n)^{O(4\log_2^3(k+n))}$$

where ϕ is the representation for \mathcal{C} . This time is indeed quasipolynomial in the size of the representation for \mathcal{C} , V , \mathcal{F} and the output $\text{MIS}(\mathcal{K}) = \text{Pref}_{\ell}(\mathcal{C}, \mathcal{F})$. \square

In the remainder of this section, we show that this theorem can apply to a class of closure systems containing atomistic modular lattices. We are interested in biatomic atomistic closure systems. Namely, we show that when minimal generators obey an independence condition, the size of V is exponential with respect to $\text{cc}(\mathcal{C})$. To do so, we show that in biatomic atomistic closure systems, each subset of a minimal generator is itself a minimal generator.

First, we need to define atomistic biatomic closure systems. Let \mathcal{C} be a standard closure system over V with associated closure operator ϕ . We say that \mathcal{C} is *atomistic* if for every $u \in V$, $\phi(u) = \{u\}$. Thus V coincides with the atoms of \mathcal{C} . Biatomic closure systems have been introduced by Birkhoff and Bennett in [Ben87, BB85]. We reformulate their definition in terms of closure systems. A closure system \mathcal{C} is *biatomic* if for every closed sets $C_1, C_2 \in \mathcal{C}$ and any atom $\{u\} \in \mathcal{C}$, $u \in \phi(C_1 \cup C_2)$ implies the existence of atoms $\{u_1\} \subseteq C_1$, $\{u_2\} \subseteq C_2$ such that $u \in \phi(u_1 u_2)$. In atomistic closure systems in particular, the biatomic condition applies to every element of V . Hence, the next property of biatomic atomistic closure systems.

PROPOSITION 21. *Let \mathcal{C} be a biatomic atomistic closure system. Let $C \in \mathcal{C}$ and $u, v \in V$ with $u, v \notin C$. If $u \in \phi(C \cup \{v\})$, then there exists an element $w \in C$ such that $v \in \phi(uw)$.*

Proof. In atomistic closure systems, every element of V is closed, therefore we apply the definition to the closed sets C and $\{u\}$. \square

We will also make use of the following folklore result about minimal generators. We give a proof for self-containment.

PROPOSITION 22. *If A_u is a minimal generator of $u \in V$, then $\phi(X) \cap A_u = X$ for any $X \subseteq A_u$.*

Proof. First, we have that $X \subseteq \phi(X) \cap A_u$ as $X \subseteq \phi(X)$ and $X \subseteq A_u$. Now suppose that there exists $v \in \phi(X) \cap A_u$ such that $v \notin X$. Then, $v \in \phi(A_u \setminus \{v\})$ as $X \subseteq A_u \setminus \{v\}$. Hence, $\phi(A_u) = \phi(A_u \setminus \{v\})$ and $u \in \phi(A_u \setminus \{v\})$, a contradiction with A_u being a minimal generator of u . \square

Our first step is to show that in a biatomic atomistic closure system, if A_u is a minimal generator for some $u \in V$, then every non-empty subset X of A_u is itself a minimal generator for some $v \in V$. We prove this statement in Lemmas 17 and 18. Recall that an element $u \in V$ is a (trivial) minimal generator of itself.

LEMMA 17. *Let $u \in V$ and let A_u be a minimal generator of u with size $k \geq 2$. Then for each $a_i \in A_u$, $1 \leq i \leq k$, there exists $v_i \in V$ such that $A_u \setminus \{a_i\}$ is a minimal generator of v_i .*

Proof. Let $A_u = \{a_1, \dots, a_k\}$ be a minimal generator of u such that $k \geq 2$. Then, for any $a_i \in A_u$, $i \in [k]$, we have $a_i \notin \phi(A_u \setminus \{a_i\})$ by Proposition 22. However, we have $u \in \phi(\{a_i\} \cup \phi(A_u \setminus \{a_i\})) = \phi(A_u)$. Thus, by Proposition 21, there must exist $v_i \in \phi(A_u \setminus \{a_i\})$ such that $u \in \phi(a_i v_i)$.

Let us show that $A_u \setminus \{a_i\}$ is a minimal generator of v_i . Assume for contradiction this is not the case. As $v_i \in \phi(A_u \setminus \{a_i\})$, there must be a proper subset A_{v_i} of $A_u \setminus \{a_i\}$ which is a minimal generator for v_i . Note that since A_u has at least 2 elements, at least one proper subset of $A_u \setminus \{a_i\}$ exists. As $A_{v_i} \subset A_u \setminus \{a_i\}$, there exists $a_j \in A_u$, $a_j \neq a_i$, such that $a_j \notin A_{v_i}$. Therefore, $A_{v_i} \subseteq A_u \setminus \{a_j\}$ and $\phi(A_{v_i}) \subseteq \phi(A_u \setminus \{a_j\})$. More precisely, $v_i \in \phi(A_{v_i})$ and hence $v_i \in \phi(A_u \setminus \{a_j\})$. However, we also have that $a_i \in \phi(A_u \setminus \{a_j\})$ as $a_i \in A_u$, $a_i \neq a_j$, and since $u \in \phi(a_i v_i)$, we must have $v \in \phi(A_u \setminus \{a_j\})$, a contradiction with A_u being a minimal generator of u . Thus, we deduce that $A_u \setminus \{a_i\}$ is a minimal generator for v_i , concluding the proof. \square

In the particular case where A_u has only two elements, say a_1 and a_2 , then $A_u \setminus \{a_1\} = \{a_2\}$ and the element a_2 is a trivial minimal generator of itself. By using inductively Lemma 17 on the size of A_u , one can derive the next straightforward lemma.

LEMMA 18. *Let \mathcal{C} be a biatomic atomistic closure system. Let A_u be a minimal generator of some $u \in V$. Then, for any $X \subseteq A_u$ with $X \neq \emptyset$, there exists $v \in V$ such that X is a minimal generator of v .*

Thus, for a given minimal generator A_u of u , any non-empty subset X of A_u is associated to some $v \in V$. We show next that when A_u also satisfies an independence condition, X will be the unique subset of A_u associated to v . Following [Grä11], we reformulate the definition of independence in an atomistic closure system \mathcal{C} , but restricted to its atoms. A subset X of V is *independent* in \mathcal{C} if for every $X_1, X_2 \subseteq X$, $\phi(X_1 \cap X_2) = \phi(X_1) \cap \phi(X_2)$.

LEMMA 19. *Let \mathcal{C} be a biatomic atomistic closure system. Let A_u be an independent minimal generator of $u \in V$, and let X be a non-empty subset of A_u . Then, there exists $v \in V$ such that X is the unique minimum subset of A_u satisfying $v \in \phi(X)$.*

Proof. Let A_u be an independent minimal generator of $u \in V$, and let X be a non-empty subset of A_u . By Lemma 18, there exists $v \in V$ such that X is a minimal generator for v , which implies $v \in \phi(X)$.

To prove that X is the unique minimum subset of A_u such that $v \in \phi(X)$, we show that for any $Y \subseteq A_u$ such that $X \not\subseteq Y$, $v \in \phi(Y)$ cannot hold. Consider $Y \subseteq A_u$ with $X \not\subseteq Y$ and suppose that $v \in \phi(Y)$. Note that Y must exist, as the empty set is always a possible choice. Since $v \in \phi(X)$, we have $v \in \phi(X) \cap \phi(Y)$. Furthermore, $\phi(X \cap Y) \subset \phi(X)$ as $X \cap Y \subset X$ and $\phi(X \cap Y) \cap A_u = X \cap Y$ by Proposition 22. Moreover, A_u is independent, so that $\phi(X) \cap \phi(Y) = \phi(X \cap Y)$. Hence, $v \in \phi(X \cap Y) \subset \phi(X)$, a contradiction with X being a minimal generator of v . \square

Hence, when A_v is independent, each non-empty subset X of A_v is the unique minimal generator of some u being included in A_v . As a consequence, we obtain the following theorem.

THEOREM 26. *Let \mathcal{C} be a biatomic atomistic closure system. If for any $u \in V$ and any minimal generator A_u of u , A_u is independent, then $\text{cc}(\mathcal{C}) \leq \lceil \log_2(|V| + 1) \rceil$.*

Proof. Let A_u be a minimal generator of for some $u \in V$ such that $\text{cc}(\mathcal{C}) = |A_u|$. As A_u is a minimal generator, $\phi(X) \neq \phi(Y)$ for any distinct $X, Y \subseteq A_u$, due to Proposition 22. Furthermore, A_u is independent by assumption. Thus, by Lemma 19, for each non-empty subset of X , there exists $v \in V$ such that X is the unique minimum subset of A_u with $v \in \phi(X)$. Consequently, V must contain at least $2^{|A_u|} - 1$ elements in order to cover each non-empty subset of A_u , that is $2^{|A_u|} - 1 \leq |V|$, which can be rewritten as $|A_u| = \text{cc}(\mathcal{C}) \leq \lceil \log_2(|V| + 1) \rceil$ as required. \square

Thus, combining Theorem 26 with Theorem 25, we obtain the following corollary.

COROLLARY 14. *The problem ELP-P(α) can be solved in output-quasipolynomial time in standard atomistic modular closure systems.*

Proof. It is known that atomistic modular closure systems are biatomic and satisfies the independence condition [Ben87, Grä11]. Applying Theorem 25, the corollary follows. \square

Remark 12. In Theorem 25, the upper bound on $\text{cc}(\mathcal{C})$ is $\log_2(|V|)$ while it is $\log_2(|V|) + 1$ in Theorem 26. This problem can be bypassed by adding element v to V without changing Σ or by adding V to \mathcal{M} . Similarly, \mathcal{F} is unchanged. The lower-preferred closed sets of \mathcal{C} w.r.t. \mathcal{F} are just augmented with v . Let \mathcal{C}' be the closure system over $V' = V \cup \{v\}$. Then, $\mathcal{C} \leq \log_2(|V'|)$ as needed.

Remark 13. For atomistic modular closure systems, the connection between the size of V and the Carathéodory number may also be derived from counting arguments on subspaces of vector spaces [Wil96]. Yet, our argument applies beyond atomistic modular lattices: it can be applied for instance to the family of convex subsets of a poset or to the family of monophonically convex subsets of a chordal graph as both these closure systems are biatomic, atomistic and have Carathéodory number 2.

3.5. Discussions and open problems

In this chapter, we have been giving intractability results for the problem ELP-P(α) beyond distributivity (see Figure 3.10). Yet, some cases are left open, whence our first question.

Question 5. *What is the complexity of ELP-P(α) in modular and extremal closure systems ?*

As for the modular case, two research tracks seem worth a try for further investigations. First, Wild shows in [Wil00] that the biatomicity of atomistic modular lattices naturally extends to modular lattices in general. The condition is rather based on join-irreducible elements than atoms of the closure system. Whether the independence condition also extends to this set-up remains unknown to our knowledge. Another way to tackle the modular case would be to use the fact that every modular lattice is obtained by gluing its maximal atomistic intervals [Grä11].

Showing that a minimal generator refines to a minimal generator of larger size in an atomistic interval would solve the problem.

Thinking about extremal closure systems, Markowsky shows in [Mar92] that every lattice can be embedded as a sublattice of an extremal lattice. His reduction is based on the bipartite graph of meet-irreducible elements. Showing that his strategy can be adapted to $\text{ELP-P}(\alpha)$ in polynomial time, especially for implications, would answer the question for this class.

More generally, we have proved that $\text{ELP-P}(\alpha)$ is untractable in lower-bounded closure systems, and equivalent to $\text{LDUAL}(\alpha)$ in acyclic convex geometries. If we connect this result to the translation task in acyclic convex geometries, the following problem is intriguing.

Question 6. *What is the exact complexity of $\text{ELP-P}(\alpha)$ in acyclic convex geometries?*

On the positive side, we have showed that the Carathéodory number is a parameter of interest for the tractability of $\text{ELP-P}(\alpha)$ (see Theorems 24 and 25). Moreover, Hirai et al. [HO18, HN20] give a characterization of the cases where $\text{ELP-P}(\alpha)$ reduces to the enumeration of the maximal independent sets of a graph. However, their characterization relies on both the closure system and the family of forbidden pairs. Therefore, we conclude with the next question.

Question 7. *Characterize those closure systems where the problem $\text{ELP-P}(\alpha)$ reduces to the enumeration of maximal independent sets of a graph for every family of forbidden pairs.*

Conclusion and perspectives

In this thesis, we faced two problems on closure systems represented by implications or meet-irreducible elements.

First, we investigated the task of translating between these two representations. We introduced a hierarchical decomposition of an implicational base by *splits* and showed that this decomposition can be conducted in polynomial time (Theorem 8). Focusing on *acyclic* splits, we studied the associated decomposition of the underlying closure system (Theorem 10), and we deduced a recursive characterization of its meet-irreducible elements (Theorem 11). Using this decomposition, we further highlighted the intimate connection between the translation problem and the dualization in lattices (see Theorem 12), which is a notably hard problem [BK17, DN20]. On the positive side, we combined this decomposition and the algorithm of Fredman and Khachiyan for hypergraph dualization [FK96] to identify new particular cases of acyclic convex geometries where translating can be conducted in output-quasipolynomial time (Section 2.4). Yet, the complexity of the problem in acyclic convex geometries (and in general!) remains unsettled, which leads to the main open question of Chapter 2 which we recall here.

Question 8. *Can CCM and SID be solved in output-quasipolynomial time in acyclic convex geometries?*

The second problem we studied relates to closure systems where some sets are forbidden as subsets or supersets. Here, the objective was to list the closed sets that are admissible or preferred (among admissible ones, the minimal or the maximal) with respect to a family of forbidden sets. Again, the dualization in lattices played a key role in the elaboration of numerous hardness results (see *e.g.* the hierarchy of Figure 3.10). Nonetheless, taking advantage of the Carathéodory number [KLS12], and other results rooted in lattice theory [BMN17, GN81, Bor86, Mar92], we devised output-polynomial and output-quasipolynomial time algorithms for particular cases of these problems (see for instance Theorems 7, 5, 17 and Corollary 13). Still, some questions stated in the conclusion of Chapter 3, are waiting to be solved and motivate future work. Among them, the following is perhaps the most intriguing.

Question 9. *Characterize those closure systems where the problem ELP-P(α) reduces to the enumeration of maximal independent sets of a graph for every family of forbidden pairs.*

As mentioned in Chapter 1, Section 1.6, all these results directly apply to Knowledge Space Theory. As such, answering these questions would help the development of this theory and its real life applications.

Our journey in the fascinating world of closure systems and lattices now reaches its end. In the course of this thesis, we have been connecting together problems, motivations, results,

and algorithms from several fields of computer science. This blend witnesses the ubiquity of closure systems and hence the importance of studying these beautiful structures.

Publications

All the results of this thesis have been obtained with Lhouari Nourine. They have led to submissions and publications in international journals, workshops and conferences. Most of the results given in Chapter 2 were presented at the conference ICTCS 2020 [NV20b] and the workshop FCA4AI 2020 [NV20a]. They are also a generalization of a first contribution published in the journal *Discrete Mathematics* [DNV21] with Oscar Defrain. Chapter 3 is an extension of the contribution [NV21] presented at the conference ICFCA 2021.

In addition, a joint work with Lhouari Nourine and Jean-Marc Petit [NPV19] must be mentioned. It has been accepted for communication at BDA'21 and is currently under review in the *Journal of Computer and System Sciences*. This contribution introduces a lattice-based framework for handling the equality in databases with inconsistencies and null values. Given a relation, each attribute is equipped with a comparability functions which maps every pair of values of the domain to a truth value in a truth lattice. Combining comparability functions, each pair of tuples of the relation is assigned a truth value measuring their similarity in the product of truth lattices. Then, $\{0, 1\}$ -interpretations of each truth lattice lay the ground for several semantic for equality. In this framework, we study abstract functional dependencies, and particular interpretations called *realities* for they preserve the semantic of classical functional dependencies. We also study the problems of deciding whether there exists a reality in which a functional dependency holds, or whether it holds in each possible reality.

Bibliography

- [ADS86] Giorgio Ausiello, Alessandro D’Atri, and Domenico Sacca. Minimal representation of directed hypergraphs. *SIAM Journal on Computing*, 15(2):418–431, 1986.
- [AGT03] Kira V. Adaricheva, Viktor A. Gorbunov, and V. I. Tumanov. Join-semidistributive lattices and convex geometries. *Advances in Mathematics*, 173(1):1–49, 2003.
- [AIKBT14] Kira V. Adaricheva, Giuseppe F. Italiano, Hans Kleine Büning, and György Turán. Horn formulas, directed hypergraphs, lattices and closure systems: Related formalisms and applications (Dagstuhl Seminar 14201). In *Dagstuhl Reports*, volume 4. Schloss Dagstuhl-Leibniz-Zentrum fuer Informatik, 2014.
- [AL17] Giorgio Ausiello and Luigi Laura. Directed hypergraphs: Introduction and fundamental algorithms—a survey. *Theoretical Computer Science*, 658:293–306, 2017.
- [ALE] ALEKS. Web site. <https://www.aleks.com/>. Accessed: 2021-September-20.
- [AN14] Kira V. Adaricheva and James B. Nation. On implicational bases of closure systems with unique critical sets. *Discrete Applied Mathematics*, 162:51–69, 2014.
- [AN17] Kira V. Adaricheva and James B. Nation. Discovery of the D-basis in binary tables based on hypergraph dualization. *Theoretical Computer Science*, 658:307–315, 2017.
- [ANR13] Kira V. Adaricheva, James B. Nation, and Robert Rand. Ordered direct implicational basis of a finite closure system. *Discrete Applied Mathematics*, 161(6):707–723, 2013.
- [AOS12] Federico Ardila, Megan Owen, and Seth Sullivant. Geodesics in CAT(0) cubical complexes. *Advances in Applied Mathematics*, 48(1):142–163, 2012.
- [Ava61] S. P. Avann. Application of the join-irreducible excess function to semi-modular lattices. *Mathematische Annalen*, 142(4):345–354, 1961.
- [BB79] Catriel Beeri and Philip A. Bernstein. Computational problems related to the design of normal form relational schemas. *ACM Transactions on Database Systems (TODS)*, 4(1):30–59, 1979.
- [BB85] Garrett Birkhoff and Mary K. Bennett. The convexity lattice of a poset. *Order—a Journal On The Theory of Ordered Sets and Its Applications*, 2(3):223–242, 1985.

- [BC93] Jean-Pierre Barthélemy and Julien Constantin. Median graphs, parallelism and posets. *Discrete mathematics*, 111(1-3):49–63, 1993.
- [BC02] Karell Bertet and Nathalie Caspard. Doubling convex sets in lattices: Characterizations and recognition algorithms. *Order—a Journal On The Theory of Ordered Sets and Its Applications*, 19(2):181–207, 2002.
- [BDVG18] Karell Bertet, Christophe Demko, Jean-François Viaud, and Clément Guérin. Lattices, closures systems and implication bases: A survey of structural aspects and algorithms. *Theoretical Computer Science*, 743:93–109, 2018.
- [BEGK04] Endre Boros, Khaled M. Elbassioni, Vladimir Gurvich, and Leonid Khachiyan. Generating maximal independent sets for hypergraphs with bounded edge-intersections. In *Latin American Symposium on Theoretical Informatics*, pages 488–498. Springer, 2004.
- [Ben87] Mary K. Bennett. Biatomic lattices. *Algebra Universalis*, 24(1-2):60–73, 1987.
- [Ber84] Claude Berge. *Hypergraphs: Combinatorics of Finite Sets*, volume 45. Elsevier, 1984.
- [BI95] Jan C. Bioch and Toshihide Ibaraki. Complexity of identification and dualization of positive Boolean functions. *Information and Computation*, 123(1):50–63, 1995.
- [Bir37] Garrett Birkhoff. Rings of sets. *Duke Mathematical Journal*, 3(3):443–454, 1937.
- [Bir40] Garrett Birkhoff. *Lattice Theory*, volume 25. American Mathematical Soc., 1940.
- [BK10] Mikhail A. Babin and Sergei O. Kuznetsov. Recognizing pseudo-intents is coNP-complete. In *CLA*, pages 294–301, 2010.
- [BK13] Mikhail A. Babin and Sergei O. Kuznetsov. Computing premises of a minimal cover of functional dependencies is intractable. *Discrete Applied Mathematics*, 161(6):742–749, 2013.
- [BK17] Mikhail A. Babin and Sergei O. Kuznetsov. Dualization in lattices given by ordered sets of irreducibles. *Theoretical Computer Science*, 658:316–326, 2017.
- [BM70] Marc Barbut and Bernard Monjardet. *Ordre et classification*, vols. 1 and 2. *Hachette, Paris, France*, 1970.
- [BM10] Karell Bertet and Bernard Monjardet. The multiple facets of the canonical direct unit implicational basis. *Theoretical Computer Science*, 411(22-24):2155–2166, 2010.
- [BMN17] Laurent Beaudou, Arnaud Mary, and Lhouari Nourine. Algorithms for k-meet-semidistributive lattices. *Theoretical Computer Science*, 658:391–398, 2017.

- [BO14] Konstantin Bazhanov and Sergei A. Obiedkov. Optimizations in computing the Duquenne–Guigues basis of implications. *Annals of mathematics and artificial intelligence*, 70(1):5–24, 2014.
- [Boo54] George Boole. *An Investigation of the Laws of Thought: On Which Are Founded the Mathematical Theories of Logic and Probabilities*, volume 2. Walton and Maberly, 1854.
- [Bor86] Jean-Paul Bordat. Calcul pratique du treillis de Galois d’une correspondance. *Mathématiques et Sciences humaines*, 96:31–47, 1986.
- [Che12] Victor Chepoi. Nice labeling problem for event structures: A counterexample. *SIAM Journal on Computing*, 41(4):715–727, 2012.
- [CM03] Nathalie Caspard and Bernard Monjardet. The lattices of closure systems, closure operators, and implicational systems on a finite set: A survey. *Discrete Applied Mathematics*, 127(2):241–269, 2003.
- [Das16] Sanjoy Dasgupta. A cost function for similarity-based hierarchical clustering. In *Proceedings of the Forty-Eighth Annual ACM Symposium on Theory of Computing*, pages 118–127, 2016.
- [Day70] Alan Day. A simple solution to the word problem for lattices. *Canadian Mathematical Bulletin*, 13(2):253–254, 1970.
- [Day92] Alan Day. The lattice theory of functional dependencies and normal decompositions. *International Journal of Algebra and Computation*, 2(4):409–432, 1992.
- [DBF⁺20] Christophe Demko, Karell Bertet, Cyril Faucher, Jean-François Viaud, and Sergei O. Kuznetsov. NextPriorityConcept: A new and generic algorithm computing concepts from complex and heterogeneous data. *Theoretical Computer Science*, 845:1–20, 2020.
- [DC60] Robert P. Dilworth and Peter Crawley. Decomposition theory for lattices without chain conditions. *Transactions of the American Mathematical Society*, 96(1):1–22, 1960.
- [DDLW15] Paul E. Dunne, Wolfgang Dvořák, Thomas Linsbichler, and Stefan Woltran. Characteristics of multiple viewpoints in abstract argumentation. *Artificial Intelligence*, 228:153–178, 2015.
- [Ded97] Richard Dedekind. über Zerlegungen von Zahlen durch ihre grössten gemeinsamen Theiler. In *Fest-Schrift Der Herzoglichen Technischen Hochschule Carolo-Wilhelmina*, pages 1–40. Springer, 1897.
- [Ded00] Richard Dedekind. über die von drei Moduln erzeugte Dualgruppe. *Mathematische Annalen*, 53(3):371–403, 1900.

- [DF85] Jean-Paul Doignon and Jean-Claude Falmagne. Spaces for the assessment of knowledge. *International journal of man-machine studies*, 23(2):175–196, 1985.
- [DF12] Jean-Paul Doignon and Jean-Claude Falmagne. *Knowledge Spaces*. Springer Science & Business Media, 2012.
- [Die87] Brenda L. Dietrich. A circuit set characterization of antimatroids. *Journal of Combinatorial Theory, Series B*, 43(3):314–321, 1987.
- [DN20] Oscar Defrain and Lhouari Nourine. Dualization in lattices given by implicational bases. *Theoretical Computer Science*, 814:169–176, 2020.
- [DNU21] Oscar Defrain, Lhouari Nourine, and Takeaki Uno. On the dualization in distributive lattices and related problems. *Discrete Applied Mathematics*, 300:85–96, 2021.
- [DNV21] Oscar Defrain, Lhouari Nourine, and Simon Vilmin. Translating between the representations of a ranked convex geometry. *Discrete Mathematics*, 344(7):112399, 2021.
- [DP02] Brian A. Davey and Hilary A. Priestley. *Introduction to Lattices and Order*. Cambridge university press, 2002.
- [DPR75] Brian A. Davey, Werner Poguntke, and Ivan Rival. A characterization of semi-distributivity. *Algebra Universalis*, 5(1):72–75, 1975.
- [DS11] Felix Distel and Barış Sertkaya. On the complexity of enumerating pseudo-intents. *Discrete Applied Mathematics*, 159(6):450–466, 2011.
- [DT96] Yannis Dimopoulos and Alberto Torres. Graph theoretical structures in logic programs and default theories. *Theoretical Computer Science*, 170(1-2):209–244, 1996.
- [Dun95] Phan Minh Dung. On the acceptability of arguments and its fundamental role in nonmonotonic reasoning, logic programming and n-person games. *Artificial intelligence*, 77(2):321–357, 1995.
- [EG95] Thomas Eiter and Georg Gottlob. Identifying the minimal transversals of a hypergraph and related problems. *SIAM Journal on Computing*, 24(6):1278–1304, 1995.
- [EGM03] Thomas Eiter, Georg Gottlob, and Kazuhisa Makino. New results on monotone dualization and generating hypergraph transversals. *SIAM Journal on Computing*, 32(2):514–537, 2003.
- [EJ85] Paul H. Edelman and Robert E. Jamison. The theory of convex geometries. *Geometriae dedicata*, 19(3):247–270, 1985.

- [Elb20] Khaled M. Elbassioni. On dualization over distributive lattices. *arXiv preprint arXiv:2006.15337*, 2020.
- [EMG08] Thomas Eiter, Kazuhisa Makino, and Georg Gottlob. Computational aspects of monotone dualization: A brief survey. *Discrete Applied Mathematics*, 156(11):2035–2049, 2008.
- [ENR21] Mohammed Elaroussi, Lhouari Nourine, and Mohammed Radjef. Lattice point of view for argumentation framework. 2021.
- [FD10] Jean-Claude Falmagne and Jean-Paul Doignon. *Learning Spaces: Interdisciplinary Applied Mathematics*. Springer Science & Business Media, 2010.
- [FJ86] Martin Farber and Robert E. Jamison. Convexity in graphs and hypergraphs. *SIAM Journal on Algebraic Discrete Methods*, 7(3):433–444, 1986.
- [FJN95] Ralph Freese, Jaroslav Ježek, and James B. Nation. *Free Lattices*, volume 42. American Mathematical Soc., 1995.
- [FK96] Michael L. Fredman and Leonid Khachiyan. On the complexity of dualization of monotone disjunctive normal forms. *Journal of Algorithms*, 21(3):618–628, 1996.
- [GD86] Jean-Louis Guigues and Vincent Duquenne. Familles minimales d’implications informatives résultant d’un tableau de données binaires. *Mathématiques et Sciences humaines*, 95:5–18, 1986.
- [GLPN93] Giorgio Gallo, Giustino Longo, Stefano Pallottino, and Sang Nguyen. Directed hypergraphs and applications. *Discrete applied mathematics*, 42(2-3):177–201, 1993.
- [GN81] H. S. Gaskill and James B. Nation. Join-prime elements in semidistributive lattices. *algebra universalis*, 12(1):352–359, 1981.
- [Grä02] George A. Grätzer. *General Lattice Theory*. Springer Science & Business Media, 2002.
- [Grä11] George A. Grätzer. *Lattice Theory: Foundation*. Springer Science & Business Media, 2011.
- [GW12] Bernhard Ganter and Rudolf Wille. *Formal Concept Analysis: Mathematical Foundations*. Springer Science & Business Media, 2012.
- [GW16] George A. Grätzer and Friedrich Wehrung. *Lattice Theory: Special Topics and Applications (Vol. 2)*. Springer, 2016.
- [GWBP17] Bernhard Ganter, Rudolf Wille, Daniel Borchmann, and Juliane Prochaska. Implications and dependencies between attributes. In *International Conference on Formal Concept Analysis*, pages 23–35. Springer, 2017.

- [HK95] Peter L. Hammer and Alexander Kogan. Quasi-acyclic propositional Horn knowledge bases: Optimal compression. *IEEE Transactions on knowledge and data engineering*, 7(5):751–762, 1995.
- [HN18] Michel Habib and Lhouari Nourine. Representation of lattices via set-colored posets. *Discrete Applied Mathematics*, 249:64–73, 2018.
- [HN20] Hiroshi Hirai and So Nakashima. A compact representation for modular semilattices and its applications. *Order-a Journal On The Theory of Ordered Sets and Its Applications*, 37(3):479–507, 2020.
- [HO18] Hiroshi Hirai and Taihei Oki. A compact representation for minimizers of k -submodular functions. *Journal of Combinatorial Optimization*, 36(3):709–741, 2018.
- [HPR94] Christian Herrmann, Douglas Pickering, and Michael Roddy. A geometric description of modular lattices. *Algebra Universalis*, 31(3):365–396, 1994.
- [HW96] Christian Herrmann and Marcel Wild. A polynomial algorithm for testing congruence modularity. *International Journal of Algebra and Computation*, 6(4):379–388, 1996.
- [JYP88] David S Johnson, Mihalis Yannakakis, and Christos H Papadimitriou. On generating all maximal independent sets. *Information Processing Letters*, 27(3):119–123, 1988.
- [KBEG07] Leonid Khachiyan, Endre Boros, Khaled M. Elbassioni, and Vladimir Gurvich. On the dualization of hypergraphs with bounded edge-intersections and other related classes of hypergraphs. *Theoretical computer science*, 382(2):139–150, 2007.
- [Kha95] Roni Khardon. Translating between Horn representations and their characteristic models. *Journal of Artificial Intelligence Research*, 3:349–372, 1995.
- [KKP18] Mamadou M. Kanté, Kaveh Khoshkhan, and Mozghan Pourmoradnasseri. Enumerating minimal transversals of hypergraphs without small holes. In *43rd International Symposium on Mathematical Foundations of Computer Science (MFCS 2018)*. Schloss Dagstuhl-Leibniz-Zentrum fuer Informatik, 2018.
- [KKS93] Henry A. Kautz, Michael J. Kearns, and Bart Selman. Reasoning with characteristic models. In *AAAI*, volume 93, pages 34–39. Citeseer, 1993.
- [KLMN14] Mamadou Moustapha Kanté, Vincent Limouzy, Arnaud Mary, and Lhouari Nourine. On the enumeration of minimal dominating sets and related notions. *SIAM Journal on Discrete Mathematics*, 28(4):1916–1929, 2014.
- [KLS12] Bernhard Korte, László Lovász, and Rainer Schrader. *Greedoids*, volume 4. Springer Science & Business Media, 2012.

- [KN10] Kenji Kashiwabara and Masataka Nakamura. Characterizations of the convex geometries arising from the double shellings of posets. *Discrete mathematics*, 310(15-16):2100–2112, 2010.
- [KO02] Sergei O. Kuznetsov and Sergei A. Obiedkov. Comparing performance of algorithms for generating concept lattices. *Journal of Experimental & Theoretical Artificial Intelligence*, 14(2-3):189–216, 2002.
- [Kos99] Gleb A. Koshevoy. Choice functions and abstract convex geometries. *Mathematical social sciences*, 38(1):35–44, 1999.
- [KSS00] Dimitris J. Kavvadias, Martha Sideri, and Elias C. Stavropoulos. Generating all maximal models of a Boolean expression. *Information Processing Letters*, 74(3-4):157–162, 2000.
- [Kun85] Joseph P. Kung. Matchings and Radon transforms in lattices. I. Consistent lattices. *Order—a Journal On The Theory of Ordered Sets and Its Applications*, 2(2):105–112, 1985.
- [Kuz96] Sergei O. Kuznetsov. Mathematical aspects of concept analysis. *Journal of Mathematical Sciences*, 80(2):1654–1698, 1996.
- [Kuz04] Sergei O. Kuznetsov. On the intractability of computing the duquenne-guigues base. *Journal of Universal Computer Science*, 10(8):927–933, 2004.
- [Lib93] Leonid Libkin. Direct product decompositions of lattices, closures and relation schemes. *Discrete Mathematics*, 112(1-3):119–138, 1993.
- [LLRK80] Eugene L. Lawler, Jan K. Lenstra, and AHG Rinnooy Kan. Generating all maximal independent sets: NP-hardness and polynomial-time algorithms. *SIAM Journal on Computing*, 9(3):558–565, 1980.
- [LO78] Claudio L. Lucchesi and Sylvia L. Osborn. Candidate keys for relations. *Journal of Computer and System Sciences*, 17(2):270–279, 1978.
- [Mai80] David Maier. Minimum covers in relational database model. *Journal of the ACM (JACM)*, 27(4):664–674, 1980.
- [Mai83] David Maier. *Theory of Relational Databases*. Computer Science Pr, 1983.
- [Mar75] George Markowsky. The factorization and representation of lattices. *Transactions of the American Mathematical Society*, 203:185–200, 1975.
- [Mar92] George Markowsky. Primes, irreducibles and extremal lattices. *Order—a Journal On The Theory of Ordered Sets and Its Applications*, 9(3):265–290, 1992.
- [Mon85] Bernard Monjardet. A use for frequently rediscovering a concept. *Order—a Journal On The Theory of Ordered Sets and Its Applications*, 1(4):415–417, 1985.

- [Moo09] Eliakim Hastings Moore. *On a Form of General Analysis with Applications to Linear Differential and Integral Equations*. Tipografia della R. Accademia dei Lincei, proprietà del cav. V. Salviucci, 1909.
- [MR92] Heikki Mannila and Kari-Jouko Rähkä. *The Design of Relational Databases*. Addison-Wesley Longman Publishing Co., Inc., 1992.
- [MR94] Heikki Mannila and Kari-Jouko Rähkä. Algorithms for inferring functional dependencies from relations. *Data & Knowledge Engineering*, 12(1):83–99, 1994.
- [MR01] Bernard Monjardet and Vololonirina Raderanirina. The duality between the anti-exchange closure operators and the path independent choice operators on a finite set. *Mathematical Social Sciences*, 41(2):131–150, 2001.
- [MRS02] Filippo Mignosi, Antonio Restivo, and Marinella Sciortino. Words and forbidden factors. *Theoretical Computer Science*, 273(1-2):99–117, 2002.
- [Nat00] James Bryant Nation. Unbounded semidistributive lattices. *Algebra and Logic*, 39(1):50–53, 2000.
- [NPV19] Lhouari Nourine, Jean Marc Petit, and Simon Vilmin. Towards declarative comparabilities: Application to functional dependencies. *arXiv preprint arXiv:1909.12656*, 2019.
- [NPW81] Mogens Nielsen, Gordon Plotkin, and Glynn Winskel. Petri nets, event structures and domains, part I. *Theoretical Computer Science*, 13(1):85–108, 1981.
- [NR99] Lhouari Nourine and Olivier Raynaud. A fast algorithm for building lattices. *Information processing letters*, 71(5-6):199–204, 1999.
- [NV20a] Lhouari Nourine and Simon Vilmin. Dihypergraph decomposition: Application to closure system representations. In *Eighth International Workshop "What Can FCA Do for Artificial Intelligence?" (FCA4AI at ECAI 2020)*, page 31, 2020.
- [NV20b] Lhouari Nourine and Simon Vilmin. Hierarchical decompositions of dihypergraphs. In *21st Italian Conference on Theoretical Computer Science (ICTCS 2021)*, 2020.
- [NV21] Lhouari Nourine and Simon Vilmin. Enumerating maximal consistent closed sets in closure systems. In *International Conference on Formal Concept Analysis*, pages 57–73. Springer, 2021.
- [OD07] Sergei A. Obiedkov and Vincent Duquenne. Attribute-incremental construction of the canonical implication basis. *Annals of Mathematics and Artificial Intelligence*, 49(1):77–99, 2007.
- [Rot97] Gian-Carlo Rota. The many lives of lattice theory. *Notices of the AMS*, 44(11):1440–1445, 1997.

- [Sch97] Markus W. Schäffter. Scheduling with forbidden sets. *Discrete Applied Mathematics*, 72(1-2):155–166, 1997.
- [Sho86] Robert C. Shock. Computing the minimum cover of functional dependencies. *Information Processing Letters*, 22(3):157–159, 1986.
- [Ste99] Manfred Stern. *Semimodular Lattices: Theory and Applications*, volume 73. Cambridge University Press, 1999.
- [Str19] Yann Strozecki. Enumeration complexity. *Bulletin of EATCS*, 3(129), 2019.
- [SU05] Frederik Stork and Marc Uetz. On the generation of circuits and minimal forbidden sets. *Mathematical programming*, 102(1):185–203, 2005.
- [Thi86] Vu Duc Thi. Minimal keys and-antikeys. *Acta Cybernetica*, 7(4):361–371, 1986.
- [TIAS77] Shuji Tsukiyama, Mikio Ide, Hiromu Ariyoshi, and Isao Shirakawa. A new algorithm for generating all the maximal independent sets. *SIAM Journal on Computing*, 6(3):505–517, 1977.
- [TVL84] Robert E. Tarjan and Jan Van Leeuwen. Worst-case analysis of set union algorithms. *Journal of the ACM (JACM)*, 31(2):245–281, 1984.
- [Whi92] Neil M. White. *Matroid Applications*, volume 40. Cambridge University Press, 1992.
- [Wil94] Marcel Wild. A theory of finite closure spaces based on implications. *Advances in Mathematics*, 108(1):118–139, 1994.
- [Wil95] Marcel Wild. Computations with finite closure systems and implications. In *International Computing and Combinatorics Conference*, pages 111–120. Springer, 1995.
- [Wil96] Marcel Wild. The minimal number of join irreducibles of a finite modular lattice. *algebra universalis*, 35(1):113–123, 1996.
- [Wil00] Marcel Wild. Optimal implicational bases for finite modular lattices. *Quaestiones Mathematicae*, 23(2):153–161, 2000.
- [Wil17] Marcel Wild. The joy of implications, aka pure Horn formulas: Mainly a survey. *Theoretical Computer Science*, 658:264–292, 2017.
- [Zan15] Bruno Zanuttini. Sur des propriétés structurelles des formules de horn. In *9es Journées d’Intelligence Artificielle Fondamentale (IAF 2015)*, 2015.