



**HAL**  
open science

# Study of the evolutionary dynamics of plant beneficial bacteria

Benjamin Dupont

► **To cite this version:**

Benjamin Dupont. Study of the evolutionary dynamics of plant beneficial bacteria. General Mathematics [math.GM]. Université de Lyon, 2020. English. NNT : 2020LYSE1241 . tel-03610806

**HAL Id: tel-03610806**

**<https://theses.hal.science/tel-03610806>**

Submitted on 16 Mar 2022

**HAL** is a multi-disciplinary open access archive for the deposit and dissemination of scientific research documents, whether they are published or not. The documents may come from teaching and research institutions in France or abroad, or from public or private research centers.

L'archive ouverte pluridisciplinaire **HAL**, est destinée au dépôt et à la diffusion de documents scientifiques de niveau recherche, publiés ou non, émanant des établissements d'enseignement et de recherche français ou étrangers, des laboratoires publics ou privés.



N°d'ordre NNT : **2020LYSE1241**

## **THESE de DOCTORAT DE L'UNIVERSITE DE LYON**

opérée au sein de  
**l'Université Claude Bernard Lyon 1**

**Ecole Doctorale** Infomaths (ED 512)

**Spécialité de doctorat** : Mathématiques

Soutenue publiquement le 20/11/2020, par:  
**Benjamin Dupont**

---

# **Réécriture modulo dans les catégories diagrammatiques**

---

Devant le jury composé de :

|                      |                                  |                       |
|----------------------|----------------------------------|-----------------------|
| Dotsenko, Vladimir   | (Université de Strasbourg)       | Examineur             |
| Elias, Ben           | (University of Oregon)           | Rapporteur            |
| Gaussent, Stéphane   | (Université Jean-Monnet)         | Co-directeur de thèse |
| Licata, Anthony      | (Australian National University) | Rapporteur            |
| Malbos, Philippe     | (Université Lyon 1)              | Directeur de thèse    |
| Millet Florence      | (Université Jean-Monnet)         | Membre invitée        |
| Ressayre, Nicolas    | (Université Lyon 1)              | Président du jury     |
| Savage Alistair      | (University of Ottawa)           | Co-directeur de thèse |
| Van Raamsdonk, Femke | (University of Amsterdam)        | Examinatrice          |
| Varagnolo Michela    | (Université de Cergy-Pontoise)   | Membre invitée        |

# Réécriture modulo dans les catégories diagrammatiques



**Benjamin DUPONT**

Thèse de doctorat



Université Claude Bernard Lyon 1  
École doctorale InfoMaths (ED 512)  
Spécialité: Mathématiques  
N°. d'ordre: 2018LYSE1262

# Réécriture modulo dans les catégories diagrammatiques

Thèse présentée en vue d'obtenir le diplôme de  
Doctorat de l'Université de Lyon

soutenue publiquement le 20 Novembre 2020 par  
Benjamin Dupont

devant le jury composé de:

|                     |                                  |                       |
|---------------------|----------------------------------|-----------------------|
| Vladimir Dotsenko   | (Université de Strasbourg)       | Examineur             |
| Ben Elias           | (University of Oregon)           | Rapporteur            |
| Stéphane Gaussent   | (Université Jean-Monnet)         | Co-directeur de thèse |
| Anthony Licata      | (Australian National University) | Rapporteur            |
| Philippe Malbos     | (Université Lyon 1)              | Directeur de thèse    |
| Florence Millet     | (Université Jean-Monnet)         | Membre invitée        |
| Nicolas Ressayre    | (Université Lyon 1)              | Examineur             |
| Alistair Savage     | (University of Ottawa)           | Co-directeur de thèse |
| Femke van Raamsdonk | (University of Amsterdam)        | Examinatrice          |
| Michela Varagnolo   | (Université de Cergy-Pontoise)   | Membre invitée        |



# Remerciements

Je voudrais tout d'abord naturellement remercier mes directeurs de thèse locaux, Philippe Malbos et Stéphane Gaussent. Je les remercie en premier lieu de m'avoir initié à ce sujet de recherche novateur et enrichissant, ainsi que de m'avoir permis d'allier les aspects réécriture et théorie des représentations qui me tenaient à coeur lors de mon stage de Master. Je voudrais également les remercier énormément pour tout le temps qu'ils ont pu m'accorder au cours de ces 3 ans, que ce soit à travailler sur divers projets, à discuter de mes questionnements mathématiques ou tout simplement à relire les divers travaux que je leur envoyais et à me conseiller sur les résultats mathématiques et la rédaction. Merci particulièrement pour avoir su m'apprendre les nombreuses valeurs nécessaires à la recherche, à savoir patience, volonté à toute épreuve ainsi que l'attention particulière pour rédiger un article correctement, et présenter le meilleur dossier possible. Merci également de m'avoir permis d'enrichir grandement mes connaissances en me permettant de pouvoir assister à de nombreuses conférences.

Je voudrais également grandement remercier Alistair Savage, à qui j'ai eu la chance de rendre visite à Ottawa pendant 3 mois, et qui a su m'ouvrir vers de nouvelles perspectives de recherche et répondre à mes interrogations mathématiques. Merci énormément pour ce temps sacrifié pour moi lors de mes visites au Canada, qui m'a permis d'apprendre beaucoup de nouvelles choses.

Merci également à Ben Elias et Anthony Licata, pour avoir accepté de reviewer ce manuscrit malgré les circonstances exceptionnelles de la période et les diverses contraintes d'organisation, ainsi qu'à tous les autres membres du jury Vladimir Dotsenko, Florence Millet, Nicolas Ressayre, Michela Varagnolo et Femke van Raamsdonk pour avoir accepté d'en faire partie.

Mes remerciements suivants sont destinés à celles et ceux avec qui j'ai eu la chance de partager ces 3 années de doctorat. Je voudrais tout d'abord remercier tout le monde avec qui j'ai partagé mon bureau, principalement le 243 où j'aurais passé la plupart du temps: Benoit (même si on n'a finalement pas été longtemps dans le même bureau) pour ta sympathie et la dose d'humour que tu réussissais à apporter à chacune de nos conversations, et aussi parce que c'était agréable de se comprendre entre ardennais, Caterina pour ton enthousiasme à toute épreuve et ta capacité à ne toujours garder que le positif de toutes les situations, Dimitri pour ta gentillesse en général et nos nombreuses discussions à relativiser sur les espaces de Hilbert et les mathématiques, Tanessi pour ton attitude toujours optimiste, ainsi que Bin, Cheikh et Paul pour votre sympathie en général. Ce fut un plaisir de partager mon bureau avec vous tous tout au long des 3 années de thèse.

Je voudrais également remercier tous les autres doctorants et doctorantes de l'ICJ avec qui j'ai vécu cette épreuve tout au long des 3 ans. Merci tout d'abord à Uran, pour nos nombreuses discussions sur les aspects de la thèse et nos échanges mathématiques, ainsi que tous nos débats sur le sport. C'était un plaisir de pouvoir échanger et s'aérer l'esprit au quotidien durant la plus grande partie de la thèse autour d'un café ou d'une session Fifa, et merci de m'avoir aidé à surmonter les moments difficiles. Merci également à Marion, pour les nombreuses discussions en salle de rencontre et sur Discord à me remonter le moral et me booster en permanence. Merci également pour ta volonté à toute épreuve qui m'a beaucoup inspiré, et pour ton aide précieuse dans les diverses démarches qui ont accompagné la fin de la thèse. Merci David, pour le plaisir d'avoir partagé un TD mémorable avec toi et nos nombreuses discussions toujours très drôles. Merci également pour le fait d'être toujours présent et prêt à aider en toutes circonstances, ainsi que pour les parties de tennis rafraichissantes. Merci Antoine, pour tous les moments sympas ponctués d'anecdotes formidables, je regrette de ne jamais avoir assisté à une conférence avec toi. Merci Maxime, pour ta gentillesse lors de chacune de nos rencontres et ton humour toujours bienveillant. Merci Théo, pour ta sympathie depuis notre rencontre en Master, et pour nos nombreuses discussions sur des sujets divers. Merci Vincent pour ton optimisme permanent, pour nos quelques discussions sur des sports très intéressants et pour notre entraide durant la fin de la thèse et le confinement. Merci Gwladys pour ton sourire et ta gentillesse lors de chacune de nos discussions. Merci Benjamin C. pour ta sympathie, ta bienveillance et ton aide généreuse apportée durant les premières années de ma thèse. Merci Rémi pour nos diverses conversations ainsi que pour les participations actives au séminaire de probabilités discrètes durant les premières années. Merci Anatole pour nos conversations toujours très agréables, et pour ton aide lors de l'élaboration des khôlles ces derniers temps. Merci Kevin pour ton énergie

positive et ton sourire permanent, même lors des semaines délicates précédant la soutenance. C'est top de partager le nouveau bureau avec vous deux. Merci Mélanie pour ta sympathie, ainsi que pour ton aide dans l'élaboration d'une page web. Merci Octave et Marina, pour votre sympathie mais également pour tout le soutien que vous avez apporté aux doctorant.e.s du labo. Merci également à tous les autres avec qui je n'ai que malheureusement trop rarement échangé: Sam, Simon Z., Khanh, Daniel, Ariane, Khanh, Jiao, Tinxian, Simon A., Thomas G., Clément G., Quentin G., j'aurais dû aller à Domus plus souvent !

Je voudrais maintenant remercier tous les doctorants du laboratoire à Saint-Etienne, avec qui ce fût un plaisir d'échanger durant mon stage de Master ainsi que durant les groupes de travaux par la suite. Merci Auguste, pour nos échanges toujours très intéressants dans le train du retour, et surtout pour ta bonne humeur en général qui est très réconfortante. Tu mérites d'avoir obtenu ce poste. Merci Kenny, toutes ces sessions de groupes de travail n'auraient pas eu la même saveur sans tes blagues. Merci également pour les bons moments passés lors du trimestre à l'IHP, que ce soit au CIRM ou à Paris. Merci Farshid, pour ta joie de vivre, ton optimisme et pour nos nombreuses discussions enrichissantes, certes beaucoup autour du football. Merci Christopher pour ta gentillesse lors de chacun de nos échanges. J'en profite également pour remercier tous les permanents et permanentes de l'ICJ à Saint-Étienne pour leur accueil toujours très chaleureux: merci à Michael, Florence, Roland, Driss, Filippo, François.

Merci également à tous mes "frères" de thèse avec qui j'ai eu la chance de partager beaucoup de conférences et de beaucoup échanger. Merci Cyrille, depuis notre première rencontre dans le train en direction de HDRA, toutes nos conversations et rencontres lors de diverses conférences auront été très agréables. Même si je ne comprends pas ton aversion pour N. Djokovic, ta mémoire tennistique m'impressionne ! Merci Clément, pour m'avoir également initié à ce sujet de recherche qui me tient à coeur aujourd'hui, pour ta patience à m'expliquer tes articles. Merci également pour les bons moments passés à Marseille ou encore à Bonn. Merci Cameron, pour ta bonne humeur, ta gentillesse et ton attitude positive. C'est dommage que nous n'ayons finalement pas été beaucoup au même endroit au même moment, que ce soit à Lyon ou à Paris, mais j'espère que l'on aura l'occasion de rattraper ça ! Merci Nohra pour ta gentillesse, même si je n'ai pas eu la chance de te côtoyer beaucoup au final tous nos échanges auront été très positifs.

Je voudrais également remercier Gael, Zahra et Dinushi pour tous les bons moments passés à l'IHP, lorsqu'il était encore possible de se réunir avant le virus. Merci beaucoup à vous trois pour votre gentillesse extrême, et pour toutes les conversations marrantes lors des cocktails de conférences. Merci également à Étienne et Elena, ce fût un plaisir de passer en grande partie la première année de mon périple lyonnais avec vous durant le Master Recherche.

Mes remerciements suivants vont tout naturellement tout droit vers ma famille. Forcément, je remercie en premier lieu mes parents. Merci de m'avoir toujours soutenu et encouragé quelles que soient mes décisions, et de m'avoir accordé une confiance aveugle depuis que je suis tout petit. Même si je ne le dis pas assez, je vous aime énormément, et il est évident que je n'aurais jamais eu à écrire ces lignes sans vous. Ensuite, vient évidemment ma soeur Aurélie. Tu as toujours été un modèle d'abnégation et de réussite pour moi, et même un modèle tout court. Tu m'as donné la motivation et le courage nécessaires pour aller au bout de cette épreuve qu'est la thèse. J'ai réussi à le faire aussi, et je n'oserai même pas de blague sur le foot ! Mes pensées suivantes sont destinées vers mes grands parents, qui nous ont tous deux quittés bien trop tôt. Je voudrais remercier ma grand mère, partie trop soudainement durant la phase de rédaction du manuscrit, et sans qui je ne serais pas là aujourd'hui. Un immense merci, malgré ton incompréhension totale envers ma vocation mathématique, pour ton exigence, ta rigueur, ta patience et ta générosité qui m'ont tellement appris étant petit et ont grandement contribué à cette réussite. Je te dois énormément. J'espère que ces quelques pages ne contiendront pas de fautes d'orthographe. Je pense également très fort à mon grand père, qui a suivi je l'espère mon parcours de là haut. J'espère que vous serez fiers de cet accomplissement. Merci également à tous les autres membres de ma famille qui ont été présents lors de cette période: Martine et André, pour les nombreux week-ends très ressourçants à Saint-Sigismond au début de ma thèse. Merci également à mon cousin Kevin, ainsi qu'à toute sa petite famille pour ces week-ends très agréables à jouer aux jeux-vidéos, à regarder le sport et à se balader en montagne. Merci à vous tous de m'avoir toujours accueilli à bras ouverts. Merci également à mes cousins Gautier et Jérémy, ainsi que leurs familles respectives, c'est toujours très agréable de vous revoir dans des circonstances joyeuses. Merci également à Laetitia et Jessica pour les bons moments passés lorsque l'on se voyait.



Vient ensuite le moment de remercier ma seconde famille. Je voudrais en particulier remercier Ludivine, qui m'a accompagné au quotidien au long de cette épreuve, et dont la force mentale et le caractère malgré les épreuves que tu as traversées m'ont plus que jamais aidé à tenir le coup. Je n'ai pas besoin d'en dire plus, tu me comprendras. Merci aussi à Mimi et Bubu qui ont été de grandes sources d'inspiration. Merci à Jérémy, le frère que je n'ai jamais eu, depuis tout petit tu as toujours été présent à mes côtés pour me soutenir, m'encourager et me remonter le moral lorsque cela était nécessaire, et parfois me lancer des balles de tennis. Il ne m'est pas possible de choisir une anecdote, et si je devais toutes les écrire le manuscrit serait sans doute deux fois plus long. Merci Nico, mon Ateam-mate, qui m'a soutenu lors des moments difficiles et a toujours été présent et prêt à aider depuis notre rencontre à Reims. Merci pour toutes les soirées, tous les délires partagés, et aussi pour la productivité du premier confinement qui aura été un grand moment. Pour te remercier je t'achèterai un clavier qui marche. Merci à Edgar, pour ta joie de vivre perpétuelle et ta bonne humeur constante, de m'avoir donné le sourire à chaque fois qu'on a eu l'occasion de se revoir. Pense à moi lorsque tu seras millionnaire. Merci Mika, pour les bons moments (trop?) conviviaux passés à chaque fois que l'on a eu l'occasion de se retrouver malgré la distance. Merci également à tous mes camarades qui m'ont accompagné lors de mes diverses études à Reims: Louis, Jonathan, Caroline, Hugo, Adrien, Sofia, Asmaa, Sophie, Pauline, Julien, Quentin B. Cela a été un plaisir de vous côtoyer durant cette étape, ce ne fut que des bons moments, et j'espère que l'on aura l'occasion d'en passer pleins d'autres. Merci également à Aurélien, Alexandre, Alexis, et encore Edgar pour tous les moments géniaux passés lors de la période lycée, notamment avec nos escapades ou encore nos découvertes fabuleuses sur internet. Merci enfin à Romain et Camille, et depuis peu Arthur, pour m'avoir facilité l'intégration dans la ville lyonnaise, et pour avoir été toujours très sympathiques et avenants. Les moments passés avec vous ont toujours été très agréables et rafraichissants.

J'ai également une pensée pour toutes les personnes qui ont participé à renforcer mon goût prononcé pour les mathématiques durant mon parcours à la fois scolaire et universitaire: je m'excuse pour la liste non exhaustive, je risque d'oublier du monde, mais un grand merci à: M. Savari Raj, Mme Klein, M. Feller, M. Devie, M. Debeaumarché, M. Ninet, M. Barka, M. Yu, M. Jacon. Vous avez tous contribué à me donner goût à la recherche mathématique.

# Résumé

En théorie des représentations, de nombreuses familles de catégories sont définies par générateurs et relations diagrammatiques. Une des questions principales dans l'étude de ces catégories est le calcul de bases linéaires des espaces de morphismes. Ces calculs de bases sont en général très difficiles en raison de la complexité combinatoire des relations. Cette thèse introduit une approche constructive permettant de calculer ces bases avec des méthodes issues de la théorie de la réécriture.

Nous introduisons un cadre catégorique de réécriture modulo, qui décrit le calcul dans une structure algébrique par application de relations orientées modulo les axiomes de la structure. Ce cadre nous permet de développer des outils pour réécrire dans des algèbres et catégories diagrammatiques admettant une structure inhérente complexe, telles que la structure de catégorie pivotale dans laquelle les diagrammes sont représentés à isotopie planaire près.

Nous définissons la notion de système de réécriture de dimension supérieure modulo, appelés polygraphes modulo, dans un contexte ensembliste et linéaire. Ces structures polygraphiques fournissent un cadre pour les preuves de cohérence modulo ainsi que le calcul de bases linéaires. En particulier, nous démontrons que des bases linéaires pour les espaces de 2-cellules de 2-catégories pivotales peuvent être obtenues à partir de présentations dont les relations forment un système de réécriture terminant, ou quasi-terminant, et confluent modulo les relations disotopie planaire. Nous étudions via ces méthodes la catégorie définie par Khovanov, Lauda et Rouquier pour catégorifier le groupe quantique associé à une algèbre de Kac-Moody symétrisable simplement lacée. Nous calculons des bases explicites des espaces de 2-cellules de cette catégorie, et montrons ainsi la non-dégénérescence du calcul diagrammatique introduit par Khovanov et Lauda, prouvant dans ce cas le théorème de catégorification du groupe quantique associé. Enfin, nous étendons la structure de polygraphe modulo au contexte de la réécriture modulo les axiomes décrits par une théorie algébrique de Lawvere. Nous démontrons un lemme des paires critiques algébrique basé sur une notion de stratégie de réécriture adaptée au contexte algébrique.



---

## Table of contents

---

|          |   |            |
|----------|---|------------|
| <b>1</b> | <b>Introduction</b>   | <b>27</b>  |
| 1.1      | Algebraic rewriting and categorification . . . . .                          | 27         |
| 1.2      | Thesis summary and main contributions . . . . .                             | 33         |
| <b>2</b> | <b>Algebraic rewriting</b>  | <b>41</b>  |
| 2.1      | Abstract rewriting . . . . .  | 42         |
| 2.2      | Confluence by decreasingness . . . . .                                      | 46         |
| 2.3      | Abstract rewriting modulo . . . . .   | 49         |
| 2.4      | Higher-dimensional polygraphs . . . . .                                     | 53         |
| 2.5      | Critical branching lemma . . . . .  | 57         |
| 2.6      | Examples . . . . .  | 61         |
| 2.7      | Linear rewriting . . . . .  | 66         |
| 2.8      | Rewriting in linear $(n + 1, n)$ -polygraphs . . . . .                      | 69         |
| 2.9      | Linear critical branching lemma . . . . .                                   | 71         |
| <b>3</b> | <b>Categorification</b>   | <b>75</b>  |
| 3.1      | Grothendieck groups . . . . .   | 75         |
| 3.2      | Naive and weak categorification . . . . .                                   | 77         |
| 3.3      | Strong categorification . . . . .   | 78         |
| 3.4      | Quantum groups . . . . .  | 79         |
| 3.5      | Khovanov and Lauda’s categorification of quantum groups . . . . .           | 81         |
| <b>4</b> | <b>Coherent confluence modulo</b>   | <b>87</b>  |
| 4.1      | Double groupoids . . . . .  | 88         |
| 4.2      | Double coherent presentations . . . . .                                     | 92         |
| 4.3      | Examples . . . . .  | 101        |
| 4.4      | Polygraphs modulo . . . . .   | 103        |
| 4.5      | Coherent confluence modulo . . . . .  | 108        |
| 4.6      | Coherent completion modulo . . . . .  | 116        |
| 4.7      | Globular coherence from double coherence . . . . .                          | 123        |
| <b>5</b> | <b>Bases in linear categories from confluence modulo</b>                    | <b>130</b> |
| 5.1      | Linear critical branching lemma modulo . . . . .                            | 131        |
| 5.2      | Confluence modulo by decreasingness modulo . . . . .                        | 135        |
| 5.3      | Rewriting modulo isotopies in pivotal linear $(2, 2)$ -categories . . . . . | 139        |
| 5.4      | Linear bases from confluence modulo . . . . .                               | 141        |
| <b>6</b> | <b>Khovanov and Lauda’s categorification and rewriting modulo</b>           | <b>144</b> |
| 6.1      | A convergent presentation of the simply-laced KLR algebras . . . . .        | 145        |
| 6.2      | Rewriting modulo isotopy in Khovanov-Lauda-Rouquier’s 2-category . . . . .  | 151        |

|  |            |
|--|------------|
| <b>7 Algebraic Polygraphs</b>  | <b>167</b> |
| 7.1 Cartesian polygraphs and theories . . . . .  | 168        |
| 7.2 Algebraic examples . . . . .   | 170        |
| 7.3 Algebraic polygraphs modulo . . . . .  | 172        |
| 7.4 Positive confluence in algebraic polygraphs modulo . . . . .                       | 176        |
| 7.5 Algebraic critical branching lemma . . . . .                                       | 179        |
| <b>8 Work in progress and perspectives</b>   | <b>181</b> |
| 8.1 Categorifying Mackey’s induction restriction theorem for Brauer algebras . . . . . | 181        |
| 8.2 Polygraphic resolutions from rewriting modulo . . . . .                            | 189        |
| <b>9 Catalogue of diagrammatic algebras</b>  | <b>192</b> |
| 9.1 Hecke type algebras . . . . .  | 192        |
| 9.2 Temperley Lieb and Brauer categories . . . . .                                     | 193        |
| 9.3 The partition category . . . . .   | 195        |
| 9.4 The affine oriented Brauer category . . . . .                                      | 197        |
| 9.5 Khovanov’s Heisenberg categorification . . . . .                                   | 204        |
| References . . . . .   | 205        |
| <b>A Appendix: Proofs of confluence of critical branchings</b>                         | <b>212</b> |
| A.1 Critical branchings for the partition category . . . . .                           | 212        |
| A.2 Critical branchings for the KLR algebras . . . . .                                 | 216        |
| A.3 Critical branchings modulo for the KLR 2-category . . . . .                        | 223        |

## RÉÉCRITURE ALGÈBRIQUE ET CATÉGORIFICATION

### Calcul formel en théorie des représentations

Le calcul formel est une branche des mathématiques et de l'informatique fondamentale qui vise à développer et implémenter des algorithmes manipulant et analysant des expressions mathématiques. De nombreux algorithmes effectifs ont été développés afin de résoudre des problèmes potentiellement difficiles dans de nombreux domaines en mathématiques. Par exemple, des outils ont vu le jour afin de simplifier des expressions structurelles, de factoriser des polynômes, de calculer des plus grands communs diviseurs etc. En algèbre, et en particulier en théorie des représentations, de tels outils sont nécessaires pour calculer dans des présentations de structures algébriques par générateurs et relations. En particulier, les questions principales sur ces présentations concernent le calcul de *syzygies*, c'est-à-dire relations entre les relations, ou le calcul de bases linéaires. Ce travail s'inscrit dans un projet visant à développer de tels outils constructifs, à partir de la théorie de la réécriture, pour étudier des présentations d'algèbres et de catégories diagrammatiques qui apparaissent dans divers domaines en mathématiques, et notamment en théorie des représentations.

**Calcul dans des structures linéaires.** En général, étant donnée une algèbre admettant une présentation par générateurs et relations, il n'est pas facile de quantifier le nombre d'éléments contenus dans cette algèbre. En effet, il peut s'avérer qu'il y ait trop de relations définissant l'algèbre, impliquant que tous les éléments sont finalement égaux à zéro. Souvent, il est faisable de déterminer un ensemble de mots en les générateurs qui engendrent l'algèbre, et que nous conjecturons en être une base. Cependant, prouver l'indépendance linéaire de cet ensemble de monômes peut être difficile, voir [46] pour des exemples. Dans la plupart des cas, la preuve de l'indépendance linéaire consiste à définir une action de l'algèbre sur un anneau de polynômes sur lequel les éléments de la base candidate agissent comme des opérateurs linéairement indépendants, d'où nous déduisons que l'un ensemble fixé d'expressions réduites de ces éléments forme une base. Toutefois, la définition d'une telle action et la preuve de l'indépendance linéaire des opérateurs induits peut être compliquée, voir see [58, 71] pour des exemples tels que les algèbres de Hecke à 2 paramètres ou encore les algèbres de Khovanov-Lauda-Rouquier. Nous montrons que ces questions peuvent être abordées par des outils provenant de la théorie de la réécriture algébrique.

De nombreuses théories du calcul basées sur le principe de la théorie de la réécriture sont apparues dans divers travaux en algèbre linéaire. En particulier, de nombreux outils ont été développés afin de calculer des formes normales pour différents types d'algèbres présentées par générateurs et relations, avec des applications dans la décidabilité du problème d'appartenance à un idéal et le calcul de bases telles que des bases de type Poincaré-Birkhoff-Witt. Par exemple, Shirshov a introduit dans [108] un algorithme permettant de calculer une base linéaire d'une algèbre de Lie présentée par générateurs et

relations, et en a déduit une preuve constructive du théorème de Poincaré-Birkhoff-Witt. La théorie des bases de Gröbner a été introduite pour calculer dans des idéaux d'anneaux de polynômes et d'algèbres commutatives, [24, 25, 26]. Buchberger a décrit un algorithme permettant de calculer des bases de Gröbner, à partir de la notion de S-polynôme, comme un analogue de la complétion de Knuth-Bendix et du lemme des branchements critiques linéaires en réécriture, décrits dans la suite. Bokut and Bergman ont ensuite indépendamment étendu les bases de Gröbner pour des algèbres associatives, avec les preuves du lemme de composition et du lemme du diamant de Bergman [13, 9]. Ces résultats ont par la suite été instanciés comme des résultats de réécriture. L'approche des bases de Gröbner et de l'algorithme de Buchberger ont mené au développement d'une approche basée sur la théorie de la réécriture afin de calculer dans des algèbres associatives, tout en s'affranchissant de l'hypothèse de compatibilité des règles de réécriture avec un ordre monomial, voir [50].

**Algèbres diagrammatiques.** L'un des objectifs principaux de cette thèse est de développer des outils pour calculer dans des algèbres diagrammatiques, c'est-à-dire des algèbres admettant des présentations par générateurs et relations qui sont représentés par des diagrammes. De nombreuses familles de telles algèbres sont apparues dans plusieurs domaines en mathématiques, par exemple les algèbres de Temperley-Lieb [116] en mécanique quantique, les algèbres de Brauer [15] en théorie des représentations des groupes orthogonaux, les algèbres de Birman-Wenzl [12] ou les algèbres planaires de Jones [59] en théorie des noeuds, ou encore les algèbres de Khovanov-Lauda-Rouquier en théorie des représentations de groupes quantiques, [71, 102].

Par exemple, pour un corps  $\mathbb{K}$  fixé, considérons la  $\mathbb{K}$ -algèbre du groupe symétrique  $S_n$  sur  $n$  lettres, notée  $\mathbb{K}[S_n]$ . Rappelons que  $S_n$  admet une présentation de groupe de Coxeter sur  $n - 1$  générateurs  $s_i$  pour  $1 \leq i \leq n - 1$ , correspondant à la transposition  $(i \ i + 1)$ . Ces générateurs sont sujets aux relations suivantes:

- i)  $s_i^2 = 1$  pour  $1 \leq i \leq n - 1$ ,
- ii)  $s_i s_j = s_j s_i$  pour tous  $i, j$  tels que  $|i - j| > 1$ ,
- iii)  $s_i s_{i-1} s_i = s_{i-1} s_i s_{i-1}$  pour tout  $2 \leq i \leq n - 1$ .

Il existe une manière classique de représenter une permutation  $w$  de  $S_n$  par un *diagramme de tresse*. C'est un diagramme, dessiné dans la bande du plan  $\mathbb{R} \times [0, 1]$ , composé de  $2n$  points répartis en deux lignes, avec  $n$  points sur la ligne  $\mathbb{R} \times \{0\}$  et  $n$  points sur la ligne  $\mathbb{R} \times \{1\}$ , et dans lequel un point de la ligne du haut est relié par un brin à un et un seul point de la ligne du bas. Dans cette représentation graphique, le générateur  $s_i$  correspond à un croisement local entre le brin numéroté  $i$  (en numérotant les brins de 1 à  $n$  de la droite vers la gauche) et le brin numéroté  $i + 1$ , comme ci-dessous:

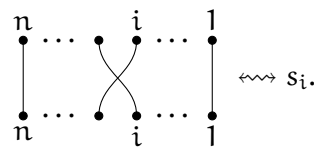

La multiplication correspond alors à la juxtaposition verticale de diagrammes du bas vers le haut. Par conséquent, les relations locales **i)**–**iii)** admettent également une interprétation diagrammatique, représentée ci-dessous:

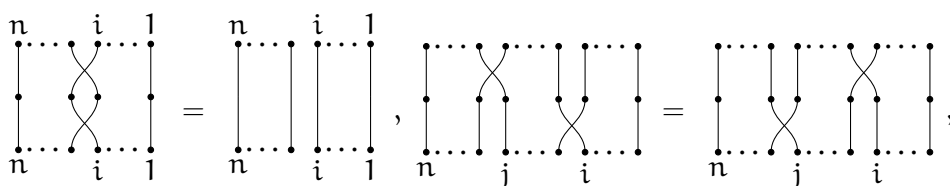

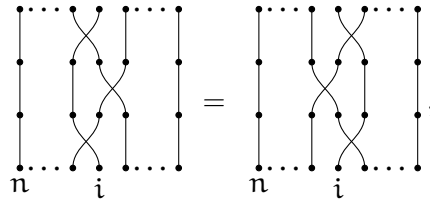

faisant de  $\mathbb{K}[S_n]$  une algèbre diagrammatique. Cependant, afin d'étudier les algèbres  $\mathbb{K}[S_n]$  pour tout  $n \in \mathbb{N}$ , ces présentations ne sont pas économiques pour les raisons suivantes:

- 1) Il faut considérer toutes les algèbres  $\mathbb{K}[S_n]$  pour chaque entier  $n \in \mathbb{N}$ , et il y a donc une infinité dénombrable d'algèbres à étudier.
- 2) Pour l'algèbre  $\mathbb{K}[S_n]$ , il y a un grand nombre de relations dans la présentation, plus grand que  $n^2$ .

Il existe en général une approche plus efficace pour étudier une telle famille dénombrable d'algèbres: les réaliser comme des espaces de morphismes d'une catégorie monoïdale  $\mathbb{K}$ -linéaire, ou comme espaces de 2-cellules d'une 2-catégorie linéaire comme suit. Considérons la catégorie monoïdale  $\mathbb{K}$ -linéaire  $Sym$  avec un unique objet générateur noté  $\mathbf{1}$ , de telle sorte que les objets de  $Sym$  sont de la forme  $\mathbf{1}^{\otimes n}$ , dénotant le produit  $\otimes$  de  $\mathbf{1}$  avec lui-même  $n$  fois pour tout  $n \in \mathbb{N}$ ,  $\mathbf{1}^{\otimes 0}$  étant l'objet unité, et une unique 1-cellule génératrice  $s : \mathbf{1} \otimes \mathbf{1} \rightarrow \mathbf{1} \otimes \mathbf{1}$ , soumise aux relations suivantes:

$$s \circ s = \mathbf{1} \otimes \mathbf{1}, \quad (s \otimes \mathbf{1}) \circ (\mathbf{1} \otimes s) \circ (s \otimes \mathbf{1}) = (\mathbf{1} \otimes s) \circ (s \otimes \mathbf{1}) \circ (\mathbf{1} \otimes s). \quad (1)$$

où par  $\mathbf{1}$  nous notons également la 1-cellule identité sur  $\mathbf{1}$ . L'ensemble  $\text{End}_{Sym}(\mathbf{1}^{\otimes n})$  est muni d'une structure de  $\mathbb{K}$ -algèbre, et est isomorphe à  $\mathbb{K}[S_n]$ , de telle sorte que nous retrouvons toutes les algèbres de groupes symétriques dans la catégorie monoïdale  $\mathbb{K}$ -linéaire  $Sym$ . Cette présentation est beaucoup plus économique, puisqu'il ne reste à étudier qu'une présentation d'une catégorie monoïdale admettant trois relations.

Notons que les algèbres diagrammatiques admettent en général une interprétation en tant que catégorie par elle-même, où peuvent être réalisées comme des espaces de morphismes de catégories linéaires de cette manière. En particulier, nous allons étudier une structure de catégories appelées *(2, 2)-catégories linéaires*, qui sont des 2-catégories telles que chaque ensemble de 2-cellules entre des 1-cellules parallèles admet une structure de  $\mathbb{K}$ -espace vectoriel pour un certain corps  $\mathbb{K}$ . Lorsque ces *(2, 2)-catégories linéaires* admettent une unique 0-cellule, cette structure coïncide avec la structure de catégorie monoïdale  $\mathbb{K}$ -linéaire. Les 2-cellules d'une telle catégorie admettent une représentation diagrammatique donnée par des *diagrammes de cordes*, définis comme suit:

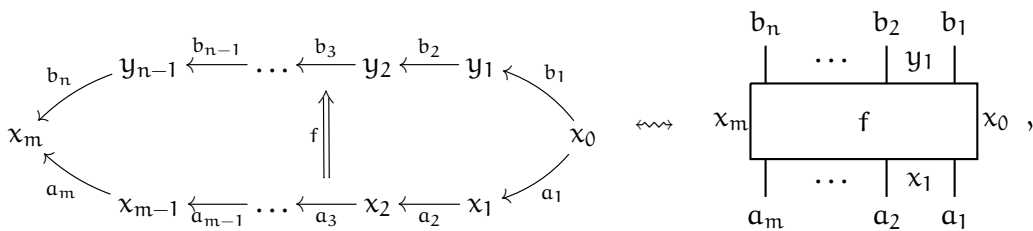

utilisant la convention qu'un diagramme de corde se lit de droite à gauche, et de bas en haut. Ceci nous permet de considérer une théorie du calcul sur des diagrammes construits à partir de diagrammes générateurs. Dans l'exemple ci-dessus, en interprétant  $Sym$  comme une *(2, 2)-catégorie linéaire* avec une seule 0-cellule, la 2-cellule génératrice  $s$  peut se représenter par un diagramme de corde de  $\mathbf{1} \otimes \mathbf{1}$  vers  $\mathbf{1} \otimes \mathbf{1}$ , par exemple un croisement comme ci-dessous:





Quand il n'y a pas d'ambiguïté, nous pouvons omettre les points et les étiquettes des 2-cellules et des 1-cellules source et but, de telle sorte que la 2-cellule (2) est juste représentée par un croisement. Les relations (1) sont alors représentées par

$$\begin{array}{c} \diagup \diagdown \\ \diagdown \diagup \end{array} = \left| \right| \left| \right|, \quad \begin{array}{c} \diagup \diagdown \\ \diagdown \diagup \end{array} = \begin{array}{c} \diagdown \diagup \\ \diagup \diagdown \end{array}. \quad (3)$$

La catégorie  $\mathcal{S}ym$  admet seulement 2 relations et sa structure est simple à étudier. En général cependant, des présentations d'algèbres et catégories diagrammatiques peuvent admettre un grand nombre de relations, certaines d'entre elles étant potentiellement induites par la structure algébrique, nécessitant des outils de calcul appropriés.

**Catégorification.** Le terme de catégorification a été introduit par Crane dans [35], suivant un précédent travail avec Frenkel [34]. Ce nom réfère au processus de remplacer toutes les notions ensemblistes par des notions catégoriques correspondantes. Afin d'étudier une structure donnée, l'idée est alors de définir une catégorie de dimension supérieure correspondant d'une certaine manière à l'objet de départ via son groupe de Grothendieck, mais admettant une structure plus riche permettant de l'étudier via l'apparition de nouveaux phénomènes. En effet, l'objectif est d'être capable d'obtenir de nouvelles informations sur l'objet original à partir de cette structure plus riche. Par exemple, afin d'étudier les représentations d'une algèbre, nous étudions des actions de cette algèbre sur des espaces vectoriel, via des applications linéaires. Dans le processus de catégorification en théorie des représentations de dimension supérieure, les espaces vectoriels sont remplacés par des catégories linéaires de dimension supérieure, les applications linéaires par des foncteurs linéaires, et les équations entre applications par des transformations naturelles de foncteurs, qui sont soumis à des relations de cohérence supplémentaires. Par conséquent, les éléments de l'algèbre sont alors considérés comme des classes d'isomorphismes d'objets d'une certaine catégorie, fournissant une structure à partir de laquelle nous souhaitons obtenir plus d'informations sur l'algèbre originale. Par exemple, considérons l'ensemble  $\mathbb{N}$  des entiers naturels. Cet ensemble peut être catégorifié par la catégorie **FinSet** admettant pour objets les ensembles finis et pour morphismes les fonctions ensemblistes via le cardinal, puisque deux ensembles finis de même cardinal sont en bijection. La somme et le produit de  $\mathbb{N}$  correspondent alors respectivement à l'union disjointe et le produit cartésien dans **FinSet**. Tandis que l'addition et la multiplication dans  $\mathbb{N}$  satisfont de nombreuses propriétés algébriques telles que la commutativité, l'associativité et la distributivité, l'union disjointe et le produit cartésien dans **FinSet** ne satisfont de telles lois qu'à isomorphisme près.

Depuis les travaux pionniers de Crane et Frenkel, beaucoup de travaux sur la catégorification sont apparus dans divers contextes, et ont aidé à résoudre de nombreux problèmes compliqués. Par exemple, la catégorification du polynôme de Jones par Khovanov [68] utilisant la théorie des catégories et l'algèbre homologique a mené à de nouvelles directions de recherche en topologie, basées sur la catégorification. Cette théorie a permis d'éclaircir de nombreux problèmes et mené à de nouveaux résultats. De nombreuses algèbres étudiées en mathématiques ont à ce jour une version catégorifiée, par exemple les algèbres de Heisenberg [70], les algèbres de Weyl [69], les algèbres de polynômes [74], les algèbres de Hecke avec la catégorie des bimodules de Soergel [109], ou les groupes quantiques [102, 67]. En théorie des représentations, de nombreuses représentations ont également été catégorifiées, telles que les représentations des algèbres de Lie semi-simples et certaines représentations des groupes de Weyl associés avec les catégories  $\mathcal{O}$  [11, 10], les représentations irréductibles de dimension finie des algèbres de Lie  $\mathfrak{sl}_m$  [5], ou encore des produits tensoriels de représentations fondamentales de  $\mathfrak{sl}_m$  [115], pour  $m \in \mathbb{N}$ . De plus, de nombreuses catégorifications sont apparues pour d'autres concepts mathématiques, telles que les actions de groupes de tresses, ou encore les invariants d'enchevêtrements [29]. Nous référons à [73, 90, 104] pour d'autres exemples de résultats nouveaux provenant de cette théorie. La plupart des catégorifications mentionnées ci-dessus ont été définies par présentation par générateurs et relations définies par des diagrammes qui sont représentés à isotopie planaire près. Par conséquent, les

(2, 2)-catégories linéaires étudiées dans ce travail sont en général enrichies d’une structure additionnelle, celle de (2, 2)-catégorie linéaire *pivotal*. Une telle structure est définie à partir de l’existence d’adjonctions sur les 1-cellules, impliquant l’existence de 2-cellules unité et counité, diagrammatiquement représentées par des cups et des caps, et satisfaisant des relations d’isotopie. Dans cette structure, deux diagrammes de cordes égaux à isotopie près représentent la même 2-cellule [32], de telle sorte que les calculs sont compliqués à implémenter. La plupart des catégorifications définies dans la littérature admettent une structure pivotal, ou quasi-pivotal, telles que la catégorie des  $\mathfrak{gl}_n$ -webs encodant la théorie des représentations de l’algèbre de Lie  $\mathfrak{gl}_n$  [30, 45], la 2-categorification d’un groupe quantique de Khovanov-Lauda et Rouquier [67, 102] ou encore les catégories de Heisenberg catégorifiant les algèbres de Heisenberg [70].

## La réécriture algébrique

**Systèmes de réécriture abstraits.** La notion sous-jacente derrière la théorie des bases de Gröbner et les travaux de Buchberger, Bergman, Bokut and Shirshov est la notion de présentation d’une algèbre par un système de réécriture *convergent*. La théorie de la réécriture est une théorie combinatoire des classes d’équivalence, [96]. La première notion de système de réécriture a été introduite par Thue en 1914 afin d’étudier le problème du mot dans des semi-groupes, c’est à dire de décider si deux mots en les générateurs sont égaux ou non modulo les relations de la présentation du semi-groupe. Cette méthode consiste à orienter les relations et à étudier les expressions irréductibles, ou *formes normales*. Par ailleurs, le problème du mot a été étudié dans de nombreux contextes en algèbre et en informatique. D’autre part, la réécriture a été grandement développée en informatique fondamentale, produisant de nombreuses variantes dépendant de la nature des objets étant transformés, par exemple: des mots dans des monoïdes [14, 54], des termes dans des théories algébriques [75, 6, 117], des  $\lambda$ -termes, des circuits booléens [78], etc.

Une classe d’équivalence pour une relation donnée est composée d’objets qui peuvent être obtenus l’un à partir de l’autre par une suite d’application de transformations non-orientées. La réécriture consiste à orienter ces transformations. De manière explicite, un *système de réécriture abstrait* est la donnée d’un ensemble  $X$  d’objet, ainsi que d’un sous ensemble  $R$  de  $X \times X$  dont les éléments  $(x, y)$  sont notés par  $x \rightarrow y$ . Dans ce cas, nous disons que  $x$  se réécrit en  $y$ , ou que  $x \rightarrow y$  est une *étape de réécriture*, ou *réduction* de  $x$  vers  $y$ . Une suite

$$x_1 \rightarrow x_2 \rightarrow \dots \rightarrow x_n \rightarrow x_{n+1} \rightarrow \dots$$

de telles étapes de réécriture est appelée un *chemin de réécriture*. A un tel système, nous associons deux propriétés fondamentales: la terminaison et la confluence. Un système de réécriture abstrait  $(X, R)$  *termine* si il n’existe pas de suite infinie de réécriture pour  $R$ . Il est dit *confluent* si pour tout *branchement*, c’est à dire une paire de chemins provenant du même élément, il existe des chemins de réécriture donnant le même résultat final, comme résumé dans le diagramme suivant:

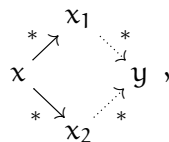

où  $\rightarrow^*$  dénote la clôture réflexive et transitive de  $\rightarrow$ . Lorsque  $(X, R)$  termine, le lemme de Newman [96] établit que sous l’hypothèse de terminaison, la confluence de  $(X, R)$  est équivalente à sa *confluence locale*, c’est à dire la confluence des *branchements locaux* de la forme  $x_1 \leftarrow x \rightarrow x_2$ . Une forme normale de  $(X, R)$  est un élément de  $X$  qui ne peut être réduit par aucune relation de  $R$ . Un système de réécriture est dit *convergent* si il est à la fois terminant et confluent, et dans ce cas tout élément  $x$  de  $X$  admet une et une seule forme normale.

**Réécriture algébrique et polygraphes.** La réécriture algébrique consiste à développer des méthodes constructives basées sur la théorie de la réécriture abstraite pour obtenir des propriétés de structures algébriques présentées par générateurs et relations. Cela consiste à orienter les relation de la présentations, et à appliquer la théorie de la réécriture en prenant en compte les axiomes de la structure inhérente. Dans ce contexte, il existe un critère local afin de déterminer la confluence locale en fonction de la confluence des chevauchements entre deux relations minimaux par rapport à la structure sous-jacente. Ces chevauchements sont appelés *branchements critiques*, [76, 97]. Avec le lemme de Newman, ces deux résultats permettent, sous l’hypothèse de terminaison, de déduire la confluence à partir d’une analyse locale et en général finie des branchements critiques. Par exemple, dans le cas de la catégorie monoïdale  $Sym$ , si nous orientons les relations (3) de la gauche vers la droite, nous avons à examiner tous les chevauchements possibles entre les sources des deux réductions, par exemple:

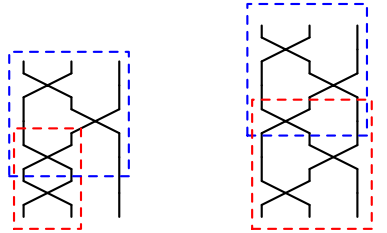

La notion de présentation convergente a été très utilisée afin d’obtenir des approches calculatoires pour déduire des invariants homologiques par le calcul d’une base des syzygies [24, 4, 77, 48, 55], où des bases linéaires de formes normales dans des structures linéaires [108, 24, 13, 9, 93, 26, 50, 2]. Dans cette thèse, nous étudions des présentations de catégories de dimension supérieure par des systèmes générateurs introduits indépendamment par Burroni sous le nom de *polygraphes* [28] et par Street sous le nom de *computads* [112, 113], voir [54] pour plus de détails sur les propriétés de réécriture de ces systèmes. Les polygraphes ont été largement utilisés dans le contexte de la réécriture algébrique, afin de calculer des présentations cohérentes de catégories globulaires strictes de dimension supérieure [51], d’obtenir des propriétés homologiques et homotopiques via les théorèmes de Squier [53, 54], de prouver des propriétés de Koszulité pour des algèbres [50] ou encore pour calculer des bases linéaires explicites d’algèbres [50] ou de catégories linéaires de dimension supérieure [2].

**Cohérence par confluence.** La théorie de la réécriture est adaptée au calcul de *présentations cohérentes* de catégories de dimension supérieure. Une présentation cohérente d’une  $n$ -catégorie étend la notion de présentation de cette catégorie par un  $(n + 1)$ -polygraphe par ajout d’une extension cellulaire acyclique, c’est à dire un ensemble de cellules en dimension  $n + 2$  qui engendrent toutes les relations entre relations de la présentations de telle sorte que le quotient de cette catégorie par la congruence engendrée par ces cellules est acyclique. Lorsque le  $n$ -polygraphe est convergent, le théorème de cohérence de Squier [111, 51] établit qu’il peut être augmenté en une présentation cohérente par adjonction d’une famille de  $(n + 1)$ -cellules génératrices dans des diagrammes de confluence de la forme

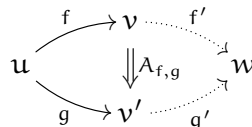

pour tout branchement critique  $(f, g)$  du  $n$ -polygraphe  $P_n$ . Les présentations cohérentes ainsi construites généralisent les systèmes de réécriture en gardant en mémoire les cellules construites par des diagrammes de confluence. Cette construction a été initiée par Squier dans [111] pour des monoïdes, et généralisée au cadre des  $n$ -catégories dans [51]. Dans les dimensions supérieures, les polygraphes peuvent être également utilisés pour construire des remplacements cofibrants de catégories globulaires strictes [53], par adjonction à une catégorie libre des sphères correspondant à des diagrammes de confluence de branchements critiques, puis des sphères dans la dimension supérieure correspondant aux diagrammes

de confluence de triples branchements critiques, etc., construisant ainsi un  $\infty$ -ensemble globulaire qui admet le même type d'homotopie que la catégorie originale.

**Réécriture linéaire.** Le contexte de réécriture linéaire introduit par Guiraud, Hoffbeck et Malbos dans [50] pour des algèbres associatives dont l'orientation des relations ne dépend pas d'un ordre monomial a été étendu au cadre des catégories linéaires de dimension supérieure par Alleaume [2]. Dans [2], de nombreux résultats de réécriture ont été établis pour des présentations de  $(2, 2)$ -catégories linéaires par des systèmes de réécriture appelés  $(3, 2)$ -polygraphes linéaires. Il y a deux difficultés principales à la réécriture dans des structures linéaires: tout d'abord, le contexte algébrique impose de spécifier des étapes de réécriture non-autorisées pour éviter des phénomènes de non-terminaison dûs au contexte linéaire, [50]. La seconde difficulté est que la preuve de la confluence locale à partir de la confluence des branchements critiques requiert une hypothèse de terminaison supplémentaire n'apparaissant pas dans le cas ensembliste, [50, Section 4.2]. En effet, certains branchements locaux qui seraient trivialement confluents si toutes les réécritures étaient autorisées peuvent devenir non confluents à cause de cette restriction, voir Remarque 2.9.3. Plus précisément, la confluence locale d'un polygraphe linéaire terminant peut être obtenue à partir de la confluence de tous ses branchements critiques, [2].

**Extension à la réécriture modulo.** La réécriture modulo un ensemble d'équations étend les méthodes constructives mentionnées précédemment en autorisant de réécrire avec un ensemble  $E$  de relations non-orientées. Cela apparaît naturellement dans le contexte de la réécriture algébrique, en réécrivant modulo les axiomes de la structure algébrique ambiante, par exemple réécriture dans des structures commutatives, groupoïdales, ou dans des catégories linéaires, non strictes, ou encore pivotales. Dans la littérature, il y a trois paradigmes principaux de réécriture modulo bien connus. La première approche, considérée comme la plus naïve, consiste à considérer le système de réécriture  ${}_E R_E$  défini par des relations de réécriture sur des classes d'équivalence modulo les relations de  $E$ . Cette approche est bien adaptée pour certaines théories équationnelles telles que l'associativité et la commutativité. Cependant, elle est inadaptée en général pour l'analyse de la confluence. En effet, la réductibilité d'une classe d'équivalence requiert de parcourir toute la classe, ce qui est difficilement implémentable si ces classes sont infinies. Une autre approche de réécriture modulo a été introduite par Huet dans [56], où les chemins de réécriture sont constitués de règles orientées et pas d'axiomes de  $E$ , mais la propriété de confluence est formulée modulo  $E$ -équivalence. Explicitement, les sources et buts des diagrammes de confluence ne sont pas nécessairement égaux, mais égaux modulo la congruence engendrée par les équations de  $E$ , comme dans le diagramme ci-dessous:

$$\begin{array}{ccc} x & \xrightarrow{*} x' & \xrightarrow{*} x'' \\ E \} & & \} E \\ y & \xrightarrow{*} y' & \xrightarrow{*} y'' \end{array} .$$

Cependant, dans un contexte algébrique, réécrire sans possibilité d'utiliser les axiomes algébriques peut s'avérer trop restrictif pour obtenir la confluence, voir [62]. Peterson et Stickel [99] ont introduit une extension de la procédure de complétion de Knuth-Bendix, [76], pour prouver la confluence d'un système de réécriture modulo une théorie équationnelle pour lequel un algorithme d'unification fini et complet est connu. Ils ont appliqué cette procédure à des systèmes de réécriture modulo des axiomes d'associativité et de commutativité, afin de réécrire dans des groupes abéliens libres, des anneaux commutatifs unitaires et des réseaux distributifs. Jouannaud et Kirchner ont élargi cette approche dans [61] avec la définition de propriétés de réécriture pour un système de réécriture modulo  $S$  qui est tel que  $R \subseteq S \subseteq {}_E R_E$ . Ils ont également prouvé un lemme des branchements critiques dans ce contexte, et développé une procédure de complétion pour le système de réécriture  ${}_E R$ , dont les étapes de réécriture consistent en l'application d'une règle de  $R$  après une  $E$ -équivalence. Leur procédure de complétion est basée sur un algorithme de  $E$ -unification fini. Bachmair et Dershowitz [7] ont développé une généralisation de la procédure de complétion de Jouannaud et Kirchner via des règles d'inférence.

De nombreuses autres approches ont également été étudiées pour des systèmes de réécriture de termes modulo certaines théories équationnelles, voir [120, 89].

**Réécriture modulo dans des 2-catégories pivotales.** Dans ce travail, de nombreux exemples sont issus de la réécriture modulo les axiomes d'isotopie de  $(2, 2)$ -catégories linéaires pivotales. Dans une telle structure, deux diagrammes de cordes égaux à isotopie près représentent la même 2-cellule, [32]. De plus, certaines relations peuvent être obtenues à partir d'autres par une simple transformation par isotopie. Nous voulons ainsi traiter ces axiomes structurels séparément des relations définissant la 2-catégorie, en réécrivant modulo ces relations. Cela autorise à déformer un diagramme de corde à isotopie près avant d'appliquer des règles de réécriture, facilitant l'analyse calculatoire de la confluence des branchements critiques.

## RÉSUMÉ DE LA THÈSE ET CONTRIBUTIONS PRINCIPALES

**Sujet de la thèse.** Cette thèse développe de nouvelles approches pour calculer dans des présentations de diverses structures algébriques par générateurs et relations. En particulier, nous introduisons des outils de réécriture adaptés aux présentations diagrammatiques de  $(2, 2)$ -catégories linéaires en utilisant la réécriture modulo, étendant ainsi les constructions polygraphiques bien connues en réécriture non modulo [51, 53, 48, 54, 50, 2]. Nous autorisons ainsi une part des relations à être considérée comme non-orientée, et à être vue comme des axiomes pouvant être utilisés librement dans les chemins de réécriture. Les objectifs principaux de ces constructions nouvelles sont le calcul de syzygies pour des présentations qui sont confluentes modulo une partie des axiomes algébriques, ou encore principalement le calcul de bases linéaires dans des  $(2, 2)$ -catégories linéaires lorsque les méthodes usuelles d'actions polynomiales sont difficilement applicables. Nous utilisons alors ces méthodes pour prouver la bonne définition de certaines catégorifications candidates, en montrant que l'ensemble des relations de la présentation définit bien une catégorie de taille attendue et non-dégénérée.

**Structure de la thèse.** Ce manuscrit est divisé en huit chapitres comme suit. Les deux premiers chapitres sont des chapitres préliminaires sur la théorie de la réécriture algébrique polygraphique et la catégorification en théorie des représentations. Dans le Chapitre 2, nous présentons la théorie de la réécriture dans un contexte abstrait, puis la réécriture (resp. réécriture linéaire) dans des catégories de dimension supérieure (resp. catégories linéaires de dimension supérieure) avec la structure de polygraphe (resp. polygraphe linéaire), et fournissons les propriétés et résultats de réécriture nécessaires pour la suite. Dans le Chapitre 3, nous rappelons l'idée sous-jacente au processus de catégorification, et expliquons les idées menant à la construction d'un tel objet. Nous mettons l'accent sur la construction de Khovanov, Lauda et Rouquier d'un groupe quantique associé à une algèbre de Kac-Moody symétrisable, menant à la définition de la 2-catégorie KLR, qui est l'un des objets d'étude principaux de ce travail. Les quatre chapitres suivants sont dédiés aux résultats principaux de cette thèse.

Dans le Chapitre 4, nous développons des méthodes de réécriture modulo pour étudier des questions de cohérence, et nous étendons ainsi le théorème de cohérence de Squier afin de calculer des présentations cohérentes de catégories globulaires strictes de dimension supérieure. Nous illustrons les résultats de ce chapitre dans le cas des monoïdes commutatifs et des 2-catégories pivotales. Dans le Chapitre 5, nous prouvons que des bases linéaires de  $(2, 2)$ -catégories linéaires peuvent être obtenues à partir d'une présentation satisfaisant une hypothèse de confluence modulo une partie des relations, et des hypothèses de terminaison supplémentaires. Ce résultat étend ainsi le résultat usuel de réécriture linéaire, établissant qu'à partir d'une présentation convergente d'algèbre, les monômes en forme normale forment une base linéaire de cette algèbre. Dans le Chapitre 6, nous illustrons ce résultat avec l'étude de la 2-catégorification du groupe quantique de Khovanov, Lauda et Rouquier, en prouvant que les ensembles conjecturés par Khovanov et Lauda comme étant des bases des espaces de 2-cellules sont en effet des bases linéaires, ce qui implique le théorème de catégorification de [67]. Dans le Chapitre 7,

nous étendons les constructions de réécriture modulo en définissant la notion de polygraphe algébrique, correspondant à des systèmes de réécriture modulo une théorie algébrique de Lawvere. Nous prouvons ainsi que l'hypothèse de terminaison du lemme des paires critiques linéaires provient d'un lemme des branchements critiques modulo dans ce contexte. Dans le Chapitre 8, nous décrivons de nouvelles pistes de recherche suggérées par ces travaux, ainsi que les travaux en cours. Enfin, le Chapitre 9 fournit un catalogue des diverses familles d'algèbres et de 2-catégories diagrammatiques qui ont à ce jour été étudiées via des méthodes de réécriture, ou de réécriture modulo.

## Cohérence modulo

Nous conjecturons que les constructions de [53] de remplacements cofibrants de catégories de dimension supérieure peuvent s'étendre au cadre de réécriture modulo. La forme cubique des diagrammes de confluence modulo suggère que les cellules à adjoindre en dimensions supérieures ne sont plus des sphères de dimension supérieure, mais des cubes de dimension supérieure. Ainsi, la structure appropriée pour établir des résultats de confluence et de cohérence est celle de  $n$ -catégorie enrichie en  $p$ -fold groupoïde, afin de prendre en compte la structure cubique dans la dimension de la réécriture et dans les dimensions supérieures. Le Chapitre 4 présente la première étape de construction d'un tel remplacement cofibrant, par adjonction à une double catégorie enrichie en double groupoïdes libres une famille de cellules carrées correspondant aux diagrammes de confluence de branchements critiques modulo. Dans la dimension supérieure, nous conjecturons que l'adjonction de cubes correspondant aux diagrammes de confluence modulo de triples branchements critiques modulo devrait être l'étape suivante afin de construire une résolution polygraphique modulo d'une catégorie de dimension supérieure, et que des constructions similaires à [53] peuvent être fournies dans toutes les dimensions.

**Polygraphes modulo.** Dans la Section 4.4, nous introduisons la notion de  $n$ -polygraphe modulo comme une donnée  $(R, E, S)$  constituée de deux  $n$ -polygraphes  $R$  et  $E$  correspondant respectivement aux règles de réécriture orientées et aux axiomes satisfaisant des conditions de compatibilité sur les cellules de basse dimension, et une extension cellulaire  $S$  qui dépend à la fois des extensions cellulaires  $R_n$  et  $E_n$ . Nous définissons les propriétés de terminaison et de confluence pour les polygraphes modulo, suivant les approches de Huet et Jouannaud-Kirchner. Nous présentons une procédure de complétion pour le  $n$ -polygraphe modulo  ${}_E R$  en terme de branchements critiques, qui implémente les règles d'inférence de complétion modulo données par Bachmair et Dershowitz dans [7], suivant la procédure de complétion de Knuth-Bendix [76].

**Confluence modulo et doubles catégories.** Nous étendons la notion de présentation cohérente d'une  $(n - 1)$ -catégorie, pour  $n > 1$ , présentée par un  $n$ -polygraphe au contexte des polygraphes modulo. Nous définissons une notion de cohérence modulo dans la structure de  $(n - 1)$ -catégorie enrichie en doubles groupoïdes. La notion de double catégorie a été initialement introduite par Ehresmann dans [44] comme une catégorie interne à la catégorie des petites catégories. Les doubles groupoïdes, c'est-à-dire des groupoïdes internes à la catégorie des groupoïdes, et leurs variantes de dimensions supérieures ont été grandement étudiées en théorie de l'homotopie, [19, 17], voir [18] et [16] pour plus de détails. Une double catégorie encode la donnée de quatre catégories liées: une catégorie verticale, une catégorie horizontale, et deux catégories de carrés ayant soit des cellules horizontales soit des cellules verticales pour sources et buts. Une cellule carrée  $A$  est ainsi représentée par

$$\begin{array}{ccc} u & \xrightarrow{f} & v \\ e \downarrow & \Downarrow A & \downarrow e' \\ u' & \xrightarrow{g} & v' \end{array}$$

où  $f, g$  sont des cellules horizontales, et  $e, e'$  sont des cellules verticales. Dans [51], les chemins de réécriture donnés par un  $n$ -polygraphe sont interprétés comme des  $n$ -cellules de la  $n$ -catégorie libre

engendrée par ce polygraphe. Suivant cette idée, nous donnons en Section 4.4 une interprétation de la confluence et la cohérence modulo pour des  $n$ -polygraphes modulo dans des  $(n-1)$ -catégories enrichies en doubles groupoïdes libres, où les cellules horizontales sont des chemins de réécriture pour  $S$ , les cellules verticales sont des  $E$ -équivalences et les cellules carrées sont des *cellules de cohérence modulo*.

**Confluence modulo cohérente.** La notion de double cohérente présentée introduite dans le Chapitre 4 est basée sur une adaptation de la structure de polygraphe, bien connue dans le cadre globulaire, [112, 100, 28], à un cadre cubique. Nous définissons ainsi un *double*  $(n+1, n-1)$ -polygraphe comme une donnée de  $P = (P^v, P^h, P^s)$  composée de deux  $n$ -polygraphes  $P^v$  et  $P^h$  ayant le même  $(n-1)$ -polygraphe sous-jacent, avec une extension cubique  $P^s$  composée de cellules carrées génératrices de la forme

$$\begin{array}{ccc} u & \xrightarrow{f} & u' \\ e \downarrow & & \downarrow e' \\ v & \xrightarrow{g} & v' \end{array}$$

où  $f, g$  sont des  $n$ -cellules de la  $(n, n-1)$ -catégorie libre  $(P^v)^\top$  engendrée par  $P^v$ , et  $e, e'$  sont des  $n$ -cellules de la  $(n, n-1)$ -catégorie libre  $(P^h)^\top$  engendrée par  $P^h$ . Nous définissons alors une *double présentation cohérente* d'une  $(n-1)$ -catégorie  $\mathcal{C}$  comme un double  $(n+1, n-1)$ -polygraphe  $P = (P^v, P^h, P^s)$  tel que  $\mathcal{C}$  est présentée par le polygraphe coproduit  $P^v \amalg P^h$ , et l'extension cubique  $P^s$  est acyclique, c'est à dire pour tout carré  $\mathbf{S}$  construit avec des cellules verticales de  $(P^v)^\top$  et des cellules horizontales de  $(P^h)^\top$ , il existe une  $(n+1)$ -cellule carrée  $A$  dans la  $(n-1)$ -catégorie enrichie en doubles groupoïdes  $P^\top$  engendrée par  $P$ , définie en Section 4.2.7, dont le bord est le carré  $\mathbf{S}$ .

Dans la Section 4.5, nous définissons la notion de confluence cohérente modulo d'un  $n$ -polygraphe modulo  $(R, E, S)$  par rapport à une extension cubique  $\Gamma$  du couple de  $n$ -catégories  $(E^\top, S^*)$ . De manière explicite,  $S$  est appelé  $\Gamma$ -confluent modulo  $E$  si pour tout branchement modulo  $(f, e, g)$  of  $S$ , il existe des  $n$ -cellules  $f', g'$  de  $S^*$ ,  $e'$  dans  $E^\top$  et une  $(n+1)$ -cellule carré  $A$  comme ci-dessous

$$\begin{array}{ccccc} u & \xrightarrow{f} & u' & \cdots & w \\ e \downarrow & & \Downarrow A & & \downarrow e' \\ v & \xrightarrow{g} & v' & \cdots & w' \end{array}$$

dans la  $(n-1)$ -catégorie enrichie en doubles catégories définie à partir de  $\Gamma$  comme en Section 4.5. Nous déduisons la confluence cohérente d'un  $n$ -polygraphe modulo à partir de propriétés de confluence cohérente locale. En particulier, le Théorème 4.5.4 est une formulation du lemme de Newman pour la confluence modulo, établissant que sous l'hypothèse de terminaison de  ${}_E R_E$ , la  $\Gamma$ -confluence modulo et la  $\Gamma$ -confluence modulo locale sont équivalentes. Enfin, avec le Théorème 4.5.7 nous donnons une formulation cohérente du lemme des branchements critiques modulo, permettant de déduire la confluence locale modulo à partir de la confluence de certains branchements critiques modulo.

**Complétion cohérente modulo.** En Section 4.6, nous présentons plusieurs manières d'étendre une présentation d'une  $(n-1)$ -catégorie par un polygraphe modulo en une double présentation cohérente de cette catégorie. À partir d'un  $n$ -polygraphe modulo, nous montrons comment construire une double présentation cohérente de la  $(n-1)$ -catégorie présentée par ce polygraphe. Le Théorème 4.6.6 donne des conditions pour étendre une extension cubique  $\Gamma$  définie sur les  $(n, n-1)$ -catégories horizontales et verticales  $E^\top$  and  $S^\top$  d'un  $n$ -polygraphe modulo  $(R, E, S)$  en une extension acyclique. En Section 4.6.1, nous définissons une *complétion cohérente* d'un  $n$ -polygraphe modulo comme une extension cubique du couple de  $(n, n-1)$ -catégories  $(E^\top, S^\top)$  dont les éléments sont des  $(n+1)$ -cellules carrées génératrices

de la forme

$$\begin{array}{ccccc}
 u & \xrightarrow{f} & u' & \xrightarrow{f'} & w \\
 e \downarrow & & \Downarrow & & \downarrow e' \\
 \underline{u} & \xrightarrow{g} & v & \xrightarrow{g'} & w'
 \end{array}$$

pour tout branchement critique  $(f, e, g)$  de  $S$  modulo  $E$ . En conséquence du Théorème 4.6.6, nous montrons comment étendre une complétion cohérente  $\Gamma$  de  $S$  modulo  $E$  et une complétion cohérente  $\Gamma_E$  de  $E$ , non modulo, en une extension cubique acyclique. En particulier, lorsque le  $n$ -polygraphe  $E$  contient un ensemble vide de  $n$ -cellules, nous retrouvons le théorème de cohérence de Squier pour des  $n$ -polygraphes convergents, tel qu'établi en [51, Theorem 5.2.], voir également [53]. Nous prouvons en Théorème 4.6.12 qu'une extension acyclique d'un couple de  $(n, n - 1)$ -catégories  $(E^\top, S^\top)$  provenant d'un polygraphe modulo  $(R, E, S)$  peut également être obtenue à partir de stratégies de normalisation pour les  $n$ -polygraphes  $S$  and  $E$  satisfaisant une hypothèse supplémentaire de commutation.

**Cohérence par double cohérence.** En Section 4.7, nous explicitons comment déduire une présentation cohérente globulaire pour une  $n$ -catégorie à partir d'une double présentation cohérente générée par un polygraphe modulo. Cette construction est basée sur la structure de *dipolygraphes*, étant définis comme des systèmes générateurs de  $\infty$ -catégories dont les  $k$ -catégories sous-jacentes ne sont pas nécessairement libres, pour  $k \in \mathbb{N}$ , voir see Section 4.2. Nous définissons les dipolygraphes comme une variation des polygraphes pour lesquels les extensions cellulaires sont définies sur des quotients de catégories libres. En Section 4.2.15, nous définissons un foncteur quotient  $V : \mathbf{DbPol}_{(n+2, n)} \rightarrow \mathbf{DiPol}_{(n+2, n)}$  de la catégorie des doubles  $(n + 2, n)$ -polygraphes vers la catégorie des  $(n + 2, n)$ -dipolygraphes.

Le dernier résultat du Chapitre 4 donne les conditions nécessaires pour pouvoir quotienter une double présentation cohérente engendrée par un polygraphe modulo lorsque le  $n$ -polygraphe  $E$  est convergent,  $S$  termine et est confluent modulo  $E$ . Le Théorème 4.7.3 montre comment déduire, d'une complétion cohérente  $\Gamma$  de  $S$  modulo  $E$ , une présentation cohérente globulaire de la  $(n - 1)$ -catégorie  $(R_{n-1}^*)_E$ , dont les  $n$ -cellules de cohérence sont définies par quotient des  $n$ -cellules cubiques de  $\Gamma$  par la congruence engendrée par  $E$ . Enfin, nous illustrons ces méthodes en montrant comment obtenir de telles présentations cohérentes pour des monoïdes commutatifs en Section 4.7.5 et pour des catégories monoïdales pivotales modulo les relations d'isotopie planaire en Section 4.7.7.

### Bases linéaires par confluence modulo

Comme mentionné précédemment, de nombreuses relations provenant de la structure inhérente des algèbres diagrammatiques apparaissant en théorie des représentations peuvent être sources d'obstructions pour les preuves de confluence, en créant un grand nombre de branchements critiques à considérer. L'un des objectifs principaux de cette thèse est d'étendre le théorème de base usuel, donné par les monômes en forme normale pour une présentation convergente, au contexte de réécriture modulo. Dans ce cadre, nous voulons affaiblir l'hypothèse de confluence globale incluant toutes les relations orientées, à une hypothèse de confluence modulo une partie non-orientée des règles.

**Confluence modulo par décroissance.** Le polygraphe modulo  ${}_E R_E$  peut ne pas terminer, et même lorsqu'il termine prouver la terminaison est en général difficile. En particulier, c'est le cas lors de l'étude de  $(3, 2)$ -polygraphes linéaires modulo présentant des  $(2, 2)$ -catégories linéaires pivotales, à cause de l'existence de 2-cellules ayant pour source et but la même 1-cellule identité, appelées *bulles*. En effet, Alleaume a démontré que des  $(2, 2)$ -catégories linéaires admettant des relations impliquant que des bulles peuvent traverser des brins de diagrammes ne peuvent être équipées d'un ordre monomial, de telle sorte qu'elles ne peuvent être présentées par des systèmes de réécriture terminants, voir [2]. De plus, la cyclicité d'une 2-cellule par rapport aux biadjonctions données par la structure pivotale implique que le diagramme de corde représentant cette 2-cellule peut être déplacé librement sur les 2-cellules cups et



caps, créant ainsi des cycles de réécriture obstruant la terminaison. Cependant, même si  ${}_{\mathbb{E}}R_{\mathbb{E}}$  n'est pas terminant, dans la plupart des cas considérés il sera quasi-terminant, c'est-à-dire que tous les chemins de réécriture infinis proviennent de cycles de réécriture. Suivant [31], l'hypothèse de terminaison de  ${}_{\mathbb{E}}R_{\mathbb{E}}$  peut être affaiblie en une hypothèse de quasi-terminaison afin de prouver la confluence modulo d'un  $(3, 2)$ -polygraphe linéaire modulo à partir de la confluence de ses branchements critiques modulo. En Section 5.2, nous introduisons également une notion de décroissance modulo pour un  $(3, 2)$ -polygraphe linéaire, basée sur la propriété de décroissance en réécriture abstraite introduite par Van Oostrom dans [119]. Nous démontrons alors le résultat suivant:

**Théorème 5.2.4.** *Soit  $(R, E, S)$  un  $(3, 2)$ -polygraphe linéaire modulo monomial à gauche. Si  $(R, E, S)$  est décroissant modulo  $E$ , alors  $S$  est confluent modulo  $E$ .*

La propriété de décroissance modulo est donnée par l'existence d'un étiquetage bien fondé sur les étapes de réécriture d'un  $(3, 2)$ -polygraphe linéaire  $(R, E, S)$ , pour lequel nous supposons que toutes les étiquettes sur les règles de  $E$  sont triviales, et vérifiant que les étiquettes sont strictement décroissantes sur les diagrammes de confluence modulo. Lorsque  ${}_{\mathbb{E}}R_{\mathbb{E}}$  quasi-terme, il existe un étiquetage particulier comptant la distance d'une 2-cellule à une quasi-forme normale choisie, c'est-à-dire une 2-cellule à partir de laquelle nous ne pouvons appliquer que des cycles de réécriture. La Proposition 5.4.6, établie dans [31], montre que la décroissance modulo ainsi que la confluence locale modulo peuvent être obtenues en prouvant que tous les branchements critiques modulo sont décroissants pour un tel étiquetage à la quasi-forme normale, ce qui revient à prouver leur confluence.

**Bases linéaires par confluence modulo.** Dans le Chapitre 5, nous prouvons comment obtenir une hom-base d'une  $(2, 2)$ -catégorie linéaire  $\mathcal{C}$  présentée par générateurs et relations, c'est à dire une famille d'ensembles  $(\mathcal{B}_{p,q})$  indexés par les couples  $(p, q)$  de 1-cellules de  $\mathcal{C}$  telle que  $\mathcal{B}_{p,q}$  est une base linéaire de l'espace vectoriel  $\mathcal{C}_2(p, q)$  des 2-cellules de  $\mathcal{C}$  ayant pour 1-source  $p$  et pour 1-but  $q$ . Rappelons que Alleaume a prouvé dans [2] qu'une telle hom-base peut être obtenue à partir d'une présentation finie convergente par un  $(3, 2)$ -polygraphe linéaire, en considérant l'ensemble des monômes en forme normale. Dans le cadre de réécriture modulo, il y a deux degrés de formes normales. Tout d'abord, nous supposons que le  $(3, 2)$ -polygraphe linéaire modulo  $(R, E, S)$  est soit normalisant, soit quasi-terminant, de telle sorte que chaque 2-cellule admette au moins une forme normale ou quasi-normale pour  $S$ . Par ailleurs, nous pouvons également considérer des formes normales pour le  $(3, 2)$ -polygraphe linéaire  $E$  des axiomes modulo, supposé convergent. Nous appelons alors forme normale pour  $(R, E, S)$  une 2-cellule apparaissant dans la décomposition monomiale de la forme normale relativement à  $E$  d'un monôme en forme normale relativement à  $S$ . En Section 5.4, nous prouvons qu'une hom-base peut alors être obtenue à partir d'un  $(3, 2)$ -polygraphe linéaire modulo satisfaisant une hypothèse de confluence modulo  $E$ . Plus précisément, considérons une  $(2, 2)$ -catégorie linéaire pivotale présentée par un  $(3, 2)$ -polygraphe linéaire  $P$ , et considérons un scindage convergent  $(R, E)$  de  $P$ , tel que défini en Section 5.4.1. Un tel scindage est donné par un couple de  $(3, 2)$ -polygraphes linéaires tel que  $E$  est convergent et contient tous les axiomes d'isotopie planaire de la structure pivotale, et  $R$  contient les autres relations. Cette donnée permet de considérer des polygraphes modulo  $(R, E, S)$ , et nous prouvons alors en Section 5.4 le théorème suivant:

**Théorème 5.4.4.** *Soit  $P$  un  $(3, 2)$ -polygraphe linéaire monomial à gauche présentant une  $(2, 2)$ -catégorie linéaire  $\mathcal{C}$ ,  $(E, R)$  un scindage convergent de  $P$  et  $(R, E, S)$  un  $(3, 2)$ -polygraphe linéaire modulo tel que*

- i)  $S$  est normalisant,
- ii)  $S$  est confluent modulo  $E$ ,

*alors l'ensemble des formes normales pour  $(R, E, S)$  est une hom-base de  $\mathcal{C}$ .*

Ce résultat est par ailleurs étendu dans le cadre quasi-terminant, en définissant une quasi-forme normale pour  $(R, E, S)$  comme étant un monôme apparaissant dans la décomposition monomiale de la  $E$ -forme normale de  $\bar{u}$ , où  $\bar{u}$  est une quasi-forme normale d'un monôme  $u$  fixée.

**Théorème 5.4.8.** *Avec les mêmes notations que dans le Théorème 5.4.4, si*

- i)  *$S$  est quasi-terminant,*
- ii)  *$S$  est confluent modulo  $E$ ,*

*l'ensemble des quasi-formes normales pour  $(R, E, S)$  est une hom-base de  $\mathcal{C}$ .*

## Catégorification du groupe quantique de Khovanov, Lauda et Rouquier

**Catégorification du groupe quantique.** Étant donnée une donnée de racines correspondant à une algèbre de Kac-Moody symétrisable  $\mathfrak{g}$ , Khovanov et Lauda ont défini dans [67] une 2-catégorie candidate pour catégorifier la version intégrale et idempotente de Lusztig du groupe quantique  $U_q(\mathfrak{g})$  associé à cette donnée de racines. Cette 2-catégorie, notée  $\mathcal{U}(\mathfrak{g})$ , est définie par générateurs et relations. Khovanov et Lauda ont prouvé [67, Theorems 1.1 & 1.2] que  $\mathcal{U}(\mathfrak{g})$  est bien une catégorification de  $U_q(\mathfrak{g})$  si le calcul diagrammatique introduit dans [67] est non-dégénéré, ce qui correspond au fait que chaque espace de 2-cellules dans  $\mathcal{U}(\mathfrak{g})$  admette une base linéaire explicite. Khovanov et Lauda ont prouvé cette non-dégénérescence pour des algèbres de Kac-Moody symétrisables de Type  $A$ , en construisant une 2-représentation de  $\mathcal{U}(\mathfrak{g})$  sur l'anneau de cohomologie de variétés de drapeaux, et en montrant que l'ensemble des relations était maximal et qu'il ne trivialisait pas la catégorie. La non-dégénérescence de ce calcul diagrammatique a ensuite été prouvée pour des données de racines de type fini et pour tout corps  $\mathbb{K}$  indépendamment par Kang et Kashiwara [66], et par Webster [121], via la non-dégénérescence de quotients cyclotomiques des algèbres KLR catégorifiant les modules de plus haut poids de  $U_q(\mathfrak{g})$ . Cependant, en type infini il existe des poids hors du cône de Tits pour lesquels les quotients cyclotomiques ne fournissent pas d'informations. Webster a introduit dans [122] des déploiements des algèbres KLR pour résoudre ce problème, et a ainsi prouvé cette non-dégénérescence dans le cas général. Dans ce travail, nous allons établir ce résultat en utilisant des techniques de réécriture modulo. Nous nous restreignons au cas des algèbres de Kac-Moody simplement lacées, c'est-à-dire des algèbres dont le graphe de Dynkin n'admet pas de boucles ni d'arêtes multiples. Dans le cas non simplement lacé, les relations définissant les algèbres KLR sont plus compliquées, les membres droits étant des polynômes contenant de nombreux monômes. Cependant, nous conjecturons que les méthodes présentées dans le Chapitre 6 s'étendent au cas général. Rouquier a défini dans [102] une 2-catégorie de Kac-Moody  $\mathcal{A}(\mathfrak{g})$ , admettant moins de 2-cellules génératrices que  $\mathcal{U}(\mathfrak{g})$ , de telle sorte que réécrire dans  $\mathcal{A}(\mathfrak{g})$  est plus adapté. Brundan a prouvé dans [20] que les deux 2-catégories  $\mathcal{U}(\mathfrak{g})$  et  $\mathcal{A}(\mathfrak{g})$  sont en réalité isomorphes. Ainsi, nous réécrivons dans la 2-catégorie  $\mathcal{A}(\mathfrak{g})$ , et translatons les calculs dans  $\mathcal{U}(\mathfrak{g})$  par cet isomorphisme afin de prouver la non-dégénérescence.

**Algèbres KLR.** Les algèbres KLR, également appelées algèbres de Hecke carquois, sont apparues dans ce processus de catégorification du groupe quantique. Elles ont été introduites indépendamment par Rouquier [102] et Khovanov et Lauda [71, 72] puisque la catégorie des modules projectifs finiment engendrés sur ces algèbres catégorifie la moitié négative du groupe quantique associé. De plus, ces algèbres agissent sur certains espaces de 2-cellules de la 2-catégorie  $\mathcal{U}(\mathfrak{g})$ , ou  $\mathcal{A}(\mathfrak{g})$ , de telle sorte que les relations de ces algèbres se retrouvent dans la 2-catégorie. Nous rappelons suivant [102] la présentation des algèbres  $(H_{\mathcal{V}}(Q))_{\mathcal{V} \in \mathbb{N}[I]}$ , où  $I$  est l'ensemble de sommets indexant le graphe de Dynkin de  $\mathfrak{g}$ , et nous spécialisons cette définition à la présentation diagrammatique de Khovanov et Lauda, notée  $(R(\mathcal{V}))_{\mathcal{V} \in \mathbb{N}[I]}$  dans le cas simplement lacé. Nous définissons une 2-catégorie  $\mathcal{C}^{\text{KLR}}$  contenant les algèbres KLR dans ses espaces de 2-cellules, et construisons une présentation polygraphique KLR de  $\mathcal{C}^{\text{KLR}}$ . Nous établissons alors le premier résultat principal de ce Chapitre:

**Théorème 6.1.6.** *Le  $(3, 2)$ -polygraphe linéaire KLR est une présentation convergente de la  $(2, 2)$ -catégorie linéaire  $\mathcal{C}^{KLR}$ .*

Par conséquent, nous obtenons des bases linéaires pour chaque algèbre  $R(\mathcal{V})$  en calculant les monômes en forme normale pour KLR. En particulier, nous retrouvons ainsi les bases linéaires décrites par Khovanov et Lauda dans [71, Theorem 2.5]. Nous prouvons suivant [102, Theorem 3.7], que ces bases sont des bases de Poincaré-Birkhoff-Witt.

**Non-dégénérescence du calcul diagrammatique de Khovanov et Lauda.** En Section 6.2, nous rappelons le théorème d'isomorphisme entre  $\mathcal{A}(\mathfrak{g})$  et  $\mathcal{U}(\mathfrak{g})$  établi par Brundan, avec la définition de nouveaux générateurs et relations dans  $\mathcal{A}(\mathfrak{g})$  induits par la définition de Rouquier. Nous prouvons ainsi des relations supplémentaires dans  $\mathcal{A}(\mathfrak{g})$ , afin d'obtenir des symétries dans l'ensemble de relations. Nous définissons alors une présentation polygraphique  $\mathcal{KLR}$  de  $\mathcal{A}(\mathfrak{g})$ , que nous scindons en deux parties comme dans le Chapitre 5: un  $(3, 2)$ -polygraphe linéaire  $E$  convergent contenant les 3-cellules d'isotopie et un  $(3, 2)$ -polygraphe linéaire  $R$  contenant les 3-cellules restantes. Nous prouvons alors le second résultat principal de ce Chapitre:

**Théorème 6.2.16.** *Soit  $(R, E)$  le scindage convergent de  $\mathcal{KLR}$  défini en Section 6.2.15. Alors le  $(3, 2)$ -polygraphe modulo  ${}_E R$  est quasi-terminant, et  ${}_E R$  est confluent modulo  $E$ .*

En conséquence, pour toutes 1-cellules  $E_i 1_\lambda$  et  $E_j 1_\lambda$  de  $\mathcal{U}(\mathfrak{g})$ , en considérant l'ensemble des monômes en quasi-forme normale, pour un choix de quasi-formes normales préétabli, avec 1-source  $E_i 1_\lambda$  et 1-but  $E_j 1_\lambda$ , et en prenant leurs formes normales relativement à  $E$ , nous obtenons une base linéaire de  $\mathcal{U}(\mathfrak{g})(E_i 1_\lambda, E_j 1_\lambda)$ . Par conséquent, nous obtenons le résultat suivant:

**Théorème 6.2.30.** *L'ensemble  $\mathcal{B}_{i,j,\lambda}$ , défini en Section 6.2.29, est une base linéaire de  $\mathcal{U}(\mathfrak{g})(E_i 1_\lambda, E_j 1_\lambda)$ .*

Nous prouvons alors, pour toutes 1-cellules  $i, j$  et pour tout  $\lambda$  dans  $X$ , que les ensembles  $\mathcal{B}_{i,j,\lambda}$  correspondent à un choix particulier de base candidate conjecturée par Khovanov et Lauda, voir [67, Section 3.2.3]. Ceci prouve la non-dégénérescence du calcul diagrammatique dans ce cadre, et donc que pour une algèbre de Kac-Moody symétrisable simplement lacée  $\mathfrak{g}$ , la  $(2, 2)$ -catégorie linéaire  $\mathcal{U}(\mathfrak{g})$  est une catégorification du groupe quantique intègre et idempotent  $U_q(\mathfrak{g})$  associé à  $\mathfrak{g}$ .

## Polygraphes algébriques et lemme des branchements critiques algébrique

Comme mentionné ci-dessus, et comme illustré dans les Chapitres 2, 4 et 5, de nombreux résultats de réécriture sont basés sur la notion de présentation confluite, ou confluite modulo. D'après ce qui précède, l'un des outils principaux pour prouver la confluence de systèmes de réécriture algébrique est le lemme des branchements critiques [76, 97], établissant que la confluence locale peut être obtenue par vérification (en général) finie de la confluence de chevauchements minimaux entre deux réductions. La notion de complétion par branchements critiques est une approche introduite au milieu des années soixante qui combine la notion de branchement critique avec les procédures de complétion [25]. Cette approche provient de la théorie de la preuve [101], de la théorie des idéaux dans des anneaux polynomiaux, [24], et du problème du mot [76, 97]. Dans les années quatre-vingt, sont apparues de nombreuses applications de ces approches en algèbre pour résoudre des problèmes de cohérence [111], ou encore pour calculer des invariants homologiques [110]. Plus récemment, des extensions en dimension supérieure ont été utilisées pour calculer des remplacements cofibrants de structures algébriques et catégoriques [53, 50]. Ces constructions basées sur la complétion par branchements critiques sont bien connues pour des monoïdes, des catégories (linéaires) de dimension supérieure, ou encore des algèbres sur un corps. Cependant, les extensions de ces méthodes à un champ de structures algébriques plus large est difficile de par l'interaction entre les règles du système de réécriture et les axiomes inhérents à la structure. Pour cette raison, les extensions de ces approches pour des structures telles que des groupes, ou des algèbres de Lie, est encore un problème ouvert.

**Lemme des branchements critiques.** Nivat a prouvé dans [97] que la confluence locale d'un système de réécriture de mots est décidable, que ce système soit terminant ou non. La preuve de ce résultat est basée sur la classification des branchements locaux, séparés en des branchements *orthogonaux*, impliquant deux règles qui ne chevauchent pas, et des *chevauchements*. Lorsque les branchements orthogonaux sont confluents, la locale confluence est vérifiée si tous les branchements critiques sont confluents. Ainsi, l'argument principal pour obtenir un lemme des branchements critique est de prouver que les branchements orthogonaux sont confluents, puis que les branchements critiques sont confluents. Pour des systèmes de réécriture de mots et de termes, les branchements orthogonaux sont toujours confluents, et la confluence des branchements critiques implique la confluence des chevauchements. La situation est plus compliquée pour des systèmes de réécriture dans une structure linéaire, comme expliqué dans la Section 2.9.1.

Les approches connues de réécriture dans un contexte linéaire consistent à orienter les règles relativement à un ordre monomial ambiant, et le lemme des branchements critiques est alors connu. Cependant, avec l'approche de réécriture linéaire introduite dans [50], il y a deux conditions supplémentaires à garantir pour obtenir un tel résultat, à savoir une restriction sur les réécritures et la terminaison. Une réduction positive pour un système de réécriture linéaire, telle que définie en Section 2.8.3, consiste en l'application d'une règle de réécriture sur un monôme qui n'apparaît pas dans le contexte polynomial. Par exemple, considérons suivant [50] le système de réécriture linéaire présentant l'algèbre associative sur un corps  $\mathbb{K}$  par générateurs  $x, y, z$  et relations  $\alpha : xy \rightarrow xz$  and  $\beta : zt \rightarrow 2yt$ . Il n'admet pas de branchement critique, mais il a un branchement orthogonal qui est non-confluent, voir Remarque 2.9.3, prouvant que l'absence de terminaison est une obstruction à la confluence des branchements orthogonaux.

**Lemme des branchements critiques algébrique.** Dans le Chapitre 7, nous introduisons un cadre catégorique pour réécrire dans des structures algébriques, qui formalise l'interaction entre les règles du système et les axiomes inhérents à la structure sous-jacente. En Section 7.1, nous rappelons la notion de 2-polygraphe cartésien, introduite dans [87], correspondant à des systèmes de réécriture présentant une théorie algébrique de Lawvere. Un 2-polygraphe cartésien définit ainsi une interprétation catégorique d'un système de réécriture de termes. Un tel objet est défini par une signature équationnelle  $(P_0, P_1)$  composée de types et d'opérations, et une extension cellulaire de la 1-théorie algébrique libre  $P_1^\times$  sur  $(P_0, P_1)$ . Nous définissons en Section 7.3 la structure de *polygraphe algébrique* comme une donnée comportant un 2-polygraphe cartésien, un ensemble  $Q$  de 1-cellules closes génératrices (appelées constantes) et une extension cellulaire  $R$  de la 1-sous-théorie des termes clos.

Nous introduisons un cadre algébrique adapté à la formulation d'un lemme des branchements critiques. Nous définissons la structure de polygraphe modulo, formalisant l'interaction entre les règles de réécriture et les axiomes de la structure, et introduisons des stratégies de réécriture basées sur le choix de certaines cellules admissibles, dont la nature dépend de la théorie algébrique sous-jacente. Nous introduisons ensuite des propriétés de réécriture relativement à ces stratégies, et prouvons une extension du lemme de Newman modulo du Chapitre 4 pour des polygraphes algébriques modulo quasi-terminants. Nous déduisons alors un lemme des branchements critiques sur des structures algébriques dont les axiomes sont spécifiés par des polygraphes cartésiens satisfaisant des hypothèses de confluence modulo associativité et commutativité des opérations. Enfin, nous instancions ces résultats dans le cadre de la réécriture linéaire, et expliquons pourquoi la terminaison est nécessaire pour caractériser la confluence locale dans ce cas.

## 1.1. ALGEBRAIC REWRITING AND CATEGORIFICATION

### Symbolic computation in representation theory

Symbolic computation is a field of mathematics and computer science that aims at developing and implementing algorithms that manipulate and analyze mathematical expressions. Many effective algorithms have been developed in order to solve complicated problems in numerous domains of mathematics. For instance, some methods have emerged in order to simplify structural expressions, to factorize some polynomials, to compute greatest common divisors and so on. In algebra, and in particular in representation theory, such tools are needed in order to study presentations of algebraic structures by generators and relations. In particular, the main questions about these presentations concern the computation of *syzygies*, that is relations among relations, or computations of linear bases. This work takes part of a project aiming at developing such constructive rewriting methods in order to study presentations by generators and relations of some algebras and 2-categories appearing in various domains of mathematics, especially in representation theory.

**1.1.1. Symbolic computation for linear structures.** In general, given an algebra admitting a presentation by generators and relations, it is not obvious to know how large this algebra is. Indeed, it may turn out that there are too many relations defining the algebra, so that it vanishes to zero. We often are able to find a set of words in the generators which span the algebra, and which we expect to be a basis. However, proving the linear independence of this set of monomials can be difficult, see [46] for some examples. In many cases, it is done by defining an action of the algebra on a polynomial ring on which the elements of the candidate basis act by linearly independent operators. For example, consider the standard action of the symmetric group  $S_n$  on a set of  $n$  elements, linearized to obtain a representation of the group algebra. It is clear that the action of distinct permutations is linearly independent, from which we deduce that a chosen set of reduced expression forms a basis. However, in general, defining such an action and proving that the operators obtained in this way are linearly independent may be complicated, see [58, 71] for some examples with Hecke algebras with 2 parameters or Khovanov-Lauda-Rouquier algebras. We show that this can be done using rewriting theory.

Many symbolic computation theories following the principles of rewriting were developed in numerous works in linear algebra. In particular, methods have been developed in order to compute normal forms for different types of algebras presented by generators and relations, with applications to the decision of the ideal membership problem, and to the construction of linear bases, such as Poincaré-Birkhoff-Witt bases. For example, Shirshov introduced in [108] an algorithm to compute a linear basis

of a Lie algebra presented by generators and relations, and deduced a constructive proof of the Poincaré-Birkhoff-Witt theorem. Gröbner basis theory was introduced to compute with ideals of commutative polynomial rings [24, 25, 26]. Buchberger described an algorithm to compute Gröbner bases from the notion of S-polynomials, using an analogous of Knuth-Bendix completion and the linear critical branching lemma described in this work. Bokut and Bergman have independently extended Gröbner bases to associative algebras with the proof of the composition lemma and the Bergman diamond lemma [13, 9]. All these results admit interpretations in the rewriting language developed in this work. The approach of Gröbner bases and Buchberger’s algorithm was extended by developing a rewriting theoretical approach to compute bases in associative algebras without any assumption of compatibility with respect to a well-founded total order on the monomials of the algebra, see [50].

**1.1.2. Diagrammatic algebras.** The main objective of this work is to develop effective tools to compute in diagrammatic algebras, that is algebras admitting presentations by generators and relations diagrammatically represented. Several families of algebras admitting diagrammatic presentations by generators and relations emerged in various domains of mathematics, such as Temperley-Lieb algebras [116] in quantum mechanics, Brauer algebras [15] for representation theory of the orthogonal groups, Birman-Wenzl algebras [12] or Jones’ planar algebras [59] in knot theory, or Khovanov-Lauda-Rouquier algebras [71, 102] in higher-representation theory.

As an example, let us consider, for a given field  $\mathbb{K}$ , the  $\mathbb{K}$ -algebra of the symmetric group  $S_n$  on  $n$  letters, denoted by  $\mathbb{K}[S_n]$ . Recall that  $S_n$  admits a Coxeter group presentation on  $n - 1$  generators  $s_i$ , for  $1 \leq i \leq n - 1$ , standing for the permutation  $(i \ i + 1)$ . It is subject to the following relations:

- i)  $s_i^2 = 1$  for  $1 \leq i \leq n - 1$ ,
- ii)  $s_i s_j = s_j s_i$  for any  $i, j$  such that  $|i - j| > 1$ ,
- iii)  $s_i s_{i-1} s_i = s_{i-1} s_i s_{i-1}$  for any  $2 \leq i \leq n - 1$ .

There is a classical way to represent a permutation  $w$  in  $S_n$  using the notion of *braid-like* diagram. This is a diagram, drawn in the strip of the plane  $\mathbb{R} \times [0, 1]$ , made of  $2n$  points arranged in two rows,  $n$  dots being on the line  $\mathbb{R} \times \{0\}$  and  $n$  dots being on the line  $\mathbb{R} \times \{1\}$ , in which a dot on the top line is linked by a strand to exactly one dot of the bottom line. In such a graphical representation, the generator  $s_i$  corresponds to a crossing of the strand numerated  $i$  from the right and the strand numerated  $i + 1$ , as follows:

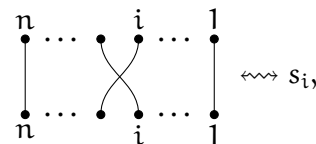

and multiplication corresponds, as usual, to vertical juxtaposition of diagrams. Therefore, the local relations i) – iii) also admit diagrammatic interpretations, represented below:

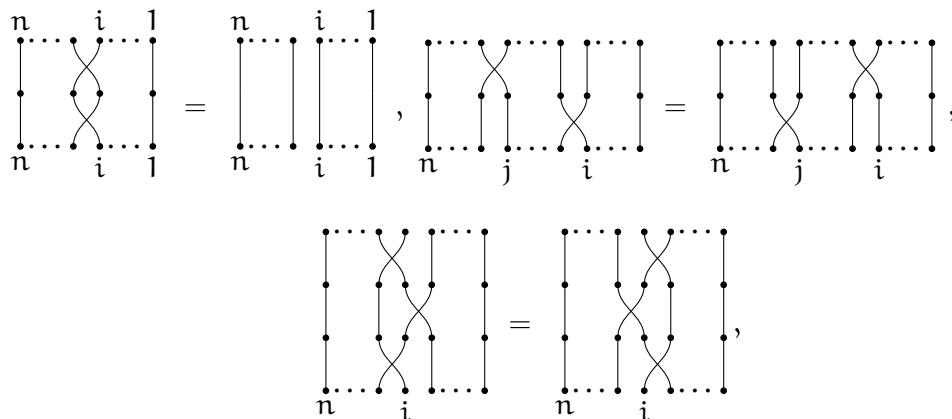

making  $\mathbb{K}[S_n]$  into a diagrammatic algebra. However, in order to study the family of algebras  $\mathbb{K}[S_n]$  for any  $n \in \mathbb{N}$ , it is quite inefficient to use these presentations for two reasons:

- 1) we have to consider the algebra  $\mathbb{K}[S_n]$  for any  $n \in \mathbb{N}$ , leading to an infinite number of algebras to study,
- 2) for the algebra  $\mathbb{K}[S_n]$ , there are a lot of relations to take into account, more than  $n^2$ .

It appears that there is a more efficient way to study this family of algebras: by realizing them as endomorphism spaces of a  $\mathbb{K}$ -linear monoidal category as follows. Let us consider the  $\mathbb{K}$ -linear monoidal category  $Sym$  with only one generating object denoted by  $\mathbf{1}$ , so that all the objects of  $Sym$  are of the form  $\mathbf{1}^{\otimes n}$  for any  $n \in \mathbb{N}$ , with  $\mathbf{1}^{\otimes 0}$  being the unit object, and only one generating 1-cell  $s : \mathbf{1} \otimes \mathbf{1} \rightarrow \mathbf{1} \otimes \mathbf{1}$ , subject to the following relations:

$$s \circ s = \mathbf{1} \otimes \mathbf{1}, \quad (s \otimes \mathbf{1}) \circ (\mathbf{1} \otimes s) \circ (s \otimes \mathbf{1}) = (\mathbf{1} \otimes s) \circ (s \otimes \mathbf{1}) \circ (\mathbf{1} \otimes s). \quad (1.1)$$

where by  $\mathbf{1}$  we also denote the identity 1-cell on  $\mathbf{1}$ . Then, note that  $\text{End}_{Sym}(\mathbf{1}^{\otimes n})$  is a  $\mathbb{K}$ -algebra that is isomorphic to  $\mathbb{K}[S_n]$ , so that we recover all the algebras of the symmetric groups inside the  $\mathbb{K}$ -linear monoidal category  $Sym$ . This presentation is more economical, since we have to study only one object, and this object only admits 3 relations.

Note that the diagrammatic algebras that we study either have a categorical structure by themselves, or can be realized as endomorphism spaces of linear categories in this way. In particular, we study a categorical structure called *linear (2, 2)-category*, that is 2-categories with a structure of vector space over a given field  $\mathbb{K}$  on each space of 2-cells between two 1-cells. When these categories admit only one 0-cell, this coincides with the notion of  $\mathbb{K}$ -linear monoidal category. The 2-cells in such a category admit a diagrammatic representation given by *string diagram* as follows:

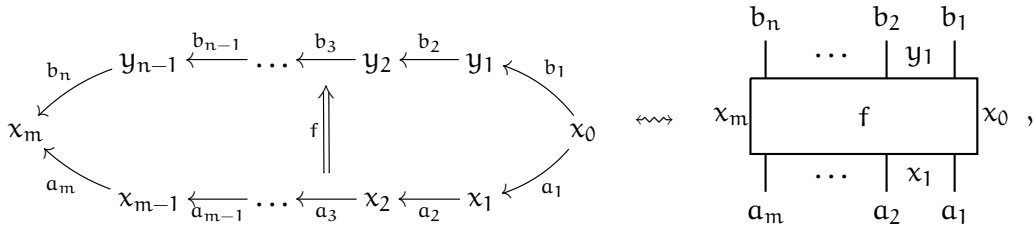

using the convention that string diagrams are read from right to left and from bottom to top. This allows us to consider computations on diagrams built from generating pieces. In the example above, the generating 2-cell (when  $Sym$  is interpreted as a linear (2, 2)-category with only one object) is diagrammatically represented by the following string diagram:

$$\begin{array}{c} \mathbf{1} \quad \mathbf{1} \\ \diagdown \quad \diagup \\ \bullet \\ \diagup \quad \diagdown \\ \mathbf{1} \quad \mathbf{1} \end{array} \quad (1.2)$$

When there is no ambiguity, we may omit dots and labels on 2-cells and on sources and targets, so that the 2-cell (1.2) is simply depicted by a crossing. The relations (1.1) are then depicted by

$$\begin{array}{c} \diagdown \quad \diagup \\ \diagup \quad \diagdown \\ \diagdown \quad \diagup \\ \diagup \quad \diagdown \end{array} = \begin{array}{c} | \quad | \\ | \quad | \end{array}, \quad \begin{array}{c} \diagdown \quad \diagup \\ \diagup \quad \diagdown \\ \diagdown \quad \diagup \\ \diagup \quad \diagdown \end{array} = \begin{array}{c} \diagdown \quad \diagup \\ \diagup \quad \diagdown \\ \diagdown \quad \diagup \\ \diagup \quad \diagdown \end{array}. \quad (1.3)$$

The category  $Sym$  admits only 2 relations and is relatively easy to study. However, in general, presentations of diagrammatic algebras admit a great number of relations, some of them being induced by the algebraic structure, needing appropriate computational methods.

**1.1.3. Categorification.** The term categorification was introduced by Crane in [35], following the ideas of a previous work with Frenkel [34]. It refers to the process of replacing set-theoretic notions by the corresponding category-theoretic analogues. In order to study a given object, the main objective is to define an higher-dimensional category corresponding in a suited way to this object, but admitting a richer structure, in order to see new phenomena appear. We expect to be able to obtain more information on the original object from this new structure. For instance, when we study the representations of an algebra, we study actions of the algebra on vector spaces via linear maps. In the process of higher-dimensional representation theory and categorification, vector spaces are replaced by higher-dimensional linear categories, linear maps are replaced by linear functors and equations between maps are replaced by natural transformations of functors, which are required to satisfy additional coherence laws. Therefore, elements of the algebra are not seen as elements anymore, but are considered as isomorphism classes of objects in a certain category, providing an additional structure from which we hope to deduce new information on the original algebra. For example, consider the set  $\mathbb{N}$  of natural numbers. This set can be categorified by the category **FinSet** of finite sets and functions, using cardinality, since two sets having the same cardinality are in bijection. The sum and product in  $\mathbb{N}$  then correspond to disjoint union and cartesian product in **FinSet** respectively. Whereas addition and multiplication in  $\mathbb{N}$  satisfy various equational laws such as commutativity, associativity and distributivity, disjoint union and cartesian product in **FinSet** satisfy such laws only up to natural isomorphisms.

Since the pioneering works of Crane and Frenkel, categorification appeared in various contexts, and helped to solve numerous complicated problems. For instance, Khovanov's categorification of the Jones' polynomial [68] using category theory and homological algebra led to new research directions in topology based on categorification. It completely changed the point of view on many long standing problems and led to new results. Numerous algebras studied in mathematics have been now categorified, for instance the Heisenberg rings [70], the Weyl algebras [69], polynomial algebras [74], the Hecke algebras with the category of Soergel bimodules [109], quantum groups [102, 67]. In representation theory, a lot of representations have also now a categorified version, such as representations of semi-simple Lie algebras and some representations of the associated Weyl groups using categories  $\mathcal{O}$  [11, 10], all finite-dimensional irreducible representations of the Lie algebras  $\mathfrak{sl}_m$  [5], or tensor products of fundamental representations of  $\mathfrak{sl}_m$  [115], for  $m \in \mathbb{N}$ . Moreover, a lot of categorifications have also emerged for several mathematical concepts, such as braid group actions [103] or invariants of tangle cobordisms [29]. We refer to [73, 90, 104] for other examples of new results coming from this area. Many of the categorifications mentioned above have been defined by presentations by generators and relations defined from diagrams that are represented up to planar isotopy. As a consequence, these 2-categories are endowed with an additional pivotal structure. Such a pivotal structure is defined from the existence of adjunctions on 1-cells, implying the existence of unit and counit 2-cells, diagrammatically represented by caps and cups satisfying isotopy relations. In this structure, two isotopic diagrams represent the same 2-cell [32], so that the computations are even more difficult to achieve. Many categorifications defined in the literature admit a pivotal structure, such as the category of  $\mathfrak{gl}_n$ -webs encoding the representation theory of the Lie algebra  $\mathfrak{gl}_n$  [30, 45], the Khovanov-Lauda-Rouquier 2-categorification of a quantum group [67, 102] and the Heisenberg categories categorifying the Heisenberg algebra [70].

## Rewriting theory

**1.1.4. Abstract rewriting systems.** The underlying notion beyond the theory of Gröbner bases and the works of Buchberger, Bergman, Bokut and Shirshov is actually the notion of presentation of an algebra by a convergent rewriting system. Rewriting theory is a combinatorial theory of equivalence classes, [96]. The first notion of abstract rewriting system was introduced by Thue in 1914 [118] to study the word problem in semi-groups, that is to decide whether two words made of the generators are equal or not modulo the relations of the semi-group. This method consists in orienting the relations of the semi-group and to study irreducible expressions, or *normal forms*. Afterwards, the word problem has been studied in many contexts in algebra and in computer science. On the other hand, rewriting has been mainly



developed in theoretical computer science, producing several variants corresponding to different objects being transformed, for instance: words in monoids [14, 54], terms in an algebraic theory [75, 6, 117],  $\lambda$ -terms, Boolean circuits [78], etc.

A class with respect to an equivalence relation is composed of pairs of objects that can be transformed one into another using sequences of non-oriented moves. Rewriting consists in orienting these moves. Explicitly, an *abstract rewriting system* is made of a set  $X$  of objects together with a subset  $R$  of  $X \times X$  whose elements  $(x, y)$  are denoted by  $x \rightarrow y$ . In that case, we say that  $x$  *rewrites* to  $y$ , or that  $x \rightarrow y$  is a *rewriting step* from  $x$  to  $y$ . A sequence

$$x_1 \rightarrow x_2 \rightarrow \dots \rightarrow x_n \rightarrow x_{n+1} \rightarrow \dots$$

of such rewriting steps is called a *rewriting sequence*. A rewriting system  $(X, R)$  is called *terminating* if there is no infinite rewriting sequence with respect to  $R$ . It is said to be *confluent* if for any *branching*, that is a pair of rewriting sequences starting from the same element, there exist rewriting sequences giving the same result, as summarized in the following diagram:

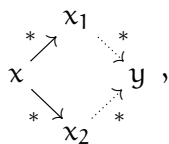

where  $\overset{*}{\rightarrow}$  denotes the reflexive and transitive closure of  $\rightarrow$ . When  $(X, R)$  is terminating, Newman's lemma [96] states that confluence can be obtained from *local confluence*, that is confluence of *local branchings* of the form  $x_1 \leftarrow x \rightarrow x_2$ . A normal form of  $(X, R)$  is an element of  $X$  that cannot be reduced by any rewriting step. A rewriting system is called *convergent* if it is both terminating and confluent. In that case, any element  $x$  admits a unique normal form.

**1.1.5. Algebraic rewriting and polygraphs.** Algebraic rewriting aims at giving constructive methods based on rewriting theory to obtain properties of higher algebraic structures presented by generators and relations. It consists in orienting relations, and applying rewriting theory by taking into account the axioms of the structure. In this context, there exists a local criterion to prove local confluence from confluence of minimal overlappings with respect to the structure between reductions, called *critical branchings*, [76, 97]. Together, these two results allow to deduce confluence from a local and finite analysis of branchings. For instance, in the case of the  $\mathbb{K}$ -linear monoidal category  $Sym$ , if we decide to orient the relations (1.3) from left to right, we have to examine all possible overlappings between the sources of the two reductions, such as for instance

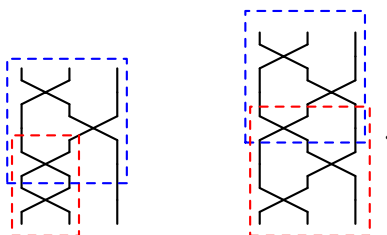

Convergent presentations have been widely used to obtain symbolic computational approaches to deduce homological properties by computing bases of syzygies, [24, 4, 77, 48, 55], or linear bases from normal forms when rewriting in linear structures, [108, 24, 13, 9, 93, 26, 50, 2]. In many constructions of this work, we study presentations of higher-dimensional categories by generating systems introduced independently by Burroni under the name of *polygraphs* [28] and by Street under the name of *computads* [112, 113], see also [54] for more details on rewriting properties of these presentations. Polygraphs have been used to compute coherent presentations of higher-dimensional categories [51], to obtain homological and homotopical properties using Squier's theorems [53, 54], to prove Koszulness property for algebras [50] or to compute explicit linear bases of algebras [50] or higher-dimensional linear categories [2].

**1.1.6. Coherence by confluence.** Rewriting theory is well-suited to compute *coherent presentations* of higher-dimensional categories. A coherent presentation of a  $n$ -category extends the notion of presentation of the  $n$ -category by an  $(n + 1)$ -polygraph by adding an acyclic cellular extension, that is a set of higher-globular cells that generate all the relations among relations of the presentation, so that the quotient of this category by the congruence generated by these cells is acyclic. When the  $n$ -polygraph is convergent, Squier’s coherence theorem [111, 51] states that it can be extended into a coherent presentation by adding generating  $(n + 1)$ -cells defined by a family of confluence diagrams of the form

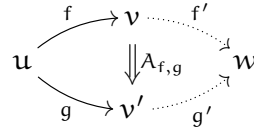

for every critical branching  $(f, g)$  of the  $n$ -polygraph  $P_n$ . Coherent presentations constructed in this way generalize rewriting systems by keeping track of the cells generated by confluence diagrams. This construction was initiated by Squier in [111] for monoids and generalized to  $n$ -categories in [51]. In the above dimensions, polygraphs can be used to compute cofibrant replacements of globular small strict categories [53], by gluing to a free category some spheres corresponding to diagrams of confluence of critical branchings, and then gluing spheres corresponding to confluence diagrams of triple critical branchings, and so on, constructing an  $\infty$ -globular set which admits the same homotopy type than the original category.

**1.1.7. Linear rewriting.** The context of linear rewriting introduced by Guiraud, Hoffbeck and Malbos in [50] for associative algebras has been extended to higher-dimensional linear categories by Alleaume [2]. In [2], many results have been established for linear  $(2, 2)$ -categories, admitting presentations by rewriting systems called linear  $(3, 2)$ -polygraphs. There are two main difficulties when rewriting in linear structures: first of all, we have to specify allowed rewriting steps in order to avoid non-termination due to the linear context, [50]. The second difficulty is that proving local confluence from confluence of critical branchings require a termination assumption, see [50, Section 4.2]. Indeed, some branchings that would be trivially confluent if all rewriting steps were allowed may become non-confluent because of this restriction, see Section 1.2.13 and Remark 2.9.3. More precisely, confluence of a terminating linear polygraph can be obtained by proving that all its critical branchings are confluent, see [2].

**1.1.8. Extension to rewriting modulo.** Rewriting modulo a set of equations extends these constructive methods by allowing to consider a set  $E$  of non-oriented relations in computations. It appears naturally in algebraic rewriting when studied reductions are defined modulo the axioms of an ambient algebraic structure, e.g. rewriting in commutative, groupoidal, linear, pivotal, weak structures. In the literature, three different paradigms of rewriting modulo are well-known. The most naive approach is to consider the rewriting system  ${}_E R_E$  consisting in rewriting on congruence classes modulo  $E$ . This approach works for some equational theories, such as associative and commutative theory. However, it appears inefficient in general for the analysis of confluence. Indeed, the reducibility of an equivalence class needs to explore all the class, hence it requires all equivalence classes to be finite. Another approach of rewriting modulo has been considered by Huet in [56], where rewriting sequences involve only oriented rules and no equivalence steps, and the confluence property is formulated modulo equivalence. Explicitely, sources and targets in confluence diagrams are not required to be equal but congruent modulo  $E$ , as summarized in the following diagram:

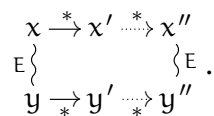

However, in an algebraic context, rewriting without allowing any  $E$ -steps in the rewriting paths may be too restrictive for computations, see [62]. Peterson and Stickel introduced in [99] an extension of Knuth-Bendix’s completion procedure, [76], to reach confluence of a rewriting system modulo an equational

theory, for which a finite, complete unification algorithm is known. They applied their procedure to rewriting systems modulo axioms of associativity and commutativity, in order to rewrite in free commutative groups, commutative unitary rings, and distributive lattices. Jouannaud and Kirchner enlarged this approach in [61] with the definition of rewriting properties for any rewriting system modulo  $S$  such that  $R \subseteq S \subseteq {}_E R_E$ . They also proved a critical branching lemma and developed a completion procedure for a rewriting system modulo  ${}_E R$ , whose one-step reductions consist in application of a rule in  $R$  using  $E$ -matching. Their completion procedure is based on a finite  $E$ -unification algorithm. Bachmair and Dershowitz in [7] developed a generalization of Jouannaud-Kirchner's completion procedure using inference rules. Several other approaches have also been studied for term rewriting systems modulo to deal with various equational theories, see [120, 89].

**1.1.9. Rewriting modulo isotopies in pivotal 2-categories.** In this work, many examples are based on rewriting modulo the pivotal axioms of pivotal linear 2-categories. Recall from [32] that in such a structure, two isotopic string diagrams represents the same 2-cells. We thus want to treat these axioms separately from the defining relations of the 2-category, and rewrite modulo these relations. This allows to deform a diagram up to isotopy in order to apply a rewriting rule on it, facilitating the computation of confluence.

## 1.2. THESIS SUMMARY AND MAIN CONTRIBUTIONS

**1.2.1. Subject of the thesis.** This thesis presents new effective tools to compute in presentations of various algebraic structures by generators and relations. In particular, we develop some tools to rewrite in string diagrammatic presentations of linear 2-categories using rewriting modulo, which extends the usual constructions in polygraphic rewriting theory [51, 53, 48, 54, 50, 2] by allowing a part of relations to be non-oriented, and to be considered as axioms that we freely use when rewriting. Among these new constructions arise the questions of computing syzygies from presentations which are confluent modulo a part of the axioms of the ambient algebraic structure, and mainly the question of computing linear bases of linear 2-categories when the usual methods of polynomial actions do not apply. We use these methods in order to prove the well-foundedness definition of some candidate categorifications.

**1.2.2. Structure of the thesis.** This manuscript is divided into eight chapters as follows. The first two chapters are preliminary chapters on rewriting theory and categorification in representation theory. In Chapter 2, we present rewriting theory (resp. linear rewriting theory) in higher dimensional categories (resp. higher-dimensional linear categories) using the notion of polygraphs (resp. linear polygraphs), and provide a state-of-the-art of the known rewriting results that we need in the sequel. In Chapter 3, we recall the idea beyond the process of categorification and how to explicitly construct such an object. We lay the emphasis on the construction of Khovanov-Lauda-Rouquier's categorification of a quantum group, leading to the definition of the KLR 2-category which is one of the main objects studied in this work. The next four chapters are dedicated to the main results of the thesis. In Chapter 4, we introduce a categorical context of rewriting modulo to study coherence problems, and we extend Squier's coherence theorem providing a method to compute coherent presentations of globular strict categories in the context of rewriting modulo. We illustrate the results of this chapter on commutative monoids and pivotal 2-categories. In Chapter 5, we prove that linear bases for the sets of 2-cells in  $(2, 2)$  linear categories can be computed from a presentation which satisfies an assumption of confluence modulo a part of the relations together with some termination assumption. This result extends the well-known rewriting result stating that from a convergent presentation of an algebra, monomials in normal form give a basis of the algebra. In Chapter 6, we illustrate this result on the KLR 2-categorification of a quantum group associated with a symmetrizable Kac-Moody algebra, proving that the sets expected by Khovanov and Lauda to be linear bases are indeed bases, implying the categorification theorem. In Chapter 7, we extend the constructions of rewriting modulo by defining algebraic polygraphs, which correspond to

rewriting systems modulo the axioms of an algebraic Lawvere theory. We thus prove that the termination assumption in the linear critical pair lemma comes from an algebraic critical branching lemma modulo. In Chapter 8, we describe the new directions of research suggested by these works and the current work in progress. Finally, Chapter 9 gives a catalogue of the numerous families of diagrammatic algebras and 2-categories that already have been studied using rewriting methods.

### Coherence modulo relations

We expect that the methods of [53] to construct cofibrant replacements of higher-dimensional categories can be extended to the context of rewriting modulo. The cubical shape of confluence diagrams suggest that we do not glue higher-dimensional spheres anymore, but higher-dimensional cubes. It turns out that the appropriate structure to present confluence and coherence results is the structure of free  $n$ -category enriched in  $p$ -fold groupoids, to take into account this cubical structure in the dimension of rewritings and in above dimensions. Chapter 4 presents the first step of such a construction, where we glue to a free double category enriched in double groupoids a family of squares corresponding to diagrams of confluence modulo of critical branchings modulo. We expect that gluing cubes corresponding to diagrams of confluence modulo of triple critical branchings should be the next step to construct a polygraphic modulo resolution of a category, and that similar constructions to [53] can be done in higher dimensions.

**1.2.3. Polygraphs modulo.** In Section 4.4 we introduce the notion of  $n$ -polygraph modulo as a data  $(R, E, S)$  made of two  $n$ -polygraphs  $R$  and  $E$  corresponding respectively to rewriting rules and axioms satisfying some compatibility conditions on cells of low dimensions and a cellular extension  $S$  depending on both cellular extensions  $R_n$  and  $E_n$ . We define termination and confluence properties for polygraphs modulo following Huet and Jouannaud-Kirchner's definitions. We present a completion procedure for the  $n$ -polygraph modulo  ${}_E R$  in terms of critical branchings that implements inference rules for completion modulo given by Bachmair and Dershowitz in [7], following Knuth-Bendix's completion procedure [76].

**1.2.4. Confluence modulo and double categories.** We extend the notion of coherent presentation of an  $(n - 1)$ -category, for  $n > 1$ , presented by an  $n$ -polygraph to the context of polygraphs modulo. We define a notion of coherence modulo using the structure of  $(n - 1)$ -category enriched in double groupoids. The notion of double category was first introduced by Ehresmann in [44] as an internal category in the category of categories. The notion of double groupoids, that is internal groupoids in the category of groupoids, and its higher-dimensional versions have been widely used in homotopy theory, [19, 17], see [18] and [16] for a complete account on the theory. A double category gives four related categories: a vertical category, an horizontal category and two categories of squares with either vertical or horizontal cells as sources and targets. A square cell  $A$  is pictured by

$$\begin{array}{ccc} u & \xrightarrow{f} & v \\ e \downarrow & \Downarrow A & \downarrow e' \\ u' & \xrightarrow{g} & v' \end{array}$$

where  $f, g$  are horizontal cells, and  $e, e'$  are vertical cells. In [51], rewriting sequences with respect to an  $n$ -polygraph are interpreted by  $n$ -cells in the free category generated by the polygraph. Following this idea, we give in Section 4.4 an interpretation of confluence and coherence modulo for  $n$ -polygraphs modulo in free  $(n - 1)$ -categories enriched in double groupoids, where the horizontal cells are the rewriting sequences with respect to  $S$ , the vertical cells are the  $E$ -equivalences and the square cells are the *coherence cells modulo*.

**1.2.5. Coherent confluence modulo.** The notion of coherent presentation modulo introduced in Chapter 4 is based on an adaptation of the structure of polygraph known in the globular setting, [112, 100, 28],

to a cubical setting. We thus define a *double*  $(n + 1, n - 1)$ -polygraph as a data  $P = (P^v, P^h, P^s)$  made of two  $n$ -polygraphs  $P^v$  and  $P^h$  with the same underlying  $(n - 1)$ -polygraph, together with a square extension  $P^s$  made of generating square cells of the form

$$\begin{array}{ccc} u & \xrightarrow{f} & u' \\ e \downarrow & & \downarrow e' \\ v & \xrightarrow{g} & v' \end{array}$$

where  $f, g$  are  $n$ -cells of the free  $(n, n - 1)$ -category  $(P^v)^\top$  generated by  $P^v$  and  $e, e'$  are  $n$ -cells of the free  $(n, n - 1)$ -category  $(P^h)^\top$  generated by  $P^h$ . We define a *double coherent presentation* of an  $(n - 1)$ -category  $\mathcal{C}$  as a double  $(n + 1, n - 1)$ -polygraph  $P = (P^v, P^h, P^s)$  such that  $\mathcal{C}$  is presented by the polygraph  $P^v \amalg P^h$ , and the square extension  $P^s$  is acyclic, that is for any square  $\mathbf{S}$  constructed with vertical cells in  $(P^v)^\top$  and horizontal cells in  $(P^h)^\top$ , there exists a square  $(n + 1)$ -cell  $A$  in the free  $(n - 1)$ -category  $P^\top$  enriched in double groupoids generated by  $P$ , defined in Subsection 4.2.7, whose boundary is  $\mathbf{S}$ .

In Section 4.5, we define the notion of confluence modulo of an  $n$ -polygraph modulo  $(R, E, S)$  with respect to a square extension  $\Gamma$  of the pair of  $n$ -categories  $(E^\top, S^*)$ . Explicitly, we say that  $S$  is  $\Gamma$ -confluent modulo  $E$  if for any branching  $(f, e, g)$  of  $S$  modulo  $E$ , there exist  $n$ -cells  $f', g'$  in  $S^*$ ,  $e'$  in  $E^\top$  and an  $(n + 1)$ -cell

$$\begin{array}{ccccc} u & \xrightarrow{f} & u' & \xrightarrow{f'} & w \\ e \downarrow & & \Downarrow A & & \downarrow e' \\ v & \xrightarrow{g} & v' & \xrightarrow{g'} & w' \end{array}$$

in a free  $(n - 1)$ -category enriched in double categories defined from  $\Gamma$  as in Section 4.5. We deduce coherent confluence of an  $n$ -polygraph modulo from local coherent confluence properties. In particular, Theorem 4.5.4 is a formulation of the Newman lemma for confluence modulo, stating that under termination of  ${}_{\varepsilon}R_E$ ,  $\Gamma$ -confluence modulo and local  $\Gamma$ -confluence modulo are equivalent properties. Finally, with Theorem 4.5.7 we give a coherent formulation of the critical branching lemma modulo, deducing coherent local confluence from coherent confluence of some critical branchings modulo.

**1.2.6. Coherent completion modulo.** In Section 4.6, we present several ways to extend a presentation of an  $(n - 1)$ -category by a polygraph modulo into a double coherent presentation of this category. Starting with an  $n$ -polygraph modulo, we show how to construct a double coherent presentation of the  $(n - 1)$ -category presented by this polygraph. Theorem 4.6.6 gives conditions for an  $n$ -polygraph modulo  $(R, E, S)$  to extend a square extension  $\Gamma$  on the vertical and horizontal  $(n, n - 1)$ -categories  $E^\top$  and  $S^\top$  into an acyclic extension. In Section 4.6.1, we define a *coherent completion* of an  $n$ -polygraph modulo  $(R, E, S)$  as a square extension of the pair of  $(n, n - 1)$ -categories  $(E^\top, S^\top)$  whose elements are the generating square  $(n + 1)$ -cells

$$\begin{array}{ccccc} u & \xrightarrow{f} & u' & \xrightarrow{f'} & w \\ e \downarrow & & \Downarrow & & \downarrow e' \\ \underline{u} & \xrightarrow{g} & v & \xrightarrow{g'} & w' \end{array}$$

for any critical branchings  $(f, e, g)$  of  $S$  modulo  $E$ . As a consequence of Theorem 4.6.6, we show how to extend a coherent completion  $\Gamma$  of  $S$  modulo  $E$  and a coherent completion  $\Gamma_E$  of  $E$  into an acyclic extension. In particular, when  $\bar{E}$  is empty, we recover Squier's coherence theorem for convergent  $n$ -polygraphs as given in [51, Theorem 5.2.], see also [53]. We prove in Theorem 4.6.12 that an acyclic extension of a pair  $(E^\top, S^\top)$  of  $(n, n - 1)$ -categories coming from a polygraph modulo  $(R, E, S)$  can also be obtained from an assumption of commuting normalization strategies for the polygraphs  $S$  and  $E$ .

**1.2.7. Globular coherence from double coherence.** In Section 4.7, we give a way to deduce a globular coherent presentation for an  $n$ -category from a double coherent presentation generated by a polygraph modulo. Our construction is based on the structure of *dipolygraph* as a presentation by generators and relations for  $\infty$ -categories whose underlying  $k$ -categories are not necessarily free, see Section 4.2. We define dipolygraphs as variations of polygraphs for which the cellular extensions are defined on quotients of free categories. In Section 4.2.15, we define a quotient functor  $V : \mathbf{DbPol}_{(n+2,n)} \rightarrow \mathbf{DiPol}_{(n+2,n)}$  from the category of double  $(n+2, n)$ -polygraphs to the category of  $(n+2, n)$ -dipolygraphs.

The last result of Chapter 4 gives the conditions on how to take the quotient of a double coherent presentation generated by a polygraph modulo when the  $n$ -polygraph  $E$  is convergent, and  $S$  is terminating and confluent modulo  $E$ . Theorem 4.7.3 shows how to deduce from a coherent completion  $\Gamma$  of  $S$  modulo  $E$  a globular coherent presentation of the  $(n-1)$ -category  $(\mathbb{R}_{n-1}^*)_E$ , whose generating  $n$ -cells are defined by quotienting the  $n$ -cells of  $\Gamma$  by the cellular extension  $E$ . Finally, we illustrate this method by showing how to construct coherent presentations for commutative monoids in Section 4.7.5 and for pivotal monoidal categories modulo isotopy relations defined by adjunction in Section 4.7.7.

### Linear bases from confluence modulo

As mentioned previously, many structural relations coming from the inherent structure of the diagrammatic algebras arising in representation theory may create obstructions to prove confluence, by leading to a huge number of critical branchings. One of the main objective of this work was then to extend the usual basis theorem given my monomials in normal form with respect to a convergent presentation to the context of rewriting modulo. In this setting, we want to weaken the whole confluence property to a property of confluence modulo these chosen axiomatic rules.

**1.2.8. Confluence modulo by decreasingness.** The polygraph modulo  ${}_E R_E$  may not terminate, and when it does the termination is in general difficult to prove. In particular, this is the case when considering linear  $(3, 2)$ -polygraphs modulo presenting pivotal linear  $(2, 2)$ -categories, due to the existence of 2-cells with source and target the same identity 1-cell, called *bubbles*. Indeed, Alleaume enlightened the fact that linear  $(2, 2)$ -categories with bubbles that can go through strands can in general not be enriched with a monomial order, so that they can not be presented by terminating rewriting systems, see [2]. Moreover, the cyclicity of a 2-cell with respect to the biadjunctions of the pivotal structure implies that the dot picturing this 2-cell can be moved around the cap and cup 2-cells, eventually creating rewriting cycles and making termination fail. However, even if  ${}_E R_E$  is not terminating, in many cases it will be quasi-terminating, that is all infinite rewriting sequences are generated by cycles. Following [31], the termination assumption for  ${}_E R_E$  can be weakened to a quasi-termination assumption, in order to prove confluence modulo of a linear  $(3, 2)$ -polygraph modulo  $(R, E, S)$  from confluence of its critical branchings modulo. We introduce in Section 5.2 a notion of decreasingness modulo for a linear  $(3, 2)$ -polygraph modulo following Van Oostrom's abstract decreasingness property [119]. We then establish the following result:

**Theorem 5.2.4.** *Let  $(R, E, S)$  be a left-monomial linear  $(3, 2)$ -polygraph modulo. If  $(R, E, S)$  is decreasing modulo  $E$ , then  $S$  is confluent modulo  $E$ .*

The property of decreasingness modulo is defined by the existence of a well-founded labelling on the rewriting steps of a linear  $(3, 2)$ -polygraph modulo  $(R, E, S)$ , for which we require that all labels on the cells of  $E$  are trivial, and such that labels are strictly decreasing on confluence modulo diagrams. When  ${}_E R_E$  is quasi-terminating, there exists a particular labelling counting the distance between a 2-cell and a fixed quasi-normal form, that is a 2-cell from which we can only apply rewriting cycles. Proposition 5.4.6, proved in [31], shows that we can obtain decreasingness by proving that all the critical branchings modulo  $E$  are decreasing with respect to any such quasi-normal form labelling.

**1.2.9. Linear bases from confluence modulo.** In Chapter 5, we give a way to compute a hom-basis of a linear  $(2, 2)$ -category  $\mathcal{C}$  presented by generators and relations, that is a family of sets  $(\mathcal{B}_{p,q})$  indexed by pairs  $(p, q)$  of 1-cells such that  $\mathcal{B}_{p,q}$  is a linear basis of the vector space  $\mathcal{C}_2(p, q)$  of 2-cells of  $\mathcal{C}$  with 1-source  $p$  and 1-target  $q$ . Recall that Alleaume proved that such a basis may be obtained from a finite convergent presentation, considering all the monomials in normal form, [2]. In the context of rewriting modulo, there are two different degrees of normal forms. First of all, we require that the linear  $(3, 2)$ -polygraphs modulo  $(R, E, S)$  is either normalizing or quasi-terminating so that one can either consider normal forms or quasi-normal forms with respect to  $S$ . Then, one can also consider normal forms with respect to the polygraph  $E$  for which we rewrite modulo, that we require to be convergent. We say that a normal form for  $(R, E, S)$  is a 2-cell appearing in the monomial decomposition of the  $E$ -normal form of a monomial in normal form with respect to  $S$ . In Section 5.4, we give a method to compute a hom-basis of a linear  $(2, 2)$ -category from an assumption of confluence modulo some relations. More precisely, we consider a pivotal linear  $(2, 2)$ -category  $\mathcal{C}$  presented by a linear  $(3, 2)$ -polygraph  $P$ , and  $(R, E)$  a convergent splitting of  $P$ , given by a couple of linear  $(3, 2)$ -polygraphs such that  $E$  is convergent and contains all the isotopy 3-cells corresponding to the pivotal axioms, and  $R$  contains the remaining relations, as defined in Section 5.4.1. This data allows to consider polygraphs modulo  $(R, E, S)$ , and we prove in Section 5.4 the following result:

**Theorem 5.4.4.** *Let  $P$  be a linear  $(3, 2)$ -polygraph presenting a linear  $(2, 2)$ -category  $\mathcal{C}$ ,  $(E, R)$  a convergent splitting of  $P$  and  $(R, E, S)$  a linear  $(3, 2)$ -polygraph modulo such that*

- i)  $S$  is normalizing,
- ii)  $S$  is confluent modulo  $E$ ,

*then the set of normal forms for  $(R, E, S)$  is a hom-basis of  $\mathcal{C}$ .*

This result is extended to the quasi-terminating setting, by defining a quasi-normal form for  $(R, E, S)$  as a monomial appearing in the monomial decomposition of the  $E$ -normal form of a monomial in the decomposition of  $\bar{u}$ , where  $\bar{u}$  is the fixed quasi-normal form of a monomial 2-cell  $u$ .

**Theorem 5.4.8.** *With the same assumptions as in Theorem 5.4.4, if*

- i)  $S$  is quasi-terminating,
- ii)  $S$  is confluent modulo  $E$ ,

*then the set of quasi-normal forms for  $(R, E, S)$  is a hom-basis of  $\mathcal{C}$ .*

## Khovanov-Lauda-Rouquier's categorification of quantum groups

**1.2.10. Categorification of quantum groups.** Given any root datum corresponding to a symmetrizable Kac-Moody algebra  $\mathfrak{g}$ , Khovanov and Lauda defined in [67] a candidate 2-category to be a categorification of Lusztig's idempotent and integral version of the quantum group  $U_q(\mathfrak{g})$  associated with this root datum. The 2-category  $\mathcal{U}(\mathfrak{g})$  is defined by a presentation by generators and relations. Khovanov and Lauda established [67, Theorems 1.1 & 1.2] that  $\mathcal{U}(\mathfrak{g})$  is a categorification of  $U_q(\mathfrak{g})$  if the diagrammatic calculus they introduce in [67] is non degenerated, which corresponds to the fact that each vector space of 2-cells in  $\mathcal{U}(\mathfrak{g})$  admits an explicit linear basis. They proved the non-degeneracy of their calculus for symmetrizable Kac-Moody algebras of type  $A$  by constructing an appropriate 2-representation of  $\mathcal{U}(\mathfrak{g})$  on the cohomology ring of flag varieties, by showing that no more relations can occur, and by proving that this set of relations does not collapse all the elements. The non-degeneracy of this diagrammatic calculus has then been proved for any root datum of finite type and any field  $\mathbb{K}$  independently by Kang and Kashiwara [66], and by Webster [121], using non-degeneracy of cyclotomic quotients of the KLR algebras categorifying highest-weight modules of  $U_q(\mathfrak{g})$ . However, in infinite types there are weights outside the Tits cone for which cyclotomic quotients provide no information. Webster introduced in

[122] unfurlings of the KLR algebras to solve this issue and to prove the non-degeneracy in the general case. In this work, we prove these results using rewriting methods. We restrict our study to the case of simply-laced symmetrizable Kac-Moody algebras, that is Kac-Moody algebras whose Dynkin graph does not admit loops nor multiple edges. In the non simply-laced setting, the relations coming from the KLR algebras are more complicated, their right hand-side being polynomials. However, we expect that these methods extend to the non simply-laced setting. Rouquier defined in [102] a Kac-Moody 2-category  $\mathcal{A}(\mathfrak{g})$ , which has less generating 2-cells than  $\mathcal{U}(\mathfrak{g})$ , so that rewriting in this 2-category is more adapted. Brundan proved in [20] that the two 2-categories  $\mathcal{U}(\mathfrak{g})$  and  $\mathcal{A}(\mathfrak{g})$  are isomorphic. Therefore, we use rewriting approaches to study  $\mathcal{A}(\mathfrak{g})$  and its diagrammatic presentation given by Brundan, and translate the computations in  $\mathcal{U}(\mathfrak{g})$  through this isomorphism in order to study the non-degeneracy.

**1.2.11. Khovanov-Lauda-Rouquier algebras.** The family of KLR algebras, also called quiver Hecke algebras, emerged in the process of categorifying quantum groups. These algebras were discovered independently by Rouquier [102], Khovanov and Lauda [71] since the category of finitely-generated projective modules over these algebras categorifies the negative part of the associated quantum group, [71, 72]. Furthermore, these algebras act on some endomorphism spaces of 2-cells of  $\mathcal{U}(\mathfrak{g})$ . We recall following [102] the presentation of the KLR algebras  $(H_{\mathcal{V}}(Q))_{\mathcal{V} \in \mathbb{N}[I]}$ , where  $I$  is the set of vertices indexing the Dynkin graph of the Kac-Moody algebra  $\mathfrak{g}$ , and we specialize this definition to Khovanov and Lauda's diagrammatic presentation, denoted by  $(R(\mathcal{V}))_{\mathcal{V} \in \mathbb{N}[I]}$  in simply-laced type. We also define a linear 2-category  $\mathcal{C}^{\text{KLR}}$  encoding the family of KLR algebras in its spaces of 2-cells, and we construct a polygraphic presentation KLR of  $\mathcal{C}^{\text{KLR}}$ . We then establish the first main result of this Chapter:

**Theorem 6.1.6.** *The linear  $(3, 2)$ -polygraph KLR is a convergent presentation of the linear 2-category  $\mathcal{C}^{\text{KLR}}$ .*

As a consequence, we obtain linear bases for each algebra  $R(\mathcal{V})$  by computing monomials in normal form with respect to KLR. In particular, we recover the linear bases described by Khovanov and Lauda in [71, Theorem 2.5]. Following [102, Theorem 3.7], we prove that these bases are Poincaré-Birkhoff-Witt bases.

**1.2.12. Non-degeneracy of Khovanov-Lauda's calculus.** In Section 6.2, we recall Brundan's isomorphism between the 2-categories  $\mathcal{A}(\mathfrak{g})$  and  $\mathcal{U}(\mathfrak{g})$  with the definition of the additional generators and relations provided by these. We prove some further relations in  $\mathcal{A}(\mathfrak{g})$  in order to obtain symmetries in the set of relations. We then define a polygraphic presentation  $\mathcal{KLR}$  of  $\mathcal{A}(\mathfrak{g})$ , that we split into two parts following the ideas of Chapter 5: a convergent linear  $(3, 2)$ -polygraph  $E$  containing all isotopy 3-cells and a linear  $(3, 2)$ -polygraph  $R$  containing the remaining 3-cells. We then prove the second main result of this Chapter:

**Theorem 6.2.16.** *Let  $(R, E)$  be the convergent splitting of  $\mathcal{KLR}$  defined in Section 6.2.15. Then  ${}_E R$  is quasi-terminating and  ${}_E R$  is confluent modulo  $E$ .*

As a consequence, for any 1-cells  $E_i 1_\lambda$  and  $E_j 1_\lambda$  of  $\mathcal{U}(\mathfrak{g})$ , fixing a set of monomials in quasi-normal forms with 1-source  $E_i 1_\lambda$  and 1-target  $E_j 1_\lambda$ , and taking their normal form with respect to  $E$  gives a linear basis of  $\mathcal{U}(\mathfrak{g})(E_i 1_\lambda, E_j 1_\lambda)$ . Therefore the following result holds:

**Theorem 6.2.30.** *The set  $\mathcal{B}_{\mathbf{i}, \mathbf{j}, \lambda}$ , defined in Section 6.2.29, is a linear basis of  $\mathcal{U}(\mathfrak{g})(E_i 1_\lambda, E_j 1_\lambda)$ .*

We prove that these sets  $\mathcal{B}_{\mathbf{i}, \mathbf{j}, \lambda}$  for any 1-cells  $\mathbf{i}, \mathbf{j}$  and any  $\lambda$  in  $X$  correspond to a particular choice for Khovanov and Lauda's expected bases, see [67, Section 3.2.3]. This proves the non-degeneracy of their diagrammatic calculus in that case, and thus that for a simply-laced symmetrizable Kac-Moody algebra  $\mathfrak{g}$ , the linear 2-category  $\mathcal{U}(\mathfrak{g})$  is a categorification of the Lusztig's quantum group  $U_q(\mathfrak{g})$  associated with  $\mathfrak{g}$ .



## Algebraic polygraphs and critical branching lemma

As explained above and illustrated in chapters 2, 4 and 5, many rewriting results are based on the notion of confluent (resp. confluent modulo) presentations. We have seen that one of the main tools to reach confluence for algebraic rewriting systems is the critical branching lemma, [76, 97], stating that local confluence can be obtained by a finite checking of minimal overlappings between two reductions. The critical pair completion (CPC) is an approach developed in the mid sixties that combines completion procedure and the notion of critical pair [25]. It originates from theorem proving [101], polynomial ideal theory [24], and the word problem [76, 97]. In the mid eighties, it has found deep applications in algebra to solve coherence problems [111], or to compute homological invariants [110]. More recently, higher-dimensional extensions of the CPC approach were used for the computation of cofibrant replacements of algebraic and categorical structures [53, 50]. These constructions based on CPC are known for monoids, small categories, and algebras over a field. However, the extension of these methods to a wide range of algebraic structures is made difficult because of the interaction between the rewriting rules and the inherent axioms of the algebraic structure. For this reason, the higher-dimensional extensions of the CPC approach for a wide range of algebraic structures, including groups, Lie algebras, is still an open problem.

**1.2.13. Critical branching lemma.** Nivat showed in [97] that the local confluence of a string rewriting system is decidable, whether it is terminating or not. The proof of this result is based on classification of the local branchings into *orthogonal* branchings, that involve two rules that do not overlap, and *overlapping* branchings. When the orthogonal branchings are confluent, if all critical branchings are confluent, then local confluence holds. Thus, the main argument to achieve critical branching lemma is to prove that orthogonal and overlapping branchings are confluent. For string and term rewriting systems, orthogonal branchings are always confluent, and confluence of critical branchings implies confluence of overlapping branchings. The situation is more complicated for rewriting systems on a linear structure, as explained in Section 2.9.1.

The well known approaches of rewriting in the linear context consist in orienting the rules with respect to an ambient monomial order, and critical branching lemma is well known in this context. However, with approach of linear rewriting where the orientation of rules does not depend of a monomial order introduced in [50], there are two conditions to guarantee a critical branching lemma, namely termination and positivity of reductions. A positive reduction for a linear rewriting system, as defined in Section 2.8.3, is the application of a reduction rule on a monomial that does not appear in the polynomial context. For instance, consider the linear rewriting system on an associative algebra over a field  $\mathbb{K}$  given in [50] defined by the rules  $\alpha : xy \rightarrow xz$  and  $\beta : zt \rightarrow 2yt$ . Following Remark 2.9.3, it has no critical branching, but one non-confluent orthogonal branching, proving that the lack of termination is an obstruction to confluence of orthogonal branchings.

**1.2.14. An algebraic critical branching lemma.** In Chapter 7, we introduce a categorical model for rewriting in algebraic structures which formalizes the interaction between the rules of the rewriting system and the inherent axioms of the algebraic structure. In Section 7.1, we recall the notion of cartesian 2-dimensional polygraph introduced in [87], corresponding to rewriting systems that present a Lawvere algebraic theory. A cartesian 2-polygraph defines a categorical interpretation of term rewriting systems. It is defined by an equational signature  $(P_0, P_1)$  made of sorts and operations, and a cellular extension of the free algebraic theory  $P_1^\times$  on  $(P_0, P_1)$ . One defines in Section 7.3 the structure of *algebraic polygraph* as a data made of a cartesian 2-polygraph  $P$  and a set  $Q$  of or generating ground 1-cells (or constants) and a cellular extension  $R$  on the set of ground 1-cells.

We introduce an algebraic setting for the formulation of the critical branching lemma. We define the structure of algebraic polygraph modulo which formalizes the interaction between the rules of the rewriting system and the inherent axioms of the algebraic structure. We introduce rewriting strategies based on the choice of only some rewriting steps, depending on whether their source is a normal form

or not with respect to the inherent algebraic axioms. We then introduce rewriting properties with respect to these strategies, and prove an extension of the terminating Newman lemma modulo proved in Chapter 4, for quasi-terminating algebraic polygraphs modulo. We then prove a critical branching lemma for algebraic polygraphs modulo. We deduce from this result a critical branching lemma for rewriting systems on algebraic structures whose axioms are specified by term rewriting systems satisfying appropriate convergence relations modulo associativity and commutativity. Finally, we explicit our results in linear rewriting, and explain why termination is a necessary condition to characterize local confluence in that case.

**Contents**

|            |   |           |
|------------|---|-----------|
| <b>2.1</b> | <b>Abstract rewriting</b> . . . . .                                     | <b>42</b> |
| <b>2.2</b> | <b>Confluence by decreasingness</b> . . . . .                           | <b>46</b> |
| <b>2.3</b> | <b>Abstract rewriting modulo</b> . . . . .                              | <b>49</b> |
| <b>2.4</b> | <b>Higher-dimensional polygraphs</b> . . . . .                          | <b>53</b> |
| <b>2.5</b> | <b>Critical branching lemma</b> . . . . .                               | <b>57</b> |
| <b>2.6</b> | <b>Examples</b> . . . . .   | <b>61</b> |
| <b>2.7</b> | <b>Linear rewriting</b> . . . . .                                       | <b>66</b> |
| <b>2.8</b> | <b>Rewriting in linear <math>(n + 1, n)</math>-polygraphs</b> . . . . . | <b>69</b> |
| <b>2.9</b> | <b>Linear critical branching lemma</b> . . . . .                        | <b>71</b> |

Rewriting theory is a combinatorial theory of equivalence classes, [96], allowing to transform one object into another by successive applications of moves, or oriented relations. It originates from combinatorial algebra, and was introduced by Thue when he considered systems of transformation rules on combinatorial objects such as strings, trees or graphs in order to solve the word problem. Rewriting tools have then been developed in many domains in theoretical computer science, and more recently in various algebraic contexts. Algebraic rewriting consists in studying presentations by generators and relations of algebraic structures by orienting the relations. Many constructions of this thesis are based on the notion of presentations of higher-dimensional globular strict categories (resp. linear categories) by generating systems called polygraphs, or computads, introduced independently by Burroni [28] and Street [112, 113].

This chapter is a preliminary chapter recalling all the rewriting properties of polygraphs and rewriting results that are used in the sequel. At first, we recall the notion of abstract rewriting system, that we see as a 1-polygraph consisting of a set of objects and a set of oriented relations between these objects. We introduce the abstract rewriting properties of termination, confluence, convergence and decreasingness in this context. We extend those definitions to the context of rewriting modulo some non-oriented relations. We then rise in dimensions by giving properties of presentations of higher-dimensional globular strict categories by higher-dimensional polygraphs, and give local criteria to reach confluence of these polygraphs from confluence of minimal overlappings of relations, called critical branchings. We then expand

these constructions in the dimensions of string rewriting systems (2-polygraphs) and of 2-categories with string diagrams (3-polygraphs).

In the last part of this Chapter, we recall following [50, 2] the linear rewriting theory. In particular, we define the notion of linear polygraphs as a presentation of higher-dimensional linear categories, and expand their rewriting properties, which differ from the non-linear case by the fact that we have to restrict the allowed reductions because of the linear context. We then recall from [50] the linear critical branching lemma.

## 2.1. ABSTRACT REWRITING

**2.1.1. Abstract rewriting systems.** An *abstract rewriting system* is a data made of a set  $X$  and a relation  $\rightarrow$  on  $X$ , that is a subset  $R$  of  $X \times X$  whose elements  $(x, y)$  are denoted by  $x \rightarrow y$ . In that case, we say that  $x \rightarrow y$  is a *rewriting step* from  $x$  to  $y$ .

Throughout this section, we fix  $(X, \rightarrow)$  an abstract rewriting system. The transitive (resp. transitive reflexive, symmetric transitive) closure of  $\rightarrow$  will be denoted by  $\xrightarrow{+}$  (resp.  $\xrightarrow{*}$ ,  $\xleftrightarrow{*}$ ). Thus recall that for any  $x$  and  $y$  in  $X$ , we have

i)  $x \xrightarrow{+} y$  if and only if there exists  $n \geq 1$  and a family  $(x_k)_{1 \leq k \leq n}$  of elements of  $X$  such that  $x = x_1$ ,  $y = x_n$  and  $x_k \rightarrow x_{k+1}$  for any  $0 \leq k \leq n - 1$ . If  $x \xrightarrow{+} y$ , we say that there  $x$  *rewrites* to  $y$ .

ii)  $x \xrightarrow{*} y$  if and only if  $x = y$  or  $x \xrightarrow{+} y$ . If  $x \xrightarrow{*} y$ , we say there there is a *rewriting sequence* from  $x$  to  $y$ .

iii)  $x \xleftrightarrow{*} y$  if and only if there exists  $n \geq 1$  and a family  $(x_k)_{1 \leq k \leq n}$  of elements of  $X$  such that

$$x = x_1 \xrightarrow{*} x_2 \xleftarrow{*} x_3 \xrightarrow{*} \dots \xrightarrow{*} x_n = y.$$

**2.1.2. 1-polygraphs.** The notion of abstract rewriting system can be encapsulated in the terminology of 1-polygraphs. A 1-polygraph is a direct graph  $P$ , that is it consists in a diagram of sets and maps

$$P_0 \begin{array}{c} \xleftarrow{t_0} \\ \xrightarrow{s_0} \end{array} P_1$$

where the set  $P_0$  correspond to the vertices of  $P$  and  $P_1$  are edges in  $P$ . The maps  $s_0$  and  $t_0$  are source and target maps of edges in  $P_1$ . The elements of  $P_i$  are called  $i$ -cells, for  $i = 0, 1$ . A 1-polygraph is said finite if it has finitely many 0-cells.

An abstract rewriting system  $(X, \rightarrow)$  can then be seen as a 1-polygraph whose 0-cells are the elements of  $X$  and whose 1-cells are edges with 1-source  $x$  and target  $y$  whenever  $x \rightarrow y$  in  $(X, \rightarrow)$ .

Let us now introduce some categorical material needed to introduce rewriting properties of 1-polygraphs that we use in the sequel. These definitions are expanded in the more general context of  $n$ -polygraphs in Section 2.4.3. Given a 1-polygraph  $P = (P_0, P_1)$ , the *free (1-)category generated by  $P$*  is the category denoted by  $P_1^*$  and defined as follows:

i) the 0-cells of  $P_1^*$  are the ones of  $P$ ,

ii) the 1-cells of  $P_1^*$  from  $x$  to  $y$  are the finite paths of  $P$ , i.e. the finite sequences

$$x \xrightarrow{u_1} x_1 \xrightarrow{u_2} x_2 \xrightarrow{u_3} \dots \xrightarrow{u_{n-1}} x_{n-1} \xrightarrow{u_n} y$$

of 1-cells of  $P$ . Such a path is said to be of *length*  $n$ , and we denote by  $\ell$  the length function.

iii) the composition of 1-cells is given by concatenation of paths, and the identities are the empty paths  $x \rightarrow x$ .

In this interpretation of an abstract rewriting system as a 1-polygraph, we have that  $x \xrightarrow{*} y$  if and only if there exists a 1-cell  $f : x \rightarrow y$  in  $P_1^*$ . This will still be denoted by  $x \xrightarrow{*} y$ . Therefore, a rewriting step corresponds to a 1-cell of  $P_1^*$  of length 1, we still denote by  $x \rightarrow y$  if there is a rewriting step with 0-source  $x$  and 0-target  $y$ . Similarly, the *free*  $(1, 0)$ -category generated by  $P$  is the 1-category denoted by  $P_1^\top$  whose 0-cells are the ones of  $P$ , and whose 1-cells with 0-source  $x$  and 0-target  $y$  are given by

$$P_1^\top(x, y) = (P_1 \amalg P_1^-)^*(x, y) / \text{Inv}(P_1),$$

where:

- i) the 1-polygraph  $P^-$  is defined from  $P$  by reversing its 1-cells, that is  $P^- = \{t_0(u) \rightarrow s_0(u) \mid u \in P_1\}$ .
- ii)  $\text{Inv}(P_1)$  is a cellular extension of  $(P_1 \amalg P_1^-)^*$ , as defined in Section 2.1.3, that contains the following families of relations for every 1-cell  $u : x \rightarrow y$  of  $P$ :

$$u \star_0 u^- \Rightarrow 1_{s_0(u)}, \quad u^- \star_0 u \Rightarrow 1_{t_0(u)},$$

where  $1_y$  denotes the identity 1-cell on the 0-cell  $y$ . In the quotient category  $P_1^\top(x, y)$ , the 1-cells  $u \star_0 u^-$  (resp.  $u^- \star_0 u$ ) and  $1_{s_0(u)}$  (resp.  $1_{t_0(u)}$ ) are thus equal.

Namely, there is a 1-cell in  $P_1^\top$  with 0-source  $x$  and 0-target  $y$  if and only if there exists a zigzag sequence

$$x \xrightarrow{u_1} x_1 \xleftarrow{u_2} x_2 \xrightarrow{u_3} \dots \xleftarrow{u_{n-2}} x_{n-2} \xrightarrow{u_{n-1}} x_{n-1} \xrightarrow{u_n} y,$$

where each  $u_i$  is a 1-cell of  $P_1^*$  for  $1 \leq i \leq n$ . We will recall more about  $(n, p)$ -categories in the sequel.

**2.1.3. Spheres and cellular extensions.** A *sphere* of a 1-category  $\mathcal{C}$  is a pair  $(u, v)$  of 1-cells  $u$  and  $v$  of  $\mathcal{C}$  such that  $s_0(u) = s_0(v)$  and  $t_0(u) = t_0(v)$ . Such 1-cells are said *parallel*. We denote by  $\text{Sph}(\mathcal{C})$  the set of all spheres of  $\mathcal{C}$ . The 1-cell  $u$  (resp.  $v$ ) is then called the *source* (resp. *target*) of the sphere  $(u, v)$ . A *cellular extension* of  $\mathcal{C}$  is a set  $\Gamma$  equipped with a map from  $\Gamma$  to  $\text{Sph}(\mathcal{C})$ . It is equivalent to the data of a set  $\Gamma$  and two maps  $s_1, t_1 : \Gamma \rightarrow \mathcal{C}$  satisfying the *globular relations*:

$$s_0 s_1 = s_0 t_1, \quad t_0 s_1 = t_0 t_1.$$

Note that the elements of such a cellular extension  $\Gamma$  can be seen as formal 2-cells tiling the corresponding spheres of  $\Gamma$ :

$$\begin{array}{ccc} & u & \\ & \curvearrowright & \\ x & & y \\ & \Downarrow \gamma & \\ & \curvearrowleft & \\ & v & \end{array} \quad \text{for } (u, v) \in \Gamma.$$

In the sequel, many rewriting properties of a 1-polygraph  $P$  are defined in terms of a cellular extension  $\Gamma$  of  $P_1^\top$ . We denote by  $\Gamma_2^\top$  the free  $(2, 1)$ -category generated by the  $(2, 1)$ -polygraph  $(P_0, P_1, \Gamma \cup \Gamma^-)$ , as defined in Section 2.4.6. Explicitly, the  $(2, 1)$ -category  $\Gamma_2^\top$  is the 2-category defined as follows:

- i) the 0-cells of  $\Gamma_2^\top$  are the ones of  $P$ ,
- ii) for any 0-cells  $x$  and  $y$  of  $P$ , the category  $\Gamma_2^\top(x, y)$  is defined as:
  - the free  $(1, 0)$ -category over the 1-polygraph whose 0-cells are the 1-cells in  $P_1^*(x, y)$ , and whose 1-cells are elements of the form

$$x' \xrightarrow{w} x \begin{array}{ccc} & u & \\ & \curvearrowright & \\ & \Downarrow \gamma & \\ & \curvearrowleft & \\ & v & \end{array} y \xrightarrow{w'} y'$$

with  $\gamma : u \Rightarrow v$  in  $\Gamma$  and  $w, w'$  in  $P_1^*$

- quotiented by the congruence generated by the cellular extension made of all the relations  $\alpha w v \star_1 u' w \beta \cong u w \beta \star_1 \alpha w v'$  for all  $\alpha : u \Rightarrow u'$  and  $\beta : v \Rightarrow v'$  in  $\Gamma$  and  $w \in P_1^*$  such that both sides are well-defined.

iii) for any 0-cells  $x, y$  and  $z$  of  $P$ , the composition functor  $\star_0$  is given by concatenation on 1-cells and, on 2-cells, as follows:

$$\begin{aligned} & (u_1 \alpha_1 u'_1 \star_1 \cdots \star_1 u_m \alpha_m u'_m) \star_0 (v_1 \beta_1 v'_1 \star_1 \cdots \star_1 v_n \beta_n v'_n) \\ &= u_1 \alpha_1 u'_1 v_1 s_1(\beta_1) v'_1 \star_1 \cdots \star_1 u_m \alpha_m u'_m v_1 s_1(\beta_1) v'_1 \star_1 u_m t_1(\alpha_m) u'_m v_n \beta_n v'_n. \end{aligned}$$

Let us also recall for the purposes of the following definitions that there are two ways to compose 1-cells in a 2-category:

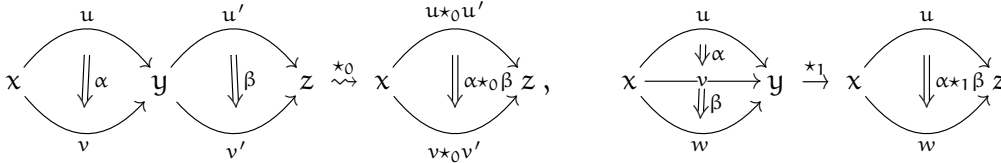

and that these compositions are required to satisfy the exchange relation, that is

$$(\alpha \star_1 \alpha') \star_0 (\beta \star_1 \beta') = (\alpha \star_0 \beta) \star_1 (\alpha' \star_0 \beta'). \quad (2.1)$$

We will give more details about the properties of globular strict  $n$ -categories and  $(n, p)$ -categories in Sections 2.4.1 and 2.4.5. For the rest of this section, let us fix a 1-polygraph  $P = (P_0, P_1)$ , and a cellular extension  $\Gamma$  of the free  $(1, 0)$ -category  $P_1^\Gamma$ .

**2.1.4. Normal forms and quasi-normal forms.** We say that a 0-cell  $x$  of  $P$  is a *normal form* if there does not exist  $y$  in  $X$  such that  $x \rightarrow y$ . A *normal form of a 0-cell*  $x$  is a normal form  $x'$  in  $P$  such that  $x \xrightarrow{*} x'$ . We say that  $P$  is *normalizing* if all 0-cells of  $P$  admit a normal form. We say that a 0-cell  $x$  in  $P$  is a *quasi-normal form* if for all 0-cell  $y$  in  $P$  such that  $x \rightarrow y$ , we have  $y \xrightarrow{*} x$ . A *quasi-normal form of*  $x$  in  $P_0$  is a quasi-normal form  $x' \in P_0$  such that  $x \xrightarrow{*} x'$ . We say that  $P$  is *quasi-normalizing* if all the 0-cells of  $P$  admit a quasi-normal form.

For instance, the 1-polygraph having  $P_0 = \{a, b\}$  as a set of 0-cells and two 1-cells  $\alpha : a \rightarrow b$  and  $\beta : b \rightarrow a$  is quasi-normalizing, since  $a$  (resp.  $b$ ) is a quasi-normal form of  $b$  (resp.  $a$ ). However,  $P$  is not normalizing since  $a$  does not admit any normal form.

**2.1.5. Termination and quasi-termination.** The 1-polygraph  $P$  is said to be *terminating* if there does not exist any sequence  $(u_k)_{k \in \mathbb{N}}$  such that  $u_k \rightarrow u_{k+1}$  for all  $k$ , namely if there does not exist any infinite rewriting sequence in  $P$ . It is said to be *quasi-terminating* if any infinite sequence  $(u_k)_{k \in \mathbb{N}}$  of 0-cells of  $P$  such that  $u_k \rightarrow u_{k+1}$  for all  $k$  contains infinitely many occurrences of the same 0-cell. In particular, a 1-polygraph is quasi-terminating if the only non-terminating derivations are provided by rewriting loops.

**2.1.6. Noetherian induction from termination.** If the 1-polygraph  $P$  is terminating, the relation  $\xrightarrow{+}$  is well-founded, that is there does not exist any infinite strictly decreasing sequence for this relation. So one can use proofs based on induction on this relation. This is called *noetherian induction*, and has been introduced by Huet in [56].

**2.1.7 Lemma.** *Any terminating abstract rewriting system is normalizing*

*Proof.* Proof is made using noetherian induction. Assume that  $P$  is terminating, and consider a 0-cell  $x$  in  $P_0$ . If  $x$  is a normal form, it is a normal form of  $x$ . Suppose that for any 0-cell  $x'$  in  $P_0$  such that  $x \xrightarrow{+} x'$ ,  $x'$  admits a normal form  $\hat{x}'$ . Then  $\hat{x}'$  is also a normal form of  $x$ .  $\square$

**2.1.8. Confluence and local confluence.** We say that  $P$  is  $\Gamma$ -confluent if for any 1-cells  $f : x \xrightarrow{*} y$  and  $g : x \xrightarrow{*} z$  in  $P_1^*$ , there exist 1-cells  $f'$  and  $g'$  in  $P_1^*$  and a 2-cell  $\gamma \in \Gamma^\top$  as depicted in the following diagram:

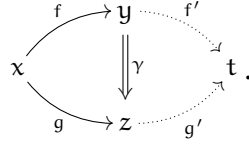

The pair of rewriting sequences  $(f, g)$  with the same 0-source  $x$  is called a *branching* of the 1-polygraph  $P$  with *source*  $x$ . Note that when  $\Gamma = \text{Sph}(P_1^*)$  the set of all 1-spheres in  $P_1^*$ , the existence of the 2-cell  $\gamma$  is trivial so that this property reduces to the existence of two rewriting sequences closing the branching  $(f, g)$ . The 1-polygraph  $P$  is said to be *confluent* if it is  $\text{Sph}(P_1^*)$ -confluent. The 1-polygraph  $P$  is said to be *locally confluent* if for rewriting steps  $f : x \rightarrow y$  and  $g : x \rightarrow z$ , there exists rewriting sequences  $f'$  and  $g'$  in  $P_1^*$  and a 2-cell  $\gamma$  in  $\Gamma^\top$  as above. Similarly, the pair of rewriting steps  $(f, g)$  is called a local branching is called a *local branching*, and  $P$  is said to be *locally confluent* if it is locally  $\text{Sph}(P_1^*)$ -confluent. We say that the triple  $(f', g', \gamma)$  is a  $\Gamma$ -confluence of the branching  $(f, g)$ .

**2.1.9 Remark.** In the sequel, we may use the notation  $(f : x \rightarrow y, g : x \rightarrow z)$  for both branchings and local branchings with source  $x$ , and omit the  $*$  on the arrows. However, we will precise the nature of the branching when referring to it, so that there is no ambiguity.

**2.1.10 Theorem** (Coherent Newman's lemma). *Consider a terminating 1-polygraph  $P$ , and  $\Gamma$  a cellular extension of  $P_1^\top$ . Then  $P$  is  $\Gamma$ -confluent if and only if it is locally  $\Gamma$ -confluent.*

*Proof.* If  $P$  is  $\Gamma$ -confluent, it is locally  $\Gamma$ -confluent. Conversely, let us assume that it is locally  $\Gamma$ -confluent, and pick a branching  $(f : x \rightarrow y, g : x \rightarrow z)$  of  $P$ . We prove the confluence of  $P$  by Noetherian induction. If  $x$  is a normal form of  $P$ , then  $x = y = z$ . Otherwise, choose some decompositions  $f = f_1 \star_0 f_2$  and  $g = g_1 \star_0 g_2$  where  $f_1$  and  $g_1$  are 1-cells of  $P_1^*$  of length 1, and  $f_2, g_2$  are in  $P_1^*$ . By local  $\Gamma$ -confluence of  $P$ , there exists a  $\Gamma$ -confluence  $(f'_1, g'_1, \gamma_1)$  of the local branching  $(f_1, g_1)$ . We then have  $f_1 : x \rightarrow t_0(f_1)$  and by induction hypothesis, there exists a  $\Gamma$ -confluence  $(f_3, h, \gamma_2)$  of the branching  $(f_2, f'_1)$  of  $P$ . By another application of the induction hypothesis on the branching  $(g_1 \star_0 h, g_2)$  of  $P$  with source  $t_0(g_1)$ , there exists a  $\Gamma$ -confluence  $(h', g_3, \gamma_3)$  of this branching. Finally, this yields a  $\Gamma$ -confluence of the branching  $(f, g)$  as summarized on the following diagram:

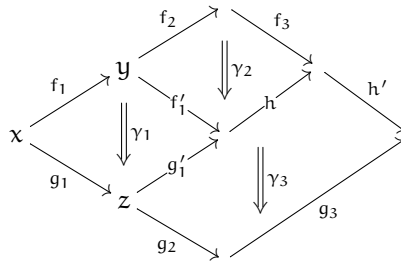

□

This theorem was originally proved by Newman in [96], and states that under a termination assumption, the confluence of an abstract rewriting system is equivalent to its local confluence.

**2.1.11. Church-Rosser's property.** The 1-polygraph  $P$  is said to be  $\Gamma$ -Church-Rosser if for any 1-cell  $h$  in  $P_1^\top$  with 0-source  $x$  and 0-target  $y$ , there exists 1-cells  $f$  and  $g$  in  $P_1^*$  and a 2-cell  $\gamma$  in  $\Gamma^\top$  as in the

following diagram:

$$\begin{array}{ccc}
 x & \xrightarrow{h} & y \\
 & \searrow f & \swarrow g \\
 & & z
 \end{array}
 \quad \Downarrow \gamma
 \quad (2.2)$$

**2.1.12 Theorem.** A 1-polygraph  $P$  is  $\Gamma$ -confluent if and only if it is  $\Gamma$ -Church-Rosser.

*Proof.* By definition, if  $P$  is  $\Gamma$ -church Rosser, it is  $\Gamma$ -confluent by considering a 1-cell  $h$  of the form  $x \xleftarrow{h_1} x_0 \xrightarrow{h_2} y$ . Let us now assume that  $P$  is  $\Gamma$ -confluent, and consider a 1-cell  $h$  in  $P_1^\top$  with 0-source  $x$  and 0-target  $y$ . Let us proceed by induction on the smallest  $n$  such that there exists a sequence  $(x_k)_{1 \leq k \leq n}$  of elements of  $X$  such that

$$x = x_1 \leftrightarrow x_2 \leftrightarrow \cdots \leftrightarrow x_{n-1} \leftrightarrow x_n = y,$$

where  $x_i \leftrightarrow x_{i+1}$  means that either  $x_i$  reduces into  $x_{i+1}$  or  $x_{i+1}$  reduces into  $x_i$  with respect to  $P$ . We show that there exists positive 1-cells  $f : x \rightarrow z$  and  $g : y \rightarrow z$  in  $P_1^*$  and a 2-cell  $\gamma$  as in (2.2). If  $n = 0$ , then  $x = y$  and we can choose identity cells. If  $n > 0$ , using induction hypothesis there exists rewriting steps  $f' : x \rightarrow t$  and  $g' : x_{n-1} \rightarrow t$  in  $P_1^*$ , and a 2-cell  $\delta$  as below. We then distinguish between two cases: if  $y \xrightarrow{h_{n-1}} x_{n-1}$ , then we choose the rewriting steps  $(f', h_{n-1} \star_0 g')$  and construct the 2-cell  $\gamma$  as in Case 1 below. If  $x_{n-1} \rightarrow y$ , we use  $\Gamma$ -confluence to prove the  $\Gamma$ -Church-Rosser property as depicted in Case 2 below.

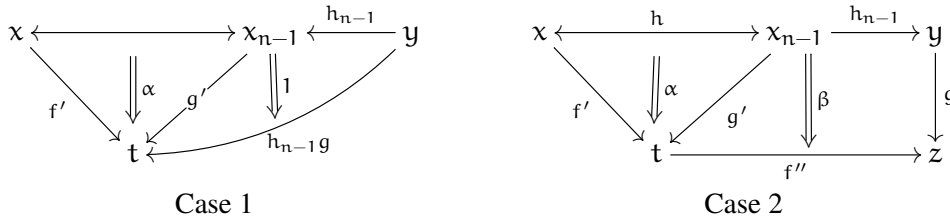

□

**2.1.13. Convergence.** We say that a 1-polygraph  $P$  is *convergent* if it is both terminating and confluent. If  $P$  is convergent, any 0-cell of  $P$  admits a unique normal form. Indeed, it is in particular terminating and thus normalizing by Lemma 2.1.7. Thus, any 0-cell of  $P$  admits at least one normal form, and if it admits two normal forms  $x_1$  and  $x_2$ , then confluence imposes that  $x_1 = x_2$ .

## 2.2. CONFLUENCE BY DECREASINGNESS

**2.2.1. Labelled polygraphs.** A *well-founded labelled 1-polygraph* is a data  $(P, X, <, \psi)$  made of:

- i) a 1-polygraph  $P$ ;
- ii) a set  $X$ ;
- iii) a well-founded order  $<$  on  $X$ ;
- iv) a map  $\psi$  which associates to each rewriting step  $f$  of  $P$  an element  $\psi(f)$  of  $X$  called the label of  $f$ .

The map  $\psi$  is called a *well-founded labelling* of  $P$ . Given a rewriting sequence  $f = f_1 \star_1 \dots \star_1 f_k$ , we denote by  $L^X(f)$  the set  $\{\psi(f_1), \dots, \psi(f_k)\}$ .



**2.2.2. Labelling to the normal form.** Let  $P$  be a terminating 1-polygraph, then from Lemma 2.1.7 any 0-cell of  $P$  admits a normal form with respect to  $P$ . For any 0-cell  $u$  in  $P_0$ , fix a normal form  $\hat{u}$  of  $u$  with respect to  $P$  such that  $d(u, \hat{u})$ , denoting the length of the shortest rewriting sequence from  $u$  to  $\hat{u}$ , is minimal. The *labelling to the normal form* is the map that associates to any rewriting step  $f$  of  $P$  the integer  $d(t_0(f), \widehat{t_0(f)})$ . Note that all the proofs made using Noetherian induction defined in Section 2.1.6 can be formalized as proofs by induction on the normal form labelling of the 1-polygraph  $P$ .

**2.2.3. Labelling to the quasi-normal form.** Let  $P$  be a quasi-terminating 1-polygraph. Then any 0-cell of  $P$  admits a quasi-normal form with respect to  $P$ . Let us fix a family of quasi-normal forms  $Q$  such that any 0-cell in  $P_0$  rewrites into a 0-cell of  $Q$ . For each  $u$  in  $P_0$ , let us choose  $\tilde{u}$  a quasi-normal form of  $u$  in  $Q$  such that  $d(u, \tilde{u})$  is minimal. The *labelling to the quasi-normal form* is the map that associates to any rewriting step  $f$  of  $P$  the integer  $d(t_0(f), \widehat{t_0(f)})$ .

**2.2.4. Multiset ordering.** Recall that a *multiset* is a collection in which elements are allowed to occur more than once or even infinitely many times, contrary to an usual set. It is called *finite* when every element appears a finite number of times. These multisets are equipped with three operations: union  $\cup$ , intersection  $\cap$  and difference  $-$ .

Given a well-founded set of labels  $(X, <)$ , we denote by  $\vee x$  the multiset  $\{y \in X \mid y < x\}$  for any  $x$  in  $X$ , and by  $\vee M$  the multiset

$$\bigcup_{x \in M} \vee x$$

for any multiset  $M$  over  $X$ . The order  $<$  extend to a partial order  $<_{\text{mult}}$  on the multisets over  $X$  defined by  $M <_{\text{mult}} N$  if there exists multisets  $M_1, M_2$  and  $M_3$  such that

- i)  $M = M_1 \cup M_2, N = M_1 \cup M_3$  and  $M_3$  is not empty,
- ii)  $M_2 \subseteq \vee M_3$ , that is for every  $x_2$  in  $M_2$ , there exists  $x_3$  in  $M_3$  such that  $x_2 < x_3$ .

Following [41], if  $<$  is well-founded, then so is  $<_{\text{mult}}$ . Let us recall the following lemma from [119, Lemma A.3.10] establishing the properties of the operations on multisets, needed to prove confluence from decreasingness:

**2.2.5 Lemma.** *For any multisets  $M, N$  and  $S$ , the following properties hold:*

- i)  $\cup$  is commutative, associative and admits  $\emptyset$  as unit element,
- ii)  $\cup$  is distributive over  $\cap$ ,
- iii)  $S \cap (M \cup N) = (S \cap M) \cup (S \cap N)$ ,      vii)  $(M \cup N) - S = (M - S) \cup (N - S)$ ,
- iv)  $M \cap (N - S) = (M \cap N) - (M \cap S)$       viii)  $(M - N) - S = M - (N \cup S)$ ,
- v)  $(M \cap N) - S = (M - S) \cap (N - S)$ ,      ix)  $M = (M \cap N) \cup (M - N)$ ,
- vi)  $(S \cup M) - N = (S - N) \cup (M - N)$ ,      x)  $(M - N) \cap S = (M \cap S) - N$ .

**2.2.6. Lexicographic maximum measure.** Let  $(P, X, <, \psi)$  be a well-founded labelled 1-polygraph. Let  $x = x_1 \dots x_n$  and  $x' = x'_1 \dots x'_m$  be two elements in the free monoid  $X^*$ . We denote by  $x^{(x')}$  the 1-cell  $\bar{x}_1 \dots \bar{x}_n$  where each  $\bar{x}_i$  is defined as

- 1 if  $x_k < x'_j$  for some  $1 \leq m$ ;
- $x_k$  otherwise.

Following [119], we consider the measure  $|\cdot|$  from  $X^*$  to the set of multisets over  $X$  and defined as follows:

- i) for any  $x$  in  $X$ , the multiset  $|x|$  is the singleton  $\{x\}$ .
- ii) for any  $i$  in  $X$  and any element  $x$  of  $X^*$ ,  $|ix| = |i| \cup |x^{(i)}|$ .

This measure is extended to the set of finite rewriting sequences of  $P$  by setting for every rewriting sequence  $f_1 \star_1 \dots \star_n f_n$ :

$$|f_1 \star_1 \dots \star_n f_n| = |k_1 \dots k_n|$$

where each  $f_i$  is labelled by  $k_i$  and  $k_1 \dots k_n$  is a product in the monoid  $X^*$ . Finally, the measure  $|\cdot|$  is extended to the set of finite branchings  $(f, g)$  of  $P$  by setting  $|(f, g)| = |f| \cup |g|$ .

Recall from [119, Lemma 3.2] that for any elements  $x_1$  and  $x_2$  in  $X^*$ , we have

$$|x_1 x_2| = |x_1| \cup |x_2^{(x_1)}|$$

and as a consequence, for any rewriting sequences  $f$  and  $g$  of  $P$ , the following relations hold:

$$|f \star_1 g| = |f| \cup |k_1 \dots k_m^{(l_1 \dots l_n)}|$$

where  $f = f_1 \star_0 \dots \star_0 f_n$  (resp.  $g = g_0 \star_0 \dots \star_0 g_m$ ) and each  $f_i$  (resp.  $g_j$ ) is labelled by  $l_i$  (resp.  $k_j$ ).

**2.2.7. Decreasingness.** Recall from [119, Definition 3.3] the definition of a decreasing confluence diagram. Let  $(P, X, <)$  be a well-founded labelled 1-polygraph. A local branching  $(f, g)$  of  $P$  is decreasing if there exists a confluence diagram of the following form

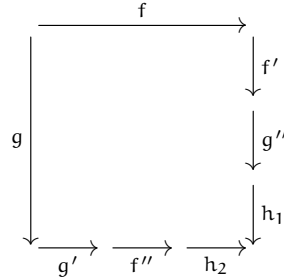

such that the following properties hold:

- i)  $k < \psi(f)$  for all  $k$  in  $L^X(f')$ .
- ii)  $k < \psi(g)$  for all  $k$  in  $L^X(g')$ .
- iii)  $f''$  is an identity or a rewriting step labelled by  $\psi(f)$ .
- iv)  $g''$  is an identity or a rewriting step labelled by  $\psi(g)$ .
- v)  $k < \psi(f)$  or  $k < \psi(g)$  for all  $k$  in  $L^X(h_1) \cup L^X(h_2)$ .

Such a 1-polygraph  $P$  is said to be *decreasing* if all its local branchings are decreasing. Following [119] and by Lemma 2.2.5, one may prove the following two lemmas needed in order to establish Theorem 2.2.10.

**2.2.8 Lemma.** *Let  $(P, X, <, \psi)$  be a decreasing labelled 1-polygraph. For every diagram of the following form*

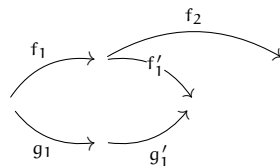

where  $f_1$  is a non trivial rewriting sequence,  $f_2$  and  $g_1$  are rewriting sequences and the confluence diagram  $(f_1 \star_0 f'_1, g_1 \star_0 g'_1)$  is decreasing, then the inequality  $|(f'_1, f_2)| \leq_{mult} |(g_1, f_1 \star_0 f_2)|$  holds.

**2.2.9 Lemma.** Let  $(P, X, <, \psi)$  be a decreasing labelled 1-polygraph. For every diagram of the following form

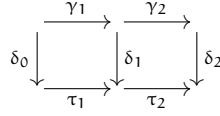

satisfying:

$$|\delta_0 \star_0 \tau_1| \leq_{mult} |(\delta_0, \gamma_1)|, \quad |\gamma_1 \star_0 \delta_1| \leq_{mult} |(\delta_0, \gamma_1)|, \quad |\delta_1 \star_0 \tau_2| \leq_{mult} |(\delta_1, \gamma_2)|, \quad |\gamma_2 \star_0 \delta_2| \leq_{mult} |(\delta_1, \gamma_2)|,$$

the following inequalities hold:

$$|\delta_0 \star_0 \tau_1 \star_0 \tau_2| \leq_{mult} |(\delta_0, \gamma_1 \star_0 \gamma_2)| \text{ and } |\gamma_1 \star_0 \gamma_2 \star_0 \delta_2| \leq_{mult} |(\delta_0, \gamma_1 \star_0 \gamma_2)|.$$

**2.2.10 Theorem** (Confluence from decreasingness, Thm 2.3.5 [119]). Any decreasing 1-polygraph is confluent.

*Proof.* Let  $(P, X, <)$  be a decreasing labelled 1-polygraph, and let  $(f, g)$  be a non trivial branching of  $P$ . We proceed by well-founded induction on the order  $<_{mult}$  on the labellings of branchings. Let us prove that  $(f, g)$  can be completed into a confluence  $(f', g')$  such that

$$|f \star_0 f'| \leq_{mult} |(f, g)|, \quad |g \star_0 g'| \leq_{mult} |(f, g)|. \quad (2.3)$$

Let us choose some decompositions  $f = f_1 \star_0 f_2$  and  $g = g_1 \star_0 g_2$  where  $f_1$  and  $g_1$  are rewriting steps of  $P$  and  $f_2, g_2$  are 1-cells of  $P_1^*$ . By decreasingness assumption, there exists a decreasing confluence  $(f'_1, g'_1)$  of the local branching  $(f_1, g_1)$ . Then, using induction on the branching  $(f_2, f'_1)$  whose labelling is smaller than  $|(f_1, g_1)|$  by decreasingness, we construct a decreasing confluence  $(f_3, f''_1)$  of the branching  $(f'_1, f'_2)$ . Now, using Lemma 2.2.8, we have  $|(g_2, g'_1 \star_0 f''_1)| <_{mult} |(f, g)|$  so that we can use induction on the branching  $(g_2, g'_1 \star_0 f''_1)$  to construct a confluence of  $(f, g)$ , which satisfies some inequalities of the form (2.3) using Lemmas 2.2.8 and 2.2.9. This is summarized in the following picture:

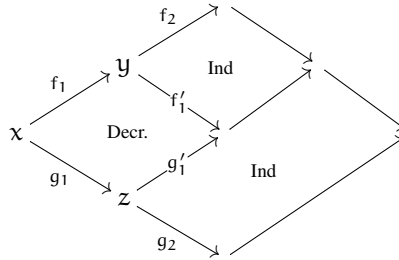

□

## 2.3. ABSTRACT REWRITING MODULO

**2.3.1. Abstract rewriting systems modulo.** Let us consider a set  $X$  and two binary relations  $\rightarrow_R$  and  $\rightarrow_E$  on  $X$ . In the sequel,

1.  $(X, \rightarrow_R)$  will be an abstract rewriting system, and reductions with respect to  $\rightarrow_R$  are oriented, that is they have a distinguished source and a distinguished target.
2.  $(X, \rightarrow_E)$  will be considered as a set of non-oriented equations on the set  $X$ , forgetting which side is the source and which side is the target.

Let us denote by  $\sim$  the congruence generated by  $E$ , that is  $\sim = \leftrightarrow_E^*$  and by  $\vdash$  the one-step congruence of  $\sim$ , that is for any  $x$  and  $x'$  in  $X$ ,

$$x \vdash x' \text{ if and only if } x \rightarrow_E x' \text{ or } x \leftarrow_E x'.$$

**2.3.2 Example.** Given a set  $X$  and two binary relations  $\rightarrow_R$  and  $\rightarrow_E$  on  $X$ , we consider three prototypical examples of abstract rewriting systems built from this data:

- i) The rewriting system  ${}_E R_E$  that consists in rewriting with  $\rightarrow_R$  on  $E$ -equivalence classes, that is  $x \rightarrow_{{}_E R_E} y$  if and only if  $\exists x', y' \in X$  such that  $x \sim x', y \sim y'$  and  $x' \rightarrow_R y'$ .
- ii) The rewriting system  ${}_E R$  that consists in rewriting with  $\rightarrow_R$  with  $E$ -matching on the sources of reductions:  $x \rightarrow_{{}_E R} y$  if and only if  $\exists x' \in X$  such that  $x \sim x'$  and  $x' \rightarrow_R y$ .
- iii) The rewriting system  $R_E$  that consists in rewriting with  $\rightarrow_R$  with  $E$ -matching on the targets of reductions:  $x \rightarrow_{R_E} y$  if and only if  $\exists y' \in X$  such that  $y \sim y'$  and  $x \rightarrow_R y'$ .

Following [61], a *abstract rewriting system modulo* is a quadruple  $(X, \rightarrow_R, \rightarrow_E, \rightarrow_S)$  satisfying

$$\rightarrow_R \subseteq \rightarrow_S \subseteq \rightarrow_{{}_E R_E}.$$

**2.3.3. 1-polygraphs modulo.** As in Section 2.1.2, the abstract rewriting systems  $(X, \rightarrow_R)$  and  $(X, \rightarrow_E)$  can be considered as 1-polygraphs  $(X, R)$  and  $(X, E)$  whose respective source and target maps are denoted by  $s_0^R, t_0^R$  and  $s_0^E, t_0^E$ . We then define the cellular extension  ${}_E R_E$  on  $X$  by the set of spheres  $(s_0^E(e), t_0^E(e'))$  where:

- i)  $e$  and  $e'$  are 1-cells of the free  $(1, 0)$ -category  $E^\top$  generated by the 1-polygraph  $(X, E)$ ,
- ii) there is a rewriting step  $f$  in  $R^*$  such that  $s_0^R(f) = t_0^E(e)$  and  $t_0^R(f) = s_0^E(e')$ .

Therefore, a rewriting step from  $u$  to  $v$  in  ${}_E R_E$  is given by a composite  $u \xrightarrow{e} u' \xrightarrow{f} v' \xrightarrow{e'} v$  where  $e$  and  $e'$  are 1-cells of  $E^\top$  and  $f$  is a rewriting step of  $R$ . A *1-polygraph modulo* is then the data of  $(X, R, E, S)$  where  $(X, R)$  and  $(X, E)$  are two 1-polygraphs, and  $S$  is a cellular extension on  $X$  such that the inclusion  $R \subseteq S \subseteq {}_E R_E$  holds. When there is no ambiguity, such a 1-polygraph modulo will be denoted by  $(X, S)$  or simply by  $S$ .

**2.3.4. E-equivalence.** If  $(X, E)$  is a 1-polygraph as above, we denote by  $x \overset{e}{\sim} y$  if there exists a 1-cell  $e : x \rightarrow y$  in the free  $(1, 0)$ -category  $E^\top$  generated by  $E$ . If moreover we have that  $\ell(e) = 1$  in  $E^\top$ , this is denoted by  $x \overset{e}{\vdash} y$ .

**2.3.5. Confluence modulo.** A 1-polygraph modulo  $(X, S)$  is said to be *confluent modulo*  $E$  if for any  $x$  and  $y$  in  $X$  such that  $x \overset{e}{\sim} y$ , and for any rewriting sequences  $f : x \rightarrow x'$  and  $g : y \rightarrow y'$  in  $S^*$ , one of them possibly being an identity, there exists rewriting sequences  $f'' : x' \rightarrow x''$  and  $g'' : y' \rightarrow y''$  in  $S^*$  such that  $x'' \overset{e''}{\sim} y''$ , as depicted on the following diagram:

$$\begin{array}{ccccc} x & \xrightarrow{f} & x' & \xrightarrow{f'} & x'' \\ \left. \begin{array}{c} \phantom{x} \\ \phantom{x} \end{array} \right\} e & & & & \left. \begin{array}{c} \phantom{x''} \\ \phantom{x''} \end{array} \right\} e' \\ y & \xrightarrow{g} & y' & \xrightarrow{g'} & y'' \end{array}$$

The triple  $(f, e, g)$  is then called a *branching modulo* of the 1-polygraph modulo  $(X, S)$ , and the triple  $(f', e', g')$  is called a *confluence modulo* of this branching.

**2.3.6. Termination.** Given a 1-polygraph modulo  $(X, R, E, S)$ , if  $S \neq R$  then  ${}_E R$  is terminating if and only if  $R_E$  is terminating, if and only if  ${}_E R_E$  is terminating, if and only if  $S$  is terminating. An order relation  $\prec$  on  $X$  is *compatible with  $\rightarrow_R$  modulo  $E$*  if it satisfies the two following conditions:

- i)  $y \prec x$ , for any  $x, y \in X$  such that there exists a rewriting sequence  $x \xrightarrow{*}_R y$ ,
- ii) if  $y \prec x$  for  $x, y \in X$ , then  $y' \prec x'$  holds for any  $x', y' \in X$  such that  $x \sim x'$  and  $y \sim y'$ .

A *termination order for  $R$  modulo  $E$*  is a well-founded order relation compatible with  $R$  modulo  $E$ . Many results of rewriting modulo will need the termination of the rewriting system  ${}_E R_E$ , which can be proved by constructing a termination order either for  ${}_E R$ ,  $R_E$  and  ${}_E R_E$ , or by constructing a termination order for  $R$  compatible with  $E$ .

**2.3.7. Normal forms.** An element  $x \in X$  is *S-reduced* if it cannot be reduced by any rewriting step of  $S$ . A *S-normal form* for an element  $x \in X$  is an  $S$ -reduced element  $y$  in  $X$  such that there is a 1-cell  $f$  in  $S^*$  with 0-source  $x$  and 0-target  $y$ . We will denote by  $\text{Irr}(S)$  the set of  $S$ -reduced elements of  $X$ , and by  $\text{NF}(S, x)$  the set of  $S$ -normal forms of an element  $x$  of  $X$ . If  $S$  is terminating, every element of  $X$  admits at least one  $S$ -normal form. If moreover  $S$  is confluent modulo  $E$ , then any  $x$  in  $X$  may admit many normal forms with respect to  $S$ , but all these normal forms are  $E$ -equivalent. Actually, the following result is proved in [56]:

**2.3.8 Lemma.** *Let us denote by  $\equiv$  the congruence generated by the coproduct 1-polygraph  $(X, R \cup E)$ . If  $S$  is terminating, then  $S$  is confluent modulo  $E$  if and only if for any  $x, y \in X$  such that  $x \equiv y$ , then  $\hat{x} \sim \hat{y}$  for any  $S$ -normal form  $\hat{x}$  (resp.  $\hat{y}$ ) of  $x$  (resp.  $y$ ).*

**2.3.9. Double Noetherian induction.** Let us recall the double Noetherian induction principle introduced by Huet in [56] to prove the equivalence between confluence modulo and local confluence modulo under a termination hypothesis. Let us fix a 1-polygraph modulo  $(X, R, E, S)$  and construct the auxiliary 1-polygraph  $(X \times X, S^{\text{II}})$  as follows: there is a rewriting step  $(x, y) \rightarrow (x', y')$  in  $S^{\text{II}}$  in any of the following situations:

- i)  $x \xrightarrow{*} x'$  with respect to  $S$  and  $y = y'$ ;
- ii)  $x \xrightarrow{*} x'$  and  $x \xrightarrow{*} y'$  with respect to  $S$ ;
- iii)  $x = x'$  and  $y \xrightarrow{*} y'$  with respect to  $S$ ;
- iv)  $y \xrightarrow{*} x'$  and  $y \xrightarrow{*} y'$  with respect to  $S$ ;
- v)  $x \stackrel{e_1}{\sim} y \stackrel{e_2}{\sim} x'$  with  $\ell(e_1) > \ell(e_2)$ .

Note that this definition implies that, if  $u \rightarrow u'$  and  $v \rightarrow v'$  with respect to  $S$ , then there is a rewriting sequence  $(u, v) \rightarrow (u', v')$  in  $S^{\text{II}}$  given by the following reduction:  $(u, v) \rightarrow (u', v) \rightarrow (u', v')$ .

**2.3.10 Lemma** ([56], Prop. 2.2). *If  ${}_E R_E$  is a terminating 1-polygraph, then so is  $S^{\text{II}}$ .*

**2.3.11. Church-Rosser modulo property.** We say that a 1-polygraph modulo  $(X, R, E, S)$  is *Church-Rosser modulo  $E$*  if for any 0-cells  $u, v$  in  $R_0$  such that there exist a zig-zag sequence

$$u \xrightarrow{f_1} u_1 \xleftarrow{f_2} u_2 \xrightarrow{f_3} \dots \xrightarrow{f_{n-2}} u_{n-1} \xleftarrow{f_{n-1}} u_n \xrightarrow{f_n} v$$

where the  $f_i$  are 1-cells of  $E^\top$  or  $R^\top$ , there exist rewriting sequences  $f' : u \rightarrow u'$  and  $g' : v \rightarrow v'$  in  $S^*$  such that  $u' \stackrel{e}{\sim} v'$ . In particular, when  $S$  is normalizing, the Church-Rosser modulo property implies that for any 0-cells  $u$  and  $v$  such that  $\bar{u} = \bar{v}$  in the category presented by the coproduct 1-polygraph  $(X, R \cup E)$ , two normal forms  $\hat{u}$  and  $\hat{v}$  of  $u$  and  $v$  respectively with respect to  $S$  are equivalent modulo  $E$ .

**2.3.12. Jouannaud-Kirchner confluence modulo E.** In [61], Jouannaud and Kirchner introduced another notion of confluence modulo E, given by two properties that they call confluence modulo E and coherence modulo E. We say that a 1-polygraph modulo  $(X, R, E, S)$  is

i) *JK confluent modulo E* if any branching  $(f, g)$  of  $S$  is confluent modulo E:

$$\begin{array}{ccccc} u & \xrightarrow{f} & v & \xrightarrow{f'} & v' \\ \parallel \downarrow & & & & \} e \\ u & \xrightarrow{g} & w & \xrightarrow{g'} & w' \end{array}$$

ii) *JK coherent modulo E*, if any branching  $(f, e) : u \rightarrow (u', v)$  modulo E is confluent modulo E:

$$\begin{array}{ccccc} u & \xrightarrow{f} & v & \xrightarrow{f'} & v' \\ e \} & & & & \} e' \\ u' & \xrightarrow{g'} & w & & \end{array}$$

with  $g'$  being a non-identity rewriting sequence of  $S$ .

However, we prove that this notion of confluence modulo is equivalent to that defined in Section 2.3.5.

**2.3.13 Lemma.** *For any linear 1-polygraph modulo  $(X, R, E, S)$  such that  $S$  is terminating, the following assertions are equivalent:*

- i)  $S$  is confluent modulo E.
- ii)  $S$  is JK confluent modulo E and JK coherent modulo E.

*Proof.* By definition, the property of confluence modulo E implies both JK confluence modulo E and JK coherence modulo E. Conversely, suppose that the 1-polygraph  $(X, R, E, S)$  is JK confluent and JK coherent modulo E and let us consider a branching  $(f, e, g)$  of  $S$  modulo E. If  $\ell(e) = 0$ , then it is clearly confluent modulo E by JK confluence modulo E so let us assume that  $\ell(e) \geq 1$ . If  $g$  is an identity 1-cell, then the confluence of the branching  $(f, e)$  modulo E is given by JK coherence modulo E. Otherwise, by JK coherence modulo E on the branching  $(f, e)$ , there rewriting sequences  $f'$  and  $h$  in  $S^*$  with  $h$  non trivial and a 1-cell  $e' : t_2(f') \rightarrow t_2(h)$  in  $E^\top$ . Applying JK confluence modulo on the branching  $(h, g)$  of  $S$ , there exists rewriting sequences  $g'$  and  $h'$  in  $S^*$  and a 1-cell  $e'' : t_2(h') \rightarrow t_2(g')$  in  $E^\top$ . By JK coherence modulo E on the branching  $((e')^-, h')$  modulo E, we get the existence of rewriting sequences  $f''$  and  $h''$  in  $S^*$  and a 1-cell  $e''' : t_2(f'') \rightarrow t_2(h'')$  in  $E^\top$  as depicted in the following diagram:

$$\begin{array}{ccccccc} u & \xrightarrow{f} & u' & \xrightarrow{f'} & u'' & \xrightarrow{f''} & u''' \\ e \downarrow & & \text{JK coh.} & & \downarrow e' & \text{JK coh.} & \downarrow e''' \\ v & \xrightarrow{h} & w & \xrightarrow{h'} & w' & \xrightarrow{h''} & w'' \\ \parallel \downarrow & & \text{JK confl.} & & \downarrow e'' & & \\ v & \xrightarrow{g} & v' & \xrightarrow{g'} & v'' & & \end{array}$$

At this point, either  $h''$  is trivial and thus  $e''' : u''' \rightarrow w'$  so that the branching  $(f, e, g)$  is confluent modulo, or it is non-trivial and we can apply JK coherence on the branching  $(h'', e'')$ . Since  $S$  is terminating, this process can not apply infinitely many times, and thus in finitely many steps we prove the confluence modulo of the branching  $(f, e, g)$ .  $\square$

Now, following [61, Theorem 5] and Lemma 2.3.13, given a linear  $(3, 2)$ -polygraph modulo  $(R, E, S)$  such that  $S$  is terminating, the following properties are equivalent:

i)  $S$  is confluent modulo  $E$ .

ii)  $S$  is Church-Rosser modulo  $E$ .

**2.3.14. Local confluence modulo.** We say that a branching  $(f, e, g)$  of  $S$  modulo  $E$  is *local* if  $f$  is a rewriting step of  $S$ ,  $g$  is a 1-cell of  $S^*$  and  $e$  is a 1-cell of  $E^\top$  such that  $\ell(g) + \ell(e) = 1$ . As a consequence, local branchings are divided into two families:

1. local branchings of the form  $(f, g)$ , where  $f$  and  $g$  are rewriting steps of  $S$ ,
2. local branchings of the form  $(f, e)$ , where  $f$  is a rewriting step of  $S$  and  $e$  is a one-step  $E$ -equivalence.

We say that  $S$  is *locally confluent modulo*  $E$  if any of its local branching modulo  $E$  is confluent modulo  $E$ . Under some termination assumptions, it is proven in Section 4.5 that the set of local branchings that need to be considered to reach local confluence can be reduced: indeed, it suffices to check that the 1-polygraph  $(X, R, E, S)$  satisfies the following two properties:

- a) for any rewriting steps  $f : x \rightarrow y$  of  $S$  and  $g : x \rightarrow z$  of  $R$ , there exists a confluence modulo  $(f', e', g')$  of  $(f, g)$ .
- b) for any rewriting step  $f : x \rightarrow y$  of  $S$  and any 1-cell  $x \xrightarrow{e} x'$  in  $E^\top$ , there exists a confluence modulo  $(f, e)$ .

This is depicted in the following diagrams:

$$\text{a) : } \left\| \begin{array}{ccc} x & \xrightarrow{S_1} & y \xrightarrow{S^*} y' \\ & & \downarrow \} \\ x & \xrightarrow{R_1} & z \xrightarrow{S^*} z' \end{array} \right. \quad \text{b) : } \left\| \begin{array}{ccc} x & \xrightarrow{S_1} & x' \xrightarrow{S^*} x'' \\ & & \downarrow \} \\ y & \xrightarrow{S^*} & y' \end{array} \right.$$

**2.3.15 Theorem** (Newman Lemma modulo). *Let  $(X, R, E, S)$  be a 1-polygraph modulo such that  ${}_E R_E$  is terminating, then  $S$  is confluent modulo  $E$  if and only if it is locally confluent modulo  $E$ .*

This result was originally proved by Huet in [56] for the case  $S = R$ . In Chapter 4, Section 4.5, this result is proved in the more general setting of  $\Gamma$ -confluence modulo, generalizing Theorem 2.1.10 to this context of cubical confluence diagrams.

## 2.4. HIGHER-DIMENSIONAL POLYGRAPHS

**2.4.1. Higher-dimensional categories.** If  $\mathcal{C}$  is a (small, globular, strict)  $n$ -category, we denote by  $\mathcal{C}_n$  the set of  $n$ -cells in  $\mathcal{C}$ . For any  $0 \leq k < n$  and any  $k$ -cells  $p$  and  $q$  in  $\mathcal{C}$ , we denote by  $\mathcal{C}_{k+1}(p, q)$  the set of  $(k+1)$ -cells in  $\mathcal{C}$  with  $k$ -source  $p$  and  $k$ -target  $q$ . If  $p$  is a  $k$ -cell of  $\mathcal{C}$ , we denote respectively by  $s_i(p)$  and  $t_i(p)$  the  $i$ -source and  $i$ -target of  $p$  for  $0 \leq i \leq k-1$ . These assignments define source and target maps, satisfying the globular relations

$$s_i \circ s_{i+1} = s_i \circ t_{i+1} \quad \text{and} \quad t_i \circ s_{i+1} = t_i \circ t_{i+1}$$

for any  $0 \leq i \leq n-2$ . Two  $k$ -cells  $p$  and  $q$  are  *$i$ -composable* when  $t_i(p) = s_i(q)$ . In that case, their  $i$ -composition is denoted by  $p \star_i q$ . The compositions of  $\mathcal{C}$  satisfy the *exchange relations*:

$$(p_1 \star_i q_1) \star_j (p_2 \star_i q_2) = (p_1 \star_j p_2) \star_i (q_1 \star_j q_2)$$

for any  $i < j$  and for all cells  $p_1, p_2, q_1, q_2$  such that both sides are defined. If  $p$  is a  $k$ -cell of  $\mathcal{C}$ , we denote by  $1_p$  its identity  $(k+1)$ -cell. A  $k$ -cell  $p$  of  $\mathcal{C}$  is *invertible with respect to  $\star_i$ -composition* ( $i$ -invertible for short) when there exists a (necessarily unique)  $k$ -cell  $q^-$  in  $\mathcal{C}$  with  $i$ -source  $t_i(p)$  and  $i$ -target  $s_i(p)$  such that

$$p \star_i q = 1_{s_i(p)} \quad \text{and} \quad q \star_i p = 1_{t_i(p)} \quad (2.4)$$

When  $i = k - 1$ , we just say that  $f$  is *invertible* and we denote by  $f^-$  its *inverse*. Note that if a  $k$ -cell  $f$  is invertible and if its  $i$ -source  $u$  and  $i$ -target  $v$  are invertible, then  $f$  is  $(i - 1)$ -invertible, with  $(i - 1)$ -inverse given by  $v^- \star_{i-1} f^- \star_{i-1} u^-$ . A *0-sphere of  $\mathcal{C}$*  is a pair  $\gamma = (f, g)$  of 0-cells of  $\mathcal{C}$  and, for  $1 \leq k \leq n$ , a *k-sphere of  $\mathcal{C}$*  is a pair  $S = (f, g)$  of  $k$ -cells of  $\mathcal{C}$  such that  $s_{k-1}(f) = s_{k-1}(g)$  and  $t_{k-1}(f) = t_{k-1}(g)$ . The  $k$ -cell  $f$  (resp.  $g$ ) is called the *source* (resp. *target*) of  $S$  denoted by  $\partial_-(S)$  (resp.  $\partial_+(S)$ ). We will denote by  $\text{Sph}_k(\mathcal{C})$  the set of  $k$ -spheres of  $\mathcal{C}$ . If  $f$  is a  $k$ -cell of  $\mathcal{C}$ , for  $1 \leq k \leq n$ , the *boundary of  $f$*  is the  $(k - 1)$ -sphere  $(\partial_-(f), \partial_+(f))$  denoted by  $\partial(f)$ .

**2.4.2. n-graphs.** An  $n$ -graph in a category  $\mathcal{C}$  is a diagram

$$G_0 \xleftarrow[s_0]{t_0} G_1 \xleftarrow[s_1]{t_1} \dots \xleftarrow[s_{n-2}]{t_{n-2}} G_{n-1} \xleftarrow[s_{n-1}]{t_{n-1}} G_n$$

such that the *globular relations*  $s_{k-1} \circ s_k = s_{k-1} \circ t_k$  and  $t_{k-1} \circ s_k = t_{k-1} \circ t_k$  hold for any  $1 \leq k \leq n - 1$ . An  $n$ -graph in the category **Set** is just called an  $n$ -graph. The maps  $s_k$  and  $t_k$  are respectively called the  $k$ -source and  $k$ -target maps, for any  $0 \leq k \leq n - 1$ . A *morphism of n-graphs*  $F : G \rightarrow G'$  is a collection  $(F_k : G_k \rightarrow G'_k)_{0 \leq k \leq n}$  of maps such that for all  $0 < k \leq n$ , the following diagrams commute:

$$\begin{array}{ccc} G_{k-1} & \xleftarrow{s_{k-1}} & G_k \\ F_{k-1} \downarrow & & \downarrow F_k \\ G'_{k-1} & \xleftarrow{s'_{k-1}} & G'_k \end{array} \quad \begin{array}{ccc} G_{k-1} & \xleftarrow{t_{k-1}} & G_k \\ F_{k-1} \downarrow & & \downarrow F_k \\ G'_{k-1} & \xleftarrow{t'_{k-1}} & G'_k \end{array}$$

We denote by **Grph<sub>n</sub>** the category of  $n$ -graphs, and by  $\mathcal{U}_n$  the forgetful functor  $\mathbf{Cat}_n \rightarrow \mathbf{Grph}_n$  consisting in forgetting the compositions and identities of an  $n$ -category  $\mathcal{C}$ . We also denote by  $\mathcal{U}_n^G : \mathbf{Grph}_{n+1} \rightarrow \mathbf{Grph}_n$  the forgetful functor consisting in forgetting the elements of  $G_{n+1}$  and the maps  $s_n, t_n$ .

**2.4.3. Cellular extensions.** We extend the notion of a cellular extension defined for a free 1-category in Section 2.1.2 to globular  $n$ -categories. A *cellular extension* of an  $n$ -category  $\mathcal{C}$  is a data made of a set  $\Gamma$  together with two maps  $s_n, t_n : \Gamma \rightarrow \mathcal{C}$  making the diagram

$$C_0 \xleftarrow[s_0]{t_0} C_1 \xleftarrow[s_1]{t_1} \dots \xleftarrow[s_{n-2}]{t_{n-2}} C_{n-1} \xleftarrow[s_{n-1}]{t_{n-1}} C_n \xleftarrow[s_n]{t_n} \Gamma$$

an  $(n + 1)$ -graph in **Set**. We define the category  $\mathbf{Cat}_n^+$  of globular  $n$ -categories with a cellular extension by the following pullback diagram in **Cat**:

$$\begin{array}{ccc} \mathbf{Cat}_n^+ & \longrightarrow & \mathbf{Grph}_{n+1} \\ \downarrow & \lrcorner & \downarrow \mathcal{U}_n^G \\ \mathbf{Cat}_n & \xrightarrow{\mathcal{U}_n} & \mathbf{Grph}_n \end{array}$$

As a consequence, there exists a forgetful functor  $\mathbf{Cat}_{n+1} \rightarrow \mathbf{Cat}_n^+$ . This functor has a left adjoint  $\mathcal{F}_{n+1}^W : \mathbf{Cat}_n^+ \rightarrow \mathbf{Cat}_{n+1}$ , which is explicitly constructed in [92], and is the free functor assigning to an  $n$ -category  $\mathcal{C}$  with a cellular extension  $\Gamma$  the *free  $(n + 1)$ -category generated by  $\Gamma$  over  $\mathcal{C}$* , denoted by  $\mathcal{C}[\Gamma]$ . Such a category is constructed by considering all the formal compositions of elements of  $\Gamma$ , seen as  $(n + 1)$ -cells with source and target in  $\mathcal{C}$ . We denote by  $(\mathcal{C})_\Gamma$  the quotient of the  $n$ -category  $\mathcal{C}$  by the congruence generated by  $\Gamma$ , i.e. the  $n$ -category one gets from  $\mathcal{C}$  by identification of the  $n$ -cells  $s_n(f)$  and  $t_n(f)$ , for all  $(n + 1)$ -cell  $f$  of  $\Gamma$ .



**2.4.4. Contexts of  $n$ -categories.** A *context* of an  $n$ -category  $\mathcal{C}$  is a pair  $(S, C)$  made of an  $(n - 1)$ -sphere  $S$  of  $\mathcal{C}$  and an  $n$ -cell  $C$  in  $\mathcal{C}[S]$  such that  $S$ , formally seen as an  $n$ -cell, appears only once in  $C$ . We often denote simply by  $C$ , such a context. Recall from [51, Proposition 2.1.3] that every context of  $\mathcal{C}$  has a decomposition

$$f_n \star_{n-1} (f_{n-1} \star_{n-2} \cdots (f_1 \star_0 S \star_0 g_1) \cdots \star_{n-2} g_{n-1}) \star_{n-1} g_n,$$

where  $S$  is an  $(n - 1)$ -sphere and, for every  $k$  in  $\{1, \dots, n\}$ ,  $f_k$  and  $g_k$  are  $n$ -cells of  $\mathcal{C}$ . Moreover, one can choose these cells so that  $f_k$  and  $g_k$  are (the identities of)  $k$ -cells. A *whisker* of  $\mathcal{C}$  is a context with a decomposition

$$f_{n-1} \star_{n-2} \cdots (f_1 \star_0 S \star_0 g_1) \cdots \star_{n-2} g_{n-1}$$

such that, for every  $k$  in  $\{1, \dots, n - 1\}$ ,  $f_k$  and  $g_k$  are  $k$ -cells.

**2.4.5.  $(n, p)$ -categories.** Let  $p \leq n$ . An  $(n, p)$ -category is an  $n$ -category such that all the  $k$ -cells are invertible for any  $k > p$ . The category of  $(n, p)$ -categories will be denoted by  $\mathbf{Cat}_{n,p}$ . There is a forgetful functor  $\mathcal{U}_{n,p} : \mathbf{Cat}_{n,p} \rightarrow \mathbf{Grph}_n$ . Similarly, the category  $\mathbf{Cat}_{n,p}^+$  of  $(n, p)$ -categories with a globular extension is defined by the following pullback diagram:

$$\begin{array}{ccc} \mathbf{Cat}_{n,p}^+ & \longrightarrow & \mathbf{Grph}_{n+1} \\ \downarrow & \lrcorner & \downarrow \mathcal{U}_n^G \\ \mathbf{Cat}_{n,p} & \xrightarrow{\mathcal{U}_{n,p}} & \mathbf{Grph}_n \end{array}$$

The functor  $\mathcal{F}_{n+1}^W$ , defined in Section 2.4.3, restricts to a free functor  $\mathbf{Cat}_{n,p}^+ \rightarrow \mathbf{Cat}_{n+1,p}$ , and this restriction is denoted by  $\mathcal{F}_{n+1,p}^W$ .

**2.4.6.  $(n, p)$ -polygraphs.** *Polygraphs* (or *computads*) are presentations by generators and relations of some higher-dimensional categories [112, 28], see also [113, 114]. We recall for any  $n \geq p \geq 1$  the definition of an  $n$ -polygraph and of an  $(n, p)$ -polygraph. We recall the presentations of  $(n, p)$ -categories by  $(n + 1, p)$ -polygraphs.

Let us define the category  $\mathbf{Pol}_{n,p}$  of  $(n, p)$ -polygraphs and the free functor  $\mathcal{F}_{n,p} : \mathbf{Pol}_{n,p} \rightarrow \mathbf{Cat}_{n,p}$  constructing the free  $(n, p)$ -category generated by an  $(n, p)$ -polygraph by induction on  $n \geq p$ . We first set  $\mathbf{Pol}_{0,0} = \mathbf{Set}$  and  $\mathcal{F}_{0,0}$  is the identity functor. Let us assume that  $\mathbf{Pol}_{n,p}$  and  $\mathcal{F}_{n,p}$  are defined for some  $n \geq p \geq 0$ . We define  $\mathbf{Pol}_{n+1,p}$  as the following pullback diagram in  $\mathbf{Cat}$ :

$$\begin{array}{ccc} \mathbf{Pol}_{n+1,p} & \xrightarrow{\mathcal{U}_{n+1,p}^G} & \mathbf{Grph}_{n+1} \\ \mathcal{U}_{n,p}^P \downarrow & \lrcorner & \downarrow \mathcal{U}_n^G \\ \mathbf{Pol}_{n,p} & \xrightarrow{\mathcal{F}_{n,p}} \mathbf{Cat}_{n,p} \xrightarrow{\mathcal{U}_{n,p}} & \mathbf{Grph}_n \end{array}$$

To define the functor  $\mathcal{F}_{n+1,p}$ , we consider at first the unique functor  $\mathcal{F}_{n+1,p}^P$  making the following diagrams commute:

$$\begin{array}{ccccc} \mathbf{Pol}_{n+1,p} & & & & \\ \downarrow \mathcal{U}_{n,p}^P & \searrow \mathcal{F}_{n+1,p}^P & \searrow \mathcal{U}_{n+1,p}^P & & \\ \mathbf{Pol}_{n,p} & \xrightarrow{\mathcal{F}_{n,p}} & \mathbf{Cat}_{n,p} & \xrightarrow{\mathcal{U}_{n,p}} & \mathbf{Grph}_n \\ & & \downarrow & \lrcorner & \downarrow \mathcal{U}_n^G \\ & & \mathbf{Cat}_{n,p}^+ & \xrightarrow{\mathcal{U}_{n,p}^+} & \mathbf{Grph}_{n+1} \end{array}$$

and define the functor  $\mathcal{F}_{n+1,p}$  as the composition

$$\mathbf{Pol}_{n+1,p} \xrightarrow{\mathcal{F}_{n+1,p}^P} \mathbf{Cat}_{n,p}^+ \xrightarrow{\mathcal{F}_{n+1,p}^W} \mathbf{Cat}_{n+1,p} .$$

Given an  $(n, p)$ -polygraph  $P$ , the  $(n, p)$ -category  $\mathcal{F}_{n,p}(P)$  is called the *free  $(n, p)$ -category generated by  $P$* . The fact that the functor  $\mathcal{F}_{n,p} : \mathbf{Pol}_{n,p} \rightarrow \mathbf{Cat}_{n,p}$  is free is proven in [92]. For  $n > p$ , an  $(n, p)$ -polygraph can be defined as a data made of an  $(n-1, p)$ -polygraph  $P$  together with a cellular extension of  $P_{n-1}^\perp$ .

**2.4.7.  $n$ -polygraphs.** An  $n$ -polygraph is an  $(n, n)$ -polygraph. In the original paper of Burroni [28],  $n$ -polygraphs were defined inductively as diagrams

$$\begin{array}{ccccccc} P_0 & & P_1 & & (\dots) & & P_{n-1} & & P_n \\ & \swarrow & & \swarrow & & \swarrow & & \swarrow & \\ P_0 & \xleftarrow{s_0, t_0} & P_1^* & \xleftarrow{s_1, t_1} & (\dots) & \xleftarrow{s_{n-2}, t_{n-2}} & P_{n-1}^* & \xleftarrow{s_{n-1}, t_{n-1}} & P_n \\ & \searrow & & \searrow & & \searrow & & \searrow & \\ & \bar{s}_0, \bar{t}_0 & & \bar{s}_1, \bar{t}_1 & & \bar{s}_{n-2}, \bar{t}_{n-2} & & & \end{array}$$

in the category  $\mathbf{Set}$ , where for any  $1 \leq k \leq n-1$ ,  $P_k^*$  is the free  $k$ -category generated by the  $k$ -polygraph  $(P_0, \dots, P_k)$  such that, for any  $k$  in  $\{0, \dots, n-1\}$ , the following two conditions hold:

- The diagram  $P_0^* \xleftarrow{\bar{s}_0, \bar{t}_0} P_1^* \xleftarrow{\bar{s}_1, \bar{t}_1} (\dots) \xleftarrow{\bar{s}_{k-1}, \bar{t}_{k-1}} P_k^*$  is a  $k$ -category,
- The diagram  $P_0^* \xleftarrow{\bar{s}_0, \bar{t}_0} P_1^* \xleftarrow{\bar{s}_1, \bar{t}_1} (\dots) \xleftarrow{\bar{s}_{k-1}, \bar{t}_{k-1}} P_k^* \xleftarrow{s_k, t_k} P_{k+1}$  is a  $(k+1)$ -graph.

For an  $n$ -polygraph  $P = (P_0, \dots, P_n)$ , for any  $0 \leq k \leq n$ , we denote by  $P_{\leq k} := (P_0, \dots, P_k)$  its underlying  $k$ -polygraph, and by  $P_{\geq k} := (P_k, \dots, P_n)$  the  $(n-k)$ -graph given by considering only the sets of  $i$ -cells, for  $i \geq k$ . We denote by  $P_n^*$  (resp.  $P_n^\perp$ ) the free  $n$ -category  $\mathcal{F}_{n,n}(P)$  (resp. the free  $(n, n-1)$ -category  $\mathcal{F}_{n,n-1}(P)$ ) generated by  $P$ . Recall from [51, Proposition 2.1.5] that every  $n$ -cell  $f$  in  $P^*$  with size  $k \geq 1$  has a decomposition

$$f = C_1[\gamma_1] \star_{n-1} \dots \star_{n-1} C_k[\gamma_k],$$

where  $\gamma_1, \dots, \gamma_k$  are generating  $n$ -cells of  $P$  and  $C_1, \dots, C_k$  are whiskers of  $P_n^*$ . We then say that  $k$  is the *length* of the  $n$ -cell  $f$ , that we denote by  $\ell(f) = k$ . For any  $1 \leq i \leq n-1$  and for any cellular extension  $\Gamma \subseteq P_{i+1}$  of  $P_i^*$ , we denote by  $\|f\|_\Gamma$  the number of occurrences of the  $(i+1)$ -cells of  $\Gamma$  in the  $(i+1)$ -cell  $f$  of  $P_{i+1}^*$ .

**2.4.8. Rewriting steps.** From now on, we fix an  $n$ -polygraph  $P = (P_0, \dots, P_n)$ . A *rewriting step* of  $P$  is an  $n$ -cell of the free  $n$ -category  $P_n^*$  of length 1. Namely, it is an application of a rule  $\gamma$  of  $P_n$  inside a context  $C$  of  $P_{n-1}^*$ . As a consequence, to any  $n$ -polygraph  $P = (P_0, \dots, P_n)$ , we associate the 1-polygraph  $P_{\geq n-1}$ , which has 0-cells the set of  $(n-1)$ -cells in  $P_{n-1}^*$  and it admits a 1-cell  $u \rightarrow v$  whenever there exists a rewriting step from  $u$  to  $v$  in  $P_n^*$ . This is an abstract rewriting system in the sense of Section 2.1.2. We thus say that an  $n$ -polygraph satisfies the rewriting property  $\mathcal{P}$  if this abstract rewriting system satisfies  $\mathcal{P}$ . In this interpretation, an  $n$ -cell of  $P_n^*$  with source  $u$  and target  $v$  corresponds to a rewriting path  $u \xrightarrow{*} v$  in  $P_{\geq n-1}$  and a rewriting step of  $P$  is indeed a rewriting step in  $P_{\geq n-1}$ .

**2.4.9. Presentation of an  $n$ -category.** Let  $\mathcal{C}$  be an  $n$ -category, and  $P$  be an  $(n+1)$ -polygraph. We say that  $P$  is a presentation of  $\mathcal{C}$  if  $\mathcal{C}$  is isomorphic to the quotient of the free  $n$ -category  $P_n^*$  by the equivalence relation generated by the cellular extension  $P_{n+1}$ . We will denote by  $\bar{P}$  the  $n$ -category presented by the polygraph  $P$ , that is  $\bar{P} := (P_n^*)_{P_{n+1}}$ .

**2.4.10. Homotopy bases and coherent presentations.** Given an  $n$ -category  $\mathcal{C}$ , a *homotopy basis* of  $\mathcal{C}$  is a cellular extension  $\Gamma$  of  $\mathcal{C}$  such that for any pair  $(\alpha, \beta)$  of parallel  $n$ -cells of  $\mathcal{C}$ , there exists an  $(n+1)$ -cell from  $\alpha$  to  $\beta$  in the free  $(n+1)$ -category generated by  $(\mathcal{C}, \Gamma) \in \mathbf{Cat}_n^+$ . A *coherent presentation* of  $\mathcal{C}$  is an  $(n+2, n)$ -polygraph such that:

- i) The underlying  $(n+1)$ -polygraph  $P_{\leq n+1}$  is a presentation of  $\mathcal{C}$ ,
- ii)  $P_{n+2}$  is an homotopy basis of the free  $(n+1, n)$ -category  $P_{n+1}^\top$ .

## 2.5. CRITICAL BRANCHING LEMMA

For an  $n$ -polygraph  $P$ , we want to obtain criteria to prove confluence  $P$  from local confluence and confluence of overlappings between rewriting steps of  $P$ .

**2.5.1. Branchings.** Recall from Section 2.1.8 that a *branching* of  $P$  is a pair of  $n$ -cells of  $P_n^*$  with the same  $(n-1)$ -source. A *local branching* of  $P$  is a pair of rewriting steps  $(f, g)$  of  $P_n$  with the same  $(n-1)$ -source. Such a branching is *confluent* if there exists  $n$ -cells  $f'$  and  $g'$  in  $P_n^*$  such that  $f \star_{n-1} f'$  and  $g \star_{n-1} g'$  have the same  $(n-1)$ -target. In that case, we say that the pair  $(f', g')$  is a *confluence* of  $(f, g)$ . Such a confluence is not unique in general. Similarly, given a cellular extension  $\Gamma$  of  $P_n^*$ , a branching  $(f, g)$  is said  $\Gamma$ -*confluent* if there exists  $n$ -cells  $f'$  and  $g'$  as above together with an  $(n+1)$ -cell  $\gamma$  in  $\Gamma^\top$  such that  $s_n(\gamma) = f \star_{n-1} f'$  and  $t_n(\gamma) = g \star_{n-1} g'$ . The triple  $(f', g', \gamma)$  is called a  $\Gamma$ -*confluence* of the branching  $(f, g)$ .

**2.5.2. Classification of local branchings.** Local branchings of an  $n$ -polygraph  $P$  can be classified into the following three families:

- i) *Aspherical* branchings, which are branchings of the form  $(\alpha, \alpha)$ :

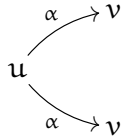

- ii) *Peiffer* branchings, which are of the form  $(\alpha \star_i v, u \star_i \beta)$  where  $u$  and  $v$  are  $k$ -cells for  $k \geq i+1$  and  $\alpha : u \rightarrow u'$  and  $\beta : v \rightarrow v'$  are rewriting steps of  $P$ :

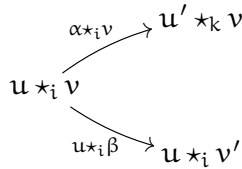

- iii) *Overlapping* branchings, which are all the remaining local branchings.

**2.5.3. Critical branchings.** Let  $\sqsubset$  be the order relation on  $P_{n-1}^*$  defined by  $u \sqsubset v$  if there exists a context  $C$  of  $P_{n-1}^*$  such that  $v = C[u]$ . A *critical branching* in  $P$  is an overlapping branching of  $P$  whose source is a minimal  $(n-1)$ -cell for the relation order  $\sqsubset$ .

**2.5.4 Theorem** (Critical pair lemma). *An  $n$ -polygraph  $P$  is locally confluent if and only if all the critical branchings of  $P$  are confluent.*

*Proof.* If  $P$  is locally confluent, then the critical branchings of  $P$  are confluent by definition. Assume now that all critical branchings of  $P$  are confluent, and let us consider a local branching  $(\alpha, \beta)$  of  $P$ . We have to distinguish three cases. If  $(\alpha, \beta)$  is an aspherical branching, that is  $\alpha = \beta$ , then it is trivially confluent via the confluence  $(1_{t_{n-1}(\alpha)}, 1_{t_{n-1}(\alpha)})$ . If  $(\alpha, \beta) = (\alpha' \star_i v, u \star_i \beta')$  is a Peiffer branching, then it is confluent via the confluence  $(u' \star_i \beta', \alpha' \star_i v')$ . If  $(\alpha, \beta)$  is an overlapping branching, there exists a critical branching  $(\alpha_0, \beta_0)$  of  $P$  and a context  $C$  of  $P_{n-1}^*$  such that  $\alpha = C[\alpha_0]$  and  $\beta = C[\beta_0]$ . By assumption, the critical branching  $(\alpha_0, \beta_0)$  is confluent, so there exists a confluence  $(\alpha'_0, \beta'_0)$  of this critical branching, and we then check that  $(C[\alpha'_0], C[\beta'_0])$  is a confluence of  $(\alpha, \beta)$ .  $\square$

**2.5.5. Coherence from convergence.** Let us fix a convergent  $n$ -polygraph  $P = (P_0, \dots, P_n)$ . Recall following [54] that a *family of generating confluences* of  $P$  is a cellular extension of  $P_n^\top$  containing exactly one  $(n+1)$ -cell  $A_{f,g}$  of the form

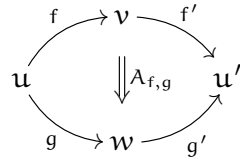

for any critical branching  $(f, g)$  of  $P$  and any choice of a confluence  $(f', g')$  of  $(f, g)$ . Note that an  $n$ -polygraph always admits a family of generating confluences, but is it not unique in general since a given critical branching may admit several confluences. In [53], a deterministic way is given to construct a family of generating confluences, using the notion of normalisation strategies.

A *Squier's completion* of  $P$  is the  $(n+1, n-1)$ -polygraph denoted by  $\mathcal{S}(P)$  defined by  $\mathcal{S}(P)_{\leq n} = P$  and  $\mathcal{S}(P)_{n+1}$  is a choice of a family of generating confluences of  $P$ . By the following result, then Squier's completion gives a way to obtain a coherent presentation of a category  $\mathcal{C}$  from a convergent presentation of  $\mathcal{C}$ :

**2.5.6 Theorem** ([111], Thm 5.2). *Let  $P$  be a convergent  $n$ -polygraph. Every family of generating confluences of  $P$  is a homotopy basis of  $P^\top$ .*

*Proof.* Let us fix a family of generating confluences  $\Gamma$  of  $P$ , and denote by  $\mathcal{S}(P)$  the associated Squier completion. We proceed in three steps, following [54].

**Step 1.** We prove that, for every local branching  $(f, g) : u \rightarrow (v, w)$  of  $P$ , there exist a  $\Gamma$ -confluence  $(f', g', \alpha)$  of  $(f, g)$ . If  $(f, g)$  is an aspherical or Peiffer branching, we can choose  $n$ -cells  $f'$  and  $g'$  in  $P_n^*$  such that  $f \star_{n-1} f' = g \star_{n-1} g'$ , and then  $\alpha$  is an identity  $(n+1)$ -cell. Moreover, if  $(f, g)$  is an overlapping branching that is not critical, there exists a context  $C$  of  $P_n^*$  such that  $(f, g) = (C[f'], C[g'])$ , and  $(f', g')$  is a critical branching of  $P$ . We consider the chosen confluence  $(f'', g'')$  of the critical branching  $(f', g')$ , and the  $(n+1)$ -cell  $A_{f',g'}$  of  $\mathcal{S}(P)$  corresponding to this confluence. We conclude that  $(f, g)$  admits the  $\Gamma$ -confluence  $(C[f''], C[g''], A_{f',g'})$ .

**Step 2.** We prove that, for every parallel  $n$ -cells  $f$  and  $g$  of  $P_n^*$  such that  $t_{n-1}(f) = t_{n-1}(g)$  is a normal form, there exists an  $(n+1)$ -cell with  $n$ -source  $f$  and  $n$ -target  $g$  in  $\mathcal{S}(P)^\top$ . Using the termination of  $P$ , we proceed by noetherian induction on the source  $u$  of the branching  $(f, g)$ . If  $u$  is a normal form, then both  $f$  and  $g$  are the identity 1-cell on  $u$ , so that  $1_u : 1_u \Rightarrow 1_u$  is an  $(n+1)$ -cell of  $\mathcal{S}(P)^\top$  from  $f$  to  $g$ . Now, assume that for any  $(n-1)$ -cell  $v$  of  $P_{n-1}^*$  such that there is a rewriting step from  $u$  to  $v$  in  $P$ , and for any parallel  $n$ -cells  $f, g : u \rightarrow \hat{v} = \hat{u}$  of  $P_n^*$ , there exists an  $(n+1)$ -cell with  $n$ -source  $f$  and  $n$ -target  $g$  in  $\mathcal{S}(P)^\top$ . Let us consider such  $n$ -cells  $f$  and  $g$ . Since the source  $u$  of the branching  $(f, g)$  is not a normal form by assumption, we can choose decompositions  $f = f_1 \star_{n-1} f_2$  and  $g = g_1 \star_{n-1} g_2$  where  $f_1$  and  $g_1$  are rewriting steps of  $P$ , and  $f_2, g_2$  are  $n$ -cells in  $P_n^*$ . Using Step 1 on the local branching  $(f_1, g_1)$ , there exists a  $\Gamma$ -confluence  $(f'_1, g'_1, \gamma)$  of this branching. Then, denote by  $u' = t_{n-1}(f'_1) = t_{n-1}(g'_1)$  and consider an  $n$ -cell  $h : u' \rightarrow \hat{u}$  in  $P_n^*$ , that must exist by confluence of  $P$ . Then, using the induction

hypothesis on the confluent branchings  $(f'_1 \star_{n-1} h, f_2)$  and  $(g'_1 \star_{n-1} h, g_2)$ , there exists  $(n+1)$ -cells  $\beta_1$  and  $\beta_2$  in  $\mathcal{S}(P)^\top$  as follows:

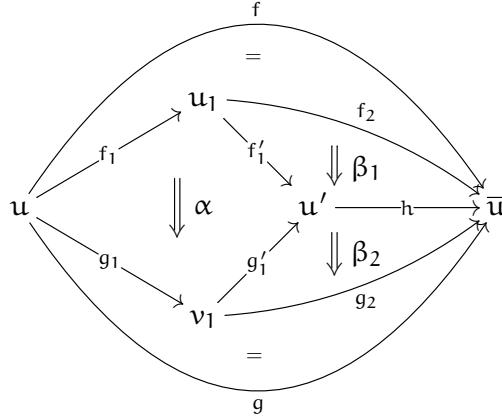

**Step 3.** We prove that every  $n$ -sphere of  $P_n^\top$  is the boundary of an  $(n+1)$ -cell of  $\mathcal{S}(P)^\top$ . First, let us consider an  $n$ -cell  $f : u \rightarrow v$  in  $P_n^*$ . Using the confluence of  $P$ , we can choose  $n$ -cells  $\sigma_u : u \Rightarrow \bar{u}$  and  $\sigma_v : v \Rightarrow \bar{v} = \bar{u}$  in  $P_n^*$ . By construction, the  $n$ -cells  $f \star_{n-1} \sigma_v$  and  $\sigma_u$  are parallel and their common target  $\bar{u}$  is a normal form. Thus, using Step 2, there exists an  $(n+1)$ -cell with  $n$ -source  $f \star_1 \sigma_v$  and  $n$ -target  $\sigma_u$  in  $\mathcal{S}(P)^\top$ . Equivalently, there is an  $(n+1)$ -cell with  $n$ -source  $f$  and  $n$ -target  $\sigma_u \star_{n-1} \sigma_v^-$  in  $\mathcal{S}(P)^\top$ , denoted by  $\sigma_f$ . Moreover, the  $(n+1, n-1)$ -category  $\mathcal{S}(P)^\top$  contains an  $(n+1)$ -cell  $\sigma_{f^-} : f^- \Rightarrow \sigma_v \star_1 \sigma_u^-$ , given by the following composite:

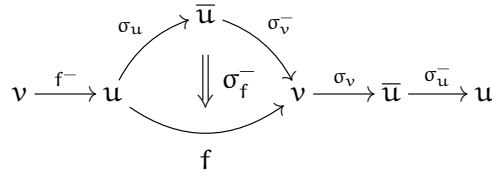

Now, let us consider an  $n$ -cell  $f : u \rightarrow v$  of  $P_n^\top$ , and consider a decomposition  $f = f_1 \star_{n-1} g_1^- \star_{n-1} f_2 \star_{n-1} \dots \star_{n-1} g_{n-1}^- \star_{n-1} f_n \star_{n-1} g_n^-$  into a zigzag of  $n$ -cells in  $P_n^*$ . We define  $\sigma_f$  as the following composite  $(n+1)$ -cell of  $\mathcal{S}(P)^\top$ , with source  $f$  and target  $\sigma_u \star_1 \sigma_v^-$ :

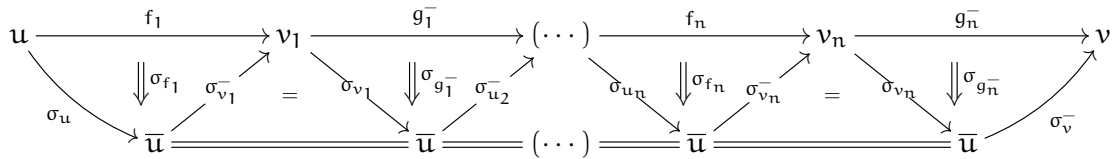

Similarly, for any other  $n$ -cell  $g : u \rightarrow v$  of  $P_n^\top$ , there is an  $(n+1)$ -cell  $\sigma_g : g \Rightarrow \sigma_u \star_1 \sigma_v^-$  in  $\mathcal{S}(P)^\top$ . Thus, the composite  $\sigma_f \star_n \sigma_g^-$  is an  $(n+1)$ -cell with  $n$ -source  $f$  and  $n$ -target  $g$  in  $\mathcal{S}(P)^\top$ .  $\square$

**2.5.7. Polygraphic resolutions from convergence.** In [53], Guiraud and Malbos give a procedure to compute Squier completions in above dimensions. Explicitly, given a convergent  $n$ -polygraph  $P$ , one can complete  $P$  into an  $(\infty, 1)$ -polygraph  $c_\infty(P)$ . The  $k$ -cells of  $c_\infty(P)$  for  $k \leq n$  are the ones of  $P$ , and the  $(n+1)$ -cells of  $c_\infty(P)$  are given by a Squier completion of  $P$ . To describe the next dimension of  $c_\infty(P)$ , we consider the critical triple branchings, that is minimal overlappings of three  $n$ -cells  $(f, g, h)$ . Using a normalisation strategy  $\sigma$ , we build the  $(n+2)$ -cell  $A_{f,g,h}$  corresponding to this triple critical

branching as follows:

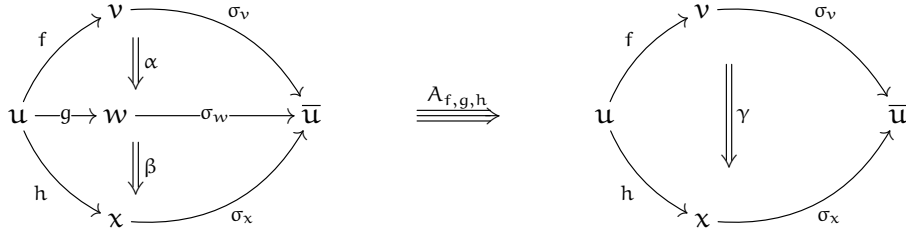

where  $\alpha$ ,  $\beta$  and  $\gamma$  are  $(n + 1)$ -cells in  $c_\infty(P)_{\leq n+1}$  built from a Squier completion of  $P$  and the normalisation strategy  $\sigma$ . The next step of the resolution would be to define  $(n + 3)$ -cells between parallel  $(n + 2)$ -cells in  $c_\infty(P)_{\leq n+2}^\top$  by considering critical 4-fold branchings, that is minimal overlappings of four rewriting steps  $(f, g, h, k)$ . In higher dimensions, we build the  $(n + 1)$ -cells of the resolution from the critical  $(l - 1)$ -fold branchings.

**2.5.8 Theorem** ([53], Thm 4.5.3). *If an  $n$ -polygraph  $P$  is a convergent presentation of an  $(n - 1)$ -category  $\mathcal{C}$ , then  $c_\infty(P)$  is a polygraphic resolution of  $\mathcal{C}$ .*

The  $(\infty, 1)$ -polygraph  $c_\infty(P)$  is a *polygraphic resolution* of the category  $\mathcal{C}$  in the sense of Métayer [91], since it produces a cofibrant approximation of  $\mathcal{C}$ , that is a free object which is homotopically equivalent to  $\mathcal{C}$  in the canonical model structure on  $\infty$ -categories [79].

**2.5.9. Termination orders of  $n$ -polygraphs.** Given an  $n$ -polygraph  $P$ , a *termination order* on  $P$  is a strict order relation  $\prec$  on  $P_{n-1}^*$  such that:

- i) for each parallel  $(n - 2)$ -cells  $u$  and  $v$  of  $P_{n-2}^*$ , the restriction of  $\prec$  to  $P_{n-1}^*(u, v)$  is a well-founded order;
- ii) for any  $(n - 1)$ -cells  $f$  and  $g$  of  $P_{n-1}^*$  such that  $g$  rewrites into  $f$ , then  $f \prec g$ .
- iii) for any parallel  $(n - 1)$ -cells  $f$  and  $g$  such that  $f \prec g$  and any context  $C$  of  $P_{n-1}^*$ , we have  $C[f] \prec C[g]$ .

Such a termination order is called a *total termination order* when we require the further assumption that its restriction to  $P_{n-1}^*(u, v)$  also is a total order. Note that a total termination order for an  $n$ -polygraph  $P$  does not always exist, see the example in Section 2.6.4.

**2.5.10. Knuth-Bendix completion.** Given a terminating and non-confluent  $n$ -polygraph  $P$ , with a termination order  $\prec$  on  $P$ , Knuth-Bendix's procedure [76] either does not terminate, or it gives a way to

complete  $P$  into a convergent  $n$ -polygraph  $\mathcal{KB}(P)$ . This procedure is defined as follows:

**Input :** A terminating  $n$ -polygraph  $P$  with a termination order  $\prec$

$\mathcal{KB}(P)_n \leftarrow P$  ;

$\mathcal{C}_b := \{\text{critical branchings of } P\}$  ;

**while**  $\mathcal{C}_b \neq \emptyset$  **do**

    Pick a branching  $(f : u \rightarrow v, g : u \rightarrow w)$  in  $\mathcal{C}_b$ :

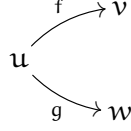

$\mathcal{C}_b := \mathcal{C}_b \setminus \{(f, g)\}$  ;

    Reduce  $v$  into a fixed normal form  $\hat{v}$  with respect to  $\mathcal{KB}(P)_n$  ;

    Reduce  $w$  into a fixed normal form  $\hat{w}$  with respect to  $\mathcal{KB}(P)_n$  ;

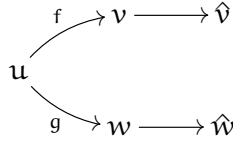

**if**  $\hat{v} \neq \hat{w}$  **then**

**if**  $\hat{w} \prec \hat{v}$  **then**

$\mathcal{KB}(P)_n := \mathcal{KB}(P)_n \cup \{\alpha : \hat{v} \rightarrow \hat{w}\}$

**else**

$\mathcal{KB}(P)_n := \mathcal{KB}(P)_n \cup \{\alpha : \hat{w} \rightarrow \hat{v}\}$

**end**

**else**

**end**

$\mathcal{C}_b := \mathcal{C}_b \cup \{\text{New critical branchings generated by } \alpha\}$

**end**

**2.5.11 Remark.** For this procedure to be implemented, we need to have a way to explicitly describe the set of all critical branchings of a polygraph, which is difficult in higher dimension. For string rewriting systems, see Section 2.6.1 computing the set of critical branchings is easy with a pattern-matching algorithm, and all the shapes of critical branchings are well known. For diagrammatic rewriting systems, see Section 2.6.3, we know all the shapes of critical branching but there does not exist an algorithmic way to provide the exhaustive list of critical branchings, because of the exchange relation which is hard to handle. In this case, we thus have to compute the set of critical branching by hand, by checking all the pairs of relations and see if there is an overlapping between them. In higher dimensions, computing the set of critical branchings is even more difficult, and so Knuth-Bendix procedure can hardly be implemented for  $n$ -polygraphs with  $n \geq 4$ .

## 2.6. EXAMPLES

**2.6.1. Dimension 2: string rewriting systems.** In this Section, we consider the example of *string rewriting systems*, that is rewriting systems over a set of strings on an alphabet. These rewriting systems originally appeared in formal language theory. They are also used in combinatorial algebra as a tool for presenting semigroups, groups or monoids. In terms of polygraphs, string rewriting systems correspond to 2-polygraphs with only one 0-cell.

Explicitly, a 2-polygraph is a triple  $P = (P_0, P_1, P_2)$  made of a 1-polygraph  $(P_0, P_1)$  and a cellular extension of the free 1-category  $P_1^*$ . When  $P$  has only one 0-cell, then  $P_1^*$  is precisely the free monoid on

the elements of  $P_1$ . For instance, the string rewriting systems on the alphabet  $\{s, t\}$  with one rewriting rule  $sts \rightarrow tst$  is described by the 2-polygraph  $P$  defined by

$$P_0 = \{\bullet\}, \quad P_1 = \{s, t\}, \quad P_2 = \{sts \xrightarrow{\alpha} tst\}.$$

The rule  $\alpha \in P_2$  corresponds to the following globular 2-cell on the free 1-category  $P_1^*$ :

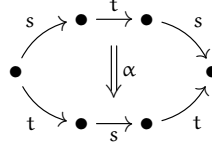

Note that this polygraph presents a monoid  $\mathcal{C}$  which is isomorphic to  $P_1^*/P_2$ , which is the braid monoid on 3-strands, given by generators and relations as follows:

$$s = \square, \quad t = \square, \quad \square = \square.$$

**2.6.2. String diagrams.** In free 2-categories, there is a convenient and intuitive way to represent the 2-cells using *string diagrams*. They were introduced by Feynman [47] and Penrose [98] in physics, and were formally studied by Joyal and Street [63]. We refer to [82, 105, 107] for complete surveys on the equivalence between 2-cells in free 2-categories and string diagrams. Consider a 2-category  $\mathcal{C}$  freely generated by a 2-polygraph  $P$ . The idea is that a 2-cell  $f : a_1 \dots a_m \Rightarrow b_1 \dots b_n$  can be thought of as a device having  $m$  inputs with types  $a_i$  and  $n$  outputs with types  $b_j$ . As a consequence, instead of using the usual globular representation for such a 2-cell as shown on the left below, there is a graphical notation adapted to this situation, as depicted on the right below:

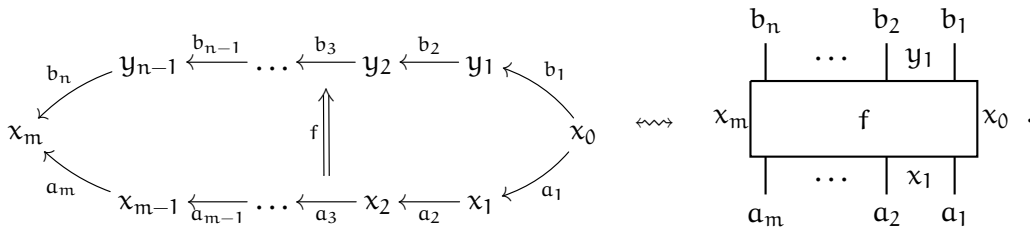

This representation is Poincaré dual to the globular representation since the 0-cells are pictured as 2-dimensional regions of the plane, 1-cells are pictured as wires or strands and 2-cells are either pictured as boxes as above, or as dots in many references. String diagrams can be composed in the two different ways expected in a 2-category. The  $\star_0$ -composition of 2-cells  $f_1 : a_1 \dots a_m \Rightarrow a'_1 \dots a'_k$  and  $f_2 : b_1 \dots b_n \Rightarrow b'_1 \dots b'_l$  is depicted by horizontal juxtaposition of the two string diagrams corresponding to  $f_1$  and  $f_2$ . The  $\star_1$ -composition of two 1-composable 2-cells  $f : a_1 \dots a_m \Rightarrow b_1 \dots b_n$  and  $g : b_1 \dots b_n \Rightarrow c_1 \dots c_k$  is depicted by vertically juxtaposing the corresponding string diagrams and linking the wires in the middle component. These two representations are summarized as follows:

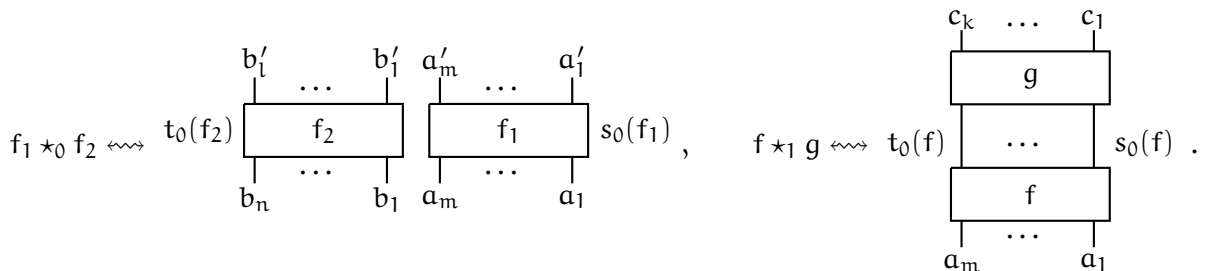

Note that by the convention chosen above, we read our diagrams from right to left and from bottom to top. We could have adopted a totally different convention, but we chose this one as it seems to be the mostly



used in the literature, and it is coherent with the work of Khovanov and Lauda on the categorification of quantum groups. Another convention that we will use in the sequel is that when the target (or the source) of a 2-cell  $f$  is the identity  $1_x$  on a 0-cell  $x$ , we omit drawing the wire labeled by  $1_x$ . For instance, if  $f : a_1 a_2 \Rightarrow 1_x$  with  $a_1 : x \rightarrow y$  and  $a_2 : y \rightarrow x$ , then the corresponding string diagram is depicted as:

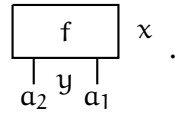

**2.6.3. Dimension 3: diagrammatic rewriting systems.** A 3-polygraph is given by the data of a cellular extension on a free 2-category. As 2-cells in such a category admit a representation by string diagrams, as explained in Section 2.6.2, such a 3-polygraph can be interpreted as a rewriting system on string diagrams, called a *diagrammatic rewriting system*. In [51, Section 5.1], Guiraud and Malbos classified all the different forms of critical branchings in this dimension, in a non linear case. There are 3 different forms of critical branchings between two rewriting steps  $\alpha$  and  $\beta$  of  $P$ :

- Regular critical branchings:

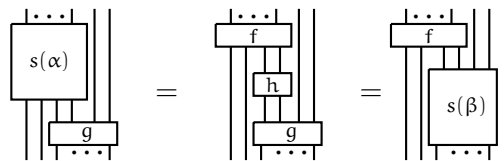

- Inclusion critical branchings:

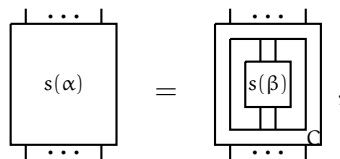

- Right-indexed critical branchings (also left-indexed, multi-indexed):

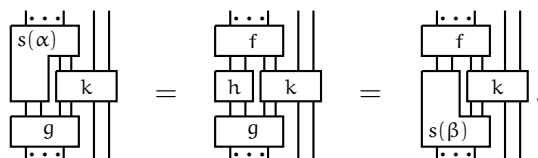

where  $f, g, h, k$  are 2-cells in  $P_2^*$ , and  $C$  is a context of  $P_2^*$ . Following [78, 51], it suffices to check the confluence of the indexed branchings for the instance  $k$  being in normal form, using the following

diagram from [51, Section 5.3]:

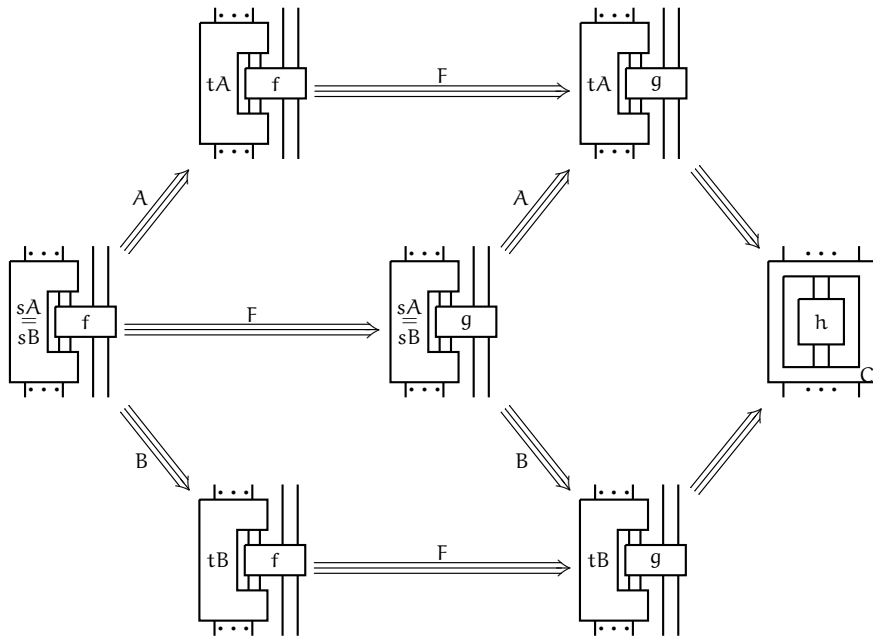

where  $g$  is the normal form of  $f$  and  $F : f \Rightarrow g$  is a 3-cell. Actually, the two squares on the left are Peiffer branchings, and thus are trivially confluent, and then the confluence of the whole square is assured by the confluence of the right square.

**2.6.4. Termination of 3-polygraphs by derivation.** In general, it may be difficult to prove termination of 3-polygraphs, since monomial orders may not exist. For instance, recall from [2] the 2-polygraph  $P$  with only one 0-cell, one 1-cell and the following two generating 2-cells:

$$\cap, \cup.$$

If there is a monomial order  $<$  on  $P$ , one of the following inequalities holds:

$$\left| \bigcirc < \bigcirc \right| \quad \text{or} \quad \bigcirc \left| < \bigcirc \right|.$$

If the first one holds (that we can assume without loss of generality since the other case is symmetric), we have

$$\left| \bigcirc \cap \right| < \bigcirc \cap = \cap \bigcirc < \left| \bigcirc \right|.$$

As a consequence, a bubble slide 3-cell (that is a 3-cell making an endomorphism of  $1_{\bullet}$  go through a vertical strand) can not be oriented in a terminating way, as it in the case in the linear  $(2, 2)$ -category  $\mathcal{AOB}$  in Section 9.4. However, in this Section we introduce following Guiraud and Malbos [49, 51] a way to prove termination of 3-polygraphs in which there are no caps and cups generating 2-cells. This is based on the notion of derivation on a 2-category.

Let us at first recall that the *category of contexts of  $\mathcal{C}$*  is the category denoted by  $\mathbf{Cont}(\mathcal{C})$ , whose objects are the 2-cells of  $\mathcal{C}$  and whose morphisms from  $f$  to  $g$  are the contexts  $C[\partial f]$  of  $\mathcal{C}$  such that  $C[f] = g$  holds. If  $C : f \rightarrow g$  and  $D : g \rightarrow h$  are morphisms of  $\mathbf{Cont}(\mathcal{C})$ , then  $D \circ C : f \rightarrow h$  is  $D[C]$ . The identity context on a 2-cell  $f$  of  $\mathcal{C}$  is the context corresponding to the sphere  $(s_1(f), t_1(f))$ . When  $P$  is a 2-polygraph, one writes  $\mathbf{Cont}(P)$  instead of  $\mathbf{Cont}(P^*)$  where  $P^*$  is the free 2-category generated by  $P$ .

**2.6.5. Modules over 2-categories.** Let  $\mathcal{C}$  be a 2-category. A  $\mathcal{C}$ -module is a functor from the category of contexts  $\mathbf{Cont}(\mathcal{C})$  to the category  $\mathbf{Ab}$  of abelian groups. Hence, a  $\mathcal{C}$ -module  $M$  is specified by an abelian group  $M(f)$  for every 2-cell  $f \in \mathcal{C}$ , and a morphism  $M(\mathcal{C}) : M(f) \rightarrow M(g)$  of groups, for every context  $\mathcal{C} : f \rightarrow g$  of  $\mathcal{C}$ .

**2.6.6 Prototypical example.** Let  $\mathbf{Ord}$  be the category of partially ordered sets and monotone maps. We will see it as a 2-category with one object, ordered sets as 1-cells and monotone maps as 2-cells. We recall that an internal abelian group in  $\mathbf{Ord}$  is a partially ordered set equipped with a structure of abelian group whose addition is monotone in both arguments.

Let us fix such an internal abelian group  $G$ , a 2-category  $\mathcal{C}$  and a 2-functor  $X : \mathcal{C} \rightarrow \mathbf{Ord}$ . Following [51], we can define a  $\mathcal{C}$ -module  $M_{X,G}$  as follows:

- Every 2-cell  $f : u \Rightarrow v$  is sent to the abelian group of morphisms  $M_{X,G}(f) = \mathbf{Ord}(X(u), G)$ .
- If  $w$  and  $w'$  are 1-cells of  $\mathcal{C}$  and  $\mathcal{C} = w \star_0 x \star_0 w'$  is a context from  $f : u \Rightarrow v$  to  $w \star_0 f \star_0 w'$ , then  $M_{X,G}(\mathcal{C})$  sends a morphism  $a : X(u) \rightarrow G$  in  $\mathbf{Ord}$  to:

$$\begin{array}{ccc} X(w) \times X(u) \times X(w') & \longrightarrow & G \\ (x', x, x'') & \longmapsto & a(x). \end{array}$$

- If  $g : u' \Rightarrow u$  and  $h : v \Rightarrow v'$  are 2-cells of  $\mathcal{C}$  and  $\mathcal{C} = g \star_1 x \star_1 h$  is a context from  $f : u \Rightarrow v$  to  $g \star_1 f \star_1 h$ , then  $M_{X,G}(\mathcal{C})$  sends a morphism  $a : X(u) \rightarrow G$  in  $\mathbf{Ord}$  to  $a \circ X$ , that is:

$$\begin{array}{ccc} X(u') & \longrightarrow & G \\ x & \longmapsto & a(X(g)(x)). \end{array}$$

By construction, when  $\mathcal{C}$  is freely generated by a 2-polygraph  $P$ , such a  $\mathcal{C}$ -module is uniquely and entirely determined by the values  $X(u)$  for every generating 1-cell  $u \in P_1$  and the morphisms  $X(\gamma) : X(u) \rightarrow X(v)$  for every generating 2-cell  $\gamma : u \Rightarrow v \in P_2$ . Note that in [51], prototypical modules  $M_{X,Y,G}$  are constructed from two functors  $X : \mathcal{C} \rightarrow \mathbf{Ord}$  and  $Y : \mathcal{C}^{op} \rightarrow \mathbf{Ord}$ , where  $\mathcal{C}^{op}$  is the 2-category  $\mathcal{C}$  in which the sources and targets of 2-cells are exchanged. We do not recall the definition of the modules  $M_{X,Y,G}$  in full generality here, since in the sequel we consider examples in which the 2-functor  $Y$  is trivial.

**2.6.7. Derivations of 2-categories.** Let  $\mathcal{C}$  be a 2-category and let  $M$  be a  $\mathcal{C}$ -module. A *derivation of  $\mathcal{C}$  into  $M$*  is a map sending every 2-cell  $f$  of  $\mathcal{C}$  to an element  $d(f) \in M(f)$  such that the following relation holds, for every  $i$ -composable pair  $(f, g)$  of 2-cells of  $\mathcal{C}$ :

$$d(f \star_i g) = f \star_i d(g) + d(f) \star_i g.$$

**2.6.8 Theorem** ([51], Thm 4.2.1). *Let  $P$  be a 3-polygraph such that there exist:*

- Two 2-functors  $X : P_2^* \rightarrow \mathbf{Ord}$  and  $Y : (P_2^*)^{op} \rightarrow \mathbf{Ord}$  such that, for every 1-cell  $a$  in  $P_1$ , the sets  $X(a)$  and  $Y(a)$  are non-empty and, for every 3-cell  $\alpha$  in  $P_3$ , the inequalities  $X(s\alpha) \geq X(t\alpha)$  and  $Y(s\alpha) \geq Y(t\alpha)$  hold.*
- An abelian group  $G$  in  $\mathbf{Ord}$  whose addition is strictly monotone in both arguments and such that every decreasing sequence of non-negative elements of  $G$  is stationary.*
- A derivation  $d$  of  $P_2^*$  into the module  $M_{X,Y,G}$  such that, for every 2-cell  $f$  in  $P_2^*$ , we have  $d(f) \geq 0$  and, for every 3-cell  $\alpha$  in  $P_3$ , the strict inequality  $d(s\alpha) > d(t\alpha)$  holds.*

*Then the 3-polygraph  $P$  terminates.*

**2.6.9 Remark.** This theorem generalizes a process described in [49] for term rewriting systems and operads. The idea is to see each 2-cell as an electrical circuit whose components are given by the generating 2-cells. Then, we fix a value for each circuit, that can be interpreted as its heat production, and with this value each input and output of the circuit receives a certain intensity of current. There are two types of currents, that is descending and ascending, that are represented by the two functors  $X$  and  $Y$ . The heat produced by a fixed circuit is calculated this way: an operator is arbitrarily chosen. Then, currents are propagated through the other operators to the chosen one. This requires that choices have been made for each operator: for each one, one must be able to compute the intensities of currents transmitted when he knows the intensities of incoming current. When one knows the intensities of each current coming into the chosen operator, one computes the heat it produces, according to values fixed in advance. Then, one repeats the same procedure for each operator, and sums the results to get the heat produced by the considered circuit, for the chosen current intensities. Two circuits with the same number of inputs and the same number of outputs are compared this way: if, for the current intensity, one produces more heat than the other one, then the first one is said to be greater. The idea to build this reduction order is to compare all the sources and targets of 2-cells following this method. We place all the values for the current intensities in  $G$ , so that it has to have an addition monotone in both variables. In a categorical framework, this construction is precisely expressed by the construction of a derivation on a 2-category, yielding Theorem 2.6.8.

## 2.7. LINEAR REWRITING

**2.7.1. Linear  $(n, p)$ -categories.** Linear  $(n, p)$ -categories are defined by induction on  $p \leq n$ . We denote by  $\mathbf{Vect}$  the category of vector spaces over a fixed field  $\mathbb{K}$ . An internal  $n$ -category in  $\mathbf{Vect}$  consists in the data of:

- an  $n$ -graph in  $\mathbf{Vect}$ :

$$V_0 \xleftarrow[s_0]{t_0} V_1 \xleftarrow[s_1]{t_1} \dots \xleftarrow[s_{n-2}]{t_{n-2}} V_{n-1} \xleftarrow[s_{n-1}]{t_{n-1}} V_n$$

- for each  $0 \leq k < l \leq n$ , there is a unit map  $V_k \rightarrow V_{k+1}$ ,  $v \mapsto 1_v$  which is linear, that is:

$$1_{\lambda u + \mu v} = \lambda 1_u + \mu 1_v$$

for any scalars  $\lambda$  and  $\mu$  and any  $k$ -cells  $u$  and  $v$  such that  $p \leq k < n$ ,

- for each  $0 \leq k < l \leq n$ , there is a composition map  $\star_k : V_l \times_{V_k} V_l$  to  $V_k$ , which is linear, that is:

$$(f + g) \star_k (f' + g') = f \star_k f' + g \star_k g', \quad \lambda f \star_k \lambda f' = \lambda (f \star_k f').$$

for any scalar  $\lambda$  and any pairs  $(f, f')$  and  $(g, g')$  of  $k$ -composable  $l$ -cells

satisfying the unit and composition axioms of an  $n$ -category. A linear  $(n, 0)$ -category is an internal  $n$ -category in  $\mathbf{Vect}$ . Let us assume linear  $(n, p)$ -categories are defined for  $p \geq 0$ . A linear  $(n + 1, p + 1)$ -category is the data of a set  $\mathcal{C}_0$  of 0-cells together with:

- for any  $a$  and  $b$  in  $\mathcal{C}_0$ , a linear  $(n, p)$ -category  $\mathcal{C}(a, b)$ ,
- for any  $a$  in  $\mathcal{C}_0$ , an identity morphism  $i_a$  from the terminal  $n$ -category  $I_n$  to  $\mathcal{C}(a, a)$ ,
- for any  $a, b$  and  $c$  in  $\mathcal{C}_0$ , a bilinear composition morphism  $\star^{a,b,c}$  from  $\mathcal{C}(a, b) \times \mathcal{C}(b, c)$  to  $\mathcal{C}(a, c)$ .

such that:

$$\mathbf{i)} \star^{a,c,d} \circ (\star^{a,b,c} \times \text{id}_{\mathcal{C}(c,d)}) = \star^{a,b,d} \circ (\text{id}_{\mathcal{C}(a,b)} \times \star^{b,c,d}),$$

- ii)  $\star^{a,a,b} \circ (i_a \times \text{id}_{\mathcal{C}(a,b)}) \circ \text{is}_l = \text{id}_{\mathcal{C}(a,b)} = \star^{a,b,b} \circ (\text{id}_{\mathcal{C}(a,b)} \times i_q) \circ \text{is}_r$  where  $\text{is}_l$  and  $\text{is}_r$  respectively denote the canonic isomorphisms from  $\mathcal{C}(a, b)$  to  $I_n \times \mathcal{C}(a, b)$  and to  $\mathcal{C}(a, b) \times I_n$ .

In particular, a linear  $(n, p)$ -category is an  $n$ -category. A *morphism of linear  $(n, p)$ -categories* from  $\mathcal{C}$  to  $\mathcal{C}'$  is an  $n$ -functor  $F = (F_0, \dots, F_n)$  such that the map  $F_k : \mathcal{C}_k \rightarrow \mathcal{C}'_k$  is linear for any  $p \leq k \leq n$  and the following diagrams commute:

$$\begin{array}{ccccccc}
\mathcal{C}_0 & \xleftarrow[s_0]{t_0} & \mathcal{C}_1 & \xleftarrow[s_1]{t_1} & \dots & \xleftarrow[s_{n-2}]{t_{n-2}} & \mathcal{C}_{n-1} & \xleftarrow[s_{n-1}]{t_{n-1}} & \mathcal{C}_n \\
F_0 \downarrow & & F_1 \downarrow & & & & F_{n-1} \downarrow & & F_n \downarrow \\
\mathcal{C}'_0 & \xleftarrow[s'_0]{t'_0} & \mathcal{C}'_1 & \xleftarrow[s'_1]{t'_1} & \dots & \xleftarrow[s'_{n-2}]{t'_{n-2}} & \mathcal{C}'_{n-1} & \xleftarrow[s'_{n-1}]{t'_{n-1}} & \mathcal{C}'_n
\end{array}$$

We denote by  $\mathbf{LinCat}_{n,p}$  the category of linear  $(n, p)$ -categories, and by  $\mathcal{U}_{n,p}$  the forgetful functor from  $\mathbf{LinCat}_{n,p}$  to  $\mathbf{Grph}_n$ . The category  $\mathbf{LinCat}_{n,p}^+$  of linear  $(n, p)$ -categories with a globular extension is defined by the following pullback diagram:

$$\begin{array}{ccc}
\mathbf{LinCat}_{n,p}^+ & \longrightarrow & \mathbf{Grph}_{n+1} \\
\downarrow & \lrcorner & \downarrow \mathcal{U}_n^G \\
\mathbf{LinCat}_{n,p} & \xrightarrow{\mathcal{U}_{n,p}} & \mathbf{Grph}_n
\end{array}$$

Similarly, the forgetful functor  $\mathbf{LinCat}_{n+1,p} \rightarrow \mathbf{LinCat}_{n,p}^+$  admits a left adjoint  $\mathcal{F}_{n+1,p}^W$  which is the free functor assigning to a linear  $(n, p)$ -category  $\mathcal{C}$  with a cellular extension  $\Gamma$  the *free linear  $(n+1, p)$ -category generated by  $\Gamma$  over  $\mathcal{C}$* .

**2.7.2. Free linear  $(n, p)$ -categories.** Let us define a free functor  $\mathcal{F}_{n,p}^c : \mathbf{Cat}_n \rightarrow \mathbf{LinCat}_{n,p}$  which constructs a free linear  $(n, p)$ -category generated by an  $n$ -category. Given an  $n$ -category  $\mathcal{C}$ , we define  $\mathcal{F}_{n,0}^c$  to be the linear  $(n, 0)$ -category such that for any  $0 \leq k \leq n$ ,  $\mathcal{F}_{n,0}^c(\mathcal{C})$  is the free  $\mathbb{K}$ -vector space over  $\mathcal{C}_k$ . Let us now assume that  $p \neq 0$ , we define  $\mathcal{F}_{n,p}^c(\mathcal{C})$  to be the linear  $(n, p)$ -category such that:

- i) for any  $0 \leq k < p$ , the linear  $(n, p)$ -category  $\mathcal{F}_{n,p}^c(\mathcal{C})$  has the same  $k$ -cells than  $\mathcal{C}$ ,
- ii) for any  $p \leq k < n$  and any parallel  $(p-1)$ -cells  $x$  and  $y$ ,  $(\mathcal{F}_{n,p}^c(\mathcal{C}))_k(x, y)$  is the free  $\mathbb{K}$ -vector space on  $\mathcal{C}_k(x, y)$ .

The compositions of  $\mathcal{F}_{n,p}^c(\mathcal{C})$  are defined by:

- for any  $0 \leq k < n$ , the compositions of  $k$ -cells of  $\mathcal{C}$  remain unchanged,
- for any  $0 \leq k < p$ , the composition  $\star_k : \mathcal{C}_{k-1}(u, v) \otimes \mathcal{C}_{k-1}(v, w) \rightarrow \mathcal{C}_{k-1}(u, w)$  is  $\mathbb{K}$ -linear,
- for any parallel  $(p-1)$ -cells  $a$  and  $b$  of  $\mathcal{C}$ , for any  $p \leq i < n$ , any  $i < j \leq n$ , any scalars  $\lambda, \mu \in \mathbb{K}$ , any  $i$ -composable  $j$ -cells  $f$  and  $f'$  of  $\mathcal{C}_j(a, b)$  and any  $i$ -composable  $j$ -cells  $g$  and  $g'$  of  $\mathcal{C}_j(a, b)$ , we have

$$(\lambda f + \mu g) \star_i (\lambda f' + \mu g') = \lambda (f \star_i f') + \mu (g \star_i g'),$$

so that the composition  $\star_i$  is linear on the set  $\mathcal{C}_j(a, b) \times_{\mathcal{C}_i} \mathcal{C}_j(a, b)$  of pairs of  $i$ -composable  $j$ -cells with source  $a$  and target  $b$ .

Moreover, these compositions satisfy some exchange relations: for any  $0 \leq i < j < p - 1$ , we have

$$\begin{aligned} & \left( \left( \sum_{x \in X} \lambda_x f_x \right) \star_i \left( \sum_{y \in Y} \mu_y g_y \right) \right) \star_j \left( \left( \sum_{x' \in X'} \lambda'_{x'} f'_{x'} \right) \star_i \left( \sum_{y' \in Y'} \mu'_{y'} g'_{y'} \right) \right) \\ &= \left( \left( \sum_{x \in X} \lambda_x f_x \right) \star_j \left( \sum_{x' \in X'} \lambda'_{x'} f'_{x'} \right) \right) \star_i \left( \left( \sum_{y \in Y} \mu_y g_y \right) \star_j \left( \sum_{y' \in Y'} \mu'_{y'} g'_{y'} \right) \right) \end{aligned}$$

whenever both sides of this equality are well defined. The functor  $\mathcal{F}_{n,p}^c$  extends  $n$ -functors between  $n$ -categories by linearity into morphisms of linear  $(n, p)$ -categories. Recall from [50, Proposition 1.2.3] that a linear  $(n, p)$ -category  $\mathcal{C}$  admits the structure of a  $(n, p)$ -category since for any  $k$ -cell  $f$  in  $\mathcal{C}$ ,  $f$  is  $(k - 1)$ -invertible and its inverse is given by  $s_{k-1}(f) + t_{k-1}(f) - f$ .

**2.7.3. Linear  $(n, p)$ -polygraphs.** Let us define the category  $\mathbf{LinPol}_{n,p}$  of linear  $(n, p)$ -polygraphs and their morphisms, together with the free functor  $\mathcal{F}_{n,p}^\ell : \mathbf{LinPol}_{n,p} \rightarrow \mathbf{LinCat}_{n,p}$  by induction on  $n \geq p$ . First of all, set  $\mathbf{LinPol}_{n,n} = \mathbf{Pol}_{n,n}$  and  $\mathcal{F}_{n,n}^\ell = \mathcal{F}_n \circ \mathcal{F}_{n,n}^c$ , where  $\mathcal{F}_n$  is the free functor  $\mathbf{Pol}_n \rightarrow \mathbf{Cat}_n$  defined in Section 2.4.6. Let us then assume that  $\mathbf{LinPol}_{n,p}$  and  $\mathcal{F}_{n,p}^\ell$  are defined for integers  $n \geq p$ . Then, we define  $\mathbf{LinPol}_{n+1,p}$  by the following pullback diagram in  $\mathbf{Cat}$ :

$$\begin{array}{ccc} \mathbf{LinPol}_{n+1,p} & \xrightarrow{\mathcal{U}_{n+1,p}^{\text{GP}}} & \mathbf{Grph}_{n+1} \\ \mathcal{U}_{n,p}^{\text{P}} \downarrow \lrcorner & & \downarrow \mathcal{U}_n^{\text{G}} \\ \mathbf{LinPol}_{n,p} & \xrightarrow{\mathcal{F}_{n,p}^\ell} \mathbf{LinCat}_{n,p} \xrightarrow{\mathcal{U}_{n,p}} & \mathbf{Grph}_n \end{array}$$

The functor  $\mathcal{F}_{n+1,p}^\ell$  is then defined as follows: first consider the unique functor  $\mathcal{F}_{n+1,p}^{\text{Pl}}$  making the following diagram commutative:

$$\begin{array}{ccccc} \mathbf{LinPol}_{n+1,p} & & & & \\ \mathcal{U}_{n,p}^{\text{P}} \downarrow & \searrow \mathcal{F}_{n+1,p}^{\text{Pl}} & \searrow \mathcal{U}_{n+1,p}^{\text{GP}} & & \\ & \mathbf{LinCat}_{n,p}^+ & \xrightarrow{\quad} & \mathbf{Grph}_{n+1} & \\ & \downarrow \lrcorner & & \downarrow \mathcal{U}_n^{\text{G}} & \\ \mathbf{LinPol}_{n,p} & \xrightarrow{\mathcal{F}_{n,p}^\ell} \mathbf{LinCat}_{n,p} & \xrightarrow{\quad} & \mathbf{Grph}_n & \end{array},$$

and then define  $\mathcal{F}_{n+1,p}^\ell$  as the following composition:

$$\mathbf{LinPol}_{n+1,p} \xrightarrow{\mathcal{F}_{n+1,p}^{\text{Pl}}} \mathbf{LinCat}_{n,p}^+ \xrightarrow{\mathcal{F}_{n+1,p}^{\text{W}}} \mathbf{LinCat}_{n+1,p}.$$

Given a linear  $(n, p)$ -polygraph  $P$ , the linear  $(n, p)$ -category  $\mathcal{F}_{n,p}^\ell(P)$  is called the *free linear  $(n, p)$ -category generated by  $P$* . When  $n = p$ , the linear  $(n, n)$ -category  $\mathcal{F}_{n,n}^\ell(P)$  is denoted by  $\mathbf{P}_n^\ell$ . Following this inductive construction, for  $n > p$ , a linear  $(n, p)$ -polygraph can be defined as a data made of an  $(n - 1, p)$ -linear polygraph  $P$  together with a cellular extension  $\Gamma$  of the linear  $(n - 1, p)$ -category  $\mathbf{P}_{n-1}^\ell$ .

**2.7.4. Presentation of a linear  $(n, p)$ -category.** Let  $n \geq p$  and  $\mathcal{C}$  be a linear  $(n, p)$ -category. We say that a linear  $(n + 1, p)$ -polygraph  $P$  is a *presentation* of  $\mathcal{C}$ , or that  $P$  *presents*  $\mathcal{C}$  if  $\mathcal{C}$  is isomorphic to the quotient of the linear  $(n, p)$ -category  $P_n^\ell$  by the congruence generated by the cellular extension  $P_{n+1}$ .

## 2.8. REWRITING IN LINEAR $(n + 1, n)$ -POLYGRAPHS

Let us fix for the rest of this chapter a non-negative integer  $n$  and a linear  $(n + 1, n)$ -polygraph  $P$ .

**2.8.1. Monomials.** A *monomial* of  $P$  is an  $n$ -cell of the  $n$ -category  $P_n^*$ . We say that  $P$  is *left-monomial* if for any  $\alpha \in P_{n+1}$ , the  $n$ -cell  $s_n(\alpha)$  is a monomial.

Any  $n$ -cell  $f$  in  $P_n^*$  can be uniquely decomposed into a sum of monomials  $f = \sum f_i$ , which is called the *monomial decomposition* of  $f$ . The *support* of  $f$ , denoted by  $\text{Supp}(f)$ , is the set  $\{f_i\}$  of  $n$ -cells that appear in the monomial decomposition of  $f$ .

**In the sequel, all the linear  $(n + 1, n)$ -polygraphs we consider are left-monomial.**

**2.8.2. Linear contexts.** A context of the linear  $(n, n)$ -category  $P_n^\ell$  has the shape  $\lambda C(\square) + h$ , where  $\lambda$  is a scalar in  $\mathbb{K}$ ,  $C$  is a context of the free  $n$ -category  $P_n^*$ , as defined in Section 2.4.4, and  $h$  is an  $n$ -cell of  $P_n^\ell$ .

**2.8.3. Rewriting steps.** A *rewriting step* of  $P$  is an  $(n + 1)$ -cell of the free  $(n + 1, n)$ -category  $P_{n+1}^\ell$  generated by  $P$  of the following form:

$$\lambda C[\alpha] + f : \lambda C[s_2(\alpha)] + f \rightarrow C[t_2(\alpha)] + f$$

where  $\alpha$  is a generating  $n + 1$ -cell in  $P_{n+1}$ ,  $C$  is a context of the free  $n$ -category  $P_n^*$  such that the monomial  $C[s_2(\alpha)]$  does not appear in the monomial decomposition of  $f$ . We denote by  $P_{\text{stp}}$  the set of rewriting steps of the linear  $(n + 1, n)$ -polygraph  $P$ .

We denote by  $P_{n+1}^\ell$  the free linear  $(n + 1, n)$ -category generated by  $P$ , as defined in Section 2.7.3. The *congruence* generated by  $P$  is the equivalence relation  $\equiv$  on  $P_n^\ell$  defined by  $u \equiv v$  if there is an  $(n + 1)$ -cell  $\alpha$  in  $P_{n+1}^\ell$  such that  $s_n(\alpha) = u$  and  $t_n(\alpha) = v$ . An  $(n + 1)$ -cell in  $P_{n+1}^\ell$  is said *elementary* if it is of the form  $\lambda C[\alpha] + h$  where  $\lambda$  is a non zero scalar,  $\alpha$  is a generating  $(n + 1)$ -cell in  $P_3$ ,  $C$  is a context of  $P_n^*$  and  $h$  is an  $n$ -cell in  $P_n^\ell$ .

An  $(n + 1)$ -cell  $\alpha$  of  $P_{n+1}^\ell$  is called *positive* if it is a  $\star_n$ -composition  $\alpha = \alpha_1 \star_2 \cdots \star_2 \alpha_n$  of rewriting steps of  $P$ . The *length* of a positive  $(n + 1)$ -cell  $\alpha$  in  $P_{n+1}^\ell$  is the number of rewriting steps of  $P$  needed to write  $\alpha$  as a  $\star_n$ -composition of rewriting steps. We denote by  $P_{n+1}^{\ell(1)}$  the set of positive  $(n + 1)$ -cells of  $P$  of length 1.

**2.8.4 Lemma** ([50], Lemma 3.1.3). *Let  $\alpha$  be an elementary  $(n + 1)$ -cell in  $P_{n+1}^\ell$ , then there exist two rewriting sequences  $\beta$  and  $\gamma$  of  $P$  of length at most 1 such that  $\alpha = \beta \star_n \gamma^-$ .*

**2.8.5. 1-polygraph of rewritings.** From this definition of rewriting step, to any linear  $(n + 1, n)$ -polygraph  $P = (P_0, \dots, P_n, P_{n+1})$ , we associate as in Section 2.4.8 the 1-polygraph  $P_{\geq n}$ , which has 0-cells the set of  $n$ -cells in the free linear  $(n, n)$ -category  $P_n^\ell$ , and has a 1-cell  $u \rightarrow v$  whenever there exists a rewriting step from  $u$  to  $v$  in  $P_{n+1}^\ell$ . This is an abstract rewriting system in the sense of Section 2.1.2. We thus say that a linear  $(n + 1, n)$ -polygraph satisfies the rewriting property  $\mathcal{P}$  if  $P_{\geq n}$  satisfies the property  $\mathcal{P}$ . In this interpretation, a positive  $(n + 1)$ -cell of  $P_{n+1}^\ell$  with  $n$ -source  $u$  and  $n$ -target  $v$  corresponds to a rewriting path  $u \xrightarrow{*} v$  in  $P_{\geq n}$ .

**2.8.6. Rewriting order.** The *rewrite order* of a linear  $(n+1, n)$ -polygraph  $P$  is the relations  $\preceq_P$  on  $P_n^\ell$  defined by:

- i) if  $u$  and  $v$  are monomials in  $P_n^\ell$ , then  $v \preceq_P u$  if  $u = v$  or there is a rewriting sequence in from  $u$  to  $v$  with respect to  $P$ ,
- ii) if for any  $y \in \text{Supp}(v)$  such that  $y \notin \text{Supp}(u)$ , there is an  $n$ -cell  $x \in \text{Supp}(u)$  with  $x \notin \text{Supp}(v)$  such that  $y \preceq_P x$ , then  $v \preceq_P u$ .

The *strict rewrite order* of  $P$  is the strict order relation  $\prec_P$  on  $P_n^\ell$  defined by  $v \prec_P u$  if  $v \preceq_P u$  but not  $u \preceq_P v$ . Note that when the linear  $(n+1, n)$ -polygraph  $P$  is terminating, this relation is well-founded. Moreover, proofs by Noetherian induction on  $P$  correspond to proofs by induction on the well-founded relation  $\prec_P$ .

**2.8.7. Linear monoidal categories and linear  $(2, 2)$ -categories.** A *(strict) monoidal category* is a category  $\mathcal{A}$  equipped with a tensor product  $\otimes : \mathcal{A} \times \mathcal{A} \rightarrow \mathcal{A}$  which is associative, a unit object  $\mathbf{1}$  in  $\mathcal{A}$  such that  $\mathbf{1} \otimes A = A = A \otimes \mathbf{1}$  for all object of  $\mathcal{A}$ . Such a category  $\mathcal{A}$  is  $\mathbb{K}$ -linear if for any 0-cells  $A$  and  $B$  in  $\mathcal{A}$ , the space  $\mathcal{A}_1(A, B)$  is a  $\mathbb{K}$ -vector space. Moreover, composition and tensor product of 1-cells are  $\mathbb{K}$ -bilinear.

A *linear  $(2, 2)$ -category* is a 2-category  $\mathcal{C}$  such that:

- i) for any  $p$  and  $q$  in  $\mathcal{C}_1$ , the set  $\mathcal{C}_2(p, q)$  is a  $\mathbb{K}$ -vector space.
- ii) for any  $p, q, r$  in  $\mathcal{C}_1$ , the map  $\star_1 : \mathcal{C}_2(p, q) \otimes \mathcal{C}_2(q, r) \rightarrow \mathcal{C}_2(p, r)$  is  $\mathbb{K}$ -linear.

When the set  $\mathcal{C}_0$  of 0-cells of a linear  $(2, 2)$ -category is a singleton, then  $\mathcal{C}$  can be interpreted as a linear monoidal category  $\mathcal{A}$  whose 0-cells are the 1-cells of  $\mathcal{C}$  and whose 1-cells are the 2-cells of  $\mathcal{C}$ . The tensor product in  $\mathcal{A}$  is given by the  $\star_0$ -composition of  $\mathcal{C}$ , and the composition of 1-cells in  $\mathcal{A}$  is given by the  $\star_2$ -composition in  $\mathcal{C}$ .

In the sequel, we consider linear  $(2, 2)$ -categories that admit presentations by generators and relations by linear  $(3, 2)$ -polygraphs, as defined in Section 2.8.8. In such a presentation, there are generating 1-cells, and generating 2-cells that are represented by string diagrams as in Section 2.6.2. A *monomial* in  $\mathcal{C}$  is a 2-cell that can be obtained from  $\star_0$  and  $\star_1$ -compositions of the generating 2-cells. Given a linear  $(2, 2)$ -category  $\mathcal{C}$ , a *hom-basis* of  $\mathcal{C}$  is a family of sets  $(\mathcal{B}_{p,q})_{p,q \in \mathcal{C}_1}$  indexed by pairs  $(p, q)$  of 1-cells of  $\mathcal{C}$  such that for any 1-cells  $p$  and  $q$ , the set  $\mathcal{B}_{p,q}$  is a linear basis of  $\mathcal{C}_2(p, q)$ . Following Section 2.8.2, a *context* of a linear  $(2, 2)$ -category  $\mathcal{C}$  has the shape

$$C = \lambda m_1 \star_1 (m_2 \star_0 \square \star_0 m_3) \star_1 m_4 + u,$$

where the  $m_i$  are monomials in  $\mathcal{C}$ ,  $\lambda$  is a scalar in  $\mathbb{K}$  and  $u$  is a 2-cell in  $\mathcal{C}$ .

**2.8.8. Linear  $(3, 2)$ -polygraphs.** Explicitely, a linear  $(3, 2)$ -polygraph is made of a data  $(P_0, P_1, P_2, P_3)$  where:

- i)  $(P_0, P_1, P_2)$  is a 2-polygraph, on which we construct the free linear  $(2, 2)$ -category  $P_2^\ell$  whose set of 0-cells is given by  $P_0$ , whose 1-cells are the 1-cells elements of  $P_1^*$  and for any  $p, q$  in  $P_1^*$ ,  $P_2^\ell(p, q)$  is the free  $\mathbb{K}$ -vector space on  $P_2^*(p, q)$ , where  $P_2^*$  is the free 2-category generated by  $(P_0, P_1, P_2)$ .
- ii)  $P_3$  is a cellular extension of  $P_2^\ell$ .



**2.8.9. Termination of linear (3, 2)-polygraphs.** We extend the derivation method to prove termination of 3-polygraphs from Theorem 2.6.8 in the linear setting. Given a linear (3, 2)-polygraph  $P$ , proving termination of  $P$  by derivation consists in constructing 2-functors  $X : P_2^\ell \rightarrow \mathbf{Ord}$  and  $Y : (P_2^\ell)^{\text{op}} \rightarrow \mathbf{Ord}$  and a derivation  $d : P_2^\ell \rightarrow M_{X,Y,G}$  as in Theorem 2.6.8. To take into account the linear structure, this data is required to satisfy the following conditions to ensure termination of  $P$ :

- i) For any 1-cell  $a$  in  $P_1$ , the sets  $X(a)$  and  $Y(a)$  are non-empty and, for any generating 3-cell  $\alpha$  in  $P_3$ , the inequalities  $X(s(\alpha)) \geq X(h)$  and  $Y(s(\alpha)) \geq Y(h)$  hold for any  $h$  in  $\text{Supp}(t(\alpha))$ .
- ii) The addition in  $G$  is strictly monotone in both arguments and every decreasing sequence of non-negative elements of  $G$  is stationary.
- iii) For any monomial  $f$  in  $P_2^\ell$ , we have  $d(f) \geq 0$  and, for every 3-cell  $\alpha$  in  $P_3$ , the strict inequality  $d(s(\alpha)) > d(h)$  holds for any  $h$  in  $\text{Supp}(t(\alpha))$ .

## 2.9. LINEAR CRITICAL BRANCHING LEMMA

**2.9.1. Terminating linear critical branching lemma.** The local branchings of linear  $(n + 1, n)$ -polygraphs can be classified in four different forms, see [2, Section 4.2]. An *aspherical branching* of  $P$  is a branching of the form

$$t(\alpha) \leftarrow s(\alpha) \rightarrow t(\alpha).$$

A *Peiffer branching* is a branching formed with two rules which does not overlap:

$$t_2(\alpha) \star_1 s_2(\beta) + h \leftarrow s_2(\alpha) \star_1 s_2(\beta) + h \rightarrow s_2(\alpha) \star_1 t_2(\beta) + h.$$

An *additive branching* is a branching of the form

$$t_2(\alpha) + s_2(\beta) \leftarrow s_2(\alpha) + s_2(\beta) \rightarrow s_2(\alpha) + t_2(\beta).$$

*Overlapping* branchings are all the remaining local branchings. In the case of left-monomial linear (3, 2)-polygraphs, the classification of overlapping branchings is the same than in the case of non-linear 3-polygraphs, given in Section 2.6.3. We define an order on monomials of  $P_2^\ell$  by  $f \sqsubseteq g$  if there exists a context  $C$  of  $P_2^*$  such that  $g = C[f]$ . A *critical branching* of  $P$  is an overlapping branching of  $P$  which is minimal for  $\sqsubseteq$ .

**2.9.2 Theorem** ([2], Thm 4.2.13). *Let  $P$  be a terminating linear (3, 2)-polygraph. Then  $P$  is locally confluent if and only if its critical branchings are confluent.*

**2.9.3 Remark.** Note that if  $P$  is not terminating, this result may fail. Indeed, because of the restriction of rewriting steps to the set of positive 3-cells in  $P_3^\ell$ , some Peiffer or additive branchings may not be confluent. For instance, consider following [50] the following example of a linear (2, 1)-polygraph ( $P_0 = \{*\}$ ,  $P_1 = \{x, y, z, t\}$ ,  $P_2 = \{\alpha : xy \rightarrow xz, \beta : zt \rightarrow 2yt\}$ ). It has an additive branching with source  $xyt + xzt$ , which is not confluent since the dotted arrows in the diagram below are 2-cells of  $P_2^\ell$  that are not positive.

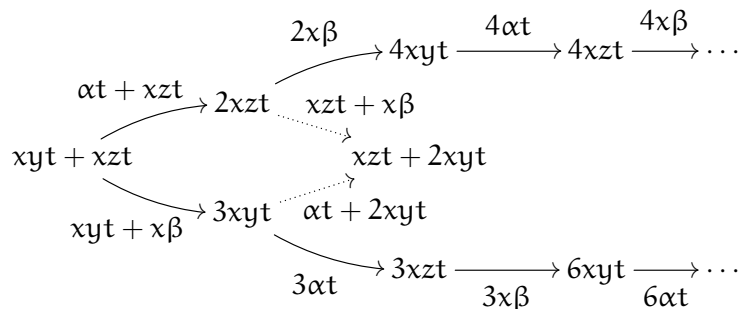

**2.9.4. Exponentiation freedom.** Let  $n$  be a non-negative integer and  $P$  be a linear  $(n+1, n)$ -polygraph. We say that  $P$  is *exponentiation free* if there is no rewriting sequence in  $P^\ell$  of the form

$$m \rightarrow \lambda m + f,$$

where  $m$  is a monomial in  $P^\ell$ ,  $\lambda$  is a non zero scalar in  $\mathbb{K}$ , and  $f$  is a non-zero  $n$ -cell of  $P^\ell$  which does not contain  $m$  in its monomial decomposition.

Note that if  $P$  is quasi-terminating, then exponentiation freedom is equivalent to the fact that for every monomial  $m$  rewriting into a  $n$ -cell  $f$  such that  $m \in \text{Supp}(f)$ , we have  $f = m$ . With the terminology of Dershowitz [40], when  $P$  is quasi-terminating and exponentiation free, then any infinite rewriting sequence contains cycles of the form

$$u_1 \rightarrow u_2 \rightarrow \dots \rightarrow u_k = u_1,$$

and no infinite rewriting sequence of the form

$$u_1^{(1)} \rightarrow u_1^{(2)} \rightarrow \dots \rightarrow u_1^{(n)}$$

where for any  $k \in \mathbb{N}$ ,  $u_1^{(k+1)}$  is a "term" containing  $u_1^{(k)}$  as a "subterm", which in the polygraphic context means that  $u_1^{(k)}$  rewrites to  $u_1^{(k+1)} = C[u_1^{(k)}]$ , where  $C$  is a context. In other words, if  $P$  is quasi-terminating and exponentiation free, then the only obstructions to termination of  $P$  are created by cycles.

**2.9.5. Quasi-terminating linear critical branching lemma.** Following [1], we prove the following result:

**2.9.6 Theorem.** *Let  $P$  be a quasi-terminating and exponentiation free linear  $(n+1, n)$ -polygraph. If all critical branchings of  $P$  are confluent, then  $P$  is locally confluent.*

*Proof.* Let us at first prove that, under these assumptions, all additive branchings of  $P$  are confluent. Let  $f$  (resp.  $g$ ) be a rewriting step of  $P$  monomial source  $u$  (resp.  $v$ ) and target  $u'$  (resp.  $v'$ ),  $\lambda$  and  $\mu$  non zero scalars in  $\mathbb{K}$  and  $h$  a  $n$ -cell of  $P_n^\ell$  which does not contain  $u$  or  $v$  in its monomial decomposition. We prove that the additive branching  $(\lambda f + \mu v + h, \lambda u + \mu g + h)$  is confluent by considering four cases.

**Case 1.** If  $u \notin \text{Supp}(v')$  and  $v \notin \text{Supp}(u')$ , the  $(n+1)$ -cells  $\lambda u' + \mu g + h$  and  $\lambda f + \mu v' + h$  are rewriting steps and make the branching confluent.

**Case 2.** If  $u \in \text{Supp}(v')$  and  $v \notin \text{Supp}(u')$ , let us write  $\lambda u + \mu v' = \gamma u + k$ , where  $u \notin \text{Supp}(k)$ . As a consequence,  $\gamma f + k + h$  is a rewriting step with source  $\gamma u + k + h$  and target  $\gamma u' + k + h$ . On the other side, the  $n$ -cell  $\lambda u' + \mu v + h$  reduces via  $\lambda u' + \mu g + h$  into  $\lambda u' + \mu v' + h = \lambda u' + h + (\gamma - \lambda)u + k + h$ . Since  $u \notin \text{Supp}(u')$ , this  $n$ -cell reduces into  $\gamma u' + k + h$ , proving the confluence of the branching. This is summarized in the following diagram:

$$\begin{array}{ccccc}
 & \xrightarrow{\lambda f + \mu v + h} & \lambda u' + \mu v + h & \longrightarrow & \lambda u' + \mu v' + k + h = \lambda u' + (\gamma - \lambda)u + k + h & \xrightarrow{\lambda u' + (\gamma - \lambda)f + k + h} & \gamma u' + k + h \\
 \lambda u + \mu v + h & & & & \uparrow \text{dotted} & & \\
 & \xrightarrow{\lambda u + \mu g + h} & \lambda u + \mu v' + h & = & \gamma u + k + h & \longrightarrow & \gamma u' + k + h
 \end{array}$$

**Case 3.** If  $u \notin \text{Supp}(v')$  and  $v \in \text{Supp}(u')$ , the proof is symmetric to Case 2.

**Case 4.** If  $u \in \text{Supp}(v')$  and  $v \in \text{Supp}(u')$ , we can write decompositions

$$u' = \gamma_v v + k_1, \quad v' = \gamma_u u + k_2$$

where  $k_1$  and  $k_2$  are  $n$ -cells such that  $u \notin \text{Supp}(k_2)$  and  $v \notin \text{Supp}(k_1)$ , and  $\gamma_v, \sigma_u$  are non zero scalars. Because  $P$  is exponentiation free, we can also assume that  $v \notin \text{Supp}(k_2)$  and  $u \notin \text{Supp}(k_1)$ . Therefore, we have the following rewriting sequence in  $P^*$ :

$$u \xrightarrow{f} u' = \gamma_v v + k_1 \xrightarrow{\gamma_v g + k_1} \gamma_v v' + k_1 = \gamma_v \gamma_u u + \gamma_v k_2 + k_1 .$$

The scalar  $\gamma_v \gamma_u$  being non zero, by exponentiation free assumption we get that  $\gamma_v k_2 + k_1 = 0$ , and since  $P$  is quasi-terminating we thus necessarily obtain that  $\gamma_v \gamma_u = 1$ . Thus, we have

$$v' = \gamma_u u + k_2, \quad u' = \gamma_v (v - k_2).$$

Now, the  $n$ -cell  $\lambda u + \mu v + h$  rewrites via  $f$  into  $\lambda u' + \mu v + h = (\lambda \gamma_v + \mu)v - \lambda \gamma_v k_2 + h$  on the one side. On the other side, by applying  $g$ , we have the following rewriting sequence in  $P^*$ :

$$\lambda u + \mu v + h \xrightarrow{\lambda u + \mu g + h} \lambda u + \mu v' + h = (\lambda + \mu \gamma_u)u + \mu k_2 + h \xrightarrow{(\lambda + \mu \gamma_u)f + \mu k_2 + h} (\lambda + \mu \gamma_u)u' + \mu k_2 + h$$

and the last term is equal to  $(\lambda \gamma_v + \mu)v + \mu k_2 + h$  using the relations satisfied by  $\gamma_u, \gamma_v, k_1$  and  $k_2$ , proving the confluence of this branching. Now, in order to prove the theorem, it remains to prove that Peiffer and overlapping local branchings are confluent. We proceed by well-founded induction on the rewriting order  $\prec_P$  defined in Section 2.8.6. If  $(f, g)$  is an overlapping branching, we can write  $(f, g) = (\lambda f' + h, \lambda g' + h)$  where  $(f', g')$  is a critical branching. By assumption, there exists a confluence  $(f'', g'')$  of the critical branching  $(f', g')$ . However, the  $(n+1)$ -cells  $\lambda f'' + h$  and  $\lambda g'' + h$  may not be positive, for instance if  $t_n(f') \in \text{Supp}(h)$  or if  $t_n(g') \in \text{Supp}(h)$ . However, if they are not positive, according to Lemma 2.8.4, there exists positive  $(n+1)$ -cells  $f_1, f_2, g_1, g_2$  in  $P_{n+1}^\ell$  of length at most 1 as in the following diagram:

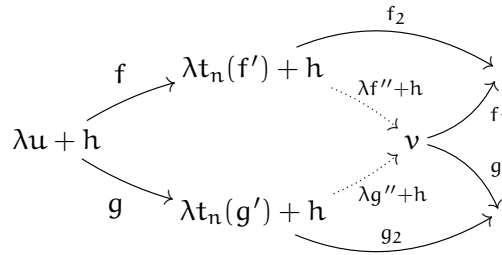

Now, if  $f_1$  and  $g_1$  are both of length 0, then the pair  $(f_2, g_2)$  is a confluence of the branching  $(f, g)$ . If  $\ell(f_1) = 1$  and  $\ell(g_1) = 0$  (the other case being symmetric), then the pair  $(f_2, g_2 \star_{n-1} g_1)$  is a confluence of the branching  $(f, g)$ . Otherwise, we have that  $v \prec_P \lambda u + h$ , and thus by induction assumption the local branching  $(f_1, g_1)$  is confluent, which proves the confluence of the branching  $(f, g)$ . The case of local Peiffer branchings of the form  $\lambda u' \star_{n-1} v + h \leftarrow \lambda u \star_{n-1} v + h \rightarrow \lambda u \star_{n-1} v' + h$  is treated in a similar fashion.  $\square$

This result fails without the assumption of exponentiation freedom. Indeed, consider the linear  $(2, 1)$ -polygraph  $P = (P = 0 = \{\bullet\}, P_1 = \{x, y\}, P_2 = \{x \Rightarrow y, y \Rightarrow -x\})$ . It is quasi-terminating, but not exponentiation free, and has a non-confluent local additive branching  $2y \Leftarrow x + y \Rightarrow 0$ .

**2.9.7. Linear bases from confluence.** Following [1], there are two different situations in which we can compute hom-bases of linear  $(n, n)$ -categories from presentations by linear  $(n+1, n)$ -polygraphs:

- a) Given a convergent presentation of a linear  $(n, n)$ -category  $\mathcal{C}$  by a linear  $(n+1, n)$ -polygraph  $P$ , for any  $(n-1)$ -cells  $p$  and  $q$  in  $\mathcal{C}_{n-1}$ , the set of monomial  $n$ -cells with source  $p$  and target  $q$  in normal form with respect to  $P$  form a linear basis of the vector space  $\mathcal{C}_n(p, q)$ , [2, Proposition 4.2.15]. As a consequence, the set of all monomials in normal form with respect to  $P$  forms a hom-basis of  $\mathcal{C}$ .

- b)** Given a presentation of a linear  $(n, n)$ -category  $\mathcal{C}$  by a quasi-terminating and confluent linear  $(n + 1, n)$ -polygraph  $P$ , fix for any  $n$ -cell  $u$  of  $\mathcal{C}$  a choice of a quasi-normal form  $\tilde{u}$  of  $u$  with respect to  $P$ . Then, for any  $n$ -cell  $u$  in  $\mathcal{C}$ , reduce  $u$  into  $\tilde{u}$  and consider all the elements in  $\text{Supp}(\tilde{u})$ . This gives a set of monomials, which are in quasi-normal form since  $P$  is left-monomial, and the reunion of these sets over all the  $n$ -cells  $u \in \mathcal{C}$  gives a hom-basis of  $\mathcal{C}$ .

**Contents**

|  |           |
|--|-----------|
| <b>3.1 Grothendieck groups</b> . . . . .                                     | <b>75</b> |
| <b>3.2 Naive and weak categorification</b> . . . . .                         | <b>77</b> |
| <b>3.3 Strong categorification</b> . . . . .                                 | <b>78</b> |
| <b>3.4 Quantum groups</b> . . . . .  | <b>79</b> |
| <b>3.5 Khovanov and Lauda's categorification of quantum groups</b> . . . . . | <b>81</b> |

The term categorification refers to the process of replacing set-theoretic notions by the corresponding category-theoretic analogues, in order to study a given algebraic structure. The objective of this process is to define an higher-dimensional category, related to the original object in the way that this object is isomorphic to the Grothendieck group of this category, in order to have a richer structure making new phenomena appear. Since the pioneer works and categorification by Crane and Frenkel [34], this idea has been used in various contexts, and helped to solve numerous complicated problems.

In this Chapter, we recall the general notions of Grothendieck groups, decategorification and weak categorification. As we are interested in categorifying objects that already admit a categorical structure, we also expand on the notion of strong categorification, and how to construct such an object. In the last part of this chapter, we illustrate these definitions and ideas by recalling Khovanov and Lauda's construction of a candidate categorification for a quantum groups associated with a symmetrizable Kac-Moody algebra. We start by recalling notions about quantum groups and root data needed in the sequel, and then recall following [81, 82, 67] the various steps in order to define the candidate 2-category.

### 3.1. GROTHENDIECK GROUPS

In this section, we recall the general notions on decategorification and Grothendieck groups for additive and abelian categories as in [90, 104].

**3.1.1. Idea of the categorification process.** The idea of categorification, coming from works of Crane and Frenkel [34], refers to the process of replacing set-theoretic notions by the corresponding category-theoretic analogues. For instance, a set should be replaced by a category, an element of this set by a

0-cell in the category, a map by a functor, a relation between elements by a 1-cell and so on. The general idea for doing this is that, replacing a “simpler“ object by something “more complicated“, one gets a bonus in the form of some extra structure which may be used to study the original object. However, the difficulty of the process is that there are no explicit rules how to categorify an algebraic object and the answer might depend on what kind of extra structure and properties one expects.

**3.1.2. Grothendieck group of a monoid.** The idea of Grothendieck group is originally defined for commutative monoids: it provides the universal way of making a monoid into an abelian group. Let  $M = (M, +, 0)$  be a commutative monoid. The *Grothendieck group* of  $M$  is a pair  $(G, \varphi)$ , where  $G$  is a commutative group and  $\varphi : M \rightarrow G$  is a homomorphism of monoids, such that for every monoid homomorphism  $\psi : M \rightarrow A$ , where  $A$  is a commutative group, there is a unique group homomorphism  $\Psi : G \rightarrow A$  making the following diagram commutative:

$$\begin{array}{ccc} M & \xrightarrow{\varphi} & G \\ & \searrow \psi & \swarrow \Psi \\ & & A \end{array}$$

The functor that sends a commutative monoid  $M$  to its Grothendieck group  $G$  is left adjoint to the forgetful functor from the category of abelian groups to the category of commutative monoids. The idea can be easily generalized to small categories with some additional structure, for instance abelian, triangulated, derived categories.

**3.1.3. Grothendieck group of additive categories.** Recall that an *additive category* is a category satisfying the two following properties:

- i) It is enriched in abelian groups, that is the space of morphisms between two given objects is an abelian group. (Sometimes, such a category is called a pre-additive category.)
- ii) It admits finite coproducts, and thus finite biproducts.

Let  $F(\mathcal{A})$  be the free abelian group with basis the isomorphism classes  $[M]$  of 0-cells  $M$  in  $\mathcal{A}$ , and let  $N^{\text{split}}(\mathcal{A})$  be the subgroup generated by the elements  $[A_1] - [A_2] + [A_3]$  for every 0-cells of  $\mathcal{A}$  such that  $A_2 \simeq A_1 \oplus A_3$ . The *split Grothendieck group* of  $\mathcal{A}$ , denoted by  $K_0^{\text{split}}(\mathcal{A})$  is the quotient group  $F(\mathcal{A})/N^{\text{split}}(\mathcal{A})$ . We still denote the image of  $[A]$  in  $K_0^{\text{split}}(\mathcal{A})$  by  $[A]$ . This comes together with a map  $(\cdot) : \mathcal{A} \rightarrow K_0^{\text{split}}(\mathcal{A})$  which maps a 0-cell  $M$  in  $\mathcal{A}$  to the class  $[M]$  in  $K_0^{\text{split}}(\mathcal{A})$ . The group  $K_0^{\text{split}}(\mathcal{A})$  then has the following universal property: for every abelian group  $\mathbf{A}$  and for any additive function  $\chi : \mathcal{A} \rightarrow \mathbf{A}$ , that is  $\chi(Y) = \chi(X) + \chi(Z)$  if  $Y = X \oplus Z$ , there is a unique group homomorphism  $\bar{\chi} : K_0^{\text{split}}(\mathcal{A}) \rightarrow \mathbf{A}$  making the following diagram commute:

$$\begin{array}{ccc} \mathcal{A} & \xrightarrow{(\cdot)} & K_0^{\text{split}}(\mathcal{A}) \\ & \searrow \chi & \swarrow \bar{\chi} \\ & & \mathbf{A} \end{array}$$

**3.1.4. Grothendieck group of abelian categories.** Let us recall that an abelian category  $\mathcal{A}$  is an additive category in which every morphism  $f : A \rightarrow B$  in  $\mathcal{A}$  admits a kernel and a cokernel, yielding the following exact sequence:

$$A \xrightarrow{p} \text{Coker Ker}(f) \xrightarrow{\bar{f}} \text{Ker Coker}(f) \xrightarrow{i} B,$$

and satisfying moreover that the arrow  $\bar{f}$  above is an isomorphism, and that every monomorphism is a kernel and every epimorphism is a cokernel. Let us assume that  $\mathcal{A}$  is a small abelian category. We still

denote by  $F(\mathcal{A})$  the free abelian group with basis the isomorphism classes  $[M]$  of 0-cells  $M$  in  $\mathcal{A}$ . Let  $N(\mathcal{A})$  be the subgroup of  $F(\mathcal{A})$  generated by the elements  $[A_1] - [A_2] + [A_3]$  for every exact sequence

$$0 \rightarrow A_1 \rightarrow A_2 \rightarrow A_3 \rightarrow 0$$

in  $\mathcal{A}$ . The *Grothendieck group* of  $\mathcal{A}$ , denoted  $K_0(\mathcal{A})$ , is the quotient group  $F(\mathcal{A})/N(\mathcal{A})$ . We still denote the image of  $[A]$  in  $K_0(\mathcal{A})$  by  $[A]$ .

For instance, if  $\mathbb{K}$  is a field and  $\mathcal{A} = \mathbf{A} \text{ mod } \text{the category of finite-dimensional left modules over some finite dimensional } \mathbb{K}\text{-algebra } A$ , the group  $[A]$  is isomorphic to the free abelian group with the basis given by classes of simple  $A$ -modules. Note that any abelian category is additive. However, if  $\mathcal{A}$  is abelian, then  $K_0^{\text{split}}(\mathcal{A})$  can be bigger than  $K_0(\mathcal{A})$  if there are exact sequences which do not split. In the sequel, we will only be interested in Grothendieck groups of additive categories, and thus we will only consider split Grothendieck groups. As a consequence, the split Grothendieck group of an additive category  $\mathcal{A}$  will be denoted by  $K_0(\mathcal{A})$ .

**3.1.5. Decategorification.** Let  $\mathcal{A}$  be an additive category. The *decategorification* of  $\mathcal{A}$  is the abelian group  $K_0(\mathcal{A})$ . Note that this is one method of decategorification that can be found in the literature, but there exist other ways of decategorifying an algebraic structure, for instance with the trace map, see [104]. In what follows, we would like to categorify algebras over some base ring, so that we have to extend the notion of decategorification to allow base rings. Let us consider a commutative ring  $\mathbb{F}$ , with unit 1. The  $\mathbb{F}$ -decategorification of  $\mathcal{A}$  is the  $\mathbb{F}$ -module

$$K_0(\mathcal{A})^{\mathbb{F}} := \mathbb{F} \otimes_{\mathbb{Z}} K_0(\mathcal{A}).$$

The element  $1 \otimes [M]$  of some  $\mathbb{F}$ -decategorification will be denoted by  $[M]$  for simplicity.

**3.1.6. Graded setup.** Let  $R$  be a  $\mathbb{Z}$ -graded ring. Consider the category  $\mathbf{R}\text{-gMod}$  of all graded  $R$ -modules and denote by  $\langle 1 \rangle$  the shift of grading autoequivalence of  $\mathbf{R}\text{-gMod}$  normalized as follows: for a graded module  $M = \bigoplus_{i \in \mathbb{Z}} M_i$  one has  $(M\langle 1 \rangle)_j = M_{j+1}$ . Assume that  $\mathcal{A}$  is a category of graded  $R$ -modules closed under  $\langle \pm 1 \rangle$ , then the group  $[A]$  becomes a  $\mathbb{Z}[v, v^{-1}]$ -module via  $v^i[M] = [M\langle -i \rangle]$  for any  $M \in \mathcal{A}$ ,  $i \in \mathbb{Z}$ .

To extend the notion of decategorification to a category of graded modules, let  $\mathbb{F}$  be a unitary commutative ring and  $\iota : \mathbb{Z}[q, q^{-1}] \rightarrow \mathbb{F}$  be a homomorphism of unitary rings. This defines a right  $\mathbb{Z}[q, q^{-1}]$ -module structure on  $\mathbb{F}$ . The  $\iota$ -decategorification of  $\mathcal{A}$  is the  $\mathbb{F}$ -module

$$[\mathcal{A}]^{(\mathbb{F}, \iota)} := \mathbb{F} \otimes_{\mathbb{Z}[q, q^{-1}]} [\mathcal{A}].$$

## 3.2. NAIVE AND WEAK CATEGORIFICATION

In this section, we fix a commutative ring with unit  $\mathbb{F}$ .

**3.2.1. Categorification of an  $\mathbb{F}$ -module.** An  $\mathbb{F}$ -categorification of an  $\mathbb{F}$ -module  $V$  is a pair  $(\mathcal{A}, \varphi)$  made of an additive category  $\mathcal{A}$  and an isomorphism  $\varphi$  from  $V$  to the  $\mathbb{F}$ -decategorification of  $\mathcal{A}$ . Whereas the decategorification of a category is uniquely defined, there are usually many different categorifications of an  $\mathbb{F}$ -module  $V$ .

**3.2.2. Example: categorification of  $\mathbb{Z}$ .** Consider the category  $\mathbf{Vect}_{\mathbb{K}}$  of all finite-dimensional  $\mathbb{K}$ -vector spaces and linear maps over a base field  $\mathbb{K}$ . Then  $K_0^{\text{split}}(\mathbf{Vect}_{\mathbb{K}}) \simeq \mathbb{Z}$ . Indeed, consider the surjective homomorphism

$$f : \mathbf{Vect}_{\mathbb{K}} \rightarrow \mathbb{Z}, V \mapsto \dim(V)$$

Since  $\dim(V \oplus W) = \dim(V) + \dim(W)$ , we have  $N(\mathbf{Vect}_{\mathbb{K}}) \subseteq \text{Ker}(f)$ . Now, let us consider an element  $\sum_{i=1}^n c_i[V_i]$  of  $\text{Ker}(f)$ . We have  $\sum_{i=1}^n c_i \dim(V_i) = f(\sum_{i=1}^n c_i[V_i]) = 0$  so in  $K_0(\mathbf{Vect}_{\mathbb{K}})$ , since  $[V_i] = \dim(V_i)[\mathbb{K}]$ , we have

$$\sum_{i=1}^n c_i[V_i] = \sum_{i=1}^n (c_i \dim(V_i))[\mathbb{K}] = 0,$$

so that  $\text{Ker}(f) = N(\mathbf{Vect}_{\mathbb{K}})$  and by the first isomorphism theorem, we get that  $K_0(\mathbf{Vect}_{\mathbb{K}}) \sim \mathbb{Z}$ , so that  $\mathbf{Vect}_{\mathbb{K}}$  is a categorification of  $\mathbb{Z}$ .

**3.2.3. Naive and weak categorification.** Let  $B$  be a unital associative  $R$ -algebra, and let  $\{b_i\}_{i \in I}$  be a fixed generating set for  $B$ . If  $M$  is a  $B$ -module, then the action of each  $b_i$  on  $M$  defines an  $R$ -linear endomorphism  $b_i^M$  of  $M$ . A *naive categorification* of  $(B, \{b_i\}_{i \in I}, M)$  is a tuple  $(\mathcal{M}, \{F_i\}_{i \in I}, \varphi)$  where  $\mathcal{M}$  is an abelian category,  $\varphi : K_0(\mathcal{M}) \otimes_{\mathbb{Z}} R \rightarrow M$  is an isomorphism, and for each  $i \in I$ ,  $F_i : \mathcal{M} \rightarrow \mathcal{M}$  is an exact endofunctor of  $\mathcal{M}$  such that the following diagram is commutative:

$$\begin{array}{ccc} K_0(\mathcal{M}) \otimes_{\mathbb{Z}} R & \xrightarrow{[F_i] \otimes \text{id}} & K_0(\mathcal{M}) \otimes_{\mathbb{Z}} R \\ \varphi \downarrow & & \downarrow \varphi \\ M & \xrightarrow{b_i^M} & M \end{array} .$$

We refer the reader to [90, 104] for details on why this is a naive concept of categorification. In this definition, we only require that the functors  $F_i$  induce the right maps on the level of the Grothendieck group. A stronger notion would be to categorify the relations amongst the generators  $b_i$ : that is, given a set of relations of  $B$  generating all the relations in  $B$ , we want isomorphism of functors that descend to these relations in the Grothendieck group. A *weak categorification*  $(\mathcal{M}, \{F_i\}_{i \in I}, \varphi)$  of  $(B, \{b_i\}_{i \in I}, M)$  is a naive categorification that satisfies more conditions given by isomorphisms of functors descending in the Grothendieck group of  $\mathcal{M}$  on the defining relations of  $B$ .

**3.2.4 Example.** Let  $B = \mathbb{C}[x]/(x^2 - 2x)$  with the generating set  $\{x\}$ . Let  $M = \mathbb{C}$  be the  $B$ -module with action given by  $b \cdot z = 0$  for  $z \in M$ , and let  $N = \mathbb{C}$  be the  $B$ -module with action given by  $b \cdot z = 2z$  for  $z \in N$ . Let  $\mathcal{M} = \mathbf{Vect}_{\mathbb{C}}$  be the category of finite-dimensional  $\mathbb{C}$ -vector spaces and define the functors  $F, G : \mathcal{M} \rightarrow \mathcal{M}$  by

$$F = 0, \quad G(V) = V \oplus V, \text{ for all } V \in \mathcal{M}.$$

Define  $\varphi : K_0(\mathcal{M}) \otimes_{\mathbb{Z}} \mathbb{C} \rightarrow M$  and  $\psi : K_0(\mathcal{M}) \otimes_{\mathbb{Z}} \mathbb{C} \rightarrow N$  by  $z[\mathbb{C}] \mapsto z$ , where  $[\mathbb{C}]$  denotes the class of the simple one-dimensional  $\mathbb{C}$ -module. For all  $z \in \mathbb{C}$ , we have

$$\varphi \circ [F](z[\mathbb{C}]) = 0 = b \cdot \varphi(z[\mathbb{C}]),$$

$$\psi \circ [G](z[\mathbb{C}]) = \psi(z[G(\mathbb{C})]) = \psi(z[\mathbb{C} \oplus \mathbb{C}]) = \psi(2z[\mathbb{C}]) = 2z = b \cdot z = b \cdot \psi(z[\mathbb{C}]),$$

so that that  $(\mathcal{M}, \psi, F)$  and  $(\mathcal{M}, \varphi, G)$  are naive categorifications of  $(B, \{b\}, M)$  and  $(B, \{b\}, N)$  respectively. Moreover, there are isomorphism of functors  $F \circ F \simeq F \oplus F$  and  $G \circ G \simeq G \oplus G$  so that in  $K_0(\mathcal{M})$  the relations  $[F]^2 = 2[F]$  and  $[G]^2 = 2[G]$  hold. So these isomorphisms lift the relation  $b^2 = 2b$ , and these categorifications are weak categorifications.

### 3.3. STRONG CATEGORIFICATION

We have defined the notion of weak categorification, allowing to categorify an algebra presented by generators and relations. However, we would like to categorify richer structures. In order to categorify something which already has the structure of a category, the categorification will be a 2-category, and we will define its Grothendieck group as the direct sum of the Grothendieck groups of the hom-categories.



**3.3.1. Grothendieck group of a 2-category.** A 2-category is said to be additive (resp. abelian, R-linear) if it is a 1-category enriched in additive (resp. abelian, R-linear) categories. Given an additive 2-category  $\mathcal{A}$ , the (split) Grothendieck group of  $\mathcal{A}$  is the 1-category  $K_0(\mathcal{A})$  whose:

- i) 0-cells are the 0-cells of  $\mathcal{A}$ ,
- ii) set of 1-cells with 0-source  $A$  and 0-target  $B$  is given by  $K_0(\mathcal{A}_1(A, B))$ , the split Grothendieck group of the additive category  $\mathcal{A}_1(A, B)$ . The composition of 1-cells in  $K_0(\mathcal{A})$  is defined by

$$[f] \circ [g] = [f \star_0 g] \quad \text{for all } f \in \mathcal{A}_1(B, C), g \in \mathcal{A}_1(A, B).$$

**3.3.2. Strong categorification.** Let  $C$  be an R-linear category. A *strong categorification* of  $C$  is a pair  $(\mathcal{C}, \varphi)$  where  $\mathcal{C}$  is an additive 2-category and  $\varphi : K_0(\mathcal{C}) \otimes_{\mathbb{Z}} \mathbb{R} \rightarrow C$  is an isomorphism. Here, the operation of tensoring the morphisms with  $\mathbb{R}$  is realized in order to turn the additive category  $K_0(\mathcal{C})$  into an R-linear category.

In particular, when  $C$  has only one 0-cell,  $C$  is a unital and associative R-algebra and thus this definition encodes the notion of weak categorification for such R-algebras. In that case, the 2-category  $\mathcal{C}$  also has only one 0-cell, and thus can be seen as a monoidal category.

**3.3.3. Karoubian envelope.** As illustrated in [90], one can require when defining a strong categorification to have a 2-category  $\mathcal{C}$  with further properties such as the Krull-Schmidt property of unique decomposition of any 1-cell into a direct sum of indecomposable 1-cells. However, there can exist in this 2-category some idempotent elements that does not split, making this property fail. A natural idea in that process is thus to take the Karoubian envelope (also called idempotent completion) of  $\mathcal{C}$ , which is in fact a category associated with  $\mathcal{C}$  in which all idempotents split. An *idempotent*  $e : x \rightarrow x$  in a category  $\mathcal{C}$  is a morphism such that  $e \circ e = e$ . The idempotent is said to split if there exist morphisms  $g : x \rightarrow x'$  and  $h : x' \rightarrow x$  such that  $e = g \star_0 h$  and  $h \star_0 g = 1_{x'}$ . In an additive category we can write  $b' = \text{Im}(e)$  so that the idempotent  $e$  can be viewed as the projection onto a summand  $b \cong \text{Im}(e) \oplus \text{Im}(1 - e)$ .

For a category  $\mathcal{C}$  the *Karoubi envelope*  $\text{Kar}(\mathcal{C})$  is a minimal enlargement of the category  $\mathcal{C}$  in which all idempotents split, see [82]. For a 2-category  $\mathcal{C}$ , its Karoubi envelope  $\text{Kar}(\mathcal{C})$  is defined as follows

- i) the 0-cells of  $\text{Kar}(\mathcal{C})$  are triples  $(b, e, \mu)$  where  $e : b \rightarrow b$  is an idempotent in  $\mathcal{C}$  and  $\mu$  is an idempotent 2-cell (under  $\star_1$ -composition) of  $e$  in  $\mathcal{C}$ .
- ii) the 1-cells of  $\text{Kar}(\mathcal{C})$  between 0-cells  $(b, e, \mu)$  and  $(b', e', \mu')$  are pairs  $(f, \beta)$  where  $f : b \rightarrow b'$  is a 1-cell in  $\mathcal{C}$  such that  $e \star_0 f \star_0 e' = f$  and  $\beta : f \Rightarrow f$  is an idempotent 2-cell in  $\mathcal{C}$  such that  $\mu \star_0 \beta \star_0 \mu' = \beta$ .
- iii) the 2-cells between parallel 1-cells  $(f, \beta), (g, \gamma) : (x, e, \mu) \rightarrow (x', e', \mu')$  are 2-cells  $\alpha : f \Rightarrow g$  in  $\mathcal{C}$  such that  $\gamma \circ \alpha \circ \beta = \alpha$ .

There is a natural inclusion of  $\mathcal{C}$  into  $\text{Kar}(\mathcal{C})$  sending a 0-cell  $x$  to the triple  $(x, 1_x, 1_{1_x})$  and the 1-cell  $f$  to  $(f, 1_f)$ . The 2-category  $\mathcal{C}$  admits the universal property that any 2-functor  $\mathcal{C} \rightarrow \mathcal{D}$  to a 2-category  $\mathcal{D}$  in which all idempotent 1-cells and 2-cells split factors through a 2-functor  $\text{Kar}(\mathcal{C}) \rightarrow \mathcal{D}$ . Note that if  $\mathcal{C}$  is an additive 2-category, we can also define an idempotent completion of  $\mathcal{C}$  by gluing the Karoubi envelopes of all the additive categories  $\mathcal{C}(x, y)$  for any 0-cells  $x$  and  $y$  in  $\mathcal{C}$  as in [82]. The notion of Karoubi envelope defined above is in general bigger than the one obtained with this construction.

## 3.4. QUANTUM GROUPS

We introduce all the required material about Kac-Moody algebras and quantum groups. We recall from [64] the definitions of symmetrizable Cartan matrices, Cartan data and root data needed in the sequel. In this section, we fix a ground field  $\mathbb{K}$ .

**3.4.1. Cartan matrices.** A matrix  $A = (a_{i,j}) \in \mathcal{M}_n(\mathbb{K})$  is a *generalized Cartan matrix* if it satisfies the following conditions:

- i) for any  $1 \leq i \leq n$ ,  $a_{i,i} = 2$ ,
- ii) for any  $1 \leq i < j \leq n$ ,  $a_{i,j} \in \mathbb{Z}_{<0}$ ,
- iii) for any  $1 \leq i, j \leq n$ ,  $a_{i,j} = 0$  if and only if  $a_{j,i} = 0$ .

**3.4.2. Realization of a matrix.** Let  $A = (a_{i,j})_{1 \leq i, j \leq n}$  a matrix of rank  $l$  with coefficients in  $\mathbb{K}$ . A *realization of  $A$*  is the data of a triple  $(\mathfrak{h}, \Pi, \Pi^\vee)$  where  $\mathfrak{h}$  is a  $\mathbb{K}$ -space and  $\Pi = \{\alpha_1, \dots, \alpha_n\} \subset \mathfrak{h}^*$ ,  $\Pi^\vee = \{\alpha_1^\vee, \dots, \alpha_n^\vee\} \subset \mathfrak{h}$  satisfying:

- $\Pi$  and  $\Pi^\vee$  are free,
- For all  $1 \leq i, j \leq n$ ,  $\langle \alpha_i^\vee, \alpha_j \rangle = a_{i,j}$ , where  $\langle \alpha_i^\vee, \alpha_j \rangle$  stands for the quantity  $\alpha_i^\vee(\alpha_j)$ ,
- $\dim(\mathfrak{h}) = 2n - l$ .

The elements of  $\Pi$  and  $\Pi^\vee$  are respectively called *simple roots* and *simple co-roots*. Recall from [64, Proposition 1.1] that any complex matrix  $A$  admits up to isomorphism a unique realization.

**3.4.3. The Kac-Moody algebra  $\mathfrak{g}(A)$ .** Let  $A = (a_{i,j})_{1 \leq i, j \leq n}$  a complex matrix of rank  $l$  and  $(\mathfrak{h}, \Pi, \Pi^\vee)$  a realization of  $A$ . We introduce an auxiliary Lie algebra  $\tilde{\mathfrak{g}}(A)$  given by generators  $e_i, f_i$  for  $1 \leq i \leq n$  and  $\mathfrak{h}$  modulo the following relations:

$$\begin{cases} [e_i, f_j] = \delta_{i,j} \alpha_i^\vee & (1 \leq i, j \leq n) \\ [h, h'] = 0 & (h, h' \in \mathfrak{h}) \\ [h, e_i] = \langle \alpha_i, h \rangle e_i & (1 \leq i \leq n, h \in \mathfrak{h}) \\ [h, f_i] = -\langle \alpha_i, h \rangle f_i & (1 \leq i \leq n, h \in \mathfrak{h}) \end{cases} \quad (3.1)$$

The unicity of the realization of  $A$  implies that  $\tilde{\mathfrak{g}}(A)$  only depends on  $A$ . We denote  $\tilde{\mathfrak{n}}_+$  (resp.  $\tilde{\mathfrak{n}}_-$ ) the subalgebra of  $\tilde{\mathfrak{g}}(A)$  generated by the  $e_i$  (resp. the  $f_i$ ). We also set  $Q = \sum_{i=1}^n \mathbb{Z} \alpha_i$  and  $Q_+ = \sum_{i=1}^n \mathbb{N} \alpha_i$ . Let  $\tau$  be the unique maximal ideal that intersects  $\mathfrak{h}$  trivially, and consider the algebra  $\mathfrak{g}(A) = \tilde{\mathfrak{g}}(A)/\tau$ . It is a Lie algebra, called the *Kac-Moody algebra* associated with the generalized Cartan matrix  $A$ . We will keep the same notation for the images of the generators  $e_i, f_i$  and  $h \in \mathfrak{h}$  in  $\mathfrak{g}(A)$ . The subalgebra  $\mathfrak{h}$  of  $\mathfrak{g}(A)$  is called the *Cartan subalgebra*. The  $e_i$  and  $f_i$  are called *Chevalley generators*.

**3.4.4 Example.** For instance, the Lie algebra of  $2 \times 2$  traceless matrices  $\mathfrak{sl}_2$  is given by the generators

$$E = \begin{pmatrix} 0 & 1 \\ 0 & 0 \end{pmatrix}, \quad F = \begin{pmatrix} 0 & 0 \\ 1 & 0 \end{pmatrix}, \quad H = \begin{pmatrix} 1 & 0 \\ 0 & -1 \end{pmatrix},$$

so that  $\mathfrak{sl}_2 = \mathbb{C}E \oplus \mathbb{C}H \oplus \mathbb{C}F$  modulo the relations  $[E, F] = H$ ,  $[H, E] = 2E$ ,  $[H, F] = -2F$ . Therefore,  $\mathfrak{sl}_2$  is a Kac-Moody algebra corresponding to the Cartan Matrix  $A = (2)$ , and the ideal  $\tau$  is trivial.

**3.4.5. Cartan datum.** A Cartan datum  $(I, \cdot)$  consists of a finite set  $I$  and a bilinear form on  $\mathbb{Z}[I]$ , taking values in  $\mathbb{Z}$  such that:

- i)  $i \cdot i \in \{2, 4, 6, \dots\}$  for any  $i \in I$ ;
- ii)  $-d_{i,j} := 2 \frac{i \cdot j}{i \cdot i} \in \{0, -1, -2, \dots\}$  for any  $i \neq j \in I$ .

We say that such a Cartan datum is simply-laced if the two following conditions hold:

i') For any  $i \in I$ ,  $i \cdot i = 2$ ;

ii') For any  $i, j \in I$ ,  $i \cdot j \in \{0, -1\}$ .

**3.4.6 Remark.** If we set  $(I, \cdot)$  a Cartan datum and  $A = \left(-2 \frac{i \cdot j}{i \cdot i}\right)_{1 \leq i, j \leq \#I}$ , then  $A$  is a generalized Cartan matrix and so we can associate to each Cartan datum a Kac-Moody algebra as in the previous section.

**3.4.7. Root datum of type  $(I, \cdot)$ .** Let us fix a Cartan datum  $(I, \cdot)$ . A *root datum of type  $(I, \cdot)$*  consists of

- i) two free finitely generated abelian groups  $X, Y$  and a perfect pairing  $\langle \cdot, \cdot \rangle: Y \times X \rightarrow \mathbb{Z}$ ;
- ii) inclusions  $I \subset X$  ( $i \mapsto \alpha_i$ ) and  $I \subset Y$  ( $i \mapsto h_i$ ) such that  $\langle i, \alpha_j \rangle = 2 \frac{i \cdot j}{i \cdot i} = -d_{ij}$  for all  $i, j \in I$ .

This implies  $\langle h_i, \alpha_i \rangle = 2$  for all  $i$ .

**3.4.8. Quantum groups.** The quantum group  $U$  associated to a root datum as above is the unital associative  $\mathbb{Q}(q)$ -algebra given by generators  $E_i, F_i, K_\mu$  for  $i \in I$  and  $\mu \in Y$ , subject to the relations:

- i)  $K_0 = 1$ ,  $K_\mu K_{\mu'} = K_{\mu+\mu'}$  for all  $\mu, \mu' \in Y$ ,
- ii)  $K_\mu E_i = q^{\langle \mu, \alpha_i \rangle} E_i K_\mu$  for all  $i \in I, \mu \in Y$ ,
- iii)  $K_\mu F_i = q^{-\langle \mu, \alpha_i \rangle} F_i K_\mu$  for all  $i \in I, \mu \in Y$ ,
- iv)  $E_i F_j - F_j E_i = \delta_{ij} \frac{\tilde{K}_i - \tilde{K}_i^{-1}}{q_i - q_i^{-1}}$ , where  $\tilde{K}_{\pm i} = K_{\pm(i \cdot i/2)i}$ ,
- v) For all  $i \neq j$ ,  $\sum_{a+b=-\langle h_i, \alpha_j \rangle + 1} (-1)^a E_i^{(a)} E_j E_i^{(b)} = 0$  and  $\sum_{a+b=-\langle h_i, \alpha_j \rangle + 1} (-1)^a F_i^{(a)} F_j F_i^{(b)} = 0$ .

## 3.5. KHOVANOV AND LAUDA'S CATEGORIFICATION OF QUANTUM GROUPS

In this section, we explain the main ideas beyond Khovanov and Lauda's construction of a strong categorification of Lusztig's idempotent and integral form  $\dot{U}(\mathfrak{g})$  of a quantum group associated to a symmetrizable Kac-Moody algebra  $\mathfrak{g}$ .

**3.5.1. The quantum group  $U_q(\mathfrak{sl}_2)$ .** The universal enveloping algebra  $\dot{U}(\mathfrak{sl}_2)$  of the Lie algebra  $\mathfrak{sl}_2$  is the associative algebra given by generators  $E, F$  and  $H$  modulo the relations

$$HE - EH = 2E, \quad HF - FH = -2F, \quad EF - FE = H.$$

The quantum group (or quantum deformation)  $U_q(\mathfrak{sl}_2)$  of  $U(\mathfrak{sl}_2)$  is an algebra over the ring  $\mathbb{Q}(q)$  of rational functions in the indeterminate  $q$  given by generators  $E, F, K, K^{-1}$  and relations

- $KK^{-1} = K^{-1}K = 1$ ,
- $KE = q^2EK$ ,
- $KF = q^{-2}FK$ ,
- $EF - FE = \frac{K - K^{-1}}{q - q^{-1}}$ .

**3.5.2. Representations of  $\mathfrak{sl}_2$  and  $U_q(\mathfrak{sl}_2)$ .** Let  $W$  be a finite dimensional representation of  $\mathfrak{sl}_2$ . As it is a semi-simple Lie algebra, such a representation admits a decomposition

$$W = \bigoplus W_\alpha \quad \text{where} \quad W_\alpha = \{w \in \mathcal{C}; H \cdot w = \alpha w\}$$

There is an action of  $E$  and  $F$  on the  $W_\alpha$ 's given by  $H(E(w)) = E(H(w)) + [H, E](w) = E(\alpha w) + 2E(w) = (\alpha + 2)E(w)$  and similarly,  $H(F(w)) = F(H(w)) + [H, F](w) = F(\alpha w) - 2F(w) = (\alpha - 2)F(w)$ . Therefore, the matrix  $E$  (resp.  $F$ ) sends an element of  $V_\alpha$  to an element of  $V_{\alpha+2}$  (resp.  $V_{\alpha-2}$ ). One can show that if  $W$  is irreducible, all the  $\alpha$  that appears in the decomposition have to be congruent modulo 2, so that one has  $W = \bigoplus_{n \in \mathbb{Z}} W_{\alpha_0 + 2n} =$

$\bigoplus_{n \in \mathbb{Z}} W_n$ . Here,  $W_n$  is called the  $n$ -th weight space and  $X = \mathbb{Z}$  is said to be the weight lattice of the Lie algebra.

Similarly, any finite-dimensional representation  $V$  of  $U_q(\mathfrak{sl}_2)$  can be decomposed into eigenspaces  $V_n$  for the action of  $K$ , with  $v \in V_n$  if and only if  $K \cdot v = q^n v$ . We are in particular interested in representations that admit a decomposition

$$V = \bigoplus_{n \in \mathbb{Z}} V_n$$

into weight spaces. Given a weight vector  $v \in V_n$  the weights of  $Ev$  and  $Fv$  are determined using the relations

$$K(Ev) = q^2 EKv = q^{n+2}(Ev), \quad K(Fv) = q^{-2}FKv = q^{n-2}(Fv),$$

so that  $E: V_n \rightarrow V_{n+2}$  and  $F: V_n \rightarrow V_{n-2}$ . Therefore, such a representation of  $U_q(\mathfrak{sl}_2)$  can be thought of as a collection of vector spaces  $V_n$  for  $n \in \mathbb{Z}$  where  $E$  maps the  $n$ th weight space to the  $n+2$  weight space and  $F$  maps the  $n$ th weight space to the  $n-2$  weight space such that the main  $\mathfrak{sl}_2$  relation  $EF - FE = \frac{K-K^{-1}}{q-q^{-1}}$  holds. Note that on a weight vector  $v \in V_n$  this relation takes the form

$$(EF - FE)v = \frac{K - K^{-1}}{q - q^{-1}}v = \frac{Kv - K^{-1}v}{q - q^{-1}} = \frac{q^n - q^{-n}}{q - q^{-1}}v = [n]v.$$

where  $[n] := \frac{q^n - q^{-n}}{q - q^{-1}} = q^{n-1} + q^{n-3} + \dots + q^{1-n}$  is called the  $n$ -quantum number.

**3.5.3. Lusztig's idempotent and integral quantum group.** Let us fix a Cartan datum  $(I, \cdot)$  and a root datum associated with it. In [85], Lusztig defined an integral and idempotent version  $\dot{U}(\mathfrak{g})$  of a quantum group  $U_q(\mathfrak{g})$  associated with a symmetrizable Kac-Moody algebra  $\mathfrak{g}$ . This version admits interesting features to study its representations. It is defined as the algebra  $U_q(\mathfrak{sl}_2)$  in which the unit element is substituted by a collection of mutually orthogonal idempotents  $1_\lambda$  projecting on the  $\lambda$  weight space for any  $\lambda \in X$  the weight lattice of  $\mathfrak{g}$ , and satisfying  $1_\lambda 1_{\lambda'} = \delta_{\lambda, \lambda'} 1_\lambda$ . In the sequel, when there is no ambiguity we simply denote the algebra  $\dot{U}(\mathfrak{g})$  by  $\dot{U}$ . It does not generally have a unit, since the infinite sum  $\sum_{\lambda \in X} 1_\lambda$  does not belong to  $\dot{U}$ . As a consequence of the relations in  $U_q(\mathfrak{g})$ , the following identities have to be satisfied in  $\dot{U}$ :

$$E_i 1_\lambda = 1_{\lambda + i\alpha_i} E_i, \quad F_i 1_\lambda = 1_{\lambda - i\alpha_i} F_i, \quad (E_i F_j - F_j E_i) 1_\lambda = \delta_{i,j} [\langle h_i, \lambda \rangle]_i 1_\lambda,$$

where  $[\langle h_i, \lambda \rangle]_i$  is the quantum number  $q_i^{\langle h_i, \lambda \rangle - 1} + \dots + q_i^{1 - \langle h_i, \lambda \rangle}$ , with  $q_i = q^{\frac{i \cdot i}{2}}$ . There are also further relations corresponding to Serre relations, see [85].

For  $\mathfrak{g} = \mathfrak{sl}_2$  (and  $\mathfrak{sl}_n$  in general), the algebra  $\dot{U}(\mathfrak{sl}_2)$  was at first introduced by Beilinson, Lusztig and MacPherson, [8]. In that case, the weight lattice  $X$  is  $\mathbb{Z}$ , so we add a collection of idempotents  $1_n$  for  $n \in \mathbb{Z}$ , and we require the following relations:

$$K 1_n = q^n 1_n, \quad E 1_n = 1_{n+2} E = 1_{n+2} E 1_n, \quad F 1_n = 1_{n-2} F = 1_{n-2} F 1_n.$$

The main  $\mathfrak{sl}_2$  relation becomes

$$EF 1_n - FE 1_n = [n] 1_n. \tag{3.2}$$

**3.5.4. The 0-cells and 1-cells of  $\mathcal{U}(\mathfrak{sl}_2)$ .** The idempotent completion  $\dot{U}(\mathfrak{sl}_2)$  can be interpreted as a  $\mathbb{K}$ -linear monoidal category whose 0-cells are the elements of  $X$  and whose 1-cells from  $n$  to  $m$  are linear combinations of elements  $1_m E_{\varepsilon_1} \dots E_{\varepsilon_s} 1_n$  where  $(\varepsilon_1, \dots, \varepsilon_s)$  is a sequence of signs,  $E_+ := E$ ,  $E_- := F$  and  $m - n = 2 \sum_{i=1}^s \varepsilon_i$ .

For a general Kac-Moody algebra  $\mathfrak{g}$  associated with a root datum  $(I, \cdot)$ ,  $\dot{U}$  is interpreted as a  $\mathbb{K}$ -linear monoidal category whose 0-cells are elements of the weight lattice  $X$  of  $\mathfrak{g}$ , and whose 1-cells are linear

combinations of elements of the form  $1'_\lambda E_{\varepsilon_1 i_1} \dots E_{\varepsilon_s i_s} 1_\lambda$  where  $i_1, \dots, i_m$  are elements of  $I$ ,  $(\varepsilon_1, \dots, \varepsilon_s)$  is a sequence of signs,  $E_{+i} := E_i$ ,  $E_{-i} := F_i$  and  $\lambda' = \lambda + \sum_{i=1}^s \varepsilon_1(i_s)\chi$ . The identity 1-cell on the 0-cell  $\lambda \in X$  is the idempotent  $1_\lambda$ , and composition of 1-cells is given by multiplication of the algebra  $\dot{\mathbf{U}}(\lambda, \mu) \otimes \dot{\mathbf{U}}(\mu, \nu) \rightarrow \dot{\mathbf{U}}(\lambda, \nu)$ .

We want to define a strong categorification of  $\dot{\mathbf{U}}$  as an additive 2-category  $\mathcal{U}$ . Following [82], we sketch the various steps to define the 1-cells and 2-cells in this category for  $\mathfrak{g} = \mathfrak{sl}_2$  so as the relations that the 2-cells should satisfy in order to construct a categorification. The 0-cells of  $\mathcal{U}$  are given by the elements of  $X = \mathbb{Z}$ . Moreover, given two weights  $n, n' \in X$ ,  $\mathcal{U}(n, n')$  has to be an additive category. The generating 1-cells  $E_+$  and  $E_-$  of  $\mathbf{U}_q(\mathfrak{sl}_2)$  should be lifted as 1-cells  $\mathcal{E}_-$  and  $\mathcal{E}_+$  in  $\mathcal{U}$ . In order to define actions of  $\mathcal{E}_-$  and  $\mathcal{E}_+$ , vector spaces should be replaced by additive categories  $\mathcal{V}_n$  for any  $n \in \mathbb{Z}$ , and in order to preserve the graded structure on the weight spaces  $\mathcal{V}_n$ , these categories are required to be equipped with an autoequivalence  $\{1\}: \mathcal{V}_\lambda \rightarrow \mathcal{V}_\lambda$  corresponding to the grading shift functor. We denote by  $\{s\}$  the auto-equivalence obtained by applying  $\{1\}$   $s$  times. All the linear maps in  $\dot{\mathbf{U}}$  are replaced by functors, and we impose that there are functors  $\mathbf{1}_n: \mathcal{V}_n \rightarrow \mathcal{V}_n$ ,  $\mathcal{E}\mathbf{1}_n: \mathcal{V}_n \rightarrow \mathcal{V}_{n+2}$ ,  $\mathcal{F}\mathbf{1}_n: \mathcal{V}_n \rightarrow \mathcal{V}_{n-2}$ , that commute with the grading shift functor. We then lift the relations of  $\dot{\mathbf{U}}$  as natural isomorphisms of 1-cells in  $\mathcal{U}$ . For instance, the relation (3.2) is lifted to

$$\begin{aligned} \mathcal{E}\mathcal{F}\mathbf{1}_n &\cong \mathcal{F}\mathcal{E}\mathbf{1}_n \oplus \mathbf{1}_n^{\oplus[n]} && \text{for } n \geq 0, \\ \mathcal{F}\mathcal{E}\mathbf{1}_n &\cong \mathcal{E}\mathcal{F}\mathbf{1}_n \oplus \mathbf{1}_n^{\oplus[-n]} && \text{for } n \leq 0, \end{aligned}$$

where we write  $\mathbf{1}_n^{\oplus[n]} := \mathbf{1}_n\{n-1\} \oplus \mathbf{1}_n\{n-3\} \oplus \dots \oplus \mathbf{1}_n\{1-n\}$ . Note that  $\mathcal{U}(n, n')$  has the structure of a  $\mathbb{Q}(q)$ -module. Following 3.1.6, we need to have a structure of  $\mathbb{Z}[q, q^{-1}]$ -module to be able to lift the action of  $q$ , and we thus consider an integral version of  $\dot{\mathbf{U}}$ , defined in [85], as the  $\mathbb{Z}[q, q^{-1}]$ -algebra  ${}_{\mathcal{A}}\dot{\mathbf{U}}$  spanned by products of divided powers of the generators  $E_+$  and  $E_-$ , that is by the elements

$$E^{(a)}\mathbf{1}_n := \frac{E^a}{[a]!}\mathbf{1}_n, \quad F^{(b)}\mathbf{1}_n := \frac{F^b}{[b]!}\mathbf{1}_n.$$

for any  $a \in \mathbb{N}$ . However, we still denote this algebra by  $\dot{\mathbf{U}}$ . We also want to identify the space  ${}_{\mathbf{1}_n}\dot{\mathbf{U}}\mathbf{1}_{n'}$  with the split Grothendieck group of an additive category denoted by  $\dot{\mathbf{U}}(n, n')$ . We further require that the 1-cells in  $\dot{\mathbf{U}}$  lift the  $\mathbb{Z}[q, q^{-1}]$ -module structure on  ${}_{\mathbf{1}_n}\dot{\mathbf{U}}\mathbf{1}_{n'}$  by requiring that  $[x\{t\}] = q^t[x]$ , so that multiplication by  $q$  lifts to the invertible functor  $\{1\}$  of shifting the grading by 1. Recall from Section 3.3.1 that the split Grothendieck group  $K_0(\dot{\mathbf{U}})$  of the additive 2-category  $\mathcal{U}$  is defined by  $K_0(\dot{\mathcal{U}}) = \bigoplus_{n, n' \in \mathbb{Z}} K_0(\dot{\mathbf{U}}(n, n'))$ , with the requirement that

$$[x] = [x_1][x_2] \quad \text{if } x = x_1 \star_0 x_2.$$

In this way, the composition of 1-cells in the 2-category  $\mathcal{U}$  corresponds to the multiplication in  $\dot{\mathbf{U}}$ . Note that this can be done since Lusztig established in [85] that the algebra  $\dot{\mathbf{U}}$  has a canonical basis  $\mathbb{B}$  which has the property that

$$[b_x][b_y] = \sum_z m_{x,y}^z [b_z] \quad \text{for } [b_x], [b_y], [b_z] \in \mathbb{B},$$

where the structure coefficients  $m_{x,y}^z$  are elements of  $\mathbb{N}[q, q^{-1}]$ . As isomorphisms classes of indecomposable 1-morphisms in  $\dot{\mathcal{U}}$ , up to grading shift, give a basis in the split Grothendieck ring  $K_0(\dot{\mathcal{U}})$ , the positivity of these structure coefficients suggests that it is possible to define  $\dot{\mathcal{U}}$  such that its indecomposable 1-cells correspond up to grading shift to elements in Lusztig's canonical basis  $\mathbb{B}$ .

To sum up, the 2-category  $\mathcal{U}(\mathfrak{sl}_2)$  has for 0-cells the set  $X = \mathbb{Z}$  of weights of  $\mathfrak{sl}_2$ , and as 1-cells all the formal direct sums (since we want any category  $\mathcal{U}(n, n')$  to be additive) of elements of the form  $\mathbf{1}_{n'}\mathcal{E}_{\underline{\varepsilon}}\mathbf{1}_n = \mathcal{E}_{\varepsilon_1} \dots \mathcal{E}_{\varepsilon_m}\mathbf{1}_n\{t\}$  where  $\varepsilon_1, \dots, \varepsilon_m$  are signs,  $\mathcal{E}_+ = \mathcal{E}$ ,  $\mathcal{E}_- = \mathcal{F}$ ,  $n' = n + \sum_{1 \leq k \leq m} 2\varepsilon_k$ , and  $t \in \mathbb{Z}$  is a grading shift. These 1-cells can be interpreted as sequences  $\underline{\varepsilon} = (\varepsilon_1, \dots, \varepsilon_m)$  of signs, together with the shift  $t \in \mathbb{Z}$ .

**3.5.5. Extension to the general case.** Using similar arguments, for a Kac-Moody algebra  $\mathfrak{g}$  associated with a root datum of type  $(I, \cdot)$ , the 2-category  $\mathcal{U}(\mathfrak{g})$  has for 0-cells the weight lattice  $X$ , for 1-cells the linear combinations of elements of the form  $\mathbf{1}_\mu \mathcal{E}_{\varepsilon_1 i_1} \dots \mathcal{E}_{\varepsilon_m i_m} \mathbf{1}_\lambda \{t\}$  where  $i_1, \dots, i_m$  are elements of  $I$ ,  $\varepsilon_1, \dots, \varepsilon_m$  are signs and  $\mathcal{E}_{+i} = \mathcal{E}_i$ ,  $\mathcal{E}_{-i} = \mathcal{F}_i$  with  $\mu = \lambda + \sum_{1 \leq k \leq m} (i_k)_X$ , and where  $t \in \mathbb{Z}$  is a grading shift. Similarly, these 1-cells can be interpreted as signed sequences of elements of  $I$ , together with the shift  $t \in \mathbb{Z}$ .

**3.5.6. Expected dimensions of the spaces of 2-cells.** In order to construct the 2-cells in  $\mathcal{U}$ , we could expect to consider only degree preserving maps, that is the space of 2-cells  $\mathcal{U}(x, y)$  between two 1-cells  $x$  and  $y$  should form a  $\mathbb{K}$ -vector space of degree preserving 2-cells. However, it is a classical argument in the theory of graded vector spaces to consider decompositions of these vector spaces into spaces of degree homogeneous 2-cells, that is

$$\mathcal{U}(x, y) := \bigoplus_{t \in \mathbb{Z}} \mathcal{U}(x\{t\}, y).$$

As a consequence, there is a map

$$\begin{aligned} \mathcal{U}(\cdot, \cdot) : \mathcal{U}_1 \times \mathcal{U}_1 &\longrightarrow \mathbf{GrVect}_{\mathbb{K}} \\ (x, y) &\longmapsto \mathcal{U}(x, y) \end{aligned}$$

assigning to 1-cells  $x$  and  $y$  in  $\mathcal{U}_1$  the graded vector space of all 2-cells with 1-source  $x$  and 1-target  $y$ . If the 1-cells of  $\mathcal{U}$  correspond to elements of  $\dot{\mathbf{U}}$ , then descending this map through the Grothendieck group gives a pairing on  $\dot{\mathbf{U}}$ :

$$\begin{array}{ccc} \mathcal{U}(\cdot, \cdot) : \mathcal{U}_1 \times \mathcal{U}_1 &\longrightarrow & \mathbf{GrVect}_{\mathbb{K}} \\ \left. \begin{array}{c} \left\{ \begin{array}{c} \mathbb{K}_0 \\ \vdots \\ \mathbb{K}_0 \end{array} \right\} & \left\{ \begin{array}{c} \mathbb{K}_0 \\ \vdots \\ \mathbb{K}_0 \end{array} \right\} & \\ \downarrow & \downarrow & \\ \left\{ \begin{array}{c} \mathbb{K}_0 \\ \vdots \\ \mathbb{K}_0 \end{array} \right\} & & \left\{ \begin{array}{c} \text{gdim} \\ \vdots \\ \text{gdim} \end{array} \right\} \end{array} \right\} & & \\ \langle \cdot, \cdot \rangle : \dot{\mathbf{U}} \times \dot{\mathbf{U}} &\longrightarrow & \mathbb{Z}[[q, q^{-1}]] \end{array}$$

That is,

$$\langle [x], [y] \rangle := \text{gdim} \text{HOM}_{\mathcal{U}}(x, y) = \sum_{t \in \mathbb{Z}} q^t \dim \text{Hom}_{\mathcal{U}}(x\{t\}, y), \quad (3.3)$$

where  $\dim \text{Hom}_{\mathcal{U}}(x\{t\}, y)$  is the usual dimension of the graded vector space  $\mathcal{U}(x\{t\}, y)$  of degree zero 2-morphisms. Hence, any choice of 2-morphisms in  $\text{Hom}_{\mathcal{U}}(x, y)$  gives rise to a pairing  $\langle [x], [y] \rangle$  on  $\dot{\mathbf{U}}$  given by taking the graded dimension  $\text{gdim}$  of the graded vector space  $\text{Hom}_{\mathcal{U}}(x, y)$ . Therefore we know that the graded Hom on the 2-category  $\mathcal{U}$  must categorify that semilinear form on  $\dot{\mathbf{U}}$ .

Actually, there is a well known candidate for such a semilinear form  $\langle \cdot, \cdot \rangle : \dot{\mathbf{U}} \times \dot{\mathbf{U}} \rightarrow \mathbb{Z}[q, q^{-1}]$ , that is Lusztig's pairing on the quantum group [85]. This map arises as the graded dimension of a certain Ext algebra between sheaves on quiver varieties in Lusztig's geometric realization of  $\dot{\mathbf{U}}$ . It has a lot of defining properties, see [82], implying that one may compute any value of this bilinear pairing. As a consequence, Khovanov and Lauda constructed the 2-cells in  $\mathcal{U}$  so that

$$\text{gdim} \text{HOM}_{\mathcal{U}}(\mathbf{1}_\lambda \mathcal{E}_{\underline{\varepsilon}} \mathbf{1}_\lambda, \mathbf{1}_\lambda \mathcal{E}_{\underline{\varepsilon}'} \mathbf{1}_\lambda) = \langle \mathbf{1}_\mu \mathcal{E}_{\underline{\varepsilon}} \mathbf{1}_\lambda, \mathbf{1}_\mu \mathcal{E}_{\underline{\varepsilon}'} \mathbf{1}_\lambda \rangle. \quad (3.4)$$

This means that each term  $\alpha q^t$  appearing in  $\langle \mathbf{1}_\mu \mathcal{E}_{\underline{\varepsilon}} \mathbf{1}_\lambda, \mathbf{1}_\mu \mathcal{E}_{\underline{\varepsilon}'} \mathbf{1}_\lambda \rangle$  is the dimension of the  $\alpha$ -dimensional homogeneous space of 2-cells in degree  $t$ . If the coefficient  $\alpha$  is zero for a term  $\alpha q^t$ , this means that there are no 2-cells in degree  $t$ . When  $\alpha$  is nonzero we add new graded 2-cells as basis vectors for the space of 2-cells in that degree.

**3.5.7. The 2-cells in  $\mathcal{U}$ .** There are only two types of generating 1-cells  $\mathcal{E}_i$  and  $\mathcal{F}_i$ , so we introduce following [82, 67] a suited string diagrammatic representation for the identity 2-cells on  $\mathcal{E}_i \mathbf{1}_\lambda\{t\}$  and  $\mathcal{F}_i \mathbf{1}_\lambda\{t\}$ : they are respectively represented by

$$\begin{array}{c} \lambda + i_x \\ \uparrow \\ \lambda \\ \downarrow \\ i \end{array} \quad \begin{array}{c} \lambda - i_x \\ \uparrow \\ \lambda \\ \downarrow \\ i \end{array}$$

in string notation. The grading shift is omitted from the string diagram so that the same diagrams corresponds to the identity 2-morphisms of  $\mathcal{E}_i \mathbf{1}_\lambda\{t\}$  and  $\mathcal{F}_i \mathbf{1}_\lambda\{t\}$  for any shift  $\{t\}$ . Now, we construct the remaining generating 2-cells using Section 3.5.6. Let us focus on the case  $\mathfrak{g} = \mathfrak{sl}_2$ , and expand on some examples of generating 2-cells. One may check that

$$\langle E1_n, E1_n \rangle = \frac{1}{1 - q^2} = 1 + q^2 + q^4 + q^6 + \dots \quad (3.5)$$

The coefficient of  $q^t$  for  $t < 0$  being always zero, this imply that  $\mathcal{U}(\mathcal{E} \mathbf{1}_n\{t\}, \mathcal{E} \mathbf{1}_n) = \{0\}$  for  $t < 0$ . The identity 2-cell of  $\mathcal{E} \mathbf{1}_n$  must be of degree zero, and we interpret the  $1 = q^0$  appearing above as the dimension of the 1-dimensional  $\mathbb{K}$ -vector space spanned by linear combinations of the identity 2-cell on  $\mathcal{E} \mathbf{1}_n$ . Because the coefficient of  $q^0$  is 1 all degree zero endomorphisms of  $\mathcal{E} \mathbf{1}_n$  should be equal to multiple of this identity 2-cell. The term  $q^2$  suggests that there should be an additional 2-morphism from  $\mathcal{E} \mathbf{1}_n$  to itself in degree 2. We formally add such a generating 2-cell that we represent by:

$$\begin{array}{c} n+2 \\ \uparrow \\ \bullet \\ \downarrow \\ n \end{array} .$$

The coefficients in (3.5) impose to define a new generator in all positive even degree, but this is not needed since one can vertically compose this degree two 2-cell with itself to get a 2-cell in every degree  $2k$  for  $k \geq 1$ . Another example is given by the computation

$$\langle EE1_n, EE1_n \rangle = (1 + q^{-2}) \left( \frac{1}{1 - q^2} \right)^2$$

imposing to define an additional generating 2-cell of degree  $-2$ , represented by

$$\begin{array}{c} \nearrow \searrow \\ \times \\ \nwarrow \nearrow \\ n \end{array} .$$

As a consequence, the vertical composition of this 2-cell with itself is a 2-cell of degree  $-4$ . However, the coefficient of  $q^{-4}$  in (3.6) is 0, so this forces to introduce a relation of the form

$$\begin{array}{c} \nearrow \searrow \\ \times \\ \nwarrow \nearrow \\ \times \\ \nwarrow \nearrow \\ n \end{array} = 0.$$

One can then repeat this process by computing different values of Lusztig's pairing to define new generating 2-cells and identify some relations between their composites. In order to see that all the needed generating 2-cells are defined, one could either show that with the appropriate relations the indecomposable 1-cells of  $\mathcal{U}$  corresponds bijectively with Lusztig's canonical basis as it was done in [81], or give a purely diagrammatic interpretation of the semilinear form and argue that these generators can account for all the diagrams, as it was done in [67].

For the general case of a symmetrizable Kac-Moody algebra  $\mathfrak{g}$  with weight lattice  $X$  and Dynkin diagram  $\Gamma$  with set of vertices  $I$ , the 2-category  $\mathcal{U}$  admits the following generating 2-cells for any  $i, j \in I$  and any  $\lambda \in X$ :

$$\begin{array}{c} \uparrow \\ \bullet \\ \downarrow \\ i \end{array}^\lambda, \quad \begin{array}{c} \nearrow \searrow \\ \times \\ \nwarrow \nearrow \\ i \quad j \end{array}^\lambda, \quad \begin{array}{c} i \\ \uparrow \\ \bullet \\ \downarrow \\ i \end{array}^\lambda, \quad \begin{array}{c} i \quad j \\ \nearrow \searrow \\ \times \\ \nwarrow \nearrow \\ i \quad j \end{array}^\lambda, \quad \begin{array}{c} \curvearrowright \\ \lambda \\ i \end{array}, \quad \begin{array}{c} \curvearrowleft \\ i \\ \lambda \end{array}, \quad \begin{array}{c} \curvearrowright \\ i \\ \lambda \end{array}, \quad \begin{array}{c} i \\ \curvearrowleft \\ \lambda \end{array}. \quad (3.6)$$

**3.5.8. Lift of the relations of  $\dot{\mathbf{U}}$ .** All the 2-cells of  $\mathcal{U}$  are now defined, and some relations that they have to satisfy have been identified. However, it remains to lift the defining relations of  $\dot{\mathbf{U}}$  to explicit isomorphisms. In the case of  $\mathfrak{sl}_2$ , we have to obtain the following isomorphisms:

$$\begin{aligned} \mathcal{E}\mathcal{F}\mathbf{1}_n &\cong \mathcal{F}\mathcal{E}\mathbf{1}_n \oplus \mathbf{1}_n^{\oplus[n]} && \text{for } n \geq 0, \\ \mathcal{F}\mathcal{E}\mathbf{1}_n &\cong \mathcal{E}\mathcal{F}\mathbf{1}_n \oplus \mathbf{1}_n^{\oplus[-n]} && \text{for } n \leq 0. \end{aligned}$$

Following [82], for  $n \geq 0$  there is a natural map  $\mathcal{F}\mathcal{E}\mathbf{1}_n \oplus \mathbf{1}_n^{\oplus[n]} \rightarrow \mathcal{E}\mathcal{F}\mathbf{1}_n$  given by the direct sum of maps:

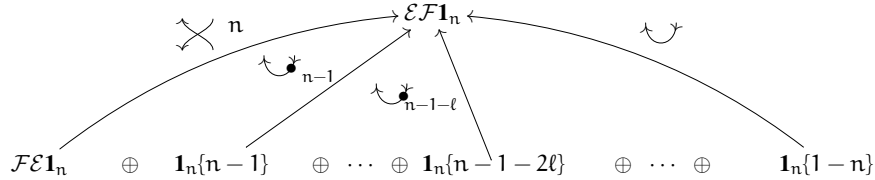

and likewise there is a similar map for  $n \leq 0$ . It then remains to define an inverse for this map, which as a component for each summand. To ensure the condition (3.3), one can explicitly compute the summands of the inverses, as in [82]. Finally, lifting all the relations of  $\dot{\mathbf{U}}$  give rise to all the missing relations between 2-cells in  $\mathcal{U}(\mathfrak{g})$ . As a consequence, we obtain a presentation by generators and relations of the candidate 2-categorification of  $\dot{\mathbf{U}}$ , which is the Karoubi envelope of the 2-category  $\mathcal{U}$  given in Section 6.2 of Chapter 6.



**Contents**

|            |   |            |
|------------|---|------------|
| <b>4.1</b> | <b>Double groupoids</b>                         | <b>88</b>  |
| <b>4.2</b> | <b>Double coherent presentations</b>            | <b>92</b>  |
| <b>4.3</b> | <b>Examples</b>                                 | <b>101</b> |
| <b>4.4</b> | <b>Polygraphs modulo</b>                        | <b>103</b> |
| <b>4.5</b> | <b>Coherent confluence modulo</b>               | <b>108</b> |
| <b>4.6</b> | <b>Coherent completion modulo</b>               | <b>116</b> |
| <b>4.7</b> | <b>Globular coherence from double coherence</b> | <b>123</b> |

Squier’s coherence theorem [111] states that a convergent presentation of a category can be extended into a coherent presentation of this category by gluing 3-cells corresponding to confluence diagrams of critical branchings of the presentations. These constructions have been extended for higher-dimensional globular strict categories [54], associative algebras [50] and higher-dimensional linear categories [1]. In this Chapter, we give a coherence result based on Squier’s constructions in the context of rewriting modulo. This Chapter recalls the results of [43].

Following the rewriting modulo approach developed by Huet [56] and Jouannaud and Kirchner [61], confluence modulo diagrams do not admit a globular shape anymore, but a cubical shape. This suggests that coherence modulo should not be defined in higher-dimensional globular strict categories anymore, but in a categorical structure adapted to these cubical shapes, that is higher-dimensional categories enriched in double groupoids. At first, we define a notion of double coherent presentation, as an adaptation of the notion of globular coherent presentation to this cubical setting. We then define the notion of higher-dimensional polygraphs modulo based on the extension of the notion of an higher-dimensional polygraph, made of oriented rules and denoted by  $R$ , by another polygraph denoted by  $E$  made of rules that are not oriented in rewriting paths. We then introduce following [61] rewriting properties of termination and confluence modulo of these polygraphs, and prove a Newman lemma and a critical branching lemma for polygraphs modulo, under an additional termination assumption. Then, we extend Squier’s coherence theorem by proving that a double coherent presentation can be obtained from a presentation that is confluent modulo by gluing a square cell for each confluence modulo diagram of critical branching modulo.

We then give a way to take the quotient of a double coherent presentation by the congruence generated by the relations in E, in order to obtain coherent presentations of categories that are not necessarily free in low dimensions. This quotient functor, with values in the category of dipolygraphs, seen as generating objects of these categories in which cellular extensions are defined categories that may not be free, gives a way to obtain a coherent presentation of a category by splitting the relations into two parts and applying these constructions of rewriting modulo one part of the rules.

**Notations.** For simplicity in the cubical relations for source and target maps, if  $f$  is a  $k$ -cell of an  $n$ -category  $\mathcal{C}$ , we denote by  $\partial_{-,i}(f)$  and  $\partial_{+,i}(f)$  respectively denote the  $i$ -source and  $i$ -target of  $f$ , while  $(k-1)$ -source and  $(k-1)$ -target will be denoted by  $\partial_-(f)$  and  $\partial_+(f)$  respectively.

## 4.1. DOUBLE GROUPOIDS

**4.1.1. Internal categories.** The notion of double category was introduced by Ehresmann in [44] as an internal category in the category  $\mathbf{Cat}$  of all (small) categories and functors. Recall that given  $\mathcal{V}$  be a category with finite limits, an *internal category*  $\mathcal{C}$  in  $\mathcal{V}$  is a data  $(\mathcal{C}_1, \mathcal{C}_0, \partial_-^{\mathcal{C}}, \partial_+^{\mathcal{C}}, \circ_{\mathcal{C}}, i_{\mathcal{C}})$ , where

$$\partial_-^{\mathcal{C}}, \partial_+^{\mathcal{C}} : \mathcal{C}_1 \longrightarrow \mathcal{C}_0, \quad i_{\mathcal{C}} : \mathcal{C}_0 \longrightarrow \mathcal{C}_1, \quad \circ_{\mathcal{C}} : \mathcal{C}_1 \times_{\mathcal{C}_0} \mathcal{C}_1 \longrightarrow \mathcal{C}_1$$

are morphisms of  $\mathcal{V}$  satisfying the usual axioms of a category, that is

$$\begin{array}{ccc} \begin{array}{ccc} \mathcal{C}_0 & \xrightarrow{i_{\mathcal{C}}} & \mathcal{C}_1 \\ & \searrow 1 & \downarrow \partial_-^{\mathcal{C}} \\ & & \mathcal{C}_0 \end{array} & \begin{array}{ccc} \mathcal{C}_0 & \xrightarrow{i_{\mathcal{C}}} & \mathcal{C}_1 \\ & \searrow 1 & \downarrow \partial_+^{\mathcal{C}} \\ & & \mathcal{C}_0 \end{array} & \begin{array}{ccc} \mathcal{C}_1 \times_{\mathcal{C}_0} \mathcal{C}_1 & \xrightarrow{\circ_{\mathcal{C}}} & \mathcal{C}_1 \\ \pi_1 \downarrow & & \downarrow \partial_-^{\mathcal{C}} \\ \mathcal{C}_1 & \xrightarrow{\partial_-^{\mathcal{C}}} & \mathcal{C}_0 \end{array} & \begin{array}{ccc} \mathcal{C}_1 \times_{\mathcal{C}_0} \mathcal{C}_1 & \xrightarrow{\circ_{\mathcal{C}}} & \mathcal{C}_1 \\ \pi_2 \downarrow & & \downarrow \partial_+^{\mathcal{C}} \\ \mathcal{C}_1 & \xrightarrow{\partial_+^{\mathcal{C}}} & \mathcal{C}_0 \end{array} \\ \\ \begin{array}{ccc} \mathcal{C}_1 \times_{\mathcal{C}_0} \mathcal{C}_1 & \xrightarrow{\circ_{\mathcal{C}} \times_{\mathcal{C}_0} 1} & \mathcal{C}_1 \times_{\mathcal{C}_0} \mathcal{C}_1 \\ 1 \times_{\mathcal{C}_0} \downarrow & & \downarrow \circ_{\mathcal{C}} \\ \mathcal{C}_1 \times_{\mathcal{C}_0} \mathcal{C}_1 & \xrightarrow{\circ_{\mathcal{C}}} & \mathcal{C}_1 \end{array} & \begin{array}{ccc} \mathcal{C}_1 \times_{\mathcal{C}_0} \mathcal{C}_1 & \xrightarrow{i_{\mathcal{C}} \times_{\mathcal{C}_0}} & \mathcal{C}_1 \times_{\mathcal{C}_0} \mathcal{C}_1 \\ \pi_2 \searrow & & \downarrow \circ_{\mathcal{C}} \\ & & \mathcal{C}_1 \\ \pi_1 \swarrow & & \end{array} \end{array}$$

where  $\mathcal{C}_1 \times_{\mathcal{C}_0} \mathcal{C}_1$  denotes the pullback in  $\mathcal{V}$  over morphisms  $\partial_-^{\mathcal{C}}$  and  $\partial_+^{\mathcal{C}}$ . An internal functor from  $\mathcal{C}$  to  $\mathcal{D}$  is a pair of morphisms  $\mathcal{C}_1 \rightarrow \mathcal{D}_1$  and  $\mathcal{C}_0 \rightarrow \mathcal{D}_0$  in  $\mathcal{V}$  making the following diagrams commute:

$$\begin{array}{ccc} \begin{array}{ccc} \mathcal{C}_1 & \xrightarrow{\partial_-^{\mathcal{C}}} & \mathcal{C}_0 \\ F_1 \downarrow & & \downarrow F_0 \\ \mathcal{D}_1 & \xrightarrow{\partial_-^{\mathcal{D}}} & \mathcal{D}_0 \end{array} & \begin{array}{ccc} \mathcal{C}_1 & \xrightarrow{\partial_+^{\mathcal{C}}} & \mathcal{C}_0 \\ F_1 \downarrow & & \downarrow F_0 \\ \mathcal{D}_1 & \xrightarrow{\partial_+^{\mathcal{D}}} & \mathcal{D}_0 \end{array} & \begin{array}{ccc} \mathcal{C}_0 & \xrightarrow{i_{\mathcal{C}}} & \mathcal{C}_1 \\ F_0 \downarrow & & \downarrow F_1 \\ \mathcal{D}_0 & \xrightarrow{i_{\mathcal{D}}} & \mathcal{D}_1 \end{array} & \begin{array}{ccc} \mathcal{C}_1 \times_{\mathcal{C}_0} \mathcal{C}_1 & \xrightarrow{\circ_{\mathcal{C}}} & \mathcal{C}_1 \\ F_1 \times F_1 \downarrow & & \downarrow F_1 \\ \mathcal{D}_1 \times_{\mathcal{D}_0} \mathcal{D}_1 & \xrightarrow{\circ_{\mathcal{D}}} & \mathcal{D}_1 \end{array} \end{array}$$

We denote by  $\mathbf{Cat}(\mathcal{V})$  the category of internal categories in  $\mathcal{V}$  and their functors. In the same way, we define an *internal groupoid*  $\mathbf{G}$  in  $\mathcal{V}$  as an internal category  $(\mathbf{G}_1, \mathbf{G}_0, \partial_-^{\mathbf{G}}, \partial_+^{\mathbf{G}}, \circ_{\mathbf{G}}, i_{\mathbf{G}})$  with an additional morphism

$$(\cdot)_{\mathbf{G}}^- : \mathbf{G}_1 \rightarrow \mathbf{G}_1$$

satisfying the axioms of groups, that is

$$\partial_-^{\mathbf{G}} \circ (\cdot)_{\mathbf{G}}^- = \partial_+^{\mathbf{G}}, \quad \partial_+^{\mathbf{G}} \circ (\cdot)_{\mathbf{G}}^- = \partial_-^{\mathbf{G}}, \quad (4.1)$$

$$i_{\mathbf{G}} \circ \partial_-^{\mathbf{G}} = \circ_{\mathbf{G}} \circ (\text{id} \times (\cdot)_{\mathbf{G}}^-) \circ \Delta, \quad i_{\mathbf{G}} \circ \partial_+^{\mathbf{G}} = \circ_{\mathbf{G}} \circ ((\cdot)_{\mathbf{G}}^- \times \text{id}) \circ \Delta, \quad (4.2)$$

where  $\Delta : \mathbf{G}_1 \rightarrow \mathbf{G}_1 \times \mathbf{G}_1$  is the diagonal functor. We denote by  $\mathbf{Grpd}(\mathcal{V})$  the category of internal groupoids in  $\mathcal{V}$  and their functors.

**4.1.2. Double categories and double groupoids.** The category of *double categories* is defined as the category  $\mathbf{Cat}(\mathbf{Cat})$ , and the category of *double groupoids* is defined as the category  $\mathbf{Grpd}(\mathbf{Grpd})$  of internal groupoids in the category  $\mathbf{Grpd}$  of groupoids and their functors. Explicitly, a double category is an internal category  $(\mathcal{C}_1, \mathcal{C}_0, \partial_{-}^{\mathcal{C}}, \partial_{+}^{\mathcal{C}}, \circ_{\mathcal{C}}, i_{\mathcal{C}})$  in  $\mathbf{Cat}$ , that gives four related categories:

$$\begin{aligned} \mathcal{C}^{sv} &:= (\mathcal{C}^s, \mathcal{C}^v, \partial_{-,1}^v, \partial_{+,1}^v, \diamond^v, i_1^v), & \mathcal{C}^{sh} &:= (\mathcal{C}^s, \mathcal{C}^h, \partial_{-,1}^h, \partial_{+,1}^h, \diamond^h, i_1^h), \\ \mathcal{C}^{vo} &:= (\mathcal{C}^v, \mathcal{C}^o, \partial_{-,0}^v, \partial_{+,0}^v, \circ^v, i_0^v), & \mathcal{C}^{ho} &:= (\mathcal{C}^h, \mathcal{C}^o, \partial_{-,0}^h, \partial_{+,0}^h, \circ^h, i_0^h), \end{aligned}$$

where  $\mathcal{C}^{sh}$  is the category  $\mathcal{C}_1$  and  $\mathcal{C}^{vo}$  is the category  $\mathcal{C}_0$ . The sources, target and identity maps pictured in the following diagram

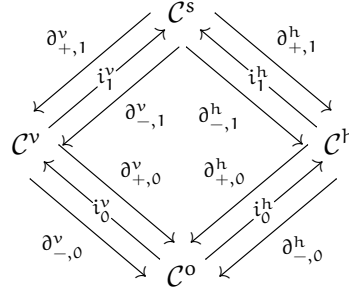

satisfy the following relations:

- i)  $\partial_{\alpha,0}^h \partial_{\beta,1}^h = \partial_{\beta,0}^v \partial_{\alpha,1}^v$ , for all  $\alpha, \beta$  in  $\{-, +\}$ ,
- ii)  $\partial_{\alpha,1}^{\mu} i_1^{\eta} = i_0^{\mu} \partial_{\alpha,0}^{\eta}$ , for all  $\alpha$  in  $\{-, +\}$  and  $\mu, \eta$  in  $\{v, h\}$ ,
- iii)  $i_1^v i_0^v = i_1^h i_0^h$ ,
- iv)  $\partial_{\alpha,1}^{\mu} (A \diamond^{\mu} B) = \partial_{\alpha,1}^{\mu} (A) \circ^{\mu} \partial_{\alpha,1}^{\mu} (B)$ , for all  $\alpha \in \{-, +\}$ ,  $\mu \in \{v, h\}$  and any squares  $A, B$  such that both sides are defined,
- v) *middle four interchange law* :

$$(A \diamond^v A') \diamond^h (B \diamond^h B') = (A \diamond^h B) \diamond^v (A' \diamond^h B'), \quad (4.3)$$

for any cells  $A, A', B, B'$  in  $\mathcal{C}^s$  such that both sides are defined.

Elements of  $\mathcal{C}^o$  are called *point cells*, the elements of  $\mathcal{C}^h$  and  $\mathcal{C}^v$  are respectively called *horizontal cells* and *vertical cells* and pictured by

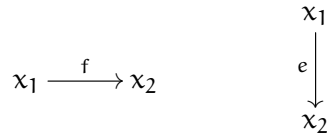

Following relations i), the elements of  $\mathcal{C}^s$  are called *square cells* and can be pictured by squares as follows:

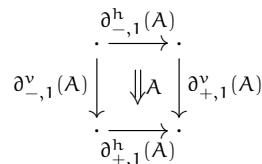

and by the followings squares for identities

$$\begin{array}{ccc}
 \begin{array}{ccc} x_1 & \xrightarrow{f} & x_2 \\ i_0^v(x_1) \downarrow & \Downarrow i_1^h(f) & \downarrow i_0^v(x_2) \\ x_1 & \xrightarrow{f} & x_2 \end{array} & \begin{array}{ccc} x & \xrightarrow{i_0^h(x)} & x \\ e \downarrow & \Downarrow i_1^h(e) & \downarrow e \\ y & \xrightarrow{i_0^h(y)} & y \end{array} & \text{or simply by} & \begin{array}{ccc} x_1 & \xrightarrow{f} & x_2 \\ \parallel \downarrow & i_1^h(f) & \downarrow \parallel \\ x_1 & \xrightarrow{f} & x_2 \end{array} & \begin{array}{ccc} x & \xrightarrow{=} & x \\ e \downarrow & i_1^v(e) & \downarrow e \\ y & \xrightarrow{=} & y \end{array}
 \end{array}$$

The compositions  $\diamond^v$  (resp.  $\diamond^h$ ) are called respectively *vertical* and *horizontal compositions*, and can be pictured as follows

$$\begin{array}{ccc}
 \begin{array}{ccccc} x_1 & \xrightarrow{f_1} & x_2 & \xrightarrow{f_2} & x_3 \\ e_1 \downarrow & \Downarrow A & \downarrow e_2 & \Downarrow B & \downarrow e_3 \\ y_1 & \xrightarrow{g_1} & y_2 & \xrightarrow{g_2} & y_3 \end{array} & \rightsquigarrow & \begin{array}{ccc} x_1 & \xrightarrow{f_1 \circ^h f_2} & x_3 \\ e_1 \downarrow & \Downarrow A \diamond^v B & \downarrow e_3 \\ y_1 & \xrightarrow{g_1 \circ^h g_2} & y_3 \end{array}
 \end{array}$$

for all  $x_i, y_i$  in  $\mathcal{C}^0$ ,  $f_i, g_i$  in  $\mathcal{C}^h$ ,  $e_i$  in  $\mathcal{C}^v$  and  $A, B$  in  $\mathcal{C}^s$ ,

$$\begin{array}{ccc}
 \begin{array}{ccc} x_1 & \xrightarrow{f} & x_2 \\ e_1 \downarrow & \Downarrow A & \downarrow e_2 \\ y_1 & \xrightarrow{g} & y_2 \\ e_1' \downarrow & \Downarrow A' & \downarrow e_2' \\ z_1 & \xrightarrow{h} & z_2 \end{array} & \rightsquigarrow & \begin{array}{ccc} x_1 & \xrightarrow{f} & x_2 \\ e_1 \circ^v e_1' \downarrow & \Downarrow A \diamond^h A' & \downarrow e_2 \circ^v e_2' \\ z_1 & \xrightarrow{h} & z_2 \end{array}
 \end{array}$$

for all  $x_i, y_i, z_i$  in  $\mathcal{C}^0$ ,  $f, g, h$  in  $\mathcal{C}^h$ ,  $e_i, e_i'$  in  $\mathcal{C}^v$  and  $A, A'$  in  $\mathcal{C}^s$ .

Similarly a double groupoid is given by the same data  $(\mathbf{G}_1, \mathbf{G}_0, \partial_-^{\mathbf{G}}, \partial_+^{\mathbf{G}}, \circ_{\mathbf{G}}, i_{\mathbf{G}})$ , with an inverse operation  $(\cdot)_{\mathbf{G}}^- : \mathbf{G}_1 \rightarrow \mathbf{G}_1$  satisfying the relations (4.1) and (4.2). As a consequence the four related categories  $\mathbf{G}^{sv}$ ,  $\mathbf{G}^{sh}$ ,  $\mathbf{G}^{vo}$  and  $\mathbf{G}^{ho}$  are groupoids. For any square cell

$$\begin{array}{ccc} \cdot & \xrightarrow{f} & \cdot \\ e \downarrow & \Downarrow A & \downarrow e' \\ \cdot & \xrightarrow{g} & \cdot \end{array}$$

in  $\mathbf{G}^s$ , the inverse square cell with respect to  $\diamond^\mu$ , for  $\mu \in \{v, h\}$ , is denoted by  $A^{-\mu}$  and satisfy the following relations

$$A \diamond^\mu (A^{-\mu}) = i_1^\mu(\partial_{-,1}^\mu(A)), \quad (A^{-\mu}) \diamond^\mu A = i_1^\mu(\partial_{+,1}^\mu(A)). \quad (4.4)$$

The sources and targets of these inverse are given as follows

$$\begin{array}{ccc}
 \begin{array}{ccc} \cdot & \xrightarrow{f^-} & \cdot \\ e' \downarrow & \Downarrow A^{-,v} & \downarrow e \\ \cdot & \xrightarrow{g^-} & \cdot \end{array} & & \begin{array}{ccc} \cdot & \xrightarrow{g} & \cdot \\ e^- \downarrow & \Downarrow A^{-,h} & \downarrow (e')^- \\ \cdot & \xrightarrow{f} & \cdot \end{array}
 \end{array}$$

**4.1.3. Squares.** A *square* of a double category  $\mathcal{C}$  is a quadruple  $(f, g, e, e')$  such that  $f, g$  are horizontal cells and  $e, e'$  are vertical cells that compose as follows:

$$\begin{array}{ccc} u & \xrightarrow{f} & v \\ e \downarrow & & \downarrow e' \\ u' & \xrightarrow{g} & v' \end{array}$$

The *boundary* of a square cell  $A$  in  $\mathcal{C}$  is the square  $(\partial_{-,h}(A), \partial_{+,h}(A), \partial_{-,v}(A), \partial_{+,v}(A))$ , denoted by  $\partial(A)$ . We will denote by  $\text{Sqr}(\mathcal{C})$  the set of square cells of  $\mathcal{C}$ .

**4.1.4. 2-categories as double categories.** From a 2-category  $\mathcal{C}$ , one can construct two canonical double categories, by setting the vertical or horizontal cells to be only identities in  $\mathcal{C}$ . In this way, 2-categories can be considered as special cases of double categories. The *quintet construction* gives another way to associate a double category, called the *double category of quintets in  $\mathcal{C}$*  and denoted by  $\mathbf{Q}(\mathcal{C})$  to a 2-category  $\mathcal{C}$ . The vertical and horizontal categories of  $\mathbf{Q}(\mathcal{C})$  are both equal to  $\mathcal{C}$ , and there is a square cell

$$\begin{array}{ccc} u & \xrightarrow{f} & u' \\ g \downarrow & \Downarrow A & \downarrow k \\ v & \xrightarrow{h} & v' \end{array}$$

in  $\mathbf{Q}(\mathcal{C})$  whenever there is a 2-cell  $A : f \star_1 k \Rightarrow g \star_1 h$  in  $\mathcal{C}$ . This defines a functor  $\mathbf{Q} : \mathbf{Cat}_2 \rightarrow \mathbf{DbCat}$ . Similarly, for  $n \geq 2$  one can associate to an  $n$ -category an  $(n-2)$ -category enriched in double categories by a quintet construction.

**4.1.5.  $n$ -categories enriched in double categories.** The coherence results for rewriting systems modulo presented in this article are formulated using the notion of  $n$ -categories enriched in double categories and double groupoids. Let us expand the latter notion for  $n > 0$ . Consider the category  $\mathbf{Cat}(\mathbf{Grpd})$  equipped with the cartesian product defined by

$$\mathcal{C} \times \mathcal{D} = (\mathcal{C}_1 \times \mathcal{D}_1, \mathcal{C}_0 \times \mathcal{D}_0, s_{\mathcal{C}} \times t_{\mathcal{D}}, c_{\mathcal{C}} \times c_{\mathcal{D}}, i_{\mathcal{C}} \times i_{\mathcal{D}}),$$

for any double groupoids  $\mathcal{C}$  and  $\mathcal{D}$ . The terminal double groupoid  $\mathbb{T}$  has only one point cell, denoted by  $\bullet$ , and identities  $i_0^v(\bullet), i_0^h(\bullet), i_1^v i_0^h(\bullet) = i_1^h i_0^v(\bullet)$ .

An  $n$ -category enriched in double groupoids is an  $n$ -category  $\mathcal{C}$  such that for any  $x, y$  in  $\mathcal{C}_{n-1}$  the homset  $\mathcal{C}_n(x, y)$  has a double groupoid structure, whose point cells are the  $n$ -cells in  $\mathcal{C}_n(x, y)$ . We will denote by  $\mathcal{C}_{n+1}^v$  (resp.  $\mathcal{C}_{n+1}^h, \mathcal{C}_{n+2}^s$ ) the union of sets  $\mathcal{C}_n(x, y)^v$  (resp.  $\mathcal{C}_n(x, y)^h, \mathcal{C}_n(x, y)^s$ ) for all  $x, y$  in  $\mathcal{C}_{n-1}$ . An  $(n+2)$ -cell  $A$  in  $\mathcal{C}_{n+2}^s$  can be represented by the following diagrams:

$$\begin{array}{ccc} u & \xrightarrow{f} & v \\ e \downarrow & \Downarrow A & \downarrow e' \\ u' & \xrightarrow{g} & v' \end{array}$$

with  $u, u', v, v'$  in  $\mathcal{C}_n$ ,  $f, g$  in  $\mathcal{C}_{n+1}^h$  and  $e, e'$  in  $\mathcal{C}_{n+1}^v$ . The compositions of the  $(n+2)$ -cells and the identities  $(n+2)$ -cells are induced by the functors of double categories

$$\star_{n-1}^{x,y,z} : \mathcal{C}_n(x, y) \times \mathcal{C}_n(y, z) \rightarrow \mathcal{C}_n(x, z), \quad 1_x : \mathbb{T} \rightarrow \mathcal{C}_n(x, x),$$

for all  $(n-1)$ -cells  $x, y, z$ . The  $(n-1)$ -composite of an  $(n+2)$ -cell  $A$  in  $\mathcal{C}_n(x, y)$  with an  $(n+2)$ -cell  $B$  in  $\mathcal{C}_n(y, z)$  of the form

$$\begin{array}{ccc} u_1 & \xrightarrow{f_1} & v_1 \\ e_1 \downarrow & \Downarrow A & \downarrow e'_1 \\ u'_1 & \xrightarrow{g_1} & v'_1 \end{array} \quad \begin{array}{ccc} u_2 & \xrightarrow{f_2} & v_2 \\ e_2 \downarrow & \Downarrow B & \downarrow e'_2 \\ u'_2 & \xrightarrow{g_2} & v'_2 \end{array}$$

is defined by  $\star_{n-1}$  compositions of  $n$ -cells, vertical  $(n+1)$ -cells and horizontal  $(n+1)$ -cells and denoted by:

$$\begin{array}{ccc} u_1 \star_{n-1} u_2 & \xrightarrow{f_1 \star_{n-1} f_2} & v_1 \star_{n-1} v_2 \\ e_1 \star_{n-1} e_2 \downarrow & \Downarrow A \star_{n-1} B & \downarrow e'_1 \star_{n-1} e'_2 \\ u'_1 \star_{n-1} u'_2 & \xrightarrow{g_1 \star_{n-1} g_2} & v'_1 \star_{n-1} v'_2 \end{array}$$

By functoriality, the  $(n-1)$ -composition satisfies the following exchange relations:

$$(A \diamond^\mu A') \star_{n-1} (B \diamond^\mu B') = (A \star_{n-1} B) \diamond^\mu (A' \star_{n-1} B'), \quad (4.5)$$

$$(A \diamond^\mu A') \star_{n-1} (B \diamond^\eta B') = ((A \star_{n-1} B) \diamond^\mu (A' \star_{n-1} B)) \diamond^\eta ((A \star_{n-1} B') \diamond^\mu (A' \star_{n-1} B')). \quad (4.6)$$

Using middle four interchange law (4.3), the identity (4.6) is equivalent to the following identity

$$(A \diamond^\mu A') \star_{n-1} (B \diamond^\eta B') = ((A \star_{n-1} B) \diamond^\eta (A \star_{n-1} B')) \diamond^\mu ((A' \star_{n-1} B) \diamond^\eta (A' \star_{n-1} B'))$$

for all  $\mu \neq \eta$  in  $\{v, h\}$  and any  $(n+2)$ -cells  $A, A', B, B'$  such that both sides are defined. We will denote by  $\mathbf{Cat}_n(\mathbf{DbCat})$  (resp.  $\mathbf{Cat}_n(\mathbf{DbGrpd})$ ) the category of  $n$ -categories enriched in double categories (resp. double groupoids) and enriched  $n$ -functors.

## 4.2. DOUBLE COHERENT PRESENTATIONS

Recall from Section 2.4.10 that a coherent presentation of an  $n$ -category  $\mathcal{C}$  is an  $(n+2, n)$ -polygraph  $P$  such that the underlying  $(n+1)$ -polygraph  $P_{\leq(n+1)}$  is a presentation of  $\mathcal{C}$  and  $P_{n+2}$  is an acyclic extension of the free  $(n+1, n)$ -category generated by  $P$ . In Section 4.2.4, we introduce dipolygraphs in order to extend the notion of coherent presentation to  $n$ -categories whose underlying  $(n-1)$ -category is not free. We also introduce the notion of double  $n$ -polygraph generating  $n$ -categories enriched in double groupoids. In Section 4.5, we will formulate coherence results modulo using the structure of double  $n$ -polygraph. Finally, we introduce in Subsection 4.2.7 double coherent presentations of  $n$ -categories. This notion allows us to obtain coherent presentations from polygraphs modulo as it will be explained in 4.7.

**4.2.1. Square extensions.** Let  $(\mathcal{C}^v, \mathcal{C}^h)$  be a pair of  $n$ -categories with the same underlying  $(n-1)$ -category  $\mathbb{B}$ . A *square extension* of the pair  $(\mathcal{C}^v, \mathcal{C}^h)$  is a set  $\Gamma$  equipped with four maps  $\partial_{\alpha, n}^\mu$ , with  $\alpha \in \{-, +\}$ ,  $\mu \in \{1, 2\}$ , as depicted by the following diagram:

$$\begin{array}{ccccc} & & \Gamma & & \\ & \swarrow \partial_{+,n}^v & & \searrow \partial_{+,n}^h & \\ & \mathcal{C}^v & & \mathcal{C}^h & \\ & \swarrow \partial_{-,n}^v & & \searrow \partial_{-,n}^h & \\ & & \mathbb{B} & & \end{array}$$

and satisfying the following relations:

$$\partial_{\alpha,n-1}^v \partial_{\beta,n}^v = \partial_{\beta,n-1}^h \partial_{\alpha,n}^h,$$

for all  $\alpha, \beta$  in  $\{-, +\}$ . The point cells of a square  $A$  in  $\Gamma$  are the  $(n-1)$ -cells of  $\mathbb{B}$  of the form

$$\partial_{\alpha,n-1}^\mu \partial_{\beta,n}^\eta(A)$$

with  $\alpha, \beta$  in  $\{-, +\}$ , and  $\eta, \mu$  in  $\{h, v\}$ . Note that by construction these four  $(n-1)$ -cells have the same  $(n-2)$ -source and  $(n-2)$ -target in  $\mathbb{B}$  respectively denoted by  $\partial_{-,n-2}(A)$  and  $\partial_{+,n-2}(A)$ .

A pair of  $n$ -categories  $(\mathcal{C}^v, \mathcal{C}^h)$  has two canonical square extensions, the empty one, and the full one that contains all squares on  $(\mathcal{C}^v, \mathcal{C}^h)$ , denoted by  $\text{Sqr}(\mathcal{C}^v, \mathcal{C}^h)$ . We will write  $\text{Sph}(\mathcal{C}^v, 1)$  (resp.  $\text{Sph}(1, \mathcal{C}^h)$ ) the square extension of  $(\mathcal{C}^v, \mathcal{C}^h)$  made of all squares of the form

$$\begin{array}{ccc} u & \xrightarrow{=} & u \\ e \downarrow & & \downarrow e' \\ v & \xrightarrow{=} & v \end{array} \quad (\text{resp.} \quad \begin{array}{ccc} u & \xrightarrow{f} & u' \\ \parallel \downarrow & & \downarrow \parallel \\ u & \xrightarrow{g} & u' \end{array})$$

for all  $n$ -cells  $e, e'$  in  $\mathcal{C}^v$  (resp.  $n$ -cells in  $f, g$  in  $\mathcal{C}^h$ ). The *Peiffer square extension* of the pair  $(\mathcal{C}^v, \mathcal{C}^h)$  is the square extension of  $(\mathcal{C}^v, \mathcal{C}^h)$ , denoted by  $\text{Peiff}(\mathcal{C}^v, \mathcal{C}^h)$ , containing the squares of the form

$$\begin{array}{ccc} u \star_i v & \xrightarrow{f \star_i v} & u' \star_i v \\ u \star_i e \downarrow & & \downarrow u' \star_i e \\ u \star_i v' & \xrightarrow{f \star_i v'} & u' \star_i v' \end{array} \quad \begin{array}{ccc} w \star_i u & \xrightarrow{w \star_i f} & w \star_i u' \\ e' \star_i u \downarrow & & \downarrow e' \star_i u' \\ w' \star_i u & \xrightarrow{w' \star_i f} & w' \star_i u' \end{array}$$

for all  $n$ -cells  $e, e'$  in  $\mathcal{C}^v$  and  $n$ -cell  $f$  in  $\mathcal{C}^h$ .

**4.2.2. Double polygraphs.** We define a *double  $n$ -polygraph* as a data  $P = (P^v, P^h, P^s)$  made of

1. two  $(n+1)$ -polygraphs  $P^v$  and  $P^h$  such that  $P_{\leq n}^v = P_{\leq n}^h$ ,
2. a square extension  $P^s$  of the pair of free  $(n+1)$ -categories  $((P^v)^*, (P^h)^*)$ .

Such a data can be pictured by the following diagram

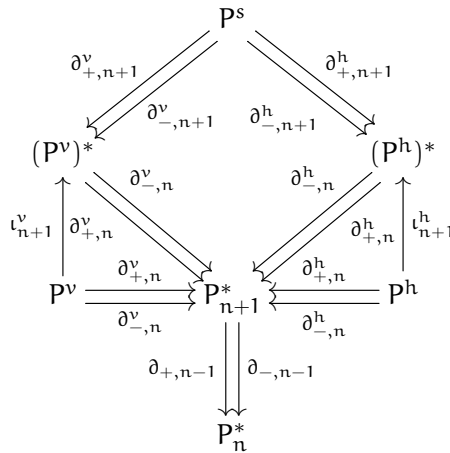

For  $0 \leq k \leq n$ , the  $k$ -cells of the  $(n+1)$ -polygraphs  $P^v$  and  $P^h$  are called *generating  $k$ -cells of  $P$* . The  $(n+1)$ -cells of  $P^v$  (resp.  $P^h$ ) are called *generating vertical  $(n+1)$ -cells of  $P$*  (resp. *generating horizontal  $(n+1)$ -cells of  $P$* ), and the elements of  $P^s$  are called *generating square  $(n+2)$ -cells of  $P$* .

**4.2.3. The category of double  $n$ -polygraphs.** Given two double  $n$ -polygraphs  $P = (P^v, P^h, P^s)$  and  $Q = (Q^v, Q^h, Q^s)$ , a *morphism of double  $n$ -polygraphs* from  $P$  to  $Q$  is a triple  $(f^v, f^h, f^s)$  made of two morphisms of  $(n + 1)$ -polygraphs

$$f^v : P^v \rightarrow Q^v, \quad f^h : P^h \rightarrow Q^h,$$

and a map  $f^s : P^s \rightarrow Q^s$  such that the following diagrams commute:

$$\begin{array}{ccc} P_{n+1}^\mu & \xleftarrow{\partial_{-,n-1}^{\mu,P}} & P^s \\ f_{n+1}^\mu \downarrow & & \downarrow f^s \\ Q_{n+1}^\mu & \xleftarrow{\partial_{-,n-1}^{\mu,Q}} & Q^s \end{array} \quad \begin{array}{ccc} P_{n+1}^\mu & \xleftarrow{\partial_{+,n-1}^{\mu,P}} & P^s \\ f_{n+1}^\mu \downarrow & & \downarrow f^s \\ Q_{n+1}^\mu & \xleftarrow{\partial_{+,n-1}^{\mu,Q}} & Q^s \end{array}$$

for  $\mu$  in  $\{v, h\}$ . We will denote by  $\mathbf{DbPol}_n$  the category of double  $n$ -polygraphs and their morphisms.

Let us explicit two full subcategories of  $\mathbf{DbPol}_n$  used in the sequel to formulate coherence and confluence results for polygraphs modulo. We define a *double  $(n + 2, n)$ -polygraph* as a double  $n$ -polygraph whose square extension  $P^s$  is defined on the pair of  $(n + 1, n)$ -categories  $((P^v)^\top, (P^h)^\top)$ . We denote by  $\mathbf{DbPol}_{(n+2,n)}$  the category of double  $(n + 2, n)$ -polygraphs. In some situations, we will also consider double  $n$ -polygraphs whose square extension is defined on the pair of  $(n + 1)$ -categories  $((P^v)^\top, (P^h)^*)$  (resp.  $((P^v)^*, (P^h)^\top)$ ). We will respectively denote by  $\mathbf{DbPol}_n^v$  (resp.  $\mathbf{DbPol}_n^h$ ) the full subcategories of  $\mathbf{DbPol}_n$  they form.

**4.2.4. Dipolygraphs.** We define the structure of dipolygraph as presentation by generators and relations for  $\infty$ -categories whose underlying  $k$ -categories are not necessarily free. Note that a similar notion was introduced by Burroni in [27]. Let us define the notion of  $n$ -dipolygraph by induction on  $n \geq 0$ . A *0-dipolygraph* is a set. A *1-dipolygraph* is a triple  $((P_0, P_1), Q_1)$ , where  $(P_0, Q_1)$  is a 1-polygraph and  $P_1$  is a cellular extension of the quotient category  $(P_0^*)_{Q_1}$ . For  $n \geq 2$ , an  *$n$ -dipolygraph* is a data  $(P, Q) = ((P_i)_{0 \leq i \leq n}, (Q_i)_{1 \leq i \leq n})$  made of

- i) a 1-dipolygraph  $((P_0, P_1), Q_1)$ ,
- ii) for every  $2 \leq k \leq n$ , a cellular extension  $Q_k$  of the  $(k - 1)$ -category

$$[P_{k-2}]_{Q_{k-1}} [P_{k-1}],$$

where  $[P_{k-2}]_{Q_{k-1}}$  denotes the  $(k - 2)$ -category

$$((((P_0^*)_{Q_1} [P_1])_{Q_2} [P_2])_{Q_3} \dots [P_{k-2}]_{Q_{k-1}}),$$

- iii) for every  $2 \leq k \leq n$ , a cellular extension  $P_k$  of the  $(k - 1)$ -category

$$[P_{k-1}]_{Q_k}.$$

For  $0 \leq k \leq n - 1$ , we will denote by  $(P, Q)_{\leq k}$  the underlying  $k$ -dipolygraph  $((P_i)_{0 \leq i \leq k}, (Q_i)_{1 \leq i \leq k})$ .

**4.2.5. Dipolygraphs.** For  $0 \leq p \leq n$ , an  $(n, p)$ -*dipolygraph* is a data  $((P_i)_{0 \leq i \leq n}, (Q_i)_{1 \leq i \leq n})$  such that:

- i)  $((P_i)_{0 \leq i \leq p+1}, (Q_i)_{1 \leq i \leq p+1})$  is a  $(p + 1)$ -dipolygraph,
- ii) for every  $p + 2 \leq k \leq n$ ,  $Q_k$  is a cellular extension of the  $(k - 1, p)$ -category

$$([P_p]_{Q_{p+1}})(P_{p+1})_{Q_{p+2}} \dots (P_{k-1}),$$



iii) for every  $p + 2 \leq k \leq n$ ,  $P_k$  is a cellular extension of the  $(k - 1, p)$ -category

$$(((P_p]_{Q_{p+1}})(P_{p+1}))_{Q_{p+2}} \cdots (P_{k-1}))_{Q_k}.$$

We define a *morphism of  $(n, p)$ -dipolygraphs*

$$((P_i)_{0 \leq i \leq n}, (Q_i)_{1 \leq i \leq n}) \rightarrow ((P'_i)_{0 \leq i \leq n}, (Q'_i)_{1 \leq i \leq n})$$

as a family of pairs  $((f_k, g_k))_{1 \leq k \leq n}$ , where  $f_k : P_k \rightarrow P'_k$  and  $g_k : Q_k \rightarrow Q'_k$  are maps such that the following diagram commute

$$\begin{array}{ccc} Q_k & \rightrightarrows & [P_{k-2}]_{Q_{k-1}} [P_{k-1}] \\ g_k \downarrow & & \downarrow \tilde{f}_{k-1} \\ Q'_k & \rightrightarrows & [P'_{k-2}]_{Q'_{k-1}} [P'_{k-1}] \end{array} \quad \begin{array}{ccc} P_k & \rightrightarrows & [P_{k-1}]_{Q_k} \\ f_k \downarrow & & \downarrow [f_{k-1}]_{g_k} \\ P'_k & \rightrightarrows & [P'_{k-1}]_{Q'_k} \end{array}$$

for any  $1 \leq k \leq p + 1$ , and such that the following diagrams commute

$$\begin{array}{ccc} Q_k & \rightrightarrows & ([P_p]_{Q_p})(P_{p+1})_{Q_{p+2}} \cdots (P_{k-1}) \\ g_k \downarrow & & \downarrow \tilde{f}_{k-1} \\ Q'_k & \rightrightarrows & ([P'_p]_{Q'_p})(P'_{p+1})_{Q'_{p+2}} \cdots (P'_{k-1}) \end{array} \quad \begin{array}{ccc} P_k & \rightrightarrows & ((([P_p]_{Q_{p+1}})(P_{p+1}))_{Q_{p+2}} \cdots (P_{k-1}))_{Q_k} \\ f_k \downarrow & & \downarrow [f_{k-1}]_{g_k} \\ P'_k & \rightrightarrows & ((([P'_p]_{Q'_{p+1}})(P'_{p+1}))_{Q'_{p+2}} \cdots (P'_{k-1}))_{Q'_k} \end{array}$$

for any  $p + 2 \leq k \leq n$ , where the map  $\tilde{f}_{k-1}$  is induced by the map  $f_{k-1}$  and the map  $[f_{k-1}]_{g_k}$  is defined by the following commutative diagram:

$$\begin{array}{ccc} ((([P_p]_{Q_{p+1}})(P_{p+1}))_{Q_{p+2}} \cdots (P_{k-1})) & \xrightarrow{\pi} & ((([P_p]_{Q_{p+1}})(P_{p+1}))_{Q_{p+2}} \cdots (P_{k-1}))_{Q_k} \\ \tilde{f}_{k-1} \downarrow & & \downarrow [f_{k-1}]_{g_k} \\ ((([P'_p]_{Q'_{p+1}})(P'_{p+1}))_{Q'_{p+2}} \cdots (P'_{k-1})) & \xrightarrow{\pi'} & ((([P'_p]_{Q'_{p+1}})(P'_{p+1}))_{Q'_{p+2}} \cdots (P'_{k-1}))_{Q'_k} \end{array}$$

We will denote by  $\mathbf{DiPol}_{(n,p)}$  the category of  $(n, p)$ -dipolygraphs and their morphisms.

**4.2.6. Presentations by dipolygraphs.** The  $(n - 1)$ -category presented by an  $n$ -dipolygraph  $(P, Q)$  is defined by

$$\overline{(P, Q)} := ([P_{n-1}]_{Q_n})_{P_n}.$$

Let  $\mathcal{C}$  be an  $(n - 1)$ -category. A *presentation of  $\mathcal{C}$*  is an  $n$ -dipolygraph  $(P, Q)$  whose presented category  $\overline{(P, Q)}$  is isomorphic to  $\mathcal{C}$ . A *coherent presentation of  $\mathcal{C}$*  is an  $(n + 1, n - 1)$ -dipolygraph  $(P, Q)$  satisfying the following conditions

- i) the underlying  $n$ -dipolygraph  $(P, Q)_{\leq n}$  is a presentation of  $\mathcal{C}$ ,
- ii) the cellular extension  $P_{n+1}$  is acyclic,
- iii) the cellular extension  $Q_{n+1}$  is empty.

**4.2.7. Double coherent presentations.** In this subsection, we introduce the notion of double coherent presentation of an  $n$ -category, defined using the structure of double  $n$ -polygraph. Let us first explicit the construction of a free  $n$ -category enriched in double categories generated by a double  $n$ -polygraph.

**4.2.8. Construction of free double categories.** The question of the construction of free double categories was considered in several works, [38, 37, 39, 36]. In particular, Dawson and Pare gave in [39] constructions of free double categories generated by double graphs and double reflexive graphs. Such free double categories always exist, and they show how to describe their cells explicitly in geometrical terms. However, they show that free double categories generated by double graphs cannot describe many of the possible compositions in free double categories. They fixed this problem by considering double reflexive graphs as generators.

The coherence results that we will state in Section 4.6 are formulated in free  $n$ -categories enriched in double categories generated by double  $n$ -polygraphs. For every  $n \geq 0$ , let us consider the forgetful functor

$$W_n : \mathbf{Cat}_n(\mathbf{DbCat}) \rightarrow \mathbf{DbPol}_n \quad (4.7)$$

that sends an  $n$ -category enriched in double categories  $\mathcal{C}$  on the double  $n$ -polygraph, denoted by

$$W_n(\mathcal{C}) = (W_{n+1}^v(\mathcal{C}), W_{n+1}^h(\mathcal{C}), W_{n+2}^s(\mathcal{C})),$$

where  $W_{n+1}^v(\mathcal{C})$  (resp.  $W_{n+1}^h(\mathcal{C})$ ) is the underlying  $(n+1)$ -polygraph of the  $(n+1)$ -category obtained as the extension of the underlying  $n$ -category of  $\mathcal{C}$  by the vertical (resp. horizontal)  $(n+1)$ -cells and  $W_{n+2}^s(\mathcal{C})$  is the square extension generated by all squares of  $\mathcal{C}$ . Explicitly, for  $\mu \in \{v, h\}$ , consider  $\mathcal{C}_{n+1}^\mu$  the  $(n+1)$ -category whose

1. underlying  $(n-1)$ -category coincides with the underlying  $(n-1)$ -category of  $\mathcal{C}$ ,
2. set of  $n$ -cells is given by

$$(\mathcal{C}_{n+1}^\mu)_n := \coprod_{x, y \in \mathcal{C}_{n-1}} (\mathcal{C}_n(x, y))^\circ,$$

3. set of  $(n+1)$ -cells is given by

$$(\mathcal{C}_{n+1}^\mu)_{n+1} := \coprod_{x, y \in \mathcal{C}_{n-1}} (\mathcal{C}_n(x, y))^\mu.$$

The  $(n-1)$ -composition of  $n$ -cells and  $(n+1)$ -cells of  $\mathcal{C}_{n+1}^\mu$  are defined by enrichment. The  $n$ -composition of  $(n+1)$ -cells of  $\mathcal{C}_{n+1}^\mu$  are induced by the composition  $\circ^\mu$ . We define  $W_{n+1}^\mu(\mathcal{C})$  as the underlying  $(n+1)$ -polygraph of the  $(n+1)$ -category  $\mathcal{C}_{n+1}^\mu$ :

$$W_{n+1}^\mu(\mathcal{C}) := \mathbf{U}_{n+1}^{\text{Pol}}(\mathcal{C}_{n+1}^\mu).$$

Finally, the square extension  $W_{n+2}^s(\mathcal{C})$  is defined on the pair of  $(n+1)$ -categories  $(\mathcal{C}_{n+1}^v, \mathcal{C}_{n+1}^h)$  by

$$W_{n+2}^s(\mathcal{C}) := \coprod_{x, y \in \mathcal{C}_{n-1}} \mathcal{C}_n(x, y)^s.$$

**4.2.9 Proposition.** *For every  $n \geq 0$ , the forgetful functor  $W_n$  defined in (4.7) admits a left adjoint functor  $F_n$ .*

The proof of this result consists in constructing explicitly in 4.2.10 the free  $n$ -category enriched in double categories generated by a double  $n$ -polygraph and the proof in 4.2.11 of universal property of free object.

**4.2.10. Free  $n$ -category enriched in double categories.** Consider a double  $n$ -polygraph  $P = (P^v, P^h, P^s)$ . We construct the *free  $n$ -category enriched in double categories* on  $P$ , denoted by  $P^\square$ , as follows:

- i) the underlying  $n$ -category of  $P^\square$  is the free  $n$ -category  $P_n^*$ ,
- ii) for all  $(n-1)$ -cells  $x$  and  $y$  of  $P_{n-1}^*$ , the hom-double category  $P^\square(x, y)$  is constructed as follows
  - a) the point cells of  $P^\square(x, y)$  are the  $n$ -cells in  $P_n^*(x, y)$ ,
  - b) the vertical cells of  $P^\square(x, y)$  are the  $(n+1)$ -cells of the free  $(n+1)$ -category  $(P^v)^*$  with  $(n-1)$ -source  $x$  and  $(n-1)$ -target  $y$ ,
  - c) the horizontal cells of  $P^\square(x, y)$  are the  $(n+1)$ -cells of the free  $(n+1)$ -category  $(P^h)^*$  with  $(n-1)$ -source  $x$  and  $(n-1)$ -target  $y$ ,
  - d) the set of square cells of  $P^\square(x, y)$  is defined recursively and contains
    - the square cells  $A$  of  $P^s$  such that  $\partial_{-,n-1}(A) = x$  and  $\partial_{+,n-1}(A) = y$ ,
    - the square cells  $C[A]$  for any context  $C$  of the  $n$ -category  $P_n^*$  and  $A$  in  $P^s$ , such that  $\partial_{-,n-1}(C[A]) = x$  and  $\partial_{+,n-1}(C[A]) = y$ ,
    - identities square cells  $i_1^h(f)$  and  $i_1^v(e)$ , for any  $(n+1)$ -cells  $f$  in  $(P^h)^*$  and  $(n+1)$ -cell  $e$  in  $(P^v)^*$  whose  $(n-1)$ -source (resp.  $(n-1)$ -target) in  $P_{n-1}^*$  is  $x$  (resp.  $y$ ),
    - all formal pastings of these elements with respect to  $\diamond^h$ -composition and  $\diamond^v$ -composition.
  - e) two square cells constructed as such formal pastings are identified by the associativity, and identity axioms of compositions  $\diamond^v$  and  $\diamond^h$  and middle four interchange law given in (4.3),
- iii) for all  $(n-1)$ -cells  $x, y, z$  of  $P_{n-1}^*$ , the composition functor

$$\star_{n-1} : P^\square(x, y) \times P^\square(y, z) \longrightarrow P^\square(x, z)$$

is defined for any

$$\begin{array}{ccc} \begin{array}{ccc} u_1 & \xrightarrow{f_1} & v_1 \\ e_1 \downarrow & \Downarrow A_1 & \downarrow e'_1 \\ u'_1 & \xrightarrow{g_1} & v'_1 \end{array} & \text{in } P^\square(x, y), \text{ and} & \begin{array}{ccc} u_2 & \xrightarrow{f_2} & v_2 \\ e_2 \downarrow & \Downarrow A_2 & \downarrow e'_2 \\ u'_2 & \xrightarrow{g_2} & v'_2 \end{array} & \text{in } P^\square(y, z), \end{array}$$

by

$$\begin{array}{ccc} u_1 \star_{n-1} u_2 & \xrightarrow{f_1 \star_{n-1} f_2} & v_1 \star_{n-1} v_2 \\ e_1 \star_{n-1} e_2 \downarrow & \Downarrow A_1 \star_{n-1} A_2 & \downarrow e'_1 \star_{n-1} e'_2 \\ u'_1 \star_{n-1} u'_2 & \xrightarrow{g_1 \star_{n-1} g_2} & v'_1 \star_{n-1} v'_2 \end{array}$$

where the square cell  $A_1 \star_{n-1} A_2$  is defined recursively using exchanges relations (4.5-4.6) from functoriality of the composition  $\star_{n-1}$ , and the middle four identities (4.3),

- iv) for all  $(n-1)$ -cell  $x$  of  $P_{n-1}^*$ , the identity map  $\top \longrightarrow P^\square(x, x)$ , where  $\top$  is the terminal double groupoid, sends the one point cell  $\bullet$  on  $x$  and the identity  $i_\alpha^\mu(\bullet)$  on  $i_\alpha^\mu(x)$  for all  $\mu \in \{v, h\}$  and  $\alpha \in \{0, 1\}$ .

**4.2.11. Universal property of a free object.** The functor  $F_n : \mathbf{DbPol}_n \rightarrow \mathbf{Cat}_n(\mathbf{DbCat})$  defined by  $F_n(P) = P^\square$  for any double  $n$ -polygraph  $P$  satisfies the universal property of a free object in  $\mathbf{Cat}_n(\mathbf{DbCat})$ . Indeed, given a double  $n$ -polygraph  $P = (P^v, P^h, P^s)$ , a morphism  $\eta_P : P \rightarrow W_n(F_n(P))$  of double  $n$ -polygraphs, an  $n$ -category enriched in double categories  $\mathcal{C}$ , and a morphism  $\varphi : P \rightarrow W_n(\mathcal{C})$  of double  $n$ -polygraphs, there exists a unique enriched morphism  $\tilde{\varphi} : F_n(P) \rightarrow \mathcal{C}$  such that the following diagram commutes

$$\begin{array}{ccc} P & \xrightarrow{\eta_P} & W_n(F_n(P)) \\ & \searrow \varphi & \downarrow W_n(\tilde{\varphi}) \\ & & W_n(\mathcal{C}) \end{array}$$

The functor  $\tilde{\varphi} = (\tilde{\varphi}_k)_{0 \leq k \leq n+2}$  is defined as follows.

- i) By construction, the morphism  $\varphi$  induces morphisms of  $(n+1)$ -polygraphs  $\varphi^\mu : P^\mu \rightarrow W_{n+1}^\mu(\mathcal{C})$ , for  $\mu \in \{v, h\}$ . The morphism  $\varphi^\mu$  extends by universal property of free  $(n+1)$ -categories into a functor  $\tilde{\varphi}^\mu : (P^\mu)^* \rightarrow \mathcal{C}_{n+1}^\mu$ . We set  $\tilde{\varphi}_k = \varphi_k^v = \varphi_k^h$  for  $0 \leq k \leq n$ , and

$$\tilde{\varphi}_{n+1}(f) = \varphi^h(f), \quad \tilde{\varphi}_{n+1}(e) = \varphi^v(e),$$

for every horizontal  $(n+1)$ -cell  $f$  and every vertical  $(n+1)$ -cell  $e$ .

- ii) By construction, any square  $(n+2)$ -cell  $A$  in  $F_n(P)$  is a composite of generating square  $(n+2)$ -cells in  $P^s$  with respect to the compositions  $\diamond^v$ ,  $\diamond^h$  and  $\star_{n-1}$ . Moreover, following [38, Theorem 1.2], if a compatible arrangement of square cells in a double category is composable in two different ways, the results are equal modulo the associativity, identity axioms of compositions  $\diamond^v$  and  $\diamond^h$ , and middle four interchange law (4.3). We extend the functor  $\varphi$  to the functor  $\tilde{\varphi}$  by setting

$$\tilde{\varphi}(A \diamond^\mu B) = \varphi(A) \diamond^\mu \varphi(B), \quad \tilde{\varphi}(A \star_{n-1} B) = \varphi(A) \star_{n-1} \varphi(B),$$

for every  $\mu \in \{v, h\}$  and all square generating  $(n+2)$ -cells  $A, B$  in  $P^s$  whenever the composites are defined.

**4.2.12. Free  $n$ -categories enriched in double groupoids.** By a similar construction to the free  $n$ -category enriched in double categories on a double  $n$ -polygraph  $P = (P^v, P^h, P^s)$  given in 4.2.10, we construct the free  $n$ -category enriched in double groupoids generated by a double  $(n+2, n)$ -polygraph  $P = (P^v, P^h, P^s)$ , that we denote by  $P^\Pi$ . It is obtained as the free  $n$ -category enriched in double categories  $P^\square$  having in addition

- inverse vertical  $(n+1)$ -cells  $e^-$  for any generating vertical  $(n+1)$ -cell  $e$ ,
- inverse horizontal  $(n+1)$ -cells  $f^-$  for any generating vertical  $(n+1)$ -cell  $f$ ,
- inverse square  $(n+2)$ -cells  $A^{-\cdot\mu}$  for any generating square  $(n+2)$ -cell  $A$  in  $P^s$ ,

that satisfy the inverses axioms of groupoids for vertical and horizontal cells and the relations (4.4) for square cells.

Finally, we will also consider the free  $n$ -category enriched in double categories, whose vertical category is a groupoid, generated by a double  $n$ -polygraph  $P = (P^v, P^h, P^s)$  in  $\mathbf{DbPol}^v$ , that we denote by  $P^{\Pi, v}$ . In that case, we only require the invertibility of vertical  $(n+1)$ -cells and the invertibility of square  $(n+2)$ -cells with respect to  $\diamond^h$ -composition.

**4.2.13. Acyclicity.** Let  $P = (P^v, P^h, P^s)$  be a double  $(n+2, n)$ -polygraph. The square extension  $P^s$  of the pair of  $(n+1, n)$ -categories  $((P^v)^\top, (P^h)^\top)$  is *acyclic* if for any square  $S$  over  $((P^v)^\top, (P^h)^\top)$  there exists a square  $(n+2)$ -cell  $A$  in the free  $n$ -category enriched in double groupoids  $P^\Pi$  such that  $\partial(A) = S$ . For example, the set of squares over  $((P^v)^\top, (P^h)^\top)$  forms an acyclic extension.

**4.2.14. Double coherent presentations of  $\bar{n}$ -categories.** Recall that a *presentation of an  $n$ -category  $\mathcal{C}$*  is an  $(n + 1)$ -polygraph  $P$  whose presented category  $\bar{P}$  is isomorphic to  $\mathcal{C}$ . We define a *double coherent presentation of  $\mathcal{C}$*  as a double  $(n + 2, n)$ -polygraph  $(P^v, P^h, P^s)$  satisfying the two following conditions:

- i) the  $(n + 1)$ -polygraph  $(P_n, P_{n+1}^v \cup P_{n+1}^h)$  is a presentation of  $\mathcal{C}$ , where  $P_n$  is the underlying  $n$ -polygraph of  $P^v$  and  $P^h$ ,
- ii) the square extension  $P^s$  is acyclic.

**4.2.15. Globular coherent presentations from double coherent presentations.** We define a quotient functor

$$V : \mathbf{DbPol}_{(n+2,n)} \rightarrow \mathbf{DiPol}_{(n+2,n)} \quad (4.8)$$

that sends a double  $(n + 2, n)$ -polygraph  $P = (P^v, P^h, P^s)$  to the  $(n + 2, n)$ -dipolygraph

$$V(P) = ((P_0, \dots, P_{n+2}), (Q_1, \dots, Q_{n+2})) \quad (4.9)$$

defined as follows:

- i)  $(P_0, \dots, P_n)$  is the underlying  $n$ -polygraph  $P_{\leq n}^v = P_{\leq n}^h := P_n$ ,
- ii) for every  $1 \leq i \leq n$ , the cellular extension  $Q_i$  is empty,
- iii)  $Q_{n+1}$  is the cellular extension  $P_{n+1}^v \xrightarrow[\partial_{+,n}^v]{\partial_{-,n}^v} P_n^*$ ,
- iv)  $P_{n+1}$  is the cellular extension  $P_{n+1}^h \xrightarrow[\tilde{\partial}_{+,n}^h]{\tilde{\partial}_{-,n}^h} (P_n^*)_{P_{n+1}^v}$ , where the maps  $\tilde{\partial}_{-,n}^h$  and  $\tilde{\partial}_{+,n}^h$  are defined by
$$\tilde{\partial}_{\mu,n}^h = \partial_{\mu,n}^h \circ \pi,$$
for any  $\mu$  in  $\{-, +\}$ , where  $\pi : P_n^* \rightarrow (P_n^*)_{P_{n+1}^v}$  denotes the canonical projection sending an  $n$ -cell  $u$  in  $P_n^*$  on its class, denoted by  $[u]^v$ , modulo  $P_{n+1}^v$ . Moreover, for any  $f : u \rightarrow v$  in  $P_{n+1}^h$ , we will denote by  $[f]^v : [u]^v \rightarrow [v]^v$  the corresponding element in  $P_{n+1}$ ,
- v) the cellular extension  $Q_{n+2}$  is empty,
- vi)  $P_{n+2}$  is defined as the cellular extension  $P^s \xrightarrow[\tilde{t}]{\tilde{s}} (P_n^*)_{P_{n+1}^v} (P_{n+1}^h)$ , where the maps  $\tilde{s}$  and  $\tilde{t}$  are defined by the following commutative diagrams:

$$\begin{array}{ccc}
P_s & & \\
\partial_{+,n+1}^h \downarrow & \searrow \tilde{s} & \\
(P_{n+1}^h)^\top & \xrightarrow{\tilde{t}} & (P_n^*)_{P_{n+1}^v} (P_{n+1}^h) \\
\partial_{+,n}^h \downarrow & & \tilde{\partial}_{+,n}^h \downarrow \\
P_n^* & \xrightarrow{\pi} & (P_n^*)_{P_{n+1}^v}
\end{array}$$

where the maps  $\tilde{\partial}_{-,n}^h$  and  $\tilde{\partial}_{+,n}^h$  are induced from  $\tilde{\partial}_{-,n}^h$  and  $\tilde{\partial}_{+,n}^h$ , and the  $(n + 1)$ -functor  $F$  is defined by:

- a)  $F$  is the identity functor on the underlying  $(n-1)$ -category  $\mathcal{P}_{n-1}^*$ ,
- b)  $F$  sends an  $n$ -cell  $u$  in  $\mathcal{P}_n^*$  to its equivalence class  $[u]^v$  modulo  $\mathcal{P}_{n+1}^v$ ,
- c)  $F$  sends an  $(n+1)$ -cell  $f : u \rightarrow v$  in  $(\mathcal{P}_{n+1}^h)^\top$  to the  $(n+1)$ -cell  $[f]^v : [u]^v \rightarrow [v]^v$  in  $(\mathcal{P}_n^*)_{\mathcal{P}_{n+1}^v}(\mathcal{P}_{n+1}^h)$  defined as follows
  - for any  $f$  in  $\mathcal{P}_{n+1}^h$ ,  $[f]^v$  is defined by **iv**),
  - $F$  is extended to the  $(n+1)$ -cells of  $(\mathcal{P}_{n+1}^h)^\top$  by functoriality by setting

$$[x_n \star_n \dots (x_1 \star_0 g \star_0 y_1) \dots \star_n y_n]^v = [x_n]^v \star_n x_{n-1} \star_n \dots (x_1 \star_0 [g]^v \star_0 y_1) \dots \star_n y_{n-1} \star_n [y_n]^v$$

for all whisker  $x_n \star_n \dots (x_1 \star_0 - \star_0 y_1) \dots \star_n y_n$  of  $(\mathcal{P}_{n+1}^h)^\top$  and  $(n+1)$ -cell  $g$  in  $(\mathcal{P}_{n+1}^h)^\top$ , and

$$[f_1 \star_n f_2]^v = [f_1]^v \star_n [f_2]^v,$$

for all  $(n+1)$ -cells  $f_1, f_2$  in  $(\mathcal{P}_{n+1}^h)^\top$ .

**4.2.16. Quotient of a square extension.** Given a generating square  $(n+2)$ -cell

$$\begin{array}{ccc} u & \xrightarrow{f} & u' \\ g \downarrow & \Downarrow A & \downarrow k \\ v & \xrightarrow{h} & v' \end{array}$$

of  $\mathcal{P}^s$ , we denote by  $[A]^v$  the generating  $(n+2)$ -cell of the globular cellular extension  $\mathcal{P}_{n+2}$  on  $(\mathcal{P}_n^*)_{\mathcal{P}_{n+1}^v}(\mathcal{P}_{n+1}^h)$  defined in (4.9) as follows:

$$\begin{array}{ccc} & [f]^v & \\ & \curvearrowright & \\ [u]^v = [u']^v & \Downarrow [A]^v & [v]^v = [v']^v \\ & \curvearrowleft & \\ & [g]^v & \end{array}$$

Note that by construction in the  $(n+2, n)$ -category  $((\mathcal{P}_n^*)_{\mathcal{P}_{n+1}^v}(\mathcal{P}_{n+1}^h))(\mathcal{P}_{n+2})$  the following relations hold

$$[A]^v \star_n [A']^v = [A \diamond^v A']^v, \quad [A]^v \star_{n+1} [A']^v = [A \diamond^h A']^v,$$

for all generating square  $(n+2)$ -cells  $A$  and  $A'$  in  $\mathcal{P}^s$  such that these compositions make sense.

**4.2.17 Proposition.** *Let  $\mathcal{P} = (\mathcal{P}^v, \mathcal{P}^h, \mathcal{P}^s)$  be a double  $(n+2, n)$ -polygraph. If the square extension  $\mathcal{P}^s$  is acyclic then the cellular extension  $\mathcal{P}_{n+2}$  of the  $(n+1)$ -category  $(\mathcal{P}_n^*)_{\mathcal{P}_{n+1}^v}(\mathcal{P}_{n+1}^h)$  defined in (4.9) is acyclic.*

*In particular, if  $\mathcal{P}$  is a double coherent presentation of an  $n$ -category  $\mathcal{C}$ . Then, the  $(n+2, n)$ -dipolygraph  $V(\mathcal{P})$  is a globular coherent presentation of the quotient  $n$ -category  $(\mathcal{P}_n^*)_{\mathcal{P}_{n+1}^v}$ , that is the  $n$ -category is isomorphic to  $\overline{V(\mathcal{P})}_{\leq(n+1)}$  and  $\mathcal{P}_{n+2}$  is an acyclic extension of  $(\mathcal{P}_n^*)_{\mathcal{P}_{n+1}^v}(\mathcal{P}_{n+1}^h)$ .*

*Proof.* Given an  $(n+1)$ -sphere  $\gamma := ([f]^v, [g]^v)$  in  $(\mathcal{P}_n^*)_{\mathcal{P}_{n+1}^v}(\mathcal{P}_{n+1}^h)$ , by definition of the functor  $V$  defined in (4.8), there exists an  $(n+1)$ -square

$$S := \begin{array}{ccc} u & \xrightarrow{f} & u' \\ e \downarrow & & \downarrow e' \\ v & \xrightarrow{g} & v' \end{array}$$

in  $((P_{n+1}^v)^\top, (P_{n+1}^h)^\top)$ , such that  $F(f) = [f]^v$  and  $F(g) = [g]^v$  and  $V(S) = \gamma$ . By acyclicity assumption, there exists a square  $(n+2)$ -cell  $A$  in the free  $n$ -category enriched in double groupoids  $(P^v, P^h, P^s)^\top$  such that  $\partial(A) = S$ . Then  $[A]^v$  is an  $(n+2)$ -cell in  $(P_n^*)_{P_{n+1}^v}(P_{n+1}^h)(P_{n+2})$  such that  $\partial([A]^v) = \gamma$ . Finally, the fact that  $V(P)_{\leq(n+1)}$  is a presentation of the quotient  $n$ -category  $(P_n^*)_{P_{n+1}^v}$  follows from the definition of the functor  $V$  and the fact that the  $(n+1)$ -polygraph  $(P_n, P_{n+1}^v \cup P_{n+1}^h)$  is a presentation of  $\mathcal{C}$ .  $\square$

### 4.3. EXAMPLES

We illustrate how to define coherent presentations of algebraic structures in terms of dipolygraphs on the cases of groups, commutative monoids and pivotal categories.

**4.3.1. Coherent presentations of groups.** A presentation of a group  $G$  is defined by a set  $X$  of generators and a set  $R$  of relations equipped with a map from  $R$  to the free group  $F(X)$  on  $X$  such that  $G$  is isomorphic to the quotient of  $F(X)$  by the normal subgroup generated by  $R$ . The free group  $F(X)$  can be presented by the 2-polygraph, denoted by  $\mathbf{Gp}_2(X)$ , with only one 0-cell, its set of generating 1-cells is  $X \cup X^-$ , where  $X^- := \{x^- \mid x \in X\}$  and its generating 2-cells are

$$xx^- \Rightarrow 1, \quad x^-x \Rightarrow 1,$$

for any  $x$  in  $X$ . A coherent presentation of the group  $G$  is a  $(3, 1)$ -dipolygraph  $(P, Q)$  such that:

- i)  $(P_0, P_1, Q_2)$  is the 2-polygraph  $\mathbf{Gp}_2(X)$ , and the cellular extension  $Q_1$  is empty,
- ii) the cellular extension  $P_2$  of  $F(X)$  has for generating set  $R$ , its source map is the identity and its target is constant equal to 1,
- iii) the cellular extension  $Q_3$  is empty, and  $P_3$  is an acyclic extension of the 2-group  $(F(X))(R)$ .

**4.3.2. Coherent presentation of commutative monoids.** A presentation of a commutative monoid  $M$  is defined by a set  $X$  of generators and a cellular extension  $R$  of relations on the free commutative monoid  $\langle X \rangle$  on  $X$  such that  $M$  is isomorphic to the quotient of  $\langle X \rangle$  by the congruence generated by  $R$ . The free commutative monoid  $\langle X \rangle$  on  $X$  can be defined by the 2-polygraph, denoted by  $\mathbf{Com}_2(X)$ , with only one 0-cell, its set of generating 1-cells is  $X$ , and the generating 2-cells are

$$x_i x_j \Rightarrow x_j x_i$$

for any  $x_i, x_j$  in  $X$ , such that  $x_i > x_j$  for a given total order  $>$  on  $X$ . A coherent presentation of the commutative monoid  $M$  is a  $(3, 1)$ -dipolygraph  $(P, Q)$  such that:

- i)  $(P_0, P_1, Q_2)$  is the 2-polygraph  $\mathbf{Com}_2(X)$ , and the cellular extension  $Q_1$  is empty,
- ii)  $P_2 = R$ ,  $Q_3$  is empty, and  $P_3$  is an acyclic extension of the 2-category  $\langle X \rangle(R)$ .

**4.3.3. Coherent presentation of monoidal pivotal categories.** Recall that a (strict monoidal) pivotal category  $\mathcal{C}$  is a monoidal category, seen as 2-category with only one 0-cell, in which every 1-cell  $p$  has a right dual 1-cell  $\hat{p}$ , which is also a left-dual, that is there are 2-cells

$$\eta_p^- : 1 \Rightarrow \hat{p} \star_0 p, \quad \eta_p^+ : 1 \Rightarrow p \star_0 \hat{p}, \quad \varepsilon_p^- : \hat{p} \star_0 p \Rightarrow 1, \quad \text{and} \quad \varepsilon_p^+ : p \star_0 \hat{p} \Rightarrow 1, \quad (4.10)$$

respectively represented by the following diagrams:

$$\begin{array}{c} \hat{p} \\ \cup \\ p \end{array}, \quad \begin{array}{c} p \\ \cup \\ \hat{p} \end{array}, \quad \begin{array}{c} \hat{p} \\ \cap \\ p \end{array}, \quad \text{and} \quad \begin{array}{c} p \\ \cap \\ \hat{p} \end{array}. \quad (4.11)$$

These 2-cells satisfy the relations

$$\begin{aligned} (\varepsilon_p^+ \star_0 1_p) \star_1 (1_p \star_0 \eta_p^-) &= 1_p = (1_p \star_0 \varepsilon_p^-) \star_1 (\eta_p^+ \star_0 1_p) \\ (\varepsilon_p^- \star_0 1_{\hat{p}}) \star_1 (1_{\hat{p}} \star_0 \eta_p^+) &= 1_{\hat{p}} = (1_{\hat{p}} \star_0 \eta_p^+) \star_1 (\eta_p^- \star_0 1_{\hat{p}}), \end{aligned}$$

that can be diagrammatically depicted as follows

$$\begin{array}{ccc} \begin{array}{c} \varepsilon_p^+ \\ \cup \\ p \quad \eta_p^- \end{array} = \begin{array}{c} | \\ p \end{array} = \begin{array}{c} \varepsilon_p^- \\ \cup \\ \eta_p^+ \quad p \end{array} & & \begin{array}{c} \varepsilon_p^- \\ \cup \\ \hat{p} \quad \eta_p^+ \end{array} = \begin{array}{c} | \\ \hat{p} \end{array} = \begin{array}{c} \varepsilon_q^+ \\ \cup \\ \eta_p^- \quad \hat{p} \end{array} \end{array}$$

Any 2-cell  $f : p \Rightarrow q$  in  $\mathcal{C}$  is *cyclic* with respect to the biadjunctions  $\hat{p} \vdash p \vdash \hat{p}$  and  $\hat{q} \vdash q \vdash \hat{q}$  defined respectively by the family of 2-cells  $(\eta_p^-, \eta_p^+, \varepsilon_p^-, \varepsilon_p^+)$  and  $(\eta_q^-, \eta_q^+, \varepsilon_q^-, \varepsilon_q^+)$ , that is  $f^* = *f$ , where  $f^*$  and  $*f$  are respectively the right and left duals of  $f$ , defined using the right and left adjunction as follows:

$$*f := \begin{array}{c} \varepsilon_q^- \quad \hat{p} \\ \cup \\ \hat{q} \quad \eta_p^+ \end{array} \quad f^* := \begin{array}{c} \hat{p} \quad \varepsilon_q^+ \\ \cup \\ \eta_p^- \quad \hat{q} \end{array}$$

A 2-category in which all the 2-cells are cyclic with respect to some biadjunction is called a *pivotal* 2-category. In this structure, it is proved in [32] that given a string diagram representing a cyclic 2-cell, between 1-cells with chosen biadjoints, then any isotopy of the diagram represents the same 2-cell.

**4.3.4 Example.** We consider a 2-category with only one 0-cell, two 1-cells  $E$  and  $F$  whose identities are respectively represented by upward and downward arrows and such that  $E \dashv F \dashv E$ , that is  $E$  and  $F$  are biadjoint. We denote respectively by  $\curvearrowright$ ,  $\curvearrowleft$ ,  $\curvearrowright$ ,  $\curvearrowleft$  the units and counits for these adjunctions. Assume that this category has 2-cells given by  $\uparrow$ ,  $\downarrow$ ,  $\times$ ,  $\times$ . Then, requiring

that the 2-cells are cyclic in this 2-category are made by the following equalities:

$$\begin{array}{c} \curvearrowright \\ \downarrow \end{array} = \downarrow = \begin{array}{c} \downarrow \\ \curvearrowright \end{array}, \quad \begin{array}{c} \curvearrowright \\ \times \\ \curvearrowright \end{array} = \times = \begin{array}{c} \times \\ \curvearrowright \end{array}.$$

and their mirror image through a reflection by a vertical axis.

We refer the reader to [63, 32] for more details about the notion of pivotal monoidal category. The cyclic relations also imply relations of the form

$$\begin{array}{c} q \quad \hat{p} \\ \cup \\ \eta_p^+ \end{array} = \begin{array}{c} q \quad \hat{p} \\ \cup \\ \eta_q^+ \end{array} *f, \quad \text{and} \quad \begin{array}{c} \hat{p} \quad q \\ \cup \\ \varepsilon_p^- \end{array} = \begin{array}{c} \hat{p} \quad q \\ \cup \\ \varepsilon_q^- \end{array} *f$$

and the same relations for cap 2-cells. A presentation of a pivotal category  $\mathcal{C}$  is defined by a set  $X_1$  of generating 1-cells, a set  $X_2$  of generating cyclic 2-cells, and a cellular extension  $R$  on the free pivotal category  $\mathcal{P}(X_1, X_2)$  on the data  $(X_1, X_2)$ , such that  $\mathcal{C}$  is isomorphic to the quotient of  $\mathcal{P}(X_1, X_2)$  by the congruence generated by  $R$ . The free pivotal category  $\mathcal{P}(X_1, X_2)$  can be presented by the 3-polygraph  $\text{Piv}_3(X_1, X_2)$  defined as follows

- i) it has only one 0-cell,



ii) its set of generating 1-cells is  $X_1 \cup \widehat{X}_1$ , where  $\widehat{X}_1 := \{\hat{p} \mid p \in X_1\}$ ,

iii) its set of generating 2-cells is

$$X_2 \cup \{\eta_p^-, \eta_p^+, \epsilon_p^-, \epsilon_p^+ \mid p \in X_1\},$$

where the 2-cells  $\eta_p^-, \eta_p^+, \epsilon_p^-, \epsilon_p^+$  are defined by (4.10),

iv) its generating 3-cells are

$$\begin{array}{ccc} \begin{array}{c} \epsilon_q^- \\ \hat{p} \\ \curvearrowright \\ \bullet_f \\ \curvearrowleft \\ \hat{q} \\ \eta_p^+ \end{array} & \Rightarrow & \begin{array}{c} \hat{p} \\ \bullet_{f^*} \\ \hat{q} \end{array} \end{array} \qquad \begin{array}{ccc} \begin{array}{c} \hat{p} \\ \epsilon_q^+ \\ \curvearrowleft \\ \bullet_f \\ \curvearrowright \\ \eta_p^- \\ \hat{q} \end{array} & \Rightarrow & \begin{array}{c} \hat{p} \\ \bullet_{f^*} \\ \hat{q} \end{array} \end{array}$$

for any generating 2-cell  $f$  in  $X_2$  or  $f$  is an identity cell.

A coherent presentation of the pivotal category  $\mathcal{C}$  is a  $(4, 2)$ -dipolygraph  $(P, Q)$  such that:

- i)  $(P_0, P_1, P_2, Q_3)$  is the 3-polygraph  $\text{Piv}_3(X_1, X_2)$  and the cellular extensions  $Q_1$  and  $Q_2$  are empty,
- ii)  $P_3 = R$ ,  $Q_4$  is empty and  $P_4$  is an acyclic extension of the 2-category  $\mathcal{P}(X_1, X_2)(R)$ .

#### 4.4. POLYGRAPHS MODULO

In this section, we introduce the notion of polygraph modulo and we define the rewriting properties of termination, confluence and local confluence for these polygraphs.

**4.4.1. Cellular extensions modulo.** Consider two  $n$ -polygraphs  $E$  and  $R$  such that  $E_{\leq n-2} = R_{\leq n-2}$  and  $E_{n-1} \subseteq R_{n-1}$ . One defines the cellular extension

$$\gamma^{E^R} : {}_E R \rightarrow \text{Sph}_{n-1}(R_{n-1}^*),$$

where the set  ${}_E R$  is defined by the following pullback in **Set**:

$$\begin{array}{ccc} E_n^\top \times_{R_{n-1}^*} R_n^{*(1)} & \xrightarrow{\pi_2} & R_n^{*(1)} \\ \pi_1 \downarrow & & \downarrow \partial_{-,n-1} \\ E_n^\top & \xrightarrow{\partial_{+,n-1}} & R_{n-1}^* \end{array}$$

and the map  $\gamma^{E^R}$  is defined by  $\gamma^{E^R}(e, f) = (\partial_{-,n-1}(e), \partial_{+,n-1}(f))$  for all  $e$  in  $E^\top$  and  $f$  in  $R_n^{*(1)}$ . Similarly, one defines the cellular extension

$$\gamma^{R^E} : R_E \rightarrow \text{Sph}_{n-1}(R_{n-1}^*),$$

where the set  $R_E$  is defined by the following pullback in **Set**:

$$\begin{array}{ccc} R_n^{*(1)} \times_{R_{n-1}^*} E_n^\top & \xrightarrow{\pi_2} & E_n^\top \\ \pi_1 \downarrow & & \downarrow \partial_{-,n-1} \\ R_n^{*(1)} & \xrightarrow{\partial_{+,n-1}} & R_{n-1}^* \end{array}$$

and the map  $\gamma^{R_E}$  is defined by  $\gamma^{R_E}(f, e) = (\partial_{-,n-1}(f), \partial_{+,n-1}(e))$  for all  $e$  in  $E^\top$  and  $f$  in  $R_n^{*(1)}$ . Finally, one defines the cellular extension

$$\gamma^{R_E} : {}_E R_E \rightarrow \text{Sph}_{n-1}(R_{n-1}^*),$$

where the set  ${}_E R_E$  is defined by the following composition of pullbacks in **Set**:

$$\begin{array}{ccccc} E_n^\top \times_{R_{n-1}^*} R_n^{*(1)} \times_{R_{n-1}^*} E_n^\top & \xrightarrow{(\pi_2, \pi_3)} & R_n^{*(1)} \times_{R_{n-1}^*} E_n^\top & \xrightarrow{\pi_2} & E_n^\top \\ \downarrow (\pi_1, \pi_2) & & \downarrow \pi_1 & & \downarrow \partial_{-,n-1} \\ E_n^\top \times_{R_{n-1}^*} R_n^{*(1)} & \xrightarrow{\pi_2} & R_n^{*(1)} & \xrightarrow{\partial_{+,n-1}} & R_{n-1}^* \\ \downarrow \pi_1 & & \downarrow \partial_{-,n-1} & & \\ E_n^\top & \xrightarrow{\partial_{+,n-1}} & R_{n-1}^* & & \end{array}$$

and the map  $\gamma^{R_E}$  is defined by  $\gamma^{R_E}(e, f, e') = (\partial_{-,n-1}(e), \partial_{+,n-1}(e'))$ .

**4.4.2. Polygraphs modulo.** A *n-polygraph modulo* is a data  $(R, E, S)$  made of

- i) an  $n$ -polygraph  $R$ , whose generating  $n$ -cells are called *primary rules*,
- ii) an  $n$ -polygraph  $E$  such that  $E_{\leq(n-2)} = R_{\leq(n-2)}$  and  $E_{n-1} \subseteq R_{n-1}$ , whose generating  $n$ -cells are called *modulo rules*,
- iii)  $S$  is a cellular extension of  $R_{n-1}^*$  such that the inclusions of cellular extensions

$$R \subseteq S \subseteq {}_E R_E$$

holds.

If no confusion may occur, an  $n$ -polygraph modulo  $(R, E, S)$  will be simply denoted by  $S$ . For simplicity of notation, the  $n$ -polygraphs modulo  $(R, E, {}_E R)$ ,  $(R, E, R_E)$  and  $(R, E, {}_E R_E)$  will be denoted by  ${}_E R$ ,  $R_E$  and  ${}_E R_E$  respectively. Given an  $n$ -polygraph modulo  $(R, E, S)$ , we will consider in the sequel the following categories:

- the free  $n$ -category  $R_{n-1}^*[R_n, E_n \coprod E_n^{-1}]/\text{Inv}(E_n, E_n^{-1})$ , denoted by  $R^*(E)$ .
- the free  $n$ -category generated by  $S$ , denoted by  $S^*$ ,
- the free  $(n, n-1)$ -category generated by  $S$ , denoted by  $S^\top$ .

**4.4.3. Branchings modulo and confluence.** Recall that a *branching of  $S$  modulo  $E$*  is a triple  $(f, e, g)$  where  $f$  and  $g$  are  $n$ -cells of  $S^*$  with  $f$  non trivial and  $e$  is an  $n$ -cell of  $E^\top$ . Such a branching is depicted by

$$\begin{array}{ccc} u & \xrightarrow{f} & u' \\ e \downarrow & & \\ v & \xrightarrow{g} & v' \end{array} \quad (4.12)$$

and is denoted by  $(f, e, g) : (u, v) \Rightarrow (u', v')$ . The pair of  $(n-1)$ -cells  $(u, v)$  (resp.  $(u, u')$ ) is called the *source* of this branching modulo  $E$ . Note that any branching  $(f, g)$  of  $S$  is also a branching modulo  $E$  of the form  $(f, e, g)$  where  $e = i_1^y(\partial_{-,n-1}^h(f)) = i_1^y(\partial_{-,n-1}^h(g))$ .

**4.4.4. Confluence and confluence modulo.** A *confluence modulo*  $E$  of the  $n$ -polygraph modulo  $S$  is a triple  $(f', e', g')$ , where  $f', g'$  are  $n$ -cells of  $S^*$  and  $e'$  is an  $n$ -cell of  $E^\top$  such that  $\partial_{+, (n-1)}^h(f') = \partial_{-, (n-1)}^v(e')$  and  $\partial_{+, (n-1)}^h(g') = \partial_{+, (n-1)}^v(e')$ . Such a confluence is denoted by  $(f', e', g') : (u', v') \Rightarrow (w, w')$ . A branching modulo  $E$  as in (4.12) is *confluent modulo*  $E$  if there exist  $n$ -cells  $f', g'$  in  $S^*$  and  $e'$  in  $E^\top$  as in the following diagram:

$$\begin{array}{ccccc} u & \xrightarrow{f} & u' & \cdots & \xrightarrow{f'} & w \\ e \downarrow & & & & & \downarrow e' \\ v & \xrightarrow{g} & v' & \cdots & \xrightarrow{g'} & w' \end{array}$$

We say that the  $n$ -polygraph modulo  $S$  is *confluent* (resp. *confluent modulo*  $E$ ) if all of its branchings (resp. branchings modulo  $E$ ) are confluent (resp. confluent modulo  $E$ ).

**4.4.5. Divergence.** The  $n$ -polygraph modulo  $S$  is called *convergent* if it is both terminating and confluent. It is called *convergent modulo*  $E$  when it is confluent modulo  $E$  and  ${}_E R_E$  is terminating. We say that  $S$  is *divergent* when  $E$  is convergent and  $S$  is convergent modulo  $E$ .

**4.4.6. Classification of local branchings modulo.** Recall that a branching  $(f, e, g)$  modulo  $E$  is *local* if  $f$  is an  $n$ -cell of  $S^{*(1)}$ ,  $g$  is an  $n$ -cell of  $S^*$  and  $e$  an  $n$ -cell of  $E^\top$  such that  $\ell(g) + \ell(e) = 1$ . Local branchings modulo are classified into the following five families:

i) *local aspherical* branchings of the form:

$$\begin{array}{ccc} u & \xrightarrow{f} & v \\ \parallel \downarrow & & \downarrow \parallel \\ u & \xrightarrow{f} & v \end{array}$$

where  $f$  is an  $n$ -cell of  $S^{*(1)}$ ;

ii) *local Peiffer* branchings of the form:

$$\begin{array}{ccc} u \star_i v & \xrightarrow{f \star_i v} & u' \star_i v \\ \parallel \downarrow & & \\ u \star_i v & \xrightarrow{u \star_i g} & u \star_i v' \end{array}$$

where  $0 \leq i \leq n-2$ ,  $f$  and  $g$  are  $n$ -cells of  $S^{*(1)}$ ,

iii) *local Peiffer modulo* of the forms:

$$\begin{array}{ccc} u \star_i v & \xrightarrow{f \star_i v} & u' \star_i v \\ u \star_i e \downarrow & & \\ u \star_i v' & & \end{array} \qquad \begin{array}{ccc} w \star_i u & \xrightarrow{w \star_i f} & w \star_i u' \\ e' \star_i u \downarrow & & \\ w' \star_i u & & \end{array} \quad (4.13)$$

where  $0 \leq i \leq n-2$ , where  $f$  is an  $n$ -cell of  $S^{*(1)}$  and  $e, e'$  are  $n$ -cells of  $E^{\top(1)}$ ;

iv) *overlapping branchings* are the remaining local branchings:

$$\begin{array}{ccc} u & \xrightarrow{f} & v \\ \parallel \downarrow & & \\ u & \xrightarrow{g} & v' \end{array}$$

where  $f$  and  $g$  are  $n$ -cells of  $S^{*(1)}$ ,

v) *overlapping branchings modulo* are the remaining local branchings modulo:

$$\begin{array}{ccc} u & \xrightarrow{f} & v \\ e \downarrow & & \\ v' & & \end{array} \quad (4.14)$$

where  $f$  is an  $n$ -cell of  $S^{*(1)}$  and  $e$  is an  $n$ -cell of  $E^{\top(1)}$ .

**4.4.7. Critical branchings modulo.** Let  $(f, e, g)$  be a branching of  $S$  modulo  $E$  with source  $(u, v)$  and a whisker  $C[\partial u]$  of  $R_{n-1}^*$  composable with  $u$  and  $v$ , the triple  $(C[f], C[e], C[g])$  is a branching of  $S$  modulo  $E$  of the  $n$ -polygraph modulo  $S$ . If  $(f, e, g)$  is local, then  $(C[f], C[e], C[g])$  is local. We denote by  $\sqsubseteq$  the order relation on branchings modulo  $E$  of  $S$  defined by  $(f, e, g) \sqsubseteq (f', e', g')$  when there exists a whisker  $C$  of  $R_{n-1}^*$  such that  $(C[f], C[e], C[g]) = (f', e', g')$  hold. A branching (resp. branching modulo  $E$ ) is *minimal* if it is minimal for the order relation  $\sqsubseteq$ . A branching (resp. branching modulo  $E$ ) is *critical* if it is an overlapping branching or an overlapping branching modulo that is minimal for the relation  $\sqsubseteq$ .

**4.4.8. Completion procedure for  ${}_{\mathcal{E}}R$ .** We give a completion procedure for an  $n$ -polygraph modulo  $(R, E, {}_{\mathcal{E}}R)$ , when  ${}_{\mathcal{E}}R$  is not confluent modulo  $E$ , following the idea of Knuth-Bendix's completion procedure. Either it does not terminate, or it computes an  $n$ -polygraph  $\check{R}$  such that  ${}_{\mathcal{E}}\check{R}$  is confluent modulo  $E$ . Note that the property of JK coherence is trivially satisfied for  ${}_{\mathcal{E}}R$ . Indeed, any branching  $(f, e)$  of  ${}_{\mathcal{E}}R$  modulo  $E$  is trivially confluent modulo  $E$  as follows:

$$\begin{array}{ccc} u & \xrightarrow{f} & v \\ e \downarrow & & \Downarrow \\ v' & \xrightarrow{e^{-} \cdot f} & v \end{array} \quad (4.15)$$

where  $e^{-} \cdot f$  is a rewriting step of  ${}_{\mathcal{E}}R$ . Following the critical branching lemma modulo, Theorem 4.5.7 given in the next section, we describe a completion procedure for confluence of  ${}_{\mathcal{E}}R$  modulo  $E$  in terms of critical branchings, similar to the Knuth-Bendix completion. From (4.15) and Theorem 4.5.7, when  ${}_{\mathcal{E}}R$  is terminating,  ${}_{\mathcal{E}}R$  is confluent modulo  $E$  if and only if all critical branchings  $(f, g)$  of  ${}_{\mathcal{E}}R$  modulo  $E$  with  $f$  in  $({}_{\mathcal{E}}R)^{*(1)}$  and  $g$  in  $R^{*(1)}$  are confluent modulo  $E$ , as depicted by:

$$\begin{array}{ccccc} u & \xrightarrow{f \in ({}_{\mathcal{E}}R)^{*(1)}} & v & \xrightarrow{f' \in ({}_{\mathcal{E}}R)^{*}} & v' \\ \parallel \downarrow & & & & \downarrow e' \\ u & \xrightarrow{g \in R^{*(1)}} & w & \xrightarrow{g' \in ({}_{\mathcal{E}}R)^{*}} & w' \end{array}$$

We denote by  $CP({}_{\mathcal{E}}R, R)$  the set of such critical branchings.

**4.4.9. Completion procedure for  ${}_{\mathcal{E}}R$ .** Let us consider  $R$  and  $E$  two  $n$ -polygraphs such that  $E_{\leq n-2} = R_{\leq n-2}$  and  $E_{n-1} \subseteq R_{n-1}$ , and  $\prec$  a termination order compatible with  $R$  modulo  $E$ . In this paragraph, we describe a procedure to compute a completion  $\check{R}$  of the  $n$ -polygraph  $R$  such that  ${}_{\mathcal{E}}\check{R}$  is confluent modulo  $E$ . We denote by  $\hat{u}^{{}_{\mathcal{E}}R}$  a normal form of an element  $u$  in  $R_{n-1}^*$  with respect to  ${}_{\mathcal{E}}R$ . To simplify the notations, for any  $(n-1)$ -cells  $u$  and  $v$  in  $R_{n-1}^*$ , we denote  $u \approx_{\mathcal{E}} v$  if there exists an  $n$ -cell  $e : u \rightarrow v$  in  $E^{\top}$ .

**Input:**

- $R$  and  $E$  2-polygraphs over a 1-polygraph  $X$ .
- $\prec$  a termination order for  $R$  compatible with  $E$ ,  
which is total on the set of  ${}_{E}R$ -irreducible elements.

**begin**

```

  C ← CP( ${}_{E}R, R$ );
  while C ≠ ∅ do
    Pick any branching  $c = (f : u \Rightarrow v, g : u \Rightarrow w)$  in  $C$ , with  $f$  in  ${}_{E}R^*$  and  $g$  in  $R^*$ ;
    Reduce  $v$  to  $\hat{v} \in {}_{E}R$  a  ${}_{E}R$ -normal form;
    Reduce  $w$  to  $\hat{w} \in {}_{E}R$  a  ${}_{E}R$ -normal form;
    C ← C \ {c};
    if  $\hat{v} \approx_E \hat{w}$  then
      if  $\hat{w} \prec \hat{v}$  then
        | R ← R ∪ { $\hat{v} \xrightarrow{\alpha} \hat{w}$ };
      end
      if  $\hat{v} \prec \hat{w}$  then
        | R ← R ∪ { $\hat{w} \xrightarrow{\alpha} \hat{v}$ };
      end
    end
    C ← C ∪ {( ${}_{E}R, R$ )-critical branchings created by  $\alpha$ };
  end
end

```

This procedure may not be terminating. However, it does not fail because of the hypothesis that  $\prec$  is total on the set of  ${}_{E}R$ -irreducible elements.

**4.4.10 Proposition.** *When it terminates, the completion procedure for  ${}_{E}R$  returns an  $n$ -polygraph  $\check{R}$  such that  ${}_{E}\check{R}$  is confluent modulo  $E$ .*

*Proof.* The proof of soundness of the completion procedure for  ${}_{E}R$  is a consequence of the inference system given by Bachmair and Dershowitz in [7] in order to get a set of rules  $\check{R}$  such that  ${}_{E}\check{R}$  is confluent modulo  $E$ . Given two  $n$ -polygraphs  $R$  and  $E$  and a termination order  $>$  compatible with  $R$  modulo  $E$ , their inference system is given by the following six elementary rules:

1) Orienting an equation:

$$(A \cup \{s = t\}, R) \rightsquigarrow (A, R \cup \{s \rightarrow t\}) \text{ if } s > t.$$

2) Adding an equational consequence:

$$(A, R) \rightsquigarrow (A \cup \{s = t\}, R) \text{ if } s \xleftarrow{*}_{RUE} u \xrightarrow{*}_{RUE} t.$$

3) Simplifying an equation:

$$(A \cup \{s = t\}, R) \rightsquigarrow (A \cup \{u = t\}, R) \text{ if } s \xrightarrow{E} u.$$

4) Deleting an equation:

$$(A \cup \{s = t\}, R) \rightsquigarrow (A, R) \text{ if } s \approx_E t.$$

5) Simplifying the right-hand side of a rule:

$$(A, R \cup \{s \rightarrow t\}) \rightsquigarrow (A, R \cup \{s \rightarrow u\}) \text{ if } t \xrightarrow{E} u.$$

6) Simplifying the left-hand side of a rule:

$$(A, R \cup \{s \rightarrow t\}) \rightsquigarrow (A \cup \{u = t\}, R) \text{ if } s \xrightarrow{E^R} u.$$

The soundness of Procedure 4.4.9 is a consequence of the following arguments:

- i) For any critical branching  $(f : u \rightarrow v, g : u \rightarrow w)$  in  $CP({}_E R, R)$ , we can add an equation  $v = w$  using the rule *Adding an equational consequence*, and simplify it to  $\hat{v}^{E^R} = \hat{w}^{E^R}$  using the rule *Simplifying an equation*.
- ii) If  $\hat{v}^{E^R} \approx_E \hat{w}^{E^R}$ , we can delete the equation using the rule *Deleting an equation*.
- iii) Otherwise, we can always orient it using the rule *Orienting an equation*.

Thus, each step of this completion procedure comes from one of the inference rules given by Bachmair and Dershowitz. Following [7], it returns a set  $R$  of rules so that  ${}_E R$  is confluent modulo  $E$ .  $\square$

**4.4.11. Completion procedure for  ${}_E R_E$ .** As noted in [7, Section 2], the polygraph  $R$  is the polygraph for which is the most difficult to reach confluence modulo  $E$ . Indeed, if  $R$  is confluent modulo  $E$ , then any polygraph modulo  $(R, E, S)$  is confluent modulo  $E$ . In particular, the polygraph  ${}_E R$  is confluent modulo  $E$  if and only if the polygraph  ${}_E R_E$  is confluent modulo  $E$ . As a consequence, we will either prove confluence modulo for  ${}_E R$  or  ${}_E R_E$  in the sequel, leading to the same quotient. We can extend the above completion procedure in the case of the polygraph modulo  ${}_E R_E$ . In that case, the critical branchings of the form  $(f, e)$  with  $f$  in  ${}_E R_E^{*(1)}$  and  $e$  in  $E^{\top(1)}$  are still trivially confluent. Let us denote by  $CP({}_E R_E, R)$  the set of critical branchings of  ${}_E R_E$  modulo  $R$ . All these critical branchings can be written as a pair  $(f \cdot e, g)$ , where  $(f, g)$  is a critical branching in  $CP({}_E R, R)$  and  $e$  is an  $n$ -cell in  $E^{\top}$ .

As a consequence, the completion procedure for  ${}_E R$  given in 4.4.9 can be adapted for the polygraph modulo  ${}_E R_E$ . In that case, the procedure differs from 4.4.9 by the fact that when adding a rule  $\alpha : u \Rightarrow v$  in  $R$ , one can choose as target of  $\alpha$  any element of the equivalence class of  $v$  with respect to  $E$ . We prove in the same way than when it terminates, this completion procedure returns an  $n$ -polygraph  $\check{R}$  such that  ${}_E R_E$  is confluent modulo  $E$ .

## 4.5. COHERENT CONFLUENCE MODULO

In this section, we introduce the property of coherent confluence modulo defined by the adjunction of a square cell for each confluence diagram modulo. Under a termination hypothesis, Theorem 4.5.4 shows how to deduce coherent confluence modulo for a polygraph modulo from coherent local confluence modulo. This result is a coherent version of Newman's lemma that states the equivalence between local confluence and confluence under a termination hypothesis, [96]. Theorem 4.5.7 formulates a coherent version of the critical branching lemma, it shows how to deduce local coherent confluence modulo from the coherent confluence modulo of critical branchings.

**4.5.1. Biaction of  $E^{\top}$  on  $\text{Sqr}(E^{\top}, S^*)$ .** Let  $(R, E, S)$  be an  $n$ -polygraph modulo. Let  $\Gamma$  be a square extension of the pair of  $n$ -categories  $(E^{\top}, S^*)$ . As the inclusions  $R \subseteq S \subseteq {}_E R_E$  of cellular extensions hold, any  $n$ -cell  $f$  in  $S^*$  can be decomposed in  $f = e_1 \star_{n-1} f_1 \star_{n-1} e_2 \star_{n-1} f_2$  with  $f_1$  in  $R^{*(1)}$ ,  $f_2$  in  $S^*$  such that  $\ell(f_2) = \ell(f) - 1$ ,  $e_1$  and  $e_2$  are  $n$ -cells in  $E^{\top}$  possibly identities, and  $\star_{n-1}$  denoting for the composition along  $(n-1)$ -cells in the free  $n$ -category generated by  $R \cup E$ .

Thus, a branching  $(f, e, g)$  of  $S$  modulo  $E$  with a choice of a generating confluence  $(f', e', g')$  may correspond to different squares in  $\text{Sqr}(E^{\top}, S^*)$ . For instance, if  $g$  can be decomposed  $g = e_1 \star_{n-1} g_1 \star_{n-1}$

$e_2$ , the following squares in  $\text{Sqr}(E^\top, S^*)$  correspond to the same branching of  $S$  modulo  $E$ :

$$\begin{array}{ccc} u & \xrightarrow{f} & v \xrightarrow{\dots} v' \\ e \downarrow & & \downarrow e' \\ u & \xrightarrow{g} & w \xrightarrow{\dots} w' \end{array} \quad \text{and} \quad \begin{array}{ccc} u & \xrightarrow{f} & v \xrightarrow{\dots} v' \\ e^*_{n-1} \downarrow & & \downarrow e' \\ u_1 & \xrightarrow{g_1 e_2} & w \xrightarrow{\dots} w' \end{array}$$

When computing a coherent presentation of  $S$  modulo  $E$ , one does not want to consider two different elements in a coherent completion of  $S$  modulo  $E$ , as defined in 4.6.1, to tile these squares which are not equal in the free  $n$ -category enriched in double category generated by the double  $(n-1)$ -polygraph  $(E, S, \Gamma \cup \text{Peiff}(E^\top, S^*))$ .

In order to avoid these redundant squares, we define a *biaction* of  $E^\top$  on  $\text{Sqr}(E^\top, S^*)$ . For any  $n$ -cells  $e_1$  and  $e_2$  in  $E^\top$  and any  $(n+1)$ -cell

$$\begin{array}{ccc} u & \xrightarrow{f} & u' \\ e \downarrow & \Downarrow A & \downarrow e' \\ u & \xrightarrow{g} & v' \end{array}$$

in  $\text{Sqr}(E^\top, S^*)$  satisfying the following conditions

- i)  $\partial_{+,n-1}(e_1) = \partial_{-,n-1}^h \partial_{-,n}^v(A)$ ,
- ii)  $\partial_{-,n-1}(e_2) = \partial_{+,n-1}^h \partial_{-,n}^v(A)$ ,
- iii)  $e_1 \partial_{-,n}^h(A) \in S$ ,
- iv)  $e_2^- \partial_{+,n}^h(A) \in S$ ,

we define the square  $(n+1)$ -cell  ${}^{e_1}_{e_2}A$  as follows:

$$\begin{array}{ccc} u_1 & \xrightarrow{e_1 f} & u' \\ e_1 e_2 \downarrow & \Downarrow {}^{e_1}_{e_2}A & \downarrow e' \\ u_2 & \xrightarrow{e_2 g} & v' \end{array}$$

where  $u_1 = \partial_{-,n-1}(e_1)$  and  $u_2 = \partial_{+,n-1}(e_2)$ . For a square extension  $\Gamma$  of  $(E^\top, S^*)$ , we denote by  $E \rtimes \Gamma$  the set containing all elements  ${}^{e_1}_{e_2}A$  with  $A$  in  $\Gamma$  and  $e_1, e_2$  in  $E^\top$ , whenever it is well defined. For any  $e_1, e_2$  in  $E^\top$  and  $A, A'$  in  $\Gamma$ , the following equalities hold whenever both sides are defined:

- i)  ${}^{e'_1}_{e'_2}({}^{e_1}_{e_2}A) = {}^{e_1 e'_1}_{e_2 e'_2}A$ ;
- ii)  ${}^{e_1}_{e_2}(A \diamond^v A') = ({}^{e_1}_{e_2}A) \diamond^v A'$ ;
- iii)  ${}^{e_1}_{e_2}(A \diamond^h A') = ({}^{e_1}_{e_2}A) \diamond^h ({}^1_{e_2}A')$ .

**4.5.2. Coherent confluence modulo.** Let  $(R, E, S)$  be an  $n$ -polygraph modulo. Let  $\Gamma$  be a square extension of the pair of  $n$ -categories  $(E^\top, S^*)$ . Let us denote

$$\Gamma^\Upsilon := (E, S, E \rtimes \Gamma \cup \text{Peiff}(E^\top, S^*))^{\text{tr}, v}$$

the free  $(n-1)$ -category enriched in double categories, whose vertical  $n$ -cells are invertible, generated by the double  $(n-1)$ -polygraph  $(E, S, E \rtimes \Gamma \cup \text{Peiff}(E^\top, S^*))$  in  $\mathbf{DbPol}_{n-1}^v$ .

A branching modulo  $E$  as in (4.12) is  $\Gamma$ -confluent modulo  $E$  if there exist  $n$ -cells  $f', g'$  in  $S^*$ ,  $e'$  in  $E^\top$  and an  $(n+1)$ -cell  $A$  in  $\Gamma^\gamma$  as in the following diagram:

$$\begin{array}{ccccc} u & \xrightarrow{f} & u' & \cdots \xrightarrow{f'} & w \\ e \downarrow & & \Downarrow A & & \downarrow e' \\ v & \xrightarrow{g} & v' & \cdots \xrightarrow{g'} & w' \end{array}$$

We say that  $S$  is  $\Gamma$ -confluent (resp. locally  $\Gamma$ -confluent, resp. critically  $\Gamma$ -confluent) modulo  $E$  if every branching (resp. local branching, resp. critical branching) modulo  $E$  is  $\Gamma$ -confluent modulo  $E$ , and that  $S$  is  $\Gamma$ -convergent if it is  $\Gamma$ -confluent modulo  $E$  and  ${}_{E}R_E$  is terminating. The polygraph modulo  $S$  is called  $\Gamma$ -diconvergent, when it is  $\Gamma$ -convergent and  $E$  is convergent. Note that when  $\Gamma = \text{Sqr}(E^\top, S^*)$  (resp.  $\Gamma = \text{Sph}(S^*)$ ), the property of  $\Gamma$ -confluence modulo  $E$  corresponds to the property of confluence modulo  $E$  (resp. confluence) given in 2.3.5.

In the sequel, proofs of confluence modulo results will be based on Huet's double Noetherian induction principle on the rewriting system  $S^\Pi$  defined in 2.3.9 and the property  $\mathcal{P}$  on  $R_{n-1}^* \times R_{n-1}^*$  defined, for any  $u, v$  in  $R_{n-1}^*$ , by

$\mathcal{P}(u, v)$  : any branching  $(f, e, g)$  of  $S$  modulo  $E$  with source  $(u, v)$  is  $\Gamma$ -confluent modulo  $E$ .

**4.5.3 Proposition** (Coherent half Newman's modulo lemma). *Let  $(R, E, S)$  be an  $n$ -polygraph modulo such that  ${}_{E}R_E$  is terminating, and  $\Gamma$  be a square extension of  $(E^\top, S^*)$ . If  $S$  is locally  $\Gamma$ -confluent modulo  $E$  then the two following conditions hold*

- i) any branching  $(f, e)$  of  $S$  modulo  $E$  with  $f$  in  $S^{*(1)}$  and  $e$  in  $E^\top$  is  $\Gamma$ -confluent modulo  $E$ ,
- ii) any branching  $(f, e)$  of  $S$  modulo  $E$  with  $f$  in  $S^*$  and  $e$  in  $E^{\top(1)}$  is  $\Gamma$ -confluent modulo  $E$ ,

*Proof.* We prove condition i), the proof of condition ii) is similar. Let us assume that  $S$  is locally  $\Gamma$ -confluent modulo  $E$ , we proceed by double induction.

We denote by  $u$  the source of the branching  $(f, e)$ . If  $u$  is irreducible with respect to  $S$ , then  $f$  is an identity  $n$ -cell, and the branching is trivially  $\Gamma$ -confluent.

Suppose that  $f$  is not an identity and assume that for any pair  $(u', v')$  of  $(n-1)$ -cells in  $R_{n-1}^*$  such that there is an  $n$ -cell  $(u, u) \rightarrow (u', v')$  in  $S^\Pi$ , any branching  $(f', e', g')$  of source  $(u', v')$  is  $\Gamma$ -confluent modulo  $E$ . Prove that the branching  $(f, e)$  is  $\Gamma$ -confluent modulo  $E$ .

We proceed by induction on  $\ell(e) \geq 1$ . If  $\ell(e) = 1$ ,  $(f, e)$  is a local branching of  $S$  modulo  $E$  and it is  $\Gamma$ -confluent modulo  $E$  by local  $\Gamma$ -confluence of  $S$  modulo  $E$ . Now, let us assume that for  $k \geq 1$ , any branching  $(f'', e'')$  of  $S$  modulo  $E$  such that  $\ell(e'') = k$  is  $\Gamma$ -confluent modulo  $E$ , and let us consider a branching  $(f, e)$  of  $S$  modulo  $E$  such that  $\ell(e) = k+1$ , with source  $u$ . We choose a decomposition  $e = e_1 \star_{n-1} e_2$  with  $e_1$  in  $E^{\top(1)}$  and  $e_2$  in  $E^\top$ . Using local  $\Gamma$ -confluence on the branching  $(f, e_1)$  of source  $u$ , there exist  $n$ -cells  $f'$  and  $f_1$  in  $S^*$ , an  $n$ -cell  $e'_1 : t_{n-1}(f') \rightarrow t_{n-1}(f_1)$  in  $E^\top$  and an  $(n+1)$ -cell  $A$  in  $\Gamma^\gamma$  such that  $\partial_{-,n}^h(A) = f \star_{n-1} f'$  and  $\partial_{+,n}^h(A) = f_1$ . Then, we choose a decomposition  $f_1 = f_1^1 \star_{n-1} f_1^2$  with  $f_1^1$  in  $S^{*(1)}$  and  $f_1^2$  in  $S^*$ . Using the induction hypothesis on the branching  $(f_1^1, e_2)$  of  $S$  modulo  $E$  of source  $u_1 := t_{n-1}(e_1) = s_{n-1}(e_2)$ , there exist  $n$ -cells  $f'_1$  and  $g$  in  $S^*$ , an  $n$ -cell  $e_2 : t_{n-1}(f'_1) \rightarrow t_{n-1}(g)$  in  $E^\top$  and an  $(n+1)$ -cell  $B$  in  $\Gamma^\gamma$  such that  $\partial_{-,n}^h(B) = f_1^1 \star_{n-1} f'_1$  and  $\partial_{+,n}^h(B) = g$ . This can be



represented by the following diagram:

$$\begin{array}{ccccc}
\mathbf{u} & \xrightarrow{f} & \mathbf{u}' & \xrightarrow{f'} & \mathbf{u}'' \\
\downarrow e_1 & & \text{Local } \Gamma\text{-conf mod } E & & \downarrow e'_1 \\
\mathbf{u}_1 & \xrightarrow{f_1^1} & \mathbf{u}'_1 & \xrightarrow{f_1^2} & \mathbf{u}''_1 \\
\downarrow \parallel & & i_1^h(f_1^1) & & \downarrow \parallel \\
\mathbf{u}_1 & \xrightarrow{f_1^1} & \mathbf{u}'_1 & \xrightarrow{f'_1} & \mathbf{u}'_2 \\
\downarrow e_2 & & \text{Induction on } \ell(e) & & \downarrow e'_2 \\
\mathbf{v} & \xrightarrow{g} & & & \mathbf{v}'
\end{array}$$

Now, there is an  $n$ -cell  $(\mathbf{u}, \mathbf{u}) \rightarrow (\mathbf{u}'_1, \mathbf{u}'_1)$  in  $S^{\text{II}}$  given by the composition

$$(\mathbf{u}, \mathbf{u}) \rightarrow (\mathbf{u}_1, \mathbf{u}_1) \rightarrow (\mathbf{u}_1, \mathbf{u}'_1) \rightarrow (\mathbf{u}'_1, \mathbf{u}'_1)$$

where the first step exists because  $\ell(e_1) > 0$  and the remaining composition is as in 2.3.9. Then, we apply double induction on the branching  $(f_1^2, f'_1)$  of  $S$  modulo  $E$  of source  $(\mathbf{u}'_1, \mathbf{u}'_1)$ : there exist  $n$ -cells  $f_2$  and  $f'_2$  in  $S^*$  and an  $n$ -cell  $e_3 : t_{n-1}(f_2) \rightarrow t_{n-1}(f'_2)$  in  $E^{\text{T}}$ . By a similar argument, we can apply double induction on the branchings  $(f_2, (e'_1)^-)$  and  $(f'_2, e'_2)$  of  $S$  modulo  $E$ , so that there exist  $n$ -cells  $f''$ ,  $f_3$ ,  $f'_3$  and  $g'$  in  $S^*$  and  $n$ -cells  $e''_1 : t_{n-1}(f'') \rightarrow t_{n-1}(f_3)$  and  $e''_2 : t_{n-1}(f'_3) \rightarrow t_{n-1}(g')$  as in the following diagram:

$$\begin{array}{ccccccc}
\mathbf{u} & \xrightarrow{f} & \mathbf{u}' & \xrightarrow{f'} & \mathbf{u}'' & \xrightarrow{f''} & \mathbf{u}''' \\
\downarrow e_1 & & \text{Local } \Gamma\text{-conf mod } E & & \downarrow e'_1 & \text{Db Ind.} & \downarrow e''_1 \\
\mathbf{u}_1 & \xrightarrow{f_1^1} & \mathbf{u}'_1 & \xrightarrow{f_1^2} & \mathbf{u}''_1 & \xrightarrow{f_2} & \mathbf{w}_1 & \xrightarrow{f_3} & \mathbf{w}'_1 \\
\downarrow \parallel & & i_1^h(f_1^1) & & \downarrow \parallel & \text{Db Ind.} & \downarrow e_3 & & \\
\mathbf{u}_1 & \xrightarrow{f_1^1} & \mathbf{u}'_1 & \xrightarrow{f'_1} & \mathbf{u}'_2 & \xrightarrow{f'_2} & \mathbf{w}_2 & \xrightarrow{f'_3} & \mathbf{w}'_2 \\
\downarrow e_2 & & \text{Induction on } \ell(e) & & \downarrow e'_2 & \text{Db Ind.} & \downarrow e''_2 & & \\
\mathbf{v} & \xrightarrow{g} & & & \mathbf{v}' & \xrightarrow{g'} & & & \mathbf{v}''
\end{array}$$

We can then repeat the same process using double induction on the branching  $(f_3, e_3, f'_3)$  of  $S$  modulo  $E$  of source  $(\mathbf{w}_1, \mathbf{w}_2)$  and so on, and this process terminates in finitely many steps, otherwise it leads to an infinite rewriting sequence wrt  $S$  starting from  $\mathbf{u}_1$ , which is not possible since  $\in \text{RE}$ , and thus  $S$ , is terminating. This yields the  $\Gamma$ -confluence of the branching  $(f, e)$ .  $\square$

**4.5.4 Theorem** (Coherent Newman's lemma modulo). *Let  $(R, E, S)$  be an  $n$ -polygraph modulo such that  $\in \text{RE}$  is terminating, and  $\Gamma$  be a square extension of  $(E^{\text{T}}, S^*)$ . If  $S$  is locally  $\Gamma$ -confluent modulo  $E$  then it is  $\Gamma$ -confluent modulo  $E$ .*

*Proof.* Prove that any branching  $(f, e, g)$  of  $S$  modulo  $E$  is  $\Gamma$ -confluent modulo  $E$ . Let us choose such a branching and denote by  $(\mathbf{u}, \mathbf{v})$  its source. We assume that any branching  $(f', e', g')$  of  $S$  modulo  $E$  of source  $(\mathbf{u}', \mathbf{v}')$  such that there is an  $n$ -cell  $(\mathbf{u}, \mathbf{v}) \rightarrow (\mathbf{u}', \mathbf{v}')$  in  $S^{\text{II}}$  is  $\Gamma$ -confluent modulo  $E$ . We follow the proof scheme used by Huet in [56, Lemma 2.7]. Let us denote by  $n := \ell(f)$  and  $m := \ell(g)$ . We

assume without loss of generality that  $n > 0$  and we fix a decomposition  $f = f_1 \star_{n-1} f_2$  with  $f_1$  in  $S^{*(1)}$  and  $f_2$  in  $S^*$ .

If  $m = 0$ , by Proposition 4.5.3 on the branching  $(f_1, e)$  of  $S$  modulo  $E$ , there exist  $n$ -cells  $f'_1$  and  $g'$  in  $S^*$ , an  $n$ -cell  $e' : t_{n-1}(f'_1) \rightarrow t_{n-1}(g')$  and an  $(n+1)$ -cell  $A$  in  $\Gamma^\gamma$  such that  $\partial_{-,n}^h(A) = f_1 \star_{n-1} f'_1$  and  $\partial_{+,n}^h(A) = g'$ . Then, since there is an  $n$ -cell  $(u, u) \rightarrow (u_1, u_1)$  in  $S^{\text{II}}$  with  $u_1 := t_{n-1}(f_1)$ , we can apply double induction on the branching  $(f_2, f'_1)$  of  $S$  modulo  $E$  as in the following diagram:

$$\begin{array}{ccccccc}
 u & \xrightarrow{f_1} & u_1 & \xrightarrow{f_2} & u_2 & \xrightarrow{f'_2} & u'_2 \\
 \parallel & & \downarrow i_1^h(f_1) & & \parallel & \text{Db Ind.} & \downarrow \\
 u & \xrightarrow{f_1} & u_1 & \xrightarrow{f'_1} & u_2 & \xrightarrow{f''_1} & u'_2 \\
 e \downarrow & & \text{Prop. 4.5.3} & & \downarrow e' & & \\
 v & \xrightarrow{g'} & & & & & v'
 \end{array}$$

We finish the proof of this case with a similar argument than in 4.5.3, using repeated double inductions that can not occur infinitely many times since  $S$  is terminating.

Now, assume that  $m > 0$  and fix a decomposition  $g = g_1 \star_{n-1} g_2$  of  $g$  with  $g_1$  in  $S^{*(1)}$  and  $g_2$  in  $S^*$ . By Step 1 on the branching  $(f_1, e)$  of  $S$  modulo  $E$ , there exist  $n$ -cells  $f'_1$  and  $h_1$  in  $S^*$ , an  $n$ -cell  $e_1 : t_{n-1}(f'_1) \rightarrow t_{n-1}(h_1)$  in  $E^\top$  and an  $(n+1)$ -cell  $A$  in  $\Gamma^\gamma$  such that  $\partial_{-,n}^h(A) = f_1 \star_{n-1} f'_1$  and  $\partial_{+,n}^h(A) = h_1$ . We distinguish two cases whether  $h_1$  is trivial or not.

If  $h_1$  is trivial, the  $\Gamma$ -confluence of the branching  $(f, e, g)$  of  $S$  modulo  $E$  is given by the following diagram

$$\begin{array}{ccccccccccc}
 u & \xrightarrow{f_1} & u_1 & \xrightarrow{f_2} & u_2 & \xrightarrow{f'_2} & u'_2 & & & & \\
 \parallel & & \downarrow i_1^h(f_1) & & \parallel & & \text{Db Ind.} & & & & \\
 u & \xrightarrow{f_1} & u_1 & \xrightarrow{f'_1} & u'_1 & \xrightarrow{f_3} & u_3 & \xrightarrow{f_4} & u_4 & \xrightarrow{f_5} & u_5 \\
 e \downarrow & & \text{Prop. 4.5.3} & & \downarrow e' & & \text{Prop. 4.5.3} & & \downarrow e_1 & & \text{Db Ind.} \\
 v & \xrightarrow{1_v} & v & \xrightarrow{g_1} & v'_1 & \xrightarrow{g'_1} & v''_1 & \xrightarrow{g''_1} & w_1 & \xrightarrow{g_3} & w_3 \\
 \parallel & & \downarrow i_1^h(1_v) & & \parallel & \downarrow i_1^h(g_1) & & \parallel & \text{Db Ind.} & & \\
 v & \xrightarrow{1_v} & v & \xrightarrow{g_1} & v'_1 & \xrightarrow{g_2} & v_2 & \xrightarrow{g'_2} & w_2 & & 
 \end{array}$$

where the branchings  $(f_1, e)$  and  $(g_1, e')$  of  $S$  modulo  $E$  are  $\Gamma$ -confluent by Proposition 4.5.3, double induction applies on the branchings  $(f_2, f'_1 \star_{n-1} f_3)$ ,  $(g'_1, g_2)$  and  $(f_4, e_1, g''_1)$  since there are  $n$ -cells

$$(u, v) \rightarrow (u, u) \rightarrow (u_1, u_1), (u, v) \rightarrow (v, v) \rightarrow (v, v'_1) \rightarrow (v'_1, v'_1) \text{ and } (u, v) \rightarrow (u_3, v) \rightarrow (u_3, v''_1)$$

in  $S^{\text{II}}$  and one can check that this process of double induction can be repeated, terminating in a finite number of steps since  $S$  is terminating and yields a  $\Gamma$ -confluence of the branching  $(f, e, g)$  modulo  $E$ .

If  $h_1$  is not trivial, let us fix a decomposition  $h_1 = h_1^1 \star_{n-1} h_1^2$  with  $h_1^1$  in  $S^{*(1)}$  and  $h_1^2$  in  $S^*$ . The  $\Gamma$ -confluence of the branching  $(f, e, g)$  of  $S$  modulo  $E$  is given by the following diagram:

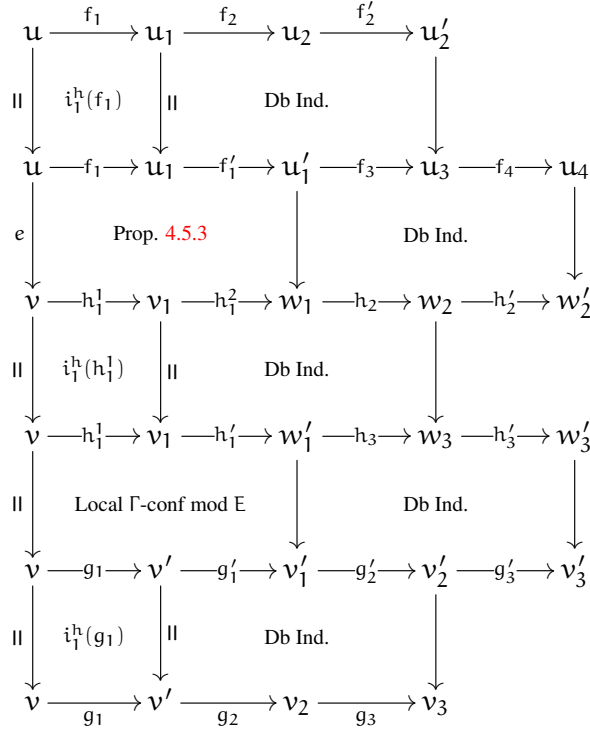

where the branching  $(f_1, e)$  modulo  $E$  is  $\Gamma$ -confluent by Proposition 4.5.3, the branching  $(h_1^1, g_1)$  is  $\Gamma$ -confluent by assumption of local  $\Gamma$ -confluence of  $S$ , and one can check that double induction applies on the branchings  $(f_2, f'_1)$ ,  $(h_1^2, h'_1)$ ,  $(g'_1, g_2)$ ,  $(f_3, h_2)$  and  $(h_3, g'_2)$ . This process of double induction can be repeated, terminating in a finite number of steps since  $S$  is terminating and yields a  $\Gamma$ -confluence of the branching  $(f, e, g)$  modulo  $E$ . □

**4.5.5. Coherent critical branching lemma modulo.** In this subsection, we show how to prove coherent local confluence of an  $n$ -polygraph modulo from coherent confluence of some critical branchings. In particular, we show that we do not need to consider all the local branchings.

**4.5.6 Proposition.** *Let  $(R, E, S)$  be an  $n$ -polygraph modulo such that  ${}_E R_E$  is terminating, and  $\Gamma$  be a square extension of  $(E^\top, S^*)$ . Then  $S$  is  $\Gamma$ -locally confluent modulo  $E$ , if and only if the two following conditions hold:*

**a)** any local branching  $(f, g) : u \Rightarrow (v, w)$  with  $f$  in  $S^{*(1)}$  and  $g$  in  $R^{*(1)}$  is  $\Gamma$ -confluent modulo  $E$ :

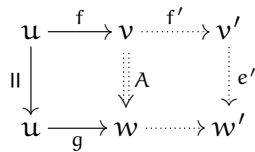

**b)** any local branching  $(f, e) : u \Rightarrow (v, u')$  modulo  $E$  with  $f$  in  $S^{*(1)}$  and  $e$  in  $E^{\top(1)}$  is  $\Gamma$ -confluent modulo  $E$ :

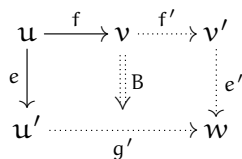

*Proof.* We prove this result using Huet's double Noetherian induction principle on  $S^{\text{II}}$  and the property  $\mathcal{P}$  on  $R_{n-1}^* \times R_{n-1}^*$  defined by: for any  $u, v$  in  $R_{n-1}^*$ ,

$\mathcal{P}(u, v)$  : any branching  $(f, e, g)$  of  $S$  modulo  $E$  of source  $(u, v)$  is  $\Gamma$ -confluent modulo  $E$ .

The only part is trivial because properties **a)** and **b)** correspond to  $\Gamma$ -confluence of some local branchings of  $S$  modulo  $E$ . Conversely, assume that  $S$  satisfy properties **a)** and **b)** and let us prove that any local branching is  $\Gamma$ -confluent modulo  $E$ . We consider a local branching  $(f, e, g)$  of  $S$  modulo  $E$ , and assume without loss of generality that  $f$  is a non-trivial  $n$ -cell in  $S^{*(1)}$ . There are two cases: either  $g$  is trivial, and the local branching  $(f, e)$  of  $S$  modulo  $E$  is  $\Gamma$ -confluent by **b)**, or  $e$  is trivial. In that case, if  $g$  is in  $R^{*(1)}$ , then  $\Gamma$ -confluence of the branching  $(f, g)$  is given by **a)**. Otherwise, let us choose a decomposition  $g = e_1 \star_{n-1} g' \star_{n-1} e_2$  with  $e_1, e_2$  in  $E^\top$  and  $g'$  in  $R^{*(1)}$ . Now, let us prove the confluence of the branching

$$\begin{array}{ccc} u & \xrightarrow{f} & v \\ e_1 \downarrow & & \\ u' & \xrightarrow{g'e_2} & v' \end{array}$$

of  $S$  modulo  $E$ , where  $g'e_2$  is an  $n$ -cell in  $S^{*(1)}$ . We will then prove the  $\Gamma$ -confluence of the branching  $(f, g)$  using the biaction of  $E^\top$  on  $\text{Sqr}(E^\top, S^*)$ . Using Proposition 4.5.3 on the branching  $(f, e_1)$  of  $S$  modulo  $E$ , there exist  $n$ -cells  $f'$  and  $f_1$  in  $S^*$ , an  $n$ -cell  $e' : t_{n-1}(f') \rightarrow t_{n-1}(f_1)$  and an  $(n+1)$ -cell  $A$  in  $\Gamma^\vee$  such that  $\partial_{-,n}^h(A) = f \star_{n-1} f'$  and  $\partial_{+,n}^h(A) = f_1$ . Using property **a)** on the local branching  $(g', g'e_2) \in R^{*(1)} \times S^{*(1)}$  and the trivial confluence given by the right vertical cell  $e_2$ , there exists an  $(n+1)$ -cell  $B$  in  $\Gamma^\vee$  such that  $\partial_{-,n}^h(B) = g'$  and  $\partial_{+,n}^h(B) = g'e_2$ . Let us choose a decomposition  $f_1 = f_1^1 \star_{n-1} f_1^2$  with  $f_1^1$  in  $S^{*(1)}$  and  $f_1^2$ . By property **a)** on the local branching  $(f_1^1, g')$ , there exist  $n$ -cells  $f_1'$  and  $g_1'$  in  $S^*$ , an  $n$ -cell  $e'' : t_{n-1}(f_1') \rightarrow t_{n-1}(g_1')$  and an  $(n+1)$ -cell  $C$  in  $\Gamma^\vee$  such that  $\partial_{-,n}^h(C) = f_1^1 \star_{n-1} f_1^2$  and  $\partial_{+,n}^h(C) = g' \star_{n-1} g_1'$  as depicted on the following diagram:

$$\begin{array}{ccccc} u & \xrightarrow{f} & u' & \xrightarrow{f'} & u'' \\ e_1 \downarrow & & \Downarrow A & & \downarrow e_1' \\ u_1 & \xrightarrow{f_1^1} & u_1' & \xrightarrow{f_1^2} & u_1'' \\ \parallel & & \downarrow i_1^h(f_1^1) & & \parallel \\ u_1 & \xrightarrow{f_1^1} & u_1' & \xrightarrow{f_1^2} & u_2' \\ \parallel & & \Downarrow C & & \downarrow e_2' \\ v & \xrightarrow{g'} & v_1 & \xrightarrow{g_2'} & v_2 \\ \parallel & & \Downarrow B & & \downarrow e_2 \\ v & \xrightarrow{g'e_2} & v' & & \end{array}$$

There are  $n$ -cells  $(u, u) \rightarrow (u_1', u_1')$  and  $(u, u) \rightarrow (v_1, v_1)$  in  $S^{\text{II}}$  given by the following compositions

$$\begin{aligned} (u, u) &\rightarrow (u_1, u_1) \rightarrow (u_1, u_1') \rightarrow (u_1', u_1') \\ (u, u) &\rightarrow (u_1, u_1) \rightarrow (u_1, v) \rightarrow (v, v) \rightarrow (v, v_1) \rightarrow (v_1, v_1) \end{aligned}$$

so that we can apply double induction on the branchings  $(f_1^2, f_1')$  and  $(g_2', e_2)$  of  $S$  modulo  $E$ , and we finish the proof of  $\Gamma$ -confluence of the branching  $(f, e, g'e_2)$  using repeated double inductions, terminating in a finite number of steps since  $S$  is terminating.

Now, we get the  $\Gamma$ -confluence of the branching  $(f, g)$  of  $S$  by the following diagram:

$$\begin{array}{ccccc}
u & \xrightarrow{f} & u' & \xrightarrow{f'} & u'' \\
\parallel & & \downarrow e_1^1 A & & \downarrow e_1' \\
u_1 & \xrightarrow{e_1 f_1^1} & u_1' & \xrightarrow{f_1^2} & u_1'' \\
\parallel & & \downarrow i_1^h(e_1 f_1^1) & & \parallel \\
u_1 & \xrightarrow{e_1 f_1^1} & u_1' & \xrightarrow{f_1'} & u_2' \\
\parallel & & \downarrow e_1^1 C & & \downarrow e_2' \\
v & \xrightarrow{e_1 g'} & v_1 & \xrightarrow{g_2'} & v_2 \\
\parallel & & \downarrow e_1^1 B & & \downarrow e_2 \\
v & \xrightarrow{e_1 g' e_2} & v' & & 
\end{array}$$

since the top rectangle is by definition tiled by the  $(n+1)$ -cell  $e_1^1 A$ , the bottom rectangle is tiled by the  $(n+1)$ -cell  $e_1^1 B$  and the remaining rectangle is tiled by the  $(n+1)$ -cell  $e_1^1 C$ . The rest of the diagram is tiled in the same way than above.  $\square$

**4.5.7 Theorem** (Coherent critical branching lemma modulo). *Let  $(R, E, S)$  be an  $n$ -polygraph modulo such that  ${}_{\mathbb{E}}R_{\mathbb{E}}$  is terminating, and  $\Gamma$  be a square extension of  $(E^{\top}, S^*)$ . Then  $S$  is  $\Gamma$ -locally confluent modulo  $E$ , if and only if the two following conditions hold*

**a<sub>0</sub>)** any critical branching  $(f, g) : u \Rightarrow (v, w)$  with  $f$  in  $S^{*(1)}$  and  $g$  in  $R^{*(1)}$  is  $\Gamma$ -confluent modulo  $E$ :

$$\begin{array}{ccccc}
u & \xrightarrow{f} & v & \xrightarrow{f'} & v' \\
\parallel & & \downarrow A & & \downarrow e' \\
u & \xrightarrow{g} & w & \xrightarrow{g'} & w'
\end{array}$$

**b<sub>0</sub>)** any critical branching  $(f, e) : u \Rightarrow (v, u')$  modulo  $E$  with  $f$  in  $S^{*(1)}$  and  $e$  in  $E^{\top(1)}$  is  $\Gamma$ -confluent modulo  $E$ :

$$\begin{array}{ccccc}
u & \xrightarrow{f} & v & \xrightarrow{f'} & v' \\
e \downarrow & & \downarrow B & & \downarrow e' \\
u' & \xrightarrow{g'} & w & & 
\end{array}$$

*Proof.* By Proposition 4.5.6, the local  $\Gamma$ -confluence is equivalent to both conditions **a)** and **b)**. Let us prove that the condition **a)** (resp. **b)**) holds if and only if the condition **a<sub>0</sub>)** (resp. **b<sub>0</sub>)**) holds. One implication is trivial. Suppose that condition **b<sub>0</sub>)** holds and prove condition **b)**. The proof of the other implication is similar. We examine all the possible forms of local branchings modulo given in 4.4.6. Local aspherical branchings modulo and local Peiffer branchings modulo of the forms (4.13) are trivially confluent modulo:

$$\begin{array}{ccc}
u \star_1 v \xrightarrow{f \star_1 v} u' \star_1 v & & w \star_1 u \xrightarrow{w \star_1 f} w \star_1 u' \\
u \star_1 e \downarrow & & e' \star_1 u \downarrow \\
u \star_1 v' \xrightarrow{f \star_1 v'} u' \star_1 v' & & w' \star_1 u \xrightarrow{w' \star_1 f} w' \star_1 u' \\
& & u' \star_1 e \downarrow
\end{array}$$

and  $\Gamma$ -confluent modulo by definition of  $\Gamma$ -confluence. The other local branchings modulo are overlapping branchings modulo  $(f, e) : u \Rightarrow (u', v)$  of the form (4.14), where  $f$  is an  $n$ -cell of  $S^{*(1)}$  and  $e$  is an  $n$ -cell of  $E^{\top(1)}$ . By definition, there exists a whisker  $C$  on  $R_{n-1}^*$  and a critical branching  $(f', e') : u_0 \Rightarrow (u'_0, v_0)$  such that  $f = C[f']$  and  $e = C[e']$ . Following condition **b**<sub>0</sub>) the branching  $(f', e')$  is  $\Gamma$ -confluent, that is there exists a  $\Gamma$ -confluence modulo  $E$ :

$$\begin{array}{ccccc} u & \xrightarrow{f'} & v & \xrightarrow{f''} & v' \\ e' \downarrow & & \downarrow \Lambda & & \downarrow e'' \\ u' & \xrightarrow{g'} & & \xrightarrow{g''} & w \end{array}$$

inducing a  $\Gamma$ -confluence for  $(f, e)$ :

$$\begin{array}{ccccc} C[u] & \xrightarrow{C[f']} & C[v] & \xrightarrow{C[f'']} & v' \\ C[e'] \downarrow & & \downarrow C[\Lambda] & & \downarrow C[e''] \\ C[u'] & \xrightarrow{C[g']} & & \xrightarrow{C[g'']} & w \end{array}$$

This proves the condition **b**). □

## 4.6. COHERENT COMPLETION MODULO

In this section, we show how to construct a double coherent presentation of an  $(n-1)$ -category  $\mathcal{C}$  starting with a presentation of this  $(n-1)$ -category by an  $n$ -polygraph modulo. We explain how the results presented in this section generalize to  $n$ -polygraphs modulo the coherence results from  $n$ -polygraphs as given in [51, 52].

**4.6.1. Coherent completion modulo.** We recall the notion of coherent completion of a convergent  $n$ -polygraph and introduce the notion of coherent completion modulo for polygraphs modulo, given by adjunction of a square cell for any confluence diagram of critical branching modulo.

**4.6.2. Coherent completion.** Recall from Section 2.5.5 that a convergent  $n$ -polygraph can be extended into a coherent globular presentation of the category it presents. Explicitly, given a convergent  $n$ -polygraph  $E$ , we consider a family of generating confluences of  $E$  as a cellular extension of the free  $(n, n-1)$ -category  $E^{\top}$  that contains exactly one globular  $(n+1)$ -cell

$$\begin{array}{ccccc} & e & \rightarrow & v & \xrightarrow{e_1} & w \\ & \searrow & & \downarrow \Downarrow E_{e,e'} & & \nearrow \\ u & \xrightarrow{e'} & v' & \xrightarrow{e'_1} & w \end{array}$$

for every critical branching  $(e, e')$  of  $E$ , where  $(e_1, e'_1)$  is a chosen confluence. Any  $(n+1, n)$ -polygraph obtained from  $E$  by adjunction of a chosen family of generating confluences of  $E$  is a globular coherent presentation of the  $(n-1)$ -category  $\bar{E}$ , [51]. This result was originally proved by Squier in [111] for  $n = 2$ . From such an  $(n+1, n)$ -polygraph we will consider a double  $(n+1, n-1)$ -polygraph  $(E, \emptyset, \Gamma_E)$ , where  $\Gamma_E$  is a square extension of the  $(n, n-1)$ -categories  $(E^{\top}, 1)$  seen as an  $n$ -category

enriched in double groupoids that contains exactly one square  $(n + 1)$ -cell

$$\begin{array}{ccc}
 u & \xrightarrow{=} & u \\
 e \downarrow & \Downarrow E_{e,e'} & \downarrow e' \\
 v & & v' \\
 e_1 \downarrow \cdots & & \downarrow \cdots e'_1 \\
 w & \xrightarrow{=} & w
 \end{array}$$

for every critical branching  $(e, e')$  of  $E$ , where  $(e_1, e'_1)$  is a chosen confluence.

**4.6.3. Coherent completion modulo.** Let  $(R, E, S)$  be an  $n$ -polygraph modulo. A *coherent completion modulo*  $E$  of  $S$  is a square extension of the pair of  $(n + 1, n)$ -categories  $(E^\top, S^\top)$  whose elements are the square  $(n + 1)$ -cells  $A_{f,g}$  and  $B_{f,e}$  of the following form:

$$\begin{array}{ccc}
 u & \xrightarrow{f} & u' & \xrightarrow{f'} & w \\
 \parallel \downarrow & & \Downarrow A_{f,g} & & \downarrow e' \\
 u & \xrightarrow{g} & v & \xrightarrow{g'} & w'
 \end{array}
 \qquad
 \begin{array}{ccc}
 u & \xrightarrow{f} & u' & \xrightarrow{f'} & w \\
 e \downarrow & & \Downarrow B_{f,e} & & \downarrow e' \\
 v & \xrightarrow{g'} & & & w'
 \end{array}
 \tag{4.16}$$

for any critical branchings  $(f, g)$  and  $(f, e)$  of  $S$  modulo  $E$ , where  $f, g$  and  $e$  are  $n$ -cells of  $S^{*(1)}$ ,  $R^{*(1)}$  and  $E^{\top(1)}$  respectively. Note that such completion is not unique in general and depends on the  $n$ -cells  $f', g', e'$  chosen to obtain the confluence of the critical branchings.

**4.6.4. Coherence by E-normalization.** In this subsection, we show how to obtain an acyclic square extension of a pair of categories  $(E^\top, S^\top)$  coming from a polygraph modulo  $(R, E, S)$ , under an assumption of confluence modulo  $E$  and of normalization of  $S$  with respect to  $E$ .

**4.6.5. Normalization in polygraphs modulo.** Let us recall the notion of normalization strategy in an  $n$ -polygraph  $P$ . Denote by  $\mathcal{C}$  the  $(n - 1)$ -category presented by  $P$ . Consider a section  $s : \mathcal{C} \rightarrow P_n^*$  of the canonical projection  $\pi : P_n^* \rightarrow \mathcal{C}$ , that sends any  $(n - 1)$ -cell  $u$  in  $\mathcal{C}$  on an  $(n - 1)$ -cell in  $P_{n-1}^*$  denoted by  $\hat{u}$  such that  $\pi(\hat{u}) = u$ . A *normalization strategy for  $P$  with respect to  $s$*  is a map

$$\sigma : P_{n-1}^* \rightarrow P_n^*$$

that sends every  $(n - 1)$ -cell  $u$  of  $P_{n-1}^*$  to an  $(n + 1)$ -cell

$$\sigma_u : u \rightarrow \hat{u}.$$

Let  $(R, E, S)$  be an  $n$ -polygraph modulo. The  $n$ -polygraph modulo  $S$  is *normalizing* if any  $(n - 1)$ -cell  $u$  admits at least one normal with respect to  $S$ , that is  $\text{NF}(S, u)$  is not empty.

A set  $X$  of  $(n - 1)$ -cells in  $R_{n-1}^*$  is *E-normalizing with respect to  $S$*  if for any  $u$  in  $X$ , the set  $\text{NF}(S, u) \cap \text{Irr}(E)$  is not empty. The  $n$ -polygraph modulo  $S$  is *E-normalizing* if it normalizing and  $R_{n-1}^*$  is *E-normalizing*. When  $S$  is *E-normalizing*, a *E-normalization strategy*  $\sigma$  for  $S$ , associates to each  $(n - 1)$ -cell  $u$  in  $R_{n-1}^*$  an  $n$ -cell  $\sigma_u : u \rightarrow \hat{u}$  in  $S^*$ , where  $\hat{u}$  belongs to  $\text{NF}(S, u) \cap \text{Irr}(E)$ . Note that a normalizing cellular extension modulo  ${}_E R_E$  is *E-normalizing*.

**4.6.6 Theorem.** *Let  $(R, E, S)$  be an  $n$ -polygraph modulo, and  $\Gamma$  be a square extension of the pair of  $(n + 1, n)$ -categories  $(E^\top, S^\top)$  such that  $S$  is  $\Gamma$ -diconvergent. If  $\text{Irr}(E)$  is *E-normalizing with respect to  $S$* , then the square extension  $E \rtimes \Gamma \cup \text{Peiff}(E^\top, S^*) \cup \Gamma_E$  is acyclic.*

*Proof.* Let  $\Gamma$  be a square extension of  $(E^\top, S^\top)$ . We will denote by  $\mathcal{C}$  the free  $n$ -category enriched in double groupoid  $(E, S, E \rtimes \Gamma \cup \text{Peiff}(E^\top, S^*) \cup \Gamma_E)^\top$  generated by the double  $(n+1, n-1)$ -polygraph  $(E, S, E \rtimes \Gamma \cup \text{Peiff}(E^\top, S^*) \cup \Gamma_E)$ . We will denote by  $\tilde{u}$  the unique normal form of an  $(n-1)$ -cell  $u$  in  $R_{n-1}^*$  with respect to  $E$  and we fix a normalization strategy  $\rho_u : u \rightarrow \tilde{u}$  for  $E$ .

By termination of  ${}_E R_E$ , the  $n$ -polygraph modulo  $S$  is normalizing. Let us fix a  $E$ -normalization strategy  $\sigma_u : u \rightarrow \hat{u}$  for  $S$ . Let us consider a square

$$\begin{array}{ccc} u & \xrightarrow{f} & v \\ e \downarrow & & \downarrow e' \\ u' & \xrightarrow{g} & v' \end{array} \quad (4.17)$$

in  $\mathcal{C}$ . By definition the  $n$ -cell  $f$  in  $S^\top$  can be decomposed (in general in a non unique way) into a zigzag sequence  $f_0 \star_{n-1} f_1^- \star_{n-1} \cdots \star_{n-1} f_{2n} \star_{n-1} f_{2n+1}^-$  with source  $u$  and target  $v$  where the  $f_{2k} : u_{2k} \rightarrow u_{2k+1}$  and  $f_{2k+1}^- : u_{2k+2} \rightarrow u_{2k+1}$ , for all  $0 \leq k \leq n$  are  $n$ -cell of  $S^*$ , with  $u_0 = u$  and  $u_{2n+2} = v$ .

By  $\Gamma$ -confluence modulo  $E$  there exist  $n$ -cells  $e_{f_i}$  in  $E^\top$  and  $(n+1)$ -cells  $\sigma_{f_i}$  in  $\mathcal{C}$  as in the following diagrams:

$$\begin{array}{ccc} u_{2k} & \xrightarrow{f_{2k}} & u_{2k+1} & \xrightarrow{\sigma_{u_{2k+1}}} & \widehat{u}_{2k+1} \\ \rho_{u_{2k}} \downarrow & & \Downarrow \sigma_{f_{2k}} & & \downarrow e_{f_{2k}} \\ \widehat{u}_{2k} & \xrightarrow{\sigma_{\widehat{u}_{2k}}} & \widehat{u}_{2k} & & \widehat{u}_{2k} \end{array} \quad \begin{array}{ccc} u_{2k+2} & \xrightarrow{f_{2k+1}^-} & u_{2k+1} & \xrightarrow{\sigma_{u_{2k+1}}} & \widehat{u}_{2k+1} \\ \rho_u \downarrow & & \Downarrow \sigma_{f_{2k+1}^-} & & \downarrow e_{f_{2k+1}^-} \\ \widehat{u}_{2k+2} & \xrightarrow{\sigma_{\widehat{u}_{2k+2}}} & \widehat{u}_{2k+2} & & \widehat{u}_{2k+2} \end{array}$$

for all  $0 \leq k \leq n$ . By definition of the normalization strategy  $\sigma$ , for any  $0 \leq i \leq 2n+1$ , the  $(n-1)$ -cell  $\widehat{u}_i$  is a normal form with respect to  $E$ , and by convergence of the  $n$ -polygraph  $E$  it follows that  $\widehat{u}_i = \widehat{u}_{i+1}$ .

Moreover, for any  $1 \leq i \leq 2n+1$ , there exists a square  $(n+1)$ -cell in  $\mathcal{C}$  as in the following diagram:

$$\begin{array}{ccc} u_{i+1} & \xrightarrow{=} & u_{i+1} \\ e_{f_i} \downarrow & \Downarrow E_{i+1} & \downarrow e_{f_{i+1}} \\ \widehat{u}_i & \xrightarrow{=} & \widehat{u}_{i+2} \end{array}$$

We define a square  $(n+1)$ -cell  $\sigma_f$  in  $\mathcal{C}$  as the following  $\diamond^v$ -composition:

$$\sigma_{f_0} \diamond^v E_1 \diamond^v \sigma_{f_1} \diamond^v \sigma_{f_2} \diamond^v \dots \diamond^v \sigma_{f_{2n}} \diamond^v E_{2n+1} \diamond^v \sigma_{f_{2n+1}}$$

For an even integer  $i \geq 0$

$$\begin{array}{cccccccccccccccc} u_i & \xrightarrow{f_i} & u_{i+1} & \xrightarrow{\sigma_{u_{i+1}}} & \widehat{u}_{i+1} & \xrightarrow{=} & \widehat{u}_{i+1} & \xleftarrow{\sigma_{u_{i+1}}} & u_{i+1} & \xleftarrow{f_{i+1}} & u_{i+2} & \xrightarrow{f_{i+2}} & u_{i+3} & \xrightarrow{\sigma_{u_{i+3}}} & \widehat{u}_{i+3} & \xrightarrow{=} & \widehat{u}_{i+3} & \dots \\ \rho_{u_i} \downarrow & & \Downarrow \sigma_{f_i} & & \downarrow e_{f_i} & \Downarrow E_{i+1} & \downarrow e_{f_{i+1}} & \Downarrow \sigma_{f_{i+1}} & \downarrow e_{f_{i+1}} & & \downarrow \rho_{u_{i+2}} & & \Downarrow \sigma_{f_{i+2}} & & \downarrow e_{f_{i+2}} & \Downarrow E_{i+3} & \downarrow e_{f_{i+3}} & \dots \\ \widehat{u}_i & \xrightarrow{\sigma_{\widehat{u}_i}} & \widehat{u}_i & \xrightarrow{=} & \widehat{u}_{i+2} & \xleftarrow{\sigma_{\widehat{u}_{i+2}}} & \widehat{u}_{i+2} & \xrightarrow{\sigma_{\widehat{u}_{i+2}}} & \widehat{u}_{i+2} & \xrightarrow{\sigma_{\widehat{u}_{i+2}}} & \widehat{u}_{i+2} & \xrightarrow{\sigma_{\widehat{u}_{i+2}}} & \widehat{u}_{i+2} & \xrightarrow{=} & \widehat{u}_{i+4} & \dots \end{array}$$

In this way, we have constructed a square  $(n+1)$ -cell

$$\begin{array}{ccc} u & \xrightarrow{f} & v \\ \rho_u \downarrow & \Downarrow \sigma_f & \downarrow \rho_v \\ \widehat{u} & \xrightarrow{\sigma_{\widehat{u}} \sigma_{\widehat{v}}} & \widehat{v} \end{array}$$



Similarly, we construct a square  $(n + 1)$ -cell  $\sigma_g$  as follows:

$$\begin{array}{ccc} \tilde{u} & \xrightarrow{\sigma_{\tilde{u}}\sigma_{\tilde{v}}^-} & \tilde{v} \\ \rho_{u'} \uparrow & \Uparrow \sigma_g & \uparrow \rho_{v'} \\ u' & \xrightarrow{g} & v' \end{array}$$

using that  $\tilde{u} = \tilde{u}'$  and  $\tilde{v} = \tilde{v}'$  by convergence of  $E$ . We obtain a square  $(n + 1)$ -cell  $E_e \diamond^v (\sigma_f \diamond^h \sigma_g^-) \diamond^v E_{e'}$ , filling the square (4.17), as in the following diagram:

$$\begin{array}{ccccccc} u & \xrightarrow{=} & u & \xrightarrow{f} & v & \xrightarrow{=} & v \\ \downarrow e & \Downarrow E_e & \downarrow \rho_u & \Downarrow \sigma_f & \downarrow \rho_v & \Downarrow E_{e'} & \downarrow e' \\ \tilde{u} & \xrightarrow{\sigma_{\tilde{u}}} & \hat{u} & \xrightarrow{\sigma_{\tilde{v}}^-} & \hat{v} & & \tilde{v} \\ \rho_{u'} \uparrow & & \uparrow \sigma_g & & \uparrow \rho_{v'} & & \\ u' & \xrightarrow{=} & u' & \xrightarrow{g} & v' & \xrightarrow{=} & v' \end{array}$$

□

**4.6.7 Corollary.** *Let  $(R, E, S)$  be a diconvergent  $n$ -polygraph modulo. If  $\text{Irr}(E)$  is  $E$ -normalizing with respect to  $S$ , then for any coherent completion  $\Gamma$  of  $S$  modulo  $E$  and any coherent completion  $\Gamma_E$  of  $E$ , the square extension  $E \rtimes \Gamma \cup \text{Peiff}(E^\top, S^*) \cup \Gamma_E$  is acyclic.*

Note that, when  $E$  is empty in Corollary 4.6.7, we recover Squier's coherence theorem [111, Theorem 5.2] for convergent  $n$ -polygraphs, [51, Proposition 4.3.4].

**4.6.8. Decreasing orders for  $E$ -normalization.** Let  $(R, E, S)$  be an  $n$ -polygraph modulo. We describe a way to prove that the set  $\text{Irr}(E)$  is  $E$ -normalizing, laying on the definition of a termination order for  $R$ .

Given an  $n$ -polygraph  $P$ , one defines a *decreasing order operator* for  $P$  as a family of functions

$$\Phi_{p,q} : P_{n-1}^*(p, q) \rightarrow \mathbb{N}^{m(p,q)}$$

indexed by pairs of  $(n - 2)$ -cells  $p$  and  $q$  in  $P_{n-2}^*$  satisfying the following conditions:

i) For any  $(n - 1)$ -cells  $u$  and  $v$  in  $P_{n-1}^*(p, q)$  such that there exists an  $n$ -cell  $f : u \rightarrow v$  in  $P^*$ , the function  $\Phi_{p,q}$  satisfy  $\Phi_{p,q}(u) > \Phi_{p,q}(v)$ , where  $>$  is the lexicographic order on  $\mathbb{N}^{m(p,q)}$ . We denote by  $>_{\text{lex}}$  the partial order on  $P_{n-1}^*$  defined by  $u >_{\text{lex}} v$  if and only if  $u$  and  $v$  have same source  $p$  and target  $q$  and  $\Phi_{p,q}(u) > \Phi_{p,q}(v)$ .

ii) For any  $u$  and  $v$  in  $P_{n-1}^*$  and any whisker  $C$  on  $P_{n-1}^*$ ,  $u >_{\text{lex}} v$  implies that  $C[u] >_{\text{lex}} C[v]$ .

iii) The normal forms in  $P_{n-1}^*(p, q)$  with respect to  $P$  are sent to the tuple  $(0, \dots, 0)$  in  $\mathbb{N}^{m(p,q)}$ .

Note that if an  $n$ -polygraph  $P$  admits a decreasing order operator, it is terminating. Actually, such a decreasing order is a terminating order for  $P$  which is similar to a monomial order, but that we do not require to be total.

**4.6.9. Proving coherence modulo using a decreasing order.** Consider an  $n$ -polygraph modulo  $(R, E, S)$  such that  $E$  is terminating. A decreasing order operator  $\Phi$  for  $E$  is *compatible with  $R$*  if for any  $n$ -cell  $f : u \rightarrow v$  in  $R^*$ , then  $\Phi_{p,q}(u) \geq \Phi_{p,q}(v)$ .

In that case, the set  $\text{Irr}(E)$  is  $E$ -normalizing with respect to  $R$ , since if  $u$  in  $R_{n-1}^*$  is a normal form with respect to  $E$ ,  $\Phi_{p,q}(u) = (0, \dots, 0)$  in  $\mathbb{N}^{m(p,q)}$  and by compatibility with  $R$ , for any  $n$ -cell  $f : u \rightarrow v$  in  $R^*$ , we get  $\Phi_{p,q}(v) = (0, \dots, 0)$  so  $v$  is still a normal form with respect to  $E$ . We can also prove that  $\text{Irr}(E)$  is  $E$ -normalizing with respect to  ${}_{\varepsilon}R$  using this method, provided for any  $(n-1)$ -cell  $u$  in  $\text{Irr}(E)$  irreducible by  $R$ , any  $(n-1)$ -cell  $u'$  such that there is an  $n$ -cell  $u \rightarrow u'$  in  $E^\top$  is also irreducible by  $R$ . This is for instance the case if  $R$  is *left-disjoint from  $E$* , that is for any  $(n-1)$ -cell  $u$  in  $s(R)$ , we have  $G_R(u) \cap E_{n-1} = \emptyset$  where:

- $s(R)$  is the set of  $(n-1)$ -sources in  $R_{n-1}^*$  of generating  $n$ -cells in  $R_n$ ,
- for any  $u$  in  $R_{n-1}^*$ ,  $G_R(u)$  is the set of generating  $(n-1)$ -cells in  $R_{n-1}$  contained in  $u$ .

With these conditions, we can apply Theorem 4.6.6 to obtain acyclic extensions of  $R$  or  ${}_{\varepsilon}R$ .

**4.6.10. Coherence by commutation.** In this subsection, we prove that an acyclic extension of a pair  $(E^\top, S^\top)$  coming from a polygraph modulo  $(R, E, S)$  can be obtained from an assumption of commuting normalization strategies for the polygraphs  $S$  and  $E$ . In particular, with further assumptions about this commutation we show how to prove  $E$ -normalization.

**4.6.11. Commuting normalization strategies.** Let  $(R, E, S)$  be an  $n$ -polygraph modulo. Let  $\sigma$  (resp.  $\rho$ ) a normalization strategy with respect to  $S$  (resp. with respect to  $E$ ). The normalization strategies  $\sigma$  and  $\rho$  are *weakly commuting* if for any  $u$  in  $R_{n-1}^*$ , there exists an  $n$ -cell  $\eta_u$  in  $S^*$  as in the following diagram:

$$\begin{array}{ccc} u & \xrightarrow{\sigma_u} & \hat{u} \\ \rho_u \downarrow & & \downarrow \rho_{\hat{u}} \\ \tilde{u} & \xrightarrow[\eta_u]{} & \tilde{\hat{u}} \end{array} \quad (4.18)$$

Given weakly commuting normalization strategies  $\sigma$  and  $\rho$ , we will denote by  $N(\sigma, \rho)$  the square extension of the pair  $(E^\top, S^\top)$  made of squares of the form (4.18), for every  $(n-1)$ -cell  $u$  in  $R_{n-1}^*$ .

The normalization strategies  $\sigma$  and  $\rho$  are said to be *commuting* if  $\eta_u = \sigma_{\tilde{u}}$  holds for all  $(n-1)$ -cell  $u$  in  $R_{n-1}^*$ . Note that, by definition  $\sigma$  and  $\rho$  commute if and only if the equality  $\hat{\tilde{u}} = \tilde{\hat{u}}$  hold for all  $(n-1)$ -cells of  $R_{n-1}^*$ .

**4.6.12 Theorem.** *Let  $(R, E, S)$  be an  $n$ -polygraph modulo, and  $\Gamma$  be a square extension of the pair of  $(n+1, n)$ -categories  $(E^\top, S^\top)$  such that  $S$  is  $\Gamma$ -diconvergent. If  $\sigma$  and  $\rho$  are weakly commuting normalization strategies for  $S$  and  $E$  respectively, then the square extension  $E \rtimes \Gamma \cup \text{Peiff}(E^\top, S^*) \cup \Gamma_E \cup N(\sigma, \rho)$  is acyclic.*

*Proof.* Denote by  $\mathcal{C}$  the free  $n$ -category enriched in double groupoids  $(E, S, E \rtimes \Gamma \cup \text{Peiff}(E^\top, S^*) \cup \Gamma_E \cup N(\sigma, \rho))^\top$ . For  $u$  in  $R_{n-1}^*$ , we denote by  $N_u$  the square  $(n+1)$ -cell in  $\mathcal{C}$  corresponding to the square (4.18).

We prove that for any  $n$ -cell  $f : u \rightarrow v$  in  $S^*$ , there exists a square  $(n+1)$ -cell  $\tilde{\sigma}_f$  in  $\mathcal{C}$  of the following form

$$\begin{array}{ccccc} \bar{u} & \xleftarrow{\sigma_u} & u & \xrightarrow{f} & v & \xrightarrow{\sigma_v} & \bar{v} \\ \rho_{\bar{u}} \downarrow & & & \Downarrow \tilde{\sigma}_f & & & \downarrow \rho_{\bar{v}} \\ \tilde{\bar{u}} & \xrightarrow{\quad} & & & & \xrightarrow{\quad} & \tilde{\bar{v}} \end{array}$$

The square  $(n+1)$ -cell  $\tilde{\sigma}_f$  is obtained as the following composition:

$$\begin{array}{ccccccccccc}
\bar{u} & \xleftarrow{\sigma_u} & u & \xrightarrow{f} & v & \xrightarrow{\sigma_v} & \bar{v} & \xrightarrow{=} & \bar{v} & \xrightarrow{=} & \bar{v} \\
\rho_{\bar{u}} \downarrow & & \Downarrow N_u & \downarrow \rho_u & & \Downarrow \eta_f & & \downarrow e_{\eta_u} & \Downarrow E_{e_{\eta_u}, e_{\bar{v}}} & \downarrow e_{\bar{v}} & \Downarrow \gamma_v & \downarrow \rho_{\bar{v}} \\
\widetilde{\bar{u}} & \xleftarrow{\eta_u} & \widetilde{u} & \xrightarrow{\eta_u} & \widetilde{v} & \xrightarrow{\sigma_{\bar{v}}} & \widetilde{\bar{v}} & \xrightarrow{=} & \widetilde{\bar{v}} & \xrightarrow{=} & \widetilde{\bar{v}}
\end{array}$$

where the  $n$ -cell  $e_{\eta_u}$  and the square  $(n+1)$ -cell  $\eta_f$  (resp. the  $n$ -cell  $e_{\bar{v}}$  and the square  $(n+1)$ -cell  $\gamma_v$ ) belong to  $\mathcal{C}$  by  $\Gamma$ -confluence modulo  $E$  of  $S$ , and the square  $(n+1)$ -cell  $E_{e_{\eta_u}, e_{\bar{v}}}$  belongs to  $\Gamma_E$ .

Now, let consider a square

$$\begin{array}{ccc}
u & \xrightarrow{f} & v \\
e \downarrow & & \downarrow e' \\
u' & \xrightarrow{g} & v'
\end{array} \quad (4.19)$$

in  $\mathcal{C}$ . By definition the  $n$ -cell  $f$  in  $S^\top$  can be decomposed (in general in a non unique way) into a zigzag sequence

$$f_0 \star_{n-1} f_1^- \star_{n-1} \cdots \star_{n-1} f_{2n} \star_{n-1} f_{2n+1}^-$$

with source  $u$  and target  $v$  where the  $f_{2k} : u_{2k} \rightarrow u_{2k+1}$  and  $f_{2k+1} : u_{2k+2} \rightarrow u_{2k+1}$ , for all  $0 \leq k \leq n$  are  $n$ -cell of  $S^*$ , with  $u_0 = u$  and  $u_{2n+2} = v$ . We define a square  $(n+1)$ -cell  $\sigma_f$  as the following vertical composition:

$$N_u \diamond^v \widetilde{\sigma_{f_0}} \diamond^v \widetilde{\sigma_{f_1}} \diamond^v \cdots \diamond^v \widetilde{\sigma_{f_{2n+1}}} \diamond^v N_v$$

as depicted on the following diagram

$$\begin{array}{ccccccccccccccc}
u_0 & \xrightarrow{\sigma_{u_0}} & \hat{u}_0 & \xleftarrow{\sigma_{u_0}} & u_0 & \xrightarrow{f_0} & u_1 & \xrightarrow{\sigma_{u_1}} & \hat{u}_1 & \xleftarrow{\sigma_{u_1}} & u_1 & \xleftarrow{f_1} & u_2 & \xrightarrow{\sigma_{u_2}} & \hat{u}_2 & \xrightarrow{\sigma_{u_2}} & u_2 & \xrightarrow{f_2} & u_3 & \xrightarrow{\sigma_{u_3}} & \hat{u}_3 & \cdots \\
\rho_{u_0} \downarrow & & \Downarrow N_{u_0} & \downarrow \rho_{\hat{u}_0} & & \Downarrow \widetilde{\sigma_{f_0}} & & \downarrow \rho_{\hat{u}_1} & & \Downarrow \widetilde{\sigma_{f_1}} & & \downarrow \rho_{\hat{u}_2} & & \Downarrow \widetilde{\sigma_{f_2}} & & \downarrow \rho_{\hat{u}_3} & & \Downarrow \widetilde{\sigma_{f_3}} & & \downarrow \rho_{\hat{u}_4} & & \cdots \\
\widetilde{u}_0 & \xrightarrow{\eta_{u_0}} & \widetilde{u}_0 & \xrightarrow{=} & \widetilde{u}_1 & \xrightarrow{=} & \widetilde{u}_2 & \xrightarrow{=} & \widetilde{u}_3 & \xrightarrow{=} & \widetilde{u}_4 & \cdots
\end{array}$$

In this way, we have constructed a square  $(n+1)$ -cell

$$\begin{array}{ccc}
u & \xrightarrow{f} & v \\
\rho_u \downarrow & \Downarrow \sigma_f & \downarrow \rho_v \\
\widetilde{u} & \xrightarrow{\eta_u \eta_v} & \widetilde{v}
\end{array}$$

Similarly, we construct a square  $(n+1)$ -cell  $\sigma_g$  as follows:

$$\begin{array}{ccc}
\widetilde{u} & \xrightarrow{\eta_u \eta_v} & \widetilde{v} \\
\rho_{u'} \uparrow & \Uparrow \sigma_g & \uparrow \rho_{v'} \\
u' & \xrightarrow{g} & v'
\end{array}$$

using that  $\widetilde{u} = \widetilde{u}'$  and  $\widetilde{v} = \widetilde{v}'$  by convergence of  $E$ . We obtain a square  $(n+1)$ -cell filling the square (4.19), as in the proof of Theorem 4.6.6.  $\square$

**4.6.13. Remarks.** Note that when  $\sigma$  and  $\rho$  are commuting,  $\text{Irr}(E)$  is  $E$ -normalizing with respect to  $S$  since  $\widehat{u} = \widetilde{u}$  implies that the normal form  $\widehat{u}$  with respect to  $S$  also is a normal form with respect to  $E$ . Then Theorem 4.6.6 applies, to prove that  $E \times \Gamma \cup \text{Peiff}(E^\top, S^*) \cup \Gamma_E$  is acyclic.

One can recover the fact that with the hypothesis of Theorem 4.6.12 and the assumption that the equality  $\eta_u = \sigma_{\widetilde{u}}$  holds for any  $u$  in  $R_{n-1}^*$ , we do not need the square  $(n+1)$ -cells  $N_u$  in the coherent extension, using the following lemma on the square (4.18).

**4.6.14 Lemma.** *Let  $S$  be an  $n$ -polygraph modulo such that  ${}_E R_E$  is terminating, and  $\Gamma$  be a square extension of the pair of  $(n+1, n)$ -categories  $(E^\top, S^\top)$  such that  $S$  is  $\Gamma$ -confluent modulo  $E$ . Then any square in  $\Gamma^\gamma$  of the form*

$$\begin{array}{ccccc} u & \xrightarrow{f} & v & \xrightarrow{f'} & w \\ e \downarrow & & & & \downarrow e' \\ u' & \xrightarrow{g} & v' & \xrightarrow{g'} & w' \end{array} \quad (4.20)$$

such that  $w$  and  $w'$  are normal forms with respect to  $S$  is the boundary of a square  $(n+1)$ -cell in  $\Gamma^\gamma$ .

*Proof.* Let us consider a square as in (4.20). By  $\Gamma$ -confluence of  $S$  modulo  $E$  on the branching  $(f, e, g)$ , there exists a  $\Gamma$ -confluence as in the following diagram:

$$\begin{array}{ccccc} u & \xrightarrow{f} & v & \xrightarrow{f_1} & v_1 \\ e \downarrow & & \Downarrow A & & \downarrow e'' \\ u' & \xrightarrow{g} & v' & \xrightarrow{g_1} & v'_1 \end{array}$$

By  $\Gamma$ -confluence on the branchings  $(f', f_1)$  and  $(g_1, g')$  of  $S$ , there exist square  $(n+1)$ -cells  $B$  and  $B'$  as follows:

$$\begin{array}{ccccccc} u & \xrightarrow{f} & v & \xrightarrow{f'} & w \\ \parallel & i_1^h(f) & \parallel & \Downarrow B & \parallel & e_1 \\ u & \xrightarrow{f} & v & \xrightarrow{f_1} & v_1 & \xrightarrow{f_2} & v_2 \\ e \downarrow & & \Downarrow A & & \downarrow e_2 & & \\ u' & \xrightarrow{g} & v' & \xrightarrow{g_1} & v'_1 & \xrightarrow{g_2} & v'_2 \\ \parallel & i_1^h(g) & \parallel & \Downarrow B' & \parallel & e_3 \\ u' & \xrightarrow{g} & v' & \xrightarrow{g'} & w' \end{array}$$

Then, we use Huet's double induction as in Section 4.5 to prove that the square

$$\begin{array}{ccc} v_1 & \xrightarrow{f_2} & v_2 \\ e_2 \downarrow & & \downarrow e_1^- e' e_2 \\ v'_1 & \xrightarrow{g_2} & v'_2 \end{array}$$

is the boundary of a square  $(n+1)$ -cell in  $\Gamma^\gamma$ . □

## 4.7. GLOBULAR COHERENCE FROM DOUBLE COHERENCE

In this section we explain how to deduce a globular coherent presentation for an  $n$ -category from a double coherent presentation generated by a polygraph modulo. We apply this construction in the situation of commutative monoids in Subsection 4.7.5 and to pivotal monoidal categories in Subsection 4.7.7.

**4.7.1. Globular coherence by convergence modulo.** Let  $(R, E, S)$  be an  $n$ -polygraph modulo and  $\Gamma$  be a square extension on  $(E^\top, S^\top)$ . Consider the double  $(n+1, n-1)$ -polygraph given by  $(E, S, E \rtimes \Gamma \cup \text{Peiff}(E^\top, S^*) \cup \Gamma_E)$ , where  $\Gamma_E$  is the square extension defined in 4.6.2. Let us denote by  $((P_i)_{0 \leq i \leq n+1}, (Q_i)_{1 \leq i \leq n+1})$  the associated  $(n+1, n-1)$ -dipolygraph  $V(E, S, E \rtimes \Gamma \cup \text{Peiff}(E^\top, S^*) \cup \Gamma_E)$  given by the functor  $V$  defined in 4.8. The cellular extension  $S$  being defined modulo the cellular extension  $E$  in the sense of 4.4.1, we adapt the construction of the  $n$ -functor  $F$  in the quotient functor  $V$  defined in Section 4.2.15-vi) as follows.

- a)  $F$  is the identity functor on the underlying  $(n-2)$ -category  $R_{n-2}^*$ , that coincides with  $E_{n-2}^*$ ,
- b)  $F$  sends an  $(n-1)$ -cell  $u$  in  $R_{n-1}^*$  to its equivalence class  $[u]^\vee$  modulo  $E_n$ ,
- c)  $F$  sends an  $n$ -cell  $f : u \rightarrow v$  in  $S^\top$  to the  $n$ -cell  $[f]^\vee : [u]^\vee \rightarrow [v]^\vee$  in  $(R_{n-1}^*)_{E_n}(P_n)$  defined as in Section 4.2.15, iv)-c), but by setting

$$[f]^\vee = [f_1]^\vee \star_{n-1} [f_2]^\vee \star_{n-1} \dots \star_{n-1} [f_k]^\vee,$$

for any decomposition of  $f = e_1 \star_{n-1} f_1 \star_{n-1} e_2 \star_{n-1} f_2 \star_{n-1} \dots \star_{n-1} e_k \star_{n-1} f_k$  in  $S^\top$ , where the  $n$ -cells  $e_i$  and  $f_i$  are in  $E^\top$  and  $R^\top$  respectively and may be identity cells.

As a consequence of Proposition 4.2.17 and Corollary 4.6.7, we get the following result:

**4.7.2 Proposition.** *Let  $(R, E, S)$  be a diconvergent  $n$ -polygraph modulo. If  $\text{Irr}(E)$  is  $E$ -normalizing with respect to  $S$ , then for any coherent completion  $\Gamma$  of  $S$  modulo  $E$ , the  $(n+1, n-1)$ -dipolygraph  $V(E, S, E \rtimes \Gamma \cup \text{Peiff}(E^\top, S^*) \cup \Gamma_E)$  is a globular coherent presentation of the  $(n-1)$ -category  $(R_{n-1}^*)_E$ .*

**4.7.3 Theorem.** *Let  $(R, E, S)$  be a diconvergent  $n$ -polygraph modulo such that  $\text{Irr}(E)$  is  $E$ -normalizing with respect to  $S$ . Let  $\Gamma$  be a coherent completion of  $S$  modulo  $E$ , then the cellular extension*

$$[\Gamma]^\vee := \{[A]^\vee \mid A \in \Gamma\}$$

*extends the  $n$ -category  $(R_{n-1}^*)_{E_n}(R_n)$  into a globular coherent presentation of the  $(n-1)$ -category  $(R_{n-1}^*)_E$ .*

*Proof.* The quotient functor  $V$  sends the cellular extension  $E \rtimes \Gamma \cup \text{Peiff}(E^\top, S^*) \cup \Gamma_E$  to  $[\Gamma]^\vee$ . Indeed, any square  $(n+1)$ -cell  $E_{e,e'}$  in  $\Gamma_E$  yields an identity  $(n+1)$ -cell in the  $(n+1)$ -category  $(R_{n-1}^*)_{E_n}(S_n)(P_{n+1})$ :

$$\begin{array}{ccc}
 \begin{array}{ccc}
 u & \xrightarrow{=} & u \\
 e \downarrow & & \downarrow e' \\
 v & \xrightarrow{E_{e,e'}} & v' \\
 e_1 \downarrow & & \downarrow e'_1 \\
 w & \xrightarrow{=} & w
 \end{array} & \rightsquigarrow & 
 \begin{array}{ccc}
 & [i_0^h(u)]^\vee & \\
 & \curvearrowright & \\
 [u]^\vee = [w]^\vee & & [u]^\vee = [w]^\vee \\
 & \Downarrow & \\
 & [i_0^h(w)]^\vee & \\
 & \curvearrowleft & 
 \end{array}
 \end{array}$$

Similarly, any  $(n+1)$ -cell in  $\text{Peiff}(E^\top, S^*)$  yields an identity  $(n+1)$ -cell in the  $(n+1)$ -category  $(R_{n-1}^*)_{E_n}(S_n)(P_{n+1})$ . Finally, two square  $(n+1)$ -cells in the same orbit for the biaction of the  $(n, n-1)$ -category  $E^\top$  on  $\text{Sqr}(E^\top, S^*)$  are sent on the same globular  $(n+1)$ -cell in  $(R_{n-1}^*)_{E_n}(S_n)(P_{n+1})$ .  $\square$

**4.7.4. Globular coherent completion procedure for  ${}_{\varepsilon}R$ .** Given a diconvergent  $n$ -polygraph modulo  $(R, E, S)$ , Corollary 4.6.7 gives a method to construct an acyclic square extension of the pair of  $(n, n-1)$ -categories  $(E^{\top}, S^{\top})$ . In many applications, this result is applied with  $S = {}_{\varepsilon}R$  and in situations where  ${}_{\varepsilon}R$  is not confluent modulo  $E$ . When  ${}_{\varepsilon}R$  is equipped with a termination order compatible with  $R$  modulo  $E$ , one can apply the completion procedure of Subsection 4.4.9 to obtain an  $n$ -polygraph  $\check{R}$  such that  ${}_{\varepsilon}\check{R}$  is confluent modulo  $E$ . Moreover, following Corollary 4.7.3 the only square cells that we have to consider in the construction of the globular coherent presentation through the quotient functor  $V$  are the square cells  $A_{f,g}$  and  $B_{f,e}$  of (4.16) of a coherent completion of  $S$  modulo  $E$ . In the particular case of  ${}_{\varepsilon}R$ , we do not have to consider square cells of the form  $B_{f,e}$ . Indeed, the critical branchings  $(f, e)$  where  $f$  is an  $n$ -cell in  $S^{*(1)}$  and  $e$  is an  $n$ -cell in  $E^{\top(1)}$  are trivially confluent from Section 4.4.9, and the square  $(n+1)$ -cell  $B_{f,e}$  obtained by the following choice of a confluence modulo  $E$ :

$$\begin{array}{ccc} u & \xrightarrow{f} & v \\ e \downarrow & & \Downarrow B_{f,e} \\ u' & \xrightarrow{e^{-1} \cdot f} & v \end{array}$$

yields an identity  $(n+1)$ -cell

$$\begin{array}{ccc} & \xrightarrow{[f]^v} & \\ [u]^v = [u']^v & & [v]^v \\ & \xrightarrow{[e^{-1} \cdot f]^v = [f]^v} & \end{array}$$

in the  $(n+1)$ -category  $((R_{n-1}^*)_{E_n}(P_n))(P_{n+1})$ . As a consequence, one only needs to choose a family of square  $(n+1)$ -cells

$$\begin{array}{ccccc} u & \xrightarrow{f} & u' & \xrightarrow{f'} & w \\ \parallel \downarrow & & \Downarrow A_{f,g} & & \downarrow e' \\ u & \xrightarrow{g} & v & \xrightarrow{g'} & w' \end{array}$$

for a choice of confluence modulo  $E$  of any critical branching  $(f, g)$  of  $S$  modulo  $E$ , where  $f$  is an  $n$ -cell of  ${}_{\varepsilon}R^{*(1)}$  and  $g$  is an  $n$ -cell of  $R^{*(1)}$ . Applying the quotient functor  $V$  of 4.8 on the set of square  $(n+1)$ -cells  $A_{f,g}$ , following Theorem 4.7.2, we obtain an acyclic extension of the  $n$ -category  $(R_{n-1}^*)_{E_n}(P_n)$  given by

$$\{ [A_{f,g}]^v \mid (f, g) \text{ is a critical branching of } S \text{ modulo } E \},$$

where bracket notation  $[-]^v$  is defined in 4.2.16.

**4.7.5. Commutative monoids.** We illustrate the completion procedure 4.7.4 to show how to compute a coherent presentation of a commutative monoid presented by a 2-polygraph modulo  $(R, E, {}_{\varepsilon}R_E)$ , where  $E$  is the 2-polygraph  $\text{Com}_2(X)$  for a finite set  $X$  defined in 4.3.2. The 2-cells of the 2-polygraph  $\text{Com}_2(X)$  are oriented with respect to a dexlex order induced by a total order on  $X$ , hence  $\text{Com}_2(X)$  is terminating. It is also confluent by confluence of any critical branching depicted as follows:

$$\begin{array}{ccccc} & & x_i x_k x_j & \xrightarrow{\alpha_{i,k} x_j} & x_k x_i x_j & & \\ & \nearrow x_i \alpha_{j,k} & & & & \searrow x_k \alpha_{i,j} & \\ x_i x_j x_k & & & & & & x_k x_j x_i \\ & \searrow \alpha_{i,j} x_k & & & & \nearrow \alpha_{j,k} x_i & \\ & & x_j x_i x_k & \xrightarrow{x_j \alpha_{i,k}} & x_j x_k x_i & & \end{array}$$

for any  $x_i, x_j, x_k$  in  $X$  such that  $x_i > x_j > x_k$ , and the 2-cells  $\alpha_{-, -}$  are the generating 2-cell of  $\text{Com}_2(X)$ .

**4.7.6. Example.** Consider such a 2-polygraph modulo with  $X = \{x_1, x_2, x_3, x_4\}$ , and

$$R_2 = \{x_1x_3 \xrightarrow{\beta} x_2x_4, x_1x_2 \xrightarrow{\gamma} x_1\}.$$

There is a critical branching of  ${}_{\mathbb{E}}R_{\mathbb{E}}$  modulo  $\mathbb{E}$  given by

$$\begin{array}{ccc} x_1x_2x_3 & \xrightarrow{\alpha_{2,3} \cdot \beta} & x_2x_4x_2 \\ \Downarrow \parallel & & \\ x_1x_2x_3 & \xrightarrow{\gamma} x_1x_3 \xrightarrow{\beta} & x_2x_4 \end{array} \quad (4.21)$$

where  $\alpha_{2,3} \cdot \beta$  is the rewriting step of  ${}_{\mathbb{E}}R_{\mathbb{E}}$  defined by  $x_1x_2x_3 \xrightarrow{\alpha_{2,3}^-} x_1x_3x_2 \xrightarrow{\beta x_2} x_2x_4x_2$ . As any permutation of the  $x_i$  in  $x_2x_4x_2$  and  $x_2x_4$  are irreducible with respect to  $R_2$ , the 1-cells  $x_2x_4x_2$  and  $x_2x_4$  are normal forms with respect to  ${}_{\mathbb{E}}R_{\mathbb{E}}$ , so the branching (4.21) is not confluent modulo  $\mathbb{E}$ . Following the completion procedure 4.4.11, we define the following 2-cell

$$\delta : x_2x_2x_4 \Rightarrow x_2x_4,$$

and we set  $R := R \cup \{\gamma\}$ . The degree lexicographic order induced by  $x_1 > x_2 > x_3 > x_4$  is a termination order compatible with  $R_2$  modulo  $\mathbb{E}$ , so that  ${}_{\mathbb{E}}R_{\mathbb{E}}$  is terminating and  $\text{Irr}(\mathbb{E})$  is trivially  $\mathbb{E}$ -normalizing with respect to  ${}_{\mathbb{E}}R_{\mathbb{E}}$ . Moreover, the 2-polygraph modulo  ${}_{\mathbb{E}}R_{\mathbb{E}}$  is confluent modulo  $\mathbb{E}$ . Indeed, all its critical branchings modulo, depicted in (4.22) and (4.23), are confluent modulo.

$$\begin{array}{ccc} x_1x_2x_3 \xrightarrow{\alpha_{2,3}^- \cdot \beta} x_2x_4x_2 \xrightarrow{\alpha_{2,4}^- \cdot \delta} x_2x_4 & x_2x_2x_4x_1 \xrightarrow{\alpha_{2,4} \cdot \gamma} x_2x_4x_1 \xrightarrow{\alpha_{1,4}^- \alpha_{1,2}^- \cdot \gamma} x_2x_4 & \\ \Downarrow \parallel & \Downarrow \parallel & \Downarrow \parallel \\ x_1x_2x_3 \xrightarrow{\gamma} x_1x_3 \xrightarrow{\beta} x_2x_4 & x_2x_2x_4x_1 \xrightarrow{\delta x_1} x_2x_4x_1 \xrightarrow{\alpha_{1,4}^- \alpha_{1,2}^- \cdot \gamma} x_2x_4 & \end{array} \quad (4.22)$$

$$\begin{array}{ccc} x_2x_4x_2x_4x_2 \xrightarrow{\alpha_{2,4}^- \cdot \delta} x_2x_4x_4x_2 \xrightarrow{(\alpha_{2,4}^-)^2 \cdot \delta} x_2x_4x_4 & & \\ \Downarrow \parallel & \Downarrow \parallel & \Downarrow \parallel \\ x_2x_4x_2x_4x_2 \xrightarrow{\alpha_{2,4}^- \cdot \delta} x_2x_4x_2x_4 \xrightarrow{\alpha_{2,4}^- \cdot \delta} x_2x_4x_4 & & \end{array} \quad (4.23)$$

Following procedure 4.7.4, one shows that an acyclic extension of the commutative monoid generated by  $X$  and submitted to relations in  $R_2$  can be computed from the the square extension  $\{A, B, C\}$  of  $(\mathbb{E}^T, {}_{\mathbb{E}}R_{\mathbb{E}}^T)$ . This acyclic extension is made of the following 3-cells.

$$\begin{array}{ccc} \begin{array}{ccc} [x_1x_2x_3] & \xrightarrow{[\beta] \star_1 [\delta]} & [x_2x_4] \\ \Downarrow [A] & & \\ [x_1x_2x_3] & \xrightarrow{[\gamma] \star_1 [\beta]} & [x_2x_4] \end{array} & \begin{array}{ccc} [x_1x_2x_2x_4] & \xrightarrow{[\delta] \star_1 [\gamma]} & [x_2x_4] \\ \Downarrow [B] & & \\ [x_1x_2x_2x_4] & \xrightarrow{[\delta] \star_1 [\gamma]} & [x_2x_4] \end{array} & \begin{array}{ccc} [x_2x_2x_2x_4x_4] & \xrightarrow{[\delta] \star_1 [\delta]} & [x_2x_4x_4] \\ \Downarrow [C] & & \\ [x_2x_2x_2x_4x_4] & \xrightarrow{[\delta] \star_1 [\delta]} & [x_2x_4x_4] \end{array} \end{array}$$

Note that if we take the commutation 2-cells as rewriting rules, the Knuth-Bendix completion is infinite, requiring to add a 2-cell  $\varepsilon_n : x_4x_3^n x_2x_2 \Rightarrow x_4x_3^n x_2$  for any  $n \geq 0$ . This yields acyclic extension made of an infinite set of 3-cells

$$\begin{array}{ccc} & \xrightarrow{\alpha_{2,3}^2} & x_4x_3^{n+1}x_2x_2 \xrightarrow{\varepsilon_{n+1}} \\ x_4x_3^n x_2x_2x_3 & \Downarrow [D_n] & x_4x_3^{n+1}x_2 \\ & \xrightarrow{\varepsilon_n x_3} & x_4x_3^n x_2x_3 \xrightarrow{\alpha_{2,3}} \end{array}$$

**4.7.7. Pivotal categories.** We present an application of the coherence Theorem 4.6.6 on a toy example in the context of diagrammatic rewriting. We consider a presentation of a pivotal monoidal category, seen as a pivotal 2-category with only one 0-cell presented by a 3-polygraph. In general, such isotopy relations produce many critical branching with primary rules of the presentation. In this example, we show how to compute a coherent presentation of a monoidal pivotal category using rewriting modulo the isotopy axioms. We consider the 3-polygraph  $P$  defined by the following data:

- i) only one generating 0-cell,
- ii) two generating 1-cells  $\wedge$  and  $\Upsilon$ ,
- iii) eight generating 2-cells pictured by

$$\uparrow, \begin{array}{c} \nearrow \\ \searrow \\ \nearrow \\ \searrow \end{array}, \downarrow, \begin{array}{c} \searrow \\ \nearrow \\ \searrow \\ \nearrow \end{array}, \curvearrowright, \curvearrowleft, \curvearrowright, \curvearrowleft, \quad (4.24)$$

iv) the generating 3-cells of  $P$  are given by:

- a) the three families of generating isotopy 3-cells:

$$\begin{array}{c} \cup \\ \Rightarrow \\ \uparrow \end{array}, \begin{array}{c} \cup \\ \Rightarrow \\ \downarrow \end{array}, \begin{array}{c} \cup \\ \Rightarrow \\ \uparrow \end{array}, \begin{array}{c} \cup \\ \Rightarrow \\ \downarrow \end{array} \quad (4.25)$$

$$\begin{array}{c} \cup \\ \cdot \\ \Rightarrow \\ \downarrow \end{array}, \begin{array}{c} \cup \\ \cdot \\ \Rightarrow \\ \uparrow \end{array}, \begin{array}{c} \cup \\ \cdot \\ \Rightarrow \\ \downarrow \end{array}, \begin{array}{c} \cup \\ \cdot \\ \Rightarrow \\ \uparrow \end{array}, \quad (4.26)$$

$$\begin{array}{c} \cup \\ \Rightarrow \\ \cup \end{array}, \begin{array}{c} \cup \\ \Rightarrow \\ \cup \end{array}, \begin{array}{c} \cup \\ \Rightarrow \\ \cup \end{array}, \begin{array}{c} \cup \\ \Rightarrow \\ \cup \end{array} \quad (4.27)$$

- b) the generating 3-cells of the 3-polygraph of permutations for both upward and downward orientations of strands:

$$\begin{array}{c} \nearrow \\ \searrow \\ \nearrow \\ \searrow \\ \Rightarrow \\ \uparrow \uparrow \end{array} \alpha_+, \begin{array}{c} \searrow \\ \nearrow \\ \searrow \\ \nearrow \\ \Rightarrow \\ \downarrow \downarrow \end{array} \alpha_-, \begin{array}{c} \nearrow \\ \searrow \\ \nearrow \\ \searrow \\ \Rightarrow \\ \uparrow \uparrow \end{array} \beta_+, \begin{array}{c} \searrow \\ \nearrow \\ \searrow \\ \nearrow \\ \Rightarrow \\ \downarrow \downarrow \end{array} \beta_- \quad (4.28)$$

- c) a generating 3-cell

$$\begin{array}{c} \nearrow \\ \searrow \\ \nearrow \\ \searrow \\ \Rightarrow \\ \circ \uparrow \end{array} \gamma \quad (4.29)$$

Note that the relations (4.25 – 4.27) correspond to the fact that the generating 1-cells  $\Upsilon$  and  $\wedge$  are biadjoints in the 2-category  $\bar{P}$  presented by  $P$ , and cups and caps 2-cells are units and counits for these adjunctions. Relations implying dots also ensure that the dot 2-cell is a cyclic 2-morphism in the sense of [32] for the biadjunction  $\Upsilon \vdash \wedge \vdash \Upsilon$ , making  $\bar{P}$  into a *pivotal 2-category*. We consider the 3-polygraph  $E$  defined by the following data

- i)  $E_{\leq 1} = P_{\leq 1}$ ,
- ii) it has six 2-cells given in (4.24) minus the two crossing 2-cells,
- iii) the isotopy 3-cells (4.25 – 4.27).



Note that this polygraph  $E$  is a non-linear instance of the polygraph  $E_I$  defined in Section 5.3.1 in the case where  $I$  is a singleton. Let  $R$  be a 3-polygraph such that  $R_{\leq 2} = P_{\leq 2}$  and whose 3-cells are given by  $(\alpha_{\pm}, \beta_{\pm}, \gamma)$  of (4.28 – 4.29), and let us consider the 3-polygraph modulo  ${}_E R$ . Following 4.4.8, the only critical branchings we have to consider are those of the form  $(f, g)$  with  $f$  in  ${}_E R^{*(1)}$  and  $g$  in  $R^{*(1)}$ . The branching (4.31) is not such a branching because the top 3-cell belongs to  $E^{\top}$ , and the top-right 2-cell is not reducible by  $R$ . The branchings of the form  $(f, g)$  with both  $f$  and  $g$  in  $R^{*(1)}$  are given by the critical branchings of the polygraph of permutations in [51, 5.4.4], together with an additional inclusion branching given by  $(\alpha^+, \gamma)$ . We also check that there is no other form of critical branchings.

**4.7.8. Decreasing order operator for  $E$ -normalization.** The 3-polygraph  $R'$  is left-disjoint from  $E$ , since no caps and cups 2-cells appear in the sources of the generating 3-cells of  $R$ . Following 4.6.9, we prove that  $\text{Irr}(E)$  is  $E$ -normalizing with respect to  ${}_E R$  using a decreasing order operator  $\Phi$  for  $E$  compatible with  $R$ .

**4.7.9 Lemma.** *Let  $E$  and  $R$  be the 3-polygraphs defined above. There exists a decreasing order operator  $\Phi$  for  $E$  compatible with  $R$ .*

*Proof.* For any 1-cells  $p$  and  $q$  in  $R_1^*$ , we set  $m(p, q) = 2$  and for any 2-cell  $u$  of source  $p$  and target  $q$  in  $R_2^*$ ,  $\Phi_{p,q}(u) = (\text{ldot}(u), I(u))$  where:

- i)  $\text{ldot}(u)$  counts the number of left-dotted caps and cups, adding for such cap and cup the number of dots on it. In particular, for any  $n$  in  $\mathbb{N}^*$ , we have

$$\text{ldot} \left( \begin{array}{c} n \\ \curvearrowright \end{array} \right) = \text{ldot} \left( \begin{array}{c} n \\ \cup \end{array} \right) := n + 1$$

for both orientations of strands.

- ii)  $I(u)$  counts the number of instances of one of the following 2-cells of  $R_2^*$  in  $u$ :



For any 3-cell  $u \Rightarrow v$  in  $E$ , we have  $\Phi(u) > \Phi(v)$  and that  $\Phi(u, u) = (0, 0)$  for any  $u$  in  $\text{Irr}(E)$ . Moreover,  $\Phi$  is compatible with  $R$  because rewritings with respect to  $R$  do not make the dot 2-cell move around a cup or a cap, or create sources of isotopies.  $\square$

**4.7.10. Acyclic square extension.** As a consequence of Theorem 4.6.6, we deduce an acyclic square extension of the pair of  $(3, 2)$ -categories  $(E^{\top}, {}_E R^{\top})$ . This square extension is made of:

- i) the 16 elements given by the diagrams of the homotopy basis or the 3-polygraph of pearls in [51, Section 5.5.3] for both orientations of strands,
- ii) the ten elements  $A_{\pm} - E_{\pm}$  given by the diagrams of the homotopy basis for the 3-polygraph of permutations from [51, Section 5.4.4] for both upward and downward orientations of strands, as depicted below,
- iii) the square cell  $\Gamma$  corresponding to the choice of confluence modulo for the branching  $(\alpha, \gamma)$ , depicted below.

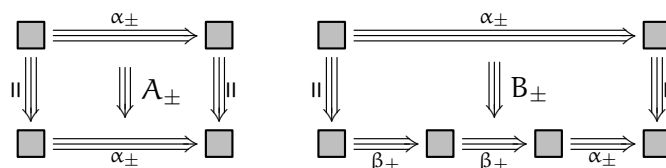

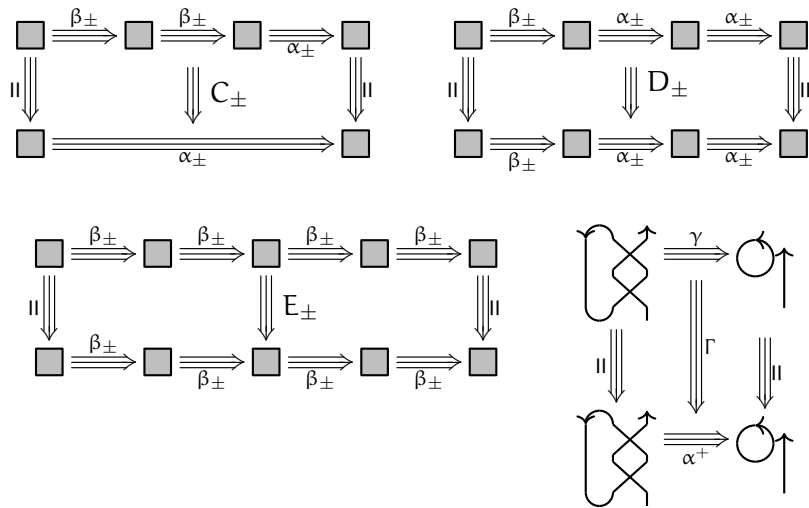

**4.7.11 Remark.** Now let us consider a new linear  $(3, 2)$ -polygraph  $P'$  defined as the same  $i$ -cells than  $P$  for  $0 \leq i \leq 2$ , and the same 3-cells than  $P$ , except that the 3-cell  $\gamma$  is replaced by the following new 3-cell  $\gamma$ :

$$\begin{array}{c}
 \begin{array}{c} \curvearrowright \\ \curvearrowleft \end{array} \xrightarrow{\gamma} \begin{array}{c} \uparrow \\ \downarrow \end{array} \\
 \cong \\
 \begin{array}{c} \curvearrowright \\ \curvearrowleft \end{array} \xrightarrow{\alpha^+} \begin{array}{c} \uparrow \\ \downarrow \end{array}
 \end{array} \tag{4.30}$$

which is relation arising in many presentations of monoidal categories appearing in representation category, see for instance Khovanov-Lauda's 2-category introduced in [67], defined in Section 6.2, the affine oriented Brauer 2-category  $\mathcal{AOB}$  defined in Section 9.4, or in the Heisenberg categories defined by Khovanov in [70], and extended by Brundan in [21]. Note that with this new relation creating branchings with the isotopy relations, the 3-polygraph  $P'$  is not confluent. Indeed, the branching

$$\begin{array}{c}
 \begin{array}{c} \curvearrowright \\ \curvearrowleft \end{array} \\
 \swarrow \quad \searrow \\
 \begin{array}{c} \curvearrowright \\ \curvearrowleft \end{array} \quad \begin{array}{c} \uparrow \\ \downarrow \end{array}
 \end{array} \tag{4.31}$$

is not confluent. Moreover, solving this obstruction to confluence using Knuth-Bendix completion may lead to adding a great number of relations, making analysis of confluence from critical branchings inefficient. To tackle this issue, this is convenient to rewrite modulo the isotopy relations. In that case, there are critical branchings modulo isotopy (of the form  $(R^{*(1)}, \varepsilon R^{*(1)})$ ) between  $\gamma$  and  $\alpha$  (resp.  $\beta$ ) with respective source

$$\begin{array}{c}
 \begin{array}{c} \curvearrowright \\ \curvearrowleft \end{array} \sim \begin{array}{c} \curvearrowright \\ \curvearrowleft \end{array}, \quad \begin{array}{c} \curvearrowright \\ \curvearrowleft \end{array} \sim \begin{array}{c} \curvearrowright \\ \curvearrowleft \end{array},
 \end{array} \tag{4.32}$$

and to get confluence of these branchings, we have to add a bubble slide relation in  $R$  of the form:

$$\begin{array}{c}
 \begin{array}{c} \circ \\ \uparrow \end{array} \xrightarrow{s_0^0} \begin{array}{c} \uparrow \\ \circ \end{array}
 \end{array}$$

As a consequence, following Section 2.6.4,  ${}_{\mathbb{E}}\mathbb{R}$  is not terminating anymore, but we prove in a similar fashion than for the linear  $(2, 2)$ -category  $\mathcal{AOB}$  in Section 9.4 that it is quasi-terminating. As a consequence, in order to compute coherent presentations for the various pivotal linear  $(2, 2)$ -categories arising in representation theory, we need to generalize Theorems 4.6.6 and 4.6.12 to the quasi-terminating setting.

As explained in [3], coherent presentations from quasi-convergent presentations are more complicated to compute, since they need to take into account coherence cells in loops created by rewriting cycles. In any case, we expect to have an homotopy basis in more elements than the square cells given in Section 4.7.10, i) and ii) and the square cells coming from the confluences modulo of the branchings described in (4.32).

---

## Bases in linear categories from confluence modulo

---

### Contents

---

|  |            |
|--|------------|
| <b>5.1 Linear critical branching lemma modulo</b>                                      | <b>131</b> |
| <b>5.2 Confluence modulo by decreasingness modulo</b>                                  | <b>135</b> |
| <b>5.3 Rewriting modulo isotopies in pivotal linear <math>(2, 2)</math>-categories</b> | <b>139</b> |
| <b>5.4 Linear bases from confluence modulo</b>   | <b>141</b> |

---

One of the main objectives of this work is to develop effective methods in order to compute linear bases of higher-dimensional linear categories, and in particular for linear  $(2, 2)$ -categories, that are 2-categories in which for any 1-cells  $u$  and  $v$ , the set of 2-cells with 1-source  $u$  and 1-target  $v$  admits the structure of a  $\mathbb{K}$ -vector space for some field  $\mathbb{K}$ . In [2], Alleaume proved that a basis for each space of 2-cells for such a 2-category can be obtained from a convergent presentation of this category, by taking all the irreducible monomials with respect to the presentation.

However, many structural relations coming from the inherent structure of the diagrammatic algebras arising in categorification problems may make confluence difficult to check or even create obstructions to confluence. However, these relations being structural should be considered from another perspective than the relations defining the category, and thus we want to rewrite modulo these relations. In particular, we are interested in the case of rewriting in pivotal linear  $(2, 2)$ -categories, which are 2-categories satisfying additional adjunctions and duality properties such that all 2-cells are represented by string diagrams that can be drawn up to isotopy. We introduce a formalism of rewriting modulo the isotopy relations provided by this structure.

In this Chapter, we extend Alleaume's basis result to presentations that are splitted into two parts  $R$  and  $E$ , satisfying that  $E$  is convergent and additional termination and confluence modulo properties. In particular, we prove that under the assumptions of Theorem 5.4.4, taking the monomials in normal form with respect to  $R$ , and then taking their  $E$ -normal forms (or all the monomials that appear in their  $E$ -normal forms) yields a basis of each space of 2-cells in the category presented by the rules in  $R$  and  $E$ .

Moreover, we give in this Chapter a first way to reach confluence modulo for presentations such that the polygraph modulo  ${}_E R_E$ , as defined in Chapter 4, is not terminating but quasi-terminating. This is based on the adaptation of the abstract notion of decreasingness introduced by Van Oostrom [119] to the context of abstract rewriting modulo. In particular, we prove that any decreasing polygraph modulo is

confluent modulo, and that decreasingness in the quasi-terminating setting can be proved by checking that all critical branchings modulo of the presentation are decreasingly confluent with respect to the quasi-normal form labelling. We then extend the basis result to the quasi-terminating setting by considering, instead of monomials in normal forms with respect to  $R$ , fixed monomials in quasi-normal form with respect to  $R$  and applying the same procedure. This result gives all the results of the paper [42].

## 5.1. LINEAR CRITICAL BRANCHING LEMMA MODULO

**5.1.1. Linear polygraphs modulo.** A linear  $(n + 1, n)$ -polygraph modulo is a data  $(R, E, S)$  made of

- i) a linear  $(n + 1, n)$ -polygraph  $R$  and a linear  $(n + 1, n)$ -polygraph  $E$  such that  $E_{\leq(n-1)} = R_{\leq(n-1)}$  and  $E_n \subseteq R_n$ ,
- ii) a cellular extension  $S$  of  $R_n^\ell$  such that  $R \subseteq S \subseteq {}_E R_E$  holds, where the cellular extension  ${}_E R_E$  is defined in a similar way than in Section 4.4.1, but the pullbacks are made on the set of positive  $(n + 1)$ -cells of length 1 in  $R_{n+1}^\ell$ . Explicitly, the elements of  ${}_E R_E$  correspond to  $n$ -spheres  $(u, v) \in R_n^\ell$  such that  $(u, v)$  is the boundary of an  $(n + 1)$ -cell  $f$  in  $R_n^\ell[R_{n+1}, E_{n+1}, E_{n+1}^-]/\text{Inv}(E_3, E_3^-)$ , the free linear  $(n, n)$ -category generated by  $R_{\leq n}$  augmented by the cellular extensions  $R, E$  and the formal inverses  $E^-$  of  $E$  modulo the corresponding inverse relations (2.4), with the following shape

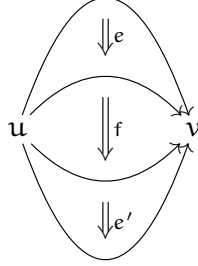

for some  $(n + 1)$ -cells  $e$  and  $e'$  in  $E_{n+1}^\ell$  and a rewriting step  $f$  of  $R$ .

This data defines a linear  $(n + 1, n)$ -polygraph  $(R_{\leq n}, S)$ , that we denote by  $S$  when there is no ambiguity.

**5.1.2. Confluence and branchings modulo.** A *branching* of  $S$  is a pair  $(f, g)$  of positive 3-cells of  $S^\ell$  with the same  $n$ -source. A *branching modulo*  $E$  of the linear  $(3, 2)$ -polygraph modulo  $S$  is a triple  $(f, e, g)$  where  $f$  is a positive 3-cell of  $S^\ell$ ,  $g$  is either a positive 3-cell of  $S^\ell$  or an identity 3-cell, and  $e$  is a 3-cell of  $E^\ell$ . A branching modulo  $(f, e, g)$  is *local* if  $f$  is a 3-cell of  $S^{\ell(1)}$ ,  $g$  is either a positive 3-cell of  $S^\ell$  or an identity and  $e$  a 3-cell of  $E^\ell$  such that  $\ell(g) + \ell(e) = 1$ . Local branchings of linear polygraphs modulo are divided into the four following families:

| Aspherical branchings   | Peiffer   | Peiffer modulo  |
|---|---|---|
| $\begin{array}{ccc} u & \xrightarrow{f} & v \\ \parallel \downarrow & & \downarrow \parallel \\ u & \xrightarrow{f} & v \end{array}$  | $\begin{array}{ccc} u \star_i v + w & \xrightarrow{f \star_i v} & u' \star_i v + w \\ \parallel \downarrow & & \\ u \star_i v + w & \xrightarrow{u \star_i g} & u \star_i v' + w \end{array}$ | $\begin{array}{ccc} u \star_i v + w & \xrightarrow{f \star_i v} & u' \star_i v + w \\ u \star_i e \downarrow & & \\ u \star_i v' + w & & \end{array}$ |
| Additive  | Additive modulo   | Overlappings  |
| $\begin{array}{ccc} u + v & \xrightarrow{f+v} & u' + v \\ \parallel \downarrow & & \\ u + v & \xrightarrow{u+g} & u + v' \end{array}$ | $\begin{array}{ccc} u + v & \xrightarrow{f+v} & u' + v \\ u+e \downarrow & & \\ u + v' & & \end{array}$   | $\dots$   |

where  $u, v, w$  are  $n$ -cells in  $R_n^\ell$ ,  $f$  and  $g$  are positive  $(n + 1)$ -cells in  $S_{n+1}^\ell$ , and  $e$  is an  $(n + 1)$ -cell

in  $E_{n+1}^\ell$ .

**5.1.3. Critical branchings.** Let  $\sqsubseteq$  be the order on monomials of the linear  $(n+1, n)$ -polygraph  $S$  defined by  $u \sqsubseteq v$  if there exists a context  $C$  of  $R_n^*$  such that  $v = C[u]$ , a *critical branching modulo  $E$*  is an overlapping local branching modulo that is minimal for the order  $\sqsubseteq$ .

**5.1.4 Theorem** (Linear critical branching lemma modulo). *Let  $(R, E, S)$  be a linear  $(3, 2)$ -polygraph modulo such that  ${}_E R_E$  is terminating. Then  $S$  is locally confluent modulo  $E$  if and only if the two following conditions hold*

**a<sub>0</sub>)** any critical branching  $(f, g)$  with  $f$  positive 3-cell in  $S^{\ell(1)}$  and  $g$  positive 3-cell in  $R^{\ell(1)}$  is confluent modulo  $E$ :

$$\begin{array}{ccccc} u & \xrightarrow{f} & v & \cdots & v' \\ \parallel \downarrow & & & & \downarrow e' \\ u & \xrightarrow{g} & w & \cdots & w' \end{array}$$

**b<sub>0</sub>)** any critical branching  $(f, e)$  modulo  $E$  with  $f$  in  $S^{\ell(1)}$  and  $e$  in  $E^\ell$  of length 1 is confluent modulo  $E$ :

$$\begin{array}{ccccc} u & \xrightarrow{f} & v & \cdots & v' \\ e \downarrow & & & & \downarrow e' \\ u' & \cdots & & & w \end{array}$$

*Proof.* By Theorem 4.5.4, the local confluence of  $S$  modulo  $E$  is equivalent to both conditions **a)** and **b)**. Let us prove that the condition **a)** (resp. **b)**) holds if and only if the condition **a<sub>0</sub>)** (resp. **b<sub>0</sub>)**) holds. One implication is trivial, let us prove the converse implication. To do so, let us proceed by Huet's double noetherian induction as introduced in [56] on the polygraph modulo  $S^\Pi$  defined in [43] which is terminating since  ${}_E R_E$  is assumed terminating. We refer to [43] for further details on this double induction.

Following the proof of the linear critical pair lemma in [50], we assume that condition **a<sub>0</sub>)** holds and prove condition **a)**. Let us consider a local branching  $(f, g)$  of  $S$  modulo  $E$  of source  $(u, v)$  with  $f$  and  $g$  positive 3-cells in  $S^{\ell(1)}$  and  $R^{\ell(1)}$  respectively. Let us assume that any local branching of source  $(u', v')$  such that there is a 3-cell  $(u, v) \rightarrow (u', v')$  in  $S^\Pi$  is confluent modulo  $E$ . The local branching  $(f, g)$  is either a local Peiffer branching, an additive branching or an overlapping branching. We prove that for each case,  $(f, g)$  is confluent modulo  $E$ .

**i)** If  $(f, g)$  is a Peiffer branching of the form

$$\begin{array}{ccc} u \star_i v + w & \xrightarrow{f \star_i v} & u' \star_i v + w \\ \parallel \downarrow & & \\ u \star_i v + w & \xrightarrow{u \star_i g} & u \star_i v' + w \end{array}$$

where  $0 \leq i \leq n-2$ ,  $w$  is a 2-cell of  $R_2^\ell$ ,  $f$  is a positive 3-cell in  $S^{\ell(1)}$  and  $g$  is a positive 3-cell in  $R^{\ell(1)}$ , there exist elementary 3-cells in  $S^\ell$  as follows:

$$\begin{array}{ccccc} u \star_i v + w & \xrightarrow{f \star_i v} & u' \star_i v + w & \cdots & u' \star_i v' + w \\ \parallel \downarrow & & & & \downarrow \parallel \\ u \star_i v + w & \xrightarrow{u \star_i g} & u \star_i v' + w & \cdots & u' \star_i v' + w \end{array}$$

However, these 3-cells are not necessarily positive, for instance if  $u'v \in \text{Supp}(w)$  or  $uv' \in \text{Supp}(w)$ . By Lemma 2.8.4, there exist positive 3-cells  $f_1, f_2, g_1, g_2$  in  $S^\ell$  of length at most 1 such that  $f \star_i v' + w = f_1 \star_2 f_2^-$  and  $u' \star_i g + w = g_1 \star_2 g_2^-$ . Then, the 3-cells  $f_2$  and  $g_2$  of  $S^\ell$  have the same 2-source and by assumption, the branching  $(f_2, g_2)$  is confluent modulo  $E$ , so there exist positive 3-cells  $f'$  and  $g'$  in  $S^\ell$  and a 3-cell  $e$  in  $E^\ell$  as follows:

$$\begin{array}{ccccc}
u \star_i v + w & \xrightarrow{f \star_i v + w} & u' \star_i v + w & \xrightarrow{f_1} & f' \\
\parallel \downarrow & & \parallel \downarrow & & \parallel \downarrow \\
u \star_i v + w & \xrightarrow{f \star_i v + w} & u' \star_i v + w & \xrightarrow{u' \star_i g + w} & u' \star_i v' + w & \xrightarrow{f_2} & f' \\
\parallel \downarrow & & \parallel \downarrow & & \parallel \downarrow & & \parallel \downarrow \\
u \star_i v + w & \xrightarrow{u \star_i g + w} & u \star_i v' + w & \xrightarrow{f \star_i v' + w} & u' \star_i v' + w & \xrightarrow{g_2} & g' \\
\parallel \downarrow & & \parallel \downarrow & & \parallel \downarrow & & \parallel \downarrow \\
u \star_i v + w & \xrightarrow{u \star_i g + w} & u \star_i v' + w & \xrightarrow{g_1} & g' & & e'
\end{array}$$

which proves the confluence modulo of the branching  $(f, g)$ .

ii) If  $(f, g)$  is an additive branching of the form

$$\begin{array}{ccc}
u + v & \xrightarrow{f+v} & u' + v \\
\parallel \downarrow & & \\
u + v & \xrightarrow{u+g} & u + v'
\end{array}$$

where  $f$  is positive 3-cells of  $S^{\ell(1)}$  and  $g$  is a positive 3-cell of  $R^{\ell(1)}$ , there exist elementary 3-cells in  $S^\ell$  as follows:

$$\begin{array}{ccccc}
u + v & \xrightarrow{f+v} & u' + v & \xrightarrow{u'+g} & u' + v' \\
\parallel \downarrow & & \parallel \downarrow & & \parallel \downarrow \\
u + v & \xrightarrow{u+g} & u + v' & \xrightarrow{f+v'} & u' + v'
\end{array}$$

However, these 3-cells are not necessarily positive, for instance if  $u \in \text{Supp}(v)$  or  $u \in \text{Supp}(v')$ . By Lemma 2.8.4, there exist positive 3-cells  $f_1, f_2, g_1, g_2$  in  $S^\ell$  of length at most 1 such that  $f \star_i v' + w = f_1 \star_2 f_2^-$  and  $u' \star_i g + w = g_1 \star_2 g_2^-$ . We then prove the confluence modulo of  $(f, g)$  in a same fashion as for case i).

iii) If  $(f, g)$  is an overlapping branching of  $S$  with  $f$  in  $S^{\ell(1)}$  and  $g$  in  $R^{\ell(1)}$  that is not critical, then by definition there exists a context  $C = m_1 \star_1 (m_2 \star_0 \square \star_0 m_3) \star_1 m_4$  of  $R_2^*$  and positive 3-cells  $f'$  and  $g'$  in  $S^\ell$  and  $R^\ell$  respectively such that  $f = C[f']$  and  $g = C[g']$ , and the branching  $(f', g')$  is critical. By property **a**<sub>0</sub>, the branching  $(f', g')$  is confluent modulo  $E$ , so that there exist positive 3-cells  $f_1$  and  $g_1$  in  $S^\ell$  and a 3-cell  $e$  in  $E^\ell$  as follows:

$$\begin{array}{ccccc}
u & \xrightarrow{f'} & u' & \xrightarrow{f_1} & w \\
\parallel \downarrow & & \parallel \downarrow & & \parallel \downarrow \\
u & \xrightarrow{g'} & v' & \xrightarrow{g_1} & w' \\
& & & & \parallel \downarrow \\
& & & & e
\end{array}$$

inducing a confluence modulo of the branching  $(f, g)$ :

$$\begin{array}{ccccc}
C[u] & \xrightarrow{f} & C[u'] & \xrightarrow{C[f_1]} & C[w] \\
\parallel \downarrow & & \parallel \downarrow & & \parallel \downarrow \\
C[u] & \xrightarrow{g} & C[v'] & \xrightarrow{C[g_1]} & C[w'] \\
& & & & \parallel \downarrow \\
& & & & C[e]
\end{array}$$

Now, suppose that conditions **b<sub>0</sub>**) holds and prove condition **b)**. Let us consider a local branching  $(f, e)$  of  $S$  modulo  $E$  of source  $(u, v)$ , with  $f$  in  $S^{\ell(1)}$  and  $e$  in  $E^\ell$  of length 1. We still assume that any local branching of source  $(u', v')$  such that there is a 3-cell  $(u, v) \rightarrow (u', v')$  in  $S^{\text{II}}$  is confluent modulo  $E$ . The branching  $(f, e)$  is either a local Peiffer branching modulo  $E$ , an additive branching modulo  $E$  or an overlapping modulo  $E$ . Let us prove that it is confluent modulo  $E$  for each case.

i') If  $(f, e)$  is a local Peiffer branching modulo of the form

$$\begin{array}{ccc} u \star_i v + w & \xrightarrow{f \star_i v} & u' \star_i v + w \\ u \star_i e \downarrow & & \\ u \star_i v' + w & & \end{array}$$

with  $w$  in  $R_2^\ell$ ,  $f$  a positive 3-cell in  $S^{\ell(1)}$  and  $e$  a 3-cell in  $E^\ell$  (the other form of such branching being treated similarly), there exist 3-cells  $f \star_i v'$  and  $u' \star_i e$  in  $S^\ell$  and  $E^\ell$  respectively as in the following diagram

$$\begin{array}{ccc} u \star_i v + w & \xrightarrow{f \star_i v} & u' \star_i v + w \\ u \star_i e \downarrow & & \downarrow u' \star_i e \\ u \star_i v' + w & \xrightarrow{\dots} & u' \star_i v' + w \\ & f \star_i v' & \end{array}$$

However, the dotted horizontal 3-cell is not necessarily positive, for instance if  $uv' \in \text{Supp}(w)$ . By Lemma 2.8.4, there exist positive 3-cells  $f_1, f_2$  in  $S^\ell$  of length at most 1 such that  $f \star_i v' = f_1 \star_2 f_2^-$ . Then, we have  $t_2^E(u' \star_i e) = s_2^S(f_2)$  and by assumption the branching  $(f_2, (u' \star_i e)^-)$  is confluent modulo  $E$ , so there exists positive 3-cells  $g$  and  $h$  in  $S^\ell$  and a 3-cell  $e'$  in  $E^\ell$  as follows:

$$\begin{array}{ccccc} u \star_i v & \xrightarrow{f \star_i v} & u' \star_i v & \xrightarrow{\dots} & w \\ u \star_i e \downarrow & & \downarrow u' \star_i e & & \downarrow e' \\ u \star_i v' & \xrightarrow{\dots} & u' \star_i v' & \xrightarrow{f_2} & u'' \\ \parallel \downarrow & f \star_i v' & \downarrow \parallel & & \downarrow \\ u \star_i v' & \xrightarrow{f_1} & u'' & \xrightarrow{h} & w' \end{array}$$

which proves the confluence modulo of  $(f, g)$ .

ii') If  $(f, e)$  is a local additive branching modulo  $E$  of the form

$$\begin{array}{ccc} u + v & \xrightarrow{f+v} & u' + v \\ u+e \downarrow & & \\ u + v' & & \end{array}$$

where  $f$  is a positive 3-cell in  $S^{\ell(1)}$  and  $e$  is a 3-cell in  $E^\ell$  of length 1 (the other form of such branching being treated similarly), there exist 3-cells  $f + v'$  and  $u' + e$  in  $S^\ell$  and in  $E^\ell$  respectively as in the following diagram

$$\begin{array}{ccc} u + v & \xrightarrow{f+v} & u' + v \\ u+e \downarrow & & \downarrow u'+e \\ u + v' & \xrightarrow{\dots} & u' + v' \\ & f+v' & \end{array}$$

However, the 3-cell  $f + v'$  in  $S^{\ell(1)}$  is not necessarily positive, for instance if  $u \in \text{Supp}(v')$  but by Lemma 2.8.4, there exist positive 3-cells  $f_1$  and  $f_2$  in  $S^*$  of length at most 1 such that  $f + v' = f_1 \star_2 f_2^-$ . We then prove the confluence modulo of the branching  $(f, e)$  by a similar argument than above.



iii') If  $(f, e)$  is an overlapping modulo, the proof is similar to the proof for property  $\mathbf{a}_0$ .

□

## 5.2. CONFLUENCE MODULO BY DECREASINGNESS MODULO

**5.2.1. Well-founded labelling modulo.** Given a linear  $(3, 2)$ -polygraph modulo  $(R, E, S)$ , a *well-founded labelling modulo of  $S$*  is a well-founded labelling  $\psi$  of  $R$  extended to  ${}_{\varepsilon}R_E$  by setting  $\psi(e) = 1$  the trivial word in  $X^*$  for any  $e$  in  $E$ . The lexicographic maximum measure defined in Section 2.2.6 then extends to the rewriting steps of  $S$  as follows:

$$|e_1 \star_1 f \star_1 e_2| = |f|$$

for any 3-cells  $e_1$  and  $e_2$  in  $E^\ell$  and rewriting step  $f$  of  $R$ . It then extends to the rewriting sequences of  $S$  and  ${}_{\varepsilon}R_E$ , and to the finite branchings  $(f, e, g)$  of  $S$  modulo  $E$ .

**5.2.2. Decreasingness modulo.** Following [119, Definition 3.3], we introduce a notion of decreasingness for a diagram of confluence modulo. Let  $(R, E, S)$  be a linear  $(3, 2)$ -polygraph modulo equipped with a well-founded labelling modulo  $(X, <, \psi)$  of  $S$ . A local branching  $(f, g)$  (resp.  $(f, e)$ ) of  $S$  modulo  $E$  is decreasing modulo  $E$  if there exists confluence diagrams of the following form

$$\begin{array}{ccc} \xrightarrow{f} & \xrightarrow{f'} & \xrightarrow{g''} & \xrightarrow{h_1} \\ \parallel \downarrow & & & \downarrow e' \\ \xrightarrow{g} & \xrightarrow{g'} & \xrightarrow{f''} & \xrightarrow{h_2} \end{array}, \quad (\text{resp. } \begin{array}{ccc} \xrightarrow{f} & \xrightarrow{f'} & \xrightarrow{h_1} \\ e \downarrow & & \downarrow e' \\ \xrightarrow{\quad} & \xrightarrow{\quad} & \xrightarrow{h_2} \end{array})$$

such that the following properties hold:

- i)  $k < \psi(f)$  for all  $k$  in  $L^X(f')$ .
- ii)  $k < \psi(g)$  for all  $k$  in  $L^X(g')$ .
- iii)  $f''$  is an identity or a rewriting step labelled by  $\psi(f)$ .
- iv)  $g''$  is an identity or a rewriting step labelled by  $\psi(g)$ .
- v)  $k < \psi(f)$  or  $k < \psi(g)$  for all  $k$  in  $L^X(h_1) \cup L^X(h_2)$  (resp.  $k \leq \psi(f)$  for any  $k$  in  $L^X(h_2)$  and  $k' < \psi(f)$  for any  $k'$  in  $L^X(h_1)$ ).

**5.2.3 Remark.** Note that the definition of decreasingness for a local branching  $(f, g)$  where  $f$  and  $g$  are positive 3-cells in  $S^{\ell(1)}$  is the same than decreasingness of a local branching in Section 2.2.7. This definition is enlarged for a local branching  $(f, e)$  where  $f$  is a positive 3-cell in  $S^{\ell(1)}$  and  $E$  is a 3-cell in  $E^\ell$  of length 1 with the large inequality  $k \leq \psi(f)$  in order to make sure that critical branchings of the form  $(f, e)$  are decreasing with respect to the quasi-normal form labelling  $\psi^{\text{QNF}}$  defined in Section 2.2.3 when rewriting with a linear  $(3, 2)$ -polygraph modulo  $(R, E, S)$  such that  ${}_{\varepsilon}R \subseteq S$ . Indeed, recall from [43, Section 3.1] that in this case these critical branchings are trivially confluent from (4.15). In that case,  $h_2 := e^- \cdot f$  has the same label than  $f$  for  $\psi^{\text{QNF}}$ , but we require that this confluence diagram is decreasing.

Such a diagram is called a decreasing confluence diagram of the branching modulo  $(f, e, g)$ . A linear  $(3, 2)$ -polygraph modulo  $(R, E, S)$  is *decreasing* if there exists a well-founded labelling  $(X, <, \psi)$  of  $R$  making all the local branchings  $(f, e, g)$  of  $S$  modulo  $E$  decreasing. It was proven in [2, Theorem 4.3.3], following the original proof by Van Oostrom for an abstract rewriting system [119], that any decreasing left-monomial linear  $(3, 2)$ -polygraph  $P$  is confluent. We adapt these proofs to establish the following result:

**5.2.4 Theorem.** Let  $(R, E, S)$  be a left-monomial linear  $(3, 2)$ -polygraph modulo. If  $(R, E, S)$  is decreasing, then  $S$  is confluent modulo  $E$ .

Let us at first prove the following two lemmas:

**5.2.5 Lemma.** Let  $(R, E, S, X, <, \psi)$  be a decreasing labelled linear  $(3, 2)$ -polygraph modulo. For every diagram of the following form

$$\begin{array}{ccccc}
 & & f_1 & \longrightarrow & & f_2 & \longrightarrow & \\
 & & \downarrow & & \downarrow & & & \\
 \parallel & & & & \parallel & & & \\
 & & f_1 & \longrightarrow & & f'_1 & \longrightarrow & \\
 e_1 & & \downarrow & & \downarrow & & e'_1 & \\
 & & g_1 & \longrightarrow & & g'_1 & \longrightarrow & \\
 & & & & & & & 
 \end{array}$$

such that the confluence modulo  $(f_1 \star_2 f'_1, g_1 \star_2 g'_1)$  is decreasing, the inequality

$$|(f'_1, f_2)| \leq_{\text{mult}} |(g_1, f_1 \star_2 f_2)|$$

holds.

*Proof.* By Lemma 2.2.5 ix), we get the following inequality:

$$|(f'_1, f_2)| = |(f'_1, f_2)| \cap \vee |f_1| \cup |(f'_1, f_2)| - \vee |f_1|.$$

Since  $\vee |f_1| <_{\text{mult}} |f_1|$ , we get that

$$|(f'_1, f_2)| <_{\text{mult}} |f_1| \cup |((f'_1)^{(f_1)}, f_2^{(f_1)})| = |f_1 \star_2 f'_1| \cup |f_2^{(f_1)}|.$$

Finally, we get from the decreasingness assumption that

$$|f_1 \star_2 f'_1| \cup |f_2^{(f_1)}| \leq_{\text{mult}} |(f_1, e_1, g_1)| \cup |f_2^{(f_1)}| = |(g_1, f_1 \star_2 f_2)|.$$

□

**5.2.6 Lemma.** Let  $(R, E, S, X, <, \psi)$  be a decreasing labelled linear  $(3, 2)$ -polygraph modulo. For every diagram of the following form

$$\begin{array}{ccccccc}
 & & f_1 & \longrightarrow & & f_2 & \longrightarrow & & h & \longrightarrow & \\
 & & \downarrow & & \downarrow & & & & & & \downarrow e_2 \\
 \parallel & & & & \parallel & & & & & & \\
 & & f_1 & \longrightarrow & & f'_1 & \longrightarrow & & & & \\
 e_1 & & \downarrow & & \downarrow & & e'_1 & & & & \\
 & & g_1 & \longrightarrow & & g'_1 & \longrightarrow & & g_2 & \longrightarrow & \\
 & & & & & & & & & & 
 \end{array}$$

such that the confluence  $(f'_1, e'_1, g'_1)$  and  $(f_2 \star_2 h, e_2, g_2)$  are decreasing, i.e. the following inequalities hold:

**a)**  $|g_1 \star_2 g'_1| \leq_{\text{mult}} |(f_1, e_1, g_1)|$  and  $|f_1 \star_2 f'_1| \leq_{\text{mult}} |(f_1, e_1, g_1)|$ ,

**b)**  $|f'_1 \star_2 e'_1 \star_2 g_2| \leq_{\text{mult}} |(f'_1, f_2)|$  and  $|f_2 \star_2 h| \leq_{\text{mult}} |(f'_1, f_2)|$

Then the following inequalities hold:

$$|g_1 \star_2 g'_1 \star_2 g_2| \leq_{\text{mult}} |(f_1 \star_2 f_2, e_1, g_1)| \quad \text{and} \quad |f_1 \star_2 f_2 \star_2 h| \leq_{\text{mult}} |(f_1 \star_2 f_2, e_1, g_1)|$$

*Proof.* To shorten the notations in this proof, we will denote the 2-cell  $f \star_2 g$  by simply  $fg$ . For the second inequality, we get that

$$\begin{aligned} |f_1 f_2 h| &= |f_1 f_2| \cup |h^{(f_1 f_2)}| = |f_1 f_2| \cup |h^{(f_1)(f_2)}| \\ &\leq_{\text{mult}} |f_1 f_2| \cup |(f'_1)^{(f_1)}| \end{aligned}$$

since  $|h^{(f_2)}| \leq_{\text{mult}} |f'_1|$  and  $|f_1 f'_1| \leq_{\text{mult}} |f_1| \cup |g_1|$  respectively by properties **b)** and **a)**. For the first inequality, we have by Lemma 2.2.5 **ix)** that

$$|g_1 g'_1 g_2| = |g_1 g'_1| \cup |g_2^{(g_1 g'_1)}| = |g_1 g'_1| \cup \left[ \left( |g_2^{(g_1 g'_1)}| \cap \vee f_1 \right) \cup \left( |g_2^{(g_1 g'_1)}| - \vee f_1 \right) \right].$$

We deduce from [119, Claim in Lemma 3.5] the following two inequalities, that we do not detail here:

$$|g_1 g'_1 g_2| \leq_{\text{mult}} |g_1| \cup |f_1| \cup |g_2^{(g_1 g'_1)(f_1)}| \leq_{\text{mult}} |g_1| \cup |f_1| \cup |g_2^{(f'_1)(f_1)}|.$$

Since  $|g_2^{(f'_1)}| \leq_{\text{mult}} |f_2|$  by **b)**, we finally get that

$$|g_1 g'_1 g_2| \leq_{\text{mult}} |g_1| \cup |f_1| \cup |f_2^{(f_1)}| = |g_1| \cup |f_1 f_2| = |(f_1 f_2, e_1, g_1)|.$$

□

Before proving Theorem 5.2.4, let us also establish the following preliminary lemma:

**5.2.7 Lemma.** *Let  $(R, E, S, X, <, \psi)$  be a decreasing labelled linear  $(3, 2)$ -polygraph modulo. For any branching  $(f, e, g)$  of  $S$  modulo  $E$  with  $f$  and  $g$  positive 3-cells in  $S^{\ell(1)}$  and  $e$  a 3-cell in  $E^\ell$  of length 1, there exist a confluence  $(f', e', g')$  of this branching such that*

$$|f \star_2 f'| \leq_{\text{mult}} |(f, e, g)| \quad \text{and} \quad |g \star_2 g'| \leq_{\text{mult}} |(f, e, g)|$$

*Proof.* Let us denote by  $(X, <, \psi)$  the well-founded labelling on  $S$  making it decreasing. We consider such a branching  $(f, e, g)$  of  $S$  modulo  $E$ , and we prove this result by well-founded induction, assuming that it is true for any branching  $(f'', e'', g'')$  of  $S$  modulo  $E$  such that  $|(f'', e'', g'')| <_{\text{mult}} |(f, e, g)|$ .

The local branching  $(f, e)$  of  $S$  modulo  $E$  being decreasing by assumption, there exist positive 3-cells  $f', f'_1$  and  $h_2$  in  $S^\ell$  such that  $k \leq \psi((f)$  for any  $k$  in  $L^X(h_2)$ . Let us fix a decomposition  $h_2 = h_2^1 \star_2 h_2^2$  where  $h_2$  is a positive 3-cell in  $S^{\ell(1)}$ . Then  $(h_2^1, g_1)$  is a local branching of  $S$  modulo  $E$  and by decreasingness, there exist a decreasing confluence of this local branching, as depicted in the following diagram:

$$\begin{array}{ccccc} & f_1 & \rightarrow & f' & \rightarrow & f'_1 & & \\ e_1 & \downarrow & & & & & \downarrow & e'_1 \\ & h_2^1 & \rightarrow & & & h_2^2 & \rightarrow & \\ \parallel & \downarrow & & \parallel & & & \downarrow & \\ & h_2^1 & \rightarrow & & & k_1 & \rightarrow & \\ \parallel & \downarrow & & \parallel & & & \downarrow & e_2 \\ & g_1 & \rightarrow & & & g'_1 & \rightarrow & \end{array}$$

By decreasingness of  $(f, e)$ , we have that  $|h_2^2| \leq_{\text{mult}} |f_1|$  and by decreasingness of  $(h_2^1, g)$ , we have that  $|k_1| <_{\text{mult}} |g_1|$  so that  $|(f, e, g)| <_{\text{mult}} |(h_2^2, k_1)|$  and by induction, this branching admits a confluence  $(h_3, e_3, k_2)$  satisfying

$$|h_2^2 \star_2 h_3| \leq_{\text{mult}} |(h_2^2, k_1)| \quad \text{and} \quad |k_1 \star_3 k_2| \leq_{\text{mult}} |(h_2^2, k_1)|$$

We can now repeat the same process on the branchings  $((e'_1)^-, h_3)$  and  $(e_2, k_2)$  to obtain a confluence modulo of these branchings as follows:

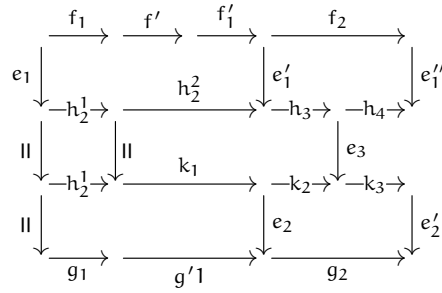

One can repeat this process, however it terminates in finitely many steps, otherwise this would lead to infinite sequences  $(h_n)_{n \in \mathbb{N}}$  and  $(k_n)_{n \in \mathbb{N}}$  satisfying

$$|f| \leq_{\text{mult}} |h_2| <_{\text{mult}} |h_3| \leq_{\text{mult}} |h_4| <_{\text{mult}} |h_5| \dots, \quad |g| <_{\text{mult}} |k_1| <_{\text{mult}} |k_2| \dots$$

yielding two infinite strictly decreasing sequences for  $<_{\text{mult}}$ , which is impossible since by assumption,  $<$  is well-founded and then so is  $<_{\text{mult}}$  as explained in section 2.2.4.  $\square$

Let us now prove Theorem 5.2.4:

*Proof.* Let us denote by  $(X, <, \psi)$  the well-founded labelling on  $S$  making it decreasing. We consider a branching  $(f, e, g)$  of  $S$  modulo  $E$  such that  $f$  and  $g$  are positive 3-cells of  $S^\ell$ . We prove by well-founded induction on the labels that  $(f, e, g)$  can be completed into a confluence modulo diagram with positive 3-cells  $f', g'$  in  $S^\ell$  and a 3-cell  $e'$  in  $E^\ell$  such that

$$|f \star_2 f'| \leq_{\text{mult}} |(f, e, g)|, \quad \text{and} \quad |g \star_2 g'| \leq_{\text{mult}} |(f, e, g)| \quad (5.1)$$

We assume that for any branching  $(f'', e'', g'')$  of  $S$  modulo  $E$  such that  $|(f'', e'', g'')| <_{\text{mult}} |(f, e, g)|$ , there exists a decreasing confluence modulo of the branching  $(f'', e'', g'')$ . Let us choose decompositions  $f = f_1 \star_2 f_2$  and  $g = g_1 \star_2 g_2$  where  $f_1, g_1$  belong to  $S^{\ell(1)}$  and  $f_2$  and  $g_2$  are in  $S^\ell$ . By Lemma 5.2.7, the branching  $(f_1, e, g_1)$  admits a confluence modulo  $(f'_1, e_1, g'_1)$  satisfying the conditions of (5.1), as depicted on the following diagram:

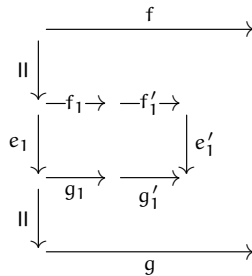

Using Lemma 5.2.5, we get that  $|f_2| \cup |f'_1| <_{\text{mult}} |(f, e, g)|$  and  $|g_2| \cup |g'_1| <_{\text{mult}} |(f, e, g)|$  so that by induction on the branchings  $(f_2, f'_1)$  and  $(g'_1, g_2)$ , there exist positive 3-cells  $f_3, f'_2, g_3, g'_2$  in  $S^\ell$  satisfying the conditions of (5.1) and 3-cells  $e_2, e'_2$  in  $E^\ell$  as in the following diagram:

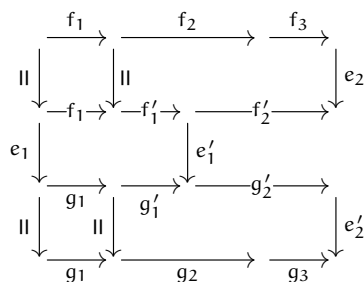

Now, either there is a 2-cell  $e''' : t_2(e_2) \rightarrow s_2(e'_2)$  in  $E^\ell$ , and the confluence diagram obtained satisfy the conditions of (5.1) using Lemma 5.2.6 on the top part of the diagram and decreasingness of the confluence modulo  $(g'_2, e'_2, g_3)$ . Otherwise, the branching  $(f'_2, e'_1, g'_2)$  is a branching of  $S$  modulo  $E$  whose label is strictly smaller than  $|(f, e, g)|$  with respect to  $<_{\text{mult}}$  by construction. Applying induction on this branching, there exists a confluence modulo  $(f'_3, e_3, g'_3)$  of this branching satisfying the conditions of (5.1). Then, we may still apply induction on the branchings  $(e_2, f'_3)$  and  $(e'_2, g'_3)$  of  $S$  modulo  $E$ , whose respective multisets  $|f'_3|$  and  $|g'_3|$  are strictly smaller than  $|(f, e, g)|$  with respect to  $<_{\text{mult}}$  by construction. We get the following situation:

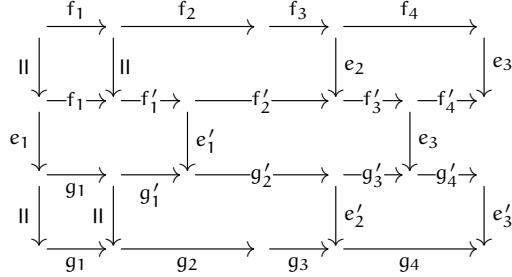

This process can be repeated, however it terminates in finitely many steps to reach a confluence modulo of the branching  $(f, e, g)$ , using a similar argument than in the proof of Lemma 5.2.7. This confluence modulo satisfy the properties of (5.1) from successive use of Lemmas 5.2.5 and 5.2.6.  $\square$

### 5.3. REWRITING MODULO ISOTOPIES IN PIVOTAL LINEAR $(2, 2)$ -CATEGORIES

**5.3.1. Example: Convergent Linear  $(3, 2)$ -polygraphs of isotopies.** We define a linear  $(3, 2)$ -polygraph whose 3-cells correspond of the isotopy axioms of a pivotal 2-category, with respect to a set  $I$  labelling the strands of the string diagrams, and cyclic 2-cells. Following Section 4.3.3, this is a prototypical example of polygraph for which we will rewrite modulo in order to present pivotal linear  $(2, 2)$ -categories. Let  $\mathcal{C}_I$  be the pivotal linear  $(2, 2)$ -category defined by

- a set  $\mathcal{C}_0$  of 0-cells denoted by  $x, y, \dots$
- two families of 1-cells  $E_i : x_i \rightarrow y_i$  and  $F_i : y_i \rightarrow x_i$  indexed by  $I$  such that  $E_i \vdash F_i \vdash E_i$ . Note that the identity 2-cells on  $E_i$  and  $F_i$  are respectively diagrammatically depicted by:

$$1_{E_i} := \begin{array}{c} \uparrow \\ x_i \vdash y_i \\ \uparrow \\ i \end{array} \quad 1_{F_i} := \begin{array}{c} \downarrow \\ y_i \vdash x_i \\ \downarrow \\ i \end{array}$$

- units and counits 2-cells  $\varepsilon_i^+ : E_i \star_0 F_i \Rightarrow 1, \eta_i^+ : 1 \Rightarrow E_i \star_0 F_i, \varepsilon_i^- : F_i \star_0 E_i \Rightarrow 1$  and  $\eta_i^- : 1 \Rightarrow F_i \star_0 E_i$  satisfying the bidualjunction relations, where the labels of regions are easily deduced and omitted:

$$\begin{array}{c} \varepsilon_i^+ \\ \uparrow \\ i \end{array} = \begin{array}{c} \uparrow \\ i \end{array} = \begin{array}{c} \eta_i^+ \\ \uparrow \\ i \end{array} \quad \begin{array}{c} \varepsilon_i^- \\ \downarrow \\ i \end{array} = \begin{array}{c} \downarrow \\ i \end{array} = \begin{array}{c} \eta_i^- \\ \downarrow \\ i \end{array}$$

- cyclic 2-cells  $\alpha_i : E_i \Rightarrow E_i$  and  $\beta_i : F_i \Rightarrow F_i$  with respect to the bidualjunction  $E_i \vdash F_i \vdash E_i$ , respectively represented by a dot on an upward strand or on a downward strand labelled by  $i$ . By definition, cyclicity yields the following relations:

$$\begin{array}{c} \beta_i \\ \uparrow \\ i \end{array} = \begin{array}{c} \uparrow \\ i \end{array} \alpha_i = \begin{array}{c} \beta_i \\ \uparrow \\ i \end{array} \quad \begin{array}{c} \alpha_i \\ \downarrow \\ i \end{array} = \begin{array}{c} \downarrow \\ i \end{array} \beta_i = \begin{array}{c} \alpha_i \\ \downarrow \\ i \end{array}$$

Note that we can omit the labels  $\alpha_i$  and  $\beta_i$  on the dots, since the label on a dot is uniquely determined by the label of the strand and the orientation of the segment of strand on which the dot is placed. We define the 3-polygraph of isotopies  $E_I$  presenting the category  $\mathcal{C}_I$  as follows:

- the 0-cells of  $E_I$  are the 0-cells of  $\mathcal{C}_0$ .
- the generating 1-cells of  $E_I$  are the  $E_i$  and  $F_i$  for  $i \in I$ , and the 1-cells of  $E_I$  are given by sequences  $(E_i^\pm, E_j^\pm, E_k^\pm, \dots)$  with  $E^+ = E$  and  $E^- = F$ .
- the generating 2-cells of  $E_I$  are given by cup and cap 2-cells  $\varepsilon_i^+, \eta_i^+, \varepsilon_i^-, \eta_i^-$ , and cyclic 2-cells  $\alpha_i$  depicted by an upward strand decorated by a dot and labelled by  $i$ , and its bidual  $\beta_i$  represented by a downward strand decorated by a dot and labelled by  $i$ .
- the 3-cells of  $E_I$  are given by:

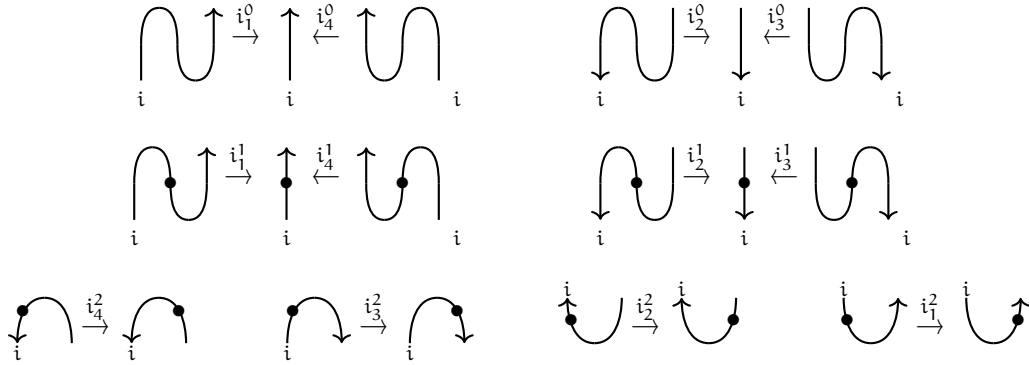

Note that the last family of relations (dot moves on caps and cups) are direct consequences of the first families of relations. However, without these 3-cells the linear  $(3, 2)$ -polygraph would not be convergent. With these 3-cells, the linear  $(3, 2)$ -polygraph  $E_I$  is confluent, the proof being similar to the proof of confluence of the 3-polygraph of pearls in [51]. Indeed, the 3-polygraph  $\mathbb{P}$ pearl of pearls of [51] is actually an instance of  $E_I$  where the set  $I$  is the singleton. As the critical branchings are considered on diagrams with the same label on each strand, there is a family of critical branchings given by  $\mathbb{P}$ pearl for any  $i \in I$ , and they are all proved confluent in the same way.

**5.3.2. Termination of  $E_I$ .** For instance, following the proof of termination for the 3-polygraphs of pearls in [51, Section 5.5.1], one proves that the linear  $(3, 2)$ -polygraph  $E_I$  of isotopies defined Section in 5.3.1 is terminating, in two steps:

- i) At first, if we consider the derivation

$$d(\cdot) = \|\cdot\|_{\{\varepsilon_i^-, \varepsilon_i^+, \eta_i^-, \eta_i^+\}}$$

into the trivial module  $M_{*,*,\mathbb{Z}}$  counting the number of oriented caps and cups of a diagram. This enables to reduce the termination of  $E_I$  to the termination of the linear  $(3, 2)$ -polygraph  $E'_I$  having for 3-cells the  $i_k^2$  for  $1 \leq k \leq 4$ .

- ii) The polygraph  $E'_I$  terminates, using the 2-functors  $X$  and  $Y$  and the derivation  $d$  into the  $(E_I)_2^*$ -module  $M_{X,Y,\mathbb{Z}}$  given by:

$$\begin{aligned} X \left( \begin{array}{c} | \\ | \end{array} \right) &= \mathbb{N}, & X \left( \begin{array}{c} \cap \\ \cap \end{array} \right) (i, j) &= (0, 0), & X \left( \begin{array}{c} | \\ \bullet \\ | \end{array} \right) (i) &= i + 1 \\ Y \left( \begin{array}{c} | \\ | \end{array} \right) &= \mathbb{N}, & Y \left( \begin{array}{c} \cup \\ \cup \end{array} \right) (i, j) &= (0, 0), & Y \left( \begin{array}{c} | \\ \bullet \\ | \end{array} \right) (i) &= i + 1 \end{aligned}$$

$$d\left(\cap\right)(i, j) = i, \quad d\left(\cup\right)(i, j) = i, \quad d\left(\begin{array}{c} | \\ \bullet \\ | \end{array}\right)(i, j) = 0$$

for any orientation of the strands and any label on it. The required inequalities of Section 2.8.9 are proved in [51].

## 5.4. LINEAR BASES FROM CONFLUENCE MODULO

We give a method to compute a hom-basis for a linear  $(2, 2)$ -category  $\mathcal{C}$  from a presentation of  $\mathcal{C}$  by a linear  $(3, 2)$ -polygraph  $P$  admitting a convergent subpolygraph  $E$  such that the polygraph with set of 3-cells  $R_3 = P_3 \setminus E_3$  is confluent modulo  $E$ , and  ${}_E R_E$  is terminating, or quasi-terminating.

**5.4.1. Splitting of a polygraph.** Given a linear  $(3, 2)$ -polygraph  $P$ , recall that a *subpolygraph* of  $P$  is a linear  $(3, 2)$ -polygraph  $P'$  such that  $P'_i \subseteq P_i$  for any  $0 \leq i \leq 3$ . A *splitting* of  $P$  is a pair  $(E, R)$  of linear  $(3, 2)$ -polygraphs such that:

- i)  $E$  is a subpolygraph of  $P$  such that  $E_{\leq 1} = P_{\leq 1}$ ,
- ii)  $R$  is a linear  $(3, 2)$ -polygraph such that  $R_{\leq 2} = P_{\leq 2}$  and  $P_3 = R_3 \coprod E_3$ .

Such a splitting is called *convergent* if we require that  $E$  is convergent. Note that any linear  $(3, 2)$ -polygraph  $P$  admits a convergent splitting given by  $(P_0, P_1, P_2, \emptyset)$  and  $(P_0, P_1, P_2, P_3)$ . It is not unique in general. The data of a convergent splitting of a linear  $(3, 2)$ -polygraph  $P$  gives two distinct linear  $(3, 2)$ -polygraphs  $R = (P_0, P_1, P_2, R_3)$  and  $E = (P_0, P_1, E_2, E_3)$  satisfying  $R_{\leq 1} = E_{\leq 1}$  and  $E_2 \subseteq P_2$ , so that we can construct a linear  $(3, 2)$ -polygraph modulo from  $R$  and  $E$ . Note that when  $P$  is left-monomial, if  $(E, R)$  is a splitting of  $P$ , then both  $E$  and  $R$  are left-monomial.

**5.4.2. Normal forms modulo.** Let us consider a linear  $(3, 2)$ -polygraph  $P$  presenting a linear  $(2, 2)$ -category  $\mathcal{C}$ ,  $(E, R)$  a convergent splitting of  $P$  and  $(R, E, S)$  a normalizing linear  $(3, 2)$ -polygraph modulo such that  $S$  is confluent modulo  $E$ .

$S$  being normalizing, each 2-cell  $u$  of  $R_2^\ell$  admits at least one normal form with respect to  $E$ , and all these normal forms are congruent with respect to  $E$ . We fix such a normal form that we denote by  $\widehat{u}$ , with the convention that if  $u$  is already a normal form with respect to  $E$ , then  $\widehat{u} = u$ . By convergence of  $E$ , any 2-cell  $u$  of  $R_2^\ell$  admits a unique normal form with respect to  $E$ , that we denote by  $\widetilde{u}$ . Note that when  $S$  is confluent modulo  $E$ , the element  $\widetilde{u}$  does not depend on the chosen normal form  $\widehat{u}$  for  $u$  with respect to  $S$ , since two normal forms of  $u$  being equivalent with respect to  $E$ , they have the same normal form with respect to  $E$ . A *normal form for*  $(R, E, S)$  of a 2-cell  $u$  in  $R_2^\ell$  is a 2-cell  $v$  such that  $v$  appears in the monomial decomposition of  $\widetilde{w}$  where  $w$  is a monomial in the support of  $\widehat{u}$ . Given a 2-cell  $u$  in  $R_2^\ell$ , we denote by  $\text{NF}_{(R, E, S)}(u)$  the set of all normal forms of  $u$  for  $(R, E, S)$ . Such a set is obtained by reducing  $u$  into its chosen normal form with respect to  $S$ , then taking all the monomials appearing in the  $E$ -normal form of each element in  $\text{Supp}(\widehat{u})$ . Note that when  $E$  is also right-monomial, the  $E$ -normal form of a monomial in normal form with respect to  $S$  already is a monomial. In particular, this is the case when  $E$  is the polygraph of isotopies described in 5.3.1.

**5.4.3 Lemma.** *Let  $P$  be a left-monomial linear  $(3, 2)$ -polygraph,  $(E, R)$  be a convergent splitting of  $P$  and  $(R, E, S)$  be a normalizing left-monomial linear  $(3, 2)$ -polygraph modulo such that  $S$  is confluent modulo  $E$ , and let  $\mathcal{C}$  be the category presented by  $P$ . Then, for any parallel 1-cells  $x$  and  $y$  in  $R_1^*$ , the map  $\gamma_{x, y} : R_2^\ell(x, y) \rightarrow \mathcal{C}(x, y)$  sending each 2-cell to its congruence class in  $\mathcal{C}$  has for kernel the subspace of  $R_2^\ell$  made of 2-cells  $u$  such that  $\widetilde{u} = 0$ .*

*Proof.* Let us denote by  $N$  the set  $\{u \in R_2^\ell ; \tilde{u} = 0\}$ . Then  $N \subseteq \text{Ker}(\gamma)$  since if  $u \in N$ , there exist positive 3-cells  $f$  in  $E^\ell$  and  $e$  in  $E^\ell$  such that

$$u \xrightarrow{f} \hat{u} \xrightarrow{e} \tilde{u} = 0$$

Thus by definition of  $S$  there exist a zig-zag sequence of rewriting steps either of  $R$  or  $E$  between  $u$  and  $0$ , so that  $\bar{u} = 0$  in  $\mathcal{C}$  and  $u$  belongs to  $\text{Ker}(\gamma)$ . Conversely, if  $u$  belongs to  $\text{Ker}(\gamma)$ , that is  $\pi(u) = 0$  where  $\pi : R_2^\ell \rightarrow \mathcal{C}$  is the canonical projection, there is a zig-zag sequence of rewriting steps  $(f_i)$  for  $0 \leq i \leq n$  with  $f_i$  being either a rewriting step of  $R$  or a rewriting step of  $E$  such that

$$u \xrightarrow{f_1} u_1 \xleftarrow{f_2} u_2 \quad \dots \xrightarrow{f_{n-2}} u_{n-1} \xleftarrow{f_{n-1}} u_n \xrightarrow{f_n} v$$

$S$  being confluent modulo  $E$ , it is Church-Rosser modulo  $E$  from 2.3.12, and then by 2.3.11, we get that there exist rewriting sequences  $f : u \rightarrow \hat{u}$  and  $g : 0 \rightarrow \hat{0}$  in  $S^\ell$  and a 3-cell  $e : \hat{v} \rightarrow \hat{0}$  in  $E^\ell$ . As  $S$  is left-monomial,  $0$  is a normal form with respect to  $S$  so that  $\hat{0} = 0$ . Then  $\hat{u}$  and  $0$  are equivalent with respect to  $E$  so that, by convergence of the linear  $(3, 2)$ -polygraph  $E$ , we get that  $\tilde{u} = \tilde{0}$ , and similarly  $\tilde{0} = 0$  since  $E$  is left-monomial and  $0$  is a normal form with respect to  $E$ . This finishes the proof.  $\square$

We then obtain the following result:

**5.4.4 Theorem.** *Let  $P$  be a linear  $(3, 2)$ -polygraph presenting a linear  $(2, 2)$ -category  $\mathcal{C}$ ,  $(E, R)$  a convergent splitting of  $P$  and  $(R, E, S)$  a linear  $(3, 2)$ -polygraph modulo such that*

- i)  $S$  is normalizing,
- ii)  $S$  is confluent modulo  $E$ ,

*then the set of all normal forms for  $(R, E, S)$  is a hom-basis of  $\mathcal{C}$ .*

*Proof.* Let us denote by  $B$  the set of  $E$ -normal forms of all monomials in normal forms with respect to  $S$ , and let  $B^{\text{Mon}}$  be the set of all normal forms for  $(R, E, S)$ . Note that by definition,  $B^{\text{Mon}}$  is obtained by considering all the 2-cells in the support of the elements of  $B$ . Since  $S$  is left-monomial, each normal form in  $R_2^\ell$  can be decomposed into a linear combination of monomials in normal form with respect to  $S$ , and by left-monomiality of  $E$ , we get that an element of  $B$  is a linear combination of monomials in  $B^{\text{Mon}}$ , so that  $B^{\text{Mon}}$  is a basis of  $B$ . For any 1-cells  $p$  and  $q$  of  $\mathcal{C}$ , the map  $\gamma_{x,y} : R_2^\ell(p, q) \rightarrow \mathcal{C}_2(p, q)$  is surjective by definition, each 2-cell of  $\mathcal{C}_2(p, q)$  having at least one representative in  $R_2^\ell(p, q)$ . Moreover, the restriction of  $\gamma_{p,q}$  to the subvector space  $B$  of  $R_2^\ell$  has for kernel  $B \cap \text{Ker}(\gamma_{p,q})$ , which is reduced to  $\{0\}$  by confluence modulo  $E$  of  $S$ , using Lemma 5.4.3. This proves that  $(\gamma_{p,q})|_B$  is a bijection between  $B$  and  $\mathcal{C}_2(p, q)$ , and so  $B^{\text{Mon}}$  is a linear basis of  $\mathcal{C}_2(p, q)$ .  $\square$

**5.4.5. Proving confluence modulo under quasi-termination.** Recall from Section 2.9.5 that if  $P$  is a quasi-terminating and exponentiation free linear  $(3, 2)$ -polygraph, then it is locally confluent if and only if all its critical branchings are confluent. This result is extended to the context of rewriting modulo in [31], where a quasi-terminating Newman lemma modulo and a quasi-terminating critical branching lemma is proved, see Theorem 7.4.3 and Proposition 7.4.7 in Chapter 7, in the context of algebraic polygraphs. Moreover, following the proof of [2, Theorem 5.2.5], we can prove the following condition for decreasingness with respect to a quasi-normal form labelling:

**5.4.6 Proposition.** *Let  $(R, E, S)$  be a left-monomial linear  $(3, 2)$ -polygraph modulo such that  ${}_E R_E$  is quasi-terminating and exponentiation free. If all critical branchings of  $S$  modulo  $E$  are decreasing with respect to the quasi-normal form  $\psi^{\text{QNF}}$ , then  $S$  is decreasing.*



**5.4.7. Linear bases under quasi-termination.** Note that both Lemma 5.4.3 and Theorem 5.4.4 have an adaptation in a non-normalizing but quasi-terminating setting. Indeed, instead of fixing a normal form  $\hat{u}$  with respect to  $S$  for any  $u$  in  $R_2^\ell$ , we fix a choice of a quasi-normal form  $\bar{u}$  for  $u$  satisfying  $\bar{u} = u$  if  $u$  already is a quasi-normal form with respect to  $S$ . By confluence modulo,  $u$  and  $v$  are 2-cells of  $R_2^\ell$  such that there is a 3-cell  $e : u \rightarrow v$  in  $E^\ell$ , then the 2-cells  $\bar{u}$  and  $\bar{v}$  are equivalent modulo  $E$ . We then say that a *quasi-normal form* for  $(R, E, S)$  is a monomial appearing in the monomial decomposition of the  $E$ -normal form of a monomial in  $\text{Supp}(\bar{u})$ . With a similar proof than above, we obtain the following result:

**5.4.8 Theorem.** *Let  $P$  be a linear  $(3, 2)$ -polygraph presenting a linear  $(2, 2)$ -category  $\mathcal{C}$ ,  $(E, R)$  a convergent splitting of  $P$  and  $(R, E, S)$  a linear  $(3, 2)$ -polygraph modulo such that*

- i)  $S$  is quasi-terminating,
- ii)  $S$  is confluent modulo  $E$ ,

*Then the set of quasi-normal forms form  $(R, E, S)$  is a hom-basis of  $\mathcal{C}$ .*

---

 Khovanov and Lauda's categorification and rewriting modulo
 

---

**Contents**

---

|            |   |            |
|------------|---|------------|
| <b>6.1</b> | <b>A convergent presentation of the simply-laced KLR algebras . . . . .</b>       | <b>145</b> |
| <b>6.2</b> | <b>Rewriting modulo isotopy in Khovanov-Lauda-Rouquier's 2-category . . . . .</b> | <b>151</b> |

---

Khovanov and Lauda [67], and Rouquier [102] defined a candidate 2-category to be a categorification of Lusztig's idempotent and integral version of a quantum group associated with a symmetrizable Kac-Moody algebra. The first authors established [67, Theorems 1.1 & 1.2] that this 2-category, denoted by  $\mathcal{U}(\mathfrak{g})$ , is indeed a categorification of  $U_q(\mathfrak{g})$  if the diagrammatic calculus they introduce is non-degenerated, which corresponds to the fact that each vector space of 2-cells admits an explicit linear basis. They proved in [67] the non-degeneracy of their calculus for symmetrizable Kac-Moody algebras of type A. The non-degeneracy of this diagrammatic calculus has then been proved for any root datum of finite type and any field  $\mathbb{K}$  independently by Kang and Kashiwara [66], and by Webster [121], using non-degeneracy of cyclotomic quotients of the KLR algebras categorifying highest-weight modules of  $U_q(\mathfrak{g})$ . In this Chapter, we prove the non-degeneracy of their calculus using rewriting modulo methods, for any symmetrizable Kac-Moody algebra associated with a root datum of simply-laced type. However, we expect that this result can be extended to the general case, requiring additional computations due to the fact that some of the relations become more complicated, and thus checking the confluence modulo should be more difficult.

In the process of categorifying a quantum group, a family of algebras called KLR algebras (or Quiver Hecke algebras) appeared, [71, 102]. These algebras act on some endomorphism spaces of the 2-category  $\mathcal{U}(\mathfrak{g})$ , so that the relations of these algebras appear in the 2-category  $\mathcal{U}(\mathfrak{g})$ . In the first part of this Chapter, we study the KLR algebras using the non-modulo rewriting methods developed by Alleaume [2]. In this way, we recover the Poincaré-Birkhoff-Witt bases given by Khovanov and Lauda [71] and Rouquier [102].

In the second part of this Chapter, we split the presentation of  $\mathcal{U}(\mathfrak{g})$  into two parts following the ideas developed in Chapter 5: one containing the isotopy relations coming from the pivotal structure, and one coming from the remaining relations defining  $\mathcal{U}(\mathfrak{g})$ . We then prove that the assumptions of Theorem 5.4.8 are satisfied, so that we are able to deduce, by a choice of quasi-normal forms with respect to the  $\mathcal{U}(\mathfrak{g})$ -relations, the expected basis of each set of 2-cells in  $\mathcal{U}(\mathfrak{g})$ , proving the non-degeneracy of

Khovanov and Lauda's diagrammatic calculus in the simply-laced setting. This Chapter gives all the results of [42].

## 6.1. A CONVERGENT PRESENTATION OF THE SIMPLY-LACED KLR ALGEBRAS

**6.1.1. The sets  $\text{Seq}(\mathcal{V})$  and  $\text{SSeq}(\mathcal{V})$ .** Let  $\mathcal{V} = \sum_{i \in I} \mathcal{V}_i \cdot i \in \mathbb{N}[I]$  be an element of  $\mathbb{N}[I]$ , the free semi-group generated by  $I$ , and let us fix  $m := |\mathcal{V}| = \sum_{i \in I} \mathcal{V}_i$ . We consider the set  $\text{Seq}(\mathcal{V})$  which consists of all sequences of vertices of  $\Gamma$  with length  $m$  in which the vertex  $i$  appears exactly  $\mathcal{V}_i$  times. For instance,  $\text{Seq}(3i + j) = \{iii, iij, ijii, jiii\}$ . There is an action of the symmetric group  $\mathcal{S}_m$  on the set  $\text{Seq}(\mathcal{V})$  defined by

$$s_k \cdot i_1 \dots i_m = i_1 \dots i_{k+1} i_k \dots i_m$$

for any  $1 \leq k \leq m - 1$ , where  $s_k$  denotes the permutation  $(k \ k + 1)$  of  $\mathcal{S}_m$ . We will also consider in Section 6.2 a signed version of this set, with *signed sequences* of vertices of  $\Gamma$ :

$$\mathbf{i} = (\epsilon_1 i_1, \epsilon_2 i_2, \dots, \epsilon_m i_m), \text{ where } \epsilon_1, \dots, \epsilon_m \in \{+, -\} \text{ and } i_1, \dots, i_m \in I.$$

We define  $\text{SSeq}(\mathcal{V})$  to be the set of all such signed sequences. We say that a sequence is *positive* (resp. *negative*) if all signs  $\epsilon_i$  are positive (resp. negative).

**6.1.2. The KLR algebras.** We recall here Rouquier's algebraic definition of the KLR algebras [102, Def 3.2.1] and their diagrammatic interpretation provided by Khovanov and Lauda in [71]. Let  $Q = (Q_{i,j})_{i,j \in I}$  a matrix with coefficients in  $\mathbb{K}[u, v]$ , where  $u$  and  $v$  are indeterminates, such that  $Q_{i,i} = 0$  for any  $i$  in  $I$ . For any  $\mathcal{V}$  in  $\mathbb{N}[I]$ , we define a (possibly non-unitary)  $\mathbb{K}$ -algebra  $H_{\mathcal{V}}(Q)$  by generators and relations. It is generated by elements  $1_i, x_{k,i}$  for  $k \in \{1, \dots, n\}$  and  $\tau_{k,i}$  for  $k \in \{1, \dots, n - 1\}$  and  $\mathbf{i} \in \text{Seq}(\mathcal{V})$ . The relations are:

- i)  $1_i 1_j = \delta_{i,j} 1_i$
- iv)  $x_{k,i} x_{l,i} = x_{l,i} x_{k,i}$
- ii)  $\tau_{k,i} = 1_{s_k(i)} \tau_{k,i} 1_i$
- v)  $\tau_{k,s_k(i)} \tau_{k,i} = Q_{i_k, i_{k+1}}(x_{k,i}, x_{k+1,i})$
- iii)  $x_{k,i} = 1_i x_{k,i} 1_i$
- vi)  $\tau_{k,s_l(i)} \tau_{l,i} = \tau_{l,s_k(i)} \tau_{k,i}$  if  $|k - l| > 1$
- vii)  $\tau_{k,i} x_{l,i} - x_{s_k(l), s_k(i)} \tau_{k,i} = \begin{cases} -1_i & \text{if } l = k \text{ and } i_k = i_{k+1} \\ 1_i & \text{if } l = k + 1 \text{ and } i_k = i_{k+1} \\ 0 & \text{otherwise.} \end{cases}$
- viii)  $\tau_{k+1, s_k s_{k+1}(i)} \tau_{k, s_{k+1}(i)} \tau_{k+1, i} - \tau_{k, s_{k+1} s_k(i)} \tau_{k+1, s_k(i)} \tau_{k, i} = \begin{cases} (x_{k+2, i} - x_{k, i})^{-1} (Q_{i_k, i_{k+1}}(x_{k+2, i}, x_{k+1, i}) - Q_{i_k, i_{k+1}}(x_{k, i}, x_{k+1, i})) & \text{if } i_k = i_{k+2} \\ 0 & \text{otherwise} \end{cases}$

Khovanov and Lauda gave in [71] a definition of a ring associated with an element  $\mathcal{V} \in \mathbb{N}[I]$ , denoted in the sequel by  $R(\mathcal{V})$ , which is a specialization of Rouquier's algebra  $H_{\mathcal{V}}(Q)$  in which

$$Q_{i,j}(u, v) = u^{d_{i,j}} + v^{d_{j,i}}, \quad \forall \quad i, j \in I, \text{ where } d_{i,j} = -2 \frac{i \cdot j}{i \cdot i}.$$

In the simply-laced setting, these coefficients are equal to 0 when  $i$  and  $j$  are not linked by an edge in  $\Gamma$ , and to 1 when they are. Moreover, they provide a diagrammatic interpretation for these algebras: for  $\mathbf{i} = i_1 \dots i_m \in \text{Seq}(\mathcal{V})$ , the generators are pictured by the diagrams

$$x_{k,i} = \begin{array}{c} | \dots | \bullet | \dots | \\ i_1 \quad i_k \quad i_m \end{array} \quad \text{and} \quad \tau_{k,i} = \begin{array}{c} | \dots \times \dots | \\ i_1 \quad i_k \quad i_{k+1} \quad i_m \end{array}$$

The relations above are then diagrammatically depicted by:

$$\begin{array}{c} \text{Diagram: two strands } i \text{ and } j \text{ crossing twice} \end{array} = \begin{cases} 0 & \text{if } i = j, \\ \begin{array}{c} | \quad | \\ i \quad j \end{array} & \text{if } i \cdot j = 0, \\ \begin{array}{c} \bullet \quad | \quad | \\ i \quad j \end{array} + \begin{array}{c} | \quad | \quad \bullet \\ i \quad j \end{array} & \text{if } i \cdot j = -1. \end{cases} \quad (6.1)$$

$$\begin{array}{c} \text{Diagram: strand } i \text{ crosses over } j \end{array} = \begin{array}{c} \text{Diagram: strand } j \text{ crosses over } i \end{array} + \delta_{i,j} \begin{array}{c} | \quad | \\ i \quad i \end{array}, \quad \begin{array}{c} \text{Diagram: strand } j \text{ crosses over } i \end{array} = \begin{array}{c} \text{Diagram: strand } i \text{ crosses over } j \end{array} - \delta_{i,j} \begin{array}{c} | \quad | \\ i \quad i \end{array} \quad (6.2)$$

$$\begin{array}{c} \text{Diagram: strands } i, j, k \text{ with crossings} \end{array} = \begin{array}{c} \text{Diagram: strands } i, j, k \text{ with crossings} \end{array} \quad \text{unless } i = k \text{ and } i \cdot j = -1 \quad (6.3)$$

$$\begin{array}{c} \text{Diagram: strands } i, j, i \text{ with crossings} \end{array} - \begin{array}{c} \text{Diagram: strands } i, j, i \text{ with crossings} \end{array} = \begin{array}{c} | \quad | \quad | \\ i \quad j \quad i \end{array} \quad \text{if } i \cdot j = -1 \quad (6.4)$$

By convention, we translate an algebraic expression into a diagram by reading the generators from right to left and the diagrams from bottom to top. Note that the diagrammatic relations correspond, up to a choice of signs in the right hand-sides, to the relations **i) – viii)** above. The first relation corresponds to **v)**, the second relation corresponds to relation **vii)** and the last one corresponds to relation **viii)** for this particular choice of polynomials  $Q_{i,j}$ . The other relations are not taken into account since they are structural relations when the algebra is interpreted as spaces of 2-cells in the linear 2-category  $\mathcal{C}^{\text{KLR}}$  defined in Section 6.1.4. Namely, the first relation corresponds to the fact that  $1_i$  is an identity 2-cell, and the other relations correspond to exchange relations of the linear 2-category  $\mathcal{C}^{\text{KLR}}$ .

**6.1.3 Remark.** We study the case of simply-laced Cartan data for simplicity in the proofs of confluence of critical branchings. In the general case, the KLR relations admit a polynomial right handside, and thus are more complicated to handle. For instance, the relation reducing a double crossing or the Yang-Baxter braid become

$$\begin{array}{c} \text{Diagram: two crossings} \\ i \quad j \end{array} = d_{i,j} \begin{array}{c} \bullet \quad | \quad | \\ i \quad j \end{array} + \begin{array}{c} | \quad | \quad \bullet \\ i \quad j \end{array} d_{j,i}$$

whenever  $i \cdot j \neq 0$ , and

$$\begin{array}{c} \text{Diagram: strands } i, j, k \text{ with crossings} \end{array} = \begin{array}{c} \text{Diagram: strands } i, j, k \text{ with crossings} \end{array} + \sum_{a=0}^{d_{i,j}-1} a \begin{array}{c} \bullet \quad | \quad | \\ i \quad j \quad k \end{array} d_{i,j-1-a}$$

whenever  $i = k$  and  $i \cdot j \neq 0$ . However, we expect that the proof of confluence in the general setting works similarly as in the simply-laced setting, but the confluence of critical branchings is more difficult to ensure due to these relations.

**6.1.4. The KLR algebras in the 2-category  $\mathcal{C}^{\text{KLR}}$ .** Following [71], we consider for any  $\mathbf{i}$  and  $\mathbf{j}$  in  $\text{Seq}(\mathcal{V})$  the set  ${}_j\mathcal{R}(\mathcal{V})_{\mathbf{i}}$  of *braid-like Khovanov-Lauda diagrams* with source  $\mathbf{i}$  and target  $\mathbf{j}$ , given by string diagrams satisfying the following conditions:

- the strands are labelled by vertices of  $\Gamma$ , and reading the labels on the bottom (resp. the top) of the diagram gives the sequence  $\mathbf{i}$  (resp.  $\mathbf{j}$ ),
- a strand does not intersect with itself.

For any  $\mathbf{i}$  and  $\mathbf{j}$  in  $\text{Seq}(\mathcal{V})$ , the set  ${}_j\mathcal{R}(\mathcal{V})_{\mathbf{i}}$  is a  $\mathbb{K}$ -vector space, and we have that  $\mathcal{R}(\mathcal{V}) = \bigoplus_{\mathbf{i}, \mathbf{j} \in \text{Seq}(\mathcal{V})} {}_j\mathcal{R}(\mathcal{V})_{\mathbf{i}}$ .

Let us consider the linear 2-category  $\mathcal{C}^{\text{KLR}}$  defined by:

- i) only one 0-cell denoted by  $*$ ,
- ii) its generating one cells are the elements of  $I$ , and the  $\star_0$  composition of 1-cells is formal concatenation of vertices, so that the 1-cells of  $\mathcal{C}^{\text{KLR}}$  correspond to sequences of vertices of  $I$ .
- iii) its generating 2-cells are given by

$$\begin{array}{c} \diagup \quad \diagdown \\ \text{i} \quad \text{j} \end{array} : \text{i} \star_0 \text{j} \rightarrow \text{j} \star_0 \text{i}, \quad \begin{array}{c} \bullet \\ | \\ \text{i} \end{array} : \text{i} \rightarrow \text{i} \quad (6.5)$$

for any  $\mathbf{i}$  and  $\mathbf{j}$  in  $I$ , so that the 2-cells of  $\mathcal{C}^{\text{KLR}}$  are obtained by all the diagrams one can form by vertical and horizontal compositions of these generating 2-cells. We require that the 2-cells of  $\mathcal{C}^{\text{KLR}}$  are subject to relations (6.1), (6.2), (6.3) and (6.4).

Note that it is clear from the definition of  $\mathcal{C}^{\text{KLR}}$  that if  $\mathbf{i}$  and  $\mathbf{j}$  are sequences of vertices of  $I$  which does not belong to the same set  $\text{Seq}(\mathcal{V})$ , then we have  $\mathcal{C}_2^{\text{KLR}}(\mathbf{i}, \mathbf{j}) = \emptyset$ . When they belong to the same  $\text{Seq}(\mathcal{V})$ , we have  $\mathcal{C}_2^{\text{KLR}}(\mathbf{i}, \mathbf{j}) = {}_j\mathcal{R}(\mathcal{V})_{\mathbf{i}}$ . As a consequence, we have an isomorphism of algebras

$$\mathcal{R}(\mathcal{V}) \simeq \bigoplus_{\mathbf{i}, \mathbf{j} \in \text{Seq}(\mathcal{V})} \mathcal{C}_2^{\text{KLR}}(\mathbf{i}, \mathbf{j})$$

so that for any  $\mathcal{V}$  in  $\mathbb{N}[I]$ , the KLR algebra  $\mathcal{C}^{\text{KLR}}$  is encoded in the linear 2-category  $\mathcal{C}^{\text{KLR}}$ .

**6.1.5. The linear (3, 2)-polygraph KLR.** In this section, we will define linear (3, 2)-polygraphs presenting these simply-laced KLR algebras and prove that they are convergent. Let KLR be the linear (3, 2)-polygraph defined by:

- One 0-cell denoted by  $*$ ,
- Its generating 1-cells are the elements  $i$  of  $I$ ,
- Its generating 2-cells are given by the elements of (6.5),
- Its generating 3-cells are given by the following oriented relations:

- i) For any  $\mathbf{i}, \mathbf{j} \in I$ ,

$$\begin{array}{c} \bullet \\ \diagup \quad \diagdown \\ \text{i} \quad \text{j} \end{array} \xrightarrow{\alpha_{\mathbf{i}, \mathbf{j}}^L} \begin{array}{c} \diagup \quad \diagdown \\ \text{i} \quad \text{j} \\ \bullet \end{array} \quad \text{and} \quad \begin{array}{c} \diagup \quad \bullet \\ \diagdown \\ \text{i} \quad \text{j} \end{array} \xrightarrow{\alpha_{\mathbf{i}, \mathbf{j}}^R} \begin{array}{c} \bullet \\ \diagup \quad \diagdown \\ \text{i} \quad \text{j} \end{array}$$

- ii) For any  $\mathbf{i} \in I$ ,

$$\begin{array}{c} \bullet \\ \diagup \quad \bullet \\ \diagdown \\ \text{i} \quad \text{i} \end{array} \xrightarrow{\alpha_{\mathbf{i}}^L} \begin{array}{c} \bullet \\ \diagup \quad \diagdown \\ \text{i} \quad \text{i} \\ \bullet \end{array} + \begin{array}{c} | \\ | \\ \text{i} \quad \text{i} \end{array} \quad \text{and} \quad \begin{array}{c} \bullet \\ \diagup \quad \bullet \\ \diagdown \\ \text{i} \quad \text{i} \end{array} \xrightarrow{\alpha_{\mathbf{i}}^R} \begin{array}{c} \bullet \\ \diagup \quad \diagdown \\ \text{i} \quad \text{i} \\ \bullet \end{array} - \begin{array}{c} | \\ | \\ \text{i} \quad \text{i} \end{array}$$

iii) For any  $i \in I$ ,

$$\begin{array}{c} \diagup \diagdown \\ \diagdown \diagup \\ i \quad i \end{array} \xRightarrow{\beta_i} 0$$

iv) For any  $i, j \in I$  such that  $i \cdot j = 0$ ,

$$\begin{array}{c} \diagup \diagdown \\ \diagdown \diagup \\ i \quad j \end{array} \xRightarrow{\beta_{i,j}} \begin{array}{c} | \\ | \\ i \quad j \end{array}$$

v) For any  $i, j \in I$  such that  $i \cdot j = -1$ ,

$$\begin{array}{c} \diagup \diagdown \\ \diagdown \diagup \\ i \quad j \end{array} \xRightarrow{\beta_{i,j}} \begin{array}{c} \bullet \\ | \\ i \end{array} + \begin{array}{c} | \\ | \\ j \end{array} + \begin{array}{c} | \\ | \\ i \end{array} + \begin{array}{c} \bullet \\ | \\ j \end{array}$$

vi) For any  $i, j, k \in I$ , and unless  $i = k$  and  $i \cdot j \neq -1$ ,

$$\begin{array}{c} \diagup \diagdown \diagup \diagdown \\ \diagdown \diagup \diagdown \diagup \\ i \quad j \quad k \end{array} \xRightarrow{\gamma_{i,j,k}} \begin{array}{c} \diagup \diagdown \diagup \diagdown \\ \diagdown \diagup \diagdown \diagup \\ i \quad j \quad k \end{array}$$

vii) For any  $i, j \in I$  such that  $i \cdot j = -1$ ,

$$\begin{array}{c} \diagup \diagdown \diagup \diagdown \\ \diagdown \diagup \diagdown \diagup \\ i \quad j \quad i \end{array} \xRightarrow{\gamma_{i,j,k}} \begin{array}{c} \diagup \diagdown \diagup \diagdown \\ \diagdown \diagup \diagdown \diagup \\ i \quad j \quad i \end{array} + \begin{array}{c} | \\ | \\ i \end{array} + \begin{array}{c} | \\ | \\ j \end{array} + \begin{array}{c} | \\ | \\ i \end{array} \cdot$$

We then establish the following result:

**6.1.6 Theorem.** *The linear (3, 2)-polygraph KLR is a convergent presentation of the linear 2-category  $\mathcal{C}^{KLR}$ .*

The 3-cells of KLR are orientations of the relations of  $\mathcal{C}^{KLR}$ , so that KLR is a presentation of  $\mathcal{C}^{KLR}$ . On the one hand, we show that KLR is terminating using the derivation method to prove termination of 3-polygraphs from [51, Thm 4.2.1], extended in the linear setting in [42]. On the other hand, we prove that KLR is confluent by proving confluence of all its critical branchings, using [2, Thm 4.2.13].

**6.1.7. Termination of KLR.** We prove that KLR is terminating using the derivation method given in Section 2.8.9. We consider the internal abelian group  $\mathbb{Z}$  in **Ord** and we set  $Y$  to be the trivial 2-functor, that is the 2-functor sending the generating 1-cell of KLR to the terminal object  $\{0\}$  of **Ord**. We define the values of the 2-functor  $X : \mathbf{KLR}_2^* \rightarrow \mathbf{Ord}$  on generating 1-cells by  $X(i) = \mathbb{N}$  for any  $i \in I$ , so that  $X(i \star_0 j) = \mathbb{N} \times \mathbb{N}$ , and on generating 2-cells by

$$X\left(\begin{array}{c} | \\ | \\ i \end{array}\right)(n) = n \quad X\left(\begin{array}{c} \bullet \\ | \\ i \end{array}\right)(n) = n - 1 \quad X\left(\begin{array}{c} \diagup \diagdown \\ \diagdown \diagup \\ i \quad j \end{array}\right)(n, m) = (m + 1, n)$$

for all  $n, m \in \mathbb{N}$  and for any  $i$  and  $j$  in  $I$ , so that we may omit the labels on the strands when computing values of the functor  $X$ . We consider the  $\mathbf{KLR}_2^*$ -module  $M_{X,*,\mathbb{Z}}$ . The following inequalities hold

$$\begin{aligned} X\left(\begin{array}{c} \diagup \diagdown \diagup \diagdown \\ \diagdown \diagup \diagdown \diagup \end{array}\right)(n, m) &= X\left(\begin{array}{c} \diagup \diagdown \\ \diagdown \diagup \end{array}\right)(m + 1, n) = (n + 1, m + 1) \\ &\geq \max\left(X\left(\begin{array}{c} \bullet \\ | \end{array}\right)(n, m), X\left(\begin{array}{c} | \\ | \end{array}\right)(n, m), X\left(\begin{array}{c} | \\ | \end{array}\right)(n, m)\right) \\ &= \max((n + 1, m), (n, m + 1), (n, m)), \end{aligned}$$

$$X(\text{diagram}) (n, m) = (m, n) \geq (m, n) = \max(X(\text{diagram}), X(\text{diagram})) (n, m),$$

$$X(\text{diagram}) (n, m) = (m + 1, n - 1) \geq (m + 1, n - 1) = \max(X(\text{diagram}), X(\text{diagram})) (n, m),$$

$$X(\text{diagram}) (n, m, l) = (l + 2, m + 1, n) \geq \max(X(\text{diagram}), X(\text{diagram})) (n, m, l).$$

Let us now define the derivation  $d$  of  $\text{KLR}_2^*$  into  $M_{X,*,\mathbb{Z}}$  on the generating 2-cells of  $\text{KLR}$  by setting

$$d\left(\begin{array}{c} | \\ i \end{array}\right) (n) = 0, \quad d\left(\begin{array}{cc} \diagdown & \diagup \\ i & j \end{array}\right) (n, m) = n, \quad d\left(\begin{array}{c} \bullet \\ i \end{array}\right) (n) = n$$

for any  $n, m \in \mathbb{N}$  and any  $i, j \in I$  so that we can omit labels on the strands when computing the derivations on 2-cells of  $\text{KLR}_2^*$ . Following [51], the following inequalities hold:

$$d(\text{diagram}) (n, m) = n + m + 1 > 0 = d\left(\begin{array}{c} | \\ | \end{array}\right) (n, m) = \max(d\left(\begin{array}{c} \bullet \\ | \end{array}\right), d\left(\begin{array}{c} | \\ \bullet \end{array}\right)) (n, m),$$

$$d(\text{diagram}) (n, m, l) = 2n + m + 1 > 2n + m = \max(d(\text{diagram}), d\left(\begin{array}{c} | \\ | \\ | \end{array}\right)) (n, m, l),$$

and we check for 3-cells  $\alpha_{i,j}^L$  (resp.  $\alpha_i^L$ ) that

$$\begin{aligned} d(\text{diagram}) (n, m) &= d\left(\begin{array}{c} \diagdown & \diagup \\ \bullet & | \end{array}\right) (n, m) + d\left(\begin{array}{c} \bullet & \diagdown \\ | & \diagup \end{array}\right) (n, m) \\ &= M_{X,*,\mathbb{Z}}(\square \star_1 \begin{array}{c} | \\ | \end{array}) (d(\text{diagram})) (n, m) + M_{X,*,\mathbb{Z}}(\begin{array}{c} \diagdown & \diagup \\ \bullet & | \end{array} \star_1 \square) (d(\text{diagram})) (n, m) \\ &= d(\text{diagram}) (n, m) + d\left(\begin{array}{c} \bullet \\ | \end{array}\right) (X(\text{diagram})) (n, m) \\ &= n + d\left(\begin{array}{c} \bullet \\ | \end{array}\right) (m + 1, n) = n + m + 1 \end{aligned}$$

and similarly,

$$d(\text{diagram}) (n, m) = n + m.$$

As a consequence, the derivation  $d$  satisfies the strict inequality

$$d(\text{diagram}) (n, m) = n + m + 1 > n + m = \max(d(\text{diagram}), d\left(\begin{array}{c} | \\ | \end{array}\right)) (n, m),$$

In a similar fashion, we show that

$$d(\text{diagram}) (n, m) = 2n > 2n - 1 = \max(d(\text{diagram}), d\left(\begin{array}{c} | \\ | \end{array}\right)) (n, m).$$

so that the 2-functor  $X$  and the derivation  $d$  satisfy the conditions **i**), **ii**) and **iii**) of Section 2.8.9, and thus the linear (3, 2)-polygraph  $\text{KLR}$  is terminating.

**6.1.8. Critical branchings of KLR.** There are four different forms for the sources of 3-cells, that we denote as follows:

$$\begin{array}{cccc}
 \begin{array}{c} \bullet \\ \diagdown \quad \diagup \\ i \quad j \end{array} & \longleftrightarrow & \text{ldot}_{i,j}, & \begin{array}{c} \bullet \\ \diagup \quad \diagdown \\ i \quad j \end{array} & \longleftrightarrow & \text{rdot}_{i,j}, & \begin{array}{c} \diagdown \quad \diagup \\ \diagup \quad \diagdown \\ i \quad j \end{array} & \longleftrightarrow & \text{dcr}_{i,j}, & \begin{array}{c} \diagdown \quad \diagup \\ \diagup \quad \diagdown \\ \diagdown \quad \diagup \\ \diagup \quad \diagdown \\ i \quad j \quad k \end{array} & \longleftrightarrow & \text{ybg}_{i,j,k}.
 \end{array}$$

There are six families of regular critical branchings, which we all prove confluent in Appendix A.2. The exhaustive list of critical branchings is given below, listing all the pairs of sources of 3-cells that overlap:

- a) Crossings with two dots of the form  $(\text{ldot}_{i,j}, \text{rdot}_{i,j})$  for any  $i$  and  $j$  in  $I$ .
- b) Triple crossings of the form  $(\text{dcr}_{j,i}, \text{dcr}_{i,j})$  for any  $i, j$  in  $I$  and any value of the bilinear form  $i \cdot j$ .
- c) Double crossings with dots of the form  $(\text{ldot}_{j,i}, \text{dcr}_{i,j})$  and  $(\text{rdot}_{j,i}, \text{dcr}_{i,j})$  for any  $i$  and  $j$  in  $I$  and any value of  $i \cdot j$ .
- d) Double Yang-Baxters of the form  $(\text{ybg}_{j,k,i}, \text{ybg}_{i,j,k})$  for any  $i, j$  and  $k$  in  $I$  and any values of  $i \cdot j, j \cdot k$  and  $i \cdot k$ .
- e) Yang-Baxters and crossings of the form  $(\text{ybg}_{i,j,k}, \text{dcr}_{j,i})$  and  $(\text{dcr}_{k,j}, \text{ybg}_{i,j,k})$  for any  $i, j$  and  $k$  in  $I$  and any values of  $i \cdot j$  and  $j \cdot k$ .
- f) Yang Baxter and dots of the form  $(\text{ldot}_{k,j}, \text{ybg}_{i,j,k})$ ;  $(\text{rdot}_{k,j}, \text{ybg}_{i,j,k})$ ;  $(\text{rdot}_{i,k}, \text{ybg}_{i,j,k})$  for any  $i, j$  and  $k$  in  $I$  and any values of  $i \cdot j, i \cdot k$  and  $j \cdot k$ .

There also are right-indexed critical branchings of the form

$$\begin{array}{c}
 \begin{array}{c} \diagdown \quad \diagup \\ \diagup \quad \diagdown \\ \diagdown \quad \diagup \\ \diagup \quad \diagdown \\ i \quad j \quad k \end{array} \\
 \text{K}
 \end{array} \tag{6.6}$$

Following the study of the 3-polygraphs of permutations in [51, Section 5.4], the 2-cells  $K$  in normal form that can be plugged in (6.6) are identities or simple crossings. With the additional dot 2-cells, the normal forms that we can plug in (6.6) are given by:

- i)  $\begin{array}{c} \bullet \\ | \\ i \end{array}$  for every  $n \in \mathbb{N}$ , which is an identity if  $n = 0$ .
- ii)  $\begin{array}{c} \diagdown \quad \diagup \\ \bullet \\ \diagup \quad \diagdown \\ i \quad l \end{array}$  for all  $n \in \mathbb{N}$  and for any  $l$  in  $I$ .

All the right-indexed critical branchings are confluent, and are drawn in Appendix A.2.

**6.1.9. Poincaré-Birkhoff-Witt bases.** Let us fix two sequences  $\mathbf{i}$  and  $\mathbf{j}$  in  $\text{Seq}(\mathcal{V})$ , with  $|\mathcal{V}| = m$ . From [2, Prop. 4.2.15], the set of monomials in normal form with respect to KLR with 1-source  $\mathbf{i}$  and 1-target  $\mathbf{j}$  forms a basis of the vector space  ${}_j\mathcal{R}(\mathcal{V})_i$ . In [71], Khovanov and Lauda described a linear basis for this vector space, given by braid diagrams between  $\mathbf{i}$  and  $\mathbf{j}$  defined from a choice of minimal representatives for the Coxeter presentation of  $\mathcal{S}_m$ , with an arbitrary number of dots at the bottom of each strand. Using this rewriting theoretical approach, the set of minimal representatives in  $\mathcal{S}_m$  is given by braid diagrams which are normal forms for the 3-cells  $\beta_{i,j}$  and  $\gamma_{i,j,k}$  for any  $i, j$  and  $k$  in  $I$ . In [102, Thm 3.7], Rouquier established that these bases are *Poincaré-Birkhoff-Witt* (PBW for short) bases. Indeed, he



described a morphism of algebras between  $H_{\mathcal{V}}(Q)$  and a wreath product algebra, and enounced that the KLR algebras satisfy a Poincaré-Birkhoff-Witt property if and only if this morphism is an isomorphism, which is equivalent to the fact that the set

$$S = \{\tau_{i_1, s_{i_2} \dots s_{i_r}(j)} \dots \tau_{i_r, j} x_{1, j}^{a_1} \dots x_{m, j}^{a_m}\}_{(i_1, \dots, i_r) \in J, (a_1, \dots, a_m) \in \mathbb{N}^m, j \in \text{Seq}(\mathcal{V})}$$

is a linear basis of the algebra  $H_{\mathcal{V}}(Q)$ , where  $J$  is a set of finite sequences of elements of  $\{1, \dots, m-1\}$  such that  $\{s_{i_1} \dots s_{i_r}\}_{(i_1, \dots, i_r) \in J}$  is a set of minimal length representatives of elements of  $\mathcal{S}_m$  for its Coxeter presentation. The multiplication by the  $x_{k, i}$  to the right corresponds to adding an arbitrary number of dots at the bottom of each strand in the diagrams. The products  $\tau_{i_1, s_{i_2} \dots s_{i_r}(j)} \dots \tau_{i_r, j}$  are given in that case by the choices of braid diagrams which are normal forms for KLR, corresponding to minimal elements in the Coxeter presentation of  $\mathcal{S}_m$  for the degree lexicographic order induced by  $s_1 > s_2 > \dots > s_{m-1}$ . As a consequence, for this choice, the elements of  $S$  correspond to the set of monomial normal forms for KLR, proving the following result:

**6.1.10 Corollary.** *The simply-laced KLR algebras admit PBW bases.*

## 6.2. REWRITING MODULO ISOTOPY IN KHOVANOV-LAUDA-ROUQUIER'S 2-CATEGORY

In this section, we define a linear  $(3, 2)$ -polygraph presenting the linear 2-category  $\mathcal{U}(\mathfrak{g})$  and prove that rewriting modulo the isotopy relations using the remaining defining 3-cells gives a quasi-terminating and confluent modulo linear  $(3, 2)$ -polygraph modulo. As a consequence, we compute linear bases for the spaces of 2-cells in  $\mathcal{U}(\mathfrak{g})$  and prove non-degeneracy of Khovanov and Lauda's diagrammatic calculus.

**6.2.1. The 2-categories  $\mathcal{A}(\mathfrak{g})$  and  $\mathcal{U}(\mathfrak{g})$ .** In this subsection, we define the linear 2-categories  $\mathcal{A}(\mathfrak{g})$  and  $\mathcal{U}(\mathfrak{g})$  defined respectively by Rouquier and Khovanov-Lauda. We recall Brundan's isomorphism theorem between these two 2-categories.

**6.2.2. Rouquier's Kac-Moody 2-category.** Let  $(I, \cdot, X, Y)$  be a root datum. The *Kac-Moody 2-category*  $\mathcal{A}(\mathfrak{g})$  defined in [102] is the strict additive  $\mathbb{K}$ -linear 2-category whose

- 0-cells are given by the elements  $\lambda$  in the weight lattice  $X$  of the Kac-Moody algebra;
- generating 1-cells are given by  $E_i 1_\lambda : \lambda \rightarrow \lambda + \alpha_i$  and  $F_i 1_\lambda : \lambda \rightarrow \lambda - \alpha_i$ ;
- generating 2-cells are given by  $x_i : E_i 1_\lambda \rightarrow E_i 1_\lambda$ ,  $\tau_{i, j} : E_i E_j 1_\lambda \rightarrow E_j E_i 1_\lambda$ ,  $\eta_i : 1_\lambda \rightarrow F_i E_i 1_\lambda$  and  $\varepsilon : E_i F_i 1_\lambda \rightarrow 1_\lambda$  which are represented respectively by the following diagrams:

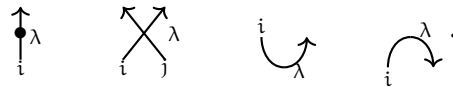

These two morphisms are subject to the following list of relations:

- i) The KLR relations for both upward and downward orientations.
- ii) Right adjunction relations:

$$\begin{array}{c} \uparrow \\ \text{N} \\ \downarrow \end{array} \lambda = \begin{array}{c} \uparrow \\ \text{I} \\ \downarrow \end{array} \lambda, \quad \begin{array}{c} \downarrow \\ \text{N} \\ \uparrow \end{array} \lambda = \begin{array}{c} \downarrow \\ \text{I} \\ \uparrow \end{array} \lambda, \quad (6.7)$$

which imply that  $F_i 1_{\lambda + \alpha_i}$  is the right dual of  $E_i 1_\lambda$ .

iii) Some inversion relations: we require the following 2-morphisms to be invertible in  $\mathcal{A}(\mathfrak{g})$ :

$$\begin{array}{c} i \\ \nearrow \\ \searrow \\ j \end{array} \lambda : E_j F_i 1_\lambda \xrightarrow{\sim} F_i E_j 1_\lambda \quad \text{if } i \neq j, \quad (6.8)$$

$$\begin{array}{c} i \\ \nearrow \\ \searrow \\ j \end{array} \lambda \oplus \bigoplus_{n=0}^{\langle h_i, \lambda \rangle - 1} \begin{array}{c} n \\ \bullet \\ \nearrow \\ i \end{array} \lambda : E_i F_i 1_\lambda \xrightarrow{\sim} F_i E_i 1_\lambda \oplus 1_\lambda^{\oplus \langle h_i, \lambda \rangle} \quad \text{if } \langle h_i, \lambda \rangle \geq 0, \quad (6.9)$$

$$\begin{array}{c} i \\ \nearrow \\ \searrow \\ j \end{array} \lambda \oplus \bigoplus_{n=0}^{-\langle h_i, \lambda \rangle - 1} \begin{array}{c} i \\ \bullet \\ \searrow \\ \lambda \end{array} n : E_i F_i 1_\lambda \oplus 1_\lambda^{\oplus -\langle h_i, \lambda \rangle} \xrightarrow{\sim} F_i E_i 1_\lambda \quad \text{if } \langle h_i, \lambda \rangle \leq 0. \quad (6.10)$$

This condition of invertibility in  $\mathcal{A}(\mathfrak{g})$  imposes that we have to define new generating 2-cells as the formal inverses of each summand in (6.8) – (6.10). Let us denote by  $\widehat{\mathcal{A}}(\mathfrak{g})$  the linear 2-category obtained by forgetting the direct sums operations and the grading on 1-cells in  $\mathcal{A}(\mathfrak{g})$ . In order to compute linear bases of  $\mathcal{A}(\mathfrak{g})$ , it is sufficient to compute linear bases in the vector spaces of 2-cells in  $\widehat{\mathcal{A}}(\mathfrak{g})$ .

**6.2.3. Khovanov-Lauda’s 2-category  $\mathcal{U}(\mathfrak{g})$ .** The 2-category  $\mathcal{U}(\mathfrak{g})$  has the same 0-cells and 1-cells than  $\mathcal{A}(\mathfrak{g})$ , and have additional generating 2-cells  $\chi' : F_i 1_\lambda \rightarrow F_i 1_\lambda$ ,  $\tau' : F_i F_j 1_\lambda \rightarrow F_j F_i 1_\lambda$ ,  $\eta' : 1_\lambda \rightarrow E_i F_i 1_\lambda$  and  $\varepsilon' : F_i E_i 1_\lambda \rightarrow 1_\lambda$  diagrammatically depicted by

$$\chi' = \begin{array}{c} i \\ \bullet \\ \downarrow \\ \lambda \end{array}, \quad \tau' = \begin{array}{c} i & i \\ \nearrow & \searrow \\ \lambda & \end{array}, \quad \eta' = \begin{array}{c} i \\ \curvearrowright \\ \lambda \end{array}, \quad \varepsilon' = \begin{array}{c} \lambda \\ \curvearrowleft \\ i \end{array}. \quad (6.11)$$

subject to some relations as the KLR relations for both upward and downward orientations and the local “ $\mathfrak{sl}_2$ ” relations which come from Lauda’s categorification of  $\mathfrak{sl}_2$ , [82]. We refer to [67, Section 3.1] to see the complete definition of this 2-category.

**6.2.4. Brundan’s isomorphism theorem.** In [20, Main Thm], Brundan defined a 2-functor from  $\mathcal{A}(\mathfrak{g})$  to  $\mathcal{U}(\mathfrak{g})$  that he proved to be an isomorphism. This functor is the identity on 0-cells and 1-cells. On 2-cells, it is the identity on the 4 generating 2-cells of  $\mathcal{A}(\mathfrak{g})$  which are also in  $\mathcal{U}(\mathfrak{g})$ . It then remains to define new 2-cells  $\chi', \tau', \eta', \varepsilon'$  in  $\mathcal{A}(\mathfrak{g})$  that will be the images of the additional generators in  $\mathcal{U}(\mathfrak{g})$  under the inverse functor. We recall here the definition of these new 2-cells in  $\mathcal{A}(\mathfrak{g})$  and the relations implied by these definitions. First of all, we define the downward dot and crossing as being the right mates under adjunction of the upward ones:

$$\chi'_i = \begin{array}{c} i \\ \bullet \\ \downarrow \\ \lambda \end{array} := \begin{array}{c} i \\ \curvearrowright \\ \lambda \end{array}, \quad \tau'_{i,j} = \begin{array}{c} j & i \\ \nearrow & \searrow \\ \lambda & \end{array} := \begin{array}{c} j & i \\ \curvearrowright & \curvearrowright \\ \lambda & \end{array}.$$

In [20], Brundan defined an additional generator for the isomorphism 2-cell:

$$\sigma_{i,j} = \begin{array}{c} i & j \\ \nearrow & \searrow \\ \lambda & \end{array} := \begin{array}{c} i \\ \curvearrowright \\ \lambda \end{array}. \quad (6.12)$$

He then defined a leftward crossing as the formal inverse of this new generator. Using the cyclicity relations proved by Brundan in [20, Section 5],  $\mathcal{A}(\mathfrak{g})$  admits a pivotal structure and thus its 2-cells are

represented up to isotopy. As a consequence, we set

$$\sigma'_{i,j} = \begin{array}{c} \nearrow^i \\ \searrow^j \\ \lambda \end{array} = \begin{array}{c} \searrow^i \\ \nearrow^j \\ \lambda \end{array} : F_i E_j 1_\lambda \rightarrow E_j F_i 1_\lambda, \quad (6.13)$$

Let us now define the new generators from [20]. Note that these definitions slightly differ depending on the value of  $\langle h_i, \lambda \rangle$ . First of all, let us assume that  $\langle h_i, \lambda \rangle \geq 0$ . The 2-cells  $\sigma'$  and  $\eta'$  are defined so that

$$- \begin{array}{c} \searrow^i \\ \nearrow^j \\ \lambda \end{array} \oplus \cdots \oplus \begin{array}{c} \searrow^i \\ \lambda \end{array} := \left( \begin{array}{c} \searrow^i \\ \nearrow^i \\ \lambda \end{array} \oplus \cdots \oplus \begin{array}{c} \searrow^{\lambda} \\ \nearrow^i \\ \lambda \end{array} \right)^{-1}, \quad (6.14)$$

assuming that  $\sigma'$  is just the inverse of  $\sigma$  if  $\langle h_i, \lambda \rangle = 0$ . We also define

$$\begin{array}{c} \searrow^{\lambda} \\ \lambda \end{array} := - \begin{array}{c} \searrow^i \\ \nearrow^{\lambda} \\ \lambda \end{array}.$$

Now, let assume that  $\langle h_i, \lambda \rangle \leq 0$ . The 2-cells  $\sigma'$  and  $\varepsilon'$  are defined so that

$$- \begin{array}{c} \searrow^i \\ \nearrow^j \\ \lambda \end{array} \oplus \cdots \oplus \begin{array}{c} \searrow^{\lambda} \\ \lambda \end{array} := \left( \begin{array}{c} \searrow^i \\ \nearrow^i \\ \lambda \end{array} \oplus \cdots \oplus \begin{array}{c} \searrow^{\lambda} \\ \nearrow^{\lambda} \\ \lambda \end{array} \right)^{-1}, \quad (6.15)$$

assuming again that  $\sigma'$  is the inverse of  $\sigma$  if  $\langle h_i, \lambda \rangle = 0$ . We set

$$\begin{array}{c} \searrow^{\lambda} \\ \lambda \end{array} := \begin{array}{c} \searrow^i \\ \nearrow^{\lambda} \\ \lambda \end{array}.$$

Using these definitions, Brundan also proved that  $F_i 1_{\lambda + \alpha_i}$  also is the right dual of  $E_i 1_\lambda$ , yielding adjunction relations of the form

$$\begin{array}{c} \uparrow \\ \lambda \end{array} = \begin{array}{c} \uparrow \\ i \end{array}, \quad \begin{array}{c} \downarrow \\ \lambda \end{array} = \begin{array}{c} \downarrow \\ i \end{array}. \quad (6.16)$$

where the 2-cells  $\eta'$  and  $\varepsilon'$  are units and counits of this left adjunction  $F_i 1_{\lambda + \alpha_i} \vdash E_i 1_\lambda$ . Brundan also proved in [20] that the dot 2-cells are cyclic under this biadjunction, yielding relations of the form:

$$\begin{array}{c} \uparrow \\ \lambda \end{array} = \begin{array}{c} \uparrow \\ \lambda \end{array}, \quad \begin{array}{c} \downarrow \\ \lambda \end{array} = \begin{array}{c} \downarrow \\ \lambda \end{array}, \quad \begin{array}{c} \uparrow \\ \lambda \end{array} = \begin{array}{c} \uparrow \\ \lambda \end{array}, \quad \begin{array}{c} \downarrow \\ \lambda \end{array} = \begin{array}{c} \downarrow \\ \lambda \end{array}.$$

**6.2.5.  $\mathbb{Z}$ -grading.** Following the definitions of Rouquier and Khovanov-Lauda, we define a  $\mathbb{Z}$ -grading on the 2-morphisms in  $\mathcal{A}(\mathfrak{g})$ , by setting for all  $i \in I$ :

$$\deg(x_i) = i \cdot i, \quad \deg(\tau_i) = -i \cdot j, \quad \deg(\varepsilon_i) = \frac{i \cdot i}{2}(1 - \langle h_i, \lambda \rangle), \quad \deg(\eta_i) = \frac{i \cdot i}{2}(1 + \langle h_i, \lambda \rangle).$$

With the previous definitions of  $x'_i, \tau'_i, \eta'_i$  and  $\varepsilon'_i$ , we can prove that

$$\deg(x'_i) = i \cdot i, \quad \deg(\tau'_i) = -i \cdot j, \quad \deg(\varepsilon'_i) = \frac{i \cdot i}{2}(1 - \langle h_i, \lambda \rangle), \quad \deg(\eta'_i) = \frac{i \cdot i}{2}(1 + \langle h_i, \lambda \rangle).$$

and that

$$\deg(\sigma_{i,j}) = 0, \quad \deg(\sigma'_{i,j}) = 0$$

for all values of  $\langle h_i, \lambda \rangle$ , so that this grading exactly to the  $\mathbb{Z}$ -grading in  $\mathcal{U}(\mathfrak{g})$  defined by Khovanov and Lauda. In order to compute the degree of a string diagram 2-cell, it suffices to sum up all the degrees of the generating 2-cells that appear in that diagram. For coherence, we set  $\deg(0) = -\infty$ .

**6.2.6. Bubbles.** For each  $\lambda \in X$ , we can define 2-cells in  $\text{END}(1_{1_\lambda})$  by putting a cap over a cup whenever the directions and labels are compatible. Thus, there is two kinds of bubble morphisms, namely clockwise bubbles and counter clockwise bubbles, and we can decorate them by placing an arbitrary number of dots on each:

$$\begin{array}{c} \bullet \\ \circlearrowleft \\ \text{n} \quad \lambda \\ \circlearrowright \\ \text{i} \end{array} \quad \begin{array}{c} \circlearrowleft \\ \lambda \quad \bullet \\ \circlearrowright \\ \text{i} \quad \text{n} \end{array} .$$

If we compute the degree of such a bubble, we have:

$$\deg \left( \begin{array}{c} \bullet \\ \circlearrowleft \\ \text{n} \quad \lambda \\ \circlearrowright \\ \text{i} \end{array} \right) = i \cdot i(1 - \langle h_i, \lambda \rangle + n) \quad ; \quad \deg \left( \begin{array}{c} \circlearrowleft \\ \lambda \quad \bullet \\ \circlearrowright \\ \text{i} \quad \text{n} \end{array} \right) = i \cdot i(1 + \langle h_i, \lambda \rangle + n).$$

Following [82, 67], we have to impose conditions on these bubbles, namely bubbles with a negative degree are zero, and bubbles of degree zero are identities. This corresponds to the following relations:

$$\begin{array}{c} \bullet \\ \circlearrowleft \\ \text{n} \quad \lambda \\ \circlearrowright \\ \text{i} \end{array} = \begin{cases} 1_{1_\lambda} & \text{if } n = \langle h_i, \lambda \rangle - 1 \\ 0 & \text{if } n < \langle h_i, \lambda \rangle - 1 \end{cases} \quad (6.17)$$

$$\begin{array}{c} \circlearrowleft \\ \lambda \quad \bullet \\ \circlearrowright \\ \text{i} \quad \text{n} \end{array} = \begin{cases} 1_{1_\lambda} & \text{if } n = -\langle h_i, \lambda \rangle - 1 \\ 0 & \text{if } n < -\langle h_i, \lambda \rangle - 1 \end{cases} \quad (6.18)$$

As in [82, Section 3.6], we introduce *fake bubbles*. These bubbles are formal symbols which correspond to bubbles decorated with a negative number of dots. It is explained in [82] that these new symbols are added in order to have an interpretation only with diagrams of the relations obtained by lifting the relations in  $\mathfrak{sl}_2$ . They are defined in terms of linear combinations of products of positively dotted bubbles. Following [20], we set for  $r, s < 0$ :

$$\begin{array}{c} \bullet \\ \circlearrowleft \\ \text{n} \quad \lambda \\ \circlearrowright \\ \text{i} \end{array} := \begin{cases} - \sum_{k \geq 0}^{-n-k-1} \begin{array}{c} \bullet \\ \circlearrowleft \\ \text{i} \quad \lambda \\ \circlearrowright \\ \text{i} \end{array} \begin{array}{c} \circlearrowleft \\ \lambda \quad \bullet \\ \circlearrowright \\ \text{i} \quad k - \langle h_i, \lambda \rangle \end{array} & \text{if } n > \langle h_i, \lambda \rangle - 1, \\ 1_{1_\lambda} & \text{if } n = \langle h_i, \lambda \rangle - 1, \\ 0 & \text{if } n < \langle h_i, \lambda \rangle - 1, \end{cases}$$

$$\begin{array}{c} \circlearrowleft \\ \lambda \quad \bullet \\ \circlearrowright \\ \text{i} \quad \text{n} \end{array} := \begin{cases} - \sum_{k \geq 0}^{\langle h_i, \lambda \rangle + k} \begin{array}{c} \circlearrowleft \\ \text{i} \quad \lambda \\ \circlearrowright \\ \text{i} \end{array} \begin{array}{c} \bullet \\ \circlearrowleft \\ \text{i} \quad -n-k-1 \end{array} & \text{if } n > -\langle h_i, \lambda \rangle - 1, \\ 1_{1_\lambda} & \text{if } n = -\langle h_i, \lambda \rangle - 1, \\ 0 & \text{if } n < -\langle h_i, \lambda \rangle - 1. \end{cases}$$

The first condition for both orientations corresponds to Lauda's inductive definition of fake bubbles coming from the infinite Grassmannian relation, see [82, Section 3.6.2]. The second two other definitions impose the same condition that fake bubbles of negative degree are zero, and that fake bubbles of degree zero are identities. With this definition, Brundan proved that the Infinite Grassmannian relation hold in  $\mathcal{A}(\mathfrak{g})$ , that is:

**6.2.7 Theorem** ([20], Thm 3.2). *For  $t > 0$ , the following relation hold in  $\mathcal{A}(\mathfrak{g})$ :*

$$\sum_{\substack{r, s \in \mathbb{Z} \\ r+s=t-2}} r \begin{array}{c} \bullet \\ \circlearrowleft \\ \text{i} \quad \lambda \\ \circlearrowright \\ \text{i} \end{array} \begin{array}{c} \circlearrowleft \\ \lambda \quad \bullet \\ \circlearrowright \\ \text{i} \quad \text{s} \end{array} = 0.$$

Using the conditions on degrees, we can restrict this relation to the following one:

$$\sum_{k=0}^{\alpha} \langle h_i, \lambda \rangle - 1 + \alpha - l \begin{array}{c} \bullet \\ \circlearrowleft \\ \text{i} \quad \lambda \\ \circlearrowright \\ \text{i} \end{array} \begin{array}{c} \circlearrowleft \\ \lambda \quad \bullet \\ \circlearrowright \\ \text{i} \quad -l \end{array} = 0 \quad \text{for all } \alpha > 0. \quad (6.19)$$

**6.2.8. The relations in  $\mathcal{A}(\mathfrak{g})$ .** In this section, we recall some of the important defining relations that arise from the invertibility condition. In [20], Brundan introduced new generators  $\left( \begin{array}{c} \curvearrowright^i \\ \bullet \\ \curvearrowleft^k \end{array} \lambda \right)_{0 \leq k \leq \langle h_i, \lambda \rangle - 1}$

and  $\left( \begin{array}{c} \curvearrowleft^k \\ \bullet \\ \curvearrowright^i \end{array} \lambda \right)_{0 \leq k \leq -\langle h_i, \lambda \rangle - 1}$  as follows:

- For  $\langle h_i, \lambda \rangle \geq 0$ ,  $\begin{array}{c} \curvearrowright^j \\ \bullet \\ \curvearrowleft^k \end{array} \lambda$  is the  $(n+1)$ -th entry of the inverse vector of the invertible 2-cell when  $\langle h_i, \lambda \rangle \geq 0$ , that is:

$$-\begin{array}{c} \curvearrowright^i \\ \bullet \\ \curvearrowleft^i \end{array} \lambda \oplus \bigoplus_{n=0}^{\langle h_i, \lambda \rangle - 1} \begin{array}{c} \curvearrowright^i \\ \bullet \\ \curvearrowleft^i \end{array} \lambda := \left( \begin{array}{c} \curvearrowright^i \\ \bullet \\ \curvearrowleft^i \end{array} \lambda \oplus \bigoplus_{n=0}^{\langle h_i, \lambda \rangle - 1} \begin{array}{c} \curvearrowright^i \\ \bullet \\ \curvearrowleft^i \end{array} \lambda \right)^{-1}. \quad (6.20)$$

- Similarly,  $\begin{array}{c} \curvearrowleft^k \\ \bullet \\ \curvearrowright^i \end{array} \lambda$  is defined for  $\langle h_i, \lambda \rangle \leq 0$  by:

$$-\begin{array}{c} \curvearrowleft^i \\ \bullet \\ \curvearrowright^i \end{array} \lambda \oplus \bigoplus_{n=0}^{-\langle h_i, \lambda \rangle - 1} \begin{array}{c} \curvearrowleft^i \\ \bullet \\ \curvearrowright^i \end{array} \lambda := \left( \begin{array}{c} \curvearrowleft^i \\ \bullet \\ \curvearrowright^i \end{array} \lambda \oplus \bigoplus_{n=0}^{-\langle h_i, \lambda \rangle - 1} \begin{array}{c} \curvearrowleft^i \\ \bullet \\ \curvearrowright^i \end{array} \lambda \right)^{-1}. \quad (6.21)$$

To establish the isomorphism between  $\mathcal{A}(\mathfrak{g})$  and  $\mathcal{U}(\mathfrak{g})$ , Brundan proved that the following relation have to hold in  $\mathcal{A}(\mathfrak{g})$ : for all  $0 \leq n \leq \langle h_i, \lambda \rangle - 1$ ,

$$\begin{array}{c} \curvearrowright^i \\ \bullet \\ \curvearrowleft^n \end{array} \lambda = \sum_{r \geq 0} \begin{array}{c} \curvearrowright^i \\ \bullet \\ \curvearrowleft^{n-r-2} \end{array} \lambda \quad \text{if } 0 \leq n < \langle h_i, \lambda \rangle, \quad (6.22)$$

$$\begin{array}{c} \curvearrowleft^n \\ \bullet \\ \curvearrowright^i \end{array} \lambda = \sum_{r \geq 0} \begin{array}{c} \curvearrowleft^{n-r-2} \\ \bullet \\ \curvearrowright^i \end{array} \lambda \quad \text{if } 0 \leq n < -\langle h_i, \lambda \rangle. \quad (6.23)$$

As a consequence, we do not have to consider these inverse 2-cells as generators in the presentation, since we will replace them by their expression in term of the other generators whenever they appear. The invertibility conditions (6.8) and (6.9) can then be expressed diagrammatically by:

$$\begin{array}{c} \curvearrowright^i \\ \bullet \\ \curvearrowleft^i \end{array} \lambda = \sum_{n=0}^{\langle h_i, \lambda \rangle - 1} \sum_{r \geq 0} \begin{array}{c} \curvearrowright^i \\ \bullet \\ \curvearrowleft^{n-r-2} \end{array} \lambda - \begin{array}{c} \curvearrowright^i \\ \bullet \\ \curvearrowleft^i \end{array} \lambda, \quad (6.24)$$

$$\begin{array}{c} \curvearrowleft^i \\ \bullet \\ \curvearrowright^i \end{array} \lambda = \sum_{n=0}^{-\langle h_i, \lambda \rangle - 1} \sum_{r \geq 0} \begin{array}{c} \curvearrowleft^i \\ \bullet \\ \curvearrowright^{n-r-2} \end{array} \lambda - \begin{array}{c} \curvearrowleft^i \\ \bullet \\ \curvearrowright^i \end{array} \lambda. \quad (6.25)$$

Besides, some other relations directly follow from this isomorphism:

i) For  $\langle h_i, \lambda \rangle > 0$  and  $0 \leq n < \langle h_i, \lambda \rangle$ , we have

$$\begin{aligned} \text{Diagram 1}^\lambda = 0, \quad \text{Diagram 2}^\lambda = 0. \end{aligned} \quad (6.26)$$

ii) For  $\langle h_i, \lambda \rangle < 0$  and  $0 \leq n < -\langle h_i, \lambda \rangle$ , we have

$$\begin{aligned} \text{Diagram 3}^\lambda = 0, \quad \text{Diagram 4}^\lambda = 0. \end{aligned} \quad (6.27)$$

The following relations also hold, and correspond to the  $\mathfrak{sl}_2$ -relations of  $\mathcal{U}(\mathfrak{g})$ , see [20, Corollary 3.5]:

$$\begin{aligned} \text{Diagram 5}^\lambda = \sum_{n=0}^{\langle h_i, \lambda \rangle} \text{Diagram 6}^\lambda, \quad \text{Diagram 7}^\lambda = - \sum_{n=0}^{-\langle h_i, \lambda \rangle} \text{Diagram 8}^\lambda. \end{aligned} \quad (6.28)$$

**6.2.9. Further relations.** We prove some further relations that we will use in the last section to prove that the linear  $(3, 2)$ -polygraph presenting  $\widehat{\mathcal{A}(\mathfrak{g})}$  is convergent.

**6.2.10 Lemma.** *The following relations hold in  $\mathcal{A}(\mathfrak{g})$ :*

$$\begin{aligned} \text{Diagram 9}^\lambda = - \sum_{n=0}^{-\langle h_i, \lambda \rangle} \text{Diagram 10}^\lambda, \quad \text{Diagram 11}^\lambda = \sum_{n=0}^{\langle h_i, \lambda \rangle} \text{Diagram 12}^\lambda. \end{aligned}$$

*Proof.* Using the symmetry in  $\mathcal{A}(\mathfrak{g})$  coming from the anti-involution  $\mathbb{T}$  defined by Brundan in [20, Thm 2.3], it suffices to prove the first relation. For  $\langle h_i, \lambda \rangle > 0$ , it follows directly from the relations (6.26).

For  $\langle h_i, \lambda \rangle = 0$ , the left handside is equal to  $-\text{Diagram 13}^\lambda$  using the definition of  $\varepsilon_i$  when  $\langle h_i, \lambda \rangle \geq 0$ . The

right handside also reduces to  $-\text{Diagram 13}^\lambda$  because the bubble that remains is an identity, using the degree conditions. Let us prove it for  $\langle h_i, \lambda \rangle < 0$ . On the one hand, using the relation of invertibility, we have

$$\begin{aligned} \text{Diagram 14}^\lambda &= \sum_{n=0}^{-\langle h_i, \lambda \rangle - 1} \sum_{r \geq 0} \text{Diagram 15}^\lambda - \text{Diagram 16}^\lambda \stackrel{(6.17)}{=} \sum_{n=0}^{-\langle h_i, \lambda \rangle - 1} \sum_{r=0}^{-\langle h_i, \lambda \rangle - 1} \text{Diagram 17}^\lambda - \text{Diagram 16}^\lambda \\ &= \sum_{n=1}^{-\langle h_i, \lambda \rangle} \sum_{r=0}^{-\langle h_i, \lambda \rangle - 1} \text{Diagram 18}^\lambda - \text{Diagram 16}^\lambda = \sum_{n=1}^{-\langle h_i, \lambda \rangle} \sum_{r=0}^{-\langle h_i, \lambda \rangle} \text{Diagram 19}^\lambda - \text{Diagram 16}^\lambda \end{aligned}$$

The last equality above is due to the fact that  $\sum_{n=1}^{-\langle h_i, \lambda \rangle} \text{Diagram 20}^\lambda = 0$  since  $n > 0$ , using

(6.17). On the other hand, we can make the dot go down using the upward KLR relations:

$$\begin{aligned}
& \text{Diagram 1} = \text{Diagram 2} - \text{Diagram 3} + \text{Diagram 4} \stackrel{(6.25)}{=} \sum_{n=0}^{-\langle h_i, \lambda \rangle - 1} \sum_{r \geq 0} -n-r-2 \text{Diagram 5} - \text{Diagram 6} - \text{Diagram 7} + \text{Diagram 8} \\
& \stackrel{(6.28)}{=} \sum_{n=0}^{-\langle h_i, \lambda \rangle - 1} \sum_{r \geq 0} -n-r-2 \text{Diagram 9} + \sum_{n=0}^{-\langle h_i, \lambda \rangle} -n-1 \text{Diagram 10} + \text{Diagram 11} - \text{Diagram 12} \\
& \stackrel{(6.17)}{=} \sum_{n=0}^{-\langle h_i, \lambda \rangle - 1} \sum_{r=0}^{-\langle h_i, \lambda \rangle - 1} -n-r-2 \text{Diagram 13} + \sum_{n=0}^{-\langle h_i, \lambda \rangle} -n-1 \text{Diagram 14} + \text{Diagram 15} - \text{Diagram 16} \\
& \stackrel{(*)}{=} \sum_{n=0}^{-\langle h_i, \lambda \rangle} \sum_{r=0}^{-\langle h_i, \lambda \rangle - 1} -n-r-2 \text{Diagram 17} + \sum_{n=0}^{-\langle h_i, \lambda \rangle} -n-1 \text{Diagram 18} + \text{Diagram 19} - \text{Diagram 20} \\
& = \sum_{n=0}^{-\langle h_i, \lambda \rangle} \sum_{r=0}^{-\langle h_i, \lambda \rangle} -n-r-1 \text{Diagram 21} + \text{Diagram 22} - \text{Diagram 23},
\end{aligned}$$

where the equality (\*) is due to the fact the term in  $-\langle h_i, \lambda \rangle$  in the first summand is zero by the degree conditions. Thus, the two expressions obtained have to be equal, and so we must have

$$\sum_{r=0}^{-\langle h_i, \lambda \rangle} -n-r-1 \text{Diagram 21} + \text{Diagram 22} = 0.$$

Using the bilinearity of the vertical composition in the linear 2-category  $\mathcal{A}(\mathfrak{g})$ , we obtain the result.  $\square$

**6.2.11. The linear  $(3, 2)$ -polygraph  $\mathcal{KLR}$ .** Let us now provide a presentation of the linear 2-category  $\widehat{\mathcal{A}(\mathfrak{g})}$  by a linear  $(3, 2)$ -polygraph, which we will prove quasi-terminating and confluent modulo its sub-polygraph of isotopies.

**6.2.12 Definition.** Let  $\mathcal{KLR}$  be the linear  $(3, 2)$ -polygraph defined by:

- i) the elements of  $\mathcal{KLR}_0$  are the weights  $\lambda \in X$  of the Kac-Moody algebra;
- ii) the elements of  $\mathcal{KLR}_1$  are given by

$$1_{\lambda'} \mathcal{E}_{\varepsilon_1 i_1} \dots \mathcal{E}_{\varepsilon_m i_m} 1_{\lambda}$$

for any signed sequence of vertices  $(\varepsilon_1 i_1, \dots, \varepsilon_m i_m)$  in  $\text{SSeq} := \prod_{\mathcal{V} \in \mathbb{N}[I]} \text{SSeq}(\mathcal{V})$ , and  $\lambda, \lambda'$  in  $X$ .

Such a 1-cell has for 0-source  $\lambda$  and 0-target  $\lambda'$ , and

$$1_{\lambda'} \mathcal{E}_{\varepsilon'_{j_1}} \dots \mathcal{E}_{\varepsilon_{j_l}} 1_{\lambda'} \star_0 1_{\lambda'} \mathcal{E}_{\varepsilon_1 i_1} \dots \mathcal{E}_{\varepsilon_m i_m} 1_{\lambda} = 1_{\lambda'} \mathcal{E}_{\varepsilon'_{j_1}} \dots \mathcal{E}_{\varepsilon_m i_m} 1_{\lambda}$$

iii) the elements of  $\mathcal{KLR}_2$  are the following generating 2-cells: for any  $i$  in  $I$  and  $\lambda'$  in  $X$ ,

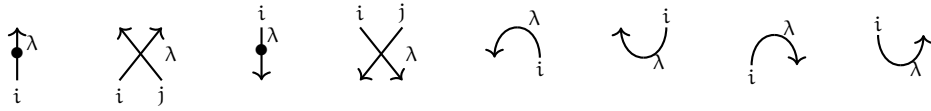

iv)  $\mathcal{KLR}_3$  consists of the following 3-cells:

- 1) The 3-cells of the linear  $(3, 2)$ -polygraph  $\text{KLR}$  for both upward and downward orientations of all strands. For any 3-cell  $\delta$  in  $\text{KLR}_3$ , we denote by  $\delta^{\lambda,+}$  (resp.  $\delta^{\lambda,-}$ ) the corresponding 3-cell in  $\mathcal{KLR}$  with upward (resp. downward) oriented strands and the rightmost region of the diagram being labelled by  $\lambda$ .

- 2) The isotopy 3-cells: for any  $i \in I$  and  $\lambda \in X$

$$\begin{array}{c} \text{strand } i \text{ with a loop} \end{array} \xrightarrow{i_1^0} \begin{array}{c} \text{strand } i \end{array}, \quad \begin{array}{c} \text{strand } i \text{ with a loop} \end{array} \xrightarrow{i_3^0} \begin{array}{c} \text{strand } i \end{array}, \quad \begin{array}{c} \text{strand } i \text{ with a loop} \end{array} \xrightarrow{i_4^0} \begin{array}{c} \text{strand } i \end{array}, \quad \begin{array}{c} \text{strand } i \text{ with a loop} \end{array} \xrightarrow{i_2^0} \begin{array}{c} \text{strand } i \end{array}, \quad (6.29)$$

$$\begin{array}{c} \text{strand } i \text{ with a dot} \end{array} \xrightarrow{i_2^1} \begin{array}{c} \text{strand } i \end{array}, \quad \begin{array}{c} \text{strand } i \text{ with a dot} \end{array} \xrightarrow{i_1^1} \begin{array}{c} \text{strand } i \end{array}, \quad \begin{array}{c} \text{strand } i \text{ with a dot} \end{array} \xrightarrow{i_3^1} \begin{array}{c} \text{strand } i \end{array}, \quad \begin{array}{c} \text{strand } i \text{ with a dot} \end{array} \xrightarrow{i_4^1} \begin{array}{c} \text{strand } i \end{array}, \quad (6.30)$$

$$\begin{array}{c} \text{strand } i \text{ with a dot} \end{array} \xrightarrow{i_1^2} \begin{array}{c} \text{strand } i \end{array}, \quad \begin{array}{c} \text{strand } i \text{ with a dot} \end{array} \xrightarrow{i_3^2} \begin{array}{c} \text{strand } i \end{array}, \quad \begin{array}{c} \text{strand } i \text{ with a dot} \end{array} \xrightarrow{i_2^2} \begin{array}{c} \text{strand } i \end{array}, \quad \begin{array}{c} \text{strand } i \text{ with a dot} \end{array} \xrightarrow{i_4^2} \begin{array}{c} \text{strand } i \end{array}, \quad (6.31)$$

- 3) The 3-cells coming from the new generators in  $\mathcal{A}(\mathfrak{g})$ : for any  $i, j \in I, \lambda \in X$

$$\begin{array}{c} \text{strand } i \text{ with a dot} \end{array} \xrightarrow{D_{i,\lambda}^-} \begin{array}{c} \text{strand } i \end{array} \quad \text{for } \langle h_i, \lambda \rangle \leq 0, \quad \begin{array}{c} \text{strand } i \text{ with a dot} \end{array} \xrightarrow{B_{i,\lambda}^+} \begin{array}{c} \text{strand } i \end{array} \quad \text{for } \langle h_i, \lambda \rangle \geq 0 \quad (6.32)$$

- 4) The 3-cells for the degree conditions on bubbles: for every  $i \in I, \lambda \in X$

$$\begin{array}{c} \text{bubble } n \end{array} \xrightarrow{b_{i,\lambda}^1} \begin{cases} 1_{1_\lambda} & \text{if } n = \langle h_i, \lambda \rangle - 1 \\ 0 & \text{if } n < \langle h_i, \lambda \rangle - 1 \end{cases} \quad (6.33)$$

$$\begin{array}{c} \text{bubble } n \end{array} \xrightarrow{c_{i,\lambda}^1} \begin{cases} 1_{1_\lambda} & \text{if } n = -\langle h_i, \lambda \rangle - 1 \\ 0 & \text{if } n < -\langle h_i, \lambda \rangle - 1 \end{cases} \quad (6.34)$$

- 5) The Infinite-Grassmannian 3-cells: for any  $i \in I, \lambda \in X$  and  $\alpha > 0$ ,

$$\begin{array}{c} \text{bubble } n \end{array} \xrightarrow{ig_\alpha} - \sum_{l=1}^{\alpha} \begin{array}{c} \text{bubble } n \end{array} \begin{array}{c} \text{bubble } n \end{array} \begin{array}{c} \text{bubble } n \end{array} \quad (6.35)$$



6) Bubble-slide 3-cells: for any  $i, j$  in  $I$  and any  $\alpha \geq 0$ ,

$$\langle h_i, \lambda + \alpha_j \rangle - 1 + \alpha \begin{array}{c} \circlearrowleft \\ \uparrow \\ j \end{array} \xrightarrow{s_{i,j,\lambda,\alpha}^+} \left\{ \begin{array}{ll} \sum_{f=0}^{\alpha} (\alpha + 1 - f) \begin{array}{c} \uparrow_{\alpha-f} \\ \circlearrowleft \\ i \end{array} \lambda & \text{if } i = j, \\ \begin{array}{c} \uparrow \\ \circlearrowleft \\ i \end{array} \lambda & \text{if } i \cdot j = 0, \\ \begin{array}{c} \uparrow \\ \circlearrowleft \\ i \end{array} \lambda & \text{if } i \cdot j = -1. \end{array} \right.$$

and for any  $i, j$  in  $I$  and any  $\alpha \geq 0$ ,

$$\begin{array}{c} \circlearrowleft \\ \uparrow \\ j \end{array} \langle h_i, \lambda + \alpha_j \rangle - 1 + \alpha \xrightarrow{s_{i,j,\lambda,\alpha}^-} \left\{ \begin{array}{ll} \begin{array}{c} \uparrow_2 \\ \circlearrowleft \\ i \end{array} \lambda & \text{if } i = j, \\ \begin{array}{c} \uparrow \\ \circlearrowleft \\ i \end{array} \lambda & \text{if } i \cdot j = 0. \\ \sum_{f=0}^{\alpha} (-1)^f \begin{array}{c} \uparrow_f \\ \circlearrowleft \\ i \end{array} \lambda & \text{if } i \cdot j = -1. \end{array} \right.$$

so as their reflections  $r_{i,j,\lambda,\alpha}^+$  and  $r_{i,j,\lambda,\alpha}^-$  through a horizontal axis, allowing to make a bubble go through a downward strand. These reflexions correspond to the images of these relations via the symmetry  $\tilde{\psi}$  defined by Khovanov and Lauda in [67, Section 3.3]. Note that these relations were originally proved by Khovanov and Lauda in [67, Props 3.3 & 3.4], and are added to this presentation to reach confluence modulo as it will be explained later.

7) The invertibility 3-cells: for any  $i, j \in I$  and  $\lambda \in X$

$$\begin{array}{c} \begin{array}{c} \uparrow \\ \circlearrowleft \\ i \end{array} \lambda \\ \downarrow \\ \begin{array}{c} \downarrow \\ \circlearrowleft \\ j \end{array} \lambda \end{array} \xrightarrow{F_{i,j,\lambda}} \begin{array}{c} \uparrow \\ \downarrow \\ i \end{array} \lambda, \quad \begin{array}{c} \begin{array}{c} \downarrow \\ \circlearrowleft \\ i \end{array} \lambda \\ \downarrow \\ \begin{array}{c} \uparrow \\ \circlearrowleft \\ j \end{array} \lambda \end{array} \xrightarrow{E_{i,j,\lambda}} \begin{array}{c} \downarrow \\ \uparrow \\ j \end{array} \lambda$$

$$\begin{array}{c} \begin{array}{c} \uparrow \\ \circlearrowleft \\ i \end{array} \lambda \\ \downarrow \\ \begin{array}{c} \downarrow \\ \circlearrowleft \\ i \end{array} \lambda \end{array} \xrightarrow{F_{i,\lambda}} - \begin{array}{c} \uparrow \\ \downarrow \\ i \end{array} \lambda + \sum_{n=0}^{\langle h_i, \lambda \rangle - 1} \sum_{r \geq 0} \begin{array}{c} \begin{array}{c} \uparrow \\ \circlearrowleft \\ i \end{array} \lambda \\ \downarrow \\ \begin{array}{c} \downarrow \\ \circlearrowleft \\ i \end{array} \lambda \end{array}$$

$$\begin{array}{c} \begin{array}{c} \downarrow \\ \circlearrowleft \\ i \end{array} \lambda \\ \downarrow \\ \begin{array}{c} \uparrow \\ \circlearrowleft \\ i \end{array} \lambda \end{array} \xrightarrow{E_{i,\lambda}} - \begin{array}{c} \downarrow \\ \uparrow \\ i \end{array} \lambda + \sum_{n=0}^{-\langle h_i, \lambda \rangle - 1} \sum_{r \geq 0} \begin{array}{c} \begin{array}{c} \downarrow \\ \circlearrowleft \\ i \end{array} \lambda \\ \downarrow \\ \begin{array}{c} \uparrow \\ \circlearrowleft \\ i \end{array} \lambda \end{array}$$

8) The 3-cells corresponding to the  $\mathfrak{sl}_2$  relations: for any  $i \in I$  and  $\lambda \in X$

$$\begin{array}{cc}
 \begin{array}{c} \text{Diagram 1} \\ \downarrow \\ \text{Diagram 2} \end{array} \xrightarrow{C_{i,\lambda}} \sum_{n=0}^{\langle h_i, \lambda \rangle} \begin{array}{c} \text{Diagram 3} \\ \downarrow \\ \text{Diagram 4} \end{array}; & \begin{array}{c} \text{Diagram 5} \\ \downarrow \\ \text{Diagram 6} \end{array} \xrightarrow{A_{i,\lambda}} - \sum_{n=0}^{-\langle h_i, \lambda \rangle} \begin{array}{c} \text{Diagram 7} \\ \downarrow \\ \text{Diagram 8} \end{array}; \\
 \begin{array}{c} \text{Diagram 9} \\ \downarrow \\ \text{Diagram 10} \end{array} \xrightarrow{B_{i,\lambda}} - \sum_{n=0}^{-\langle h_i, \lambda \rangle} \begin{array}{c} \text{Diagram 11} \\ \downarrow \\ \text{Diagram 12} \end{array}; & \begin{array}{c} \text{Diagram 13} \\ \downarrow \\ \text{Diagram 14} \end{array} \xrightarrow{D_{i,\lambda}} \sum_{n=0}^{\langle h_i, \lambda \rangle} \begin{array}{c} \text{Diagram 15} \\ \downarrow \\ \text{Diagram 16} \end{array}.
 \end{array}$$

**6.2.13 Remark.** The 3-cells defining the new caps and cups generators in 3) are redundant in this presentation since they can be recovered using the  $\mathfrak{sl}_2$  relations of 8), the degree condition relations on bubbles of 4) and the KLR relations of 1): for instance, we have the following rewriting sequence in  $\mathcal{KLR}$ : for  $\langle h_i, \lambda \rangle > 0$ ,

$$\begin{array}{c} \text{Diagram 17} \\ \downarrow \\ \text{Diagram 18} \\ \downarrow \\ \text{Diagram 19} \end{array} - \sum_{a+b=\langle h_i, \lambda \rangle-1} \begin{array}{c} \text{Diagram 20} \\ \downarrow \\ \text{Diagram 21} \end{array} \equiv 0 - \begin{array}{c} \text{Diagram 22} \\ \downarrow \\ \text{Diagram 23} \end{array}$$

Similarly, one proves that the relations (6.26) - (6.27) can be recovered with this presentation, so the corresponding 3-cells can be removed from the presentation. We still denote by  $\mathcal{KLR}$  the linear  $(3, 2)$ -polygraph defined as above but with the 3-cells of 3) removed.

Following [67, 20], the 3-cells in  $\mathcal{KLR}$  are sufficient to recover all the relations in  $\mathcal{A}(\mathfrak{g})$ , so that we have the following result:

**6.2.14 Proposition.** *The linear  $(3, 2)$ -polygraph  $\mathcal{KLR}$  presents the linear 2-category  $\widehat{\mathcal{A}(\mathfrak{g})}$ .*

**6.2.15. Convergent splitting of  $\mathcal{KLR}$ .** We define a convergent splitting  $(E, R)$  of the linear  $(3, 2)$ -polygraph  $\mathcal{KLR}$  as follows: the linear  $(3, 2)$ -polygraph  $E$  has the same 0-cells and 1-cells than  $\mathcal{KLR}$ , its generating 2-cells are given by the six following 2-cells

$$\begin{array}{cccccc}
 \begin{array}{c} \uparrow \\ \bullet \\ \downarrow \\ i \end{array} & \begin{array}{c} i \\ \bullet \\ \downarrow \\ \lambda \end{array} & \begin{array}{c} \lambda \\ \curvearrowright \\ i \end{array} & \begin{array}{c} \curvearrowleft \\ \lambda \\ i \end{array} & \begin{array}{c} \lambda \\ \curvearrowright \\ i \end{array} & \begin{array}{c} i \\ \curvearrowleft \\ \lambda \end{array}
 \end{array}$$

and the 3-cells of  $E$  are the isotopy 3-cells of  $\mathcal{KLR}$  given in (9.4) – (6.31). Note that following [42], the linear  $(3, 2)$ -polygraph  $E$  is convergent. The linear  $(3, 2)$ -polygraph  $R$  is then defined by  $R_i = \mathcal{KLR}_i$  for  $0 \leq i \leq 2$  and  $R_3 = \mathcal{KLR}_3 \setminus E_3$ . In the sequel, we will consider rewriting with respect to the linear  $(3, 2)$ -polygraph  $S := {}_E R$ , and we will prove the following result:

**6.2.16 Theorem.** *The linear  $(3, 2)$ -polygraph modulo  $(R, E, {}_E R)$  is quasi-terminating and confluent modulo  $E$ .*

**6.2.17. Quasi-reduced monomials.** Following 2.6.4, linear 2-categories admitting relations making bubbles go through strands cannot be equipped with a monomial order, and thus cannot be presented by terminating but rather quasi-terminating rewriting systems. This is the case in this setting because of the bubble slide relations creating rewriting cycles, as for instance:

$$\begin{array}{c} \text{Diagram 24} \\ \downarrow \\ \text{Diagram 25} \\ \downarrow \\ \text{Diagram 26} \end{array} \xrightarrow{s_{i,j,\lambda,0}^+} \begin{array}{c} \text{Diagram 27} \\ \downarrow \\ \text{Diagram 28} \end{array} \xrightarrow{r_{i,j,\lambda-\alpha_j,0}^-} \begin{array}{c} \text{Diagram 29} \\ \downarrow \\ \text{Diagram 30} \end{array} = \begin{array}{c} \text{Diagram 31} \\ \downarrow \\ \text{Diagram 32} \end{array}$$

for any  $i$  and  $j$  such that  $i \cdot j = 0$ , and where the last equality is due to the exchange relation of 2-category  $\mathcal{A}(\mathfrak{g})$ . Note that there are the same kind of cyclic rewriting sequences in  $\mathcal{KLR}$  for different labels  $i$  and  $j$ , different orientations of bubbles and different number of dots decorating them. There also are the same kind of relations with caps replaced by cups, these relations are not drawn here.

However, following [2], we say that a monomial in  $\mathcal{A}(\mathfrak{g})$  is *quasi-reduced* if we can only apply to it one of the rewriting sequences given above.

**6.2.18 Remark.** Note that rewriting with respect to the linear  $(3, 2)$ -polygraph modulo  ${}_{\mathbb{E}}R$  brings additional loops coming from indexed diagrams of the form

$$\begin{array}{c} \text{---} \\ \text{---} \\ \text{---} \\ \text{---} \\ \text{---} \\ \text{---} \\ \text{---} \\ \text{---} \\ \text{---} \end{array} \begin{array}{c} \text{---} \\ \text{---} \\ \text{---} \\ \text{---} \\ \text{---} \\ \text{---} \\ \text{---} \\ \text{---} \\ \text{---} \end{array} \begin{array}{c} \text{---} \\ \text{---} \\ \text{---} \\ \text{---} \\ \text{---} \\ \text{---} \\ \text{---} \\ \text{---} \\ \text{---} \end{array} \lambda, \quad \begin{array}{c} \text{---} \\ \text{---} \\ \text{---} \\ \text{---} \\ \text{---} \\ \text{---} \\ \text{---} \\ \text{---} \\ \text{---} \end{array} \begin{array}{c} \text{---} \\ \text{---} \\ \text{---} \\ \text{---} \\ \text{---} \\ \text{---} \\ \text{---} \\ \text{---} \\ \text{---} \end{array} \lambda. \quad (6.35)$$

using the dot move 3-cells  $i_j^2$  for  $1 \leq j \leq 4$ , where  $k$  is a 2-cell in  $R_2^*$ . Note that when  $k$  is a 2-cell built of a  $\star_0$  and  $\star_1$  composite of dots, cups and caps 2-cells, the diagram in (6.35) is irreducible by  $R$ , and thus by  ${}_{\mathbb{E}}R_{\mathbb{E}}$ . When  $k$  is built with crossings, one checks that there are cycles of the following form:

$$\begin{array}{c} \text{---} \\ \text{---} \\ \text{---} \\ \text{---} \\ \text{---} \\ \text{---} \\ \text{---} \\ \text{---} \\ \text{---} \end{array} \begin{array}{c} \text{---} \\ \text{---} \\ \text{---} \\ \text{---} \\ \text{---} \\ \text{---} \\ \text{---} \\ \text{---} \\ \text{---} \end{array} \begin{array}{c} \text{---} \\ \text{---} \\ \text{---} \\ \text{---} \\ \text{---} \\ \text{---} \\ \text{---} \\ \text{---} \\ \text{---} \end{array} \lambda \rightleftharpoons \begin{array}{c} \text{---} \\ \text{---} \\ \text{---} \\ \text{---} \\ \text{---} \\ \text{---} \\ \text{---} \\ \text{---} \\ \text{---} \end{array} \begin{array}{c} \text{---} \\ \text{---} \\ \text{---} \\ \text{---} \\ \text{---} \\ \text{---} \\ \text{---} \\ \text{---} \\ \text{---} \end{array} \begin{array}{c} \text{---} \\ \text{---} \\ \text{---} \\ \text{---} \\ \text{---} \\ \text{---} \\ \text{---} \\ \text{---} \\ \text{---} \end{array} \lambda - \delta_{i,j} \begin{array}{c} \text{---} \\ \text{---} \\ \text{---} \\ \text{---} \\ \text{---} \\ \text{---} \\ \text{---} \\ \text{---} \\ \text{---} \end{array} \begin{array}{c} \text{---} \\ \text{---} \\ \text{---} \\ \text{---} \\ \text{---} \\ \text{---} \\ \text{---} \\ \text{---} \\ \text{---} \end{array} \lambda \equiv_{\mathbb{E}} \begin{array}{c} \text{---} \\ \text{---} \\ \text{---} \\ \text{---} \\ \text{---} \\ \text{---} \\ \text{---} \\ \text{---} \\ \text{---} \end{array} \begin{array}{c} \text{---} \\ \text{---} \\ \text{---} \\ \text{---} \\ \text{---} \\ \text{---} \\ \text{---} \\ \text{---} \\ \text{---} \end{array} \begin{array}{c} \text{---} \\ \text{---} \\ \text{---} \\ \text{---} \\ \text{---} \\ \text{---} \\ \text{---} \\ \text{---} \\ \text{---} \end{array} \lambda - \delta_{i,j} \begin{array}{c} \text{---} \\ \text{---} \\ \text{---} \\ \text{---} \\ \text{---} \\ \text{---} \\ \text{---} \\ \text{---} \\ \text{---} \end{array} \begin{array}{c} \text{---} \\ \text{---} \\ \text{---} \\ \text{---} \\ \text{---} \\ \text{---} \\ \text{---} \\ \text{---} \\ \text{---} \end{array} \lambda \rightleftharpoons \begin{array}{c} \text{---} \\ \text{---} \\ \text{---} \\ \text{---} \\ \text{---} \\ \text{---} \\ \text{---} \\ \text{---} \\ \text{---} \end{array} \begin{array}{c} \text{---} \\ \text{---} \\ \text{---} \\ \text{---} \\ \text{---} \\ \text{---} \\ \text{---} \\ \text{---} \\ \text{---} \end{array} \begin{array}{c} \text{---} \\ \text{---} \\ \text{---} \\ \text{---} \\ \text{---} \\ \text{---} \\ \text{---} \\ \text{---} \\ \text{---} \end{array} \lambda - \delta_{i,j} \begin{array}{c} \text{---} \\ \text{---} \\ \text{---} \\ \text{---} \\ \text{---} \\ \text{---} \\ \text{---} \\ \text{---} \\ \text{---} \end{array} \begin{array}{c} \text{---} \\ \text{---} \\ \text{---} \\ \text{---} \\ \text{---} \\ \text{---} \\ \text{---} \\ \text{---} \\ \text{---} \end{array} \lambda + \delta_{i,j} \begin{array}{c} \text{---} \\ \text{---} \\ \text{---} \\ \text{---} \\ \text{---} \\ \text{---} \\ \text{---} \\ \text{---} \\ \text{---} \end{array} \begin{array}{c} \text{---} \\ \text{---} \\ \text{---} \\ \text{---} \\ \text{---} \\ \text{---} \\ \text{---} \\ \text{---} \\ \text{---} \end{array} \lambda \quad (6.36)$$

and from the same diagram closed on its right by a rightward cap and a leftward cup. Similarly, if for  $k \geq 0$  we denote by

$$\begin{array}{c} \text{---} \\ \text{---} \\ \text{---} \\ \text{---} \\ \text{---} \\ \text{---} \\ \text{---} \\ \text{---} \\ \text{---} \end{array} \begin{array}{c} \text{---} \\ \text{---} \\ \text{---} \\ \text{---} \\ \text{---} \\ \text{---} \\ \text{---} \\ \text{---} \\ \text{---} \end{array} \begin{array}{c} \text{---} \\ \text{---} \\ \text{---} \\ \text{---} \\ \text{---} \\ \text{---} \\ \text{---} \\ \text{---} \\ \text{---} \end{array} \lambda$$

the diagram obtained as the superposition of  $2k$  composable crossings, closed on the left using a cap and a cup, there are cycles in  ${}_{\mathbb{E}}R$  given by:

$$\begin{array}{c} \text{---} \\ \text{---} \\ \text{---} \\ \text{---} \\ \text{---} \\ \text{---} \\ \text{---} \\ \text{---} \\ \text{---} \end{array} \begin{array}{c} \text{---} \\ \text{---} \\ \text{---} \\ \text{---} \\ \text{---} \\ \text{---} \\ \text{---} \\ \text{---} \\ \text{---} \end{array} \begin{array}{c} \text{---} \\ \text{---} \\ \text{---} \\ \text{---} \\ \text{---} \\ \text{---} \\ \text{---} \\ \text{---} \\ \text{---} \end{array} \lambda \rightleftharpoons \begin{array}{c} \text{---} \\ \text{---} \\ \text{---} \\ \text{---} \\ \text{---} \\ \text{---} \\ \text{---} \\ \text{---} \\ \text{---} \end{array} \begin{array}{c} \text{---} \\ \text{---} \\ \text{---} \\ \text{---} \\ \text{---} \\ \text{---} \\ \text{---} \\ \text{---} \\ \text{---} \end{array} \lambda$$

and similarly for a superposition of  $2k$  upward oriented crossings closed on its right by a rightward cap and a leftward cup, and for downward oriented crossings. However, one can always leave the cycles of the form (6.36) using the 3-cells  $\beta_{i,j}^+$  or  $\beta_{i,j}^-$  when the dot is not inside a double crossing, so that we do not take these cycles into account when considering quasi-reduced monomials.

**6.2.19. Termination without bubble slide 3-cells.** Before proving that  ${}_{\mathbb{E}}R$  is quasi-terminating, let us at first prove the following result stating that, without the bubble slide 3-cells, the linear  $(3, 2)$ -polygraph  $R$  defined in Section 6.2.15 is terminating.

**6.2.20 Lemma.** *The linear  $(3, 2)$ -polygraph  $R' = (R_0, R_1, R_2, R_3 \setminus \{s_{i,j,\lambda}^+, s_{i,j,\lambda}^-\})$  is terminating.*

*Proof.* We proceed into three steps.

- i) At first, let us extend the derivation  $d$  defined in Section 6.1.7 by keeping the same value on crossings and dots, no matter the orientation of strands, and by setting the value on caps and cups 2-cells as 0. Using this derivation, we get that  $d(s_2(\delta)) > d(t_2(\delta))$  for any 3-cell  $\delta$  coming from the linear  $(3, 2)$ -polygraph  $\text{KLR}$ . As a consequence, one gets that if the linear  $(3, 2)$ -polygraph  $R''$  defined as  $R'$  minus every  $\text{KLR}$  3-cell terminates, then so does  $R'$ . Indeed, otherwise there would be an infinite reduction sequence  $(f_n)_{n \in \mathbb{N}}$  in  $R'$  and thus, an infinite decreasing sequence  $(d(f_n))_{n \in \mathbb{N}}$  of natural numbers. Moreover, this sequence would be strictly decreasing at each step that is generated by any  $\text{KLR}$  3-cell. Thus, after some natural number  $p$ , this sequence would be generated by the other 3-cells only. This would yield an infinite reduction sequence  $(f_n)_{n \geq p}$  in  $R''$ , which is impossible by assumption.
- ii) Let us prove that  $R''$  is terminating in the two remaining steps. First of all, let us consider the derivation  $\|\cdot\|_{\{\tau_{i,j}^+, \tau_{i,j}^-\}_{i,j \in I}}$  into the trivial module  $M_{*,*,\mathbb{Z}}$ , counting the number of crossing generators in a given 2-cell. Then for any 3-cell  $\delta$  belonging to  $\{A_{i,\lambda}, B_{i,\lambda}, C_{i,\lambda}, D_{i,\lambda}, E_{i,j,\lambda}, F_{i,j,\lambda}\}$ , we get that  $d(s_2(\delta)) > d(t_2(\delta))$ , and we prove in a same way that if the linear  $(3, 2)$ -polygraph  $R'''$  defined as  $R$  with only all 3-cells implying bubbles as 3-cells is terminating, then so is  $R'$ .
- iii) To prove that  $R'''$  is terminating, we consider the derivation  $d'$  into the trivial module  $M_{*,*,\mathbb{Z}}$  defined for any 2-cell  $u$  in  $\mathcal{KLR}_2$  by

$$d'(u) = \begin{cases} \#\{\text{bubbles in } u\} + \sum_{\pi \text{ clockwise oriented bubble in } u} \deg(\pi) & \text{if } u \text{ contains bubbles,} \\ 0 & \text{if } u \text{ has no bubbles,} \\ -\infty & \text{if } u = 0. \end{cases}$$

One then easily checks that

$$d'(s_2(b_{i,\lambda}^1)) = d'(s_2(b_{i,\lambda}^{0,n})) = 1 + 2(1 - \langle h_i, \lambda \rangle + n) > 0 = \max(d'(t_2(b_{i,\lambda}^1)), d'(t_2(b_{i,\lambda}^{0,n})))$$

$$d'(s_2(c_{i,\lambda}^1)) = d'(s_2(c_{i,\lambda}^{0,n})) = 1 > 0 = \max(d'(t_2(c_{i,\lambda}^1)), d'(t_2(c_{i,\lambda}^{0,n})))$$

$$\begin{aligned} d'(s_2(\text{ig}_\alpha)) &= d' \left( \langle h_i, \lambda \rangle - 1 + \alpha \cdot \text{ig}_\alpha \right) = 1 + \alpha i \cdot i > 2 + (\alpha - 1) i \cdot i \\ &= d' \left( \langle h_i, \lambda \rangle - 1 + \alpha - 1 \cdot \text{ig}_\alpha \right) \end{aligned}$$

since  $l \geq 1$  and  $i \cdot i = 2$ .

□

**6.2.21. Quasi-orderings.** Following [40], a quasi-ordered set is a set  $A$  equipped with a transitive and reflexive binary relation  $\succsim$  on elements of  $A$ . For example, for any abstract rewriting system  $(A, \rightarrow_R)$ , the derivability relation  $\rightarrow_R^*$  is a quasi-ordering on the set  $A$ . Given a quasi-ordering  $\succsim$  on a set  $A$ , we define the associated equivalence relation  $\approx$  as both  $\succsim$  and  $\precsim$  and the strict partial ordering  $>$  as  $\succsim$  but not  $\precsim$ . Such a quasi-ordering is said *total* if for any  $a, b$  in  $A$ , we have either  $a \succsim b$  or  $b \succsim a$ . The strict part  $>$  of a quasi-ordering is *well-founded* if and only if all infinite quasi-descending sequences  $a_1 \succsim a_2 \succsim \dots$  of elements of  $A$  contains a pair  $s_j \precsim s_k$  for  $j < k$ . A quasi-ordering defined on a set of 2-cells of a linear  $(2, 2)$ -category  $\mathcal{C}$  is said *monotonic* if

$$(u \succsim v) \Rightarrow (C[u] \succsim C[v])$$

for any context  $C$  of  $\mathcal{C}$ . From [40], if  $\succsim$  is monotonic then  $\approx$  is a congruence. Many termination and quasi-termination proofs in the literature are made using well-founded quasi-orderings defined by monotonic polynomial interpretations, [80]. In the case of linear  $(2, 2)$ -categories, these polynomial interpretations will be given by weight functions.

**6.2.22. Weight functions.** Let  $\mathcal{C}$  a linear 2-category. Recall from [2] that a *weight function* on  $\mathcal{C}$  is a function  $\tau$  from  $\mathcal{C}_2$  to  $\mathbb{N}$  such that

- i)  $\tau(u \star_i v) = \tau(u) + \tau(v)$  for  $i = 0, 1$  for any  $i$ -composable 2-cells  $u$  and  $v$ ,
- ii) for each 2-cell  $u$  in  $\mathcal{C}_2$ ,  $\tau(u) = \max\{\tau(u_i) \mid u_i \in \text{Supp}(u)\}$ .

Note that when  $\mathcal{C}$  is presented by a linear  $(3, 2)$ -polygraph  $P$ , such a weight function is uniquely and entirely determined by its values on the generating 2-cells of  $P_2$ . This enables to define a *quasi-ordering*  $\succeq$  on  $\mathcal{KLR}_2^\ell$  by  $u \succeq v$  if  $\tau(u) \geq \tau(v)$ , where  $\tau$  is an appropriate weight function on  $\mathcal{KLR}_2^\ell$ . We define such a weight function on  $\mathcal{KLR}_2^\ell$  by its following values on generating 2-cells:

$$\tau(\downarrow \curvearrowright) = \tau(\curvearrowleft \downarrow) = \tau(\cup \curvearrowright) = \tau(\curvearrowleft \cup) = 0, \quad \tau(\uparrow \downarrow) = \tau(\downarrow \uparrow) = 0, \quad \tau(\nearrow \nwarrow) = \tau(\nwarrow \nearrow) = 3.$$

Note that for any 3-cell  $\alpha$  in  $E_3$ , we have  $\tau(s_2(\alpha)) = \tau(t_2(\alpha))$  so that the isotopy 3-cells preserve this weight function. Then, starting with a monomial  $u$  of  $\mathcal{KLR}_2^\ell$ :

- While  $u$  can be rewritten with respect to  ${}_{\mathbb{E}}R$  into a 2-cell  $u'$  such that  $\tau(u') < \tau(u)$ , then assign  $u$  to  $u'$ .
- While  $u$  can be rewritten with respect to  ${}_{\mathbb{E}}R$  into a 2-cell  $u'$  without any of the 3-cells depicted in Section 6.2.17, then assign  $u$  to  $u'$ .

From Lemma 6.2.20 and well-foundedness of the quasi-ordering  $\succeq$ , this procedure terminates and returns a linear combination of monomials in  $\mathcal{KLR}_2^\ell$  which are quasi-reduced, proving that  ${}_{\mathbb{E}}R$  is quasi-terminating.

**6.2.23. Confluence modulo E.** We prove that  ${}_{\mathbb{E}}R$  is confluent modulo  $E$  by proving that it is decreasing modulo  $E$ . To prove that it is decreasing, we prove that all critical branchings of the form  $(f, g)$ , where  $f$  is a positive 3-cell in  $S^{\ell(1)}$  and  $g$  is a positive 3-cell in  $R^{\ell(1)}$  are decreasingly confluent with respect to the quasi-normal form labelling  $\psi^{\text{QNF}}$ . First of all, let us provide an exhaustive list of such critical branchings. Note that the branchings implying 3-cells  $b_{i,\lambda}^{k,n}$ ,  $b_{i,\lambda}^{k,n}$  and  $I_\alpha$  for  $k = 0, 1$  and  $\alpha > 0$  are trivially confluent by definition of bubbles with a negative number of dots and the Infinite Grassmanian relation. Notice also that the bubble slide 3-cells does not overlap with the degree condition 3-cells since their sources are bubbles with positive degrees by definition. Let us now study the remaining critical branchings, that we split into two sets: those implying the KLR 3-cells and the remaining branchings between 3-cells  $A_{i,\lambda}$ - $F_{i,\lambda}$ .

**6.2.24. Critical branchings from KLR relations.** First of all, we have to consider all the the critical branchings of the linear  $(3, 2)$ -polygraph KLR presenting the KLR algebra for both downward and upward orientation of strands. These are all confluent from 6.1.8 and Appendix A.2. The 3-cells coming from KLR also provide the following critical branchings of  ${}_{\mathbb{E}}R$  modulo  $E$ :

$$(A_{i,\lambda}, \alpha_{i,\lambda}^{L,+}), (B_{i,\lambda}, i_4^2 \cdot \alpha_{i,\lambda}^{L,+}), (C_{i,\lambda}, i_3^2, \alpha_{i,\lambda}^{R,+}), (D_{i,\lambda}, \alpha_{i,\lambda}^{R,+}), (E_{i,\lambda}, \alpha_{i,\lambda}^{L,+}), (F_{i,\lambda}, \alpha_{i,\lambda}^{R,+}).$$

for any value of  $\langle h_i, \lambda \rangle$ , of respective sources

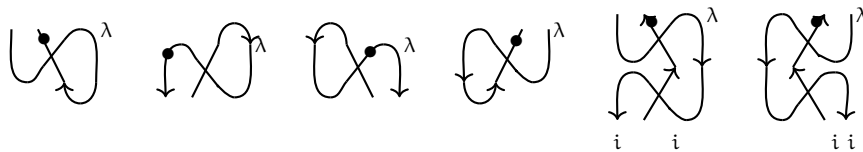

There are also critical branchings coming from isotopy given by

$$(\beta_{i,j}^{\lambda,+}, (i_1^0 \star_2 i_4^0)^- \cdot F_{i,j,\lambda}), \quad (\alpha_{i,\lambda}^{R,+}, (i_1^0 \star_2 i_4^0)^- \star_2 i_3^2 \star_2 i_1^2 \cdot F_{i,j,\lambda}), \quad (\gamma_{j,i,j}^{\lambda,+}, (i_1^0 \star_2 i_4^0)^- \cdot F_{i,j,\lambda})$$

of respective sources

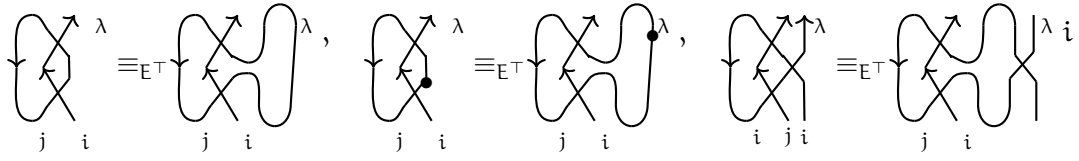

Similarly, there are critical branchings of the form

$$(\beta_{i,j}^{\lambda,+}, (i_1^0 \star_2 i_4^0)^- \cdot E_{i,j,\lambda}), \quad (\alpha_{i,\lambda}^{1,+}, (i_1^0 \star_2 i_4^0)^- \star_2 (i_2^2 \star_2 i_4^2)^- \cdot E_{i,j,\lambda}).$$

All these branchings are proved confluent modulo E with respect to  $\varepsilon R$  in Appendix A.3.1. Besides, it is clear that each rewriting step drawn in the confluence diagrams in Appendix A.3.1 make the distance to a quasi-normal form decrease by 1, proving decreasing confluence of these critical branchings for  $\psi^{\text{QNF}}$ .

**6.2.25. Critical branchings between 3-cells A – F.** Let us now classify critical branchings between the 3-cells  $A_{i,\lambda}$ ,  $B_{i,\lambda}$ ,  $C_{i,\lambda}$ . We denote at first that if  $i, j \in I$  with  $i \neq j$ , there are two critical branchings given by  $(E_{i,j,\lambda}, F_{i,j,\lambda})$  and  $(F_{i,j,\lambda}, E_{i,j,\lambda})$  which are trivially confluent. When both strands are labelled by the same vertex  $i$ , the 3-cells  $E_{i,\lambda}$  and  $F_{i,\lambda}$  overlap with the  $\mathfrak{sl}_2$  3-cells, and we describe below a way to list these overlappings, depending on the notion of *type* of a 2-cell.

**6.2.26 Definition.** For any 2-cell  $u$  in  $\mathcal{KLR}_2$ , we define the *type* of  $u$  as follows:

- i) If  $u$  has a 1-source (resp. 1-target)  $\mathcal{E}$  and an identity 1-cell as target (resp. source), that is if  $u$  is represented by a closed diagram at its top (resp. at its bottom), we set the type of  $D$  to be

$$\text{sgn}(\mathcal{E})^d \quad (\text{resp. } \text{sgn}(\mathcal{E})^u),$$

where  $\text{sgn}(\mathcal{E})$  depicts the sequence of signs appearing in  $\mathcal{E}$ .

- ii) If  $u$  is a 2-cell in  $\mathcal{KLR}_2$  between two non-identity 1-cells, then the type of  $u$  is given by two elements  $\text{sgn}(\mathcal{E})^d$  and  $\text{sgn}(\mathcal{F})^u$

For instance, the following diagrams have respectively for type  $(+, -)^d$  and  $(-, +)^d$ ,  $(-, +)^u := (-, +)^{u,d}$ :

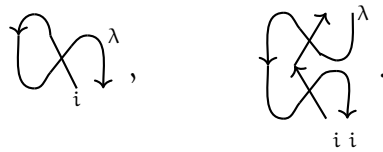

Moreover, all the 3-cells named by a letter A have the same type  $(-, +)^u$ , we thus call it type A. We do the same thing for the other 3-cells and we recover the different types for our 3-cells in an array:

| Type of the 3-cell | Type of the diagram |
|--------------------|---------------------|
| A                  | $(-, +)^u$          |
| B                  | $(-, +)^d$          |
| C                  | $(+, -)^d$          |
| D                  | $(+, -)^u$          |
| E                  | $(-, +)^{d,u}$      |
| F                  | $(+, -)^{d,u}$      |

There is a critical branching between two such relations if and only if they overlap on an element

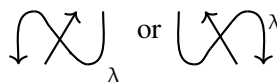

Thus, we can notice that there is a branching only between 3-cells of opposed type, that is in which we reverse all the signs and we change the orientation. For instance, there is a branching between A and C whose source is:



Following this observation, the pairs of 3-cells that lead to a critical branching are:

$$(C_{i,\lambda}, A_{i,\lambda}), (F_{i,\lambda}, A_{i,\lambda}), (B_{i,\lambda}, D_{i,\lambda}), (B_{i,\lambda}, F_{i,\lambda}), (C_{i,\lambda}, E_{i,\lambda}), (E_{i,\lambda}, D_{i,\lambda}), (E_{i,\lambda}, F_{i,\lambda}), (F_{i,\lambda}, E_{i,\lambda})$$

for any  $i$  in  $I$ , any  $\lambda$  in  $X$  and any possible value of  $\langle h_i, \lambda \rangle$ . We check that all these critical branchings are confluent modulo  $E$ , all the drawings are given in Appendix A.3.

**6.2.27. Categorification of quantum groups.** In this section, we prove using rewriting that the generating set that Khovanov and Lauda conjectured to be a linear basis indeed is a basis, by proving that this generating set corresponds to a set of quasi-normal forms for the linear  $(3, 2)$ -polygraph  ${}_{\mathbb{E}}R$  defined from  $\mathcal{KLR}$ . As an immediate consequence of the results of [67], we obtain that the linear 2-category  $\mathcal{U}(\mathfrak{g})$  is a categorification of the quantum group  $\check{U}_q(\mathfrak{g})$  associated with a symmetrizable Kac-Moody algebra  $\mathfrak{g}$  whose Dynkin diagram  $\Gamma$  is a simply-laced graph.

**6.2.28. Khovanov-Lauda's generating set.** In [67], Khovanov and Lauda described a general generating set for the vector space  $\mathcal{U}(\mathfrak{g})(E_i 1_\lambda, E_j 1_\lambda)$ , for any  $\mathbf{i}$  and  $\mathbf{j}$  in  $S\text{Seq}(\mathcal{V})$ , and  $\lambda$  in  $X$ . To define this set, consider  $m$  points (resp.  $n$  points) on the lower (resp. upper) boundary  $\mathbb{R} \times \{0\}$  (resp.  $\mathbb{R} \times \{1\}$ ) of the planar strip  $\mathbb{R} \times [0, 1]$ , with  $m + n$  even, and choose an immersion of  $\frac{n+m}{2}$  strands into the strip  $\mathbb{R} \times [0, 1]$  having these points as endpoints. We say that a strand is a *through strand* if it links an endpoint of  $\mathbb{R} \times \{0\}$  to an endpoint of  $\mathbb{R} \times \{1\}$ . We fix an orientation and a label for each of these strands, so that any endpoint inherits a label from the strand he is linked to, and a sign which is  $+$  if the strand is upward oriented when reaching the endpoint,  $-$  otherwise. These orientations and labels on the upper (resp. the lower) endpoints then define signed sequences  $\mathbf{i}$  and  $\mathbf{j}$  in  $S\text{Seq}(\mathcal{V})$ . These immersions between  $\mathbf{i}$  and  $\mathbf{j}$  are defined modulo boundary-preserving homotopies, and are called  $(\mathbf{i}, \mathbf{j})$ -pairings. We will consider *minimal*  $(\mathbf{i}, \mathbf{j})$ -pairings, that is such pairings in which strands have no self-intersections and any two strands intersect at most once.

Any  $(\mathbf{i}, \mathbf{j})$ -pairing has a minimal diagram, as defined in [67], and we denote by  $p(\mathbf{i}, \mathbf{j})$  a set of fixed minimal  $(\mathbf{i}, \mathbf{j})$ -pairing  $\tilde{u}$  for any  $(\mathbf{i}, \mathbf{j})$ -pairing  $u$ . Let us also denote by  $\Pi_\lambda$  the set of 2-cells  $\mathcal{U}(\mathfrak{g})(1_\lambda, 1_\lambda)$  containing all products of clockwise and counterclockwise oriented bubbles with exterior region labelled by  $\lambda$ , having an arbitrary number of dots on it and such that the degree of each bubble is positive. Following [67], let us consider the set  $\mathcal{B}_{\mathbf{i}, \mathbf{j}, \lambda}$  consisting of the union, over all  $u$  in  $p(\mathbf{i}, \mathbf{j})$ , of diagrams built out of  $u$  by fixing a choice of an interval on each strand, away from the intersections, and placing an arbitrary number of dots on each of these intervals, and placing any diagram representing a monomial in  $\Pi_\lambda$  to the right of this new diagram. Khovanov and Lauda proved that this space spans the  $\mathbb{K}$ -vector space  $\mathcal{U}(\mathfrak{g})(E_i 1_\lambda, E_j 1_\lambda)$ .

**6.2.29. Monomials in quasi-normal form.** In this section, we will fix a particular set of monomials in quasi-normal form for the linear  $(3, 2)$ -polygraph  ${}_{\mathbb{E}}R$ . Before defining this set, let us expand a few remarks on reductions of 2-cells using rewriting modulo with respect to  ${}_{\mathbb{E}}R$ , allowing to change a diagram up to isotopy to apply 3-cells of  $\mathcal{KLR}$ .

- a) Note that a 2-cell  $u$  can be reduced into a linear combination of diagrams in which all 2-cells have positive degree, using the infinite Grassmannian 3-cell and the degree condition 3-cells.
- b) A 2-cell  $u$  containing bubbles can be reduced into a linear combination of 2-cells  $u'$  in which all the bubbles moved to the rightmost region using the bubble slide relations.
- c) If a 2-cell  $u$  contains a strand that intersect twice with another strand, one can use isotopies and 3-cells  $E_{i,\lambda}$ ,  $F_{i,\lambda}$  or  $\beta_{i,j,\lambda}^\pm$  to remove these intersections. As a consequence, two different strands can intersect at most once.
- d) If a 2-cell contains a non through strand that intersect with itself, one can use isotopies and 3-cells  $A_{i,\lambda}$  (or  $B_{i,\lambda}$ ,  $C_{i,\lambda}$ ,  $D_{i,\lambda}$ ) on the part of the diagram next to the intersection to remove this intersection.
- e) If a 2-cell contains a through strand with dots on it, the dots can be moved to the bottom of the strand using the KLR 3-cells  $\alpha_{i,\lambda}^{L,\pm}$ .
- f) If a 2-cell contains a non through strand with a dot on it, and this strand does not intersect with another strand, the dot can be placed anywhere. Taking the normal form will respect to  $E$  will then make the dot move to the right.
- g) If this non-through strand intersect with another strand, we are in one of the following situations:

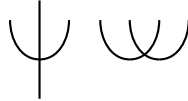

or the mirror image of it through the anti-involution  $\mathbb{T}$  defined in [20], for any orientation and labels on strands. In the first case, if the dot is placed on the left of the cup, it can be moved to the right using isotopy and the 3-cell  $\alpha_{i,j,\lambda}^{L,\pm}$ . In the second situation, if the dot is placed on the leftmost cup (resp. on the rightmost cup), it can be reduced with the KLR 3-cell  $\alpha_{i,j}^{L,\pm}$  (or just an identity if the dot is already in the good position) in

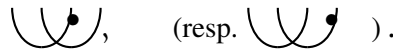

As a consequence, one can choose a set of  $E$ -normal forms of quasi-normal forms with respect to  ${}_{E}\mathcal{R}$  containing 2-cells in  $\mathcal{KLR}_2$  having: all bubbles placed in the rightmost region and all dots placed to the right of a bubble, a minimal number of crossings and crossings moved as far as possible to the right using the Yang-Baxter 3-cells  $\gamma_{i,j,\lambda}^\pm$ , no strands with self-intersection and no double intersections between two different strands, dots placed on the bottom on every through strand and on the rightmost part of every non-through strand. This choice of set of quasi-normal forms correspond to a particular set  $\mathcal{B}_{i,j,\lambda}$  of Khovanov and Lauda. As a consequence of [42, Thm 2.5.6], we get the following result:

**6.2.30 Theorem.** *The set  $\mathcal{B}_{i,j,\lambda}$  defined above is a linear basis of  $\mathcal{U}(\mathfrak{g})(E_i 1_\lambda, E_j 1_\lambda)$ .*

**6.2.31. Categorification of quantum groups.** In [67], Khovanov and Lauda defined a map  $\gamma$  between Lusztig's idempotent and integral form  $\check{\mathcal{U}}(\mathfrak{g})$  defined in [85] of the quantum group  $\mathbf{U}_q(\mathfrak{g})$  associated with a symmetrizable Kac-Moody algebra and the Grothendieck group of the (additive) linear 2-category  $\mathcal{U}(\mathfrak{g})$ . They established that this map is surjective for any Kac-Moody algebra  $\mathfrak{g}$  and any field  $\mathbb{K}$ . However, the injectivity of  $\gamma$  holds if and only if the graphical calculus they introduce is non-degenerate, which is equivalent to the fact that the generating set  $\mathcal{B}_{i,j,\lambda}$  is a linear basis of the  $\mathbb{K}$ -vector space of 2-cells  $\mathcal{U}(\mathfrak{g})(E_i 1_\lambda, E_j 1_\lambda)$  for any  $\mathbf{i}$  and  $\mathbf{j}$  in  $\text{SSeq}(\mathcal{V})$ . From Theorem 6.2.30, this is true for any Kac-Moody algebra  $\mathfrak{g}$  defined from a simply-laced Cartan datum, namely for any Kac-Moody algebra having a simply-laced Dynkin Diagram, so we obtain as a corollary the following result:

**6.2.32 Corollary.** *For a Kac-Moody algebra  $\mathfrak{g}$  defined by a simply-laced Cartan datum, the linear 2-category  $\mathcal{U}(\mathfrak{g})$  is a categorification of  $\check{\mathcal{U}}(\mathfrak{g})$ .*



**Contents**

|   |            |
|---|------------|
| <b>7.1 Cartesian polygraphs and theories . . . . .</b>                  | <b>168</b> |
| <b>7.2 Algebraic examples . . . . .</b>                                 | <b>170</b> |
| <b>7.3 Algebraic polygraphs modulo . . . . .</b>                        | <b>172</b> |
| <b>7.4 Positive confluence in algebraic polygraphs modulo . . . . .</b> | <b>176</b> |
| <b>7.5 Algebraic critical branching lemma . . . . .</b>                 | <b>179</b> |

Many rewriting results given above are based on the notion of confluent (resp. confluent modulo) presentations. We have seen that one of the main tools to prove confluence of a polygraph is by the critical branching lemma, giving a way to deduce confluence from a finite checking of confluence of local minimal overlappings of two reductions. However, the extension of these methods to a wide range of algebraic structures is made difficult because of the interaction between the rewriting rules and the inherent axioms of the algebraic structure. For instance, in the case of string rewriting systems, Nivat proved [97] that it suffices to check confluence of critical branchings to obtain local confluence. However, this is wrong in the linear setting, and it requires an additional termination assumption, see Remark 2.9.3 for a counter-example. For this reason, extensions of this approach to a wide range of algebraic structures, including groups, Lie algebras, is still an open problem.

In this Chapter, we introduce a categorical model for rewriting in algebraic structures which formalizes the interaction between the rules of the rewriting system and the inherent axioms of the algebraic structure. We recall the notion of cartesian 2-dimensional polygraph introduced in [87], corresponding to rewriting systems that present a Lawvere algebraic theory. We introduce an algebraic setting for the formulation on the critical branching lemma, by defining the structure of algebraic polygraph modulo which consists in rewriting with respect to the rules of a structure modulo the ambient algebraic axioms. We introduce rewriting strategies based on a restriction on rewriting steps, depending on whether their source is a normal form or not with respect to the inherent algebraic theory. We then introduce rewriting properties with respect to these strategies, and prove an extension of the terminating Newman lemma modulo for quasi-terminating algebraic polygraphs modulo, and a critical branching lemma for rewriting systems on algebraic structures whose axioms are specified by term rewriting systems satisfying appropriate convergence relations modulo associativity and commutativity. Finally, we explicit our results in

linear rewriting, and explain why termination is a necessary condition to characterize local confluence in that case. We expect that these constructions can be adapted to rewriting in various algebraic structures, such as groups, differential algebras, Weyl algebras, Ore extensions, and higher-dimensional structures.

## 7.1. CARTESIAN POLYGRAPHS AND THEORIES

In section we recall the notion of algebraic theory from [83] and of cartesian polygraph introduced in [87].

**7.1.1. Signature and terms.** A *signature* is defined by a set  $P_0$  of *sorts* and a 1-polygraph, *i.e.* a directed graph,

$$P_0^* \begin{array}{c} \xleftarrow{\partial_0^-} \\ \xrightarrow{\partial_0^+} \end{array} P_1$$

on the free monoid  $P_0^*$  over  $P_0$ . Elements of  $P_1$  are called *operations*. For an operation  $\alpha$  in  $P_1$ , its source  $\partial_0^-(\alpha)$  is called its *arity* and its target  $\partial_0^+(\alpha)$  its *coarity*. For sorts  $s_1, \dots, s_k$ , we denote  $\underline{s} = s_1 \dots s_k$  their product in the free monoid  $P_0^*$ . We denote  $|\underline{s}| = k$  the *length* of  $\underline{s}$  and the sort  $s_i$  in  $\underline{s}$  will be denoted by  $\underline{s}_i$ .

Recall from [83] that an (*multityped Lawvere algebraic*) *theory* for a given set of sorts  $P_0$  is a category with finite products  $\mathbb{T}$  together with a map  $\iota$  from  $P_0$  and with values in its set of 0-cells  $\mathbb{T}_0$ , and such that every 0-cell in  $\mathbb{T}_0$  is isomorphic to a finite product of 0-cells in  $\iota(P_0)$ . We denote by  $P_1^\times$  the free theory generated by a signature  $(P_0, P_1)$  whose products on 0-cells of  $P_1^\times$  are induced by products of sorts in  $P_0^*$ , and the 1-cells of  $P_1^\times$  are *terms* over  $P_1$  defined by induction as follows:

- i) the canonical projections  $x_i^{\underline{s}} : \underline{s} \rightarrow \underline{s}_i$ , for  $1 \leq i \leq |\underline{s}|$  are terms, called *variables*,
- ii) for any terms  $f : \underline{s} \rightarrow r$  and  $f' : \underline{s} \rightarrow r'$  in  $P_1^\times$ , there exists a unique 1-cell  $\langle f, f' \rangle : \underline{s} \rightarrow rr'$ , called *pairing* of terms  $f, f'$ , such that  $x_1^{rr'} \langle f, f' \rangle = f$  and  $x_2^{rr'} \langle f, f' \rangle = f'$ ,
- iii) for every operation  $\varphi : \underline{r} \rightarrow s$  in  $P_1$ ,  $\underline{s}$  in  $S_0^*$  and terms  $f_i : \underline{s} \rightarrow \underline{r}_i$  in  $P_1^\times$  for  $1 \leq i \leq |\underline{r}|$ , there is a term  $\varphi \langle f_1, \dots, f_{|\underline{r}|} \rangle : \underline{s} \rightarrow s$ .

We define the *size* of a term  $f$  as the minimal number, denoted by  $|f|$ , of operations used to its definition.

For any 0-cells  $\underline{s}, \underline{s}'$  in  $P_1^\times$ , we denote by  $1_{\underline{s}}$  the identity 1-cell on a 0-cell  $\underline{s}$ , we denote by  $\epsilon_{\underline{s}}$  the *eraser* 1-cell defined as the unique 1-cell from  $\underline{s}$  to the terminal 0-cell  $0$ , and we denote by  $\delta_{\underline{s}} = \langle 1_{\underline{s}}, 1_{\underline{s}} \rangle : \underline{s} \rightarrow \underline{s} \times \underline{s}$  the *duplicator* 1-cell. We denote respectively by  $x_{\underline{s}}^{\underline{ss}'}$  (resp.  $x_{\underline{s}'}^{\underline{ss}'}$ ) the canonical projections. Finally, we denote by  $\tau_{\underline{s}, \underline{s}'} : \underline{ss}' \rightarrow \underline{s}'\underline{s}$  the *exchange* 1-cell defined by  $\tau_{\underline{s}, \underline{s}'} = \langle x_{\underline{s}'}^{\underline{ss}'}, x_{\underline{s}}^{\underline{ss}'} \rangle$ .

**7.1.2. Two-dimensional cartesian polygraph.** A *cartesian 2-polygraph* is a data  $(P_0, P_1, P_2)$  made of

- i) a signature  $(P_0, P_1)$ ,
- ii) a cellular extension of the free theory  $P_1^\times$ , that is a set  $P_2$  equipped with two maps

$$P_1^\times \begin{array}{c} \xleftarrow{\partial_1^-} \\ \xrightarrow{\partial_1^+} \end{array} P_2$$

satisfying the following *globular conditions*  $\partial_0^\mu \circ \partial_1^- = \partial_0^\mu \circ \partial_1^+$ , for  $\mu \in \{-, +\}$ .

An element  $\alpha$  of  $P_2$  is called a *rule* with *source*  $\partial_-(\alpha)$  and *target*  $\partial_+(\alpha)$  that we denote respectively by  $\alpha_-$  and  $\alpha_+$  so that such a rule is denoted by  $\alpha : \alpha_- \Rightarrow \alpha_+$ . The globular conditions impose that such a rule  $f \Rightarrow g$  relates terms of same arity  $\underline{s}$  and same coarity  $\underline{r}$ , and it will be pictured as follows:

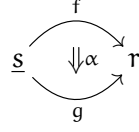

**7.1.3. Two-dimensional theories.** Recall that a *2-dimensional theory*, or *2-theory* for a given set of sorts  $P_0$  is a 2-category with the additional following cartesian structure:

- i) it has a terminal 0-cell, that is for every 0-cell  $\underline{s}$  there exists a unique 1-cell  $e_{\underline{s}} : \underline{s} \rightarrow 1$ , called *eraser*, and the identity 2-cell is the unique endo-2-cell on an eraser,
- ii) it has products, that is for all 0-cells  $\underline{r}, \underline{r}'$  there is a product 0-cell  $\underline{r}\underline{r}'$  and 1-cells  $x_{\underline{r}'}^{\underline{r}\underline{r}'} : \underline{r}\underline{r}' \rightarrow \underline{r}$  and  $x_{\underline{r}}^{\underline{r}\underline{r}'} : \underline{r}\underline{r}' \rightarrow \underline{r}'$  satisfying the two following conditions:
  - for any 1-cells  $f_1 : \underline{s} \rightarrow \underline{r}$  and  $f_2 : \underline{s} \rightarrow \underline{r}'$ , there exists a unique pairing 1-cell  $\langle f_1, f_2 \rangle : \underline{s} \rightarrow \underline{r}\underline{r}'$ , such that  $x_{\underline{r}}^{\underline{r}\underline{r}'} \langle f_1, f_2 \rangle = f_1$ , and  $x_{\underline{r}'}^{\underline{r}\underline{r}'} \langle f_1, f_2 \rangle = f_2$ ,
  - for any 2-cells  $\alpha_1 : f_1 \Rightarrow f_1'$ ,  $\alpha_2 : f_2 \Rightarrow f_2'$ , there exists a unique 2-cell  $\langle \alpha_1, \alpha_2 \rangle : \langle f_1, f_2 \rangle \Rightarrow \langle f_1', f_2' \rangle$ .

We refer the reader to [87] for a detailed construction.

**7.1.4. Free 2-theories.** We denote by  $P_2^\times$  the free 2-theory generated by a cartesian 2-polygraph  $(P_0, P_1, P_2)$ . We briefly recall its construction and refer the reader to [87] for details. The underlying 1-category of  $P_2^\times$  is the free theory  $P_1^\times$  generated by the signature  $(P_0, P_1)$ . Its 2-cells are defined inductively as follows:

- i) for any 2-cell  $\alpha : u \Rightarrow v$  in  $P_2$  and 1-cell  $w$  in  $P_1^\times$ , there is a 2-cell  $\alpha w : u \star_0 w \Rightarrow v \star_0 w$  in  $P_2^\times$ ,
- ii) for any 2-cells  $\alpha, \beta$  in  $P_2^\times$ , there is a 2-cell  $\langle \alpha, \beta \rangle : \langle \alpha_-, \beta_- \rangle \Rightarrow \langle \alpha_+, \beta_+ \rangle$  in  $P_2^\times$ ,
- iii) for any 2-cell  $\alpha$  in  $P_2^\times$ , there are 2-cells in  $P_2^\times$  of the form  $A[\alpha] : A[\alpha_-] \Rightarrow A[\alpha_+]$  where  $A[\square]$  denotes an *algebraic context* of the form:

$$A[\square] := f \langle \text{id}_{f_1}, \dots, \square_i, \dots, \text{id}_{f_k} \rangle : \underline{s} \rightarrow \underline{r},$$

where  $f_1, \dots, f_k : \underline{s} \rightarrow \underline{r}_i$  and  $f : \underline{r} \rightarrow \underline{r}$  are 1-cells of  $P_1^\times$ , and  $\square_i$  is the  $i$ -th element of the pairing.

- iv) these 2-cells are submitted to the following exchange relations

$$f \langle f_1, \dots, f_i, \dots, \beta, \dots, f_k \rangle \star_1 f \langle f_1, \alpha, \dots, f_j, \dots, f_k \rangle = f \langle f_1, \dots, \alpha, \dots, f_j, \dots, f_k \rangle \star_1 f \langle f_1, \dots, f_i, \dots, \beta, \dots, f_k \rangle$$

where  $f_i : \underline{s} \rightarrow \underline{r}_i$  and  $f : \underline{r} \rightarrow \underline{r}$  are 1-cells in  $P_1^\times$ ,  $\alpha$  and  $\beta$  are 2-cells in  $P_2$ . We will denote by  $\langle f_1, \dots, \alpha, \dots, \beta, \dots, f_k \rangle$  the 2-cell defined above.

- v) The  $\star_1$ -composition of 2-cells in  $P_2$  is given by sequential composition.

The source and target maps  $\partial_1^\pm$  extend to  $P_2^\times$  and we denote  $\alpha_-$  and  $\alpha_+$  for  $\partial_1^-(\alpha)$  and  $\partial_1^+(\alpha)$ .

**7.1.5. Ground terms.** Let  $(P_0, P_1, P_2)$  be a cartesian 2-polygraph. A *ground term* in the free theory  $P_1^\times$  is a term with source  $\mathbf{0}$ . A 2-cell  $\alpha$  in the free theory  $P_2^\times$  is called *ground* when  $\alpha_-$  is a ground term. Finally, an algebraic context  $A[\square] = f \langle f_1, \dots, \square_i, \dots, f_{|I|} \rangle$  is called *ground* when the  $f_i$  are ground terms.

**7.1.6. Free (2, 1)-theory.** A *free (2, 1)-theory* is a theory  $\mathbb{T}$  whose any 2-cell is invertible with respect to the  $\star_1$ -composition. That is, any 2-cell  $\alpha$  of  $\mathbb{T}_2$  has an inverse  $\alpha^- : \alpha_+ \Rightarrow \alpha_-$  satisfying the relations  $\alpha \star_1 \alpha^- = 1_{\alpha_-}$  and  $\alpha^- \star_1 \alpha = 1_{\alpha_+}$ .

We denote by  $P_2^\top$  the free (2, 1)-theory generated by a cartesian 2-polygraph  $(P_0, P_1, P_2)$ . The 2-cells of the (2, 1)-theory  $P_2^\top$  corresponds to elements of the equivalence relation generated by  $P_2$ .

**7.1.7. Rewriting properties of cartesian polygraphs.** Let  $P$  be a cartesian 2-polygraph. The algebraic contexts of the cartesian 2-polygraph  $P$  can be composed, and we will denote by  $AA'[\square] := A[A'[\square]]$ . In the same way, one defines a *multi-context* (of arity 2) as

$$B[\square_i, \square_j] := f(\text{id}_{f_1}, \dots, \square_i, \dots, \square_j, \dots, \text{id}_{f_k}),$$

where the  $f_k : \underline{s} \rightarrow \underline{r}_k$  and  $f : \underline{r} \rightarrow \underline{r}$  are 1-cells in  $P_1^\times(X)$ , and  $\square_i$  (resp.  $\square_j$ ) has to be filled by a 1-cell  $g_i : \underline{s} \rightarrow \underline{r}_i$  (resp.  $g_j : \underline{s} \rightarrow \underline{r}_j$ ).

A 2-cell of the form  $A[\alpha w]$  where  $A$  is an algebraic context,  $w$  is a 1-cell in  $P_1^\times$  and  $\alpha$  is a rule in  $P_2$  is called a *rewriting step* of  $P$ . A *rewriting path* is a non-identity 2-cell of  $P_2^\times$ . Such a 2-cell can be decomposed as a  $\star_1$ -composition of rewriting steps:

$$\alpha = A_1[\alpha_1] \star_1 A_2[\alpha_2] \star_1 \dots \star_1 A_k[\alpha_k].$$

The *length* of a 2-cell  $\alpha$  in  $P_1^\times$ , denoted by  $\ell(f)$ , is the minimal number of rewriting steps in any  $\star_1$ -decomposition of  $\alpha$ . In particular, a rewriting step is a 2-cell of length 1.

**7.1.8. Notations.** For the sake of readability, we will denote terms and rewriting rules of cartesian polygraphs as in term rewriting theory, [117]. The canonical projections  $x_i^s : \underline{s} \rightarrow \underline{s}_i$ , for  $1 \leq i \leq |\underline{s}|$  are identified to "variables"  $x_1, \dots, x_{|\underline{s}|}$ . And a 1-cell  $f : \underline{s} \rightarrow \underline{r}$  is denoted by  $f(x_1, \dots, x_{|\underline{s}|})$ , and a rule  $\alpha : f \Rightarrow g$  with  $f, g : \underline{s} \rightarrow \underline{r}$  will be denoted by

$$\alpha_{x_1, \dots, x_{|\underline{s}|}} : f(x_1, \dots, x_{|\underline{s}|}) \Rightarrow g(x_1, \dots, x_{|\underline{s}|}).$$

## 7.2. ALGEBRAIC EXAMPLES

**7.2.1. Associative and commutative magmas.** Denote by  $\text{MAG}$  the cartesian 2-polygraph whose signature has a unique sort denoted by 1 and an unique generating 1-cell  $\mu : 2 \rightarrow 1$  and an empty set of generating 2-cells. Denote by  $\text{ASS}$  the cartesian 2-polygraph such that  $\text{ASS}_1 = \text{MAG}_1$  and with an unique generating 2-cell:

$$A_{x,y,z}^\mu : \mu(\mu(x, y), z) \Rightarrow \mu(x, \mu(y, z)) \quad (7.1)$$

Denote by  $\text{AC}^\mu$  (or simply  $\text{AC}$  when there is no ambiguity) the cartesian 2-polygraph such that  $\text{AC}_1 = \text{MAG}_1$ , and  $\text{AC}_2 = \text{ASS}_2 \cup \{C\}$  with

$$C^\mu : \mu(x, y) \Rightarrow \mu(y, x) \quad (7.2)$$

that correspond to the rule  $C^\mu : \mu\tau \Rightarrow \mu$ , where  $\tau$  is the exchanging operator defined in Section 7.1.1. Note that the cartesian 2-polygraph  $\text{AC}$  is not terminating, and that the rule  $C$  can not be oriented in a terminating way. As a consequence, in the sequel when  $P_2$  is defined by a set of relations together with relations corresponding to commutativity and associativity axioms for some operation  $\mu$ , we will chose to work modulo the polygraphs  $\text{AC}^\mu$ .

**7.2.2. Monoids.** We define the cartesian polygraph  $\text{MON}$  whose signature has a unique sort  $1$ ,  $\text{MON}_1 = \text{ASS}_1 \cup \{e : 0 \rightarrow 1\}$ , and  $\text{MON}_2 = \text{MAG}_2 \cup \{E_1^\mu, E_r^\mu\}$  with

$$E_1^\mu : \mu(e, x) \Rightarrow x \quad E_r^\mu : \mu(x, e) \Rightarrow x. \quad (7.3)$$

Then the theory  $\overline{\text{P}}$  is the theory of monoids that we will denote by  $\mathbb{M}$ . We also define the cartesian polygraph  $\text{CMON}$  by  $\text{CMON}_i = \text{MON}_i$  for  $0 \leq i \leq 1$  and  $\text{CMON}_2 = \text{MON}_2 \cup \{C^\mu\}$  where  $C^\mu$  is the commutativity 2-cell defined in (7.2).

**7.2.3. Groups.** We define the cartesian polygraph  $\text{GRP}$  whose signature has a unique sort  $1$ ,  $\text{GRP}_1 = \text{MON}_1 \cup \{\iota : 1 \rightarrow 1\}$ , and  $\text{GRP}_2 = \text{MON}_2 \cup \{I_1^\mu, I_r^\mu\}$  with

$$I_1^{\mu, \iota} : \mu(\iota(x), x) \Rightarrow e \quad I_r^{\mu, \iota} : \mu(x, \iota(x)) \Rightarrow e \quad (7.4)$$

Note that following [57], the following set of generating 2-cells gives a cartesian polygraph that is Tietze equivalent to  $\text{GRP}$  (that is it also presents the theory  $\overline{\text{GRP}}$ ) and convergent modulo the cartesian polygraph  $\text{ASS}$ :

$$G_1^{\mu, \iota} : \iota(e) \Rightarrow e \quad G_2^{\mu, \iota} : \iota(\iota(x)) \Rightarrow x \quad G_3^{\mu, \iota} : \iota(\mu(x, y)) \Rightarrow \mu(\iota(y), \iota(x)) \quad (7.5)$$

$$G_4^{\mu, \iota} : \mu(x, \mu(\iota(x), y)) \Rightarrow y \quad G_5^{\mu, \iota} : \mu(\iota(x), \mu(x, y)) \Rightarrow y \quad (7.6)$$

**7.2.4. Abelian groups.** Consider the cartesian polygraph  $\text{AB}$  whose signature has a unique sort  $1$ ,  $\text{AB}_1 = \text{GRP}_1$  and  $\text{AB}_2 = \text{GRP}_2 \cup \{C\}$  where  $C$  is the commutativity generating 2-cell defined in (7.2).

**7.2.5. Rings.** Consider the cartesian polygraph  $\text{RING}$  whose signature has a unique sort  $1$ ,  $\text{RING}_1 = \text{AB}_1 \coprod \text{MON}_1$  with the following notations:

$$\text{AB}_1 = \{+ : \mathbf{2} \rightarrow \mathbf{1}, 0 : \mathbf{0} \rightarrow \mathbf{1}, - : \mathbf{1} \rightarrow \mathbf{1}\}, \quad \text{MON}_1 = \{\cdot : \mathbf{2} \rightarrow \mathbf{1}, 1 : \mathbf{0} \rightarrow \mathbf{1}\},$$

and  $\text{RING}_2 = \text{AB}_2 \cup \text{MON}_2 \cup \{D_1, D_r\}$ , where

$$D_1 : x \cdot (y + z) \Rightarrow x \cdot y + x \cdot z \quad D_r : (y + z) \cdot x \Rightarrow y \cdot x + z \cdot x \quad (7.7)$$

The cartesian 2-polygraph  $\text{CRING}$  (commutative rings) is the cartesian 2-polygraph whose signature has a unique sort  $1$ ,  $\text{CRING} = \text{RING}_1$  with the same notations as above, and  $\text{CRING}_2 = \text{RING}_2 \cup \{C\}$  where  $C$  is the commutativity generating 2-cell

$$C : \cdot(x, y) \Rightarrow \cdot(y, x) \quad (7.8)$$

Following [99, Example 12.2], the following set of generating 2-cells gives a cartesian polygraph that is Tietze equivalent to  $\text{CRING}$ , and is convergent modulo  $\text{AC}$ :

$$E_r^+, I_r^{+, -}, G_1^{+, -}, G_2^{+, -}, G_3^{+, -}, D_r, R_1 : x \cdot 0 \Rightarrow 0, R_2 : x \cdot (-y) \Rightarrow -(x \cdot y), E_r^- \quad (7.9)$$

**7.2.6. Modules over a commutative ring.** The cartesian 2-polygraph  $\text{MOD}$  with  $\text{MOD}_0 = \{\mathbf{m}, \mathbf{r}\}$ , and  $\text{MOD}_1 = \text{CRING}_1 \cup \text{AB}_1 \cup \{\eta : \mathbf{r}\mathbf{m} \rightarrow \mathbf{m}\}$  with the following notations

i)  $\text{CRING}_0 = \{\mathbf{r}\}$ ,  $\text{CRING}_1 = \{+ : \mathbf{r}\mathbf{r} \rightarrow \mathbf{r}, 0 : \mathbf{0} \rightarrow \mathbf{r}, - : \mathbf{r} \rightarrow \mathbf{r}, \cdot : \mathbf{r}\mathbf{r} \rightarrow \mathbf{r}, 1 : \mathbf{0} \rightarrow \mathbf{r}\}$ ;

ii)  $\text{AB}_0 = \{\mathbf{m}\}$ ,  $\text{AB}_1 = \{\oplus : \mathbf{m}\mathbf{m} \rightarrow \mathbf{m}, 0^\oplus : \mathbf{0} \rightarrow \mathbf{m}, \iota : \mathbf{m} \rightarrow \mathbf{m}\}$ ;

iii) If there is no possible confusion, we will denote  $\eta(\lambda, x) = \lambda \cdot x$  for  $\lambda$  and  $x$  of type  $\mathbf{r}$  and  $\mathbf{m}$  respectively.

and  $\text{MOD}_2 = \text{CRING}_2 \cup \text{AB}_2 \cup \{M_1, M_2, M_3, M_4\}$  with

$$M_1 : \lambda.(\mu.x) \Rightarrow (\lambda \cdot \mu).x \quad M_2 : 1.x \Rightarrow x \quad (7.10)$$

$$M_3 : \lambda.(x \oplus y) \Rightarrow (\lambda.x) \oplus (\lambda.y) \quad M_4 : \lambda.x \oplus \mu.x \Rightarrow (\lambda + \mu).x \quad (7.11)$$

Following [57], the 2-cells in (7.9) together with the following set of 2-cells

$$M_1, \quad M_2, \quad M_3, \quad M_4, \quad N_1 : x \oplus 0^\oplus \Rightarrow x, \quad N_2 : x \oplus (\lambda.x) \Rightarrow (1 + \lambda).x, \quad (7.12)$$

$$N_3 : x \oplus x \Rightarrow (1 + 1).x, \quad N_4 : x.0^\oplus \Rightarrow 0^\oplus, \quad N_5 : 0.x \Rightarrow 0^\oplus, \quad N_6 : \iota(x) \Rightarrow (-1).x \quad (7.13)$$

gives a convergent presentation of the theory of modules over a commutative ring modulo  $\text{AC} \coprod \text{AC}^+$ , which contains all the associativity and commutativity relations for the operations  $\cdot$  and  $+$ . This presentation can be summarized with the following set of generating 2-cells:

|  |                      |   |                      |
|--|----------------------|---|----------------------|
| $x + 0 \Rightarrow x$                  | (ring <sub>1</sub> ) | $x + (-x) \Rightarrow 0$                            | (ring <sub>2</sub> ) |
| $-0 \Rightarrow 0$                     | (ring <sub>3</sub> ) | $-(-x) \Rightarrow x$                               | (ring <sub>4</sub> ) |
| $-(x + y) \Rightarrow (-x) + (-y)$     | (ring <sub>5</sub> ) | $x \cdot (y + z) \Rightarrow x \cdot y + x \cdot z$ | (ring <sub>6</sub> ) |
| $x \cdot 0 \Rightarrow 0$              | (ring <sub>7</sub> ) | $x \cdot (-y) \Rightarrow -(x \cdot y)$             | (ring <sub>8</sub> ) |
| $1 \cdot x \Rightarrow x$              | (ring <sub>9</sub> ) | $a \oplus 0^\oplus \Rightarrow a$                   | (mod <sub>1</sub> )  |
| $x.(y.a) \Rightarrow (x \cdot y).a$    | (mod <sub>2</sub> )  | $1.a \Rightarrow a$                                 | (mod <sub>3</sub> )  |
| $x.a \oplus y.a \Rightarrow (x + y).a$ | (mod <sub>4</sub> )  | $x.(a \oplus b) \Rightarrow (x.a) \oplus (y.b)$     | (mod <sub>5</sub> )  |
| $a \oplus (r.a) \Rightarrow (1 + r).a$ | (mod <sub>6</sub> )  | $a \oplus a \Rightarrow (1 + 1).a$                  | (mod <sub>7</sub> )  |
| $x.0^\oplus \Rightarrow 0^\oplus$      | (mod <sub>8</sub> )  | $0.a \Rightarrow 0^\oplus$                          | (mod <sub>9</sub> )  |
| $I(a) \Rightarrow (-1).a$              | (mod <sub>10</sub> ) |   |                      |

Let us denote by  $\text{MOD}'_2$  the set containing the 2-cells (7.9), (7.12) and (7.13), and denote by  $\text{MOD}^c$  the cartesian 2-polygraph  $(\text{MOD}_0, \text{MOD}_1, \text{MOD}'_2 \cup \text{AC} \cup \text{AC}^+)$ . It also presents the theory of modules over a commutative ring.

### 7.3. ALGEBRAIC POLYGRAPHS MODULO

In this section we introduce the notion of algebraic polygraph as a cellular extension on closed terms. In Subsection 7.3.10, we introduce the notion of algebraic polygraph modulo following the constructions of Chapter 4.

**7.3.1. Constants.** Let  $(P_0, P_1)$  be a signature, and  $Q$  be a set of *generating 1-cell (called constants)* with source  $\mathbf{0}$  and target a sort in  $P_0$ . We denote by  $P_1\langle Q \rangle$  the set of ground terms of the free theory  $(P_1 \cup Q)^\times$ .

**7.3.2. Algebraic polygraph.** An *algebraic polygraph* is a data  $(P, Q, R)$  where,

- i)  $P$  is a cartesian 2-polygraph,
- ii)  $Q$  is a family of set of generating constants  $(Q_s)_{s \in P_0}$ ,
- iii)  $R$  is a cellular extension of the set of ground terms  $P_1\langle Q \rangle$ .

Note that the cellular extension  $R$  is indexed by the sorts of  $P_0$ , that is it defines a family  $(F_s, R_s)_{s \in P_0}$  of 1-polygraphs, where  $F_s = P_1\langle Q \rangle_s$ .

**7.3.3. Example.** Let  $\text{MON}_2$  be the cartesian 2-polygraph defined in (7.2.2). One defines an algebraic polygraph by setting:

$$Q = \{s, t : \mathbf{0} \rightarrow \mathbf{1}\}, \quad R = \{ \alpha : (s \cdot t) \cdot s \Rightarrow t \cdot (s \cdot t) \}. \quad (7.14)$$

**7.3.4. Rewriting in algebraic polygraphs.** Let  $\mathcal{P} = (P, Q, R)$  be an algebraic polygraph, and let  $\alpha : f \Rightarrow g$  be a ground 2-cell in  $R$ . A *R-rewriting step* is a ground 2-cell in the free 2-theory  $R^\times$  on  $(P_1 \cup Q, R)$  of the form

$$A[\alpha] : A[f] \Rightarrow A[g],$$

where  $A[\square]$  is a ground context. It can be depicted by the following diagram:

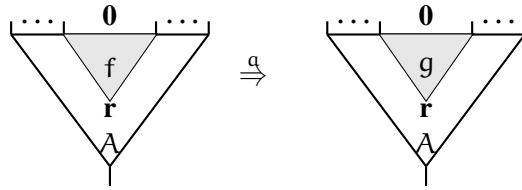

A *R-rewriting path* is a finite or infinite sequence  $\underline{a} = a_1 \star_1 a_2 \star_1 \dots \star_1 a_k \star_1 \dots$  of  $R$ -rewriting steps  $a_i$ . The *length* of 2-cell  $\underline{a}$  in  $R^\times$ , denoted by  $\ell(\underline{a})$ , is the minimal number of  $R$ -rewriting steps needed to write  $\underline{a}$  as a composition as above

**7.3.5. Example.** Consider the rule  $\alpha$  defined in (7.14). And the algebraic contexte  $A[\square] = (s \cdot \square) \cdot t$ , we have the rewriting step

$$A[\alpha] : (s \cdot ((s \cdot t) \cdot s)) \cdot t \Rightarrow (s \cdot (t \cdot (s \cdot t))) \cdot t.$$

**7.3.6. Algebraic polygraph of axioms.** The cellular extension  $P_2$  defined on  $P_1^\times$  extends to a cellular extension on the free 1-theory  $(P_1 \cup Q)^\times$  denoted by  $\widehat{P}_2$ , whose source and target maps are defined in such a way that the following diagram commutes

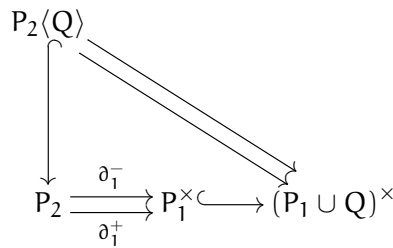

and denote by  $P_2\langle Q \rangle$  (resp  $P_2\langle Q \rangle^\top$ ) the set of ground 2-cells in  $\widehat{P}_2^\times$  (resp.  $\widehat{P}_2^\top$ ). The set  $P_2\langle Q \rangle$  thus contains the groundified 2-cells of  $P_2$ . The data  $(P, Q, P_2\langle Q \rangle)$  defines an algebraic polygraph, that we call the *algebraic polygraph of axioms*. We say that two terms  $f$  and  $g$  in  $P_1\langle Q \rangle$  are *algebraically equivalent* with respect to  $P$ , denoted by  $f \equiv_{P_2} g$ , if there exists a ground 2-cell in  $P_2\langle Q \rangle^\top$  from  $f$  to  $g$ .

We will denote by  $\overline{P\langle Q \rangle}$  the quotient of the full sub-category  $P_1\langle Q \rangle$  of  $P_1 \cup Q^\times$  by the congruence generated by the 2-cells in  $P_2\langle Q \rangle$ . Namely, two terms  $f$  and  $g$  that are related by a 2-cell in  $P_2\langle Q \rangle^\top$  are identified in the quotient.

Note that the algebraic polygraph  $(P, Q, P_2\langle Q \rangle)$  shares the rewriting properties of the cartesian 2-polygraph  $P$ . In particular, if  $P$  is terminating (resp. quasi-terminating, confluent, confluent modulo  $P'$ ), then  $(P, Q, P_2\langle Q \rangle)$  is terminating (resp. quasi-terminating, confluent, confluent modulo  $(P', Q, P_2\langle Q \rangle)$ ).

**7.3.7. Example.** In the example of the algebraic polygraph defined in (7.14), the set  $P_2\langle Q \rangle$  is defined by the associativity relations on ground terms on the constants  $s$  and  $t$ . For instance,  $P_2\langle Q \rangle$  contains the following ground 2-cell:

$$A_{s,t,s} : (s \cdot t) \cdot s \Rightarrow s \cdot (t \cdot s).$$

**7.3.8. Positivity.** Denote  $\pi : P_1\langle Q \rangle \rightarrow \overline{P\langle Q \rangle}$  the canonical projection, and let  $\sigma : \overline{P\langle Q \rangle} \rightarrow \mathbf{Set}$  be a map such that for any  $\bar{f} \in \overline{P\langle Q \rangle}$ ,  $\sigma(\bar{f})$  is a chosen non-empty subset of  $\pi^{-1}(\bar{f})$ . Such a map is called a *positive strategy* with respect to  $(P, Q)$ . A rewriting step  $\alpha$  in  $R^\times$  is called  $\sigma$ -*positive* if  $\alpha_-$  belongs to  $\sigma(\overline{\alpha_-})$ . A rewriting path  $\alpha_1 \star_1 \dots \star_1 \alpha_k$  in  $R^\times$  is called  $\sigma$ -*positive* if any of its rewriting steps is positive.

**7.3.9. Strategies to define positivity.** We introduce positivity strategies that depend on the inherent cartesian 2-polygraph  $P$ . Suppose that  $P$  is such that  $P_2 = P'_2 \cup P''_2$ , with  $P'_2$  confluent modulo  $P''_2$ . For every 1-cell  $\bar{f}$  in  $\overline{P\langle Q \rangle}$ , we set  $\sigma(\bar{f}) = \text{NF}(f, P'_2 \text{ mod } P''_2)$ , where  $f \in \pi^{-1}(\bar{f})$ , the set of normal forms of  $f$  for  $P'_2$  modulo  $P''_2$ . Note that this is well-defined following [56, Lemma 2.6], since if  $f, f' \in \pi^{-1}(\bar{f})$ , then  $\text{NF}(f, P'_2 \text{ mod } P''_2) \equiv_{P''_2} \text{NF}(f', P'_2 \text{ mod } P''_2)$ .

In many algebraic situations, we will set  $\text{ASS} \subseteq P''_2$ . In particular, in the case of SRS,  $P'_2$  will be empty and  $P''_2 = \text{ASS}$ . In that case, any term in  $P_1\langle Q \rangle$  is a normal form for the empty polygraph modulo  $\text{ASS}$ , and thus the positive strategy consists in taking all the fiber. In the case of LRS,  $P''_2$  will be  $\text{AC}$ , the algebraic polygraph corresponding to associativity and commutativity relations of the operations, and  $P'_2$  will be the convergent presentation of  $\text{RMOD}$  modulo  $\text{AC}$  given in Section 7.2.6.

**7.3.10. Algebraic polygraphs modulo.** Given an algebraic polygraph  $\mathcal{P} = (P, Q, R)$  and a positive strategy  $\sigma$  on  $\mathcal{P}$ , one denotes by  ${}_P R_P$  the cellular extension

$$P_1\langle Q \rangle \xleftarrow{\quad} {}_P R_P$$

defined as in 4.4.1, and made of triple  $(e, \alpha, e')$ , where  $e$  and  $e'$  are ground 2-cells in  $P_2\langle Q \rangle^\Gamma$  and  $\alpha$  is a  $R$ -rewriting step. Such a triple will be denoted by  $e \star \alpha \star e'$ , called a  ${}_P R_P$ -*rule*. Such a rule is called  $\sigma$ -*positive* if  $\alpha$  is a  $\sigma$ -positive  $R$ -rewriting step. An *algebraic polygraph modulo* is a data  $(P, Q, R, S)$  made of

- i) an algebraic polygraph  $(P, Q, R)$ ,
- ii) a cellular extension  $S$  of  $P_1\langle Q \rangle$  such that  $R \subseteq S \subseteq {}_P R_P$ .

Note that the data  $(P, Q, S)$  defines an algebraic polygraph modulo.

**7.3.11. Example.** Let us consider the algebraic polygraph  $(P, Q, R)$  defined in (7.14), then the following composition gives a rewriting step in  ${}_P R_P$ :

$$(s \cdot (s \cdot (t \cdot s))) \cdot t \equiv_{P_2} (s \cdot ((s \cdot t) \cdot s)) \cdot t \xrightarrow{A[\alpha]} (s \cdot (t \cdot (s \cdot t))) \cdot t \equiv_{P_2} ((s \cdot t) \cdot (s \cdot t)) \cdot t.$$

**7.3.12. Termination properties.** An algebraic polygraph  $\mathcal{P} = (P, Q, R)$  is called

- i) *algebraically terminating* if for each sequence  $(f_n)_{n \in \mathbb{N}}$  of 1-cells of  $P_1\langle Q \rangle$  such that for each  $n \in \mathbb{N}$ , there is a rewriting step  $f_n \rightarrow f_{n+1}$ , the sequence  $(f_n)_{n \in \mathbb{N}}$  contains an infinite number of occurrences of same 1-cell in context, that is, there exist  $k, l \in \mathbb{N}$ , such that  $f_{k+l} = A[f_k]$  where  $A$  is a possibly empty ground context of  $\mathcal{P}$ ,
- ii) *exponentiation free* if there is no rewriting path with source a 1-cell  $f$  of  $P_1\langle Q \rangle$  and target  $C[f]$ , where  $A$  is a nontrivial ground context of  $\mathcal{P}$ .



Any quasi-terminating polygraph is algebraically terminating. But the converse implication is false in general, indeed the rewriting system  $a \rightarrow a \cdot a$  is algebraically terminating, but not quasi-terminating. In fact, it is not exponentiation free either. One proves that both properties algebraically terminating and exponentiation free implies the quasi-terminating property.

An algebraic polygraph modulo  $(P, Q, R, S)$  is called *terminating* (resp. *quasi-terminating*) if the algebraic polygraph  $(P, Q, S)$  is terminating (resp. quasi-terminating). Note that an algebraic polygraph is a special case of algebraic polygraph modulo when  $S = R$ . In the sequel we will consider only polygraphs modulo.

**7.3.13. Quasi-normal forms.** When the algebraic polygraph modulo  $\mathcal{P}$  is quasi-terminating, any 1-cell  $f$  of  $P_1\langle Q \rangle$  admits at least a quasi-normal form. Such a quasi-normal form is neither  $S$ -irreducible nor unique in general. A *quasi-normal form strategy* is a map  $s : P_1\langle Q \rangle \rightarrow P_1\langle Q \rangle$  sending a 1-cell  $f$  on a chosen quasi-normal form  $\tilde{f}$ . We define a map

$$d : P_1\langle Q \rangle \rightarrow \mathbb{N}$$

sending a 1-cell  $f$  to the integer  $d(f)$  counting the minimal number of  ${}_pR_p$ -rewriting steps needed to reach  $f$  from  $\tilde{f}$ .

**7.3.14. Algebraic rewriting system.** Note that the cellular extension  $S$  defined on  $P_1\langle Q \rangle$  extends to a cellular extension of  $\overline{P}\langle Q \rangle$ , with source and target maps defined respectively by  $\overline{\partial}_1^- := \pi \circ \partial_1^-$  and  $\overline{\partial}_1^+ := \pi \circ \partial_1^+$ . An *algebraic rewriting system* on an algebraic polygraph modulo  $(P, Q, R, S)$  with a positive strategy  $\sigma$  is a cellular extension  $\overline{S}$  of  $\overline{P}\langle Q \rangle$  defined in such a way that the following diagram commutes

$$\begin{array}{ccc} & & S \\ & \nearrow \overline{\partial}_1^+ & \downarrow \pi' \\ & \overline{P}\langle Q \rangle & \overline{S} \\ & \longleftarrow \overline{\partial}_1^- & \end{array}$$

where the map  $\pi'$  assigns to a  $S$ -rule  $e \star a \star e'$  an element  $\overline{a}$  in  $\overline{S}$  with source  $\overline{a}_-$  and target  $\overline{a}_+$ . Explicitly,

$$\overline{S} = \{\overline{a} : \overline{a}_- \Rightarrow \overline{a}_+ \mid e \star a \star e' \in S\}.$$

Note that  $\overline{S} = \overline{R}$  for any  $R \subseteq S \subseteq {}_pR_p$ . Let us consider the subset  $\overline{S}^\sigma$  of  $\overline{S}$  defined by  $\overline{S}^\sigma = \{\overline{a} : \overline{a}_- \Rightarrow \overline{a}_+ \mid a \text{ is a } \sigma\text{-positive } S\text{-rule}\}$ .

A  $\overline{S}$ -rewriting step (resp. a  $\overline{S}^\sigma$ -rewriting step) is the quotient of a  $S$ -rewriting step (resp.  $\sigma$ -positive rewriting step) by the canonical projection  $\pi$ , that is a 2-cell of the form  $\overline{C}[\overline{a}] : \overline{C}[\overline{a}_-] \Rightarrow \overline{C}[\overline{a}_+]$ , where  $C$  is a ground context of  $P_1\langle Q \rangle$  and  $C[a]$  is a  $S$ -rewriting step (resp.  $\sigma$ -positive  $S$ -rewriting step). A  $S$ -rewriting path is a sequence of  $\overline{S}$ -rewriting steps.

**7.3.15. Example: string rewriting systems.** A SRS can be deduced as a quotient algebraic polygraph as follows. We consider an algebraic polygraph  $(MON, Q, R, S)$ , where  $MON$  is the cartesian polygraph defined in 7.2.2. The set of constants  $Q$  is the set of generating 1-cells of the SRS, and  $R$  corresponds to fibrations of rules of the SRS on the fibers modulo associativity.

For instance, consider the algebraic polygraph defined in (7.14). Then by quotient, we obtain the string rewriting system

$$\langle s, t \mid sts \Rightarrow tst \rangle$$

that presents the monoid  $B_3^+$  of braids on 3 strands.

**7.3.16. Example: linear rewriting systems.** A linear rewriting system (LRS) is an algebraic rewriting system on an algebraic polygraph modulo  $(P, Q, R, S)$  such that  $\text{MOD}^c \subseteq P$ , where  $\text{MOD}^c$  is the cartesian 2-polygraph presenting the theory of modules over a commutative ring defined in Section 7.2.6.

## 7.4. POSITIVE CONFLUENCE IN ALGEBRAIC POLYGRAPHS MODULO

In this section we present confluence properties of algebraic polygraphs modulo with fixed positive strategies.

**7.4.1. Branchings in algebraic polygraphs modulo.** Let  $\mathcal{P} = (P, Q, R, S)$  be an algebraic polygraph modulo and  $\sigma$  a positive strategy on  $\mathcal{P}$ . A  $\sigma$ -branching of  $(P, Q, R, S)$  is a triple  $(\alpha, e, \beta)$  where  $f$  and  $g$  are  $\sigma$ -positive 2-cells of  $S^\times$  and  $e$  is a 1-cell of  $P_2\langle Q \rangle^\top$  such that  $e_- = \alpha_-$  and  $e_+ = \beta_-$ . Such a  $\sigma$ -branching is depicted as follows

$$\begin{array}{ccc} u & \xrightarrow{\alpha} & u' \\ e \downarrow & & \\ v & \xrightarrow{\beta} & v' \end{array} .$$

Note that the 2-cells are represented by simple arrows in confluence diagrams for better readability in the diagrams in the sequel. The 2-cell  $\beta$  (resp.  $\alpha$ ) can be an identity 2-cell of  $S^\times$ , and in that case the  $\sigma$ -branching is of the form  $(\alpha, e)$  (resp.  $(e, \beta)$ ). The source of such a  $\sigma$ -branching is the pair  $(f, f)$  where  $f = \alpha_- = e_-$  (resp.  $f = \beta_- = e_+$ ). The 2-cell  $e$  in  $P_2\langle Q \rangle^\top$  can also be trivial, and in that case the  $\sigma$ -branching modulo is a regular  $\sigma$ -branching  $(\alpha, \beta)$ . We denote by  $(u, u)$  its source, where  $u = \alpha_- = \beta_-$ .

Such a  $\sigma$ -branching is  $\sigma$ -confluent modulo if there exist  $\sigma$ -positive 2-cells  $\alpha'$  and  $\beta'$  in  $S^\times$  and a 2-cell  $e'$  of  $P_2\langle Q \rangle^\top$  as follows:

$$\begin{array}{ccccc} f & \xrightarrow{\alpha} & f' & \xrightarrow{\alpha'} & h \\ e \downarrow & & & & \downarrow e' \\ g & \xrightarrow{\beta} & g' & \xrightarrow{\beta'} & h' \end{array}$$

We say that the triple  $(\alpha', e', \beta')$  is a  $\sigma$ -confluence modulo of the  $\sigma$ -branching modulo  $(\alpha, e, \beta)$ , and that the pair of terms  $(f, g)$  is the *source* of the  $\sigma$ -branching  $(\alpha, e, \beta)$ . Such a  $\sigma$ -branching is *local* if  $\alpha$  is a rewriting step of  $S$ ,  $\beta$  is  $\ell(e) + \ell(\beta) = 1$ . Namely, it is either of the form  $(\alpha, e)$  or  $(\alpha, \beta)$ .

We say that the algebraic polygraph modulo  $(P, Q, R, S)$  is *confluent modulo* (resp. *locally confluent modulo*) if any  $\sigma$ -branching modulo (resp. local  $\sigma$ -branching modulo) is confluent modulo.

**7.4.2. Double induction on the distance to the quasi-normal form.** Consider the distance map  $d : P_1\langle Q \rangle \rightarrow \mathbb{N}$  defined in Section 7.3.13. We extend this distance on 1-cells of  $P_1\langle Q \rangle$  to a distance on  $\sigma$ -branchings modulo  $(\alpha, e, \beta)$  by defining

$$d(\alpha, e, \beta) := d(\alpha_-) + d(\alpha_+).$$

We then define a well-founded order  $\prec$  on the set of  $\sigma$ -branchings of  $S$  modulo  $P$  by:

$$(\alpha, e, \beta) \prec (\alpha', e', \beta') \text{ if } d(\alpha, e, \beta) < d(\alpha', e', \beta').$$

The confluence proofs in the sequel will be made using induction on this order. Note that this corresponds to a process of induction on sources of  $\sigma$ -branchings modulo, that is pairs of 1-cells in  $P_1\langle Q \rangle$ , with respect to distance of the quasi-normal form with respect to  ${}_P R_P$ . This follows Huet's double induction principle in the terminating setting, based on induction on an auxiliary rewriting system constructed on pairs of terms.

**7.4.3 Theorem** (Newman lemma modulo for algebraic polygraphs modulo). *Let  $\mathcal{P}$  be a quasi-terminating algebraic polygraph modulo, and  $\sigma$  be a positive strategy on  $\mathcal{P}$ . If  $\mathcal{P}$  is locally  $\sigma$ -confluent modulo, then it is  $\sigma$ -confluent modulo.*

*Proof.* The proof of this result follows the scheme of the proof of Theorem 2.3.15 in the terminating setting, by replacing each use of Huet's double induction principle by induction on the well-founded order  $\prec$  on branchings modulo defined above.  $\square$

**7.4.4. Classification of local  $\sigma$ -branchings.** The local  $\sigma$ -branchings modulo of  $\mathcal{P}$  can be classified in the following families:

i) *trivial*  $\sigma$ -branchings of the form

$$\begin{array}{ccc} A[a_-] & \xrightarrow{A[a]} & A[a_+] \\ \Downarrow & & \\ A[a_-] & \xrightarrow{A[a]} & A[a_+] \end{array}$$

for some ground context context  $A$  and  $\sigma$ -positive S-rewriting step  $a$ .

ii) *inclusion independant*  $\sigma$ -branchings modulo of the form

$$\begin{array}{ccc} A[a_-] & \xrightarrow{A[a]} & A[a_+] \\ \Downarrow & & \\ A[A'[b_-]] & \xrightarrow{A[A'[b]]} & A[A'[b_+]] \end{array}$$

for some ground contexts context  $A$  and  $A'$ , and  $\sigma$ -positive S-rewriting steps  $a$  and  $b$ .

iii) *orthogonal*  $\sigma$ -branchings modulo of the form

$$\begin{array}{ccc} B[a_-, b_-] & \xrightarrow{B[a, b_-]} & B[a_+, b_-] \\ \Downarrow & & \\ B[a_-, b_-] & \xrightarrow{B[a_-, b]} & B[a_-, b_+] \end{array}$$

$$\begin{array}{ccc} B[a_-, e_-] & \xrightarrow{B[a, e_-]} & B[a_+, e_-] & B[e'_-, b_-] & \xrightarrow{B'[e'_-, b]} & B'[e'_-, b_+] \\ B[a_-, e_-] \downarrow & & & B'[e'_-, b_-] \downarrow & & \\ B[a_-, e_+] & & & B'[e'_+, b_-] & & \end{array}$$

for some ground multi-contexts  $B$  and  $B'$  of arity 2, S-rewriting steps  $a, b$  and  $c$  of  $S$ , and 2-cells  $e$  and  $e'$  in  $P_2\langle Q \rangle^\top$ .

iv) *non orthogonal*  $\sigma$ -branchings are the remaining local  $\sigma$ -branchings, that is nor inclusion independant nor orthogonal.

**7.4.5. Critical  $\sigma$ -branchings.** We define an order relation on  $\sigma$ -branchings modulo of an algebraic polygraph modulo  $(P, Q, R, S)$  by setting  $(a, e, b) \sqsubseteq (a', e', b')$  if there exists a ground context  $A$  of  $P_1\langle Q \rangle$  such that  $a' = A[a]$ ,  $e' = A[e]$  and  $b' = A[b]$ . A *critical  $\sigma$ -branching modulo* is a local  $\sigma$ -branching modulo  $P$  which is non trivial, non orthogonal and minimal for the order relation  $\sqsubseteq$ .

**7.4.6. Positively confluence.** An algebraic polygraph modulo  $(P, Q, R, S)$  with a positive strategy  $\sigma$  is called *positively  $\sigma$ -confluent* if, for any  $S$ -rewriting step  $f$ , there exists a representing  $\widetilde{a}_- \in \sigma(a_-)$  of  $a_-$  and two  $\sigma$ -positive  $S$ -reductions  $a'$  and  $b'$  of length at most 1 as in the following diagram

$$\begin{array}{ccc} \widetilde{a}_- & \xrightarrow{a'} & \downarrow e'' \\ \downarrow e & & \\ a_- & \xrightarrow{a} \xrightarrow{e'} \xrightarrow{b'} & \downarrow \end{array}$$

**7.4.7 Proposition** (Terminating critical branching theorem modulo). *Let  $(P, Q, R, S)$  be a quasi-terminating and positively  $\sigma$ -confluent algebraic polygraph modulo with a positive strategy  $\sigma$ . Then it is locally  $\sigma$ -confluent modulo if and only if the two following properties hold:*

**a<sub>0</sub>)** any critical  $\sigma$ -branching modulo  $(a, b)$ , where  $a$  and  $b$  are  $S$ -rewriting steps, is  $\sigma$ -confluent modulo.

**b<sub>0</sub>)** any critical  $\sigma$ -branching modulo  $(a, e)$ , where  $a$  is an  $S$ -rewriting step and  $e$  is a 2-cell in  $P_2\langle Q \rangle^\top$  of length 1, is  $\sigma$ -confluent modulo.

*Proof.* The left to right implication is trivial. Let us prove the converse. Suppose that condition **a<sub>0</sub>**) holds and prove condition **a**). The proof of the other implication is similar. We prove this by examine all the possible cases of local  $\sigma$ -branchings modulo given in Section ???. Local aspherical  $\sigma$ -branchings are always  $\sigma$ -confluent modulo. Let us consider a local orthogonal  $\sigma$ -branching modulo of the form

$$\begin{array}{ccc} B[a_-, b_-] & \xrightarrow{B[a, b_-]} & B[a_+, b_-] \\ \parallel \downarrow & & \\ B[a_-, b_-] & \xrightarrow{B[a_-, b]} & B[a_-, b_+] \end{array}$$

where  $B[a, b_-]$  and  $B[a_-, b]$  are  $\sigma$ -positive  $S$ -reductions. There are natural 2-cells in  $S^\times$  that give a  $\sigma$ -confluence modulo of this diagram:

$$\begin{array}{ccccc} B[a_-, b_-] & \xrightarrow{B[a, b_-]} & B[a_+, b_-] & \xrightarrow{B[a_+, b]} & B[a_+, b_+] \\ \parallel \downarrow & & & & \downarrow \parallel \\ B[a_-, b_-] & \xrightarrow{B[a_-, b]} & B[a_-, b_+] & \xrightarrow{B[a, b_+]} & B[a_+, b_+] \end{array}$$

However, it may happen that these reductions are not  $\sigma$ -positive. Without loss of generality, let us assume that they are both not  $\sigma$ -positive. By positive  $\sigma$ -confluence assumption, there exists a representative  $B[\widetilde{a}_+, b_-]$  (resp.  $B[\widetilde{a}_-, b_+]$ ) of  $B[a_+, b_-]$  (resp.  $B[a_-, b_+]$ ) in  $P_1\langle Q \rangle$ ,  $\sigma$ -positive  $S$ -rewriting sequences  $h_1$  and  $h_2$ , and 2-cells  $e_1, e_2$  in  $P_2\langle Q \rangle^\top$  as in the following diagram:

$$\begin{array}{ccccccc} & & B[\widetilde{a}_+, b_-] & \xrightarrow{\quad} & & & \\ & & \downarrow & & & & \\ & & & & & f_1 \xrightarrow{c_1} & \\ & & & & & \downarrow e_1 & \\ B[a_-, b_-] & \xrightarrow{B[a, b_-]} & B[a_+, b_-] & \xrightarrow{B[a_+, b]} & B[a_+, b_+] & & \\ \parallel \downarrow & & & & \downarrow \parallel & & \\ B[a_-, b_-] & \xrightarrow{B[a_-, b]} & B[a_-, b_+] & \xrightarrow{B[a, b_+]} & B[a_+, b_+] & & \\ & & \downarrow & & \downarrow e_2 & & \\ & & & & f_2 \xrightarrow{c_2} & & \\ & & & & & & \end{array}$$

Then, we have  $d(f_1) < d(B[a_-, b_-])$  and  $d(f_2) < d(B[a_-, b_-])$  so that we can use induction of the  $\sigma$ -branching modulo  $(c_1, e_1 \star e_2, c_2)$  of source  $(f_1, f_2)$ . As a consequence, there exists a  $\sigma$ -confluence modulo  $(c'_1, e, c'_2)$  of this  $\sigma$ -branching modulo, and we then construct a  $\sigma$ -confluence modulo of  $(B[a, b_-], B[a_-, b])$  by successive applications of induction as in the proof of Theorem 2.3.15. This process terminates since  ${}_P\mathcal{R}_P$  is quasi-terminating, and thus the order  $\prec$  on  $\sigma$ -branchings modulo defined in Section 7.4.2 is well-founded. Let us now consider an overlapping  $\sigma$ -branching modulo of the form  $(a, b)$  where  $a$  and  $b$  are  $\sigma$ -positive  $S$ -rewriting steps. By definition, there exists a ground context  $A$  of  $P_1\langle Q \rangle$  and a critical  $\sigma$ -branching modulo  $(a', b')$  such that  $(a, b) = (A[a'], A[b'])$ . Following condition  $\mathbf{a}_0$ , the critical  $\sigma$ -branching  $(a', b')$  is  $\sigma$ -confluent modulo, and there exists a  $\sigma$ -confluence modulo  $(a'', e', b'')$  of this  $\sigma$ -branching. However, the reductions  $A[a'']$  and  $A[b'']$  that would give a confluence modulo of  $(a, b)$  are not necessarily  $\sigma$ -positive:

$$\begin{array}{ccc}
 \mathbf{u} & \xrightarrow{a} & A[a''] \\
 \parallel \downarrow & & \downarrow A[e'] \\
 \mathbf{u} & \xrightarrow{b} & A[b'']
 \end{array}$$

However, using positive  $\sigma$ -confluence of  $S$ , we are able to construct a  $\sigma$ -confluence modulo of the  $\sigma$ -branching modulo  $(a, b)$  as in the previous case.  $\square$

**7.4.8. Full positive strategy.** When all reductions are positive, that is when  $\sigma(\bar{f}) = \pi^{-1}(\bar{f})$  for any 1-cell  $\bar{f}$ , we say that  $\sigma$  is a *full positive strategy*. In that case, the quasi-termination assumption in Proposition ?? is not needed, since the natural confluences represented by dotted arrows are  $\sigma$ -positive. Moreover, the positive  $\sigma$ -confluence is always satisfied, by considering  $a' = a$  and  $b' = 1_{t_1(a)}$ .

## 7.5. ALGEBRAIC CRITICAL BRANCHING LEMMA

By taking the quotient of the  $S$ -rewriting paths in Proposition ??, in this section we obtain an algebraic critical branching lemma, that we apply to string rewriting systems and linear rewriting systems.

**7.5.1. Algebraic critical branchings.** Let  $\mathcal{P} = (P, Q, R, S)$  be an algebraic polygraph modulo with a positive strategy  $\sigma$  and let  $\mathcal{A}$  be an algebraic rewriting system on  $\mathcal{P}$ . The *critical branchings* of  $\mathcal{A}$  are the projections of the critical  $\sigma$ -branchings modulo of  $\mathcal{P}$  of the form  $\mathbf{a}_0$ , that is pairs  $(\bar{a}, \bar{b})$  of  $\bar{S}^\sigma$ -rewriting steps such that there is a  $\sigma$ -branching modulo in  $\mathcal{P}$  with source  $(\widetilde{\bar{a}}, \widetilde{\bar{b}})$ . As a consequence of Proposition ??, we deduce the following result.

**7.5.2 Theorem.** *Let  $\mathcal{P} = (P, Q, R, S)$  be an algebraic polygraph modulo with a positive strategy  $\sigma$  such that  ${}_P\mathcal{R}_P$  is quasi-terminating and positively  $\sigma$ -confluent. An algebraic rewriting system on  $\mathcal{P}$  is locally confluent if and only if its critical branchings are confluent.*

As an immediate consequence, we deduce the following usual critical branching lemma.

**7.5.3 Corollary.** *Let  $\mathcal{P}$  be an algebraic polygraph modulo with a full positive strategy. Any algebraic rewriting system on  $\mathcal{P}$  is locally confluent if and only if all its critical branchings are confluent.*

**7.5.4. Critical branching lemma for string rewriting systems.** When  $\text{MON}$  is the cartesian 2-polygraph presenting the theory  $\mathbb{M}$  of monoids given in (7.2.2), Theorem 7.5.2 corresponds to critical branching lemma for string rewriting systems as proved by Nivat, [97]. In that case, the choice of positive strategy  $\sigma$  making all the 2-cells in  $S^\times$  be  $\sigma$ -positive implies that we do not need the additional quasi-termination and positive  $\sigma$ -confluence property, as explained in Remark 7.4.8.

**7.5.5. Critical branching lemma for linear rewriting systems.** Suppose that  $P$  contains the cartesian 2-polygraph  $\text{MOD}^c$  presenting the theory of modules over a commutative ring defined in Section 7.2.6. If  $P'_2$  is the 2-polygraph  $\text{AC}^+ \cup \text{AC}^-$ , and  $P'_2$  is  $\text{MOD}^c$ , then Theorem 7.5.2 corresponds to the critical branching lemma for linear rewriting systems proved in [50, Theorem 4.3.2]. Indeed, given an algebraic polygraph modulo  $(P, Q, R, S)$  with the  $\sigma$ -strategy of normal forms modulo  $\text{AC}$  defined in 7.3.9, the positivity confluence of  $S$  with respect to  $\sigma$  implies the factorization property given in Lemma 2.8.4, stating that any rewriting step  $\bar{\alpha}$  of  $\bar{S}$  can be decomposed as  $\bar{\alpha} = \bar{b} \star \bar{c}^{-1}$  where  $\bar{b}$  and  $\bar{c}$  are either rewriting steps of  $\bar{S}^\sigma$  or identities, as pictured in the following diagram:

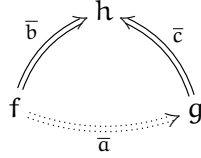

Note that if  $\bar{\alpha}$  is already a rewriting step of  $\bar{S}^\sigma$ , this factorization is trivial. When  $\bar{\alpha}$  is in  $\bar{S}$  but not in  $\bar{S}^\sigma$ , that is  $\bar{\alpha}$  is a quotient of a non- $\sigma$ -positive  $S$ -rewriting sequence, it states that  $\bar{\alpha}$  can be factorized using positive reductions.

Note that in that case,  ${}_p R_P$  can never be terminating: indeed, because of the linear context, for any R-rule  $\alpha : f \Rightarrow g$ , we have a  ${}_p R_P$ -rewriting step given by

$$g \equiv_p -f + (g + f) \xrightarrow{-\alpha + (g+f)} -g + (g + f) \equiv_p f \quad (7.15)$$

However, the quasi-termination assumption of  ${}_p R_P$  is equivalent to the termination assumption of  $\bar{S}^\sigma$  given in [50, Theorem 4.3.2]. Indeed, by definition an infinite rewriting path in  $\bar{S}^\sigma$  comes from an infinite  ${}_p R_P$ -rewriting path that is not created by a cycle of the form (7.15), since the rule  $-\alpha + (g + f)$  above is not  $\sigma$ -positive.

---

Work in progress and perspectives

---

**Contents**

---

|            |   |            |
|------------|---|------------|
| <b>8.1</b> | <b>Categorifying Mackey’s induction restriction theorem for Brauer algebras . . . . .</b> | <b>181</b> |
| <b>8.2</b> | <b>Polygraphic resolutions from rewriting modulo . . . . .</b>                            | <b>189</b> |

---

In this Chapter, we introduce the current works in progress and perspectives that are suggested by the previous works. The first work in progress aims at defining a categorification of the Mackey induction/restriction theorem for the Brauer algebras, following the constructions of Khovanov [70] for the algebras of the symmetric groups and of Mackaay and Savage for the degenerate cyclotomic Hecke algebras [86]. The first Section of this chapter provides preliminary results towards this objective, with the study of structures of modules for the tower of Brauer algebras.

The second work in progress consists in extending the coherence modulo constructions of [43] in higher dimensions. Chapter 4 suggests that these constructions would take place in higher-dimensional globular strict categories enriched in  $p$ -fold groupoids, in which the higher-dimensional cubical cells would be constructed from cubes built from confluence diagrams of critical branchings modulo.

**8.1. CATEGORIFYING MACKEY’S INDUCTION RESTRICTION THEOREM FOR BRAUER ALGEBRAS**

**8.1.1. Brauer algebras.** The Brauer algebras were introduced by Brauer in 1937 [15] to study the representation theory of the orthogonal group  $O_n$ , and plays the same role than the symmetric group for the representation theory of  $GL_n$  in Schur-Weyl duality. Let  $R$  be a noetherian integral domain, and  $\delta$  be an element of  $R$ . The Brauer algebra  $B_n(\delta)$  of degree  $n$  over  $R$  is the unital  $R$ -algebra with basis the set of Brauer diagrams with  $2n$  points. A *Brauer diagram* with  $2n$  points is a graph with  $2n$  vertices arranged in two rows each containing each point, and in which every vertex has degree 1, that is each vertex admits exactly one incident edge. In each row, vertices are numbered from 1 to  $n$  from right to left. The top (resp. bottom) row of a Brauer diagram  $b$  will be denoted by  $\text{Top}(b)$  (resp.  $\text{Bot}(b)$ .) For

example, here is a Brauer diagram with 14 points:

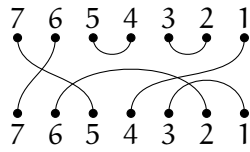

In the sequel, when this is not necessary, we omit to label the vertices of the graph. To define the multiplication in  $B_n(\delta)$ , it is enough to define a multiplication rule on two Brauer diagrams on  $n$  points  $b_1$  and  $b_2$ . The product  $b_1 b_2$  is defined as follows: place the diagram of  $b_1$  on top of the diagram of  $b_2$ , and identify  $\text{Bot}(b_1)$  with  $\text{Top}(b_2)$ , remove the inside cycles consisting of paths that start and finish in this middle row of vertices, and multiply the resulting diagram by  $\delta^{\gamma(b_1, b_2)}$ , where  $\gamma(b_1, b_2)$  is the number of cycles removed.

For instance, if

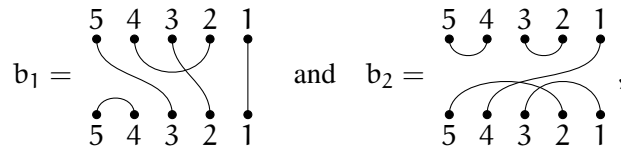

then

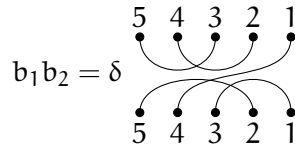

The algebra  $B_n(\delta)$  admits a unit  $\mathbf{1}_n$  given by the Brauer diagram on  $2n$  points in which the vertex  $i$  in top is joined to vertex  $i$  in the bottom by a vertical strand:

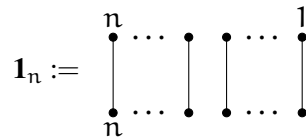

An edge in a Brauer diagram  $b$  linking an element of the top row to an element of the bottom row will be called a *through strand*, and an edge linking two elements of the same row will be called an *arc*. A permutation  $\sigma \in S_n$  can be realized as a Brauer diagram on  $2n$  points with only through strands, so that we have an inclusion  $kS_n \subset B_n$ . An Brauer diagram on  $2n$  strands that belongs to  $kS_n$  will be called a *permutation*. The algebra  $B_n(\delta)$  admits a presentation by generators and relations as follows: it has generators  $s_1, \dots, s_{n-1}, e_1, \dots, e_{n-1}$  subject to relations

$$e_i^2 = \delta e_i, \quad s_i^2 = s_i, \quad e_i s_i = e_i = s_i e_i, \tag{8.1}$$

$$e_i e_j e_i = e_i, \quad s_i s_j s_i = s_j s_i s_j, \quad s_i s_j e_i = e_j e_i, \text{ for any } i, j \text{ such that } |i - j| = 1 \tag{8.2}$$

$$e_i s_j s_i = e_i e_j, \quad e_i s_j e_i = e_i \text{ for any } i, j \text{ such that } |i - j| = 1 \tag{8.3}$$

$$e_i e_j = e_j e_i, \quad s_i s_j = s_j s_i, \quad s_i e_j = e_j s_i \text{ for any } i, j \text{ such that } |i - j| > 1 \tag{8.4}$$

The generator  $e_i$  (resp.  $s_i$ ) corresponds to the following Brauer diagram on  $2n$  points:

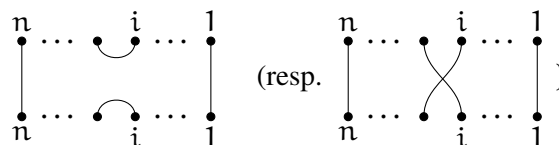



**8.1.2. Induction and restriction functors.** Throughout this section, fix a parameter  $\delta \in \mathbb{R}$  and for simplicity, denote  $B_n := B_n(\delta)$ . For any  $n \in \mathbb{N}$ , there is a canonical inclusion  $B_n \hookrightarrow B_{n+1}$  defined as follows:

$$\begin{array}{ccc}
 \begin{array}{|c|c|} \hline n & 1 \\ \hline \bullet & \bullet \\ \hline \end{array} & \xrightarrow{\quad} & \begin{array}{|c|c|} \hline n & 1 \\ \hline \bullet & \bullet \\ \hline \end{array} \\
 \begin{array}{|c|c|} \hline \bullet & \bullet \\ \hline \end{array} & & \begin{array}{|c|c|} \hline \bullet & \bullet \\ \hline \end{array} \\
 \hline
 \end{array}
 \quad (8.5)$$

The *induction functor*  $\text{Ind}_n^{n+1} : B_n - \text{Mod} \rightarrow B_{n+1} - \text{Mod}$  is defined for any  $B_n$ -module  $M$  by

$$\text{Ind}_n^{n+1}(M) = B_{n+1} \otimes_{B_n} M.$$

The *restriction functor*  $\text{Res}_{n+1}^n : B_{n+1} - \text{Mod} \rightarrow B_n - \text{Mod}$  is defined for any  $B_{n+1}$ -module  $M$  as the set  $M$  with a left action of  $B_n$ . For unital inclusion of rings  $A \subset B$ , the induction functor  $A - \text{Mod} \rightarrow B - \text{Mod}$  is always left adjoint to the restriction functor  $B - \text{Mod} \rightarrow A - \text{Mod}$ . It is also right adjoint precisely when  $B$  is a Frobenius extension of  $A$ , see [94].

**8.1.3. Brauer algebras are Frobenius algebras.** Recall that an algebra  $A$  over a field  $k$  is a *Frobenius algebra* if and only if, equivalently:

- i) There exists a non-degenerate associative  $k$ -bilinear form

$$(\cdot, \cdot) : A \times A \rightarrow k$$

- ii) There exists a  $k$ -linear form  $\phi : A \rightarrow k$  such that  $\text{Ker}(\phi)$  does not contain a non-zero right (or left) ideal.
- iii) There exists an isomorphism  $\psi : A \rightarrow \text{Hom}_k(A, k)$  of right (or left)  $A$ -modules.

A Frobenius algebra  $A$  over  $k$  is said to be *symmetric* if the non-degenerate associative  $k$ -bilinear form  $(\cdot, \cdot)$  is further symmetric, that is for any  $a$  and  $a'$  in  $A$ , we get  $(a, a') = (a', a)$ .

Similarly, recall from [95] that for a unital inclusion of algebras  $A \subset B$  over  $k$ ,  $B$  is a Frobenius extension of  $A$  if and only if, equivalently:

- i) There exists a non-degenerate associative  $k$ -bilinear form  $B \times B \rightarrow A$ .
- ii) There exists an isomorphism of  $(A, A)$ -bimodules  $B \rightarrow A$ , called the *trace map* of the Frobenius extension.

**8.1.4. The trace map.** If the parameter  $\delta$  is not an integer, Wenzl proved in [123, Prop. 2.2 & Cor. 3.3] admits a non-degenerate  $k$ -linear form  $\tau_n : B_n \rightarrow k$ , making  $B_n$  into a Frobenius algebra over  $k$ . The map  $\tau_n$  is defined inductively as follows:

- a) First of all, for any  $b \in B_n$ , there exists a unique  $\varepsilon_{n-1}(b) \in B_{n-1}$  such that  $e_n b e_n = \delta \varepsilon_{n-1}(b) e_n$ , and  $\varepsilon_{n-1}(b) = b$  for  $b \in B_{n-1}$ .
- b) Then, consider the linear map  $\tau_n : B_n \rightarrow k$  defined inductively by  $\tau_n(1) = 1$  and  $\tau_n(b) = \tau_n(\varepsilon_{n-1}(b))$  for  $b \in B_n$ . It is proved in [123] that  $\tau_n$  is uniquely determined inductively by

$$\tau_n(b_1 \chi b_2) = \delta^{-1} \tau_n(b_1 b_2) \text{ for } \chi \in \{e_{n-1}, s_{n-1}\} \text{ and } b_1, b_2 \in B_{n-1}.$$

and satisfies the property that  $\tau_n(b' \varepsilon_{n-1}(b)) = \tau_n(b' b)$  for any  $b \in B_n$  and  $b' \in B_{n-1}$ .

This definition also emphasizes the fact that there exists a non-degenerate map  $\varepsilon_n : B_n \rightarrow B_{n-1}$ . Following [123], this map is defined as follows: if  $b \in B_n$  admits a through strand joining  $n \in \text{Top}(b)$  to  $n \in \text{Bot}(b)$ , then  $b$  is in  $B_{n-1}$  and  $\varepsilon_n(b) = b$ . Otherwise, if  $b \in B_n \setminus B_{n-1}$ , consider the element  $e_n b e_n \in B_{n+1}$ . It is clear from the definition of the generator  $e_n$  that the vertex  $n$  in  $\text{Top}(e_n b e_n)$  is joined to vertex  $n+1$  in  $\text{Bot}(e_n b e_n)$ . As a consequence, the remaining Brauer diagram on the remaining  $2(n-1)$  points gives an element  $b'$  in  $B_{n-1}$ , and define  $\varepsilon_n(b) := b'$ .

### 8.1.5 Example.

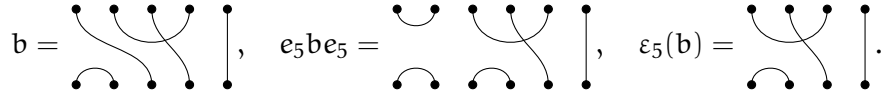

Diagrammatically, the map  $\varepsilon_n$  corresponds to the usual Markov trace construction [60, 12] of taking a Brauer diagram on  $2n$  points and closing off the leftmost strand to the left as follows:

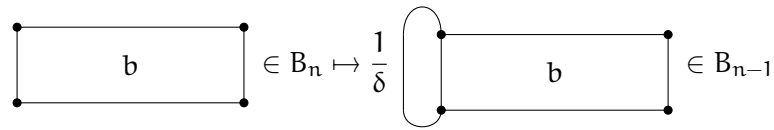

Note that this trace map is normalized by the parameter  $\frac{1}{\delta}$  so that the identity  $\mathbf{1}_n$  of  $B_n$  is sent to the identity  $\mathbf{1}_{n-1}$  of  $B_{n-1}$ .

### 8.1.6 Example.

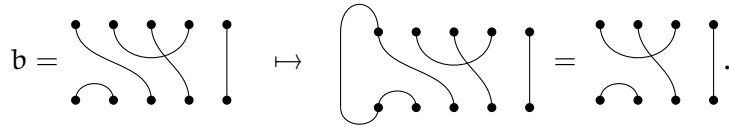

As a consequence, from the inductive definition of the linear map  $\tau_n : B_n \rightarrow \mathbb{K}$ , this map corresponds to the operation of closing off all the  $n$  strands on the left:

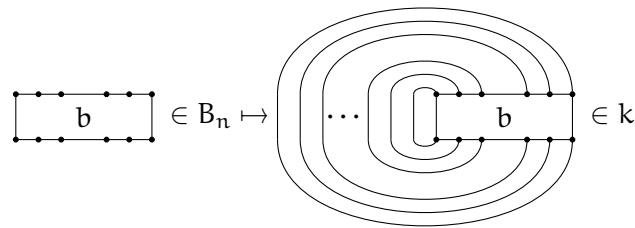

Note that this element is in  $\mathbb{K}$  because it is given by the following composite in the linear 2-category  $\mathcal{B}$ :

$$D \mapsto \left( \text{diagram with two arcs} \right) \star_1 (1^{\star_0 n} \star_0 D) \star_1 \left( \text{diagram with two arcs} \right) \in \text{End}(1_{\star}) \simeq k.$$

**8.1.7. Units and counits of biadjunctions Ind - Res.** Given a unital inclusion of rings  $A \subset B$ , the unit and counit for the left adjunction  $\text{Ind}_A^B \vdash \text{Res}_B^A$  are defined by:

$$\begin{array}{c} \text{B} \\ \curvearrowright \\ \text{A} \end{array} : \begin{array}{l} B \otimes_A B \rightarrow B \\ b \otimes b' \mapsto bb' \end{array}$$

$$\begin{array}{c} \curvearrowright \\ \text{B} \\ \text{A} \end{array} : \begin{array}{l} A \rightarrow {}_A B_A \\ a \mapsto a \end{array}$$

When  $B$  is a Frobenius extension of  $A$  with trace map  $\tau : B \rightarrow A$  which is an homomorphism of  $(A, A)$ -bimodules, the unit and counit for the right adjunction  $\text{Res}_B^A \vdash \text{Ind}_A^B$  are defined by:

$$\begin{array}{c} \curvearrowleft \\ \text{B} \\ \text{A} \end{array} : {}_A B_A \xrightarrow{\tau} A$$

$$\begin{array}{c} \curvearrowright \\ \text{A} \\ \text{B} \end{array} : \begin{array}{l} B \rightarrow B \otimes_A B \\ 1 \mapsto \sum_{b \in \mathcal{B}} b \otimes \check{b} \end{array}$$

where  $\mathcal{B}$  is a basis of  $B$  as a left (or right)  $A$ -module, and  $\{\check{b} \mid b \in \mathcal{B}\}$  is a dual basis of  $\mathcal{B}$  for the non-degenerate  $k$ -bilinear form  $\langle \cdot, \cdot \rangle : B \times B \rightarrow A$  defined by

$$\langle b, b' \rangle = \tau(bb'),$$

that is for any  $b$  and  $b'$  in  $\mathcal{B}$ , we have  $\tau(bb') = \delta_{b,b'}$ .

**8.1.8 Lemma.** *The set  $\{1_n, e_{n-1}, s_{n-1}\}$  is a basis of  $B_n$  as a  $(B_{n-1}, B_{n-1})$ -bimodule.*

*Proof.* Let us fix  $b \in B_n$ . If  $n \in \text{Top}(b)$  is linked to  $n \in \text{Bot}(b)$ , then  $b$  is in  $B_{n-1}$  for the inclusion (8.5). If  $b \in B_n \setminus B_{n-1}$ , consider three cases, depending on whether the vertices labeled  $n$  in  $\text{Top}(b)$  and  $\text{Bot}(b)$  belong to one, two or no arcs.

- i) If they do not belong to any arc, then  $n \in \text{Top}(b)$  is sent to some  $l \in \text{Bot}(b)$ , and  $n \in \text{Bot}(b)$  is sent to some  $k \in \text{Top}(b)$  with  $1 \leq l, k \leq n-1$ . Then, there exist permutations  $b_1, b_2$  in  $kS_{n-1} \subset B_{n-1}$  and an element  $b' \in B_{n-2}$  such that

$$b_1 b b_2 = \begin{array}{c} \bullet \quad \bullet \\ \diagdown \quad \diagup \\ \bullet \quad \bullet \\ \bullet \quad \bullet \end{array} \quad \begin{array}{c} \bullet \quad \bullet \\ \text{---} \\ \bullet \quad \bullet \\ \text{---} \\ \bullet \quad \bullet \end{array} \quad b'$$

Indeed, consider for instance for  $p_1$  the transposition  $(n-1, m)$  and for  $p_2$  the transposition  $(n-1, l)$ . Then, we get that  $b = (b_1)^{-1} b' s_{n-1} (b_2)^{-1}$ .

- ii) If they both belong to an arc, we prove in the same way than in Case i) that there exist permutations  $b_1, b_2$  in  $kS_{n-1} \subset B_{n-1}$  and an element  $b' \in B_{n-2}$  such that

$$b_1 b b_2 = \begin{array}{c} \bullet \quad \bullet \\ \text{---} \\ \bullet \quad \bullet \\ \text{---} \\ \bullet \quad \bullet \end{array} \quad \begin{array}{c} \bullet \quad \bullet \\ \text{---} \\ \bullet \quad \bullet \\ \text{---} \\ \bullet \quad \bullet \end{array} \quad b'$$

In that case, we get that  $b = (b_1)^{-1} b' e_{n-1} (b_2)^{-1}$ .

- iii) Suppose now that only one vertex  $n$  belongs to an arc, for instance  $n \in \text{Bot}(b)$  is sent to  $l \in \text{Bot}(b)$  without loss of generality. Similarly, there exist permutations  $b_1, b_2$  in  $B_{n-1}$  and  $b' \in B_{n-3}$  such that

$$b_1 b b_2 = \begin{array}{c} \bullet \quad \bullet \\ \diagdown \quad \diagup \\ \bullet \quad \bullet \\ \text{---} \\ \bullet \quad \bullet \\ \text{---} \\ \bullet \quad \bullet \end{array} \quad \begin{array}{c} \bullet \quad \bullet \\ \text{---} \\ \bullet \quad \bullet \\ \text{---} \\ \bullet \quad \bullet \end{array} \quad b'$$

In this case, we check that  $b_1 b b_2 = b' e_{n-1} e_{n-2}$ , and thus

$$b = ((b_1)^{-1} b') e_{n-1} (e_{n-2} (b_2)^{-1}).$$

As a consequence, any element of  $B_n$  is either in  $B_{n-1}$ , or can be written as  $b_1\chi b_2$ , with  $b_1, b_2 \in B_{n-1}$  and  $\chi \in \{e_{n-1}, s_{n-1}\}$ , proving the result.  $\square$

The next step to define the counit of the adjunction  $\text{Res}_{n+1}^n \vdash \text{Ind}_n^{n+1}$  is to find a basis of  $B_n$  as a right  $B_{n-1}$ -module, and to find a basis that is left dual for the bilinear form  $\langle \cdot, \cdot \rangle_n : B_n \rightarrow B_{n-1}$  defined by  $\langle b, b' \rangle := \tau_n(bb')$ .

Let us define some elements in  $B_n$  of key importance in the sequel: for  $1 \leq i \leq n$ , consider the elements

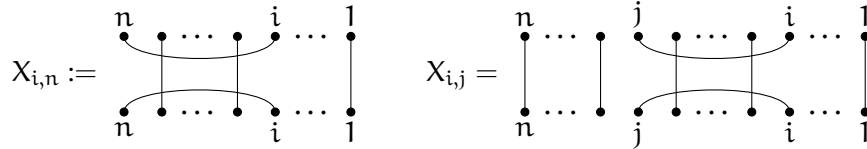

**8.1.9 Remark.** It is a well-known fact that the set  $\{s_n \dots s_i \mid 1 \leq i \leq n\}$  forms a basis of  $S_n$  as a right  $S_{n-1}$ -module.

**8.1.10. Projective bases.** Let  $R$  be a ring and  $M$  be a left  $R$ -module.  $M$  is said *free* if it is a direct summand of copies of  $R$ . It is said to be projective if it is isomorphic to a direct summand of a free  $R$ -module  $F_R$ . Following [65], a left  $R$ -module  $M$  is finite projective if it admits a *left projective basis*, that is a family of elements  $(x_i)_{i \in I}$  of  $M$  indexed by a finite set  $I$ , together with a family of left  $R$ -module homomorphisms  $(\psi_i : M \rightarrow R)_{i \in I}$  such that for any  $x \in M$ , the following equality holds:

$$x = \sum_{i \in I} \psi_i(x)x_i. \quad (8.6)$$

Note that the same definition and characterization also holds for right  $R$ -modules. In our case, let us prove that  $B_n$  is projective as a left  $B_{n-1}$ -module by providing a finite left projective basis for  $B_n$ . Let us consider the following subsets of  $B_n$ :

- i)  $B_{n-1}$  via the embedding (8.5),
- ii)  $X_n^l$  consisting of all the Brauer diagrams  $b$  on  $2n$  points such that  $n \in \text{Top}(b)$  is linked to  $l \in \text{Bot}(b)$ , with  $l \leq n - 1$ , via a through strand. We also denote by  $X_n = \bigcup_{1 \leq l \leq n-1} X_n^l$ . For example,

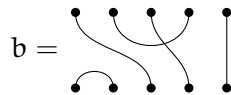

belongs to  $X_5^3$ .

- iii)  $Y_n$  consisting of all the Brauer diagrams  $b$  on  $2n$  points such that  $n \in \text{Top}(b)$  is linked to some  $m \in \text{Top}(b)$ , with  $m \leq n - 1$  via an arc. For example,

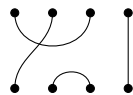

belongs to  $Y_5$ .

It is easy to check that if  $b$  is a Brauer diagram on  $2n$  points, then  $b$  is either in  $B_{n-1}$ , in  $X_n$  or in  $Y_n$ .

**8.1.11 Proposition.** i) For  $b \in S_n$ , the following equality holds:

$$b = \varepsilon_{n-1}(b)(n \ l),$$

where  $l$  is the integer such that  $b \in X_n^l$ .

**ii)** For  $b \in Y_n$ , the following equality holds for any arc  $(i, j)$  in  $\text{Bot}(b)$ :

$$b = \delta \varepsilon_{n-1}(bX_{j,n})X_{j,n}X_{i,j}.$$

**iii)** For  $b \in X_n^l$ , the following equality holds for any arc  $(i, j)$  in  $\text{Bot}(b)$ :

$$b = \varepsilon_{n-1}(bX_{j,n})(n \ l)X_{j,n}X_{i,j},$$

where  $(n \ l)$  is the permutation of  $n$  and  $l$  in  $S_n$ .

*Proof.* **i)** In the Brauer diagram on  $2n$  dots corresponding to the transposition  $(n \ l)$ , any element  $k \notin \{l, n\}$  in the bottom row is linked to  $k$  in the top row, and  $l \in \text{Bot}((n \ l))$  (resp.  $l \in \text{Top}((n \ l))$ ) is linked to  $n \in \text{Top}((n \ l))$  (resp.  $n \in \text{Bot}((n \ l))$ ). Therefore, on the one hand  $b = b'(n \ l)$  where  $b' \in B_{n-1}$  corresponds to the Brauer diagram such that:

- a) Any vertex  $k \neq l$  in the bottom row of  $b'$  is linked to  $k'$  in  $b'$ , where  $k'$  is the vertex linked to  $k \in \text{Bot}(b)$  in  $b$ .
- b)  $l \in \text{Bot}(b')$  is linked to  $n'$  in  $b'$ , where  $n'$  is the vertex linked to  $n \in \text{Bot}(b)$  in  $b$ .

On the other hand, taking the trace  $\varepsilon_{n-1}$  of  $b'$  gives  $\frac{1}{\delta}$  times the Brauer diagram on  $2(n-1)$  dots in which the strand linking  $n$  in the top row and  $l$  in the bottom row of  $b$  is removed, and replaced by a strand linking  $l$  in the bottom row to  $n'$ . So it is clear that  $b' = \delta \varepsilon_{n-1}(b)$ , hence the equality.

**ii)** Let us consider an arc linking  $i \in \text{Bot}(b)$  to  $j \in \text{Bot}(b)$ , with  $1 \leq i < j \leq n-1$ . In the Brauer diagram corresponding to  $X_{j,n}X_{i,j}$ , any  $k \notin \{i, j, n\}$  in the bottom is sent to  $k$  in the top via a vertical strand, there is one arc  $(i, j)$  (resp.  $(n, j)$ ) in  $\text{Bot}(X_{j,n}X_{i,j})$  (resp. in  $\text{Top}(X_{j,n}X_{i,j})$ ), and  $n \in \text{Bot}(X_{j,n}X_{i,j})$  is sent to  $i \in \text{Top}(X_{j,n}X_{i,j})$  via a through strand. Now, as  $b \in Z_n$ , suppose that  $b$  has an arc  $(n, l)$  in its top row, and a through strand linking  $n \in \text{Bot}(b)$  to  $m \in \text{Top}(b)$ . Then, we check that  $b = b'X_{j,n}X_{i,j}$  where  $b'$  is the Brauer diagram on  $2n$  points uniquely determined by:

- a)  $n \in \text{Bot}(b')$  is sent to  $n \in \text{Top}(b')$  via a vertical strands, that is  $b' \in B_{n-1}$ .
- b) Any  $k \notin \{i, j, n\}$  in  $\text{Bot}(b')$  is linked to  $k'$ , where  $k'$  is the unique vertex linked to  $k \in \text{Bot}(b)$ .
- c)  $i \in \text{Bot}(b')$  is sent to  $m \in \text{Top}(b')$ .
- d)  $j \in \text{Bot}(b')$  is sent to  $l \in \text{Top}(b')$ .

It thus remains to prove that  $b' = \delta \varepsilon_{n-1}(bX_{j,n})$ . The Brauer diagram  $bX_{j,n}$  contains the following strands:

- i)** It has an arc  $(n, j)$  in its bottom row, and and arc  $(n, l)$  in its top row.
- ii)** It has a through strand linking  $i \in \text{Bot}(bX_{j,n})$  to  $m \in \text{Top}(bX_{j,n})$ .
- iii)** Any  $k \notin \{i, j, n\}$  in  $\text{Bot}(bX_{j,n})$  is linked to  $k'$ , where  $k'$  is the vertex linked to  $k \in \text{Bot}(b)$  in  $b$ .

By taking the trace map  $\varepsilon_{n-1}$  of this diagram, the through strands  $(i, m)$  and the strands  $(k, k')$  of **ii)** and **iii)** are still in the resulting diagram, and the arcs  $(n, j)$  and  $(n, l)$  of **i)** disappear, giving a through strand linking  $l \in \text{Top}(\varepsilon_{n-1}(bX_{j,n}))$  to  $j \in \text{Bot}(\varepsilon_{n-1}(bX_{j,n}))$ . Moreover, as  $\varepsilon_{n-1}(bX_{j,n}) \in B_{n-1}$ , when embedded in  $B_n$  it has a vertical strand from  $n$  in bottom to  $n$  in top, so that we get that  $b' = \delta \varepsilon_{n-1}(bX_{j,n})$ .

**iii)** Let us consider an arc  $(i, j)$  in  $\text{Bot}(b)$ , with  $1 \leq i < j \leq n$ . In the Brauer diagram  $(n \ l)X_{j,n}X_{i,j}$ , there is an arc  $(i, j)$  in the bottom row and an arc  $(l, j)$  in the top row, any  $k \notin \{i, j, l, n\}$  is sent to  $k$  in the top,  $l$  in the bottom row is sent to  $n$  in the top row and  $n$  in the bottom row is sent to  $i$  in the top row. As a consequence, we prove that  $b = \frac{1}{\delta} b'(n \ l)X_{j,n}X_{i,j}$  where  $b' \in B_{n-1}$  is the Brauer diagram defined by:

- a) The arcs in the top row of  $b$  are also arcs in the top row of  $b'$ .
- b) Any  $k \notin \{i, j, l, n\}$  in  $\text{Bot}(b')$  is linked to  $k'$ , which is the vertex linked to  $k \in \text{Bot}(b)$  in  $b$ .
- c)  $i \in \text{Bot}(b')$  is sent to  $n' \in \text{Top}(b')$ , where  $n'$  is the vertex linked to  $n \in \text{Bot}(b)$  in  $b$ .
- d) There is an arc  $(l, j)$  in  $\text{Bot}(b')$ , creating a loop in  $b'(n \ l)X_{j,n}X_{i,j}$  imposing to add a factor  $\delta$  to the resulting diagram, which is erased by the multiplication by  $\frac{1}{\delta}$ .

Now, it remains to prove that  $b' = \delta \varepsilon_{n-1}(bX_{j,n})$ . The Brauer diagram corresponding to  $bX_{j,n}$  contains:

- i) An arc  $(n, j)$  in its bottom row,
- ii) A strand linking any  $k \notin \{i, j, n\}$  to  $k'$ , which is the vertex linked to  $k \in \text{Bot}(b)$  in  $b$ ,
- iii) A through strand linking  $l \in \text{Bot}(bX_{j,n})$  to  $n \in \text{Top}(X_{j,n})$ ,
- iv) A strand linking  $i \in \text{Bot}(bX_{j,n})$  to  $n'$ , which is the vertex linked to  $n \in \text{Bot}(b)$  in  $b$ .

Therefore,  $\varepsilon_{n-1}(bX_{j,n})$  is  $\frac{1}{\delta}$  times the Brauer diagram on  $2(n-1)$  points in which the strands given by **ii)** and **iii)** above remain unchanged, and the strands given by **i)** and **iv)** disappear to give an arc  $(l, j)$  in  $\text{Bot}(\varepsilon_{n-1}(bX_{j,n}))$ . Hence it is clear that  $b' = \delta \varepsilon_{n-1}(bX_{j,n})$ . □

Let us now consider the set

$$\{(n \ l)X_{j,n}X_{i,j} \mid 1 \leq l \leq n, 1 \leq i, j \leq n\}$$

with the convention that  $(n \ n) = \delta \mathbf{1}_n$  and  $X_{j,j} = \delta \mathbf{1}_n$  for any  $1 \leq j \leq n$ , and the following maps:

$$\begin{aligned} \psi_{i,j,l} : B_n &\rightarrow B_{n-1} \\ b &\mapsto \begin{cases} 0 & \text{if } b \notin X_n^l \\ 0 & \text{if } (i, j) \text{ is not an arc in } \text{Bot}(b) \\ \frac{1}{A(b)} \varepsilon_{n-1}(bX_{j,n}) & \text{otherwise} \end{cases} \end{aligned} \quad (8.7)$$

for any  $1 \leq l \leq n-1, 1 \leq i \leq j \leq n$  and the maps

$$\begin{aligned} \psi_{i,j,n} : B_n &\rightarrow B_{n-1} \\ b &\mapsto \begin{cases} 0 & \text{if } (i, j) \text{ is not an arc in } \text{Bot}(b) \\ \frac{1}{A(b)} \varepsilon_{n-1}(bX_{j,n}) & \text{otherwise} \end{cases} \end{aligned} \quad (8.8)$$

for any  $1 \leq i \leq j \leq n$ , where the number  $A(b)$  stands for the number of arcs in the bottom or top row of  $b$ .

Note that for any  $1 \leq l \leq n-1$  and any  $1 \leq i \leq j \leq n$ , the map  $\psi_{i,j,l}$  is the following composite of maps:

$$\psi_{i,j,l} = \frac{1}{A(b)} \varepsilon(\cdot X_{j,n}) \circ \Pi_{X_{i,j}^l},$$

where  $\Pi_{X_{i,j}^l} : B_n \rightarrow B_n$  is the projection on the subset  $X_{i,j}^l$  of  $B_n$  corresponding to Brauer diagram with an arc between vertices  $i$  and  $j$  in the bottom row, and in which  $n$  in the top row is sent to  $l$  in the bottom row. As this set is stable by left-multiplication by  $B_{n-1}$ , since the arcs in the bottom row and the vertex to which  $n$  in the top row is linked are preserved, it is clear that the map  $\Pi_{X_{i,j}^l}$  is a left-module homomorphism, and finally so are the maps  $\psi_{i,j,l}$  as composites of left  $B_{n-1}$ -module homomorphisms. Similarly, we can prove that the maps  $\psi_{i,j,n}$  for any  $1 \leq i \leq j \leq n$  are left  $B_{n-1}$ -module homomorphisms.

Moreover, following Proposition 8.1.11, the following equality holds for any  $b \in B_n$ :

$$b = \sum_{1 \leq i \leq j \leq n, 1 \leq l \leq n} \psi_{i,j,l}(b)(n \ l)X_{j,n}X_{i,j}. \quad (8.9)$$

Indeed, consider a Brauer diagram  $b$  in  $B_n$ , then:

- i)  $\psi_{i,j,l}(b)$  is 0 if  $b \notin X_n^l$ . In particular, if  $n \in \text{Top}(b)$  belongs to an arc, then all the  $\psi_{i,j,l}(b)$  for  $1 \leq l \leq n-1$  are 0.
- ii)  $\psi_{i,j,l}(b)$  is 0 if  $(i, j)$  is not an arc in  $\text{Bot}(b)$ , so that the only terms giving non-zero elements correspond to the bottom arcs of  $b$ .

Moreover, by Proposition 8.1.11, we get that for any  $b \in B_n$ , we have that

$$\psi_{i,j,l}(b)(n-l)X_{j,n}X_{i,j} = \frac{1}{A(b)}b,$$

hence the equality (8.9). As a consequence, we proved the following statement:

**8.1.12 Proposition.** *The set*

$$\{(n-l)X_{j,n}X_{i,j} \mid 1 \leq l \leq n, 1 \leq i, j \leq n\}$$

*together with the maps  $\psi_{i,j,l}$  defined above is a left projective basis of  $B_n$  as a left  $B_{n-1}$ -module.*

The next step to be able to define the left cup for the biadjunction  $\text{Ind}_n^{n+1} \vdash \text{Res}_{n+1}^n$  is to find a dual basis for the projective basis given in Proposition 8.1.12 with respect to the bilinear form  $\langle \cdot, \cdot \rangle$  on  $B_n \times B_n$  defined by

$$\langle b, b' \rangle = \varepsilon_{n-1}(bb').$$

Once this is done, all the unit and counit maps for the biadjunction  $\text{Ind-Res}$  are defined, and it remains to define the remaining generating 2-cells in the spirit of Khovanov [70], as in Section 9.5. We then have to find relations that are satisfied by the 2-cells made on this generators, part of them giving the Mackey decomposition theorem for the Brauer algebra, which is unknown in these terms. Once the 2-category is completely defined with all the relations, we would like to use rewriting modulo the pivotal axioms to compute an hom-basis, in order to be able to compute the Grothendieck group of it and identify which algebra it categorifies.

## 8.2. POLYGRAPHIC RESOLUTIONS FROM REWRITING MODULO

**8.2.1. Triple categories.** A *triple category* is an internal category in the category  $\mathbf{DbCat}$  of double categories and their morphisms. Explicitely, it is given by a diagram

$$(C_1 \xrightarrow{s_C} C_0) \rightrightarrows (D_1 \xrightarrow{s_D} D_0)$$

where  $C_1, C_0, D_1$  and  $D_0$  are 1-categories whose 0-cells and 1-cells respectively have the following shapes:

- i) 0-cells of  $D_0 = \{\bullet\}$ ,

$$\text{iv) 1-cells of } D_1 = \left\{ \begin{array}{ccc} \bullet & \xrightarrow{s_D(A)} & \bullet \\ \downarrow & \xrightarrow{A} & \downarrow \\ \bullet & \xrightarrow{t_D(A)} & \bullet \end{array} \right\}$$

- ii) 1-cells of  $D_0 = \{\bullet \longrightarrow \bullet\}$

$$\text{iii) 0-cells of } D_1 = \left\{ \begin{array}{c} \bullet \\ \downarrow \\ \bullet \end{array} \right\}$$

$$\text{v) 0-cells of } C_0 = \left\{ \begin{array}{ccc} & & t(f) \\ & \nearrow f & \\ s(f) & & \end{array} \right\}$$

$$\begin{array}{l}
\text{vi) 1-cells of } C_0 = \left\{ \begin{array}{c} \begin{array}{ccc} & t(f) & \xrightarrow{t(A)} & t(g) \\ f \nearrow & \xrightarrow{A} & \searrow g & \\ s(f) & \xrightarrow{s(A)} & s(g) & \end{array} \end{array} \right\} \\
\text{vii) 0-cells of } C_1 = \left\{ \begin{array}{c} \begin{array}{ccc} & s_C(A) & \bullet & t(A) \\ \bullet & \downarrow A & \bullet & \downarrow \\ s(A) & \bullet & t_C(A) & \bullet \end{array} \end{array} \right\} \\
\text{viii) 1-cells of } C_1 = \left\{ \begin{array}{c} \begin{array}{ccccccc} & & \bullet & & \bullet & & \\ & a \nearrow & \vdots & \xrightarrow{f} & \vdots & \searrow d & \\ \bullet & \downarrow A & \bullet & \xrightarrow{\gamma} & \bullet & \downarrow B & \\ e \downarrow & \bullet & \bullet & \xrightarrow{g} & \bullet & \downarrow k & \\ \bullet & \xrightarrow{i} & \bullet & \xrightarrow{l} & \bullet & \xrightarrow{h} & \bullet \end{array} \end{array} \right\}
\end{array}$$

with  $A = s_C(\gamma)$ ,  $B = t_C(\gamma)$ ,  $\alpha = s_C(A)$ ,  $i = t_C(A)$ ,  $d = s_C(B)$  and  $k = t_C(B)$ . The square in front is  $s(\gamma)$  and the square behind is  $t(\gamma)$ .

**8.2.2. Cubical coherence from triple critical branchings modulo.** To mimick the constructions of Section 4.6, we could like to generate an  $n$ -category enriched in 3-fold categories from an  $n$ -polygraph modulo  $(R, E, S)$  in which:

- i) the horizontal category is given the free  $n$ -category  $S_n^*$  generated by  $S$ ,
- ii) the vertical category is given by the free  $(n, n - 1)$ -category  $E_n^\top$ ,
- iii) the diagonal category is given by the free  $(n, n - 1)$ -category  $E_n^\top$ .

Given a triple of categories  $(\mathcal{C}^h, \mathcal{C}^v, \mathcal{C}^d)$ , together with three square extensions  $\Gamma^{h,d}$ ,  $\Gamma^{h,v}$  and  $\Gamma^{v,d}$  respectively on the pairs of categories  $(\mathcal{C}^v, \mathcal{C}^d)$ ,  $(\mathcal{C}^h, \mathcal{C}^v)$  and  $(\mathcal{C}^v, \mathcal{C}^f)$ , we define a *3-fold extension* as a set  $\Gamma$  equipped with maps  $\partial_{-,n+1}^{\mu,\nu}, \partial_{+,n+1}^{\mu,\nu} : \Gamma \rightarrow \Gamma^{\mu,\nu}$  for any  $\mu, \nu \in \{v, h, d\}$  satisfying relations such that the elements of  $\Gamma$  are 3-cubical sets. We would like to extend the notion of polygraphic resolution from [53] recalled in Section Namely, given a triple of categories  $(\mathcal{C}^h, \mathcal{C}^v, \mathcal{C}^d)$ , together with three square extensions  $\Gamma^{h,d}$ ,  $\Gamma^{h,v}$  and  $\Gamma^{v,d}$  respectively on the pairs of categories  $(\mathcal{C}^v, \mathcal{C}^d)$ ,  $(\mathcal{C}^h, \mathcal{C}^v)$  and  $(\mathcal{C}^v, \mathcal{C}^f)$ , we define a *3-fold square extension* as a set  $\Gamma$  equipped with maps  $\partial_{-,n+1}^{\mu,\nu}, \partial_{+,n+1}^{\mu,\nu} : \Gamma \rightarrow \Gamma^{\mu,\nu}$  for any  $\mu, \nu \in \{v, h, d\}$  satisfying relations such that the elements of  $\Gamma$  are 3-cubical sets. to this context of rewriting modulo by constructing an "acyclic" 3-fold extension on  $(S^*, E^\top, E^\top)$ , that is a set of cubical  $(n+2)$ -cells whose compositions would tile every cube made with horizontal arrows in  $S^*$ , and vertical or diagonal arrows in  $E^\top$ . We expect to be able to define such a 3-fold extension on the triple of categories  $(S^*, E^\top, E^\top)$  from triple critical branchings as follows. Let  $(R, E, S)$  be an  $n$ -polygraph modulo. A *triple critical branching* of  $S$  modulo  $E$  is a quintuple  $(f, e_1, g, e_2, h)$  such that  $(f, e_1, g)$ ,  $(g, e_2, h)$  and  $(f, e_1 \star_{n-1} e_2, h)$  are local branchings of  $S$  modulo  $E$  and  $(f, e_1, g, e_2, h)$  is minimal for the order  $\sqsubseteq$  defined in Section 4.4.7. Such a data is depicted on the following diagram:

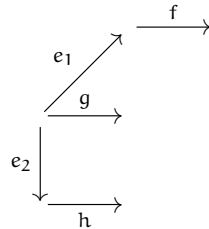

Following [53], we construct the candidate 3-fold extension using normalization strategies for the polygraph modulo  $S$ . Let us fix a normalization strategy  $\sigma_v : v \rightarrow \hat{v}$  with respect to  $S$ , and for any  $n$ -cell  $k$  in  $S^*$ , denote by  $\hat{k}$  the  $n$ -cell  $k \star_{n-1} \sigma_{t_{n-1}(k)}$ . By confluence of  $S$  modulo  $E$  assumption, there exist  $n$ -cells  $e'_1$  and  $e'_2$  in  $E^\top$  as in the first diagram below. Now, let us fix a choice  $Cd(E)$  of a square extension



given by a family of generating confluences for the convergent  $n$ -polygraph  $E$ . By convergence of  $E$ , there exist  $n$ -cells  $e_3$  and  $e_4$  in  $E^\top$  as in the second diagram below. Now, by confluence modulo on the branching  $(e_3, \widehat{h})$ , there exists a confluence modulo  $(h', e'_3)$  of this branching, and using the confluence modulo assumption, we can assume that  $h' = \widehat{h}'$ . We then construct the  $n$ -cell  $e'_4$  in  $E^\top$  closing the cube by convergence of the  $n$ -polygraph  $E$ . This process is summarized in the following steps:

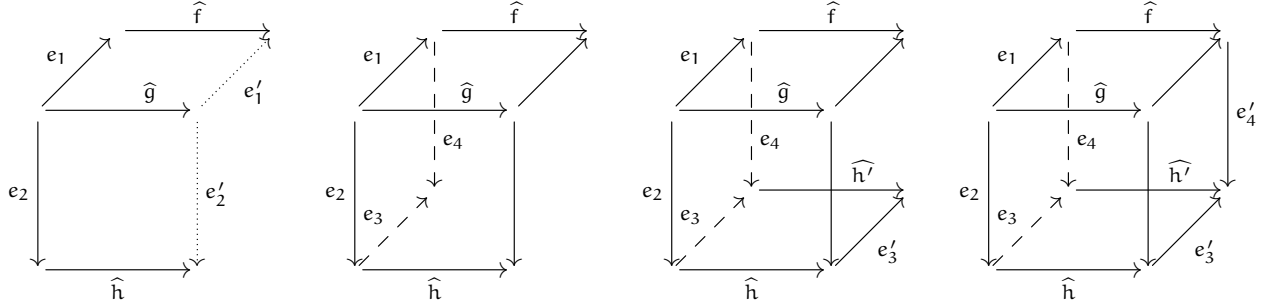

The left and right faces of the cube thus constructed are tiled by square cells in  $\Gamma_E$ , and the top, bottom, front and behind faces are tiled by square cells in the square extension provided by Theorem 4.6.6. We consider the set  $\Gamma^{(3)}$  of cubical  $(n+2)$ -cells tiling the set of all cubes thus constructed, for any choice of generating confluence  $\Gamma_E$  of  $E$  and of Squier completion  $\Gamma$  of  $S$  modulo  $E$ .

**8.2.3 Conjecture.** *The set  $\Gamma^{(3)}$  is an acyclic 3-fold extension on the triple of categories  $(S^*, E^\top, E^\top)$ .*

Adapting this construction in the above dimensions, we expect to construct  $k$ -fold extensions on the  $k$ -uples of categories  $(S^*, E^\top, \dots, E^\top)$  made of  $k$ -cubical cells constructed from  $k$ -critical branchings of  $S$  modulo  $E$ , and a normalization strategy with respect to  $S$  as in [53].

---

Catalogue of diagrammatic algebras

---

**Contents**

---

|  |     |
|--|-----|
| 9.1 Hecke type algebras . . . . .                    | 192 |
| 9.2 Temperley Lieb and Brauer categories . . . . .   | 193 |
| 9.3 The partition category . . . . .                 | 195 |
| 9.4 The affine oriented Brauer category . . . . .    | 197 |
| 9.5 Khovanov’s Heisenberg categorification . . . . . | 204 |
| References . . . . .                                 | 205 |

---

In this Chapter, we give a catalogue of the various families of diagrammatic algebras and categories that have been studied using various rewriting (resp. rewriting modulo) methods: the Hecke type algebras, introduced in [46], including the nil Hecke algebras and the KLR algebras, the Brauer and Temperley-Lieb categories (encoding the Brauer and Temperley-Lieb algebras), the partition category, the affine oriented Brauer category and Khovanov’s categorification of the Heisenberg category.

9.1. HECKE TYPE ALGEBRAS

**9.1.1. Hecke type presentations.** Elias introduced in [46] a family of algebras including the KLR algebras which he called *Hecke type presentations*. These are presentations of monoidal categories or their endomorphism rings with only two kind of generators: crossings and dots with possible colours/labels satisfying the symmetric group relations

$$\begin{array}{c} \diagup \\ \diagdown \end{array} = \begin{array}{c} \diagdown \\ \diagup \end{array}, \quad \begin{array}{c} \diagup \\ \diagdown \\ \diagup \\ \diagdown \end{array} = \begin{array}{c} | \\ | \end{array} \quad (9.1)$$

and “commutation” relations of the form

$$\begin{array}{c} \bullet \\ \diagup \\ \diagdown \end{array} = \begin{array}{c} \diagup \\ \diagdown \\ \bullet \end{array} + \begin{array}{c} | \\ | \end{array}. \quad (9.2)$$

In [46], it is proved that one can compute a linear basis for such a presentation using the Bergman diamond lemma. This lemma states that, if there exist an orientation of the relations of the presentation with respect to a monomial order, and if all minimal overlappings between reductions are confluent, then the monomials in normal form gives a hom-basis of the presentation. This is analogous to Section 2.9.7.

In that setting, there always are indexed critical branchings of the form (6.6), that we have to prove confluent for all cases of colours/labels of the strands as in Appendix A.2. The critical branchings implying the symmetric group relations on one colour/label of the strands are always confluent, and the proof of their confluence is given in the proof of confluence of the 3-polygraph of permutations in [51].

**9.1.2 Remark.** In [46, Thm 5.12], Elias gives an exhaustive list of the critical branchings that need to be checked in order to prove confluence for these algebras using the Manin-Schechtman theory. Manin and Schechtman [88] made an analysis of reduced expressions in the Coxeter presentation of the symmetric group, and of orientations in the corresponding reduction graph. These orientations were extended in [46] to non-reduced expressions using the idea of rewriting modulo the commutation relations  $s_i s_j = s_j s_i$  for  $|j - i| > 1$  of this presentation, by identifying two words in the reduction graph if they only differ by these relations.

**9.1.3. The nil Hecke algebras.** Given a ground ring  $\mathbb{K}$ , the *nil Hecke algebra*  $\mathcal{NH}_n$  of degree  $n$  is the  $\mathbb{K}$ -algebra presented by generators  $\xi_j$  for  $1 \leq j \leq n$  and  $\partial_i$  for  $1 \leq j \leq n - 1$  submitted to relations

- i)  $\xi_i \xi_j = \xi_j \xi_i,$
- ii)  $\partial_i \xi_j = \xi_j \partial_i$  if  $|i - j| > 1,$
- iii)  $\partial_i \partial_j = \partial_j \partial_i$  if  $|i - j| > 1,$
- iv)  $\partial_i^2 = 0,$
- v)  $\partial_i \partial_{i+1} \partial_i = \partial_{i+1} \partial_i \partial_{i+1},$
- vi)  $\xi_i \partial_i - \partial_i \xi_{i+1} = 1,$
- vii)  $\partial_i \xi_i - \xi_{i+1} \partial_i = 1.$

As in Section 6.1.4, the algebra  $\mathcal{NH}_n$  is isomorphic to  $\text{End}_{\mathcal{C}}^{\mathcal{NH}}(n)$ , where  $\mathcal{C}^{\mathcal{NH}}$  is the 2-category with only one 0-cell, one generating 1-cell  $*$ , so that  $(\mathcal{C}^{\mathcal{NH}})_1^* \sim \mathbb{N}$ , two generating 2-cells crossing and dot, and the following four relations

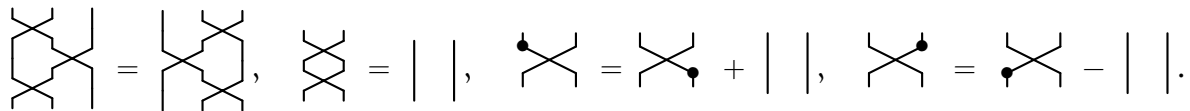

The algebra  $\mathcal{NH}_n$  is an instance of the KLR algebra  $R(\mathcal{V})$  associated to a Dynkin graph with only one vertex. Therefore, this algebra appears in the process of categorification of the quantum group associated with  $\mathfrak{sl}_2$ . The proof of convergence for the KLR algebras adapt to this situation, and thus orienting the above relations from left to right gives a convergent presentation of the nil Hecke algebras.

## 9.2. TEMPERLEY LIEB AND BRAUER CATEGORIES

**9.2.1. The Temperley-Lieb category.** The Temperley-Lieb algebras were at first introduced in 1971 by Temperley and Lieb in [116]. It plays an important role in mathematics and physics, for instance it underlies the study of Potts models, ice-type models and Andrews-Baxter-Forrester models. It can also be connected to categorical quantum mechanics and even to logic and computation. Let  $R$  be a noetherian integral domain, and  $\delta$  be an element of  $R$ . The Temperley-Lieb algebra  $\mathbb{T}L_n(\delta)$  of degree  $n$  over  $R$  is the unital  $R$ -algebra with basis the set of diagrams corresponding to graphs on  $2n$  vertices arranged in two rows each containing  $n$  points, and in which:

1. every vertex has degree 1, that is each vertex admits exactly one incident edge, and two vertices of the same row can be linked.
2. two different edges does not intersect.

As in the case of Brauer algebras in Section 8.1.1, the vertices are numerated from 1 to  $n$  from right to left in each row. The multiplication in  $\mathcal{TL}_n(\delta)$  is defined as in  $B_n(\delta)$ : we place the first diagram on top of the second one by identifying the middle row of points, remove all the loops and multiply by  $\delta$  everytime a loop is removed. The Temperley-Lieb algebra  $\mathcal{TL}_n(\delta)$  is the R-algebras presented by generators  $e_1, \dots, e_{n-1}$  which are diagrammatically represented as the generators  $e_i$  in Section 8.1.1 submitted to relations

$$e_i^2 = \delta e_i, \quad e_i e_{i\pm 1} e_i = e_i, \quad e_i e_j = e_j e_i \text{ if } |i - j| > 1.$$

Let us define a category  $\mathcal{TL}(\delta)$  encoding the Temperley-Lieb algebras in every degree as in Section 6.1.4 as follows: let  $\mathcal{TL}(\delta)$  be the linear  $(2, 2)$ -category defined by:

i) only one 0-cell,

ii) its 1-cells are given by the elements  $\{0, \dots, m\}$  for any  $m$  in  $\mathbb{N}^*$  and the tensor product (or  $\star_0$ -composition) is defined by

$$\{1, \dots, m\} \star_0 \{1, \dots, n\} := \{1, \dots, m, m + 1, \dots, m + n\}$$

iii) its generating 2-cells are caps and cups 2-cells: 

iv) the 2-cells of  $\mathcal{TL}(\delta)$  are subject to the following relations:

$$\bigcirc = \delta, \quad \begin{array}{c} \text{---} \\ \text{---} \\ \text{---} \end{array} = \begin{array}{c} \text{---} \\ \text{---} \\ \text{---} \end{array} = \begin{array}{c} \text{---} \\ \text{---} \\ \text{---} \end{array}$$

**9.2.2. The Brauer category.** Similarly, we define a linear  $(2, 2)$ -category  $\mathcal{B}(\delta)$ , called the *Brauer category* encoding the Brauer algebras  $B_n(\delta)$  for any  $n \in \mathbb{N}$  as follows:

i)  $\mathcal{B}(\delta)_{\leq 1} = \mathcal{TL}(\delta)_{\leq 1}$  and  $\mathcal{B}(\delta)_2 = \mathcal{TL}(\delta)_2 \cup \{ \text{---} \}$ ,

ii) The 2-cells of  $\mathcal{B}(\delta)$  are subject to the relations of  $\mathcal{TL}(\delta)$  and the following relations implying crossings:

$$\begin{array}{c} \text{---} \\ \text{---} \\ \text{---} \end{array} = \begin{array}{c} \text{---} \\ \text{---} \\ \text{---} \end{array}, \quad \begin{array}{c} \text{---} \\ \text{---} \\ \text{---} \end{array} = \begin{array}{c} \text{---} \\ \text{---} \\ \text{---} \end{array}, \quad \begin{array}{c} \text{---} \\ \text{---} \\ \text{---} \end{array} = \begin{array}{c} \text{---} \\ \text{---} \\ \text{---} \end{array}, \quad \begin{array}{c} \text{---} \\ \text{---} \\ \text{---} \end{array} = \begin{array}{c} \text{---} \\ \text{---} \\ \text{---} \end{array}$$

### 9.3. THE PARTITION CATEGORY

**9.3.1. Partition diagrams and the partition category.** For  $m, \ell \in \mathbb{N}$ , a *partition* of type  $\binom{\ell}{m}$  is a partition of the set  $\{1, \dots, m, 1', \dots, \ell'\}$ . The elements of the partition will be called *blocks*. We will depict such a partition as a simple graph with  $\ell$  vertices in the top row labelled  $1', \dots, \ell'$  from right to left, and  $m$  vertices in the bottom row, labelled  $1, \dots, m$  from right to left. We draw edges joining elements of each block of the partition. For example, the partition  $\{\{1, 5\}, \{2\}, \{3, 1'\}, \{4, 4', 7'\}, \{2', 3'\}, \{5'\}, \{6'\}\}$  of type  $\binom{7}{5}$  is depicted as follows:

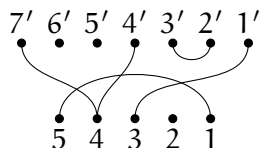

As the labels of vertices are clear according to the number of dots in each row, we may omit them. If  $D$  is a partition of type  $\binom{\ell}{m}$ , we write that  $D : m \rightarrow \ell$ . There are unique partitions of types  $\binom{1}{0}$  and  $\binom{0}{1}$  that are respectively denoted by

$$\uparrow : 0 \rightarrow 1 \quad \text{and} \quad \downarrow : 1 \rightarrow 0.$$

Given two partitions  $D' : m \rightarrow \ell$ ,  $D : \ell \rightarrow k$ , one can stack  $D$  on top of  $D'$  to obtain a diagram  $D''$  with three rows of vertices. The number of connected components in the middle row of this new diagram is denoted by  $\alpha(D, D')$ . Let  $D \star D'$  be the partition of type  $\binom{k}{m}$  with the following property: vertices are in the same block of  $D \star D'$  if and only if the corresponding vertices in the top and bottom rows of  $D''$  are in the same block.

The *partition category*  $\mathcal{Par}(\delta)$  is the strict  $\mathbb{K}$ -linear monoidal category whose 0-cells are elements  $n \in \mathbb{N}$  and, given two objects  $m, \ell$  in  $\mathcal{Par}(\delta)$ , the 1-cells from  $m$  to  $\ell$  are  $\mathbb{K}$ -linear combinations of partitions of type  $\binom{\ell}{m}$ . The vertical composition is given by

$$D \circ D' = \delta^{\alpha(D, D')} D \star D'$$

for composable partition diagrams  $D, D'$ , and extended by linearity. The bifunctor  $\otimes$  is given on objects by

$$\otimes : \mathcal{Par}(\delta) \times \mathcal{Par}(\delta) \rightarrow \mathcal{Par}(\delta), \quad (m, n) \mapsto m + n.$$

The tensor product on 1-cells is given by horizontal juxtaposition of diagrams, extended by linearity.

For example, if

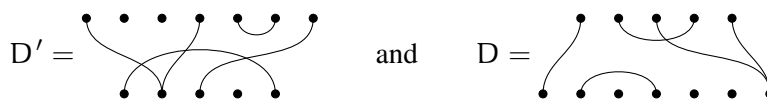

then

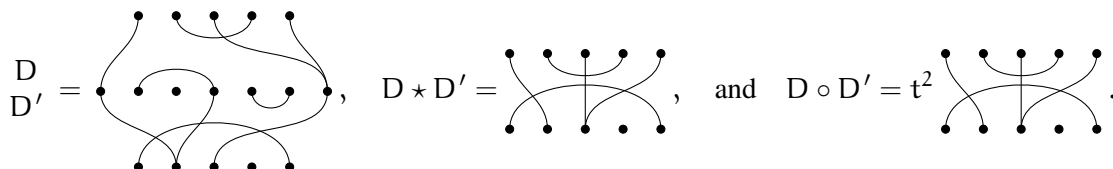

**9.3.2. Confluent presentation.** Following [33, 84], this category admits a presentation by a linear  $(3, 2)$ -polygraph as follows:

**9.3.3 Proposition.** *The linear  $(3, 2)$ -polygraph  $\overline{\mathcal{Par}(\delta)}$  defined by:*

1.  $\overline{\mathcal{Par}(\delta)}_0 = \{*\}$ ,
2.  $\overline{\mathcal{Par}(\delta)}_1 = \{1\}$  so that the 1-cells in  $\overline{\mathcal{Par}(\delta)}^*$  are non-negative integers  $n \in \mathbb{N}$ ,

$$3. \overline{\mathcal{P}ar(\delta)}_2 = \left\{ \wedge : 2 \rightarrow 1, \vee : 1 \rightarrow 2, \times : 2 \rightarrow 2, \uparrow : 0 \rightarrow 1, \downarrow : 1 \rightarrow 0 \right\}$$

4.  $\overline{\mathcal{P}ar(\delta)}_3$  is the set of following 3-cells:

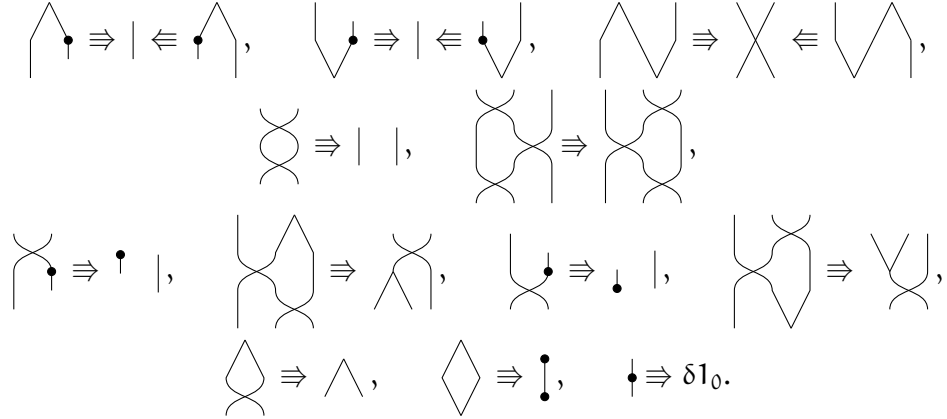

is a presentation of  $\mathcal{P}ar(\delta)$ .

It is easy to see that the linear  $(3, 2)$ -polygraph  $\overline{\mathcal{P}ar(\delta)}$  is not confluent. Checking the first critical branchings, we notice that we have to add new relations in  $\overline{\mathcal{P}ar(\delta)}$  so that our set of 3-cells is stable under some symmetries through horizontal and vertical axis. Moreover, checking the confluence with this new stable-by-symmetry set of 3-cells still requires to add new 3-cells.

**9.3.4 Definition.** Let us consider the linear  $(3, 2)$ -polygraph  $\mathcal{C}Par$  defined by:  $\mathcal{C}Par_i = \overline{\mathcal{P}ar(\delta)}_i$  for  $0 \leq i \leq 2$ , and  $\mathcal{C}Par_3$  contains the following 3-cells:

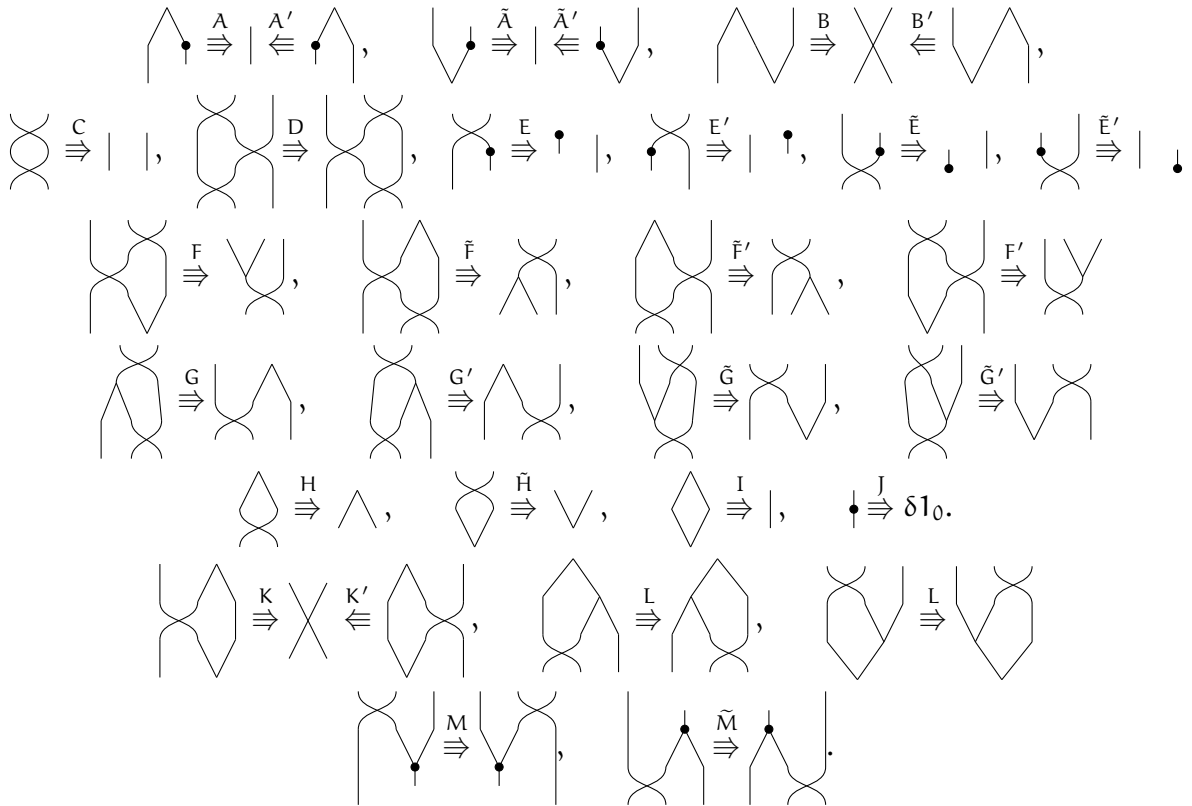

Note that we adopted some notations such that, for any 3-cell  $\gamma$  in  $\mathcal{C}Par_3$ :

- i)  $\gamma'$ , if it exists, has for source  $\iota(s_2(\gamma))$  and for target  $\iota(t_2(\gamma))$  where  $\iota : \mathcal{P}ar(\delta) \rightarrow \mathcal{P}ar(\delta)^{op}$  is the involution of  $\mathcal{P}ar(\delta)$  sending a diagram to its image through a reflexion by a vertical axis.

ii)  $\tilde{\gamma}$ , if it exists, has for source  $\tau(s_2(\gamma))$  and for target  $\tau(t_2(\gamma))$  where  $\tau : \mathcal{P}ar(\delta) \rightarrow \mathcal{P}ar(\delta)^{op}$  is the involution of  $\mathcal{P}ar(\delta)$  sending a diagram to its image through a reflexion by an horizontal axis.

As a consequence, if a critical branching of the form  $(\gamma, \delta)$  is confluent, then by applying  $\iota$  (resp.  $\tau$ ) on all the 2-cells in the confluence diagram yields a confluence for the critical branching  $(\gamma', \delta')$  (resp.  $(\tilde{\gamma}, \tilde{\delta})$ ). Therefore, this reduces the number of critical branchings that we have to take into account when proving confluence. Note that some of these 3-cells are symmetric by the  $\tilde{\phantom{x}}$  and  $'$ -involutions, for instance the following inequalities hold:

$$\tilde{C} = C, \quad C' = C, \quad \tilde{D} = D, \quad H' = H, \quad \tilde{H}' = \tilde{H}.$$

The list of critical branchings for  $\mathcal{C}P\mathcal{a}r$  that we need to prove confluent is given by:

$$\begin{aligned} & (C, C), (C, D), (D, C), (C, E), (C, F), (C, G), (G, C), (C, H), (D, E), (D, E'), (D, F'), \\ & (D, H), (E, \tilde{F}), (E, \tilde{F}'), (E, G), (E, G'), (E, \tilde{G}), (E, \tilde{G}'), (E, H), (E', \tilde{F}), (E', \tilde{F}'), (F, G), \\ & (F, H), (G, H), (G, \tilde{H}), (H, \tilde{H}), (L, C), (L, D), (L, E), (L, E'), (L, F'), (L, \tilde{F}), (L, \tilde{G}'), \\ & (L, \tilde{H}), (M, C), (M, D), (M, \tilde{E}), (M, \tilde{E}'), (M, \tilde{F}'), (M, G'), (M, H). \end{aligned}$$

**9.3.5 Proposition.** *All the critical branchings enumerated above are confluent.*

*Proof.* The proof of confluence of all these critical branchings is given in Appendix A.1. □

In order to obtain a convergent presentation, we also conjecture that the following result holds:

**9.3.6 Conjecture.** *The linear  $(3, 2)$ -polygraph  $\mathcal{C}P\mathcal{a}r$  is terminating.*

We conjecture that this can be proved using the derivation method of Section 2.6.4, but after fixing an appropriate value for the derivation on each generating 2-cell, there are a lot of inequalities to check to ensure conditions **i**)-**iii**).

Note that the following inclusions of linear  $(2, 2)$ -categories hold:

$$\mathcal{T}\mathcal{L}(\delta) \subseteq \mathcal{B}(\delta) \subseteq \mathcal{P}ar(\delta)$$

so that computing a convergent presentation, and thus a hom-basis using Section 2.9.7 of the  $(2, 2)$ -category  $\mathcal{P}ar(\delta)$  yields a convergent presentation, and thus hom-bases, for the linear  $(2, 2)$ -categories  $\mathcal{T}\mathcal{L}(\delta)$  and  $\mathcal{B}(\delta)$ .

## 9.4. THE AFFINE ORIENTED BRAUER CATEGORY

In this section, we illustrate the previous results by computing a hom-basis for the affine Oriented Brauer linear  $(2, 2)$ -category  $\mathcal{A}\mathcal{O}\mathcal{B}$ . We describe a linear  $(3, 2)$ -polygraph  $(E, R, \varepsilon R)$  for which we prove that  $\varepsilon R$  is quasi-terminating and  $\varepsilon R$  is confluent modulo. As a consequence, we prove that a choice of quasi-normal forms yields to the well-known basis obtained in [22, 2].

**9.4.1. A presentation of  $\mathcal{A}\mathcal{O}\mathcal{B}$ .** We recall from [105] the natural presentation of the affine oriented Brauer category from the degenerate affine Hecke monoidal category.

**9.4.2. The degenerate affine Hecke category.** Let  $\mathcal{A}\mathcal{H}^{\text{deg}}$  be the linear  $(2, 2)$ -category with only one 0-cell, one generating 1-cell  $\uparrow$ , two generating 2-cells

$$\begin{array}{c} \uparrow \\ \diagdown \quad \diagup \\ \uparrow \end{array} : \uparrow_{\star_0} \uparrow \rightarrow \uparrow_{\star_0} \uparrow \quad \text{and} \quad \begin{array}{c} \uparrow \\ \bullet \\ \uparrow \end{array} : \uparrow \rightarrow \uparrow$$

and three relations

$$\begin{array}{c} \uparrow \downarrow \\ \downarrow \uparrow \end{array} = \uparrow \uparrow, \quad \begin{array}{c} \uparrow \downarrow \\ \downarrow \uparrow \end{array} = \begin{array}{c} \uparrow \downarrow \\ \downarrow \uparrow \end{array}, \quad \begin{array}{c} \uparrow \downarrow \\ \downarrow \uparrow \end{array} = \begin{array}{c} \uparrow \downarrow \\ \downarrow \uparrow \end{array} + \uparrow \uparrow.$$

Following [105],  $\text{End}_{\mathcal{AH}^{\text{deg}}}(\uparrow^{\otimes n})$  is isomorphic to the degenerate affine Hecke algebra of degree  $n$ .

**9.4.3. The linear  $(2, 2)$ -category  $\mathcal{AOB}$ .** To define the affine oriented Brauer linear  $(2, 2)$ -category  $\mathcal{AOB}$ , we add to this data an additional generating 1-cell  $\downarrow$  that we require to be right dual to  $\uparrow$ . Following Section 4.3.3, this requires the existence of unit and counit 2-cells

$$\cup : 1 \rightarrow \downarrow \star_0 \uparrow, \quad \text{and} \quad \cap : \uparrow \star_0 \downarrow \rightarrow 1.$$

where 1 denoted the identity 1-cell on the only 0-cell of  $\mathcal{AH}^{\text{deg}}$ . These 2-cells have to satisfy the adjunction relations

$$\cup \uparrow = \uparrow, \quad \downarrow \cap = \downarrow.$$

We also add an additional 2-cell defined by a right-crossing as follows:

$$\begin{array}{c} \uparrow \downarrow \\ \downarrow \uparrow \end{array} := \begin{array}{c} \uparrow \downarrow \\ \downarrow \uparrow \end{array}$$

that we require to be invertible, namely there exists a two-sided inverse to this 2-cell, that we will denote by  $\begin{array}{c} \downarrow \uparrow \\ \uparrow \downarrow \end{array}$ . The resulting category  $\mathcal{AOB}$  is called the *affine oriented Brauer category*. It was proved to be a pivotal linear  $(2, 2)$ -category in [21], with  $\downarrow$  also being the left dual of  $\uparrow$  and the unit and counit 2-cells being defined as follows:

$$\cup = \begin{array}{c} \cup \\ \downarrow \end{array}, \quad \cap = \begin{array}{c} \cap \\ \uparrow \end{array}$$

The left crossing 2-cell is then proved to be equal to

$$\begin{array}{c} \downarrow \uparrow \\ \uparrow \downarrow \end{array}$$

The inverse condition is then given by the following two relations:

$$\begin{array}{c} \downarrow \uparrow \\ \uparrow \downarrow \end{array} = \begin{array}{c} \downarrow \\ \uparrow \end{array}, \quad \begin{array}{c} \downarrow \uparrow \\ \uparrow \downarrow \end{array} = \begin{array}{c} \downarrow \\ \uparrow \end{array}$$

**9.4.4. The linear  $(3, 2)$ -polygraph  $\mathcal{AOB}$ .** Let  $\overline{\mathcal{AOB}}$  be the linear  $(3, 2)$ -polygraph having:

- i) one 0-cell,
- ii) two biadjoint generating 1-cells  $\uparrow$  and  $\downarrow$ ,



iii) 8 generating 2-cells:

$$\begin{array}{cccccccc} \begin{array}{c} \nearrow \\ \searrow \\ \nwarrow \\ \nearrow \end{array} & \begin{array}{c} \nwarrow \\ \nearrow \\ \searrow \\ \nearrow \end{array} & \begin{array}{c} \uparrow \\ \bullet \end{array} & \begin{array}{c} \downarrow \\ \bullet \end{array} & \begin{array}{c} \curvearrowright \end{array} & \begin{array}{c} \curvearrowleft \end{array} & \begin{array}{c} \curvearrowright \end{array} & \begin{array}{c} \curvearrowleft \end{array} \end{array} \quad (9.3)$$

iv) the following families of 3-cells:

a) Isotopy 3-cells:

$$\begin{array}{c} \begin{array}{c} \curvearrowright \\ \bullet \\ \curvearrowright \end{array} \stackrel{i_1^\alpha}{\cong} \begin{array}{c} \uparrow \\ \bullet \end{array}, \quad \begin{array}{c} \curvearrowleft \\ \bullet \\ \curvearrowleft \end{array} \stackrel{i_3^\alpha}{\cong} \begin{array}{c} \downarrow \\ \bullet \end{array}, \quad \begin{array}{c} \curvearrowright \\ \bullet \\ \curvearrowright \end{array} \stackrel{i_4^\alpha}{\cong} \begin{array}{c} \uparrow \\ \bullet \end{array}, \quad \begin{array}{c} \curvearrowleft \\ \bullet \\ \curvearrowleft \end{array} \stackrel{i_2^\alpha}{\cong} \begin{array}{c} \downarrow \\ \bullet \end{array}, \quad \text{for any } \alpha \in \{0, 1\} \end{array} \quad (9.4)$$

$$\begin{array}{c} \begin{array}{c} \curvearrowright \\ \bullet \\ \curvearrowright \end{array} \stackrel{i_1^2}{\cong} \begin{array}{c} \curvearrowright \\ \bullet \\ \curvearrowright \end{array}, \quad \begin{array}{c} \curvearrowleft \\ \bullet \\ \curvearrowleft \end{array} \stackrel{i_3^2}{\cong} \begin{array}{c} \curvearrowleft \\ \bullet \\ \curvearrowleft \end{array}, \quad \begin{array}{c} \curvearrowright \\ \bullet \\ \curvearrowright \end{array} \stackrel{i_2^2}{\cong} \begin{array}{c} \curvearrowright \\ \bullet \\ \curvearrowright \end{array}, \quad \begin{array}{c} \curvearrowleft \\ \bullet \\ \curvearrowleft \end{array} \stackrel{i_4^2}{\cong} \begin{array}{c} \curvearrowleft \\ \bullet \\ \curvearrowleft \end{array} \end{array} \quad (9.5)$$

b) degenerate affine Hecke 3-cells:

$$\begin{array}{c} \begin{array}{c} \nearrow \\ \searrow \\ \nwarrow \\ \nearrow \end{array} \stackrel{\alpha_+}{\cong} \begin{array}{c} \uparrow \\ \uparrow \end{array}, \quad \begin{array}{c} \nearrow \\ \searrow \\ \nwarrow \\ \nearrow \end{array} \stackrel{\beta_+}{\cong} \begin{array}{c} \nearrow \\ \searrow \\ \nwarrow \\ \nearrow \end{array}, \quad \begin{array}{c} \nearrow \\ \searrow \\ \bullet \\ \nearrow \end{array} \stackrel{\gamma_{l,+}}{\cong} \begin{array}{c} \nearrow \\ \searrow \\ \bullet \\ \nearrow \end{array} + \begin{array}{c} \uparrow \\ \uparrow \end{array}, \quad \begin{array}{c} \nwarrow \\ \nearrow \\ \bullet \\ \nwarrow \end{array} \stackrel{\gamma_{r,+}}{\cong} \begin{array}{c} \nwarrow \\ \nearrow \\ \bullet \\ \nwarrow \end{array} - \begin{array}{c} \uparrow \\ \uparrow \end{array} \end{array}$$

and the corresponding 3-cells with downward orientations respectively denoted by  $\alpha_-$ ,  $\beta_-$ ,  $\gamma_{l,-}$  and  $\gamma_{r,-}$ .

c) Invertibility 3-cells:

$$\begin{array}{c} \begin{array}{c} \curvearrowright \\ \curvearrowright \\ \curvearrowright \end{array} \stackrel{E}{\cong} \begin{array}{c} \uparrow \\ \downarrow \end{array}, \quad \begin{array}{c} \curvearrowleft \\ \curvearrowleft \\ \curvearrowleft \end{array} \stackrel{F}{\cong} \begin{array}{c} \uparrow \\ \downarrow \end{array} \end{array}$$

d) 3-cells defining the caps and cups:

$$\begin{array}{c} \begin{array}{c} \curvearrowright \\ \curvearrowright \end{array} \stackrel{A}{\cong} \begin{array}{c} \curvearrowright \end{array}, \quad \begin{array}{c} \curvearrowleft \\ \curvearrowleft \end{array} \stackrel{B}{\cong} \begin{array}{c} \curvearrowleft \end{array}, \quad \begin{array}{c} \curvearrowright \\ \curvearrowright \end{array} \stackrel{C}{\cong} \begin{array}{c} \curvearrowright \end{array}, \quad \begin{array}{c} \curvearrowleft \\ \curvearrowleft \end{array} \stackrel{D}{\cong} \begin{array}{c} \curvearrowleft \end{array} \end{array}$$

e) sliding 3-cells  $s_n^0$  and  $s_n^1$  and ordering 3-cells  $o_n$  defined by induction in [22], and oriented in the same way than in [2].

We easily prove following [105] that this linear  $(3, 2)$ -polygraph is a presentation of  $\mathcal{AOB}$ . To study this linear  $(3, 2)$ -polygraph modulo, we consider its convergent subpolygraph  $E$  defined by  $E_i = \overline{\mathcal{AOB}}_i$  for  $i = 0, 1$ ,  $E_2$  contains the last six generating 2-cells in 9.3 and  $E_3$  contains exactly the isotopy 3-cells (9.4). Following 5.3.1,  $E$  is convergent. We denote by  $R$  the linear  $(3, 2)$ -polygraph having the same  $i$ -cells than  $\overline{\mathcal{AOB}}$  for  $i = 0, 1, 2$  and such that  $R_3 = \overline{\mathcal{AOB}}_3 \setminus E_3$ . From the data of  $E$  and  $R$ , we can then consider the linear  $(3, 2)$ -polygraph  $(R, E, {}_E R)$ , and prove the following result:

**9.4.5 Theorem.** *Let  $(R, E)$  be the splitting of  $\mathcal{AOB}$  defined above, then  ${}_E R$  is quasi-terminating and  $R$  is confluent modulo  $E$ .*

**9.4.6. Quasi termination of  ${}_{\mathbb{E}}R$ .** To prove quasi-termination of the linear  $(3, 2)$ -polygraph  ${}_{\mathbb{E}}R$  is quasi-terminating, we will proceed in two steps: at first we will prove that the linear  $(3, 2)$ -polygraph  $R$  minus the sliding 3-cells is terminating using derivations as in 2.6.4. Then, using a notion of quasi-ordering and a suited notion of polynomial interpretation on  $\mathcal{AOB}_2^{\ell}$ , we will describe in the same fashion than in [2] a procedure proving that every 2-cell in  $\mathcal{AOB}$  can be rewritten in a finite number of steps into a monomial on which the only 3-cells that can be applied are the cells creating cycles. Let us at first state the following lemma:

**9.4.7 Lemma.** *The linear  $(3, 2)$ -polygraph  $R' = R \setminus \{s_n^0, s_n^1\}_{n \in \mathbb{N}}$  is terminating.*

*Proof.* Let us proceed in three steps, using the derivation method given in 2.6.4. We at first consider a derivation  $d$  defined by  $d(u) = \|u\|_{\{\nearrow, \searrow\}}$  into the trivial modulo  $M_{*,*,\mathbb{Z}}$ , counting the number of crossing generators in a given 2-cell. We have that  $d(s_2(\omega)) > d(\omega_i)$  for any 3-cell  $\omega$  in  $\{A, B, C, D, E, F, \alpha\}$  and any  $\omega_i$  in  $\text{Supp}(t(\omega))$ . As a consequence, one gets that if the linear  $(3, 2)$ -polygraph  $R''$  defined as  $R'$  minus each of these 3-cell terminates, then so does  $R'$ . Indeed, otherwise there would exist an infinite reduction sequence  $(f_n)_{n \in \mathbb{N}}$  in  $R'$  and thus, an infinite decreasing sequence  $(d(f_n))_{n \in \mathbb{N}}$  of natural numbers. Moreover, this sequence would be strictly decreasing at each step that is generated by any of these 3-cells and thus, after some natural number  $p$ , this sequence would be generated by the other 3-cells only. This would yield an infinite reduction sequence  $(f_n)_{n \geq p}$  in  $R''$ , which is impossible by assumption.

It remains to prove that the linear  $(3, 2)$ -polygraph  $(R_0, R_1, R_2, \{\beta_{\pm}, \gamma_{l,\pm}, \gamma_{r,\pm}, o_n\}_{n \in \mathbb{N}})$  terminates. We can still reduce this problem to the termination of the rules  $\beta_{\pm}, \gamma_{l,\pm}$  and  $\gamma_{r,\pm}$  by considering a derivation  $d'$  with values in the trivial modulo  $M_{*,*,\mathbb{Z}}$  counting the number of clockwise oriented bubbles. Let us consider  $X$  the 2-functor  $X : \mathcal{AOB}_2^* \rightarrow \mathbf{Ord}$  on generating 2-cells by:

$$X(\mid)(n) = n \quad X(\bullet)(n) = in - 1 \quad X(\nearrow)(n, m) = (m + 1, n) \quad \forall n, m \in \mathbb{N}$$

for both orientations of strands, and we consider the  $\mathcal{AOB}_2^*$ -module  $M_{X,*,\mathbb{Z}}$  and define the derivation  $d : \mathcal{AOB}_2^* \rightarrow M_{X,*,\mathbb{Z}}$  on the generating 2-cells by

$$d(\mid)(n) = 0, \quad d(\nearrow)(n, m) = n, \quad d(\bullet)(n) = n.$$

With these assignments, we obtain the same inequalities than in Section 6.1.7, so that the 2-functor  $X$  and the derivation  $d$  satisfy the conditions **i**), **ii**) and **iii**) of Section 2.8.9, and thus the corresponding linear  $(3, 2)$ -polygraph is terminating.  $\square$

However, as explained in [2], the addition of the sliding 3-cells create rewriting cycles, so that  $R$  is not terminating. Nethertheless, we will prove that it is quasi-terminating. Following [2], we say that a monomial in  $\mathcal{AOB}$  is *quasi-reduced* if it can be rewritten by only one of the 3-cells derived from ordering and sliding 3-cells in  ${}_{\mathbb{E}}R$  on the following subdiagrams:

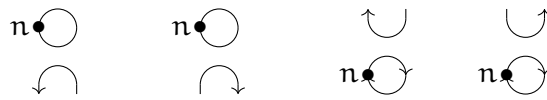

for any  $n$  in  $\mathbb{N}$ . We call a 2-cell of  $\mathcal{AOB}_2^{\ell}$  quasi-reduced if all monomials in its monomial decomposition are quasi-reduced.

We then define as in Section 6.2.22 a weight function on  $\overline{\mathcal{AOB}_2^{\ell}}$  by its following values on generating 2-cells:

$$\tau(\curvearrowright) = \tau(\curvearrowleft) = \tau(\cup) = \tau(\cap) = 0, \quad \tau(\uparrow) = \tau(\downarrow) = 0, \quad \tau(\nearrow) = \tau(\searrow) = 3.$$

Note that for any 3-cell  $\alpha$  in  $E_3$ , we have  $\tau(s_2(\alpha)) = \tau(t_2(\alpha))$  so that the isotopy 3-cells preserve this weight function. Then, starting with a monomial  $u$  of  $\overline{\mathcal{AOB}_2^{\ell}}$ :

- While  $u$  can be rewritten with respect to  ${}_{\mathbb{E}}R$  into a 2-cell  $u'$  such that  $\tau(u') < \tau(u)$ , then assign  $u$  to  $u'$ .
- While  $u$  can be rewritten with respect to  ${}_{\mathbb{E}}R$  into a 2-cell  $u'$  without any of the 3-cells depicted above, then assign  $u$  to  $u'$ .

From Lemma 9.4.7 and well-foundedness of the quasi-ordering  $\succsim$  defined as in Section 6.2.22, this procedure terminates and returns a linear combination of monomials in  $\overline{\mathcal{AOB}}_2^l$  which are quasi-reduced.

**9.4.8. Confluence modulo.** We prove that the linear  $(3, 2)$ -polygraph modulo  ${}_{\mathbb{E}}R$  is confluent modulo  $E$  using Theorem 5.2.4 and Proposition 5.4.6. Let us at first enumerate the list of all critical branchings modulo that we have to prove decreasing with respect to  $\psi^{\text{QNF}}$ . First of all, there are 6 regular critical branchings implying the degenerate affine Hecke 3-cells:

$$(\alpha_{\pm}, \alpha_{\pm}), (\alpha_{\pm}, \beta_{\pm}), (\beta_{\pm}, \alpha_{\pm}), (\alpha_{\pm}, \gamma_{\eta, \pm})_{\eta \in \{l, r\}}, (\beta_{\pm}, \gamma_{\eta, \pm})_{\eta \in \{l, r\}}, (\gamma_{l, \pm}, \gamma_{r, \pm}).$$

The first three families are proved confluent modulo in the same way that the polygraph of permutations is proved confluent in [51]. The remaining critical branchings are decreasingly confluent as follows:

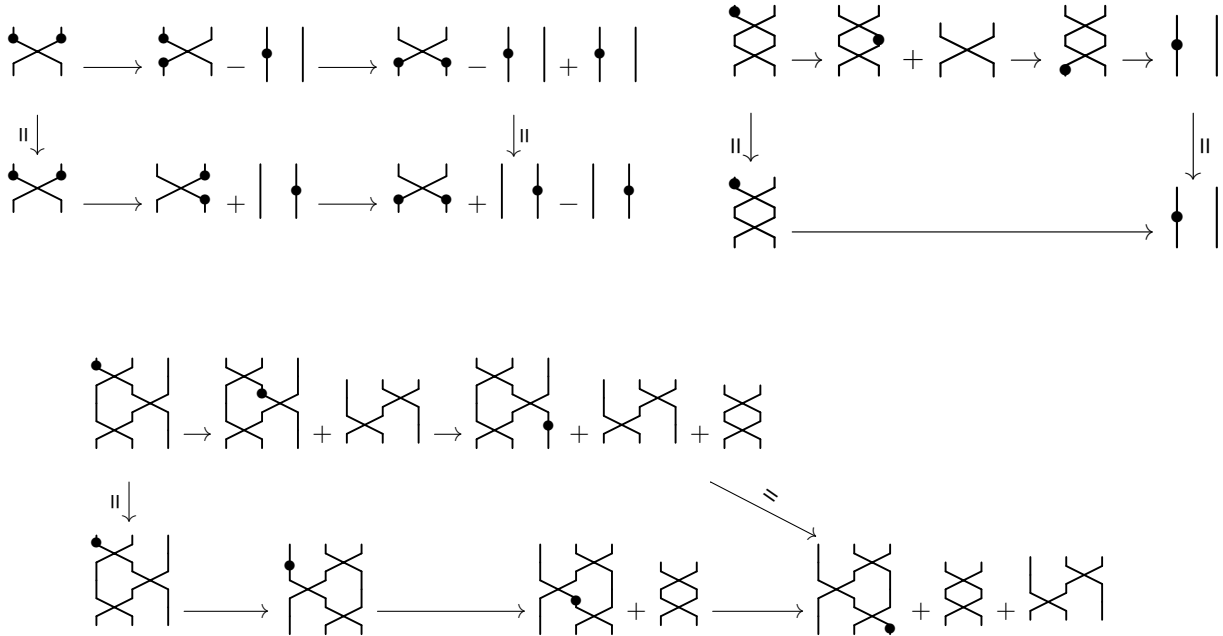

for both orientations of strands. In the last two cases, we proceed similarly if the dot is placed on another strand. Following the study of the 3-polygraphs of permutations in [51], there also are right-indexed critical branchings of the form (6.6), forgetting the labels on the strands. We have two families of normal forms that we can plug in this indexation, as in Section 6.1.8. These indexed critical branchings are confluent modulo  $E$ , and the proof of their confluence is similar to the confluence of indexed critical branchings for the KLR algebras, see Appendix A.2. The critical branchings modulo implying the sliding and ordering 3-cells are proved confluent modulo  $E$  in a similar fashion than in [2]. We then give the exhaustive list of all critical branchings modulo implying the 3-cells  $A, B, C, D, E$  and  $F$ . First of all, these branchings overlap with degenerate affine Hecke relations to give the following sources of critical branchings modulo:

$$(A, C), (B, D), (B, F), (E, D), (C, E), (E, F), (F, E), (A, \gamma_{l,+}), (B, i_4^2, \gamma_{l,+}), (D, \gamma_{r,+}), (E, \gamma_{l,+}),$$

$$(\gamma_{r,+}, i_3^2, C), (F, \gamma_{r,+}), (\alpha_+, i_1^0 \star_2 i_4^0, F), (\gamma_{r,+}, i_1^0 \star_2 i_4^0 \star_2 (i_3^2 \star_2 i_1^2)^-, F),$$

$$(\beta_+, i_1^0 \star_2 i_4^0, F), (\alpha_+, i_1^0 \star_2 i_4^0, E), (\gamma_{l,+}, i_1^0 \star_2 i_4^0 \star_2 (i_2^2 \star_2 i_4^2)^-, E).$$

Some of these branchings are proved decreasingly confluent with respect to  $\psi^{\text{QNF}}$  by the confluence modulo diagrams below. The remaining one are obtained by symmetries of the diagrams and are thus not drawn.

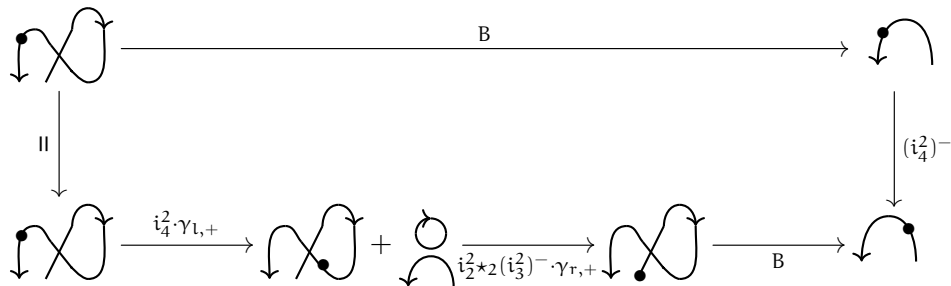
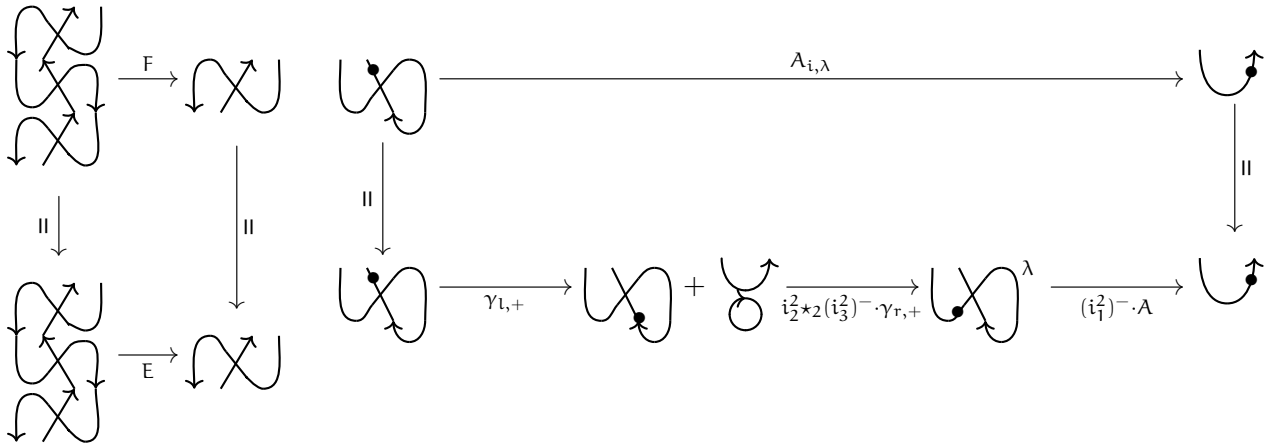
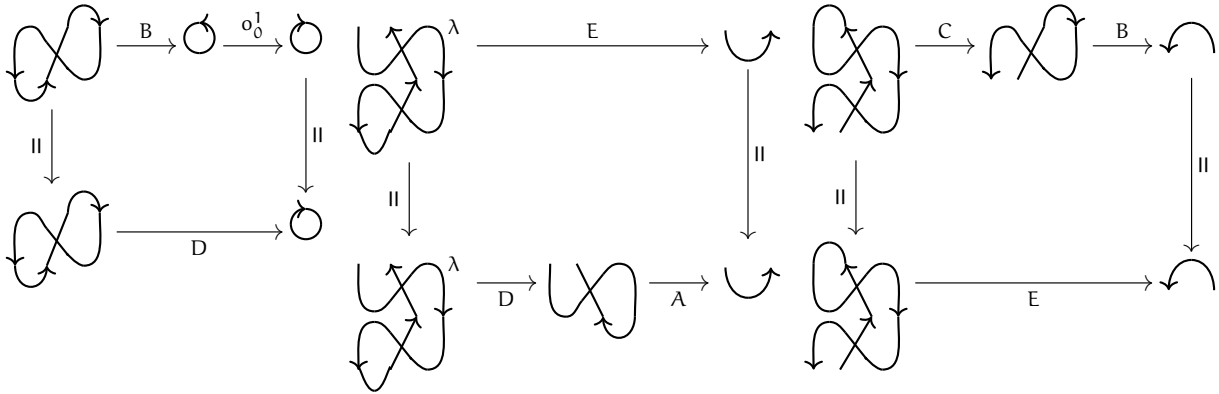
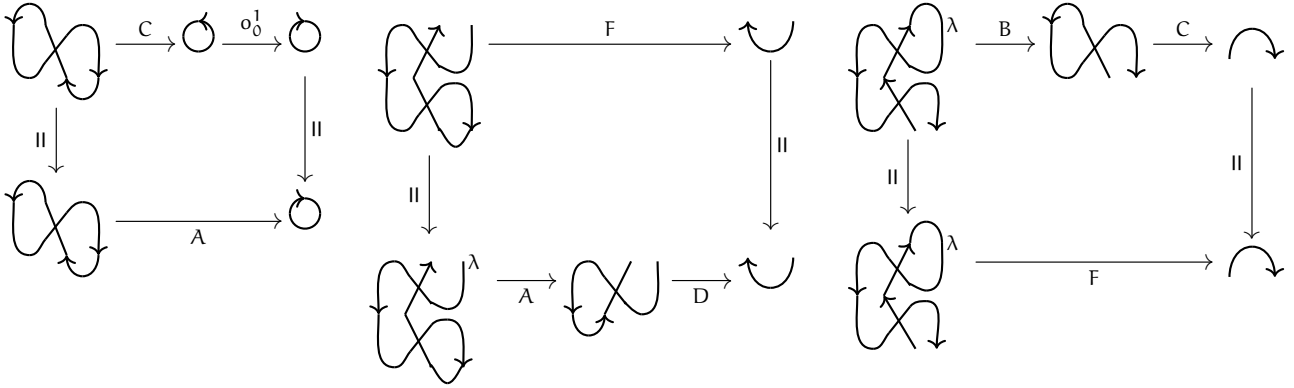

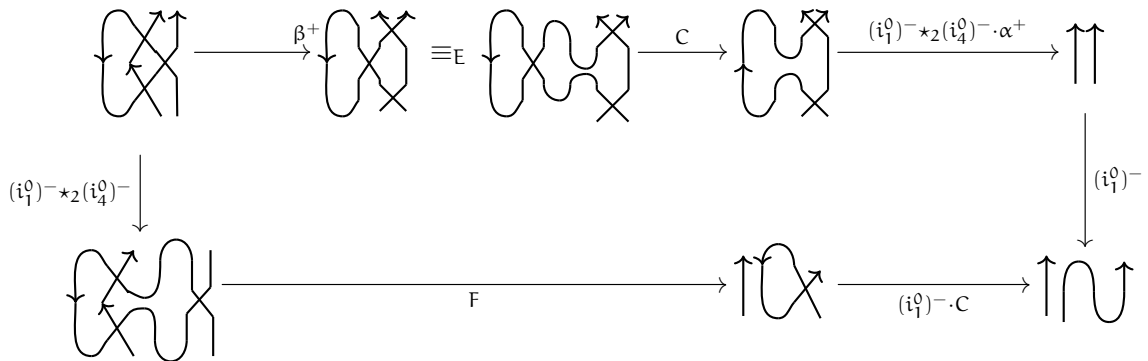
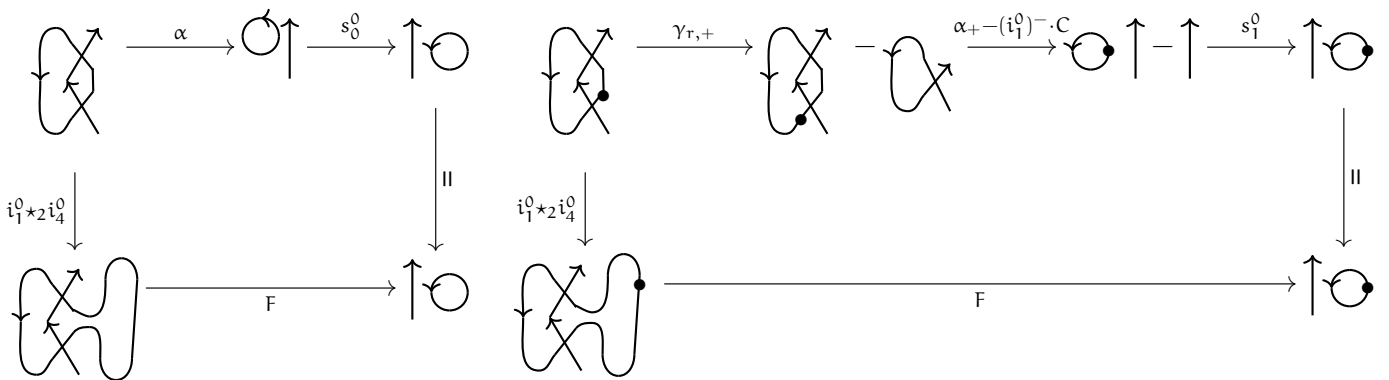
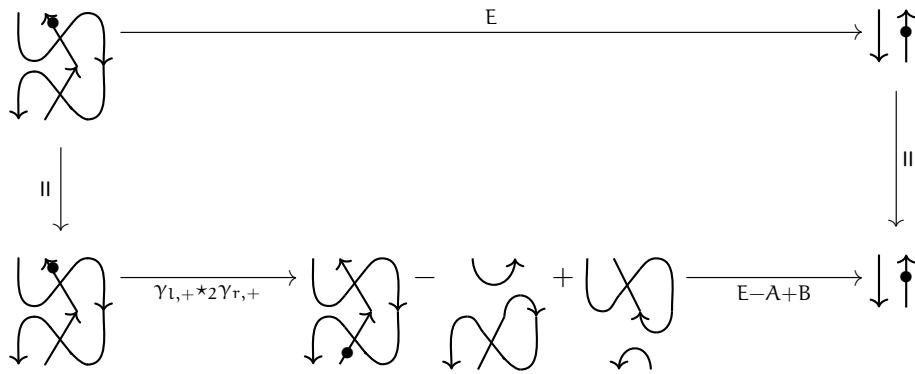

**9.4.9. Normally ordered Brauer diagrams.** A dotted oriented Brauer diagram is a planar string diagram built from  $\star_0$  and  $\star_1$ -compositions of the above generating 2-cells in which every edge is oriented and is either a bubble or have a boundary point as source and target, each edge is decorated with an arbitrary number of dots not allowed to pass through the crossings. Such a diagram is said *normally ordered* if all its bubbles are clockwise oriented and located in the leftmost region, and if all dots are either on a bubble or a segment pointing toward a boundary (or in the opposite direction). In a similar fashion than [2, Lemma 5.2.6], we prove that each 2-cell of  $\mathcal{AOB}_2^\ell$  can be rewritten with respect to  ${}_E R$  into a linear combination of diagrams whose normal forms with respect to  $E$  are normally ordered dotted oriented Brauer diagrams. As a consequence, we get from 5.4.8 that the set of such diagrams with 1-source  $u$  and 1-target  $v$  form a basis of the  $\mathbb{K}$ -vector space  $\mathcal{AOB}_2(u, v)$ , and we recover the result from [22, 2].

## 9.5. KHOVANOV'S HEISENBERG CATEGORIFICATION

**9.5.1. The Heisenberg algebra.** Let  $\mathbb{K}$  be some ground commutative ring. The *Heisenberg algebra*  $\mathbf{H}$  is the  $\mathbb{K}$ -algebra presented by generators  $p_n, q_n$  for  $n \in \mathbb{Z}$  and relations

$$p_n q_m = q_m p_n + \delta_{n,m} 1, \quad p_n p_m = p_m p_n, \quad q_n q_m = q_m q_n. \quad (9.6)$$

Let us consider a strict  $\mathbb{K}$ -linear monoidal category  $\mathcal{H}'$ , seen as a 2-category with only one 0-cell, admitting two generating 1-cells  $Q_+$  and  $Q_-$  whose identities are respectively diagrammatically represented by



and as generating 2-cells:

$$\begin{array}{cccccccc} \nearrow \searrow & \searrow \nearrow & \nwarrow \swarrow & \swarrow \nwarrow & \curvearrowright & \curvearrowleft & \curvearrowright & \curvearrowleft \end{array} \quad (9.7)$$

submitted to relations

$$\begin{array}{ccc} \begin{array}{c} \nearrow \searrow \\ \nwarrow \swarrow \end{array} = \begin{array}{c} \uparrow \\ \uparrow \end{array} & \begin{array}{c} \nwarrow \swarrow \\ \searrow \nearrow \end{array} = \begin{array}{c} \nwarrow \swarrow \\ \searrow \nearrow \end{array} & \begin{array}{c} \nearrow \searrow \\ \nwarrow \swarrow \end{array} = \begin{array}{c} \nearrow \searrow \\ \nwarrow \swarrow \end{array} \end{array} \quad (9.8)$$

$$\begin{array}{ccccccc} \begin{array}{c} \nwarrow \swarrow \\ \nearrow \searrow \end{array} = \begin{array}{c} \uparrow \\ \downarrow \end{array} & \begin{array}{c} \nwarrow \swarrow \\ \searrow \nearrow \end{array} = \begin{array}{c} \downarrow \\ \uparrow \end{array} - \begin{array}{c} \curvearrowright \\ \curvearrowleft \end{array} & \bigcirc = 1 & \begin{array}{c} \curvearrowright \\ \curvearrowleft \end{array} = 0. \end{array} \quad (9.9)$$

Any 1-cell  $Q$  in  $\mathcal{H}'$  can then be decomposed as a linear combination of elements  $Q_{\varepsilon_1} \star_0 \cdots \star_0 Q_{\varepsilon_m}$ , denoted by  $Q_\varepsilon$ , where  $\varepsilon = (\varepsilon_1, \dots, \varepsilon_m)$  is a finite sequence of signs. We denote by  $Q_\varepsilon^n$  the element  $Q_\varepsilon \star_0 \cdots \star_0 Q_\varepsilon$  made of  $\star_0$ -compositions of  $n$ -copies of  $Q_\varepsilon$ , for  $\varepsilon \in \{-, +\}$ . The space of 2-cells with 1-source  $Q_\varepsilon$  and 1-target  $Q_{\varepsilon'}$  is then given by diagrams constructed from horizontal and vertical compositions (whenever it is well-defined) of the generating 2-cells above, modulo the relations. In Khovanov's original paper, it is expressed that all these diagrams are oriented compact one-manifolds into the plane strip  $\mathbb{R} \times [0, 1]$ , modulo boundary isotopies, which in fact makes  $\mathcal{H}'$  into a pivotal 2-category.

The relations (9.9) correspond to the fact there is an isomorphism  $Q_{-+} \simeq Q_{+-} \oplus 1$  in  $\mathcal{H}$ , given by the following maps:

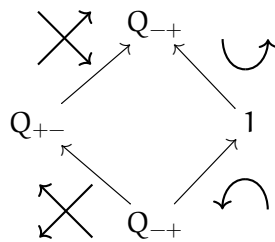

Note that we have  $\mathbb{K}[S_n] \subseteq \mathcal{H}'(Q_\varepsilon^n, Q_\varepsilon^n)$ , and the symmetrization and antisymmetrization idempotents in  $\mathbb{K}[S_n]$  produce 1-cells in  $\mathcal{H} := \text{Kar}(\mathcal{H}')$ , that can be seen as symmetric and exterior powers of the generating 1-cells  $Q_+$  and  $Q_-$ , that we denote as follows

$$S_\varepsilon^n := S^n(Q_\varepsilon), \quad \Lambda_\varepsilon^n = \Lambda^n(Q_\varepsilon) \text{ for any } \varepsilon \in \{-, +\}.$$

It is conjectured in [70] that  $\mathcal{H}$  is a strong categorification of the Heisenberg algebra, with the isomorphism  $K_0(\mathcal{H}) \rightarrow \mathbf{H}$  being given by:

$$[S_+^n] \mapsto p_n, \quad [\Lambda_-^n] \mapsto q_n.$$

It is proved in [70] that this map is injective, and this conjecture was finally proved in a more general setting for degenerate Heisenberg categories in [23].

**9.5.2. Induction and Restriction for the symmetric groups.** The monoidal category  $\mathcal{H}'$  was discovered by considering compositions of induction and restriction functors for the inclusions of symmetric group algebras  $\mathbb{K}[S_n] \subseteq \mathbb{K}[S_{n+1}]$  as defined in Section 8.1.2. Following [70], we adopt simple notations for modules and by modules over the symmetric group algebras. For instance  ${}_n(n+1)$  stands for  $S_{n+1}$  viewed as a left  $S_n$ -module, and  ${}_n(n+1)_{n-1}$  stands for  $S_{n+1}$  viewed as a  $(S_n, S_{n-1})$ -bimodule for the standard inclusions  $S_n \subset S_{n+1} \supset S_n \supset S_{n-1}$ . This notation is also suited for tensor products of modules as follows:  ${}_n(n+1)_n(n+2)$  stands for  $S_{n+1} \otimes_{B_n} S_{n+2}$  viewed as a  $(S_n, S_{n+2})$ -bimodule.

Let us represent the identity endomorphism of the induction functor  $\text{Ind}_n^{n+1} : S_n - \text{Mod} \rightarrow S_{n+1} - \text{Mod}$  (resp. of the restriction functor) as an upward (resp. downward) oriented arrow as follows:

$$n+1 \begin{array}{c} \uparrow \\ n \end{array} \quad n \begin{array}{c} \downarrow \\ n+1 \end{array}$$

This functor corresponds to tensoring with the bimodule  $(n+1)_n$  (resp.  ${}_n(n+1)$ ). It is proved in [70] that the functors  $\text{Ind}_n^{n+1}$  and  $\text{Res}_{n+1}^n$  are biadjoint with unit and counit morphisms given by

$$\begin{array}{l} \begin{array}{c} \curvearrowright \\ n \end{array} : \begin{array}{ccc} (n+1)_n(n+1) & \rightarrow & (n+1) \\ g \otimes h & \mapsto & gh \end{array} & \quad & \begin{array}{c} \curvearrowleft \\ n \end{array} : \begin{array}{ccc} (n) & \rightarrow & {}_n(n+1)_n \\ g & \mapsto & g \end{array} \\ \begin{array}{c} \curvearrowleft \\ n \end{array} : \begin{array}{ccc} {}_n(n+1)_n & \rightarrow & (n) \otimes_n (n+1) \\ g & \mapsto & \rho_n(g) \end{array} & \quad & \begin{array}{c} \curvearrowright \\ n \end{array} : \begin{array}{ccc} (n+1) & \rightarrow & (n+1) \otimes_n (n+1) \\ g & \mapsto & \sum_{i=1}^{n+1} g s_i s_{i+1} \dots s_n \otimes s_n \dots s_{i+1} s_i \end{array} \end{array}$$

where  $\rho_g(n)$  is the map defined by  $\rho_n(g) = g$  if  $g \in S_n$  and 0 otherwise. Khovanov also defined the following four generating morphisms

$$\begin{array}{l} \begin{array}{c} \nearrow \searrow \\ n \end{array} : \begin{array}{ccc} (n+2)_n & \rightarrow & (n+2)_n \\ g & \mapsto & g s_{n+1} \end{array} & \quad & \begin{array}{c} \searrow \nearrow \\ n \end{array} : \begin{array}{ccc} {}_n(n+2) & \rightarrow & {}_n(n+2) \\ g & \mapsto & s_{n+1} g \end{array} \\ \begin{array}{c} \searrow \nearrow \\ n \end{array} : \begin{array}{ccc} (n)_{n-1}(n) & \rightarrow & {}_n(n+1)_n \\ g \otimes h & \mapsto & g s_n h \end{array} & \quad & \begin{array}{c} \nearrow \searrow \\ n \end{array} : \begin{array}{ccc} {}_n(n+1)_n & \rightarrow & (n)_{n-1}(n) \\ g \in S_n & \mapsto & \delta g, \\ g s_n h & \mapsto & g \otimes h \end{array} \end{array}$$

Following [?, Prop. 7], with these definitions of generating 2-cells, the relations (9.8)-(9.9) are satisfied for every diagram with rightmost region labeled by  $n$ . The relations (9.8) follow from the definition of the bimodule map defined by the upward crossing, and come from relations  $s_n^2 = 1$  and  $s_{n+1} s_{n+2} s_{n+1} = s_{n+2} s_{n+1} s_{n+2}$  in the symmetric groups. The relations of (9.9) encode the bimodule decomposition  ${}_n(n+1)_n \simeq (n)_{n-1}(n) \oplus (n)$ , giving an isomorphism

$$\text{Res}_{n+1}^n \circ \text{Ind}_n^{n+1} \simeq \text{Ind}_{n-1}^n \circ \text{Res}_n^{n-1} \oplus 1_{S_n - \text{Mod}} \quad (9.10)$$

of endofunctors in  $\mathbb{K}[S_n] - \text{mod}$ , giving the Mackey decomposition theorem for the algebras of the symmetric groups.

**9.5.3 Remark.** We can prove that orienting the relations (9.8)-(9.9) and rewriting modulo the isotopy axioms of pivotality gives a confluent modulo presentation of the category  $\mathcal{H}'$  in a similar fashion than for  $\mathcal{AOB}$  in Section 9.4. We thus find an hom-basis of  $\mathcal{H}'$ . Actually, a family  $\mathcal{Heis}_k$  of *degenerate Heisenberg categories* with central charge  $k \in \mathbb{Z}$  were introduced in [21] and admit as special case  $\mathcal{H}'$  for  $k = -1$  and  $\mathcal{AOB}$  for  $k = 0$ . These categories admit a presentation given in [21, Theorem 1.2] for general  $k \in \mathbb{Z}$ , and we expect that these methods of rewriting modulo can be adapted to compute hom-bases of these categories. In [106], these constructions were extended by considering a family of monoidal supercategories  $\mathcal{Heis}_{F,k}$  associated to a graded Frobenius superalgebra  $F$  and integer  $k$ . One expects that the methods of Chapter 5 can be extended to linear  $(2, 2)$ -supercategories, in which the exchange law is up to a sign, and that we could also compute hom-bases of these categories for any algebra  $F$ .

---

## Bibliography

---

- [1] Clément Alleaume. *Higher-dimensional linear rewriting and coherence in categorification and representation theory*. Theses, Université de Lyon, June 2018.
- [2] Clément Alleaume. Rewriting in higher dimensional linear categories and application to the affine oriented Brauer category. *J. Pure Appl. Algebra*, 222(3):636–673, 2018.
- [3] Clément Alleaume and Philippe Malbos. Coherence of string rewriting systems by decreasingness. preprint, arXiv:1612.09193, 2016.
- [4] David J. Anick. On monomial algebras of finite global dimension. *Trans. Amer. Math. Soc.*, 291(1):291–310, 1985.
- [5] Susumu Ariki. On the decomposition numbers of the Hecke algebra of  $G(m, 1, n)$ . *J. Math. Kyoto Univ.*, 36(4):789–808, 1996.
- [6] Franz Baader and Tobias Nipkow. *Term Rewriting and All That*. Cambridge University Press, 1998.
- [7] Leo Bachmair and Nachum Dershowitz. Completion for rewriting modulo a congruence. *Theoretical Computer Science*, 67(2):173 – 201, 1989.
- [8] A. A. Beilinson, G. Lusztig, and R. MacPherson. A geometric setting for the quantum deformation of  $GL_n$ . *Duke Math. J.*, 61(2):655–677, 1990.
- [9] George M. Bergman. The diamond lemma for ring theory. *Adv. in Math.*, 29(2):178–218, 1978.
- [10] J. N. Bernstein and S. I. Gelfand. Tensor products of finite- and infinite-dimensional representations of semisimple Lie algebras. *Compositio Math.*, 41(2):245–285, 1980.
- [11] I. N. Bernšteĭn, I. M. Gelfand, and S. I. Gelfand. A certain category of  $S(\mathfrak{g})$ -modules. *Funkcional. Anal. i Priložen.*, 10(2):1–8, 1976.
- [12] Joan S. Birman and Hans Wenzl. Braids, link polynomials and a new algebra. *Trans. Amer. Math. Soc.*, 313(1):249–273, 1989.
- [13] Leonid A. Bokut. Imbeddings into simple associative algebras. *Algebra i Logika*, 15(2):117–142, 245, 1976.
- [14] Ronald Book and Friedrich Otto. *String-rewriting systems*. Texts and Monographs in Computer Science. Springer-Verlag, 1993.
- [15] Richard Brauer. On algebras which are connected with the semisimple continuous groups. *Annals of Mathematics*, 38(4):857–872, 1937.
- [16] Ronald Brown. Crossed complexes and homotopy groupoids as non commutative tools for higher dimensional local-to-global problems. In *Galois theory, Hopf algebras, and semiabelian categories*, volume 43 of *Fields Inst. Commun.*, pages 101–130. Amer. Math. Soc., Providence, RI, 2004.
- [17] Ronald Brown and Philip J. Higgins. On the connection between the second relative homotopy groups of some related spaces. *Proc. London Math. Soc. (3)*, 36(2):193–212, 1978.



- [18] Ronald Brown, Philip J. Higgins, and Rafael Sivera. *Nonabelian algebraic topology*, volume 15 of *EMS Tracts in Mathematics*. European Mathematical Society (EMS), Zürich, 2011. Filtered spaces, crossed complexes, cubical homotopy groupoids, With contributions by Christopher D. Wensley and Sergei V. Soloviev.
- [19] Ronald Brown and Christopher B. Spencer. Double groupoids and crossed modules. *Cahiers Topologie Géom. Différentielle*, 17(4):343–362, 1976.
- [20] Jonathan Brundan. On the definition of Kac-Moody 2-category. *Math. Ann.*, 364(1-2):353–372, 2016.
- [21] Jonathan Brundan. On the definition of Heisenberg category. *Algebraic Combinatorics*, 1(4):523–544, 2018.
- [22] Jonathan Brundan, Jonathan Comes, David Nash, and Andrew Reynolds. A basis theorem for the affine oriented Brauer category and its cyclotomic quotients. *arXiv:1404.6574*, April 2014.
- [23] Jonathan Brundan, Alistair Savage, and Ben Webster. The degenerate Heisenberg category and its Grothendieck ring, 2018. preprint arXiv:1812.03255.
- [24] Bruno Buchberger. *Ein Algorithmus zum Auffinden der Basiselemente des Restklassenringes nach einem nulldimensionalen Polynomideal (An Algorithm for Finding the Basis Elements in the Residue Class Ring Modulo a Zero Dimensional Polynomial Ideal)*. PhD thesis, Mathematical Institute, University of Innsbruck, Austria, 1965. English translation in *J. of Symbolic Computation, Special Issue on Logic, Mathematics, and Computer Science: Interactions*. Vol. 41, Number 3-4, Pages 475–511, 2006.
- [25] Bruno Buchberger. History and basic features of the critical-pair/completion procedure. *J. Symbolic Comput.*, 3(1-2):3–38, 1987. *Rewriting techniques and applications (Dijon, 1985)*.
- [26] Bruno Buchberger. An algorithm for finding the basis elements of the residue class ring of a zero dimensional polynomial ideal. *J. Symbolic Comput.*, 41(3-4):475–511, 2006. Translated from the 1965 German original by Michael P. Abramson.
- [27] Albert Burroni. Une autre approche des orientaux. unpublished manuscript.
- [28] Albert Burroni. Higher-dimensional word problems with applications to equational logic. *Theoret. Comput. Sci.*, 115(1):43–62, 1993. 4th Summer Conference on Category Theory and Computer Science (Paris, 1991).
- [29] Sabin Cautis and Joel Kamnitzer. Knot homology via derived categories of coherent sheaves. I. The  $\mathfrak{sl}(2)$ -case. *Duke Math. J.*, 142(3):511–588, 2008.
- [30] Sabin Cautis, Joel Kamnitzer, and Scott Morrison. Webs and quantum skew howe duality. *Mathematische Annalen*, 360(1):351–390, Oct 2014.
- [31] Cyrille Chenavier, Benjamin Dupont, and Philippe Malbos. Algebraic polygraphs modulo and linear rewriting. preprint, arXiv:2004.14361, 2020.
- [32] J. Robin B. Cockett, Jurgen Koslowski, and Robert A. G. Seely. Introduction to linear bicategories. *Math. Structures Comput. Sci.*, 10(2):165–203, 2000. *The Lambek Festschrift: mathematical structures in computer science (Montreal, QC, 1997)*.
- [33] Jonathan Comes. Jellyfish partition categories, 2016. preprint arXiv:1612.05182.
- [34] L. Crane and I. B. Frenkel. Four-dimensional topological quantum field theory, Hopf categories, and the canonical bases. *Journal of Mathematical Physics*, 35:5136–5154, October 1994.
- [35] Louis Crane. Clock and category: is quantum gravity algebraic? *J. Math. Phys.*, 36(11):6180–6193, 1995.
- [36] R. J. M. Dawson, R. Pare, and D. A. Pronk. Free extensions of double categories. *Cah. Topol. Géom. Différ. Catég.*, 45(1):35–80, 2004.
- [37] Robert Dawson. A forbidden-suborder characterization of binarily-composable diagrams in double categories. *Theory Appl. Categ.*, 1:No. 7, 146–155, 1995.
- [38] Robert Dawson and Robert Paré. General associativity and general composition for double categories. *Cahiers Topologie Géom. Différentielle Catég.*, 34(1):57–79, 1993.
- [39] Robert Dawson and Robert Paré. What is a free double category like? *J. Pure Appl. Algebra*, 168(1):19–34, 2002.
- [40] Nachum Dershowitz. Termination of rewriting. *J. Symb. Comput.*, 3(1-2):69–115, February 1987.

- [41] Nachum Dershowitz and Zohar Manna. Proving termination with multiset orderings. In *Automata, languages and programming (Sixth Colloq., Graz, 1979)*, volume 71 of *Lecture Notes in Comput. Sci.*, pages 188–202. Springer, Berlin-New York, 1979.
- [42] Benjamin Dupont. Rewriting modulo isotopies in pivotal linear  $(2, 2)$ -categories. preprint, arXiv:1906.03904, 2019.
- [43] Benjamin Dupont and Philippe Malbos. Coherent confluence modulo relations and double groupoids. preprint arXiv:1810.08184, 2018.
- [44] Charles Ehresmann. Catégories structurées. *Ann. Sci. École Norm. Sup. (3)*, 80:349–426, 1963.
- [45] Ben Elias. Light ladders and clasp conjectures. preprint, arXiv:1510.06840, 2015.
- [46] Ben Elias. A diamond lemma for Hecke-type algebras. preprint arXiv:1907.10571, 2019.
- [47] R. P. Feynman. Space-time approach to quantum electrodynamics. *Phys. Rev. (2)*, 76:769–789, 1949.
- [48] Stéphane Gaussent, Yves Guiraud, and Philippe Malbos. Coherent presentations of Artin monoids. *Compos. Math.*, 151(5):957–998, 2015.
- [49] Yves Guiraud. Termination orders for three-dimensional rewriting. *J. Pure Appl. Algebra*, 207(2):341–371, 2006.
- [50] Yves Guiraud, Eric Hoffbeck, and Philippe Malbos. Convergent presentations and polygraphic resolutions of associative algebras. *Math. Z.*, 293(1-2):113–179, 2019.
- [51] Yves Guiraud and Philippe Malbos. Higher-dimensional categories with finite derivation type. *Theory Appl. Categ.*, 22:No. 18, 420–478, 2009.
- [52] Yves Guiraud and Philippe Malbos. Coherence in monoidal track categories. *Math. Structures Comput. Sci.*, 22(6):931–969, 2012.
- [53] Yves Guiraud and Philippe Malbos. Higher-dimensional normalisation strategies for acyclicity. *Adv. Math.*, 231(3-4):2294–2351, 2012.
- [54] Yves Guiraud and Philippe Malbos. Polygraphs of finite derivation type. *Math. Structures Comput. Sci.*, 28(2):155–201, 2018.
- [55] Nohra Hage and Philippe Malbos. Knuth’s coherent presentations of plactic monoids of type A. *Algebr. Represent. Theory*, 20(5):1259–1288, 2017.
- [56] Gérard Huet. Confluent reductions: abstract properties and applications to term rewriting systems. *J. Assoc. Comput. Mach.*, 27(4):797–821, 1980.
- [57] Jean-Marie Hullot. A catalogue of canonical term rewriting systems. 1980. SRI International, Technical Report CSL 113.
- [58] James E. Humphreys. *Reflection groups and Coxeter groups*, volume 29 of *Cambridge Studies in Advanced Mathematics*. Cambridge University Press, Cambridge, 1990.
- [59] V. F. R. Jones. Planar algebras, I. *arXiv:math/9909027*, September 1999.
- [60] Vaughan F. R. Jones. A polynomial invariant for knots via von Neumann algebras. *Bull. Amer. Math. Soc. (N.S.)*, 12(1):103–111, 1985.
- [61] Jean-Pierre Jouannaud and Helene Kirchner. Completion of a set of rules modulo a set of equations. In *Proceedings of the 11th ACM SIGACT-SIGPLAN Symposium on Principles of Programming Languages, POPL ’84*, pages 83–92, New York, NY, USA, 1984. ACM.
- [62] Jean-Pierre Jouannaud and Jianqi Li. Church-Rosser properties of normal rewriting. In *Computer science logic 2012*, volume 16 of *LIPICs. Leibniz Int. Proc. Inform.*, pages 350–365. Schloss Dagstuhl. Leibniz-Zent. Inform., Wadern, 2012.
- [63] André Joyal and Ross Street. The geometry of tensor calculus. I. *Adv. Math.*, 88(1):55–112, 1991.
- [64] Victor G. Kac. *Infinite-dimensional Lie algebras*. Cambridge University Press, Cambridge, third edition, 1990.

- [65] Lars Kadison. *New examples of Frobenius extensions*, volume 14 of *University Lecture Series*. American Mathematical Society, Providence, RI, 1999.
- [66] Seok-Jin Kang and Masaki Kashiwara. Categorification of highest weight modules via Khovanov-Lauda-Rouquier algebras. *Invent. Math.*, 190(3):699–742, 2012.
- [67] M. Khovanov and A. D. Lauda. A diagrammatic approach to categorification of quantum groups III. *Quantum Topology, Vol 1, Issue 1, 2010, pp. 1-92*, July 2008.
- [68] Mikhail Khovanov. A categorification of the Jones polynomial. *Duke Math. J.*, 101(3):359–426, 2000.
- [69] Mikhail Khovanov. Nilcoxeter algebras categorify the Weyl algebra. *Comm. Algebra*, 29(11):5033–5052, 2001.
- [70] Mikhail Khovanov. Heisenberg algebra and a graphical calculus. *Fund. Math.*, 225(1):169–210, 2014.
- [71] Mikhail Khovanov and Aaron D. Lauda. A diagrammatic approach to categorification of quantum groups. I. *Represent. Theory*, 13:309–347, 2009.
- [72] Mikhail Khovanov and Aaron D. Lauda. A diagrammatic approach to categorification of quantum groups II. *Trans. Amer. Math. Soc.*, 363(5):2685–2700, 2011.
- [73] Mikhail Khovanov, Volodymyr Mazorchuk, and Catharina Stroppel. A brief review of abelian categorifications. *Theory Appl. Categ.*, 22:No. 19, 479–508, 2009.
- [74] Mikhail Khovanov and Radmila Sazdanovic. Categorifications of the polynomial ring. *Fund. Math.*, 230(3):251–280, 2015.
- [75] Jan Willem Klop. Term rewriting systems. In *Handbook of Logic in Computer Science*, volume 2, chapter 1, pages 1–117. Oxford University Press, 1992.
- [76] Donald Knuth and Peter Bendix. Simple word problems in universal algebras. In *Computational Problems in Abstract Algebra (Proc. Conf., Oxford, 1967)*, pages 263–297. Pergamon, Oxford, 1970.
- [77] Yuji Kobayashi. Complete rewriting systems and homology of monoid algebras. *J. Pure Appl. Algebra*, 65(3):263–275, 1990.
- [78] Yves Lafont. Towards an algebraic theory of boolean circuits. *Journal of Pure and Applied Algebra*, 184(2):257 – 310, 2003.
- [79] Yves Lafont, François Métayer, and Krzysztof Worytkiewicz. A folk model structure on omega-cat. *Adv. Math.*, 224(3):1183–1231, 2010.
- [80] Dallas Lankford. On proving term rewriting systems are noetherian. 1979. Technical Report MTP-3, Louisiana Technical University.
- [81] Aaron D. Lauda. A categorification of quantum  $sl(2)$ . *Adv. Math.*, 225(6):3327–3424, 2010.
- [82] Aaron D. Lauda. An introduction to diagrammatic algebra and categorified quantum  $sl(2)$ . *Bull. Inst. Math. Acad. Sin. (N.S.)*, 7(2):165–270, 2012.
- [83] F. William Lawvere. Functorial semantics of algebraic theories. *Proc. Nat. Acad. Sci. U.S.A.*, 50:869–872, 1963.
- [84] Samuel Nyobe Likeng, Alistair Savage, and appendix with Christopher Ryba. Embedding Deligne’s category  $\text{Rep}(s_t)$  in the Heisenberg category, 2019. preprint arXiv:1905.05620.
- [85] George Lusztig. *Introduction to quantum groups*. Modern Birkhäuser Classics. Birkhäuser/Springer, New York, 2010. Reprint of the 1994 edition.
- [86] Marco Mackaay and Alistair Savage. Degenerate cyclotomic hecke algebras and higher level Heisenberg categorification. *J. Algebra*, 505:150–193, 2018.
- [87] Philippe Malbos and Samuel Mimram. Cartesian polygraphic resolutions. in preparation, 2020.
- [88] Yu. I. Manin and V. V. Schechtman. Arrangements of hyperplanes, higher braid groups and higher Bruhat orders. In *Algebraic number theory*, volume 17 of *Adv. Stud. Pure Math.*, pages 289–308. Academic Press, Boston, MA, 1989.

- [89] Claude Marche. Normalized rewriting: an alternative to rewriting modulo a set of equations. *Journal of Symbolic Computation*, 21(3):253 – 288, 1996.
- [90] Volodymyr Mazorchuk. *Lectures on algebraic categorification*. QGM Master Class Series. European Mathematical Society (EMS), Zürich, 2012.
- [91] François Métayer. Resolutions by polygraphs. *Theory Appl. Categ.*, 11:No. 7, 148–184, 2003.
- [92] François Métayer. Cofibrant objects among higher-dimensional categories. *Homology Homotopy Appl.*, 10(1):181–203, 2008.
- [93] Teo Mora. An introduction to commutative and noncommutative Gröbner bases. *Theoret. Comput. Sci.*, 134(1):131–173, 1994. Second International Colloquium on Words, Languages and Combinatorics (Kyoto, 1992).
- [94] Kiiti Morita. Adjoint pairs of functors and Frobenius extensions. *Sci. Rep. Tokyo Kyoiku Daigaku Sect. A*, 9:40–71 (1965), 1965.
- [95] Tadasi Nakayama and Tosihiro Tsuzuku. On Frobenius extensions. I. *Nagoya Math. J.*, 17:89–110, 1960.
- [96] Maxwell Newman. On theories with a combinatorial definition of “equivalence”. *Ann. of Math. (2)*, 43(2):223–243, 1942.
- [97] Maurice Nivat. Congruences parfaites et quasi-parfaites. In *Séminaire P. Dubreil, 25e année (1971/72), Algèbre, Fasc. 1, Exp. No. 7*, page 9. Secrétariat Mathématique, Paris, 1973.
- [98] Roger Penrose. Applications of negative dimensional tensors. In *Combinatorial Mathematics and its Applications (Proc. Conf., Oxford, 1969)*, pages 221–244. Academic Press, London, 1971.
- [99] Gerald E. Peterson and Mark E. Stickel. Complete sets of reductions for some equational theories. *J. Assoc. Comput. Mach.*, 28(2):233–264, 1981.
- [100] A. J. Power. An  $n$ -categorical pasting theorem. In *Category theory (Como, 1990)*, volume 1488 of *Lecture Notes in Math.*, pages 326–358. Springer, Berlin, 1991.
- [101] J. A. Robinson. A machine-oriented logic based on the resolution principle. *J. Assoc. Comput. Mach.*, 12:23–41, 1965.
- [102] R. Rouquier. 2-Kac-Moody algebras. December 2008. preprint arXiv:0812.5023.
- [103] Raphael Rouquier. Categorification of the braid groups, 2004. preprint arXiv:math/0409593.
- [104] Alistair Savage. Introduction to categorification, 2014. CRM mini-course lecture notes, arXiv:1401.6037.
- [105] Alistair Savage. String diagrams and categorification. *Interactions of Quantum Affine Algebras with Cluster Algebras, Current Algebras and Categorification, Progress in Mathematics*, 2018. to appear.
- [106] Alistair Savage. Frobenius heisenberg categorification. *Algebr. Comb.*, 2(5):937–967, 2019.
- [107] P. Selinger. A survey of graphical languages for monoidal categories. In *New structures for physics*, volume 813 of *Lecture Notes in Phys.*, pages 289–355. Springer, Heidelberg, 2011.
- [108] Anatoly Illarionovich Shirshov. Some algorithmic problems for Lie algebras. *Sib. Mat. Zh.*, 3:292–296, 1962.
- [109] Wolfgang Soergel. Kazhdan-Lusztig-Polynome und unzerlegbare Bimoduln über Polynomringen. *J. Inst. Math. Jussieu*, 6(3):501–525, 2007.
- [110] Craig Squier and Friedrich Otto. The word problem for finitely presented monoids and finite canonical rewriting systems. In *Rewriting techniques and applications (Bordeaux, 1987)*, volume 256 of *Lecture Notes in Comput. Sci.*, pages 74–82. Springer, Berlin, 1987.
- [111] Craig C. Squier, Friedrich Otto, and Yuji Kobayashi. A finiteness condition for rewriting systems. *Theoret. Comput. Sci.*, 131(2):271–294, 1994.
- [112] Ross Street. Limits indexed by category-valued 2-functors. *J. Pure Appl. Algebra*, 8(2):149–181, 1976.
- [113] Ross Street. The algebra of oriented simplexes. *J. Pure Appl. Algebra*, 49(3):283–335, 1987.
- [114] Ross Street. Higher categories, strings, cubes and simplex equations. *Appl. Categ. Structures*, 3(1):29–77, 1995.

- [115] Joshua Sussan. *Category  $O$  and  $sl(k)$  link invariants*. ProQuest LLC, Ann Arbor, MI, 2007. Thesis (Ph.D.)–Yale University.
- [116] H. N. V. Temperley and E. H. Lieb. Relations between the 'percolation' and 'colouring' problem and other graph-theoretical problems associated with regular planar lattices: Some exact results for the 'percolation' problem. *Proceedings of the Royal Society of London. Series A, Mathematical and Physical Sciences*, 322(1549):251–280, 1971.
- [117] Terese. *Term rewriting systems*, volume 55 of *Cambridge Tracts in Theoretical Computer Science*. Cambridge University Press, 2003.
- [118] Axel Thue. Probleme über Veränderungen von Zeichenreihen nach gegebenen Regeln. *Kristiania Vidensk. Selsk. Skr.*, 10:493–524, 1914.
- [119] Vincent van Oostrom. Confluence by decreasing diagrams. *Theor. Comput. Sci.*, 126(2):259–280, April 1994.
- [120] Patrick Viry. Rewriting modulo a rewrite system. 1995. Technical Report-95-20, University of Pisa.
- [121] Ben Webster. Knot invariants and higher representation theory. *Mem. Amer. Math. Soc.*, 250(1191):v+141, 2017.
- [122] Ben Webster. Unfurling Khovanov-Lauda-Rouquier algebras. preprint arXiv:1603.06311, 2018.
- [123] Hans Wenzl. On the structure of Brauer's centralizer algebras. *Ann. of Math. (2)*, 128(1):173–193, 1988.

---

Appendix: Proofs of confluence of critical branchings

---

A.1. CRITICAL BRANCHINGS FOR THE PARTITION CATEGORY

We prove that all the critical branchings of the linear  $(3, 2)$ -polygraph  $\mathcal{CP}ar$  defined in Section 9.3.2 are confluent. The branchings between relations C and D and the associated indexed critical branchings are proved confluent as in the proof of confluence of the 3-polygraph of permutations in [51]. The remaining ones are respectively confluent as follows:

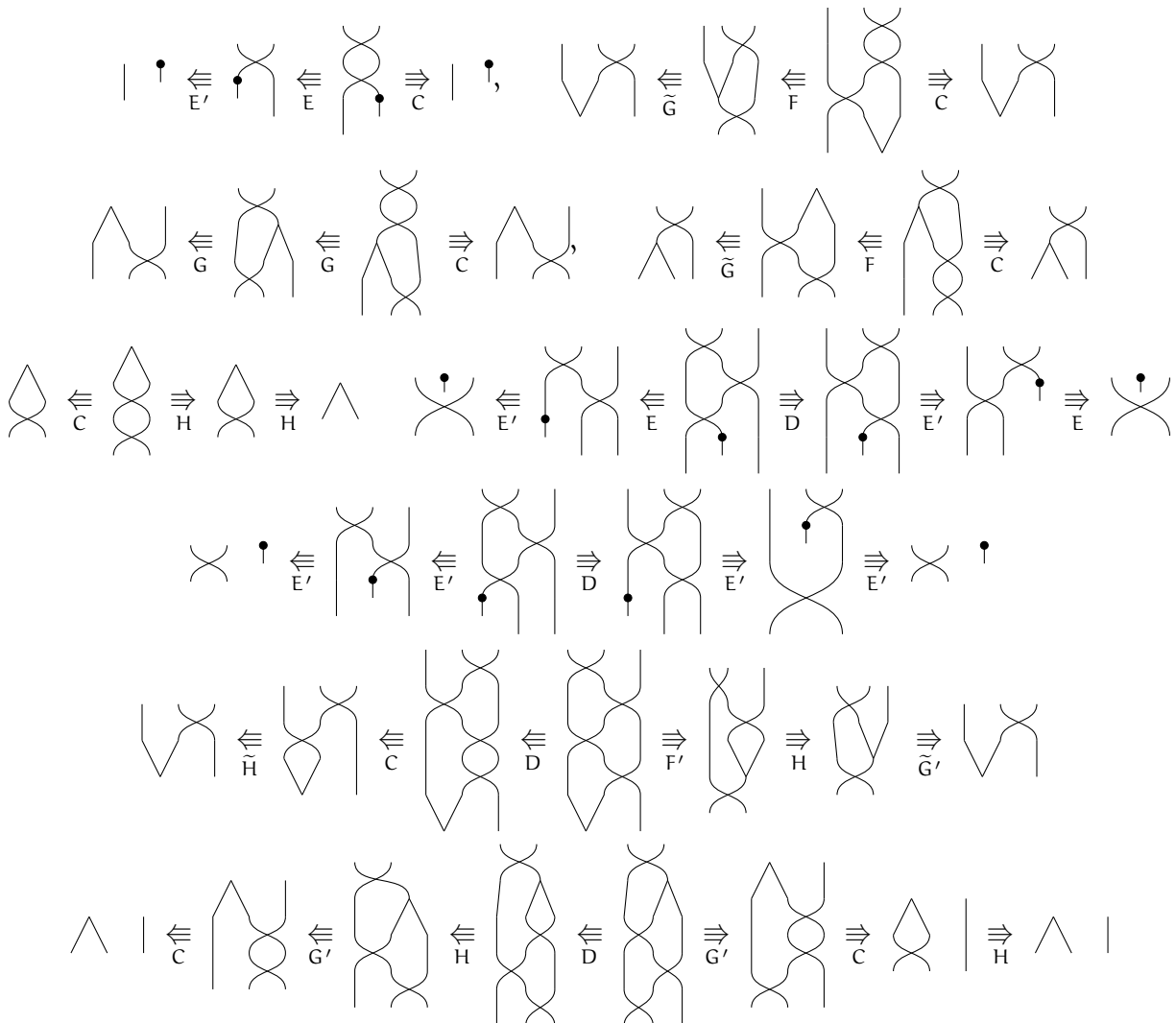

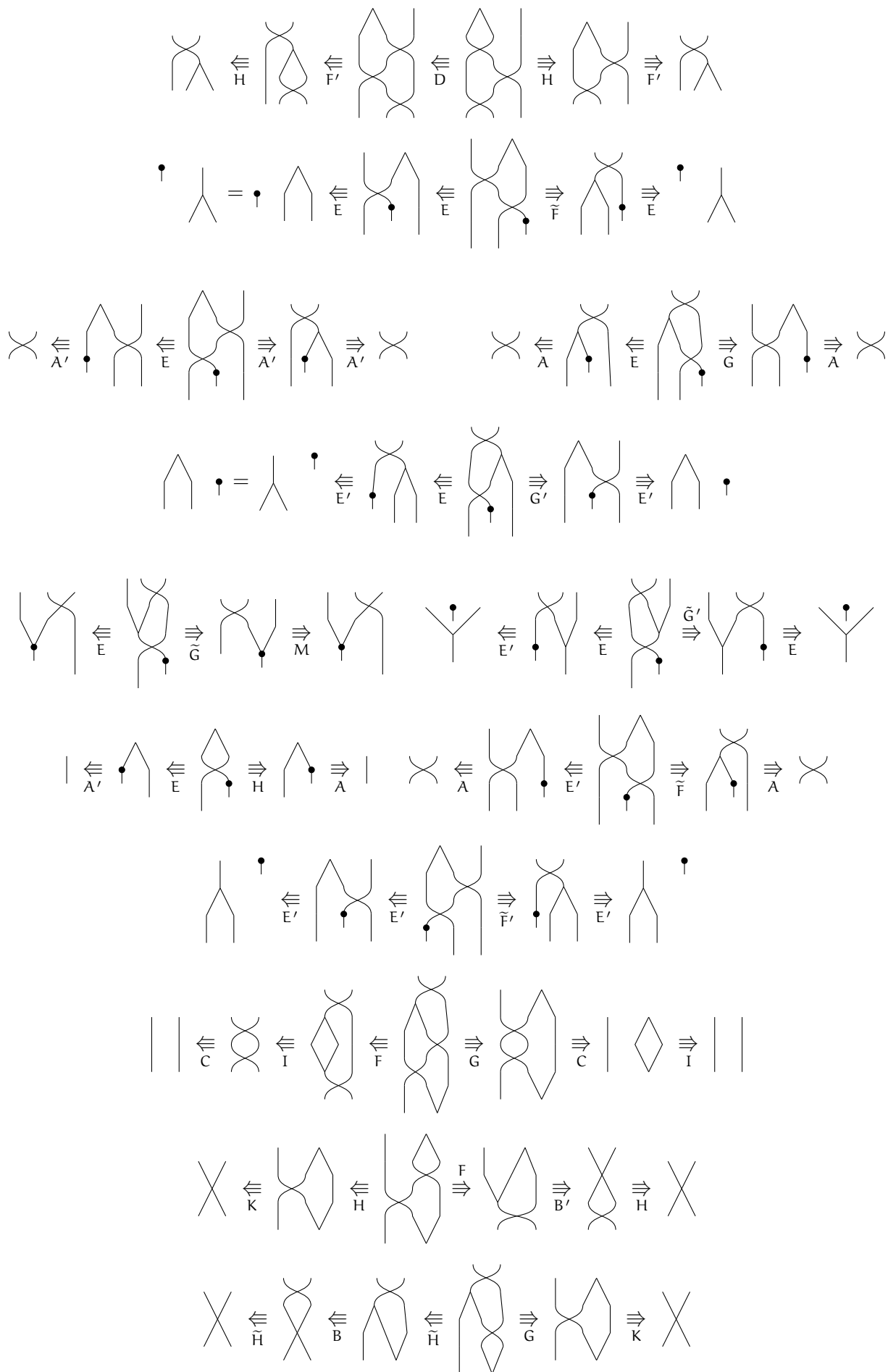





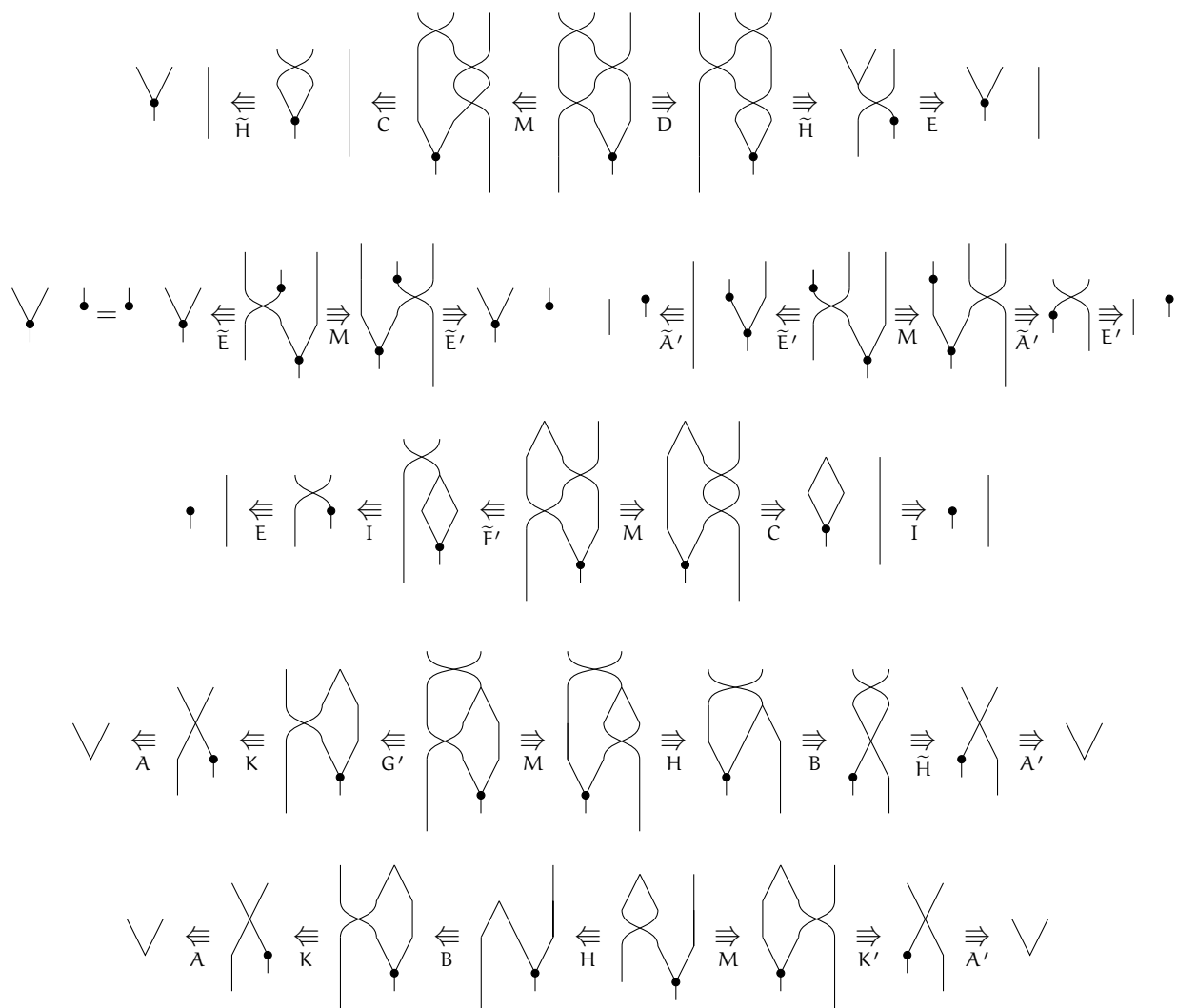

## A.2. CRITICAL BRANCHINGS FOR THE KLR ALGEBRAS

In this section, we will draw all the diagram corresponding to the given list of critical branchings for the linear  $(3, 2)$ -polygraph KLR.

### Crossings with two dots:

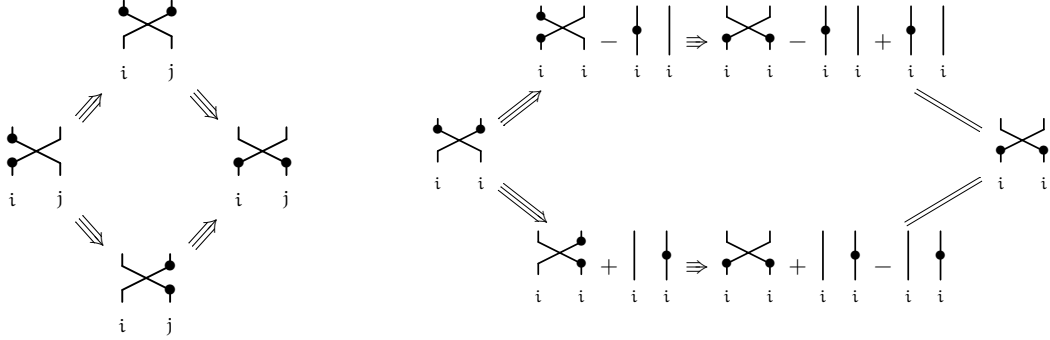

### Triple crossings:

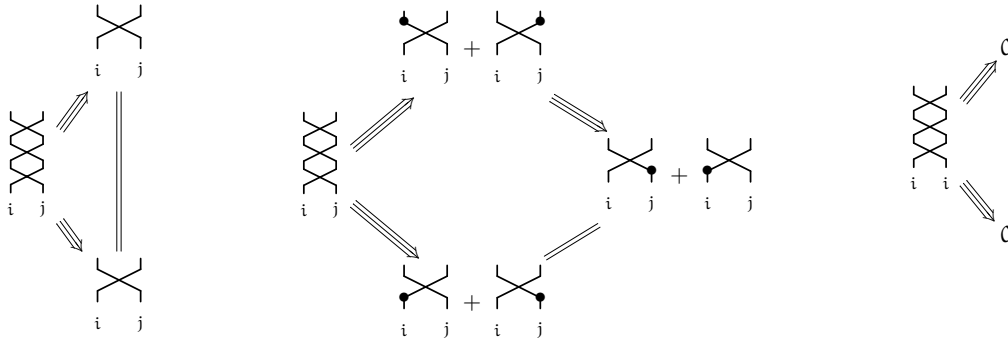

respectively when  $i \cdot j = 0$ ,  $i \cdot j = -1$  and  $i \neq j$ .

### Double crossings with dots:

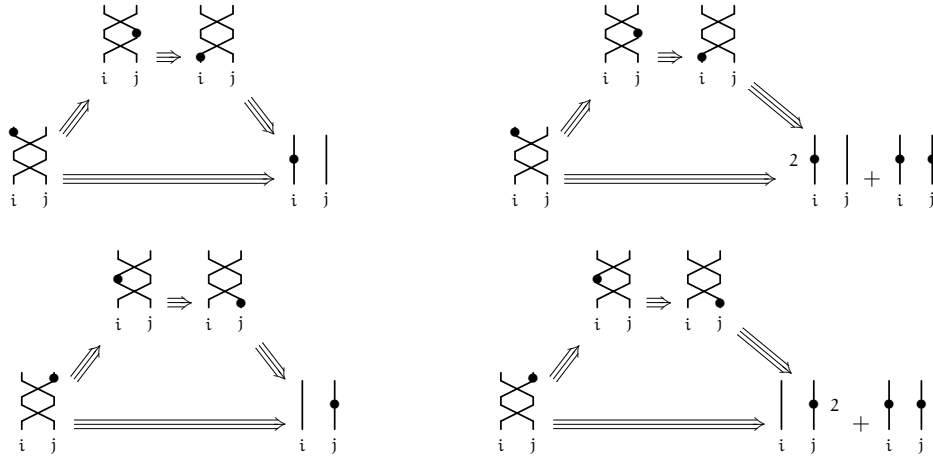

when  $i \neq j$  and  $i \cdot j = 0$  or  $i \cdot j = -1$  respectively. When  $i = j$ , we have the following situation:



**Double braid relation:** The form of this critical branching depends on the labels on the three strands and the value of the bilinear form  $\cdot$  between them.

- i) First of all, we consider the case where two consecutive vertices are equal: for instance  $i = j \neq k$ . The other cases would provide the same discussion.

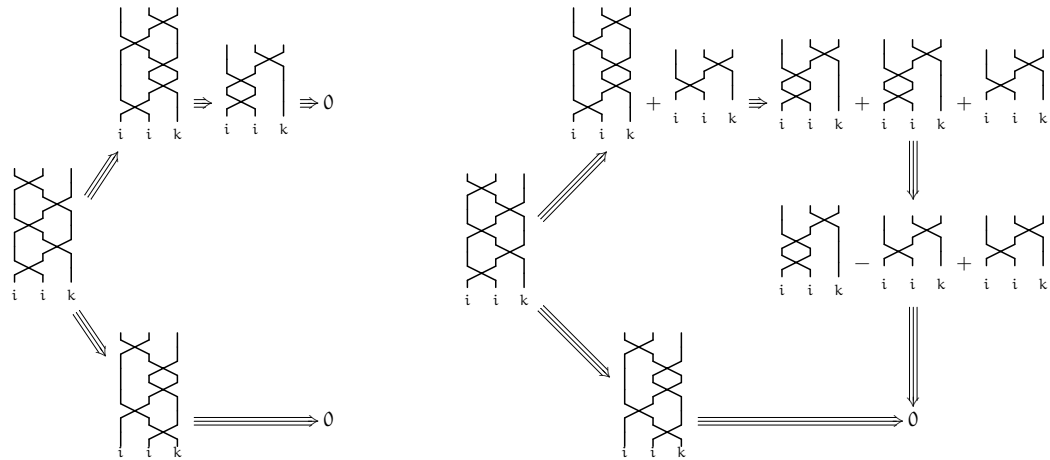

when  $i \cdot k = 0$  and  $i \cdot k = -1$  respectively.

- ii) When three vertices are distinct: we have to distinguish 6 cases according to the values of  $i \cdot j$ ,  $j \cdot k$  and  $i \cdot k$ . We focus on the case  $i \cdot j = i \cdot k = j \cdot k = -1$ , the other forms are proved confluent similarly.

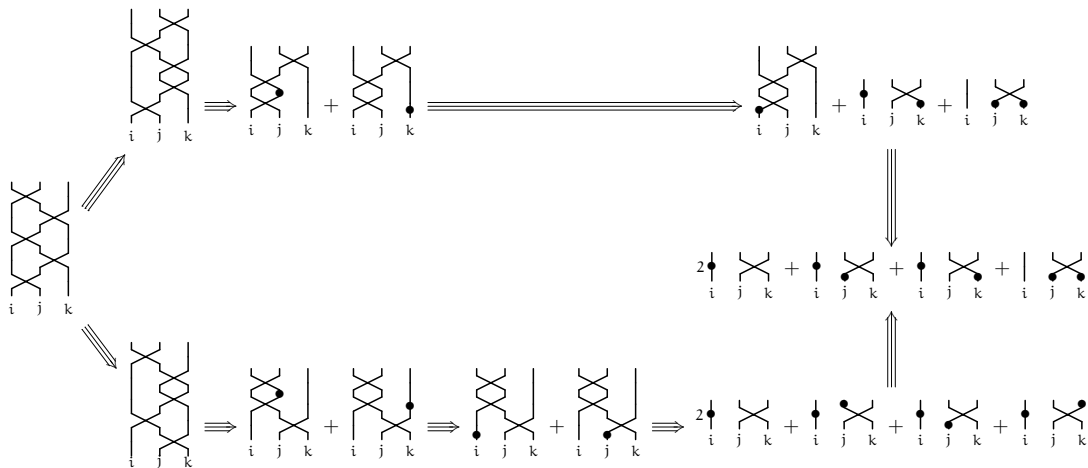

- iii) Let us consider the case  $i = k$ :

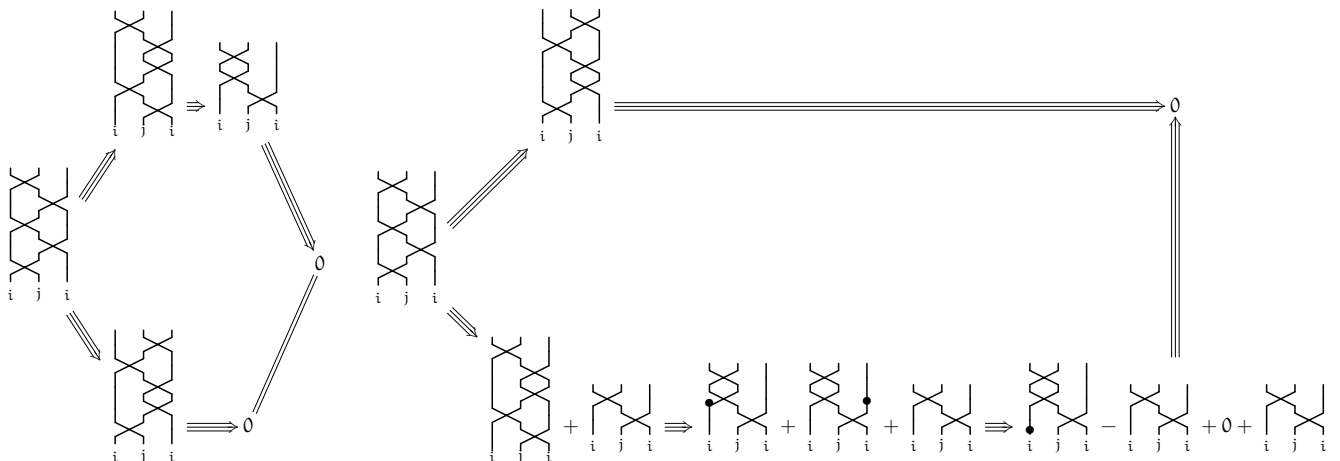

when  $i \cdot j = 0$  and  $i \cdot j = -1$  respectively.

**Braid relation and crossings:**

i) We treat at first the case when two consecutive vertices are equal. For instance if  $i = j$  or  $i = k$ , we have respectively:

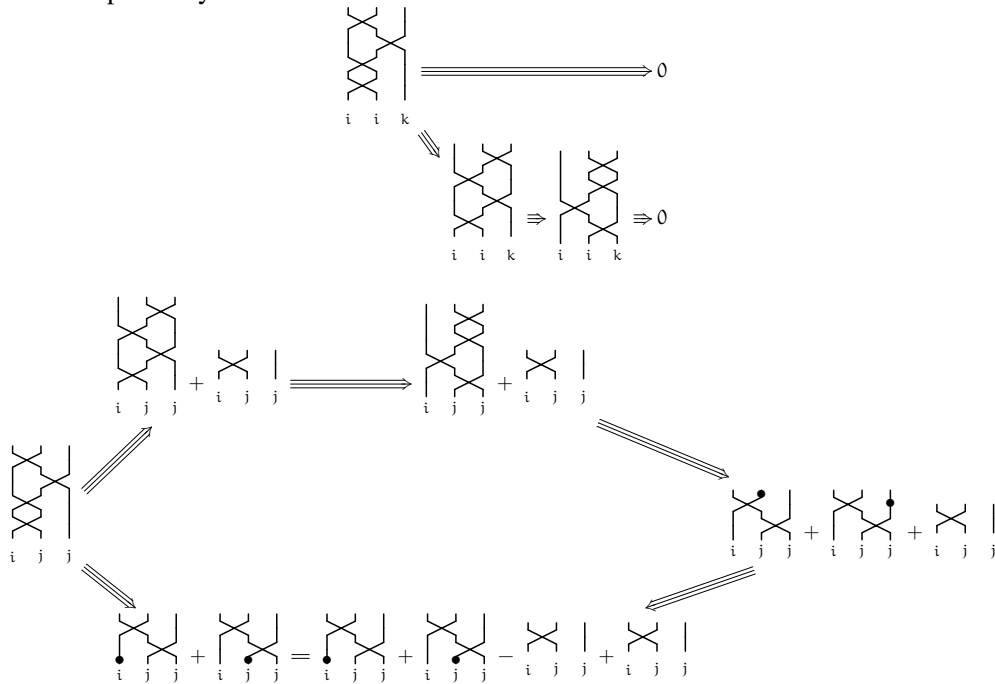

when  $i \cdot j = -1$ .

ii) We check the case where all the vertices are different: one can check that the critical branching only depends on the value of  $i \cdot k$ :

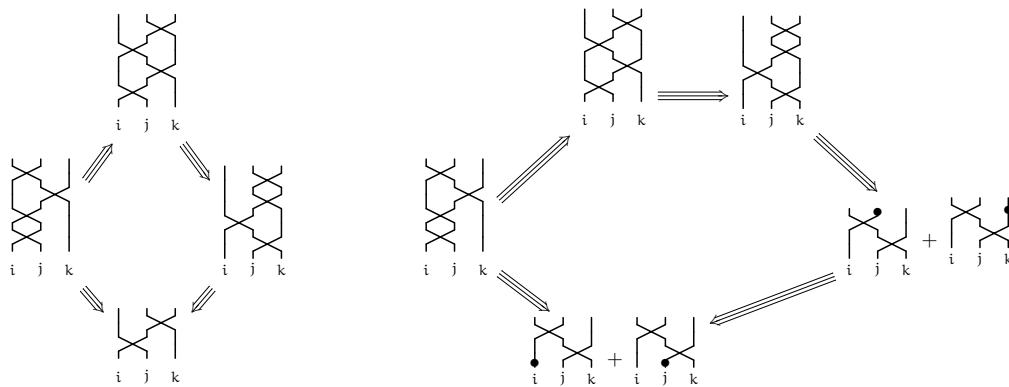

when  $i \cdot k = 0$  and  $i \cdot k = -1$  respectively.

iii) When the bottom sequence is  $iji$ , we focus on the case  $i \cdot j = -1$  and the other case would be similar:

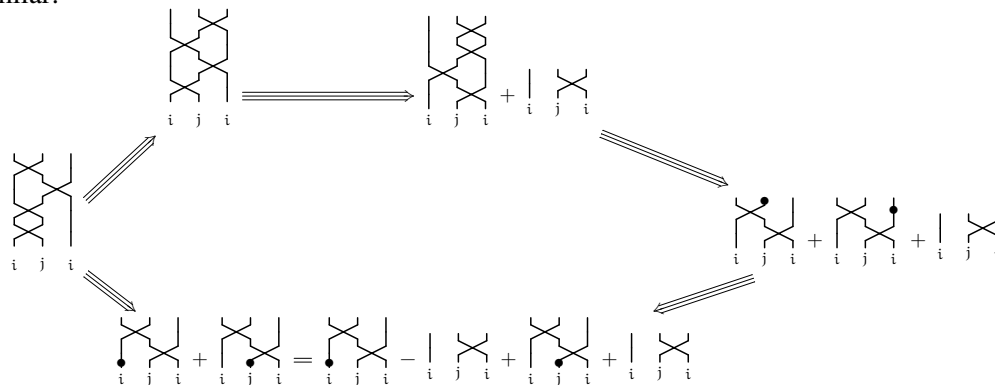

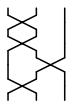
We study the confluence diagrams of all the forms of the branching  in the same way.

**Braid relation + dots :**

- i) When the three vertices are distinct, the diagrams do not depend on the values of the bilinear pairing.

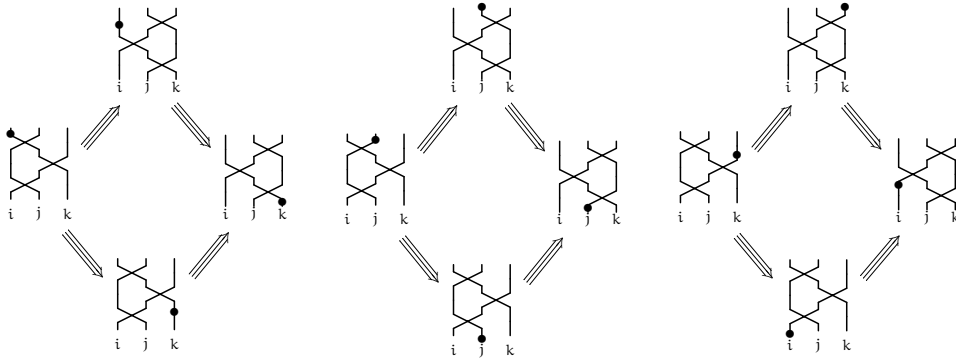

- ii) When two consecutive vertices are equal, for instance if  $i = j \neq k$ , if a dot is placed on the left strand, then it will go down in the diagram without creating any additive term because there will be no crossing with two strands with the same label, so that the branching is trivially confluent. For the other cases, the same process applies. Let us prove the confluence when there is a dot on the rightmost strand:

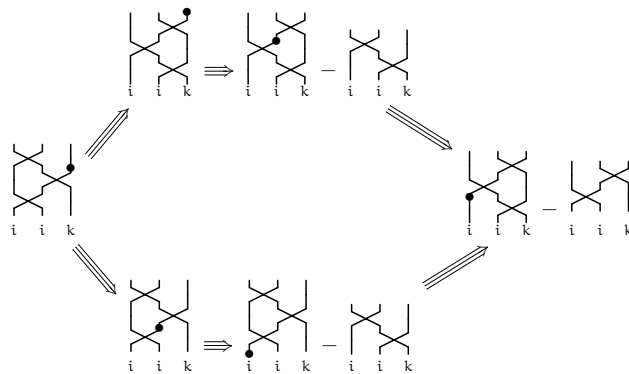

One may apply the same process for the case  $i \neq j = k$  with a dot placed on the top of the leftmost (or middle) strand.

- iii) When the bottom sequence is  $iji$ , the way to make a dot go down is the same no matter where the dot is placed at the beginning, we only check confluence for a dot placed on the leftmost strand. It would provide the same diagram for the other cases.

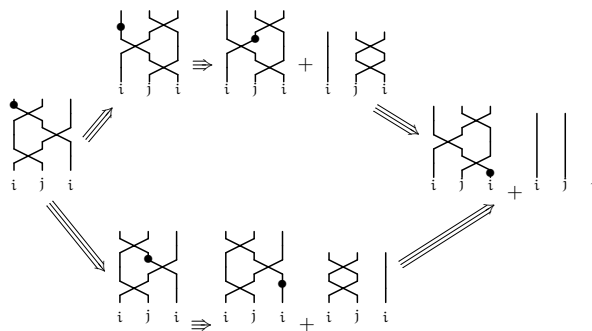

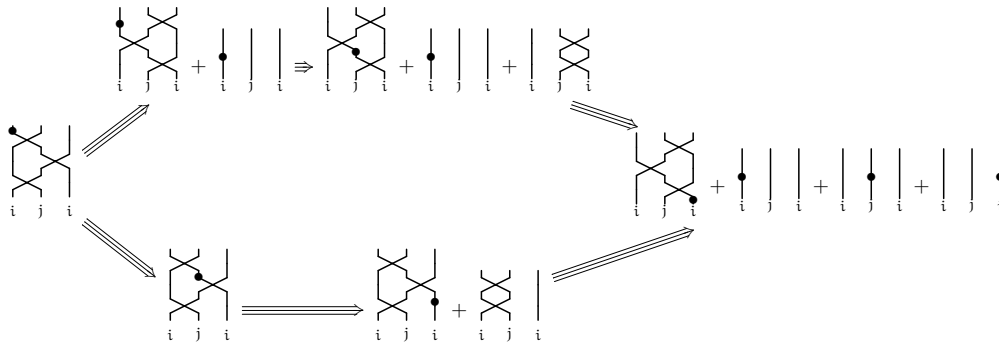

when  $i \cdot j = 0$  and  $i \cdot j = -1$  respectively.

**Indexed critical branchings :** Let us prove that the indexed critical branchings of the form (6.6) given in Section 6.1.8 are confluent, in the following two cases: plug in (6.6) is given by the following 2-cells:

i)  $\begin{array}{c} | \\ \bullet \\ | \\ i \end{array}^n$  for every  $n \in \mathbb{N}$ ,

ii)  $\begin{array}{c} \diagup \quad \diagdown \\ \bullet \\ \diagdown \quad \diagup \\ i \quad l \end{array}^n$  for all  $n \in \mathbb{N}$  and for any  $l$  in  $I$ .

For the first case, the instance for  $n = 0$  was already checked in the Double Yang-Baxter family of critical branchings. Let us prove the confluence of this indexed critical branchings in the particular case when  $i = k$  and  $i \cdot j = -1$ . This is the "most complicated" case in the sense that it is the one that creates the most additive terms.

Let us denote by  $\alpha_{i,j}^{L,n}$  and  $\alpha_{i,j}^{R,n}$  the 3-cells

$$\alpha_{i,j}^{L,n} = \underbrace{\alpha_{i,j}^L * \alpha_{i,j}^L \cdots * \alpha_{i,j}^L}_{n \text{ times}} \quad (\text{resp. } \alpha_{i,j}^{R,n} = \underbrace{\alpha_{i,j}^R * \alpha_{i,j}^R \cdots * \alpha_{i,j}^R}_{n \text{ times}})$$

depicted by

$$\begin{array}{c} \bullet \\ \diagdown \quad \diagup \\ i \quad j \end{array}^n \xrightarrow{\alpha_{i,j}^{L,n}} \begin{array}{c} \diagup \quad \diagdown \\ \bullet \\ i \quad j \end{array}^n, \quad \begin{array}{c} \bullet \\ \diagdown \quad \diagup \\ i \quad i \end{array}^n \xrightarrow{\alpha_{i,i}^{L,n}} \begin{array}{c} \diagup \quad \diagdown \\ \bullet \\ i \quad i \end{array}^n + \sum_{a+b=n-1} \begin{array}{c} | \\ \bullet \\ | \\ i \end{array}^a \begin{array}{c} | \\ \bullet \\ | \\ i \end{array}^b,$$

$$\begin{array}{c} \diagup \quad \diagdown \\ \bullet \\ i \quad j \end{array}^n \xrightarrow{\alpha_{i,j}^{R,n}} \begin{array}{c} \diagdown \quad \diagup \\ \bullet \\ i \quad j \end{array}^n, \quad \begin{array}{c} \diagdown \quad \diagup \\ \bullet \\ i \quad i \end{array}^n \xrightarrow{\alpha_{i,i}^{R,n}} \begin{array}{c} \diagdown \quad \diagup \\ \bullet \\ i \quad i \end{array}^n - \sum_{a+b=n-1} \begin{array}{c} | \\ \bullet \\ | \\ i \end{array}^a \begin{array}{c} | \\ \bullet \\ | \\ i \end{array}^b.$$

Thus, we have:

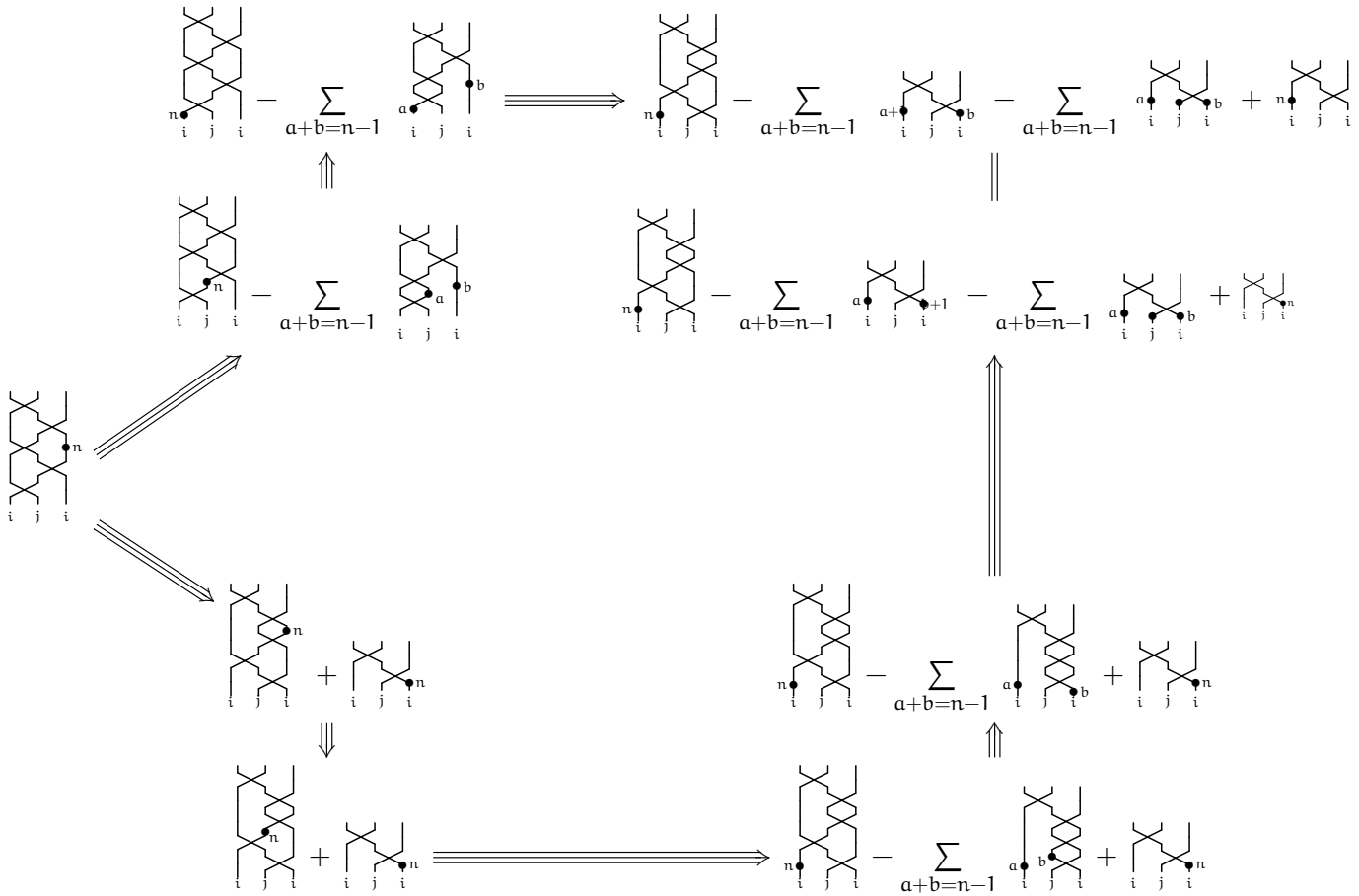

For the second indexation, one remarks that the fourth vertex of the sequences does not matter in the reductions. We consider the case where the bottom sequence is  $ijk$  with  $i \cdot j = 0$ . Let us at first consider this indexation for  $n = 0$ :

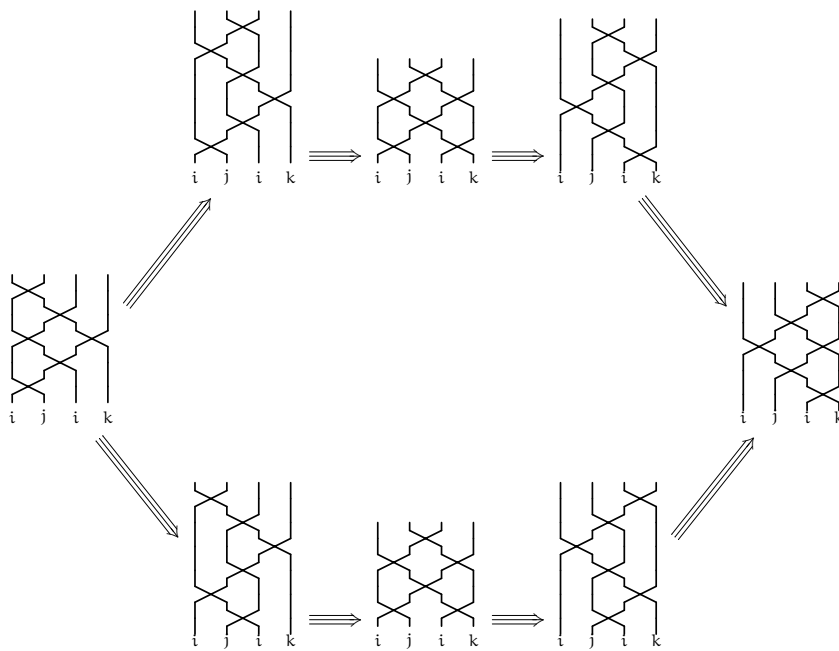

This diagram was given in [51] for the indexation of  $\times$  in the double Yang-Baxter diagram. When  $i \cdot j = -1$ , it is the same branching except that it creates an extra term



in both reducing paths. For  $n > 0$ , the bottom line of (A.1) defines a 3-cell

$$\gamma_{ijk} : \begin{array}{c} \text{Diagram 1} \\ \text{---} \\ \text{Diagram 2} \end{array} \Rightarrow \cdot$$

As we started reducing only the bottom part on the diagram, we can apply the same reductions on the diagram

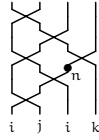

since the dot 2-cell never appears in the source of any reduction. This enables us to define, for any  $n \in \mathbb{N}$ , a 3-cell

$$\gamma_n : \begin{array}{c} \text{Diagram 1} \\ \text{---} \\ \text{Diagram 2} \end{array} \Rightarrow \begin{array}{c} \text{Diagram 3} \\ \text{---} \\ \text{Diagram 4} \end{array} + \begin{array}{c} \text{Diagram 5} \\ \text{---} \\ \text{Diagram 6} \end{array}$$

Then we have:

$$\begin{array}{c} \begin{array}{c} \text{Diagram 1} \\ \text{---} \\ \text{Diagram 2} \end{array} \\ \Downarrow \\ \begin{array}{c} \text{Diagram 1} \\ \text{---} \\ \sum_{a+b=n-1} \text{Diagram 3} \\ \Downarrow \\ \text{Diagram 4} \\ \text{---} \\ \sum_{a+b=n-1} \text{Diagram 5} \\ \Downarrow \\ \begin{array}{c} \text{Diagram 6} \\ \text{---} \\ \sum_{a+b=n-1} \text{Diagram 7} \\ \text{---} \\ \sum_{a+b=n-1} \text{Diagram 8} \\ \Downarrow \\ \begin{array}{c} \text{Diagram 9} \\ \text{---} \\ \text{Diagram 10} \end{array} \end{array} \end{array} \begin{array}{c} \Downarrow \\ \text{Diagram 11} \\ \text{---} \\ \text{Diagram 12} \\ \text{---} \\ \text{Diagram 13} \\ \text{---} \\ \sum_{a+b=n-1} \text{Diagram 14} \\ \Downarrow \\ \begin{array}{c} \text{Diagram 15} \\ \text{---} \\ \text{Diagram 16} \\ \text{---} \\ \sum_{a+b=n-1} \text{Diagram 17} \\ \Downarrow \\ \begin{array}{c} \text{Diagram 18} \\ \text{---} \\ \text{Diagram 19} \end{array} \end{array} \end{array}$$



### A.3. CRITICAL BRANCHINGS MODULO FOR THE KLR 2-CATEGORY

**A.3.1. Further 3-cells in  $\mathcal{KLR}$ .** In this subsection, we define some additional 3-cells in  $\mathcal{KLR}_3$ , which we will use to prove the confluence modulo of the linear  $(3, 2)$ -polygraph modulo  ${}_{\mathbb{E}}\mathcal{R}$ . First of all, using the degree conditions on bubbles on the terms

$$\sum_{r \geq 0} n-r-2 \cdot \text{bubble}(i, \lambda, n, r) ; \quad (\text{resp. } \sum_{r \geq 0} \lambda \cdot \text{bubble}(i, \lambda, n, r-2) ),$$

when  $r > -\langle h_i, \lambda \rangle - 1$  (resp.  $r \leq \langle h_i, \lambda \rangle - 1$ ), then  $n-r-2 < -\langle h_i, \lambda \rangle - 1$  (resp.  $n-r-2 < \langle h_i, \lambda \rangle - 1$ ) and then the bubble reduces to 0. We then denote by  $b'_{i,\lambda}$  and  $c'_{i,\lambda}$  the following 3-cells in KLR obtained by application of the 3-cells  $b^0_{i,\lambda}$  and  $c^0_{i,\lambda}$ :

$$\sum_{r \geq 0} n-r-2 \cdot \text{bubble}(i, \lambda, n, r) \xrightarrow{b'_{i,\lambda}} \sum_{r=0}^{-\langle h_i, \lambda \rangle - 1} n-r-2 \cdot \text{bubble}(i, \lambda, n, r) ; \quad \sum_{r \geq 0} \lambda \cdot \text{bubble}(i, \lambda, n, r-2) \xrightarrow{c'_{i,\lambda}} \sum_{r=0}^{\langle h_i, \lambda \rangle - 1} \lambda \cdot \text{bubble}(i, \lambda, n, r-2)$$

We also define the 3-cell  $A'_{i,\lambda}$  for  $\langle h_i, \lambda \rangle \geq 0$  having as 2-source



and as 2-target either 0 if  $n < \langle h_i, \lambda \rangle$  or  $-\text{bubble}(i, \lambda)$  if  $n = \langle h_i, \lambda \rangle$  as the following composite of rewriting steps in  ${}_{\mathbb{E}}\mathcal{R}$ :

$$\text{crossing}(i, n, \lambda) \xrightarrow{(i_3^2)^- \cdot \alpha_{i,\lambda}^{R,+}} \text{bubble}(i, \lambda, n) - \sum_{a+b=n-1} \text{bubble}(i, \lambda, a) \xrightarrow{(i_1^2)^- \cdot A_{i,\lambda}} 0 - \sum_{a+b=n-1} \text{bubble}(i, \lambda, a) \xrightarrow{b_{i,\lambda}} -\delta_{n, \langle h_i, \lambda \rangle} \text{bubble}(i, \lambda)$$

where:

- the 3-cell  $(i_3^2)^- \cdot \alpha_{i,\lambda}^{R,+}$  is the rewriting step of  ${}_{\mathbb{E}}\mathcal{R}$  given by

$$\text{crossing}(i, n, \lambda) = \text{bubble}(i, \lambda, n) \sim \text{crossing}(i, n, \lambda) \xrightarrow{\alpha_{i,\lambda}^{R,+}} \text{crossing}(i, n, \lambda) - \sum_{a+b=n-1} \text{bubble}(i, \lambda, a)$$

- the 3-cell  $b_{i,\lambda}$  is defined by successive applications of the cells  $b^0_{i,\lambda}$  since  $\text{bubble}(i, \lambda)$  reduces to 0 unless  $n = \langle h_i, \lambda \rangle$  and  $a = 0, b = \langle h_i, \lambda \rangle - 1$ , and in that case  $\text{bubble}(i, \lambda)$  reduces to  $1_{i,\lambda}$  by  $b^1_{i,\lambda}$ .

We define in a similar fashion 3-cells

$$\text{crossing}(i, n, \lambda) \xrightarrow{B'_{i,\lambda}} \begin{cases} -\text{bubble}(i, \lambda) & \text{if } n = \langle h_i, \lambda \rangle \\ 0 & \text{if } n < \langle h_i, \lambda \rangle \end{cases} ; \quad \text{crossing}(i, n, \lambda) \xrightarrow{C'_{i,\lambda}} \begin{cases} \text{bubble}(i, \lambda) & \text{if } n = -\langle h_i, \lambda \rangle \\ 0 & \text{if } n < -\langle h_i, \lambda \rangle \end{cases} ; \quad \text{crossing}(i, n, \lambda) \xrightarrow{D'_{i,\lambda}} \begin{cases} \text{bubble}(i, \lambda) & \text{if } n = -\langle h_i, \lambda \rangle \\ 0 & \text{if } n < -\langle h_i, \lambda \rangle \end{cases}$$

for  $\langle h_i, \lambda \rangle \geq 0$  for  $B'_{i,\lambda}$  and  $\langle h_i, \lambda \rangle \leq 0$  for  $C'_{i,\lambda}$  and  $D'_{i,\lambda}$ .

### Branchings from KLR relations

**A.3.2. Critical branchings**  $(A_{i,\lambda}, \alpha_{i,\lambda}^{L,+})$ . For any  $i$  in  $I$  and  $\lambda$  in  $X$  the weight lattice, and for any value of  $\langle h_i, \lambda \rangle$ , the critical branchings  $(A_{i,\lambda}, \alpha_{i,\lambda}^{L,+})$  are confluent modulo  $E$  as follows:

$$\begin{array}{ccc}
 \begin{array}{c} \text{Diagram 1} \\ \Downarrow \parallel \\ \text{Diagram 2} \end{array} & \xrightarrow{A_{i,\lambda}} & - \sum_{n=0}^{-\langle h_i, \lambda \rangle} \begin{array}{c} \text{Diagram 3} \\ \Downarrow (i_1^2)^- \\ \text{Diagram 4} \end{array} \\
 \begin{array}{c} \text{Diagram 2} \\ \xrightarrow{\alpha_{i,\lambda}^{L,+}} \text{Diagram 5} + \text{Diagram 6} \\ \xrightarrow{i_2^2 * 2(i_3^2)^- \cdot \alpha_{i,\lambda}^{R,+}} \text{Diagram 7} \\ \xrightarrow{(i_1^2)^- \cdot A_{i,\lambda}} \text{Diagram 8} \end{array} & & - \sum_{n=0}^{-\langle h_i, \lambda \rangle} \begin{array}{c} \text{Diagram 4} \end{array}
 \end{array}$$

**A.3.3. Critical branchings**  $(B_{i,\lambda}, i_4^2 \cdot \alpha_{i,\lambda}^{L,+})$ .

$$\begin{array}{ccc}
 \begin{array}{c} \text{Diagram 1} \\ \Downarrow \parallel \\ \text{Diagram 2} \end{array} & \xrightarrow{B_{i,\lambda}} & - \sum_{n=0}^{-\langle h_i, \lambda \rangle} \begin{array}{c} \text{Diagram 3} \\ \Downarrow i_4^2 \\ \text{Diagram 4} \end{array} \\
 \begin{array}{c} \text{Diagram 2} \\ \xrightarrow{i_4^2 \cdot \alpha_{i,\lambda}^{L,+}} \text{Diagram 5} + \text{Diagram 6} \\ \xrightarrow{i_2^2 * 2(i_3^2)^- \cdot \alpha_{i,\lambda}^{R,+}} \text{Diagram 7} \\ \xrightarrow{B_{i,\lambda}} \text{Diagram 8} \end{array} & & - \sum_{n=0}^{-\langle h_i, \lambda \rangle} \begin{array}{c} \text{Diagram 4} \end{array}
 \end{array}$$

**A.3.4. Critical branchings**  $(i_3^2 \cdot C_{i,\lambda}, \alpha_{i,\lambda}^{R,+})$ .

$$\begin{array}{ccc}
 \begin{array}{c} \text{Diagram 1} \\ \Downarrow \parallel \\ \text{Diagram 2} \end{array} & \xrightarrow{i_3^2 \cdot C_{i,\lambda}} & \sum_{n=0}^{\langle h_i, \lambda \rangle} \lambda \begin{array}{c} \text{Diagram 3} \\ \Downarrow (i_3^2)^- \\ \text{Diagram 4} \end{array} \\
 \begin{array}{c} \text{Diagram 2} \\ \xrightarrow{\alpha_{i,\lambda}^{R,+}} \text{Diagram 5} - \text{Diagram 6} \\ \xrightarrow{(i_1^2)^- * 2i_4^2 \cdot \alpha_{i,\lambda}^{L,+}} \text{Diagram 7} \\ \xrightarrow{C_{i,\lambda}} \text{Diagram 8} \end{array} & & \sum_{n=0}^{\langle h_i, \lambda \rangle} \lambda \begin{array}{c} \text{Diagram 4} \end{array}
 \end{array}$$

**A.3.5. Critical branchings**  $(D_{i,\lambda}, \alpha_{i,\lambda}^{R,+})$ .

$$\begin{array}{ccc}
 \begin{array}{c} \text{Diagram 1} \\ \Downarrow \parallel \\ \text{Diagram 2} \end{array} & \xrightarrow{D_{i,\lambda}} & \sum_{n=0}^{\langle h_i, \lambda \rangle} \lambda \begin{array}{c} \text{Diagram 3} \\ \Downarrow (i_2^2)^- \\ \text{Diagram 4} \end{array} \\
 \begin{array}{c} \text{Diagram 2} \\ \xrightarrow{\alpha_{i,\lambda}^{R,+}} \text{Diagram 5} - \lambda \begin{array}{c} \text{Diagram 6} \\ \Downarrow (i_1^2)^- * 2i_4^2 \cdot \alpha_{i,\lambda}^{L,+} \\ \text{Diagram 7} \end{array} \\ \xrightarrow{D_{i,\lambda}} \text{Diagram 8} \end{array} & & \sum_{n=0}^{\langle h_i, \lambda \rangle} \lambda \begin{array}{c} \text{Diagram 4} \end{array}
 \end{array}$$

**A.3.6. Critical branchings**  $(E_{i,\lambda}, \alpha_{i,\lambda}^{L,+})$  **and**  $(F_{i,\lambda}, \alpha_{i,\lambda}^{R,+})$ . Let us prove that for any  $i$  in  $I$  and  $\lambda$  in  $X$ , and for any value of  $\langle h_i, \lambda \rangle$ , the critical branching  $(E_{i,\lambda}, \alpha_{i,\lambda}^{L,+})$  is confluent modulo  $E$ . The proof of confluence modulo of this branching follows the proof scheme of Lemma 6.2.10, and we prove the confluence of the critical branching  $(F_{i,\lambda}, \alpha_{i,\lambda}^{L,+})$  similarly. Let us denote by  $\alpha_i$  the following composition of 3-cells of  $\mathcal{E}R$ :

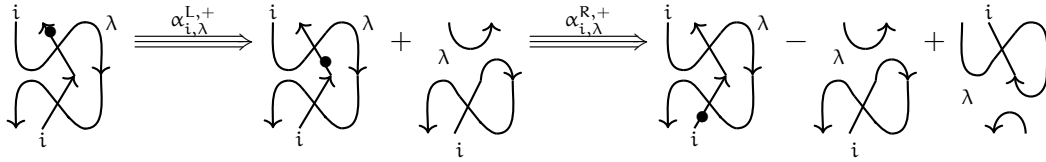

i) For  $\langle h_i, \lambda \rangle > 0$ ,

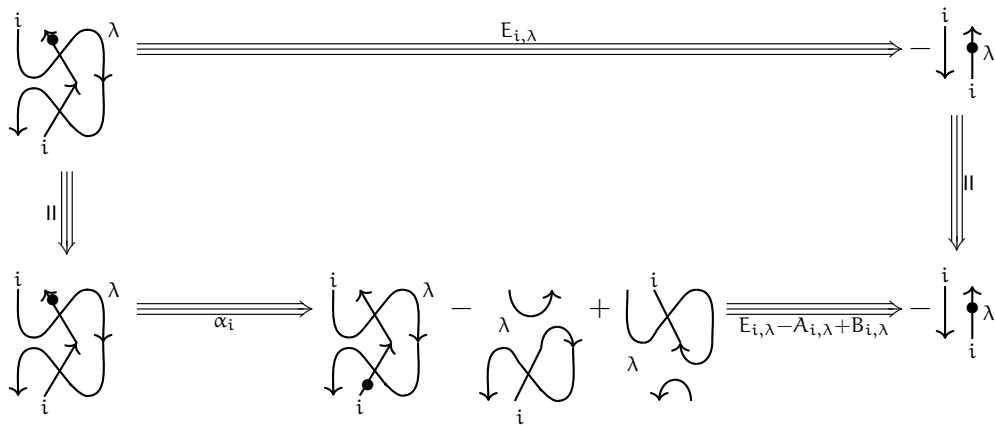

using that for  $\langle h_i, \lambda \rangle > 0$ ,  $A_{i,\lambda}$  and  $B_{i,\lambda}$  admit 0 as 2-target, and where the 3-cell  $E_{i,\lambda} - A_{i,\lambda} + B_{i,\lambda}$  is actually a composite of three rewriting steps of  $\mathcal{E}R$ .

ii) For  $\langle h_i, \lambda \rangle = 0$ , the 2-cells

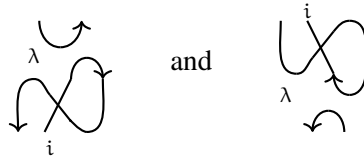

both rewrites with respect to  $\mathcal{E}R$  into

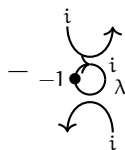

so that the 2-target of the 3-cell  $E_{i,\lambda} - A_{i,\lambda} + B_{i,\lambda}$  is unchanged, which proves the confluence of the branching.

iii) For  $\langle h_i, \lambda \rangle < 0$ ,

$$\begin{array}{ccc}
 \begin{array}{c} i \\ \downarrow \\ \text{Diagram} \\ \downarrow \\ i \end{array} \xrightarrow{E_{i,\lambda}} \begin{array}{c} i \\ \downarrow \\ \text{Diagram} \\ \downarrow \\ i \end{array} + \sum_{n=0}^{-\langle h_i, \lambda \rangle - 1} \sum_{r \geq 0} -n-r-2 \begin{array}{c} i \\ \uparrow \\ \text{Diagram} \\ \downarrow \\ i \end{array} \xrightarrow{b'_{i,\lambda}} \begin{array}{c} i \\ \downarrow \\ \text{Diagram} \\ \downarrow \\ i \end{array} + \sum_{n=0}^{-\langle h_i, \lambda \rangle - 1} \sum_{r=0}^{-\langle h_i, \lambda \rangle} -n-r-2 \begin{array}{c} i \\ \uparrow \\ \text{Diagram} \\ \downarrow \\ i \end{array} \\
 \parallel \qquad \qquad \qquad \parallel \\
 \begin{array}{c} i \\ \downarrow \\ \text{Diagram} \\ \downarrow \\ i \end{array} \xrightarrow{\alpha_i} \begin{array}{c} i \\ \downarrow \\ \text{Diagram} \\ \downarrow \\ i \end{array} - \begin{array}{c} i \\ \downarrow \\ \text{Diagram} \\ \downarrow \\ i \end{array} + \begin{array}{c} i \\ \downarrow \\ \text{Diagram} \\ \downarrow \\ i \end{array} \xrightarrow{\gamma} \begin{array}{c} i \\ \downarrow \\ \text{Diagram} \\ \downarrow \\ i \end{array} + \sum_{n=1}^{-\langle h_i, \lambda \rangle} \sum_{r=0}^{-\langle h_i, \lambda \rangle} -n-r-1 \begin{array}{c} i \\ \uparrow \\ \text{Diagram} \\ \downarrow \\ i \end{array}
 \end{array}$$

where the 3-cell  $\gamma$  is defined as the following composite of 3-cells of  $(\mathbb{E}R)_3^\ell$ :

$$\begin{array}{l}
 \begin{array}{c} i \\ \downarrow \\ \text{Diagram} \\ \downarrow \\ i \end{array} - \begin{array}{c} i \\ \downarrow \\ \text{Diagram} \\ \downarrow \\ i \end{array} + \begin{array}{c} i \\ \downarrow \\ \text{Diagram} \\ \downarrow \\ i \end{array} \xrightarrow{E_{i,\lambda} - A_{i,\lambda} + B_{i,\lambda}} \sum_{n=0}^{-\langle h_i, \lambda \rangle - 1} \sum_{r \geq 0} -n-r-2 \begin{array}{c} i \\ \uparrow \\ \text{Diagram} \\ \downarrow \\ i \end{array} - \sum_{n=0}^{-\langle h_i, \lambda \rangle} -n-1 \begin{array}{c} i \\ \uparrow \\ \text{Diagram} \\ \downarrow \\ i \end{array} + \sum_{n=0}^{-\langle h_i, \lambda \rangle} -n-1 \begin{array}{c} i \\ \uparrow \\ \text{Diagram} \\ \downarrow \\ i \end{array} \\
 \xrightarrow{b'_{i,\lambda}} \sum_{n=0}^{-\langle h_i, \lambda \rangle - 1} \sum_{r=0}^{-\langle h_i, \lambda \rangle - 1} -n-r-2 \begin{array}{c} i \\ \uparrow \\ \text{Diagram} \\ \downarrow \\ i \end{array} - \sum_{n=0}^{-\langle h_i, \lambda \rangle} -n-1 \begin{array}{c} i \\ \uparrow \\ \text{Diagram} \\ \downarrow \\ i \end{array} + \sum_{n=0}^{-\langle h_i, \lambda \rangle} -n-1 \begin{array}{c} i \\ \uparrow \\ \text{Diagram} \\ \downarrow \\ i \end{array} \\
 = \sum_{n=0}^{-\langle h_i, \lambda \rangle - 1} \sum_{r=-1}^{-\langle h_i, \lambda \rangle - 1} -n-r-2 \begin{array}{c} i \\ \uparrow \\ \text{Diagram} \\ \downarrow \\ i \end{array} - \sum_{n=0}^{-\langle h_i, \lambda \rangle} -n-1 \begin{array}{c} i \\ \uparrow \\ \text{Diagram} \\ \downarrow \\ i \end{array} + \sum_{n=0}^{-\langle h_i, \lambda \rangle} -n-1 \begin{array}{c} i \\ \uparrow \\ \text{Diagram} \\ \downarrow \\ i \end{array} \\
 = \sum_{n=1}^{-\langle h_i, \lambda \rangle} \sum_{r=0}^{-\langle h_i, \lambda \rangle} -n-r-1 \begin{array}{c} i \\ \uparrow \\ \text{Diagram} \\ \downarrow \\ i \end{array}
 \end{array}$$

where the equalities are obtained from the linear structure using reindexations of sums.

### A.3.7. Critical branchings $(\beta_{i,j}^{\lambda,+}, (i_1^0 \star_2 i_4^0)^- \cdot F_{i,j,\lambda})$ .

i) First of all, let us consider the case where  $i = j$ , and thus the source of this branching rewrites to 0 using  $\beta_{i,\lambda^+}$ . The other side of this critical branching is given by the following scheme of rewritings

with respect to  $\mathbb{E}R$ :

$$\begin{aligned}
 & \text{Diagram with two crossings} \xrightarrow{F_{i,\lambda}} -\uparrow_i^\lambda \circlearrowleft_i + \sum_{n=0}^{\langle h_i, \lambda \rangle - 1} \sum_{r \geq 0} -n-r-2 \text{Diagram with crossings} \\
 & \xrightarrow{b'_{i,\lambda}} -\uparrow_i^\lambda \circlearrowleft_i + \sum_{n=0}^{\langle h_i, \lambda \rangle - 1} \sum_{r=0}^{\langle h_i, \lambda \rangle - 1} -n-r-2 \text{Diagram with crossings} \\
 & \equiv_{\mathbb{E}} -\uparrow_i^\lambda \circlearrowleft_i + \sum_{n=0}^{\langle h_i, \lambda \rangle - 1} \sum_{r=0}^{\langle h_i, \lambda \rangle - 1} -n-r-2 \text{Diagram with crossings}
 \end{aligned}$$

Each summand in the above sum rewrites using the bubble slide 3-cells as follows:

$$-n-r-2 \text{Diagram} \xrightarrow{s_{i,\lambda}^-} n+r+2 \text{Diagram} - 2 n+r+1 \text{Diagram} + n+r \text{Diagram}$$

and we easily check that the above sums are telescopic, so that it remains the 2-cell

$$\sum_{r=0}^{\langle h_i, \lambda \rangle - 1} \left[ \uparrow_i^r \circlearrowleft_i^{-r} - \uparrow_i^{r+1} \circlearrowleft_i^{-r-1} + \uparrow_i^{\langle h_i, \lambda \rangle + r + 1} \circlearrowleft_i^{-\langle h_i, \lambda \rangle - r - 1} - \uparrow_i^{\langle h_i, \lambda \rangle + r} \circlearrowleft_i^{-\langle h_i, \lambda \rangle - r} \right]$$

After simplification, it only remains

$$\uparrow_i^\lambda \circlearrowleft_i$$

and thus the starting diagram reduces to 0, and this critical branching is confluent modulo  $\mathbb{E}$ .

ii) Now, let us consider the case where  $i \neq j$  and  $i \cdot j = 0$ . Let us at first notice that in that case, we have the following rewriting step given by a bubble slide 3-cell:

$$\text{Diagram} \xrightarrow{\beta_{i,j,\lambda}^+} \text{Diagram} \xrightarrow{s_{i,\lambda}^-} \text{Diagram}$$

where  $\alpha = \langle h_i, \lambda + \alpha_j \rangle + 1$ . Hence, the decreasing confluence of this critical branching is given by the following diagram:

$$\begin{array}{ccc}
 \text{Diagram} & \xrightarrow{\beta_{i,j,\lambda}^+} & \text{Diagram} \xrightarrow{s_{i,\lambda}^-} \text{Diagram} \\
 \Downarrow & & \Downarrow \\
 \text{Diagram} & \xrightarrow{F_{i,j,\lambda}} & \text{Diagram}
 \end{array}$$

iii) Let us now consider the last case where  $i \neq j$  and  $i \cdot j = -1$ . In that case, we have the following rewriting step in  $\mathcal{E}\mathcal{R}$ :

$$\begin{array}{c} \text{Diagram 1} \\ \lambda \\ i \quad j \end{array} \xrightarrow{\beta_{i,j,\lambda}^+} \begin{array}{c} \text{Diagram 2} \\ \lambda \\ i \quad j \end{array} + \begin{array}{c} \text{Diagram 3} \\ \lambda \\ i \quad j \end{array}$$

Using the bubble slide 3-cells, the first summand (resp. the second summand) rewrites into

$$\sum_{f=0}^{\langle h_i, \lambda \rangle + 1} (-1)^f \begin{array}{c} \text{Diagram 4} \\ \lambda \\ i \end{array} \quad \left( \text{resp.} \quad \sum_{f=0}^{\langle h_i, \lambda \rangle + 1} (-1)^f \begin{array}{c} \text{Diagram 5} \\ \lambda \\ i \end{array} \right)$$

so that the sum is equal to

$$\begin{array}{c} \text{Diagram 6} \\ \lambda \\ i \end{array}$$

and this critical branching is confluent modulo  $\mathcal{E}$ .

**A.3.8. Critical branchings**  $(\alpha_{i,\lambda}^{R,+}, (i_1^0 \star_2 i_4^0)^- \star_2 i_3^2 \star_2 i_1^2 \cdot F_{i,j,\lambda})$ . When  $i \neq j$  and  $i \cdot j = 0$ :

$$\begin{array}{c} \text{Diagram 7} \\ \lambda \\ j \quad i \end{array} \xrightarrow{\gamma_{r,+}} \text{Diagram 8} \xrightarrow{\alpha_{i,j}^{R,+}} \begin{array}{c} \text{Diagram 9} \\ \lambda \\ j \quad i \end{array} \xrightarrow{s_{i,j,\lambda, -\langle h_i, \lambda + \alpha_j \rangle + 2}^-} \begin{array}{c} \text{Diagram 10} \\ \lambda \\ i \quad j \end{array} \\ \Downarrow i_1^0 \star_2 i_4^0 \\ \text{Diagram 11} \xrightarrow{F_{i,\lambda}} \begin{array}{c} \text{Diagram 12} \\ \lambda \\ i \quad j \end{array} \\ \Downarrow \parallel \end{array}$$

When  $i \cdot j = -1$ , we have

$$\begin{array}{c} \text{Diagram 13} \\ \lambda \\ j \quad i \end{array} \xrightarrow{\gamma_{r,+}} \text{Diagram 14} \xrightarrow{\alpha_{i,j}^{R,+}} \begin{array}{c} \text{Diagram 15} \\ \lambda \\ j \quad i \end{array} + \begin{array}{c} \text{Diagram 16} \\ \lambda \\ j \quad i \end{array} \\ \Downarrow i_1^0 \star_2 i_4^0 \\ \text{Diagram 17} \xrightarrow{F_{i,\lambda}} \begin{array}{c} \text{Diagram 18} \\ \lambda \\ i \quad j \end{array} \end{array}$$

Using the bubble slide 3-cells  $s_{i,j,\lambda, \langle h_i, \lambda \rangle + 1}^-$  and  $s_{i,j,\lambda, \langle h_i, \lambda \rangle + 2}^-$  respectively, we get that

$$\begin{array}{c} \text{Diagram 15} \\ \lambda \\ j \quad i \end{array} \xrightarrow{s_{i,j,\lambda, \langle h_i, \lambda \rangle + 1}^-} \sum_{f=0}^{\langle h_i, \lambda \rangle + 1} (-1)^f \begin{array}{c} \text{Diagram 19} \\ \lambda \\ j \quad i \end{array} \quad \text{and} \quad \begin{array}{c} \text{Diagram 16} \\ \lambda \\ j \quad i \end{array} \xrightarrow{s_{i,j,\lambda, \langle h_i, \lambda \rangle + 2}^-} \sum_{f=0}^{\langle h_i, \lambda \rangle + 2} (-1)^f \begin{array}{c} \text{Diagram 20} \\ \lambda \\ j \quad i \end{array}$$

and one then proves the confluence of this critical branchings modulo using reindexations of the sums.

In the case  $i = j$ , we get the following situation:

$$\begin{array}{c}
 \begin{array}{c} \text{Diagram 1} \\ \text{Diagram 2} \end{array} \xrightarrow{\gamma_{r,+}} \begin{array}{c} \text{Diagram 3} \\ \text{Diagram 4} \end{array} \xrightarrow{\beta_i^+ - (i_1^0)^- \cdot C_{i,\lambda}} \sum_{n=0}^{\langle h_i, \lambda \rangle} \begin{array}{c} \text{Diagram 5} \\ \text{Diagram 6} \end{array} \equiv_E \sum_{n=0}^{\langle h_i, \lambda \rangle} \begin{array}{c} \text{Diagram 7} \\ \text{Diagram 8} \end{array} \\
 \downarrow i_1^0 * 2 i_4^0 \\
 \begin{array}{c} \text{Diagram 9} \end{array} \xrightarrow{F_{i,\lambda}} \begin{array}{c} \text{Diagram 10} \\ \text{Diagram 11} \\ \text{Diagram 12} \end{array}
 \end{array}$$

Because of the degree conditions on bubbles 3-cells, the last summand in the last term of the bottom line of this critical branching modulo is equal to 0 whenever  $n + r > \langle h_i, \lambda \rangle - 1$ . As a consequence, it reduces to

$$\sum_{n+r=0}^{\langle h_i, \lambda \rangle - 1} \begin{array}{c} \text{Diagram 13} \\ \text{Diagram 14} \end{array}$$

and one then proves the confluence modulo of this branchings using a reindexation of this sum and the bubble slide 3-cells as in the previous proof of confluence of critical branching.

### A.3.9. Critical branchings $(\gamma_{j,i,j}^{\lambda,+}, (i_1^0 * 2 i_4^0)^- \cdot F_{i,j,\lambda})$ .

$$\begin{array}{c}
 \begin{array}{c} \text{Diagram 15} \\ \text{Diagram 16} \end{array} \xrightarrow{\beta^+} \begin{array}{c} \text{Diagram 17} \\ \text{Diagram 18} \end{array} + \delta_{i,j=-1} \begin{array}{c} \text{Diagram 19} \\ \text{Diagram 20} \end{array} \equiv_E \begin{array}{c} \text{Diagram 21} \\ \text{Diagram 22} \end{array} + \delta_{i,j=-1} \begin{array}{c} \text{Diagram 23} \\ \text{Diagram 24} \end{array} \\
 \downarrow (i_1^0)^- * 2 (i_4^0)^- \\
 \begin{array}{c} \text{Diagram 25} \end{array} \xrightarrow{F_{i,\lambda}} \begin{array}{c} \text{Diagram 26} \\ \text{Diagram 27} \end{array} \xrightarrow{(i_1^0)^- \cdot C_{i,\lambda}} \sum_{n=0}^{\langle h_i, \lambda \rangle} \begin{array}{c} \text{Diagram 28} \\ \text{Diagram 29} \end{array}
 \end{array}$$

Using the 3-cell  $C_{i,\lambda}$ , the term in the top line reduces to

$$\sum_{n=0}^{\langle h_i, \lambda \rangle} \begin{array}{c} \text{Diagram 30} \\ \text{Diagram 31} \end{array} \equiv_E \sum_{n=0}^{\langle h_i, \lambda \rangle} \begin{array}{c} \text{Diagram 32} \\ \text{Diagram 33} \end{array} \xrightarrow{\alpha_{i,j}^{L,n,+}} \sum_{n=0}^{\langle h_i, \lambda \rangle} \begin{array}{c} \text{Diagram 34} \\ \text{Diagram 35} \end{array} \quad (\text{A.1})$$

When  $i \cdot j = 0$ , this rewrites using  $\beta_{i,j}^+$  to

$$\sum_{n=0}^{\langle h_i, \lambda \rangle} \begin{array}{c} \text{Diagram 36} \\ \text{Diagram 37} \end{array}$$

so that this branching is confluent modulo E. In the case  $i \cdot j = 1$ , this rewrites to

$$\sum_{n=0}^{\langle h_i, \lambda \rangle} \begin{array}{c} \text{Diagram 38} \\ \text{Diagram 39} \end{array} + \sum_{n=0}^{\langle h_i, \lambda \rangle} \begin{array}{c} \text{Diagram 40} \\ \text{Diagram 41} \end{array}$$

Then note that

$$\sum_{n=0}^{\langle h_i, \lambda \rangle} \text{bubble}_{-n-1} \uparrow \uparrow_{n+1}^\lambda + \text{bubble}_i \uparrow \uparrow_i^\lambda = \sum_{n=0}^{\langle h_i, \lambda \rangle - 1} \text{bubble}_{-n} \uparrow \uparrow_n^\lambda$$

so that the top line of this branching rewrites to

$$\sum_{n=0}^{\langle h_i, \lambda \rangle} \text{bubble}_{-n-1} \uparrow \uparrow_n^\lambda + \sum_{n=0}^{\langle h_i, \lambda \rangle - 1} \text{bubble}_{-n} \uparrow \uparrow_n^\lambda$$

and we check the confluence modulo of this branching using the bubble slide 3-cells, the dots on the leftmost strand being cancelled by the 3-cells  $s_{i,j,\lambda}^-$  for  $i \cdot j = -1$ .

### Branchings between isomorphism and $\mathfrak{sl}_2$ relations

**A.3.10. Critical branchings between types A and C.** We prove that for any  $i \in I$  and  $\lambda \in X$ , and for any value of  $\langle h_i, \lambda \rangle$ , the critical branchings  $(A_{i,\lambda}, C_{i,\lambda})$  are confluent modulo E.

i) For  $\langle h_i, \lambda \rangle < 0$ ,

The diagram shows a confluence starting from a source 2-cell (a crossing of two strands with a dot on the top strand) labeled  $i_\lambda$ . A horizontal arrow labeled  $C_{i,\lambda}$  points to the right, ending at a 0 object. A vertical arrow labeled  $A_{i,\lambda}$  points down to another source 2-cell. From this second source, a sequence of arrows leads to 0: first  $A_{i,\lambda}$  to a sum of two terms, then  $b_{i,\lambda}^{0,n}$  to a sum of two terms, then  $I_1$  to a sum of two terms, and finally  $I_1$  to 0. A large vertical arrow labeled  $\parallel$  on the right indicates confluence modulo E.

ii) For  $\langle h_i, \lambda \rangle = 0$ ,

The diagram shows a confluence starting from a source 2-cell labeled  $i_\lambda$ . A horizontal arrow labeled  $C_{i,\lambda}$  points to a 2-cell with a dot on the top strand. From there, an arrow labeled  $c_{i,\lambda}^{1, -\langle h_i, \lambda \rangle - 1}$  points to a 2-cell with a dot on the bottom strand, which then has an arrow labeled  $I_1$  to 0. A vertical arrow labeled  $A_{i,\lambda}$  points down to another source 2-cell. From this second source, an arrow labeled  $A_{i,\lambda}$  points to a 2-cell with a dot on the bottom strand, which then has an arrow labeled  $b_{i,\lambda}^{1, \langle h_i, \lambda \rangle - 1}$  to 0. A large vertical arrow labeled  $\parallel$  on the right indicates confluence modulo E.

iii) For  $\langle h_i, \lambda \rangle > 0$ , the computation is similar to the case  $\langle h_i, \lambda \rangle < 0$ , except that the source 2-cell reduces to 0 by  $A_{i,\lambda}$  instead of  $C_{i,\lambda}$ .

### A.3.11. Critical branchings between types A and F.



i) For  $\langle h_i, \lambda \rangle < 0$ ,

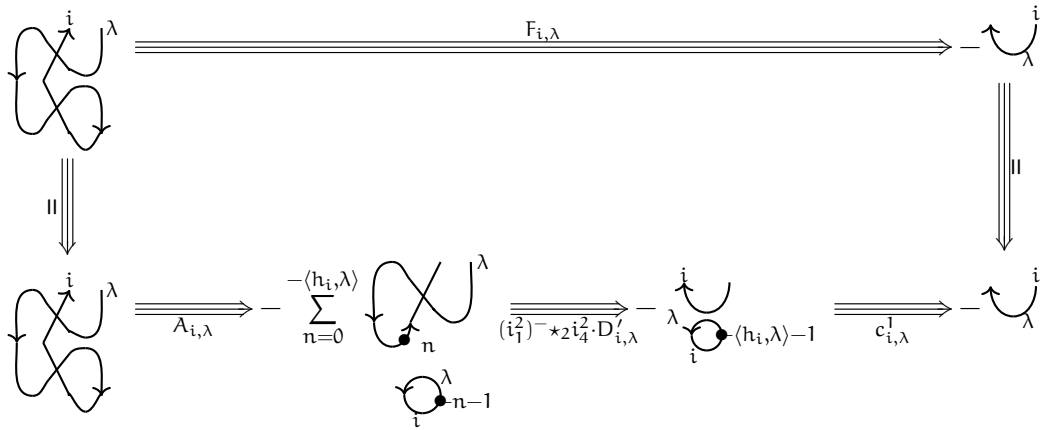

where  $D'_{i,\lambda}$  is a composite of  $n$  positive 3-cells of  $(\mathcal{E}R)_3^{\ell}$ , which represents the sum  $D'_{i,\lambda,1} + \dots + D'_{i,\lambda,-\langle h_i, \lambda \rangle}$ , where the 3-cell  $D'_{i,\lambda,k}$  is defined for any  $1 \leq k \leq -\langle h_i, \lambda \rangle$  in Appendix A.3.1.

ii) For  $\langle h_i, \lambda \rangle = 0$ ,

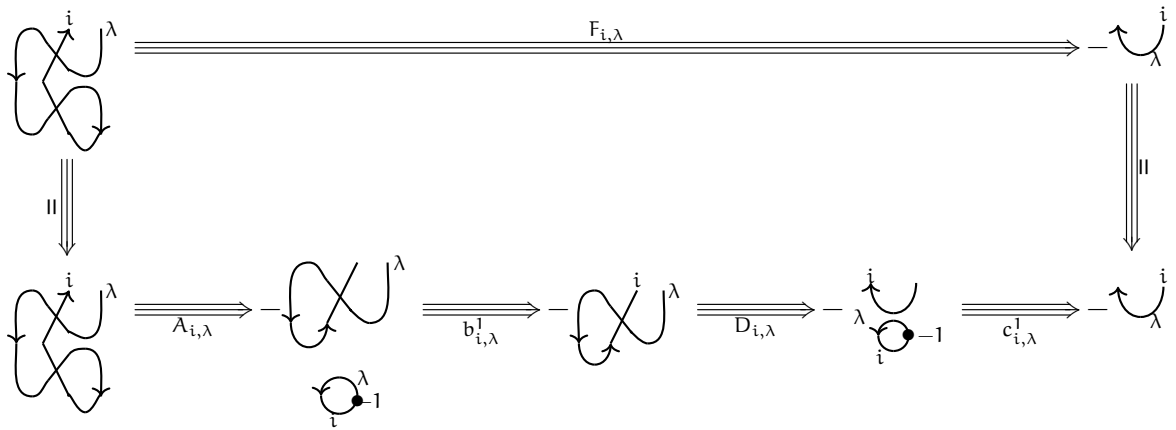

iii) For  $\langle h_i, \lambda \rangle > 0$ ,

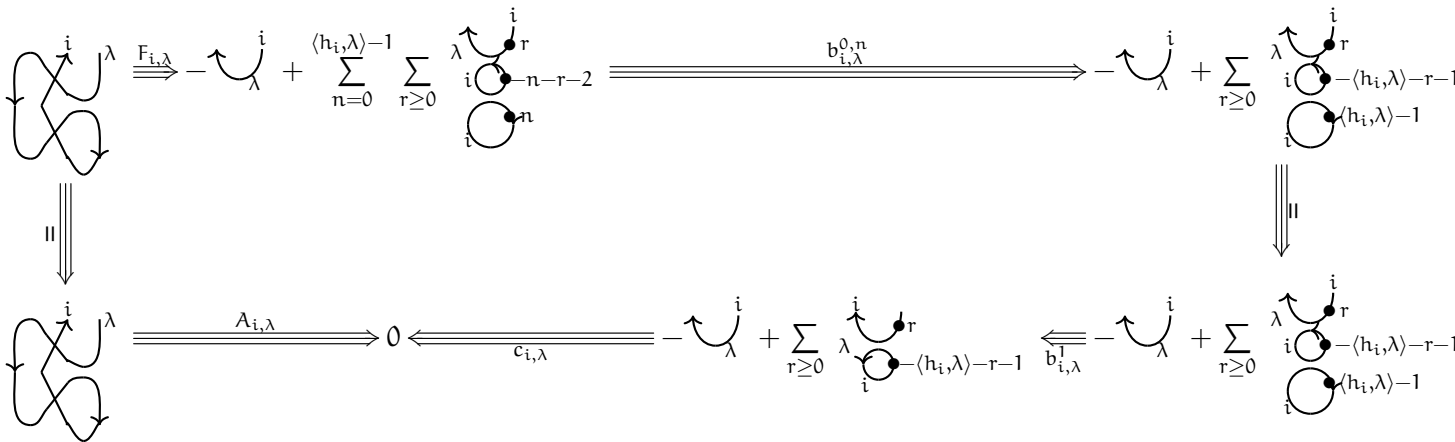

where the cell  $c_{i,\lambda}$  is defined as the composite of rewriting steps of  $\mathcal{E}R$  given by  $c_{i,\lambda}^{1,-\langle h_i, \lambda \rangle - 1} + c_{i,\lambda}^{0,-\langle h_i, \lambda \rangle - 2} + \dots$ , using degree condition 3-cells on bubbles to prove that the only term remaining is for  $r = 0$ , and is  $\text{loop}$ .

### A.3.12. Critical branchings between types B and D.

i) For  $\langle h_i, \lambda \rangle < 0$ ,

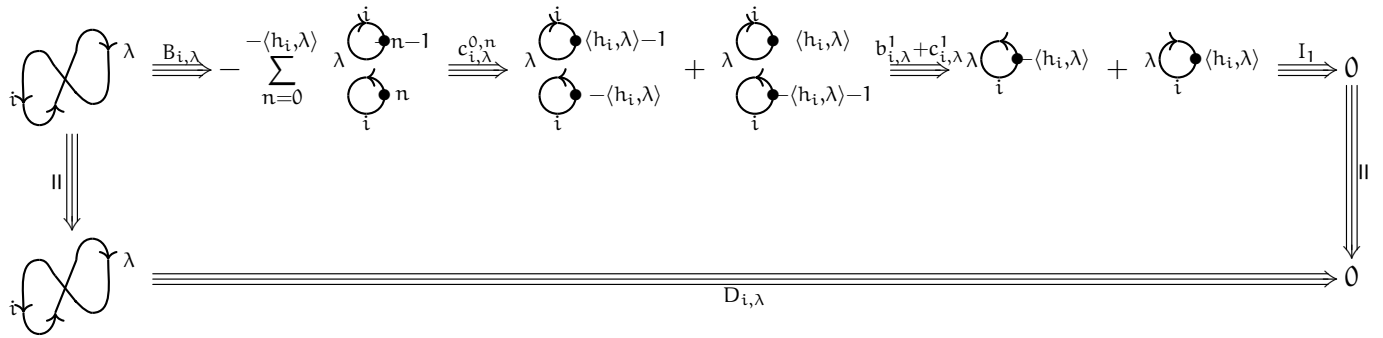

ii) For  $\langle h_i, \lambda \rangle = 0$ ,

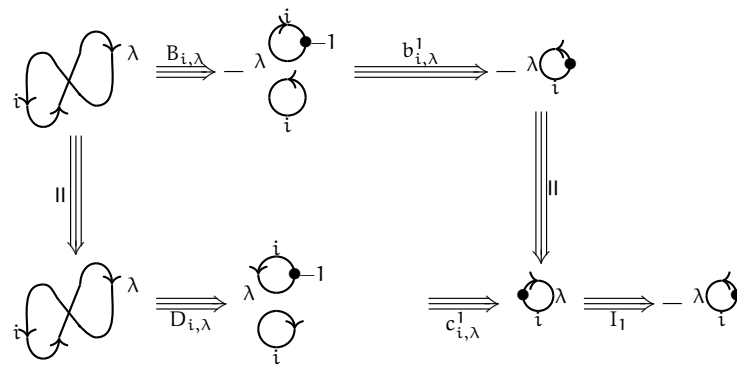

iii) For  $\langle h_i, \lambda \rangle > 0$ ,

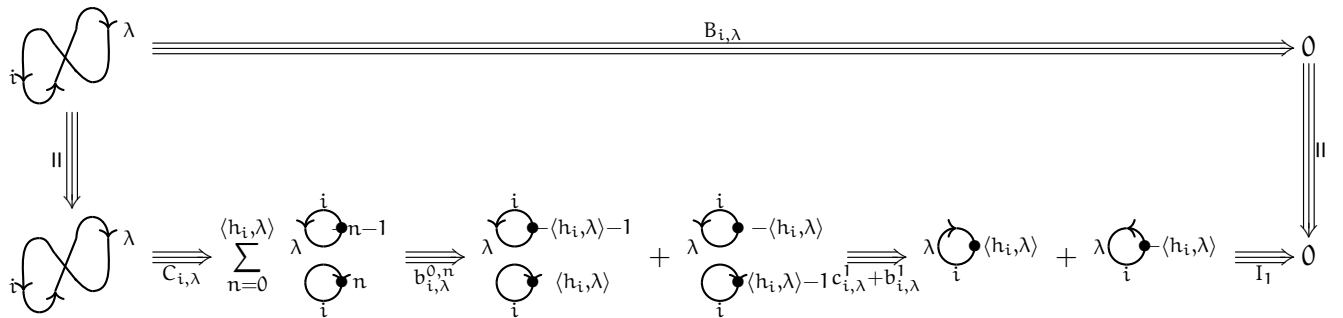

### A.3.13. Critical branchings between types B and F.

i) For  $\langle h_i, \lambda \rangle < 0$ ,

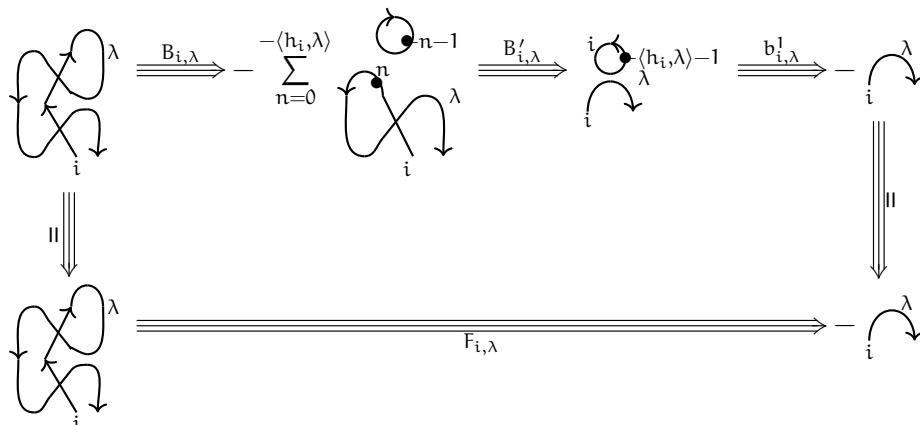

where  $B'_{i,\lambda}$  is the positive 3-cell of  $(\mathcal{E}R)_3^\ell$  corresponding to  $B'_{i,\lambda,0} + \cdots + B'_{i,\lambda,-\langle h_i,\lambda \rangle}$  where each 3-cell  $B'_{i,\lambda,k}$  for  $0 \leq k \leq -\langle h_i,\lambda \rangle$  is defined in Appendix A.3.1.

ii) For  $\langle h_i,\lambda \rangle = 0$ ,

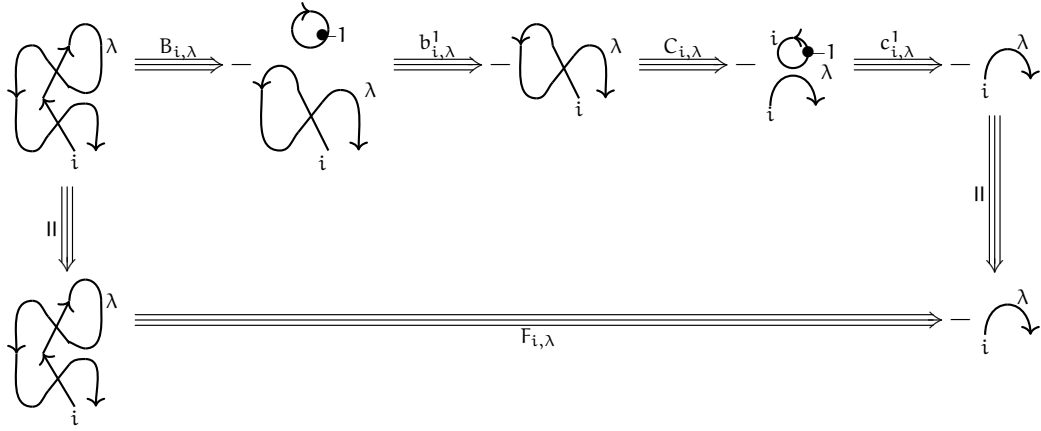

iii) For  $\langle h_i,\lambda \rangle > 0$ ,

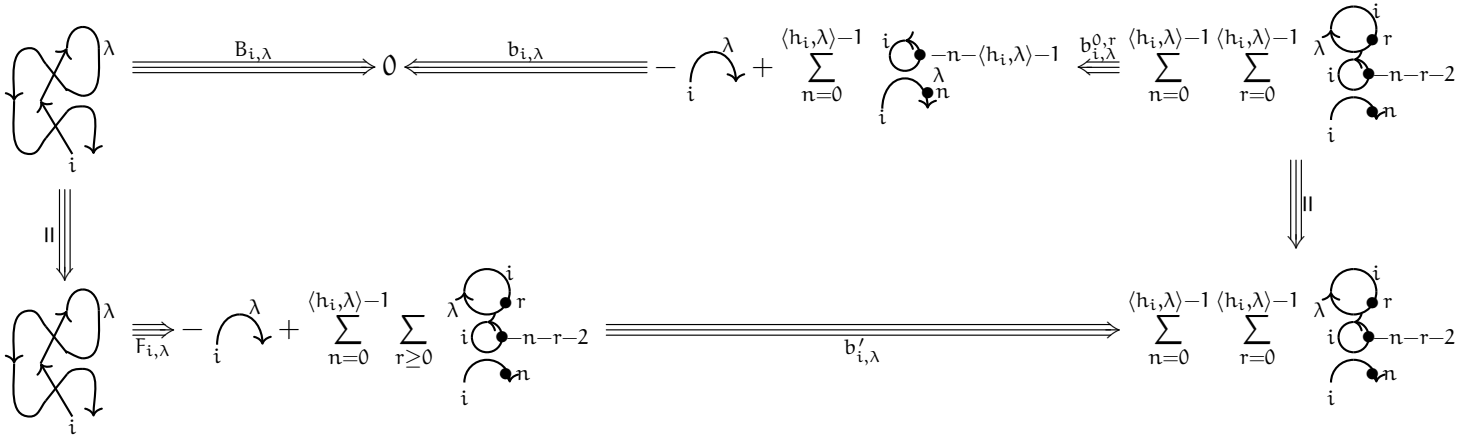

where  $b_{i,\lambda}$  is the 3-cell of  $(\mathcal{E}R)_3^\ell$  reducing each bubble by  $b_{i,\lambda}^{0,-n-\langle h_i,\lambda \rangle - 1}$  into 0 when  $n \neq 0$  and by  $b_{i,\lambda}^1$  into  $1_{1_\lambda}$  when  $n = 0$ .

### A.3.14. Critical branchings between types E and D.

i) For  $\langle h_i,\lambda \rangle < 0$ ,

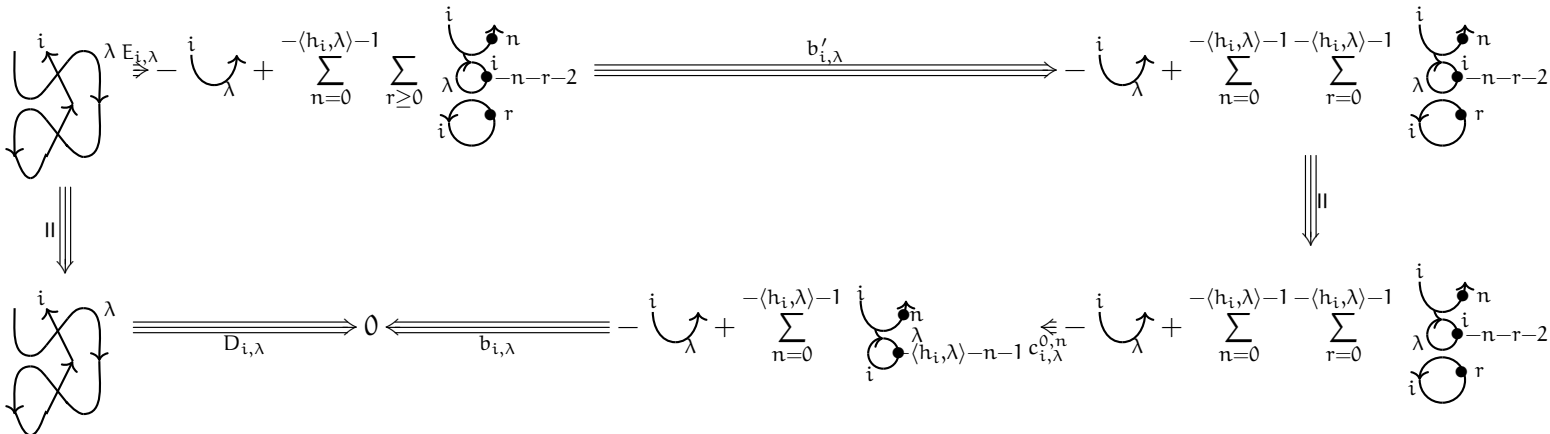

where  $b_{i,\lambda}$  is the 3-cell of  $(\mathcal{E}R)_3^\ell$  reducing each bubble by  $b_{i,\lambda}^{0,-n-\langle h_i,\lambda \rangle - 1}$  into 0 when  $n \neq 0$  and by  $b_{i,\lambda}^1$  into  $1_{1_\lambda}$  when  $n = 0$ .

ii) For  $\langle h_i, \lambda \rangle = 0$ ,

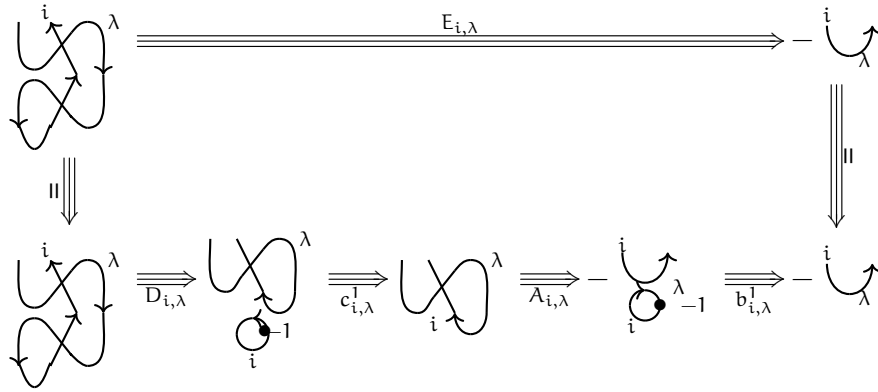

iii) For  $\langle h_i, \lambda \rangle > 0$ ,

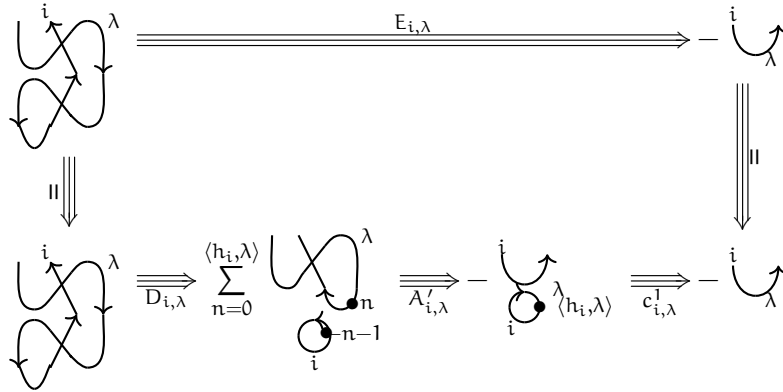

where the 3-cell  $A'_{i,\lambda}$  is defined as the 3-cell  $A'_{i,\lambda,0} + \dots + A'_{i,\lambda,\langle h_i, \lambda \rangle}$ , where each 3-cell  $A'_{i,\lambda,k}$  for  $0 \leq k \leq \langle h_i, \lambda \rangle$  is defined in Appendix A.3.1 and has for 2-target 0 if  $n < \langle h_i, \lambda \rangle$  and  $-\text{crossing}$  if  $n = \langle h_i, \lambda \rangle$ .

### A.3.15. Critical branchings between types C and E.

i) For  $\langle h_i, \lambda \rangle < 0$ ,

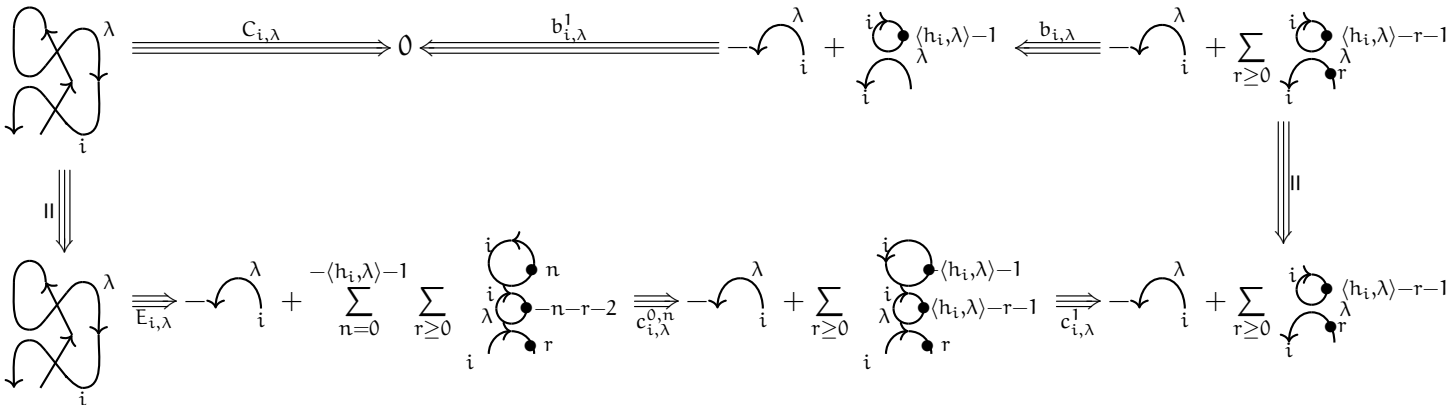

ii) For  $\langle h_i, \lambda \rangle = 0$ ,

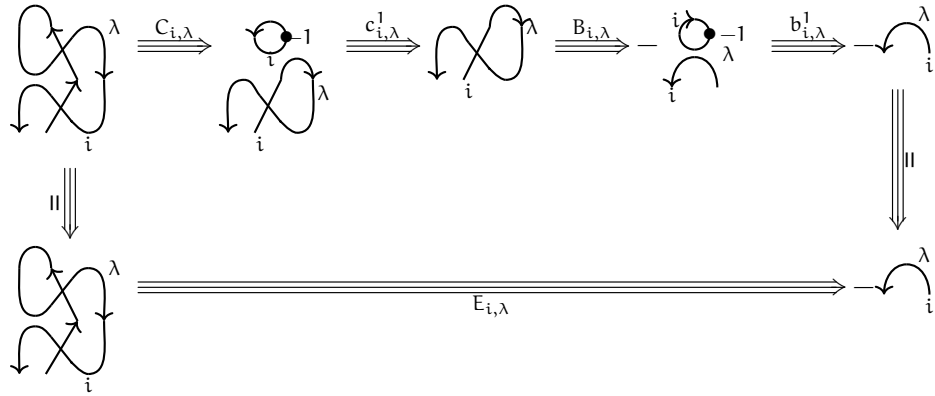

iii) For  $\langle h_i, \lambda \rangle > 0$ ,

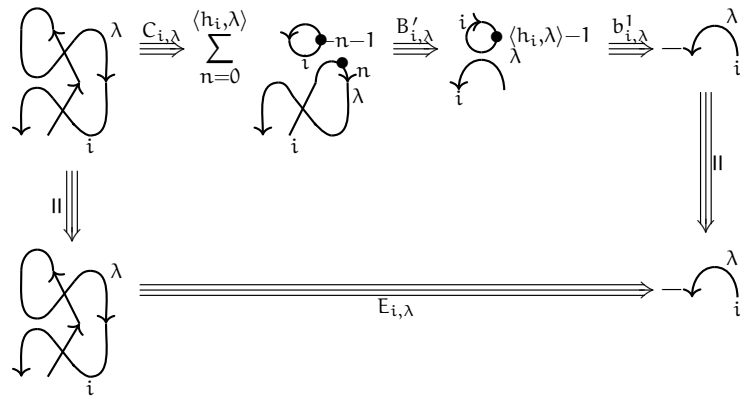

where the 3-cell  $B'_{i,\lambda}$  is defined as the 3-cell  $B'_{i,\lambda,0} + \dots + B'_{i,\lambda,\langle h_i, \lambda \rangle}$ , where each 3-cell  $B'_{i,\lambda,k}$  for  $0 \leq k \leq \langle h_i, \lambda \rangle$  is defined in A.3.1, and has for 2-target 0 if  $n < \langle h_i, \lambda \rangle$  and  $-\curvearrowright_i^\lambda$  if  $n = \langle h_i, \lambda \rangle$ .

**A.3.16. Critical branchings between types E and F.** For any  $i$  in  $I$  and  $\lambda$  in  $X$ , there are two types of critical branchings implying 3-cells  $E_{i,\lambda}$  and  $F_{i,\lambda}$ , depending on if the source 2-cell of  $E_{i,\lambda}$  is vertically composed below or above the source 2-cell of  $F_{i,\lambda}$ . Following 6.2.25, we denote by  $(E_{i,\lambda}, F_{i,\lambda})$  (resp.  $(F_{i,\lambda}, E_{i,\lambda})$ ) these two families of critical branchings. We will prove that for any  $i$  and  $\lambda$ , the critical branchings  $(E_{i,\lambda}, F_{i,\lambda})$  are confluent modulo  $E$ , the other family of branchings would be proved confluent modulo  $E$  similarly.

i) For  $\langle h_i, \lambda \rangle < 0$ ,

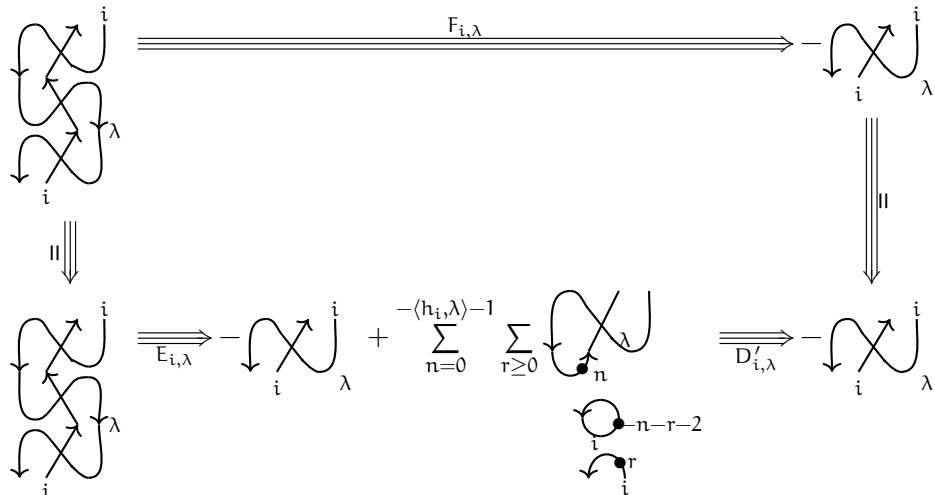

where  $D'_{i,\lambda}$  is the 3-cell of  $(\mathbb{E}\mathbb{R})_3^\ell$  defined as the composite of 3-cells  $D'_{i,\lambda,0} + \dots + D'_{i,\lambda,-\langle h_i,\lambda \rangle - 1}$ , where these cells are defined for  $0 \leq k \leq -\langle h_i,\lambda \rangle - 1$  in Appendix A.3.1, and have all 0 as 2-target.

ii) For  $\langle h_i,\lambda \rangle = 0$ ,

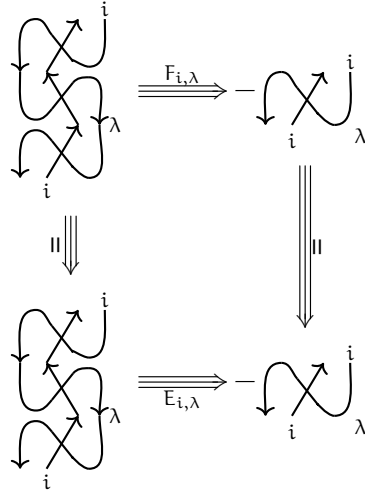

iii) For  $\langle h_i,\lambda \rangle > 0$ ,

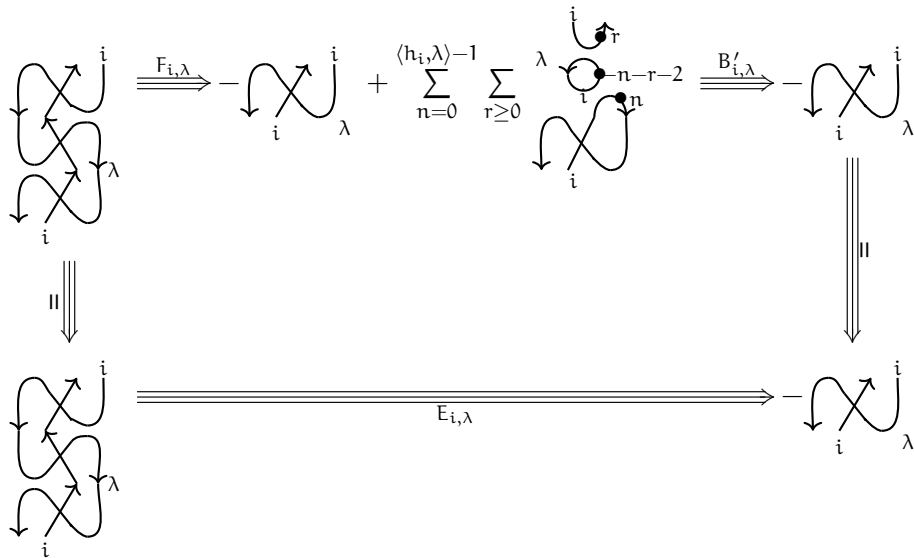

where  $B'_{i,\lambda}$  is the 3-cell of  $(\mathbb{E}\mathbb{R})_3^\ell$  defined as the composite of 3-cells  $B'_{i,\lambda,0} + \dots + B'_{i,\lambda,\langle h_i,\lambda \rangle - 1}$ , where these cells are defined for  $0 \leq k \leq \langle h_i,\lambda \rangle - 1$  in Appendix A.3.1, and have all 0 as 2-target.

# Réécriture modulo dans les catégories diagrammatiques

**Résumé.** En théorie des représentations, de nombreuses familles de catégories sont définies par générateurs et relations diagrammatiques. Une des questions principales dans l'étude de ces catégories est le calcul de bases linéaires des espaces de morphismes. Ces calculs de bases sont en général très difficiles en raison de la complexité combinatoire des relations. Cette thèse introduit une approche constructive permettant de calculer ces bases avec des méthodes issues de la théorie de la réécriture.

Nous introduisons un cadre catégorique de réécriture modulo, qui décrit le calcul dans une structure algébrique par application de relations orientées modulo les axiomes de la structure. Ce cadre nous permet de développer des outils pour réécrire dans des algèbres et catégories diagrammatiques admettant une structure inhérente complexe, telles que la structure de catégorie pivotale dans laquelle les diagrammes sont représentés à isotopie planaire près.

Nous définissons la notion de système de réécriture de dimension supérieure modulo, appelés polygraphes modulo, dans un contexte ensembliste et linéaire. Ces structures polygraphiques fournissent un cadre pour les preuves de cohérence modulo ainsi que le calcul de bases linéaires. En particulier, nous démontrons que des bases linéaires pour les espaces de 2-cellules de 2-catégories pivotales peuvent être obtenues à partir de présentations dont les relations forment un système de réécriture terminant, ou quasi-terminant, et confluent modulo les relations disotopie planaire. Nous étudions via ces méthodes la catégorie définie par Khovanov, Lauda et Rouquier pour catégorifier le groupe quantique associé à une algèbre de Kac-Moody symétrisable simplement lacée. Nous calculons des bases explicites des espaces de 2-cellules de cette catégorie, et montrons ainsi la non-dégénérescence du calcul diagrammatique introduit par Khovanov et Lauda, prouvant dans ce cas le théorème de catégorification du groupe quantique associé. Enfin, nous étendons la structure de polygraphe modulo au contexte de la réécriture modulo les axiomes décrits par une théorie algébrique de Lawvere. Nous démontrons un lemme des paires critiques algébrique basé sur une notion de stratégie de réécriture adaptée au contexte algébrique.

**Mots-clés:** Réécriture modulo, polygraphes modulo, algèbres diagrammatiques, catégorification, groupes quantiques.



ED 512

INFO MATHS

Ecole doctorale

