



**HAL**  
open science

# Dynamic Material Flow Analysis for Estimation of Iron Flows, Stocks and Recycling Indicators in EU-27

Daryna Panasiuk

► **To cite this version:**

Daryna Panasiuk. Dynamic Material Flow Analysis for Estimation of Iron Flows, Stocks and Recycling Indicators in EU-27. Other. Université de Technologie de Troyes, 2019. English. NNT : 2019TROY0021 . tel-03620529

**HAL Id: tel-03620529**

**<https://theses.hal.science/tel-03620529>**

Submitted on 26 Mar 2022

**HAL** is a multi-disciplinary open access archive for the deposit and dissemination of scientific research documents, whether they are published or not. The documents may come from teaching and research institutions in France or abroad, or from public or private research centers.

L'archive ouverte pluridisciplinaire **HAL**, est destinée au dépôt et à la diffusion de documents scientifiques de niveau recherche, publiés ou non, émanant des établissements d'enseignement et de recherche français ou étrangers, des laboratoires publics ou privés.

**Daryna PANASIUK**

# Dynamic Material Flow Analysis for Estimation of Iron Flows, Stocks and Recycling Indicators in EU-27

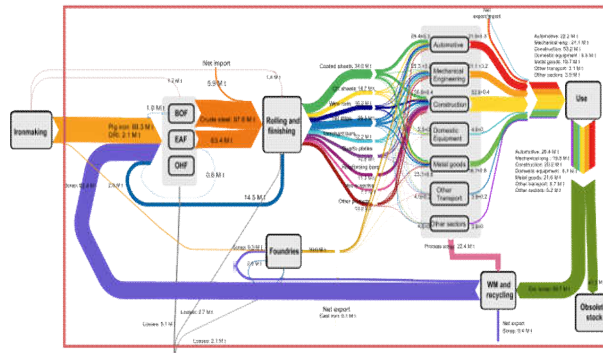

**Champ disciplinaire :**  
Sciences pour l'Ingénieur

2019TROY0021

Année 2019

---

---

# THESE

*pour l'obtention du grade de*

## DOCTEUR

de l'UNIVERSITE DE TECHNOLOGIE DE TROYES

EN SCIENCES POUR L'INGENIEUR

**Spécialité : SYSTEMES SOCIOTECHNIQUES**

*présentée et soutenue par*

**Daryna PANASIUK**

*le 27 août 2019*

---

---

**Dynamic Material Flow Analysis for Estimation of Iron Flows,  
Stocks and Recycling Indicators in EU-27**

---

---

## JURY

M. B. YANNOU	PROFESSEUR DES UNIVERSITES	Président
M. B. ROSE	PROFESSEUR DES UNIVERSITES	Rapporteur
Mme P. ZWOLINSKI	PROFESSEURE DES UNIVERSITES	Rapporteuse
M. J.-P. BIRAT	PRESIDENT - IF STEELMAN	Examineur
M. I. DAIGO	ASSOCIATE PROFESSOR	Examineur
Mme K. HABIB	ASSISTANT PROFESSOR	Examinatrice
M. B. LARATTE	ENSEIGNANT CHERCHEUR	Directeur de thèse
M. S. REMY	MAITRE DE CONFERENCES - HDR	Directeur de thèse



University of Technology of Troyes

DYNAMIC MATERIAL FLOW ANALYSIS  
FOR ESTIMATION OF IRON FLOWS, STOCKS  
AND RECYCLING INDICATORS IN EU-27

Daryna Panasiuk

A thesis submitted for the degree of Doctor of the  
University of Technology of Troyes

Specialty: Sociotechnical Systems

Troyes, June 2019

## *Abstract*

Recycling is an important component in the optimization of the increasing global consumption of natural resources. The study of anthropogenic metal stocks and flows is needed to evaluate the quantity of metals being accumulated over time, and to estimate potential scrap availability for recycling. Based on a dynamic material flow analysis of steel and cast iron in EU-27 in the period 1945-2015, this study follows the flows of elemental iron to analyse the stock in use, its distribution across seven industrial sectors and to calculate recycling efficiency indicators over time. The model is based on historical statistical data on production and trade of pig iron and crude steel. It makes it possible to calculate iron losses, consumption of steel and cast iron, and integrates a detailed distribution of steel by steel product and by industrial sector. The annual consumption of scrap is estimated from process-specific mass balances.

The model provides detailed annual material flows involved in socio-economic metabolism, annual discard of iron from use and the evolution of in-use stock. The results indicated that 0.2 t/cap of iron was discarded from use in 2015, 59% of which was collected and processed. 41% is assumed to remain in the obsolete stock. The in-use stock increased constantly and reached 7.3 t/cap in EU-27 in 2015. The average value of recycling of end-of-life recycling rate between 1970 and 2015 in EU-27 is estimated to equal 65%. The main impacts on the results are caused by the distribution of iron by industrial sectors and by assumed lifetimes.

Key-words:

- Material Flow Analysis
- Iron - Recycling
- Circular economy
- Industrial ecology
- Iron - Metallurgy

## Résumé

Le recyclage est une composante importante pour l'optimisation de l'utilisation des ressources naturelles, notamment dans un contexte de consommation croissante. L'étude des stocks et des flux anthropiques des métaux est nécessaire pour évaluer la quantité de matière accumulée dans l'anthroposphère au fil du temps, et estimer la disponibilité potentielle de ferraille pour le recyclage. En appliquant l'Analyse de Flux de Matière (AFM) dynamique aux flux d'acier et de fonte dans l'UE-27 sur la période 1945-2015, cette étude analyse le stock de fer en utilisation et calcule les indicateurs d'efficacité du recyclage au fil du temps. Le modèle est basé sur des données statistiques historiques sur la production et le commerce de fonte et d'acier. Il permet de calculer les pertes de fer, la consommation d'acier et de fonte, et intègre une distribution croisée de l'acier par produit sidérurgique et selon sept secteurs industriels. La consommation annuelle de ferraille est estimée à partir des bilans de masse spécifiques aux procédés considérés, impliqués dans le métabolisme socio-économique.

Le modèle détaille annuellement les flux de matières, l'évolution du stock en cours d'utilisation, ainsi que la disponibilité de la vieille ferraille. Les résultats indiquent que 0,2 t/habitant de fer est arrivé en fin de vie en 2015, dont 59% ont été collectés et traités. 41% est supposé rester dans le stock obsolète. Le stock en utilisation augmente constamment atteignant 7,3 t/habitant en 2015. La valeur moyenne du taux de recyclage de la vieille ferraille entre 1970 et 2015 est estimée à 65%. Les résultats de ce modèle sont principalement impactés par la distribution du fer selon les secteurs industriels, et par les durées de vie supposées des produits.

### Mots-clés:

- Analyse de Flux de Matière
- Fer - Recyclage
- Économie circulaire
- Écologie industrielle
- Fer - Métallurgie

## *Acknowledgements*

This thesis has been carried out within the Institute of Technological Research on Materials, Metallurgy and Processes (IRT M2P). I am grateful to the University of Technology of Troyes, IRT M2P and the industrial partners of the project “Raw material and recycling in Life Cycle Assessment” - ArcelorMittal, Constellium, Safran, Renault and Derichebourg for providing me with an opportunity to conduct this study.

This PhD dissertation would not have been possible without the support of numerous individuals and institutions. First, I would like to express my gratitude to my two PhD supervisors Sebastien Remy and Bertrand Laratte, for their guidance, constant support, and the challenges and opportunities they gave me. Working with them was a great experience.

I would like to thank my defense committee members: Peggy Zwolinski, Bertrand Rose, Bernard Yannou, Ichiro Daigo, Komal Habib and Jean-Pierre Birat for their time and interest.

I also want to thank my industrial committee, who guided me through all these years: Jean-Pierre Birat for his generous support, for shaping my thinking and invaluable comments during the writing of this thesis and, Philippe Russo for insights into recycling, patient explanations and the pleasure of our collaboration. I also thank my work colleagues Gaël Fick and Morgane Pelote for a friendly work environment. I am grateful to Muriel Whitchurch for the proofreading of the manuscript and for her kind explanations of the intricacies of the English language.

I greatly appreciate the support received through the collaborative work with Eurofer and Worldsteel. during the different stages of the PhD. Thanks to Jeroen Vermeij, Freddy Caufriez, Donato Marchetti and Aurelio Braconi and Henk Reimink for their support during the data collection. I appreciated the advice and comments given by Adam Szewczyk, which were of great help in understanding statistical data.

I consider myself lucky to have spent five weeks as a guest at the Department of Materials Engineering at the University of Tokyo. I am thankful to Ichiro Daigo for this opportunity, for his support, fruitful input and kindness, as well as to all the lab members, who made this time intellectually and culturally enriching.

Finally, this PhD journey would have been much harder without my family and friends. Thank you to my parents for believing in me and encouraging me throughout all of my life, to my brother for just being there and making me laugh. Thank you to my friends Olivier, Nataliya, Axel, Katia for their patience and continued support when my life became PhD-centered and they had to listen to a lot of material flow analysis talk. I am grateful that they kept their sense of humour, especially when I was losing mine. And, finally, to Steve for being by my side unconditionally throughout the whole PhD, for keeping me going and arranging the perfect environment for finishing the manuscript.





# Table of Contents

<b>TABLE OF FIGURES</b>	<b>IX</b>
<b>LIST OF TABLES</b>	<b>XIII</b>
<b>ACRONYMS AND ABBREVIATIONS</b>	<b>XV</b>
<b><u>INTRODUCTION</u></b>	<b><u>1</u></b>
<b><u>CHAPTER 1 CONTEXT OF THE STUDY</u></b>	<b><u>3</u></b>
1.1 BACKGROUND	5
1.2 CONTEXT AND SCOPE OF THE STUDY	9
1.3 RECYCLING OF FERROUS METALS	11
1.4 PROBLEM DEFINITION	15
<b><u>CHAPTER 2 RESEARCH BASIS</u></b>	<b><u>21</u></b>
2.1 LITERATURE REVIEW	23
2.1.1 KEY CONCEPTS OF MATERIAL FLOW ANALYSIS	23
2.1.2 LITERATURE REVIEW	25
2.2 GOAL AND SCIENTIFIC CONTRIBUTION	33
<b><u>CHAPTER 3 DEVELOPMENT OF MODEL FOR THE FLOW OF IRON IN EU-27</u></b>	<b><u>37</u></b>
3.1 METHODOLOGY	39
3.2 TEMPORAL AND SPATIAL BOUNDARIES	43
3.3 IDENTIFICATION OF PROCESSES, STOCKS AND FLOWS	45
3.3.1 PRODUCTION	47
3.3.2 PROCESSING AND MANUFACTURING	53
3.3.3 USE	54
3.3.4 WASTE MANAGEMENT AND RECYCLING	58
<b><u>CHAPTER 4 DATA COLLECTION AND DETERMINATION OF MASS FLOWS, STOCKS, AND CONCENTRATIONS</u></b>	<b><u>61</u></b>
4.1 REVIEW OF AVAILABLE NUMERICAL DATA	65
4.1.1 PRODUCTION	65
4.1.2 PROCESSING AND MANUFACTURING	80
4.1.3 USE	82
4.1.4 WASTE MANAGEMENT AND RECYCLING	83
4.1.5 SUMMARY	84

<b>4.2 DEFINITION OF THE IRON CONTENT OF THE FLOWS AND ESTABLISHMENT OF MASS BALANCE AT THE LEVEL OF PROCESSES</b>	<b>86</b>
4.2.1 BASIC OXYGEN FURNACE	87
4.2.2 ELECTRIC ARC FURNACE	97
4.2.3 OPEN HEARTH FURNACE	101
4.2.4 ROLLING AND FINISHING	104
4.2.5 FOUNDRIES	108
<b>4.3 DEFINITION OF MASS FLOWS</b>	<b>112</b>
4.3.1 PRODUCTION	115
4.3.2 PROCESSING AND MANUFACTURING	133
4.3.3 WASTE MANAGEMENT AND RECYCLING	148
<b>4.4 PARAMETERS FOR THE CALCULATION OF THE STOCK IN-USE AND OF THE INITIAL STOCK IN 1945.</b>	<b>149</b>
4.4.1 LIFETIME DISTRIBUTION	149
4.4.2 INITIAL STOCK	151
<b>4.5 SOURCES OF UNCERTAINTY</b>	<b>154</b>
4.5.1 CONSUMPTION OF STEEL PRODUCTS (F8)	154
4.5.2 DISTRIBUTION OF STEEL PRODUCTS BY INDUSTRIAL SECTORS	159
4.5.3 IMPACT OF DIFFERENTIATION OF FLOWS PER THEIR IRON CONTENT ON FINAL RESULTS	161
<b>CHAPTER 5 DEFINITION OF RECYCLING INDICATORS</b>	<b>163</b>
<b>CHAPTER 6 RESULTS AND LIMITS OF THE STUDY</b>	<b>171</b>
<b>6.1 RESULTS AND DISCUSSION</b>	<b>173</b>
6.1.1 ANNUAL MFA FOR 2015	173
6.1.2 IN-USE STOCK IN EU-27 AND AT EUROPEAN COUNTRIES LEVEL	176
6.1.3 IRON DISCARDED FROM THE IN-USE STOCK USE	182
6.1.4 RECYCLING INDICATORS	187
6.1.5 IRON LOSS DURING THE PRODUCTION STAGE	197
<b>6.2 INVESTIGATION OF UNCERTAINTY, RELATED TO THE ESTIMATION OF STOCK</b>	<b>204</b>
6.2.1 IMPACT OF THE INITIAL STOCK	204
6.2.2 IMPACT OF LIFETIME	205
6.2.3 IRON LOSSES DURING USE	208
<b>CONCLUSIONS AND PERSPECTIVES</b>	<b>211</b>
<b>REFERENCES</b>	<b>218</b>
<b>APPENDIX A ESTIMATION OF IRON LOSSES DUE TO CORROSION</b>	<b>A-1</b>
<b>APPENDIX B COMPARISON OF CALCULATED PRODUCTION OF FINISHED STEEL PRODUCTS WITH REPORTED STATISTICAL DATA</b>	<b>B-1</b>

<b><i>APPENDIX C DESIGNATION OF SYSTEM VARIABLES AND PARAMETERS</i></b>	<b><i>C-1</i></b>
<b><i>APPENDIX D ESTIMATION OF THE IRON CONTENT OF THE CRUDE STEEL</i></b>	<b><i>D-1</i></b>
<b><i>APPENDIX E RESUME DE LA THESE DE DOCTORAT « ANALYSE DE FLUX DE MATIERE DYNAMIQUE POUR UNE ESTIMATION DES FLUX, DES STOCKS ET DES INDICATEURS DU RECYCLAGE DE FER DANS L'UE-27 » REDIGEE EN ANGLAIS</i></b>	<b><i>E-1</i></b>



## *Table of figures*

FIGURE 1 GLOBAL MATERIAL PRODUCTION OF KEY MATERIALS SINCE 1900. DATA: USGC (SOURCE: (WORRELL AND REUTER 2014) .....	5
FIGURE 2 CONCENTRATION OF IRON DURING STEEL LIFE CYCLE .....	19
FIGURE 3 EUROPEAN UNION 27 (NAIC.EDU).....	43
FIGURE 4 PROCESSES AND FLOWS INCLUDED IN THE PRESENT STUDY .....	46
FIGURE 5 PRODUCTION OF STEEL IN OPEN HEARTH FURNACES IN EU-27, 1945-2015, IN MT. (WORLDSTEEL, BRITISH GEOLOGICAL SURVEY).....	47
FIGURE 6 STEELMAKING PROCESS .....	48
FIGURE 7 FLOWS RELATED TO THE MODELLED BOF PROCESS.....	49
FIGURE 8 FLOWS RELATED TO THE MODELLED EAF PROCESS .....	50
FIGURE 9 FLOWS RELATED TO THE MODELLED OHF PROCESS .....	51
FIGURE 10 FLOWS RELATED TO THE MODELLED PROCESS OF ROLLING AND FINISHING .....	52
FIGURE 11 FLOWS RELATED TO THE MODELLED FOUNDRIES PROCESS.....	53
FIGURE 12 FLOWS RELATED TO THE MODELLED PROCESSING AND MANUFACTURING PROCESS .....	54
FIGURE 13 ILLUSTRATION OF THE IN-USE STOCK.....	55
FIGURE 14 FLOWS RELATED TO THE MODELLED USE PROCESS.....	58
FIGURE 15 RELATIONSHIP BETWEEN IN-USE STOCK, OBSOLETE STOCK AND WASTE MANAGEMENT .....	59
FIGURE 16 ILLUSTRATION OF METHODS USED FOR FLOW QUANTIFICATION .....	63
FIGURE 17 AVAILABILITY OF STATISTICAL DATA ON FLOWS RELATED TO THE PRODUCTION STAGE .....	66
FIGURE 18 ESTIMATION OF HOME SCRAP GENERATION FROM STATISTICAL DATA .....	75
FIGURE 19 ILLUSTRATION OF THE DIFFERENCE BETWEEN NET IMPORTS OF STEEL PRODUCTS REPORTED BY TWO CLASSIFICATIONS OF UN COMTRADE (SITC REV.1 AND HS) .....	78
FIGURE 20 FLOWS RELATED TO THE STAGE OF PROCESSING AND MANUFACTURING, REPORTED IN STATISTICS .....	81
FIGURE 21 FLOWS RELATED TO THE STAGE OF USE, REPORTED IN STATISTICS.....	82
FIGURE 22 FLOWS RELATED TO THE STAGE OF WASTE MANAGEMENT AND RECYCLING, REPORTED IN STATISTICS .....	83
FIGURE 23 FLOWS RELATED TO THE MODELLED BOF PROCESS (DUPLICATE OF FIGURE 7).....	87
FIGURE 24 THE USE OF STEEL SLAG IN EUROPE, 2002-2014 (EUROSLAG WEBSITE, 2017).....	89
FIGURE 25 GENERATION OF HOME SCRAP, AS PERCENTAGE OF CRUDE STEEL PRODUCTION REPORTED BY TWO SOURCES.....	91
FIGURE 26 GENERATION OF HOME SCRAP DURING CONTINUOUS CASTING (AS PERCENTAGE TO CRUDE STEEL PRODUCTION), APPLIED TO THE STEELMAKING PROCESSES .....	92
FIGURE 27 IRON INPUT AND OUTPUT OF BOF PROCESS IN 2015 .....	96
FIGURE 28 INPUT AND OUTPUT FLOWS TO BOF PROCESS, 1945-2015 .....	97
FIGURE 29 FLOWS RELATED TO THE MODELLED EAF PROCESS (DUPLICATE OF FIGURE 8) .....	97
FIGURE 30 IRON INPUT AND OUTPUT OF EAF PROCESS IN 2015 .....	100
FIGURE 31 INPUT AND OUTPUT FLOWS TO EAF PROCESS, 1945-2015.....	101
FIGURE 32 FLOWS RELATED TO THE MODELLED OHF PROCESS (DUPLICATE OF FIGURE 9) .....	101
FIGURE 33 IRON INPUT AND OUTPUT OF OHF PROCESS IN 2015 .....	103
FIGURE 34 INPUT AND OUTPUT FLOWS TO OHF PROCESS, 1945-2015.....	104
FIGURE 35 MASS BALANCE OF THE PROCESS OF ROLLING AND FINISHING, ESTABLISHED FOR THE PRODUCTION OF ONE TON OF FINISHED PRODUCTS .....	107
FIGURE 36 MASS BALANCE OF THE PROCESS OF ROLLING AND FINISHING, CONVERTED FOR THE INFLOW OF ONE TON OF CRUDE STEEL...108	108
FIGURE 37 FLOWS RELATED TO THE MODELLED FOUNDRIES PROCESS (DUPLICATE OF FIGURE 11).....	109
FIGURE 38 IRON INPUT AND OUTPUT OF FOUNDRY PROCESS .....	110
FIGURE 39 ANNOTATION OF FLOWS APPLIED FOR THE CALCULATION OF THE MASS FLOWS.....	114
FIGURE 40 CONSUMPTION OF PIG IRON PER COUNTRY OF EU-27, 1945-2015 .....	116
FIGURE 41 CONSUMPTION OF DRI IN COUNTRIES OF EU-27, 1970-2015 .....	117
FIGURE 42 EU-27 DRI CONSUMPTION BEFORE AND AFTER CORRECTION OF NEGATIVE VALUES, EU-27, 1945-2015 .....	118

FIGURE 43 CRUDE STEEL PRODUCTION IN COUNTRIES OF EU-27, 1945-2015 .....	120
FIGURE 44 PRODUCTION OF CRUDE STEEL PER PROCESS AND THE SHARE OF THESE PROCESSES IN EU-27, 1945-2015 .....	122
FIGURE 45 PRODUCTION OF CAST IRON IN EU-27, 1945-2015 .....	123
FIGURE 46 COMPARISON OF THE CONSUMPTION OF PIG IRON, SCRAP AND DRI, CALCULATED WITH THE FIRST APPROACH, WITH REPORTED STATISTICS, EU-27 .....	125
FIGURE 47 COMPARISON OF THE SCRAP CONSUMPTION, CALCULATED ACCORDING TO THE SECOND APPROACH WITH WORLDSTEEL ESTIMATION, EU-27 .....	127
FIGURE 48 PRODUCTION OF HOME SCRAP IN MT OF IRON, EU-27, 1945-2015 .....	128
FIGURE 49 CONSUMPTION OF STEEL IN EU-27, 1945-2015 .....	130
FIGURE 50 CONSUMPTION OF STEEL PRODUCTS IN COUNTRIES OF EU-27, 1945-2015 .....	131
FIGURE 51 CONSUMPTION OF STEEL PER INDUSTRIAL SECTOR, EU-27, 1945-2015 .....	138
FIGURE 52 SECTOR-SPECIFIC GENERATION OF PROCESS SCRAP (USINOR) .....	142
FIGURE 53 COMPARISON OF HISTORIC PROCESS SCRAP GENERATION, REPORTED BY USINOR AND IISI .....	142
FIGURE 54 GENERATION OF PROCESS SCRAP IN EU-27, 1945-2015 .....	144
FIGURE 55 ILLUSTRATION OF CORRECTION OF THE FLOW OF "OTHER TRANSPORT" .....	147
FIGURE 56 FLOW OF IRON ENTERING THE USE, EU-27, 1945-2015 .....	147
FIGURE 57 EXAMPLE OF PARAMETRIC AND NONPARAMETRIC LIFETIME DISTRIBUTION .....	149
FIGURE 58 FLOW OF IRON ENTERING THE USE BETWEEN 1850 AND 1944, EU-27 .....	153
FIGURE 59 INITIAL STOCK ESTIMATION, EU-27, 1850-1945 .....	153
FIGURE 60 COMPARISON BETWEEN THE CONSUMPTION OF STEEL PRODUCTS REPORTED BY ASU INDICATOR AND CALCULATED FROM THE PRODUCTION AND TRADE (HS), EU-15 .....	155
FIGURE 61 COMPARISON BETWEEN THE CONSUMPTION OF STEEL PRODUCTS REPORTED BY ASU INDICATOR AND CALCULATED FROM THE PRODUCTION AND TRADE (SITC REV.1), EU-27 .....	157
FIGURE 62 COMPARISON BETWEEN THE CONSUMPTION OF STEEL PRODUCTS CALCULATED FROM THE PRODUCTION AND TWO TRADE CLASSIFICATIONS (SITC REV.1 AND HS), EU-15 .....	158
FIGURE 63 COMPARISON BETWEEN THE CONSUMPTION OF STEEL PRODUCTS CALCULATED ACCORDING TO VERSIONS 1, 2 AND 3 .....	159
FIGURE 64 IMPACT OF SECTOR DISTRIBUTION ISSUED FROM DIFFERENT SOURCES .....	160
FIGURE 65 TOTAL FLOW ENTERING USE PROCESS, EXPRESSED IN MILLIONS TONS OF ELEMENTAL IRON, CAST IRON AND STEEL .....	161
FIGURE 66 ANNOTATION OF FLOWS APPLIED FOR THE CALCULATION OF THE MASS FLOWS (DUPLICATE OF FIGURE 39) .....	165
FIGURE 67 MFA OF IRON IN EU-27, 2015 .....	175
FIGURE 68 EVOLUTION OF THE IRON STOCK IN EU-27, 1945-2015 .....	176
FIGURE 69 EVOLUTION OF IN-USE STOCK PER CAPITA, EU-27, 1945-2015 .....	177
FIGURE 70 IN-USE STOCK IN COUNTRIES OF EU-27 .....	178
FIGURE 71 IN-USE STOCK PER CAPITA IN EUROPEAN COUNTRIES, 2015 .....	180
FIGURE 72 COMPARISON OF RESULTS OF THE IN-USE STOCK IN 2008 FOR SELECTED EUROPEAN COUNTRIES WITH THE STUDY OF PAULIUK ET AL. (2013) .....	180
FIGURE 73 COMPARISON OF RESULTS OF THE IN-USE STOCK IN 1945 FOR SELECTED EUROPEAN COUNTRIES WITH THE STUDY OF PAULIUK ET AL. (2013) .....	181
FIGURE 74 TOTAL FLOW OF EOL IRON DISCARDED FROM THE IN-USE STOCK .....	182
FIGURE 75 THE SHARE OF IRON DISCARDED FROM USE COMPARED TO THE IN-USE STOCK, EU-27, 1945-2015 .....	183
FIGURE 76 DISCARD OF IRON FROM THE INITIAL STOCK .....	183
FIGURE 77 GENERATION OF EOL IRON PER INDUSTRIAL SECTOR, EU-27, 1945-2015 .....	184
FIGURE 78 GENERATION OF EOL IRON PER INDUSTRIAL SECTOR, WORLD (RUSSO, 2014) .....	186
FIGURE 79 EoL RR FOR EU-27, 1945-2015 .....	188
FIGURE 80 EoL RR OF IRON FOR 17 COUNTRIES OF EU-27, 1970-2015 .....	190
FIGURE 81 AVERAGE VALUE OF EOL RR IN EUROPEAN COUNTRIES BETWEEN 1970-2015 .....	191
FIGURE 82 IMPACT OF SCRAP TRADE ON EOL RR OF EU-27 .....	193
FIGURE 83 ILLUSTRATION OF THE OBSOLETE STOCK COMPARED TO THE IN-USE STOCK, EU-27, 1945-2015 .....	194
FIGURE 84 ORER FOR EU-27, 1945-2015 .....	195

FIGURE 85 AVERAGE VALUES OF ORER INDICATOR IN EUROPEAN COUNTRIES BETWEEN 1970-2015.....	195
FIGURE 86 RECYCLING INDICATORS FOR SELECTED EUROPEAN COUNTRIES .....	197
FIGURE 87 IRON IN BOF BY-PRODUCTS AND THE GENERATION OF BOF DUST, SLAG AND MILL SCALE .....	199
FIGURE 88 IRON IN BOF BY-PRODUCTS, INCLUDING HOME SCRAP AND RESPECTIVE SHARES OF RECYCLED AND LOST IRON .....	199
FIGURE 89 IRON CONTAINED IN EAF BY-PRODUCTS AND THE GENERATION OF EAF DUST, SLAG AND MILL SCALE .....	200
FIGURE 90 IRON CONTAINED IN OHF BY-PRODUCTS AND THE GENERATION OF OHF DUST, SLAG AND MILL SCALE .....	201
FIGURE 91 IRON CONTAINED IN BY-PRODUCTS OF THE PROCESS OF ROLLING AND FINISHING AND THE GENERATION OF THESE BY-PRODUCTS .....	201
FIGURE 92 THE SHARE OF IRON FROM STEELMAKING PROCESSES RECYCLED AND LOST WITH AND WITHOUT CONSIDERING HOME SCRAP .....	202
FIGURE 93 IRON CONTAINED IN BY-PRODUCTS OF THE FOUNDRY PROCESS .....	203
FIGURE 94 IMPACT OF HIGHER LIFETIMES DURING THE PERIOD 1850-1944 ON THE CURRENT IN-USE STOCK.....	204
FIGURE 95 IMPACT OF LIFETIME VARIATION ON THE FLOW OF IRON DISCARDED FROM IN-USE STOCK .....	206
FIGURE 96 IMPACT OF LIFETIME VARIATION ON IN-USE STOCK AND EOL RR .....	206
FIGURE 97 IMPACT OF LOWER LIFETIMES ON THE OBSOLETE AND IN-USE STOCKS.....	207
FIGURE 98 IMPACT OF IRON LOSS ON EOL RR .....	209





## *List of tables*

TABLE 1 CONTENT OF TRAMP ELEMENTS IN RAW MATERIALS AND ACCEPTABLE LIMITS IN STEEL PRODUCTS IN PERCENTAGE (ADAPTED FROM (BJÖRKMAN AND SAMUELSSON, 2014; KING, 2001).....	13
TABLE 2 EUROPEAN SCRAP QUALITY SPECIFICATION (EFR, 2007) .....	13
TABLE 3 SUMMARY TABLE OF MFA/DMFA STUDIES REVIEW.....	27
TABLE 4 IDENTIFIED DATA SOURCES FOR THE PRODUCTION OF PIG IRON .....	67
TABLE 5 IDENTIFIED DATA SOURCES FOR THE TRADE OF PIG IRON .....	68
TABLE 6 IDENTIFIED DATA SOURCES FOR THE PRODUCTION OF CRUDE STEEL.....	70
TABLE 7 IDENTIFIED DATA SOURCES FOR CRUDE STEEL PRODUCTION PER PROCESS.....	72
TABLE 8 IDENTIFIED DATA SOURCES FOR CRUDE STEEL IMPORTS AND EXPORTS .....	72
TABLE 9 IDENTIFIED DATA ON PRODUCTION, IMPORTS AND EXPORTS OF CAST IRON.....	73
TABLE 10 IDENTIFIED DATA SOURCES FOR PRODUCTION OF FINISHED STEEL PRODUCTS .....	74
TABLE 11 IDENTIFIED DATA SOURCES FOR TRADE OF FINISHED STEEL PRODUCTS .....	76
TABLE 12 COUNTRY-SPECIFIC DIFFERENCE BETWEEN IMPORTS AND EXPORTS OF STEEL PRODUCTS REPORTED BY HS AND SITC CLASSIFICATION OF UN COMTRADE, EU-15, 1990-2015.....	78
TABLE 13 IDENTIFIED DATA SOURCES FOR CONSUMPTION OF FINISHED STEEL PRODUCTS .....	79
TABLE 14 DATA PROVIDED BY WORLDSTEEL FOR INDIRECT TRADE .....	81
TABLE 15 IDENTIFIED DATA SOURCES FOR THE TRADE OF SCRAP .....	83
TABLE 16 SUMMARY OF MATERIAL FLOWS AND METHOD OF DEFINITION OF THEIR MASS .....	84
TABLE 17 ESTIMATION OF IRON CONTENT IN CRUDE STEEL .....	88
TABLE 18 GENERATION RATE AND IRON CONTENT OF BY-PRODUCTS OF BOF PROCESS (EXCEPT HOME SCRAP) .....	90
TABLE 19 FERROUS INPUT TO BOF (REMUS ET AL., 2003).....	92
TABLE 20 THEORETICAL AND MEASURED IRON CONTENT IN PROCESS SCRAP .....	94
TABLE 21 THEORETICAL AND MEASURED IRON CONTENT IN OBSOLETE SCRAP.....	94
TABLE 22 ESTIMATION OF IRON CONTENT OF PROCESS AND EOL SCRAP FED TO FURNACES .....	95
TABLE 23 BOF PROCESS SPECIFICATION APPLICABLE TO 2015.....	96
TABLE 24 ESTIMATION OF IRON CONTENT IN EAF DUST IN ACCORDANCE WITH STEEL TYPE .....	98
TABLE 25 FERROUS INPUT TO EAF (REMUS ET AL., 2003) .....	99
TABLE 26 EAF PROCESS SPECIFICATION APPLICABLE TO 2015 .....	100
TABLE 27 EXAMPLE OF OHF CHARGING USED ON A 100 T FURNACE (ADAPTED FROM (CAMP AND FRANCIS, 1920).....	103
TABLE 28 OHF PROCESS SPECIFICATION APPLICABLE TO 2015 .....	104
TABLE 29 GENERATION RATE, IRON CONTENT AND UTILISATION OF BY-PRODUCTS OF ROLLING AND FINISHING .....	106
TABLE 30 ROLLING AND FINISHING PROCESS SPECIFICATION .....	108
TABLE 31 GENERATION OF SLAG AND DUST IN DIFFERENT TYPES OF FOUNDRY FURNACES AND THEIR IRON CONTENT.....	109
TABLE 32 FOUNDRY PROCESS SPECIFICATION .....	111
TABLE 33 ANNOTATION OF FLOWS APPLIED FOR THE CALCULATION OF THE MASS FLOWS .....	112
TABLE 34 LIST OF ASSUMPTIONS APPLIED FOR ESTIMATION OF CRUDE STEEL PRODUCTION BY PROCESS .....	121
TABLE 35 COUNTRY SPECIFIC RESULTS OF COMPARISON OF SCRAP CONSUMPTION .....	127
TABLE 36 COUNTRY-SPECIFIC CALCULATION OF THE CONSUMPTION OF STEEL PRODUCTS .....	129
TABLE 37 COMPARISON OF STEEL DISTRIBUTION PER SECTOR .....	134
TABLE 38 EXAMPLE OF EUROFER MATRIX FOR FRANCE FOR 2005-2010 (EUROFER).....	135
TABLE 39 DESCRIPTION OF PRODUCTS CATEGORIES INCLUDED IN END-USE SECTORS.....	136
TABLE 40 COUNTRIES SELECTED AS A PROXY FOR ESTIMATION OF CONSUMPTION PER INDUSTRIAL SECTOR .....	137
TABLE 41 COMPARISON OF PROCESS SCRAP GENERATION RATE.....	139
TABLE 42 DATA DESCRIPTION FOR DEFINITION OF THE GENERATION RATE OF PROCESS SCRAP.....	140
TABLE 43 PROCESS SCRAP GENERATION RATE APPLIED IN THE PRESENT STUDY .....	141
TABLE 44 EXAMPLE OF THE HISTORIC EVOLUTION OF PROCESS SCRAP GENERATION FOR AUTOMOBILE SECTOR.....	142

TABLE 45 DISTRIBUTION OF FOUNDRY PRODUCTS .....	144
TABLE 46 WEIBULL PARAMETERS APPLIED IN THE PRESENT STUDY FOR SIMULATION OF FLOW DISCARDED FROM USE .....	151
TABLE 47 ALTERNATIVE ESTIMATIONS OF THE CONSUMPTION OF STEEL PRODUCTS .....	154
TABLE 48 COUNTRY-SPECIFIC COMPARISON BETWEEN THE CONSUMPTION OF STEEL PRODUCTS REPORTED BY ASU INDICATOR AND CALCULATED FROM THE PRODUCTION AND TRADE (HS) .....	155
TABLE 49 COUNTRY-SPECIFIC COMPARISON BETWEEN THE CONSUMPTION OF STEEL PRODUCTS REPORTED BY ASU INDICATOR AND CALCULATED FROM THE PRODUCTION AND TRADE (SITC REV.1) .....	157
TABLE 50 COUNTRY-SPECIFIC COMPARISON OF THE CONSUMPTION OF STEEL PRODUCTS ACCORDING TO VERSIONS 2 AND 3 OF CALCULATION .....	158
TABLE 51 DIFFERENCE BETWEEN SHARE OF INDUSTRIAL SECTORS DEPENDING ON DATA SOURCE .....	160
TABLE 52 SUMMARY OF VALIDATION METHODS.....	168
TABLE 53 RESULTS OF OPTIMIZATION ROUTINE FOR LIFETIME (YEARS), APPLIED BY PAULIUK ET AL. (2013) .....	182
TABLE 54 COMPARISON OF THE GENERATION OF EoL SCRAP BY INDUSTRIAL SECTORS, REPORTED IN DIFFERENT STUDIES.....	185
TABLE 55 MINIMAL, MAXIMAL AND AVERAGE VALUES OF EoL RR FOR THE PERIOD 1970-2015 FOR EUROPEAN COUNTRIES .....	192
TABLE 56 MINIMAL, MAXIMAL AND AVERAGE VALUES OF ORER INDICATOR FOR THE PERIOD 1970-2015 FOR EUROPEAN COUNTRIES.....	196
TABLE 57 IMPACT OF LIFETIME VARIATION ON THE IN-STOCK IN 2015, DETAILED BY INDUSTRIAL SECTOR .....	206
TABLE 58 IMPACT OF THE VARIATION OF THE LIFETIME ON THE DISTRIBUTION OF THE DISCARDED FLOW OF EoL SCRAP BY INDUSTRIAL SECTORS, 2015 .....	208

## *Acronyms and Abbreviations*

ASU	Apparent Steel Use
BF	Blast furnace
BIR	Bureau of International Recycling
BOF	Basic Oxygen Furnace
CR	Collection Rate
DMFA	Dynamic Material Flow Analysis
DRI	Direct Reduced Iron
EAF	Electric Arc Furnace
EoL	End-of-life
EoL RR	End-of-Life Recycling Rate
EU	European Union
EW-MFA	Economy-Wide Material Flow Accounting
HS	Harmonized System
IRT M2P	Institute of Technological Research on Materials, Metallurgy and Processes
ISSB	International Steel Statistics Bureau
LCA	Life Cycle Assessment
LCI	Life Cycle Inventory
LIVES	Lifespan Database for Vehicles, Equipment, and Structures
MFA	Material Flow Analysis
NACE	Statistical classification of economic activities in the European Community (from French « Nomenclature statistique des Activités économiques dans la Communauté Européenne »)
NSR	New Scrap Ratio
OHF	Open Hearth Furnaces
OSR	Old Scrap ratio
PR	Processing Rate
RC	Recycled Content
RIR	Recycling Input Rate

SITC	Standard International Trade Classification
SFA	Substance Flow Analysis
STAF	Stock and Flow project
WBCSD	World Business Council for Sustainable development
WCED	World Commission on Environment and Development
WEEE	Waste Electrical and Electronic Equipment
UN	United Nations
UNEP	United Nations Environmental Program

## *Introduction*

National economies and social well-being rely on the use and the availability of natural resources. The growing extraction and production of materials, and the associated environmental impacts have made the sustainable management of natural resources one of the priorities of the global and national political agendas. Recycling contributes significantly to the optimisation of the use of natural resources. Important quantities of materials are accumulated in the anthroposphere in the form of goods providing social and economic functions. These materials constitute a future source of secondary materials for recycling. From the viewpoint of management and exploitation of accumulated materials, comprehensive information about the flow and stocks of materials and substances in the anthroposphere is necessary, as well as about the efficiency of resource recycling.

Ferrous metals, being important structural materials, are particularly interesting because of their ability to be recycled almost indefinitely. The estimation of recycling efficiency is important at an industrial level for design, reporting and for marketing support. However, the reported information varies considerably depending on the definition of indicators, studied perimeters and applied methodologies. Metals available for recycling today are directly linked to past production, as they generally remain in use for many years. In order to estimate the recycling efficiency with respect to the total quantity of metal produced historically, it is necessary to consider the accumulation of metals in anthroposphere.

In the present study material flows of steel and cast iron are investigated for the European Union of 27 countries during the period 1945-2015. Dynamic Material Flow Analysis (MFA) has been used as a tool for the estimation of these material flows, their accumulation in the anthroposphere and scrap availability for recycling. The originality of this approach is to focus on the iron content of ferrous flows in order to consider its evolution along the lifecycle, whereas it has traditionally been assumed that steel is composed only of iron. The results of the model are further used for estimation of the recycling efficiency indicators.

The present thesis is subdivided into six chapters.

Chapter 1 presents the general context of the study and the motivation of the industrial partners for developing a better estimate of the recycling efficiency of ferrous metals. The research problem is defined, as well as the tool applied - Material Flow Analysis - on the basis of the motivation to quantify material flows and stocks for estimation of recycling efficiency in European countries.

Chapter 2 provides definitions of the goal and scope of the study – what is the conservative material on which the study focuses and what are the geographical and temporal boundaries. It does so by reviewing the existing literature on flows and stock of iron and steel and points to a proper methodology for modelling of material flows and stocks of iron and steel, with a critical view on the limitations of existing approaches.

Chapters 3 and 4 are dedicated to the construction of the model used in the present work.

Chapter 3 defines in detail the methodology, the flows and processes taken into consideration, the method used for estimating the stock, and explains the reasons for these choices.

Chapter 4 presents all the data necessary for the calculation of material flows and stock: it provides a review of available statistical data and, by selecting an appropriate data source, defines the iron content of all flows on the basis of a literature review and of a collaboration with industrial partners. It also establishes process-specific mass balance equations for steelmaking processes and foundries, and assumptions applied to the calculation of material flows and stocks. Sources of uncertainty are also discussed.

Chapter 5 defines indicators for estimation of the recycling efficiency on the base of the defined system.

Finally, Chapter 6 provides the results for iron flows, stocks and recycling efficiency indicators in EU-27 and in individual countries. This chapter also discusses the availability of end-of-life scrap, and investigates the impact of previous assumptions on results.

## Chapter 1 Context of the study

The objective of the first chapter is to provide a context of the present study and to introduce the research problem. This chapter is subdivided into four parts:

- The first part describes the background of the thesis: importance of natural resources and associated concerns.
- The second part presents the context of the study and reasons to focus on ferrous metals in the European Union.
- The third part provides a description of the recycling system of ferrous metals, as a part of the background information.
- Finally, the fourth part explains the problems faced by industry, which motivated the origin of the present thesis.
- .





## 1.1 Background

Natural resources are essential for material needs of society. These resources provide raw materials for the production of materials, which are used for goods, further providing services. Goods-producing industries include mining, manufacturing, construction and agriculture, as they produce physical objects satisfying human needs, like housing, transportation, water, food or energy. Service-producing industries provide intangibles, comprising professional, consumer and governmental services, such as banking, communications, trade, engineering, medicine, defense and entertainment (UNEP, 2010a).

Economic development is therefore directly related to the use of raw materials. In developed countries resource demand is associated with the desire for a better life quality, while in developing countries this demand is driven by increasing urbanization, improvement of living conditions and rapid population growth (UNEP, 2011a). As a consequence, since the beginning of the 20th century, the production and use of materials on a global scale has increased exponentially, as shown in Figure 1, (Behrens et al., 2007; Krausmann et al., 2009; UNEP, 2011a; Worrell and Reuter, 2014). The largest amounts, but also the highest growth rates are observed for cement, steel and iron. During the last 20 years, this rise has mainly been driven by China and other developing countries, like India and Indonesia, due to their rapid economic growth, as pointed out in scientific publications and by international entities (OECD, 2015; Rankin, 2011; Worrell and Reuter, 2014).

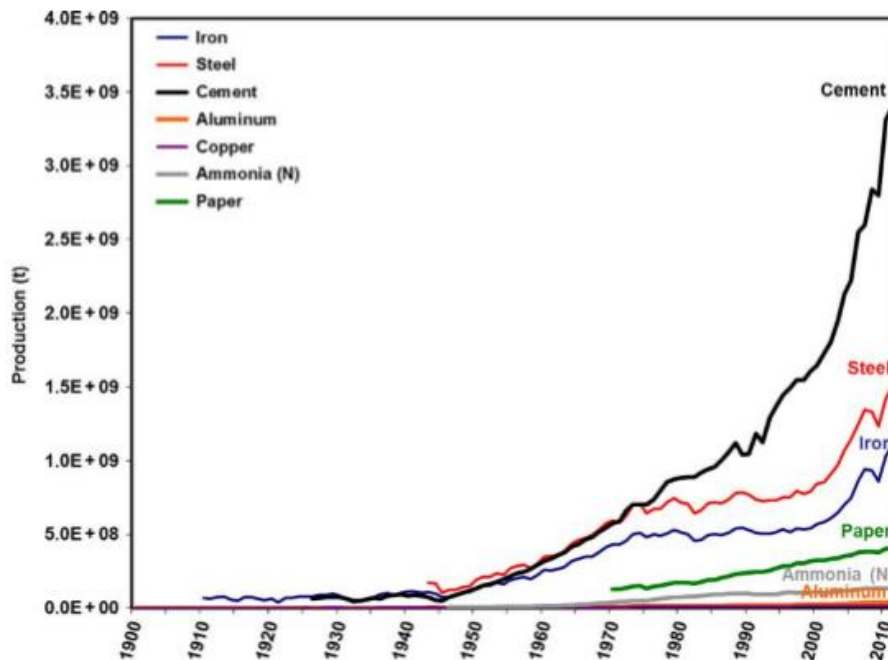

Figure 1 Global material production of key materials since 1900. Data: USGC (Source: (Worrell and Reuter 2014)

However, increasing consumption and production of natural resources raise concerns about several issues, as acknowledged by leading international environmental and economic organizations: the availability of natural resources, their unequal distribution on Earth's surface, and environmental pressures (OECD, 2015; UNEP, 2010b).

The **first concern** is related to the **availability of natural resources**. The discussion remains ongoing (Giurco et al., 2009), as two different paradigms can be distinguished. The first paradigm is called "fixed stock". It is based on the perception of Earth's resources as finite, so that increasing consumption would deplete these stocks. The time horizon of depletion depends on the rate of consumption. There are, however, several shortcomings to this approach. Materials can be recycled and reused thus diminishing the consumption of primary resources and postponing their depletion. Moreover, if the cost of a specific material increases because of depletion, it can be substituted by others. Finally, economic depletion<sup>1</sup> occurs before actual physical depletion, partially because of the increasing cost of exploration, extraction and processing. That is why Tilton argues in favor of the second paradigm, called "opportunity cost". It determines the availability of resources as a competition between (i) resource depletion, which increases the cost of the resource due to, for example, increasing rarity and associated extraction cost, and (ii) new technological advances, which could reduce this extraction cost, make progress in exploration, processing or recycling of obsolete products (Tilton, 2010).

From a historical point of view, the concern about resource availability can be summarized in three waves (Ruttan, 1996):

1. The first wave took place in late 1940s-early 1950s and was focused on the relationship between the growth in production and in consumption and the availability of non-renewable resources. This consideration led to a focus on efficient use of natural resources and improvement of technological efficiency.
2. During the second wave in late 1960s-early 1970s a new concern was added: the resilience of ecological systems to anthropogenic pollution. The 1970 report "The limits to growth" of the Club of Rome (also known as the Meadow report) exposed the negative impact of the exponential growth of population and consumption on resource depletion, pollution and deterioration of natural systems (Meadows et al., 1972). Since this work, the awareness of the finite nature of the biophysical boundaries of our planet has been gradually growing. Resource scarcity and consideration of ecosystems resilience to pollution were integrated into international and regional policy levels. In 1972, one of the principles adopted in the declaration of the United Nations (UN) Conference on Human Rights in Stockholm, stated that non-renewable resources must be used in such a way as to preserve them from exhaustion and be shared to all mankind.

---

<sup>1</sup> Economic depletion means the depletion of resources, when the increasing cost of extraction makes it non-profitable, since it equals or exceeds the market price of the resource

3. Since the mid-1980s a third group of concerns has been added in connection with environmental changes which impact on a global scale, such as global warming, ozone depletion, acid rain, and others. During this period the UN report “Our common future” (also called the Brundtland Report) popularized the term “sustainable development”, defined as "development which meets the needs of current generations without compromising the ability of future generations to meet their own needs" (WCED, 1987). Different interpretations of the integration of social, economic and ecological dimensions have resulted in weak and strong approaches to sustainability (substitutability versus complementarity of natural and human-made capital) (Costanza et al., 1997). Resource efficiency remains on the international political agenda of the UN (e.g. chapter 30 of Agenda 21 adopted at UN Conference on Environment and Development in Rio in 1992, and Goal 9 of agenda for “Transforming our world: the 2030 Agenda for Sustainable Development” adopted in 2015 at the UN Sustainable Development Summit in New York (called Rio +20)).

The **second concern** associated with increasing consumption and production of natural resources is related to the **unequal distribution of mineral reserves** on Earth's surface. Historically, mines were located in developed countries, and shifted to developing and newly industrializing countries in the middle of the last century, which then became major exporters of resources (Rankin, 2011; UNEP, 2011a). Indeed, the extraction of mineral resources in many developed countries is not economically competitive due to the decrease of ore concentration and increased difficulty of exploration and mining due to social factors (opposition, population density, labour costs) (Rankin, 2011), but also due to low cost of sea transport.

Unequal distribution also implies that resources are traded all over the world, since not all countries have enough resources to satisfy their economic activity and be independent of others. In order to protect and support national resources, some exporting countries take measures in the form of export taxes, barriers and escalating prices. These restrictions contribute to geopolitical issues and economic vulnerability of countries dependent on exports.

The **third** group of issues is related to the **environmental pressure** associated with the extraction of natural resources, their transport, processing to produce materials and goods, use and disposal (related to the third wave of concerns about resource availability). The extraction of raw materials has a direct impact on ecosystems<sup>2</sup> and landscape. Pollution and waste generated during extraction and further stages of the life cycle cause the degradation of the environment and its ecosystem services, but also impact human health (OECD, 2015; UNEP, 2010b). As a consequence, one drawback of the shift of mine locations to developing countries is that they face problems related to the destruction of the environment and poor social conditions of miners.

---

<sup>2</sup> An ecosystem is a dynamic complex of plant, animal, and microorganism communities and the nonliving environment interacting as a functional unit (Millennium Ecosystem Assessment, 2005)

These issues perfectly illustrate the importance of materials' exploitation for humankind's development. As previously said, materials are interconnected with natural resources, technology, environment and economy. This in turn makes resource use a central question for mankind.

In order to meet the growing demand for materials and to reduce associated environmental impacts, the efficiency of resource and materials use must be improved. The concept of material efficiency (Allwood et al., 2011; Worrell et al., 1995) or eco-efficiency (Huppel and Ishikawa, 2005; WBCSD, 2000a, 2000b) refers to the concept of providing material services while reducing resource consumption and associated environmental impact. The World Business Council for Sustainable Development (WBCSD), one of the most influential international association of companies promoting a sustainable future for business society and the environment encourages different strategies for the improvement of material efficiency (WBCSD, 2000b):

- Reduced material and energy intensity;
- Maximized use of renewables;
- Extended product life;
- Increased service intensity;
- Enhanced recyclability;
- Reduced dispersion of toxic substances.

The present work is positioned in a framework of current concerns related to recycling ability. Recycling reintroduces discarded material into a new cycle. Life cycle of a material or product is a series of stages that materials or products undergo during their lifetime, starting from the extraction of raw materials, production of the material, further transformation into product, packaging, distribution, use and the End of Life (EoL) treatment. The material cycle is often open: once extracted, transformed and used, materials are partially recycled and partially discarded to the environment. The material loops can be closed if products or their parts are reused or if materials from discarded products are recovered and inserted into a new cycle. Thus, recycling can contribute to resource efficiency by generating a secondary raw material and displacing the need for extraction and production of a primary resource. From this point of view, the materials stored in the economy in the form of infrastructure, buildings, transport, equipment and goods (the anthropogenic stock), represent a significant source of secondary resources (Birat, 2012; Gordon et al., 2006; UNEP, 2010c) (Birat, 2012; Gordon et al., 2006; UNEP, 2010c), which has been exploited through recycling.

## 1.2 Context and scope of the study

The present study was conducted at the Institute of Technological Research on Materials, Metallurgy and Processes in Metz, France (IRT M2P) ([www.irt-m2p.eu](http://www.irt-m2p.eu)). The work is a part of the project “Raw material and recycling in Life Cycle Assessment”, which aims (i) to contribute to a resource efficiency and (ii) to reduce the environmental impact related to materials. The project is supported by five industrial and two academic partners:

- ArcelorMittal – an international integrated steel and mining company, represented by experts from the department of Global Research and Development Scrap Quality & Steel Recycling;
- Constellium - a global producer of aluminum products, represented by experts from the Technological Centre;
- Safran – an international high-technology group specializing in aviation, space, defense and security sectors;
- Renault – a French multinational automobile manufacturer, part of the Renault-Nissan Alliance, which is the largest automobile producer in the world;
- Derichebourg - a global operator in environmental services to businesses and to local and municipal authorities and a major scrap dealer;
- The University of Technology of Troyes;
- The University of Lorraine.

**The present study focuses on ferrous metals.** Ferrous metals englobe iron and iron-based alloys, meaning that the primary composition elements are alloys of iron and carbon, other elements are present only at a significantly lower level of concentration compared to iron and carbon. Ferrous metals can be broadly grouped in two categories, depending on the amount of carbon:

- Cast iron - group of alloys composed of iron, carbon (2-4%), silicon (1-3%) and other alloying elements (like nickel, copper, manganese, chromium, molybdenum, titanium).
- Steel - a material composed of iron, carbon (0.005-2.0%) and other elements. Steel covers a broad series of iron alloys, from mild steels (i.e. steel with very low level of carbon, less than 0.2%), to high-alloy steels.

Ferrous metals are important structural materials widely used in numerous economic sectors, like construction, infrastructure, machinery and equipment for households and industry, etc. As noticed by the Global Metal Flows Group of the UNEP:

*“Modern technology is totally dependent on perhaps four of them (structural materials) – the iron and manganese that (with minor amounts of other metals) form structural steels, the aluminium widely used in transportation, the lead used for storage batteries, and the copper that transmits power from the generator to the user” (UNEP, 2010c).*

In 2015, world crude steel production was 1.6 billion tons and 166.1 million tons in the European Union (EU) (Worldsteel, 2016). Iron and steel industry uses about 99% of mined iron, the remaining 1% being used for production of catalysts and pigments (Cornell and Schwertmann, 2003). This study focuses solely on materials produced by iron and steel industry. Due to their importance for society and extensive use, ferrous metals represents a common material of interest for the thesis industrial partners.

Ferrous metals are studied within the spatial boundaries of the European Union (EU) of 27 members. The EU-27 comprises the following Member States: Austria, Belgium, Bulgaria, Cyprus, Czech Republic, Denmark, Estonia, Finland, France, Germany, Greece, Hungary, Ireland, Italy, Latvia, Lithuania, Luxembourg, Malta, Netherlands, Poland, Portugal, Romania, Slovak Republic, Slovenia, Spain, Sweden, and the United Kingdom. These boundaries were defined before Croatia joined the EU and before initiation of Brexit talk.

This perimeter is selected because the EU constitutes an open market, which behaves in many respect as a regional political entity, and to be coherent with the European legislative framework. Over the past decades, European policies addressed the improvement of resource use and material efficiency. Challenges related to the sustainable management of resources and wastes are addressed in the Europe 2020 Strategy, which aims at the long-term to create a “smart, sustainable and inclusive growth” (EC, 2010). The meaning of these 3 priorities is to develop an economy based on knowledge and innovation, promote resource efficiency, greener and more competitive economy and foster a high-employment economy delivering social and territorial cohesion.

The Roadmap to a resource efficient Europe is a part of the "Resource Efficient Europe" Initiative of the Europe 2020 Strategy. One of the goals of the Roadmap is to increase recycling and use of anthropogenic resources – materials present in society and that can be fed back into the economy as a secondary raw material. The Roadmap defines the framework for implementation, sets up milestones and actions to be reached by 2020. In 2015 the European Commission adopted Circular Economy package to stimulate the transition toward circular economy, where

*“the value of products, materials and resources is maintained in the economy for as long as possible, and the generation of waste minimized”* (EC, 2015).

The European objective of transition from a linear approach of waste management to a circular one, contributes to the boost of competitiveness, creation of jobs and sustainable growth by closing loops in material cycles (EC, 2015). The Circular Economy package consists of revised legislative proposals on wastes and EU Action plan for the Circular Economy. EU represents then a coherent geographical and legislative framework, with accessible data, to conduct the present study.

### 1.3 Recycling of ferrous metals

A product reaches its EoL because of failure (fatigue, wear, corrosion or erosion) (Rausand and Høyland, 2004) or because it is discarded by its user (Müller et al., 2007). Once discarded, products become a potential source of secondary raw materials: the closure of the materials cycle relies on **recycling**. As defined by the Directive 2008/98/EC of the European Parliament and of the Council on waste (EP, 2008), recycling is

*“any recovery operation by which waste materials are reprocessed into products, materials or substances whether for the original or other purposes.”*

Steel can be recycled nearly indefinitely (Birat et al., 2013). It is the most recycled material in the world. According to the Bureau of International Recycling (BIR), in 2015 90.61 million tons of steel scrap were used for steelmaking in EU-28 and 555 million tons on a World scale (BIR, 2017). The recycling of steel reduces the quantity of waste and decreases energy consumption compared to primary production: for example, the production of steel by scrap-based steelmaking (in electric arc furnace) requires only 20% of energy compared to the integrated route (basic oxygen furnace) (Birat et al., 2013).

Recycling consists of the operations of collecting, pre-processing and processing of EoL products. Steel and iron scrap available for recycling originates from three sources, so the stages of collection and pre-processing may have different levels of complexity:

- **Home scrap** is generated during steel and iron production, for example defective products, cut offs of billets and slabs, etc. Home scrap in principle has a known composition, can be easily collected and sorted by steel grade and does not need pre-processing. This type of scrap is recycled internally within the steel mill and does not usually enter the scrap market (Gros, 2007; King, 2001).
- **Process (or prompt) scrap** is generated during the manufacturing of final goods from steel products and includes leftovers from cutting, extruding, stamping or machining. It is considered as high-quality scrap, as it does not need pre-processing, except cutting to size. The scrap is mostly handled by scrap processors and dealers, but can be sent directly to steel mills or foundries (Gros, 2007; King, 2001).
- **Old scrap** consists of iron and steel originating from products, which have been discarded after the end of their use (like EoL vehicles, ships, electric appliances, buildings, etc.). The collection process involves the removal of EoL products from the user’s premises and their transport to a treatment facility. Ferrous scrap is collected separately or as a mix with other materials. Due to the use of iron and steel in goods from different industrial sectors, more actors are involved in the collection of old scrap than of home and process scrap: waste operators, targeting the needs of local communities; retailers, taking back old products upon purchase of new ones; installers of

technical equipment in buildings; scrap processors, serving industries and merchants, and wrecking companies for buildings or automotive sector (Gros, 2007).

Modern products contain many components made of a variety of materials, necessary to provide the intended functions of the product. At the end of their use, products generate a complicated flow of combined materials which can be difficult to separate (Graedel and Reck, 2014; Rankin, 2011; van Schaik and Reuter, 2004). To recover valuable materials from collected EoL products, they are pre-processed. It includes, disassembling (manual and/or mechanical) to separate parts to be reused and to liberate materials, and further sorting with various processes according to the type. Steel can be separated fairly easily from other materials with the help of mechanical processes, like shredding, and magnetic separation due to its magnetic properties (Birat et al., 2013). However, steel as an alloy, contains metallurgically-bounded elements that are difficult to separate. Moreover, EoL scrap is often mixed with or coated by other elements, like zinc, cadmium, aluminum, chrome or nickel, which are not retrieved individually in the end-processing as it is usually organized. This is why EoL scrap contains a higher level of tramp elements than home and process scrap.

The last step of recycling consists of reintroducing the secondary materials into a new cycle. This plays an important role in closing the material cycle, as it recycles steel scrap into a new material cycle. One of the main challenges for scrap recycling is to provide a scrap of a defined quality with a content of tramp elements as low, as possible. Steel producers, on their side, aim to maintain the quality of steel and to avoid contamination with tramp elements (Gros, 2007; Rankin, 2011). Thus, the efficiency of this step relies on the quality of the recovered materials produced during pre-processing. For efficient metal recycling, the chemical composition of the materials recovered in waste collection and separation plants must match specifications of scrap quality.

Tramp elements are defined as elements that are present in steel and difficult to remove by current metallurgical processes (Björkman and Samuelsson, 2014; Rankin, 2011). Typical tramp elements in steel are copper (Cu) (from electrical components, especially in car bodies), tin (Sn) (from tinplate and tin-based solders), chromium (Cr), nickel (Ni), molybdenum (Mo) (elements added intentionally in alloy steel), lead (Pb) (used as alloying element in some engineering alloys, from solders and brasses), antimony (Sb) (from brasses and lead-based alloys), bismuth (Bi) (used as alloying element) and arsenic (As) (used as a pigment in glass and, occasionally, as an alloying agent in copper) (Bell et al., 2006; Rankin, 2011). Table 1 illustrates the typical content of tramp elements (expressed as Cu+Cr+Ni+Mo+Sn, percent by weight) in various raw materials and their acceptable limits for different steel products (Björkman and Samuelsson, 2014; King, 2001). It can be noted, that high quality steel products, like sheets for car bodies or for tinplate, require a low level of impurities, which can be achieved by mixing scrap and primary iron, while other steel products, like steel for reinforcement bars, can be produced from lower grades of scrap.



Table 1 Content of tramp elements in raw materials and acceptable limits in steel products in percentage (adapted from (Björkman and Samuelsson, 2014; King, 2001)

Raw materials	Content of tramp elements, %	Steel products	Content of tramp elements, %
Direct reduced iron	0.02	Auto body sheet	0.08
Pig iron	0.03-0.06	Tinplate	0.12
Scrap No. 1 bundles	0.13	Wire rod	0.18
Scrap No. 1 heavy melting scrap	0.20-0.36	Commercial quality sheet	0.22
Shredded scrap	0.40-0.51	Special bar quality	0.25-0.35
Scrap No. 2 bundles	0.61	Building sheet	0.30
Scrap No.2 heavy melting scrap	0.70-0.73	Merchant bar quality	0.50

Another example of tracking tramp elements is the European Scrap Quality Specification, defining limits for tramp element contents in different scrap qualities (Table 2) (Birat and Zaoui, 2002; EFR, 2007).

Table 2 European Scrap Quality Specification (EFR, 2007)

Name	Symbol	Origin	Composition			
			Steriles <sup>3</sup>	Cu (%)	Sn (%)	Other metals (Cr, Ni, Mo)
Obsolete scrap	E3	"heavy" demolition (buildings, ships, bridges); homogenic composition, good quality	< 1	< 0,250	< 0,010	< 0,250
	E1	"light" demolition (equipment; poor quality, oxidation)	< 1,5	< 0,400	< 0,020	< 0,300
Low-residual scrap	E2	busheling	< 0,3		< 0,300	
	E8	busheling	< 0,3		< 0,300	
	E6	new bundles	< 0,3		< 0,300	
Shredded scrap	E40	EoL vehicles, Waste Electrical and Electronic Equipment (WEEE), furniture (low quality)	< 0,4	< 0,250	< 0,020	unspecified
	E46	incinerated packaging	unspecified	< 0,500	< 0,070	unspecified
Turnings	E5H	homogeneous	known from actual analysis			
	E5M	heterogenic	unspecified	< 0,400	< 0,030	< 1,000
High-residual scrap	EHRB	reinforcing bars, wire	< 1,5	< 0,450	< 0,030	< 0,350
	EHRM	mechanical pieces	< 0,7	< 0,400	< 0,030	< 1,000

From a material's (steel) perspective, most of the alloying elements that give steel its properties are present in low composition and mostly oxidize when scrap is remelted (C, Si, Mn, etc.) (Birat et al., 2013).

<sup>3</sup> Non-metallic residuals

However, the removal of Cu, Sn and Sb presents the biggest challenges for steel recycling because of their physical and thermodynamic properties (UNEP, 2013). Alloying elements, like nickel, tungsten, molybdenum and cobalt have a lower affinity for oxygen than iron, thus they cannot be removed by oxidation and they stay in metallic iron (UNEP, 2013).

Four main ways exist to deal with the problem of tramp elements in metals, applied independently or in combination (Rankin, 2011):

1. Separation is a physical removal of tramp elements during pre-processing. It can be performed easily for simple products, but for complex products like electronic equipment it is difficult or impossible.
2. Dilution is used to decrease the concentration of tramp elements by addition of primary material to correspond to the desired alloy requirement. For example, operators of furnaces use alternative sources of iron, like direct reduced iron, which is not contaminated by tramp elements (King, 2001; Rankin, 2011; Remus et al., 2003).
3. Refining comprises technologies for diminishing the concentration of tramp elements, but it can be expensive and technically difficult. For example, scrap thermal and/or chemical pretreatment in solid state and treatment of molten metal (i.e. vacuum distillation for removal of copper and tin) (Savov et al., 2003).
4. Downgrading is a production of a lower grade material, that can be acceptable for other applications.

## 1.4 Problem definition

To stimulate the EU's transition towards a circular economy, the EU Action Plan for the Circular Economy defines implementation measures related to four stages of the value chain:

- Product design – promotion of a better product design that improves product reparability, durability, upgradability and recyclability;
- Production processes – promotion of sustainable sourcing of raw materials, efficient material use and lower waste generation;
- Consumption – actions related to purchasing decisions (e.g. environmental labelling, price, guarantee), innovative forms of consumption (e.g. shared use, sell of service instead of a product), extension of product's lifetime through reuse and repair and decrease of household waste;
- Waste management and re-introduction of the secondary raw materials in a new material cycle. Actions related to waste management aim to encourage a closure of material loops by promotion of high-quality recycling, collection, material sorting and reducing landfilling and incineration. To promote the re-introduction of the secondary raw materials in a new material cycle the Action Plan shows the need in quality standards for secondary raw materials, simplification of waste transportation between EU countries, assessment of interaction of legislation on waste, products and chemicals.

To assess the progress toward circular economy the Action Plan underlines the importance to have a set of reliable indicators. Indicators are used in order to ease the understanding of complex physical, economic or social systems in respect to a specific question (Gallopín, 1997), as the progress toward circular economy or efficiency of recycling. Generally, indicators aggregate several numerical data in one number to reflect a particular property (key information) of the system. When applied over a period of time, indicators show trends in relation to the goal. Indicators are used in different fields (e.g. economic, social, environmental, sustainable development indicators, etc.) for comparison (e.g. with a baseline), communication and reporting, as well as for assessment of system condition in respect to the target. To reflect the main elements of the circular economy, the Action Plan stipulates to complement the existing indicators (Resource Efficiency Scoreboard and the Raw Materials Scoreboard) by indicators related to the security of raw materials supply, repair and reuse, waste generation, waste management, trade in secondary raw materials, and the use of recycled materials. The Action Plan also considers the need to address issues related to the calculation of recycling rates for the improvement of comparability between countries.

In this context of transition to the circular economy, efficient use of resources and enhanced recyclability, industry is concerned about having a clear vision of the entire material lifecycle – on resources being

extracted, materials produced, the mechanism of material use in different sectors and recycled flows. Such integrated material perspective contributes to:

- the knowledge of the overall magnitude of material flows, including the availability of secondary resources;
- the strategy development of the industry;
- the reduction of supply dependency and price volatility.

The present work focuses on the need of knowledge of material flows for ferrous materials.

The transition to higher material recycling also involves the **need for recycling indicators**. In case of recycling-related indicators, industry may use them to answer different questions, for example:

- does a company/facility achieve objectives fixed by legislation;
- how does material produced by a company/facility perform comparing to others in the sectors or comparing to other competitive materials;
- how material circularity is integrated within a company;
- what is overall recycling of scrap and by-products;
- what is the performance in EoL scrap recycling.

Currently, the calculation methods employed for recycling indicators differ depending on approach. For example, the main indicators applied previously to iron and steel are recycled content (RC), old scrap ratio (OSR) and End of Life Recycling Rate (EoL RR). Depending on the geographical perimeter studied, time period and methodology applied, available ranges of estimates show that:

- the RC varies between 28% and 52% (UNEP, 2011b);
- the OSR varies between 52% and 65% (UNEP, 2011b);
- the EoL RR is between 52% to 90% (Davis et al., 2007; UNEP, 2011b).

One reason of this variability is the **definition** of the recycling indicators, which is not uniformly applied by all stakeholders. For example, the definition of recycled content indicator may be used interchangeably, being sometimes applied to the level of material production (e.g. relationship between ferrous scrap and steel products) and sometimes to the level of material consumption (relationship between ferrous scrap and total input of primary and secondary material). Another example is the EoL RR indicator: it may include data only on EoL scrap, or data on process and EoL scrap summed up. In case of considering process scrap, the indicator does not reflect the efficiency of recycling of old scrap anymore and leads to an artificially higher value of the indicator. Moreover, sometimes recycling indicators are communicated without any background information, making it impossible to understand data used for the estimation of indicator and good interpretation of the results.

Another source of difference in estimated recycling indicators is the **calculation method** employed:

- Indicators can be estimated directly, by what we call "ad-hoc models" - a model built for a particular purpose, that cannot be generalized or adapted for other purposes. Example is the model of Philippe Russo of ArcelorMittal aiming at calculation of an EoL recycling efficiency directly (Russo, 2014).
- Indicators can be inferred from a Material Flow Analysis (MFA) model – a model of a well-defined system in terms of flows, processes and stocks, preferably a time-dynamic MFA (DMFA) model.

Additionally, some recycling indicators, like collection rate and EoL RR, require data on the total quantity of material available for recycling. The information on the availability can be estimated through different approaches, for example:

- application of metal content to reported/estimated waste flow of EoL products;
- by dividing the recycled EoL scrap by the efficiency of every step of the recycling system (collection and processing);
- application of lifetime distributions for end-use sectors (inferred from mining or production data).

The first two approaches reflect only the efficiency of collection and dismantling and do not take into consideration the linkage between recycling, material production in the past material production and time period during which the material remains in use. Material stock creates a linkage between the current flow of materials available for recycling and past material production (Pauliuk and Müller, 2014; Weisz et al., 2015). The third approach considers material stock and, thus, represents a more rigorous method, as it ensures the respect of mass balance principle through the time.

Yet another source of difference is the **reference frame** in which the analysis of recycling is carried out in terms of space and time, such as world, or country, or Europe, and the present year, or the last 10 years or the whole period since the end of the Second World War.

The methodological framework of **Material Flow Analysis** is widely used for **the physical quantification and analysis of material flows and stocks within a system defined in space and time, based on the mass balance principle** (Brunner and Rechberger, 2004). Previously, MFA was applied to iron and/or steel flows in order to:

- understand the distribution and the magnitude of material flows (Cullen et al., 2012; Moll et al., 2005; Wang et al., 2007),
- estimate material stocks (Daigo et al., 2007; Davis et al., 2007; Geyer et al., 2007; Müller et al., 2006; Pauliuk et al., 2013b; Wang et al., 2015)
- evaluate current and future scrap availability (Birat and Zaoui, 2002; Hatayama et al., 2010; Oda et al., 2013).

Results of MFA can also be further applied to the definition of actions aiming at the improvement of material efficiency (Cullen et al., 2012), the reduction of environmental impact (Moll et al., 2005), the

exergy analysis<sup>4</sup> of the steel sector (Michaelis and Jackson, 2000a, 2000b) or to evaluate the recycling performance (Chen, 2013; Daigo et al., 2015; Davis et al., 2007; Glöser et al., 2013). Nevertheless, MFA, being a powerful and rigorous tool for studying of material flows and stocks, has still not been explored a lot as a base for the estimation of material recycling indicators for ferrous metals.

In addition, to the consideration of material stock, three points are essential for a sound estimation of recycling efficiency of ferrous metals. First, the consideration of both materials, steel and cast iron. Iron and steel industries are partially fed by iron, extracted from iron ore, and by scrap. Scrap consumption is interrelated between these industries: cast iron production uses steel process and EoL scrap, while steel production consumes EoL cast iron. Thus, foundries generate an additional demand for scrap, and, at the same time, cast iron is itself a source of scrap. In order to have a complete picture of materials involved in recycling, both industries, steelmaking and foundry must be included in the study.

Second, the consideration of the variation of the iron content along the lifecycle of both ferrous metals. For example, iron ore, pig iron, steel and foundry products have different iron content. Focusing on scrap, the iron content also differs, depending on its origin:

- home and process scrap are considered high-quality scrap because they are not contaminated, their iron content is the same or close to the iron content of the alloy of crude steel used;
- the iron content of EoL scrap is lower than in steel, because of oxidation and contamination by other materials, coatings or paint, which were not removed during the separation stage of recycling (Fick et al., 2017).

Figure 2 illustrates the variation of the iron content in different flows related to the lifecycle of steel – from iron ore to EoL scrap. This overall review of iron content is based on a literature review (Ashby and Jones, 2013; Astier, 2005; Babich et al., 2008; Birat and Zaoui, 2002; EFR, 2007; Gros, 2007; King, 2001)). These examples show that the quantity of iron supplied for recycling by ton of steel and ton of cast iron (or by a ton of process scrap and a ton of EoL scrap) differs. This variation must be taken into consideration in order to ensure the mass balance of the system.

---

<sup>4</sup> Exergy of a system or a product is the maximum amount of useful work that can be obtained from this system or resource when it is brought to equilibrium with the surroundings through reversible processes in which the system is allowed to interact only with the environment (Dewulf et al., 2008)

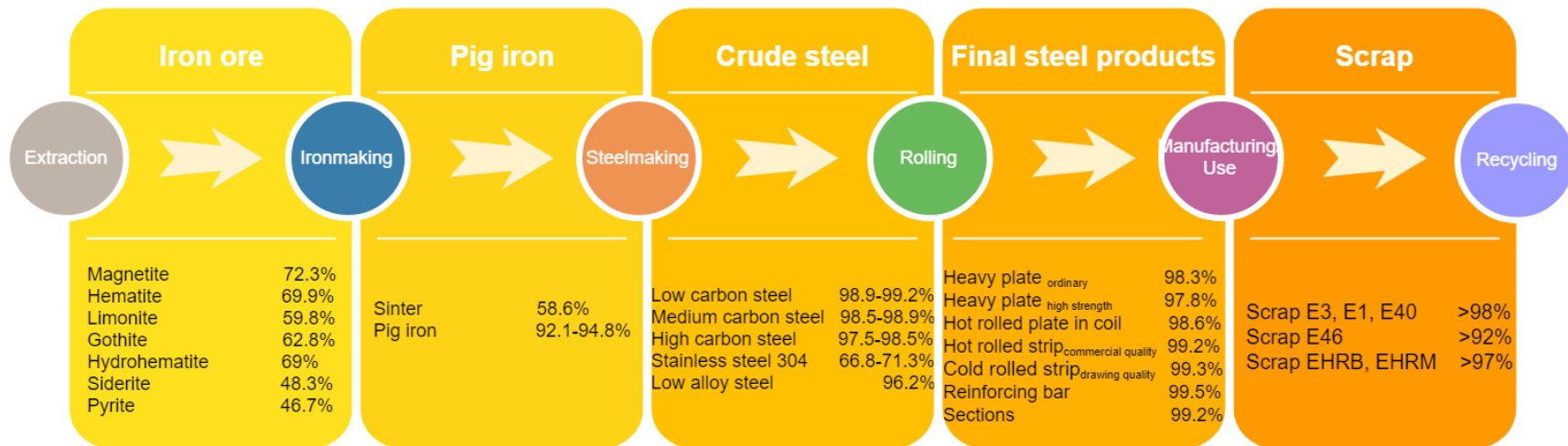

Figure 2 Concentration of iron during steel life cycle

Finally, the third point is related to the estimation of flows needed to calculate the recycling efficiency. Indeed, material flow data might be imprecise, affected by errors and uncertainties or simply are not known and therefore have to be estimated. A particular attention must be paid to the estimation of flows that impact the recycling efficiency for the reliability of the estimation.



## Chapter 2 Research basis

The present chapter analyses the current scientific and grey literatures<sup>5</sup> on the quantification of material flows and stocks applied to iron and steel. The review shows a lack of studies focusing on the estimation of recycling indicators especially within a European perimeter. The chapter further defines the objective and scientific contributions of the thesis.

The first part of the chapter explains the main concepts of MFA, as a theoretical background for the overview of methodological choices applied in previous steel and iron-related MFA studies and their adequacy for estimation of recycling. Peer-reviewed scientific literature is the main source of information, and collaboration with industrial partners made it possible to include another MFA study conducted internally at ArcelorMittal (thus being part of the so called grey literature).

The second part states the objective and put forward the scientific contribution based on that literature review.

---

<sup>5</sup> Grey literature - literature produced on all levels of government, academics, business and industry in electronic and printed formats but not controlled by commercial publishers (Auger 1998)



## 2.1 Literature review

### 2.1.1 Key concepts of Material Flow Analysis

Baccini, Bringezu, Brunner, Daigo, Gerst, Graedel, Kleijn, Rechberger, Udo de Haes and Van der Voet have reached a consensus about the terminology used in MFA studies (Baccini and Brunner, 1991; Birat et al., 2014; Bringezu and Moriguchi, 2002; Brunner and Rechberger, 2004; Gerst and Graedel, 2008; Udo de Haes et al., 1997; Van Der Voet, 2002). One of the main methodological guidelines for MFA practitioners, written by Brunner and Rechberger (Brunner and Rechberger, 2016, 2004), summarizes the vocabulary and the procedure for conducting an MFA. The term “material” in MFA is used to include both substances and goods. *Substances* are defined, as in chemistry – a chemical element or a compound composed of pure elements. *Goods* are defined as substances or mixtures of substances that have a positive or negative economic value. According to Brunner and Rechberger, the investigated material must be conservative, i.e. not destroyed or transformed during its life cycle (Brunner and Rechberger, 2004) in order to ensure the mass balance of the system.

In MFA, a system is composed of a set of **interconnected processes, stocks and flows**, and their **interaction** with other processes beyond a set of well-**defined spatial and temporal boundaries** (Brunner and Rechberger, 2004).

**Processes** are natural or man-made successions of operations implying a physical transformation, transport or storage of substances and goods. Transformation can occur at any moment of the material life cycle, for example production of goods from materials or extraction of phosphorus from phosphate rock. Selected processes have to be representative to describe the functioning of the system and the issue investigated. Stocks are material reservoirs within the system analysed. **Stocks** can be constant, can increase, as a result of material accumulation or can decrease if the stock input is lower than its output.

**Flows and fluxes** are a movement of material between processes, connecting them with each other. Flows are expressed as units of mass per unit of time, while fluxes are measured as mass per time and generalised concept of cross-section. For example, the annual generation of municipal waste in France is a flow, while its annual generation per capita is a flux. In this case, the cross-section is a population, other examples could be a surface area or a household. According to Brunner and Rechberger (2004), the use of fluxes simplifies the comparison between different processes and systems. In practice, the word “flux” is rarely used in MFA studies. Flows or fluxes entering and exiting the process are called inputs and outputs, respectively, when they enter or leave the system, crossing its boundaries, they are called **imports and exports**.

**The spatial boundaries** of the system are defined by a territory. Here we adopt the definition of the term “territory” proposed by Moine, because of its systemic perspective (Moine, 2006): the territory is a complex system covering three dimensions:

- the material dimension perceives the territory as a geographical area, including its geosystem, anthropogenic, social and political systems;
- the organisational dimension defines the territory as a system of social and institutional stakeholders, who use, develop and manage it;
- the identity dimension corresponds to the perception of the territory (individual, ideological, societal) by social and institutional stakeholders.

Following this definition, the MFA territory can be defined in different ways, depending on the subject of the study: it can be a firm, a city, a region, a country or the whole world. MFA can also be applied to a specific economic activity, for example, the agricultural sector or a waste treatment system.

**The temporal boundaries** define the period over which the system is analysed. They must be representative of how the system functions and should help formulate answers to the question raised in the study. Temporal boundaries can be retrospective (analysis of past flows and stocks), prospective (focusing on the forecast of future stocks and flows), a combination of both is also possible. Temporal boundaries are characterised by the reporting period and the time span of investigation:

- The reporting period is the period of reference covered by a particular set of physical or economic data. For example, statistical organizations report data monthly, quarterly or annually. In MFA studies, the reporting period is generally one year, because of data availability (in firms or on regional/national levels accounting and reporting are performed on an annual basis). In some cases, shorter reporting periods might be more adequate, like 1 month, 1 day or 1 hour, for example for investigating the material flows of a factory.
- The time span of the investigation defines for how long in the past and in the future the system is analysed. Depending on the research question, the time span of investigation can vary from one year (or one month, day, etc.) to longer time periods, like several years in the case of the study of materials used in long-lived products (e.g. cement or steel in buildings).

The definition of temporal boundaries determines whether the MFA system is modelled statically or dynamically. Static MFA models are a “snapshot of a system” (Gaustad et al., 2011) at a given instant; they describe the behaviour of the system at rest, its output depending only on current input. Dynamic models describe the behaviour of a system over an expected time interval. Its output depends not only on present input, but also on historical input, usually because there is a time delay between input and its effect on output. Dynamic modelling is further discussed in section 2.2.3, since it is the methodological focus of this study.

### 2.1.2 Literature review

The number of steel and iron-related studies in recent years has been growing, with increasing attention to anthropogenic stocks and to the availability of scrap. Material flows of iron and steel of varying scope have already been studied in terms of quantity, composition of the stocks and future availability. The methodology of MFA is considered as “firm” (Graedel and Lifset, 2016), i.e. capable of being unaffected by small variation in the procedure. A generic procedure of the MFA study is summarized in literature and consists of the following steps (Bringezu and Moriguchi, 2002; Brunner and Rechberger, 2004; Udo de Haes et al., 1997; Van Der Voet, 2002):

1. Definition of the goal and scope of the study
2. Identification of the processes representative for a studied system
3. Definition of material flows, stocks and concentrations and mass balancing
4. Modelling of material flows and stocks
5. Analysis of results

The variations include methodological choices applied in MFA studies, like definition of system boundaries, level of aggregation of processes and flows, consideration of temporal dynamics, approach for estimation of flows and stocks. These methodological choices can be performed in different ways, in order to be aligned with the study goal and to answer the research question, but they do not impact the methodology.

The focus of the present study is on applying MFA for estimation of recycling indicators for the spatial boundaries of the European Union. The aim of the literature review is to provide an overview of existing MFA studies for ferrous metals, analyze their objectives, system boundaries and associated methodological choices. With the perspective of the use of MFA for the estimation of recycling efficiency, methodological choices made in previous studies might be not representative. In addition to objectives and spatial boundaries, the following points impacting recycling estimation and presented in part 1.4 are addressed:

- need to consider material flows of both materials - steel and cast iron;
- need to express material flows of steel and cast iron in terms of their iron content in order to ensure the mass balance of the system;
- need to provide a detailed estimation of flows impacting the recycling. Simplifications may give a fair estimation of the magnitude of material flows and stocks, but recycling estimation needs a higher precision to be trustworthy.

The literature search is not limited to published peer-reviewed papers, but it also includes the grey literature. The search process resulted in the identification of 27 studies related to material cycle of iron

and steel. Since the present study focuses on overall flows and stock of iron and steel, exclusion criteria are defined:

- studies not published in English because of the language barrier (Hsu et al., 2010; Takamatsu et al., 2014);
- studies investigating particular alloy of steel or alloying elements, out of the scope of the present study (Daigo et al., 2010; Igarashi et al., 2007);
- studies aiming to estimate material stock or scrap generation in general or in particular sector, but not applying MFA approach, excluded for comparison reason (Gauffin et al., 2013; Hatayama et al., 2014; Hattori et al., 2013; Hu et al., 2010; Müller, 2006). Studies considering steel in a particular economic sector apply different methodology, and thus are not comparable with studies which consider the total flow and its distribution per sector. For example, estimation of the steel stock in residential buildings using population and its lifestyle as parameters (Hu et al., 2010; Müller, 2006) or using night time light satellite images (Hattori et al., 2013). Indeed, integration of sector-specific results in a global estimation of flows or stock could be strongly biased by variations in stock estimation methodologies. Three studies were excluded for this reason.

The application of exclusion criteria resulted in 18 academic papers suitable for consideration (summarized in Table 3) and two studies from the grey literature: the study carried out at Arcelor Mittal (Birat, 2017; Birat and Zaoui, 2002; Moreau, 2005) and the study from the European Topic Centre on Resource and Waste Management (Moll et al., 2005).

Table 3 Summary table of MFA/DMFA studies review

Author, publication year	Approach	Spatial & temporal scale	Study objective	Material/intermediate products #/end use #	Life cycles					Stock estimation	Retrospective/Prospective
					extraction	production	processing	use	EoL		
(Cullen et al., 2012)	static	global, 2008	mapping of flows	Cast iron and steel/19/10	x	✓	✓	x	x	x	retrosp.
(Moll et al., 2005)	static	EU-15, 2000	mapping of flows	Cast iron and steel/no/10	✓	✓	✓	✓	x	x	retrosp.
(Wang et al., 2007)	static	global, 2000	mapping of flows	Iron/7 /5	✓	✓	✓	x	✓	x	retrosp.
(Wang et al., 2015)	static	China, 2000 and 2010	Estimation of stock growth	Cast iron and steel/no/>250 subcategories grouped in 5 sectors	x	x	x	✓	✓	bottom up	retrosp.
(Yellishetty et al., 2011)	static	global, 1950-2005	estimation of flows and CO <sub>2</sub> emissions	Iron ore and steel/no/no	✓	✓	x	x	x	x	retrosp.
(Birat, 2017; Birat and Zaoui, 2002; Moreau, 2005)	dynamic	EU-15, 1950-1995	estimation of scrap generation	Steel/no/15	x	✓	✓	✓	✓	top-down	retrosp.
(Dahlström et al., 2004)	dynamic	UK, 1960-2001	estimation of stock and scrap generation	Cast iron and steel/no/9	x	✓	✓	✓	✓	top-down	retrosp.
(Daigo et al., 2007)	dynamic	Japan, 1920-2003	stocks assessment	Steel/no/7	x	x	✓	✓	✓	top-down	retrosp.
(Geyer et al., 2007)	dynamic	UK, 1970-2000	estimation of scrap generation	Cast iron and steel/no/9	x	✓	✓	x	x	top-down	mix
(Davis et al., 2007)					x	x	x	✓	✓		
(Hatayama et al., 2010)	dynamic	Global (42 countries), 2005-2050	estimation of future steel demand	Steel/no/8	x	x	x	✓	✓	top-down	prosp.
(Michaelis and Jackson, 2000a)	dynamic	UK, 1954-1994	analysis of material and energy flow	Cast iron and steel/no/no	✓	✓	✓	✓	✓	top-down	retrosp.
(Michaelis and Jackson, 2000b)	dynamic	UK, 1994-2019	scenario analysis of material and energy flows		prosp.						
(Müller et al., 2006)	dynamic	USA, 1900-2004	stocks assessment	Iron/no/4	x	x	✓	x	x	top-down	retrosp.

(Müller et al., 2011)	dynamic	US, AU, CA FR, JP, UK, 1900-2000	analysis of stock pattern	Iron/no/4	✓	✓	✓	✓	✓	top-down	retrosp.
(Oda et al., 2013)	dynamic	global, 1870–2012	estimate past and future scrap consumption	Cast iron and steel/no/7	*	✓	✓	✓	✓	top-down	mix
(Park et al., 2011)	dynamic	S. Korea 1993-2020	stocks assessment and future stock forecast	Steel/no/5	✓	✓	✓	✓	✓	top-down	mix
(Pauliuk et al., 2012)	dynamic	China, 1900-2100	forecast production, recycling, and iron ore consumption	Iron/no/5	✓	✓	✓	✓	✓	top-down	mix
(Pauliuk et al., 2013b)	dynamic	global, on country level, 1700-2008	mapping of flows and stocks	Iron/no/4	*	✓	✓	✓	✓	top-down	retrosp.
(Pauliuk et al., 2013a)	dynamic	10 world regions, 1950-2100	estimation of future steel demand and scrap availability	Iron/no/4	✓	✓	✓	✓	✓	top-down	prosp. (based on previous retrosp. study)



The review shows that previous studies mainly aim at the estimation of material flows and stock, as well as at the evaluation of current and future scrap availability; **recycling indicators for iron and steel were not in the focus previously.**

Regarding **spatial boundaries**, studies analysed were carried out at global and country levels. The European perimeter, which is the main interest in the present study, was previously investigated for 15 member states in a static study (Moll et al., 2005) and for 12 member states in a dynamic study (Birat, 2017; Birat and Zaoui, 2002; Moreau, 2005). Separate studies for steel were conducted for the United Kingdom (Dahlström et al., 2004; Davis et al., 2007; Geyer et al., 2007; Michaelis and Jackson, 2000a, 2000b). Information concerning some European countries can be obtained from global studies, where the global flow is based on the summary flows of individual countries (Hatayama et al., 2010; Pauliuk et al., 2013b).

It appears then that, until now, there has not been any detailed study for EU-27, probably due to the fact that MFA studies at EU scale requires a wide range of collected data. Furthermore, the European Union (EU) is dynamic in time, making up-to-date research results hard to maintain. For instance, only one publicly financed study has been conducted so far, investigating EU-15 at one year (Moll et al., 2005);

The objective of the study obviously impacts the **choice of material** to be investigated. The definition of the material is important because it establishes the basis for the mass balance and contributes to the definition of processes to be included in the study. In the studies analysed, three ways of addressing the **choice of the conservative material** for steel and cast iron can be distinguished:

1. the first group includes both materials, cast iron and steel, and selects iron as the conservative material, thus the mass balance of the whole system is based on this element. All flows are expressed in iron-equivalent by multiplying the flow of pig iron, cast iron and iron ore (estimated or quantified from statistical data) by respective iron concentration (Wang, Müller, and Graedel 2007; Pauliuk, Wang, and Müller 2013; Pauliuk et al. 2013; Pauliuk, Wang, and Müller 2012; D. B. Müller, Wang, and Duval 2011; D. B. Müller et al. 2006). The main assumption of these studies is that steel is 100% composed iron. The consideration of the *iron content* of ferrous metals makes it possible to estimate losses of iron to tailings ponds, slag repositories and landfills. However, the assumption that iron content in steel equals 100% neglects the presence of other elements in steel composition and the lower iron content of EoL scrap.
2. the second group also includes cast iron and steel but defines both of them as conservative materials. Thus, flows of steel and cast iron include all alloying elements (Cullen et al., 2012; Dahlström et al., 2004; Davis et al., 2007; Geyer et al., 2007; Michaelis and Jackson, 2000a, 2000b; Moll et al., 2005; Oda et al., 2013). This approach does not consider the variation of the iron content along the lifecycle. Also, it does not provide an explanation concerning the mass balance

for steel and cast iron in relation to the flow of pig iron and scrap, which is used for their production.

3. the third group focuses only on steel and does not include cast iron. In this case steel is defined as a conservative material. Most of the studies do not include steel production processes in the study and use information on steel production to calculate the generation of scrap and estimate stock in use (Birat, 2017; Birat and Zaoui, 2002; Daigo et al., 2007; Hatayama et al., 2010). One study includes iron extraction, iron- and steelmaking processes, without providing details concerning iron content and mass balances (Park et al., 2011). This study is similar to studies of the second group in terms of the processes included and limited discussion of the mass balance between steel production and the consumption of iron ore/pig iron.

Only studies of the first and third groups ensure the mass balance of the system: the first group considers the iron content of material flows and studies of the third group focus only on steel. As for the iron content, the assumption that steel scrap consists of 100% iron might have had an important impact on the estimation of the recycling efficiency of ferrous materials. As mentioned previously, following steel with assumption of 100% Fe excludes the presence of other elements in its composition. Moreover, the iron contents of steel and EoL scrap are not the same (Figure 2) due to remains of unwanted elements, such as paint or oxides and tramp elements with increasing number of recycling loops. The omission of this difference could then produce a model providing less precise results.

The objective of the study impacts also the **number of processes and the complexity of modelled system**. For example, if the objective is to investigate the in-use stock and the generation of old scrap, the consideration of production and processing stages is not necessary (i.e. (Daigo et al., 2007; Müller et al., 2006).

In previous studies the differentiation between steelmaking processes (BOF, EAF, OHF) is not always included, while the quantity of input materials (pig iron and scrap) depend on the type of steelmaking process. The detailed estimation of flows at the production stage is also informative regarding the quantity of generated by-products and their recycling at the production site. Losses during iron and steelmaking in the form of slag, sludge and dust were only addressed in a few studies (Moll et al., 2005; Müller et al., 2011, 2006; Pauliuk et al., 2013b, 2013a, 2012; Wang et al., 2007). The estimation of losses makes it possible to respect the mass balance by considering iron-bearing flows.

Another example demonstrates the difference in flow and process granularity between static and dynamic studies. In dynamic studies, focus is made on the material stock, material production being addressed in a simplified way and limited to the main flows and processes. In static studies, focus is made on transformation of material flows, resulting in a higher level of details on production and manufacturing stages, attributing a share of finished steel products consumption per industrial sector (Cullen et al., 2012; Wang et al., 2007). So, the distribution of finished products according to industrial sectors has never

previously been applied to a dynamic study. The inclusion of this distribution would offer a more precise estimation of generation of process scrap during the processing stage, due to the application of product-specific and sector-specific rates instead of overall rate or only sector-specific rate. For example, in the dynamic study Hatayama et al. applied a process scraps generation rate of 19% for the automotive sector (Hatayama et al., 2010), but in the static study Cullen et al. shows for the same sector the rate of 10% for wire rods, 40% for cold rolled sheets and 20% for merchant bars (Cullen et al., 2012), thus offering more adjustable calculations and better precision.

During an MFA study, data gathering and handling is reported to be the most time- and resource-consuming stage: the information has to be gathered from many sources and should be representative of the system under investigation. Most data used in MFA studies results from statistics. However there is a limited discussion concerning the reliability of these sources, which was also mentioned previously (Gerst and Graedel, 2008). For example, in the case where several institutions collect/report the same data, it is necessary to verify whether those values are coherent. Data gathering and handling is then an extremely important step, to be conducted with great care.

In general, two approaches to recycling are distinguished in literature – product-centric and material-centric (Reuter et al., 2005; UNEP, 2013). The material-centric approach focuses on recycling the materials, disregarding the type of goods, of which they are part. The product-centric approach considers the recycling of goods, as a whole, taking into consideration simultaneously all materials of the EoL goods. These two approaches explain the existence of recycling indicators focusing on the efficiency of the recycling of products and on the efficiency of recycling of materials. MFA studies focused on the characterization of the material cycle might be used for the estimation of the efficiency of material recycling, disregarding the type of product (such as buildings, EoL vehicles, WEEE, etc) containing the material.

As discussed in part 1.4, the definition of recycling efficiency indicators is not generally accepted. UNEP and Chen summarized indicators for material cycle (Chen, 2013; UNEP, 2011b). UNEP provides indicators for a simplified material cycle on the global scale (UNEP, 2011b). These indicators must be adapted for a regional scale in order to consider trade flows. Chen reviewed these indicators with application to the aluminium cycle in the USA, and extended them with indicators related to stocks (Chen, 2013). He categorized indicators into four groups:

- the first group of indicators is related to the measurement of the recycling efficiencies of EoL scrap at the stage of Waste management and recycling. They evaluate the efficiency of the collection system (EoL collection rate), of dismantling and separation (EoL processing rate), and of the recycling of old scrap (EoL recycling rate).
- The second group of indicators compare the use of new and old scrap with the total consumption of scrap in metal production. It includes two indicators Old Scrap Ratio and New Scrap Ratio,

estimating the fraction of consumed old scrap or new scrap (home and process) related to the total scrap consumption.

- the third group compares the use of EoL scrap to the total metal input from primary and secondary raw material. This indicator is called Recycled Content.
- finally, the fourth group includes indicators aiming at the share of metal in sinks in relation to the cumulative flow of metal entering in use. These sinks include:
  - o Metal accumulated in use;
  - o Metal lost to the environment: in the case of steel it is iron lost due to corrosion and iron contained in by-products, which are recycled externally (e.g. road construction, concrete production) or landfilled. Thus, the metal is lost to further recycling.
  - o Metal lost due to export for recycling in the country where metal is generated.
  - o Metal lost in unspecified sinks, which includes possible net export of EOL products, hibernating stock, losses in the collecting process. Hibernating stock, also referred as obsolete stock, is composed of goods that are no longer in use, but are not collected yet (Bringezu and Moriguchi, 2002; Daigo et al., 2007; Elshkaki et al., 2004; Kapur and Graedel, 2006).

MFA is widely accepted tool to provide quantitative evaluation of material recycling. Previously MFA was used for estimation of various recycling indicators, mostly for metals. Graedel et al. provides an overview of available estimates of recycling rates for 18 metals (aluminum, chromium, cobalt, copper, gold, iron, lead, manganese, nickel, niobium, palladium, platinum, rhenium, rhodium, silver, tin, titanium and zinc) (Graedel et al., 2011). Moreover recycling indicators were inferred from MFA models for aluminium (Buchner et al., 2014; Chen, 2013) and copper (Glöser et al., 2013). Estimation of the recycling indicators was not in a focus previously for ferrous metals, as summarized in Table 3. Only three of reviewed studies estimated the recycling efficiency for steel:

- ad-hoc model of Russo estimated the global EoL RR of steel (Russo, 2014);
- dynamic MFA study of Moreau focused on EU-15 EoL RR of steel (Birat, 2017; Birat and Zaoui, 2002; Moreau, 2005);
- dynamic MFA study of Davis et al. inferred UK recycling rate in 2001 for steel and cast iron (Davis et al., 2007).

The application of MFA for estimation of recycling efficiency obviously impact on the methodological choices, e.g. spatial and temporal boundaries, choice of investigated material, level of aggregation of processes and flows. In order to estimate recycling efficiency for ferrous metals it is necessary to define a representative conservative material, flows and associated processes to be considered in the system.

## 2.2 Goal and scientific contribution

**The aim of this thesis is to develop a model to calculate recycling indicators of ferrous materials based on the estimation of availability of secondary resources by analysis of material flows and simulation of the material stock in use according to its geographic distribution.**

The thesis builds on and contributes to work in the field of socioeconomic metabolism, focusing on material flows and stock of iron. Although a number of studies have examined material flows and stocks of steel and iron, there has not been a strong focus on the recycling efficiency indicators. Moreover, the thesis covers the perimeter of the EU, which previously was not fully considered in a dynamic study.

To contribute to the estimation of the recycling efficiency, additional insights are given about methodological choices, that might impact the result of recycling indicators. This focus brings the following points, providing a different perspective from previous studies:

1. Identification of material substance, representative for the investigation of the recycling

Expressing all mass flows in term of their iron content is a different approach compared with previous studies on iron (Wang, Müller, and Graedel 2007; Pauliuk, Wang, and Müller 2013; Pauliuk et al. 2013; Pauliuk, Wang, and Müller 2012; D. B. Müller, Wang, and Duval 2011; D. B. Müller et al. 2006). Considering flows of steel and cast iron, these studies took into account iron (Fe) concentration only for flows of pig iron, cast iron and steelmaking by-products. Furthermore they assumed that steel, steel products (intermediate and final steel products) and scrap are composed of 100% iron. These studies made this assumption supposing no or minimal impact on final results of stock due to a high iron content in steel. The present study provides data to estimate the relevance of this assumption.

In consequence, we conclude that only elemental iron must be considered as a conservative material to make it possible to respect the mass balance. Indeed, focusing on steel and cast iron would introduce high levels of uncertainty for the mass balance between input and output flows throughout the cycle being modelled (in particular, for the processes of steel production). Thus, the present study adopts a chemical engineering standpoint and **follows elemental iron (Fe)** and considers the iron content of all relevant flows.

This approach ensures the respect of the mass balance of iron, takes into account the presence of other elements in steel and cast iron, as well as variation of iron content along the material lifecycle (e.g. lower iron content of EoL scrap compared to home and process scrap due to contamination). Such a detailed consideration of the iron content for cast iron and steel flows was not previously applied either in dynamic, or in static studies. Expression of flows in terms of their iron content implies gathering data on mass flows, their iron content and by-product generation during production.

2. Granularity: processes and flows included in the study scope

Cullen et al. underline the importance of modelling the entire supply chain to understand the impact of material efficiency options (Cullen et al., 2012). In all previous dynamic studies, the modelling of the production and manufacturing phases is simplified compared to static studies. Dynamic studies are limited to the main flows and processes, focusing mostly on materials stock and the availability of EoL scrap. Static studies provide a detailed estimation of iron losses and model the link between steel products and industrial sectors (Cullen et al., 2012; Wang et al., 2007). The present study integrates the detailed modelling of production and manufacturing stages in a dynamic approach with the expectation that a broader definition of included processes will make it possible to realize more precise assumptions for building an overall model.

The modelling of the stages of production, processing and manufacturing differs from the previous dynamic studies for iron and steel in terms of included flows. In fact, inspired by static MFA studies, data is gathered to implement the following points in the dynamic study:

- For each process of the production stage, iron losses from iron-bearing by-products are calculated in details;
- For the process of processing and manufacturing this study established country-specific product-to-use matrices and calculated the flow of process scrap, taking into the consideration specific generation depending on the type of steel product and the industrial sector.

### 3. Verification of data and results

A close collaboration with the industrial partners made it possible to use data issued from industrial experience, and to compare current model results to these reference values. Results of this study provide information concerning the magnitude of material flows, accumulation of iron in use, the generation of different types of scrap throughout the lifecycle, the quantity of iron lost to further metallurgical use and the efficiency of recycling of EoL scrap. Results concerning sources of EoL scarp are compared with previous MFA studies, but also with industrial data on scrap purchases. This was not done previously, due to a limited data availability.

In addition, the model provides knowledge about the situation in small countries, usually aggregated with bigger ones or discarded as not representative or limited by data availability. These results should be relevant for further studies on planning of recycling facilities. The in-depth knowledge generated during the modelling of iron material flow could also be extended to other materials. Ultimately, improved knowledge of material cycles of different materials could be used:

- during product/service design stages to select the material best suited for the application, from the recycling perspective (current and future availability of materials);
- for Life Cycle Assessment studies as a robust information source.

To summarize, the methodology should be developed for a dynamic model of iron flows and stocks in EU-27 which further allows the improvement of MFA application for recycling indicators for iron over time. Dynamic modelling is more adapted than static modelling for understanding the evolution of the system, trends in production, manufacturing, use and recycling. Moreover, the consideration of material stocks is a basis for the estimation of the availability of secondary resources, respecting the mass balance between past production and current recycling. The methodology should also focus on the estimation of material flows contributing to the estimation of recycling efficiency, e.g. generation of home, process and EoL scrap, scrap consumption and trade, expresses in iron content. Data collection and selection process must be defined.





## Chapter 3 Development of model for the flow of iron in EU-27

The third chapter describes the methodology applied and system studied, making it possible to calculate availability of secondary resources and further to estimate the recycling indicators for ferrous materials.

In the first section of the chapter four steps of MFA methodology applied in the study are detailed – definition of the system, data collection, modelling and model results analysis.

The second section defines temporal boundaries of the studied system, discusses the issues related to data collection for a territory including numerous countries and explains how they are addressed.

The third section describes processes and flows included in the system in order to fulfil the aims of the study. All processes are grouped into four stages, corresponding to different stages of a material lifecycle – production, processing and manufacturing, use, waste management and recycling.

A summary of the chapter is given in section four.



## 3.1 Methodology

In order to construct a dynamic MFA model of iron for estimation of the recycling indicators as a function of its geographic distribution, the present study applies the following steps.

### 1. Definition of the system

This step defines processes and stock, as well as flows between processes and flows crossing system boundary.

### 2. Data collection for material flows and stocks

The second step include identification, selection and collection of the data necessary for the definition of mass flows and iron content of material flows. The identification of appropriate data is an important step in MFA as it constitutes the base of the model. Available sources can differ depending on considered data. Jay W. Forrester, a founder of system dynamics<sup>6</sup>, defined three sources of information useful for modelling (Forrester, 1980):

- a mental database: non-documented information, based on knowledge, experience and observation of the system and its behaviour;
- a written database: a record of a mental database in the form of published materials, such as articles, books, reports and notes;
- a numerical database: measured information available in a numerical form, such as time series data and values of parameters.

Forrester stresses the importance of a mental database, as a rich source of knowledge about the structure and functioning of a system, compared to both written and numerical databases (Forrester, 1992). A written database is a precious source of information because of its wide availability. Numerical databases are useful for the statistical overview of flows. The use of these three sources during modelling would lead to better progress in increasing and sharing knowledge (Ford, 2009). Thus, the present study aims to consider and consolidate these three available sources of information from literature, organisations providing statistical data, and industrial partners. Industrial organizations have an internal knowledge of their field, which is sometimes deeper than that published in the scientific literature. The possibility of including their observations in our model will make it more reliable for final industrial use.

---

<sup>6</sup> System dynamics investigates and models the dynamic behavior of complex systems, considering internal feedback loops and time delays, which impact the behavior of the system.

The data gathering process consists of four steps:

- the definition of available statistical and literature data;
- the definition of relevant data sources, and validation by industrial experts;
- the set-up of the database.

These steps are performed for every flow (variable) and parameter.

Several sources of data might be identified for a given flow or parameter. It is then necessary to prioritize available data sources to select the most appropriate one, using the following scale (from first to last priority):

- a. Publicly available and regularly updated, data from statistical or industrial organizations. These sources are presumed to be accurate and complete for European perimeter;
- b. Frequently updated, but not publicly available data from statistical and professional organizations/associations gathered through surveys of members;
- c. Literature data.

Selection according to this scale is first based on a review of all available sources, to determine data coherence: for instance, source 1 may provide wide range of data whereas source 3 only several data points, but source 3 could be preferred if source 1 shows high inconsistency. This review is based on four criteria on data quality (Di Zio et al., 2016):

- Relevance: the qualitative evaluation of the degree to which the data reflect the studied flow, as defined by ISO/TS 14048:2002. Data is considered as relevant if it corresponds to the investigated flow, and to both geographical and temporal boundaries;
- Completeness: availability of data compared to the total data of interest. Here the priority is given to the source covering more countries for longer periods of time;
- Coherence: the degree to which statistical data are consistent over time and with other logically connected data;
- Accuracy: the degree to which recorded data reflects the actual value.

Next to these quality criteria, attention is given to the availability of data in electronic format for time constraints: at equivalent quality, electronic format was preferred to published time-series, as the latter needs to be manually copied, increasing the risk of mistakes.

Finally, the whole selection process is validated in collaboration with industrial experts, regularly consulted for verification of data, methodology and followed hypothesis.

### 3. Numerical modelling of material flows and stocks

The modelling is based on the mass balance principle: the sum of the mass of all inputs of a process equals the sum of the mass of all its outputs and of the change of stock within a process:

$$\sum_{j=1}^i m_i = \sum_{j=1}^o m_j + \Delta S$$

where  $i$  stands for number of inputs,  $o$  – for number of outputs,  $m$  – material flow,  $j$  - number of substances,  $\Delta S$  – change in stock.

The mathematical model of MFA describes the relationship between elements of a system (defined during the first step of the MFA procedure in terms of mathematical functions. Mathematical functions consist of variables and parameters. Variables vary depending on conditions (for example, in time and space). Examples of variables are flows and stock. Parameters are items impacting the model, they reflect specific characteristics of the dynamic of the process and can either be constant or can change in space and/or time. Parameters connect variables in an equation and help to describe the system. In MFA, parameters are, for example, content of specific metal in different goods or process efficiency. The parameter “content of chromium in stainless steel” can be used to estimate the associated flow of this alloying element; process efficiency parameter is used to estimate losses.

To estimate material mass flows, process-specific mass balances are established here with the consideration of iron content of every flow. Calculation of mass flows are based on statistical data and process-specific mass balances.

The study used a top-down approach for stock estimation. This approach involves the quantification of annual production, its disaggregation to sector-specific consumption, and assumption of sector-specific lifetime distribution; thus, proceeding from a larger picture of the system to its disaggregation into sub-systems. The method derives the stock estimate as the sum of the initial stock in society and the cumulative difference between inflow and outflow (Birat et al., 2014; Gerst and Graedel, 2008; Liu and Müller, 2013; UNEP, 2010c), as shown in following equation:

$$S(t_n) = S(0) + \sum_{t=t_0}^{t_n} (I(t) - O(t))$$

where  $S(t)$  is the in-use stock at the end of year  $t$  as a function of time,  $n$  – considered year,  $S(0)$  – the initial value of the stock,  $I(t)$  – the inflow to the Use phase (consumption),  $O(t)$  – the outflow from the use phase (discarded material).

The top-down approach, starting from the production flow, makes it possible to track the material during material cycle and to investigate the magnitude of flows. It also provides information on the evolution of material use (Gerst and Graedel, 2008; Müller et al., 2006).

#### 4. Interpretation of quantitative results of the model

In addition to the estimation of the recycling efficiency indicators, the study also analyses results for material flows and stocks in order to understand the impact of assumptions applied on the results of indicators. The present study provides the following results:

- Illustration of an annual material cycle for EU-27 for a better understanding and visualization of the magnitude of flows with the help of Sankey diagram. A Sankey diagram is a graphic illustration of material flows, where the width of the arrows is proportional to the magnitude of flow;
- Results of stocks are represented by graphs showing stock evolution and the share of iron being in use in industrial sectors. These results are discussed and compared with previous studies;
- The availability of secondary resources is analysed. Results are shown for a total flow and for flows discarded by industrial sectors. Results are compared with previous studies. The availability of secondary resources can be approximated from industrial data on scrap purchase, provided by industrial experts. The comparison of obtained results with these data makes it possible to discuss the correspondence between MFA results and “real world”.
- Finally, estimations of the recycling indicators are analysed.

### 3.2 Temporal and spatial boundaries

**The temporal boundaries of the study** are set from 1945 to 2015. In fact, steel is present in products with lifetimes varying from one year (packaging) to several decades (construction and infrastructure). A long-time horizon of 70 years should therefore allow us to cover at least one cycle of products with a very long lifetime, which is necessary to track the dynamic behavior of iron stock. Moreover, the period since 1945 is a relatively politically stable one, allowing good data availability. **All flows** are expressed as annual rates of flow, **in tons per year (t/annum)**.

Within these temporal boundaries, the territory of the EU has evolved: from 6 countries in 1957 (Belgium, France, Italy, Luxembourg, the Netherlands and West Germany, which created the European Economic Community (EEC)) to 27 countries in 2007<sup>7</sup>. EU-27 comprises the following Member States (Figure 3): Austria, Belgium, Bulgaria, Cyprus, Czech Republic, Denmark, Estonia, Finland, France, Germany, Greece, Hungary, Ireland, Italy, Latvia, Lithuania, Luxembourg, Malta, Netherlands, Poland, Portugal, Romania, Slovak Republic, Slovenia, Spain, Sweden, and the United Kingdom. Overseas territories of EU countries are not included in the scope of the study.



Figure 3 European Union 27 (naic.edu)

<sup>7</sup> In 2013 Croatia became the 28th member.

Thus EU territory is dynamic, and still subjected to new changes (like withdrawal of the United Kingdom from the EU). The borders of several European countries also changed during the period of the study:

- Algeria was a part of France until 1962, then became an independent country. During the period of the study data was selected so as to refer to metropolitan France only, Algeria is not included;
- in 1989, the Berlin Wall was pulled down and East and West Germany were reunited in 1990. Before 1990, material flows of Germany were calculated by summing up consumption of East and West Germany. In this way, trade flows between them are not counted twice. After 1990 data for Germany is used;
- Slovenia has been an independent country since 1990. Earlier data was estimated from Yugoslavia's data, in proportion to the share of Slovenia's total flow in its first year with separate data;
- in 1993, Czechoslovakia was separated into the Czech Republic and Slovakia. To estimate the stock in both countries separately before 1993, the historical flows of Czechoslovakia are divided between the two countries in proportion to their share in the total consumption of the Czech Republic and Slovakia in the first year with separate data;
- since 1921 Belgium and Luxembourg have been members of the Belgium–Luxembourg Economic Union, established by the UEBL convention (or BLEU convention in French). Consequently, the international trade of these two countries has been reported as a whole since then. Country-specific statistics are available only since 1999, when the convention was amended to be in conformity with European community. Due to these data limitations, material flows and stock are calculated together for Belgium and Luxembourg.

Due to the evolution of the boundaries of the European Union, overall statistical data for EU-27 does not exist before 2007, which makes the estimation of material flows and stocks at the level of each individual country-member EU-27 more appropriate.



### 3.3 Identification of processes, stocks and flows

This section defines processes which are representative of the objectives of the study. Processes are grouped into four life stages, according to the literature: "Production", "Processing and Manufacturing", "Use", "Waste management and Recycling". Application of these four stages makes the model flexible and makes it possible to focus on a particular stage for more detailed investigation. These generic stages are in turn subdivided into relevant processes, to increase the system granulometry. This approach of connected, well-identified and separate modules makes it possible to visualize a complex system, such as the material cycle, in a concise representation.

Figure 4 shows all the processes related to the material cycle of iron – extraction and beneficiation of iron ore, ironmaking (including sintering, pelletization and blast furnace), production of crude steel, steel products and cast iron, processing and manufacturing of final goods, use and processes of waste management and recycling. From the perspective of the intended use of the model, not all the processes illustrated in Figure 4 contribute to the objective of the estimation of the in-use stock and recycling efficiency indicators. To estimate the in-use stock only, both input and output to this process must be calculated. To estimate the recycling efficiency, the study must consider all processes which:

- generate scrap: Blast Oxygen Furnace (BOF), electric arc furnace (EAF), Open Hearth Furnace (OHF), rolling and finishing, processing and manufacturing;
- consume scrap: BOF, EAF, OHF and foundries;
- handle scrap: processes of waste management and recycling stage.

The boundary of the present study is shown in red on the Figure 4. It includes the processes and flows considered, their detailed description is provided further. Other processes, which do not contribute to the estimation of stock and to the recycling of scrap (ironmaking, direct reduction and mining) are excluded.

The processes considered are related to the material cycle of iron extracted for the use in iron and steel industries (which represents 99% of the mined ore). Iron used as a pigment and catalysts (1% of the extracted iron) and iron present in natural global biogeochemical cycles (e.g. iron contained in rocks and water) are out of the scope of the present study, as only products of iron and steel industry are the main focus here. However, it has to be noted that there is an interaction between the defined system, the excluded processes and the environment. In fact, flows of iron leaving the system can be:

- recycled within excluded processes of ironmaking;
- recycled in other industries, like cement production or road construction, therefore they are considered as lost to further metallurgical use;
- landfilled, this iron is also considered as lost (but it might be collected and recycled in the future);
- lost to the environment due to corrosion or wear.

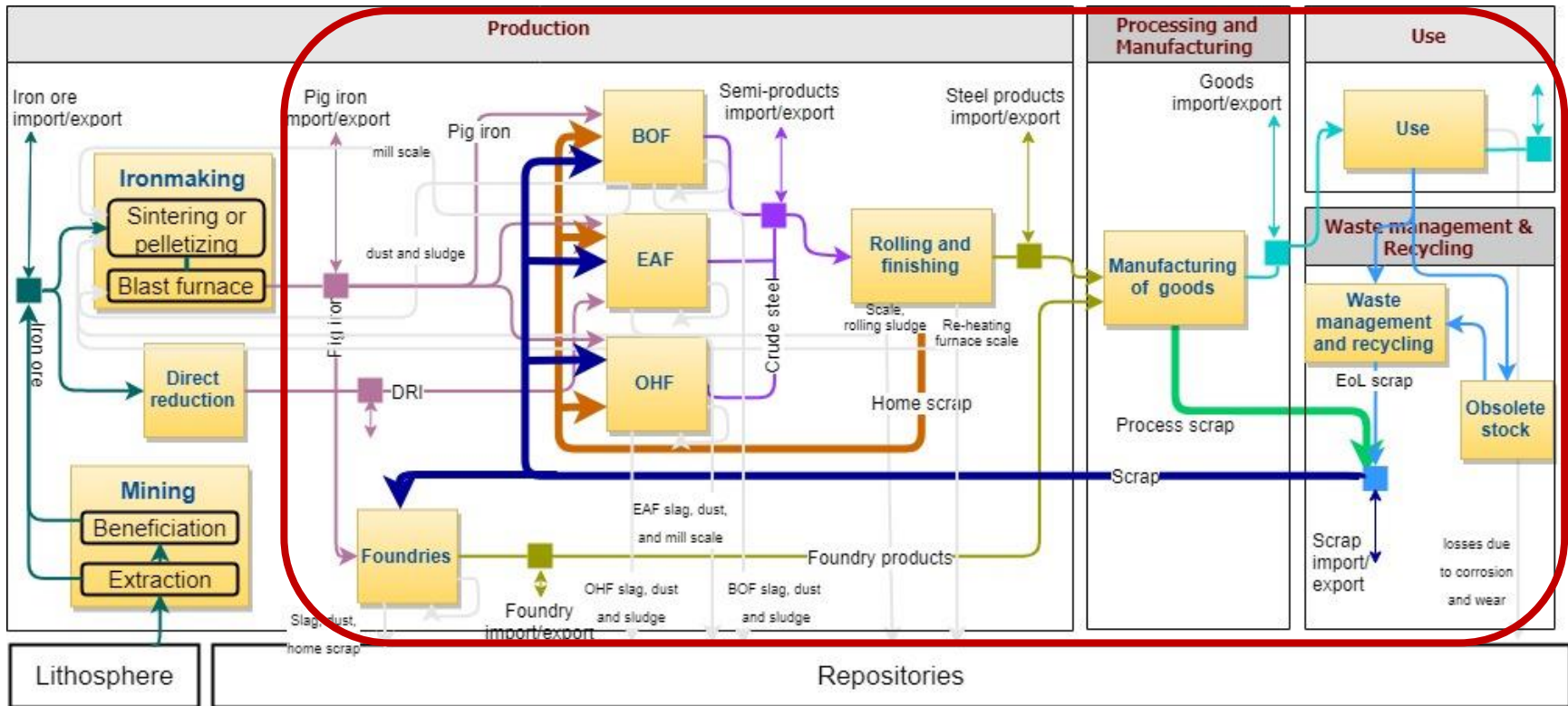

Figure 4 Processes and flows included in the present study

### 3.3.1 Production

This section describes the processes involved in the production stage of the iron and steel industry included in the model – from production of steel and cast iron to production of finished steel products and iron castings.

Production stage includes steelmaking processes (BOF, EAF, OHF), foundries, rolling and finishing. Currently, steel is essentially produced by two processes, which differ with respect to the raw material used:

1. the **integrated route**, also called the **primary route**, relies on iron ore as a raw material for the production of steel;
2. the **electric arc furnace (EAF) route**, also called the **secondary route**, which is fed by ferrous scrap as a raw material.

Historically, a third process of steel production was also used - (OHF). The numbers of these furnaces in Europe has dropped since 1970 disappearing completely in 2010. Figure 5 illustrates the fall in steel production by these furnaces. The main reasons for this waning are (i) their very low productivity compared to more recent processes, such as the integrated route or the EAF and (ii) the fact that OHF could not match the level of steel quality, achieved by more modern processes, which was desired (Birat, 2016).

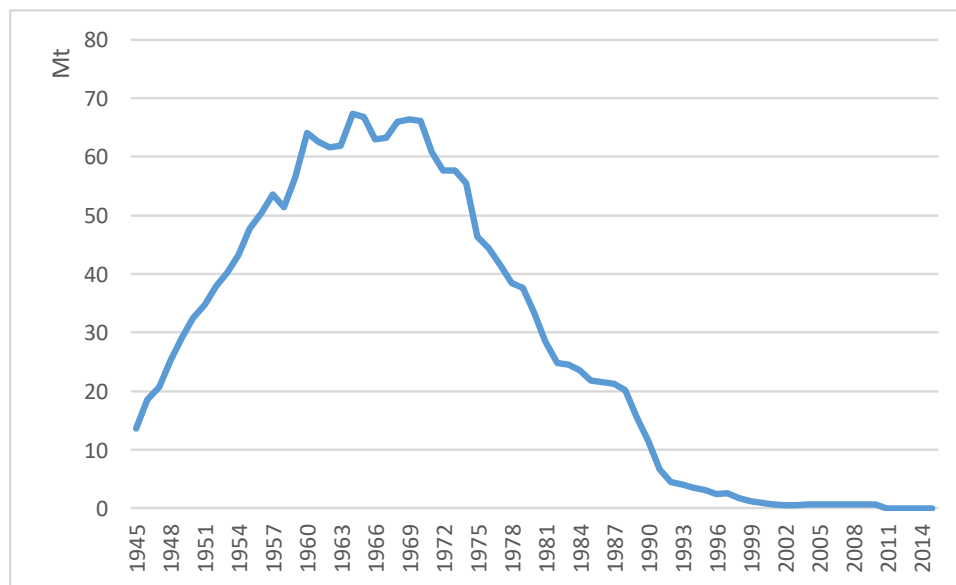

Figure 5 Production of steel in Open Hearth Furnaces in EU-27, 1945-2015, in Mt. (Worldsteel, British Geological Survey)

According to the defined temporal boundaries, all three steelmaking processes are considered in the present study.

Steelmaking processes produce liquid steel, which is further poured into a ladle for **secondary metallurgical treatment** (Figure 6). This stage is used for mixing and homogenising, removing excess oxygen and undesirable gases, adding alloying elements and trimming the temperature for casting. This step defines the final grade of the steel. Liquid steel is then **cast**, either in ingots (especially OHF steel), but mostly, today, in slabs, billets or blooms by continuous casting. These products are the first solidified form of steel, they can be commercialized as semi-products. In statistics, these ingots, continuous cast semi-products and liquid steel for foundry are termed “crude steel” (IISI, 1978).

Steelmaking processes, described further, aggregate the production of liquid steel, secondary metallurgy and casting. This aggregation is made for two reasons: first, to simplify the modelling, and, second, these processes are done without interruption during the production.

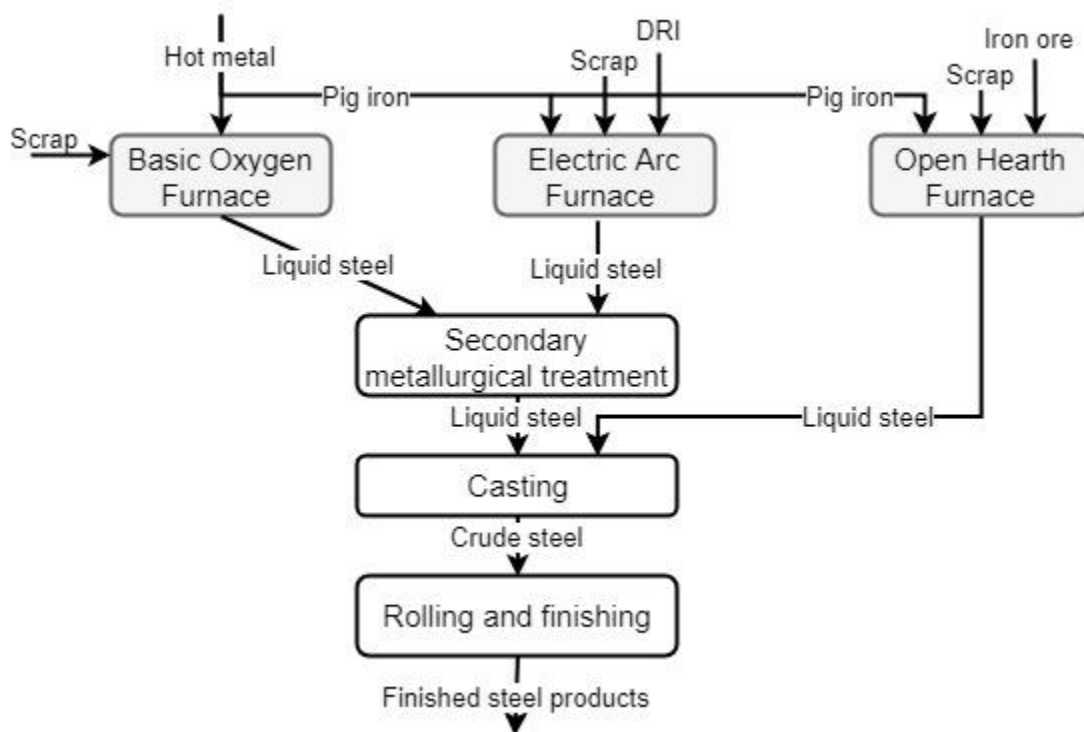

Figure 6 Steelmaking process

### Basic Oxygen Furnace steelmaking

**BOF** is a process used to produce liquid steel by blowing pure oxygen and simultaneously adding fluxing agents (mostly limestone and/or dolomite) to remove excess carbon and impurities from the input. In the European context, BOF is fed by hot metal<sup>8</sup>, produced in the blast furnace (a ferrous alloy of iron and

<sup>8</sup> The product of blast furnace is called hot metal in liquid form and pig iron in solid form.

carbon, also called pig iron in cold state), together with a smaller quantity of scrap, iron ore and other iron materials (DRI, oxides) (Remus et al., 2003). The present study considers only three sources of iron entering the process of BOF – hot metal, scrap (home, process and EoL) and other Fe materials (from internal recycling of slag), as illustrated in Figure 7. The use of iron ore (less than 2% (Remus et al., 2003)), is considered as marginal and is not included in the study.

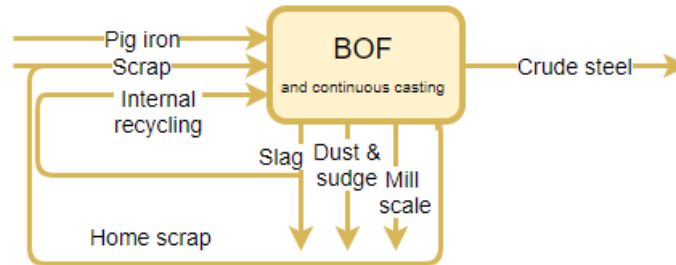

Figure 7 Flows related to the modelled BOF process

The BOF process produces crude steel and generates iron-bearing by-products (Figure 7):

- BOF slag –generated during the removal of impurities in the metal (carbon, silicon, manganese, phosphorus) with the help of fluxing agents. These impurities are separated from the liquid steel and constitute BOF slag. Prior to further use, the molten BOF slag is cooled, dried and processed by crushing, grinding and electromagnetic separation to remove the metallic part (called skulls or reverts). This metallic part is used internally in the steelmaking furnace, while most steel slag is used in road construction, in cement clinker manufacturing processes, temporarily stored or landfilled (Euroslag website, 2017).
- dust and sludge - generated during the cleaning of off-gases emitted during the steelmaking process. These gases are reused as an energy source in the plant, but have first to be purified in order to meet purity requirements. Coarse dust is removed with dust-catchers or cyclones and fine dust is separated by wet scrubbing, forming BOF dust and sludge. Dust and sludge, after preparation, can be partially reinjected into the blast furnace; however this recycling is limited by the zinc content of dust and sludge (Atkinson and Kolarik, 2001; Das et al., 2007; Remus et al., 2003; U.S. Department of Energy, 2016).
- home scrap – generated during the continuous casting of liquid steel from cut-off heads and tails of slabs and billet. It is entirely recycled in the furnace together with process and EoL scrap.
- mill scale – a layer of iron oxides formed on the surface of steel during the continuous casting and must be removed. It is frequently used in sintering (Remus et al., 2003).

The recycling of iron contained in slag (except iron recycled internally in the process), dust and sludge mill scale, is done in processes of ironmaking or in other industries. Since these processes are not included in the present study, flows of iron in slag, dust, sludge and mill scale leave the modelled system. Flows recycled in ironmaking enter it again in the composition of a flow of pig iron. Iron, which not recycled by

iron- and steelmaking is considered as lost for metallurgical purposes because its further recycling as a metal is not possible anymore.

### Electric Arc Furnace steelmaking

In EAF the charged materials are melted by means of an electric arc to produce liquid steel. Alloying elements may be added directly to the EAF or during secondary metallurgy treatment, as in the case of BOF steel production. Further, the same techniques are applied to the casting of EAF liquid steel as to BOF liquid steel (Remus et al., 2003).

Ferrous scrap is the main input to EAF. Pig iron and direct reduced iron (DRI)<sup>9</sup> are also fed into this process (Figure 8). The use of DRI in the EAF as a substitute to scrap, helps to deal with fluctuating prices (Grobler and Minnitt, 1999), availability of scrap (Astier, 2005) and to lower the concentration of metallic tramp elements, such as copper or tin (Astier, 2005).

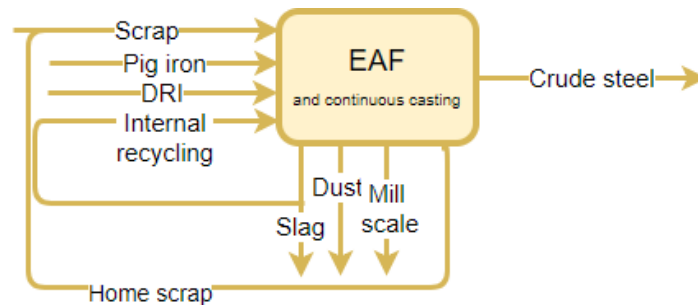

Figure 8 Flows related to the modelled EAF process

The production of liquid steel in EAF generates two iron-bearing by-products – steel slag (EAF slag) and dust (Figure 8). EAF slag is formed during the melting of scrap. Its processing is the same as for BOF slag: the molten slag is air-cooled in pits, crushed, screened, sized and subjected to electromagnetic separation. Part of EAF slag is used internally in the steelmaking furnace (Euroslag website, 2017). EAF dust is mainly landfilled, used in the external recovery of zinc or recovered through other processes (Remus et al., 2003). Two other by-products are generated during casting - mill scale and home scrap, as in the BOF process. Home scrap is recycled internally in the processes.

The EAF cannot recycle its own by-products in internal processes of blast furnace or sintering, as integrated steel mills can. Thus, the flows of iron contained in EAF and dust mill scale leave the system

<sup>9</sup> The process of direct reduction is an ironmaking technology, where the reduction of iron is carried out via a reducing agent (natural gas or coal) in the solid state. The product of direct reduction is called direct reduced iron (DRI) and consists of metallic iron, unreduced oxides, carbon and gangue. Direct reduction occurs at high temperature, below the melting point of iron and therefore, does not involve a liquid phase. For this reason, iron is not fully reduced and gangue elements are not removed in slag, like in the blast furnace. Unreduced oxides thus must be further removed, for example in the EAF.

under study and are considered as lost for metallurgical recycling. Non-recycled slag is also treated outside of the defined system.

### Open Hearth Furnace steelmaking

The OHF process produces steel from hot metal and scrap in OHF. Natural gas, coke oven gas, producer gas, powdered coal, fuel oil and, sometimes, tar are used for heating OHF, depending on their location. Melting temperature is reached through the preheating of combustion air. In OHF the charge is oxidized by the oxygen of the air in the furnace and by the oxygen contained in the iron ore, added for this purpose. Gangue elements with small amount of iron are removed with slag. After melting, different additives are added to the furnace bath to achieve the desired composition. Further liquid steel is cast.

The charge of OHF consists of pig iron, scrap and iron ore (Figure 9).

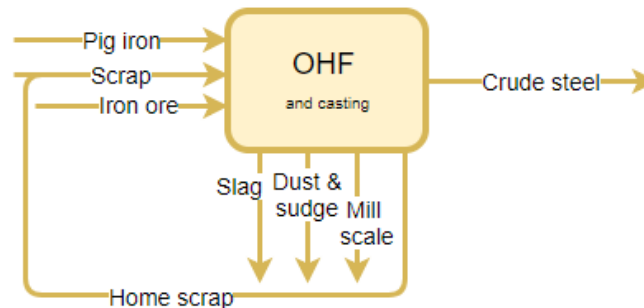

Figure 9 Flows related to the modelled OHF process

Like BOF and EAF, OHF generates slag and gas. The latter is further used to heat stoves and to generate power after cleaning from dust. This cleaning generates dust and sludge, containing iron. OHF slag is not recycled internally; it is mostly dumped or used for production of Portland cement (Camp and Francis, 1920). No information has been identified for the management of dust and sludge. It is assumed that they are not recycled within metallurgical processes, analogously to OHF slag. Casting generates a flow of mill scale and home scrap. It is assumed that casting by-products are processed, as during BOF: the mill scale is recycled in ironmaking and home scrap is recycled internally.

### Rolling and finishing

To reach the final shape of steel products, semi-finished products are **rolled** and subjected to hot and cold forming processes. Blooms and billets are used for long products, such as rods, bars or wires; slabs are used for flat products, like plates and sheets. Hot rolling and cold rolling are also aggregated in a single process called “Rolling and finishing”. Hot rolling process comprises conditioning the input, scarfing (removal of surface defects by an oxy-fuel flame), heating to rolling temperature, rolling and finishing. Cold rolling includes pickling, rolling, annealing or heat treatment, temper rolling and finishing (EC, 2001).

The process of rolling and finishing is fed by crude steel (slabs, blooms, billets, produced during continuous casting or ingots) and produces final steel products (Figure 10).

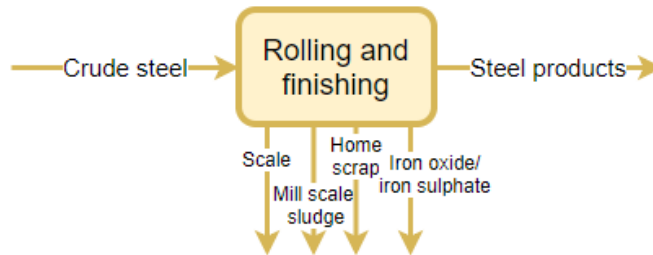

Figure 10 Flows related to the modelled process of rolling and finishing

Figure 10 also illustrates iron-bearing by-products formed during rolling and finishing process:

- mill scale is generated during hot rolling during removal of surface defects (scarfing, grinding and shot blasting), in re-heating furnaces and during descaling. Scale from scarfing, grinding and shot blasting is mostly recycled in the sinter plant, as well as re-heating scale (EC, 2001).
- mill scale sludge is generated during cold and hot rolling: water used for removing scale and impurities contains small solid particles, oils and greases, which are separated and form sludge. A small part of that sludge is recycled in the sinter plant, while this by-product is mainly landfilled or incinerated (U.S. Department of Energy, 2016). Information on the treatment of this by-product in a European context is not identified. It is thus assumed to be treated externally to the studied system.
- rolling also generates spent pickle liquor during acid pickling – a finishing process applied in hot and cold rolling aimed at removing scale from the metal surface. Spent pickle liquor contains up to 140 - 170 g Fe/t (EC, 2001). Spent pickle liquor is not further taken into consideration in the present study, because its iron content is lower than 1%.
- During regeneration of acid used for pickling, other iron-bearing by-products are generated – iron oxide or iron sulphate (depending on the acid used). This by-product is recycled externally: in waste water treatment or by the chemical industry (EC, 2001), so this flow leaves the modelled system.
- Home scrap also arises during operations of pickling and finishing (cutting off heads and tails). Usually home scrap does not leave the boundaries of the steel mill and is recycled internally in the steelmaking process.

## Foundries

Beside steel production, iron is also used in the foundry sector. The **foundry industry** manufactures products close to their finished shape (like engine blocks or components for machinery). The process of foundries process comprises all operations performed for production of cast iron products: melting,



casting or pouring, cooling and finishing. Within the foundry process numerous furnace types are applied: cupola; induction; rotary and electric arc furnaces.

The input flows to the process **of foundry** include pig iron, steel scrap and foundry home scrap (Figure 11). Four iron-containing output flows are related to the process: cast iron products, which are the main output, home scrap, slag and dust. Slag and dust are generated during the melting process, then further disposed of or used externally (i.e. in construction) (EC, 2005). Home scrap is produced during finishing, as returns from quality control and from production residues (like gates and risers). It can be only partially recycled by in the process due to technological limitations. For example, in steel foundries the reuse of home scrap is limited by the amount of dissolved oxygen and in nodular foundries by high amount of silicon (EC, 2005).

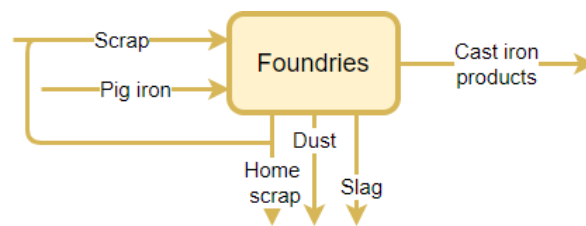

Figure 11 Flows related to the modelled Foundries process

### 3.3.2 Processing and Manufacturing

Steel and cast products are sold to many industrial sectors, like construction, the automotive industry, other transport (railway vehicles, shipbuilding), domestic equipment, etc. These sectors have specific needs in terms of types of steel products: depending on the expected function of the goods, specific characteristics are defined to ensure this service and to be compatible with the manufacturing processes (shape, size of steel product, grade and quality of steel, resistance to wear, etc.). For example, the construction sector mostly uses reinforcing bars, wire rods and hot-rolled strips, steel beams, merchant bars; the automotive sector purchases cold-rolled or coated sheets, hot-rolled strips, wire rods and merchant bars (Roesch, 2003).

The Processing and Manufacturing stage includes the process of manufacturing of goods. This process covers the most common operations for transformation of steel products into final goods<sup>10</sup> - cutting, hot and cold forming, machining, heat treatment, surface treatment and coating, mechanical assembly and control (Roesch, 2003). The process is subdivided into sub-processes corresponding to different industrial

<sup>10</sup> Final goods are goods produced for the use of consumers and not undergoing further processing.

sectors considered in the study (e.g. manufacturing of goods of construction, automotive, mechanical engineering, etc. sectors). All industry-specific sub-processes are illustrated in Figure 12.

The process is fed by steel and cast iron products. The present study distinguishes different types of steel products being transformed and their distribution by industrial sectors, as these two factors influence the quantity of process scrap generated during the manufacturing of final goods (Cullen et al., 2012; Hatayama et al., 2010). Products of cast iron are also distributed by industrial sectors, but they do not generate process scrap because they are integrated into final goods without much transformation. Process scraps can be melted directly within manufacturing facility (for example, automobile producers have foundries) or sold to recycler. This complexity is difficult to consider in the model, so a simplified case is assumed: the generated process scrap is sent to recycler. Process scrap is handled within a short period of time to avoid storage space and inventory control costs (USGS, 2003), so the study do not consider storage time, assuming that it is shorter than one year.

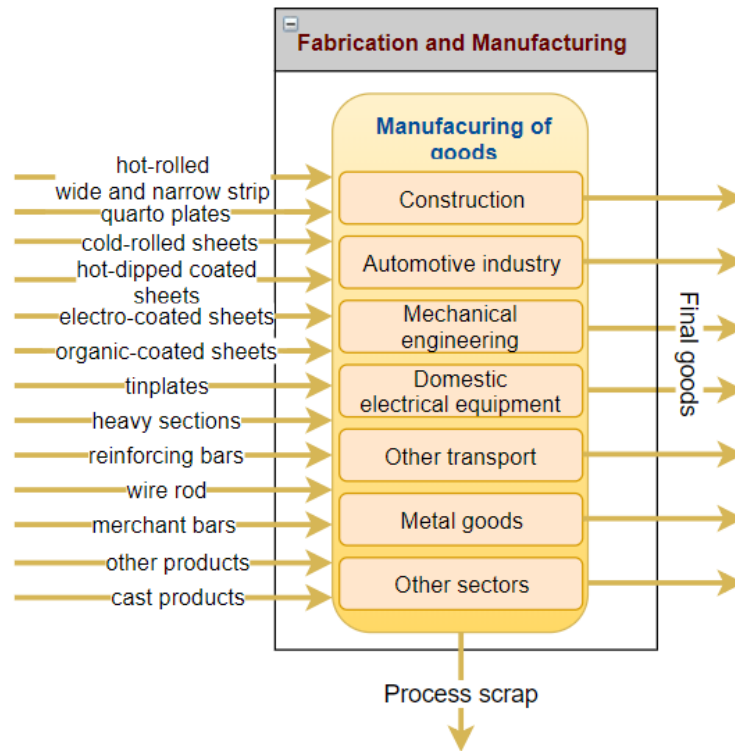

Figure 12 Flows related to the modelled Processing and manufacturing process

### 3.3.3 Use

The Use stage includes only one process, "Use". During Use the final goods perform their economic and social function. This process is fed by iron-bearing consumer goods, which further represents the material

stock of materials: cast iron and steel, incorporated in final goods, are owned by consumers on the territory of an investigated country until the end of the good's useful lifetime and its discard to waste management and recycling. Thus, the input flow and product lifetime determine the output flow of the use process.

In line with Murakami's definition, the present study defines the lifetime of the goods as the period when they are used on the territory of the country, corresponding to the domestic service lifespan (Murakami et al., 2010). Consumer goods, like cars, for example, can be exported to another country as a secondhand products, which extends the overall lifetime of a good. this study focuses, however, on national boundaries, so for an investigated country the lifetime of the sold product is considered as reached. The differentiation of input flow by industrial sector makes it possible to apply a lifetime, representative for each sector. The study distinguishes seven categories of consumer's goods..

In the present study it is considered that the in-use stock englobes periods of active used and hibernating periods. Hibernating is the period within product lifetime when the product is not in active use. It can occur, for example, between two users (like storing before resale as second-hand goods) or when the user stores the product before its discard to waste management (Figure 13). At the end of their lifetime, materials are discarded from the in-use stock and become available for the waste management and recycling.

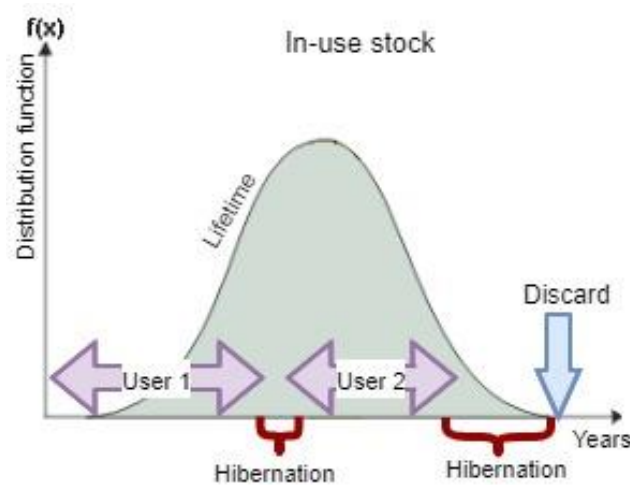

Figure 13 Illustration of the in-use stock

In MFA studies it is considered that the use process stores materials without any intended transformation of material flows. However, natural transformation may also occur: spare and broken parts are discarded from use, corrosion and wear may arise, causing the loss of iron.

**Corrosion** is a “physicochemical interaction between a metal and its environment that results in changes in the properties of the metal, and which may lead to significant impairment of the function of the metal, the environment, or the technical system, of which these form a part” (ISO 8044:2015). The term “rusting”

is applied to a process of oxidation of iron (or corrosion), in which the surface of metallic iron reacts with water and oxygen to form iron oxide (a rust) on the surface of iron. Corrosion does not only cause a loss of metal, which will therefore not be available for recycling, it is also a reason for equipment failure and has a tremendous economic cost. Economic issues are related to the cost of replacement of corroded structures, machinery, equipment and their components and also the cost associated with the maintenance necessary to prevent corrosion (like painting and coating). The estimated cost of corrosion is said to represent 2-4% of GDP, mostly caused by atmospheric corrosion (Sutter, 2016).

**Wear** is progressive damage to a surface caused by a relative motion with respect to another substance (Bayer, 2004). The surface iron is removed due to the interaction by contact with other bodies in relative motion, producing friction, heat, and a progressive change of surface state (for example, a wear on a rail surface). Wear is investigated by the scientific field of tribology, which studies friction, wear and lubrication of interacting surfaces. Wear is an important source of material deterioration: in developed countries losses due to friction represent 3.5-4% of GDP (Frêne and Zaïdi, 2011). In a modern car 25% of the engine's displayed power is lost because of friction (Frêne and Zaïdi, 2011).

In previous MFA studies, **corrosion** was not considered, as its rate is considered too low to significantly impact the size of iron flows and stock (Müller et al., 2006). In-use corrosion and dissipation was estimated to be 4% of the total quantity of iron released to the environment (tailings, landfill, slag and other by-products) (Wang et al., 2007). To define whether it is necessary to include the flow of iron lost due to corrosion, the impact of in-use corrosion has been evaluated here. A simplified estimation of iron loss is performed using references provided by Müller and colleagues. Details of the estimation are provided in Appendix A .

The results show that the application of extreme ranges of corrosion rate to one ton of steel could lead from 1.2% up to 52.5% of lost mass after 30 years of use. But this dramatically high level of corrosion should be considered carefully, as one of the most efficient solutions to slow down this process, especially in aggressive environments, is maintenance and coating. It is possible that corrosion rates applied in this estimation do not consider the existence of such protective processes. These corrosion rates are representative for raw material, but in practice, the protective processes are commonly used. For example, carbon steel is never used in its pure state in the construction sector, it is usually coated with paint or zinc (Sutter, 2016; T.I., 2004). Zinc coating protects iron and steel from corrosion due to its own better corrosion resistance. Sutter summarized the corrosion resistance of a hot-dip 80 microns galvanized zinc coating:

- In rural environments: 40 years
- In urban and marine environments: 16 years
- In industrial environments: 8,5 years

It means that, first, in rural environments for instance, the 80 microns of Zn coating will corrode, with the end of full coating corrosion process arising entirely after 40 years. Corrosion will only then begin to affect the coated material.

Another example of corrosion protection is the Eiffel Tower: every seven years it is repainted with 60 tons of paint, necessary to treat a surface of 250 000 m<sup>2</sup> (Sutter, 2016).

Inclusion of losses due to corrosion therefore appears to be a complex task, subject to very important variations: corrosion is a time-running process highly dependent on context, local conditions of use, and the surface state of considered body with maintenance, which is one of the most influential parameters. More long-term and detailed studies are needed to get consistent and representative data to feed into our model (such as the classification defined in ISO 12944-2, giving six categories of corrosion risk and levels based on common usage of low-carbon steel). Thus, to avoid any serious distortion due to a lack of coherent and global data, corrosion is excluded from sources of iron losses and will only be considered when discussing the limits of the present model.

As for the iron losses due to the process of **wear**, the behavior of a system consisting of two or more contacting bodies depends on several parameters, highly dependent on time and nature of contact. Main tribological parameters are (Woydt, 2004):

- pression of contact;
- velocity of friction;
- surface of materials being in contact;
- density of friction energy;
- presence of lubrication;
- relative humidity;
- temperature.

Furthermore, the internal dynamics of the system constantly redefine the contact conditions, i.e. the tribological process itself. This makes experimentation primordial in tribology field: general laws are expressed with several adjustment parameters which have to be contextualized. As a consequence, results of wear are expressed as wear rate, for example mm<sup>3</sup>/(N\*m) and for well-defined experimental conditions: the rate of material removal or dimensional change due to wear per unit of applied force and distance of relative movement (DIN EN 50324), for bodies of specific materials (couple material A/material B), contacting surface geometry, under specific atmosphere, etc. The term « applied force x distance » has the dimension of energy (N\*m is equivalent to Joule), a concept allowing complex dynamics of a system with multi-dimensional relations to be more easily express.

Another important tribological parameter for a given material couple A/B is defined by the friction coefficient. Dimensionless, this parameter reflects how strong friction forces (i.e. forces in opposite

direction to the movement, mainly due to ploughing and adhesion process at the interface) are with regard to the normal force applied to (and by) the surfaces during their movement. Here again, this parameter can only be defined in a context: the friction coefficient of steel alone has little sense, as friction always occurs between two elements, and under a specific modality.

Moreover, it has also to be noted that corrosion and tribology may be deeply linked in tribo-corrosion effects i.e. the synergy of both processes (friction wear in maritime context), or competitive effects (oxidation of a steel surface makes it harder, protecting it from a mechanical wear)

This shows how much tribology is context-dependent, like corrosion. The consideration of tribological losses is partially taken into account in MFA models by inclusion of spare parts in the flow of final goods. But, as in case of corrosion, the consideration of iron dissipation to the environment caused by wear in our model would need a much deeper analysis. In order to be included as a robust parameter, it would require the acquisition and reduction of data into a coherent set regarding this phenomenon. For instance, in case of adhesive wear, some material volume of B may effectively be removed, but transferred to A; thus, the mass balance between A and B will be conserved despite loss for B. This is typical of the complexities to be addressed to answer the question of tribological impacts on iron losses during the use phase, necessitating much more data, usage context, and usage classification, before possibly including it in the model.

Corrosion and wear will then only be considered here as highly probable factors of material loss to the environment, but not further included in the model. As consequence, the modelling of the use process represents a simplified case when the iron input to the process equals its output and no iron loss occurs (Figure 14).

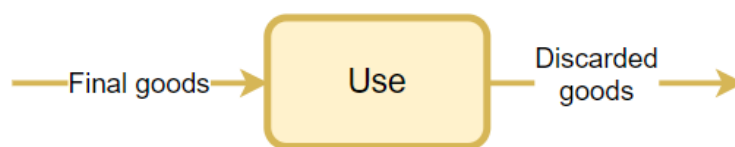

Figure 14 Flows related to the modelled Use process

### 3.3.4 Waste management and Recycling

Once discarded from use, iron contained in obsolete final goods becomes a potential source of secondary materials and enters the stage of Waste management and recycling. Another input flow to this stage is process scrap due to its collection and treatment by metal recyclers. This stage includes two processes: (i) waste management and recycling and (ii) obsolete stock. The flow of discarded goods is partially collected. The collected flow enters the process of waste management and recycling. Collection of obsolete goods is not efficient, thus non-collected flow is directed to the process of obsolete stock (Figure 15).

The process of waste management and recycling covers first two steps of recycling – collection and pre-processing (separation and sorting). The introduction of scrap to furnaces (processing - a third step of recycling) takes place in the processes of steelmaking and foundries (Production stage).



Figure 15 Relationship between in-use stock, obsolete stock and waste management

Before iron can be processed in furnaces, it must be separated from other materials, combined in a product. Techniques of scrap separation differ depending on type of EoL goods. Larger items may be cut with torches and/or mechanical/hydraulic shears to dimensions suitable for further processing. Some products require a removal of product parts that can be reused or must be recycled separately. Products are further shredded into pieces for separation of different individual materials. Due to magnetic properties, iron in the composition of steel and cast iron can be easily separated with the help of magnetic separation (Birat et al., 2013; Yellishetty et al., 2011). Nevertheless, losses can occur for reasons related to product design or separation technology (e.g. materials are incompletely liberated from mixed particles, technical parameters of magnets). These losses are not considered in previous MFA studies, probably due to data availability constraints and the consideration of high magnetic properties of ferrous metals. The present study also excludes this source of iron loss.

Obsolete stock is a process, that accumulates iron discarded from the use process but not collected by the process of waste management and recycling and which, therefore, remains in the anthroposphere (Daigo et al., 2007; Müller et al., 2006). Examples of obsolete stock are abandoned infrastructure, sunken ships, illegal dumping, closed landfills. Materials from obsolete stock can be further collected for recycling, but such collection and recovery is still difficult for both economic and technical reasons, which may change in the future.

Two flows of this phase are of interest for the definition of recycling efficiency: (i) the flow discarded from the use phase and (ii) the flow of EoL scrap, generated by waste management and recycling.





## Chapter 4 Data collection and determination of Mass Flows, Stocks, and Concentrations

This chapter corresponds to the third step of the MFA methodology: modelling of material flows and stocks. To estimate recycling indicators, the model focuses on the quantification of scrap generation and consumption. Estimation of home, process and EoL scrap generation involves the quantification of annual production, its disaggregation to sector-specific consumption, and assumption of sector-specific lifetime distributions for products' lifetime. Scrap consumption estimation is based on type of steelmaking process, respective annual productions, annual consumption of primary materials, and generation of iron-bearing by-products per process.

This details data sources identified in the literature and from industrial sources necessary to calculate mass flows of inputs and outputs and to estimate the in-use stock, as identified in chapter 3 and illustrated on Figure 4. It provides explanations about selection and use of this data and infers all relevant equations, presents all the variables and parameters applied.

This chapter is divided into five parts:

- **Review of available statistical data**, and definition of appropriate data for further use. Subsections of this part focuses on reported flows related to each lifecycle stage of iron. Data gathered from statistical reports is time series, i.e. sequences of numerical data points in chronological order at equally spaced time intervals. This part then defines spatial and temporal extension of reported data, and determines the most suitable data sources, as well as missing data that are further estimated. This analysis is supported by Adam Szewczyk, head of economic and statistical analysis of Worldsteel.
- Definition of **iron content** and **process-specific mass balances**. To establish the mass balance equation for each of the five processes of the production stage (BOF, EAF, OHF, rolling and finishing, foundries), iron content was defined for every flow related to these processes. Data was gathered from the relevant literature and industrial documentation, and reviewed by industrial experts in steel and recycling (Jean-Pierre Birat - IF Steelman and Philippe Russo - ArcelorMittal) in order to define a consistent set.
- **Calculation of mass flows** are based on statistical data, defined in part 4.1, and process mass balance equations, defined in 4.2. Assumptions needed to ensure that flows fit the investigated temporal and spatial boundaries are presented. Figure 16 summarizes methods used for estimation of each flow.
- The forth part defines **parameters for the calculation of the stock in-use** and of **the initial stock** in 1945.

- Finally, the fifth part discusses **sources of uncertainty** related to data sources, parameters and model assumptions environment due to corrosion or wear.

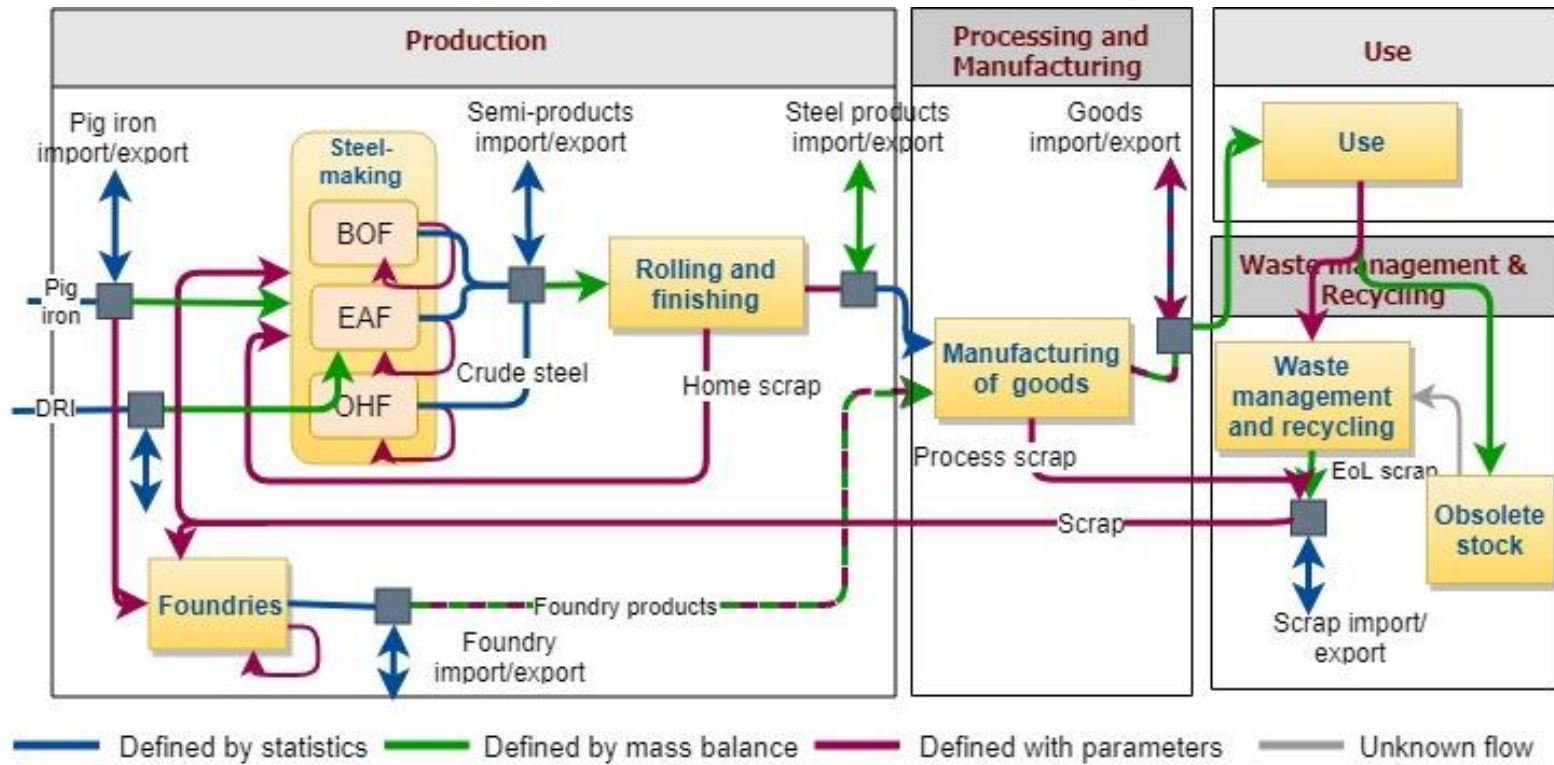

Figure 16 Illustration of methods used for flow quantification



## 4.1 Review of available numerical data

The present part focuses on the numerical database: it reviews available statistical data and selects appropriate sources for calculating mass flows (section 4.3). These sources of selected data are related to production, consumption and trade for each stage of the material lifecycle (production, processing and manufacturing, use and EoL management):

- production statistics concern data on production of materials and goods;
- trade statistics cover imports and exports of materials and goods;
- consumption statistics reflect the quantities of materials used per country.

Within reviewed sources, some of them are estimations based on statistics provided by industrial associations, whereas the majority is from publicly reported statistical data.

The data collection was performed in close collaboration with two steel associations: **Eurofer** (Jeroen Vermeij, Freddy Caufriez, Donato Marchetti and Aurelio Braconi) and **Worldsteel** (Adam Szewczyk, Henk Reimink, Clare Broadbent). The main sources of numerical database for iron and steel industry include:

- Worldsteel – World Steel Association, which publishes annual statistical yearbooks.
- Eurofer – European Steel Association.
- The statistical book published by Wirtschaftsvereinigung Stahl (WV Stahl) (German Steel Federation) (Stahl, 2013).
- The British Geological Survey (BGS) is a geoscience centre. Data is partially downloaded from the database and partially extracted from statistical yearbooks (BGS, 2016), available online.
- The International History Statistic 1750-1988 (Mitchell, 1992).
- The United Nations International Trade Statistics Database (UN Comtrade).

The steel committee of the Organization for Economic Co-operation and Development (OECD) also provides statistical data on iron and steel industry for the period 1996-2004 (OECD, 2018). Finally this source was not adopted, because reported time series were short compared to the period under investigation.

Selected data sources and related methods for calculating flows are summarized in section 4.1.5.

### 4.1.1 Production

The production stage is well covered by statistics, compared to other stages - production and trade statistics are provided for most of the flows. Consumption statistics are only reported for the flow of steel products. If data on production or trade is not reported, assumptions must be made in order to estimate

mass flows. If consumption is not reported, it is estimated based on production and trade, as the sum of production plus import, minus export. All these cases are discussed in section 4.3: definition of mass flow.

The production stage includes five processes: BOF, EAF, OHF, rolling and finishing and foundries. Flows related to these processes are well covered by statistical data.

Figure 17 shows the availability of statistical data for flows at the production stage:

- Blue lines show flows directly reported by statistics. These flows are production and trade data for the flows of pig iron, DRI, crude steel, cast iron and steel products, consumption of finished steel products and scrap consumption by steelmaking processes.
- Grey lines represent flows not reported in statistics, and that must be estimated. Some of them can be estimated from statistics in a straightforward manner (i.e. consumption of pig iron, DRI, crude steel, foundry products) others must be estimated with the help of parameters (generation of home scrap, distribution of pig iron and scrap between steel and ironmaking processes). Thin grey lines represent flows of iron-bearing by-products, which are also not reported by statistics.

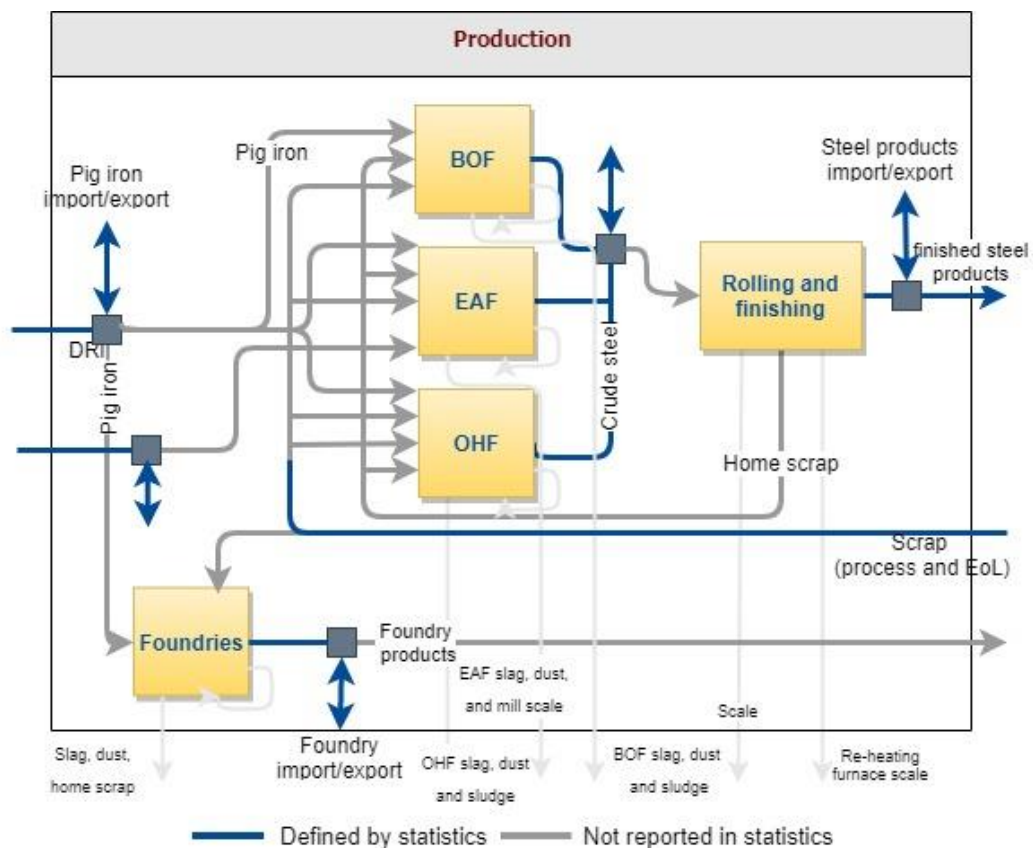

Figure 17 Availability of statistical data on flows related to the Production stage

Further, this section reviews available statistical data, defines whether data are representative for a mass flow or the use of parameters is more appropriate and, finally, selects appropriate data sources.

a. Pig iron

The production of pig iron by countries of EU-27 is published in several sources: Worldsteel, Eurofer, WV Stahl (Stahl, 2013); BGS and the statistical book (Mitchell, 1992) - see Table 4. It can be noted that data for pig iron is easily available: most of the investigated countries are covered, over different periods of time. Out of 27 countries, only five did not produce pig iron – Cyprus, Ireland, Latvia, Lithuania and Malta.

Table 4 Identified data sources for the production of pig iron

Period	Source	Countries	Format	Origin of data
1945-1988	(Mitchell, 1992)	1945-1970: 19 countries Austria, Belgium, Bulgaria, Czechoslovakia (Czech Republic and Slovakia), Denmark, Finland, France, Germany, Hungary, Italy, Luxembourg, Netherlands, Poland, Romania, Slovenia, Spain, Sweden, United Kingdom 1970-2010: 22 countries Previous 18 countries + Estonia, Greece and Portugal	Portable Document Format	Compilation of reported official governmental data
1945-2010	British Geological Survey	1945-1970: 18 countries Austria, Belgium, Bulgaria, Czechoslovakia (Czech Republic and Slovakia), Denmark, Finland, France, Germany, Hungary, Italy, Luxembourg, Netherlands, Poland, Romania, Spain, Sweden, United Kingdom 1970-2010: 22 countries Previous 18 countries + Estonia, Greece and Portugal		
1945-2012	WV Stahl	1945-1985: 9 countries Belgium, Denmark, France, Germany, Italy, Luxembourg, Netherlands, United Kingdom (Ireland has no pig production) 1985-1985: 12 countries Previous 9 countries + Spain, Portugal and Greece 1985-1995: 15 countries Previous 12 countries + Austria, Finland and Sweden 2000-2012: 22 countries	book	Compilation of governmental statistical sources (i.e. Wiesbaden regional statistical office, Eurostat, United Nations) and WV Stahl
1970-2015	Worldsteel	22 countries	Electronic format	Compilation of data reported by association members
1980-2013	Eurofer	19 countries Austria, Belgium, Bulgaria, Czech Republic, Slovakia, Finland, France, Germany, Greece, Hungary, Italy, Luxembourg, Netherlands, Poland, Portugal, Romania, Spain, Sweden, the United Kingdom		

The detailed comparison of time series for **pig iron production** is not conducted due to the complexity of the conversion of data sources to electronic format. It requires the conversion of 1077 data entries for the period 1945-1969 (i.e. Mitchell and the BGS contain 443 data points each, WV Stahl - 191). However,

it can be noted that the following is valid for the period 1945-1970 for the three sources (BGS, WV Stahl and Mitchell):

- while BGS and Mitchell cover the same 18 countries, different units are used: Mitchell uses metric tons, while the BGS uses long tons. To compare the corresponding two data sets, 10 random data points from both sources were compared (corresponding to 2.3% of 432 data points). Based on this sample, the two data sources were consistent with a rounded-up approximation.
- the comparison of data by WV Stahl and Mitchell shows that data have the same order of magnitude for all 9 countries reported by WV Stahl, however values differ, probably because WV Stahl and Mitchell use different data sources. A more profound investigation is necessary to evaluate the difference between these two sources and to understand its origin. Such inaccuracy within data sources might be explained by definition of reporting periods, data collection process and the rounding-up of numbers.

In the present study, time series for pig iron production were based on the data provided by Mitchell for the period 1945-1969, as this source provides a more complete dataset, but also expresses data in metric tons, which prevents unnecessary conversion. For the subsequent period of 1970 to 2015, time series were provided by WV Stahl, Worldsteel and Eurofer (since 1980). For that period, Worldsteel data is the most appropriate, as the dataset is the most complete, compared to Eurofer and WV Stahl.

Data on **trade of pig iron** was published by the BGS (BGS, 2016), Worldsteel and by the United Nations International Trade Statistics Database (UN Comtrade database) (UN, 2017), as detailed in Table 5.

Table 5 Identified data sources for the trade of pig iron

Period	Source	Countries	Format	Origin of data
1945-2015	British Geological Survey	1945- 1970: 19 countries Austria, Belgium-Luxembourg, Bulgaria, Czechoslovakia (Czech Republic and Slovakia), Denmark, Finland, France, Germany, Greece, Hungary, Ireland, Italy, Netherlands, Poland, Spain, Sweden, United Kingdom  From 1970: 20 countries 18 countries + and Romania	Before 1980: Portable Document Format  From 1980: electronic format	Compilation of reported official governmental data
1971-2015	Worldsteel	20 countries Austria, Belgium-Luxembourg, Bulgaria, Czechoslovakia (Czech Republic and Slovakia), Denmark, Finland, France, Germany, Greece, Hungary, Ireland, Italy, Netherlands, Poland, Romania, Spain, Sweden, United Kingdom	Portable Document Format	Based on UN Comtrade



1962-2015	UN Comtrade database	1994-2015 27 countries Code 7201, HS classification 1962-2015 27 countries Code 6712, SITC Rev.1	Electronic format	Trade statistics reported by custom declarations
-----------	----------------------	---	-------------------	--

The comparison of data reported by the BGS and Worldsteel from 1971 shows that these sources report the same values, because they are both based on the UN Comtrade database. Reported quantities of imports and exports of pig iron correspond to the UN Comtrade code 7201 of Harmonized System (HS) classification, and to code 6712 of Standard International Trade Classification (SITC). Data reported by UN Comtrade (SITC) is used, because they are the original source of trade data and provide longer time series. It is completed by the BGS data (converted to metric tons) for the period 1945-1961.

Several authors report inconsistencies in the UN Comtrade trade data. In theory, data reported as exported by one country to another and data registered as imported by the other country from the first one should be equal, but this is not always the case in practice (Liu et al., 2013; Liu and Müller, 2013; Worldsteel, 2015). This is applicable to pig iron and to all other flows. To face this inconsistency, some studies prefer to use only import data and to assume that the flow of goods imported by country A from country B equals to the flow exported by country B to A (e.g. Liu et al., 2011). The present study does not conduct the verification of country-specific origin and/or destination of trade flows, as it is outside of the scope. Trade data are used, as reported.

To summarize, the present study uses :

- pig iron production data published by Mitchell (Mitchell 1992) for the period 1945-1969 and data by Worldsteel for the period 1970-2015.
- pig iron trade reported by UN Comtrade database for the period 1945-2015.

This data is complete, accurate, regularly updated and cover the investigated countries over the period of 1945-2015. This data was used to calculate the consumption of pig iron (detailed in 4.3.1.a).

*b. DRI*

In Europe, DRI is only produced in two countries – Germany and, in marginal quantities, Sweden. Annual time series on production are reported by two sources:

- Worldsteel reports data for both countries since 1970;
- statistical reports “World Direct Reduction Statistics”, published by Midrex Technologies Inc. Only three online reports from this company have been identified (Midrex, 2016, 2014, 2013), containing time series from 1994, solely for Germany.

These two sources report the same values and probably have the same origin (Midrex reporting to Worldsteel). The present study uses the data published by Worldsteel (1970-2015), as it is more complete. Worldsteel is a trustworthy source containing good quality data, verified by experts. **Trade data** is published in UN Comtrade from 1962 for all investigated countries (code 67133 of SITC). Worldsteel and UN Comtrade data are used for calculation of the consumption of DRI, as detailed in section 4.3.1.b.

*c. Crude steel*

Two types of crude steel production data are gathered from statistical sources: the total crude steel production and production of crude steel by three processes (BOF, EAF and OHF). Data on steel production by process is necessary to establish the mass balance for processes of steelmaking and foundries. Types and quantities of input material (pig iron, DRI and scrap) differ between BOF, EAF, OHF and foundries. However, only the total amount of these inputs is available (Figure 17), their distribution by processes must be estimated on the base of output flow. Data on total production of crude steel is necessary to verify the consistency of data by process. Data sources are reviewed further in two steps: for total production of crude steel and for the production by steelmaking process.

Time series data on **total production of crude steel** are published by the same sources as production of pig iron: Worldsteel, Eurofer, the BGS, Mitchell and WV Stahl. Time periods and countries covered by each source are summarized in Table 6.

*Table 6 Identified data sources for the production of crude steel*

Time period	Source	Countries	Format	Origin of data
1945-1988	(Mitchell, 1992)	1945-1970: 21 countries	Portable Document Format	Compilation of reported official governmental data
1945-2010	British Geological Survey	Austria, Belgium, Bulgaria, Czechoslovakia (Czech Republic and Slovakia), Denmark, Finland, France, Germany, Hungary, Ireland, Italy, Luxembourg, Netherlands, Poland, Portugal, Romania, Spain, Sweden, Slovenia, United Kingdom 1970-1979: 22 countries 21 countries + Greece 1980- 2010: 23 countries 22 countries + Latvia		
1945-2012	WV Stahl	1945-1985: 9 countries Belgium, Denmark, France, Germany, Italy, Luxembourg, Netherlands, the United Kingdom (Ireland has no pig production) 1985-1985: 12 countries Previous 9 countries + Spain, Portugal and Greece 1985-1995: 15 countries Previous 12 countries + Austria, Finland and Sweden	book	

		2000-2012: 27 countries		
1969-2015	Worldsteel	1969-1991 22 countries Austria, Belgium, Bulgaria, Czechoslovakia (Czech Republic and Slovakia), Denmark, Finland, France, Germany, Greece, Hungary, Ireland, Italy, Luxembourg, Netherlands, Poland, Portugal, Romania, Spain, Sweden, Slovenia, the United Kingdom 1992-2015 23 countries 22 countries + Latvia	Electronic format	Compilation of data reported by association members
1980-2014	Eurofer	1980-2014 19 countries Austria, Belgium, Bulgaria, Czech Republic, Slovakia, Finland, France, Germany, Greece, Hungary, Italy, Luxembourg, Netherlands, Poland, Portugal, Romania, Spain, Sweden, the United Kingdom		

The period 1945-1969 is reported in three sources: WV Stahl, Mitchell and the BGS (BGS, 2016; Mitchell, 1992; Stahl, 2013). By analogy to pig iron production, the BGS publishes data in long tons, Mitchell and WV Stahl – in metric tons.

For the period 1945-1969, the comparison between WV Stahl and Mitchell (which reported data in the same metrics) shows that data is consistent for most of the countries (6 out of 9); differences are observed for Belgium, France and Italy. This study does not further investigate the reason for these differences.

To compare data published by Mitchell and the BGS for the same period, a sample dataset of 20 random data entries was chosen, which corresponds to 3.8% of total quantity (524 data points). After conversion of long tons to metric tons, data published by Mitchell and the BGS is equivalent. Moreover, the data published by Mitchell is identical to Worldsteel data for the subsequent period 1969-1988. Therefore, for the period 1945-1969 Mitchell data is selected, because this source is complete and does not require unit conversion.

For the period 1970-2015, the time series of Worldsteel are used, because they are more complete compared to others (in terms of covered countries), and provide data in electronic format.

Therefore, for the production of crude steel the present study uses the same data sources as for pig iron production – Mitchell for the period 1945-1969 (Mitchell, 1992) and Worldsteel for the period 1970-2015.

The production of **crude steel by steelmaking process** (BOF, EAF and OHF) is reported by the BGS and Worldsteel. Time periods and countries reported by these sources are summarized in Table 7. Both sources are merged (as they do not cover the same time frame), and the resulting production of steel by

process is expressed as a percentage of the total steel production for verification of data inconsistency. Results and calculations are detailed in section 4.3.1.c.

Table 7 Identified data sources for crude steel production per process

Period	Source	Countries	Format	Origin of data
1945-1970	British Geological Survey	<p><b>1945-1954: 7 countries</b> Belgium, France, Germany (Federal Republic), Luxembourg, Sweden and the United Kingdom Spain is also reported, but production by BOF and OHF are summed up.</p> <p><b>1955 -1970: 12 countries</b> 7 countries + Austria (from 1958), Czechoslovakia (Czech Republic and Slovakia), Germany (Democratic Republic) and Portugal (from 1962)</p>	Portable Document Format	Compilation of reported official governmental data
1970-2015	Worldsteel	<p><b>1970-2015: 23 countries</b> EU-27, except Cyprus, Estonia, Lithuania and Malta, who do not have steel production</p>	Electronic format	Compilation of data reported by association members

The statistics on **trade of crude steel** is reported by three sources: UN Comtrade, BGS and Worldsteel, as detailed in Table 8.

Table 8 Identified data sources for crude steel imports and exports

Period	Source	Countries	Format	Origin of data
1945-2015	British Geological Survey	<p><b>1945-1979: 14 countries</b> Austria (from 1949), Belgium-Luxembourg (from 1948), Denmark (from 1957), Finland (from 1951) France, Germany (Federal Republic), Greece (from 1956), Hungary (from 1960), Italy, Netherlands, Spain, Sweden and the United Kingdom</p> <p><b>1980 -2015: 27 countries</b> Latvia and Lithuania from 1994.</p>	Portable Document Format	
1962-2015	UN Comtrade	<p><b>1962-1975: 15 countries</b> Austria (from 1963), Belgium-Luxembourg, Denmark, Finland (from 1963), France, Germany (Federal Republic), Greece (from 1964), Ireland (from 1963), Italy, Netherlands, Portugal, Spain, Sweden and the United Kingdom</p> <p><b>1976 -1983 16 countries</b> 15 countries + Cyprus</p> <p><b>1984-1988: 17 countries</b> 16 countries + Poland</p> <p><b>1989 -1991: 19 countries</b> 17 countries + Malta and Romania</p> <p><b>1992: 21 countries</b></p>	Electronic format	Trade statistics reported by custom declarations

		19 countries + Hungary and Slovenia 1993: 22 countries 21 countries + Czech Republic 1994 -2015: 27 countries  Codes 6723, 6725, SITC Rev.1		
1985-2015	Worldsteel	1985-1991: 22 countries Austria, Belgium-Luxembourg, Bulgaria, Czechoslovakia (Czech Republic and Slovakia), Denmark, Finland, France, Germany (Federal and Democratic Republics), Greece (from 1964), Hungary, Ireland (from 1963), Italy, Netherlands, Poland, Portugal, Romania, Slovenia, Spain, Sweden and the United Kingdom 1992-2015: 27 countries	Portable Document Format	Compilation of data reported by association members

Data reported by BGS and Worldsteel has the same order of magnitude. The comparison of these data with UN Comtrade shows a difference of 2-3% (on the base of comparison of 25 data points). According to the statistical expert, it can be related to the selection of codes of UN Comtrade classifications. However, the expert cannot clarify the codes reported by Worldsteel, since data on trade of crude steel is provided by the International Steel Statistics Bureau (ISSB), a supplier of global trade data for steel. Data used by Worldsteel is preferred, because they are provided by expert organizations specialized in the trade of steel (ISSB). It is assumed that ISSB has the best knowledge of appropriate codes in UN Comtrade database.

Data on the production of crude steel, and on its trade, were used for calculation of the crude steel consumption (4.3.1.c).

*d. Foundries*

For the production of cast iron, data was collected from the annual edition of the foundry magazine Modern Casting “Census of World Casting”. The trade of cast iron is reported by the UN Comtrade database. These sources, detailed in Table 9, are subsequently used for the calculation of mass flows. However, assumptions are necessary to be consistent with the spatial and temporal boundaries described in section 4.3.1.d.

*Table 9 Identified data on production, imports and exports of cast iron*

Period	Flow	Source	Countries	Format	Origin of data
1997-2015	Production	Census of World Casting	1997-2015: 18 countries Austria, Belgium, Czech Republic, Slovakia, Finland, France, Germany, Hungary, Italy, Lithuania (2004-2007),	Portable Document Format	Compilation of association statistics

			Netherlands, Poland, Portugal, Romania, Slovenia, Spain, Sweden, the United Kingdom		
1962-2015	Trade	UN Comtrade	<p><b>1962-1973: 15 countries</b> Austria (from 1963), Belgium-Luxembourg, Denmark, Finland (from 1963), France, Germany (Federal Republic), Greece (from 1964), Ireland (from 1963), Italy, Netherlands, Portugal, Spain, Sweden and the United Kingdom</p> <p><b>1974 -1983 16 countries</b> 15 countries + Cyprus</p> <p><b>1984-1988: 18 countries</b> 16 countries + Poland and Malta</p> <p><b>1989 -1991: 19 countries</b> 18 countries + Romania</p> <p><b>1992: 21 countries</b> 19 countries + Hungary and Slovenia</p> <p><b>1993: 22 countries</b> 21 countries + Czech Republic</p> <p><b>1994 -2015: 27 countries</b></p> <p>Code 679, SITC Rev.1</p>	Electronic format	Trade statistics reported by custom declarations

*e. Finished steel products*

For all flows described in previous sections, statistics report only production and trade; consumption has to be estimated. In the case of finished steel products, both production and consumption are reported.

**Production.** Data on production of steel products are published by Worldsteel, as summarized in Table 10.

*Table 10 Identified data sources for production of finished steel products*

Flow	Period	Source	Countries	Format	Origin of data
Production	1970-2015	Worldsteel	<p>1970-1989 10 countries Austria, Belgium, France, Germany (F. R.), Italy, Netherlands, Luxembourg, Portugal, Spain, the United Kingdom.</p> <p>1990-2015 23 countries 10 countries + Bulgaria, Czechoslovakia (Czech Republic and Slovakia), Denmark Finland, Greece, Hungary, Ireland, Latvia, Poland, Romania, Slovenia, Sweden</p>	Portable Document Format	Compilation of data reported by association members

Production data is expected to be coherent with data on crude steel consumption: the difference between the consumption of crude steel and the production of finished steel products represents the quantity of home scrap generated during the process rolling and finishing.

The coherence was verified by the calculation of home scrap of rolling and finishing, which equals to the difference between the consumption of crude steel and the production of finished steel products. This calculation of home scrap flow can be carried out for the period 1990-2015, for which data for deliveries is available for most of the countries under study. The result identifies the following data inconsistency:

- negative values for some years for 11 countries (Bulgaria, Slovakia, Greece, Hungary, Italy, Latvia, Netherlands, Portugal, Slovenia, Spain and Sweden). There are 34 negative data entries out of 594, corresponding to 5.7%. The exclusion of negative values shows that most of the data lies in the range between 1% and 25%.
- certain values are higher than 25% (30 data entries out of 594, corresponding to 5.1%), which is unrealistic according to the literature - the generation of home scrap varies between 70 and 150 kg per ton of finished products (EC, 2001), corresponding to 7-15%.

Once inconsistent data points (negative values and values higher than 25%) are excluded, the generation of home scrap can be illustrated. Figure 18 shows the share of home scrap generation for EU-27 in the blue line. Grey and yellow lines correspond to maximal and minimal values of home scrap generation identified at country level.

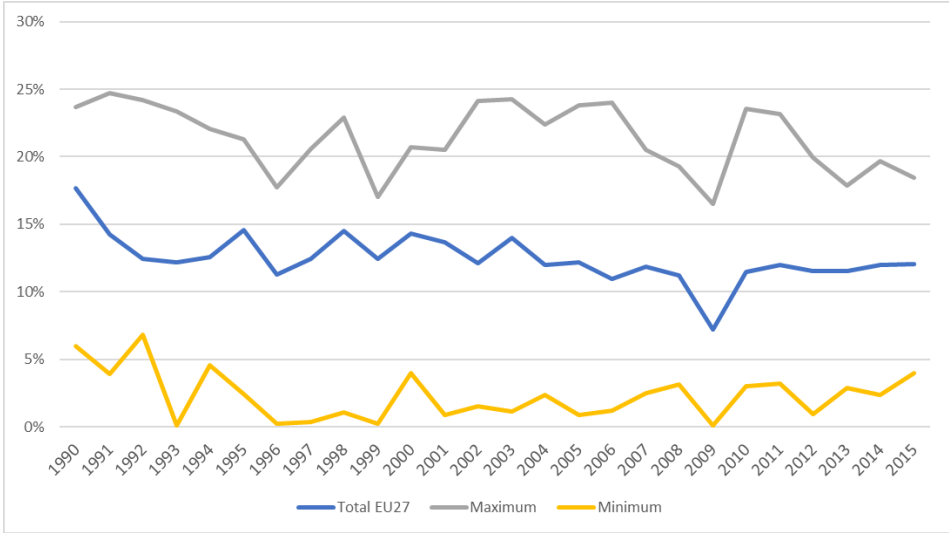

Figure 18 Estimation of home scrap generation from statistical data

The result for EU-27 corresponds to ranges found in the literature, i.e. 7-15% (EC, 2001). However, the method described above for calculation of home scrap is not optimal at the level of individual countries due to :

- data inconsistency.
- time period: data on production of finished steel products mainly covers the period 1990-2015, meaning the calculation for home scrap cannot be applied to the period 1945-1989.
- the fact that home scrap calculated by this method only reflects the home scrap generated during the process of rolling and finishing. As shown in section 3.3.1, home scrap is also generated during casting, which must be added to this calculation.

Therefore, the reported data on production of finished steel products is not coherent with the consumption of crude steel and are not suitable for estimation of material flows. Moreover, industrial experts refer to crude steel production as a more trustworthy data source compared to the production of finished steel products. Therefore, to respect the mass balance for the process of rolling and finishing, the production of finished steel products was calculated based on the mass balance for this process (4.2.4). The comparison between calculated and reported production of finished steel products is provided in Appendix B

**Trade.** Statistical data on imports and exports of steel products are identified in three sources – UN Comtrade, Worldsteel and Eurofer, as detailed in Table 11.

*Table 11 Identified data sources for trade of finished steel products*

Period	Source	Countries	Format	Origin of data
1962-2015	UN Comtrade	27 countries Austria, Belgium-Luxembourg, Bulgaria (from 1993), Cyprus (from 1969) Czech Republic (from 1993), Slovakia (from 1994), Denmark, Estonia (from 1995), Finland, France, Germany (Germany F.R.), Greece, Hungary (from 1991), Ireland, Italy, Latvia (from 1994), Lithuania (from 1994), Malta, Netherlands, Poland (from 1984), Portugal, Romania (from 1989), Slovenia (from 1992), Spain, Sweden United Kingdom	Electronic format	Trade statistics reported by custom declarations
1980-2015	Worldsteel	<i>1969-1985</i> Trade is reported as total of semi and finished products <i>1985-2015</i> Trade of finished products		International Steel Statistics Bureau
1953-1999	Eurofer	15 countries Austria, Belgium-Luxembourg, Denmark, Finland, France, Germany, Greece, Ireland, Italy, Netherlands, Portugal, Spain, Sweden, United Kingdom		International Iron and Steel Institute (currently Worldsteel)



Data from UN Comtrade corresponds to the SITC classification Rev. 1. (codes 673, 674, 675, 676, 677, 678), which is in line with a previous MFA study (Pauliuk et al., 2013b).

Data published by Worldsteel and the International Iron and Steel Institute (IISI) is coherent (the difference represents less than 0.1%), since it is the same organisation. Data originates from the ISSB, as the trade of semi-finished products. ISSB compiles data of UN Comtrade according to another classification of UN Comtrade – a Harmonized System (HS). The trade of steel products in this classification corresponds to codes 7208-7217, 7219-7223, 7225-7229 and 7304-7307<sup>11</sup>. The main limitation of HS classification in UN Comtrade database is that data is available only since 1994.

The comparison of data reported by these two classifications shows a consistent difference for imports and exports. Figure 19 illustrates the difference between net imports reported by two classifications of UN Comtrade – SITC rev. 1 and HS. Six countries (Germany, UK, Belgium-Luxembourg, Netherlands, Italy and France) and EU-15 are illustrated in this example. Solid lines correspond to net imports reported by SITC classification, dashed lines correspond to HS classification, reported by Worldsteel/ISSB. The average difference in imports for EU-15 for the period 1990-2015 is around 31%, while for exports around 26% (Table 12).

The consultation of conversion tables between SITC and HS classifications shows that codes do not correspond exactly:

- SITC codes that correspond to HS codes are 67271, 673, 674, 6782, 6783, 6784. Thus, the extraction of data from UN Comtrade for SITC must be conducted on a lower level of aggregation (at the level of 5-digit codes), than the one applied.
- SITC codes 675 and 676 are not included in the HS classification.

This probably explains the difference in values reported by the two classifications. Szewczyk (Worldsteel) encountered the same difficulty when comparing data from two classifications for indirect trade (section 4.2.2): differences can be as high as 20% for the corresponding codes. According to the experts' opinion, incoherence between values for steel products reported by the two classifications might be in the same order of magnitude (20 %) and this limitation is difficult, if not impossible, to overcome. The comparison of imports and exports of steel products reported by two classifications or EU-15 between 1990 and 2015 shows that the difference can be much higher (Table 12). Szewczyk suggests using the reported data on finished steel products consumption to decrease the level of uncertainty related to the trade of steel products.

---

<sup>11</sup> These are 4-digit codes, aggregating 6-digit HS codes. The code 7307 aggregates steel and cast iron products, thus data for trade of steel products must be excluded on the level of 6-digit HS codes.

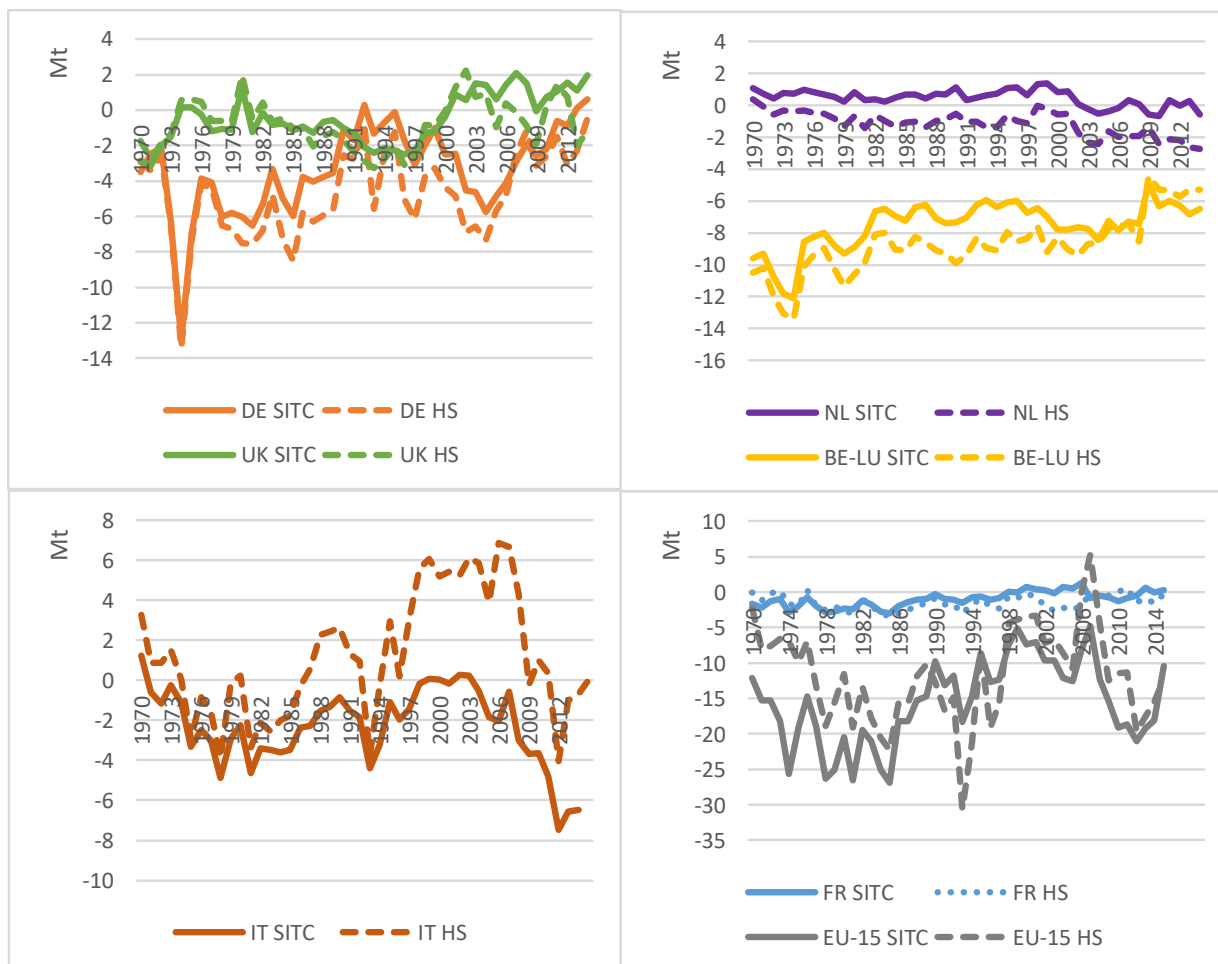

Figure 19 Illustration of the difference between net imports of steel products reported by two classifications of UN Comtrade (SITC rev.1 and HS)

Table 12 Country-specific difference between imports and exports of steel products reported by HS and SITC classification of UN Comtrade, EU-15, 1990-2015

Country	Import, percentage difference <sup>12</sup>			Export, percentage difference			Net import, percentage difference		
	Min	Max	Average	Min	Max	Average	Min	Max	Average
Austria	8.5%	65.2%	19.6%	4.6%	22.2%	13.1%	0%	44%	15%
Belgium-Luxembourg	32.7%	54.4%	44.9%	14.5%	40.0%	30.5%	2%	41%	18%
Denmark	9.5%	53.1%	28.3%	1.1%	24.0%	10.2%	1%	94%	29%
Finland	0.1%	55.3%	19.8%	11.4%	152.7%	56.7%	1%	3080%	274%
France	27.0%	40.4%	35.6%	24.9%	60.9%	41.1%	2%	5031%	285%
Germany	8.4%	25.7%	16.7%	16.9%	34.0%	22.3%	3%	2243%	120%
Greece	27.3%	89.0%	54.9%	0.7%	74.8%	17.6%	29%	8333%	322%
Ireland	0.2%	143.7%	15.3%	0.0%	46.2%	13.5%	0%	178%	14%

<sup>12</sup> A percentage difference ( $\Delta V$ ) is used to calculate the difference between two values when the direction of change is not known. It is equal to the absolute value of the difference between two values divided by their average:

$$\Delta V = \left| \frac{V_1 - V_2}{(V_1 + V_2)/2} \right| * 100\%$$

Italy	54.9%	70.3%	60.3%	14.0%	28.6%	20.7%	12%	2893%	364%
Netherlands	5.8%	54.6%	14.6%	19.7%	59.5%	40.5%	84%	2398%	594%
Portugal	9.1%	82.3%	26.6%	2.0%	71.6%	14.2%	0%	7948%	240%
Spain	26.1%	47.4%	37.3%	2.5%	17.3%	10.3%	1%	425%	83%
Sweden	5.7%	21.1%	13.2%	7.3%	43.3%	28.3%	0%	94531%	2246%
United Kingdom	10.6%	34.7%	22.4%	12.3%	67.1%	33.8%	1%	3080%	274%
EU-15	24.9%	37.3%	31.3%	19.0%	33.6%	26.7%	5%	4288%	137%

Data on **finished steel products consumption** corresponds to the quantity of finished steel products consumed in a given country. Data is reported by Worldsteel, the covered perimeter is detailed in Table 13.

Table 13 Identified data sources for consumption of finished steel products

Period	Source	Countries	Format	Origin of data
1967-2015	Worldsteel	<p><i>1967-1984: 22 countries</i>  Austria, Belgium-Luxembourg, Bulgaria, Czechoslovakia (Czech Republic, Slovakia), Denmark, Finland, France, Germany (Germany F.R. and Germany D.R.), Greece, Hungary, Ireland, Italy, Netherlands, Poland, Portugal, Romania, Slovenia (as the part of Yugoslavia), Spain, Sweden, the United Kingdom</p> <p><i>1985-1991: 24 countries</i>  22 countries + Cyprus, Malta</p> <p><i>1991-1992: 26 countries</i>  24 countries + Estonia, Latvia</p> <p><i>Since 1993: 27 countries</i>  26 countries + Lithuania</p> <p><i>Since 1970 reported in finished steel equivalent</i></p>	Portable Document Format	Compilation of data reported by association members

The consumption of finished steel products is an estimation called Apparent Steel Use (ASU). It is calculated as the sum of crude steel production in a country and the net import of semi and finished steel, and expressed in crude steel or finished steel equivalent. This estimation also takes into account the generation of home scrap during transformation of crude steel into semi- and finished products by considering the share of continuous casting.

ASU in finished steel equivalent is a convenient source of data for the flow of steel products consumption, particularly because it makes it possible to overcome incoherence related to the trade of steel products, as suggested by Worldsteel's expert in statistics<sup>13</sup>. The reported data does not fully cover the investigated time period, thus the statistical data must be completed by estimations. To calculate the mass flow of finished steel products, this study used the following data:

- for the period of 1970-2015, ASU data was used;

<sup>13</sup> The comparison between the calculation of the consumption of finished steel products on the base of the production/trade and from ASU is provided in 4.5.1.

- for the period 1945-1969<sup>14</sup> the consumption is calculated based on production and trade:
  - o The production of steel products is calculated on the base of the mass balance for the process of Rolling and finishing (4.3.1.d);
  - o The trade data of ISII are used because it is reported by ISSB, an expert statistical organization specialized in steel. It corresponds to the investigated time period and to the trade data used by Worldsteel for calculation of the ASU.

The calculation and results are presented in the section 4.3.1.g.

#### *f. Consumption of scrap in steelmaking*

The consumption of scrap in steelmaking is reported by Worldsteel, Eurofer and the Bureau of International Recycling (BIR), a global association of the recycling industry. This data is reported for the period 1971-2015 and represents estimated values. It covers the consumption of the three types of scrap (home, process and EoL) in steelmaking, without making any distinction by type. Originating from steelmaking industry, this data does not include the scrap used in foundries.

Thus, the present study calculates the consumption of scrap in steelmaking and foundries from the established mass balances (4.2). Worldsteel data is only used for comparison purposes.

#### 4.1.2 Processing and manufacturing

Flows related to the process of manufacturing are shown in Figure 20: bold line show flows which are reported in statistics (trade of final goods) and thin lines show flows that are not reported and therefore must be estimated.

---

<sup>14</sup> Consumption in Cyprus, Malta, Estonia, Latvia and Lithuania are calculated for a longer period due to data availability

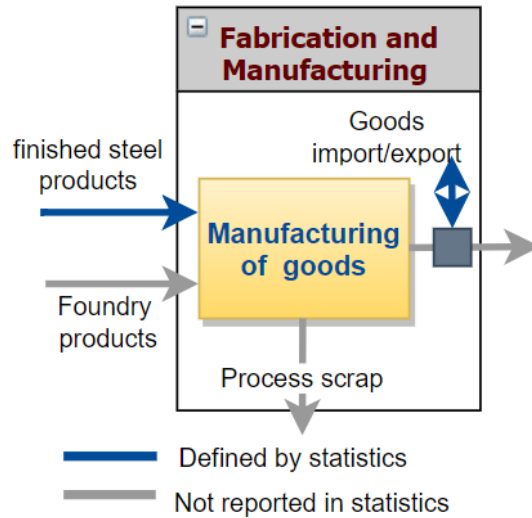

Figure 20 Flows related to the stage of processing and manufacturing, reported in statistics

The only flow related to the stage of processing and manufacturing, which is reported in statistics or has been previously estimated, is the trade of final goods containing iron and steel. The trade of iron and steel as a part of manufactured goods that contain steel is called indirect trade of steel (Worldsteel, 2015).

The UN Comtrade database contains data on final goods containing steel and cast iron. To estimate the quantity iron (in cast iron and steel) embodied in these products it is necessary:

- to extract imports and exports data for cast iron- and steel-bearing goods;
- to define the concentration of cast iron and steel per product category;
- to group iron-bearing goods, according to industrial sectors considered in the study;
- to calculate the flow of iron in cast iron and steel in traded goods as the product of traded mass by cast iron/steel concentration in products and by iron content of cast iron/steel;
- to sum up the flows of traded iron with respect to the corresponding industrial sectors.

The estimation of indirect trade of steel has been recently published by Worldsteel (Worldsteel association 2015) based on the UN Comtrade database. Table 14 summarizes the temporal and spatial perimeter covered by the Worldsteel estimation, as well as the type of estimated flow (total or grouped by industrial sectors). According to the industrial experts' evaluation, data provided by Worldsteel is sufficient for further calculation. The downside of this data is that it probably does not consider the cast iron, since Worldsteels's focus is on steel.

Table 14 Data provided by Worldsteel for indirect trade

Period	Country	Type of flow
1962-1965	10 countries Austria, Belgium-Luxembourg, Denmark, France, Germany, Italy, Netherlands, Sweden, the United Kingdom	Total imports and exports

1970, 1975, 1980, 1985, 1990, 1995, 2000, 2005, 2009, 2011	4 countries France, Germany, Italy, the United Kingdom	Imports and exports per 6 industrial sectors (metal products, mechanical machinery, electrical equipment, domestic appliances, automotive, other transport)
2000-2015	27 countries	Total imports and exports
2012-2015	27 countries	Imports and exports per 6 industrial sectors (metal products, mechanical machinery, electrical equipment, domestic appliances, automotive, other transport)

4.1.3 Use

The stage of use includes only one process (Figure 21), which is fed by the iron contained in the final goods and generates the flow of iron discarded from use. Statistics does not report any of the flows, associated with this stage and must be estimated.

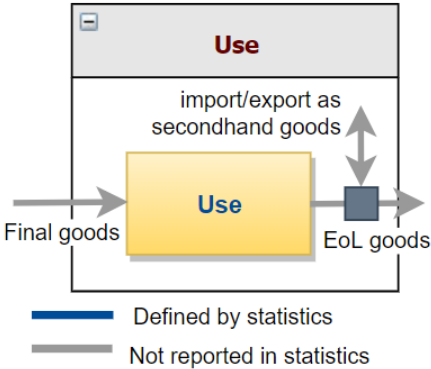

Figure 21 Flows related to the stage of use, reported in statistics

The traded flow associated with this stage is the flow of goods which are discarded from use in European countries, but can nevertheless be sold and continue their lifetime in other countries. The European car market is a typical example of the trade of second-hand goods: cars from Western Europe are sold in Eastern Europe or exported out of the territory. Another example is ships sold to Asian countries to be dismantled (Birat, 2016). The UN Comtrade database does not make a distinction between the trade of new and second-hand products, which would influence the estimation of the stock in use. The distinction between the trade of new and second-hand goods would:

- decrease the quantity of available scrap in an exporter country;
- increase in-use stock and quantity of available scrap in an importer country.

The literature review identified that the collection of data on second-hand trade is performed only for the automotive sector (Fuse et al., 2009; Mehlhart et al., 2011). Data is available for a limited number of years in the 2000s and requires additional conversion into iron equivalent. Due to limited data availability and

the absence of data for other industrial sectors, the trade of second-hand goods is not considered in the calculation of material flows.

#### 4.1.4 Waste management and recycling

The only flow reported in statistics related to the stage of waste management and recycling is imports and exports of scrap (Figure 22). The reported data of traded scrap represents the total quantity of process and EoL scrap. Two sources report this flow - BGS and UN Comtrade, as detailed in Table 15. Data from UN Comtrade is complemented with data from the BGS because it covers the period 1945-1961.

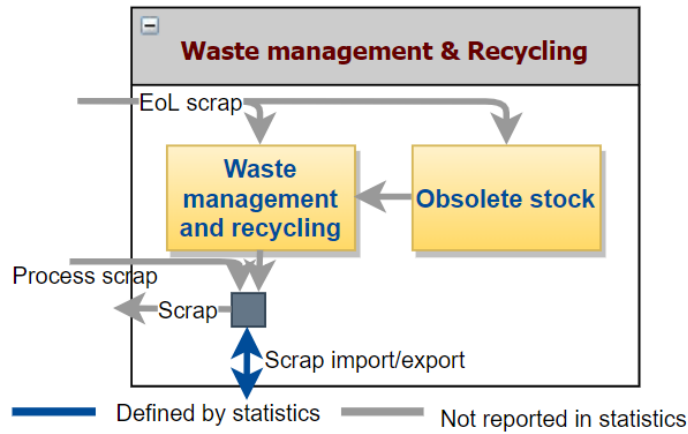

Figure 22 Flows related to the stage of waste management and recycling, reported in statistics

Table 15 Identified data sources for the trade of scrap

Period	Source	Countries	Format	Origin of data
1945-2015	British Geological Survey	1945- 1970: 14 countries: Austria, Belgium-Luxembourg, Denmark, Finland, France, Germany, Greece, Italy, Netherlands, Portugal, Spain, Sweden, United Kingdom From 1970: 27 countries 14 countries + Bulgaria, Czechoslovakia (Czech Republic and Slovakia), Cyprus, Estonia, Hungary, Ireland, Latvia Lithuania, Malta, Poland, Slovenia, Romania,	Before 1980: Portable Document Format From 1980: electronic format	Compilation of reported official governmental data
1962-2015	UN Comtrade database	27 countries Code 2820, SITC Rev.1	Electronic format	Trade statistics reported by custom declarations

#### 4.1.5 Summary

The review of available statistical data made it possible to select appropriate data and define which flows must be calculated. Despite a wide availability of reported data, especially for the flows related to the production stage, not all of them can be used. For example, the reported production of finished steel products is not coherent with the consumption of crude steel. Incoherence was also identified for the trade of finished steel products and (less important) for crude steel – showing a need for a collaboration with statistics experts.

To conclude the review of statistical data described in the part 4.2, Table 16 summarizes all material flows considered in the present study and the method for calculation of their mass – from statistics or by calculation.

*Table 16 Summary of material flows and method of definition of their mass*

#	Material flow	Method for calculating	Data source	
1	Pig iron	total production	statistics	1945-1969 Mitchell (1992) 1970-2015 Worldsteel
2		trade	statistics	1945-1961 BGS 1962-2015 UN Comtrade
3		total consumption	calculated by mass balance	
4		consumption in BOF, EAF, OHF/foundries	Calculated with parameters	
5	DRI	total production	statistics	1970-2015 Worldsteel
6		trade	statistics	1962-2015 UN Comtrade
7		total consumption	calculated by mass balance	
8	Cast iron	total production	statistics	1945-1998 estimated 1997-2012 Census of World Casting
9		trade	statistics	1962-2015 UN Comtrade
10		total consumption	calculated by mass balance	
11		distribution per industrial sectors	calculated with parameters	
12	Crude steel	total production	statistics	1945-1969 Mitchell (1992) 1970-2015 Worldsteel
13		production in BOF, EAF, OHF	statistics	1945-1969 BGS 1970-2015 Worldsteel
14		trade	statistics	1945-1969 BGS 1962-2015 Worldsteel
15		total consumption	calculated from by mass balance	
16	Finished steel products	total production	calculated with parameters	
17		Trade	calculated by mass balance	
18		total consumption	statistics	1945-1969 calculated 1970-2015 Worldsteel
19		distribution per industrial sectors	calculated with parameters	
20	Final goods	Total production	calculated by mass balance	



21		trade	statistics	1945-1961 calculated 1962-1990 Worldsteel
22		total consumption	calculated by mass balance	
23		consumption per industrial sectors	calculated with parameters	
24	Scrap	production of home scrap	calculated with parameters	
25		production of process scrap	calculated with parameters	
26		production of EoL scrap	calculated with parameters	
27		trade	statistics	1945-1961 BGS 1962-2015 UN Comtrade
28		Consumption (total and in BOF, EAF, OHF, foundries)	calculated with parameters	
29		By-products	BOF slag	calculated with parameters
30	BOF dust and sludge		calculated with parameters	
31	BOF mill scale		calculated with parameters	
32	EAF slag		calculated with parameters	
	EAF dust		calculated with parameters	
33	EAF mill scale		calculated with parameters	
34	OHF slag		calculated with parameters	
35	OHF dust		calculated with parameters	
36	OHF mill scale		calculated with parameters	
37	Rolling and finishing scale of scarfing, grinding, shot blasting and re-heating scale		calculated with parameters	
38	Rolling and finishing scale from descaling		calculated with parameters	
39	Rolling and finishing mill scale sludge		calculated with parameters	
40	Rolling and finishing iron oxide/iron sulphate		calculated with parameters	
41	Foundry slag		calculated with parameters	
42	Foundry dust	calculated with parameters		

## 4.2 Definition of the iron content of the flows and establishment of mass balance at the level of processes

This part aims to define the iron content associated with each flow in order to establish the mass balance at the level of processes. The definition of iron content is particularly important for the flows included in the production stage because the overall iron content of input and output flows of that stage is different.

**Mass balances** are established for every process of the **production stage**: BOF, EAF, OHF, rolling and finishing, foundries. For steelmaking process, mass balances are established for one ton of crude steel produced. This is done for two reasons:

- statistical data on crude steel production is considered by industrial experts as more reliable than data of pig iron. In fact, crude steel is traded, so is subjected to a better accountability, while the flow of hot metal is not always solidified (pig iron - a solidified form of hot metal), as it is fed from blast furnace to BOF. In this case, the accountability is less precise;
- to have a common reference flow for two subsequent processes of production (steelmaking process followed by rolling and finishing), allowing easier data processing;

The processes of three other lifecycle stages - processing and manufacturing, use and waste management and recycling do not require the establishment of the mass balance per ton of input or output. Inputs and outputs of these processes have the same iron content as crude steel and foundry products. Only the flow of EoL scrap, the output of the process of waste management and recycling, has a lower iron content due to contamination. In the following, iron content of process scrap and EoL scrap is discussed, as these flows are fed to and steelmaking processes and foundries.

The mass balance is defined in terms of variables and parameters. As explained in part 3.1, variables are flows; stock variables are not defined in the present section. The mathematical definition of system variables is expressed according to the following form,  $Fu(d, s)_{ext}^{BOF}$ , where:

- $Fu$  is a unitary flow, a flow generated per ton of output flow (expressed in kg/t of crude steel);  
 $\widehat{Fu}$  is a unitary flow expressed in iron equivalent (kg Fe/t crude steel)
- the superscript designates the process generating the flow;
- the subscript designates the process of the destination of the flow.

Then  $Fu(d, s)_{ext}^{BOF}$  means the flow of dust and sludge, generated per ton of crude steel in BOF and used externally of BOF process. These unitary flows are defined for mass balances and are used in part 4.3 to calculate the total mass flows.

The present part defines also parameters related to iron content. Their mathematical definition is expressed according to the following form,  $IC(d, s)^{BOF}$ , where:

- $IC$  designates the iron content, expressed in percentage mass, of the corresponding flow indicated in brackets;
- superscript designates the process generating the flow;

Here,  $IC(d, s)^{BOF}$  means the iron content of dust and sludge, generated in BOF.

The designation applied to all variables and parameters is summarized in Appendix C .

#### 4.2.1 Basic Oxygen Furnace

As explained in part 3.3, each steelmaking process (BOF, EAF, OHF) aggregates the production of liquid steel, secondary metallurgy and casting. In order to establish the mass balance at the level of iron for the BOF process, the present study considers three input flows (pig iron, scrap and internal recycling of iron from EAF slag) and the five output flows (crude steel, slag, dust and sludge, mill scale and home scrap), as explained in part 3.3.1 and shown in Figure 23. This figure is a duplicate of Figure 7, copied here for a better reading comfort.

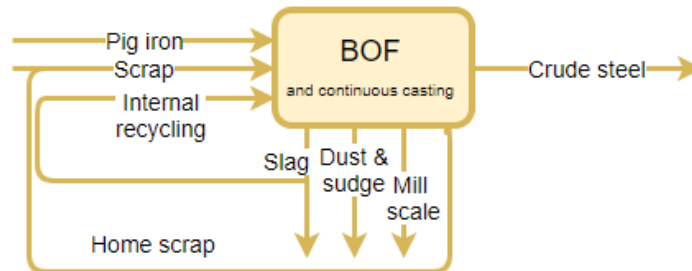

Figure 23 Flows related to the modelled BOF process (duplicate of Figure 7)

According to the mass balance principle, the iron input to the process must be equal to the iron output of the process. Since the mass balance is established for one ton of crude steel, the total flow of iron entering the BOF process (fed by pig iron and scrap<sup>15</sup>) is defined as the sum of iron contained in crude steel and in by-products generated during this process:

$$\begin{aligned} \widehat{Fu}(Fe\ tot)_{BOF} &= Fu(CS)_{RF}^{BOF} * IC(CS) + Fu(ms)_{ext}^{BOF} * IC(ms)^{BOF} + Fu(d, s)_{ext}^{BOF} * IC(d, s)^{BOF} \\ &+ Fu(sl)_{ext}^{BOF} * IC(sl)^{BOF} + hScr^{steel} * Fu(CS)_{RF}^{BOF} * IC(CS) \end{aligned}$$

where:

<sup>15</sup> The flow of BOF slag recycled internally in the process is not included in the formula, because its output from the process equals its input to the process.

- $\widehat{Fu}(Fe\ tot)_{BOF}$  stands for total flow (sum) of iron from pig iron and scrap fed to the BOF process for production of one ton of crude steel;
- $Fu(CS)_{RF}^{BOF}$  – flow of one ton of crude steel produced in the BOF and available for rolling and finishing (or export);
- $IC(CS)$  – iron content of crude steel;
- $Fu(ms)_{ext}^{BOF}$  – flow of mill scale produced in the BOF continuous casting and used externally of BOF process;
- $IC(ms)^{BOF}$  - iron content of mill scale generated in the BOF;
- $Fu(d, s)_{ext}^{BOF}$  – flow of dust and sludge, generated in the BOF and used externally of the BOF process;
- $IC(d, s)^{BOF}$  - iron content of dust and sludge, generated in the BOF;
- $Fu(sl)_{ext}^{BOF}$  – flow of slag, generated in the BOF and used externally of the BOF process;
- $IC(sl)^{BOF}$  – iron content of slag generated in the BOF;
- $hScr^{steel}$ - home scrap generation during continuous casting, expressed in percentage of crude steel<sup>16</sup>.

Thus, to estimate the total flow of iron entering the BOF, it is necessary to define:

- iron content of crude steel;
- flows of by-products generated during the BOF process (slag, dust and sludge, mill scale and home scrap);
- iron content of by-products.

#### a. BOF output flows

The iron content of the crude steel is defined as a weighted average of three groups of steel grades, defined by the European standard EN 10020:2000, which are non alloy steel, stainless steel and alloy steel. The iron content of the crude steel is estimated based on the established iron content of each steel groups and their respective production shares, as summarized in Table 17. The resulting weighted average of **iron content of crude steel** is equal to 97.1% and is rounded up to **97%**. Details on estimation of the iron content of the crude steel is provided in Appendix D .

Table 17 Estimation of iron content in crude steel

Type of steel	Iron content, %	Production share, %	Weighted average iron content, %
Non alloy steel	98.3	83.4	97.1
Alloy steel	96.18	13.4	
Stainless steel	69.01	3.2	

<sup>16</sup> The flow of home scrap is fully recycled within BOF process; this flow is however estimated as an output, rather than internal recycling in order to distinguish the quantity of three types of scrap fed to the furnace.

Regarding the **generation rate and iron content of by-products** in Europe:

- According to the literature, the *generation* of BOF slag ranges from 85-165 kg per ton of liquid steel (Kumar et al., 2009; Remus et al., 2003). This data is gathered from different BOF plants located in Europe, so variation in process settings, depending on location, could explain the variability in BOF slag generation. Monthly measurements provided by ArcelorMittal for 2014 show a generation of slag from 78 to 106 kg of slag per ton of liquid steel, in line with literature data. The present study adopts ArcelorMittal’s average value for generation of BOF slag - 98.1 kg/t of liquid steel. The *iron content* of slag varies between 14-24% (Rankin, 2011; Yildirim and Prezzi, 2011). This value is chosen to be 16% after experts’ validation. The metallic part of slag is used internally in the steelmaking furnace. According to Euroslag, this part represents currently 10-11%, while most steel slag is used in road construction (40-60%), in cement clinker manufacturing processes (1-8%), temporarily stored (5-19%) or landfilled (6-24%) (Figure 24) (Euroslag website, 2017). Experts advised using the value of 10% for modelling; 90% is considered as recycled externally and, therefore, lost for metallurgical purposes.

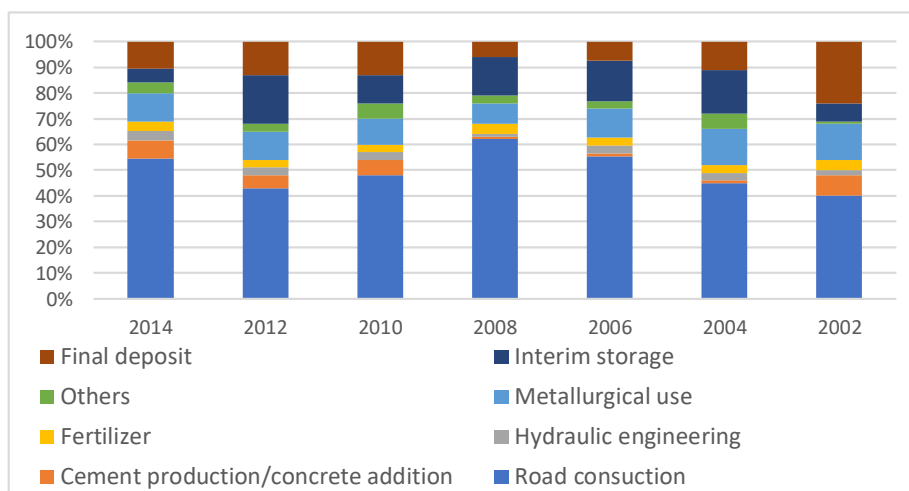

Figure 24 The use of steel slag in Europe, 2002-2014 (Euroslag website, 2017)

- Typically 12-23 kg of **dust and sludge** are generated per ton of liquid steel produced in the BOF (Remus et al., 2003). The iron content of these by-products is 50-80% (Rankin, 2011; U.S. Department of Energy, 2016). Based on the experts’ judgment, the following figures are used for modelling:
  - o the production of one ton of liquid steel generates 20 kg of BOF dust and sludge,
  - o the iron content of these by-products is 56%.

In Europe, only 55% of dust and sludge is recycled to the sinter plant because of their zinc content, 33% is used externally and 12% is landfilled (Remus et al., 2003). This study uses the reported values, considering that 45% of dust and sludge are lost for metallurgical processes.

- During continuous casting 2.3 – 6.4 kg of **mill scale** per ton of crude steel are generated with an iron content of 33-72% (Remus et al., 2003). The present study adopts an average value – 4,4 kg; the iron content is defined with the experts as equal to 65%.

Table 18 summarizes the generation rate and iron content of by-products of BOF process (except home scrap). It must be noted that these parameters are static, as no information was identified about their historical evolution, while the generation of home scrap is estimated with a dynamic parameter due to the availability of historical information and its importance for estimating the recycling rate.

*Table 18 Generation rate and iron content of by-products of BOF process (except home scrap)*

<b>Flow</b>	<b>Flow, kg/t CS</b>	<b>Iron content, %</b>	<b>Recycling</b>
BOF slag	98.1	16%	10%, internally
BOF dust and sludge	20	56%	90%, ironmaking
Mill scale	4.4	65%	100%, ironmaking
Crude steel	1000	97%	

In 2003, Remus et al. demonstrated that during continuous casting 2.8 - 15 kg of **home scrap** are generated per ton of crude steel (Remus et al., 2003). This range is representative of current technology of continuous casting. In consequence, this study considers the evolution of yield improvement of home scrap generation, which makes the parameter of home scrap generation time-dynamic.

The historical variation of home scrap generation as a percentage of crude steel production is reported by two sources: Usinor model and Worldsteel model of scrap generation, Figure 25. Usinor curve is issued from statistical data gathered by Moreau for EU-15 (Birat, 2017; Birat and Zaoui, 2002; Moreau, 2005). The Worldsteel curve is an estimation for a world global perimeter. Both graphs show the same tendency: the generation of home scrap decreased from the second half of 1960s. The lower generation of home scrap in Europe is explained by industrial experts by a better technology than in other parts of the world. The increase of home scrap generation between 1958 and 1963 could not be explained.

The present study applies Usinor’s home scrap generation coefficient. This source is directly appropriate for the European context. Moreover, it is based on a reliable system of data collection, trusted by industrial experts. However, this data must be adapted to be representative for flows of home scrap as defined in the present study.

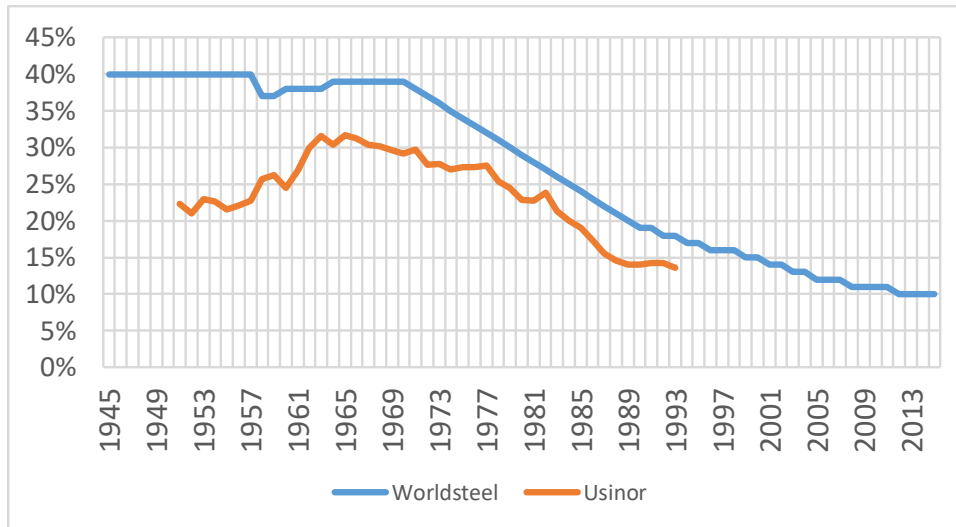

Figure 25 Generation of home scrap, as percentage of crude steel production reported by two sources

The first adaptation concerns temporal boundaries, as data reported by Usinor covers the period 1951-1993. Thus, for the period 1945-1950, the same coefficient of home scrap generation is applied as for year 1951. For the period 1994-2015 the following estimation was performed:

- most recent data from literature (2001-2003) shows that the generation of home scrap varies between 66.5 and 142 kg per ton of crude steel, which corresponds to 7.3-16.5% of crude steel production. Thus, the generation rate in 2015 is assumed to be 10%, in the order of magnitude of the literature and equal to the estimation of Worldsteel.
- the generation rate of home scrap in 1993 is 13.5% of crude steel, as reported by Usinor;
- uniform annual decrease of 0.16% is assumed between 1993 and 2015.

The second adaptation concerns the allocation of the reported generation of home scrap to steelmaking processes and to the process of rolling and finishing. It can be seen that the generation of home scrap on Figure 25 is much higher than reported by Remus et al. (2.8 - 15 kg per ton of crude steel), because Usinor and Worldsteel data sum-up home scrap generated during steelmaking processes and during the process of rolling and finishing. In fact, out of 66.5 - 142 kg of home scrap generated per ton of crude steel, 2.8 - 15 kg are generated during steelmaking and 63.7-127 kg - during rolling and finishing (for more details, see the part 4.2.1.d, dedicated to this process). In order to consider the yield improvement made by continuous casting (included in steelmaking processes), it is assumed that:

- in 2015, considering the total home scrap generation of 10% of crude steel production, 9% is generated by rolling and finishing and 1% is generated by continuous casting (based on their respective shares of 89-96% and 4-11% of scrap generation);

- for the period 1945-2014, a constant share of 9% is allocated to home scrap generation from rolling and finishing and the share allocated to steelmaking is estimated as the complement to the difference between total generation and rolling (varying between 1% and 23%).

The resulting values for the parameter of home scrap generation during continuous casting is illustrated in Figure 26. Home scrap is fully recycled internally in the BOF process. The iron content of home scrap is the same as the iron content of steel – 97%, because it is mostly composed of cut-offs of semi-products.

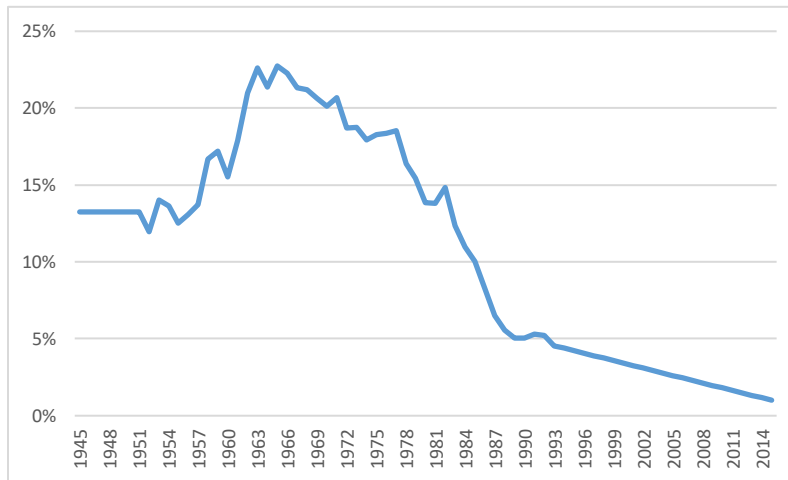

Figure 26 Generation of home scrap during continuous casting (as percentage to crude steel production), applied to the steelmaking processes

#### b. BOF input flows

Input flows to the BOF process are pig iron, scrap and iron contained in slag, recycled internally. The quantity of iron provided by pig iron and scrap is estimated from the mass balance. The calculated total flow of iron to BOF ( $\widehat{F}u(Fe\ tot)_{BOF}$ ) is further allocated to pig iron (90%) and scrap (10%) on a base on expert judgment and the range of raw materials necessary for production of one ton of liquid steel (Table 19).

Table 19 Ferrous input to BOF (Remus et al., 2003)

Raw material	Input	Unit
Hot metal	788 – 931	kg/t LS
Scrap	101 – 340	kg/t LS
Iron ore	0.02 – 19.4	kg/t LS
Other Fe material	0 – 60	kg/t LS

To calculate unitary flows of iron fed to the BOF process by pig iron and scrap per ton of crude steel, the total flow of iron is multiplied by their respective shares:



$$\widehat{F}u(PI)_{BOF} = \widehat{F}u(Fe\ tot)_{BOF} * k(PI)_{BOF}$$

$$\widehat{F}u(scr)_{BOF} = \widehat{F}u(Fe\ tot)_{BOF} * k(scr)_{BOF}$$

where:

- $\widehat{F}u(PI)_{BOF}$  is a flow of iron from pig iron fed to the BOF per one ton of crude steel;
- $\widehat{F}u(scr)_{BOF}$  is a flow of iron from scrap fed to the BOF;
- $k(PI)_{BOF}$  is a share of total flow iron fed to the BOF allocated to pig iron;
- $k(scr)_{BOF}$  is a share of total flow iron fed to the BOF allocated to scrap.

To estimate the **iron content** of **pig iron**, a data collection was performed from the literature review and consultation with industrial experts. According to the measurements, provided by ArcelorMittal and found in the literature (King, 2001; Rankin, 2011, p. 176), pig iron contains 92.1-94.8% of iron. The iron content in the hot metal is influenced by the charge to the blast furnace and its operation. An iron content of **94.5%**, which corresponds to the value applied for calculations at European ArcelorMittal plants, is applied here.

The flow of scrap entering the BOF is composed of three types of scrap: home scrap (from steelmaking, rolling and finishing), process scrap and EoL scrap. This must be taken into account during the estimation of the **iron content** of **scrap** fed to the BOF and other steelmaking processes and foundries.

As defined previously, all home scrap is recycled internally and its iron content is equal to 97%. The remaining part of iron is supplied by a **mix of process and EoL scrap**. To define the **iron content** of the mix, first the iron content of process scrap and EoL scrap is estimated. Further, it is calculated as a weighted average of a typical charge and iron content of scrap categories.

The iron content of process scrap is expected to be the same or close to alloys used to produce final steel products (97% in the case of present study). To verify this assumption, the review of existing data is done. The European Scrap Quality Specification contains two categories of process scrap: low-residual scrap (E2, E8 and E6) and turnings (E5H and E5M) (EFR, 2007). The specification indicates the minimal iron content in these two categories: 98% and 97%, respectively. However, the measurements of the iron content in different categories of scrap provided by ArcelorMittal demonstrate that the iron content of turnings is lower than 97%, being 91% and 93% (Table 20). These measurements were observed during melting tests or calculated by BOF iron mass balance equations. No explanation for could be found. For the sake of simplicity, in the present study a simplification is adopted: the iron content of process scrap is equal to the one of steel - 97%.

Table 20 Theoretical and measured iron content in process scrap

Name	Symbol	Origin	Theoretical Fe content, %	Measured Fe content, %
Low-residual scrap	E2	busheling	>98	98,5
	E8	busheling	>98	98,5
	E6	new bundles	>98	98
Turnings	E5H	homogeneous	>97	93
	E5M	heterogenic	>97	91

As in the case of the process scrap, the expected **iron content of the EoL scrap** is published in the European Scrap Quality Specification. These expected values are presented in Table 21, according to their origin (column Theoretical Fe content). The specification indicates a minimal iron content 98% in all categories, except E46 (originating from incinerated packaging). The measurements of iron content in these categories, provided by ArcelorMittal, demonstrate that the iron content is lower in all scrap categories compared to the European specification (column Measures Fe content, Table 21). Similarly to the process scrap, these measurements were observed during melting tests or calculated by the BOF iron mass balance equations. The discrepancy between iron content defined in the European Scrap Quality Specification and measured iron content might be due to the inefficiency of the pre-processing stage of recycling (i.e. separation of metal).

Table 21 Theoretical and measured iron content in obsolete scrap

Name	Symbol	Origin	Theoretical Fe content, %	Measured Fe content, %
Obsolete scrap	E3	"heavy" demolition (buildings, ships, bridges); homogenic composition, good quality	>98	95
	E1	"light" demolition (equipment; poor quality, oxidation)	>98	92
Shredded scrap	E40	EoL vehicles, WEEE, furniture (low quality)	>98	94,5
	E46	incinerated packaging	>92	90
High-residual scrap	EHRB	reinforcing bars, wire	>98	95
	EHRM	mechanical pieces	>98	96

According to the information provided by ArcelorMittal, this **typical charge** is as following:

- 36% of charge to the furnace originates from “heavy” demolition,
- 29% - from “light demolition”,
- 14% - from process scrap
- 21% - from shredded scrap.

The iron content of these categories is provided in Table 22. The resulting weighted average of **iron content of scrap** fed to steel furnaces, additionally to home scrap, is equal to **93.8%**<sup>17</sup>.

*Table 22 Estimation of iron content of process and EoL scrap fed to furnaces*

Name	Symbol	Origin	Measured iron content of scrap, %	Part in charge, %
Obsolete scrap	E3	"heavy" demolition (buildings, ships, bridges); homogenic composition, good quality	95	36
	E1	"light" demolition (equipment; poor quality, oxidation)	92	29
Low-residual scrap	E2	busheling	97	14
	E8	busheling		
	E6	new bundles		
Turnings	E5H	homogenic	97	14
	E5M	Heterogenic		
Shredded scrap	E40	EoL vehicles, WEEE, furniture (low quality)	94,5	21
	E46	incinerated packaging	90%	

Finally, the mass balance of the BOF process is established for the production of one ton of crude steel based on the preceding values. Figure 27 illustrates the mass balance applicable to the year 2015. Table 23 summarizes input and output flows related to the BOF process and their iron content in 2015. Figure 28 shows the time dynamics for all input and output flows. Because of the dynamic generation of home scrap, the input flows of iron to BOF is also dynamic: the more home scrap is generated during the process, the higher the iron input is.

---

<sup>17</sup> Statistical sources do not report the types of scrap which are imported and exported. Here it is assumed that both process scrap and EoL scrap are traded and the iron content of traded scrap is the same as in scrap fed to iron and steelmaking processes - 93.8%.

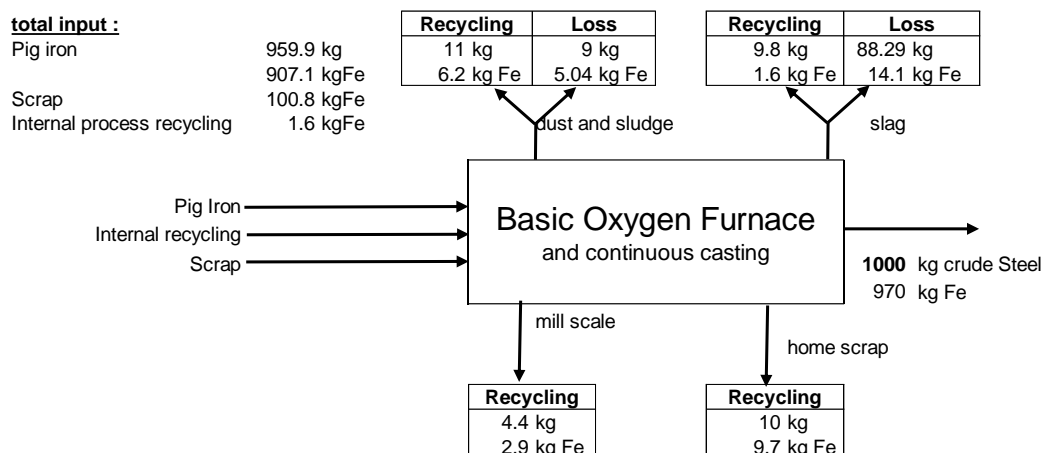

Figure 27 Iron input and output of BOF process in 2015

Table 23 BOF process specification applicable to 2015

	Flow	Flow	Iron content, %	Recycling	Behaviour
Input	Pig iron	959.9 kg/t CS 907.1 kg Fe/t CS	94.5	N/A	Flow: dynamic Iron content: static
	Scrap	100.8 kg Fe/t CS	97 home scrap 93.8 process and EoL scrap	N/A	Flow: dynamic Iron content: static
	Internal recycling	BOF slag: 9.8 kg/t CS 1.6 kg Fe/t CS	16	N/A	Static
Output	BOF slag	98.1 kg/t CS 15.7 kg Fe/t CS	16	10%, internally	Static
	BOF dust and sludge	20 kg/t CS 11.2 kg Fe/t CS	56	90%, ironmaking	Static
	Mill scale	4.4 kg/t CS 2.9 kg Fe/t CS	65	10%, ironmaking	Static
	Home scrap	10 kg/t CS 9.7 kg Fe/t CS	97	100%, internally	Flow: dynamic Iron content: static
	Crude steel	1000 kg/t CS 970 kg Fe/t CS	97	N/A	Iron content: static

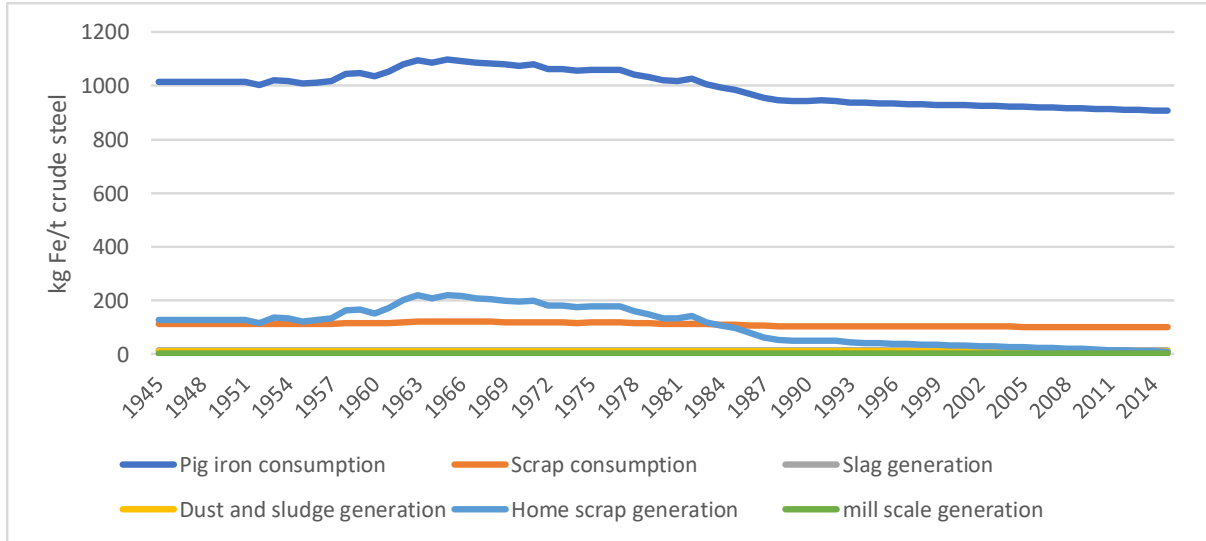

Figure 28 Input and output flows to BOF process, 1945-2015

#### 4.2.2 Electric Arc Furnace

To establish the mass balance for iron for the process of EAF, four input flows (scrap, DRI, pig iron and internal recycling of iron from EAF slag), and five output flows (crude steel, slag, dust, mill scale and home scrap) are considered, as shown on Figure 29 (duplicate of Figure 8) and explained in section 3.3.1.

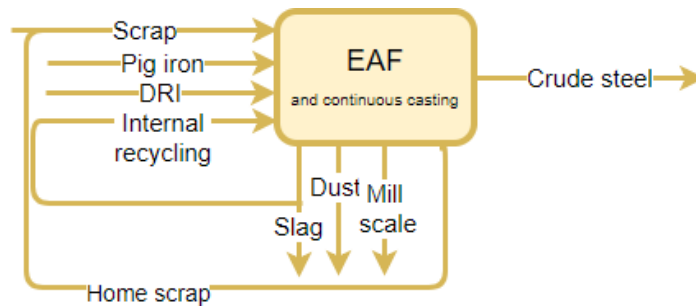

Figure 29 Flows related to the modelled EAF process (duplicate of Figure 8)

The iron input of EAF from scrap, pig iron and DRI<sup>18</sup> is estimated as the sum of iron contained in crude steel and in by-products generated during this process, similarly to the mass balance of the BOF process:

$$\widehat{Fu}(Fe\ tot)_{EAF} = Fu(CS)_{RF}^{EAF} * IC(CS) + Fu(ms)_{ext}^{EAF} * IC(ms)^{EAF} + Fu(d)_{ext}^{EAF} * IC(d)^{EAF} + Fu(sl)_{ext}^{EAF} * IC(sl)^{EAF} + hScr^{steel} * Fu(CS)_{RF}^{EAF} * IC(CS)$$

where:

<sup>18</sup> The flow of EAF slag recycled internally in the process is not included in the formula, because its output from the process is equal to its input to the process.

- $\widehat{Fu}(Fe\ tot)_{EAF}$  - total flow of iron from scrap, pig iron and DRI fed to the EAF process per ton of crude steel;
- $Fu(CS)_{RF}^{EAF}$  – flow of crude steel produced in the EAF and available for rolling and finishing (or export);
- $Fu(ms)_{ext}^{EAF}$  – flow of mill scale produced in the EAF and used externally of the EAF process;
- $IC(ms)_{ext}^{EAF}$  - iron content of mill scale generated in the EAF;
- $Fu(d)_{ext}^{EAF}$  - flow of dust, generated in the EAF and used externally of the EAF process;
- $IC(d)_{ext}^{EAF}$  - iron content of dust generated in the EAF;
- $Fu(sl)_{ext}^{EAF}$  - flow of slag, generated in the EAF and used externally of the EAF process;
- $IC(sl)_{ext}^{EAF}$  - iron content of slag generated in the EAF.

To estimate the total flow of iron entering EAF, it is necessary to define the generation rate and the iron content of its by-products.

#### a. EAF output flows

The iron content of crude steel has been defined in section 4.2.1.a and is equal to 97%.

The generation of **EAF slag** ranges from 60 to 260 kg per ton of liquid steel in Europe, depending on furnace efficiency (Kumar et al., 2009; Remus et al., 2003). The content of iron in EAF slag varies between 10-40% (Euroslag website, 2017; Kumar et al., 2009; Yildirim and Prezzi, 2011), depending on the type of steel produced, while the most common concentration is 32% (Remus et al., 2003). An average value is applied for definition of slag generation, i.e. 160 kg of EAF slag per ton of liquid steel with iron content of 32%. By analogy with BOF slag, 10% of EAF slag is considered as internally recycled (Euroslag website, 2017).

In the EAF, 10-30 kg of **dust** is generated per one ton of liquid steel (Remus et al., 2003). The present study applies the average value – 20 kg. The content of iron varies depending on the type of steel produced – carbon, alloy or stainless steel, as shown in Table 24. The iron content of dust is estimated as a weighted average of the iron content of dust generated during the production of the three types of steel, following their respective shares. This results in an iron content of 27.9% (rounded up to 28%). EAF dust is not recycled for metallurgical purposes and considered as lost (34% is landfilled, 32% is for recovery of zinc, 34% is recovered through other processes (Remus et al., 2003)).

Table 24 Estimation of iron content in EAF dust in accordance with steel type

Steel type	Ranges of iron content in EAF dust, %	Average value, %	Steel production share, %	Weighted average, %
carbon/low alloyed steel	10-45	27.5	83.4	27.9
alloy steel	17-37	27	13.4	
stainless steel	20-65	42.5	3.2	

For the generation of **mill scale and home scrap** the same values are taken as for BOF continuous casting:

- 4.4 kg of mill scale per ton of crude steel with iron content of 65%;
- home scrap generation is dynamic, with iron content of 97%.

Industrial experts estimated that the mill scale from the continuous casting of EAF liquid steel is not sent for recycling in sintering (cf. BOF mill scale). For the EAF process it is assumed that the mill scale is recycled externally and therefore is lost for metallurgical purposes. Home scrap is fully recycled internally.

#### *b. EAF input flows*

In the same way as the mass balance of BOF process, the input to the EAF is dynamic because of the dynamic generation of home scrap. The total flow of iron fed to the EAF consists of iron from scrap, pig iron and DRI, as reported in literature for the European context and summarized in Table 25 (Remus et al., 2003). Based on this, the study assumes that 80% of iron from scrap, 10% from DRI and 10% from pig iron.

*Table 25 Ferrous input to EAF (Remus et al., 2003)*

Raw material	Input	Unit
Scrap	1039-1232	kg/t LS
Pig iron	0-153	kg/t LS
DRI	0-215	kg/t LS

The input flows of iron from scrap, pig iron and DRI per ton of crude steel are calculated as the product of total iron flow fed to EAF and respective shares of the total iron flow for each material:

$$\widehat{Fu}(scr)_{EAF} = \widehat{Fu}(Fe\ tot)_{EAF} * k(scr)_{EAF}$$

$$\widehat{Fu}(PI)_{EAF} = \widehat{Fu}(Fe\ tot)_{EAF} * k(PI)_{EAF}$$

$$\widehat{Fu}(DRI)_{EAF} = \widehat{Fu}(Fe\ tot)_{EAF} * k(DRI)_{EAF}$$

where:

- $\widehat{Fu}(scr)_{EAF}$  is a flow of iron from scrap fed to the EAF;
- $\widehat{Fu}(PI)_{EAF}$  is a flow of iron from pig iron fed to the EAF;
- $\widehat{Fu}(DRI)_{EAF}$  is a flow of iron from DRI fed to the EAF;
- $k(scr)_{EAF}$  is a share of total flow iron fed to the EAF allocated to scrap;
- $k(PI)_{EAF}$  is a share of total flow iron fed to the EAF allocated to pig iron;
- $k(DRI)_{EAF}$  is a share of total flow iron fed to the EAF allocated to DRI.

The iron content of these input flows is the following:

- As for the BOF process, the flow of scrap is composed of home scrap, with iron content of 97% and of the mix of process and EoL scrap, with iron content of 93.8%.
- The iron content of pig iron is 94.5%, as explained in 4.2.1.b.
- The iron content of DRI is 92%, as reported by Astier (Astier, 2005).

Figure 30 and Table 26 summarize input and output flows related to the EAF process and their iron content, applicable to 2015. Figure 31 shows inputs and outputs for the period 1945-2015.

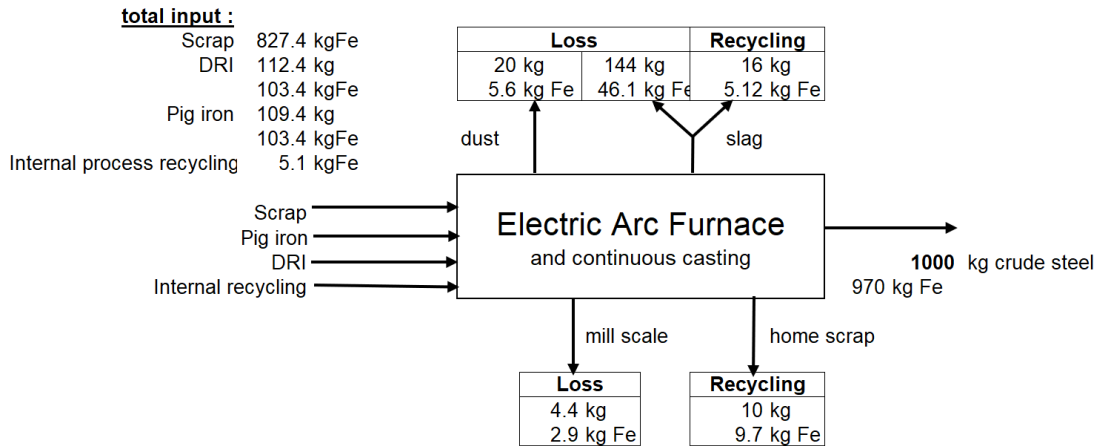

Figure 30 Iron input and output of EAF process in 2015

Table 26 EAF process specification applicable to 2015

	Flow	Flow	Iron content, %	Recycling	Behaviour
Input	Scrap	827.4 kg Fe/t CS	97 home scrap 93.8 process and EoL scrap	N/A	Flow: dynamic Iron content: static
	Pig iron	109.4 kg/t CS 103.4 kg Fe/t CS	94.5	N/A	Flow: dynamic Iron content: static
	DRI	112.4 kg/t CS 103.4 kg Fe/t CS	92	N/A	Flow: dynamic Iron content: static
	Internal recycling	EAF slag: 16 kg/t CS 5.1 kg Fe/t CS	32	N/A	Static
Output	EAF slag	160 kg/t CS 51.2 kg Fe/t CS	32	10%, internally	Static
	EAF dust	20 kg/t CS 5.6 kg Fe/t CS	28	100% externally	Static
	Mill scale	4.4 kg/t CS 2.9 kg Fe/t CS	65	100% externally	Static
	Home scrap	10 kg/t CS 9.7 kg Fe/t CS	97	100%, internally	Flow: dynamic Iron content: static
	Crude steel	1000 kg/t CS 970 kg Fe/t CS	97	N/A	Iron content: static



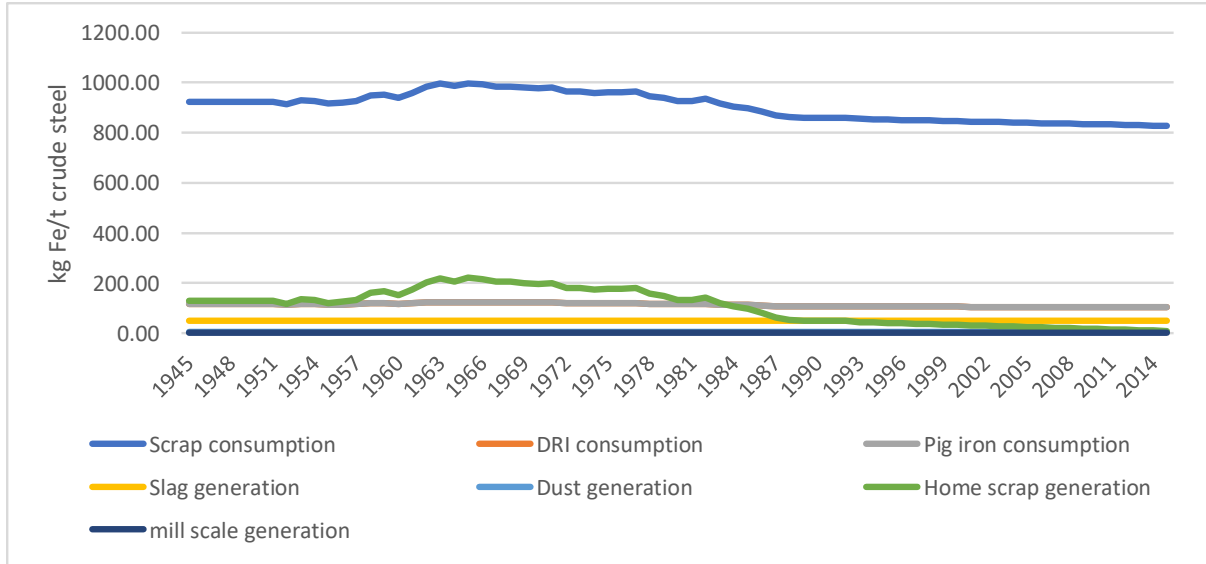

Figure 31 Input and output flows to EAF process, 1945-2015

#### 4.2.3 Open Hearth Furnace

Input and output flows related to the OHF process are shown in Figure 32 (copy of Figure 9).

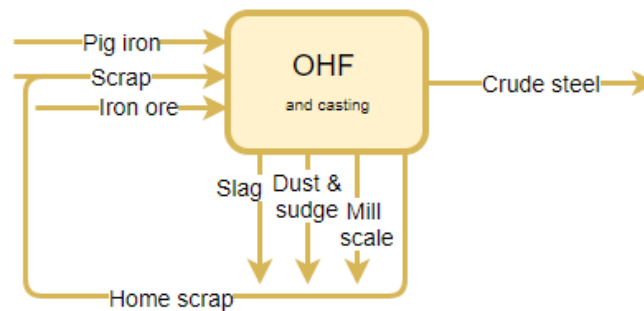

Figure 32 Flows related to the modelled OHF process (duplicate of Figure 9)

The mass balance for this process is established in a similar way to BOF and EAF: the total input of iron from pig iron, scrap and iron ore is estimated as a sum of iron contained in crude steel and in generated by-products:

$$\widehat{Fu}(Fe\ tot)_{OHF} = Fu(CS)_{RF}^{OHF} * IC(CS) + Fu(ms)_{ext}^{OHF} * IC(ms)^{EAF} + Fu(d, s)_{ext}^{OHF} * IC(d, s)^{OHF} + Fu(sl)_{ext}^{OHF} * IC(sl)^{OHF} + hScr^{steel} * Fu(CS)_{RF}^{OHF} * IC(CS)$$

where:

- $\widehat{Fu}(Fe\ tot)_{OHF}$  - total flow of iron from pig iron, scrap and iron ore fed to the OHF process;
- $Fu(CS)_{R\&F}^{OHF}$  - flow of crude steel produced in the OHF and available for rolling and finishing (or export);

- $Fu(ms)_{ext}^{OHF}$  – flow of mill scale produced in the OHF casting and used externally of the OHF process;
- $IC(ms)^{OHF}$  - iron content of mill scale generated in the OHF;
- $Fu(d, s)_{ext}^{OHF}$  – flow of dust and sludge, generated in the OHF and used externally of the OHF process;
- $IC(d, s)^{OHF}$  - iron content of dust and sludge generated in the OHF;
- $Fu(sl)_{ext}^{OHF}$  – flow of slag, generated in the OHF and used externally of the OHF process;
- $IC(sl)^{OHF}$  – iron content of slag generated in the OHF.

#### *a. OHF output flows*

OHF output flows include crude steel, slag, dust and sludge, generated during steelmaking, and mill scale and home scrap, generated during casting. The iron content of crude steel is 97%, as for steel produced by the BOF and EAF processes.

Since no information is identified concerning the quantity of slag, dust and sludge formed in the OHF, expert estimations are used for modeling and calculation. According to the experts' view, the amount of slag, dust and sludge formed by OHF might be similar to the corresponding amounts formed during the BOF process: 98.1 kg of slag and 20 kg of dust and sludge per ton of liquid steel. Moreover, slag is dumped or recycled externally (Camp and Francis, 1920). Therefore, dust and sludge might be treated in a like manner, i.e. not recycled internally in the process.

The iron content of OHF slag is 24% (Camp and Francis, 1920). Since the information concerning the iron content of OHF dust and sludge is not found, 56% is assumed for calculation, referring to the BOF process.

The reported loss of iron in mill scale varies between 2-5% of iron of crude steel, which is higher than for BOF and EAF processes (Camp and Francis, 1920). The present study uses the average value for the loss of iron in mill scale, 34 kg per ton of crude steel. Iron content of 56% is assumed for mill scale, analogically to BOF and EAF mill scale. The OHF mill scale is reported to be fully recycled in ironmaking (Camp and Francis, 1920).

For the generation of home scrap, the same values as for BOF and EAF processes are applied.

#### *b. OHF input flows*

The total flow of iron fed to OHF by pig iron, scrap and iron ore is estimated from the mass balance. The amount of each input depends on the furnace type (Monell OHF and Trade OHF). Table 27 shows an example of charging for 100-ton OHF – Monell OHF requires 75-100% of pig iron, while trade OHF can use less than 75% of pig iron and consumes more scrap (Camp and Francis, 1920). The average values are applied for allocation of iron to each flow:

- 63.2% of iron is allocated to pig iron;
- 33.7% of iron is allocated to scrap;

- 3.1% of iron is allocated to iron ore.

Table 27 Example of OHF charging used on a 100 t furnace (adapted from (Camp and Francis, 1920)

Material	Monell OHF, t	Monell OHF, %	Trade OHF, t	Trade OHF, %
Pig iron	74.8	77.1	52.2	49.3
Scrap	20.4	21	49.1	46.4
Iron ore	1.8	1.9	4.5	4.3

The input flows of iron from pig iron, scrap and iron ore per ton of crude steel are calculated as the product of total iron flow fed to the OHF and the respective shares of each material:

$$\widehat{Fu}(PI)_{OHF} = \widehat{Fu}(Fe\ tot)_{OHF} * k(PI)_{OHF}$$

$$\widehat{Fu}(scr)_{OHF} = \widehat{Fu}(Fe\ tot)_{OHF} * k(scr)_{OHF}$$

$$\widehat{Fu}(ore)_{OHF} = \widehat{Fu}(Fe\ tot)_{OHF} * k(ore)_{OHF}$$

where:

- $\widehat{Fu}(PI)_{OHF}$  is a flow of iron from pig iron fed to the OHF;
- $\widehat{Fu}(scr)_{OHF}$  is a flow of iron from scrap fed to the OHF;
- $\widehat{Fu}(ore)_{OHF}$  is a flow of iron from iron ore fed to the OHF;
- $k(PI)_{OHF}$  is a share of total flow iron fed to the OHF allocated to pig iron;
- $k(scr)_{OHF}$  is a share of total flow iron fed to the OHF allocated to scrap;
- $k(ore)_{OHF}$  is a share of total flow iron fed to the EAF allocated to iron ore.

Figure 33 and Table 28 summarize the flows and their iron content related to the OHF as applied in 2015.

Figure 34 illustrates input and output flows related to the OHF process for the period 1945-2015.

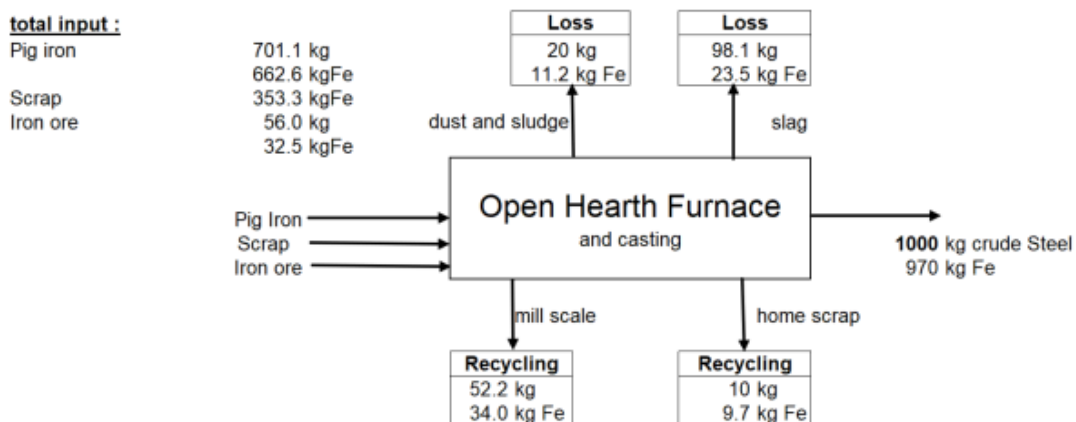

Figure 33 Iron input and output of OHF process in 2015

Table 28 OHF process specification applicable to 2015

	Flow	Flow	Iron content, %	Recycling	Behaviour
Input	Pig iron	701.1 kg/t CS 662.6 kg Fe/t CS	94.5	N/A	Flow: dynamic Iron content: static
	Scrap	353.3 kg Fe/t CS	97 home scrap 93.8 process and EoL scrap	N/A	Flow: dynamic Iron content: static
	Iron ore	56 kg/t CS 32.5 kg Fe/t CS	58	N/A	Flow: dynamic Iron content: static
Output	OHF slag	98.1 kg/t CS 23.5 kg Fe/t CS	24	100%, externally	Static
	OHF dust and sludge	20 kg/t CS 11.2 kg Fe/t CS	56	100% externally	Static
	Mill scale	52.2 kg/t CS 34 kg Fe/t CS	65	100% ironmaking	Static
	Home scrap	10 kg/t CS 9.7 kg Fe/t CS	97	100% internally	Flow: dynamic Iron content: static
	Crude steel	1000 kg	97	N/A	

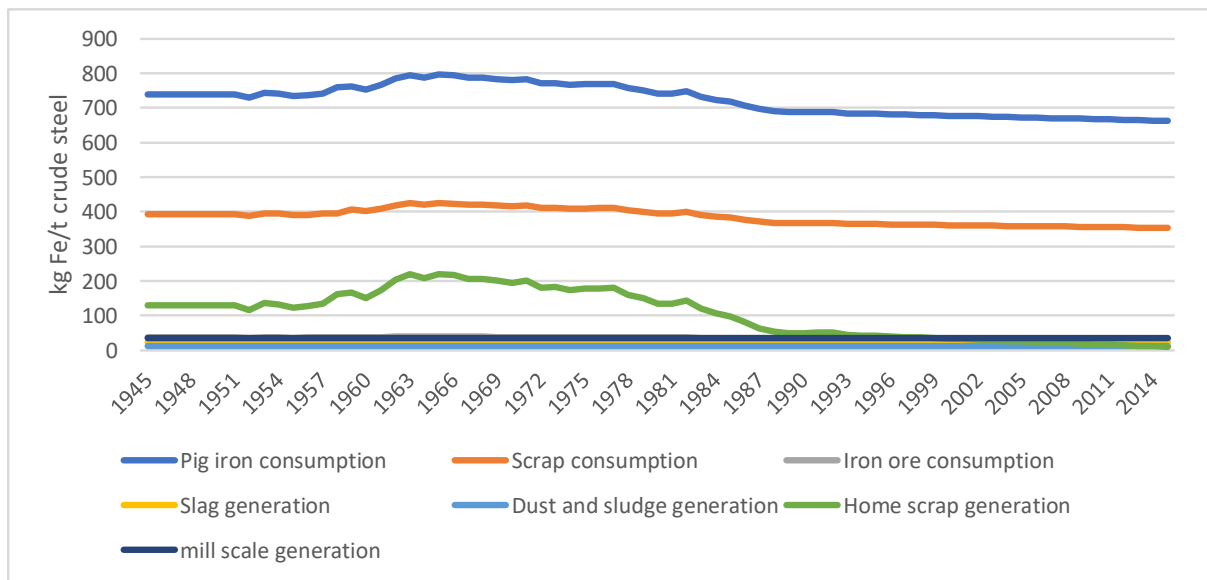

Figure 34 Input and output flows to OHF process, 1945-2015

#### 4.2.4 Rolling and finishing

The generation and the iron contents of by-products are reviewed to establish the mass balance for the process of rolling and finishing. The process is fed by crude steel. Its output flows are:

- finished steel products,
- home scrap,
- iron-bearing by-products: mill scale, mill scale sludge and iron oxide or iron sulphate

The mass balance of the process of rolling and finishing is established based on two steps. First, the mass balance is established for one ton of produced steel products with respect to data reported in literature. In this case, the input of iron is calculated as the sum of iron in steel products and generated by-products:

$$\widehat{Fu}(CS)_{RF} = Fu(SP)_{FM}^{RF} * IC(CS) + Fu(ms)_{ext}^{RF} * IC(ms)^{RF} + Fu(mss)_{ext}^{RF} * IC(mss)^{OHF} + Fu(os)_{ext}^{OHF} * IC(os)^{OHF} + hScr^{RF} * Fu(SP)_{FM}^{RF} * IC(CS)$$

where:

- $\widehat{Fu}(CS)_{RF}$  - flow of iron from crude steel fed to the process of rolling and finishing;
- $Fu(SP)_{FM}^{RF}$  - flow steel products produced during rolling and finishing and fed to processing and manufacturing (or exported);
- $Fu(ms)_{ext}^{RF}$  - flow of mill scale produced during rolling and finishing and used externally of the process;
- $IC(ms)^{RF}$  - iron content of mill scale generated during rolling and finishing;
- $Fu(mss)_{ext}^{RF}$  - flow of mill scale sludge, generated during rolling and finishing and used externally of the process;
- $IC(mss)^{OHF}$  - iron content of mill scale sludge generated during rolling and finishing;
- $Fu(os)_{ext}^{OHF}$  - flow of iron oxide/iron sulphate, generated during rolling and finishing and used externally of the process;
- $IC(os)^{OHF}$  - iron content of iron oxide/iron sulphate, generated during rolling and finishing;
- $hScr^{RF}$  - home scrap generation during rolling and finishing.

However, the generation of home scrap during this process is linked to the steel production processes (BOF, EAF and OHF). To calculate the total generation of home scrap per one ton of steel, the mass balance established for the production of one ton of steel products must be converted to the mass balance for one ton of crude steel, fed to the process of rolling and finishing. This constitutes the second step. The iron contained in finished products is calculated as a difference between iron contained in crude steel and iron of by-products:

$$\widehat{Fu}(SP)_{FM}^{RF} = Fu(CS)_{RF} * IC(CS) - Fu(ms)_{ext}^{RF} * IC(ms)^{RF} - Fu(mss)_{ext}^{RF} * IC(mss)^{OHF} - Fu(os)_{ext}^{OHF} * IC(os)^{OHF} - hScr^{RF} * Fu(CS)_{FM}^{RF} * IC(CS)$$

The iron content of both crude steel and steel products is equal – 97%, as the composition of steel is not changing during rolling and finishing.

As explained in subsection 3.3.1, the generation of by-products depends on the operation of rolling – cold or hot. The generation of by-products, their iron content and utilisation are reported in literature (Das et al., 2007; EC, 2001; U.S. Department of Energy, 2016) and summarized in Table 29.

Table 29 Generation rate, iron content and utilisation of by-products of rolling and finishing

By-product	Generation, kg/t finished steel products	Fe content, %	Utilisation
Hot rolling			
Scale of scarfing, grinding, shot blasting	0.2-35 with average value of 3.5	48.55 - 69.4	95.9% recycled in sintering 3.4% external use 0.7% landfilled
Re-heating scale	0.07-15 with average value of 4		
Scale from descaling	oil-free scale: 12.7 - 16 oily scale: 1.9 - 3.5	70	37.6% in integrated steel mills 52.1% sold or used externally 10.3% Landfilled
Home scrap (rolling rejections, cuttings, etc)	70-150		100% used in steelmaking
Cold and hot rolling			
Mill scale sludge	12	30-60	Small part – recycled in sintering Mostly landfilled or incinerated
Pickling: Iron oxide (HCl)	4-12 with average value of 5.5	70	>99.9% sold, used externally <0.1% landfilled
Iron sulphate	2.5-25, average 17	37	
Home scrap from pickling (head/tail ends of strip and coil)	30-45		100% used in steelmaking

The present study adopts the average values indicated in Table 29 for the generation rate and iron content for three types of scale (from scarfing, grinding, shot blasting; re-heating scale; scale from descaling) and mill scale sludge. Due to missing data for re-heating scale, its iron content and utilization are assumed to be the same as scale of scarfing, grinding and shot blasting (59%). For the same reason, it is assumed that 10% of mill scale sludge is recycled in sintering and 90% is landfilled or incinerated. The type of by-product generated during pickling - iron oxide or iron sulphate depends on the acid used (HCl or H<sub>2</sub>SO<sub>4</sub>) and it is not possible to differentiate the final by-product generated. Therefore, average values are assumed for the generation rate (11.2 kg/t of steel products) and the iron content (53.5%).

The generation of 70-150 kg of home scrap per ton of finished products corresponds to the total quantity of home scrap generated during hot rolling. The generation of home scrap during pickling, shown in Table 29, is specified for strips and coils. But it is not clear if the similar generation of home scrap during pickling is obtained for other steel products. Moreover, it is not obvious, if this generation is included in the total quantity reported for hot rolling. Thus, data for home scrap generation during pickling is not considered further.

Data on historical improvement of home scrap generation during rolling and finishing could not be found in the literature. Thus, a static parameter is applied. In the mass balance for one ton of steel products (first step), the generation of home scrap is calculated to correspond to the generation of 90 kg in the mass balance for one ton of crude steel (second step). It is equal to 101.7 kg per ton of finished steel products. The iron content of home scrap generated during rolling and finishing is equal to 97%. Finally, Figure 35 illustrates the mass balance established for one ton of steel products.

Figure 36 illustrates the mass balance for rolling and finishing converted for the input of one ton of crude steel. Table 30 summarizes input and output flows related to the process of rolling and finishing and their iron content for both mass balances. Only the mass balance established for one ton of crude steel (second step) is applied further in part 4.3 for calculation of mass flows.

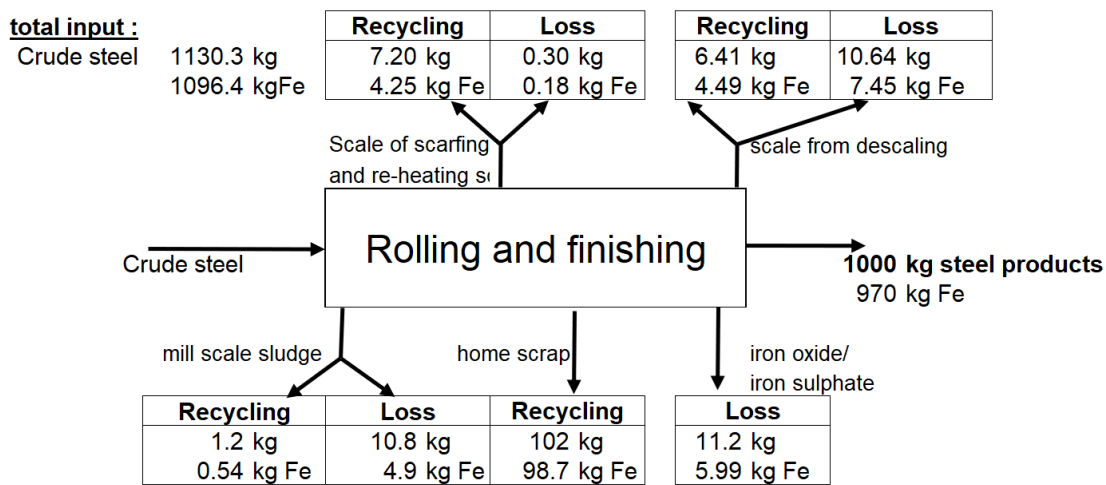

Figure 35 Mass balance of the process of Rolling and finishing, established for the production of one ton of finished products

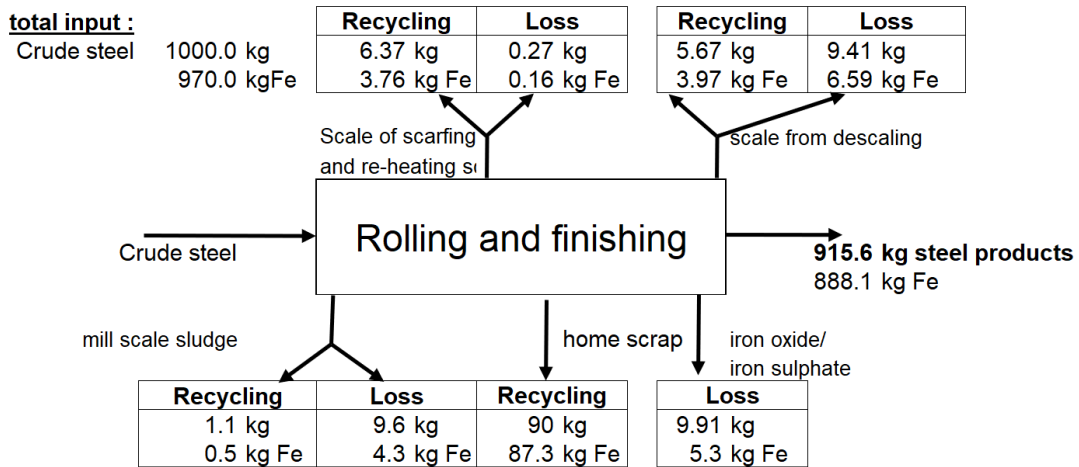

Figure 36 Mass balance of the process of Rolling and finishing, converted for the inflow of one ton of crude steel

Table 30 Rolling and finishing process specification

Flow		Flow for 1 ton of steel products (SP) produced	Flow for 1 ton of crude steel fed	Iron content, %	Recycling	Behaviour
Input	Crude steel	1130.3 kg/t SP 1096.4 kg Fe/t SP	1000 kg/t CS 970 kg Fe/t CS	97	N/A	Static
Output	Scale of scarfing, grinding, shot blasting and re-heating scale	7.5 kg/t SP 4.43 kg Fe/t SP	6.64 kg/t CS 3.91 kg Fe/t CS	59	96 % sintering 4% externally	Static
	scale from descaling	17.05 kg/t SP 11.9 kg Fe/t SP	15.08 kg/t CS 10.56 kg Fe/t CS	70	37.6% ironmaking 62.4% externally	Static
	Mill scale sludge	12 kg/t SP 5.4 kg Fe/t SP	10.6 kg/t CS 4.8 kg Fe/t CS	45	10% sintering 90% externally	Static
	iron oxide/iron sulphate	11.2 kg/t SP 5.99 kg Fe/t SP	9.91 kg/t CS 5.3 kg Fe/t CS	53.5	100% externally	
	Home scrap	101.7 kg/t SP 98.7 kg Fe/t SP	90 kg/t CS 87.3 kg Fe/t CS	97	100% steelmaking	Static
	Steel products	1000 kg	915.6 kg/t CS 888.1 kg Fe/t CS	97	N/A	Static

#### 4.2.5 Foundries

Flows associated with the process of foundries are summarized in Figure 37 (copy of Figure 11).



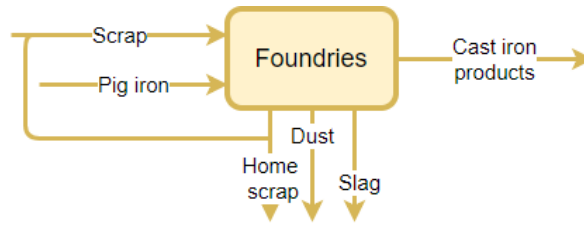

Figure 37 Flows related to the modelled Foundries process (duplicate of Figure 11)

The mass balance of this process is established per ton of cast iron. The total flow of iron from scrap and pig iron is calculated as a sum of iron contained in cast products and generated by-products:

$$\widehat{Fu}(Fe\ tot)_{Fnd} = Fu(Cast)_{FM}^{Fnd} * IC(Cast) + Fu(s)_{ext}^{Fn} * IC(s)^{Fnd} + Fu(d)_{ext}^{Fnd} * IC(d)^{Fnd} + hScr^{Fnd} * Fu(Cast)_{FM}^{Fnd} * IC(Cast)$$

where:

- $\widehat{Fu}(Fe\ tot)_{Fnd}$  stands for total flow of iron from scrap and pig iron fed to foundries;
- $Fu(Cast)_{FM}^{Fnd}$  – cast iron produced in foundries and available for processing and manufacturing;
- $IC(Cast)$  – iron content of cast iron;
- $Fu(s)_{ext}^{Fnd}$  – flow of slag produced in foundries and used externally of the process;
- $IC(s)^{Fnd}$  - iron content of slag produced in foundries;
- $Fu(d)_{ext}^{Fnd}$  – flow of dust, generated in in foundries and used externally of the process;
- $IC(d)^{Fnd}$  - iron content of dust, generated in in foundries;
- $hScr^{Fnd}$ - home scrap generation in foundries expressed in percentage of cast iron production.

#### a. Foundries output flows

As reported by Ashby and Jones, the iron content of cast iron varies between 93.2% and 95.4% (Ashby and Jones, 2013). The average value of 94.3% is used for further calculation.

The generation of by-products during melting (slag and dust) and their iron content vary depending on furnace types applied: cupola; induction; rotary and electric arc furnaces, as shown in Table 31 (EC, 2005). None of these by-products is recycled internally (EC, 2005).

Table 31 Generation of slag and dust in different types of foundry furnaces and their iron content

Type of furnace	Slag generation, kg/t of metal charge	Iron content of slag, %	Dust generation, kg/t of metal charge	Iron content of dust
EAF	10 - 40	0.5 - 1	5 - 8	30 - 60
Induction	10 - 20	10-30	0.06 - 1	30 - 70
Cupola	40 - 80	1 - 6	4 - 12	30 - 60
Rotary	20 - 60	(no information)	0.3 - 2.9	50 - 75

The average values for slag and dust generation are used for modelling and calculation:

- 33.8 kg of slag per ton of metal charge, with iron content of 8.1%,
- 4.2 kg of dust per ton of metal charge, with iron content of 50.6%.

The generation of home scrap depend on the type of cast iron: 32% of production for lamellar iron, 37% for nodular iron and 55% for steel (EC, 2005). In steel foundries the reuse of home scrap is limited, as explained in 3.3.1. The maximum amount fed to the furnace is estimated by operators to be 60% of the generated scrap (EC, 2005). In the present study the generation of home scrap is chosen to be 40% of the cast iron production, 50% of which is recycled internally, according to the literature (Gros, 2007). The generation of home scrap for this process is static.

*b. Foundries input flows*

The total flow of iron entering the process of foundries is allocated to scrap (80%) and pig iron (20%) on the base of literature (EC, 2005). The flows of iron fed to foundries by pig iron and scrap are calculated as the product of total iron flow and respective shares of each material:

$$\widehat{Fu}(PI)_{Fnd} = \widehat{Fu}(Fe\ tot)_{Fnd} * k(PI)_{Fnd}$$

$$\widehat{Fu}(scr)_{Fnd} = \widehat{Fu}(Fe\ tot)_{Fnd} * k(scr)_{Fnd}$$

where:

- $\widehat{Fu}(PI)_{Fnd}$  is a flow of iron from pig iron fed to foundries;
- $\widehat{Fu}(scr)_{Fnd}$  is a flow of iron from scrap fed to foundries;
- $k(PI)_{Fnd}$  is a share of total flow iron fed to foundries allocated to pig iron;
- $k(scr)_{Fnd}$  is a share of total flow iron fed to foundries allocated to scrap.

The flow of scrap is composed of home scrap generated in foundries and a mix of steel process and EOL scrap. The iron content of home scrap is equal to 94.3%, the same as the iron content of cast iron. The iron content applied to the mix of process and EoL scrap and for pig iron is the same, as applied for BOF, EAF and OHF: 93.8% for scrap and 94.5% for pig iron, respectively.

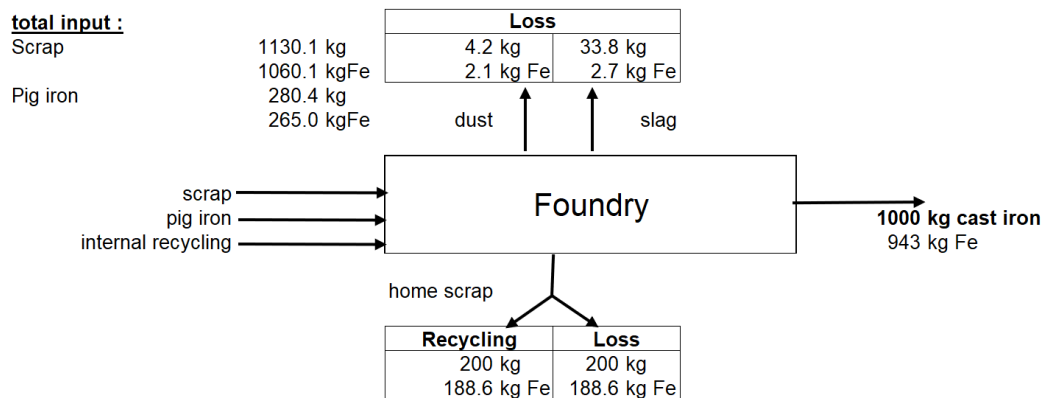

Figure 38 Iron input and output of Foundry process

Figure 38 and Table 32 summarize input and output flows related to the Foundry process and their iron content. These values are applied for all the period of 1945-2015.

Table 32 Foundry process specification

Flow		Flow, kg/t cast iron	Iron content, %	Recycling	Behaviour
Input	Scrap	1130.3 kg/t CS 1060.1 kg Fe/t CS	93.8	N/A	Static
	Pig iron	280.4 kg/t CS 265.0 kg Fe/t CS	94.3 home scrap 93.8 process and EoL scrap	N/A	Static
Output	Slag	33.8 kg/t CS 2.7 kg Fe/t CS	8.1	100%, treated externally	Static
	Dust	4.2 kg/t CS 2.1 kg Fe/t CS	50.6	100%, treated externally	Static
	Home scrap	400 kg/t CS 377.2 kg Fe/t CS	94.3	50%, internally	Static
	Cast iron products	1000 kg kg/t CS kg Fe/t CS	94.3	N/A	

### 4.3 Definition of mass flows

This part is dedicated to the calculation of mass flows. The first section of this part presents assumptions and calculations related to the stage of steel production. The second section focuses on the flows of the stage of processing and manufacturing of goods. These sections also discuss assumptions applied to calculation of flows in order to be coherent with the investigated temporal and spatial boundaries.

As in part 4.2, the system is expressed in terms of variables and parameters. The mathematical definition of system variables is designated differently than for unitary flows ( $F_u$ ), established for mass balances for iron and steelmaking processes. All flows are annotated as numbers and are detailed in Figure 39. For example:

- $F2(t, c)$  means the total consumption of pig iron per country, per year;
- $\widehat{F2}(t, c)$  means the same flow in iron equivalent;
- $F2.1(t, c)$ ,  $F2.2(t, c)$ ,  $F2.3(t, c)$  and  $F2.4(t, c)$  mean the respective distributions of pig iron to the processes of steel-making and foundries;

Imports and exports are designated with T and are also numbered. For example:

- $T1i(t, c)$  – imports of pig iron;
- $T1e(t, c)$  – exports of pig iron.

Table 33 summarizes the designation of all flows, as used further in the present part.

*Table 33 Annotation of flows applied for the calculation of the mass flows*

#	Flow	#	Flow
F1	Pig iron production	F10	Cast iron consumption
F2	Pig iron consumption (total)	F11	Final goods production
F2.1	Pig iron consumption in BOF	F12	Final goods consumption
F2.2	Pig iron consumption in EAF	F13	Process scrap generation
F2.3	Pig iron consumption in OHF	F14	EoL materials discarded from use
F2.4	Pig iron consumption in Foundries	F14.1	EoL materials that are collected and processes
F2.1	Pig iron consumption in BOF	F14.2	EoL materials that that are not collected and processes
F3	DRI production	F15	EoL scrap
F4	Home scrap generation and consumption (total)	F16	Flow of scrap (mix of EoL and process scrap)
F4.1	Home scrap generation and consumption in BOF	F16.1	Flow of scrap consumed in BOF
F4.2	Home scrap generation and consumption in EAF	F16	Flow of scrap consumed in EAF
F4.3	Home scrap generation and consumption in OHF	F16	Flow of scrap consumed in OHF
F4.4	Home scrap generation and consumption in Foundries	F16	Flow of scrap consumed in Foundries
F4.1	Home scrap generation and consumption in BOF	F17	DRI consumption
F5	Crude steel production (total)	T1i, T1e	Pig iron imports and exports

F5.1	Crude steel production in BOF	T2i, T2e	DRI imports and exports
F5.1	Crude steel production in EAF	T3i, T3e	Crude steel imports and exports
F5.1	Crude steel production in OHF	T4i, T4e	Finished steel products imports and exports
F6	Crude steel consumption	T4i, T4e	Finished steel products imports and exports
F7	Finished steel products production	T5i, T5e	Cast iron imports and exports
F8	Finished steel products consumption	T6i, T6e	Indirect imports and exports
F9	Cast iron production	T4i, T4e	Scrap imports and exports (mix of EoL and process scrap)

The variables needed for the estimation of mass flows are defined in this part and include:

- distribution of steel products by type;
- distribution of steel products by industrial sector;
- distribution of cast products by industrial sector;
- generation of process scrap;
- historic improvement of process scrap generation.

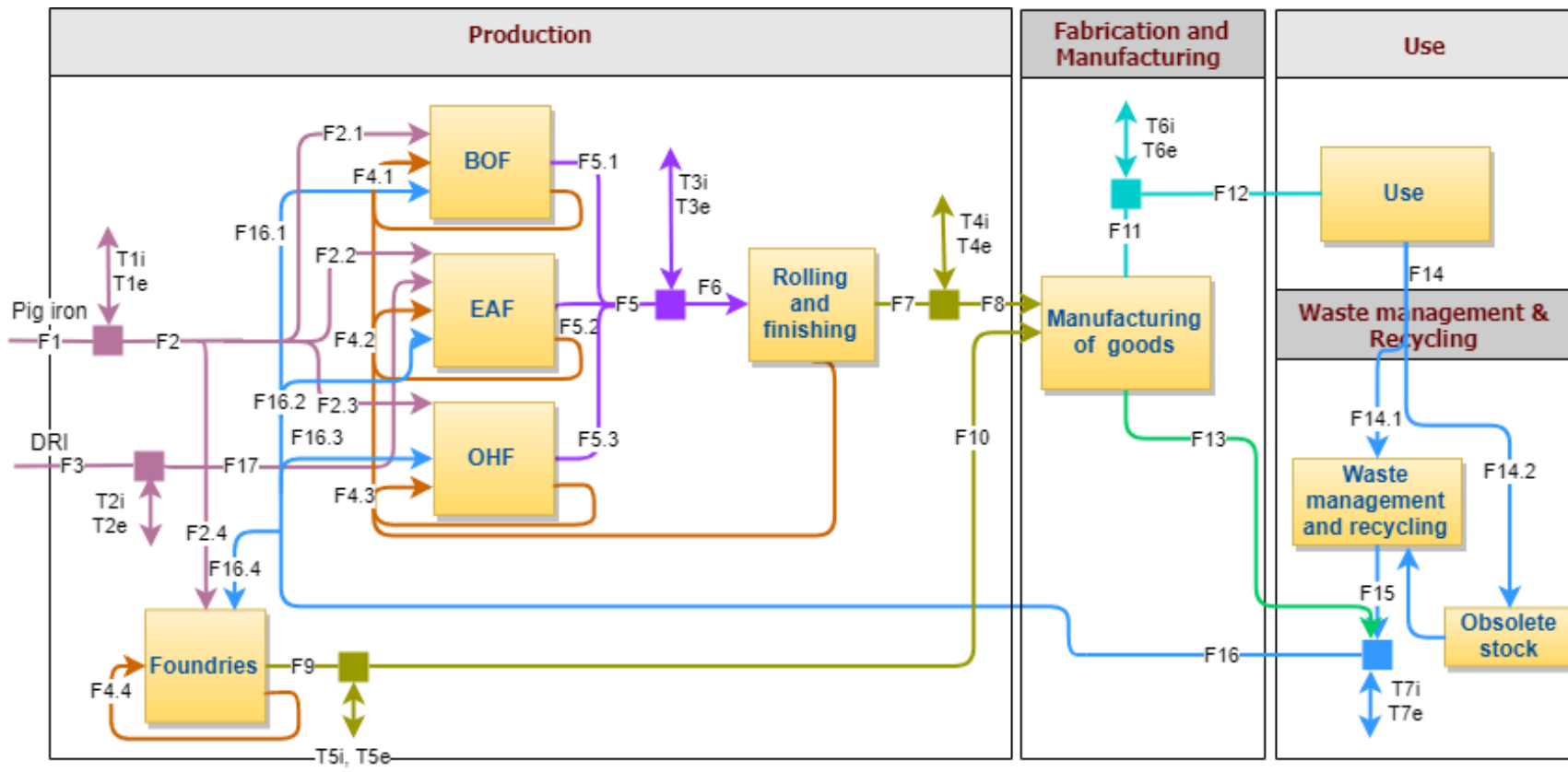

Figure 39 Annotation of flows applied for the calculation of the mass flows

### 4.3.1 Production

This section provides calculations of mass flows for the stage of Production on the basis of statistics and established process-specific mass balances. As summarized in Table 16, four flows related to the production stage are calculated directly from statistical data, namely total consumption of pig iron, DRI, crude steel and cast iron. Nevertheless, assumptions must be applied to some statistical data to be coherent with temporal and geographical perimeters. For example, to estimate the production of steel in some countries during non-reported period, to correct inaccuracies in the reported distribution of crude steel production per steelmaking process and to assume the production of cast iron in foundries to deal with data gaps. Scrap consumption, generation of home scrap and production of finished steel products are estimated on the base of process-specific mass balances.

#### a. Pig iron ( $F2$ )

As shown in the section 4.1.1, the chosen data on production ( $F1$ ) and trade ( $T1i, T1e$ ) of pig iron cover the whole period studied. So, the total consumption of pig iron can be calculated according to the following formula:

$$F2(t, c) = F1(t, c) + T1i(t, c) - T1e(t, c)$$

To convert this flow into iron equivalent ( $\widehat{F2}(t, c)$ ), it is multiplied by the iron content of pig iron  $IC(PI)$ .

Special attention was only necessary to Slovenia, as the pig iron production and trade are not explicitly given but were included into the pig iron consumption of Yugoslavia between 1945 and 1990. The consumption of pig iron in Slovenia is confirmed by the presence of the OHF "Ravne Steelworks" (previously called Guštanj Steelworks), which has been operating since 1945 (Oder, n.d.). Thus, for the period 1945-1990 the consumption of pig iron in Slovenia is calculated on the base of steel and cast iron production and the process mass balance, as described in section 4.2:

$$\widehat{F2}(t, c) = F5.1(t, c) * \frac{\widehat{F}u(PI)_{BOF}(t, c)}{1000} + F5.2 * \frac{\widehat{F}u(PI)_{EAF}(t, c)}{1000} + F5.3 * \frac{\widehat{F}u(PI)_{OHF}(t, c)}{1000} + F8 * \frac{\widehat{F}u(PI)_{Fnd}}{1000}$$

From 1991, the consumption of pig iron in Slovenia is estimated in the same way as in other countries. Figure 40 summarizes the consumption of pig iron in countries of EU-27, expressed in tons, between 1945 and 2015.

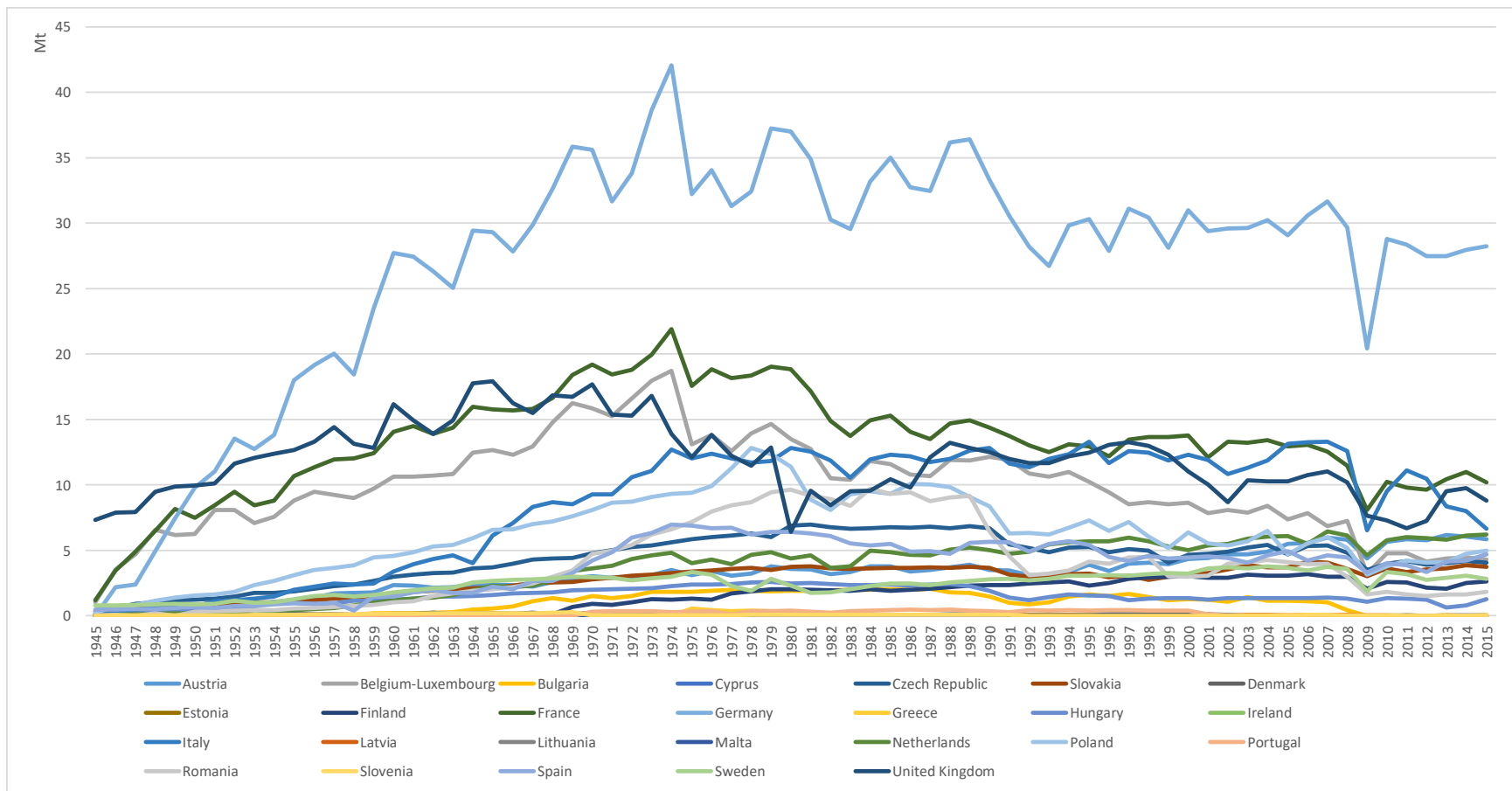

Figure 40 Consumption of pig iron per country of EU-27, 1945-2015



b. DRI (F17)

The production of DRI is reported in statistics since 1970, while trade flows are reported from 1962. The consumption of DRI is estimated as the sum of production and import minus export for 27 countries:

$$F17(t, c) = F3(t, c) + T2i(t, c) - T2e(t, c)$$

The resulting mass flows are shown in Figure 41, expressed in tons of DRI.

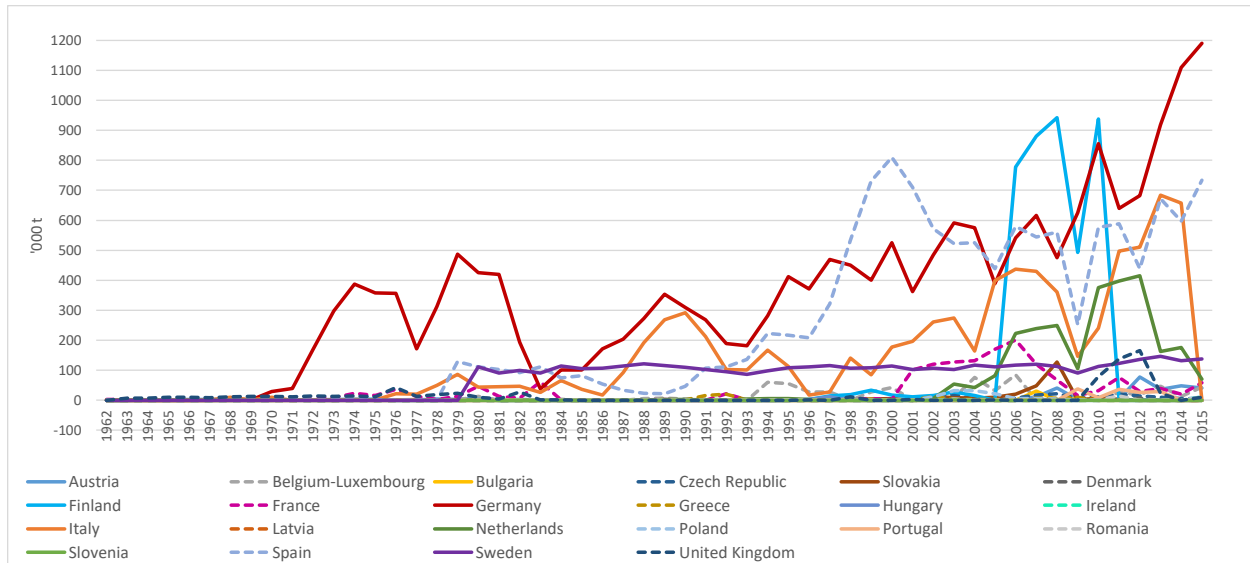

Figure 41 Consumption of DRI in countries of EU-27, 1970-2015

The result of this calculation shows that only for 6 countries the DRI consumption does not contain negative values (Germany, Greece, Hungary, Italy, Malta, Spain). For the other 20 countries, 100 points are negative (representing 6.6% of the total 1512 data points for the period 1962-2015, which means that the export flow is higher than the sum of the production and import flow. As most of countries do not produce DRI, possible reasons for this data discrepancy may be related to the presence of a commercial stock in the country or to the UN Comtrade data itself (Muryawan, 2012):

- UN Comtrade data is based on customs declarations, where the value of trade flow is more important than mass flow, thus always recorded. The physical flow of traded materials is not always recorded and might be estimated.
- Some countries do not report data due to confidentiality reasons.

For the sake of data consistency, negative values are treated as missing values and are replaced by zero. This estimation does not have an important impact on consumption, as can be seen in Figure 42. The difference between the consumption of DRI in EU-27 before and after treatment of negative values for the period 1962-2015 is calculated as percentage difference. For the period 1970-2015 the average difference is 1%. For the period 1962-1969 the average difference is higher because of the absence of production data for Sweden.

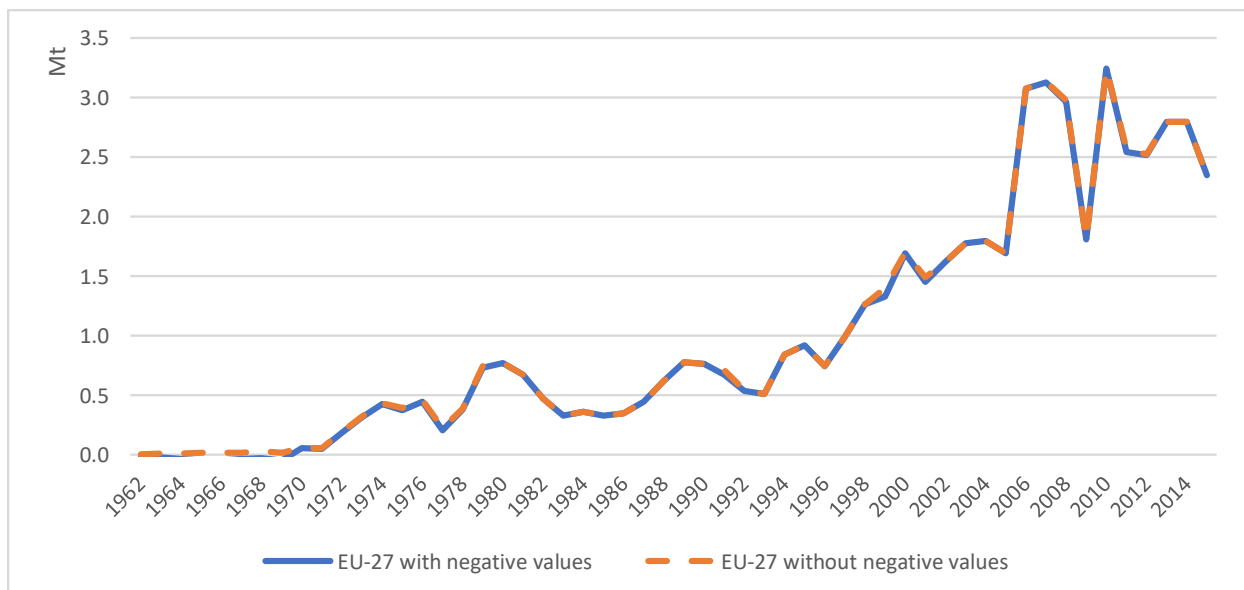

Figure 42 EU-27 DRI consumption before and after correction of negative values, EU-27, 1945-2015

As can be seen from Figure 41 and Figure 42, the DRI consumption increased between 1962 and 2015. Thus, the consumption of DRI before 1962 is assumed to be lower and is not calculated. The amount of iron, provided by DRI in mass balances is assumed to be replaced by scrap.

### c. Crude steel (F5, F5.1-F5.3, F6)

Here, the mass flows of produced (total and per process) and consumed crude steel are calculated. To deal with data gaps concerning the flows of the crude steel, two points are addressed:

- Assumptions applied for the estimation of crude steel production in Slovenia and Greece before 1980 and 1967 respectively;
- Assumptions concerning crude steel consumption per steelmaking process;

The **production** and trade of crude steel is reported for the whole period for most countries. Four countries of EU-27 do not produce steel (Cyprus, Estonia and Malta) or only very small amounts (Lithuania). The data reported for Lithuania is incomplete<sup>19</sup> and is not taken into consideration. Data on crude steel production for Slovenia and Greece is available since 1980 and 1967, respectively. For previous years, the crude steel production is estimated in the following way:

- Between 1945 and 1967 two steel producers are identified in Greece: Viohalco, who launched steel production in 1960s (Viohalco, 2016) and Halyvourgiki, producing steel from 1938 onward (Halyvourgiki, 2016). Greek steel production in 1945 is estimated based on Halyvourgiki's

<sup>19</sup> Lithuanian production is reported randomly by Worldsteel: 1 - 8 thousand tons of crude steel per year between 1980 and 1994 (11 data points). No steel mills are identified on its territory, only steel transformation plant, which produces finished steel products. While a data request was sent to clarify the origin of crude steel production, no answer was obtained.

furnaces. In 1945, the company owned 2 electric furnaces with the capacity of 6-8 tons. To estimate annual production of these two furnaces, it is assumed that:

- they work 345 days a year with 20 days of production downtime (for holidays and maintenance);
- furnaces are charged several times per day, tap-to-tap time varies between 2 and 3 hours (Camp and Francis, 1920), resulting in 8-12 charges in 24h.

The annual production of crude steel thus varies between 33,000 and 66,000 tons. An average value is assumed for steel production in 1945 in Greece – 49,680 tons. To estimate annual production between 1945 and 1967, an average annual growth is defined based on production in 1945 and in 1967 and applied to every year in between.

- Data for Slovenia is reported since 1980. As mentioned in 4.3.1.a, an OHF has been operating on the territory of Slovenia since 1945 (Oder, n.d.). Crude steel production for Slovenia between 1945 and 1980 is estimated from the production of Yugoslavia, reported in statistics. Slovenian production in 1980 corresponds to 14% of Yugoslavian production in 1979. This share is applied to Yugoslavian crude steel production between 1945 and 1979 to estimate steel production in Slovenia.

Figure 43 summarizes the total production of crude steel in countries of EU-27 from 1945 to 2015. This data is obtained from the reported statistics, plus estimations performed for Greece and Slovenia.

**The production of crude steel per steelmaking process**, is reported by the BGS for 1945-1969 and by Worldsteel for 1970-2015. After the comparison of data on total crude steel production with crude steel production per process, inaccuracies have been identified in the Worldsteel data. Between 1970 and 1975 the difference between two datasets varies between 20% and 60% for Belgium, France, Greece, Germany and Luxembourg. These inaccuracies can be explained by the quantity of steel produced by Bessemer and Linz–Donawitz processes, which are not included in the Worldsteel data provided, but are included in the BGS database. In the BGS database crude steel production by BOF, Bessemer and Linz–Donawitz processes are reported differently, depending on country:

- Some countries report all processes separately;
- Some countries sum them up;
- Some countries report a category “Others”, which covers different processes, depending on the country.

The absence of other processes in the Worldsteel classification caused inaccurate quantities of steel for countries which report steel production by Bessemer and BOF separately. This inconsistency is corrected, by considering the shares of EAF, OHF and, particularly, by bringing figures in line with the share of the BOF process before 1970 (from BGS) and after 1975, when their data is correct.

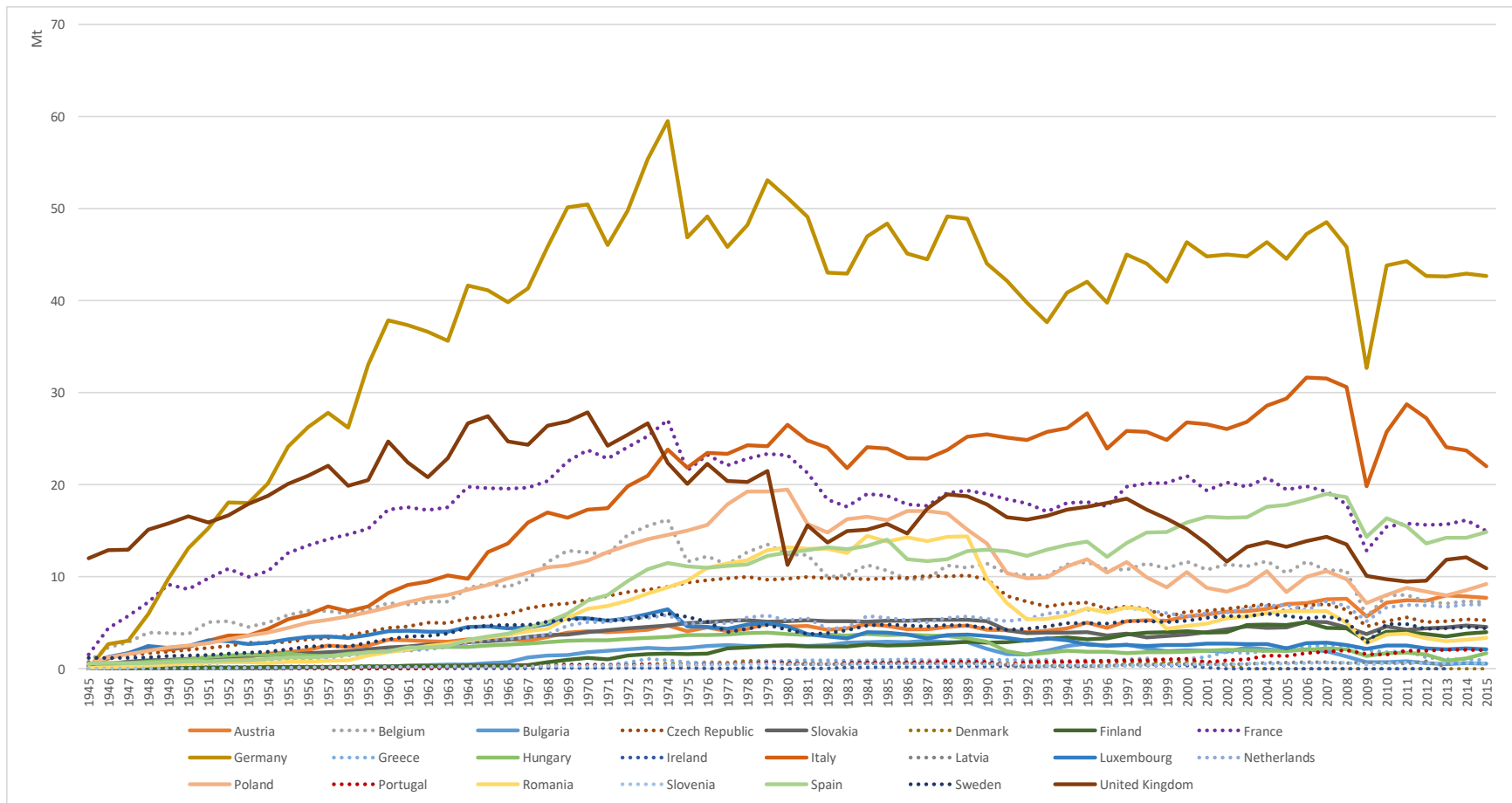

Figure 43 Crude steel production in countries of EU-27, 1945-2015

Moreover, the BGS time series for the period 1945-1970 does not report steel production by process for all countries of EU-27, as shown in Table 7 (4.1.1.c):

- 7 countries are reported for the period 1945-1954, producing 72-84% of crude steel in EU-27, depending on the year;
- 12 countries are reported for the period 1955-1969, producing 71-81% of crude steel in EU-27, depending on the year.

For 11 countries not reported by BGS, the same distribution is applied as in the first reported year, as listed in Table 34. Based on data of BGS, Worldsteel and the assumptions described, the resulting production of crude steel by process in EU-27 for the period 1945-2015 and the corresponding shares are shown in Figure 44.

*Table 34 List of assumptions applied for estimation of crude steel production by process*

Period	Countries	
1945-1953	Germany (Democratic Republic)	No data about distribution of crude steel production, so the same distribution as in 1954 is applied
1945-1954	Czechoslovakia (Czech Republic and Slovakia),	No data about distribution of crude steel production, so the same distribution as in 1955 is applied
1945-1957	Austria	No data about distribution of crude steel production, so the same distribution as in 1958 is applied
1945-1961	Portugal	No data about distribution of crude steel production, so the same distribution as in 1962 is applied
1945-1969	Bulgaria, Finland, Greece, Italy, Ireland, Netherlands, Poland, Portugal, Romania, Slovenia and Spain	No data about distribution of crude steel production, so the same distribution as in 1970 is applied
1970-1974	Belgium, France, Greece, Germany and Luxembourg	Correction of BOF share

The **consumption** of crude steel is calculated as the sum of crude steel production and import minus export:

$$F6(t, c) = F5(t, c) + T3i(t, c) - T3e(t, c)$$

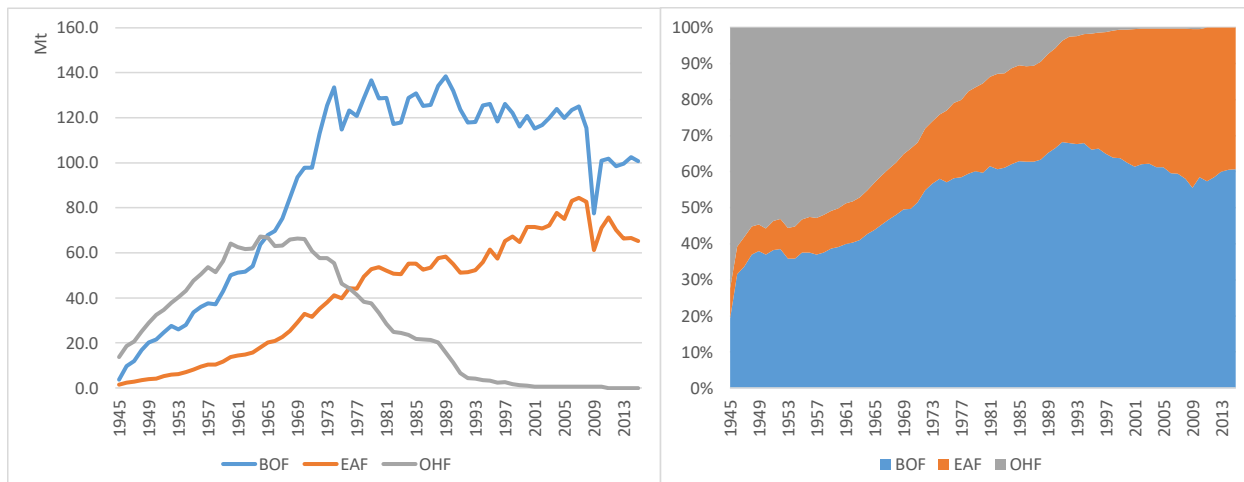

Figure 44 Production of crude steel per process and the share of these processes in EU-27, 1945-2015

#### d. Cast iron (F9, F10)

The production of cast iron is only partially covered by statistical data reported by “Census of World Casting” which covers the period 1998-2015. However, this source covered only 18 countries that are members of the European Foundry Association. The search for foundry enterprises in non-reported countries (Bulgaria, Cyprus, Estonia, Greece, Ireland, Latvia, Luxembourg, Malta) indicates the presence of this activity, but no statistical data on cast iron production in these countries is identified. Thus, the exclusion of the production in these countries would result in underestimating the cast iron production.

To estimate the production of cast iron for the period of 1945-1997, an assumption is elaborated on the base of reported data for the 1960s in the UK (Donaldson, 1971). According to this source, the production of cast iron in 1960 represented 17% of crude steel production; in 1998, this share was 10%. This shows the decrease of 7% in the share of cast iron production compared to the production of steel. It is reasonable to assume that the share was higher in 1945, than in 1960. It was agreed with industrial experts to assume that the share of cast iron production in 1945 was 10% higher than in 1998 in all countries. A linear function is assumed for the share of cast iron production in relation to crude steel production between 1945 and 1998.

For non-reported countries with steel production (Bulgaria, Greece, Ireland and Luxembourg) an average share in EU-27 during the period 1998-2015 is applied: 5.9%. For the period of 1945-1997, the same growth is assumed, as in reported countries. The cast production in countries without steel production (Cyprus, Estonia, Latvia and Malta) is not estimated.

The resulting production of cast iron in EU-27 is illustrated in Figure 45.

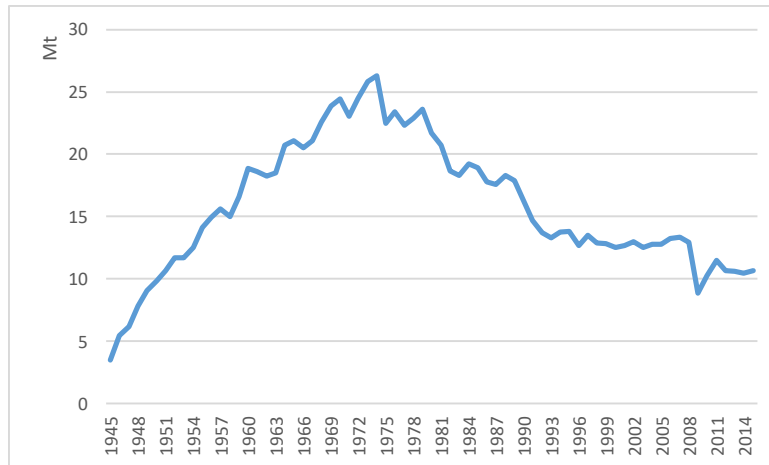

Figure 45 Production of cast iron in EU-27, 1945-2015

Reported data on cast iron does not consistently indicate the difference between the production of gray iron, ductile iron, malleable iron and steel. The production of steel foundries represents 7% of the total production in the reported period of 1998-2010. It is thus difficult to make a distinction in terms of their iron content (97% for steel and 94.3% for cast iron). This difference is not taken into consideration, thus reducing cast iron production in iron equivalent. The impact of this assumption is however negligible, as it represents less than 1% (calculated as percentage difference).

The consumption of cast iron is calculated as the sum of production and import minus export:

$$F10(t, c) = F9(t, c) + T5i(t, c) - T5e(t, c)$$

*e. Total scrap consumption (sum of F4 and F16)*

Here, scrap consumption represents the total demand for scrap in steelmaking processes and in foundries for their production. The flow of scrap represents the sum of home, process and EoL scrap consumed by the process. In 4.2 the consumption of scrap per ton of output is calculated for different processes. Here, these parameters are used for calculation of the mass flow. Two approaches have been followed for the calculation of the scrap consumption:

- The first approach consists of the application of the defined mass balances for BOF, EAF and OHF to the flow of crude steel produced. This is performed for steelmaking processes, and compared to statistical data on consumption of pig iron, DRI and scrap. Since this approach is based on the mass balance for every process, and data on crude steel production by process, it calculates input flows of pig iron, scrap and DRI for each process, thus making it possible to estimate the distribution of pig iron between the three – BOF, EAF and OHF (flows F2.1, F2.2 and F2.3 in Figure 39).

- The second approach calculates the total scrap consumption of steelmaking processes and scrap consumption in foundries. For steelmaking processes, the total scrap consumption is inferred from the crude steel production and pig iron consumption:
  - o The total iron demand (from pig iron and scrap) is calculated by application of process mass balances to the crude steel production;
  - o Iron from pig iron and DRI (reported in statistics) is subtracted from the total iron demand (excluding pig iron used in foundries);

This approach satisfies the global mass balance of steelmaking and foundry processes. For steelmaking processes, it only determines the total flow of iron from pig iron (F2) and from scrap (sum of F4 and F16); the process specific inputs of pig iron (F2.1, F2.2, F2.3) and scrap (F4.1, F4.2, F4.3, F16.1, F16.2 and F16.3) cannot be calculated.

**The first approach** calculates flows of pig iron and scrap based on crude steel production and mass balances of BOF, EAF and OHF. The flow of pig iron (in iron equivalent) consumed in each steelmaking process is calculated as a product of crude steel production per type of furnace and the flow of iron provided by pig iron (defined in mass balances, section 4.3.1):

$$\widehat{F2.1}(t, c) = F5.1 * \frac{\widehat{Fu}(PI)_{BOF}}{1000}$$

$$\widehat{F2.2}(t, c) = F5.2 * \frac{\widehat{Fu}(PI)_{EAF}}{1000}$$

$$\widehat{F2.3}(t, c) = F5.3 * \frac{\widehat{Fu}(PI)_{OHF}}{1000}$$

Total flow of consumed iron from pig iron is then estimated as a sum of these products.

Scrap and DRI consumed in steelmaking are calculated by analogy, as a product of crude steel production per type of furnace and the flow of iron provided by scrap/DRI:

$$\widehat{F4.1}(t, c) + \widehat{F16.1}(t, c) = F5.1 * \frac{\widehat{Fu}(scr)_{BOF}}{1000}$$

$$\widehat{F4.2}(t, c) + \widehat{F16.2}(t, c) = F5.2 * \frac{\widehat{Fu}(scr)_{EAF}}{1000}$$

$$\widehat{F4.3}(t, c) + \widehat{F16.3}(t, c) = F5.3 * \frac{\widehat{Fu}(scr)_{OHF}}{1000}$$

$$\widehat{F17}(t, c) = F5.2 * \frac{\widehat{Fu}(DRI)_{EAF}}{1000}$$



The calculated consumptions of scrap, pig iron and DRI are further compared with their values reported in statistics, expressed in tons. Calculated flows of iron in pig iron and DRI are converted into tons by dividing them by their respective iron contents. To convert the flow of iron in scrap to tons, the flow of home scrap is divided by the iron content of crude steel (97%) and the difference between the total scrap and home scrap is divided by the iron content of the mix of process and EoL scrap (93.8%)

As can be seen in Figure 46, the results of this approach are not consistent with reported statistical data. The same trend is observed for every country with steel production:

- The calculated flows of pig iron consumption and DRI are overestimated, compared to reported data in statistics. The average percentage difference for EU-27 for pig iron is 15% for the period 1945-2015 and 151% for DRI for the period 1962-2015.
- The estimated flow of scrap consumption is underestimated, compared to the flow estimated by Worldsteel. The average percentage difference for EU-27 is 29.6% for the period 1971-2015, varying between 24.6% and 39.1%.

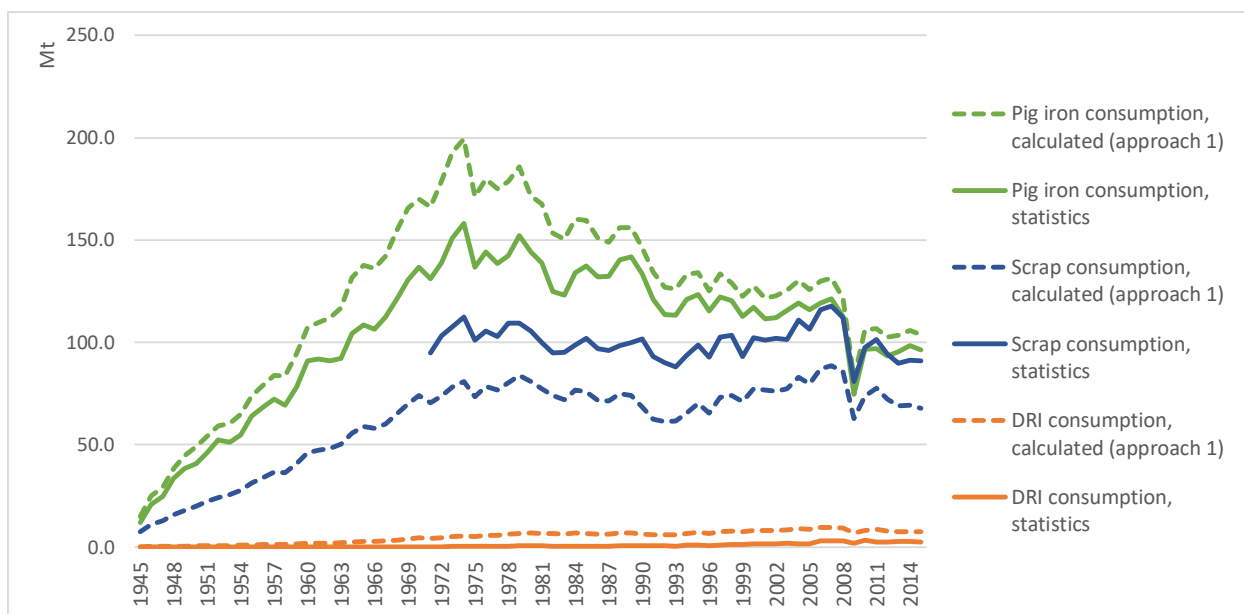

Figure 46 Comparison of the consumption of pig iron, scrap and DRI, calculated with the first approach, with reported statistics, EU-27

Potential reason for this incoherence is the uncertainty related to the definition of parameter values for process-specific mass balances:

- distribution of inputs shares defined in mass balances is established on the base of literature. The incoherence between estimated and reported flows is observed even for current years. Moreover, this parameter is static in time, which does not correspond to reality.
- iron content of all flows applied in mass balances;

- Static generation of by-products.

Due to the significant differences between calculated values by the first approach and statistical values, the first approach is not used further. This point should be analysed in more depth to make it possible to estimate the specific consumption of pig iron and scrap in steelmaking processes.

**The second approach** is thus applied to estimate scrap consumption. The flow of iron from scrap used in steelmaking is estimated as the difference between total iron demand and iron from consumed pig iron and DRI, excluding pig iron used in foundries:

$$\sum_{F_i \in F_I} \hat{F}_i(t, c) = 0.001 * (F5.1(t, c) * \widehat{Fu}(Fe\ tot)_{BOF} + F5.2(t, c) * \widehat{Fu}(Fe\ tot)_{EAF} + F5.3(t, c) * \widehat{Fu}(Fe\ tot)_{OHF}) - F2(t, c) * IC(PI) - F17(t, c) * IC(DRI) + F9(t, c) * \widehat{Fu}(PI)_{Fnd}/1000$$

$$F_I = \{4.1, 4.2, 4.3, 16.1, 16.2, 16.3\}$$

To compare the resulting flow of iron consumption from scrap with scrap consumption reported by Worldsteel, it must be expressed in tones. Since this flow represents the mix of home, process and EoL scrap, the conversion is the same as in the first approach: the flow of home scrap is divided by the iron content of crude steel (97%) and the difference between the total scrap and home scrap is divided by the iron content of the mix of process and EoL scrap (93.8%).

The consumption of scrap in steelmaking processes calculated according to this approach is illustrated in Figure 47. The blue line shows the consumption of pig iron and DRI consumed by steelmaking processes. Red lines represent total scrap consumption: dashed line stands for the calculation result, while solid line illustrates Worldsteel data. The second approach fits the estimation of scrap consumption reported by Worldsteel better compared to the first approach. The average difference for EU-27 is 9.7% for the period 1971-2015, varying between 0.4% and 22.9%.

Country-specific results of minimal, maximal and average difference between Worldsteel's estimations and calculations according to the second approach are summarized in Table 35. This approach is selected for the estimation of scrap consumption.

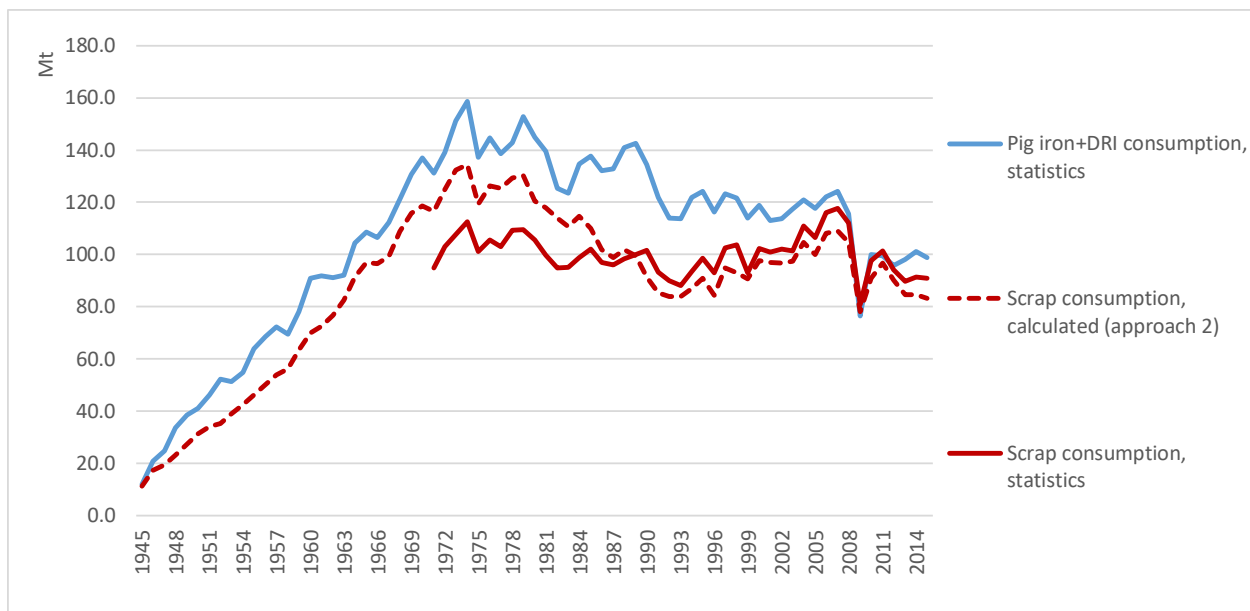

Figure 47 Comparison of the scrap consumption, calculated according to the second approach with Worldsteel estimation, EU-27

Table 35 Country specific results of comparison of scrap consumption

Country	Period of comparison	Percentage difference			Country	Period of comparison	Percentage difference		
		Min	Max	Average			Min	Max	Average
Austria	1971-2015	0.0%	35.8%	11.9%	Italy	1971-2015	0.1%	18.9%	9.6%
Belgium-Luxembourg	1971-2015	0.1%	39.1%	14.2%	Latvia	1992-2013	1.3%	93.5%	35.2%
Bulgaria	1989-2015	0.3%	50.5%	12.1%	Netherlands	1971-2015	0.2%	54.9%	17.8%
Czech Republic	1971-2015	0.4%	47.8%	17.7%	Poland	1971-2015	0.3%	22.5%	9.8%
Slovakia	1971-2015	1.0%	60.8%	15.9%	Portugal	1971-2015	0.2%	44.8%	11.0%
Denmark	1971-2015	0.1%	158.2%	32.6%	Romania	1999-2015	1.4%	23.3%	8.5%
Finland	1971-2015	0.6%	63.9%	21.2%	Slovenia	1971-2015	0.4%	41.1%	16.2%
France	1971-2015	5.6%	35.4%	20.1%	Spain	1971-2015	0.1%	19.3%	4.0%
Germany	1971-2015	0.1%	26.7%	8.2%	Sweden	1971-2015	0.7%	30.8%	10.4%
Greece	1985-2015	0.1%	10.9%	4.6%	United Kingdom	1971-2015	0.6%	22.9%	8.2%
Hungary	1971-2015	0.8%	32.4%	11.5%	Total EU27	1971-2015	0.4%	20.6%	9.7%
Ireland	1985-2015	0.0%	28.8%	5.1%					

f. Home scrap (F4)

The flow of home scrap from the processes of steelmaking and rolling and finishing is calculated as a product of crude steel production and the sum of the generation of home scrap during steelmaking and during rolling and finishing:

$$\widehat{F4}(t, c) = F5(t, c) * \frac{(\widehat{Fu}(h. scr)^{steel}(t) + \widehat{Fu}(h. scr)^{RF}(t))}{1000}$$

Figure 48 illustrates the calculated flow of home scrap and its percentage of crude steel production.

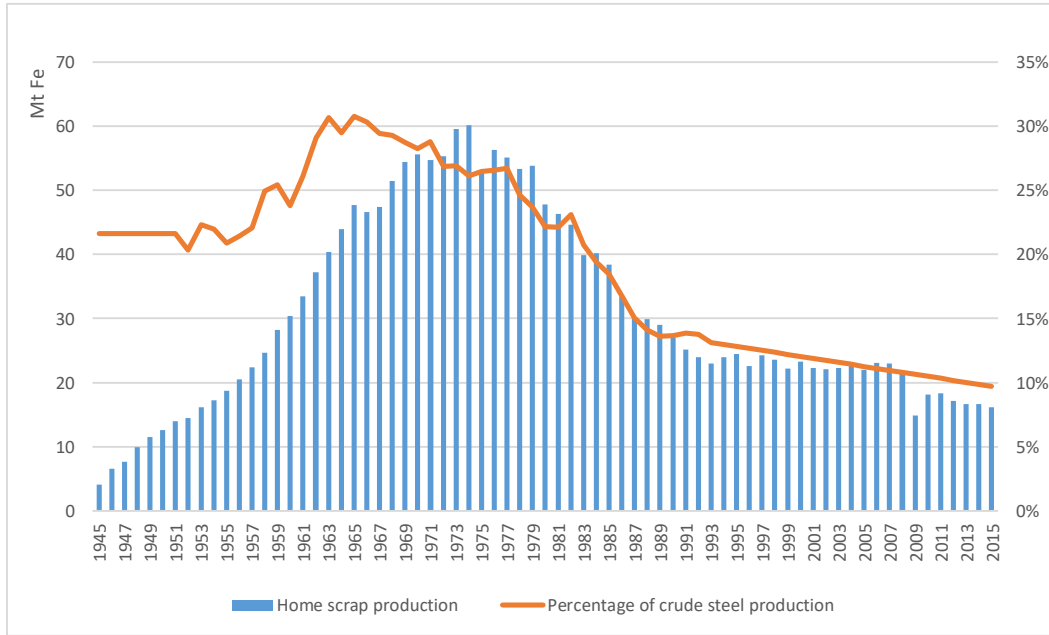

Figure 48 Production of home scrap in Mt of iron, EU-27, 1945-2015

*g. Finished steel products (F7, F8, T4)*

The consumption of finished steel products is derived from statistical ASU data. However, for most counties this data is reported from 1970, and from the 1990s for five countries, thus the flow must be calculated during the period which is not covered with data.

For this period, when ASU data are used, it is necessary to estimate the traded flow, expressed as net import or net export. It equals to the difference between consumption and production:

$$T4(t, c) = F8(t, c) - F7(t, c)$$

During the period 1945-1969, the consumption of finished steel products is calculated as the sum of production and net import:

$$F8(t, c) = F7(t, c) + T4i(t, c) - T4e(t, c)$$

The flow of produced finished steel products is calculated based on the mass balance for rolling and finishing, as the product of crude steel consumption and unitary flow of steel products produced during rolling and finishing:

$$\widehat{F7}(t, c) = F6(t, c) * \frac{\widehat{Fu}(SP)_{FM}^{RF}}{1000}$$

$$F7(t, c) = \widehat{F7}(t, c) / IC(CS)$$

This calculation can be applied to most of the countries listed in the first line of Table 36, for which the production of finished steel products can be calculated and trade statistics are known.

For countries listed in the second line of Table 36, the production of steel products can be calculated, but trade statistics are not known for the period of 1945-1969. Thus, the consumption of finished steel products during that period is calculated as a product of production of steel products and the relation between the production and consumption of steel products in 1970.

Finally, for countries without crude steel production and without trade data (listed in the third line of Table 36) an average annual growth of 5% is applied for the period of 1945-1980s or 1990s. The average annual growth is inferred from the reported countries during the period 1945-1990.

*Table 36 Country-specific calculation of the consumption of steel products*

#	Country	Calculation of the consumption of finished steel products
1	Austria, Belgium-Luxembourg, Denmark, Finland, France, Germany, Greece, Ireland, Italy, Netherlands, Portugal, Spain, Sweden, United Kingdom	<p><b>1970-2015</b> ASU data reported in statistics</p> <p><b>1953-1969</b> Production + import – export</p> <ul style="list-style-type: none"> <li>- Production is calculated (<i>F7</i>)</li> <li>- Trade is reported in statistics (<i>T4i and T4e</i>)</li> </ul> <p><b>1945-1952</b> Consumption is calculated as a product of production of steel products in year <i>t</i> and the relation between the production and consumption of steel products in 1953</p>
2	Bulgaria, Czech Republic, Slovakia, Hungary, Poland, Romania, Slovenia	<p><b>1970-2015</b> ASU data reported in statistics</p> <p><b>1945-1969</b> Consumption is calculated as a product of production of steel products and the relation between the production and consumption of steel products in 1970</p>
3	Cyprus, Estonia, Latvia, Lithuania, Malta	<p><b>1985-2015</b> (or since other year, depending on the country) ASU data reported in statistics</p> <p><b>1945-1984</b> Average annual growth of steel consumption (countries of first two groups, 1945-1990) is applied, which equals to 5%.</p>

The consumption of finished steel products (FSP) in EU-27 reached 153.9 Mt in 2015, as illustrated in Figure 49. The figure shows the consumption expressed in tons (blue line) and the consumption expressed in tons of iron (orange line). The difference between these two lines constitutes 3%, since a constant iron content of 97% is applied to flows of steel and steel products. The consumption per country is illustrated in Figure 50 (expressed in tons). The distribution of steel products by type and by industrial sector is discussed in the following subsection.

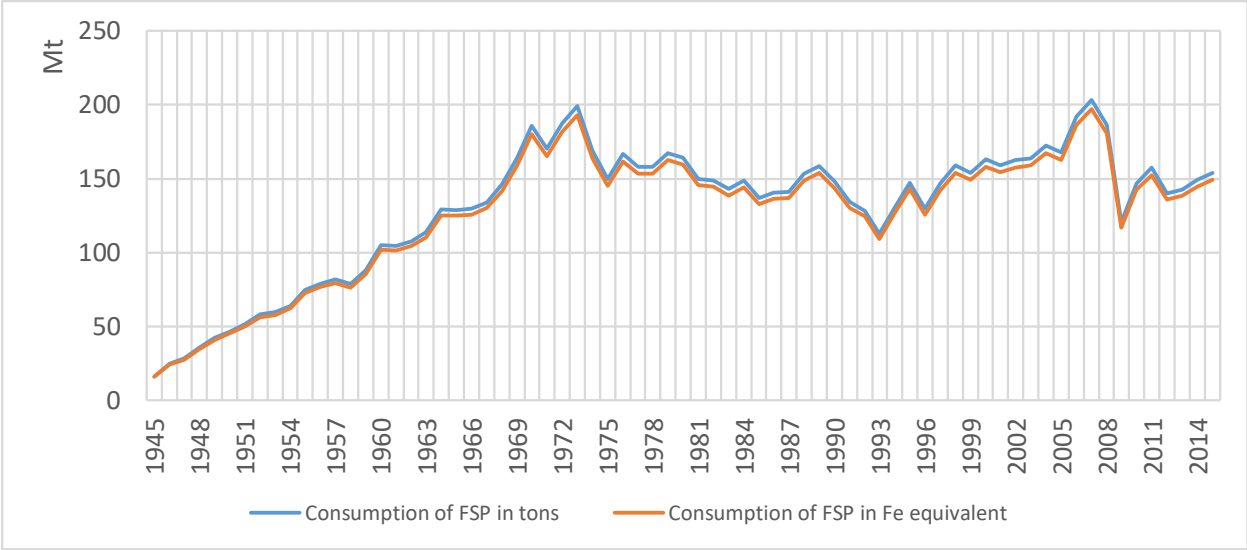

Figure 49 Consumption of steel in EU-27, 1945-2015

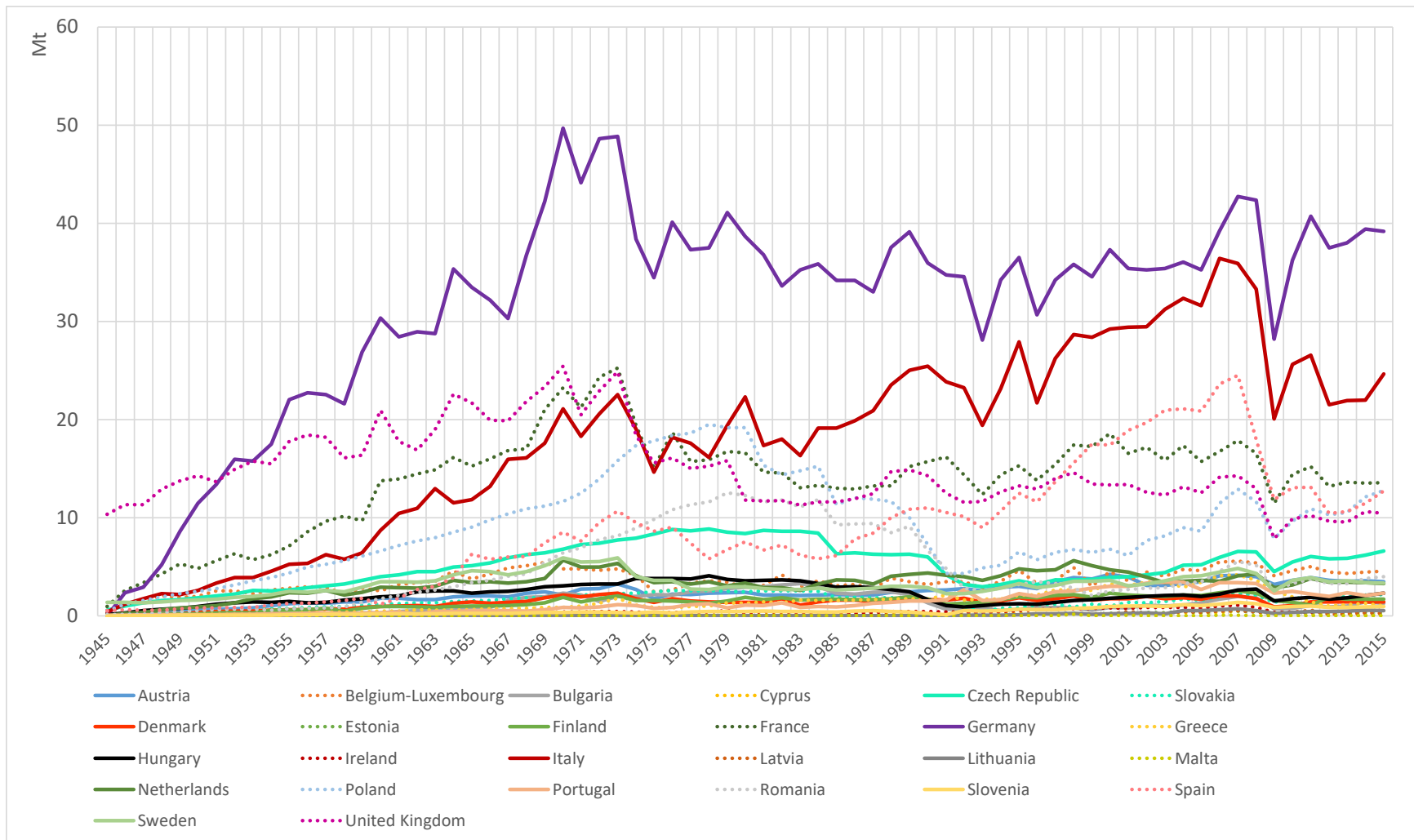

Figure 50 Consumption of steel products in countries of EU-27, 1945-2015





### 4.3.2 Processing and manufacturing

Mass flows associated with the process of processing and manufacturing are the input flow of steel products (F8) and cast products (F10) and output flows of final goods (F11) and process scrap (F13). Assumptions concerning calculation of indirect trade are also included in this section. The following parameters are defined here:

- distribution of steel products per type
- distribution of steel products per industrial sector
- distribution of cast products per industrial sector
- generation of process scrap
- historic improvement of process scrap generation

#### *a. Distribution of steel products by type and by industrial sectors*

The distribution of steel products by sectors is not reported in statistics. The review of values applied in previous dynamic and static MFA studies for the European perimeter is provided in Table 37. The distributions of iron and steel by industrial sectors applied across studies are difficult to compare between them since the definitions of industrial sectors and their number differ. Additionally, some studies apply a dynamic sector distribution, varying in time (third line of Table 37).

It can be observed that the highest share of iron and steel is used in the sector of construction - around 30%, but it can vary from 7% to 50% in some years. It is followed by the automotive sector, then mechanical engineering. Metal goods can be also an important sector in iron and steel consumption.

Pauliuk et al. point out three issues related to available data on the distribution of steel products by industrial sectors (Pauliuk et al., 2013b):

- Reported data on consumption of steel products per industrial sector do not provide detailed definitions of goods included in the sector, for example by reference to Statistical classification of economic activities in the European Community (NACE). Thus, use of reported data to sectors defined in MFA study can lead to wrong interpretation.
- Classifications can contain steel used by service centers, which are selling steel to other industrial sectors. Thus, country-specific knowledge on the steel industry is necessary to model the final consumption sector.
- Moreover, the reported consumption of steel per industrial sector is often representative for domestic production, while the distribution of imported steel products is unclear.

Table 37 Comparison of steel distribution per sector

	Wang et al., 2007	Davis et al., 2007 ; Geyer et al., 2007	Moll et al., 2005	Dahlström et al. 2004	Pauliuk et al., 2013	Oda et al., 2013	Birat and Zaoui, 2002 (Usinor model)	<b>Present study: Eurofer matrix</b>
Perimeter	Europe, 2000	UK, 1970-2000	EU-15, 2000	UK, 1970-2001	EU country-specific, 1700-2008	Europe, 1870-2012	EU-12, 1950-1995	EU country-specific
Variation over time	static	static	static	dynamic	static	static	dynamic	<b>dynamic</b>
Mechanical engineering	15%	17%	12%	18-24%	10-32%	22%	17-22%	<b>6-30%</b>
Electrical engineering		5%	3%	5-7%			3-4%	
Shipbuilding/ Other transport	33%	0	1%	0-6%	11-32%	0.5%	3.7-8%	<b>0-7%</b>
Vehicles		17%	19%	15-25%			34%	
Steelwork and building and civil engineering	36%	26%	30%	7-33%	31-47%	37%	42-50%	<b>21-52%</b>
Metal goods	11%	7%	15%	8-20%	10-15% (products)	NA	5%	<b>6-38%</b>
Domestic appliances		included in el. eng	included in el. eng.	included in el. eng			3-5%	
Cans and metal boxes	NA	4%	0	5-10%			3-5%	<b>NA</b>
Boilers, drums and other vessels	NA	4%	0	3-7%			NA	<b>NA</b>
Other industries	5%	20%	20%				6.5%	NA

The present study uses data provided by Eurofer, which details the distribution of final steel products throughout industrial sectors in the form of country-specific matrices. These matrices are constructed every five years from 1995 to 2010, based on members' surveys and on the economic activity of industrial sectors (reported by Oxford Economics). This data overcomes all the limitations shown by Pauliuk et al. First, it is based on NACE classification<sup>20</sup> of industrial sectors, so it is possible to know precisely the types of products which are included in each industrial sector. This point also partially affects the second limitation: the data contains the industrial sector "other sector", but the products included are known. The third limitation is compensated by Oxford Economics data's consideration of the evolution of

<sup>20</sup> NACE - Nomenclature statistique des activités économiques dans la Communauté européenne (Statistical classification of economic activities in the European Community)

economic activity of industrial sectors, thus it should reflect the consumption of domestically produced and imported steel products.

Additionally, for country-specific consumption of steel per industrial sectors, Eurofer matrices distinguish steel product types consumed by each industrial sector. Thus, Eurofer matrices make it possible, for the first time, to model the distribution of different types of steel products per industrial sector in a dynamic study.

The matrices show the distribution of 12 steel products<sup>21</sup> within a number of industrial sectors that evolve over time (construction, mechanical engineering, automotive industry, domestic electrical equipment, other transport, metal goods, first transformation, tubes and other sectors). Table 38 illustrates one of Eurofer matrix for France for the period 2005-2010.

Table 38 Example of Eurofer matrix for France for 2005-2010 (Eurofer)

000 Metric tonnes	Building & Civil Eng.	Structural Steelworks	Mechanical Engineering	Automotive Industry	Domestic Electrical Equipment	Other transport	Tubes	Metal Goods	Other Sectors	Total
HR Wide and Narrow Strip	283	458	556	590	61	1	470	246	0	2665
Quarto Plate	25	275	512	0	2	52	138	15	0	1019
Cold Rolled Sheets	100	46	112	408	266	1	75	533	0	1541
Hot Dipped Coated	565	99	87	2121	59	0	24	187	0	3142
Electro Coated	39	7	8	148	31	0	0	94	0	327
Organic Coated	438	12	6	2	27	0	0	20	0	505
Tin Plate	0	0	0	0	0	0	0	618	0	618
Heavy Sections	262	598	28	0	0	0	0	37	9	934
Reinforcing Bars	708	0	0	0	0	0	0	0	0	708
Wire Rod	929	0	169	169	0	0	0	422	0	1689
Merchant Bars	177	133	709	192	0	0	0	236	30	1477
Other Products	0	0	6	28	0	0	861	272	0	1167
Total	3526	1628	2193	3658	446	54	1568	2680	39	15792

However, Eurofer matrices are not completely representative of the industrial sectors under study in terms of the homogeneity of reported industrial sectors, spatial and temporal perimeters:

- **Sector distribution:** Eurofer contain sectors of first transformation and tubes, which do not correspond to the definition of final steel consumption sectors, as they include products which used further in other sectors:
  - o The category “First transformation” is present only in the matrix of 1995. The sector of first transformation includes welded steel mesh, wire drawing, rolling, etc.
  - o The consideration of tubes as an industrial sector can be explained by the definition of steel products applied by Eurofer. Eurofer uses the definition established by the European Coal and Steel Community (ECSC): steel products are products obtained by rolling. Thus, seamless tubes are considered as a finished steel product, as they are produced by piercing and rolling of tube rounds, while welded tubes are classified as an industrial

<sup>21</sup> 12 steel products: hot rolled wide and narrow strip, quarto plate, cold rolled sheet, hot dipped coated, electro coated, organic coated sheet, tinplate, heavy section, reinforcing bar, wire rod, merchant bar and other products.

sector, being produced from steel products (hot-rolled or cold-rolled strip or plate) by welding.

- **Spatial perimeter:** Eurofer matrices do not cover all countries: the matrix for 1995 covers only 7 countries, matrices for 2000, 2005 and 2010 cover 13 countries, which represent 77% and 91% of steel consumption of EU-27, respectively.
- **Temporal perimeter:** the period between 1945 and 1994 is not covered.

Nevertheless, Eurofer matrices represent a rich source of information, never previously applied to MFA studies. The following modifications of matrices are necessary to make them fit the study perimeter:

- **Sector distribution:** to ensure the homogeneity of industrial sectors in matrices for the period 1995-2000 with matrices for later periods, the sector “first transformation” is distributed among the other final sectors. “Tubes” is also distributed to other sectors, to be coherent with the final industrial sector definition. This assumption is based on the wide use of products of the first transformation and tubes in other industrial sectors, like construction, transportation, in production of mechanical parts and of metal goods (Roesch, 2003). The sector segmentation applied in the present study corresponds to the statistical classification of economic activities NACE Rev. 2 (Eurostat, 2008). Table 39 describes the in-use sectors included in the study.

*Table 39 Description of products categories included in end-use sectors*

#	Sector name	Products
1	Construction	construction of building and civil engineering, manufacturing of structural metal products, like doors, windows, tanks, containers, boilers, etc.
2	Automotive industry	manufacture of motor vehicles, trailers, semi-trailers and parts for them. Motor vehicle include passenger cars, vans, lorries, buses
3	Mechanical engineering	manufacture of general machinery, like motors, generators, transformers, pumps, compressors, lifting equipment, etc. and of specialized machinery for different industrial sectors
4	Domestic electrical equipment	electric and electrothermic appliances
5	Other transport	building of ships, boats and motorcycles, manufacture of railway locomotives and rolling stock
6	Metal goods	Manufacture of cutlery, tools and general hardware, weapon and ammunition, steel drums and similar containers, metal packaging
7	Other sectors	Manufacture of computer, electronic, optical products, communication and photographic equipment, instruments and appliances for measuring, testing and navigation, non-electric domestic appliances, manufacture of aircraft engine instruments

- **Spatial perimeter:** for countries which are not covered by Eurofer matrices a matrix of another country is used as a proxy. The definition of countries with similar industrial structures on the

base of economic data (e.g. Gross fixed capital formation<sup>22</sup>) is not possible due to data limitation for the investigated countries. The choice of countries for proxy is done on the base of expert judgment and summarized in Table 40. Matrices of the United Kingdom are often applied because the consumption per sector is fairly equally distributed between mechanical engineering, automotive industry and metal goods; the leading steel consumption is in construction sector, as in all other countries, except Sweden.

Table 40 Countries selected as a proxy for estimation of consumption per industrial sector

Country not reported by Eurofer	Proxy country matrix	Country not reported by Eurofer	Proxy country matrix
Bulgaria	Hungary	Latvia	Netherlands
Cyprus	United Kingdom	Lithuania	Slovakia
Denmark	United Kingdom	Malta	United Kingdom
Estonia	Slovakia	Portugal	Spain
Finland	Sweden	Romania	Poland
Greece	Hungary	Slovenia	Slovakia
Ireland	United Kingdom		

- **Temporal perimeter:** matrices do not cover the whole period studied. Due to this limitation, the last available matrix for the previous years is used (1945-1995 or 2000), which means a constant sectoral distribution before 1995(or 2000).

All matrices are converted into percentages with respect to the general total of lines and columns (because they are reported as a mass flows, as shown in Table 44). If we take Table 38 as example, the share of hot rolled (HR) wide and narrow strip in construction (first cell) is equal to 1.8%, as a quotient of 283 from 15792. This is parameter  $SSP_{i,j}$ , where SSP is a share of steel products distributed by type i and industrial sector j. To calculate the flow of steel products consumed by each industrial sector (F8j), the total flow of steel products (F8) is multiplied by sum of all types of steel products:

$$F8_j(t, c) = F8(t, c) * \sum_i SSP_{i,j}(t, c)$$

The resulting consumption of steel products per sector in EU-27 between 1945 and 2015 is illustrated in Figure 51. The historical analysis of these results is difficult because data before 1995 is static. A high consumption of steel products by “other sectors” before 2000 can be explained by a high share of this sector in matrices of 1995: for example in France and Spain 20% of steel products are attributed to this

<sup>22</sup> Gross fixed capital formation (GFCF) refers to an increase in fixed assets, calculated on the base of investments minus disposal. Fixed assets are goods that are used in production for more than one year; they include physical goods (tangible assets), like buildings, infrastructure, machinery, transport, office equipment, agricultural livestock etc. It was assumed that economic data on the distribution of the GFCF by industrial sectors will make it possible to identify countries with similar pattern of investment and to define proxy countries on the base of economic data.

sector. A further collaboration with Eurofer is necessary for a better understanding of the difference between matrices for 1995 and matrices for further years.

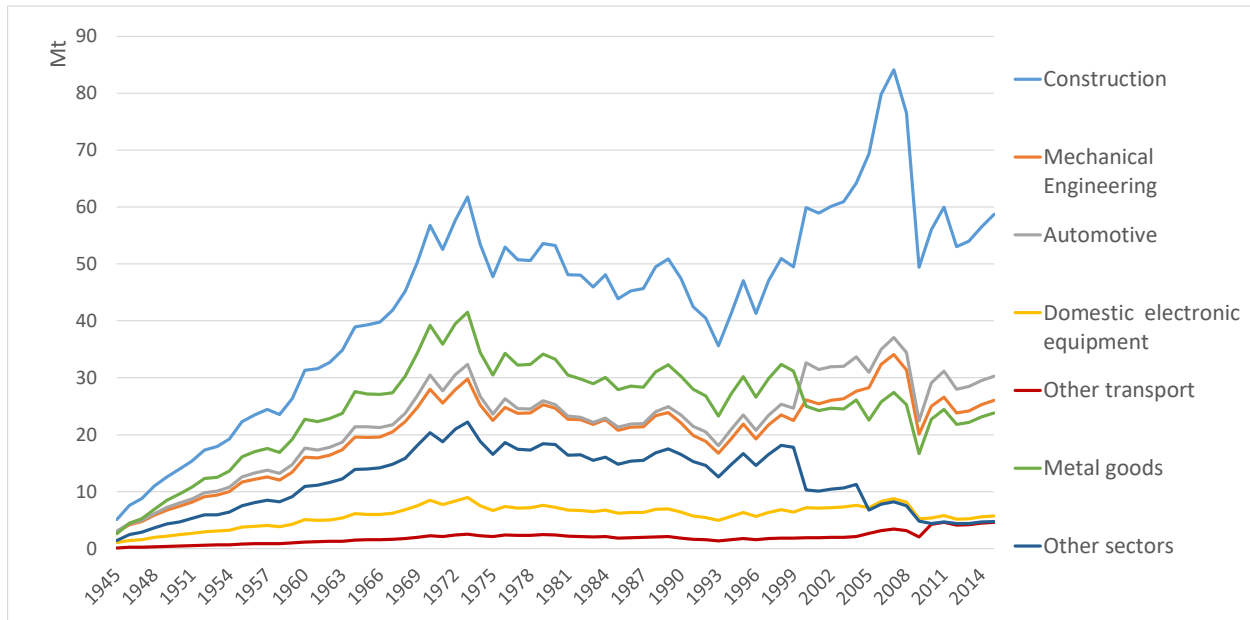

Figure 51 Consumption of steel per industrial sector, EU-27, 1945-2015

#### b. Process scrap generation (F13)

The quantity of process scrap is not reported in statistics, two MFA studies used empirical data, generated from manufacturing surveys (Birat and Zaoui, 2002; Daigo et al., 2007). Further parameters for scrap generation are defined on the base of the distribution of steel products by industrial sectors. The historical improvement of the yield is also discussed and defined.

The review of the parameter values for process scrap generation applied in previous studies is summarized in Table 41. Four cases can be distinguished for calculation of process scrap generation:

- Application of sector- and product-specific static generation, corresponding to the first column of the table (Cullen et al., 2012);
- Application of sector specific static generation, corresponding to the next three columns (Dahlström et al., 2004; Davis et al., 2007; Geyer et al., 2007; Hatayama et al., 2010; Moll et al., 2005; Pauliuk et al., 2013b);
- Application of dynamic generation without distinction between industrial sectors, corresponding to the fifth column (Müller et al., 2011; Oda et al., 2013);
- Application of sector-specific dynamic generation, corresponding to the last column (Birat, 2017; Birat and Zaoui, 2002).

Table 41 Comparison of process scrap generation rate

	Cullen et al., 2012	Moll et al., 2005, Dahlström et al. 2004, Davis et al., 2007; Geyer et al., 2007	Pauliuk et al., 2013	Hatayama et al., 2010	Müller et al., 2011 Oda et al., 2013	Birat and Zaoui, 2002, Birat 2017 (Usinor model)
Mechanical engineering	5-40%	10%	17%	16%	1965: 20%	11-14%
Electrical engineering	10-20%	10%			1970: 19%	13-20%
Shipbuilding/ Other transport	10-20%	10%	27%	7%	1975: 21%	15-21%
Vehicles	5-40%	10%			1980: 16%	27-35%
Steelwork and building and civil engineering	5-10%	5%	7.4%	6%	1985: 16%	4.4-5.5%
Metal goods	20-30%	10%	23% (products)	NA	1990: 14%	9-17%
Domestic appliances	20%	NA		19%	10-14%	
Cans and metal boxes	30%	17%		8%	1995: 12%	12%
Boilers, drums and other vessels	NA	10%		NA	2000: 12%	NA
Other industries	NA	10%		5%	2005: 12%	NA

To estimate a sector-, product-specific dynamic generation of process scrap a matrix is constructed based on the Eurofer matrices and on the literature. Eurofer matrix define industrial sectors and steel products considered. For the generation of process scrap, the focus is given to studies which provide information for the European perimeter and offer detailed sector-specific rates (Birat, 2017; Birat and Zaoui, 2002; Cullen et al., 2012; Dahlström et al., 2004; Hatayama et al., 2010). First, the matrix for the current period is defined. The matrix was reviewed and validated by industrial experts.

The generation rate of process scrap determined by Cullen at al. is taken as the basis for the definition of generation in the present study (Cullen et al., 2012). This study is the only one which demonstrates the generation of process scrap depending on the type of steel product and the industrial sector using it. However, the reported values are gathered for the worldwide perimeter, thus these values need to be reviewed for the European perimeter. Not all links between steel products and industrial sectors are considered by Cullen et al. compared to the Eurofer matrices. Thus, when the link is reported, the process scrap rate published by Cullen et al. is applied, otherwise a sector specific rate from the literature is used. All explanations, classified by industrial sector, are summarized in Table 42. The resulting matrix of scrap generation per sector is provided in Table 43. The generation of process scrap is designated by a parameter  $PrScr_{i,j}$ , where  $PrScr$  means the generation of process scrap, expressed as a percentage,  $i$  stands for steel product and  $j$  – for industrial sector.

Table 42 Data description for definition of the generation rate of process scrap

Construction	<ul style="list-style-type: none"> <li>- Cullen et al. reports rates for HR wide and narrow strip, quarto plate, CR sheet, hot dipped coated sheet, heavy section, reinforcing bar, wire rod and merchant bar.</li> <li>- For electro coated, organic coated, tin plate and other products a sector specific rate of Hatayama is allocated, which is equal to 6% and in a line with Usinor data (5%).</li> </ul>
Mechanical engineering	<ul style="list-style-type: none"> <li>- Cullen et al. reports rates for quarto plate, CR sheet, electro coated sheet, wire rod and merchant bar.</li> <li>- For HR wide and narrow strip, hot dipped coated, organic coated sheet, tin plate and other products a sector specific rate of Usinor data is applied, based on expert judgment (12%). This value is an average of the rate reported for this sector by Hatayama (14%) and Dahlström et al. (10%);</li> <li>- The application of sector-specific rates for heavy section and reinforcing bar are judged by industrial experts as too high, since they are not subjected to big modifications; therefore, the rate of 5% is applied.</li> </ul>
Automotive	<ul style="list-style-type: none"> <li>- Cullen et al. reports rates for hot dipped coated sheet, wire rod and merchant bar;</li> <li>- For all other products, except heavy sections and reinforcing bars a sector specific rate is applied from the Hatayama (19%) because rates of Cullen et al. include already products the most subjected to scrap generation.</li> <li>- The application of sector-specific rates for heavy sections and reinforcing bars are judged by industrial experts as too high, since they are not subjected to big modifications; therefore, the rate of 5% is applied.</li> </ul>
Domestic Electrical Equipment	<ul style="list-style-type: none"> <li>- Cullen et al. reports rates for CR and organic coated sheets.</li> <li>- For all other products, except heavy sections and reinforcing bars, an average sector-specific rate of three sources (Usinor (15%), Hatayama (7%) et al. and Dahlström et al. (10%)) is applied.</li> <li>- The application of sector-specific rates for heavy sections and reinforcing bars are judged by industrial experts as too high, since they are not subjected to big modifications; therefore, the rate of 5% is applied.</li> </ul>
Other Transport	<ul style="list-style-type: none"> <li>- Cullen et al. reports rates for quarto plate, wire rod and merchant bar.</li> <li>- For all other products, except heavy sections and reinforcing bars, a sector specific rate of Hatayama.</li> <li>- The application of sector-specific rates for heavy sections and reinforcing bars are judged by industrial experts as too high, since they are not subjected to big modifications; therefore, the rate of 5% is applied.</li> </ul>
Metal Goods	<ul style="list-style-type: none"> <li>- Cullen et al. reports rates for HR wide and narrow strip, quarto plate, CR sheet, organic coated sheet, wire rod and merchant bar.</li> <li>- for all other products, except heavy sections and reinforcing bars, a sector specific rate of Usinor data is applied, based on expert judgment (9%), which is in line with Dahlström et al. (10%).</li> <li>- The application of sector-specific rates for heavy sections and reinforcing bars are judged by industrial experts as too high, since they are not subjected to big modifications; therefore, the rate of 5% is applied.</li> </ul>
Other sectors	<ul style="list-style-type: none"> <li>- For all products, except tin plate, a sector specific rate of Hatayama et al. is applied.</li> <li>- Tin plates in Other sectors corresponds to it use for the packaging, thus a sector specific rate of Usinor data is applied (12%). This is lower than reported by Cullen et al. (30%), but since Usinor data are representative for European perimeter, this source is preferred.</li> </ul>



Table 43 Process scrap generation rate applied in the present study

	Construction	Mechanical Engineering	Automotive Industry	Domestic Electrical Equipment	Other Transport	Metal Goods	Other sectors
HR Wide and Narrow Strip	10%	12%	19%	14%	11%	25%	5%
Quarto Plate	10%	20%	19%	14%	20%	25%	5%
Cold Rolled Sheet	10%	40%	19%	20%	11%	30%	5%
Hot Dipped Coated	10%	12%	40%	14%	11%	9%	5%
Electro Coated	6%	20%	19%	14%	11%	9%	5%
Organic Coated	6%	12%	19%	20%	11%	30%	5%
Tin Plate	6%	12%	19%	14%	11%	9%	12%
Heavy Section	5%	5%	5%	5%	5%	5%	5%
Reinforcing Bar	5%	5%	5%	5%	5%	5%	5%
Wire Rod	5%	10%	10%	14%	10%	20%	5%
Merchant Bar	10%	20%	20%	14%	20%	30%	5%
Other Products	6%	12%	19%	14%	11%	9%	5%
Legend:	Source: Cullen et al. 2012	Source: Hatayama et al. 2010	Source: expert judgment	Source: Usinor data			

To consider the historical improvement of process scrap generation, two sources were identified: the Usinor model (Birat, 2017; Birat and Zaoui, 2002; Moreau, 2005) and data published by Müller et al., originating from IISI (Müller et al., 2011). The Usinor model contains empirical data of sector-specific process scrap generation, obtained from a manufacturing survey for the European perimeter (Figure 52). The evolution reported by Müller et al. shows world average non-sector-specific values as a function of time. The comparison of the historical improvement reported by these two sources is illustrated in Figure 53. The generation reported by the IISI is higher than the data of Usinor, which can be explained by different perimeters – world and Europe.

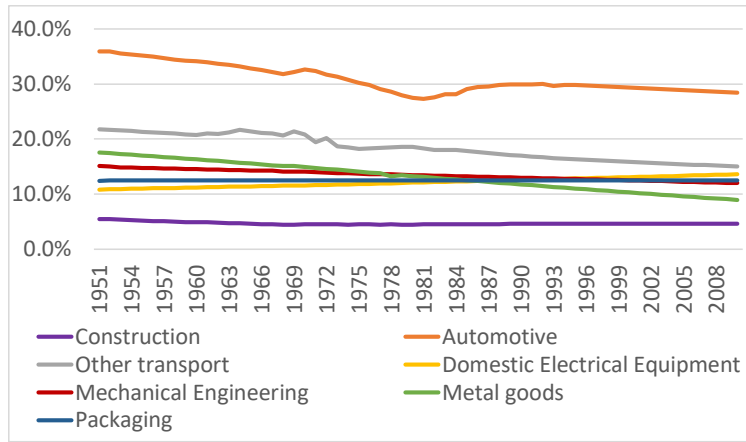

Figure 52 Sector-specific generation of process scrap (Usinor)

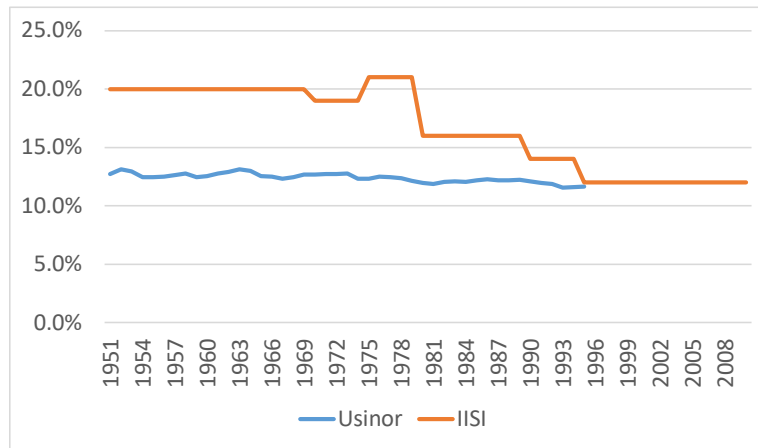

Figure 53 Comparison of historic process scrap generation, reported by Usinor and IISI

Industrial experts favour Usinor data because they judge it to be of superior quality. Moreover, this source corresponds to the spatial perimeter of the study and provides sector-specific evolution of the generation of process scrap.

The elaborated matrix for the generation of process scrap is applied to the period 1995-2015. Sector-specific evolution of scrap generation is applied for the period before 1995. Sector specific evolution reported by Usinor in 1995 is considered as 100%; the evolution is defined in relation to 1995. Table 44 is used to illustrate this conversion better, taking automobile sector as example. This parameter for historic evolution of sector-specific process scrap generation is annotated as  $Epr_j$ .

Table 44 Example of the historic evolution of process scrap generation for automobile sector

	1985	1986	1987	1988	1989	1990	1991	1992	1993	1994	1995
Process scrap generation, % (Usinor)	29.1	29.5	29.6	29.8	29.9	29.9	30.0	30.0	29.7	29.8	29.8

Epr <sub>j</sub> , %	97.3	98.5	98.8	99.6	99.9	99.9	99.9	99.9	99.9	99.9	100.0%
----------------------	------	------	------	------	------	------	------	------	------	------	--------

Finally, to calculate the generation of process scrap per sector, the total consumption of steel products (*F8*) is multiplied by the sum product of the share of steel products (distributed by type and industrial sector) and the scrap generation, then multiplied by the sector-specific evolution of process scrap generation:

$$F13_j(t, c) = F8(t, c) * \sum_i (SSP_{i,j}(t, c) * PrScr_{i,j}) * Epr_j(t)$$

The resulting generation of process scrap is illustrated in Figure 54, expressed in millions of tons. The generation is in line with the distribution of steel products by industrial sector, for example:

- The increase in the generation of process scrap in the automotive sector after 2000 corresponds to a higher amount of steel products used in this sector (Figure 51);
- The quantity of steel products used for metal goods decreases after 2000, which is also reflected in the generation of the process scrap;
- The consumption of steel by the construction sector increased after 2000, and consequently the generation of process scrap increased too.

Additionally, the generation of process scrap is impacted by the attributed sector-specific generation. Hence, the sectors that consume more steel are not the biggest source of process scrap. For instance, the construction sector is the biggest consumer of steel, but steel products used in this sector are not subjected to important modifications and the generation of process scrap is lower than in the automotive sector, metal goods or mechanical engineering.

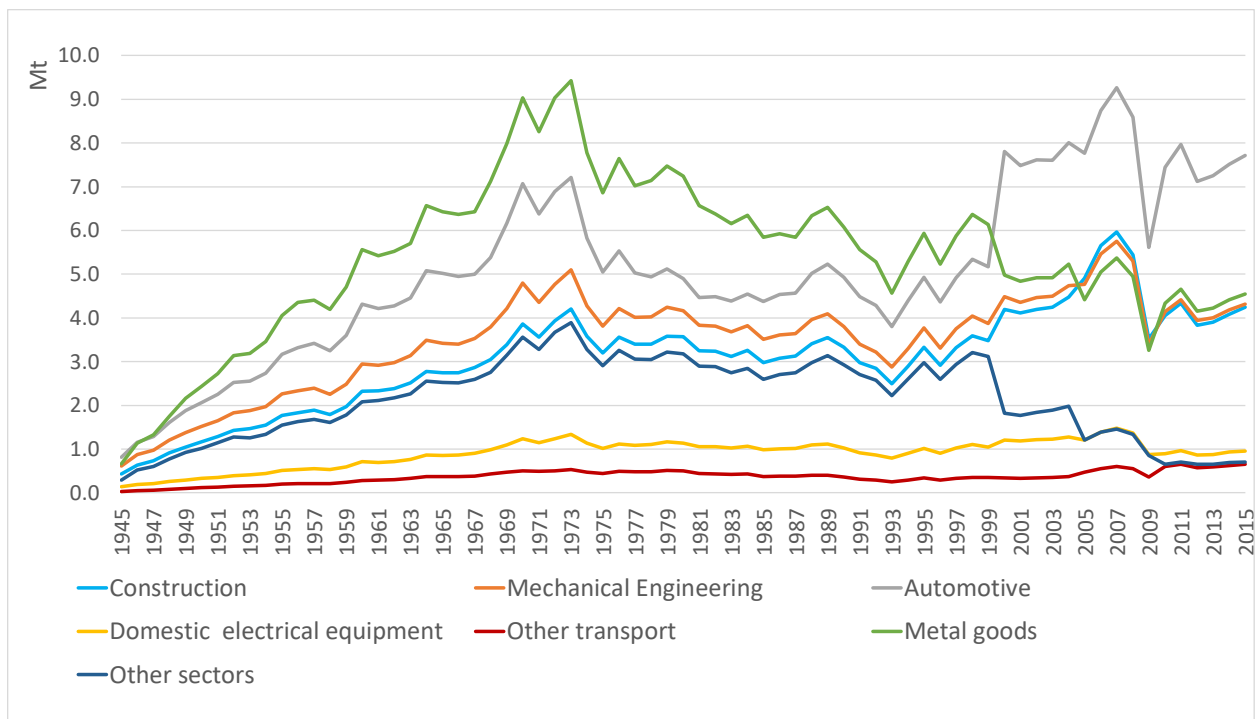

Figure 54 Generation of process scrap in EU-27, 1945-2015

c. Distribution of cast iron per industrial sector

All identified sources of data concerning the distribution of foundry products are listed in Table 45. It can be noted that most of cast products are consumed by the automotive industry, followed by mechanical engineering.

Table 45 Distribution of foundry products

Sector	Europe (CAEF, 2012)	Europe (EC, 2005)	UK (CTI, n.d.)	UK (Donaldson, 1971)	Germany (Schumacher, 2015)
Construction	4%	10%		12-14%	
Automotive industry	54%	50%	49%	16-27%	56%
Mechanical engineering	28%	30%	26%	19-24%	26%
Electrical engineering	4%				
Other transport	2%				
NA (Other/steel)	8%	10%		41-45%	18%

The present study does not consider the historical evolution of consumption of cast iron per sector. This point can be improved in further study. The data reported by the European Foundry Association (CAEF) is applied to all countries for the period 1945-2015, as the most complete source corresponding to the European perimeter.

The share of cast iron products per industrial sector is a parameter  $SCP_j$ , where SCP is a share of cast products distributed by industrial sector  $j$ . To calculate the flow of cast iron products consumed by each industrial sector ( $F10_j$ ), the total flow of cast iron ( $F10$ ) is multiplied the share of the sector:

$$F10_j(t, c) = F10(t, c) * SCP_j$$

Finally, when the distribution of cast iron, steel per industrial sector and generation of process scrap for steel are defined, it is possible to calculate the flow of iron in final goods produced in a country per industrial sector ( $F11$ ). It is calculated as a sum of the difference between steel consumption per sector and process scrap generation per sector and cast iron consumption per sector. All flows are expressed in iron.

$$\widehat{F11}_j(t, c) = IC(CS) * (F8_j(t, c) - F13_j(t, c)) + IC(CI) * F10_j(t, c)$$

#### d. Indirect Trade

The use of data on indirect trade requires adaptations for the present study. Worldsteel estimates an indirect trade based on the amount of traded goods, steel content and the amount of finished steel products needed to produce one ton of manufactured product (Worldsteel, 2015). For example, in case of imported automobiles, the process scrap generated in the country of production is assumed to be imported into Europe, alongside the car itself. Therefore, coefficients of steel content in final goods, applied by Worldsteel, can be greater than 1.

The methodology applied by Worldsteel cannot be used as such in the methodology of the present study, because the process scrap generated during processing and manufacturing of goods stays in the country of origin. The direct use of the Worldsteel estimation would lead to double counting of process scrap. In order to be aligned with the methodology, it is necessary to calculate indirect trade for these periods, not covered by Worldsteel and to adapt the Worldsteel estimation as follows:

- first, the total flow of indirect imports and exports for the non-reported periods is estimated proportionally to the ratio between traded flow and ASU of the year of first available data.
- second, the share of each industrial sector in the total traded flow, as reported in 2012 is applied to the period 1945-2011;
- third, net export of each industrial sector is calculated as the difference between export and import;
- finally, the net import is multiplied by the complement of process scrap rate with respect to 100% ( $1 - PrScr_j$ ) in order to avoid the double counting of process scrap.

The flow of traded goods is also expressed in iron content, by multiplying the resulting flow by the iron content of steel. The application of the iron content of steel is a simplification because final goods can contain both – steel and cast iron. However, the consideration of cast iron is not mentioned in available

information. For verification of this assumption, it is necessary to collect data on the trade of goods and define their content of steel and cast iron.

*e. Flow entering the use stage*

The flow of iron and steel products that enters use ( $F12$ ) is distributed by sector calculated in iron equivalent according to the following equation:

$$\widehat{F12}_j(t, c) = \widehat{F11}_j(t, c) + \widehat{T61}_j(t, c) - \widehat{T6e}_j(t, c)$$

The calculation results in negative values for the sector of “other transport” 145 negative points, representing 7.8% of the total number of points (1846). Negative values for this sector mean that the net export of final goods in given year is higher than the production of final goods. The countries most impacted are France, Czech Republic, Italy and United Kingdom, whose share of “other transport” in Eurofer matrices is less than or close to one percent (1.2% for Italy). Negative results are also observed for Austria (with a sector share of 0%), Germany (1.6%), Sweden (0%), Slovakia (0.34%), Finland (0%).

Since the sector of “other transport” is the only sector with negative results, there are two potential explanations for this phenomenon:

- For example, collected data for France indicates that 4-6% of steel is used in “other transport” (Birat, 2017; Birat and Zaoui, 2002; Moreau, 2005).
- Definition of goods included in the sector, applied by Eurofer and Worldsteel: as shown in Table 39, in Eurofer matrices, this sector includes ship building, boats and motorcycles, manufacture of railway locomotives and rolling stock. Worldsteel includes pedal and motor cycles, railway rolling stock, ships and marine engineering, aircraft (Worldsteel, 2015). All products, except aircraft correspond to the Eurofer definition, which categorizes “manufacture of aircraft engine instruments” in “other sectors”.

A more profound investigation will be necessary, since the distribution of steel products per sector, as well as data on indirect trade, is subject to a higher level of uncertainty than data on production. Since aircraft equipment is reported in different sectors in Eurofer and Worldsteel and “other sectors” are not subjected to indirect trade, negative values for the sector of “other transport” are corrected at the expense of “other sectors”. Negative values are replaced by zeros, and an equal quantity of steel is subtracted from the flow of “other sectors”.

Figure 55 illustrates the result of the correction for EU-27. The difference between calculated and corrected values for “other transport” varies between 0% and 269%, while the impact of the correction on “other sectors” is less – 2% in average, varying between 0% and 10%.

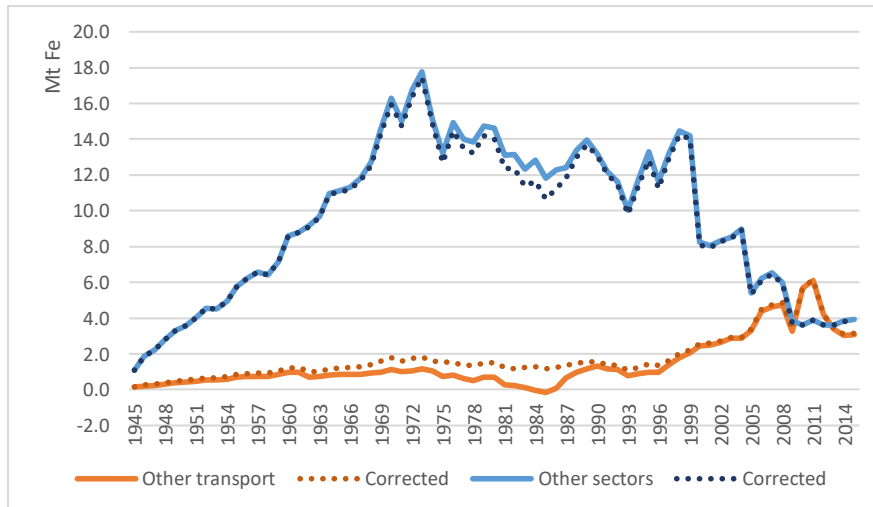

Figure 55 Illustration of correction of the flow of "other transport"

Finally, Figure 56 illustrates the calculated flow of iron which enters the process of use from steel and cast iron. According to the calculation, in 2015 in EU-27 most iron is used in construction (41%), the automotive industry (17%) and in mechanical engineering (16%).

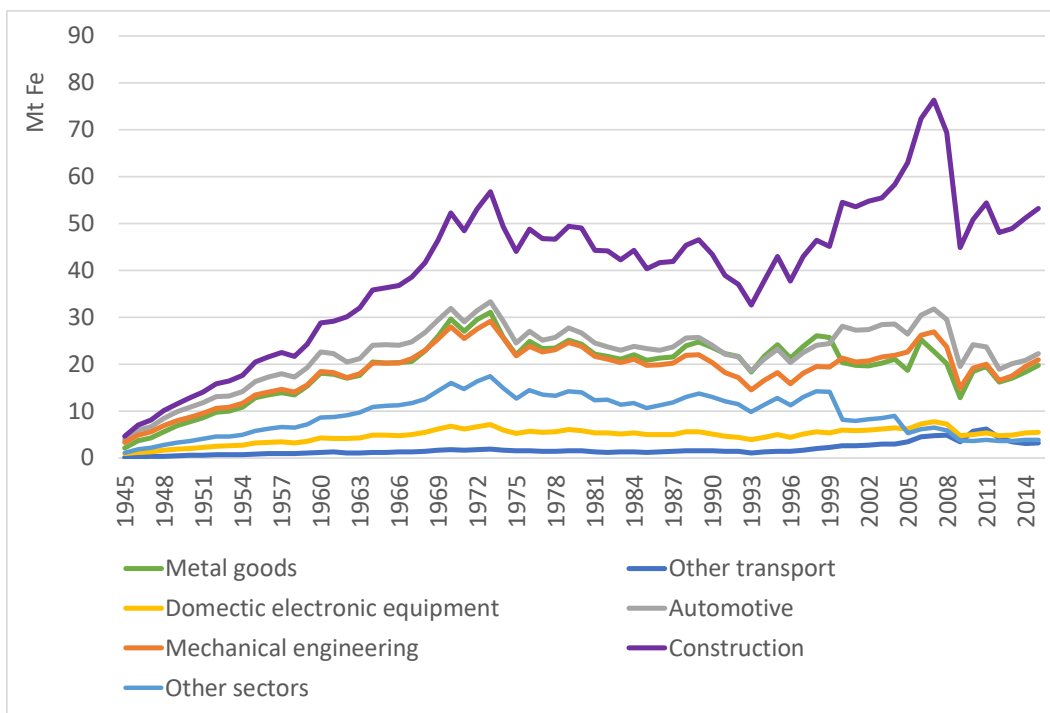

Figure 56 Flow of iron entering the use, EU-27, 1945-2015

### 4.3.3 Waste management and recycling

For the stage of waste management and recycling the following mass flows must be estimated:

- iron discarded from use (F14, Figure 39), entering to the process of waste management and recycling (F14.1) or obsolete stock (14.2);
- iron processes by waste management and recycling (F15).

The flow of iron discarded from use is calculated based on lifetime function, specific for each of seven end-use sectors. Iron discarded from industrial sectors ( $j$ ) is modeled using the following equation:

$$\widehat{F14}(t, c) = \sum_{j=7} \sum_{x=0}^{t-t_0} \widehat{F12}_j(t-x) * f_j(x)$$

where

$\widehat{F12}_j(t-x)$  indicates the flow of iron embedded in goods of sector  $j$  entering the use in  $t-x$ ;

$f_j(x)$  indicates the probability of discard at age  $x$  of goods belonging to industrial sector  $j$

Parametric distribution applied is explained in the section 4.4.

Part of the discarded flow, designated as F14.1 enters the process of waste management and recycling. This flow equals to the output of the process – F15, as no losses assumed during the process

$$\widehat{F14.1}(t, c) = \widehat{F15}(t, c)$$

The flow entering the obsolete stock is estimated as a difference between total discarded flow of iron and flow treated in waste management and recycling:

$$\widehat{F14.2}(t, c) = \widehat{F14}(t, c) - \widehat{F14.1}(t, c)$$

Mass flow of iron output from waste management and recycling process (F15) represents the quantity of iron in scrap collected, separated, traded/recovered in the country. It is estimated as a sum of EoL scrap consumption in steelmaking processes and foundries and scrap export, subtracted by scrap import.

$$\widehat{F15}(t, c) = \sum_{F_i \in F_I} \widehat{F}_i(t, c) - \widehat{F4}(t, c) - \widehat{F13}(t, c) + \widehat{T7e}(t, c) - \widehat{T7i}(t, c)$$

$$\widehat{F}_I = \{4.1, 4.2, 4.3, 4.4, 16.1, 16.2, 16.3, 16.4\}$$

where  $\widehat{F}_i(t, c) - \widehat{F4}(t, c) - \widehat{F13}(t, c)$  indicates the total quantity of EoL scrap consumed - the difference between total consumption of iron in foundries and steelmaking processes (sum of F4 and F16), and the generation of home scrap (F4) and process scrap (F13).

To convert scrap trade into iron equivalent, the flow is multiplied by the iron content of the mix of process scrap and EoL scrap (93.8%).



## 4.4 Parameters for the calculation of the stock in-use and of the initial stock in 1945.

The top down approach derives the stock estimate as the sum of the initial stock in society and the cumulative difference between inflow and outflow. This part defines the lifetime distribution applied to calculate the discarded flow, the data used for the estimation of the initial stock.

### 4.4.1 Lifetime distribution

To estimate the lifetime of products, two general approaches can be distinguished: (i) a nonparametric approach, when data on discarded quantities or product lifetimes are gathered from surveys and field studies, and (ii) a parametric approach, when a statistical distribution is applied to estimate the probability of discard (Murakami et al., 2010; Oguchi et al., 2010a; Rausand and Høyland, 2004). The parametric approach has the advantage of being easy to use, analyse and interpret. The non-parametric approach to lifetime distribution can provide an apparently more precise distribution, but the literature mainly reports average values of distribution (Oguchi et al., 2010a). Figure 57 illustrates the example of a parametric (in magenta) and a nonparametric (in blue) lifetime distribution. The choice of approach depends on data availability, on knowledge about life characteristics of the investigated products (like reliability, probability of failure or mean life), on assumptions about the regularity or smoothness of the distribution and on the objective of the study (Lawless, 2002).

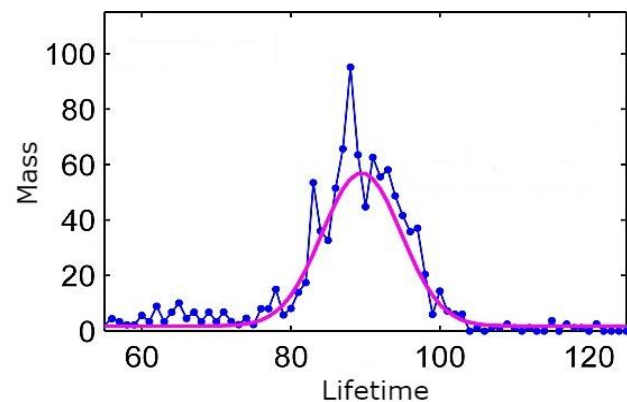

Figure 57 Example of parametric and nonparametric lifetime distribution

Various parametric distributions are used in DMFA

studies for modelling lifetime; in a review of 60 DMFA studies, the authors point out the application of Dirac, Weibull, normal, log-normal, beta and gamma distributions. The most commonly applied distributions are the constant life time (Dirac delta distribution) and the Weibull distribution (Müller et al., 2014). The choice of the model depends on how precisely the lifetime distribution represents the probability of discard of the products under study, as a function of time.

Literature mentions that data for lifetime distribution can be difficult to obtain (Birat et al., 2014; Murakami et al., 2010). They are obtained from sales data, consumers' surveys or surveys of discarded products (Oguchi et al., 2010a). Thus, the lifetime of products is defined retrospectively and might not be representative for products currently in use. Moreover, the lifetime is not constant, as it depends on the

nature of the product, on the country, historical points in time and legislation (for example, regulation of electrical and electronic wastes). Scientific efforts to define the lifetime distribution for different goods and countries are summarized in a Lifespan Database for Vehicles, Equipment, and Structures (LiVES) (Murakami et al., 2010; Oguchi et al., 2010a).

Lifetime is an important parameter, directly influencing the size of stock and of EoL flows. The parametric approach was applied in most of the studies reviewed. The application of nonparametric approach was only rarely performed, such as for the category “passenger cars and trucks” which was possible due to availability of statistical data (Daigo et al., 2007). The Weibull distribution is widely used to model lifetime distributions (Dahlström et al., 2004; Davis et al., 2007; Rausand and Høyland, 2004; Spatari et al., 2005), due to its flexibility to take different shapes. The proper choice of these parameters can then model different types of failure behavior – decreasing, constant or increasing. Also it allows all products to exit the use phase (Spatari et al., 2005). Melo demonstrated that the Weibull distribution is relevant to describe the lifespan of many types of goods (Melo, 1999). Moreover, it was also pointed out as fitting the lifespan of automobiles (Oguchi et al., 2010a; Oguchi and Fuse, 2015; van Schaik et al., 2002) and other consumer durable goods well (Müller et al., 2007).

But the suggestion of applying Weibull distribution for cars is not unanimous: normal distribution functions also shows a good fit (Müller et al., 2007). The same study indicated that the lognormal distribution fits the lifetime of dwelling better (Müller et al., 2007), even if the sensitivity analysis for different products categories showed a very small difference between the results when using a Weibull or a lognormal distribution (Dahlström et al., 2004; Davis et al., 2007; Glöser et al., 2013). In the following, a Weibull distribution is used in the present study to approximate the lifetime distribution, as the distribution used for most of the sectors of goods categories, considered in the study.

The probability density function of Weibull distribution is defined as:

$$f(x) = \frac{\alpha}{\beta} \left( \frac{x - \gamma}{\beta} \right)^{\alpha-1} \cdot \exp \left( - \left( \frac{x - \gamma}{\beta} \right)^{\alpha} \right)$$

where:

- the shape parameter  $\alpha$  determines the basic shape of the function: if it is less than one, the failure rate decreases with time, if it is equal to one, the failure rate is constant and if it is greater than one, the failure rate increases with time;
- the scale parameter  $\beta$  affects its horizontal stretching;
- location parameter  $\gamma$  positions the distribution along the abscissa.

If the value of the location parameter is zero, the distribution becomes a two-parameter distribution, the form generally used in DMFA studies. In the present study, a two-parameter Weibull distribution is applied.

The value of the shape parameters has been demonstrated as having a low sensitivity for the estimation of average lifespans of cars (Oguchi and Fuse, 2015) and of electrical and electronic equipment (Oguchi et al., 2006) compared to the scale parameter (Melo, 1999). For these sectors the shape parameter can be considered as constant over time (Oguchi et al., 2010b; Tasaki et al., 2001) and the difference between countries can be disregarded (Oguchi and Fuse, 2015). Suggested values for shape parameter is equal to 2.4 for electrical and electronic equipment (Oguchi et al., 2010b, 2006) and 3.6 for cars (Oguchi and Fuse, 2015). Both values are used in the present study. For other categories, values for shape parameter mentioned by (Davis et al., 2007) are used (see Table 38).

In the literature, a constant scale parameter is used. However, the industrial experts mentioned that this value should be variable, as the lifetime of products differs as a function of time and by country. Unfortunately, the study of modeling of dynamic behavior proved to be difficult, since no data is identified in literature, nor provided by industrial experts. This point is to be considered for further investigation.

Therefore, the present study applies constant scale parameters, defined by Davis et al. and summarized in Table 46 (Davis et al., 2007). These values are representative for the UK, unfortunately no data is given for European countries, apart from the UK. Therefore, it is assumed that the scale parameters for all European countries are equivalent to scale parameters for the UK. Moreover, the category Domestic electronic equipment is not used in the study of Davis et al. (Davis et al., 2007). Thus, the lifespan of these goods for European countries is extracted from the Database LiVES (Murakami et al., 2010). The lifetime of 25 years for other sectors was considered as too high by industrial experts and was decreased to 7 years. Table 38 summarizes lifetimes and the parameters of Weibull distribution applied in the present study.

*Table 46 Weibull parameters applied in the present study for simulation of flow discarded from use*

End use sector	Average lifetime (years)	Weibull scale parameter	Weibull shape parameter
Construction	60	65.3	5
Automotive	13	14.2	3,6
Domestic electronic equipment	10	10	2,4
Other transport	60	65.3	5
Mechanical engineering	16	16.28	5
Metal goods	13	14.2	5
Other sectors	7	7	5

#### 4.4.2 Initial stock

The initial stock in 1945 is estimated as it influences the stock during the period under study – iron and steel produced before 1945 are in fact available for recycling after 1945. The initial stock is estimated per

country with a top-down approach. Compared to the modeling applied for the period under the study, a simplified approach is used for the estimation of the initial stock.

The estimation is based on statistical data for the period of 1850-1944 on:

- pig iron production, reported by Mitchell (Mitchell, 1992);
- pig iron trade, reported by the BGS;
- crude steel production, reported by Mitchell (Mitchell, 1992). The statistics on steel production are only available only from 1860. Before this year, steel was produced, however its quantity was significantly lower and therefore not recorded in statistics. The trade of crude steel is not reported and considered negligible.

The process specific mass balances are not established for the period 1850-1944. From an historic point of view, steel production processes were different in 19<sup>th</sup> century: steel was produced by the Bessemer process, puddling and as crucible steel. As a simplified estimation, the quantity of pig iron used in steelmaking is calculated by the application of mass balances (described in part 4.3.1) and using the same distribution of steel production by process as in 1945. The remaining pig iron is considered as used in foundries. It is assumed that 60% of the foundry input is pig iron and 40% is scrap. 30% of losses as home and process scrap are assumed in steelmaking, and 40% for foundries.

Figure 58 illustrates the resulting flow of iron that enters use for the period of 1850-1944 for EU-27. The highest consumption is observed in United Kingdom, Germany and France, which represent all together 78% of the total iron consumption. Four countries do not have an initial stock - Cyprus, Estonia, Malta and Slovenia, since no data for pig iron is reported.

The difference between the production of steel/cast iron and its losses constitutes the flow of iron that enters the use process. The distribution by industrial sector of the iron flow applied in each country is the same as in 1945. To take into consideration two World Wars occurring during the period of 1850-1944, the lifetimes were divided by two (compared to the values shown in Table 46) to estimate the output of the use process.

The estimated initial stock is illustrated on Figure 59. In 1945, the initial stock is estimated to be 555 Mt of iron.

Once the 3 components necessary for the calculation of the stock (initial stock, input and output) are estimated, the stock during the period 1945-2015 can be calculated (chapter 6).

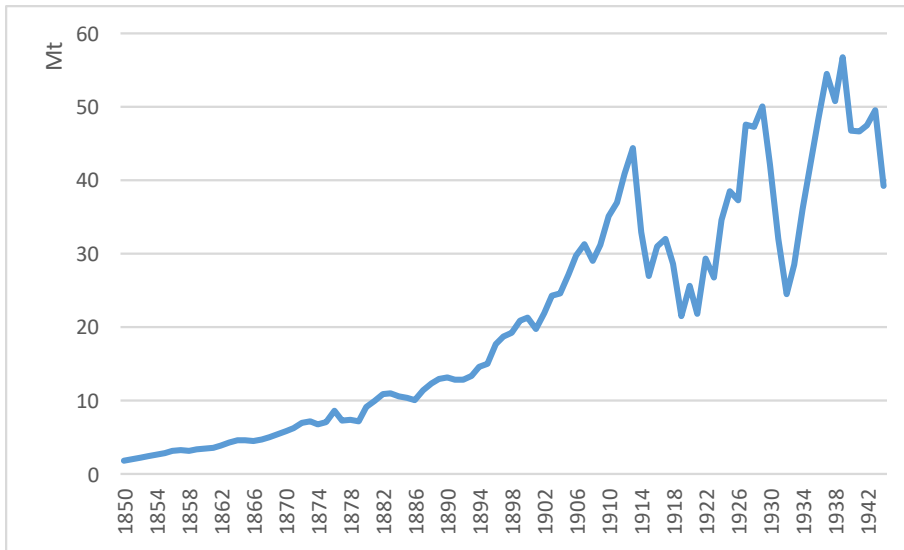

Figure 58 Flow of iron entering the use between 1850 and 1944, EU-27

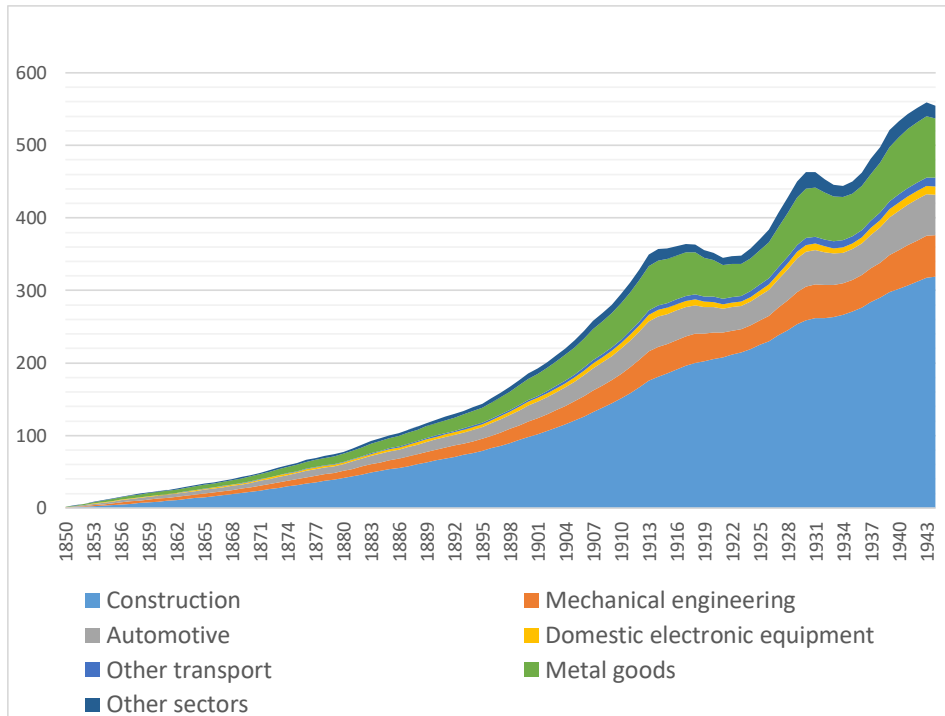

Figure 59 Initial stock estimation, EU-27, 1850-1945

## 4.5 Sources of uncertainty

On the base of reviewed statistical data, this part investigates sources of uncertainties, arising from applied data (temporal and spatial aggregation, simplification, approximation or lack of data) that might impact the flow entering the use. Limits related to data include limited access to certain data, the fact that data collection is time demanding, and unknown error ranges of statistical data. The data collection process gathered data from various sources. In collaboration with industrial experts, appropriate sources were selected and applied. This part, however, compares our obtained results of mass flows with mass flows, which could be obtained by using alternative data sources. It contributes to the understanding of the impact of data choice on the calculated flows, which, in turn impacts the estimation of stock.

Sources of uncertainty, related to the estimation of stock are reviewed in chapter 6, after presentation of results.

### 4.5.1 Consumption of steel products (F8)

As explained in part 4.2.1, the present study uses the reported ASU for the period 1970-2015 and calculates the consumption of finished steel products for the period 1945-1969. However, the use of different data leads to differences in the mass flow of consumed steel products, which, in turn impacts the mass flows of process scrap and the flow entering the process of use. This section demonstrates how the application of different data affects the total flow of consumed steel products.

The mass flow, calculated for the present study is compared with other possible calculations, as detailed in Table 47. Version 1 corresponds to the consumption indicator ASU, applied in this study. Versions 2 and 3 correspond to the calculation of the consumption as the sum of the production of steel products (calculated on the base of mass balance) and imported steel products minus exported steel products. Versions 2 and 3 differ in the classification of the UN Comtrade database applied:

- Version 2 applies imports and exports reported by the HS classification of the UN Comtrade. This data was used by the IISI and Worldsteel.
- Version 3 applies imports and exports reported by the SITC Rev.1 classification of the UN Comtrade database. This data was used in a previous MFA study (Pauliuk et al., 2013b).

*Table 47 Alternative estimations of the consumption of steel products*

	Consumption	Production	Trade	Countries
Version 1 (applied in the study)	1970-2015: ASU			EU-27

Version 2	Production + import - export	calculated from mass balance	1970-2015: ISII/Worldsteel (HS classification)	EU-15
Version 3	Production + import - export	calculated from mass balance	1970-2015: UN Comtrade (SITC classification)	EU-27

As explained in section 4.2.1, the difference between imports and exports reported by the two classifications can be as high as 60-70% at the level of individual countries. At the level of EU-15, the average difference for the period of 1991-2015 is 31.3% for imports and 26.7% for exports. Thus, this subsection investigates the impact of this difference for the flow of consumption of steel products. The period of comparison is 1970-2015 in line with reported ASU data. Only countries with available data are compared.

The difference between consumption of steel products in EU-15, calculated according to versions 1 and 2 is illustrated in Figure 60. The solid line illustrates the mass flow applied in the present study (Version 1, ASU), while the dotted line illustrates the result of the calculation of the production of steel products and use of HS classification for imports and exports (Version 2). The results are expected to be similar, since the calculation of Version 2 uses the same trade classification as Worldsteel for the calculation of ASU data. In most cases, ASU report lower values than estimated from production and trade data. The highest average differences are observed for Belgium-Luxembourg, Finland and Netherlands, the lowest – for Germany, Ireland and Italy, as detailed in Table 48. The average difference for EU-15 is 8.3% variation between 1% and 29%. The highest difference is observed during the period of 1970-1980.

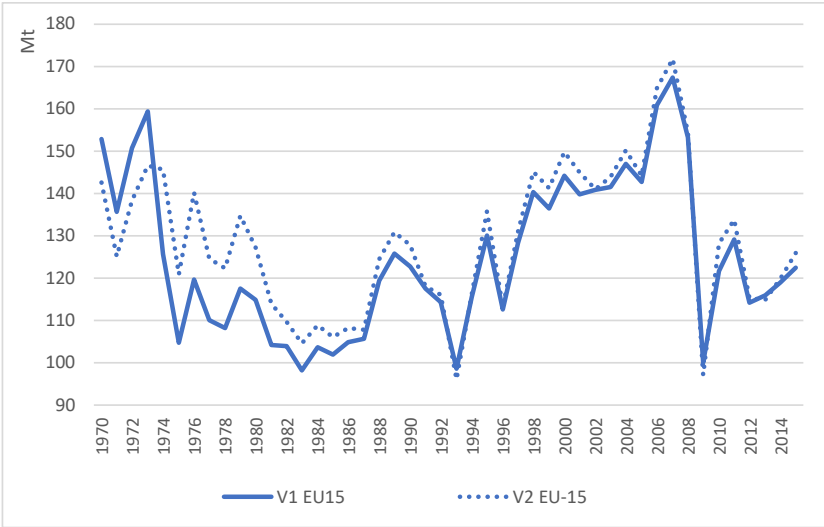

Figure 60 Comparison between the consumption of steel products reported by ASU indicator and calculated from the production and trade (HS), EU-15

Table 48 Country-specific comparison between the consumption of steel products reported by ASU indicator and calculated from the production and trade (HS)

Country	Percentage difference	Country	Percentage difference
---------	-----------------------	---------	-----------------------

	Min	Max	Average		Min	Max	Average
<b>Austria</b>	0.1%	46.4%	12.2%	<b>Italy</b>	1.0%	15.5%	7.8%
<b>Belgium-Luxembourg</b>	1.9%	69.1%	29.1%	<b>Netherlands</b>	1.6%	43.1%	14.7%
<b>Denmark</b>	0.0%	39.1%	11.7%	<b>Portugal</b>	0.6%	61.9%	9.2%
<b>Finland</b>	0.1%	57.3%	16.0%	<b>Spain</b>	0.8%	28.9%	8.3%
<b>France</b>	0.1%	18.3%	7.9%	<b>Sweden</b>	0.4%	45.0%	14.1%
<b>Germany</b>	0.2%	14.6%	3.4%	<b>United Kingdom</b>	0.1%	45.1%	12.0%
<b>Greece</b>	0.3%	42.1%	14.4%		0.0%	15.8%	4.9%
<b>Ireland</b>	0.1%	27.5%	4.0%	<b>Total EU15</b>	0.8%	28.9%	8.3%

The main reasons for the differences between these two calculations is the estimation of the production of steel products:

- ASU calculates iron losses during production by consideration of the share of continuous casting (coefficient, described in 4.1.2);
- to calculate the production of steel products in the Version 2 (and in the present study before 1970), a dynamic generation of home scrap is applied and iron losses are considered, so the share of continuous casting is the same in all countries.
- trade of crude steel, used for calculation of crude steel consumption and consequent production of finished steel products. As mentioned in 4.2.1, a difference of 2-3% was identified between data reported by UN Comtrade and Worldsteel/BGS.

Versions 1 and 3 compare the consumption of steel products reported by Worldsteel as ASU, and calculated consumption on the base of the production of steel products and their trade, reported according to the classification SITC. Rev. 1 of the UN Comtrade database. The comparison is performed for the same period – 1970-2015 and for 27 countries, due to the availability of trade data. Nine countries having limited historical trade data before 1990 are estimated (as a product of production of steel products and the relation between the production and consumption of steel products in 1970 - described in 4.4.1). For these countries two ranges are shown in Table 49 – the period when trade data is available and the whole period, including estimation.

Figure 61 illustrates the difference between Versions 1 and 3 of the calculation for EU-27 for the period 1970-2017. Here again, the solid line is used for version 1, applied in the present study and dotted line is used for version 3. It can be noted that the difference between versions 1 and 3 (5.4% in average) is lower than the comparison of versions 1 and 2 (8.3%). However, if in the previous case, the difference is concentrated mostly at the beginning of the compared period, here it is fairly uniform over the time. The main reason for the difference here is the application of different classifications of trade data, complemented by differences in calculation of the production of steel products, as in the previous case.

Table 49 summarizes country-specific difference in the consumption of steel products according to versions 1 and 3 of the calculation.



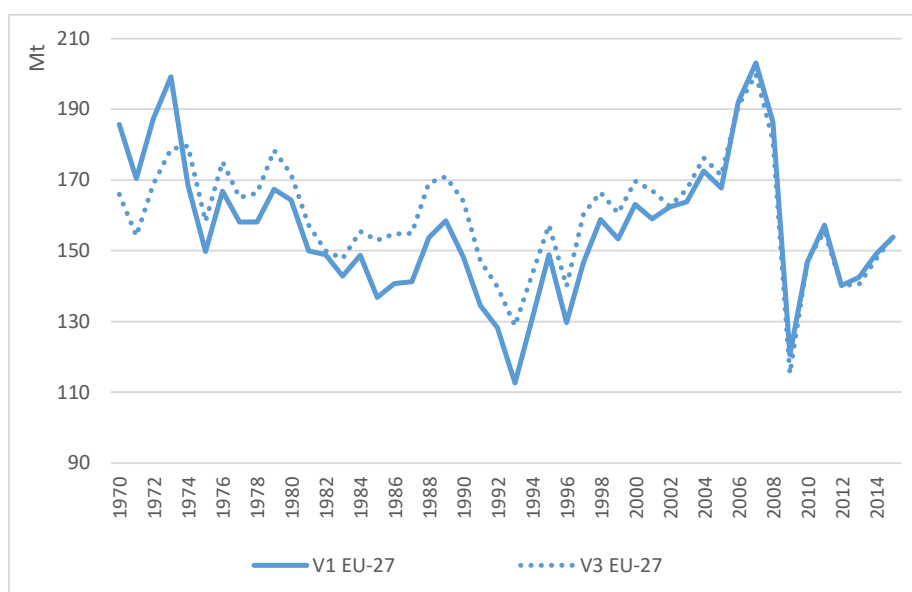

Figure 61 Comparison between the consumption of steel products reported by ASU indicator and calculated from the production and trade (SITC Rev.1), EU-27

Table 49 Country-specific comparison between the consumption of steel products reported by ASU indicator and calculated from the production and trade (SITC Rev.1)

Country	Period of comparison	Percentage difference			Country	Period of comparison	Percentage difference		
		Min	Max	Average			Min	Max	Average
Austria	1970-2015	0.1%	46.2%	14.2%	Italy	1971-2015	0.4%	22.8%	9.9%
Belgium-Luxembourg	1970-2015	0.3%	86.0%	50.2%	Latvia	1992-2015	2.0%	172.1%	30.4%
						1970-2015	2.0%	172.1%	95.4%
Bulgaria	1996-2015	2.3%	80.6%	38.2%	Lithuania	1993-2015	0.1%	65.3%	6.6%
	1970-2015	0.1%	97.0%	33.8%		1970-2015	0.1%	65.3%	13.5%
Cyprus	1985-2015	0.1%	74.4%	7.8%	Malta	1990-2015	0.4%	200.0%	51.4%
	1970-2015	0.1%	114.3%	14.1%		1970-2015	0.4%	200.0%	72.0%
Czech Republic	1993-2015	0.1%	28%	7.8%	Netherlands	1971-2015	0.0%	56.0%	31.3%
	1970-2015	0.1%	58.1%	25.7%					
Slovakia	1994-2015	7%	133.6%	48.7%	Poland	1987-2015	1.6%	55.0%	16.2%
	1970-2015	3.9%	159.6%	68.3%		1970-2015	1.6%	55.0%	16.7%
Denmark	1970-2015	0.5%	32.9%	12.1%	Portugal	1971-2015	0.2%	59.1%	20.4%
Estonia	1995-2015	0.7%	33.4%	9.2%	Romania	1989-2015	5.6%	34.6%	18.0%
	1970-2015	0.7%	90.6%	52.4%		1970-2015	4.2%	39.1%	21.2%
Finland	1970-2015	0.5%	83.2%	27.0%	Slovenia	1992-2015	0.1%	127.5%	13.7%
France	1970-2015	0.8%	19.3%	9.2%		1970-2015	0.1%	127.5%	16.5%
Germany	1970-2015	0.2%	14.2%	5.2%	Spain	1971-2015	0.4%	20.3%	10.3%
Greece	1970-2015	0.2%	73.3%	22.5%	Sweden	1971-2015	9.3%	43.7%	25.0%
Hungary	1992-2015	15.2%	40.0%	24.6%	United Kingdom	1971-2015	0.1%	22.9%	6.5%
	1970-2015	0.5%	45.8%	19.5%					
Ireland	1970-2015	0.1%	175.5%	12.9%	EU27	1970-2015	0.0%	13.4%	5.4%

To understand the impact of data reported by two classifications of the UN Comtrade better, versions 2 and 3 are compared. In these versions, the production is calculated in the same way, so the difference is related solely to the trade statistics. The comparison is done for EU-15 for the period 1970-2015. The comparison shows the lowest difference, compared to previous cases of comparison with ASU – the average difference is 2.7% (Figure 62).

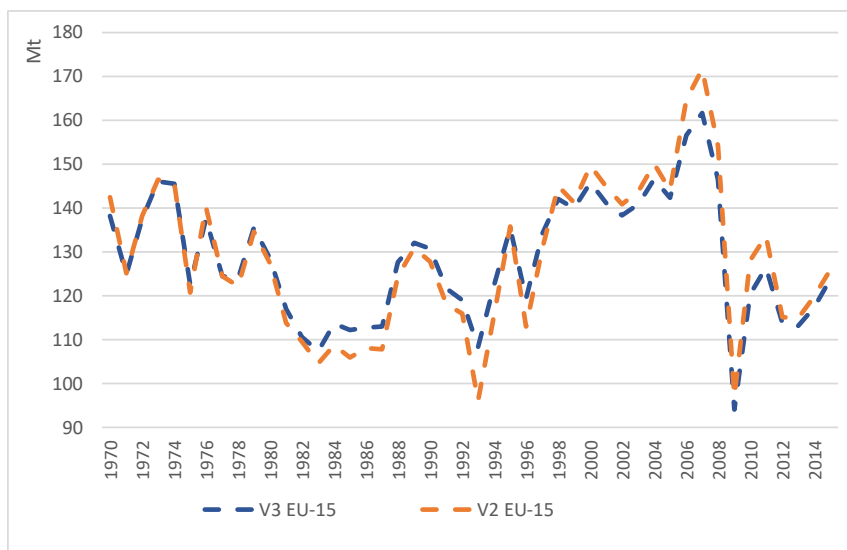

Figure 62 Comparison between the consumption of steel products calculated from the production and two trade classifications (SITC Rev.1 and HS), EU-15

Important differences in trade, reported by the two classifications (shown in 4.2.1.e) do not drastically impact of the results of consumption at the level of EU-27. At country level, data reported by different classifications for finished steel products has also a limited impact for countries of EU-15, which have a significant enough production to mitigate the difference related to trade. The biggest average differences are observed for the Netherlands, Greece and Finland (Table 50). A closer look at differences in the net import for these countries is necessary. Nevertheless, the comparison of the impact of trade on consumption could not be conducted for other countries of the European union due to data limitations. Excluded countries have a lower consumption of finished steel products than countries of EU-15 and might be impacted more highly.

Table 50 Country-specific comparison of the consumption of steel products according to versions 2 and 3 of calculation

Country	Percentage difference consumption			Country	Percentage difference		
	Min	Max	Average		Min	Max	Average
Austria	0.2%	46.0%	8.1%	Italy	2.3%	28.4%	14.0%
Belgium-Luxembourg	2.2%	68.2%	26.1%	Netherlands	13.1%	70.5%	37.5%
Denmark	0.7%	59.3%	19.4%	Portugal	0.3%	77.4%	23.3%
Finland	0.8%	72.0%	28.9%	Spain	0.4%	20.2%	9.3%
France	0.2%	21.1%	6.4%	Sweden	0.1%	33.8%	11.7%
Germany	0.5%	14.1%	4.0%	United Kingdom	0.6%	41.2%	7.6%
Greece	11.4%	66.6%	32.5%				

Ireland	0.1%	174.9%	12.0%	Total EU15	0.0%	12.0%	2.7%
---------	------	--------	-------	------------	------	-------	------

Finally, the consumption of steel products for the three versions of the calculation is illustrated for EU-15 in Figure 63. The difference between trade statistics and the calculation of steel products’ production has the influence on the consumption of steel products. In general, the smaller the production of the country is, the more the calculation of its consumption is influenced by trade data. Within the present study, the ASU data were applied in accordance with the advice of a statistical expert. This data made it possible to decrease the uncertainty related (i) to the selection of codes in SITC Rev.1 classification of the trade statistics and (ii) to the absence of imports and exports reported in the HS classification for countries other than EU-15. However, ASU is a “black box” indicator, since it is not possible to make a distinction between quantities produced and traded. The application of this indicator implies accepting this limitation. A further investigation of correspondence between the two classifications of UN Comtrade is necessary in order to align them with data reported by ISSB and eliminate the need for ASU.

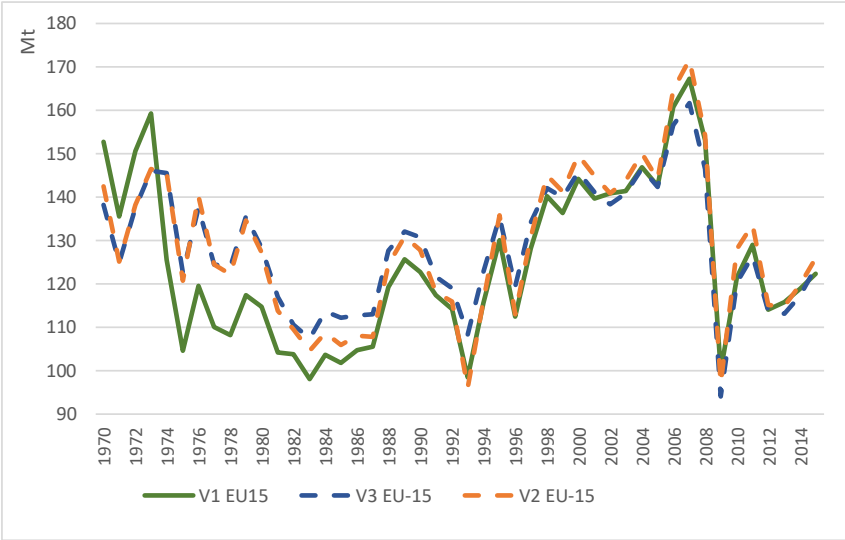

Figure 63 Comparison between the consumption of steel products calculated according to versions 1, 2 and 3

#### 4.5.2 Distribution of steel products by industrial sectors

One of the most important parameters is the distribution of steel products by industrial sectors. Iron-bearing products are grouped into industrial sectors in order to approximate a representative lifetime. Thus, the quantity of iron used in each sector impacts the size of the stock. In the present study Eurofer matrices were used to model the distribution, because they are country specific. The down-side of the matrices is that they do not offer a historic view on the distribution. Alternative data is identified – the Usinor model (Birat, 2017; Birat and Zaoui, 2002; Moreau, 2005), which contains historical data for the

period 1945-1995. The down-side of the Usinor data is that they are based on France, thus only one country is used as a proxy for EU-27. The comparison is carried out for these two distributions and is illustrated in Figure 64. Solid lines correspond to calculations on the base of Eurofer matrices, while the dotted lines correspond to results making use of the Usinor alternative data source.

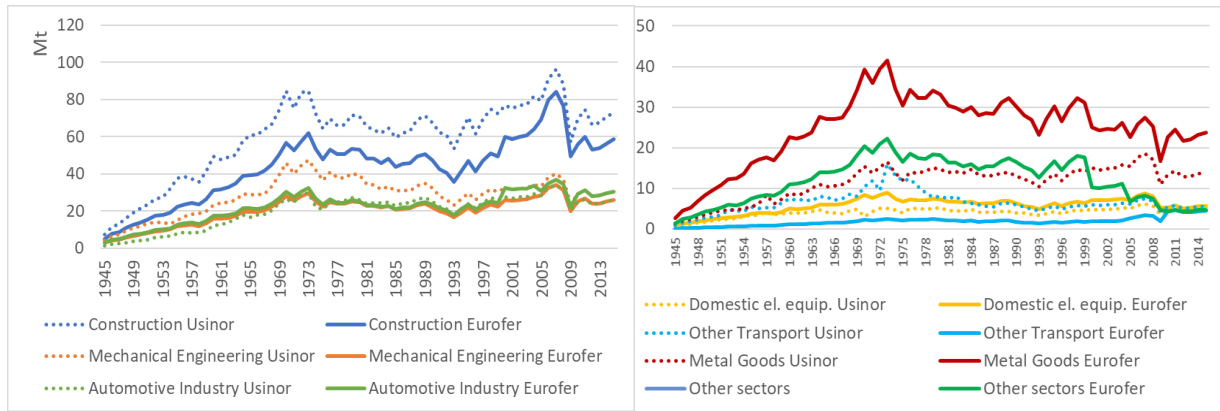

Figure 64 Impact of sector distribution issued from different sources

The biggest difference is observed for the sector of other transport, followed by metal goods, mechanical engineering and construction. Table 51 summarizes the difference obtained for the flow of steel in each industrial sector, depending on the data source. It must be noted, that Eurofer matrices contain the sector “other sectors”, which is not present in Usinor data. The average share of this sector in EU-27 is 9% during the period of 1945-2015, varying between 3% and 12%.

Table 51 Difference between share of industrial sectors depending on data source

Industrial sector	Percentage difference		
	min	max	average
Construction	13%	51%	33%
Mechanical Engineering	15%	51%	34%
Automotive Industry	1%	75%	21%
Domestic electric equipment	5%	95%	32%
Other Transport	20%	164%	113%
Metal Goods	38%	98%	73%

In the context of the study it is not possible to provide a more detailed investigation of the selection of data source for distribution of material by industrial sectors. A possible way for verification is the use of statistical information on the quantity of products entering the use, containing the investigated material and the concentration of the material in these products. Thus, in theory, this approach should provide an alternative indication, that could be a base for selection of data source on material distribution. However, it requires an exhaustive counting of all products entering the use and identification of a representative concentration of material in products (changes with technological evolution over time and within different brands).

#### 4.5.3 Impact of differentiation of flows per their iron content on final results

In the present study, the iron content of steel and cast iron was estimated to be equal to 97% and 94.3% respectively. In order to estimate the impact of this assumption on results of in-use stock and EoL RR, the iron content of these flows is changed to 100% in order to express these flows as a total mass.

Figure 65 shows the difference between the flow which enters the use process, expressed in tonnage of cast iron and steel and in terms of elemental iron. The percentage difference between these two flows varies between 2% and 4%, depending on the quantity of cast iron. The difference for stock results will be at the same order of magnitude.

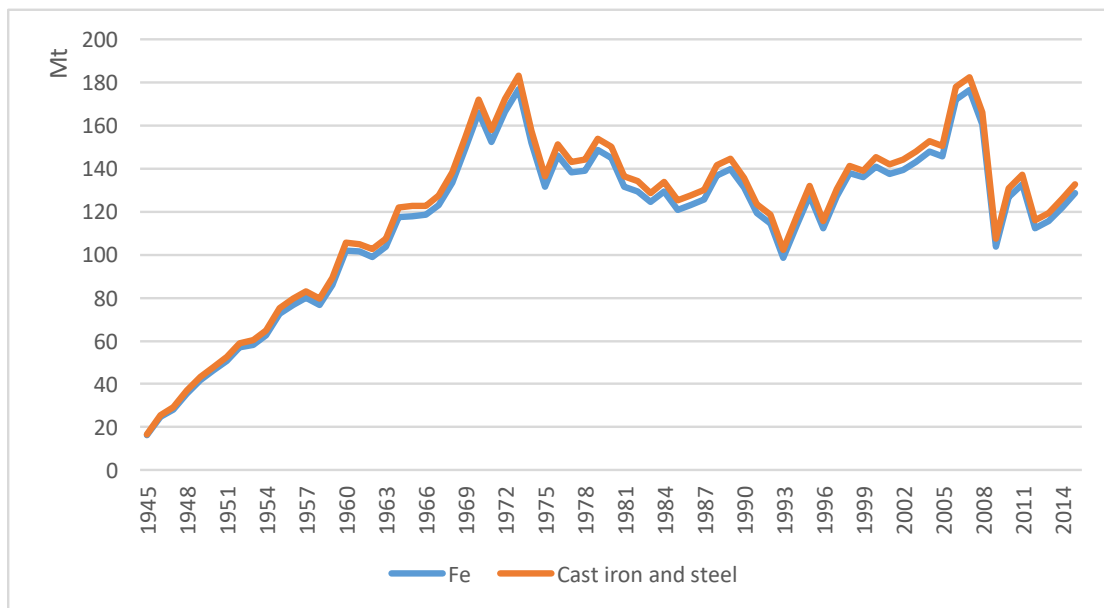

Figure 65 Total flow entering use process, expressed in millions tons of elemental iron, cast iron and steel

The impact of this assumption on the recycling indicators cannot, in fact, be investigated. The consumption of iron from scrap was estimated on the base of process-specific mass balances, which consider the iron content of steel and cast iron, as well as iron losses. Thus, the comparison is impossible due to the methodological choice to follow the flow of iron.



## Chapter 5 Definition of recycling indicators

MFA model is used to evaluate the efficiency of iron recycling on the regional level of EU-27 and country level. To investigate the efficiency of closure of material cycle, this part focuses on the estimate of the recycling efficiency of EoL scrap.

The first group of indicators in particular focuses on the efficiency of recycling at the stage of Waste management and recycling. EoL collection rate is estimated as a fraction of collected EoL scrap related to the discarded quantity of materials, EoL processing rate- as a fraction of recycled metal from old scrap related to the collected old scrap, while EoL recycling rate – as a fraction of recycled EoL scrap related to the total discarded amount. The efficiency of the collection depends on price of a metal, but also legislative, organizational, social and cultural aspects (Reck and Graedel, 2012). Processing rate reflects the efficiency of the separation of metal from other materials and the efficiency of its processing in furnaces. It includes iron loss due to oxidation in the slag and iron loss in the dust. **EoL Recycling Rate** (EoL RR) is more representative, since it englobes efficiencies of collection and processing and reflects the overall efficiency of EoL recovery. In respect to the defined system and annotated flows for estimation of mass flows (duplicated on Figure 66), the formula for the estimation of the EoL RR is the following:

$$EoL\ RR = \frac{\widehat{F15}(t, c)}{\widehat{F14}(t, c)}$$

This equation is associated with uncertainties related to both, numerator and denominator.

The numerator of the EoL RR indicator is the flow of iron processed (collected and prepared for consumption and trade) in waste management and recycling. It is calculated from scrap consumption, generation of home and process scrap and scrap trade (4.3.3):

$$\begin{aligned} & \textit{Processed EoL scrap} \\ & = \textit{Scrap consumption} - \textit{process scrap} - \textit{home scrap} + \textit{scrap export} \\ & \quad - \textit{scrap import} \end{aligned}$$

Since the total consumption of scrap, as well as the generation of process and home scrap, are all estimated, the calculation of the processed EoL scrap is impacted by uncertainties associated with each of these flows.

The denominator of the EoL RR indicator is the flow of iron discarded from the in-use stock use and theoretically available for recycling. This flow is estimated from sector-specific lifetime distributions, thus the uncertainties are associated with:

- parameters used for the estimation of sector-specific lifetime of final goods;

- uncertainties associated with the estimation of the flow entering the use process (e.g. distribution of iron by industrial sector, process scrap generation, iron content in traded final goods, exclusion of secondhand trade, etc.).

Indicators of second and third groups do not reflect the efficiency of scrap collection and processing and are not further considered. Indicators of the fourth group compare accumulated materials with materials entering in use. These indicators are out of the scope of the study.



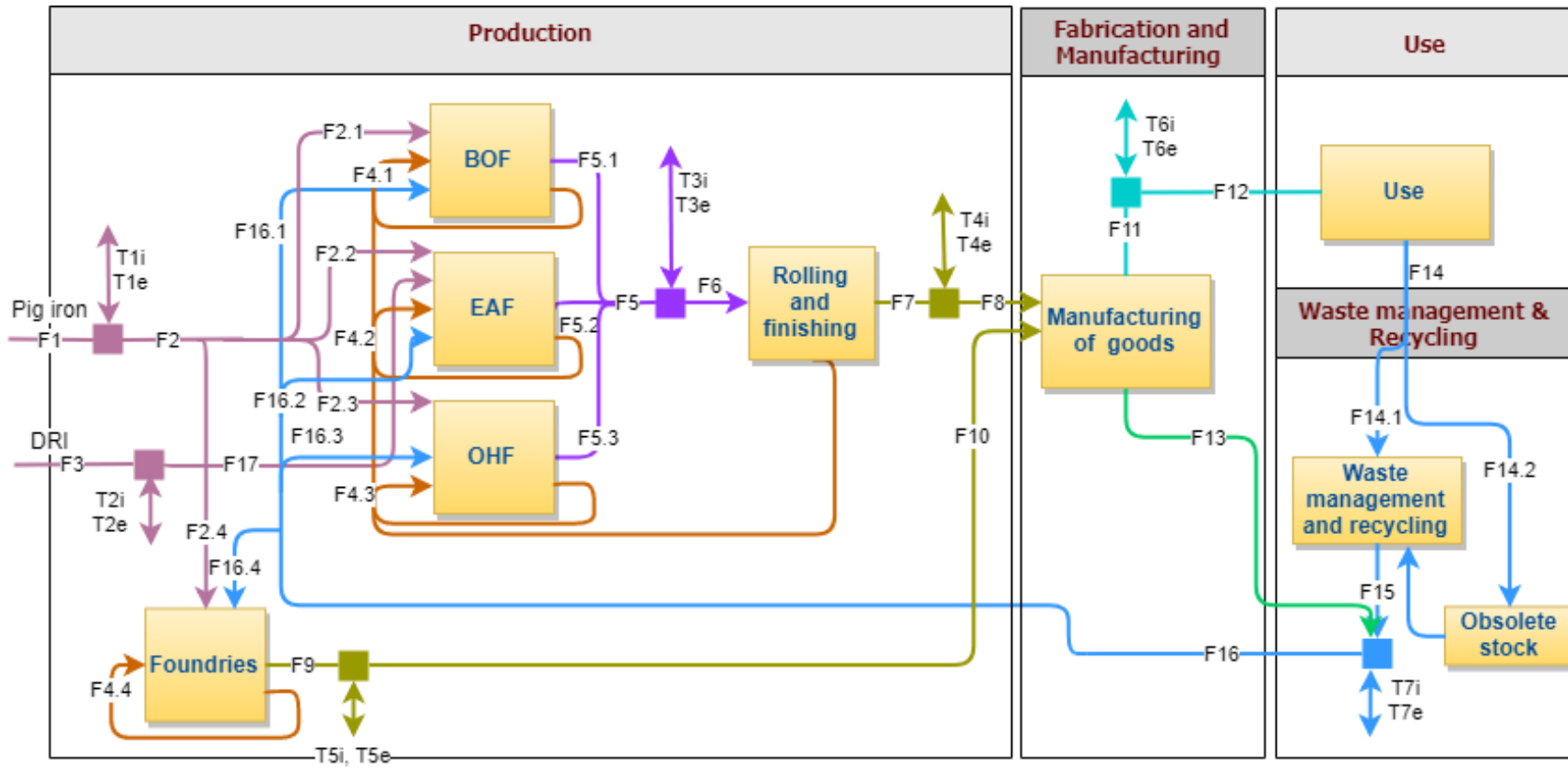

Figure 66 Annotation of flows applied for the calculation of the mass flows (duplicate of Figure 39)



Industry reports also some other recycling indicators, not included by UNEP and Chen. Eurometaux, European non-ferrous metals association, reports the **Overall Recycling efficiency rate** (ORER) (Eurometaux, 2012). This indicator focuses on consumption and availability of EoL and process scrap. It is calculated as the relationship between the total quantity of scrap consumed in metal production and the total quantity of generated process scrap and EoL scrap discarded from use.

$$ORER = \frac{\widehat{F16}(t, c)}{\widehat{F14}(t, c) + \widehat{F13}(t, c)}$$

This indicator does not take into account the trade of scrap, thus it reflects the relationship between generated scrap and demand. For example, a country producing steel only in EAF, may generate insufficient quantity of scrap to cover its consumption. ORER is not related to the efficiency of the recycling system, but rather shows the dependency of production from scrap. This indicator is still estimated, because some other indicators can be derived from it.

The International Aluminium Institute<sup>23</sup> complements this indicator by also adding the traded scrap. In this case, the indicator reflects the collection, processing and recycling of process and EoL scrap compared to the total quantity of generation of EoL and process scrap. This indicator is further designated as *ORER(+t)*.

$$ORER(+t) = \frac{\widehat{F16}(t, c) + \widehat{T7e}(t, c) - \widehat{T7i}(t, c)}{\widehat{F14}(t, c) + \widehat{F13}(t, c)}$$

*ORER(+t)* is similar to EoL RR, it complements EoL RR with the consideration of process scrap. The inclusion of the process scrap in a recycling indicator increases the rate of recycling, since process scrap has a collection rate close to 100%. Additionally, high generation of process scrap may be considered as the result of process inefficiency (Reck and Graedel, 2012).

In collaboration with industrial partners, this latest indicator is complemented with home scrap and, thus, to compare the processed scrap with the total amount of available scrap, meaning “overall RR”. This indicator also reflects the closure of the material cycle, since the use of home scrap reduces the consumption of virgin materials. This indicator is referenced further as *ORER(+t+h)*:

$$ORER(+t + hscr) = \frac{\widehat{F16}(t, c) + \widehat{F4}(t, c) + \widehat{T7e}(t, c) - \widehat{T7i}(t, c)}{\widehat{F14}(t, c) + \widehat{F13}(t, c) + \widehat{F4}(t, c)}$$

As can be noticed, ORER and derived indicators are have a strong correlation with EoL RR because they are calculated on the base of the same flows. Thus, sources of uncertainty for ORER and derived indicators are the same as for EoL RR.

In a common definition, a validated indicator is well founded and adequate to the intended objective (Bockstaller and Girardin, 2003; de Neufville, 1978). On a base of a decision tree summarizing the

---

<sup>23</sup> <http://recycling.world-aluminium.org/review/recycling-indicators/>

possibilities of output validation for indicators proposed by Bockstaller and Girardin, this study adopts modeling approach to indicator validation. This approach is also adopted because recycling efficiency indicators are inferred from MFA model, thus their validity depends on the model validity. Two types of validation are considered – design validation and output validation.

Design validation is defined as ensuring that indicator reflect the intended purpose and is scientifically founded. The proposed method for scientific foundation is a peer review. Out of four considered indicators, EoL RR, ORER+t, and ORER+t+hscr correspond to the objective of estimation of material recycling efficiency. ORER indicator reflects the dependency of a country on scrap importation. As for scientific foundation, EoL RR is the only indicator widely used in academia, three others are originating from industrial background and where not published in peer-reviewed articles. Nevertheless, ORER+t, and ORER+t+hscr contribute to the estimation of closure of material cycle.

Output validation evaluates if results provide a realistic estimations. One of the suggested output validation methods is through comparison with available observed data. In the case of present model the model output represent generation of home, process and EoL scrap and scrap consumption. Only scrap consumption can be compared with reported estimates from Worldsteel. For scrap generation a sensitivity analysis is performed. The goal of sensitivity analysis is to investigate the reaction of model outputs to extreme values of the model inputs and to drastic changes of the model structure, with an emphasis on finding the most sensitive input parameters (Kennedy and O’Hagan, 2001; Kleijnen, 1994; Law and Kelton, 2000; Saltelli et al., 2004). Application of sensitivity analysis allows to study the allocation of uncertainty in output to uncertainty in input parameters. Another suggested output validation methods is expert validation. Industrial experts participating in the study validated all four indicators. Methods applied for validation are summarized in Table 52.

Table 52 Summary of validation methods

Type of validation	Question	Method	EoL RR	ORER	ORER+t	ORER+t+hscr
Design validation	Reflect purpose?		+	-	+	+
	Scientifically founded?	Per review	+	-	-	-
Output validation	Realistic?	Validation through comparison	Comparison with reported data and sensitivity investigation			
		Expert validation	+	+	+	+

**The EoL RR, ORER and two derived indicators were selected for estimation of recycling efficiency.** In fact, the EoL indicator reflects the recycling performance, as it encompasses the efficiency of collection, separation and consequent processes of scrap preparation. Moreover, the metal industry supports the EoL recycling approach, as it promotes the availability of secondary metal resource. EoL RR indicator evaluates the performance of the recycling system, and is adapted for application in design for recycling and management of products (Atherton, 2007).

Material-centric recycling indicators can be used by material producers for estimation of recycling efficiency and availability of secondary materials. These indicators are also representative for manufacturing companies – for selection of materials during design stage in terms of their availability and recyclability.



## Chapter 6 Results and limits of the study

The elaborated model makes it possible to extract results at different levels (part one):

- The collection of annual data at the country level makes it possible to visualize the iron material cycle for any given year (corresponding to a static study) for a given country. Sankey diagram is provided in this section to illustrate the magnitude of material flows of iron for one year (2015), distinguishing steel products types and industrial sectors.
- The dynamic approach makes it possible to estimate the material stock of iron, to analyse its evolution and distribution by industrial sector. Results of the in-use stock are provided for EU-27 and for individual countries in years 1945-2015 and compared with previous studies.
- The model estimates also the flow of iron discarded from in-use stock and (theoretically) available for waste management and recycling. This result is analysed by industrial sector, compared with previous studies and industrial data.
- Recycling efficiency indicators are then calculated based on modeled flows.
- The detailed modelling of stages of production also makes it possible to show the efficiency of iron recovery on this level on the base of calculated flows of by-products of steelmaking processes and foundries, as well as the flow of iron contained in these by-products.

The second part analyses the limits of the model related to data sources, parameters and model assumptions.





## 6.1 Results and discussion

### 6.1.1 Annual MFA for 2015

Flows calculated in 4.4 are presented in a concise graphical representation, in order to give a complete vision of the modelled material flows. A Sankey diagram is used to visualize the material cycle of iron. This representation highlights the investigated system and illustrates all calculated flows and the relation between processes, as defined in the model. In a Sankey type of diagram the width of the arrows reflects the flow magnitude.

Figure 67 summarizes flows of steel and cast iron in EU-27 for the year 2015 within the defined boundaries: from production of steel and cast iron to their further processing, manufacturing, use and recycling. All flows are expressed in terms of their iron content.

Input and output flows related to the processes of production, processing and manufacturing are given for 2015. These flows are calculated from statistical data or with the help of parameters, as described in Chapter 4. Steelmaking processes are fed by pig iron, DRI and scrap. The consumption of pig iron and DRI is estimated from statistics, while the consumption of scrap is calculated on the base of mass balance. It shows that in **EU-27 54% of iron fed to steelmaking originates from primary resources** (pig iron and DRI), while **46% is from scrap** (37.3% of process and EoL scrap and 8.7% of home scrap of rolling and finishing).

The process of processing and manufacturing was modelled, considering the distribution of iron by steel products and industrial sectors. The allocation of Eurofer matrices to the flow of iron in steel products results in the **following shares for flows of final steel products in EU-27 in 2015:**

- hot rolled wide and narrow strip – 19%;
- coated sheets - 23% (aggregating hot dipped coated (14%), electro coated (3%), organic coated (3%) and tin plate (5%) for a clearer graphical representation);
- wire rod - 11%;
- cold rolled sheets - 10%;
- other products - 9%;
- merchant bars - 8%;
- reinforcing bars - 8%;
- quarto plate - 7%;
- heavy sections - 5%.

The resulting distribution of final steel products by industrial sector is as follows:

- construction - 38%;

- automotive Industry - 20%;
- mechanical engineering - 17%;
- metal goods - 15%;
- domestic electrical equipment- 4%
- other transport - 3%;
- other sectors - 3%.

The flow discarded from use is calculated from the sector-specific lifetime distribution. This flow is related to past production that is discarded in 2015. The model estimates this flow to be equal to 100 Mt of iron. 58.7% of this flow is collected and processed within EU-27 for further trade or consumption in steel mills and foundries. The difference between the modelled discarded flow of iron and the collected flow of EoL, being 41.3% of the total discarded flow, constitutes the flow that enters the obsolete stock.

# MFA of iron, EU-27, 2015

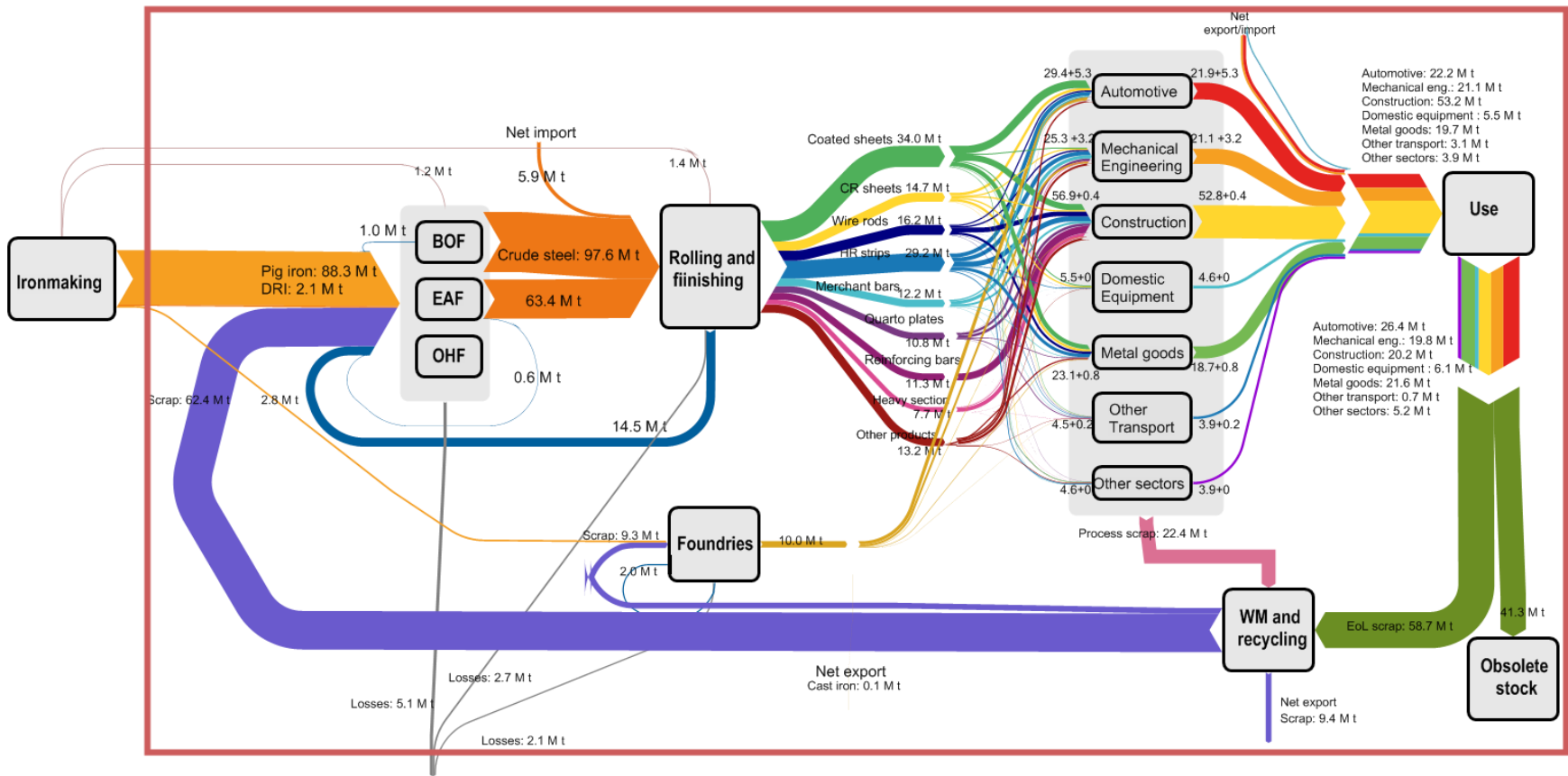

Figure 67 MFA of iron in EU-27, 2015

### 6.1.2 In-use stock in EU-27 and at European countries level

The iron in-use stock is estimated for EU-27 using a dynamic analysis. Historic data on flows of steel and cast iron, expressed in terms of iron content, is compiled to calculate the flows entering the in-use stock. The output flow of the in-use stock is calculated by applying the sector-specific lifetime distribution. The stock is estimated as the sum of the initial stock plus the net annual changes of stock. The stock of EU-27 between 1945 and 2015 represents the sum of the stocks of the 27 countries investigated in this study.

Figure 68 illustrates the evolution of the in-use stock of iron between 1945 and 2015. The results show that the stock of iron increases constantly with time from 555 Mt in 1945 to 3,678 Mt in 2015. Iron is mainly stored in construction (70%), followed by the automotive sector and mechanical engineering (9% each).

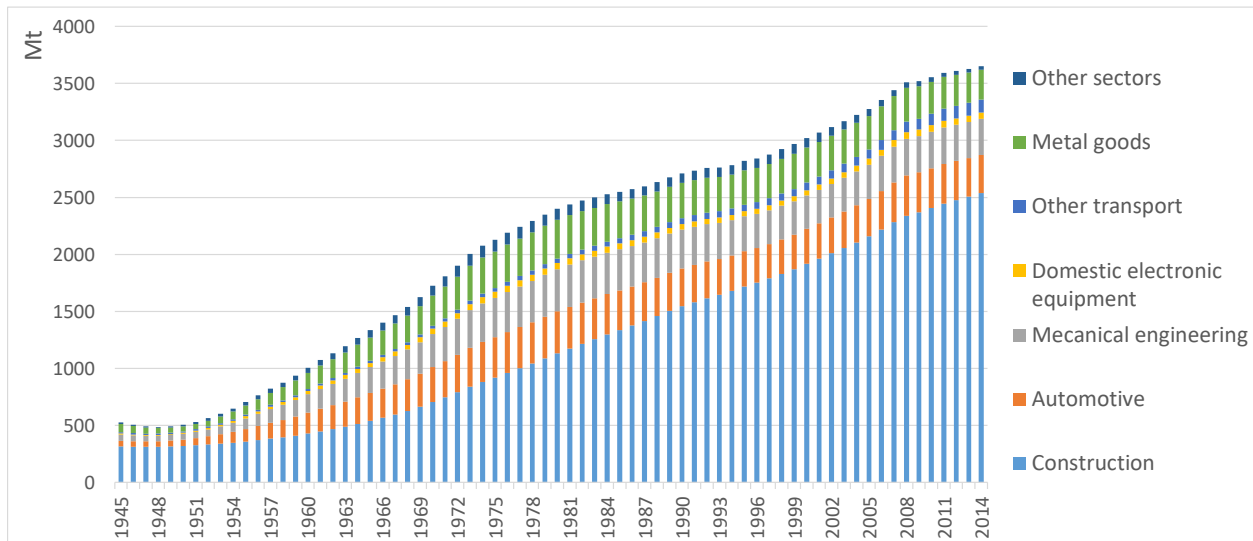

Figure 68 Evolution of the iron stock in EU-27, 1945-2015

In terms of **stock per capita**, in 2015 the stock of iron is equal to 7.3 t/cap (Figure 69). This result cannot be compared to other DMFA studies, as they do not cover the perimeter of EU-27. For instance, Hatayama determined that in 2005 the steel stock in Europe is 2 billion tons, corresponding to 5.1 t/cap (Hatayama et al., 2010). This is lower than calculated in the present study (3.3 billion tons in 2005, corresponding to 6.9 t/cap), probably because of the countries included: Hatayama considered only Belgium-Luxembourg, Germany, Greece, Norway, Spain, Turkey, the United Kingdom, so it does not include at least three countries with high steel consumption – Italy, France and Spain. The results of in-use stock are compared to previous studies at individual country level, as detailed below.

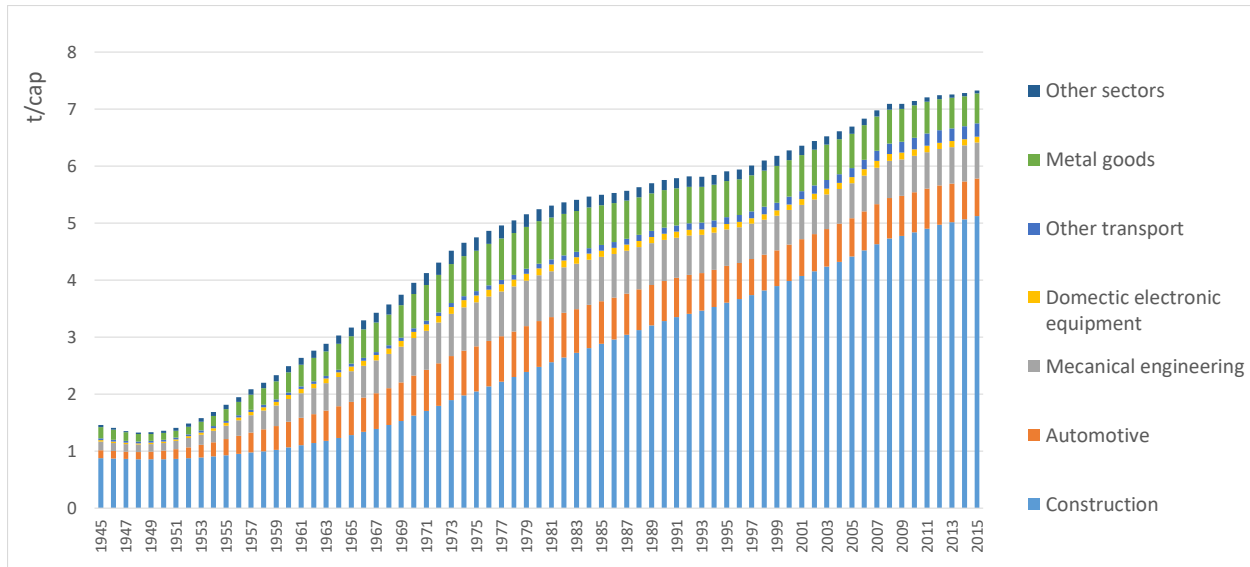

Figure 69 Evolution of in-use stock per capita, EU-27, 1945-2015

The stock in-use at country level is shown in Figure 70. The highest stocks of iron are observed in Germany (722 Mt in 2015), Italy (608 Mt), United Kingdom (387 Mt), France (350 Mt) and Spain (303 Mt). These countries have the biggest iron consumptions and, consequently, the most important stocks. The countries with the smallest in-use stock include Malta (1.4 Mt), Estonia (5.6 Mt), Cyprus (6 Mt), Latvia (6.3 Mt) and Lithuania (8.5 Mt). They have a very small or zero steel production and, thus, their consumption relies on imports.

On the base of the pattern of the evolution of the in-use stock of iron, European countries can be subdivided into two groups: the first group is characterized by a steady growth in the in-use stock over the period of 1945-2015, while for the second group the evolution of the in-use stock does not grow uniformly. To have a better understanding of these variations, results of the in-use stock are put into their historic context. Political conditions have an impact on steel consumption: this may be via imposed trade tariffs or any other external factors such as wars, conflicts, regime changes, volatile foreign exchange markets, etc.

The first group includes most of the countries of the Western Europe (Austria, Belgium-Luxembourg, Denmark, Finland, Germany, Italy, Malta, Portugal and Spain) and Baltic states (Estonia, Latvia and Lithuania). The creation of the European Coal and Steel Community, an economic coalition around coal and steel in 1951, contributed to the growth, not only, of production but also stimulated the imports and exports of steel products. A fairly steady rise of the iron stock is observed over the whole period of 1945-2015.

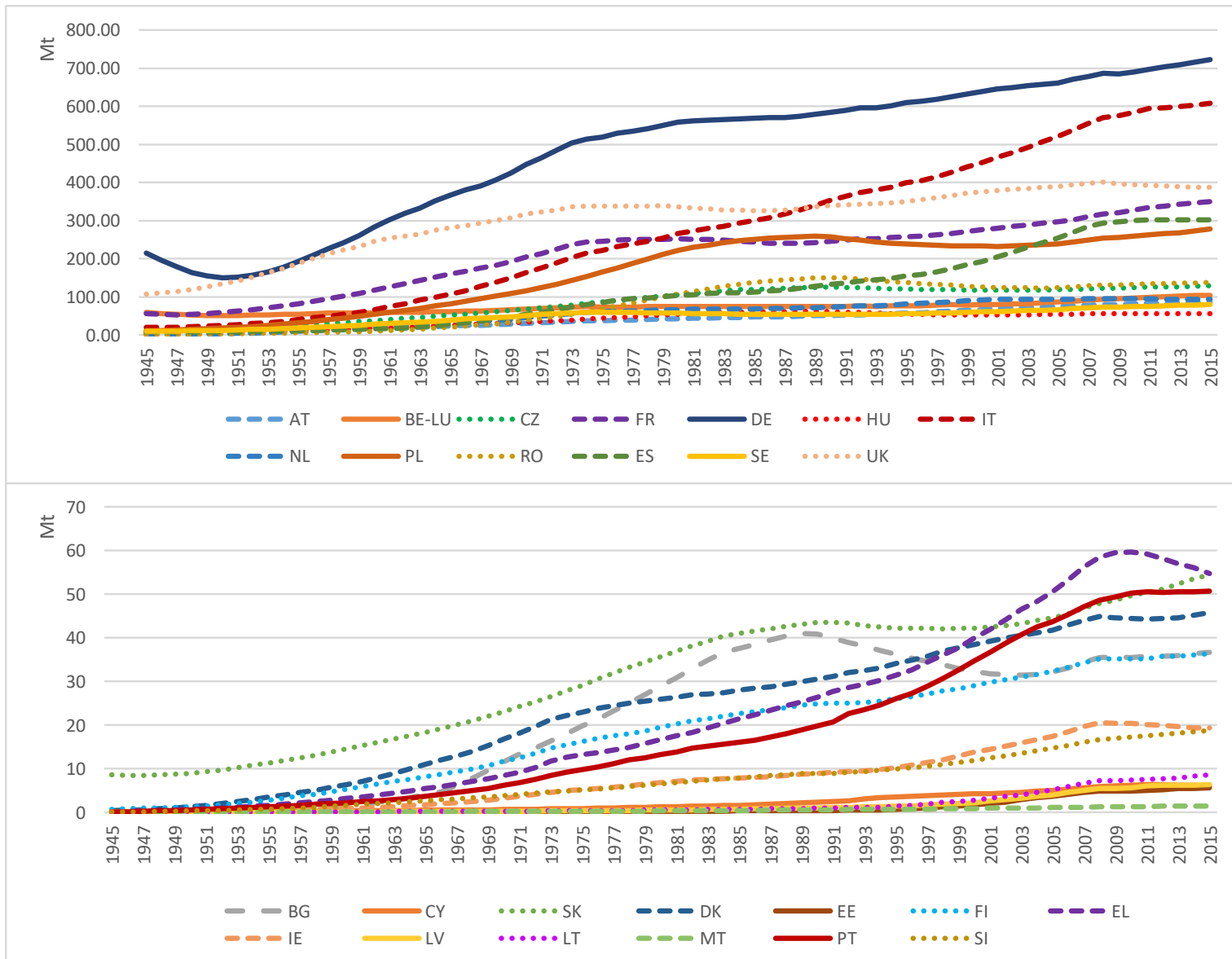

Figure 70 In-use stock in countries of EU-27

The second group of countries is characterized by stock variations, which correlates with periods of economic crisis:

- At the end of 1970s a decrease of the in-use stock is observed in France and Sweden, in the Netherlands and the United Kingdom the stock also shows a small decrease or stagnation. This can be explained by the oil crisis of 1973. The demand for steel drastically decreased between 1973 and 1975, which impacted the results of the in-use stock.
- The countries of Eastern Europe (Bulgaria, the Czech Republic, Slovakia, Hungary, Poland, Romania) had a decreasing stock at the beginning of the 1990s due to the decrease of steel consumption related to the collapse of the Iron Curtain and of the Communist countries' economies. This phenomena was also observed by Hatayama (Hatayama et al., 2010).
- Finally, a decrease in stock is observed in Cyprus, Greece, Ireland and the United Kingdom at the end of the 2000s, which correlates with the crisis of 2008. The following years were economically unstable and the impact could also be seen on steel consumption, with consequences also on the calculated in-use stock.

The normalization of the in-use stock results by population makes it possible to align country results to a common scale – stock per capita. Figure 71 illustrates the in-use stock per capita in European countries in 2015 and the distribution of the stock by industrial sectors. The highest stock is observed in Czech Republic (12.2 t/cap), followed by Austria, Slovakia and Italy (10 t/cap), and then Slovenia (9 t/cap), Germany and Belgium-Luxembourg (8.9 t/cap). The lowest stock is observed in Latvia, Lithuania and Malta (2.9 - 3.4 t/cap).

At the level of EU-27, for all countries, the biggest stock of iron is contained in the construction sector. The share of iron stock in construction varies between 39% and 87% of the total stock. The next largest sectors in terms of stock are the automotive sector, metal goods or mechanical engineering, depending on the country. The only exception to this trend is Denmark, where the second contributor of the in-use stock is the sector of other transport. A high in-use stock of other transport in Denmark can be explained by a high level of indirect imports for this sector, and the long lifetime, attributed to the sector.

Analysis of the in-use stock at country level makes it possible to compare results with previous studies, which were focused on big countries. The comparison is performed with the study of Pauliuk et al, reporting stock for European countries and Muller et al., who calculated the stock for France and the United Kingdom (Müller et al., 2011; Pauliuk et al., 2013b).

Compared to both of these studies, the results of the present study show lower values of in-use stock. Müller reported the in-use stock of iron in France and the United Kingdom to be around 9 t/cap in 2005 (4.8 and 6.5 in the present study). Figure 72 illustrates the comparison of the in-use stock in 2008 between the present study and Pauliuk et al. (2013). The percentage difference between the results varies from 9% for Italy to 70% for the United Kingdom.

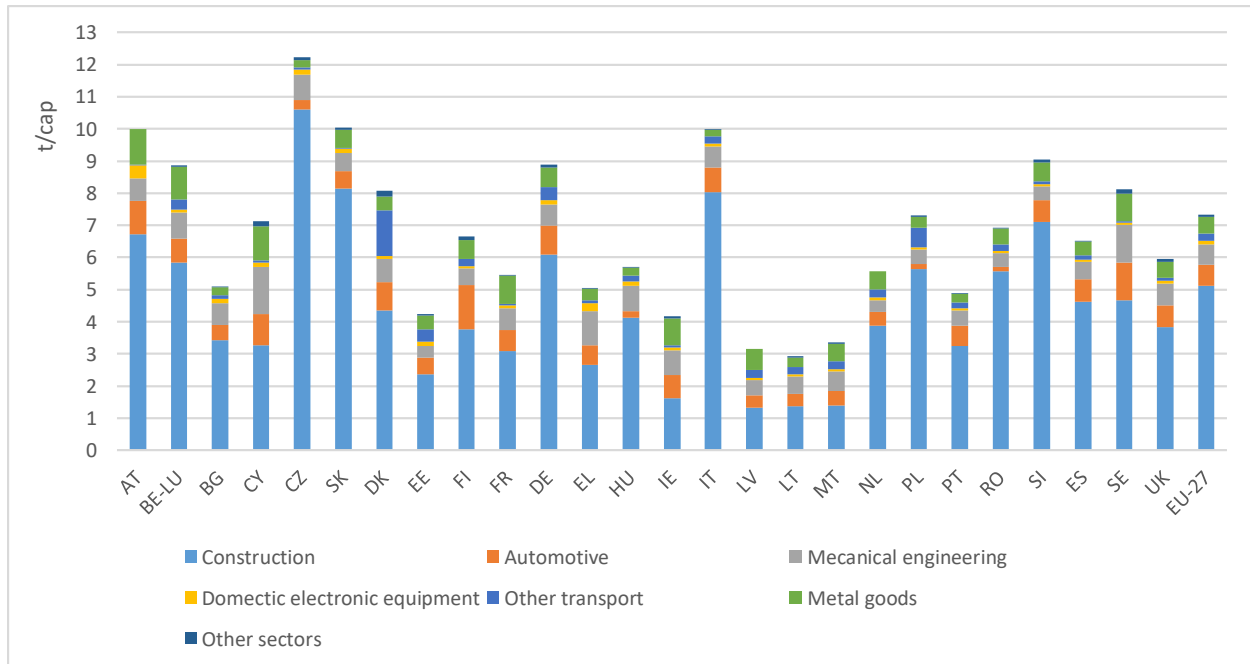

Figure 71 In-use stock per capita in European countries, 2015

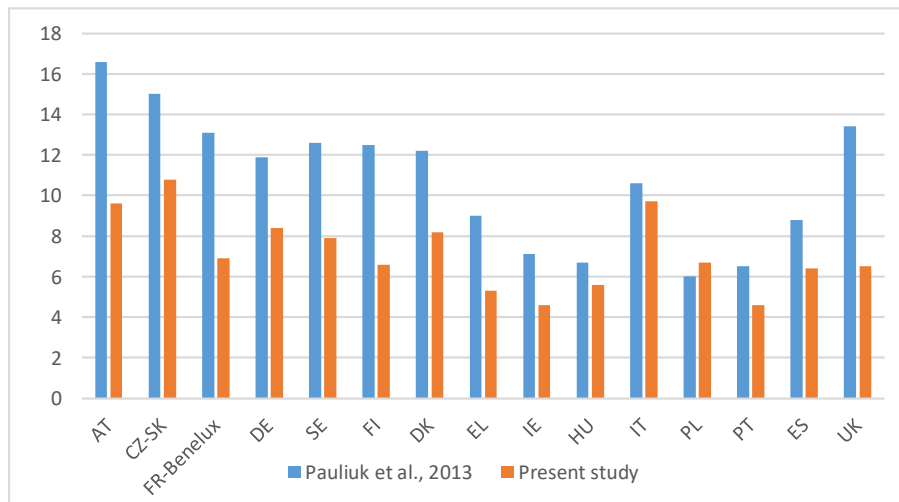

Figure 72 Comparison of results of the in-use stock in 2008 for selected European countries with the study of Pauliuk et al. (2013)

Several reasons for these differences were identified:

- Assumptions applied in the present study for estimation of the initial stock in 1945. In our study, it is assumed that the lifetimes during the period of 1850-1944 is half that during the period 1945-2015. In this case, most flows from the initial stock are discarded within the first ten years of the studied period (except construction and other transport) and have no impact on the current level of the in-use stock. In Pauliuk's study the period 1850-1944 is included in the



perimeter of the study and the applied lifetime is uniform during the whole investigated period. Values of lifetimes are also higher than in the present study. The comparison of the estimated stock in 1945 shows lower results in the present study (Figure 73). The application of the same lifetime as during the studied period, increases the initial stock per capita. For example, for the UK, the stock increases from 2.2 t/cap to 3.8 t/cap, although is still lower than estimated by Pauliuk et al.

The difference in the in-use stock in 1945 could also have been impacted by the estimation of foundry production. The calculation of the foundry production from pig iron depends on the attributed share of the consumption of pig iron and scrap. For example, in the present study, it is assumed that for the period of 1850-1945 60% of the foundry input is pig iron and 40% is scrap. A lower share of pig iron leads to higher foundry production, resulting in a higher value of the initial stock.

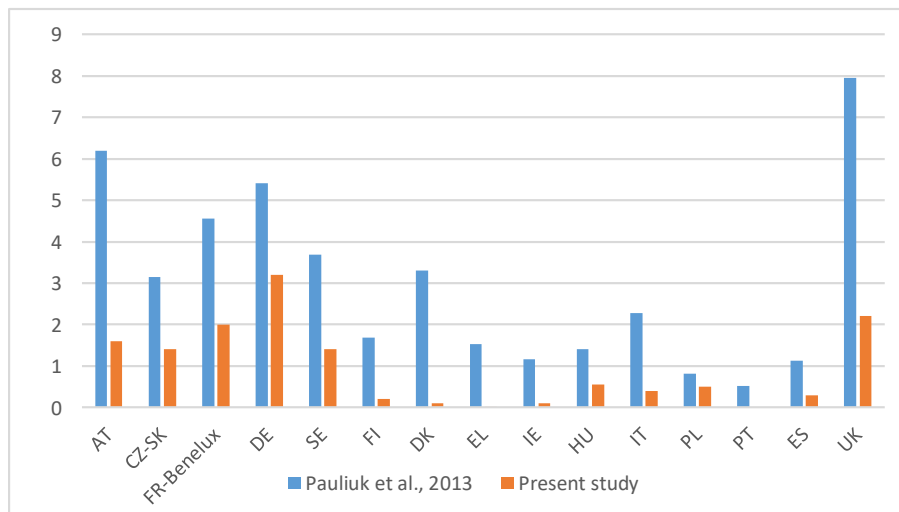

Figure 73 Comparison of results of the in-use stock in 1945 for selected European countries with the study of Pauliuk et al. (2013)

- Use of different data on the trade of steel products.

As shown in section 4.2.1.e, the imports and exports of steel products reported by UN Comtrade differs depending on the classification (SITC Rev.1 or HS). The present study used data from the HS classification, while Pauliuk et al. applied SITC Rev.1. The impact of the use of different UN Comtrade classifications on the calculated flow of the iron consumption is investigated in 5.2.2.

- Distribution of iron by industrial sectors and lifetimes.

Pauliuk noted that results of his model show higher in-use stock compared to previous studies due to these two parameters. Construction is particularly important due to the high share of iron used by this sector and to long lifetime. As shown in Table 53, the optimization routine applied by Pauliuk results in high lifetimes for the construction sector, reaching up to 100 years.

Table 53 Results of optimization routine for lifetime (years), applied by Pauliuk et al. (2013)

	AT, FR- BE-NL-LU, GR, IE, PT, UK	CZ	BG, RO	DK, MT	FI, SK ES	DE, PL	IT, SE
Construction	100	50	38	100	75	50	50
Transport	27	13	10	27	20	13	20
Machinery	40	20	15	40	30	20	30
Products	20	10	8	20	15	10	15

### 6.1.3 Iron discarded from the in-use stock use

First this part focuses on the **total amount of iron discarded from use** process:

- analyzing it from the point of view of the total discarded quantities,
- defining which industrial sectors are at the origin of the discard
- comparing this result with previous MFA studies and with the industrial vision.

The total amount of iron discarded from use represents the EoL scrap available for recycling. It is calculated from historical production, trade, distribution of iron by industrial sectors and assumptions on the lifetime distributions for industrial sectors, as presented in sections 4.3 and 4.4. This calculated flow of iron discarded from use (F14, Figure 39) is the key component for estimation of recycling indicators. In 2015, the flow of discarded EoL iron is equal to 100 Mt (Figure 74), which represents 2.7% of the in-use stock.

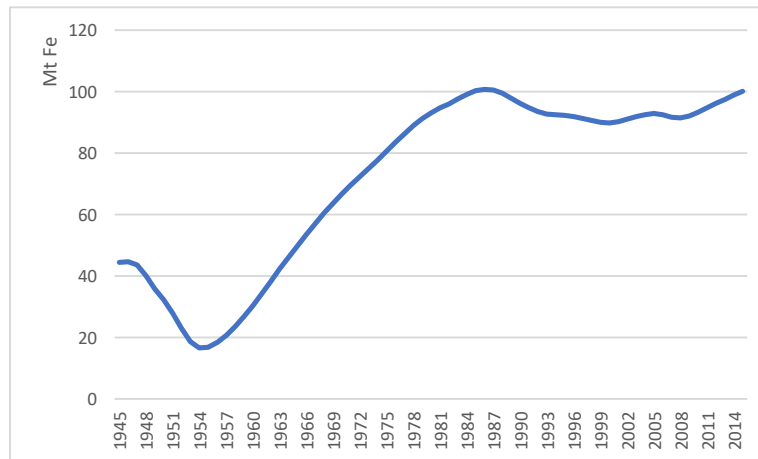

Figure 74 Total flow of EoL iron discarded from the in-use stock

Since 1955 the **relation between the discarded flow and in-use stock** is fairly constant – the discarded flow represents 2.4%-4% of the in-use stock (Figure 75). During the 1945-1954 period, the discarded flow

reached 9% of the stock ( in 1947), which is related to the high quantity of iron discarded from the initial stock, i.e. before 1945. In fact, as shown in Figure 76, illustrating the flow of iron produced before the period of the study and discarded after 1945, the peak of discarded iron reached 13 Mt in 1945. Most iron from the initial stock is discarded before 1955, exceptions are iron contained in the sectors of construction and other transports, which are characterized by longer lifetimes. Thus, the dip observed in Figure 75 (and peak in Figure 76) corresponds to the transition between two sets of lifetime values applied for the initial and in-use stock calculation. The application of identical lifetimes for the estimation of the initial stock and in-use stock will result in a uniform flow of discarded EoL iron.

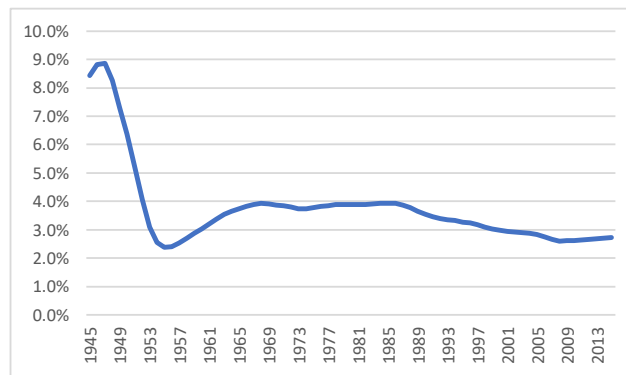

Figure 75 The share of iron discarded from use compared to the in-use stock, EU-27, 1945-2015

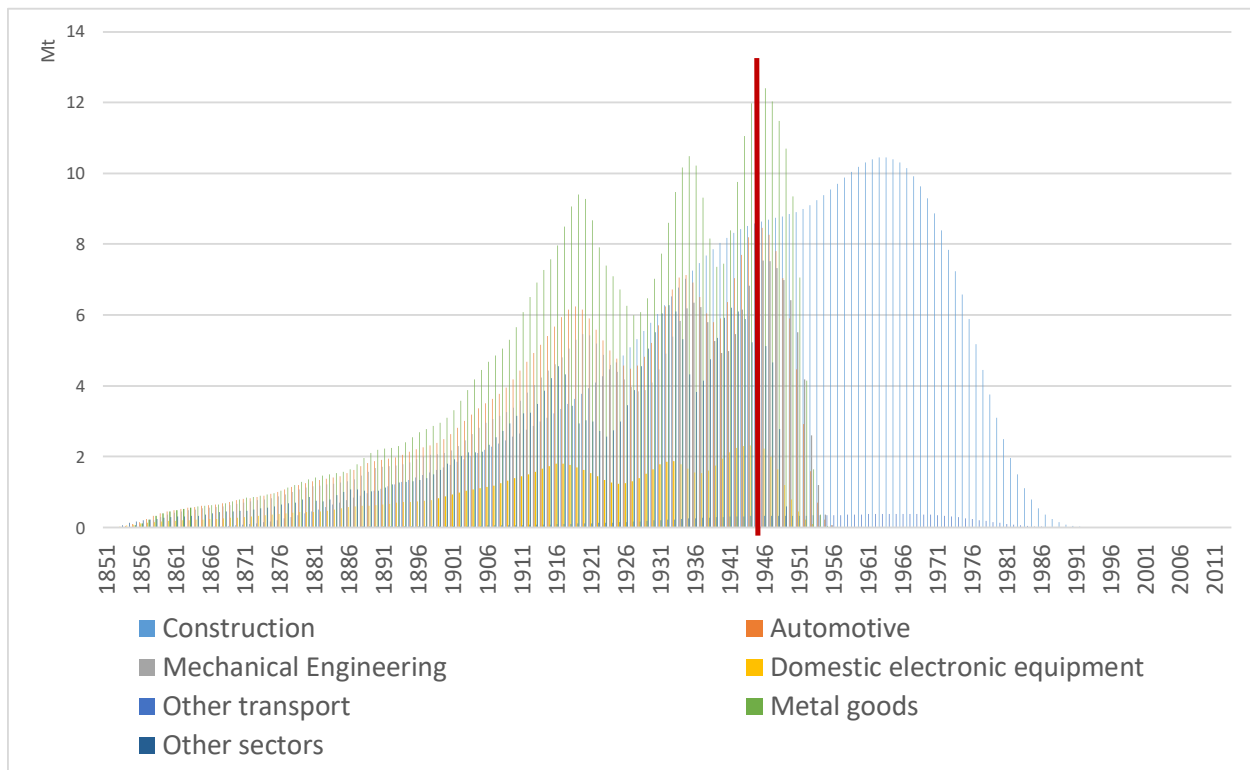

Figure 76 Discard of iron from the initial stock

The **repartition of discarded iron by industrial sectors** is as follows: automotive sector (26% in 2015), metal goods (22%), construction and mechanical engineering (20% each). Figure 77 illustrates this repartition, in absolute value (upper) and relative value regarding the total quantity of the discarded iron (lower).

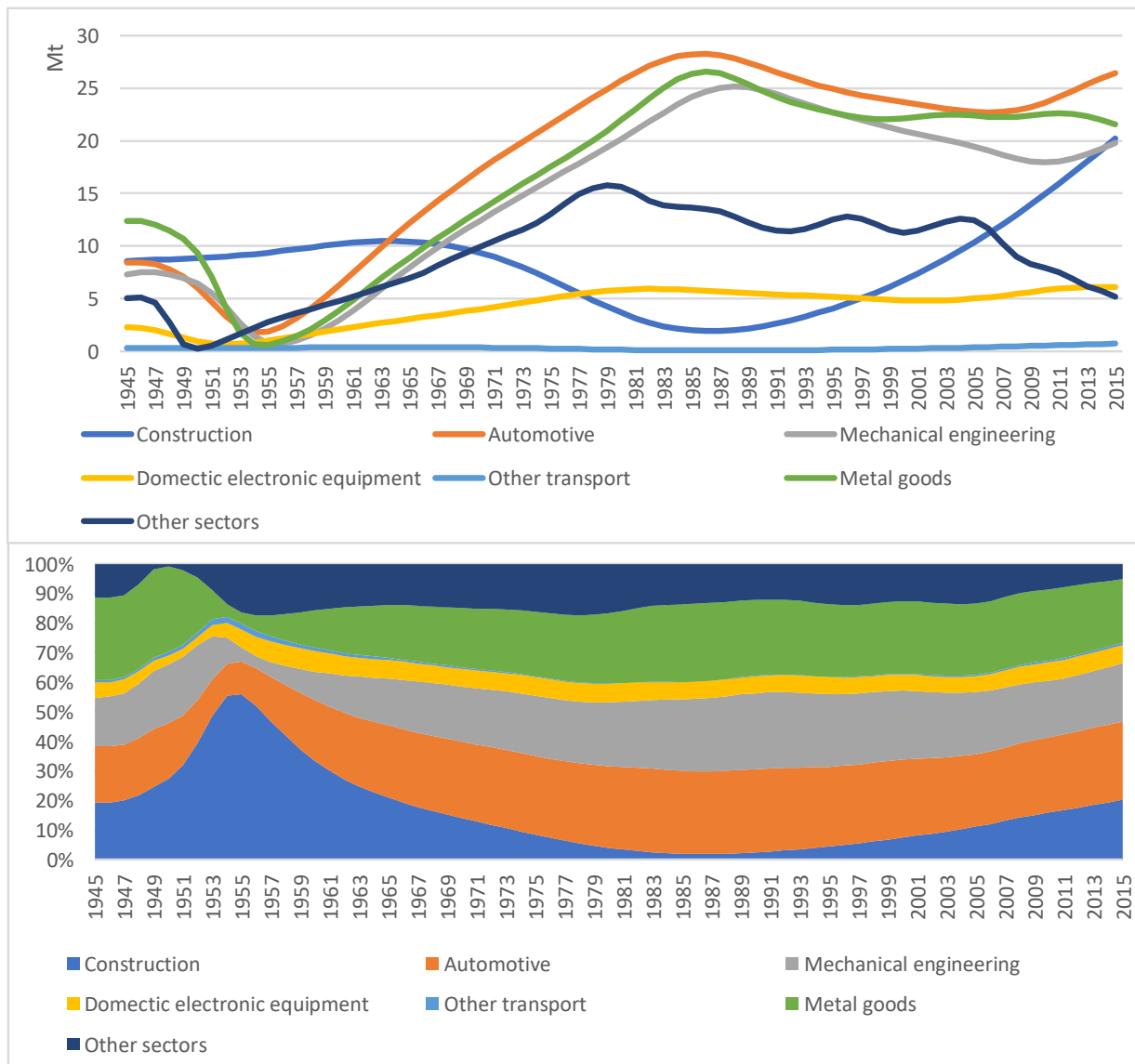

Figure 77 Generation of EoL iron per industrial sector, EU-27, 1945-2015

The obtained repartition of discarded iron by industrial sectors is in line with other MFA studies. Table 54 compares the discarded flow of iron calculated with the current model for 2001 with previous studies. It summarizes the studies of Davis et al. and Dahlström et al., whose perimeter was the United Kingdom, as well as studies of Hatayama et al and Wang et al., reporting the flow of the discarded iron on a world-wide scale (Dahlström et al., 2004; Davis et al., 2007; Hatayama et al., 2010; Wang et al., 2007). The table

contains the results of the present study for EU-27 (perimeter of the present study), but also the UK for comparing with the results of Davis et al. and Dahlström et al.

Table 54 Comparison of the generation of EoL scrap by industrial sectors, reported in different studies

	Davis, UK (2001)	Dahlström, UK (2001) (Dahlström et al., 2004)[108]	Hatayama, world (2005)	Wang, world (2000)	Present study, EU-27 (2001)	Present study, UK (2001)
Mechanical engineering	19%	20%	16%	32%	23%	22%
Electrical engineering	6%	6%	13%			
Shipbuilding/Other transport	0%	0%	2%		0%	0%
Automotive	22%	23%	20%	23%	26%	33%
Structural steelwork and building/civil engineering	10%	11%	20%	23%	8%	15%
Metal goods	14%	12%	NA	NA	25%	15%
Packaging	8%	4%	7%	NA	NA	NA
Boilers, drums and other vessels	5%	6%	NA	NA	NA	NA
Other	16%	17%	22%	Municipal wastes: 16% WEEE: 5%	Other sectors: 13% WEEE: 5%	Other sectors: 6% WEEE: 8%

The total quantity of generated EoL scrap in EU-27 cannot be compared to any reference, because this perimeter was not investigated before. At country level, for the UK, the total generated quantity calculated here is in line with two other studies for that perimeter:

- Davis et al. - 10 453 kt;
- Dahlström et al. - 10 013 kt.
- The present study - 10 973 kt.

As for the repartition of discarded iron by industrial sectors, the results of these three studies indicate that the highest share is discarded from the automotive sector (Table 54). The present study shows, however, a higher share for that sector - 33% instead of 22-23%. Since the applied lifetimes are similar, this higher share can be explained by differences in values of parameters used to calculate of the flow entering use, namely:

- the share of iron consumed by the automotive sector;
- the generation of the process scrap;
- the iron content in final goods for calculation of the indirect trade.

Worldwide, both studies show a fairly similar distribution, even if the definition of the industrial sectors differs. The highest share of EoL scrap is generated from machinery and large transport equipment (in

Hatayama’s study the equivalent of this sector is mechanical, electrical engineering and shipbuilding), followed by automotive and construction sectors. Yellishetty reports, however, EoL vehicles to be the largest source of scrap for the world perimeter (Yellishetty et al., 2011).

An interesting point to discuss is the similarity in the results of the repartition of discarded iron by industrial sectors for studies covering the same geographical perimeter. This may increase confidence in the obtained values but may also result from the similarity in methodological approach. For this reason it is interesting to compare the distribution of the discarded iron with Russo’s model, which applied a different approach to the calculation of the discarded flow (Russo, 2014). Russo used the share of each industrial sector on a world-wide scale from Worldsteel and data on consumption of EoL scrap from BIR. The generation of the EoL scrap was defined by adjusting sector-specific lifetimes and considering the recovery rate (the resulting weighted average equals 86%). Russo’s model indicated that the highest quantity of EoL scrap originated from the construction sector (42%), followed by mechanical engineering (26.6%) and the automotive sector (24%), illustrated in Figure 78.

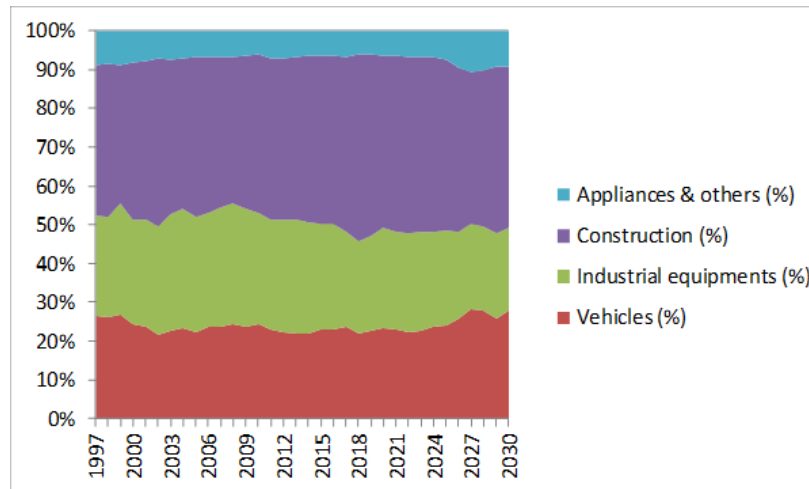

Figure 78 Generation of EoL iron per industrial sector, world (Russo, 2014)

Thus, Russo’s model shows a different result compared to DMFA studies. Unfortunately, statistical information on the generation of EoL scrap by industrial sectors is not reported by professional recycling organizations and governmental bodies. This is confirmed by Gros, reporting that even in case of the survey conducted by the recycling federations for their own members, the information was poor. This is related to the historical competition in the sector of metal recycling, and fear of disclosing the sources of scrap to competitors, in addition to limited time and resources (Gros, 2007). Without this statistical information, it is impossible to perform a comparison of the result of DMFA models, as no reference is available.

According to Russo, currently, the best possible approach to determining the origin of the EoL scrap is to investigate scrap according to process of its processing during recycling – cutting or shredding. This

processing distribution may be estimated using the categories of the European Scrap Quality Specification, on the basis of consultation with industrial experts:

- categories E1 and E3 correspond to the scrap from the demolition of buildings, infrastructure, ships and equipment. These heavy structures are cut for further recycling.
- category E40 covers scrap from consumption goods, like EoL vehicles, WEEE, furniture. The splitting is achieved by shredding.
- categories EHRB and EHRM correspond to scrap from reinforcing bars, wire and mechanical pieces. These categories are also cut.

The information on the acquisition of EoL scrap by European division of ArcelorMittal is assumed to be a representative sample of EoL scrap produced in Europe. According to this data, shredded scrap (E40) represents 22% of the total quantity of cut and shredded EoL scrap (sum of E1, E3, E40, EHRB and EHRM). This means that 78% of EoL scrap originates from buildings and infrastructure, reinforcing bars, wire and mechanical pieces (E1, E3, EHRB and EHRM). Moreover, EoL vehicles represent approximately 50% of the input to the shredder (E40). Therefore, according to Russo, it is almost impossible that the automotive sector represents the main source of EoL scrap in Europe. The investigation of the impact of lifetime parameters on the flow of iron discarded from the in-use stock and its repartition of by industrial sectors is provided in 6.2.2.

The derived flow of iron discarded from the in-use stock represents the potential availability of EoL scrap (in iron equivalent) on the territory. In order analyze iron recycling over the time and on different scales (EU-27/individual European countries) the main focus is on the estimation of iron that was actually recovered from of the total discarded quantity.

#### 6.1.4 Recycling indicators

This section presents and discuss results for the recycling indicators, derived from iron flows calculated in the model. The main focus in this part is on EoL RR and ORER indicators, since they have been used in previous studies and their definition is established and accepted:

- the EoL RR indicator compares the discarded quantity of the EoL scrap with its collection and processing in a country. Here, results of the calculated EoL RR indicator are presented at the level of EU-27 and at country level. The dissipative losses are not considered here; the EoL scrap generation represents the total quantity of iron discarded from the in-use.
- ORER compares the consumption of EoL and process scrap with their generation.

- ORER+t is derived from the previous indicator, complemented by the trade of scrap, thus comparing the processed quantity (collected and pre-processed) in the country with their total generation.
- Finally, ORER+t+h, is the ORER+t indicator which includes the generation and the consumption of home scrap.

These recycling indicators are calculated according to the formulae presented in Chapter 5.

*a. EoL RR*

The solid line in Figure 79 illustrates the calculated EoL RR for EU-27 during the period 1945-2015. During the period 1953-1957 the calculated recycled rate is higher than 100%. This means that the quantity of recovered EoL scrap exceeds its discard from the use. Some studies explain this by the recovery of discarded materials from the obsolete stock (Birat, 2017; Daigo et al., 2015). This explanation is not applicable here, as indicator values higher than 100% are correlated with the dip in the calculated generation of the EoL scrap, as shown on Figure 74. Thus, for the period 1953-1957 the value of the indicator higher than 100% is related solely to the application of two sets of lifetimes for the period of the initial stock and for the period of investigation. The application of the same lifetimes for both periods shows that the EoL RR does not exceed 100%, as shown by a dotted line on Figure 79. **From 1970**, when statistical data is better quality and the generation is not impacted by the discard from the initial stock, **the average EoL RR is 65%, varying from 57% to 79%.**

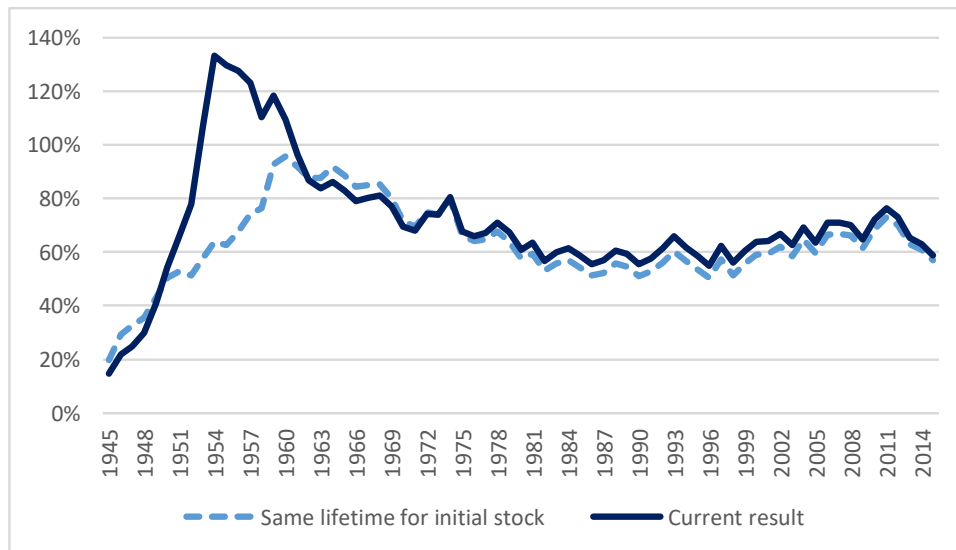

Figure 79 EoL RR for EU-27, 1945-2015

Figure 80 illustrates the result for EoL RR on a country level. It can be noted, that country results are more subjected to negative values or values higher than 100%, compared to the European level values. Only six countries – Austria, Germany, Hungary, Italy, Spain, Sweden, the UK do not have outlying values during the period 1970-2015. Seven other countries have only one or two outlying values -Belgium-Luxembourg,



Denmark, France, Ireland, Netherlands, Poland and Romania. For a better visibility of the differences between countries, Figure 81 shows the average value of the calculated indicator EoL RR for the period 1970-2015 for European countries.

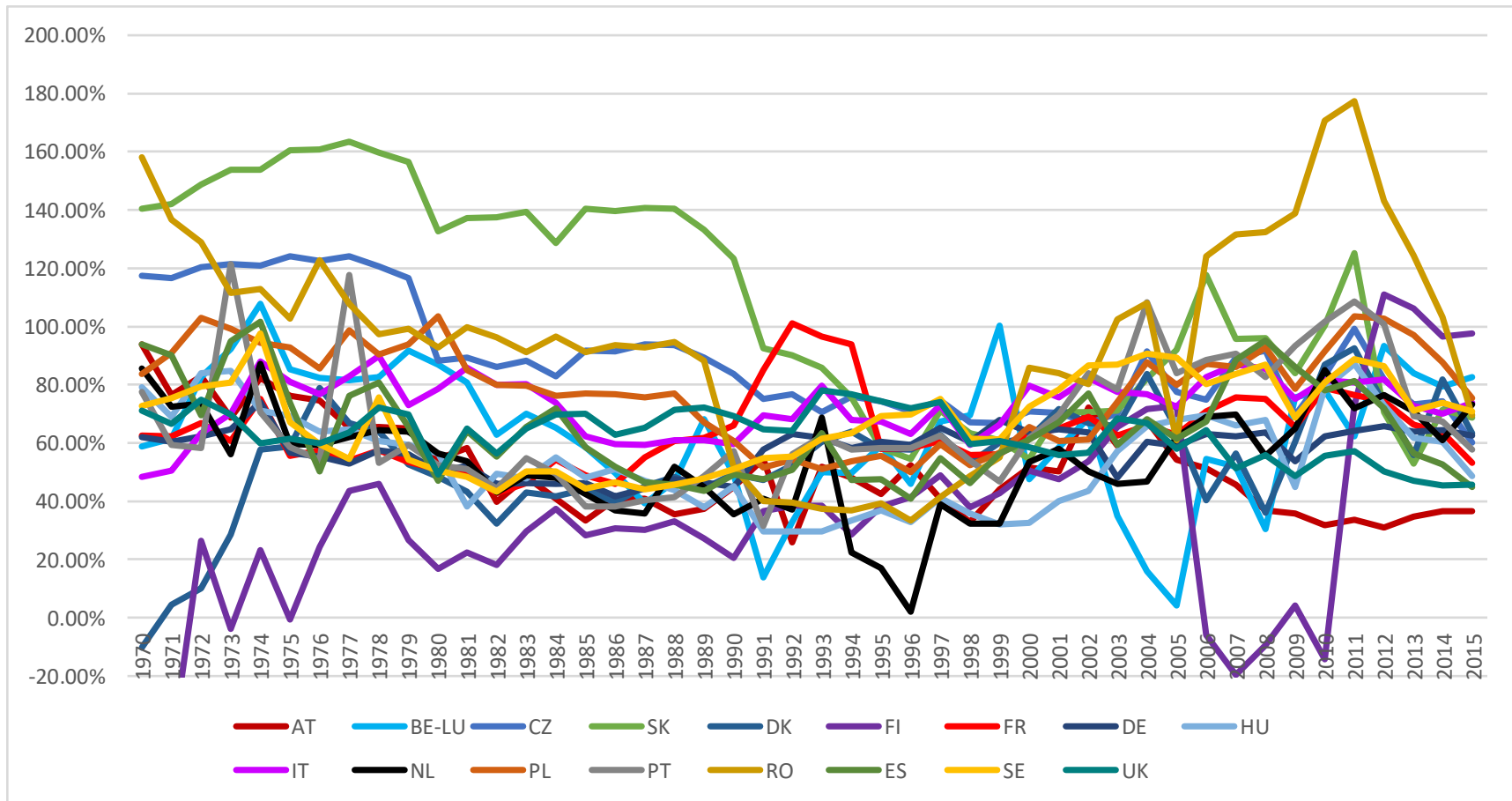

Figure 80 EoL RR of iron for 17 countries of EU-27, 1970-2015

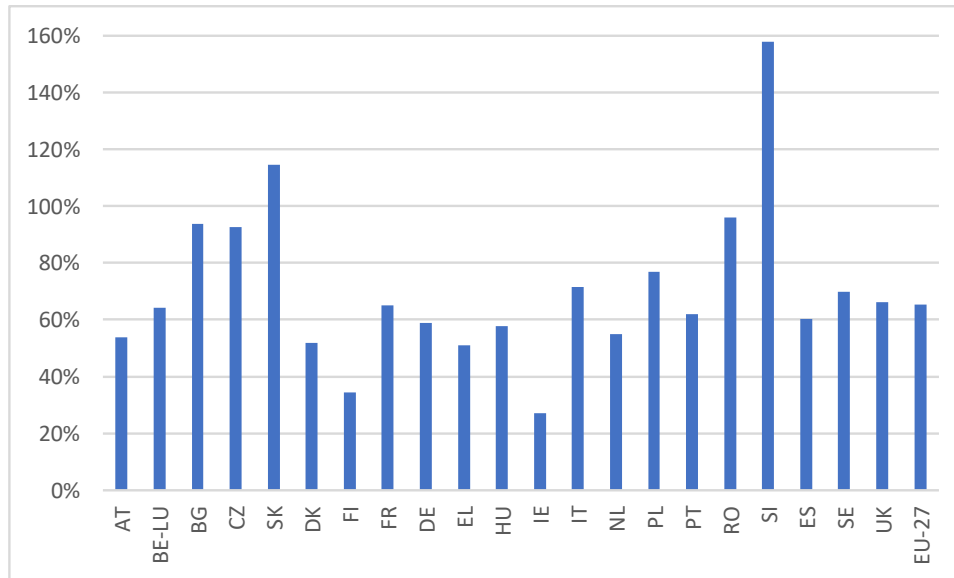

Figure 81 Average value of EoL RR in European countries between 1970-2015

On the country level, it is difficult to define a clear trend in the change of EoL RR, because the calculation of the nominator of this indicator is impacted by imports and exports:

- the consumption of scrap is influenced by the trade of pig iron: higher net imports leads to a higher consumption of pig iron and, consequently lower consumption of scrap;
- the quantity of processed EoL scrap (collected and prepared for consumption and trade) is impacted by imports and exports of scrap.

Outlying values can be explained by uncertainties related to trade data. The impact is particularly noticeable for countries without steel production, like Cyprus, Estonia, Lithuania, Malta:

- their scrap consumption is equal to zero, since the production of foundries could not be estimated;
- home scrap generations is also equal to zero;
- process scrap is generated during transformation of imported steel products;
- scrap is traded

Thus, if net export of scrap is lower than calculated process scrap generation, the result for the processed EoL scrap is negative. Countries with production of steel and cast iron are less subject to negative values, which can however occur if, for example, scrap imports increased or exports decreased, compared to previous or subsequent years.

Table 55 details minimal, maximal and average values for this indicator for the period 1970-2015 and details reasons for outlying values (less than zero or higher than 100%).

Table 55 Minimal, maximal and average values of EoL RR for the period 1970-2015 for European countries

Country	Average	Min	Max	Explanation
AT	54%	28%	92%	-
BE-LU	64%	4%	108%	2 outlying values of more than 100% are caused by a higher net export compared to consequent/previous years; this resulted in the collection higher than the generation.
BG	94%	38%	243%	During the whole period the quantity of processed EoL scrap is increasing fairly uniformly. In the beginning of the 70s the quantity of processed EoL scrap is higher than its generation, which only starts to grow; after 1994, the generation of EoL scrap decreases due to the decrease of steel consumption in 90s. This infers EoL RR >100%
CY	-20%	-65%	42%	During almost the whole period (except for 10 years), the generation of the process scrap is higher than net export, resulting in negative values of processed EoL scrap and EoL RR < 0.
CZ	92%	60%	121%	As for Bulgaria
SK	114%	51%	168%	Before 1990 the quantity of processed EoL scrap is higher than the generation (more than 50% of scrap consumption is provided by EoL scrap, additionally SK is a net exporter of scrap). After 2005 the generation of EoL scrap decreases due to the decrease of steel consumption in 90s, while the processed quantity of EoL shows peaks, related to trade (net export). This infers EoL RR >100%
DK	52%	-10%	84%	1 negative point in the nominator due to trade and generation of the process scrap
EE	429%	-56%	4136%	Before 1992 no production of steel and cast iron, neither trade of scrap; only generation of process scrap. This results in negative values of processed EoL scrap and EoL RR < 0. After 1992, the country is a net exporter of scrap, the calculated quantity of processed EoL scrap is higher than its generation, which infers EoL RR >100%
FI	34%	-44%	108%	Negative values are observed in the beginning of 70s and after 2006 for years when import is high compared to consumption
FR	65%	43%	110%	2 values higher than 100% are related to increase of the scrap net export
DE	59%	43%	73%	-
EL	51%	-24%	271%	In the beginning of the 70s the growth of steel production inferred higher scrap demand. This caused the higher quantity of processed EoL scrap, compared to its generation and EoL RR >100%. 2 negative values are observed in 90s because net import was of the same order of magnitude as consumption, resulting in EoL RR < 0.
HU	58%	32%	88%	-
IE	27%	-10%	65%	One negative value in 1972 due to low scrap consumption
IT	72%	45%	88%	-
LV	853%	-59%	3467%	Before 1980 there was no steel and cast iron production, nor a trade of scrap; only generation of process scrap. This results in negative values of processed EoL scrap and EoL RR < 0. After 1980, the country produces steel and trades scrap, but the quantity of processed EoL scrap is higher than its generation, which infers EoL RR >100%

LT	222%	-55%	1442%	As for Latvia, before 1990 only process scrap is generated, resulting in negative values of processed EoL scrap and EoL RR < 0. After 1990 net export of scrap is higher than generation of EoL scrap. This infers EoL RR >100%.
MT	2%	-71%	422%	As for Latvia, before 1990 only process scrap is generated, resulting in negative values of processed EoL scrap and EoL RR < 0. After 1990 there are 2 negative points, because net export of scrap is higher than the generation of EoL scrap, resulting in EoL RR >100%
NL	55%	2%	89%	1 outlying value of 2% is related to a low net export
PL	77%	50%	102%	2 values higher than 100% in 2011-2012 are related to the decrease of the generation of EoL scrap after 90s, while the processed quantity of EoL shows peaks, related to trade (net export). This infers EoL RR >100%
PT	62%	30%	107%	5 points higher than 100% related to the decrease of net export
RO	96%	35%	182%	Same reason as for Poland
SI	158%	71%	303%	The collection is higher than generation, country is a net importer of scrap
ES	60%	40%	91%	-
SE	70%	46%	95%	-
UK	66%	46%	85%	-
EU-27	65%	55%	80%	-

Based on the review of country specific results of EoL RR indicator, it can be seen that the reported statistical data for trade of scrap impacts the result of EoL RR. On the European level the net export of scrap does not have an important impact, as shown in Figure 82: generally net imports and net exports represent less than 4% of the scrap consumption, except for three periods:

- between 1955 and 1957: 6%,
- between 1991 and 1994: 7%-12%;
- since 2009: 12%-16%.

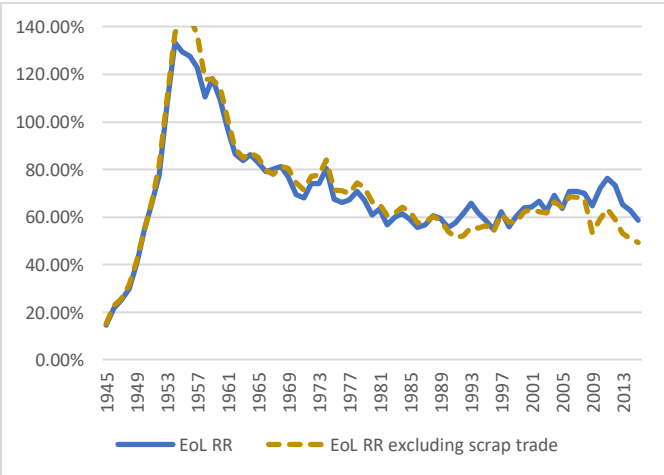

Figure 82 Impact of scrap trade on EoL RR of EU-27

The EoL RR indicator is related to obsolete stock: the indicator shows the relationship between processed and generated EoL scrap, while the obsolete stock represents the accumulation of iron flows that were not processed by waste management and recycling and, therefore, remain in the anthroposphere (1.3.1). The annual input to the obsolete stock is calculated as the difference between the calculated iron flow discarded from the in-use stock and the flow processed by waste management and recycling. The obsolete stock can increase and decrease over time. The growth of the obsolete stock means that the input flow is higher than the output, while the decrease of this stock means that the quantity of iron collected from the obsolete stock is higher than the input. The decrease of the obsolete stock is illustrated, for example, by cases when the calculated EoL RR is higher than 100%.

Figure 83 illustrates the obsolete stock in comparison to the in-use stock for EU-27. In 2015, obsolete stock reached about 1730 Mt, which represents 47% of the in-use stock. During the period 1945-2015 obsolete stock represents on average 28% of the in-use stock, varying between 7% and 47%.

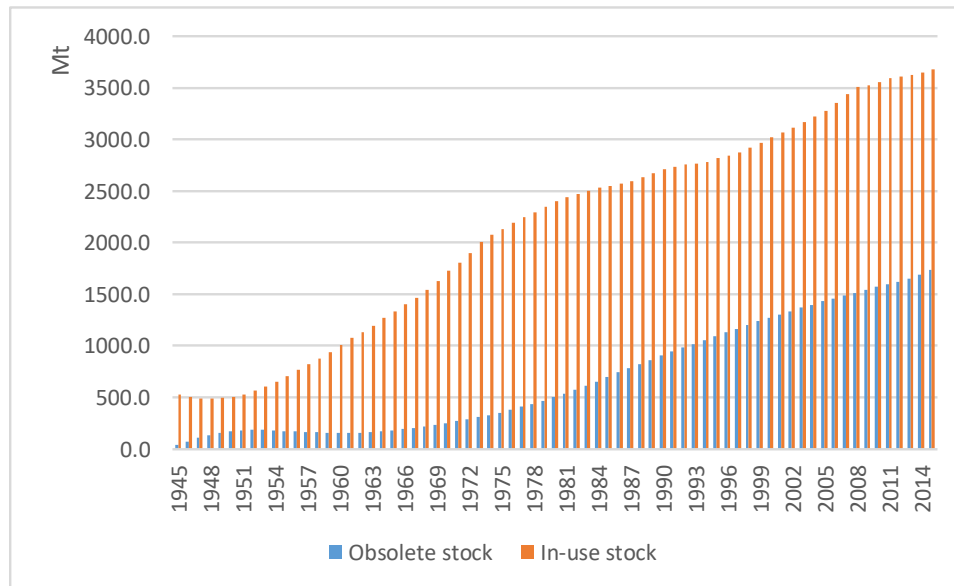

Figure 83 Illustration of the obsolete stock compared to the in-use stock, EU-27, 1945-2015

*b. ORER and derived indicators*

The ORER indicator shows the relation between the consumption of process and EoL scrap and their generation:

$$ORER = \frac{\text{consumption process scrap} + EoL}{\text{generation process scrap} + EoL}$$

The evolution of the ORER indicator for EU-27 between 1945 and 2015 is shown in Figure 84. This indicator is not dependent on scrap trade, that is why, for the EU-27, the graph is similar to the graph of EoL RR.

Average values for European countries for the period 1970-2015 are shown in Figure 85. . For ORER, values higher than 100% are not surprising: it means that the country uses more scrap than it generates. Thus, countries with a high share of steel production in EAF show higher values for this indicator. This is the case for Spain, Italy, Belgium-Luxembourg. Table 56 again summarizes here maximal, minimal and average values for the ORER indicator at country level for the period 1970-2015.

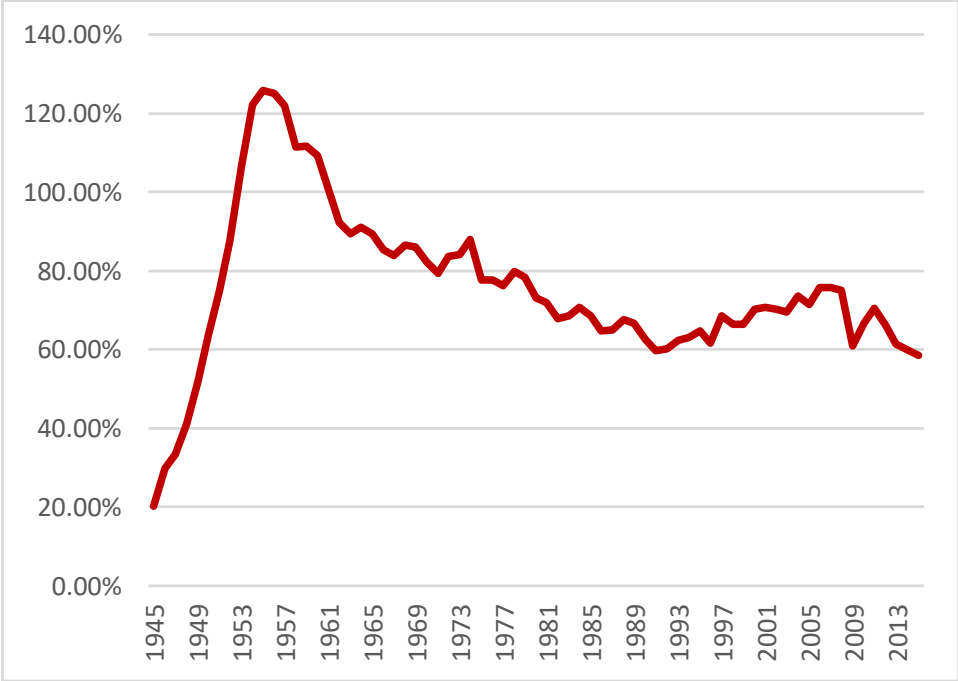

Figure 84 ORER for EU-27, 1945-2015

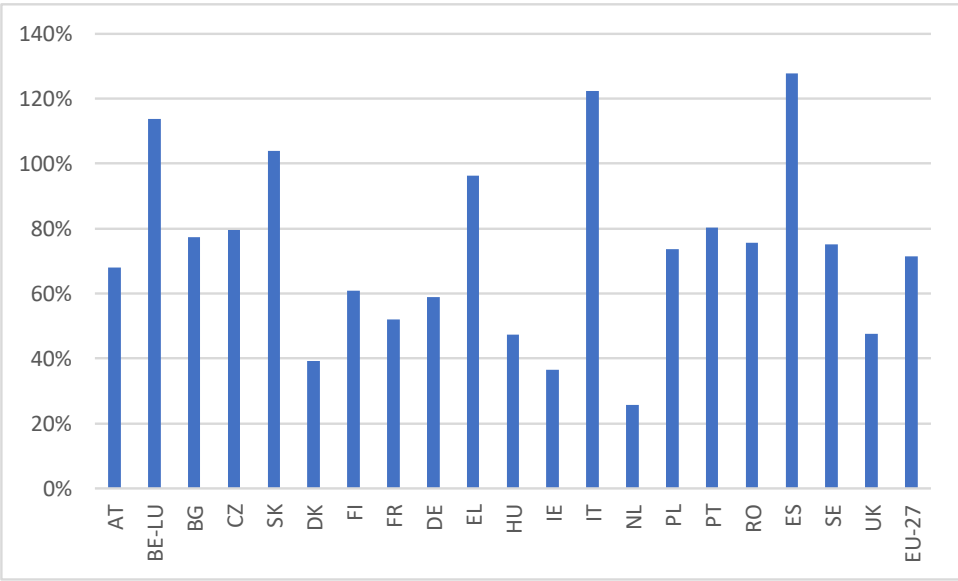

Figure 85 Average values of ORER indicator in European countries between 1970-2015

Table 56 Minimal, maximal and average values of ORER indicator for the period 1970-2015 for European countries

Country	Average	Min	Max	Country	Average	Min	Max
AT	68%	45%	99%	IE	36%	0%	78%
BE-LU	114%	53%	193%	IT	122%	99%	155%
BG	77%	42%	171%	NL	26%	9%	79%
CZ	79%	41%	115%	PL	74%	42%	101%
SK	104%	56%	149%	PT	80%	34%	276%
DK	39%	4%	85%	RO	76%	36%	152%
FI	61%	33%	117%	SI	184%	94%	256%
FR	52%	36%	65%	ES	128%	95%	157%
DE	59%	46%	78%	SE	75%	33%	106%
EL	96%	42%	212%	UK	48%	14%	80%
HU	47%	16%	88%	EU-27	71%	59%	87%

Results of derived ORER indicators are given in Figure 86 for five countries, and EU-27, as an example. Blue lines reflect the EoL RR indicator, red lines illustrate values for ORER. Yellow lines are used for ORER+t and grey lines for ORER+t+h. The values of these two last indicators correlate with EoL RR due to the similarity in the definition of the indicators. They are higher than EoL RR, since they consider the generation and recycling of process and home scrap, which are fully collected and recycled. ORER is the only indicator which does not consider the trade of scrap, its behaviour is different from other illustrated indicators. Comparatively high with respect to other countries, the ORER of Italy highlights the predominance of secondary steelmaking on its territory (more than 50% of produced steel since late 70s). Previously, Davis estimated that 68-70% of scrap was recycled in the UK in 2001. This estimation corresponds to the modified version of ORER indicator – ORER+t, because it included the process scrap (Davis et al., 2007). Values obtained by Davis are higher than in the present study, where it is equal to 63%. This might be explained by:

- the difference between the estimation of the process scrap. The present study estimates the generation of process scrap with steel product- and industrial sector-specific parameters, while Davis applied 10% generation to all sectors, except construction and packaging, where 5% and 17% were applied respectively.
- Scrap consumption is also estimated in a different way – in the present study from the mass balance and expressed in iron equivalent, in Davis from ISSB statistics and the British Metals Recycling Association and expressed in tons of scrap



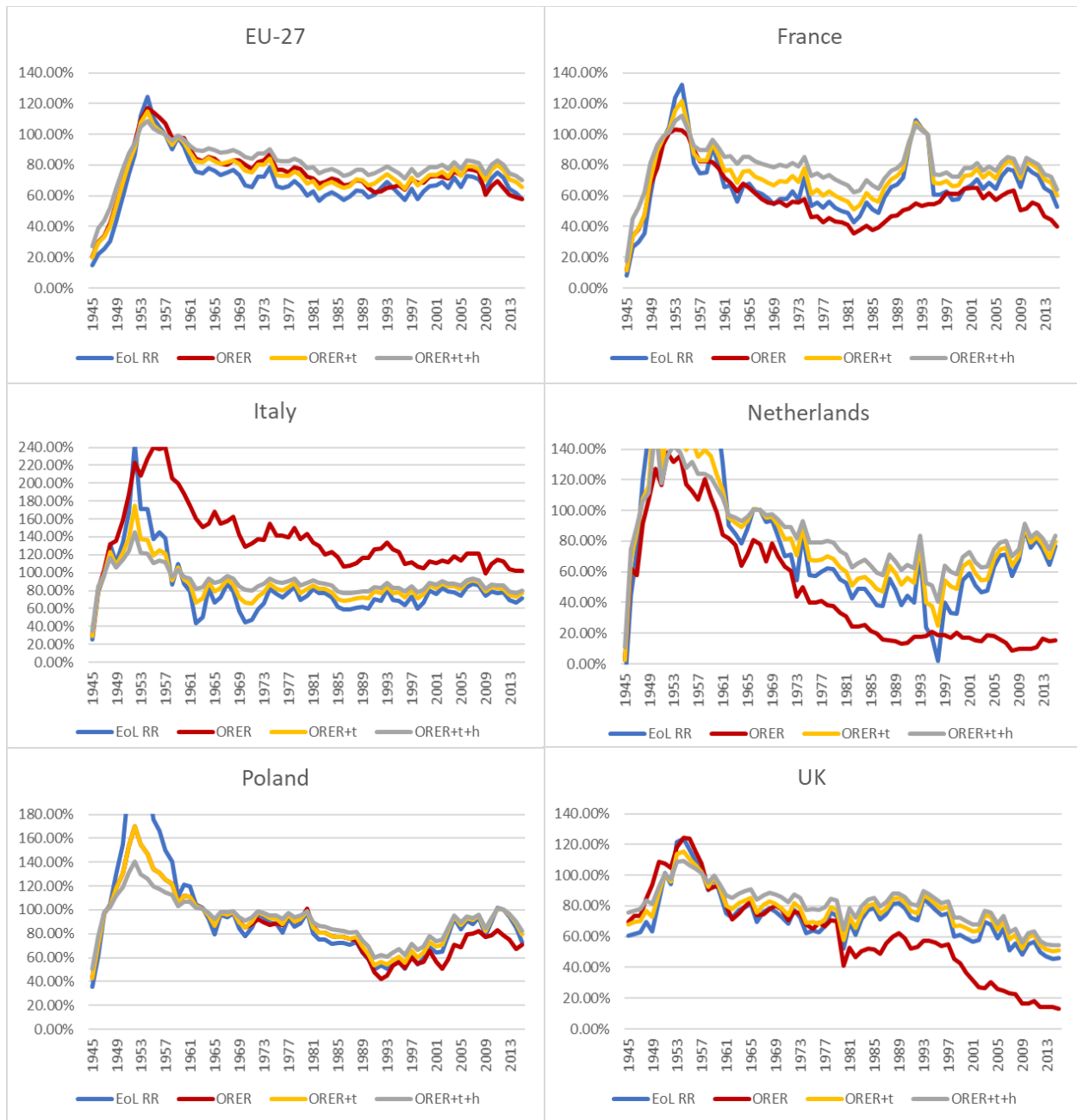

Figure 86 Recycling indicators for selected European countries

### 6.1.5 Iron loss during the production stage

This section presents the quantity of iron generated during processes of steelmaking and foundries and associated with by-products. This iron is partially recycled within metallurgical processes, partially recycled in other industries (this iron cannot be further recycled as a metal) and landfilled. Home scrap, generated during steelmaking processes (BOF, EAF, OHF and rolling and finishing) is excluded from this

part, as it is considered as a source of scrap, which is fully recycled. Moreover, the generation of the home scrap is higher compared to iron contained in by-products, so its inclusion would distort the results. To illustrate this, the inclusion of the home scrap as a by-product is shown for BOF and steel industry. For foundries, the generation of home scrap is included as a by-product, because only 50% of it is recycled.

The production of by-products is not reported in statistics, probably because they are not routinely measured. Identified annual production of steel slag, for example, is estimated based on average generations per ton of crude steel (Sofili et al., 2012). Moreover, the amounts of by-products generated depend on raw materials used, type of furnace and grade of steel or type of cast iron. In the following, results for iron contained in by-products are presented. The calculation is done on the basis of established mass balances for processes of steelmaking (BOF, EAF, OHF, rolling and finishing) and foundries (section 4.3). These mass balances define the generation of by-products and their content, in collaboration with industrial experts, from industrial data and on the basis of the literature. The applied parameters are representative for the current state of technology and are constant over the time. This means that the iron in by-products can be underestimated for earlier time periods when the technologies were less efficient.

All figures are shown for EU-27.

During **BOF process** iron is lost to slag, dust and sludge, mill scale. The amount of iron contained in these flows is shown on Figure 87 (left). The right figure illustrates the generation of by-products, expressed as mass. The total amount of iron in by-products varies between 0.1 Mt and 4.1 Mt during the period 1945-2015. 5% of this iron is recycled internally within the process, 35% is recycled in ironmaking and 60% is recycled externally (e.g. production of concrete, roads, fertilizers) or landfilled<sup>24</sup>.

---

<sup>24</sup> From section 4.3.1:

- 10% of BOF slag are recycled within the process, 90% are recycled externally;
- 55% of dust and sludge are recycled to the sinter plant, 33% are used externally and 12% are landfilled (Remus et al., 2003)
- 100% of mill scale are recycled in sintering.

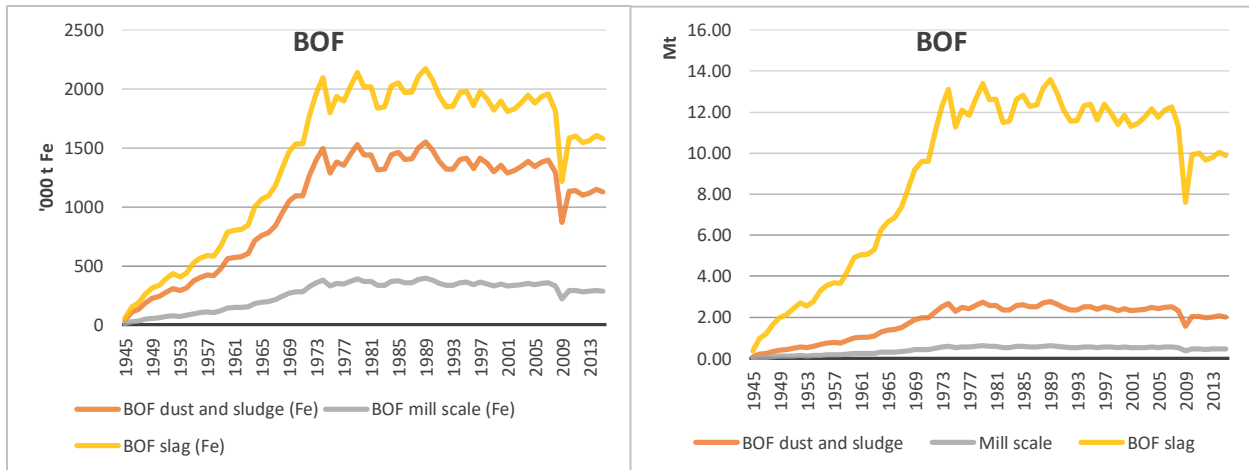

Figure 87 Iron in BOF by-products and the generation of BOF dust, slag and mill scale

The inclusion of home scrap leads to a higher share of recycled iron because it is fully recycled. The result shows that, during the period of 1945-2015 55-95% of iron are recycled (Figure 88). The decrease in the recycled quantity is related to the improvement of the home scrap yield.

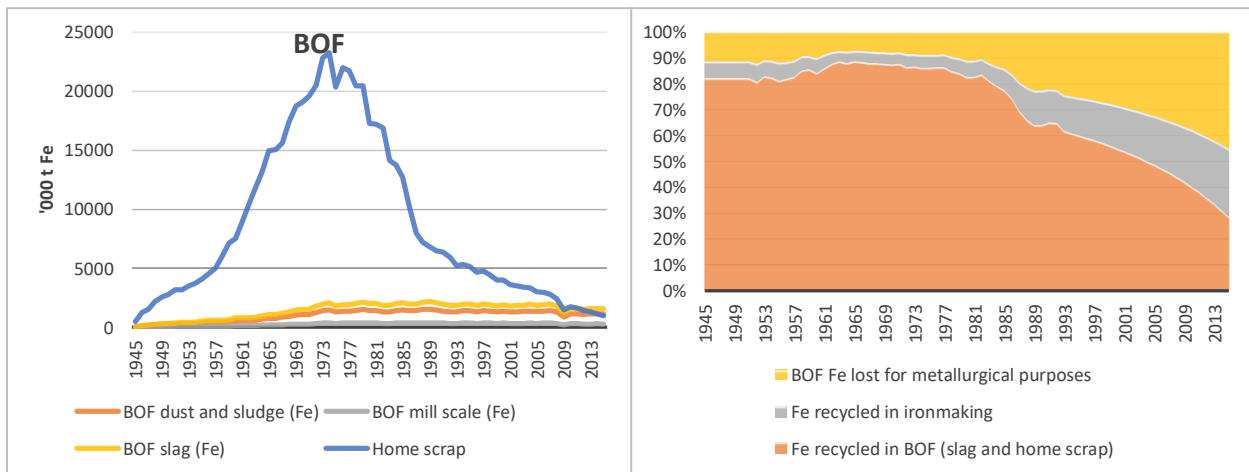

Figure 88 Iron in BOF by-products, including home scrap and respective shares of recycled and lost iron

During the EAF, slag and dust are generated, together with the mill scale during casting. Figure 89 illustrates the quantity of iron in EAF by-products (left), as well as the generation of these by-products, expressed as mass (right). The most important flow is the slag, as in BOF. 9% of the total iron generated in this process is recycled internally in the process (corresponding to 10% of the slag); 5% is recycled in sintering (corresponding to 100% of the mill scale), 86% is lost to metallurgical recycling due to external recycling or landfill<sup>25</sup>.

<sup>25</sup> From section 4.3.1 :

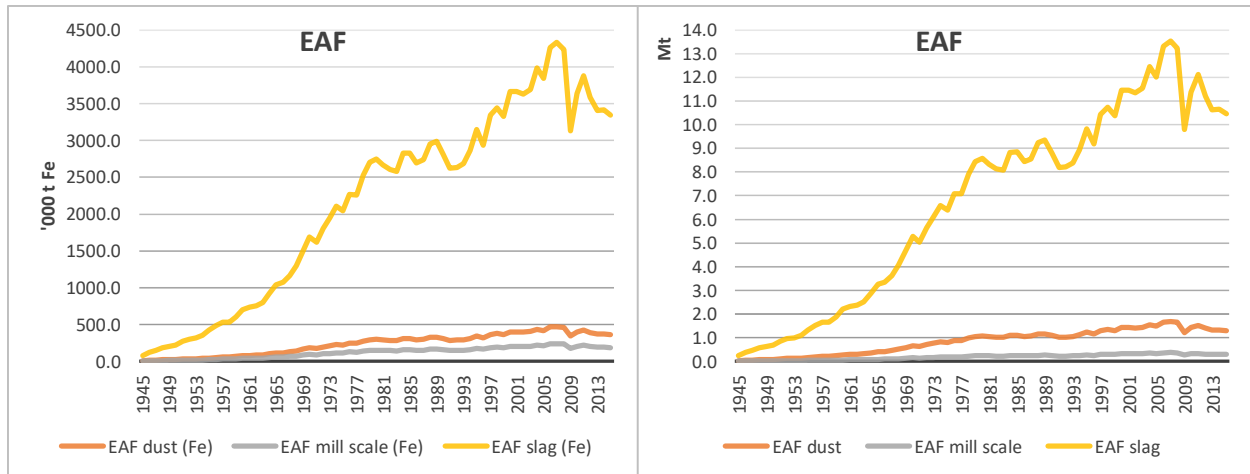

Figure 89 Iron contained in EAF by-products and the generation of EAF dust, slag and mill scale

The **process of OHF** generates slag, dust and mill scale from casting. Since the OHF process is no longer used, it was rather difficult to find corresponding technical information for elaboration of the mass balance. The information was in part identified in the literature and BOF process was in part used as a proxy. Thus, the mass balance of the OHF reflects a mix of old and modern data.

As can be noted from the left side of Figure 90, the largest amount of iron is generated from the mill scale. This can be explained by a higher amount of the generated mill scale issued from historical data, compared to BOF and EAF (34 kg Fe/t crude steel against 2.9 kg Fe/t crude). The iron content of the mill scale is assumed to be 56%, by analogy with BOF and EAF mill scale. Thus, because of the high generation and iron content compared to OHF slag, it represents the highest flow of iron. The right side of the Figure 90 illustrates the generation of by-products in terms of their mass. Slag represents the biggest flow, since in terms of mass, the generation of the slag is higher than that of mill scale. Mill scale is richer in iron. 49% of the total iron is recycled in sintering, corresponding to 100% of the mill scale.

The reported historic generation of the mill scale might be also valid for processes of BOF and EAF. This confirms an eventual underestimation of the by-products for BOF and EAF. However, considering historical improvement the generation of mill scale might be as high for other processes too (at the same level as for OHF).

- 10% of EAF slag are recycled within the process, 90% are recycled externally;
- 100% of EAF dust are used externally (34% landfilled, 32% are used in the external recovery of zinc, 34% are recovered through other processes);
- 100% of mill scale are recycled in sintering.

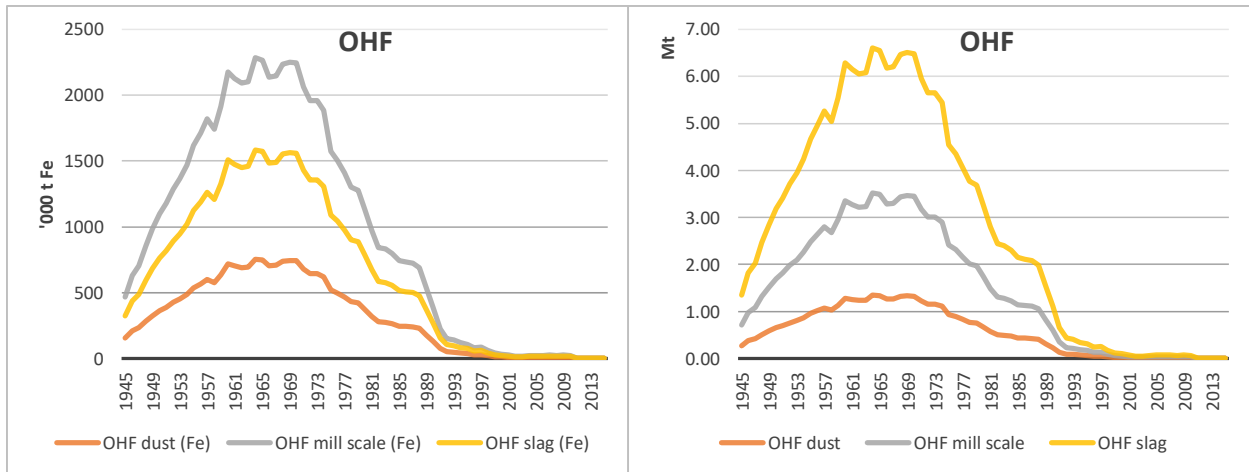

Figure 90 Iron contained in OHF by-products and the generation of OHF dust, slag and mill scale

During the process **Rolling and finishing**, the following iron-bearing by-products are generated: scale from scarfing, grinding, shot blasting and reheating scale; scale from descaling; mill scale sludge and iron oxide/iron sulphate from pickling. The iron lost to these by products, as well as the generated flow of by-products is shown in Figure 91. 33% of iron in these by-products is recycled in ironmaking, corresponding to:

- 96% of iron from scale of scarfing, grinding, shot blasting and re-heating scale;
- 37.6% of scale from descaling
- 10% of mill scale sludge

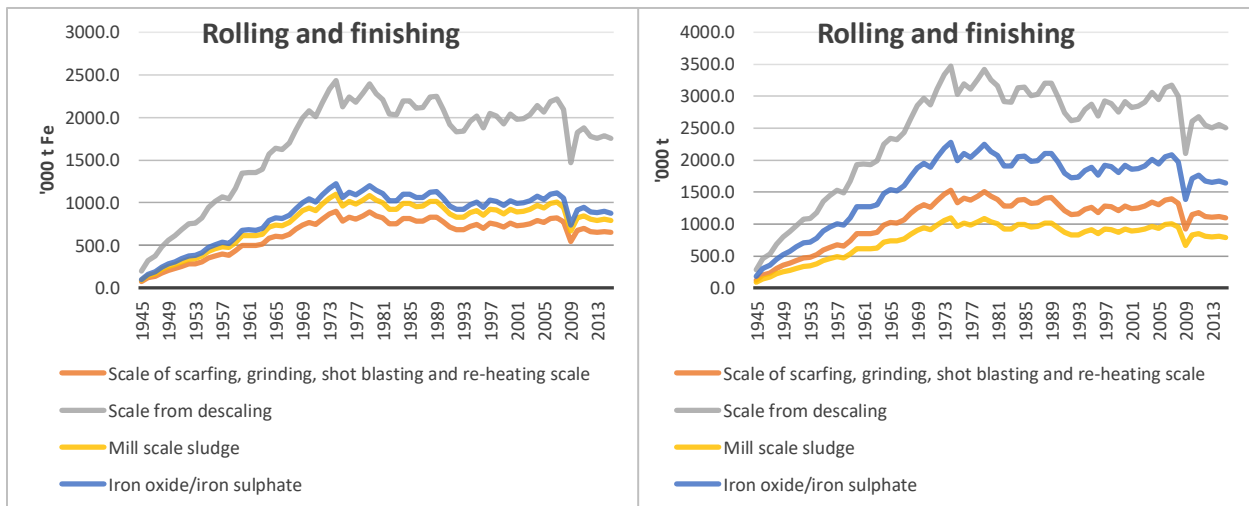

Figure 91 Iron contained in by-products of the process of rolling and finishing and the generation of these by-products

For the steel industry at the level of EU-27 (englobing processes of BOF, EAF, OHF, rolling and finishing), during the period of 1945-2015, 27-36% of the generated iron is recycled (in sintering, blast furnace or steel-making process), the rest is lost for metallurgical purposes (Figure 92, left). The decrease in the recycled quantity is related to the extinction of the OHF, which generated a large quantity of iron in mill scale, which was fully recycled in sintering. It shows that the improvement of the production yield decreases the recycled quantity.

The inclusion of home scrap, which is fully recycled, shows that 71%-91% of total generated iron is recycled. The decrease in the recycled quantity is related to the decrease of OHF production and to the improvement of home scrap yield.

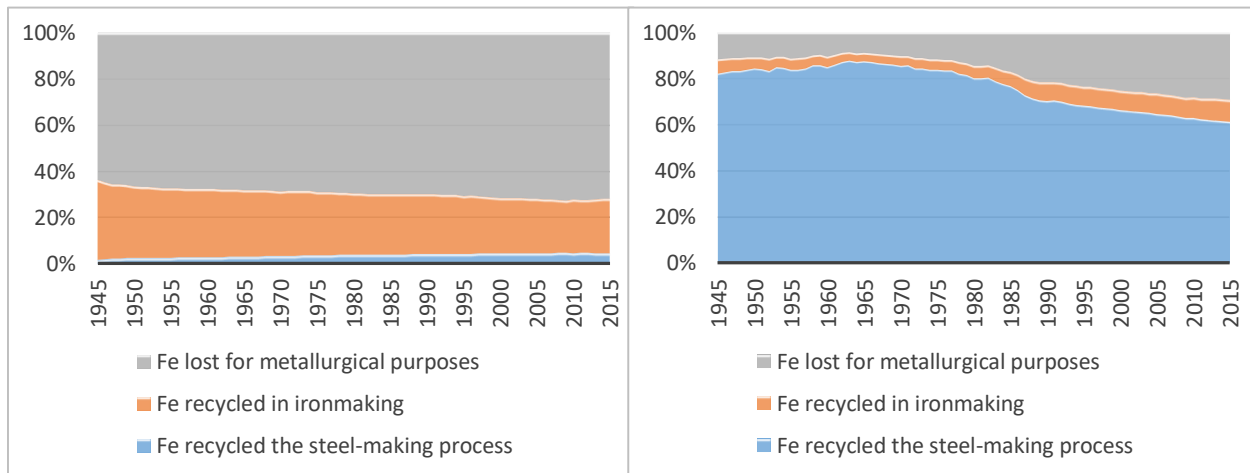

Figure 92 The share of iron from steelmaking processes recycled and lost with and without considering home scrap

The production of cast iron in **Foundries** generates iron-bearing slag, dust and home scrap. Figure 93 shows the generation of these by-products in terms of the flow of iron and in tonnage. 47% of iron is recycled, corresponding to 50% of recycled home scrap. Slag, dust and 50% of home scrap are not recycled.

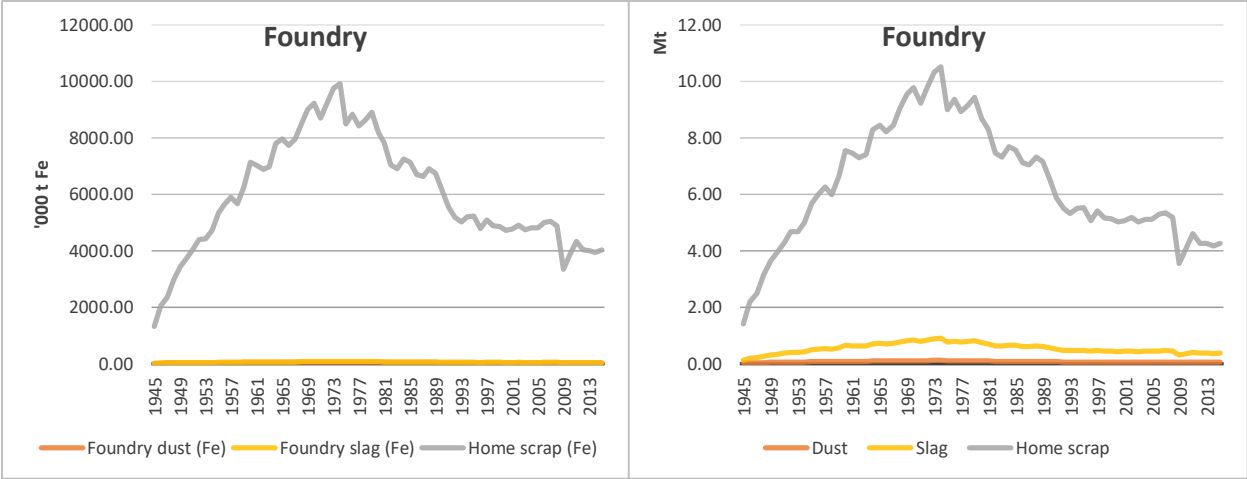

Figure 93 Iron contained in by-products of the foundry process

## 6.2 Investigation of uncertainty, related to the estimation of stock

### 6.2.1 Impact of the initial stock

This section investigates further the impact of the initial stock calculation and lifetime parameters on the results of in-use stock.

To calculate the initial stock, the present study assumes that during the period 1850-1944 lifetimes are half as long. To verify the impact of this assumption on the current level of the in-use stocks, the same lifetimes are applied for the period 1850-1944, as for 1945-2015. Figure 94 illustrates the in-use stock for EU-27 and several individual countries (Czech Republic, France, Spain, UK) between 1945 and 2015. The solid line shows the current result of the in-use stocks, while dotted line shows the in-use stock with the application of an identical lifetime to the whole period 1850-2015. It can be observed that the percentage difference can be up to 56% in first five years (depending on the country), but it decreases with time and represents less than 1% after 2010. The calculated initial stock, thus, does not have a significant impact on current results of the in-use stock. However, calculated flows of production during the period of initial stock, as well as assumptions concerning lifetimes impacts the evolution of the in-use stock.

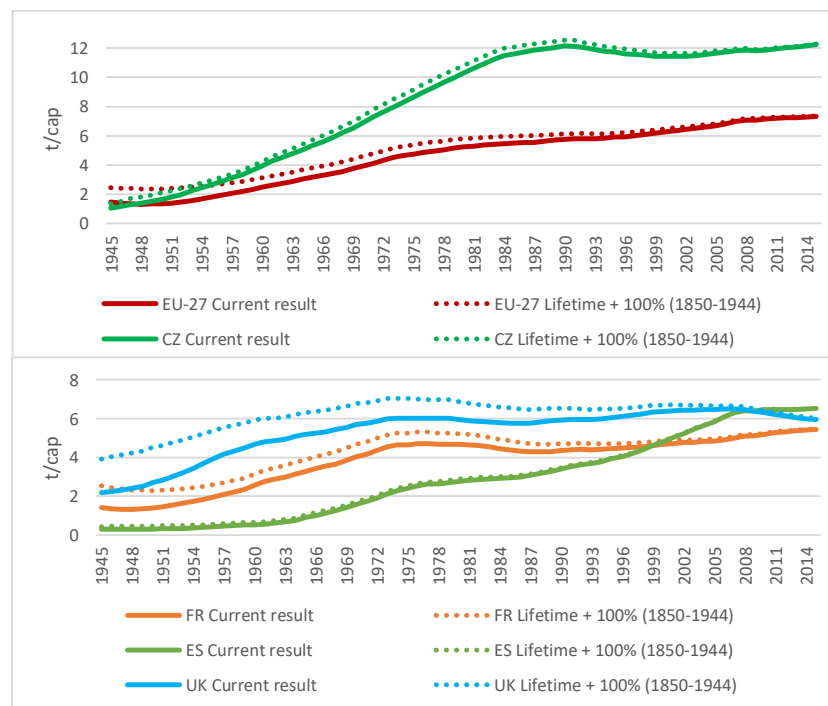

Figure 94 Impact of higher lifetimes during the period 1850-1944 on the current in-use stock



## 6.2.2 Impact of lifetime

Average lifetimes are used to define the flow of iron discarded from the in-use stock. Lifetimes influence both the size of the in-use stock and the results of recycling indicators:

- the in-use stock is calculated from the difference between stock input and output flows;
- the flow of iron discarded from the in-use stock is then directly used to calculate recycling indicators.

In addition, the impact of lifetime is investigated on the repartition of discarded iron by industrial sectors: as discussed in 5.1.3, the current results show that most discarded iron originated from the automotive sector. However, according to the information on acquisition of EoL scrap by the European division of ArcelorMittal and the Russo's model (Russo, 2014), the main source of EoL scrap is the construction sector. Therefore, this part also investigates the relation between lifetimes and sector-specific discard of iron.

To investigate the impact of lifetimes, values of the scale parameter of Weibull distribution, defined in 4.5, are varied here. The construction sector, consuming most iron and having the longest lifetime, is chosen as the sector defining the amplitude of variation tested here, based on extreme values found in literature for this sector: Russo – 45 years (Russo, 2014) and Pauliuk - highest lifetimes of 75-100 years (Pauliuk et al., 2013b). The initial lifetime chosen here is 60 years (scale parameter equals to 65.3), so that a variation of  $\pm 1/3$  allows these extremes in construction (43.5 as low value of scale parameter, 87.1 for high one) to be covered. This variation of  $\pm 1/3$  is applied to all other sectors.

Figure 95 illustrates total flows of iron discarded from the in-use stock, depending on the lifetime variation: the solid line corresponds to the current result, the dotted line to the result obtained from the application of  $1/3$  lower lifetimes, and the dashed line – of  $1/3$  higher lifetimes.

Figure 96 illustrates the impact of the lifetime variation on the in-use stock and EoL RR. For the in-use stock longer lifetimes lead to a higher stock, because less material is discarded. Table 57 details the impact of lifetime variation on stock in EU-27 in 2015. The table shows the distribution of in-use stock by industrial sector in EU-27 in 2015. The percentage difference is defined in relation to current results. Compared to other sectors, changes in lifetimes have less impact on construction and other transport due to their longer lifetimes. However, in all cases the impact of lifetime values on in-use stock is significant to important and ranges from at least 6 % (other transport, higher lifetime), up to 43 % (automotive, lowest lifetime).

For EoL RR a higher lifetime diminishes the discarded quantity and consequently increases results for this indicator, because the nominator of the formula decreases. Conversely, lower lifetimes increase the discarded quantity and decrease the EoL RR. The same trend was previously observed for the estimation of recycling efficiency of copper (Glöser et al., 2013).

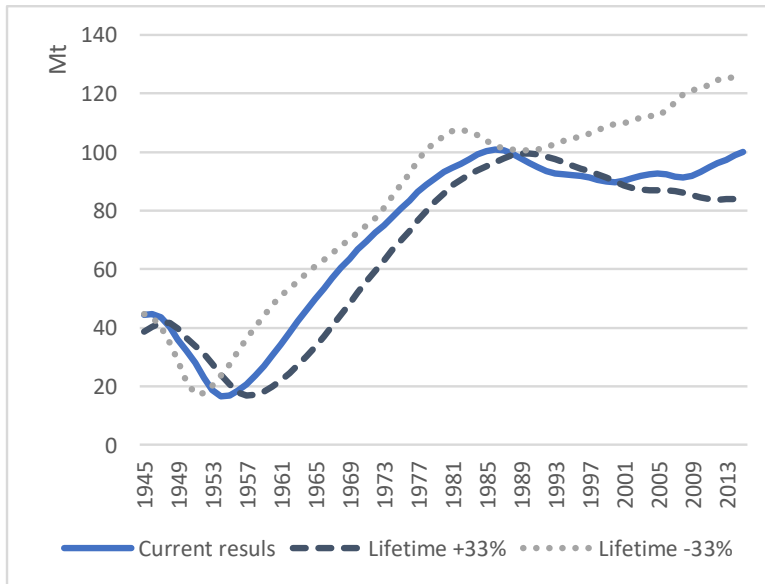

Figure 95 Impact of lifetime variation on the flow of iron discarded from in-use stock

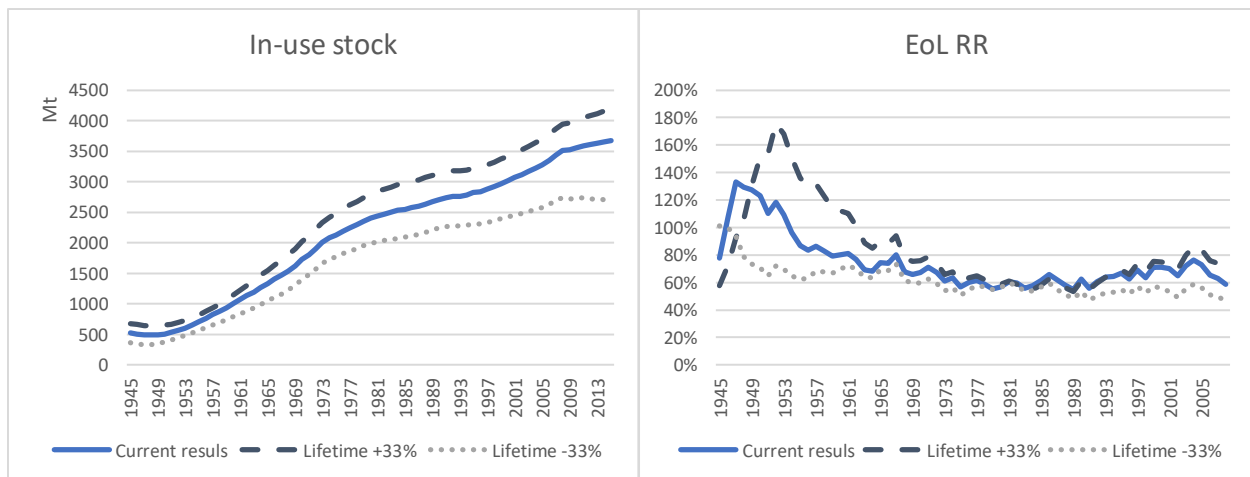

Figure 96 Impact of lifetime variation on in-use stock and EoL RR

Table 57 Impact of lifetime variation on the in-stock in 2015, detailed by industrial sector

	Current results, kt	Higher lifetime, kt	Percentage difference	Lower lifetime, kt	Percentage difference
Construction	2,572,496	2,759,415	7%	1,966,882	27%
Automotive	32,9148	435,055	28%	212,477	43%
Mechanical engineering	318,759	411,850	25%	213,305	40%
Domestic electronic equipment	52,666	70,250	29%	34,333	42%
Other transport	11,6661	123,543	6%	95,749	20%
Metal goods	26,1689	358,320	31%	170,771	42%

Other sectors	27,073	39,326	37%	17,867	41%
total	3,678,491	4197760	13%	2711384	30%

Lower values of lifetimes lead to a higher discard of EoL iron and higher obsolete stock (because the amount of collected and processed EoL scrap is not modified since it is calculated from scrap consumption and trade). Decreasing of lifetimes by 1/3 leads to the obsolete stock, comparable to the in-use stock (2535 Mt and 2711 Mt respectively), as shown in Figure 97.

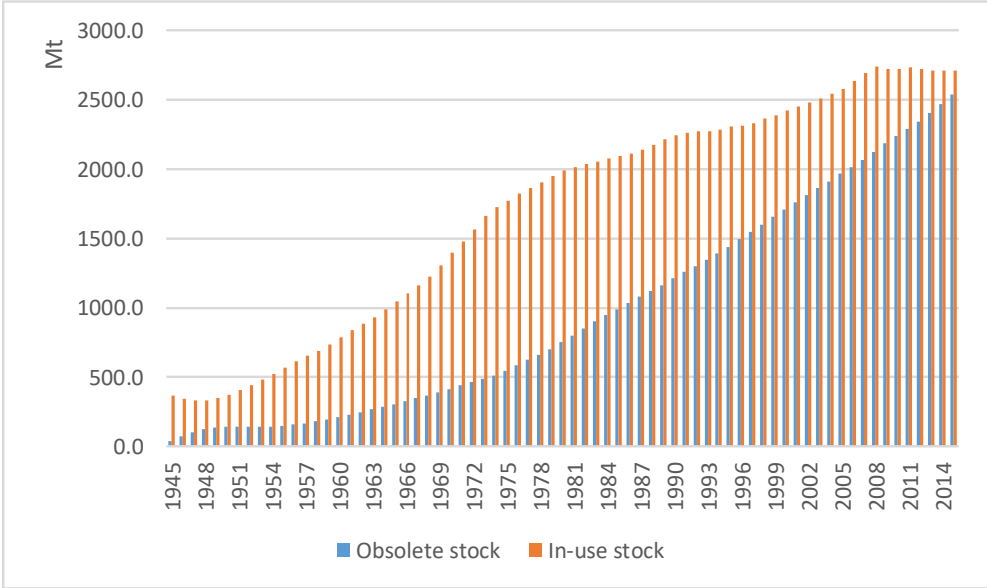

Figure 97 Impact of lower lifetimes on the obsolete and in-use stocks

Finally, sector-specific discard of iron from in-use is investigated and how it is impacted by the lifetimes. Russo reports that 42% of iron is discarded from construction (Russo, 2014). The type of lifetime distribution and values of lifetime applied in the present study and by Russo (Russo, 2014) differ: here a Weibull distribution (section 4.5) is used, while Russo applied a constant lifetime. Russo applied a lifetime of 45 years for construction, meaning that 100% of the flow entering in-use is discarded after this time period. The present study estimated this lifetime to be 60 years (with Weibull scale parameter equal to 65.3 and shape parameter to 5). The application of the Weibull distribution for a scale parameter of 45 (keeping shape parameter constant) results in 59% of the flow being discarded after 45 years. In order to obtain a value for EoL scrap generated by the construction sector equal to 42% of total generation (as in Russo’s model, following constant distribution), the lifetime of construction must be taken as equal to 12-13 years using a Weibull distribution. This very low value is highly improbable.

Table 58 gives a first overview of the impact of the lifetime on the sector-specific generation of EoL scrap for 2015:

- approach 1 shows the generation obtained if 42% of EoL scrap originates from construction (value to align current model and Russo's);
- approach 2 corresponds to the generation obtained with a lifetime for construction (current results) decreased by 1/3;
- approach 3 corresponds to the generation obtained by decreasing the current results for lifetimes of all industrial sectors by 1/3.

Table 58 Impact of the variation of the lifetime on the distribution of the discarded flow of EoL scrap by industrial sectors, 2015

	Results of Russo (2015)	Current results (2015)	Approach 1	Approach 2	Approach 3
Construction	42%	20%	42%	35%	34%
Automotive	22%	26%	19%	21%	22%
Mechanical engineering	19%	20%	14%	16%	18%
Metal goods	17%	22%	16%	18%	17%
Domestic appliances		6%	4%	5%	5%
Other transport		1%	1%	1%	1%
Other sectors		5%	4%	4%	3%

The comparison between the current results and approaches 1-3 shows that the variation of the lifetime for the construction has the biggest impact on the repartition of discarded iron by industrial sector. The decrease of the lifetime by 1/3 uniquely for the construction sector results in the generation of the discarded iron coming mainly from this sector, which is in line with Russo's model (Russo, 2014) and with the information on acquisition of EoL scrap by ArcelorMittal. This decrease of the lifetime for the construction sector influences on the quantity of iron discarded from the in-use stock: since the lifetime is shorter, the discarded quantity increases. For example, for EU-27 it increased from 100 Mt in 2015 to 126 Mt.

### 6.2.3 Iron losses during use

The present study does not consider the quantity of iron that is lost due to corrosion and wear and therefore does not reach recycling. Moreover, some materials are difficult to collect, like steel in building foundations. The inclusion of iron losses decreases the quantity of iron discarded from the use and, consequently increase the EoL RR. In order to investigate the impact of these phenomena on the result of EoL RR, two assumptions are investigated:

- 10% of iron discarded from construction is accumulated as obsolete stock, which corresponds to the amount used in foundation walls or underground pipes (Allwood and Cullen, 2011);
- 5% of iron loss due to corrosion and wear.

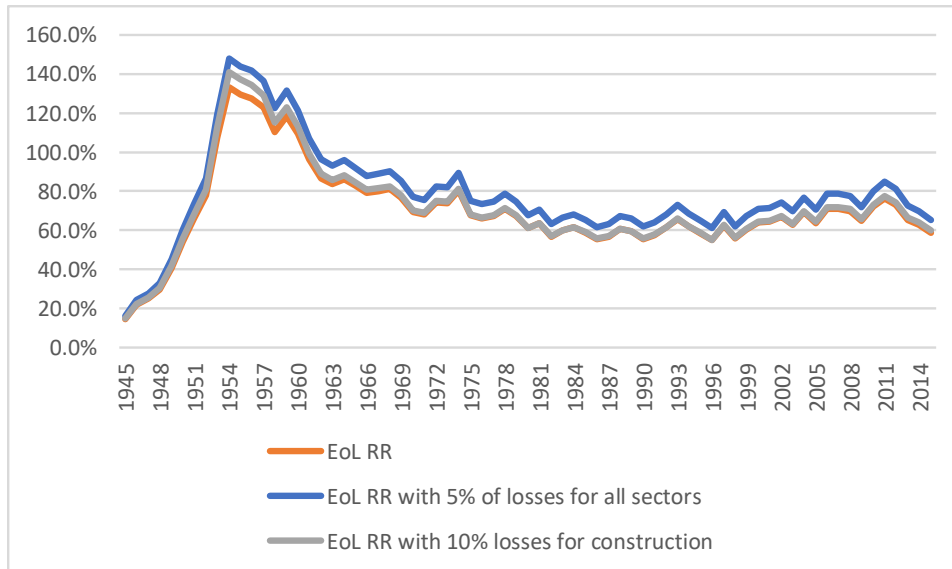

Figure 98 Impact of iron loss on EoL RR

The inclusion of iron losses has the following impact on EoL RR (Figure 98):

- The application of 10% losses for the construction sector results in a higher EoL RR, compared to the current results: the difference varies between 0.2 and 5.8% depending on the year (calculated as the percentage difference), with an average of 1.6%. For, example in 2015 the inclusion of losses increased the value of EoL RR from 59% to 60%.
- the consideration of 5% of iron losses to all sectors leads also to higher results of EoL RR - the difference with the current result is 10.1%. The difference does not vary through time because the same value is applied to all sectors and all years. The inclusion of losses increases the EoL RR from 59% to 65% in EU-27 in 2015.



## Conclusions and perspectives

This work has analysed **the flows and stocks of ferrous metals at the level of EU-27** in order to estimate their **recycling efficiency**. It defined available, relevant and reliable statistical and industrial data for modelling the magnitude of flows and stocks of ferrous metals, estimated the recycling indicators and analyses the impact of selected data sources and some of the model parameters on calculated results.

A dynamic MFA study has been used to estimate material flows of cast iron and steel, and their accumulation in society in the form of in-use stock and obsolete stock. Material flows and stocks are modelled for EU-27, as well as for each country member-state for the period 1945-2015.

To investigate the recycling efficiency, the present study adopts a new methodological approach - flows of ferrous metals are expressed in terms of their iron content. Previous studies either included all alloying elements of ferrous metals and considered cast iron and steel as conservative materials, or assumed that steel and steel scrap are composed of 100% of iron. But these hypotheses contain the following drawbacks:

- for mass flows of cast iron and steel the mass balance along the lifecycle cannot be respected because of the variation of iron content during iron- and steel-making processes: the iron content of pig iron is 92%-95%, while the iron content of steel can vary from 67% for stainless steel to 99% for carbon steel.
- With the assumption of 100% of iron in steel and scrap, the existence of other elements in steel alloys and the deterioration of the iron content at the end of life is not considered: iron content of alloyed and carbon steel varies between 96% and 99%, while the measured iron content of end of life scrap is lower - 90%-96% due to contamination.

The consideration of iron content of all flows makes it thus possible to respect the mass balance and to consider the loss of iron in EoL scrap.

Additionally, a focus is driven on the estimation of material flows that influences the estimation of the recycling efficiency. Inspired by the detailed modelling of flows, processes and their interaction related to the stages of production, processing and manufacturing in previous static studies, the present work has integrated the estimation of various iron-bearing by-products, and the distribution of steel products by industrial sector. Adding this level of details into the current dynamic approach allowed us to calculate process scrap generation depending on industrial sector and on type of steel product used (previous dynamic studies apply only a sector-specific generation of process scrap)

A collaboration with industrial partner made it possible to use industrial data, validate values for parameters and compare results of the model on the sources of available scrap with industrial knowledge.

The application of the DMFA methodology resulted in the calculation of the **iron stock in EU-27 equal to 7.3 t/cap in 2015**. In the same year, the in-use stock in the various European countries varies between 3 t/cap and 12 t/cap. Approximately half the considered countries have a constant, almost linear growth of stock (Austria, Belgium-Luxembourg, Denmark, Estonia, Finland, Germany, Italy, Latvia, Lithuania Malta, Portugal and Spain). In the other countries (Bulgaria, Czech Republic, Cyprus, France, Greece Ireland, Hungary, Netherlands, Poland, Romania, Slovakia Sweden and United Kingdom) stock also grows, but with local negative variations, which correlate with periods of economic crisis (oil crisis, collapse of the Soviet Union or 2008 crisis).

The estimation of the generation of **EoL scrap** according to its distribution by industrial sector was 100 Mt in 2015, which is predominantly discarded from the automotive sector (26%), metal goods (22%), construction and mechanical engineering (20% each). These results are aligned with other MFA studies, which confirms the coherence of the proposed model with previous results in the domain. Results on the generation of EoL scrap by industrial sectors are difficult to compare with the real world, since statistical information is not reported. The source of scrap is approximated with the process of its processing during recycling. According to the industrial information on scrap acquisition, scrap mainly originates from construction sector and mechanical pieces. This result does not align with DMFA results. The adaptation of DMFA results is not done, since the assumption used for the approximation is uncertain. Moreover, a wider database for scrap acquisition is necessary to collect in order to investigate data representativeness. However, this shows the importance of model result verification, especially if further used in decision-making.

As a result, the elaborated model made it possible to calculate the **recycling efficiency indicators** for iron. The present study estimates two well-established indicators – EoL RR and ORER, as well as two variants of the latest indicator. Regarding EoL RR, defined as the fraction of the recycled EoL scrap over the total discarded amount of EoL scrap, the results show that during the period of 1970-2015 the average EoL RR in EU-27 is equal to 65%, varying between 55% and 80%. The largest steel producing countries shows the following average values of EoL RR:

- Germany - 59%
- Italy - 72%
- Spain - 60%
- France - 65%
- United Kingdom – 66%
- Belgium-Luxembourg – 64%

At country level, the obtained results are not consistent over time: they contain negative values and values higher than 100%. Values higher than 100% might be accepted for a limited amount of time, assuming for example that iron is collected from the obsolete stock. However negative values do not have physical reality. This inconsistency can be explained by uncertainty in estimation of input and output flows of the



in-use stock (i.e. distribution of iron by industrial sectors and lifetimes, discussed below), but also the influence of imports and exports of pig iron and scrap on the calculation of this indicator: the influence of traded flows is higher in countries with little or no steel production, where the results are mostly driven by trade flows and not production flows and more subject to outlying values.

The **ORER** indicator reflects the consumption of process and EoL scrap in relation to their generation. This indicator reflects the ability of the country to consume scrap. Consequently, the countries showing the highest value of this indicator among European countries are those producing steel with EAF, i.e. Italy and Spain. This indicator is not representative for recycling efficiency, The complement of this indicator with scrap trade (ORER+t) data compares the quantity of collected and processed process scrap and EoL scrap, with the total amount of process scrap and discarded EoL iron from in-use stock. This makes it similar to EoL RR, but with inclusion of process scrap. The complement of ORER with trade and home scrap (ORER+t+h) compares the amount of three types of scrap collected and processed with their total generated (home and process) and discarded (EoL) quantity. The values of these two latest indicators are higher than EoL RR because all three types of scrap are included and two of them are fully collected.

Results on EoL RR, ORER+t and ORER+t+h follow the same trend over time (overall and local variation) : this is mainly due to the fact that they are all based on the collection and processing of different types of scrap, as a nominator, and on their total availability as denominator. The present study focuses on the recycling indicators used to characterize the material cycle, it considers solely recycling the materials, disregarding the type of goods, of which they are part. In this context of material-centric recycling EoL RR is a representative indicator for investigation of the recycling efficiency, as it focuses on the EoL scrap and includes the efficiency of its collection and processing. The application of EoL RR indicator for estimation of the efficiency of the recycling of products is influenced by scope definition (Horta Arduin et al., 2019).

The expression of material flows in terms of their iron content, and not as total tonnage did not have an important impact on calculated flow entering in use and, consequently on in-use stock. In fact, the percentage difference between the flow expressed in iron and in tonnage varies between 2% and 4% for the period of 1945-2015, depending on the quantity of cast iron. The impact on the EoL RR cannot be actually investigated due to the methodological choice to follow the flow of iron. The estimation of the iron content of steel performed in the present study represents, however, a simplified case, since country-specific production of different steel grades, and the distinction between traded grades was not applied.

Sources of uncertainties were also investigated. The obtained results on in-use stock, EoL scrap generation and recycling efficiency indicators are strongly dependent on:

- historical statistical data;
- assumptions used to model the distribution of iron by industrial sectors;

- their respective lifetimes.

The review of various sources of **statistical data** made it possible to identify a large amount of coherent data on production of pig iron and crude steel. As for subsequent flows of production of finished steel flows and their imports and exports, the following limitations are identified:

- Data on the production of finished steel products does not cover the investigated spatial and temporal period. Moreover, the reported data does not respect the mass balance with the consumption of crude steel at level of countries. Therefore, these data were not used to estimate the production of finished steel products, which were instead calculated so as to respect the mass balance. The average percentage difference for the period 1990-2015 between calculated and reported data is less than 10% for all compared countries (except Latvia and Romania, 27% and 12% respectively). At the level of EU-27, the average difference is 3%.
- Data on imports and exports of finished steel products are reported by UN Comtrade according to two classifications - SITC Rev.1 and HS, which provide different totals of traded amounts for all countries.

The application of different classifications to the calculation of the consumption of steel products does not have a big influence on the consumption of finished steel products at the European level (i.e. 3%-5% of average percentage difference, depending on classification and compared perimeter), because countries with high production mitigate the differences. Nevertheless, at the level of individual countries, depending on the classification chosen, the difference can be up to 60%, especially for countries strongly relying on imports. The present study used ASU data to estimate the flow of consumption of finished steel products. This decreases the quantity of datasets to manipulate, but it does not make it possible to distinguish between production and trade. To improve the estimation of the consumed finished steel products, an in-depth investigation for the selection of appropriate trade codes is required, since the conversion between the two classifications is not straightforward.

**The distribution of iron by industrial sector** has a considerable impact on the resulting in-use stock. This study applies country-specific distributions (referenced as Eurofer matrices) since 1995; before 1995 the same distribution is assumed as in 1995. An alternative source of steel distribution was identified (Usinor data), based on data collected in France, and covering the period 1953-1990. That data was applied to EU-27 to compare with current results based on Eurofer. Usinor's distribution is characterized by a higher share of iron used in sectors of construction and other transport. Since these sectors are characterized by long lifetimes, the resulting in-use stock is higher than the present results: the difference between the two sets of results of in-use stock varies between 24% and 44% for the period 1945-2015. The application of Usinor's distribution leads to the stock per capita equal to 9.3 t/cap in 2010, compared to 7.1 t/cap with Eurofer distribution.

**Lifetimes** constitute one of the biggest sources of uncertainties and the base of discussion with industrial experts: for example, the lifetimes of 60 years for construction and 13 years for cars, as applied from literature, are respectively considered as too long and too short by experts. The variation of lifetimes shows their impact on results of in-use stock and EoL RR: the decrease of the lifetime increases the availability of the EoL scrap within the studied period of time and, consequently, decreases the value of EoL RR. The modelling of the use process can be improved by the use of non-parametric approach for lifetime estimation (e.g. Daigo et al., 2007). However, product- and country-specific knowledge on lifetime is limited.

Regarding the **limits** of the present study, the following points can be mentioned:

- **Methodology:** in order to calculate process-specific inputs for the stage of production (i.e. pig iron and scrap fed to BOF, EAF and OHF), process-specific mass balances were elaborated and applied to statistical data on crude steel production. The comparison of the resulting inputs with statistical data at first showed an incoherence between the two data sets, making it impossible to calculate process-specific inputs to steelmaking processes. A first correction, by estimation of the total consumption of scrap from statistical data of crude steel production and pig iron/DRI consumption, has been made on the basis of the established mass balances. This correction did not make it possible to define process-specific inputs, but provided a total consumption of scrap showing a good fit with Worldsteel data, and respecting the mass balance. This result led to the calculation of the quantity of collected and processed scrap, and further to recycling indicators.
- The second-hand trade of final goods is not considered within the present study. These goods impact the results of material stocks. There are studies focusing on the estimation of the second-hand trade for the automotive sectors (e.g. (Fuse et al., 2009; Mehlhart et al., 2011)). The integration of these studies must be done to improve results.
- During the stage of waste management and recycling losses during dismantling are not considered due to a limited information availability. However, according to industrial experts this may not be an important source of iron loss, as they mostly constitute big parts that are not problematic to dismount and the separate of ferrous metals is rather easy due to their magnetic properties. The model could not distinguish between process and EoL scrap, as they are both collected different actors of recycling for treatment and trade. An assumption was necessary for the estimation of the iron content of the mix of these two scraps. This point shows one more time the lack of information concerning the EoL stage, which must be improved in the context of circular economy.
- Iron losses due to corrosion and wear are not investigated. In fact, these phenomena and their impacts on the overall flow of material scale at national and international level are very complex to model, due to their inherent dynamics which are largely context-dependent. Massive field statistics precisely focusing on corrosion and wear are needed to integrate them better into an

MFA model. However, the impact of iron losses on results of EoL RR is investigated as a source of uncertainty for two cases – if 10% of construction EoL flow is not collected and if 5% of all iron is lost.

- Unfortunately, precise values for the size of material stock or the availability of EoL scrap do not exist. For example, France's Agency for Environment and Energy Management reported the collected quantity of EoL steel, which includes process and EoL scrap. The collected scrap is estimated from purchases of steel mills and foundries and from external trade of scrap (ADEME, 2012). However, this type of data is still rare, and significantly differs from the total quantity of discarded materials. In this context, the knowledge of experts constitutes a precious basis for numerous assumptions. At the same time, the industrial partners have a certain vision of the availability of EoL scrap, based on their experience, which gives an opportunity to compare their viewpoint with obtained results. Then, besides this lack of information, partially solved by the present work at the European level, such a collaboration between industrial and academics is necessary to address a worldwide problematic based on estimations, several decades old, of international material flows and their usage in the anthroposphere.

As for the investigated indicators for recycling efficiency, EoL RR is a sound and well-established indicator for the estimation of the efficiency of the EoL scrap recycling. The availability of the EoL scrap is not accounted in statistics, so MFA is a viable method for the estimation of the discarded quantities. The estimation of the EoL RR is associated with the uncertainties related to the MFA model (e.g. distribution of iron by industrial sectors, lifetime distribution, etc), to trade data of pig iron and scrap. The present study could not make a distinction between process and EoL scrap share in traded and consumed flows. The estimation of the iron content of this flows is another source of uncertainty.

The inclusion of scrap from other sources in the formulae of EoL RR, like in indicators  $ORER+t$  and  $ORER+t+h$ , shows how much scrap is recycled compared to the discarded. However, the efficiency of the collection of home and process scrap is close to 100%. Thus, the inclusion of home and process scrap in the recycling indicator doesn't provide additional information on the recycling efficiency and increases the value of the indicator. It also do not fully reflect the closure of material cycle of iron, since some iron is recycled outside of the studied system. To investigate the closure of iron cycle, it is sound to expand the system definition in order to include processes of iron ore preparation and iron-making, as these processes recycle iron from steel-making by-products.

Finally, during this project, a workshop was organized in Metz in order to discuss the methodology applied in the study. The workshop involved experts from 10 international organisations in France and Belgium (ArcelorMittal, Worldsteel, Eurofer, ESTEP, European Aluminium Association, Constellium, VITO, IF Steelman, UTT, University of Lorraine) . The first results were presented in order to validate, complete, modify, collect opinions and expert feeling. The main point highlighted by the stakeholders concerned

limits of statistical data, which could be a basis for collaboration between different steel associations in order to harmonize classifications, to communicate on data gathering process and associated errors, and to make gathered data and models publicly available. The creation of such a database for MFA studies, similar to life cycle inventory (LCI) data for its use in LCA, would significantly contribute to data availability and data collection issues.

As for further improvement of the elaborated model, a focus on the distribution of finished steel products entering use might be interesting. Currently, this information is only used to estimate the generation of the process scrap, depending on type of steel product and industrial sector. The potential of this integration of finished steel products is not fully exploited. For example, different types of steel products can be associated with a precise “functionality” - e.g. in car-making steel sheets are mostly used for car bodies, cast iron for engines etc. On the base of this second-level segmentation, component-specific lifetimes could be elaborated, potentially improving the overall estimation of lifetimes depending on the industrial sector and the generation of the EoL scrap.

The results of the in-use stock could also be compared with results of a bottom-up stock estimation, still to be made. This information can be used, for example, for verification of iron used in industrial sectors.

## References

- ADEME, 2012. Bilan du recyclage 2001-2010. Volume 2: Filières matériaux et filières REP (No. n° 1002C0011). ADEME.
- Allwood, J., Cullen, J., 2011. Sustainable Materials With Both Eyes Open. UIT Cambridge, Cambridge, England.
- Allwood, J.M., Ashby, M.F., Gutowski, T.G., Worrell, E., 2011. Material efficiency: A white paper. *Resour. Conserv. Recycl.* 55, 362–381. <https://doi.org/10.1016/j.resconrec.2010.11.002>
- Ashby, M.F., Jones, D.R.H., 2013. Chapter 1 - Metals, in: *Engineering Materials 2 (Fourth Edition)*, International Series on Materials Science and Technology. Butterworth-Heinemann, Boston, pp. 3–14. <https://doi.org/10.1016/B978-0-08-096668-7.00001-2>
- Astier, J., 2005. Réduction directe. *Tech. Ing. Métaux Ferr. Élabor. Métal Prim.* base documentaire : TIB366DUO.
- Atherton, J., 2007. Declaration by the Metals Industry on Recycling Principles. *Int. J. Life Cycle Assess.* 12, 59–60. <https://doi.org/10.1065/lca2006.11.283>
- Atkinson, M., Kolarik, R., 2001. Steel Industry Technology Roadmap. AISI's Strategic Planning for Research and Development committee.
- Atlas Steels, 2013. The Atlas Steels Technical Handbook of Stainless Steels (No. rev. August 2013). Atlas Steels Technical Department.
- Babich, A., Senk, D., Gudenau, H.W., Mavrommatis, K., 2008. Ironmaking. Insitute für Eisenhüttenkunde der RWTH Aachen, Aachen.
- Baccini, P., Brunner, P.H., 1991. *Metabolism of the Anthroposphere*. Springer, Berlin; New York.
- Bayer, R.G., 2004. *Mechanical Wear Fundamentals and Testing, Revised and Expanded*. CRC Press.
- Behrens, A., Giljum, S., Kovanda, J., Niza, S., 2007. The material basis of the global economy. *Ecol. Econ., Special Section - Ecosystem Services and Agriculture* 64, 444–453. <https://doi.org/10.1016/j.ecolecon.2007.02.034>
- Bell, S., Davis, B., Javaid, A., Essadiqi, E., 2006. Final Report on Effect of Impurities in Steel. <https://doi.org/10.13140/RG.2.2.33946.85440>
- BGS, 2016. World mineral statistics archive. MineralsUK [WWW Document]. *Br. Geol. Surv. Nat. Environ. Res. Counc.* URL <https://www.bgs.ac.uk/mineralsuk/statistics/worldArchive.html> (accessed 4.18.17).
- BIR, 2017. World steel recycling in figures 2012-2016. Steel scrap - a raw material for steelmaking., BIR global facts & figures. Ferrous metals. Bureau of International Recycling. Ferrous Division.
- Birat, J.-P., 2017. First attempts at structuring MFA in the 1990s at USINOR (ARCELORMITTAL) in the “Cycle of Iron” project.
- Birat, J.-P., 2016. Principaux produits sidérurgiques. *Tech. Ing. Sidérurgie Métaux Ferr.*, réédition actualisée de l'article M7020v2 paru en 2006 et rédigé par Marc GRUMBACH base documentaire : TIB368DUO.
- Birat, J.-P., 2012. Materials, beyond Life Cycle Thinking. *Rev. Métallurgie – Int. J. Metall.* 109, 273–291. <https://doi.org/10.1051/metal/2012026>
- Birat, J.-P., Chiappini, M., Ryman, C., Riesbeck, J., 2013. Cooperation and competition among structural materials. *Rev. Métallurgie* 110, 95–129. <https://doi.org/10.1051/metal/2013057>
- Birat, J.-P., Daigo, I., Matsuno, Y., 2014. Chapter 4.3 - Methods to Evaluate Environmental Aspects of Materials A2 - Seetharaman, Seshadri, in: *Treatise on Process Metallurgy*. Elsevier, Boston, pp. 1459–1505.
- Birat, Zaoui, 2002. “Le Cycle du Fer” ou le recyclage durable de l'acier. *Rev. Métallurgie CIT*, 795–807.

- Björkman, B., Samuelsson, C., 2014. Chapter 6 - Recycling of Steel, in: Handbook of Recycling. Elsevier, Boston, pp. 65–83. <https://doi.org/10.1016/B978-0-12-396459-5.00006-4>
- Bockstaller, C., Girardin, P., 2003. How to validate environmental indicators. *Agric. Syst.* 76, 639–653. [https://doi.org/10.1016/S0308-521X\(02\)00053-7](https://doi.org/10.1016/S0308-521X(02)00053-7)
- Bringezu, S., Moriguchi, Y., 2002. Material flow analysis, in: A Handbook of Industrial Ecology. Edward Elgar Publishing Limited.
- Brunner, P.H., Rechberger, H., 2016. Handbook of Material Flow Analysis: For Environmental, Resource, and Waste Engineers, Second Edition, 2 edition. ed. CRC Press, Boca Raton.
- Brunner, P.H., Rechberger, H., 2004. Practical Handbook of Material Flow Analysis. CRC Press LLC.
- Buchner, H., Laner, D., Rechberger, H., Fellner, J., 2014. In-depth analysis of aluminum flows in Austria as a basis to increase resource efficiency. *Resour. Conserv. Recycl.* 93, 112–123. <https://doi.org/10.1016/j.resconrec.2014.09.016>
- CAEF, 2012. The European Foundry Industry.
- Camp, J.M. (James M., Francis, C.B. (Charles B., 1920. The making, shaping and treating of steel. Pittsburgh, Pa., Carnegie Steel Company.
- Chen, W.-Q., 2013. Recycling Rates of Aluminum in the United States. *J. Ind. Ecol.* 17, 926–938. <https://doi.org/10.1111/jiec.12070>
- Cornell, R.M., Schwertmann, U., 2003. Rocks and Ores, in: The Iron Oxides. Wiley-VCH Verlag GmbH & Co. KGaA, pp. 409–431. <https://doi.org/10.1002/3527602097.ch15>
- Costanza, R., Cumberland, J.H., Daly, H., Goodland, R., Norgaard, R.B., 1997. An Introduction to Ecological Economics, 1 edition. ed. CRC Press.
- CTI, n.d. The foundry process [WWW Document]. *Cast. Technol. Int.* URL <http://www.castingstechnology.com/public/documents/000000000000129.pdf> (accessed 9.14.14).
- Cullen, J.M., Allwood, J.M., Bambach, M.D., 2012. Mapping the Global Flow of Steel: From Steelmaking to End-Use Goods. *Environ. Sci. Technol.* 46, 13048–13055. <https://doi.org/10.1021/es302433p>
- Dahlström, K., Ekins, P., He, J., Davis, J., Clift, R., 2004. Iron, Steel and Aluminium in the UK: Material Flows and their Economic Dimensions (Final Project Report No. ISSN: 1464-8083), CES Working Paper 03/04. Centre for Environmental Strategy, University of Surrey, Surrey.
- Daigo, I., Iwata, K., Ohkata, I., Goto, Y., 2015. Macroscopic evidence for the hibernating behavior of materials stock. *Environ. Sci. Technol.* <https://doi.org/10.1021/acs.est.5b01164>
- Daigo, I., Matsuno, Y., Adachi, Y., 2010. Substance flow analysis of chromium and nickel in the material flow of stainless steel in Japan. *Resour. Conserv. Recycl.* 54, 851–863. <https://doi.org/10.1016/j.resconrec.2010.01.004>
- Daigo, Igarashi, Y., Matsuno, Y., Adachi, Y., 2007. Accounting for Steel Stock in Japan. *ISIJ Int.* 47, 1065–1069. <https://doi.org/10.2355/isijinternational.47.1065>
- Das, B., Prakash, S., Reddy, P.S.R., Misra, V.N., 2007. An overview of utilization of slag and sludge from steel industries. *Resour. Conserv. Recycl.* 50, 40–57. <https://doi.org/10.1016/j.resconrec.2006.05.008>
- Davis, J., Geyer, R., Ley, J., He, J., Clift, R., Kwan, A., Sansom, M., Jackson, T., 2007. Time-dependent material flow analysis of iron and steel in the UK: Part 2. Scrap generation and recycling. *Resour. Conserv. Recycl.* 51, 118–140. <https://doi.org/10.1016/j.resconrec.2006.08.007>
- de Neufville, J.I., 1978. Validating Policy Indicators. *Policy Sci.* 10, 171–188.
- Dewulf, J., Van Langenhove, H., Muys, B., Bruers, S., Bakshi, B.R., Grubb, G.F., Paulus, D.M., Sciubba, E., 2008. Exergy: Its Potential and Limitations in Environmental Science and Technology. *Environ. Sci. Technol.* 42, 2221–2232. <https://doi.org/10.1021/es071719a>

- Di Zio, M., Fursova, N., Gelsema, T., Gießing, S., Guarnera, U., Petrauskienė, J., Quensel-von Kalben, L., Scanu, M., ten Bosch, K.O., van der Loo, M., Walsdorfer, K., 2016. Methodology for data validation 1.0. Essnet Validat Foundation.
- Donaldson, E.G., 1971. Castings Production in the UK, in: Castings, Production Engineering Series. Palgrave, London, pp. 181–196. [https://doi.org/10.1007/978-1-349-01179-7\\_19](https://doi.org/10.1007/978-1-349-01179-7_19)
- EC, 2015. Communication from the Commission. Closing the loop - an EU action plan for the Circular Economy.
- EC, 2010. Communication from the Commission. Europe 2020: A strategy for smart, sustainable and inclusive growth.
- EC, 2005. Integrated Pollution Prevention and Control. Reference Document on Best Available Techniques in the Smitheries and Foundries Industry.
- EC, 2001. Integrated Pollution Prevention and Control (IPPC). Reference Document on Best Available Technologies in the Ferrous Metals Processing Industry. European Commission.
- EFR, 2007. EU-27 Steel Scrap Specification.
- Elshkaki, A., Van Der Voet, E., Van Holderbeke, M., Timmermans, V., Claeys, P., Geerken, T., 2004. Development of a dynamic model for Substance Flow Analysis: Part 2 - Integration of stock and flow model Report (No. 2004/IMS/R/293). Flemish Institute for Technological Research (VITO), Mol, Belgium.
- EP, 2008. Directive 2008/98/EC of the European Parliament and of the Council of 19 November 2008 on waste and repealing certain Directives., Directive 2008/98/EC of the European Parliament and of the Council of 19 November 2008 on waste and repealing certain Directives.
- Eurometaux, 2012. Recycling Rates for Metals.
- Euroslag website, 2017. Euroslag. Products: statistics [WWW Document]. URL <http://www.euroslag.com/products/statistics/2002/> (accessed 12.15.17).
- Eurostat, 2008. NACE Rev. 2. Statistical classification of economic activities in the European Community. Office for Official Publications of the European Communities, Luxembourg.
- Fick, G., Russo, P., Neel, O., Collignon, F., 2017. Shredding End-of-Life Vehicles to evaluate material recycling rate.
- Ford, A., 2009. Modeling the Environment, Second Edition edition. ed. Island Press, Washington, DC.
- Forrester, J.W., 1992. Policies, decisions and information sources for modeling. *Eur. J. Oper. Res.* 59, 42–63. [https://doi.org/10.1016/0377-2217\(92\)90006-U](https://doi.org/10.1016/0377-2217(92)90006-U)
- Forrester, J.W., 1980. Information Sources for Modeling the National Economy. *J. Am. Stat. Assoc.* 75, 555–566. <https://doi.org/10.2307/2287644>
- Frêne, J., Zaïdi, H., 2011. Introduction à la tribologie. *Tech. Ing. Frott. Usure base documentaire : TIB464DUO*.
- Fuse, M., Kosaka, H., Kashima, S., 2009. Estimation of world trade for used automobiles. *J. Mater. Cycles Waste Manag.* 11, 348. <https://doi.org/10.1007/s10163-009-0263-3>
- Gallopin, G.C., 1997. Indicators and their use : information for decision-making, in: Moldan, B., Bilharz, S. (Eds.), *Sustainability Indicators. A Report on the Project on Indicators of Sustainable Development*. Wiley, Chichester, pp. 13–27.
- Gauffin, A., Ekerot, S., Tilliander, A., Jönsson, P., 2013. KTH Steel Scrap Model – Iron and Steel Flow in the Swedish Society 1889–2010. *J. Manuf. Sci. Prod.* 13, 47–54. <https://doi.org/10.1515/jmsp-2012-0033>
- Gaustad, G., Olivetti, E., Kirchain, R., 2011. Toward Sustainable Material Usage: Evaluating the Importance of Market Motivated Agency in Modeling Material Flows. *Environ. Sci. Technol.* 45, 4110–4117. <https://doi.org/10.1021/es103508u>
- Gerst, M.D., Graedel, T.E., 2008. In-Use Stocks of Metals: Status and Implications. *Environ. Sci. Technol.* 42, 7038–7045. <https://doi.org/10.1021/es800420p>



- Geyer, R., Davis, J., Ley, J., He, J., Clift, R., Kwan, A., Sansom, M., Jackson, T., 2007. Time-dependent material flow analysis of iron and steel in the UK: Part 1: Production and consumption trends 1970–2000. *Resour. Conserv. Recycl.* 51, 101–117. <https://doi.org/10.1016/j.resconrec.2006.08.006>
- Giurco, D., Evans, G., Cooper, C., Mason, L., Franks, D., 2009. Mineral futures discussion paper: sustainability issues, challenges and opportunities. Prepared for CSIRO Minerals Down Under Flagship, by the Institute for Sustainable Futures (University of Technology, Sydney) and the Centre for Social Responsibility in Mining, Sustainable Minerals Institute (University of Queensland).
- Glöser, S., Soulier, M., Tercero Espinoza, L.A., 2013. Dynamic Analysis of Global Copper Flows. Global Stocks, Postconsumer Material Flows, Recycling Indicators, and Uncertainty Evaluation. *Environ. Sci. Technol.* 47, 6564–6572. <https://doi.org/10.1021/es400069b>
- Gordon, R.B., Bertram, M., Graedel, T.E., 2006. Metal stocks and sustainability. *Proc. Natl. Acad. Sci.* 103, 1209–1214. <https://doi.org/10.1073/pnas.0509498103>
- Graedel, T.E., Allwood, J., Birat, J.-P., Reck, B.K., Sibley, S.F., Sonnemann, G., Buchert, M., Hagelüken, C., 2011. Recycling rates of metals. A status report. United Nation Environment Programme.
- Graedel, T.E., Lifset, R.J., 2016. Industrial Ecology's First Decade, in: *Taking Stock of Industrial Ecology*. Springer Chem, pp. 3–20. [https://doi.org/10.1007/978-3-319-20571-7\\_1](https://doi.org/10.1007/978-3-319-20571-7_1)
- Graedel, T.E., Reck, B.K., 2014. Chapter 3 - Recycling in Context, in: *Handbook of Recycling*. Elsevier, Boston, pp. 17–26.
- Grobler, R.C. a. \*\*, Minnitt, F.\* &, 1999. The increasing role of direct reduced iron in global steelmaking. *J. South. Afr. Inst. Min. Metall.* 99, 111–116.
- Gros, B., 2007. *Recyclage des biens d'équipement contenant du fer Aspects généraux*. Tech. Ing. Sidérurgie Métaux Ferr. base documentaire : TIB368DUO.
- Halyvourgiki, 2016. Halyvourgiki. Corporate profile [WWW Document]. Halyvourgiki. URL [http://www.halyvourgiki.com/inside\\_page.aspx?MAIN\\_SUBCATEGORIES=18&Id=2](http://www.halyvourgiki.com/inside_page.aspx?MAIN_SUBCATEGORIES=18&Id=2) (accessed 4.21.17).
- Hatayama, H., Daigo, I., Matsuno, Y., Adachi, Y., 2010. Outlook of the World Steel Cycle Based on the Stock and Flow Dynamics. *Environ. Sci. Technol.* 44, 6457–6463. <https://doi.org/10.1021/es100044n>
- Hatayama, H., Daigo, I., Tahara, K., 2014. Tracking effective measures for closed-loop recycling of automobile steel in China. *Resour. Conserv. Recycl.* 87, 65–71. <https://doi.org/10.1016/j.resconrec.2014.03.006>
- Hattori, R., Horie, S., Hsu, F.-C., Elvidge, C.D., Matsuno, Y., 2013. Estimation of in-use steel stock for civil engineering and building using nighttime light images. *Resour. Conserv. Recycl.* <https://doi.org/10.1016/j.resconrec.2013.11.007>
- Horta Arduin, R., Grimaud, G., Martínez Leal, J., Pompidou, S., Charbuillet, C., Laratte, B., Alix, T., Perry, N., 2019. Influence of scope definition in recycling rate calculation for European e-waste extended producer responsibility. *Waste Manag.* 84, 256–268. <https://doi.org/10.1016/j.wasman.2018.12.002>
- Hsu, F.-C., Daigo, I., Matsuno, Y., Adachi, Y., 2010. Estimation of Steel Stock in Building and Civil Construction by Satellite Images. *Tetsu--Hagane* 96, 517–523. <https://doi.org/10.2355/tetsutohagane.96.517>
- Hu, M., Pauliuk, S., Wang, T., Huppel, G., van der Voet, E., Müller, D.B., 2010. Iron and steel in Chinese residential buildings: A dynamic analysis. *Resour. Conserv. Recycl.* 54, 591–600. <https://doi.org/10.1016/j.resconrec.2009.10.016>
- Huppel, G., Ishikawa, M., 2005. Eco-efficiency and Its Terminology. *J. Ind. Ecol.* 9, 43–46. <https://doi.org/10.1162/108819805775247891>

- Igarashi, Y., Daigo, I., Matsuno, Y., Adachi, Y., 2007. Dynamic material flow analysis for stainless steels in Japan - reductions potential of CO2 emissions by promoting closed loop recycling of stainless steels. *ISIJ Int.* 47, 758–763. <https://doi.org/10.2355/isijinternational.47.758>
- IISI, 1978. A handbook of world steel statistics. International Iron and Steel Institute, Brussels.
- Kapur, A., Graedel, T.E., 2006. Copper Mines Above and Below the Ground. *Environ. Sci. Technol.* 40, 3135–3141. <https://doi.org/10.1021/es0626887>
- Kennedy, M.C., O'Hagan, A., 2001. Bayesian calibration of computer models. *J. R. Stat. Soc. Ser. B Stat. Methodol.* 63, 425–464. <https://doi.org/10.1111/1467-9868.00294>
- King, 2001. Iron and steel, in: *The International Scrap and Recycling Industry Handbook*. Woodhead Publishing, Cambridge.
- Kleijnen, J.P.C., 1994. Sensitivity Analysis Versus Uncertainty Analysis: When to Use What?, in: Grasman, J., Straten, G. van (Eds.), *Predictability and Nonlinear Modelling in Natural Sciences and Economics*. Springer Netherlands, pp. 322–333. [https://doi.org/10.1007/978-94-011-0962-8\\_27](https://doi.org/10.1007/978-94-011-0962-8_27)
- Krausmann, F., Gingrich, S., Eisenmenger, N., Erb, K.-H., Haberl, H., Fischer-Kowalski, M., 2009. Growth in global materials use, GDP and population during the 20th century. *Ecol. Econ.* 68, 2696–2705. <https://doi.org/10.1016/j.ecolecon.2009.05.007>
- Kumar, G.S., Basu, D., Hung, Y.-T., Wang, L.K., 2009. Waste Treatment in the Iron and Steel Manufacturing Industry, in: Wang, L.K., Shammas, N.K., Hung, Y.-T. (Eds.), *Waste Treatment in the Metal Manufacturing, Forming, Coating, and Finishing Industries*. CRC Press, Taylor & Francis Group, Boca Raton.
- Law, A.M., Kelton, W.D., 2000. *Simulation Modelling and Analysis*, 3rd edition. ed. McGraw Hill Higher Education, Boston.
- Lawless, J.F., 2002. Basic Concepts and Models, in: *Statistical Models and Methods for Lifetime Data*. John Wiley & Sons, Inc., pp. 1–47. <https://doi.org/10.1002/9781118033005.ch1>
- Leygraf, C., Wallinder, I.O., Tidblad, J., Graedel, T., 2016. Appendix F: The Atmospheric Corrosion Chemistry of Iron and Low Alloy Steels, in: *Atmospheric Corrosion*. John Wiley & Sons, Inc., pp. 302–315. <https://doi.org/10.1002/9781118762134.app6>
- Liu, G., Bangs, C.E., Müller, D.B., 2013. Stock dynamics and emission pathways of the global aluminium cycle. *Nat. Clim. Change* 3, 338–342. <https://doi.org/10.1038/nclimate1698>
- Liu, G., Bangs, C.E., Müller, D.B., 2011. Unearthing Potentials for Decarbonizing the U.S. Aluminum Cycle. *Environ. Sci. Technol.* 45, 9515–9522. <https://doi.org/10.1021/es202211w>
- Liu, G., Müller, D.B., 2013. Centennial Evolution of Aluminum In-Use Stocks on Our Aluminized Planet. *Environ. Sci. Technol.* 47, 4882–4888. <https://doi.org/10.1021/es305108p>
- Meadows, D.H., Meadows, D.L., Randers, J., Behrens, W.W.I., 1972. *The Limits to Growth: A Report for the Club of Rome's Project on the Predicament of Mankind*, 1st edition. ed. Universe Books, New York.
- Mehlhart, G., Merz, C., Akkermans, L., Jordal-Jorgensen, J., 2011. European second-hand car market analysis (Final Report No. Contract Number No. 07.0307/2009/549021/SER/C5). Öko-Institut e.V., Transport & Mobility Leuven, COWI A/S for European Commission - DG Environment.
- Melo, M.T., 1999. Statistical analysis of metal scrap generation: the case of aluminium in Germany. *Resour. Conserv. Recycl.* 26, 91–113. [https://doi.org/10.1016/S0921-3449\(98\)00077-9](https://doi.org/10.1016/S0921-3449(98)00077-9)
- Michaelis, P., Jackson, T., 2000a. Material and energy flow through the UK iron and steel sector. Part 1: 1954–1994. *Resour. Conserv. Recycl.* 29, 131–156. [https://doi.org/10.1016/S0921-3449\(00\)00048-3](https://doi.org/10.1016/S0921-3449(00)00048-3)
- Michaelis, P., Jackson, T., 2000b. Material and energy flow through the UK iron and steel sector: Part 2: 1994–2019. *Resour. Conserv. Recycl.* 29, 209–230. [https://doi.org/10.1016/S0921-3449\(00\)00041-0](https://doi.org/10.1016/S0921-3449(00)00041-0)
- Midrex, 2016. 2016 World Direct Reduction statistics. Midrex Technologies Inc.

- Midrex, 2014. 2014 World Direct Reduction statistics. Midrex Technologies Inc.
- Midrex, 2013. 2013 World Direct Reduction statistics. Midrex Technologies Inc.
- Millennium Ecosystem Assessment, 2005. Ecosystems and Human Well-Being: Current State and Trends: Findings of the Condition and Trends Working Group. Island Press.
- Mitchell, B.R., 1992. International Historical Statistics Europe 1750–1988, 3rd ed. Palgrave Macmillan UK, London.
- Moine, A., 2006. Le territoire comme un système complexe : un concept opératoire pour l'aménagement et la géographie. *Espace Geogr.* 35, 115–232.
- Moll, S., Acosta, J., Schütz, H., 2005. Iron and steel - a materials system analysis. Pilot study examining the material flows related to the production and consumption of steel in the European Union (ETC/RWM working paper 2005/3). European Topic Centre on Resource and Waste Management.
- Moreau, A., 2005. L'acier en mouvement : Transformation des marchés mondiaux 1874-2004. Presses de l'École des Mines, Paris.
- Müller, D.B., 2006. Stock dynamics for forecasting material flows—Case study for housing in The Netherlands. *Ecol. Econ.* 59, 142–156. <https://doi.org/10.1016/j.ecolecon.2005.09.025>
- Müller, D.B., Cao, J., Kongar, E., Altonji, M., Weiner, P.-H., Graedel, T.E., 2007. Service Lifetimes of Mineral End Uses (Final Report). U.S. Geological Survey, Minerals Resources External Research Program, New Haven: Yale University.
- Müller, D.B., Wang, T., Duval, B., 2011. Patterns of Iron Use in Societal Evolution. *Environ. Sci. Technol.* 45, 182–188. <https://doi.org/10.1021/es102273t>
- Müller, D.B., Wang, T., Duval, B., Graedel, T.E., 2006. Exploring the engine of anthropogenic iron cycles. *Proc. Natl. Acad. Sci.* 103, 16111–16116. <https://doi.org/10.1073/pnas.0603375103>
- Müller, E., Hilty, L.M., Widmer, R., Schluep, M., Faulstich, M., 2014. Modeling Metal Stocks and Flows: A Review of Dynamic Material Flow Analysis Methods. *Environ. Sci. Technol.* 48, 140204134136005. <https://doi.org/10.1021/es403506a>
- Murakami, S., Oguchi, M., Tasaki, T., Daigo, I., Hashimoto, S., 2010. Lifespan of Commodities, Part I: The Creation of a Database and its Review. *J. Ind. Ecol.* 14, 598–612. <https://doi.org/10.1111/j.1530-9290.2010.00250.x>
- Muryawan, M., 2012. MSP2012 - Markie Muryawan - UN COMTRADE: Understanding trade data.
- Oda, J., Akimoto, K., Tomoda, T., 2013. Long-term global availability of steel scrap. *Resour. Conserv. Recycl.* 81, 81–91. <https://doi.org/10.1016/j.resconrec.2013.10.002>
- Oder, K., n.d. Mati fabrika – Železarna Ravne 33.
- OECD, 2018. Iron and Steel Industry [WWW Document]. OECD ILibrary Iron Steel Ind. URL [https://www.oecd-ilibrary.org/industry-and-services/iron-and-steel-industry\\_19962819](https://www.oecd-ilibrary.org/industry-and-services/iron-and-steel-industry_19962819) (accessed 6.21.18).
- OECD, 2015. Material Resources, Productivity and the Environment. Organisation for Economic Co-operation and Development, Paris.
- Oguchi, M., Fuse, M., 2015. Regional and Longitudinal Estimation of Product Lifespan Distribution: A Case Study for Automobiles and a Simplified Estimation Method. *Environ. Sci. Technol.* 49, 1738–1743. <https://doi.org/10.1021/es505245q>
- Oguchi, M., Kameya, T., Tasaki, T., Tamai, N., Tanikawa, N., 2006. Estimation of Lifetime Distributions and Waste Numbers of 23 Types of Electrical and Electronic Equipment. *J. Jpn. Soc. Waste Manag. Experts* 17, 50–60. <https://doi.org/10.3985/jswme.17.50>
- Oguchi, M., Murakami, S., Tasaki, T., Daigo, I., Hashimoto, S., 2010a. Lifespan of Commodities, Part II. *J. Ind. Ecol.* 14, 613–626. <https://doi.org/10.1111/j.1530-9290.2010.00251.x>
- Oguchi, M., Tasaki, T., Moriguchi, Y., 2010b. Decomposition Analysis of Waste Generation From Stocks in a Dynamic System. *J. Ind. Ecol.* 14, 627–640. <https://doi.org/10.1111/j.1530-9290.2010.00248.x>

- Park, J., Hong, S., Kim, I., Lee, J., Hur, T., 2011. Dynamic material flow analysis of steel resources in Korea. *Resour. Conserv. Recycl.* 55, 456–462. <https://doi.org/10.1016/j.resconrec.2010.12.007>
- Pauliuk, S., Milford, R.L., Müller, D.B., Allwood, J.M., 2013a. The Steel Scrap Age. *Environ. Sci. Technol.* 47, 3448–3454. <https://doi.org/10.1021/es303149z>
- Pauliuk, S., Müller, D.B., 2014. The role of in-use stocks in the social metabolism and in climate change mitigation. *Glob. Environ. Change* 24, 132–142. <https://doi.org/10.1016/j.gloenvcha.2013.11.006>
- Pauliuk, S., Wang, T., Müller, D.B., 2013b. Steel all over the world: Estimating in-use stocks of iron for 200 countries. *Resour. Conserv. Recycl.* 71, 22–30. <https://doi.org/10.1016/j.resconrec.2012.11.008>
- Pauliuk, S., Wang, T., Müller, D.B., 2012. Moving Toward the Circular Economy: The Role of Stocks in the Chinese Steel Cycle. *Environ. Sci. Technol.* 46, 148–154. <https://doi.org/10.1021/es201904c>
- Rankin, W.J., 2011. *Minerals, Metals and Sustainability: Meeting Future Material Needs*. CRC Press, Boca Raton, Fla.
- Rausand, M., Høyland, A., 2004. *System Reliability Theory: Models, Statistical Methods, and Applications*, 2nd edition. ed. John Wiley & Sons, Inc., New Jersey.
- Reck, B.K., Graedel, T.E., 2012. Challenges in Metal Recycling. *Science* 337, 690–695. <https://doi.org/10.1126/science.1217501>
- Remus, R., Aguado Monsonet, M.A., Roudier, S., Delgado Sancho, L., 2003. Best Available Techniques (BAT) reference document for Iron and Steel Production: industrial emissions Directive 2010/75/EU.
- Reuter, M., Heiskanen, K., Boin, U.M.J., Schaik, A., Verhoef, E., Yang, Y., 2005. The Metrics of Material and Metal Ecology, Harmonizing the resource, technology and environmental cycles.
- Roesch, L., 2003. *L'acier: sa fabrication, ses propriétés, sa mise en oeuvre, ses emplois*. OTUA, Paris la defense.
- Russo, P., 2014. The Steel Recycling Rate. Presented at the Society and Materials conference (SAM-9), Luxembourg.
- Ruttan, V.W., 1996. Population Growth, Environmental Change and Technical Innovation: Implications for Sustainable Growth in Agricultural Production, in: *The Impact of Population Growth on Well-Being in Developing Countries, Population Economics*. Springer, Berlin, Heidelberg, pp. 139–173. [https://doi.org/10.1007/978-3-662-03239-8\\_5](https://doi.org/10.1007/978-3-662-03239-8_5)
- Saltelli, A., Tarantola, S., Campolongo, F., Ratto, M., 2004. *Sensitivity Analysis in Practice: A Guide to Assessing Scientific Models*, 1 edition. ed. Wiley, Hoboken, NJ.
- Savov, L., Volkova, E., Janke, D., 2003. Copper and tin in steel scrap recycling. *RMZ - Mater. Nad Geoenvironment* 50, 627–240.
- Schumacher, 2015. Status and Challenges for the foundry industry.
- Sofili, T., Sofili, U., Brnardi, I., 2012. The significance of iron and steel slag by-product for utilization in road construction. Presented at the 12th International Foundrymen Conference, Opatija, Croatia, p. 18.
- Spatari, S., Bertram, M., Gordon, R.B., Henderson, K., Graedel, T.E., 2005. Twentieth century copper stocks and flows in North America: A dynamic analysis. *Ecol. Econ.* 54, 37–51. <https://doi.org/10.1016/j.ecolecon.2004.11.018>
- Stahl, W., 2013. *Statistisches Jahrbuch der Stahlindustrie 2013/2014*. Stahleisen, Düsseldorf.
- Sutter, E., 2016. *Corrosion atmosphérique*. Tech. Ing. Corros. Vieil. Phénom. Mécanismes base documentaire : TIB371DUO.
- Takamatsu, N., Yonezawa, K., Ueno, H., Tamaki, W., Hayashi, S., 2014. Steel Recycling Circuit in the World. *Tetsu--Hagane* 100, 740–749. <https://doi.org/10.2355/tetsutohagane.100.740>
- Tasaki, T., Oguchi, M., Kameya, T., Urano, K., 2001. A Prediction Method for the Number of Waste Durable Goods. *J. Jpn. Soc. Waste Manag. Experts* 12, 49–58. <https://doi.org/10.3985/jswme.12.49>

- T.I., 2004. La corrosion des aciers. Tech. Ing. Tech. Bâtim. Connaître Matér. Constr. base documentaire : TIE804DUO.
- Tilton, J.E., 2010. Is Mineral Depletion a Threat to Sustainable Mining? Issue Soc. Econ. Geol. Newsl.
- Udo de Haes, H.A., Van Der Voet, E., Kleijn, R., 1997. Substance flow analysis (SFA), an analytical tool for integrated chain management, in: *Regional and National Material Flow Accounting: From Paradigm to Practice of Sustainability*. Proceedings of the ConAccount Workshop January 21–23, 1997. Leiden, The Netherlands.
- UN, 2017. UN Comtrade | International Trade Statistics Database [WWW Document]. UN Comtrade Database. URL <https://comtrade.un.org/> (accessed 4.18.18).
- UNEP, 2013. Metal Recycling: Opportunities, Limits, Infrastructure, A Report of the Working Group on the Global Metal Flows to the International Resource Panel. United Nations Environment Programme.
- UNEP, 2011a. Decoupling natural resource use and environmental impacts from economic growth, A Report of the Working Group on Decoupling to the International Resource Panel. Fischer-Kowalski, M., Swilling, M., von Weizsäcker, E.U., Ren, Y., Moriguchi, Y., Crane, W., Krausmann, F., Eisenmenger, N., Giljum, S., Henricke, P., Romero Lankao, P., Siriban Manalang, A., Sewerin, S.
- UNEP, 2011b. Recycling rates of metals. A Status report. United Nations Environment Programme.
- UNEP, 2010a. ABC of SCP: Clarifying Concepts on Sustainable Consumption and Production. United Nations Environment Programme.
- UNEP, 2010b. Assessing the Environmental Impacts of Consumption and Production: Priority Products and Materials (A Report of the Working Group on the Environmental Impacts of Products and Materials to the International Panel for Sustainable Resource Management). United Nations Environment Programme.
- UNEP, 2010c. Metal Stocks in Society. Scientific Synthesis. United Nations Environment Programme.
- U.S. Department of Energy, 2016. Steel Industry Technology Roadmap [WWW Document]. Off. Energy Effic. Renew. Energy. URL <https://www.energy.gov/eere/amo/downloads/steel-industry-technology-roadmap> (accessed 3.8.18).
- USGS, 2003. Recycling - metals, Michael D. Fenton. U.S. Geological Survey.
- Van Der Voet, E., Yuichi, 2002. Substance flow analysis methodology, in: *A Handbook of Industrial Ecology*. Edward Elgar Publishing Limited.
- van Schaik, A., Reuter, M.A., 2004. The time-varying factors influencing the recycling rate of products. *Resour. Conserv. Recycl.* 40, 301–328. [https://doi.org/10.1016/S0921-3449\(03\)00074-0](https://doi.org/10.1016/S0921-3449(03)00074-0)
- van Schaik, A., Reuter, M.A., Boin, U.M.J., Dalmijn, W.L., 2002. Dynamic modelling and optimisation of the resource cycle of passenger vehicles. *Miner. Eng.* 15, 1001–1016. [https://doi.org/10.1016/S0892-6875\(02\)00080-8](https://doi.org/10.1016/S0892-6875(02)00080-8)
- Viohalco, 2016. Viohalco. History [WWW Document]. Viohalco Success Story More 75 Years. URL <http://viohalco.com/603/en/History/> (accessed 4.21.17).
- Wang, T., Müller, D.B., Graedel, T.E., 2007. Forging the anthropogenic iron cycle. *Environ. Sci. Technol.* 41, 5120–5129.
- Wang, T., Müller, D.B., Hashimoto, S., 2015. The Ferrous Find: Counting Iron and Steel Stocks in China's Economy. *J. Ind. Ecol.* 19, 877–889. <https://doi.org/10.1111/jiec.12319>
- WBCSD, 2000a. Eco-efficiency: Creating more with less. World Business Council for Sustainable Development.
- WBCSD, 2000b. Measuring Eco-Efficiency: A guide to reporting company performance. World Business Council for Sustainable Development.
- WCED, 1987. Our Common Future, 1 edition. ed. Oxford University Press.
- Weisz, H., Suh, S., Graedel, T.E., 2015. Industrial Ecology: The role of manufactured capital in sustainability. *Proc. Natl. Acad. Sci.* 112, 6260–6264. <https://doi.org/10.1073/pnas.1506532112>

- Worldsteel, 2016. Steel Statistical Yearbook 2016. World Steel Association. Economics Committee, Brussels.
- Worldsteel, 2015. Indirect Trade in Steel. World Steel Association.
- Worrell, E., Faaij, A.P.C., Philipsen, G.J.M., Blok, K., 1995. An approach for analysing the potential for material efficiency improvement. *Resour. Conserv. Recycl.* 13, 215–232. [https://doi.org/10.1016/0921-3449\(94\)00050-F](https://doi.org/10.1016/0921-3449(94)00050-F)
- Worrell, Reuter, M.A., 2014. Recycling: A Key Factor for Resource Efficiency, in: *Handbook of Recycling*. Elsevier, Boston, pp. 3–8. <https://doi.org/10.1016/B978-0-12-396459-5.00001-5>
- Woydt, M., 2004. Application des données tribologiques des matériaux. *Tech. Ing. Frott. Usure base documentaire : TIB464DUO*.
- Yellishetty, M., Mudd, G.M., Ranjith, P.G., Tharumarajah, A., 2011. Environmental life-cycle comparisons of steel production and recycling: sustainability issues, problems and prospects. *Environ. Sci. Policy* 14, 650–663. <https://doi.org/10.1016/j.envsci.2011.04.008>
- Yildirim, I.Z., Prezzi, M., 2011. Chemical, Mineralogical, and Morphological Properties of Steel Slag [WWW Document]. *Adv. Civ. Eng.* <https://doi.org/10.1155/2011/463638>

## Appendix A Estimation of iron losses due to corrosion

Economic issues related to corrosion are mostly associated with atmospheric corrosion (Sutter, 2016). Estimation of iron loss due to corrosion concentrates then on this type of corrosion. One of main parameter used to characterize a corrosion process is the speed of corrosion, defined by the speed of chemical and electrochemical reactions between a product surface and its surrounding environment, and usually expressed by a thickness or mass loss over a unit of surface of the corroded body. This reaction depends on the material and its surface properties, on the environment (atmosphere, water or soil) and on location (indoor or outdoor).

To illustrate the influence of material on the corrosion rate, it is acknowledged that weathering steel has a lower corrosion rate than carbon steel (Leygraf et al., 2016). Figure A-1 shows an example of corrosion speed variation for two types of steel during four years (T.I., 2004). Here, after four years the loss of mass of weathering steel S355 is two times lower of steel S355. .

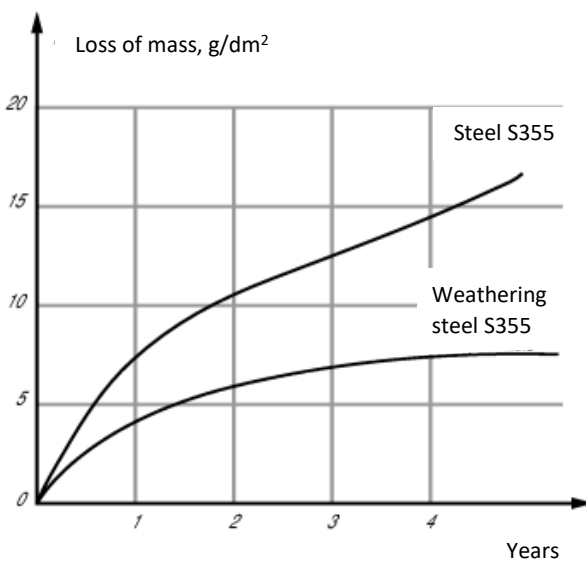

Figure A-1 Example of corrosion speed depending on steel type (T.I., 2004)

Concerning the influence of the environment, atmospheric corrosion is impacted by climatic parameters, like humidity, temperature, time of exposure to humidity (like the occurrence of condensation) and presence of particles and pollutants in the atmosphere (sulphurous and carbonic gases, chlorides). The norm ISO 12944-2 classifies atmospheric environment to which steel structures are exposed according to their corrosivity (Table A-1). Thickness and mass losses shown here are indicated after the first year of exposure; losses may reduce over subsequent years, as seen in Figure A-1.

Table A-1 Classification of atmospheric corrosivity for low-carbon steel after one year of exposure to various environments (ISO 12944-2)

Corrosivity category and risk	Low-carbon steel		Examples of typical environments in a temperate climate (informative only)	
	Mass loss (g/m <sup>2</sup> )	Thickness loss (µm)	Exterior	Interior
C1 very low	≤ 10	≤ 1.3	-	Heated buildings with clean atmospheres, e.g. offices, shops, schools, hotels
C2 low	> 10 to 200	> 1.3 to 25	Atmospheres with low level of pollution Mostly rural areas	Unheated buildings where condensation may occur, e.g. depots, sports halls
C3 medium	> 200 to 400	> 25 to 50	Urban and industrial atmospheres, moderate sulphur dioxide pollution Coastal area with low salinity	Production rooms with high humidity and some air pollution e.g. food-processing plants, laundries, breweries, dairies
C4 high	> 400 to 650	> 50 to 80	Industrial areas and coastal areas with moderate salinity	Chemical plants, swimming pools, coastal, ship and boatyards
C5-I very high (industrial)	> 650 to 1500	> 80 to 200	Industrial areas with high humidity and aggressive atmosphere	Buildings or areas with almost permanent condensation and high pollution
C5-M very high (marine)	> 650 to 1500	> 80 to 200	Coastal and offshore areas with high salinity	Buildings or areas with almost permanent condensation and high pollution

Table A-1 shows that, between C1 and C5-M categories (i.e., interior heated buildings and offshore areas), mass loss of low-carbon steel due to atmospheric corrosion ranges from less than 10 g/m<sup>2</sup> up to 1500 g/m<sup>2</sup> i.e. a factor of 150 (same results for thickness loss). The influence of location on corrosion is explained by the structure exposure: in open air, in presence of rain, sunshine and pollutants, structures are more subjected to corrosion. Indoor structures can be impacted by poor ventilation, high humidity or condensation.

Müller and colleagues (Müller et al., 2006). provides the following corrosion rates for carbon steel as a reference for low iron loss due to corrosion (Leygraf et al., 2016):

- In rural environment: 4–65µm/year
- In urban environment: 23–71µm/year
- In industrial environment: 26–175 µm/year
- In marine environment: 26–104µm/year

These corrosion rates are quasi-linear with time (Leygraf et al., 2016). The corrosion rates shown in Table A-1 and by Leygraf et al. are for different materials (low-carbon steel and carbon steel, correspondingly), which could explain the difference in values (e.g. higher ranges for rural, urban and industrial environments (C2, C3 and C4) and lower ranges marine environment (C5-M)). However, levels of corrosion



rate from these two sources are of the same order of magnitude, and thus constitute a good basis to run a first level of analysis.

In accordance with previous MFA study of Müller and colleagues, this study applies the corrosion rates from (Leygraf et al., 2016); minimal and maximal corrosion rates are applied (4 and 175  $\mu\text{m}/\text{year}$ ) to 1 ton of steel being in use for 30 years. To estimate the quantity of iron lost due to corrosion, one ton of steel (corresponding to a certain volume) must be expressed in terms of equivalent surface, as corrosion rates are expressed in mass loss/ $\text{m}^2$ , or thickness (mm). To define this equivalent surface, first, an equivalent volume of 1 ton of steel is estimated using (1) steel density – 7.8 t/ $\text{m}^3$ , (2) 10 mm thickness for steel products, as advised by industrial experts. Thus, one ton of steel 10 mm thick corresponds to a surface of 12.8  $\text{m}^2$ . It must be noted that the thickness impacts directly the result – the higher the thickness, the lower the surface and consequently, the lower the calculated corroded part of metal. Only one side of the surface is considered to have an open-air exposure.

The application of extreme ranges of corrosion rate to one ton of steel shows that from 1.2% to 52.5% of the mass could be lost from corrosion after 30 years of use (corresponding to 0.012 t and 0.525 t, Table A-2)

Table A-2 Simplified estimation of corroded steel over 30 years

Mass of steel, t	Average lifetime, years	Annual corrosion rate, mm/year	Volume of steel, $\text{m}^3$	Average thickness of steel products, mm	Surface of 1t of steel, $\text{m}^2$	Corroded volume, annually, $\text{m}^3$	Corroded mass, annually, t	Corroded mass during the lifetime, t
1	30	0.004	0.128	10	12.8	0.00005	0.0004	0.012
1	30	0.175	0.128	10	12.8	0.002	0.0175	0.525

## References

- Leygraf, C., Wallinder, I.O., Tidblad, J., Graedel, T., 2016. Appendix F: The Atmospheric Corrosion Chemistry of Iron and Low Alloy Steels, in: Atmospheric Corrosion. John Wiley & Sons, Inc., pp. 302–315. <https://doi.org/10.1002/9781118762134.app6>
- Müller, D.B., Wang, T., Duval, B., Graedel, T.E., 2006. Exploring the engine of anthropogenic iron cycles. Proc. Natl. Acad. Sci. 103, 16111–16116. <https://doi.org/10.1073/pnas.0603375103>
- Sutter, E., 2016. Corrosion atmosphérique. Tech. Ing. Corros. Vieil. Phénom. Mécanismes base documentaire : TIB371DUO.
- T.I., 2004. La corrosion des aciers. Tech. Ing. Tech. Bâtiment. Connaître Matér. Constr. base documentaire : TIE804DUO.

## Appendix B Comparison of calculated production of finished steel products with reported statistical data

As shown in section 4.2.1, the reported production data are not in line with the mass balance, so it was chosen to calculate this flow. This part compares the calculated flow with data reported in statistics to estimate the difference. The comparison of production of finished steel products can be performed for eight countries for the period of 1970-2015 (Austria, Belgium-Luxembourg, France, Germany, Italy, Netherlands, Spain and the United Kingdom). For other countries (and EU-27) the comparison is performed for the period 1990-2015, when data are reported.

Figure B-1 illustrates the comparison for the period of 1970-2015. The calculated production fits the reported data. The average percentage difference for the period of 1970-2015 is 4-8% depending on the country (Table B-1). An important difference between the estimated and the reported values for Germany before 1991 is related to the fact that the production of this flow if not reported for the Democratic Republic of Germany.

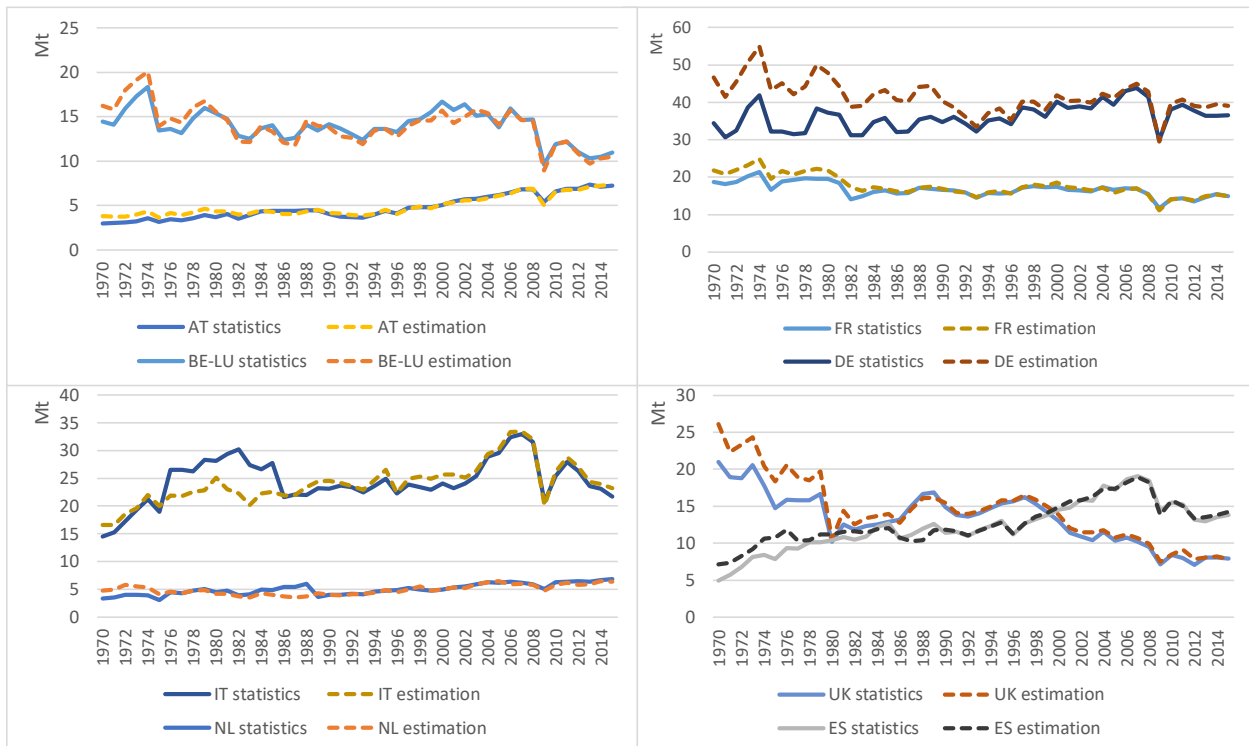

Figure B-1 Comparison of calculated production of finished steel products with reported statistics for eight countries

For the period 1990-2015, the difference was not calculated for Cyprus, Lithuania and Malta because data on production of finished steel products were not reported. According to the calculation, Lithuania and Cyprus had some production for a few years when they were reported as net importers of crude steel. The country-specific maximal, minimal and average difference is summarized in Table B-2.

Table B-1 Percentage difference between calculated and reported data on production of steel products

Country	Compared period	Percentage difference			Country	Compared period	Percentage difference		
		min	max	average			min	max	average
Austria	1970-2015	0%	23%	7%	Italy	1970-2015	0%	31%	8%
Belgium-Luxembourg	1970-2015	0%	12%	5%	Latvia	1992-2015	2%	193%	27%
Bulgaria	1990-2015	0%	52%	14%	Netherlands	1970-2015	0%	11%	4%
Czech Republic	1990-2015	6%	29%	12%	Poland	1990-2015	0%	19%	7%
Slovakia	1990-2015	0%	13%	4%	Portugal	1990-2015	1%	31%	9%
Denmark	1990-2015	0%	21%	6%	Romania	1990-2015	0%	30%	12%
Finland	1990-2015	0%	6%	2%	Slovenia	1992-2015	0%	22%	9%
France	1970-2015	0%	20%	5%	Spain	1970-2015	0%	36%	7%
Germany	1970-2015	2%	33%	14%	Sweden	1990-2015	3%	12%	7%
Greece	1990-2015	0%	11%	6%	United Kingdom	1970-2015	0%	26%	8%
Hungary	1990-2015	0%	20%	6%	Total EU27	1990-2015	1%	9%	3%
Ireland	1990-2001	1%	33%	7%					

The production of steel products, calculated from the consumption of steel and mass balance for the process of rolling and finishing, is rather in line with reported data. Globally, the calculated production is higher than the statistically reported values (Figure B-2). At the level of EU-27, the average difference is 3% for the period 1990-2015.

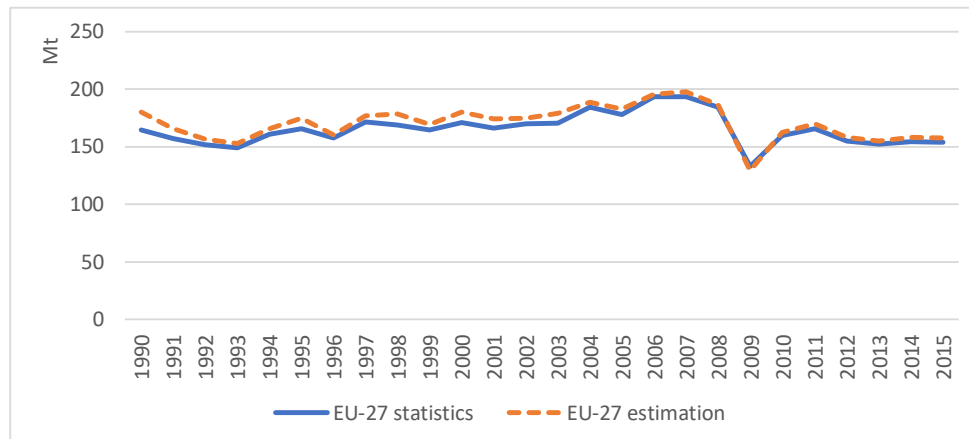

Figure B-2 Comparison of calculated production of finished steel products with reported statistics, EU-27, 1990-2015

The comparison between the production of steel products reported in statistics and calculated basing on the mass balance shows that the percentage difference is less than 10% on the level of individual countries. The highest difference is observed for countries with a small steel production, like Latvia or Bulgaria; this can be explained by the impact of data on the crude steel, used to calculate the consumption of crude steel. Indeed, as Latvia and Bulgaria have a small production, their consumption is influenced by the variability in reported imports and exports of crude steel (4.2.1).

## Appendix C Designation of system variables and parameters

### System variables related to mass balance equations

#	Related process	Variable designation	Variable description
1	BOF	$\widehat{F}u(Fe\ tot)_{BOF}$	total flow (sum) of iron from pig iron and scrap fed to the BOF process for production of one ton of crude steel
2		$Fu(CS)_{R\&F}^{BOF}$	flow of one ton of crude steel produced in the BOF and available for rolling and finishing (or export)
3		$Fu(ms)_{ext}^{BOF}$	flow of mill scale produced in the BOF continuous casting per ton of crude steel and used externally of BOF process
4		$Fu(d, s)_{ext}^{BOF}$	flow of dust and sludge, generated in the BOF per ton of crude steel and used externally of the BOF process
5		$Fu(sl)_{ext}^{BOF}$	flow of slag, generated in the BOF per ton of crude steel and used externally of the BOF process
6		$\widehat{F}u(PI)_{BOF}$	flow of iron from pig iron fed to the BOF per one ton of crude steel
7		$\widehat{F}u(scr)_{BOF}$	flow of iron from scrap fed to the BOF per one ton of crude steel
8	EAF	$\widehat{F}u(Fe\ tot)_{EAF}$	total flow of iron from scrap, pig iron and DRI fed to the EAF process per ton of crude steel
9		$Fu(CS)_{R\&F}^{EAF}$	flow of crude steel produced in the EAF and available for rolling and finishing (or export)
10		$Fu(ms)_{ext}^{EAF}$	flow of mill scale produced in the EAF and used externally of EAF process
11		$Fu(d)_{ext}^{EAF}$	flow of dust, generated in the EAF and used externally of the EAF process
12		$Fu(sl)_{ext}^{EAF}$	flow of slag, generated in the EAF and used externally of EAF process
13		$\widehat{F}u(scr)_{EAF}$	flow of iron from scrap fed to the EAF
14		$\widehat{F}u(PI)_{EAF}$	flow of iron from pig iron fed to the EAF
15		$\widehat{F}u(DRI)_{EAF}$	flow of iron from DRI fed to the EAF
16	OHF	$\widehat{F}u(Fe\ tot)_{OHF}$	total flow of iron from pig iron, scrap and iron ore fed to the OHF process
17		$Fu(CS)_{R\&F}^{OHF}$	flow of one ton of crude steel produced in OHF and available for rolling and finishing (or export)
18		$Fu(ms)_{ext}^{OHF}$	flow of mill scale produced in the OHF casting and used externally of the OHF process
19		$Fu(d, s)_{ext}^{OHF}$	flow of dust and sludge, generated in the OHF and used externally of the OHF process;
20		$Fu(sl)_{ext}^{OHF}$	flow of slag, generated in the OHF and used externally of the OHF process
21		$\widehat{F}u(PI)_{OHF}$	flow of iron from pig iron fed to the OHF
22		$\widehat{F}u(scr)_{OHF}$	flow of iron from scrap fed to the OHF
23		$\widehat{F}u(ore)_{OHF}$	flow of iron from iron ore fed to the OHF
24	Rolling and finishing	$\widehat{F}u(CS)_{RF}$	flow of iron from crude steel fed to the process of rolling and finishing
25		$Fu(SP)_{FM}^{RF}$	flow steel products produced during rolling and finishing and fed to processing and manufacturing (or exported)
26		$Fu(ms)_{ext}^{RF}$	flow of mill scale produced during rolling and finishing and used externally of the process

27		$Fu(mss)_{ext}^{RF}$	flow of mill scale sludge, generated during rolling and finishing and used externally of the process
28		$Fu(os)_{ext}^{OHF}$	flow of iron oxide/iron sulphate, generated during rolling and finishing and used externally of the process
29	<b>Foundries</b>	$\widehat{Fu}(Fe\ tot)_{Fnd}$	total flow of iron from scrap and pig iron fed to foundries
30		$Fu(Cast)_{FM}^{Fnd}$	cast iron produced in foundries and available for processing and manufacturing
31		$Fu(s)_{ext}^{Fnd}$	flow of slag produced in foundries and used externally of the process
32		$Fu(d)_{ext}^{Fnd}$	flow of dust, generated in in foundries and used externally of the process
33		$\widehat{Fu}(PI)_{Fnd}$	flow of iron from pig iron fed to foundries per one ton of cast iron
34		$\widehat{Fu}(scr)_{Fnd}$	flow of iron from scrap fed to foundries per one ton of cast iron

### System variables related to mass flows

#	Variable designation	Variable description
1	F1	Pig iron production
2	F2	Pig iron consumption (total)
3	F2.1	Pig iron consumption in BOF
4	F2.2	Pig iron consumption in EAF
5	F2.3	Pig iron consumption in OHF
6	F2.4	Pig iron consumption in Foundries
7	F2.1	Pig iron consumption in BOF
8	F3	DRI production
9	F4	Home scrap generation and consumption (total)
10	F4.1	Home scrap generation and consumption in BOF
11	F4.2	Home scrap generation and consumption in EAF
12	F4.3	Home scrap generation and consumption in OHF
13	F4.4	Home scrap generation and consumption in Foundries
14	F4.1	Home scrap generation and consumption in BOF
15	F5	Crude steel production (total)
16	F5.1	Crude steel production in BOF
17	F5.1	Crude steel production in EAF
18	F5.1	Crude steel production in OHF
19	F6	Crude steel consumption
20	F7	Finished steel products production
21	F8	Finished steel products consumption
22	F9	Cast iron production
23	F10	Cast iron consumption
24	F11	Final goods production
25	F12	Final goods consumption
26	F13	Process scrap generation
27	F14	EoL materials discarded from use
28	F14.1	EoL materials that are collected and processes
29	F14.2	EoL materials that that are not collected and processes
30	F15	EoL scrap
31	F16	Flow of scrap (mix of EoL and process scrap)
32	F16.1	Flow of scrap consumed in BOF
33	F16	Flow of scrap consumed in EAF

34	F16	Flow of scrap consumed in OHF
35	F16	Flow of scrap consumed in Foundries
36	F17	DRI consumption
37	T1i, T1e	Pig iron imports and exports
38	T2i, T2e	DRI imports and exports
39	T3i, T3e	Crude steel imports and exports
40	T4i, T4e	Finished steel products imports and exports
41	T4i, T4e	Finished steel products imports and exports
42	T5i, T5e	Cast iron imports and exports
43	T6i, T6e	Indirect imports and exports
44	T4i, T4e	Scrap imports and exports (mix of EoL and process scrap)
45	$S(t_{n,c})$	In-use stock
46	$S(0)$	Initial stock
47	$S(obs)$	Obsolete stock

### System parameters

#	Related process	Parameter designation	Parameter description
1	BOF, EAF, OHF	$IC(PI)$	Iron content of pig iron
2		$IC(DRI)$	iron content of DRI
3		$IC(CS)$	iron content of crude steel
4		$hScr^{steel}$	home scrap generation during continuous casting, expressed in percentage of crude steel
5	BOF	$IC(ms)^{BOF}$	iron content of mill scale generated in the BOF
6		$IC(d,s)^{BOF}$	iron content of dust and sludge, generated in the BOF
7		$IC(sl)^{BOF}$	iron content of slag generated in the BOF
8		$k(PI)_{BOF}$	share of total flow iron fed to the BOF allocated to pig iron
9		$k(scr)_{BOF}$	share of total flow iron fed to the BOF allocated to scrap
10	EAF	$IC(ms)^{EAF}$	iron content of mill scale generated in the EAF
11		$IC(d)^{EAF}$	iron content of dust, generated in the EAF
12		$IC(sl)^{EAF}$	iron content of slag generated in the EAF
13		$k(scr)_{EAF}$	share of total flow iron fed to the EAF allocated to scrap
14		$k(PI)_{EAF}$	share of total flow iron fed to the EAF allocated to pig iron
15		$k(DRI)_{EAF}$	share of total flow iron fed to the EAF allocated to DRI
16	OHF	$IC(ms)^{OHF}$	iron content of mill scale generated in the OHF
17		$IC(d,s)^{OHF}$	iron content of dust and sludge generated in the OHF
18		$IC(sl)^{OHF}$	iron content of slag generated in the OHF
19		$k(PI)_{OHF}$	share of total flow iron fed to the OHF allocated to pig iron
20		$k(scr)_{OHF}$	share of total flow iron fed to the OHF allocated to scrap
21		$k(ore)_{OHF}$	share of total flow iron fed to the EAF allocated to iron ore
22	Rolling and finishing	$IC(ms)^{RF}$	iron content of mill scale generated during rolling and finishing
23		$IC(mss)^{OHF}$	iron content of mill scale sludge generated during rolling and finishing
24		$IC(os)^{OHF}$	iron content of iron oxide/iron sulphate, generated during rolling and finishing
25		$Fu(h.scr)^{RF}$	home scrap generation during rolling and finishing

26	Foundries	$IC(CI)$	iron content of cast iron
27		$IC(s)^{Fnd}$	iron content of slag produced in foundries
28		$IC(d)^{Fnd}$	iron content of dust, generated in in foundries
29		$hScr^{Fnd}$	home scrap generation in foundries
30		$k(PI)_{Fnd}$	share of total flow iron fed to foundries allocated to pig iron
31		$k(scr)_{Fnd}$	share of total flow iron fed to foundries allocated to scrap
32	Processing and manufacturing	$SSP_{i,j}$	share of steel products distributed by type $i$ and industrial sector $j$
33		$PrScr_{i,j}$	Generation of process scrap expressed in percentage by type of steel product $i$ and by industrial sector $j$
34		$Epr_j$	historic evolution of sector-specific process scrap generation
35		$SCP_j$	share of cast products distributed by industrial sector $j$

## Appendix D Estimation of the iron content of the crude steel

The iron content of the crude steel is defined as a weighted average of three groups of steel grades, defined by the European standard EN 10020:2000, which are non alloy steel, stainless steel and alloy steel. The iron content of the crude steel is estimated, based on the established iron content of different steel groups and their respective production shares

**Non alloy steel** (also called carbon steel) is composed mostly of iron and carbon and contains only a small amount of undeliberate alloying elements, like manganese, silicon, sulphur and phosphorus. Non alloy steel can be segregated into three further categories, based on the carbon content: low, medium and high carbon steel. Their generic composition is shown in Table D-1 (Ashby and Jones, 2013). The iron content in non alloy steel varies between 97.5% and 99.16%, having the average value of 98.3%.

Table D-1 Generic composition of non alloy steel

	C, %	Mn, %	Fe, %
Low carbon steel	0.04-0.3	0.8	98.9 - 99.16
Medium carbon steel	0.3-0.7	0.8	98.5 - 98.9
High carbon steel	0.7-1.7	0.8	97.5- 98.5

Alloy steels have a larger quantity of alloying elements than carbon steels. Their generic composition is shown in Table D-2 (Ashby and Jones, 2013); the iron content of alloy steel is 96.18%.

Table D-2 Generic composition of alloy steel

	C, %	Mn, %	Cr, %	Ni, %	Fe, %
Low alloy steel	0.02	0.8	1	2	96.18

The group of stainless steel also contains numerous grades. Typical chemical compositions of these grades is available in the literature, like for example (Atlas Steels, 2013). In the present study, for estimation of iron content of steel, the iron content of a typical stainless-steel grade (grade 304) is applied to simplify the estimation (Table D-3). For this grade the average iron content is equal to 69,01%.

Table D-3 Composition of a typical grade of stainless steel (304)

	C, %	Si, %	Mn, %	P <sub>max</sub>	S, %	N, %	Cr, %	Ni, %	Fe
Stainless steel 304	≤ 0.07	≤ 1	≤ 2	0.045	≤ 0.015	≤ 0.11	17.5 – 19.5	8 – 10.5	66.76- 71.26

Based on Worldsteel data for 21 country of EU-27, the production of carbon steel represents 81-86% of the total steel production, alloy steel – 11-15% and stainless steel – 3-4% (Figure D-1). The average values for the period from 1990 to 1998 equal to 83.4%, 13.4% and 3.2% respectively.



Finally, based on the established iron content of different steel groups and their respective production shares, the iron content of the crude steel is estimated (Table D-4). The resulting weighted average of the iron content of crude steel equals to 97.1% and is rounded up to **97%**.

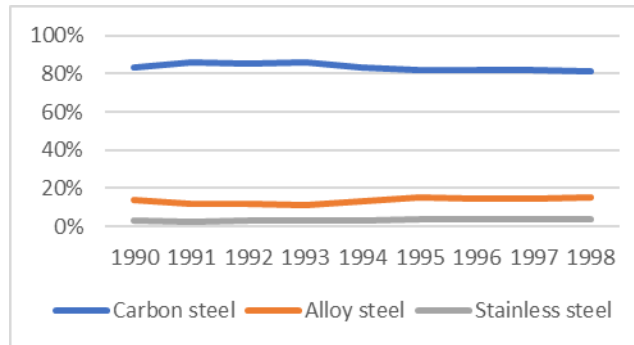

Figure D-1 Shares of production of crude steel by group of steel grade in EU (Worldsteel)

Table D-4 Estimation of iron content in crude steel

Type of steel	Iron content, %	Production, %	Weighted average iron content, %
Non alloy steel	98.3	83.4	97.1
Alloy steel	96.18	13.4	
Stainless steel	69.01	3.2	

## References

Ashby, M.F., Jones, D.R.H., 2013. Chapter 1 - Metals, in: Engineering Materials 2 (Fourth Edition), International Series on Materials Science and Technology. Butterworth-Heinemann, Boston, pp. 3–14. <https://doi.org/10.1016/B978-0-08-096668-7.00001-2>

Atlas Steels, 2013. The Atlas Steels Technical Handbook of Stainless Steels (No. rev. August 2013). Atlas Steels Technical Department

## *Appendix E Résumé de la thèse de doctorat « Analyse de Flux de Matière dynamique pour une estimation des flux, des stocks et des indicateurs du recyclage de fer dans l'UE-27 » rédigée en anglais*

### **1. Contexte et problématique**

Le développement économique et le bien-être social dépendent de l'utilisation et de la disponibilité des ressources naturelles, nécessaires pour satisfaire la demande croissante en bien et service. La production et l'utilisation des matériaux est en croissance exponentielle depuis le début du 20<sup>ème</sup> siècle, ce qui suscite des préoccupations concernant l'épuisement des ressources, leur distribution inégale à travers le monde et l'impact environnemental associé à leur extraction, transport, transformation, utilisation et traitement en fin de vie. Ainsi, la gestion durable des ressources est devenue une des priorités au niveau mondial, régional et national.

Le recyclage contribue à limiter l'utilisation des ressources puisqu'il permet de réintroduire les matériaux en fin de vie dans un nouveau cycle de production en les substituant à la matière première vierge. Nos sociétés ont accumulé une grande quantité de matériaux sous forme de produits : bâtiments, véhicules, équipements industriels ou biens de consommation. Ce stock représente une source de matière secondaire pour le recyclage.

La recyclabilité de métaux ferreux au sein des frontières géographiques de l'UE-27 est le sujet de cette étude. Les métaux ferreux, et l'acier en particulier, sont des matériaux importants pour l'activité économique et présents dans la plupart des secteurs industriels. Pour ces raisons, ces métaux représentent un intérêt en commun pour les partenaires industriels de l'étude (ArcelorMittal, Constellium, Safran, Renault et Derichebourg). Le périmètre de l'UE-27 a été considéré comme le plus adapté du fait d'un cadre législatif commun. Au cours des dernières décennies, les politiques européennes promeuvent l'amélioration de l'utilisation des ressources, et notamment de l'efficacité de l'utilisation des matériaux. La stratégie Europe 2020 visant à long terme à créer un «développement intelligent, durable et inclusif», elle aborde les défis liés à la gestion durable des ressources et des déchets [1]. « La Feuille de route pour une Europe efficace dans l'utilisation des ressources » fait partie de la stratégie Europe 2020. L'un des objectifs de la feuille de route est d'accroître le recyclage et l'utilisation des ressources accumulées dans l'anthroposphère. En 2015, la Commission européenne a adopté un plan d'action pour la transition vers une économie circulaire, où «la valeur des produits, des matériaux et des ressources est maintenue dans l'économie aussi longtemps que possible et la production de déchets minimisée» [2]. Dans le cadre de l'économie circulaire, la durabilité et le recyclage des produits et de leurs composants sont pris en compte de sorte qu'ils puissent être réutilisés ou redevenir des matières premières.

Dans le contexte de la transition vers l'économie circulaire, de l'utilisation efficace des ressources et de l'amélioration du recyclage, l'industrie a besoin d'avoir une vision claire du cycle de vie du matériau dans son ensemble : ressources extraites, matériaux produits, mécanisme d'utilisation des matériaux dans différents secteurs, flux recyclés. Cette vision intégrée contribue à :

- la connaissance des flux de matières, y compris la disponibilité des ressources secondaires;
- le développement de la stratégie de l'industrie;
- la réduction de la dépendance vis-à-vis de l'offre et de la volatilité des prix.

Cette étude se focalise sur la connaissance des flux de matériaux pour les métaux ferreux.

La transition vers le recyclage amélioré des matériaux implique le besoin d'indicateurs de recyclage. Les indicateurs sont utilisés pour faciliter la compréhension de systèmes physiques, économiques ou sociaux complexes par rapport à une question spécifique [3]. Les indicateurs de recyclage peuvent informer l'industrie concernant plusieurs questions, par exemple :

- est-ce qu'une entreprise/installation atteint les objectifs fixés par la législation?
- comment se comparent les matériaux produits par une entreprise/installation par rapport à d'autres du secteur ou par rapport à d'autres matériaux concurrents?
- jusqu'à quel degré la circularité des matériaux est intégrée dans une entreprise ?;
- quel est le taux de recyclage global de déchets et de co-produits?
- quelle est la performance du recyclage de la ferraille de fin de vie ?

Les indicateurs du recyclage constituent une information importante pour le suivi de la performance du recyclage à travers le temps. Actuellement, les méthodes de calcul utilisées pour les indicateurs de recyclage diffèrent selon l'approche. Par exemple, les principaux indicateurs appliqués précédemment aux métaux ferreux comprennent le contenu recyclé (CR), le taux de la vieille ferraille (OSR) et le taux de recyclage de vieille ferraille (EoL RR). En fonction du périmètre géographique étudié, de la période et de la méthodologie appliquées, les estimations disponibles montrent que:

- RC varie entre 28% et 52% [4];
- OSR varie entre 52% et 65% [4];
- EoL RR varie entre 52% et 90% [4], [5].

Une des raisons de cette variabilité est la **définition** des indicateurs de recyclage, qui n'est pas uniformément appliquée par toutes les parties prenantes. Par exemple, la définition de l'indicateur de contenu recyclé peut être utilisée de manière interchangeable, étant parfois calculé au niveau de la production de matériaux (par exemple la relation entre la ferraille et acier brut) et sans prendre en considération les pertes, parfois au niveau de la consommation de matériaux (ferraille/matières premières et matières secondaires). Un autre exemple est l'indicateur EoL RR: la ferraille neuve peut être ajoutée à la vieille ferraille, ce qui augmente artificiellement le taux de recyclage. De plus, des indicateurs de recyclage sont parfois communiqués sans aucune information de base sur leur définition, rendant impossibles la compréhension des données utilisées pour l'estimation de l'indicateur et une bonne interprétation des résultats.

Une autre source de variabilité est la **méthode de calcul** employée. Les indicateurs peuvent être estimés par les "modèles ad-hoc" - un modèle construit pour un usage particulier, qui ne peut pas être généralisé ni adapté à d'autres objectifs (e.g. [6]). Ils peuvent être déduits d'un modèle d'analyse des flux de matières (AFM), de préférence dynamique (e.g. [7]). AFM est une analyse physique et quantitative des flux de matière et du stock dans un système défini dans le temps et l'espace [8].

Certains indicateurs de recyclage nécessitent des données sur la quantité totale de matériaux disponible pour le recyclage. La disponibilité des matériaux pour le recyclage dépend non seulement de l'efficacité de la collecte et du démantèlement, mais aussi de la production dans le passé et de la période de temps pendant laquelle les matériaux restent en utilisation par les consommateurs [9]- [11]. Le stock de matière utilisé dans la société crée un lien entre le flux de matière disponible pour le recyclage et la production de

matériaux dans le passé. La prise en compte du stock de matière est donc une condition nécessaire pour l'estimation de la disponibilité des ressources secondaires et de leur recyclage. Ceci garantit le respect du principe du bilan massique dans le temps.

Une autre source de différence est le **cadre de référence** dans lequel l'estimation du recyclage est effectuée en termes d'espace et de temps.

Précédemment, l'AFM a été utilisée pour évaluer la quantité de matière engagée dans la société [12]-[14], le stock de matière [5], [15]-[18] et la disponibilité de la matière première secondaire [19]-[21]. Les résultats d'AFM peuvent être utilisés par la suite pour une évaluation des indicateurs de recyclage [5], [7], [22], [23]. Néanmoins, l'AFM, un outil puissant et rigoureux pour l'étude des flux et des stocks de matière n'a pas été beaucoup exploré comme base pour l'estimation d'indicateurs de recyclage pour les métaux ferreux.

En plus de la prise en compte du stock, trois autres points sont essentiels pour une bonne estimation de l'efficacité recyclage des métaux ferreux :

- La prise en compte de l'acier et de la fonte, puisque ces industries sont alimentées par fer extrait du minerai de fer et par la ferraille. La consommation de ferraille est interdépendante entre ces industries: ils génèrent une demande de ferraille et, dans le même temps, leurs produits sont eux-mêmes une source de ferraille.
- la prise en compte de la variation de la teneur en fer au cours du cycle de vie de ces deux métaux ferreux afin d'assurer la balance de masse. En effet :
  - o le contenu en fer de l'acier, de la fonte et de la fonte brute ne sont pas les mêmes ;
  - o lors de la production d'acier il y a des pertes de fer dans les co-produits (laitiers, poussières et boues) ;
  - o le contenu en fer de la ferraille en fin de vie n'est pas le même que celui de la ferraille neuve à cause de la contamination par les peintures et d'autres matières qui n'ont pas été séparés lors du démantèlement du produit, ainsi qu'à cause des pertes par oxydation durant la vie du produit;
- Une attention particulière doit être portée à l'estimation des flux ayant un impact sur l'efficacité du recyclage pour la fiabilité de l'estimation du taux de recyclage. En effet, les données de flux de matières peuvent être imprécises, faussées par des erreurs et des incertitudes ou tout simplement ne pas être connues et doivent donc être estimées.

Avec le marché commun européen, les flux de matières ne se bornent pas aux limites des territoires nationaux. Cependant, les données ont été collectées pour chaque pays-membre puisque l'UE-27 n'a pas toujours existé sur la période étudiée.

## **2. Objectif et contribution**

L'objectif de la thèse est de développer un modèle pour estimer les indicateurs du recyclage pour les métaux ferreux à partir de la disponibilité de la matière secondaire en fonction de leur distribution géographique.

La revue bibliographique des études d'AFM pour l'acier et la fonte montre que les précédentes études visent principalement à estimer les flux de matières et les stocks, ainsi qu'à évaluer la disponibilité actuelle

et future de la ferraille; **l'application d'AFM pour une estimation des indicateurs de recyclage** n'a pas été étudiée en détail pour les métaux ferreux.

En ce qui concerne les **frontières spatiales**, les études ont été réalisées aux niveaux mondial et national. Le périmètre européen, qui constitue le principal intérêt de la présente étude, a déjà été étudié pour 15 États membres dans une étude statique dans le temps [13] et pour 12 États membres dans une étude dynamique [20], [24], [25]. Des études ont été menées pour le Royaume-Uni [5], [15], [26]–[28]. Des informations concernant certains pays européens peuvent être obtenues à partir d'études mondiales, dans lesquelles le flux mondial est basé sur les flux récapitulatifs des pays individuels [16], [19]. Jusqu'à présent, **aucune étude détaillée sur l'UE-27** n'a été réalisée, probablement parce que les études AMF à l'échelle de l'UE nécessitent un large éventail de données. En outre, le territoire de l'UE change dans le temps, ce qui rend difficile le maintien et l'actualisation des résultats de recherche.

L'objectif de l'étude a évidemment un impact sur le choix du matériau à étudier. Dans les études analysées, trois approches pour le choix du matériau sont distinguées :

- Une partie de ces études se concentre uniquement sur l'acier et n'inclut pas la fonte, ce qui n'est pas représentatif pour l'estimation des indicateurs du recyclage [18], [19], [25], [29].
- L'autre partie considère la fonte et l'acier dans leur totalité ; ainsi les flux contiennent tous les éléments de ces matériaux (fer, carbone, manganèse, silicium, éléments d'alliage, etc.), rendant la balance de masse difficile, voire impossible à établir [5], [12], [13], [15], [21], [26]–[28].
- Enfin la troisième partie suit l'élément fer, en appliquant l'hypothèse que l'acier est composé intégralement de fer [14], [16], [17], [30]–[32]. Cette approche assure la balance de masse et permet d'estimer les pertes en fer, mais ne prend pas en compte la présence d'autres éléments dans la composition, et la dégradation du contenu en fer dans la vieille ferraille (important pour l'estimation après plusieurs cycles de recyclage).

La troisième approche semble donc la plus pertinente pour l'estimation du recyclage. Néanmoins, ces études sont basées sur l'hypothèse que la ferraille est composée à 100% de fer, en supposant que l'impact de la non prise en compte d'autres éléments sur les résultats du stock est minime, compte tenu de la teneur élevée en fer dans l'acier. Sachant que pour une étude sur l'efficacité du recyclage des matériaux ferreux, cette hypothèse pu impacter le résultat, parce que la teneur de fer de la vieille ferraille est inférieur à celle des matériaux. La présente étude fournit des données permettant d'estimer la pertinence de cette hypothèse.

Ainsi, la présente étude suit le fer élémentaire (Fe) et considère la teneur en fer de tous les flux pertinents. Cette approche garantit le respect du bilan massique du fer, tout en tenant compte de la présence d'autres éléments en acier et en fonte, ainsi que de la variation de la teneur en fer au cours du cycle de vie du matériau. Une telle étude détaillée de la teneur en fer n'avait pas encore été réalisée jusqu'à présent.

L'objectif de l'étude a également un impact sur le **nombre de processus et la complexité du système** modélisé. Dans les études précédentes, la différenciation entre les processus de fabrication de l'acier (BOF, EAF, OHF) n'était pas toujours prise en compte, malgré le fait que la quantité de matières premières (fonte brute et ferraille) dépend du type de processus de fabrication de l'acier. L'estimation des pertes permet de respecter la balance de masse, les pertes n'ont été incluses que dans quelques études [13], [14], [16], [17], [30]–[32].

Un autre exemple de la complexité du système étudié est la différence de granularité de flux et de processus entre les études statiques et dynamiques. Dans les études dynamiques, l'accent est mis sur le stock de matériaux, la production de matériaux étant abordée de manière simplifiée et limitée aux principaux flux et processus. Dans les études statiques, l'accent est mis sur la transformation des flux de matières, ce qui donne un niveau de détails plus élevé sur les étapes de production et de fabrication, attribuant une part de la consommation de produits en acier finis par secteur industriel [12], [14]. La distribution des produits finis par secteur industriel n'a donc jamais été appliquée à une étude dynamique.

La présente étude intègre la modélisation détaillée des étapes de production et de fabrication dans une approche dynamique, dans l'espoir qu'une définition plus large des processus permettra de réaliser des estimations plus précises. En s'inspirant des études statiques AMF, des données sont rassemblées pour appliquer les éléments suivants de l'étude dynamique:

- pour chaque processus de la production, calcul des pertes en fer des sous-produits contenant du fer;
- pour le processus de fabrication, cette étude prend en compte la génération de la nouvelle ferraille en fonction du type de produit en acier et du secteur industriel. L'inclusion de cette distribution offre une estimation plus précise en raison de l'application de taux spécifiques à un produit et à un secteur au lieu du taux global ou spécifique juste aux secteurs.

Au cours d'une étude MFA, la collecte et le traitement des données est l'étape la plus consommatrice en temps. La plupart des données utilisées dans les études AMF proviennent de statistiques. Cependant, la **fiabilité de ces sources** fait l'objet d'un débat limité [33]. Une collaboration étroite avec les partenaires industriels a permis d'utiliser des données issues de l'expérience industrielle et de comparer les résultats du modèle avec ces valeurs. Les résultats concernant les sources de la vieille ferraille sont comparés aux précédentes études AMF, mais également aux données industrielles sur les achats de ferraille. Cela n'a pas été fait auparavant, en raison d'une disponibilité limitée des données.

### **3. Modèle appliqué au flux de fer dans l'UE-27**

#### **3.1 Méthodologie**

Le cadre méthodologique de l'Analyse de Flux de Matière (AFM) inclut les concepts suivants :

- Processus: succession d'opérations qui impliquent la transformation physique, le transport ou le stockage des substances, matières ou produits.
- Flux : mouvement de matière entre les processus, exprimés en unité de masse par unité du temps. Les flux entrants et sortants des frontières du système s'appellent respectivement « imports » et « export ». L'AFM peut étudier les flux de substances, matériaux ou de produits en fonction de son objectif.
- Les frontières spatiales peuvent être définies par un territoire géographique (monde, pays, région, ville, etc.), un secteur industriel, une entreprise ou même une usine.
- Les frontières temporaires définissent la période sur laquelle le système est étudié (d'une journée à plusieurs décennies).

Dans le cadre de l'AFM, un système est donc composé d'un ensemble de processus et flux interconnectés observés sur un territoire et durant une échelle de temps donnés (le tout étant également connecté avec des processus en dehors des limites temporelles et géographiques établies).

La méthodologie appliquée dans cette étude comprend les étapes suivantes :

1. Définition du système : description des éléments du système pris en compte.
2. Collecte des données, composée de trois étapes : l'identification des données statistiques et bibliographiques disponibles; la définition des sources de données pertinentes, et leur validation par des experts industriels; la mise en place de la base de données.
3. Modélisation des flux de matière et des stocks : le modèle mathématique, composé de variables et paramètres, formalisant la relation entre les différents éléments du système et permettant de calculer les flux et stocks. Les variables changent en fonction des conditions (par exemple, de temps et d'espace). Dans un modèle AMF, les variables sont des flux et des stocks. Les paramètres, eux, relient les variables dans une équation, et aident à décrire le système en reflétant des caractéristiques spécifiques de la dynamique du process. Ils peuvent être constants ou changer dans l'espace et/ou le temps. La modélisation est basé sur le principe de la balance de masse: la somme de la masse de toutes les entrées d'un processus est égale à la somme de la masse de toutes ses sorties et du changement de stock au sein d'un processus.

Pour chaque processus de production, les balances de masse spécifiques sont établies en tenant compte de la teneur en fer de chaque flux. La masse des flux de matière est basée sur ces balances et les données statistiques. La méthode descendante (top-down) est utilisée pour calculer le stock en utilisation. Cette approche implique la quantification de la production annuelle, sa répartition par secteur industriel, et l'application de la distribution de durée de vie spécifique. La méthode définit l'estimation du stock comme la somme du stock initial dans la société et la différence cumulée entre les flux entrant et sortants :

$$S(t_n) = S(0) + \sum_{t=t_0}^{t_n} (I(t) - O(t))$$

où  $S(t)$  est le stock en utilisation en fonction du temps,  $n$  – l'année considéré,  $S(0)$  – valeur du stock initial (en 1945),  $I(t)$  – le flux entrant dans le processus de l'utilisation,  $O(t)$  – le flux sortant du processus de l'utilisation (fer qui arrive en fin de vie).

4. Interprétation des résultats quantitatifs du modèle : le modèle estime les indicateurs du recyclage et analyse les résultats pour les flux et les stocks afin de comprendre l'impact des hypothèses appliquées sur les résultats des indicateurs. Les résultats incluent :
  - l'illustration d'un cycle annuel des matières pour l'UE-27 permettant de mieux comprendre et visualiser l'ampleur des flux à l'aide du diagramme de Sankey ;
  - les résultats des stocks sont représentés par des graphiques montrant l'évolution des stocks et la part de fer utilisée dans les secteurs industriels étudiés. Ces résultats sont discutés et comparés aux études précédentes.
  - la disponibilité des ressources secondaires est analysée. Les résultats sont présentés pour un flux total de fer et pour les flux rejetés par les secteurs industriels. Les résultats sont comparés aux études précédentes et discutés avec des experts industriels;
  - les estimations des indicateurs de recyclage sont analysées.

### **3.2. Définition du système**

L'échelle temporelle choisie pour le système étudié est la période entre 1945 et 2015. La réalisation d'une étude pour une période de temps aussi longue permet d'appréhender les évolutions passées et de mieux

considérer les produits contenant des métaux, ayant une durée de vie longue, tels que les bâtiments. En raison de l'évolution des frontières de l'Union européenne, il n'existe pas de données statistiques globales pour l'UE-27 avant 2007, ce qui rend plus appropriée l'estimation des flux et des stocks de matières au niveau de chaque pays membre de l'UE-27.

Le système inclut les flux et les processus pertinents pour estimer le stock et l'efficacité du recyclage. Ainsi, le système doit prendre en compte tous les processus qui génèrent, consomment et traitent la ferraille. La figure E-1 illustre le cycle de vie de fer : à partir de l'extraction et jusqu'à la gestion de la fin de vie des produits. Les frontières du système sont indiquées en rouge. Elles incluent les processus et les flux considérés. Bien que les processus d'extraction du minerai, sa préparation et l'élaboration de la fonte au haut-fourneau font partie du cycle socio-économique du fer, ils n'ont pas été inclus parce qu'ils ne recyclent pas la ferraille. En conséquence, seuls les flux de la fonte et du minerai de fer préréduit sont considérés car ils représentent les imports du système. Les processus du système sont groupés en quatre étapes du cycle de vie : « la production », « la fabrication », « l'utilisation » et « la gestion des déchets et le recyclage ».

L'étape de la production inclus trois processus de production d'acier – convertisseur à l'oxygène (BOF), four électrique à l'arc (EAF) et four Martin (OHF), ainsi que les fonderies. Actuellement, l'acier n'est plus produits par les fours Martin en Europe ; ils sont néanmoins inclus compte tenu de l'étendue de l'échelle temporelle. Ces quatre processus sont alimentés par les flux de fonte brute, de ferraille et de minerai de fer préréduit. La génération de ferraille interne et de co-produits contenant du fer est prise en compte (flèches grises). Le processus de fabrication des produits sidérurgique finis (Rolling and finishing) transforme l'acier brut en produits d'acier (produits longs et plats issus du laminage à chaud, et tôles laminées à froid). Ce processus génère lui aussi de la ferraille interne, consommée dans les fours sidérurgiques. Les co-produits contenant le fer sont également pris en compte.

L'étape de la fabrication correspond à la fabrication de produits finis contenant de l'acier et de la fonte. Cette étude intègre également la répartition des produits finaux en acier et en fonte dans les différents secteurs industriels. En effet, la quantité de la ferraille neuve formée au cours de la production de biens diffère selon le secteur.

Au cours de l'étape d'utilisation, les produits contenant de l'acier forment un stock de matériaux, qui sera disponible pour le recyclage après leur rejet par les consommateurs en fin de vie. La distribution du fer par secteur industriel permet d'appliquer une durée de vie représentative pour chaque secteur. Dans le cadre de cette étude, la durée de vie est définie comme la période de temps durant laquelle les produits finis sont utilisés sur le territoire d'un pays [38]. Le flux entrant au processus d'utilisation est donc distribué entre les différents secteurs industriels de manière à pouvoir associer une durée de vie en fonction de l'usage. Le stock de matériaux inclus les périodes d'usage effectif et quand l'usage du produit est en hibernation (figure E-2), comme par exemple entre deux utilisateurs ou lors de son stockage avant la fin de vie.

Durant l'usage, des pertes en fer peuvent avoir lieu, dues à la corrosion ou à l'usure. Ces deux phénomènes sont fortement liés au contexte d'utilisation et ne sont pas constants dans le temps. Par exemple, la corrosion est impactée par l'environnement d'utilisation (humidité, polluants, changement de température) et par les mesures de protection prises pour ralentir le phénomène (revêtements, peinture). L'usure, elle, est principalement liée à des phénomènes de friction dépendant également du contexte ; elle est indirectement prise en compte dans le flux des pièces détachées.



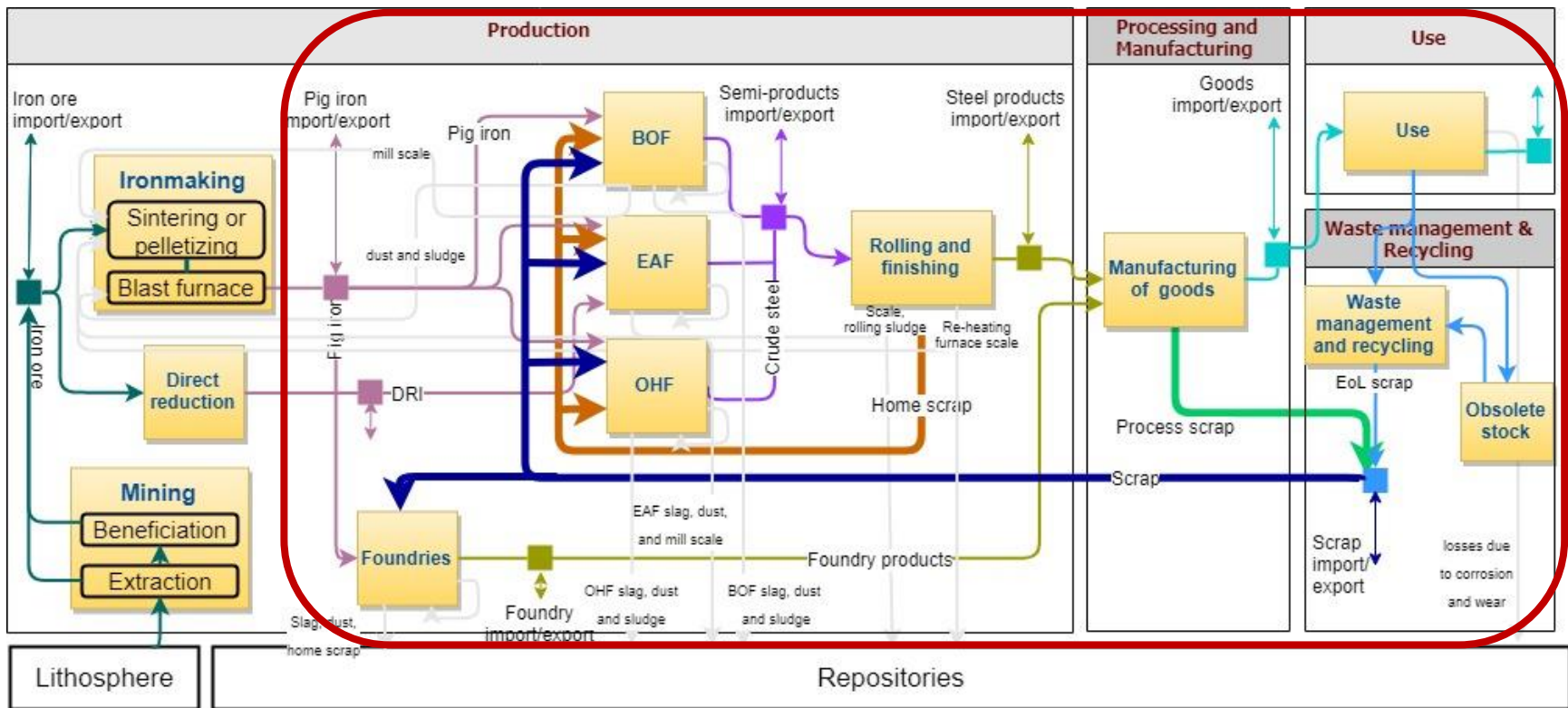

Figure E-1 Flux et processus pris en compte dans l'étude

Afin d'intégrer la corrosion et l'usure comme paramètres robustes dans le modèle, une analyse plus approfondie est nécessaire (non réalisée durant cette étude). Le processus d'utilisation modélisé ici est donc un cas simplifié où le flux entrant est égal au flux sortant, ne prenant pas en compte la quantité de matière perdue par la corrosion et l'usure.

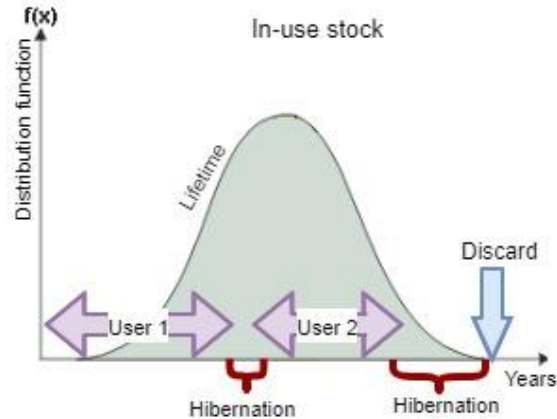

Figure E-2 Illustration du stock en utilisation

Enfin, la dernière étape concerne la gestion des déchets et leur recyclage, qui comprend deux processus: (i) la gestion et le recyclage des déchets et (ii) le stock obsolète (figure E-3). Le premier processus combine la collecte des produits en fin de vie et leur prétraitement (démantèlement manuel et/ou mécanique pour libérer les matériaux, qui sont ensuite triés en fonction du type et de la source). Ce processus est alimenté aussi par la ferraille neuve, qui est collectée et traitée par les recycleurs. Grâce aux propriétés magnétiques, le fer dans la composition de l'acier et de la fonte peut être facilement séparé des autres matériaux à l'aide de la séparation magnétique [39], [40]. Néanmoins, des pertes peuvent survenir pour des raisons liées à la conception du produit ou à la technologie de démantèlement (par exemple, les matériaux ne sont pas totalement libérés, paramètres techniques des aimants). Ces pertes ne sont pas prises en compte dans les précédentes études AFM, probablement en raison de contraintes de disponibilité des données et de la prise en compte des propriétés magnétiques élevées des métaux ferreux. La présente étude exclu également cette source de perte de fer.

Le stock obsolète est composé de fer rejeté par le processus d'utilisation mais non collecté par le processus de gestion des déchets et de recyclage ; par conséquent, ce stock reste dans l'anthroposphère [17], [18]. Des exemples de stocks obsolètes sont les infrastructures abandonnées, les navires coulés, les décharges illégales, les décharges fermées.



Figure E-3 Relation entre le stock en utilisation, le stock obsolète et le processus de la gestion des déchets et recyclage

A chaque étape les flux sont corrigés par les imports et exports de manière à être représentatifs de ce qui est consommé sur le territoire de l'étude.

En résumé, la prise en compte des processus et des flux liés aux étapes de production, fabrication, utilisation et gestion des déchets et recyclage permet de modéliser la génération de différents types de ferraille (interne, neuve et vieille, illustrés par des flèches plus grandes sur la figure E-1). Ces processus sont essentiels à l'estimation du stock et de l'efficacité du recyclage.

### **3.3 Collecte des données**

La collecte des données a été réalisée en collaboration avec deux associations de professionnels de l'acier - Eurofer (Jeroen Vermeij, Freddy Caufriez, Donato Marchetti and Aurelio Braconi) et Worldsteel (Adam Szewczyk, Henk Reimink, Clare Broadbent). Les données ont aussi été collectées depuis la base de données de British Geological Survey (BGS) et «The International History Statistic 1750-1988 » [41].

Pour l'étape de production, les sources statistiques fournissent des données de production et de commerce pour les flux de la fonte, de la fonte brute, de l'acier et des produits finis en acier. L'étude de diverses sources de données statistiques a permis d'identifier une grande quantité de données cohérentes sur la production de fonte brute et d'acier brut. En ce qui concerne les flux ultérieurs de production d'acier finis et ses importations et exportations, les limites suivantes ont été identifiées:

- Les données sur la production de produits finis en acier ne couvrent pas la période spatiale et temporelle étudiée. De plus, les données rapportées ne respectent pas le bilan de masse avec la consommation d'acier brut au niveau des pays. Par conséquent, ces données ne sont pas utilisables et doivent plutôt être calculées de manière à respecter le bilan de masse.
- Les données sur les importations et les exportations de produits finis en acier sont fournies par Comtrade selon deux classifications - SITC Rev.1 et HS, qui donnent différentes quantités échangées pour tous les pays d'UE. Afin de corriger cela, les données sur la consommation sont utilisées.

Pour les étapes suivantes, les données disponibles concernent seulement le commerce. Pour l'étape de la fabrication, c'est le commerce indirect - le commerce du fer et de l'acier faisant partie de produits manufacturés. En accord avec les experts, une estimation de Worldsteel a été appliquée au lieu de calcul à partir des données de UN Comtrade. Pour l'étape de l'utilisation, il n'existe pas de données statistiques. Le commerce des produits de seconde main n'est pas rapporté. Cette étude n'est donc pas en mesure de le prendre en compte, et ce commerce est inclus dans le commerce indirect. Les seuls flux signalés dans les statistiques relatives à l'étape de la gestion des déchets et leur recyclage sont les importations et les exportations de la ferraille.

La figure E-4 résume les méthodes utilisées pour estimer chaque flux.

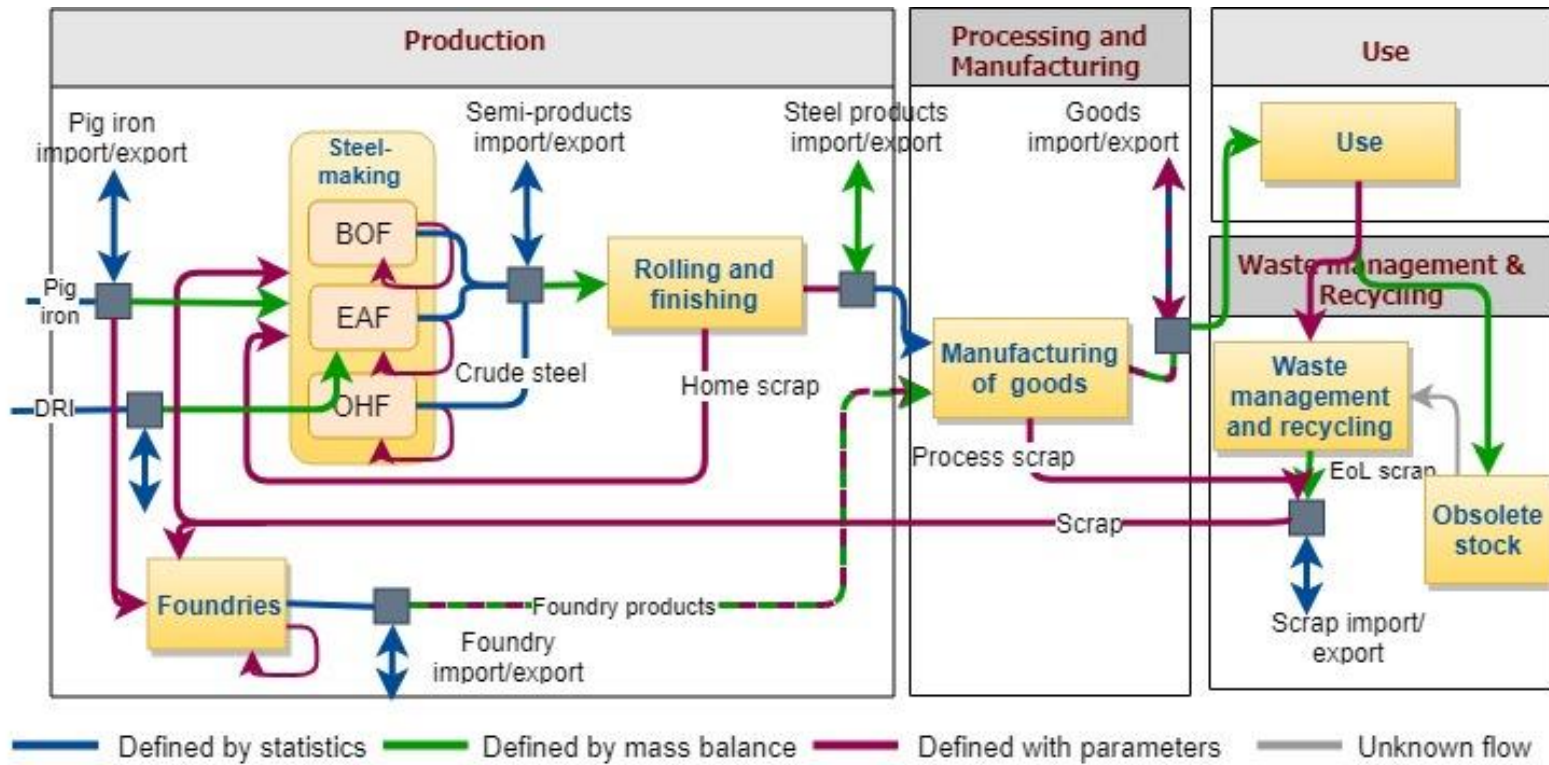

Figure E-4 Illustration des méthodes utilisées pour la quantification des flux

### 3.4 Modélisation des flux de matière et des stocks

Afin d'établir la balance de masse pour chaque processus de la phase de production, il est nécessaire d'estimer :

- les flux entrants (fonte brute et ferraille) en fonction du processus sidérurgique et pour les fonderies;
- la génération de co-produits ;
- la génération de la ferraille interne en prenant en compte l'amélioration du rendement de la phase de production suite à l'intégration du process de coulée continue ;
- le contenu en fer de chaque flux : la fonte brute, la fonte, l'acier, les co-produits.

La balance de masse spécifique à chaque processus de cette phase a été établi en collaboration avec des experts industriels (J.-P. Birat et P. Russo). Pour les process de BOF, EAF et OHF, la balance est établie pour une tonne d'acier produit, car les données sur la production d'acier sont considérées de meilleure qualité comparativement aux données de la production de la fonte brute. En effet, l'acier étant vendu, sa quantité est bien comptabilisée. Pour le process de la fabrication de produits sidérurgique la balance de masse est établie pour une tonne d'acier entrant, ce qui permet de calculer la quantité de la ferraille interne générée par une tonne d'acier produite.

La figure E-5 illustre le bilan de masse pour BOF applicable à l'année 2015 à titre d'exemple des bilans établis pour chaque process. Compte tenu de la génération dynamique de ferraille interne, les flux d'entrée de fer vers le BOF sont également dynamiques: plus la quantité de ferraille produite au cours du processus est élevée, plus l'apport en fer est élevé (Figure E-6). La génération de la ferraille est le seul paramètre dynamique. Aucune donnée historique n'a été identifiée pour les co-produits. Ainsi, les données actuelles (2015) sur les laitiers, les poussières et la boue sont appliquées entre 1945 et 2015, ce qui sous-estime leur génération dans le temps. Les teneurs en fer de tous les flux sont aussi supposés constants durant la période 1945-2015.

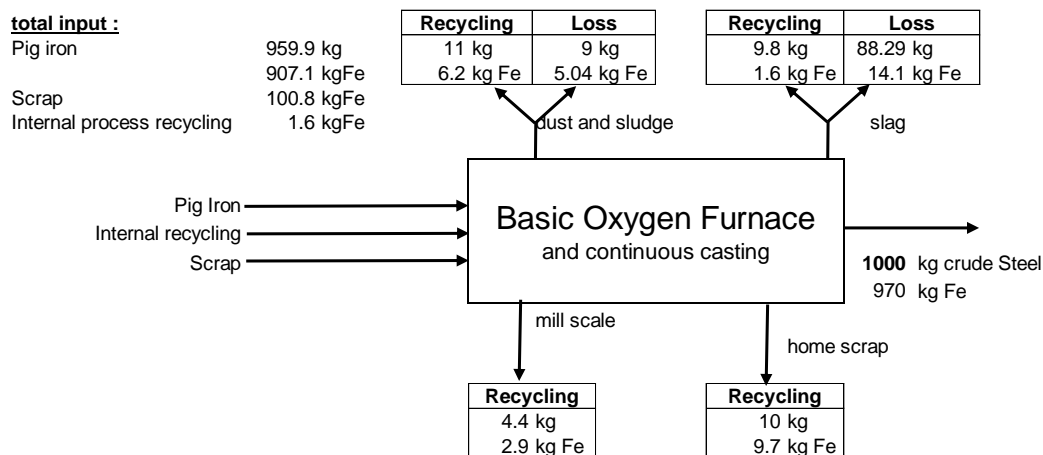

Figure E-5 Flux entrant et sortant de processus BOF en 2015

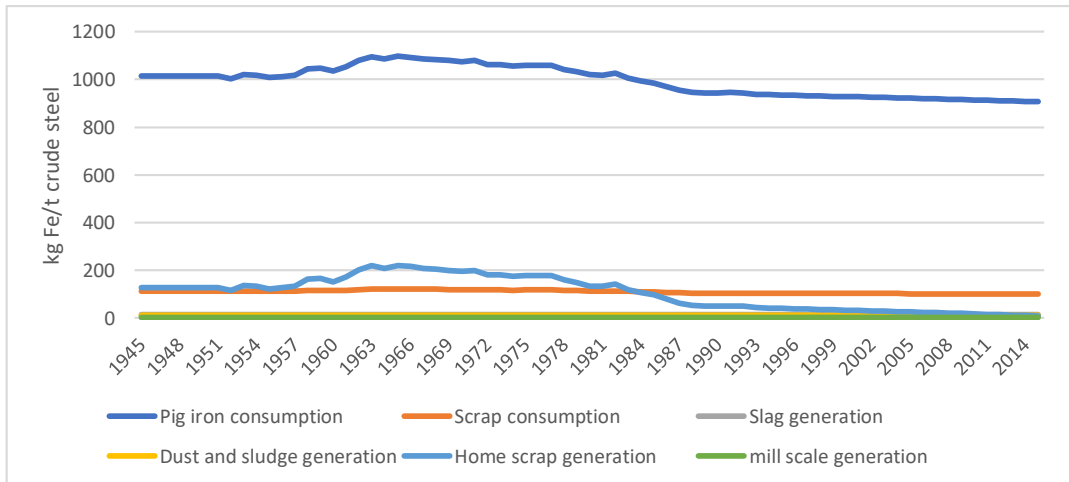

Figure E-6 Flux entrant et sortant de processus BOF, 1945-2015

Les flux massiques associés au processus de fabrication sont les flux d'entrée des produits sidérurgiques et des produits moulés de la fonte, et les flux de sortie des biens finaux et de ferraille neuve. Le flux des biens finaux contenant le fer commercialisé (indirect trade) est également inclus dans cette phase. Les paramètres suivants ont été définis pour quantifier ces flux :

- distribution de produits en acier par type ;
- distribution de produits en acier par secteur industriel ;
- distribution de produits moulés par secteur industriel ;
- génération de ferraille par type de produit sidérurgique et par secteur industriel ;
- amélioration historique de la production de ferraille neuve.

La présente étude utilise des données fournies par Eurofer, qui détaille la distribution des produits en acier dans tous les secteurs industriels sous la forme de matrices spécifiques à chaque pays. Ces matrices sont construites tous les cinq ans de 1995 à 2010, sur la base des enquêtes des membres et de l'activité économique des secteurs industriels (rapportée par Oxford Economics). Ces données permettent de dépasser certaines des limites montrées dans la littérature [16]:

- les matrices sont basées sur la classification NACE des secteurs industriels, de sorte qu'il est possible de connaître précisément les types de produits qui sont inclus dans chaque secteur;
- étant basées sur les données de l'évolution de l'activité économique des secteurs industriels, ces matrices reflètent la consommation de produits sidérurgiques produits dans les pays, mais aussi la consommation des produits importés.

Ainsi, même si ces matrices ne correspondent pas complètement au périmètre temporel et spatial, elles représentent néanmoins une source d'information précieuse qui n'avait jusqu'ici pas encore été utilisée dans les études dynamiques. Pour la distribution de produits moulés par secteur industriel les données rapportées par l'Association européenne des fonderies (CAEF) sont appliquées à tous les pays pour la période 1945-2015, en tant que source la plus complète correspondant au périmètre européen [42].

Une matrice globale a alors été élaborée à partir de ces matrices Eurofer et de la littérature, pour estimer la génération de la ferraille neuve spécifique par secteur et par produit (tableau E-1). L'accent est mis sur les études fournissant des informations sur le périmètre européen et présentant des taux spécifiques par

secteur [12], [19], [25], [26], [29]. La matrice de génération de ferraille neuve a été revue et validée par des experts industriels.

Le taux de production de ferraille neuve déterminé par Cullen et al. [12] est pris ici comme base pour la définition des taux. La présente étude permet donc, pour la première fois, d'estimer la production de ferraille neuve en fonction du type de produit en acier et du secteur industriel qui l'utilise en EU-27 durant la période 1945-2015, selon les hypothèses suivantes :

- les valeurs rapportées sont collectées pour le périmètre mondial [12], et doivent donc être revues pour le périmètre européen en collaboration avec les experts industriels.
- les liens entre les produits de l'acier et les secteurs industriels ne sont pas tous pris en compte par Cullen et al. par rapport aux matrices Eurofer. Ainsi, lorsqu'ils sont rapportés, le taux de la ferraille neuve est appliqué, sinon un taux spécifique au secteur issu de la littérature est utilisé.

Les valeurs pour le paramètre de l'amélioration historique de la production de la ferraille neuve ont été extraites des données acquises par d'ArcelorsMittal dans les années 1990 [24], [25], [29].

Tableau E-1 Paramètres appliqués pour quantifier le flux de la ferraille neuve

	Construction	Mechanical Engineering	Automotive Industry	Domestic Electrical Equipment	Other Transport	Metal Goods	Other sectors
HR Wide and Narrow Strip	10%	12%	19%	14%	11%	25%	5%
Quarto Plate	10%	20%	19%	14%	20%	25%	5%
Cold Rolled Sheet	10%	40%	19%	20%	11%	30%	5%
Hot Dipped Coated	10%	12%	40%	14%	11%	9%	5%
Electro Coated	6%	20%	19%	14%	11%	9%	5%
Organic Coated	6%	12%	19%	20%	11%	30%	5%
Tin Plate	6%	12%	19%	14%	11%	9%	12%
Heavy Section	5%	5%	5%	5%	5%	5%	5%
Reinforcing Bar	5%	5%	5%	5%	5%	5%	5%
Wire Rod	5%	10%	10%	14%	10%	20%	5%
Merchant Bar	10%	20%	20%	14%	20%	30%	5%
Other Products	6%	12%	19%	14%	11%	9%	5%
Legend:	Source: Cullen et al. 2012	Source: Hatayama et al. 2010	Source: expert judgment	Source: Usinor data			

Les données historiques sur les flux d'acier et de fonte, exprimées en termes de teneur en fer, sont compilées pour calculer les flux entrants dans le stock d'utilisation. Le flux de sortie du stock en cours d'utilisation est calculé en appliquant la distribution de durée de vie spécifique par secteur. La durée de vie est définie à partir de publications scientifiques et de la base de données Lifespan database for Vehicles, Equipment, and Structures [38]. Il est néanmoins difficile de définir précisément la durée de vie de certains biens, il est donc aussi nécessaire de s'appuyer sur l'avis d'experts afin de valider certaines de ces hypothèses.

La distribution de Weibull est largement utilisée pour modéliser les distributions de vie en raison de sa flexibilité à prendre différentes formes. Différents types de comportement peuvent en effet être modélisés, en fonction du réglage des paramètres de cette distribution : décroissant, constant ou croissant. Cette distribution permet également à tous les produits de sortir de la phase d'utilisation [43]. Melo a démontré que la distribution de Weibull est pertinente pour décrire la durée de vie de nombreux types de biens [44], ce qui a été confirmé par d'autres études [45]. Cette distribution est, notamment, bien adaptée à la durée de vie des automobiles [46]–[48].

La variable aléatoire à densité de Weibull est définie comme suit :

$$f(x) = \frac{\alpha}{\beta} \left( \frac{x - \gamma}{\beta} \right)^{\alpha-1} \cdot \exp \left( - \left( \frac{x - \gamma}{\beta} \right)^\alpha \right)$$

où :

- le paramètre de forme  $\alpha$  détermine la forme de base de la fonction: s'il est inférieur à 1, le taux de défaillance diminue avec le temps, s'il est égal à 1, le taux de défaillance est constant et s'il est supérieur à 1, le taux de défaillance augmente avec le temps;
- le paramètre d'échelle  $\beta$  détermine son étirement horizontal;
- le paramètre de localisation  $\gamma$  positionne la distribution en abscisse.

La présente étude applique des paramètres de Weibull définis majoritairement par Davis et al. [5] avec les particularités suivantes :

- ces valeurs sont celles trouvées pour le Royaume-Uni ;
- aucune donnée n'est disponible pour les pays européens. Par conséquent, il est supposé que les paramètres choisis ici sont équivalents pour tous les pays européens.
- la catégorie équipement électronique domestique n'est pas utilisée dans l'étude de Davis et al. [5]. Ainsi, la durée de vie de ces biens pour les pays européens est extraite de la base de données LIVES [38].
- La durée de vie de 25 ans pour les « autres secteurs » a été considérée comme élevée par les experts industriels et a été ramenée à 7 ans.

Le tableau E-2 résume les durées de vie et les paramètres de la distribution de Weibull appliqués dans la présente étude.

*Tableau E-2 Paramètres Weibull appliqués pour modéliser le flux sortant d'utilisation*

End use sector	Average lifetime (years)	Weibull scale parameter	Weibull shape parameter
Construction	60	65.3	5
Automotive	13	14.2	3,6
Domestic electronic equipment	10	10	2,4
Other transport	60	65.3	5
Mechanical engineering	16	16.28	5
Metal goods	13	14.2	5
Other sectors	7	7	5



Le stock initial est lui aussi estimé avec une approche top-down. Le stock initial en 1945 a une influence directe sur le stock au cours de la période étudiée - le fer et l'acier produits avant 1945 sont effectivement recyclés après 1945. L'estimation de ce stock initial est basée sur des données statistiques pour la période 1850-1944 portant sur:

- la production de fonte, rapportée par Mitchell [41];
- le commerce de la fonte, rapporté par le BGS;
- la production d'acier brut, rapportée par Mitchell [41].

#### 4. Définition des indicateurs de recyclage

Quatre indicateurs pour le recyclage sont sélectionnés en collaboration avec les partenaires industriels et sur base de la littérature [4], [7], [49]. La figure E-7 illustre un cycle métallique simplifié décrivant les flux utilisés pour le calcul des indicateurs de recyclage sélectionnés :

1. Le taux de recyclage de la vieille ferraille (EoL RR), qui reflète la fraction de la vieille ferraille consommée par rapport à sa disponibilité totale :

$$EoL\ RR = \frac{g}{e}$$

Cet indicateur est bien établi et utilisé.

2. Le taux global d'efficacité du recyclage (ORER – Overall Recycling Efficiency Rate), exprimant la relation entre la quantité totale de ferraille consommée et la quantité totale de ferraille disponible :

$$ORER = \frac{l + k}{h + e}$$

Cet indicateur ne prend pas en compte le commerce de la ferraille, il reflète donc la relation entre la ferraille générée et la demande. ORER n'est pas lié à l'efficacité de recyclage, mais montre plutôt la dépendance de la production d'acier et de fonte de ferraille. Cet indicateur est inclus, car d'autres indicateurs peuvent en être dérivés.

3. ORER+t est le complément d'ORER par les flux de ferraille commercialisés afin de comparer la quantité collectée et traitée à la quantité générée. Cet indicateur est aussi similaire à EoL RR, il le complète en prenant en compte la ferraille neuve. L'inclusion de la ferraille dans un indicateur de recyclage augmente le taux de recyclage, car la ferraille neuve a un taux de collecte proche de 100%. De plus, la production élevée de la ferraille neuve peut être le résultat d'une inefficacité des processus qui la génère.

4. ArcelorMittal a demandé à compléter ce dernier indicateur par la ferraille interne et à comparer ainsi la ferraille traitée de trois sources à la quantité totale de ferraille disponible. Cet indicateur reflète également la fermeture du cycle de la matière, puisque l'utilisation de la ferraille interne réduit la consommation de matières vierges. Cet indicateur est référencé plus loin par ORER + t + h

$$ORER + t + h = \frac{i + j + l + k + o}{i + j + h + e}$$

Comme on peut le constater, l'indicateurs ORER et ses dérivés ont une forte corrélation avec le EoL RR, puisque ils sont calculés sur la base des mêmes flux.

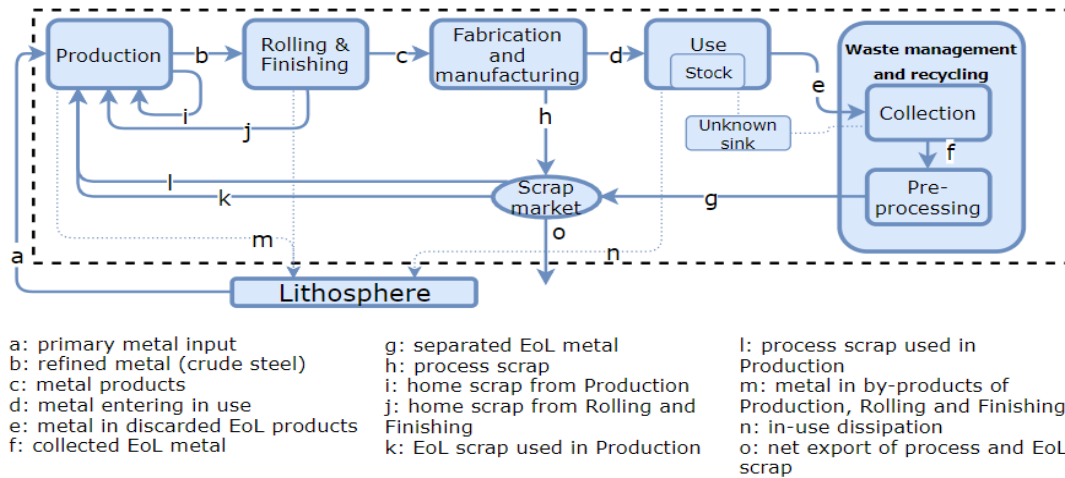

Figure E-7 Flux du cycle d'acier simplifié (adapté de [1])

## 5. Résultats et discussions

Le modèle élaboré permet d'extraire des résultats à différents niveaux :

- La collecte de données annuelles au niveau des pays permet de visualiser le cycle du matériaux ferreux pour une année donnée (correspondant à une étude statique) pour un pays donné. Pour illustrer cela la visualisation des flux de matière de fer est fait pour une période d'un an (2015), distinguant les types de produits en acier et les secteurs industriels ;
- L'approche dynamique permet d'estimer le stock de fer, d'analyser son évolution et sa répartition par secteur industriel. Les résultats du stock en cours d'utilisation sont fournis pour les niveaux régional et national entre 1945 et 2015 et comparés à ceux des études antérieures.
- Le modèle estime également le flux de fer rejeté du stock et (théoriquement) disponible pour le recyclage. Ce résultat est analysé par secteur industriel, comparé aux études précédentes et aux données industrielles.
- Les indicateurs de recyclage sont ensuite calculés sur la base de flux modélisés.

### AFM de fer pour l'EU-27 en 2015

Un diagramme de Sankey est utilisé pour visualiser le cycle du matériau du fer (figure E-8). Ce diagramme permet de présenter les flux calculés dans une représentation graphique concise, afin de donner une vision complète des flux de matériaux modélisés. Il met en évidence le système étudié et illustre tous les flux calculés, ainsi que la relation entre les processus tels que définis dans le modèle. La largeur des flèches reflète l'importance du flux en terme de tonnage.

La figure E-6 synthétise les flux d'acier et de fonte dans l'UE-27 pour l'année 2015 dans les limites définies: de la production d'acier et de fonte à leur traitement ultérieur, leur fabrication, leur utilisation et leur recyclage. Tous les flux sont exprimés en termes de teneur en fer. Cette analyse montre que dans l'UE-27, 54% du fer entré en sidérurgie provient des ressources primaires (fonte brute et minerai préproduit), 46% de la ferraille (37,3% de ferraille neuve et 8,7% de ferraille interne).

# MFA of iron, EU-27, 2015

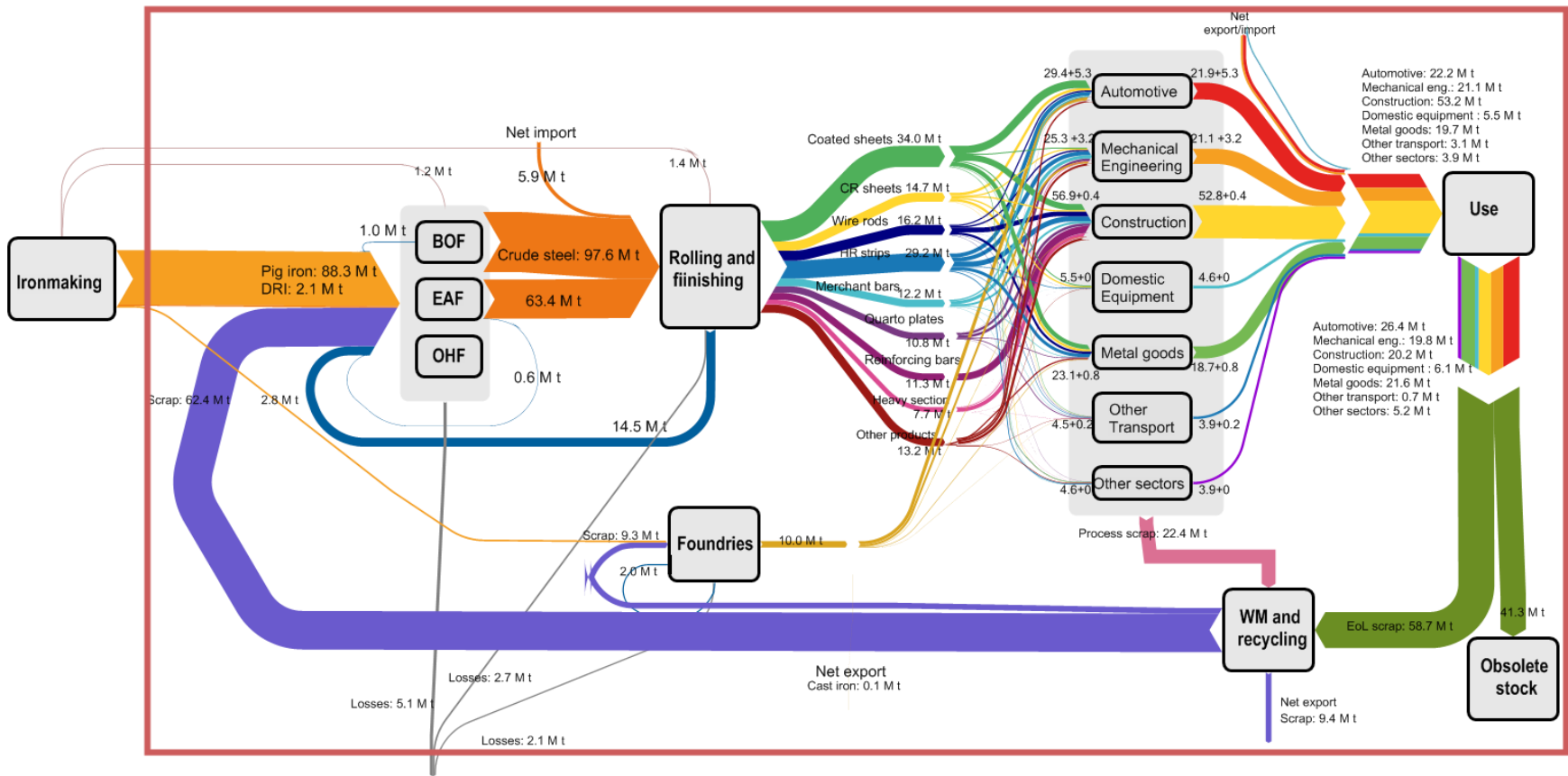

Figure E-8 AFM de fer dans l'UE-27, 2015

Le flux issu du processus d'utilisation est calculé à partir de la distribution de durée de vie spécifique par secteur. Ce flux est lié à la production passée, et rejetée en 2015. Le modèle estime que 100 Mt de fer ont été disponible pour le recyclage en l'UE-27 en 2015. 58,7% de ce flux ont été collectés et traités dans l'UE-27 pour être commercialisés ou consommés dans des aciéries et des fonderies. La différence entre le flux de fer rejeté modélisé et le flux de EoL collecté, soit 41,3% du total rejeté, constitue le flux qui entre dans le stock obsolète.

### Stock en utilisation dans l'EU-27

La figure E-9 illustre l'évolution du stock de fer en utilisation entre 1945 et 2015 pour l'UE-27. Les résultats montrent que le stock de fer augmente constamment avec le temps, passant de 555 Mt en 1945 à 3 678 Mt en 2015. Le fer est principalement stocké dans la construction (70%), suivi du secteur automobile et de la construction mécanique (9% chacun).

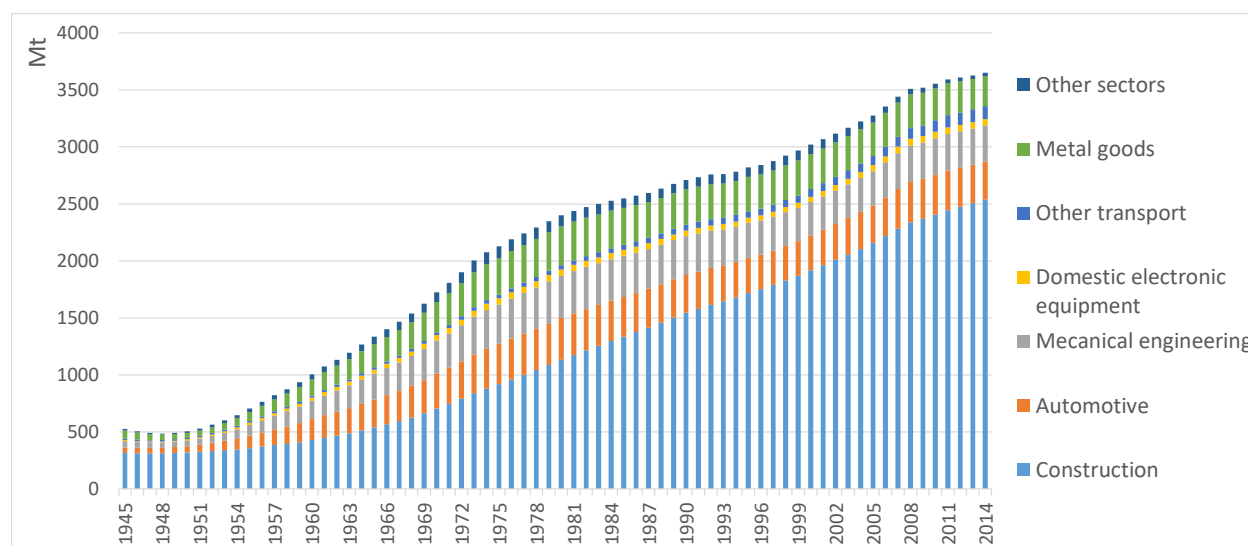

Figure E-9 Evolution du stock de fer dans l' EU-27, 1945-2015

En termes de stock par habitant, en 2015, le stock de fer est égal à 7,3 t / cap. Ce résultat est difficile à comparer à d'autres études AFM dynamiques car ils ne couvrent pas le périmètre de l'UE-27. Par exemple, Hatayama a déterminé qu'en 2005 le stock d'acier en Europe est de 2 milliards de tonnes, ce qui correspond à 5,1 t / cap [28]. Ce chiffre est inférieur à celui de la présente étude (6,9 t / cap), probablement à cause des pays inclus: Hatayama étudie uniquement Belgique-Luxembourg, Allemagne, Grèce, Norvège, Espagne, Turquie, Royaume-Uni, et ne prend pas en compte au moins trois pays à forte consommation d'acier - l'Italie, la France et l'Espagne. Les résultats du stock en cours d'utilisation sont néanmoins comparés aux études précédentes au niveau des pays pour lesquels les données sont disponibles.

Les stocks de fer en utilisation les plus élevés sont observés en Allemagne (722 Mt en 2015), en Italie (608 Mt), au Royaume-Uni (387 Mt), en France (350 Mt) et en Espagne (303 Mt). Ces pays ont les plus grandes consommations de fer et, par conséquent, ont les stocks les plus importants. Les pays ayant le plus petit stock d'utilisation sont Malte (1,4 Mt), l'Estonie (5,6 Mt), Chypre (6 Mt), la Lettonie (6,3 Mt) et la Lituanie (8,5 Mt). Leur production d'acier est très petite ou nulle et, par conséquent, leur consommation est basée essentiellement, voir uniquement, des importations.

Les pays européens peuvent être subdivisés en deux groupes sur la base de la structure de l'évolution du stock de fer en service : le premier groupe est caractérisé par une croissance régulière du stock en service sur la période 1945-2015, tandis que pour le deuxième groupe, l'évolution du stock d'utilisation ne progresse pas de manière uniforme. Pour mieux comprendre ces variations, les résultats du stock en cours d'utilisation sont replacés dans leur contexte historique. Les conditions politiques ont un impact sur la consommation d'acier: cela peut être dû à des tarifs commerciaux imposés ou à d'autres facteurs externes tels que les guerres, les conflits, les changements de régime, la volatilité des marchés, etc.

Le premier groupe comprend la plupart des pays d'Europe occidentale (Autriche, Belgique-Luxembourg, Danemark, Finlande, Allemagne, Italie, Malte, Portugal et Espagne) et des pays baltes (Estonie, Lettonie et Lituanie). La création de la Communauté européenne du charbon et de l'acier, coalition économique autour du charbon et de l'acier en 1951, a contribué à la croissance non seulement de la production, mais a également stimulé les importations et les exportations de produits sidérurgiques. Une augmentation régulière du stock de fer est observée pour ces pays sur toute la période 1945-2015.

Le deuxième groupe de pays est caractérisé par des variations de stock en corrélation avec les périodes de crise économique :

- A la fin des années 1970, on observe une diminution du stock en utilisation en France et en Suède, tandis qu'aux Pays-Bas et au Royaume-Uni le stock montre plutôt une légère baisse ou stagnation. Cela peut s'expliquer par la crise pétrolière de 1973. La demande d'acier a drastiquement diminué entre 1973 et 1975, ce qui a eu un impact sur les résultats du stock en utilisation.
- Les pays d'Europe de l'Est (Bulgarie, République Tchèque, Slovaquie, Hongrie, Pologne, Roumanie) avaient un stock décroissant au début des années 1990 en raison de la baisse de la consommation d'acier liée à l'effondrement du rideau de fer et des économies communistes.
- Enfin, une baisse des stocks est observée à Chypre, en Grèce, en Irlande et au Royaume-Uni à la fin des années 2000, ce qui est corrélé avec la crise de 2008. Les années suivantes ont été économiquement instables, et donc la consommation d'acier l'a été, ce qui impacte le stock en utilisation calculé.

La normalisation des résultats du stock en cours d'utilisation par habitant permet d'aligner les résultats des pays sur une échelle commune. La figure E-10 illustre le stock par habitant dans les pays européens en 2015 et sa répartition par secteur industriel. Le stock le plus élevé est observé en République Tchèque (12,2 t / cap), suivi par l'Autriche, la Slovaquie et l'Italie (10 t / cap), puis en Slovénie (9 t / cap), en Allemagne et Belgique-Luxembourg (8,9 t / cap) . Le stock le plus bas est observé en Lettonie, en Lituanie et à Malte (2,9 - 3,4 t / cap).

Au niveau de l'UE-27, pour tous les pays, le stock de fer contenu dans le secteur de la construction représente la part la plus importante - entre 39% et 87% du stock total de fer. Suivent ensuite, selon les pays, le secteur automobile, les produits métalliques et la construction mécanique. La seule exception à cette tendance est le Danemark, où le deuxième contributeur du stock en service est le secteur des autres transports. Un stock élevé d'autres moyens de transport au Danemark peut s'expliquer par un niveau élevé d'importations indirectes pour ce secteur et la longue durée de vie attribuée à ce secteur.

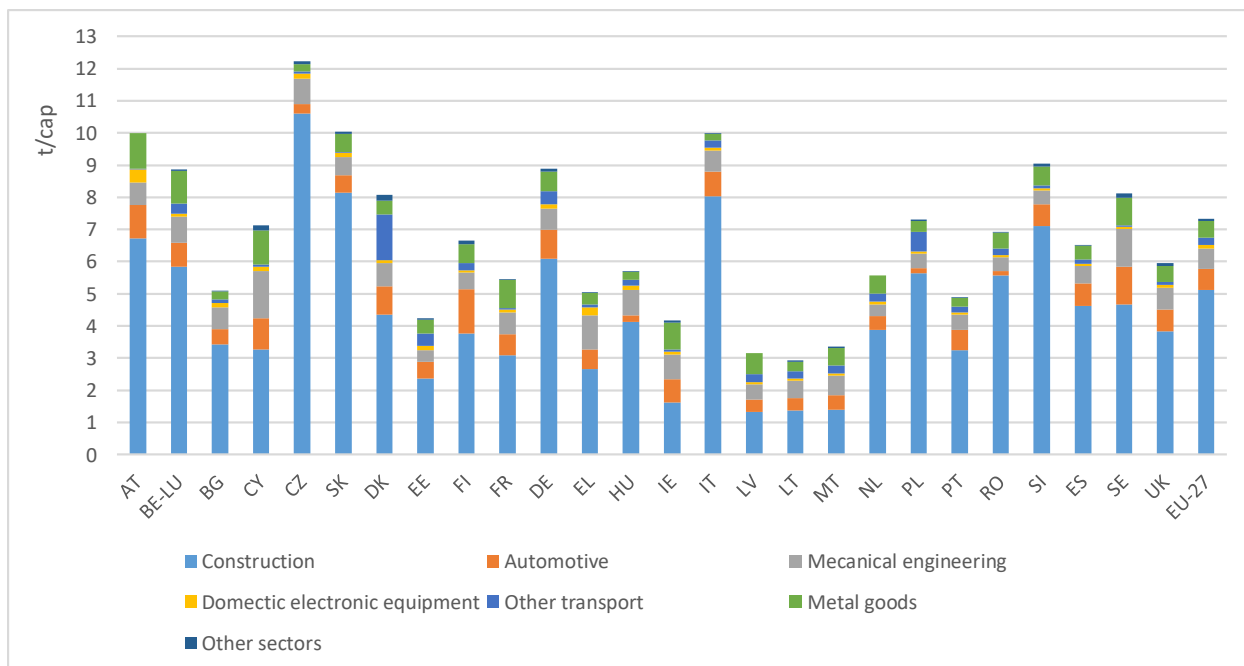

Figure E-10 Stock en utilisation par habitant dans le pays Européens , 2015

Ces résultats sur le stock en utilisation au niveau des pays ont été comparés avec l'étude de Pauliuk et al. pour les pays européens et Muller et al. pour la France et le Royaume-Uni [16], [17]. Les résultats de la présente étude montrent des valeurs plus faibles du stock en cours d'utilisation. Ceci peut être expliqué par les différences entre les paramètres de la répartition du fer entre les secteurs industriels et de durée de vie.

### Disponibilité de la vieille ferraille

Cette partie focalise sur la quantité totale de fer rejetée par le processus d'utilisation, et donc disponible pour le recyclage. Ce flux est la composante clé pour l'estimation des indicateurs de recyclage.

En 2015, le flux de rejets de fer est égal à 100 Mt, soit 2,7% du stock en utilisation. La répartition des rejets de fer par secteur industriel est la suivante: secteur automobile (26% en 2015), produits métalliques (22%), construction et construction mécanique (20% chacun). La figure E-11 illustre cette répartition, en valeur absolue (en haut) et en valeur relative (en bas) par rapport à la quantité totale rejetée. Cette répartition par secteurs industriels est alignée avec celle des autres études AMF, de méthodologies similaires. Ainsi il est intéressant de confronter ces résultats à ceux du modèle ad-hoc de Russo [6], qui obtient pour sa part que la majorité de la vieille ferraille provient de la construction (42%), de l'ingénierie mécanique (26.6%) et du secteur automobile (24%).

L'analyse du paramètre de durée de vie a montré que le secteur de la construction est le secteur le plus impactant sur les résultats de la disponibilité de la vieille ferraille : en diminuant ce paramètre, il est possible d'obtenir un modèle dans lequel la plupart de la vieille ferraille provient de ce secteur.

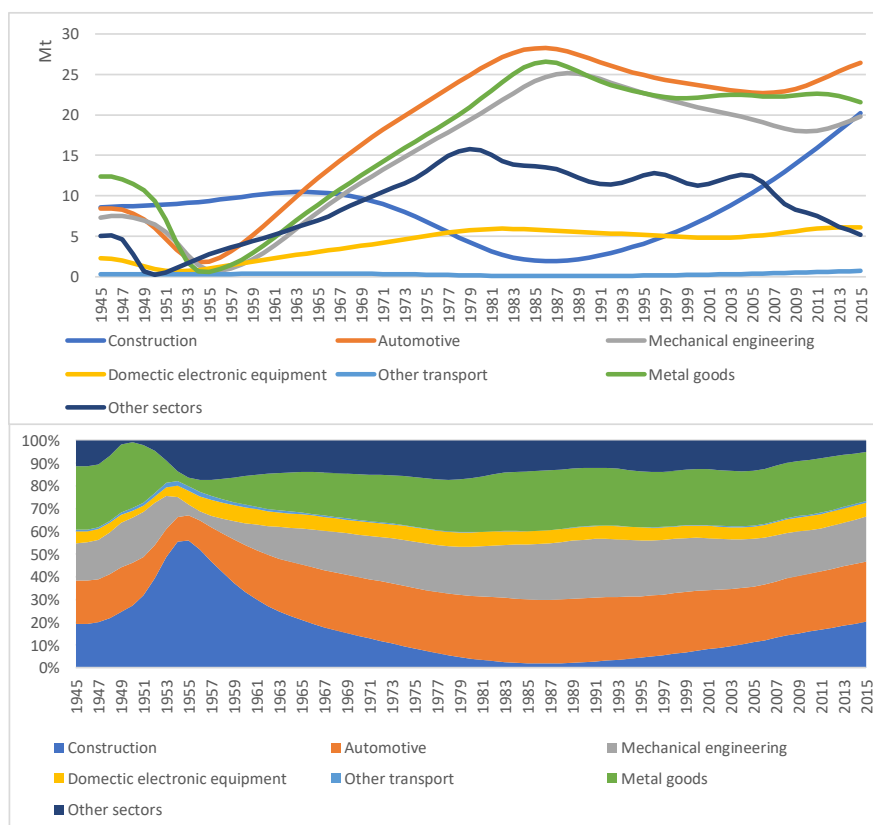

Figure E-11 Génération de la vieille ferraille par secteur industriel of EoL, EU-27, 1945-2015

### Indicateurs du recyclage

La figure E-12 illustre le EoL RR pour l'UE-27 entre 1945 et 2015. Au cours de la période 1953-1957, le contenu recyclé calculé est supérieur à 100%; cela peut s'expliquer par l'impact du stock initial sur la disponibilité de la vieille ferraille. A partir de 1970, lorsque les données statistiques sont de meilleure qualité et que la production n'est plus affectée par le rejet du stock initial, le EoL RR moyen est de 65%, variant de 57% à 79%.

La figure E-13 montre la valeur moyenne de l'indicateur EoL RR pour la période 1970-2015 pour les pays européens. Au niveau de pays les valeurs extrêmes (inférieures à zéro ou supérieures à 100%) rendent difficile l'élaboration d'une tendance claire dans la distribution par pays de cet indicateur. En effet, ce calcul est influencé par les importations et les exportations aux niveaux suivants:

- la consommation de ferraille est influencée par le commerce de la fonte: des importations nettes plus élevées entraînent une consommation plus élevée de fonte et, par conséquent, une réduction de la consommation de ferraille;
- la quantité de la ferraille collectée et préparée pour la consommation est influencée par le commerce de la ferraille.

L'évolution de l'indicateur ORER pour l'UE-27 entre 1945 et 2015 est donnée à la figure E-14. Cet indicateur ne dépend pas du commerce de la ferraille. Les valeurs supérieures à 100% ne sont pas

surprenantes : cela signifie que le pays utilise plus de ferraille qu'il n'en génère. Ainsi, les pays ayant une part importante de production d'acier dans le processus de production EAF affichent des valeurs plus élevées pour cet indicateur (Espagne, Italie, Belgique-Luxembourg).

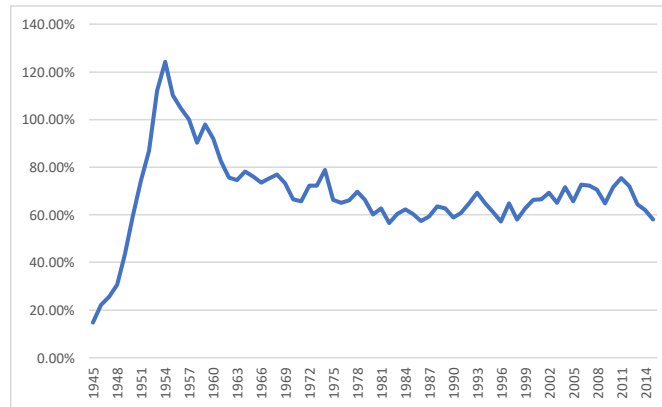

Figure E-12 EoL RR dans l' EU-27, 1945-2015

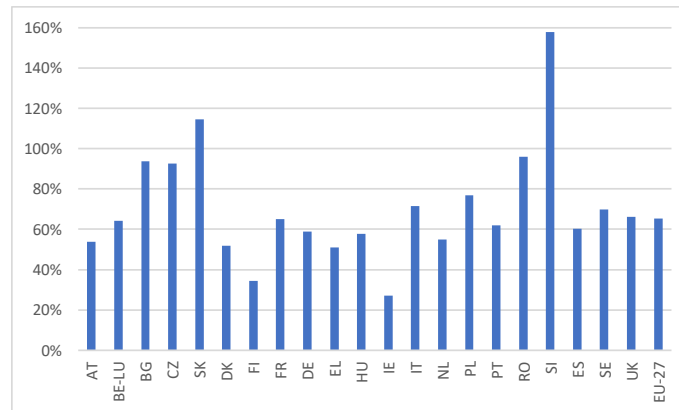

Figure E-13 Valeur moyenne de EoL RR dans l'EU-27, 1970-2015

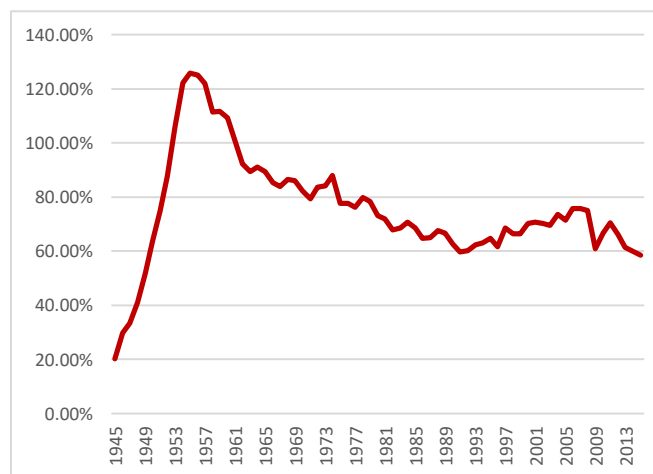

Figure E-14 ORER dans l'EU-27, 1945-2015



Les versions modifiées des indicateurs ORER sont données dans la figure E-15 pour l'UE-27, et cinq pays à titre d'exemple. Les variations des valeurs de ORER+t et ORER+t+h sont similaires à celles de EoL RR car ces indicateurs se basent sur les mêmes flux. Cependant ORER+t et ORER+t+h sont plus élevés que le EoL RR car ils considèrent la production et le recyclage de la ferraille neuve et interne (entièrement collectés et recyclés). ORER est le seul indicateur qui ne considère pas le commerce de la ferraille, et son comportement est donc différent des autres indicateurs illustrés. Relativement élevé par rapport aux autres pays, l'ORER de l'Italie souligne la prédominance de la sidérurgie secondaire sur son territoire (plus de 50% de l'acier produit depuis la fin des années 70).

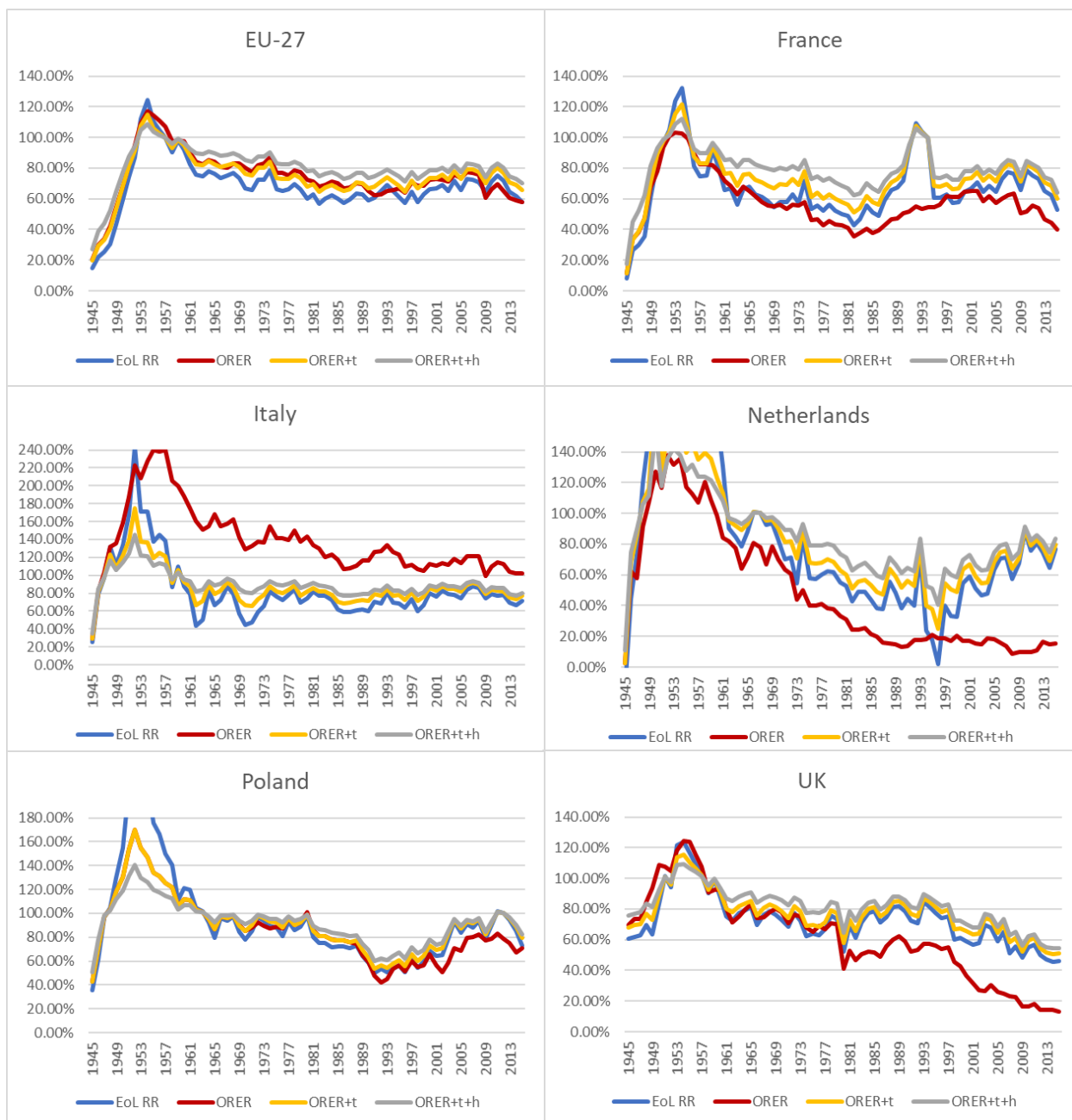

Figure E-15 Indicateurs du recyclage pour le fer dans les pays Européens.

Une partie des sources d'incertitudes a également été étudiée. Les résultats obtenus sur le stock en cours d'utilisation, la production de rebuts de fin de vie et les indicateurs d'efficacité du recyclage dépendent fortement :

- des données statistiques pour le commerce;
- des hypothèses utilisées pour modéliser la distribution du fer par secteurs industriels;
- et des durées de vie respectives.

L'application de différentes classifications (SITC Rev.1 et HS) au calcul de la consommation de produits sidérurgiques n'a pas une grande influence sur la consommation de produits finis en acier au niveau global européen (3% - 5% de différence moyenne en pourcentage, selon la classification et le périmètre comparé), parce que les pays à forte production atténuent ces différences. Néanmoins, au niveau des pays, la différence peut atteindre 60%, notamment pour les pays fortement liés aux importations. La présente étude a utilisé des données « apparent steel use » pour estimer le flux de consommation de produits finis en acier. Cela diminue la quantité de données à manipuler, mais ne permet pas de distinguer production et commerce. Pour améliorer l'estimation du flux de produits sidérurgiques consommés, il est nécessaire d'effectuer une étude approfondie concernant les codes appropriés, la conversion entre les deux classifications n'étant pas simple.

La distribution du fer par secteur industriel a un impact considérable sur le stock en utilisation. Cette étude applique des distributions spécifiques aux pays (matrices Eurofer) depuis 1995; avant 1995, la répartition est supposée identique à celle de 1995. Une source alternative de distribution de l'acier a été identifiée (données Usinor), sur la base des données collectées en France et couvrant la période 1953-1990. Ces données ont été appliquées à l'UE-27 afin de les comparer aux résultats actuels basés sur Eurofer. La distribution d'Usinor se caractérise par une part plus importante de fer utilisée dans les secteurs de la construction et autres transports. Ces secteurs étant caractérisés par de longues durées de vie, le stock d'utilisation qui en résulte est supérieur aux résultats obtenus ici : la différence entre les deux séries varie entre 24% et 44% pour la période 1945-2015. L'application de la distribution d'Usinor conduit à un stock par habitant égal à 9,3 t / cap en 2010, comparé à 7,1 t / cap avec la distribution d'Eurofer.

La durée de vie de la construction a le plus d'impact sur les stocks en utilisation et sur les indicateurs de recyclage, en raison de la part élevée de fer utilisée dans ce secteur et de la longévité de ces biens : les bâtiments et les infrastructures sont construits pour être utilisés pendant des décennies. Ainsi, comme la construction cumule une part importante de fer utilisée depuis longtemps, sa durée de vie a naturellement le plus d'impact parmi les paramètres. La variation des durées de vie montre leur impact sur les résultats du stock en cours d'utilisation et du EoL RR : la diminution de la durée de vie augmente la disponibilité des déchets EoL dans la période étudiée et, par conséquent, diminue la valeur de EoL RR.

Les durées de vie constituent l'une des principales sources d'incertitudes, à la base d'une discussion avec les experts industriels : par exemple, les durées de vie de 60 ans pour la construction et de 13 ans pour les voitures sont jugées respectivement trop longues et trop courtes par les experts. L'amélioration de la définition des fonctions de distribution les plus appropriées et des paramètres liés n'a pas été incluse dans la présente étude. Le modèle actuel pourra donc encore être amélioré sur ce point, une fois que des valeurs de paramètres plus représentatifs auront pu être définis.

## 6. Limites et perspectives

En ce qui concerne les limites de la présente étude, les points suivants peuvent être mentionnés:

- **Méthodologie** : pour calculer les entrants spécifiques au processus de production (fonte brute et ferraille alimentant le BOF, l'EAF et OHF), des bilans de masse spécifiques au processus ont été élaborés et appliqués aux données statistiques sur la production d'acier brut. La comparaison des intrants obtenus avec les données statistiques a d'abord montré une incohérence entre les deux ensembles de données, rendant impossible le calcul d'intrants spécifiques aux processus de fabrication de l'acier. Une première correction, par estimation de la consommation totale de ferraille à partir des données statistiques de la production d'acier brut et de la consommation de fonte brute et de DRI, a été effectuée sur la base des balances de masse. Cette correction a fourni une consommation totale de ferraille correspondant aux données de Worldsteel et respectant le bilan massique. Ce résultat a permis de calculer la quantité de ferraille consommée, collectée et traitée, puis des indicateurs de recyclage.
- Le commerce des biens d'occasion n'est pas pris en compte dans la présente étude. Ces biens ont une incidence sur les résultats des stocks de matériaux. Il existe des études axées sur l'estimation du commerce de seconde main pour les secteurs de l'automobile (par exemple [50], [51]) ; les autres secteurs montrent peu ou pas de données. Une fois ces études disponibles, leur intégration pourra être réalisée dans le modèle, ce qui permettra d'affiner les résultats.
- Les pertes de fer dues à la corrosion et à l'usure ne sont pas étudiées. En effet, ces phénomènes et leurs impacts sur le flux global sont très complexes à modéliser, notamment du fait de leur dynamique inhérente largement dépendante du contexte. Des statistiques de terrain massives se concentrant précisément sur la corrosion et l'usure sont nécessaires pour mieux les intégrer dans un modèle d'AMF. L'impact des pertes de fer sur les résultats de EoL RR est cependant étudié dans deux cas - si 5% de tout le fer sont perdus, et si 10% du flux de fin de vie de construction ne sont pas collectés.
- Il n'existe pas de valeurs précises sur la taille du stock de matériaux ou la disponibilité de la vieille ferraille; les données doivent donc être directement recueillies sur le terrain. Dans ce contexte, la connaissance des experts constitue une base précieuse pour de nombreuses hypothèses. Dans le même temps, les partenaires industriels ont une certaine vision de la disponibilité de la vieille ferraille, basée sur leur expérience, ce qui permet de comparer leur point de vue aux résultats obtenus. Ce manque d'information, partiellement résolu par le présent travail au niveau européen, appelle à renforcer à l'avenir de telles collaborations entre industriels et universitaires. Cette collaboration est indispensable pour aborder la complexité de la problématique traitée, basée sur des estimations de plusieurs décennies, des flux internationaux de matériaux et de leurs diverses utilisations dans l'anthroposphère.

En ce qui concerne les indicateurs de recyclage, EoL RR est un indicateur solide et bien établi pour l'estimation de l'efficacité de recyclage de la vieille ferraille. La disponibilité de la vieille ferraille n'est pas prise en compte dans les statistiques, ainsi l'AMF est une méthode viable pour l'estimation des quantités rejetées. L'estimation du EoL RR est associée aux incertitudes liées au modèle AMF (par exemple, la distribution du fer par secteurs industriels, la distribution sur la durée de vie, etc.) et aux données de la fonte brute et de la ferraille commercialisé. La présente étude n'a pas pu faire la distinction entre la ferraille neuve et vieille dans les flux consommés et consommés. L'estimation de la teneur en fer de ces flux est une autre source d'incertitude.

L'inclusion de la ferraille provenant d'autres sources dans la formule de EoL RR, comme dans les indicateurs ORER + t et ORER + t + h, compare la quantité de ferraille recyclée par rapport à la quantité jetée. Cependant, l'efficacité de la collecte de la ferraille interne et neuve est proche de 100%. Ainsi, leur inclusion dans l'indicateur de recyclage ne fournit pas d'informations supplémentaires sur l'efficacité du recyclage et augmente la valeur de cet indicateur. Cela ne reflète pas non plus le niveau de la fermeture du cycle de fer, car une partie du fer est recyclée en dehors du système étudié. Pour étudier la fermeture du cycle du fer, il est judicieux d'élargir la définition du système afin d'inclure les processus de préparation du minerai de fer et de fabrication de la fonte brute, car ils recyclent le fer issu de sous-produits de la sidérurgie.

En ce qui concerne l'amélioration du modèle, il pourrait être intéressant de mettre l'accent sur la distribution des produits finis en acier entrant en usage. À l'heure actuelle, cette information est utilisée uniquement pour estimer la production de déchets de traitement, selon le type de produit d'acier et le secteur industriel. Le potentiel de cette intégration des produits finis en acier n'est pas pleinement exploité. Par exemple, différents types de produits en acier peuvent être associés à une "fonctionnalité" précise. Sur la base de cette segmentation de second niveau, des durées de vie spécifiques aux composants pourraient être élaborées, améliorant potentiellement l'estimation globale des durées de vie en fonction du secteur industriel et le calcul de la génération de vieille ferraille.

Les résultats du stock en cours d'utilisation, calculés selon une approche descendante du stock (top-down) pourraient également être comparés aux résultats d'une estimation ascendante (bottom-up), qui reste à faire. Cette information peut être utilisée, par exemple, pour la vérification du fer utilisé dans les secteurs industriels.

Enfin, lors de ce projet, un atelier a été organisé à Metz afin de discuter de la méthodologie appliquée dans l'étude. L'atelier a réuni des experts de 10 organisations internationales en France et en Belgique (ArcelorMittal, Worldsteel, Eurofer, ESTEP, European Aluminium Association, Constellium, VITO, IF Steelman, UTT, Université de Lorraine). Les premiers résultats ont été présentés afin de valider, compléter, modifier l'approche, en collectant les opinions et des expertises. Le principal point souligné par les parties prenantes concernait les limites des données statistiques, qui pourraient servir de base à la collaboration entre différentes associations sidérurgiques afin d'harmoniser les classifications, de communiquer sur le processus de collecte des données et les erreurs associées, et de rendre publiques les données et modèles collectés. La création d'une telle base de données pour les études AMF, similaire aux données de l'inventaire du cycle de vie (LCI) pour son utilisation dans l'analyse du cycle de vie (ACV), permettrait de traiter de manière efficace le problème de la collecte des données, et d'améliorer significativement leur qualité (par leur harmonisation notamment).

## Références

- [1] EC, "Communication from the Commission. Europe 2020: A strategy for smart, sustainable and inclusive growth." 2010.
- [2] EC, "Communication from the Commission. Closing the loop - an EU action plan for the Circular Economy." 2015.
- [3] G. C. Gallopín, "Indicators and their use : information for decision-making," in Sustainability indicators. A report on the Project on indicators of sustainable development., B. Moldan and S. Bilharz, Eds. Chichester: Wiley, 1997, pp. 13–27.
- [4] UNEP, "Recycling rates of metals. A Status report," United Nations Environment Programme, 2011.
- [5] J. Davis et al., "Time-dependent material flow analysis of iron and steel in the UK: Part 2. Scrap generation and recycling," *Resources, Conservation and Recycling*, vol. 51, no. 1, pp. 118–140, Jul. 2007.
- [6] P. Russo, "The Steel Recycling Rate," presented at the Society and Materials conference (SAM-9), Luxembourg, 2014.
- [7] W.-Q. Chen, "Recycling Rates of Aluminum in the United States," *Journal of Industrial Ecology*, vol. 17, no. 6, pp. 926–938, 2013.
- [8] P. H. Brunner and H. Rechberger, *Practical Handbook of Material Flow Analysis*. CRC Press LLC, 2004.
- [9] S. Pauliuk and D. B. Müller, "The role of in-use stocks in the social metabolism and in climate change mitigation," *Global Environmental Change*, vol. 24, pp. 132–142, Jan. 2014.
- [10] H. Weisz, S. Suh, and T. E. Graedel, "Industrial Ecology: The role of manufactured capital in sustainability," *PNAS*, vol. 112, no. 20, pp. 6260–6264, May 2015.
- [11] I. Daigo, K. Nakajima, M. Fuse, E. Yamasue, and K. Yagi, "Sustainable materials management on the basis of the relationship between materials' properties and human needs," *Matériaux & Techniques*, vol. 102, no. 5, p. 506, 2014.
- [12] J. M. Cullen, J. M. Allwood, and M. D. Bambach, "Mapping the Global Flow of Steel: From Steelmaking to End-Use Goods," *Environ. Sci. Technol.*, vol. 46, no. 24, pp. 13048–13055, Dec. 2012.
- [13] S. Moll, J. Acosta, and H. Schütz, "Iron and steel - a materials system analysis. Pilot study examining the material flows related to the production and consumption of steel in the European Union," European Topic Centre on Resource and Waste Management, ETC/RWM working paper 2005/3, Dec. 2005.
- [14] T. Wang, D. B. Müller, and T. E. Graedel, "Forging the anthropogenic iron cycle," *Environ. Sci. Technol.*, vol. 41, no. 14, pp. 5120–5129, Jul. 2007.
- [15] R. Geyer et al., "Time-dependent material flow analysis of iron and steel in the UK: Part 1: Production and consumption trends 1970–2000," *Resources, Conservation and Recycling*, vol. 51, no. 1, pp. 101–117, Jul. 2007.
- [16] S. Pauliuk, T. Wang, and D. B. Müller, "Steel all over the world: Estimating in-use stocks of iron for 200 countries," *Resources, Conservation and Recycling*, vol. 71, pp. 22–30, Feb. 2013.
- [17] D. B. Müller, T. Wang, B. Duval, and T. E. Graedel, "Exploring the engine of anthropogenic iron cycles," *PNAS*, vol. 103, no. 44, pp. 16111–16116, Oct. 2006.
- [18] Daigo, Y. Igarashi, Y. Matsuno, and Y. Adachi, "Accounting for Steel Stock in Japan," *ISIJ International*, vol. 47, no. 7, pp. 1065–1069, 2007.
- [19] H. Hatayama, I. Daigo, Y. Matsuno, and Y. Adachi, "Outlook of the World Steel Cycle Based on the Stock and Flow Dynamics," *Environ. Sci. Technol.*, vol. 44, no. 16, pp. 6457–6463, Aug. 2010.

- [20] J.-P. Birat and A. Zaoui, “‘Le Cycle du Fer’ ou le recyclage durable de l’acier,” *La Revue de Métallurgie*, vol. CIT, pp. 795–807, 2002.
- [21] J. Oda, K. Akimoto, and T. Tomoda, “Long-term global availability of steel scrap,” *Resources, Conservation and Recycling*, vol. 81, pp. 81–91, Dec. 2013.
- [22] I. Daigo, K. Iwata, I. Ohkata, and Y. Goto, “Macroscopic evidence for the hibernating behavior of materials stock,” *Environ. Sci. Technol.*, Jun. 2015.
- [23] S. Glöser, M. Soulier, and L. A. Tercero Espinoza, “Dynamic Analysis of Global Copper Flows. Global Stocks, Postconsumer Material Flows, Recycling Indicators, and Uncertainty Evaluation,” *Environ. Sci. Technol.*, vol. 47, no. 12, pp. 6564–6572, Jun. 2013.
- [24] A. Moreau, *L’acier en mouvement : Transformation des marchés mondiaux 1874-2004*. Paris: Presses de l’Ecole des Mines, 2005.
- [25] J.-P. Birat, “First attempts at structuring MFA in the 1990s at USINOR (ARCELORMITTAL) in the ‘Cycle of Iron’ project,” presented at the Society and Materials Conference (SAM), Trondheim, 15-May-2017.
- [26] K. Dahlström, P. Ekins, J. He, J. Davis, and R. Clift, “Iron, Steel and Aluminium in the UK: Material Flows and their Economic Dimensions,” Centre for Environmental Strategy, University of Surrey, Surrey, Final Project Report ISSN: 1464-8083, Merch 2004.
- [27] P. Michaelis and T. Jackson, “Material and energy flow through the UK iron and steel sector. Part 1: 1954–1994,” *Resources, Conservation and Recycling*, vol. 29, no. 1–2, pp. 131–156, May 2000.
- [28] P. Michaelis and T. Jackson, “Material and energy flow through the UK iron and steel sector: Part 2: 1994–2019,” *Resources, Conservation and Recycling*, vol. 29, no. 3, pp. 209–230, Jun. 2000.
- [29] Birat and Zaoui, “‘Le Cycle du Fer’ ou le recyclage durable de l’acier,” *La Revue de Métallurgie*, vol. CIT, pp. 795–807, 2002.
- [30] S. Pauliuk, R. L. Milford, D. B. Müller, and J. M. Allwood, “The Steel Scrap Age,” *Environ. Sci. Technol.*, vol. 47, no. 7, pp. 3448–3454, Apr. 2013.
- [31] S. Pauliuk, T. Wang, and D. B. Müller, “Moving Toward the Circular Economy: The Role of Stocks in the Chinese Steel Cycle,” *Environ. Sci. Technol.*, vol. 46, no. 1, pp. 148–154, Jan. 2012.
- [32] D. B. Müller, T. Wang, and B. Duval, “Patterns of Iron Use in Societal Evolution,” *Environ. Sci. Technol.*, vol. 45, no. 1, pp. 182–188, 2011.
- [33] M. D. Gerst, “Linking material flow analysis and resource policy via future scenarios of in-use stock: an example for copper,” *Environ. Sci. Technol.*, vol. 43, no. 16, pp. 6320–6325, Aug. 2009.
- [34] J.-P. Birat, I. Daigo, and Y. Matsuno, “Chapter 4.3 - Methods to Evaluate Environmental Aspects of Materials A2 - Seetharaman, Seshadri,” in *Treatise on Process Metallurgy*, Boston: Elsevier, 2014, pp. 1459–1505.
- [35] M. D. Gerst and T. E. Graedel, “In-Use Stocks of Metals: Status and Implications,” *Environ. Sci. Technol.*, vol. 42, no. 19, pp. 7038–7045, Oct. 2008.
- [36] G. Liu and D. B. Müller, “Centennial Evolution of Aluminum In-Use Stocks on Our Aluminized Planet,” *Environ. Sci. Technol.*, vol. 47, no. 9, pp. 4882–4888, May 2013.
- [37] UNEP, “Metal Stocks in Society. Scientific Synthesis,” United Nations Environment Programme, 2010.
- [38] S. Murakami, M. Oguchi, T. Tasaki, I. Daigo, and S. Hashimoto, “Lifespan of Commodities, Part I: The Creation of a Database and its Review,” *Journal of Industrial Ecology*, vol. 14, no. 4, pp. 598–612, Aug. 2010.

- [39] J.-P. Birat, M. Chiappini, C. Ryman, and J. Riesbeck, "Cooperation and competition among structural materials," *Rev. Metall.*, vol. 110, no. 1, pp. 95–129, 2013.
- [40] M. Yellishetty, G. M. Mudd, P. G. Ranjith, and A. Tharumarajah, "Environmental life-cycle comparisons of steel production and recycling: sustainability issues, problems and prospects," *Environmental Science & Policy*, vol. 14, no. 6, pp. 650–663, Oct. 2011.
- [41] B. R. Mitchell, *International Historical Statistics Europe 1750–1988*, 3rd ed. London: Palgrave Macmillan UK, 1992.
- [42] CAEF, "The European Foundry Industry," presented at the International Foundry Forum, Prague, 22/09-2012.
- [43] S. Spatari, M. Bertram, R. B. Gordon, K. Henderson, and T. E. Graedel, "Twentieth century copper stocks and flows in North America: A dynamic analysis," *Ecological Economics*, vol. 54, no. 1, pp. 37–51, Jul. 2005.
- [44] M. T. Melo, "Statistical analysis of metal scrap generation: the case of aluminium in Germany," *Resources, Conservation and Recycling*, vol. 26, no. 2, pp. 91–113, May 1999.
- [45] D. B. Müller, J. Cao, E. Kongar, M. Altonji, P.-H. Weiner, and T. E. Graedel, "Service Lifetimes of Mineral End Uses," U.S. Geological Survey, Minerals Resources External Research Program, New Haven: Yale University, Final Report, Nov. 2007.
- [46] M. Oguchi, S. Murakami, T. Tasaki, I. Daigo, and S. Hashimoto, "Lifespan of Commodities, Part II," *Journal of Industrial Ecology*, vol. 14, no. 4, pp. 613–626, Aug. 2010.
- [47] M. Oguchi and M. Fuse, "Regional and Longitudinal Estimation of Product Lifespan Distribution: A Case Study for Automobiles and a Simplified Estimation Method," *Environ. Sci. Technol.*, vol. 49, no. 3, pp. 1738–1743, Feb. 2015.
- [48] A. van Schaik, M. A. Reuter, U. M. J. Boin, and W. L. Dalmijn, "Dynamic modelling and optimisation of the resource cycle of passenger vehicles," *Minerals Engineering*, vol. 15, no. 11, Supplement 1, pp. 1001–1016, Nov. 2002.
- [49] Eurometaux, "Recycling Rates for Metals," 2012.
- [50] M. Fuse, H. Kosaka, and S. Kashima, "Estimation of world trade for used automobiles," *J Mater Cycles Waste Manag*, vol. 11, no. 4, p. 348, Dec. 2009.
- [51] G. Mehlhart, C. Merz, L. Akkermans, and J. Jordal-Jorgensen, "European second-hand car market analysis," Öko-Institut e.V, Transport & Mobility Leuven, COWI A/S for European Commission - DG Environment, Final Report Contract Number No. 07.0307/2009/549021/SER/C5, 2011.

# Daryna PANASIUK

## Doctorat : Systèmes SocioTechniques

### Année 2019

#### AFM dynamique pour une estimation des flux, des stocks et des indicateurs du recyclage de fer dans l'UE-27

Le recyclage est important pour l'optimisation de l'utilisation des ressources naturelles, notamment dans un contexte de la consommation croissante. L'étude des stocks et des flux anthropiques de métaux est nécessaire pour évaluer la quantité de métaux accumulés dans l'anthroposphère, et estimer la disponibilité de la ferraille pour le recyclage. En appliquant l'Analyse des Flux de Matière dynamique aux flux d'acier et de fonte dans l'UE-27 sur la période 1945-2015, cette étude suit les flux de fer pour analyser le stock de cet élément et calculer les indicateurs du recyclage. Le modèle est basé sur les données statistiques historiques. Il permet de calculer les pertes de fer, la consommation d'acier et de fonte, et intègre une distribution détaillée de l'acier par produit sidérurgique et selon 7 secteurs industriels. La consommation annuelle de la ferraille est estimée à partir des bilans de masse spécifiques aux procédés considérés.

Le modèle détaille des flux de matières annuels, l'évolution du stock en utilisation, ainsi que la disponibilité de la vieille ferraille. Les résultats pour l'UE-27 indiquent que 0,2 t/habitant de fer sont disponibles pour le recyclage en 2015, dont 59% sont collectés et traités. 41% restent dans le stock obsolète. Le stock en utilisation augmente constamment atteignant 7,3 t/habitant. La valeur moyenne du taux de recyclage de la vieille ferraille entre 1970 et 2015 est estimée à 65%. Les résultats de ce modèle sont principalement impactés par la distribution du fer selon les secteurs industriels, et par les durées de vie.

Mots clés : analyse de flux de matière – fer, recyclage – économie circulaire – écologie industrielle – fer, métallurgie.

#### Dynamic Material Flow Analysis for Estimation of Iron Flows, Stocks and Recycling Indicators in EU-27

Recycling is an important component in the optimization of the increasing global consumption of natural resources. The study of anthropogenic metal stocks and flows is needed to evaluate the quantity of metals being accumulated over time, and to estimate potential scrap availability for recycling. Based on a dynamic material flow analysis of steel and cast iron in EU-27 in the period 1945-2015, this study follows the flows of elemental iron to analyse the stock in use, its distribution across seven industrial sectors and to calculate recycling efficiency indicators over time. The model is based on historical statistical data on production and trade of pig iron and crude steel. It makes it possible to calculate iron losses, consumption of steel and cast iron, and integrates a detailed distribution of steel by steel product and by industrial sector. The annual consumption of scrap is estimated from process-specific mass balances.

The model provides detailed annual material flows involved in socio-economic metabolism, annual discard of iron from use and the evolution of in-use stock. The results indicated that 0.2 t/cap of iron was discarded from use in 2015, 59% of which was collected and processed. 41% is assumed to remain in the obsolete stock. The in-use stock increased constantly and reached 7.3 t/cap in EU-27 in 2015. The average value of recycling of end-of-life recycling rate between 1970 and 2015 in EU-27 is estimated to equal 65%. The main impacts on the results are caused by the distribution of iron by industrial sectors and by assumed lifetimes.

Keywords: material flow analysis – iron, recycling – circular economy – industrial ecology – iron, metallurgy.

Thèse réalisée en partenariat entre :

