



HAL
open science

Key characteristics identification by tolerance-based sensitivity analysis

Dana Idriss

► **To cite this version:**

Dana Idriss. Key characteristics identification by tolerance-based sensitivity analysis. Mechanical engineering [physics.class-ph]. Université Clermont Auvergne, 2021. English. NNT : 2021UCFAC049 . tel-03621232

HAL Id: tel-03621232

<https://theses.hal.science/tel-03621232v1>

Submitted on 28 Mar 2022

HAL is a multi-disciplinary open access archive for the deposit and dissemination of scientific research documents, whether they are published or not. The documents may come from teaching and research institutions in France or abroad, or from public or private research centers.

L'archive ouverte pluridisciplinaire **HAL**, est destinée au dépôt et à la diffusion de documents scientifiques de niveau recherche, publiés ou non, émanant des établissements d'enseignement et de recherche français ou étrangers, des laboratoires publics ou privés.



Key characteristics identification by tolerance-based sensitivity analysis

A thesis submitted by

Dana IDRIS

in partial fulfillment of the requirements of the degree of

Doctor of Philosophy

Mechanical Engineering

Defended in public on February 8, 2021, in front of the following jury:

Dr. Alex Ballu,	Université de Bordeaux	Reviewer
Dr. Christian Gogu,	Université Paul Sabatier	Reviewer
Pr. Jean Yves Dantan,	LCFC, Arts et Métiers ParisTech	Examiner
Pr. Zohra Cherfi Boulanger,	Université de Technologie de Compiègne	Examiner
Pr. Emmanuel Duc,	SIGMA Clermont	Examiner
M. Laurent Gauvrit,	Engineer, RADIALL	Invited
Pr. Nicolas Gayton,	SIGMA Clermont	Thesis director
Dr. Pierre Beaurepaire,	SIGMA Clermont	Co-advisor
Dr. Lazhar Homri,	LCFC, Arts et Métiers ParisTech	Co-advisor

**Université Clermont Auvergne CNRS, SIGMA Clermont, Institut Pascal,
F-63000 Clermont-Ferrand, France**

Acknowledgements

It is with great pleasure that I write these last lines of my research work carried out in SIGMA Clermont. I would like to express my deep sense of gratitude to numerous persons who contributed to this work and that deserve greatest appreciation.

First and foremost, I am deeply grateful to my supervisors Pr. Nicolas Gayton, Dr. Pierre Beaurepaire and Dr. Lazhar Homri for their extreme support and encouragement during my PhD. This work could not have been accomplished without their help, guidelines and their constructive criticism.

My thanks and appreciations go also to the jury members for participating in my PhD defence. A special thank is dedicated to the jury president Pr. Jean Yves Dantan, to the reporters, Dr. Alex Ballu and Dr. Christian Gogu, for the time they have devoted to read and review my manuscript.

A very big part of my gratitude goes to the AHTLAND project partners for the valuable meetings and enriched discussions.

I would like to thank my friends and office mates- Chahrazed, Rawan, Van-Dong, Nicolas, Mathieu, Rym, Thilbault for a cherished time spent together and for the good company.

My appreciation also goes out to my parents and my brothers for their endless motivation and support.

Finally, I would like to thank my beloved **Hadi** who has supported me throughout my thesis. Thank you for encouraging me to hold on until the end and for being there for me.

Abstract

During the design stage of product manufacturing, the designers try to specify only the necessary critical dimensions or what is called “Key Characteristics”. Knowing that dealing with Key Characteristics is time consuming and costly, it is preferable to reduce their number and exclude the non-contributing parameters. Different strategies that are based on qualitative or quantitative approaches for the identification of these dimensions are followed by the companies. The common way is to define the critical functional requirements which are expressed in terms of dimensions. When the functional requirements are set as critical, all the involved dimensions are labelled as Key Characteristics. However they do not have the same importance and need to be classified between contributing and non-contributing parameters. There is not a quantitative method that serves for the identification of Key Characteristics in the critical functional requirements. This thesis suggests numerical methodologies which are steps forward to a better ranking of the Key Characteristics.

The first methodology is based on the global sensitivity analysis and more precisely on Sobol’ approach. The sensitivity of the Non Conformity Rate corresponding to the production of the product is measured with respect to the variable parameters characterizing the dimensions. The method is applied, first on a simple two-part example, and on a system having a linearised functional requirement and finally on a system with two non-linear functional requirements. The results show the main effects of the dimensions in addition to their interactions. Consequently it is possible to prioritize some and neglect the effect of the others and classify them respectively as Key Characteristics or not.

The second methodology is based on iso-sensitivity tolerance allocation. It takes into consideration the tolerance intervals, the capability requirements and the mathematical formulation of the topological loop comprising the studied dimensions. This method consists of considering that all the dimensions involved in a critical functional requirement have equal sensitivities, and then estimate the corresponding tolerance intervals to match what is called

“Iso-sensitivity tolerance allocation”. This is done under the conditions that are required by the companies for a high quality production. The condition to be satisfied is that the Non Conformity Rate should be equal to a target value. So this is an optimization problem with an objective to have equal sensitivities and equality constraints on the Non Conformity Rate to estimate the tolerance intervals. First a design is proposed and then an optimal design is found after applying the proper optimization algorithm. The estimated tolerance intervals are then compared to reference tolerance values that can be achieved by the manufacturer. So when a tolerance interval for a corresponding dimension cannot be achieved, it is considered as a Key Characteristic.

Finally both methodologies are applied on an over-constrained system, showing their ability to be extended to industrial cases.

Keywords: Tolerance analysis, Tolerance allocation, Key Characteristic, Sensitivity analysis, Non Conformity Rate

Table of Contents

Acknowledgements	iii
Abstract	v
List of Abbreviations	xiv
List of Symbols	xv
General Introduction	1
I Tolerance Analysis and Key Characteristics	7
I.1 Introduction	7
I.2 Tolerance analysis	7
I.2.1 Basic concepts of tolerance analysis	8
I.2.2 Modelling of the geometrical variations	9
I.2.3 Modelling of the geometrical behaviour of a mechanism	12
I.2.4 Tolerance analysis for over-constrained systems	14
I.2.5 Synthesis on the tolerance analysis	17
I.3 Probabilistic methods for tolerance analysis	17
I.3.1 Formulation of the failure probability	18
I.3.2 Monte Carlo simulation	18
I.3.3 Approximation methods	20
I.3.4 Importance Sampling	23
I.3.5 Synthesis on the probabilistic methods	24
I.4 Key Characteristics	25
I.4.1 Definitions of Key Characteristics	25
I.4.2 Qualitative approaches	27
I.4.3 Quantitative approaches	28
I.4.4 Industrial practices	28
I.4.5 Synthesis on Key Characteristic methods	29
I.5 Conclusion	30

II Sensitivity Analysis Methods	31
II.1 Introduction	32
II.2 Sensitivity analysis model output	33
II.2.1 Local sensitivity analysis	33
II.2.2 Screening methods: elementary effects and Morris method	34
II.2.3 Derivative based Global Sensitivity Measures (DGSM)	36
II.2.4 Variance-based sensitivity analysis (Sobol' Method)	37
II.2.5 Density-based sensitivity analysis	40
II.2.6 Synthesis on the sensitivity analysis methods	41
II.3 Reliability sensitivity analysis with respect to distribution parameters	42
II.3.1 Local reliability sensitivity measures	42
II.3.2 Screening methods for reliability sensitivity analysis	45
II.3.3 DGSM for reliability sensitivity analysis	45
II.3.4 Variance-based reliability sensitivity analysis	45
II.3.5 Synthesis on reliability sensitivity measures	46
II.4 Conclusion	46
III Method 1: Key Characteristics Identification by Sobol' Sensitivity Indices	49
III.1 Introduction	50
III.2 Sensitivity analysis in tolerancing area	50
III.2.1 Local sensitivity analysis in tolerancing	51
III.2.2 Global sensitivity analysis	51
III.2.3 Limitations of the methods	52
III.3 Proposed approach based on Sobol' sensitivity index	53
III.3.1 Variation of the statistical samples	54
III.3.2 Strategies for the selection of input and output parameters of the model .	57
III.3.3 Different steps of the proposed approach	59
III.3.4 Formulation of the Non-Conformity Rates	61
III.3.5 Sensitivity analysis of the statistical parameters on the NCR	63
III.4 Applications	64
III.4.1 Linear stack-up example	65
III.4.2 Linearized system of the electrical plug from RADIALL	68
III.4.3 Non-linear Toyota pedal system	70
III.5 Conclusion	72
IV Method 2: Key Characteristics Identification based on Iso-Sensitivity Tol-	
erance Allocation	75

IV.1	Introduction	76
IV.2	Tolerance allocation	76
IV.2.1	Traditional tolerance allocation methods	77
IV.2.2	Tolerance cost optimization	78
IV.2.3	Synthesis on tolerance allocation methods	79
IV.3	Proposed approach based on iso-sensitivity tolerance allocation	80
IV.3.1	Formulation of the problem	80
IV.3.2	Statistical models' assumptions	82
IV.3.3	NCR and Sensitivity analysis for different statistical models	83
IV.3.4	Gradient-based optimization	86
IV.4	Applications	90
IV.4.1	Linear stack-up example	90
IV.4.2	Linearised system of the Electrical plug from RADIALL	94
IV.4.3	Non-linear clutch system	96
IV.5	Conclusion	98
V	Key Characteristics Identification for an Over-constrained System	99
V.1	Introduction	100
V.2	Description of the system	100
V.2.1	Geometrical modelling	101
V.2.2	Formulation of the assembly problem and non-assembly probability . . .	104
V.2.3	Input random variables	105
V.3	Application of Method 1: Sobol' sensitivity indices	106
V.3.1	Sobol' for 2D problem	106
V.3.2	Problem with nineteen variables	107
V.4	Application of Method 2: Tolerance allocation by iso-sensitivity	108
V.4.1	Optimization with imposed gradient functions	108
V.4.2	Optimization with re-weighting technique	111
V.4.3	Transformation into a 2D problem	112
V.4.4	Problem with nineteen variables	115
V.5	Conclusion	117
	Conclusion	119
	Appendix A Geometrical modelling of the RADIALL electrical plug	124
	Bibliography	129

List of Figures

1	AHTOLand Project presentation.	2
2	Uncertainty quantification methodology.	4
I.1	Nominal surface and substitution surface related to the real surface (Dumas, 2014).	10
I.2	Types of contacts (Dantan and Ballu, 2002).	12
I.3	Example of a mechanism of three parts.	13
I.4	The graphical representation of the mechanism with topological loops.	13
I.5	Representation of the deviation domain for a rectangular plane with dimensions (a and b) and a normal vector \vec{z} subjected to a tolerance t	15
I.6	Representation of the gap domain for a cylinder to cylinder joint of z axis and J difference in diameters.	15
I.7	Representation of Monte Carlo Simulation in the physical space.	20
I.8	Concepts of FORM approximation.	22
I.9	Concepts of SORM approximation.	22
I.10	Representation of importance sampling simulation in physical and u-space.	24
II.1	Possible input and output choices for a sensitivity analysis.	33
II.2	Representation of a four-level grid ($p = 4$) in a three-dimensional input space.	36
II.3	Representation of input parameters in $\sigma - \mu^*$ diagram.	36
II.4	Shift between the density corresponding to Y and the conditional density.	40
III.1	Deviating 2D line (Ziegler and Wartzack, 2015a,b).	53
III.2	Types of process capability.	55
III.3	Zone of acceptable processes in Inertial Tolerancing.	56
III.4	Zone of acceptable processes in Process Tolerancing.	57
III.5	Representation of the capability domain V_D (grey area).	57
III.6	Steps of the proposed Approach.	60
III.7	Simple two-part example.	65
III.8	Local sensitivity indices calculated by the partial derivatives of Y with respect to X_i for the four process cases.	66

III.9	First and Total order indices based on Sobol' sensitivity analysis on the functional characteristic Y with respect to X_i	67
III.10	First and Total order indices based on Sobol' sensitivity analysis on the NCR with respect to the distribution parameters δ_i and σ_i corresponding to X_i	67
III.11	Simplified Electrical Plug.	68
III.12	First and Total order Sobol' Sensitivity indices for RADIALL case dimensions.	69
III.13	Sensitivity of the NCR to the KCs, to the non-KCs and to their interactions.	70
III.14	Toyota Gas Pedal System.	71
III.15	First and total order Sobol' indices for Toyota Gas Pedal dimensions.	72
IV.1	Representation of tolerance allocation.	77
IV.2	Optimization Model.	78
IV.3	Capability domains.	83
IV.4	Steps of the method with imposed gradients.	90
IV.5	Representation of the objective and constraint functions for case 1 as well as the optimization solution obtained from two different strategies.	92
IV.6	The objective and the constraint function with respect to the number of MC samples.	92
IV.7	Representation of the objective and constraint functions for case 3 as well as the optimization solution obtained from two different strategies.	94
IV.8	Non-linear clutch mechanism (Glancy and Chase, 1999).	96
V.1	Representation of the electrical plug by RADIALL (Dumas, 2014).	101
V.2	Graph of the mechanism (Dumas,2014).	102
V.3	Sobol' sensitivity indices of the non-assembly probability to the geometrical displacement deviations.	107
V.4	Sobol' sensitivity indices of the non-assembly probability to the geometrical displacement deviations.	107
V.5	Steps of the method with imposed gradients.	109
V.6	Steps of the method with re-weighting.	112
V.7	Representation of the direction of the gradients of (a) the constraint function and (b) the objective function, and (c) the optimization path.	113
V.8	The contour-lines of the non-assembly probability estimated by the re-weighting technique for two different starting points (a) and (b) and the reference ones (c).	114

V.9 The contour-lines of the objective function estimated by the re-weighting technique for two different starting points (a) and (b) and the reference ones (c). 114

V.10 Sensitivity indices by score functions of the non-assembly probability to the geometrical displacement deviations. 116

V.11 Sensitivity indices by score functions of the non-assembly probability to the geometrical displacement deviations with re-weighting. 116

List of Tables

II.1	Properties of Borgonovo's δ -index.	41
II.2	Properties of Sensitivity analysis methods.	42
III.1	Four different process cases of the input data for the linear stack-up example.	66
III.2	Coefficients, target values, tolerance intervals and capability requirements for RADIALL case input parameters.	69
III.3	Target values, tolerance intervals and capability requirements for Toyota gas pedal input parameters.	71
IV.1	Input parameters of the linear stack-up example.	91
IV.2	Tolerance intervals and sensitivities for case 1 when analytical formulas and score functions are performed.	93
IV.3	Tolerance intervals and sensitivities for case 3 when analytical formulas and score functions are performed.	94
IV.4	Estimated tolerance intervals and sensitivity indices by analytical formula for RADIALL case input parameters.	95
IV.5	Input data for variables of the clutch mechanism.	97
IV.6	Tolerances allocated by iso-sensitivity and the corresponding sensitivities for variables of the clutch mechanism.	97
V.1	SDT according to the type of surface and torsor according to the type of tolerance.	104
V.2	Values of the random variables of the electrical plug.	105
V.3	Tolerance intervals obtained from the reference optimization and from the one coupled with re-weighting.	115
V.4	Comparison between the two strategies used for iso-sensitivity based opti- mization.	116
V.5	Comparison between the two proposed methods in this work.	121

List of Abbreviations

AHTOLAND	Advanced Hybrid TOLerance ANalysis software Diffusion
CAD	Computer Aided Design
DGSM	Derivative based Global Sensitivity Measures
FMEA	Failure Mode and Effects Analysis
FMECA	Failure Mode, Effects and Criticality Analysis
FORM	First Order Reliability Method
KC	Key Characteristic
KCs	Key Characteristics
MC	Monte Carlo
NCR	Non Conformity Rate
SDT	Small Displacement Torsor
SLSQP	Sequantial Least Squares Programming
SORM	Second Order Reliability Method

List of Symbols

X	Random variables
\mathbf{X}	Vector of dimensions modelled by random variables
Y	Functional characteristic
f	Relation function
\mathbf{x}	Realization of the random vector \mathbf{X} in reliability methods, vector of geometrical deviations in tolerance analysis
T_i	Target value of the dimension X_i
t_i	Tolerance interval of the dimension X_i
t_Y	Tolerance interval of the resulting dimension
μ_i	Mean value of the dimension X_i
δ_i	Mean shift of the dimension X_i
σ_i	Standard deviation of the dimension X_i
LSL_i	Lowest specification limit corresponding to t_i
USL_i	Upper specification limit corresponding to t_i
LSL_Y	Lowest specification limit corresponding to t_Y
USL_Y	Upper specification limit corresponding to t_Y
C_{pi}	Capability index of the dimension X_i
C_{pki}	Capability index for off-center process of the dimension X_i
$C_{pi}^{(r)}$	Capability requirement of the dimension X_i
$C_{pki}^{(r)}$	Capability requirement for off-center process of the dimension X_i

General Introduction

Context

This thesis is within the project AHTOLAND (Advanced Hybrid TOLerance ANalysis software Diffusion). This project is funded by the FUI (Fonds Unique Interministériel) and joins the LCFC - Arts et Métiers Paris Tech Campus of Metz, Sigma Clermont of the Institut Pascal, Phimeca, Mécamaster, Pierburg, Valeo and Radiall. Each partner has a specific role to play, as represented in Figure (1), to guarantee the success of the project. This project offers the development of new methods that will address challenges for the tolerance analysis. It will take into account the form defects, the deformability of parts and the sensitivity analysis. Consequently, two objectives have to be fulfilled in the AHTOLAND project:

1. Industrialisation: introducing to the market a new software that enhances the value of the scientific developments of previous and current projects: Tolsis. This software is based on powerful methods of probabilistic tolerancing. It needs to be compatible with CAD software and to new functionalities for a more detailed and realistic tolerance analysis. It covers the following subjects:
 - Tolerance analysis of over-constrained mechanisms.
 - Verification of specifications.
2. R&D (Research and Development) :
 - Development and implementation of tolerance analysis approaches by taking into account the form defects (Goka, 2019).
 - **Analysis of the overall sensitivities of the tolerances and capabilities on the failure probabilities or the Non-Conformity Rates (NCR)**. This is the idea considered in this work.

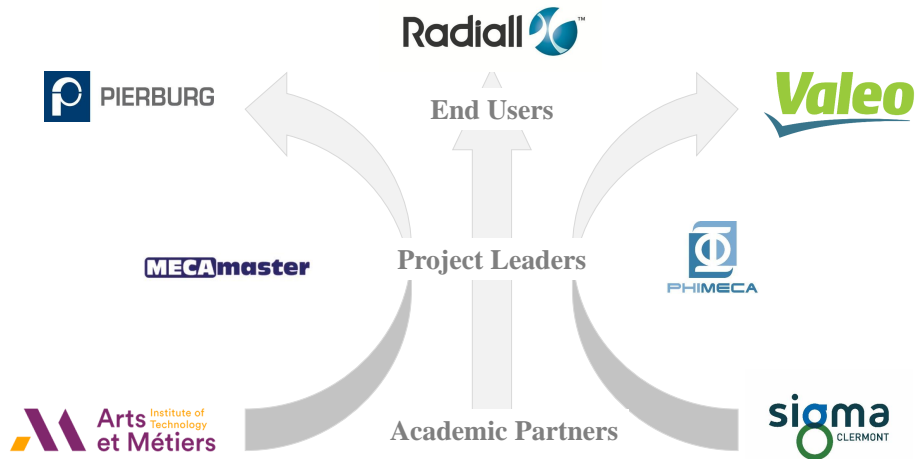

Figure 1 – AHTOLand Project presentation.

Problematic

Manufacturing high quality products with reduced costs necessitates to monitor properly the different phases of the production. The manufacturing of the products is a process subjected to uncertainties. The uncertainties are revealed by the geometrical imperfections that the products are subjected to. The imperfections cause unfavourable effects on the performance of the system. In addition, it is impossible to have the same geometries of the product parts, so it is probable to have defects especially in mass productions. To prevent undesirable consequences of these imperfections, it is preferable to consider them during the design phase. The probabilistic approach provides a suitable framework to consider such imperfections, the dimensions of a part can be modelled using random variables and the uncertainties are subsequently propagated to the response of the system. The scatter associated with the system's performance is characterized, which allows designers to ensure the fulfilment of the quality requirements.

One of the main sources of uncertainty in products consisting of mating or interconnecting sub-components is the variation arising from manufacturing processes. The ability to design components when variations are presented is the goal of tolerancing. Tolerancing is therefore an important part of design phase and a key element that should be considered when dealing with robustness of any product. Tolerancing decisions should respect the limited capabilities of the required manufacturing processes as well as the functionality of the product. Tolerance analysis procedure's objective is to study the impact of variations of an analysed dimension or geometric feature for a given Geometric Dimensioning and Tolerancing (GD&T) scheme.

Generally, designers provide the manufacturers with drawings for the designed products

where they specify the nominal dimensions and the corresponding allowable tolerance intervals as well as the critical dimensions, i.e. the dimensions with a major impact on the performance of the system. This is an important matter as additional inspection efforts are deployed during the manufacturing for the critical dimensions. Consequently, a large number of critical dimensions will cause high costs of production, so they need to be reduced as much as possible. The critical dimensions are named Key Characteristics (KC) in this work.

Objectives of the thesis

Based on the stated problematic, this thesis aims to develop new approaches for the identification of Key Characteristics in a tolerancing framework. This is achieved by fulfilling the following objectives:

- O1** Understanding the tolerancing schemes and frameworks adopted in manufacturing processes as well as the existing strategies to identify the KCs.
- O2** Establishing a link between the statistical parameters defining the random variables and the manufacturing processes capabilities.
- O3** Developing the new approaches based on sensitivity analysis methods that should be selected properly depending on the problem statement.
- O4** Demonstrating the proposed approaches on study cases as well as industrial examples.

Uncertainty Quantification methodology

In order to reach the objectives described above, it is necessary to understand and follow the steps of the Uncertainty Quantification methodology. The uncertainties in the geometric dimensions and their propagation to the quantity of interest should be taken into account. The different steps of this methodology are presented in Figure (2) and they are the following (Pasanisi and Dutfoy, 2012):

Step A. The first step consists in specifying the model which can be defined analytically or by a computer code. This step also includes specifying model inputs that are either random or deterministic. Then the quantity of interest is defined, it can be the model output, or the probability to exceed a threshold.

Step B. The second step consists in quantifying the sources of uncertainties affecting the input variables. This can be achieved by modelling the probability density function of the random input variables. Modelling uncertain input variables can be done based on historical data or on the expert opinion, or even by direct observation of the model outputs. In the scope of this work, it is required to set the relation between the statistical parameters defining the random input variables and the tolerance intervals deduced from the manufacturing process capabilities.

Step C. The third step necessitates propagating uncertainties to estimate the quantity of interest. In the scope of this work the failure probability (or NCR) is the most considered output quantity. Various methods can be applied for the computation of this quantity such as the analytical formula, Monte Carlo sampling strategies, approximation methods (FORM, SORM), etc.

Step D. The fourth step involves analysing the sensitivity of the quantity of interest to the inputs in order to rank uncertainty sources. This step is well established in this manuscript since the sensitivity analysis is used as a tool to attain the objectives of the work.

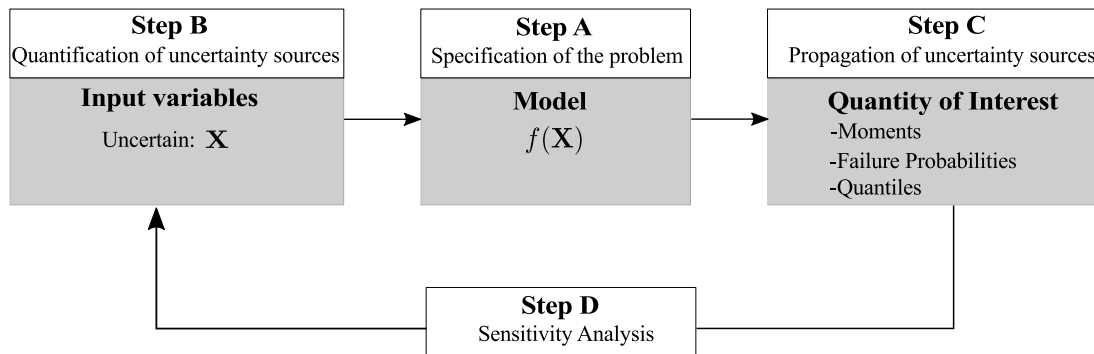

Figure 2 – Uncertainty quantification methodology.

Organisation of the thesis

This manuscript is divided into five chapters which are presented as follows:

Chapter I draws up a review on the existing tolerance analysis methods, as well as the available KCs identification practices.

Chapter II consists in an overview of the various sensitivity analysis methods and the reliability sensitivity measures.

Chapter III describes the first proposed approach for the identification of KCs. This approach is based on the Sobol' sensitivity indices.

Chapter IV describes the second approach proposed for the identification of the KCs. It is based on the concept of iso-sensitivity tolerance allocation.

Chapter V illustrates the application of the two proposed approaches on an industrial example.

Publications and communications

Some of the work carried out during this thesis has been published and presented in journals and conferences:

Journal paper:

Idriss D, Beaurepaire P, Homri L, Gayton N (2020) Key Characteristics Identification by Global Sensitivity Analysis. *International Journal on Interactive Design and Manufacturing (IJIDeM)* 14(2):423-434. (Idriss et al., 2020)

International conference:

Idriss D, Beaurepaire P, Homri L, Gayton N (2018) Key Characteristics Identification by Sensitivity Methods. *Procedia CIRP*, 75:33-38. (Idriss et al., 2018)

National conference:

Idriss D, Beaurepaire P, Homri L, Gayton N (2019) Key Characteristics Identification based on Tolerance Allocation by Iso-Sensitivity. 24ème Congrès Français de Mécanique, Brest, France.

International workshop:

Idriss D, Beaurepaire P, Homri L, Gayton N (2019) Key Characteristics Identification by iso-sensitivity tolerance allocation. 17th International Probabilistic Workshop 2019- Edinburgh, Scotland.

Tolerance Analysis and Key Characteristics

I.1 Introduction

This chapter is divided into two main parts. The first part defines the tolerance analysis and describes the common practices used in this context. Then, the probabilistic approaches that have been used in previous works in the tolerancing context are detailed. These approaches are used to estimate the failure probability of the system. The purpose of the first part is to understand the basic notions of tolerance analysis schemes and to build the framework of the problem statement of this thesis. The second part of this chapter states the existing definitions of the Key Characteristics in the literature. Then, it sets the definition on which the work of this thesis is based. Moreover, this part reviews some common practices used for the Key Characteristics identification.

I.2 Tolerance analysis

The tolerance analysis, is a tool used in the design stage to verify that the geometric specifications and tolerances of the parts of a product are well respected and do not affect the assembly and functionality of this product. The designer takes into account the manufacturing conditions and works to add specifications expressing the acceptable variations from the nominal model. These specifications are called tolerances and are defined with respect to ISO and ANSI standards. Tolerances are defined as the acceptable deviations in the geometry and positioning of parts in a mechanical assembly, to guarantee its functionality. According to Chase et al. (2004), tolerances do not only affect the ability to assemble the final product, but also the cost of production, process selection, tooling, installation cost and operator skills. They also affect

the engineering performance and robustness of a design. These tolerances should be analysed to estimate the effects on the capability of a design to meet its design requirements using tolerance analysis. Tolerance analysis is a method for understanding how variations in different dimensional or geometric tolerances affect the behaviour of a mechanical system with respect to functional requirements. Dantan et al. (2012) have stated that the tolerance analysis makes it possible to estimate the impact of geometrical and dimensional variations of dimensions on the final assembly, as well as its performance. The integration of the tolerance analysis into the product design cycle process is essential and affects the quality of the product, its cost and its performance (Dantan et al.,2012).

The main objective of tolerance analysis is the evaluation of the quality of the product for given design data such as the tolerance intervals. The analysis must therefore use a mathematical formulation that is most representative of reality, and that is able to take into account geometrical deviations and gaps. The essential concerns to consider in tolerance analysis are the following (Dantan et al., 2012):

- The development of the tolerancing techniques such as worst-case searching and statistical analysis.
- The models for representing the geometrical deviations.
- The mathematical model for calculating the system behaviour with deviations.

I.2.1 Basic concepts of tolerance analysis

Functional Characteristic

The design of a mechanical system is established with respect to the functional characteristic on the quantity of interest. A functional characteristic can be modelled by a function relating a chain of dimensions. The dimensions are modelled by random variables \mathbf{X} that influence the functional characteristic Y . In the case of an explicit function f , the functional characteristic is written as following:

$$Y = f(\mathbf{X}) \tag{I.1}$$

This function depends on the mechanical system, it is explicit when the mechanical system is simple. In the design of mechanical systems, the engineers' challenge is to find the right compromise between manufacturing cost and product quality. The manufacturing cost is directly related to the part tolerance intervals, imposed by the designer on the manufacturer. The tighter these intervals are, the more costly is the production. From the analysis objectives, two

techniques have been used for the tolerance analysis, the worst case tolerance analysis and the statistical tolerance analysis.

Worst case tolerance analysis

The worst-case tolerance analysis involves establishing the dimensions and tolerances such that any possible combination produces a functional assembly, i.e. the probability of non-assembly is identically equal to zero. It considers the worst possible combinations of individual tolerances and examines the functional characteristic (Greenwood and Chase, 1987; Scholz, 1995). The worst-case method calculates the tolerance t_Y of the resulting dimension as an arithmetic sum of tolerances t_i of all partial dimensions. The variation interval is expressed as:

$$t_Y = \sum_{i=1}^n |a_i| t_i \quad (\text{I.2})$$

where a_i is the linear coefficient of every dimension X_i and t_i is the tolerance associated to X_i .

Statistical tolerance analysis

The statistical analysis, unlike the worst case method, does not result in a zero failure probability. It allows a certain number of non-compliant assemblies (Evans, 1975; Greenwood and Chase, 1987; Scholz, 1995). The variation interval is given by the following expression:

$$t_Y = \sqrt{\sum_{i=1}^n (a_i t_i)^2} \quad (\text{I.3})$$

The advantage of the worst-case method is that it guarantees a zero failure probability. However, it results unnecessarily tight tolerances and hence high production costs. In manufacturing processes the tight tolerances require more efforts and hence high production costs. Designing by using the worst-case analysis guarantee that the parts will assemble and function properly, however, it is an expensive way to design. In the other hand, the statistical tolerancing, is a more practical and economical way of looking at tolerances and works on setting the tolerances so as to ensure a desired yield. For this reason, the statistical tolerancing is adopted in this work.

I.2.2 Modelling of the geometrical variations

For the design of a mechanical part, the designer starts by setting the nominal geometry of this part, this geometry remains perfect. However, it is impossible to manufacture the exact

geometry of the part due to sources of variations that can affect the manufacturing process. The imperfections in manufacturing processes are caused by form defects or geometrical deviations. They are also called manufacturing deviations (Ballu et al., 2008). The geometry of a part is shown in Figure (I.1). The three different surface models are the following:

- Nominal surface: is the perfect surface which dimensions and position ideally match the design dimensions.
- Real surface : is the actual surface of the manufactured parts which are subjected to all the imperfections produced during the manufacturing, measurement and assembly process (ISO17450-1).
- Substitution surface: is often used to approximate the real surface without taking the form defects into consideration. It is a representation of the real surface driven by a finite number of parameters which ensure a compromise between the level of detail, the difficulty of calculation and the validity of the results. The orientations and positions of this model depend on the real surface (Dantan, 2000).

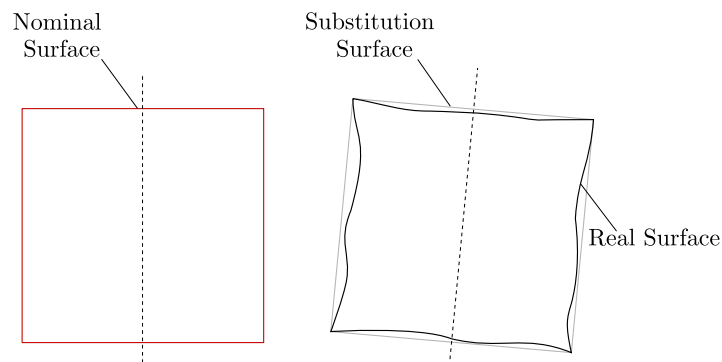

Figure I.1 – Nominal surface and substitution surface related to the real surface (Dumas, 2014).

Assumptions of the work: The form defects are neglected in the work of this thesis. They were taken into account in the work of Goka (2019) within the AHTOLAND project.

The geometrical deviations represent the deviations noted between the nominal surface and the real one, they are expressed by random variables noted as the vector $\mathbf{x} = \{x_1 \dots x_n\}$. They are represented by:

- Dimensional deviations: they are specified for each substitution surface. They represent the variation of the dimensions of the surface. For example, a cylinder dimensional deviation is the variation of its diameter with respect to the nominal surface.

- Positional deviations: they define the orientation and position of the substitution surface with respect to the reference axis associated to the nominal surface.

One of the main steps of the tolerance analysis is the mathematical modelling of the deviations. Numerous mathematical models exist in the literature for the modelling of the geometrical deviations such as the vector loops (Chase and Parkinson, 1991), the Small Displacement Torsors (SDT) (Bourdet et al., 1996; Dantan et al., 2005; Sergent et al., 2010; Qureshi et al., 2012; Dumas et al., 2015), matrix representation (Gupta and Turner, 1993; Roy and Li, 1999; Zou and Morse, 2004) and small kinematic adjustments (Walter et al., 2013). In the scope of the AHTOLAND project the SDTs are used for the modelling of geometrical variables, therefore the SDT method is adopted in this work. The concept of the SDT has been proposed by Bourdet and Clement (1976) to characterize the geometrical deviations of manufactured surfaces. The use of this method is done under the assumption that the produced parts are rigid bodies and that their rotation is very small. A SDT of a plane is used to express the relationships between the associated plane and the nominal plane in the origin of coordinates O . Two vectors \mathbf{R} and \mathbf{T} are used to present respectively the rotations (α, β, γ) and the translations (u, v, w) and are gathered in a SDT $T_{ia/i}$ of a surface a on a part i in a given base R_0 and is expressed as:

$$T_{ia/i} = \left\{ \begin{array}{cc} \alpha_{ia/i} & u_{ia/i} \\ \beta_{ia/i} & v_{ia/i} \\ \gamma_{ia/i} & w_{ia/i} \end{array} \right\}_{R_0} \quad (\text{I.4})$$

The gaps torsor is defined in a given base R_0 and at a given point. A gap torsor represents the possible displacement in position and orientation of a substitution surface with respect to another of the two potentially contacting parts. The components of a gap torsor are free variables. The variables sets are noted \mathbf{g} . The expression of a gap torsor between a surface a on part i and a surface a on part j is given by:

$$\mathbf{g}_{ia/ja} = \left\{ \begin{array}{cc} \alpha_{ia/ja} & u_{ia/ja} \\ \beta_{ia/ja} & v_{ia/ja} \\ \gamma_{ia/ja} & w_{ia/ja} \end{array} \right\}_{R_0} \quad (\text{I.5})$$

The gaps must be determined by the analysis method and depend on the types of contact modelled (Dantan and Ballu, 2002).

Types of Contact

There exist three types of contact in the mechanical systems: fixed contact, slipping contact and floating contact (see Figure (I.2)) (Dantan and Ballu, 2002).

- Fixed contacts have contact surfaces held in a particular position because of a mechanical stress which prevents any relative displacement of the two surfaces during the use of the mechanism. The components of the gap torsor in this type of contact are set to zero on the assumption that the surfaces are free from form defects.
- The slipping contacts have their connecting surfaces also maintained by a mechanical action which allows tangential displacements during normal use; non tangential relative displacements (normal displacements, displacements relative to the normals of the surfaces in contact) are not possible. The components of the gap torsor in the cases of a slipping contact are those of kinematic displacements i.e. displacements which are possible. The other components are set to zero or to known specific values.
- Floating contacts are contacts where all the relative displacements of the two surfaces are possible (tangential and normal displacements). The floating contact torsor has all the components of the six degrees of freedom which are unknown.

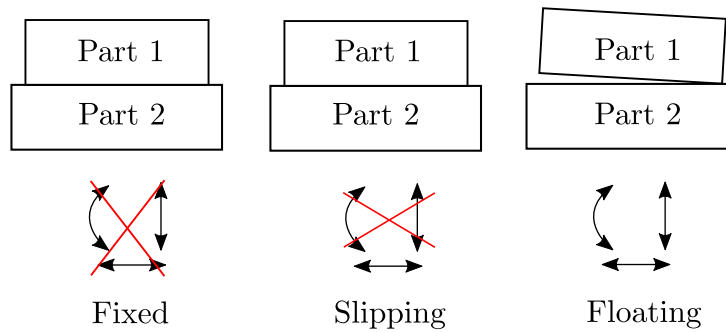

Figure I.2 – Types of contacts (Dantan and Ballu, 2002).

I.2.3 Modelling of the geometrical behaviour of a mechanism

The geometrical behaviour of a mechanism is defined by various hulls such as:

- Compatibility equations: $C_c(\mathbf{x}, \mathbf{g}) = 0$.

The compatibility equations represent the relations between small displacements of the surfaces. The geometrical behaviour of the mechanism is defined by the composition relations of displacements in the topological loops (Ballot and Bourdet, 1997; Dantan and Ballu, 2002). The compatibility equations between the deviations and the gaps are derived from the composition relations. These equations define the propagation of the geometrical deviations and the gaps in an assembly. It is necessary to know the equations relating the different deviations and gaps to characterize the equilibrium between the positions and orientations

of the different parts of the mechanism. The topological structure of a mechanical system is represented by a graph. The graph is composed of multiple topological loops. Every loop starts from a point to end at the same point (see Figures (I.3) and (I.4)). Every loop allows to write six compatibility equations, each one written according to the axes of each torsors' component (3 translations and 3 rotations).

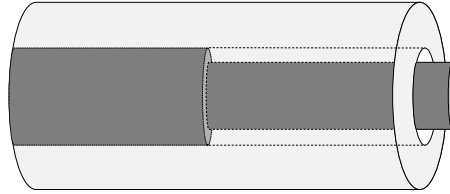

Figure I.3 – Example of a mechanism of three parts.

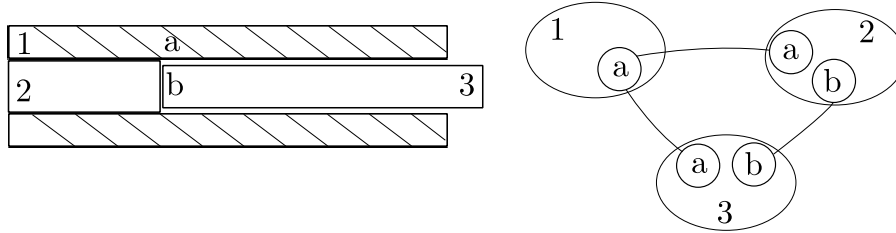

Figure I.4 – The graphical representation of the mechanism with topological loops.

- Interface constraints: $C_i(\mathbf{x}, \mathbf{g}) \leq 0$ and $C_{i*}(\mathbf{x}, \mathbf{g}) = 0$.

The interface constraints limit the displacements relative to two substituted surfaces and characterise the non-interference or association between these surfaces that are nominally in contact (Walter et al., 2013). Then, the gaps between the two substituted surfaces are limited. The interface constraints depend on the type of surface contact. For a floating contact, the relative positions of the substitution surfaces are constrained by the non-interference, so the interface constraints are defined by inequalities $C_i \leq 0$. For a fixed or slipping contact, the relative positions are constrained by mechanical actions, so the corresponding interface constraints are defined by equality equations $C_{i*} = 0$ (Dantan and Ballu, 2002).

- Functional requirement: $C_f(\mathbf{x}, \mathbf{g}) \geq 0$.

The functional requirement limits the orientation and/or the location between surfaces, which are in functional relation. It represents the constraints on one or many functional characteristics set for the mechanism. The expressions of the functional characteristics can be written in function of the geometrical parameters by defining a topological loop passing through the functional joint. It is then possible to write one or more compatibility

equations taking into account the functional characteristic(s). It is possible to consider several functional topological loops if several surfaces involved in contact are of functional interest.

I.2.4 Tolerance analysis for over-constrained systems

An over-constrained system is a mechanical system where the response function between Y and \mathbf{X} is implicit. When the system is over-constrained, the gaps should be taken into account. For this type of systems, the quality of the product is measured by taking into consideration two different conditions: the assembly condition and the functionality condition.

- Assembly condition: a mechanism with gaps must be assembled despite the geometric deviations and without there being any interpenetration between its parts.
- Functionality condition: the functional requirements for one or several functional characteristics should be respected to ensure the functionality of the system after being assembled. The variations of the functional characteristic are caused by the geometrical deviations and by the gaps.

Two different approaches can be distinguished for the formulation of the tolerance analysis problem: tolerance accumulation, and displacement accumulation.

1. **Tolerance accumulation:** the purpose of tolerance accumulation is to simulate tolerances linearly. The acceptable geometrical deviations are established geometrically through an allowable deviation domain. The bounds of this domain are defined by the specified tolerances on the components of the mechanism. For the gaps, the allowable displacement domain ensures the non-penetration of the contact surfaces. Several techniques exist to represent the allowable deviations such as: deviation domain (Giordano et al., 1999; Giordano et al., 2003), T-Map® (Ameta et al., 2011), or specification hull (Morse and You, 2013). These techniques are based on the use of different domains:

- Deviation Domain: the deviation domain represents the range of allowable variations of the components modelling the displacement with respect to their tolerance zones. For the deviation domains, only the variable components of the torsor of the small movements are used to create the variation space. The space is also defined using geometrical deviations. The values of the tolerances set the boundaries of the deviation domains (Ameta et al., 2011). Figure (I.5) is an example of a deviation domain for a rectangular plane with a normal \vec{z} subjected to a location tolerance of t_l value. The deviation domain limits three

components: the t_z translation along the \vec{z} axis and the r_x and r_y rotations around the x and y axes. The boundaries of the domain are defined by the values of the tolerance t_l and lengths a and b of the sides of the rectangular plane.

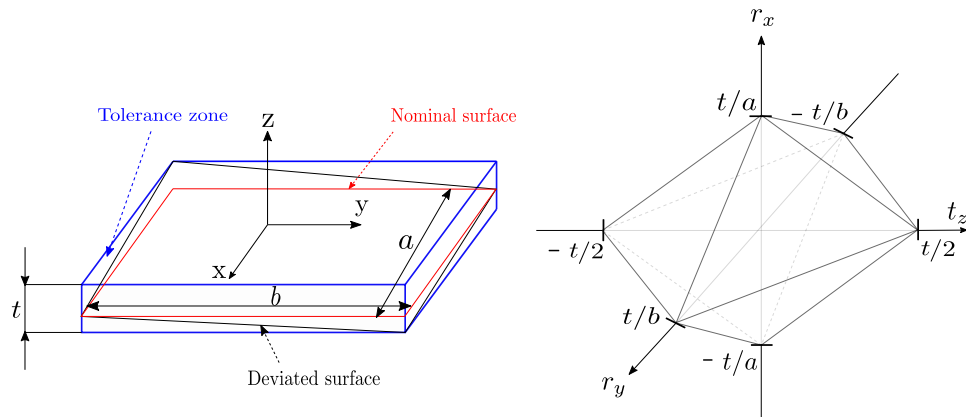

Figure I.5 – Representation of the deviation domain for a rectangular plane with dimensions (a and b) and a normal vector \vec{z} subjected to a tolerance t .

- Gap domain (or clearance domain as found in the literature): the gap domain represents the space of the allowable variations of a surface compared to another. The domain is not necessarily completely closed. Figure (I.6) shows a gap domain of a cylinder-cylinder connection with an \vec{z} axis and of which the difference in diameters is equal to J . The gap domain shows the displacement t_x , t_y and t_z translation components so that no interpenetration is possible of matter. The translation component t_z along the \vec{z} of the joint axis is not limited because it is a degree of freedom of the connection.

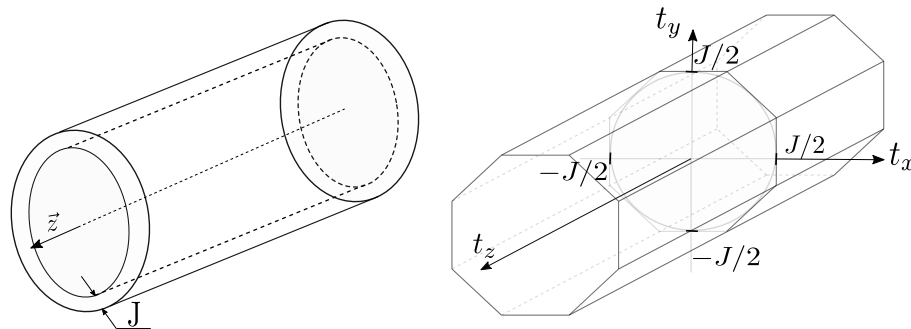

Figure I.6 – Representation of the gap domain for a cylinder to cylinder joint of z axis and J difference in diameters.

- Functional domain: the functional domain is a specific gap domain that characterizes the functional requirement. It is a permissible variation range for the functional characteristic aspects of the mechanism (Ameta et al., 2011).
- Accumulation of the domains: the influence of deviations and gaps cannot be studied

independently. The mechanism as a whole must be taken into account. The equations of compatibility from the topological loops of the mechanism are used to combine deviation and gap domains to build accumulation domains called residual gap domains (Mansuy, 2013). The intersection of residual gap domains allows to build the resulting gap domain.

The tolerance accumulation mainly uses the worst-case method of analysis. This method consists of defining the part dimensions and tolerances in such a way that all possible combinations of parts can be assembled, i.e. probability that a mechanism doesn't assemble is zero. For the functional requirement study, the worst combination of each possible deviation is considered. Therefore, this type of analysis involves defining much tighter tolerances and thus increase manufacturing costs resulting in possible over-quality (Hong and Chang, 2002).

2. **Displacement accumulation:** the displacement accumulation simulates the influences of deviations on the geometrical behaviour of the mechanism. The geometrical deviations \mathbf{x} are modelled by random variables \mathbf{X} whose distributions and their parameters are chosen in accordance with the process of manufacturing and/or specified tolerances on components. The displacement accumulation technique is based on the method of statistical analysis. The purpose of this method is to consider that manufacturing variability has a sufficiently controlled influence to ensure the quality of the production. In mass production, this means allowing the production of a large number of products with a small proportion of the mechanisms not meeting the assembly requirements, or functionality. As a result, tolerances of some components can be increased. This significantly reduces manufacturing costs. The objective of the statistical analysis is to calculate the probability that the functional requirements and mountability conditions are met for given tolerances (Nigam and Turner, 1995; Morse, 2018; Beaucaire et al., 2013). These probabilities are indicators of the quality of any mechanism.

In fact, the calculated probability is the proportion of mechanisms that will not be mountable or functional. From an industrial point of view, this probability is called Non-Conformity Rate (NCR). According to the equations of the behaviour model, the assembly and functional conditions are expressed as follows (Dantan and Ballu, 2002; Qureshi et al., 2012):

- Assembly condition: *"If there exists on configuration of the mechanism such as the value of the functional characteristic is less than or equal to the tolerance, then the geometrical product requirement is respected"*. Mathematically speaking, it can be represented by the quantifier \exists :

$$\exists \mathbf{g} \in \mathbb{R}^m : \{C_c(\mathbf{x}, \mathbf{g}) = 0 \cap C_i(\mathbf{x}, \mathbf{g}) \leq 0 \cap C_{i^*}(\mathbf{x}, \mathbf{g}) = 0\} \quad (\text{I.6})$$

- Functional requirement: *“If for all configurations of the mechanism, the value of the functional characteristic is less than or equal to the tolerance, then the geometrical product requirement is respected”*. This condition uses the mathematical quantifier \forall :

$$C_f(\mathbf{x}, \mathbf{g}) > 0, \forall \mathbf{g} \in \mathbb{R}^m : \{C_c(\mathbf{x}, \mathbf{g}) = 0 \cap C_i(\mathbf{x}, \mathbf{g}) \leq 0 \cap C_{i^*}(\mathbf{x}, \mathbf{g}) = 0\} \quad (\text{I.7})$$

In the case of assembly, checking the assembly condition is equivalent to checking the existence of an admissible configuration of the mechanism such that all constraints are satisfied. As for the functional requirement, it must be verified for all permissible configurations. However, it is possible to check only one of them. It is sufficient to determine the permissible configuration of the corresponding to the worst possible functional requirement. If for this configuration the mechanism is functional, then it is functional for all permissible configurations. The difficulty lies in determining the worst case configuration.

I.2.5 Synthesis on the tolerance analysis

The tolerance analysis is an important quality measure for the manufactured products in mass production. The two common policies to perform a tolerance analysis are the worst-case and the statistical tolerancing. In one hand, the worst-case approach is used to ensure a zero failure probability but engenders tight tolerances. In another hand, the statistical tolerancing allows a certain number of non-functional systems but reduces the manufacturing costs. In the context of the AHTOLAND project, the statistical approaches are adopted.

The dimensions included in the chains of dimensions are modelled as random variables. Their distributions represent the manufacturing process. The uncertainty in the statistical parameters propagates to the functional requirement and by consequence to Non-Conformity Rate. The estimation of the Non-Conformity Rate can be performed by adopting the probabilistic methods already used for reliability analysis and can be adapted to tolerance analysis problems.

I.3 Probabilistic methods for tolerance analysis

This section describes briefly the probabilistic approaches to estimate the failure probability when dealing with reliability problems. It summarizes some reliability methods that were originally used in the structural reliability problems where the failure probability must be estimated (Lemaire, 2009).

I.3.1 Formulation of the failure probability

The uncertain parameters are modelled using the vector $\mathbf{X} = \{X_1 \dots X_n\}$. The vector of realisations of a random variable is noted as $\mathbf{x} = \{x_1 \dots x_n\} \in D_{\mathbf{X}}$. A failure state is defined using a performance function $G(\mathbf{x})$. Therefore, two domains can be defined:

1. Safe Domain $D_s = \{\mathbf{x} \in D_{\mathbf{X}} : G(\mathbf{x}) > 0\}$.
2. Failure Domain $D_f = \{\mathbf{x} \in D_{\mathbf{X}} : G(\mathbf{x}) \leq 0\}$.

The two domains are separated by the zero performance function ($G(\mathbf{x}) = 0$) called the limit-state function. The reliability analysis becomes more difficult when the limit state function is complex such for non-linear cases. The failure probability P_f is defined mathematically by:

$$P_f = \text{Prob}(G(\mathbf{X}) \leq 0) \quad (\text{I.8})$$

This probability is also expressed by the joint density function $f_{\mathbf{X}}(\mathbf{x})$ of \mathbf{X} :

$$P_f = \int_{D_f} f_{\mathbf{X}}(\mathbf{x}) d\mathbf{x} \quad (\text{I.9})$$

In most of the cases, Equation (I.9) does not have an analytical solution because either it is impossible to integrate analytically the joint density function, or the failure domain D_f has a complex shape. Many reliability methods can be used for the calculation of the failure probability. Among these methods, the Monte Carlo (MC) simulation method, the approximation methods such as FORM and SORM and the Importance Sampling (IS).

I.3.2 Monte Carlo simulation

Monte Carlo simulation is a widely used statistical analysis technique in engineering problems. To estimate the failure probability, the MC sampling technique is employed. This sampling technique consists of generating random or pseudo-random variables according to their probability distribution functions. The performance function is then evaluated and the number of outcomes in the failure domain is counted. It is known that if the value of $G(\mathbf{x})$ is less than zero, it indicates failure. The MC simulation gives an approximation of the integral written in Equation (I.9), an estimate of the failure probability can be expressed as:

$$P_f = \int_{D_{\mathbf{X}}} \mathbb{I}(\mathbf{x}) f_{\mathbf{X}}(\mathbf{x}) d\mathbf{x} \quad (\text{I.10})$$

where \mathbb{I} is an indicator function, defined by:

$$\mathbb{I}(\mathbf{x}) = \begin{cases} 1 & \text{if } G(\mathbf{x}) \leq 0 \\ 0 & \text{if } G(\mathbf{x}) > 0 \end{cases} \quad (\text{I.11})$$

The MC estimator of P_f is derived from the sample mean of the failure indicator function:

$$P_f \approx \tilde{P}_f^{MC} = \frac{1}{N_{MC}} \sum_{i=1}^{N_{MC}} \mathbb{I}(\mathbf{x}^{(j)}) \quad (\text{I.12})$$

where $\{\mathbf{x}^{(j)}, j = 1 \dots N_{MC}\}$ are N_{MC} independent samples of the random vector \mathbf{x} , and N_{MC} is the sample size. This means that there is need to evaluate the performance function N_{MC} times to estimate the failure probability. Figure (I.7) shows the basic concept of the Monte Carlo sampling technique in the physical space. The approximation \tilde{P}_f becomes more accurate when N_{MC} tends to infinity. The accuracy of this approximation is estimated in terms of its variance computed as:

$$\text{Var}(\tilde{P}_f^{MC}) = \frac{(1 - \tilde{P}_f^{MC})\tilde{P}_f^{MC}}{N_{MC}} \quad (\text{I.13})$$

The statistical accuracy of the failure probability to be estimated is measured by the coefficient of variation:

$$\delta_{\tilde{P}_f^{MC}} = \frac{\sqrt{\text{Var}(\tilde{P}_f^{MC})}}{\mathbb{E}[\tilde{P}_f^{MC}]} \approx \frac{1 - \tilde{P}_f^{MC}}{N_{MC}\tilde{P}_f^{MC}} \quad (\text{I.14})$$

The less is the coefficient of variation, the better is the accuracy of the estimated failure probability. It is noted from Equation (I.14) that the convergence rate of the Monte Carlo simulation depends on N_{MC} . It is proportional to $1/\sqrt{N_{MC}}$. It can be concluded that when the failure probability to be estimated by the MC simulation get lower, a larger number of N_{MC} samples is needed. Alternative time reduced methods exist for the estimation of P_f such as the approximations methods or the variance reduction technique such as the Importance Sampling (IS). It is important to mention that the Monte Carlo simulation is the reference method when the number of the simulations is enough for th estimation of P_f . The results' accuracy from alternative methods is checked by comparing them to the MC simulation results.

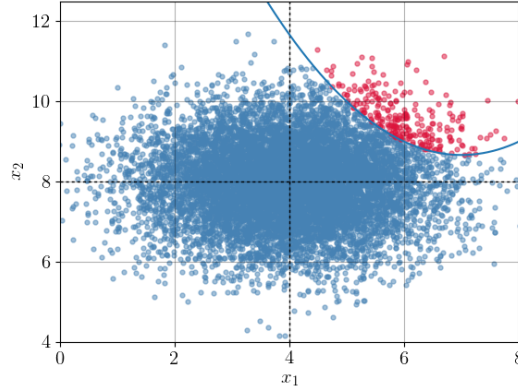

Figure I.7 – Representation of Monte Carlo Simulation in the physical space.

I.3.3 Approximation methods

The approximation methods consist of replacing the limit state by an approximate form. These methods are achieved through transforming the random variables \mathbf{X} from their original physical space $D_{\mathbf{X}}$ into the variables \mathbf{U} in the standard normal space \mathbb{U}^n . In the standard normal space, the random variables follow the standard normal distribution ($\mathcal{N}(0,1)$). Such transformations are called iso-probabilistic transformation and are noted T :

$$\mathbf{U} = T(\mathbf{X}) \quad (\text{I.15})$$

They conserve the value of the failure probability. The performance function in the standard normal space is noted H and is obtained as the following:

$$H(\mathbf{U}) = G(T^{-1}(\mathbf{U})) \quad (\text{I.16})$$

$$P_f = \text{Prob}(G(\mathbf{X}) \leq 0) = \text{Prob}(H(\mathbf{U}) \leq 0) \quad (\text{I.17})$$

The failure domain is now defined as $D_f = \{\mathbf{u} \in \mathbb{U}^n : H(\mathbf{u}) \leq 0\}$. For the case of a non-correlated Gaussian variable X_i , this transformation is simple and linear:

$$x_i \xrightarrow{T} u_i = \frac{x_i - \mu_i}{\sigma_i} \quad (\text{I.18})$$

where μ_i and σ_i are respectively the mean and the standard deviation of X_i . When the random variable is independent and follow any distribution, the transformation is of the form:

$$x_i \xrightarrow{T} u_i = \Phi^{-1}(F_{X_i}(x_i)) \quad (\text{I.19})$$

where F_{X_i} and Φ are the cumulative density functions of X_i and U_i . Different transformations exists in the literature but not developed in this work such as the Rosenblatt transformation, when the joint density is known, and the Nataf transformation, when the probabilistic model is only made up of the marginal densities and of the matrix covariance (Lemaire, 2009).

Some methods require the identification of what is called the design point or the most probable failure point noted as P^* . It corresponds to the nearest point on limit state to the origin of the standard normal space. The identification of this point is performed in the standard normal space using the following optimization problem:

$$\begin{aligned}
 &\text{Find } \mathbf{u}^* \text{ such that} \\
 &\mathbf{u}^* = \text{Argmin} \|\mathbf{u}\| \\
 &s.t. \ H(\mathbf{u}) = 0
 \end{aligned} \tag{I.20}$$

where \mathbf{u}^* represents the coordinates of the design point P^* . The distance between the design point and the origin of the standard normal space is called the Hasofer-Lind index noted as β .

First Order Reliability Method: FORM

FORM consists in replacing the failure surface by a hyperplane tangent to the failure surface at the design point in the standard normal space (see Figure (I.8)). The equation of the hyperplane tangent to P^* is the following:

$$\tilde{H}(\mathbf{u}) = \sum_{i=1}^n \alpha_i u_i + \beta = 0 \tag{I.21}$$

where α_i is the cosine direction of the variable U_i and allows the definition of the orientation of the limit state. The hyperplane is orthogonal to the vector P^*O and the approximated failure domain is $\tilde{D}_f = \{\mathbf{u} \in \mathbb{U}^n : \tilde{H}(\mathbf{u}) \leq 0\}$. The limit state is linearised using the first order Taylor development around the point P^* . The failure probability is given by:

$$P_f \approx \tilde{P}_f^{FORM} = \Phi(-\beta) \tag{I.22}$$

where Φ is the cumulative distribution of the standard normal density function.

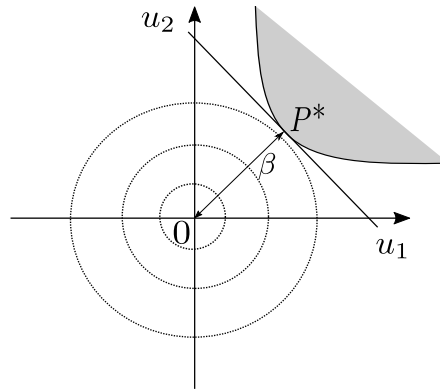

Figure I.8 – Concepts of FORM approximation.

Second Order Reliability Method: SORM

While FORM replaces the limit-state by hyperplane, SORM replaces it with a function of order two (Lemaire, 2009). The Second Order Reliability Method (SORM) uses the second order Taylor expansion to approximate the performance function at P^* . The Second-order methods improve the accuracy of first-order probability estimate by including curvature information at the point P^* , and approximating the failure surface by a quadratic surface (see Figure (I.9)). As in FORM, it is necessary to identify the design point first. The difference between the first and second-order estimates of the probability gives an indication of the curvature of the failure surface. If there is a significant difference it suggests that the use of a reference method like the Monte Carlo method that should be used to confirm the probability of failure estimate.

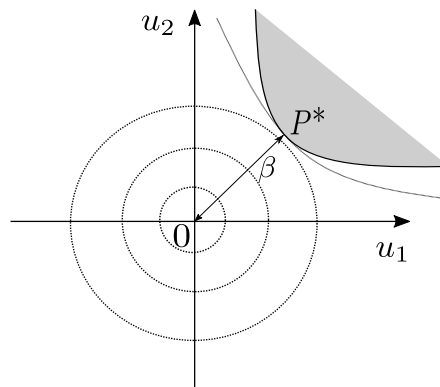

Figure I.9 – Concepts of SORM approximation.

I.3.4 Importance Sampling

As stated previously, the main problem of the Monte Carlo method, when dealing with low probabilities, is its time-consuming calculation. Importance sampling simulation has the objective of reducing the variance of P_f for a fixed calculation cost. The aim of this simulation is to choose outputs of random variables in an area closer to the area of failure (Melchers, 1990). The outputs are centred around the point P^* such as shown in Figure (I.10), thus the proportion of points belonging to the failure domain increases. This significantly improves the accuracy of the failure probability. Consider another probability density function (*pdf*) $h_{\mathbf{X}}$ called importance sampling *pdf* or instrumental *pdf*. The integral to be evaluated is then given in the form of:

$$P_f = \int_{D_{\mathbf{X}}} \mathbb{I}(\mathbf{x}) \frac{f_{\mathbf{X}}}{h_{\mathbf{X}}} h_{\mathbf{X}} d\mathbf{x} \quad (\text{I.23})$$

The failure probability can also be defined as:

$$P_f \approx \tilde{P}_f^{IS} = \frac{1}{N_{IS}} \sum_{i=1}^{N_{IS}} \mathbb{I}(\mathbf{x}^{(j)}) \frac{f_{\mathbf{X}}(\mathbf{x}^{(j)})}{h_{\mathbf{X}}(\mathbf{x}^{(j)})} \quad (\text{I.24})$$

where $\{\mathbf{x}^{(j)}, j = 1 \dots N_{IS}\}$ are N_{IS} independent samples of the random vector \mathbf{x} following the *pdf* $h_{\mathbf{X}}$, and N_{IS} is the sample size. The importance sampling density is selected to reduce the variability of the term $\mathbb{I}(\mathbf{x}^{(j)}) \frac{f_{\mathbf{X}}(\mathbf{x}^{(j)})}{h_{\mathbf{X}}(\mathbf{x}^{(j)})}$. The variance of the Importance Sampling estimator is given by:

$$\text{Var} \left[\tilde{P}_f^{IS} \right] = \frac{1}{N_{IS}} \left(\mathbb{E} \left[\mathbb{I}(\mathbf{X}) \left(\frac{f_{\mathbf{X}}(\mathbf{X})}{h_{\mathbf{X}}(\mathbf{X})} \right)^2 \right] - P_f^2 \right) \quad (\text{I.25})$$

The optimal importance sampling density function is defined as (Bucklew, 2004):

$$h(\mathbf{x}) = \mathbb{I}(\mathbf{x}) \frac{f_{\mathbf{X}}(\mathbf{x})}{P_f} \quad (\text{I.26})$$

The accuracy of the approximation given by importance sampling depends on the choice of the probability density function. However, since the failure probability is not known, the optimal importance sampling density function cannot be identified. This function is usually chosen as a standard normal non-centred density such as: $h(\mathbf{u}) = \varphi(\mathbf{u} - \mathbf{u}^*)$ where \mathbf{u}^* represents the coordinates of the design point in the standard normal space (Lemaire, 2009). Then the number of points in the failure domain is higher and the estimation of the failure probability requires less simulations.

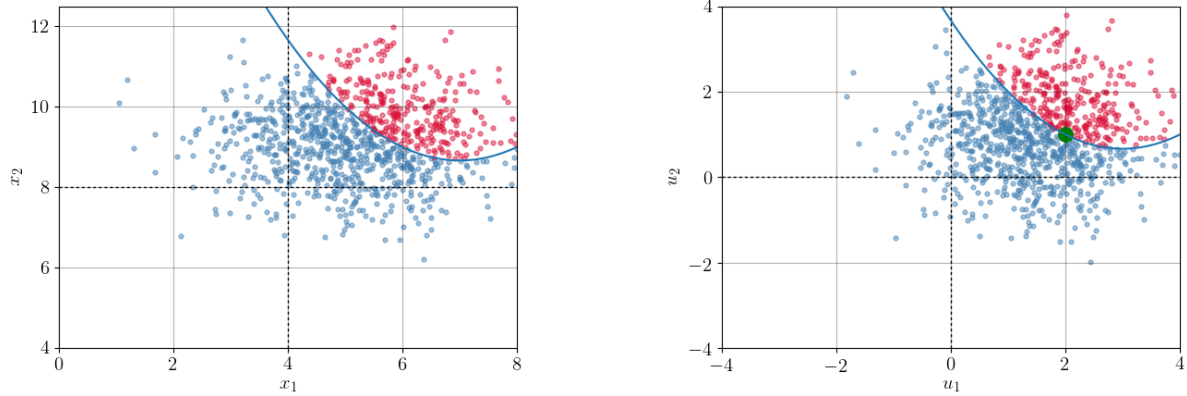

Figure I.10 – Representation of importance sampling simulation in physical and u-space.

I.3.5 Synthesis on the probabilistic methods

The probabilistic methods for reliability analysis will serve as a tool for the tolerancing problems in this work. The concept of reliability methods is adopted with the following modifications:

- The term failure probability P_f is replaced by the NCR.
- The term performance function is replaced by the functional requirement.

This is done when the studied system is linear or non-linear. For over-constrained systems, previous works exist where the reliability methods have been used in the tolerance analysis problems to estimate the non-functionality or non-assembly probabilities of a system (Qureshi et al., 2012; Dumas et al., 2015). The purpose of this work is not to find a tool for the estimation of the NCR, but to study the effect of the tolerances associated to the dimensions on this quantity of interest.

This study would enable to know the most and least contributing components in a chain of dimensions and thus to eliminate the non-contributing components from the analysis. The most contributing parts in a mechanical system are also known as Key Characteristics. Their definition as well as the existing methods for their identification are detailed in the following.

I.4 Key Characteristics

I.4.1 Definitions of Key Characteristics

Several definitions of the Key Characteristics can be found in the literature.

Definition 1. The European EN9100 has defined the KC *“as an attribute on feature whose variation has a significant effect on product fit, form, function, performance, service life”*.

Thornton has stated several definitions that have been collected from a variety of interviews and work with companies (Thornton, 1999, 2004):

Definition 2. *“Key Characteristics are designated to identify those part or assembly features/interfaces where variation from nominal results in the greatest loss, statistical process control (SPC) measurements are focused on these characteristics to minimize variation, ensure capable processes and reduce unnecessary inspection requirements”*.

Definition 3. *“A feature becomes a Key Characteristic if the variation from its nominal value has significant effect on fit, performance, or service life of the product”*.

Definition 4. *“Critical Parameters are the measurable design variables that directly affect the performance of a system/subsystem”*.

Definition 5. *“Significant Characteristics are those that are important to customer satisfaction and require special control”*.

Definition 6. *“Identifying features as important or critical does not make them good Key Characteristics. If manufacturing cannot economically measure and chart such features, then the basic requirement of a Key Characteristic—statistical control and process capability—cannot be demonstrated”*.

Definition 7. *“A Key Characteristic is a quantifiable feature of a product or its assemblies, parts, or processes whose expected variation from target has an unacceptable impact on the cost, performance, or safety of the product”*.

The last definition has been also adopted by Whitney (2006) and by Zheng et al. (2008). Thornton (2004) has presented different vital notions that characterize a KC :

- The target value of the KC and the corresponding variation should be quantifiable. This enables the evaluation of the production process whether it is convenient with the drawings and allows the enhancement of the process.
- The expected variation of the KC must have important influence on the essential measures such as the product cost, performance or safety.
- The expected variation of the KC should be probable. When the variation of is impossible

to occur, the corresponding part is not a KC even if it has a significant impact on the system measures.

The KCs can be categorized according to different point of views. Zheng and Chin (2005) have classified the KCs into four categories based on the discipline of the characteristics :

- Geometric characteristics (such as dimension and tolerance, geometric tolerances, and roughness).
- Mechanical characteristics (such as hardness and strength).
- Physical characteristic (such as weight).
- Chemical characteristic (such as chemical ingredients of component material, corrosion resistance of surface).

In this work, since it is dealing with tolerancing problems, only geometric characteristics are considered and more specifically the dimensions and tolerances of the parts involved in the mechanical system.

Key Characteristics need special attention and efforts during their production for several reasons:

- They have critical effects on the performance, safety or regulations of the mechanical system.
- There is a possibility that they will not be manufactured well due to the variations of the process.
- They affect the satisfaction of the end customer, and may cause additional costs due to adjustment of functionality, reliability and quality.

The identification of Key Characteristics engenders the following actions:

- Tightening tolerance intervals, increasing capability requirements.
- Monitoring manufacturing more regularly.
- No derogation possible on the desired level of quality.
- Means of control: specific repeatability and reproducibility on KCs.

Due to the high cost caused by these actions, the larger the number of dimensions set as KC the higher is the cost of manufacturing. There is a need to reduce the number of KCs by identifying only the necessary ones. The design department, in any manufacturing company, work to have the highest quality of a product, by selecting concepts and dimensions to minimize its sensitivity to variation. The majority of the products are transitioned into production after encountering some variation-related problems. During this transition phase it is necessary to verify that the products are within the required norms and to eliminate the excess variation. The major problem in controlling the products is that there are thousands of tolerances given by the designers. It is difficult and uneconomical to check and review all these values. Thornton (1999) has stated that the organizations are using the KCs to overcome the problem of the large number of tolerances to verify.

Different methods exist for the KCs' identification. They can be distinguished between qualitative and quantitative methods. The procedure of identifying the KCs needs a team effort, and is done using any one or a combination of approaches (The Boeing Group, 1998).

I.4.2 Qualitative approaches

Some qualitative approaches are listed in the following:

- Risk Analysis: An analytic method using the ratings of selected criteria to identify significant product or process characteristics for further study. Often the objective of this analysis is to identify product characteristics that most influence the loss function. The criteria are chosen such that they represent elements of the loss function. The criteria for the product characteristics are then rated and multiplied together to produce a risk number representing loss.
- Historical Data: It is convenient to begin a risk analysis having previous data on cause and effect analysis. To estimate data on such things such as rejections, revise, discarded, unit performance, test results, and warranty costs from actual or similar parts and assemblies, or processes where patterns or repetitive nonconformities may indicate symptoms of root-cause problems in a design or process.
- Flow-down: Some qualitative methods are based on the concept of the KC flow-down. To flow down customer requirements is to identify end-item and high-level key characteristics. To flow end-item or high-level key characteristics down to lower level key characteristics on assemblies, components, details, processes and key process parameters. The KC flow-down is a method that can identify the low level key characteristics such as the sub-assemblies of

the product (The Boeing Group, 1998). However, the classification of the identified KCs is not possible when KC flow-down approach is used. Dantan et al. (2008) have proposed an information model, based on KC-Flowdown and some quantitative information, to formalize and capitalize the causality between Manufacturing Process KCs and Part/Product KCs.

The lack of knowledge in the qualitative approaches pushed researchers to adopt quantitative methods for the identification of KCs.

I.4.3 Quantitative approaches

Some quantitative approaches can be mentioned such as:

- Loss Function: to evaluate and compare the potential economic loss due to variation from target of product features and characteristics. The greater the deviation from target, the greater the loss. Exact loss is rarely known. The loss function is normally used conceptually since it usually cannot be expressed explicitly. Thornton (1999) has identified the key characteristics by applying a sensitivity analysis based on the Taguchi loss function. The Taguchi loss function was used as a measure of the relative quality of the product-KC and proposed a variation model to calculate the impact of a KC, which is dependent on the sensitivity to the variation of product quality.
- Statistical variation: to study the overall variation of interacting dimensions by simulating or statistically tolerancing combinations of components, where each component is defined in terms of a statistical distribution.

I.4.4 Industrial practices

According to the EN16602-30-02 (2015), the Failure Mode and Effect Analysis (FMEA) is an analysis by which each potential failure mode in a product is analysed to determine its effects. It is a mutual examination tool for evaluating risks and reliability issues. It is a methodical analysis of the failure modes of a product, process or project and how they take place, why they occur, what effects the failure might lead to and what should be done in order to reduce the risk. The FMEA is intended to recognize and evaluate potential failures of a product process and the related effects, identify actions that could eliminate or reduce the chance of a failure mode occurring, and document the process. The purpose of the FMEA is to find and prioritize the potential failure modes so that the most efficient countermeasures are being deployed. The FMEA is thus a tool for distributing resources to minimize the costs for unforeseen events along

the product or process life cycle.

An extension of the FMEA with more quantitative focus that adds a criticality assessment to the analysis - the so-called failure mode, effect and criticality analysis (FMECA). In FMECA, the failure modes are classified according to their criticality, the combined measure of the severity of a failure mode and its probability of occurrence (Reliability Analysis Center, 1968). FMECA is one of the methods adopted by an important number of companies to control the quality. It is a process that pushes industries to predict in order to not review later. It is performed to examine the potential failures in products or processes, to evaluate the risk associated with those failures, to classify them in terms of importance and to correct actions that address the most critical concerns. FMECA is a methodical method of product or process analysis that is implemented to identify potential failures that could affect the customer's expectations of product quality or process performance. It is relatively a new technique; it started to be known in the early 1950s in the aerospace industries as flight control systems became more complex (Military Standard, 1980). FMECA is a common method used for the identification of critical chains (Reliability Analysis Center, 1968). In industrial practice, once a chain of dimensions is set as critical, all the involved components are set as KCs (Van Hoecke, 2013). This is a very conservative way to identify the KCs since the impact of these parts is not the same. Some dimensions have first order impact and some others have reduced impacts. **The objective of this work is to develop methods for the identification of the most influencing dimensions and classify them as KCs in one or several chains of dimensions subjected to functional requirements.** The approaches already mentioned for the identification of KCs do not provide the uncertain impacts of each dimension in the early design stage. Han et al. (2018) have detailed a review on the KCs, it is stated that both the qualitative and the quantitative methods identify the key process characteristics. However, the concern of this study is to identify the KCs in the design stage.

I.4.5 Synthesis on Key Characteristic methods

All the existing definitions of KC establish a relation between the variation from nominal with the important measures of product. This variation decreases the quality of the product, and dealing with this issue increases its cost. It is impossible to eliminate the variations, this is why designers should find a way to improve the quality without increasing the cost. Based on this information, the concern of this thesis is to identify the parts which variations have a major impact on the failure probability of the product. It is believed that the identification of KC would automatically decrease the cost of the product. The expected variations are dependent of the tolerance intervals set for the dimensions and the capability requirements of

the manufacturing process. Consequently, the approach to be followed should be quantitative, compatible with tolerancing issues and applied in the design stage. The existing methods for the identification of KCs do not give answers to the problematic of this work. Therefore, it is needed to find quantitative new approaches based on sensitivity analysis that allow the designers to set a reasonable number of KCs on the industrial drawings.

I.5 Conclusion

This chapter has set the general framework of the tolerance analysis. It provides a review on the different techniques and assumptions that are adopted in tolerancing schemes. The described strategies serve as the first three steps of the uncertainty propagation methodology.

This chapter also presents the most common strategies adopted in industries and companies to identify the Key Characteristics. In the scope of this work, it is required to identify the KCs in the design stage of the production, and to reduce the number of KCs in one critical chain of dimensions already specified by the FMECA method. The existing KCs methods are either qualitative or quantitative applied mainly in the process stage. They cannot be applied to fill the objective of this work. The methods to be developed for this purpose are based on sensitivity analysis approaches that need to be adapted to tolerancing problems. The sensitivity analysis represent the backward step of the uncertainty propagation methodology. In the next chapter, a review of the main sensitivity analysis methods is provided.

Sensitivity Analysis Methods

Contents

I.1	Introduction	7
I.2	Tolerance analysis	7
I.2.1	Basic concepts of tolerance analysis	8
I.2.2	Modelling of the geometrical variations	9
I.2.3	Modelling of the geometrical behaviour of a mechanism	12
I.2.4	Tolerance analysis for over-constrained systems	14
I.2.5	Synthesis on the tolerance analysis	17
I.3	Probabilistic methods for tolerance analysis	17
I.3.1	Formulation of the failure probability	18
I.3.2	Monte Carlo simulation	18
I.3.3	Approximation methods	20
I.3.4	Importance Sampling	23
I.3.5	Synthesis on the probabilistic methods	24
I.4	Key Characteristics	25
I.4.1	Definitions of Key Characteristics	25
I.4.2	Qualitative approaches	27
I.4.3	Quantitative approaches	28
I.4.4	Industrial practices	28
I.4.5	Synthesis on Key Characteristic methods	29
I.5	Conclusion	30

II.1 Introduction

The sensitivity analysis, also known as importance ranking, is a further step of the uncertainty propagation in uncertainty quantification such as presented in Figure (2). It is the estimation of sensitivity or importance indices of the components of the uncertain input variables with respect to a given quantity of interest in the output (see Figure (II.1)). De Rocquigny et al. (2008) have presented the sensitivity analysis as a propagation step, or a post-treatment specific to the sensitivity indices considered, normally including some statistical analysis of the input/output relations that generate quantities of interest involving the measure of uncertainty in the outputs and inputs. Saltelli et al. (2004) have defined the sensitivity analysis as the study of how the uncertainty of input parameters can influence the uncertainty of the output of a model. The idea behind the sensitivity analysis is to know the importance of the input design parameters. The performance of the system can be improved by dealing carefully with these important parameters. Numerous sensitivity analysis methods exist in the literature and are being developed progressively. Mokhtari and Frey (2003) have categorized the sensitivity analysis methods as mathematical, statistical and graphical methods. Another manner to classify these methods depending on the problem setting is to distinguish between local sensitivity analysis, screening and global sensitivity analysis. Borgonovo and Plischke (2016) have given detailed review of the existing local and global sensitivity methods and then have interpreted the results of the sensitivity analysis by giving a classical example. Iooss et al. (2015) have explained the methodological framework of different global sensitivity analysis methods. In this manuscript, two different points of view are adopted to categorize the sensitivity analysis methods.

The first categorization differentiates between the model output and the reliability sensitivity measures. This classification depends on the quantity of interest chosen for the output. The sensitivity analysis model output methods are considered when the quantity of interest is the model output Y . The reliability sensitivity analysis methods when the quantity of interest is, either related to the failure domain or a safety measure such as a failure probability or a reliability index (In this work it is the failure probability see Figure (II.1)). Chabridon (2019) has compared clearly the two different methodologies. They are also presented briefly in this chapter.

The second categorization distinguishes between the local and the global sensitivity methods, and depends on the investigated domain of the input variables.

- Local sensitivity analysis studies the local impact of inputs' variations on model output by focusing on the sensitivity around a set of an input value. Such sensitivities are often

evaluated through gradients or partial derivatives of the model output at this input value. The values of other inputs are fixed when studying the local sensitivity of a specific input.

- Global sensitivity analysis focuses on the output uncertainty over the entire range of values of the input parameters. Global sensitivity analysis explores the parameter space so that they provide robust sensitivity measures in the case of non-linearity and in the presence of interactions between the parameters. Global sensitivity method gives more detailed results than local ones. However, it is more time consuming.

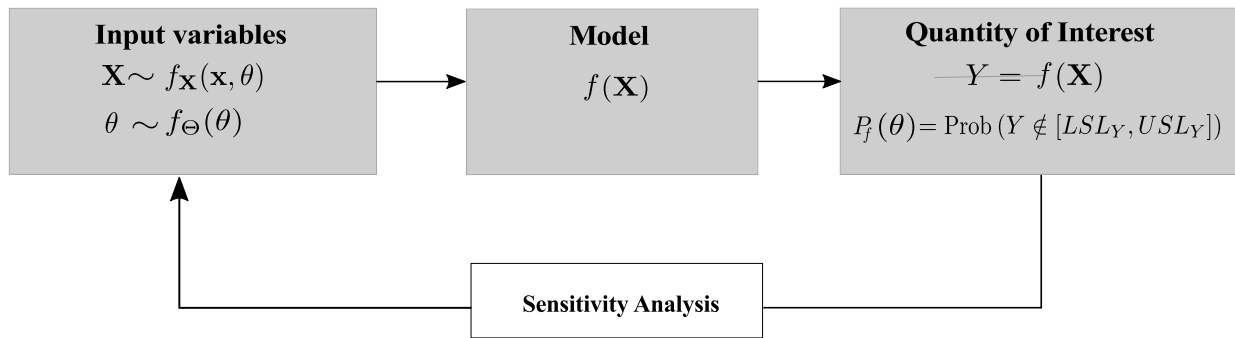

Figure II.1 – Possible input and output choices for a sensitivity analysis.

II.2 Sensitivity analysis model output

The Sensitivity Analysis Model Output methods are found frequently in the literature (Iooss et al., 2015, Borgonovo and Plischke, 2016). They have been commonly used for the analysis of the model output of computer models. This section presents the most widely used sensitivity methods and that can be adapted in the context of reliability sensitivity analysis.

II.2.1 Local sensitivity analysis

Local sensitivity considers the influence of the input parameters in the vicinity of a reference point in the space of input parameters denoted by $\mathbf{x}^{(0)} = (x_1^{(0)}, x_2^{(0)}, \dots, x_n^{(0)})$. Mathematically, the local sensitivity analysis consists in estimating the partial derivative with respect to each variable input that characterizes the effect on the model around a nominal value such as the mean of the input random variables. Let $\mathbf{x}^{(0)}$ be a particular realization of the input vector. The local sensitivity index is expressed by the following relation:

$$S_i(\mathbf{x}^{(0)}) = \frac{\partial f}{\partial x_i}(\mathbf{x}^{(0)}) \quad (\text{II.1})$$

In case all the input parameters are not expressed in the same units (e.g. the stiffness of the spring is in N/m; dimensions are in mm; a Young's modulus in GPa, etc), then all the sensitivity indices are not expressed in the same unit as well, therefore they cannot be compared. To overcome this problem the elasticity coefficients may be used instead by applying the following formula:

$$E_i(\mathbf{x}^{(0)}) = \frac{x_i}{f(\mathbf{x}^{(0)})} \cdot \frac{\partial f}{\partial x_i}(\mathbf{x}^{(0)}) \quad (\text{II.2})$$

The derivatives give information only on the reference point $\mathbf{x}^{(0)}$ where they are calculated and do not investigate the rest of the input factors. According to Saltelli et al. (2008), the main limitation of the derivative-based approach is that it gives results that may not be representative when dealing with non-linear models. To overcome this limitation, screening methods can be used.

II.2.2 Screening methods: elementary effects and Morris method

The local methods already described in Section (II.2.1) discuss the variation of a model around only one point in the input variables. They do not allow a complete investigation of the performance of the model at various points in the model input space. Screening methods permit to generalize the local index by evaluating it several times over the concerned domain. The objective of the screening methods is to identify the most important variables from among a large number. They are computationally cheap since they require a small number of model evaluations (Saltelli et al., 2004). They were considered in order to evaluate models involving tens or hundreds of model inputs. Computationally expensive methods of sensitivity analysis can be excluded if a model comprises a large number of inputs and computationally expensive. In such cases, a possible alternative is the use of screening methods, which enable the identification of the most important among many model inputs. The principal assumption is that the number of important inputs in the model is small compared to the total number of inputs. Therefore, the purpose of screening is to exclude unimportant inputs in order to concentrate efforts on the most significant. Screening methods are based on a discretization of the inputs in levels (grid), and the computation of indices is done on a point of this grid (Iooss et al., 2015). The simplest screening design is the One-At-a-Time designs (OAT) design. It consists of using a reference condition and then modifies each parameter individually to a higher and a lower value, while keeping other parameters at the reference value. The difference between the outcome for the high and the low value is then used as a measure of the influence of the parameter on the system. The main advantage of this design is its simplicity and the fact that it only requires $2n$ experiments, with n being the number of parameters studied.

The Morris method proposes an experimental plan composed of a set of randomised OAT experiments (Morris, 1991). The first step of this method consists of mapping the space to a n -dimensional hypercube $H^n = [0, 1]^n$. Then, the input space is discretised in p levels. The experimentation region is a n -dimensional p -level grid (see Figure (II.2)). A number of OAT designs is performed along the grid following random sample paths. The application of Morris method necessitates the computation of elementary effects. It is achieved by perturbing one input variable for every path. The elementary effect of the i^{th} input variable is defined as:

$$EE_i(\mathbf{x}) = \frac{f(x_1, \dots, x_{i-1}, x_i + \Delta, x_{i+1}, \dots, x_n) - f(\mathbf{x})}{\Delta} \quad (\text{II.3})$$

where Δ is the perturbation step, it is set as multiple $1/(p-1)$. The number of elementary effects within the unit hypercube for each input variable is $pn - 1[p - \Delta(p-1)]$, which follows a given discrete probability density function noted as F_i . The sensitivity measures, μ and σ , proposed by Morris are respectively the mean and the standard deviation of the distribution F_i . The mean μ assesses the overall influence of the factor on the output. The standard deviation σ estimates the ensemble of the factor's higher order effects, i.e. non-linear and/or due to interactions with other factors. Consider $EE_{n,i}$ is performed on the trajectory ($j = 1, \dots, r$) relative to the variation of the parameter X_i . The equations corresponding to the mean and the standard deviation are the following:

$$\mu_i = \frac{1}{r} \sum_{j=1}^r EE_{j,i} \quad (\text{II.4})$$

$$\sigma_i = \sqrt{\frac{1}{r} \sum_{j=1}^r (EE_{j,i} - \mu_i)^2} \quad (\text{II.5})$$

Campolongo et al. (2007) have presented an improved version of the Elementary Effects method, where a new measure μ_i^* is defined which alone assesses the factors' importance:

$$\mu_i^* = \frac{1}{r} \sum_{j=1}^r |EE_{j,i}| \quad (\text{II.6})$$

The use of the absolute value of the EE_i allows to solve the problem of the effects of opposite signs which occurs when the model is non-monotonic. Figure (II.3) is a representation of how the input parameters can be presented in a $\sigma - \mu^*$ diagram. The points that are in group A are the less effective since they are the closest to the origin. The points in group B have a large mean, that is, they have an important linear effect on the output. The points in group C have a large mean and a large standard deviation, that is, they have important non-linear effect on the output, or they interact with other factors.

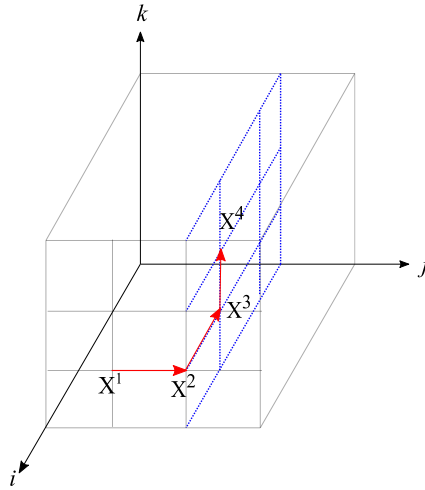

Figure II.2 – Representation of a four-level grid ($p = 4$) in a three-dimensional input space.

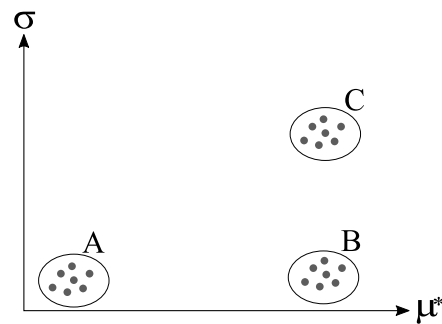

Figure II.3 – Representation of input parameters in $\sigma - \mu^*$ diagram.

As a conclusion, screening methods are known to be efficient for an approximate but fast investigation of the input. However, the results they provide are more qualitative than quantitative. The global methods providing quantitative importance measures are detailed in the next section.

II.2.3 Derivative based Global Sensitivity Measures (DGSM)

The global sensitivity estimator called Derivative based Global Sensitivity Measures (DGSM) is a generalization of the Morris method. DGSM are obtained by implementing a global procedure where local derivatives are considered and not variations on a fixed grid. This allows to take into consideration the input distributions. The DGSM estimator was first introduced by Sobol and Gershman (1995) and more investigated later by Kucherenko and Iooss (2010, 2017); Kucherenko and Song (2017). The idea of this method is to average local derivatives using Monte Carlo or Quasi Monte Carlo sampling methods. Assume $\mathbf{X} = (X_1, \dots, X_n)$ a n -

dimensional vector of n independent Gaussian random variables, with joint probability density function $f_{\mathbf{X}}$ defined on $D_{\mathbf{X}}$, the DGSM index v_i associated with the i^{th} input X_i , is the following (Sobol and Kucherenko, 2009):

$$v_i = \int_{D_{\mathbf{X}}} \left(\frac{\partial f(\mathbf{x})}{\partial x_i} \right)^2 f_{\mathbf{X}} d\mathbf{x} \quad (\text{II.7})$$

Other indices can be defined when the variables follow other types of probability distributions such as uniformly distributed random variables over the unit hypercube H^n (Kucherenko and Song, 2017). The sensitivity indices estimates from DGSM are more accurate than those obtained from Morris that only considers local sensitivities to evaluate the sensitivity measures. The DGSM strategy is less time consuming than other global sensitivity measures. However, the results that provide are more qualitative than quantitative. This means that the variables can be only classified as important or non-important.

II.2.4 Variance-based sensitivity analysis (Sobol' Method)

One of the global sensitivity analysis methods, is the variance-based approach. It uses variance as a measure of uncertainty, and seeks to apportion a model's output variance into contributions from each of the factors, as well as their interactions. One of the most used variance based methods is the Sobol' approach which is based on the work of Cukier et al. (1973). This approach was first introduced by Sobol (1993). He has demonstrated that a square integrable function f can be decomposed into integrands therefore the variance of the model is also decomposed into fractions that are used then as inputs for the model. In other words, f can be expressed as the sum of elementary functions such as:

$$Y = f(\mathbf{X}) = f_0 + \sum_{i=1}^n f_i(X_i) + \sum_{1 \leq i < j \leq n} f_{ij}(X_i, X_j) + \dots f_{12\dots n}(X_1, X_2, \dots, X_n) \quad (\text{II.8})$$

where $f_0 = \mathbb{E}[Y] = \int_{H^n} f(\mathbf{X}) f_{\mathbf{X}}(\mathbf{x})$ is a constant, and $f_{\mathbf{X}}$ the product of n uniform marginals over the domain $[0, 1]$. Similar relations are obtained for higher order terms of the decomposition:

$$f_i(X_i) = \mathbb{E}[Y|X_i] - \mathbb{E}[Y] \quad (\text{II.9})$$

$$f_{ij}(X_i, X_j) = \mathbb{E}[Y|X_i, X_j] - \mathbb{E}[Y|X_i] - \mathbb{E}[Y|X_j] - f_0 \quad (\text{II.10})$$

where \mathbb{E} is the mathematical expectation. Assume that the model parameters are independent or uncorrelated, the total variance of model output is composed of the variance from individual parameters, and the variances from cooperative parameters. The proportion of variance resulting from individual and cooperative parameters to the total variance is applied to estimate the

first order and interactive sensitivity indices of parameters. The variance decomposition is also called ANOVA decomposition and can be expressed as:

$$\text{Var}[Y] = \sum_{i=1}^n V_i + \sum_{1 \leq i < j \leq n} V_{ij} + \dots V_{12\dots n} \quad (\text{II.11})$$

where $\text{Var}[Y]$ is the total variance of model output; $V_i = \text{Var}[\mathbb{E}[Y|X_i]]$ is the first order contribution of the i^{th} model parameter; $V_{ij} = \text{Var}[\mathbb{E}[Y|X_i, X_j]] - V_i - V_j$ is the effect of the interaction of the i^{th} and j^{th} parameters. The use of this approach allows the measurement of the first-order sensitivity index, or the main effect which is the contribution to the output variance of the main effect of one parameter, hence it measures the impact of the variation of an input parameter alone, and averaged over variations in other input parameters. The equation corresponding to the first order index is given by:

$$S_i = \frac{V_i}{\text{Var}[Y]} = \frac{\text{Var}[\mathbb{E}[Y|X_i]]}{\text{Var}[Y]} \quad (\text{II.12})$$

If the value of S_i is zero, it can be deduced that the function f does not depend on X_i . In another hand if S_i is equal to 1, it means that f depends only on X_i . Another measurement to be estimated using the Sobol' approach is the second order sensitivity index. It gives the sensitivity of the variance of the output to the interaction between the input factors X_i , X_j . It is expressed as:

$$S_{ij} = \frac{V_{ij}}{\text{Var}[Y]} = \frac{\text{Var}[\mathbb{E}[Y|X_i, X_j]] - V_i(Y) - V_j(Y)}{\text{Var}[Y]} \quad (\text{II.13})$$

If n is the number of the model parameters, $2^n - 1$ indices can be estimated. Finally, the total Sensitivity index can be estimated. It measures the interaction of each variable with the other variables (Homma and Saltelli, 1996). All the terms of the decomposition in Equation (II.11) where i is involved are used. It is expressed as:

$$S_{Ti} = S_i + \sum_j S_{ij} + \sum_{j,k} S_{ijk} + \dots \quad (\text{II.14})$$

It can be also expressed as:

$$S_{Ti} = 1 - \frac{\text{Var}[\mathbb{E}[Y|\mathbf{X}^{-i}]]}{\text{Var}[Y]} \quad (\text{II.15})$$

where \mathbf{X}^{-i} stands for \mathbf{X} without the i^{th} component X_i . There is absence of interaction between X_i and other variables, if the value of the total effects is equal to the value of the main effects.

Estimation of the Sobol' indices

The common way to compute the Sobol' indices is to use what is known as the brute force *Monte Carlo approach* (Saltelli et al., 2006; 2010). Two matrices A and B are generated comprising

the input parameters denoted respectively a_{ji} and b_{ji} where $i = 1, \dots, n$ and $j = 1 \dots N$. n is the number of input variables and N is the number of generated samples.

$$A = \begin{bmatrix} a_{11} & \cdots & a_{1i} & \cdots & a_{1n} \\ \vdots & \cdots & \vdots & \cdots & \vdots \\ a_{j1} & \cdots & a_{ji} & \cdots & a_{jn} \\ \vdots & \cdots & \vdots & \cdots & \vdots \\ a_{N1} & \cdots & a_{Ni} & \cdots & a_{Nn} \end{bmatrix} \quad B = \begin{bmatrix} b_{11} & \cdots & b_{1i} & \cdots & b_{1n} \\ \vdots & \cdots & \vdots & \cdots & \vdots \\ b_{j1} & \cdots & b_{ji} & \cdots & b_{jn} \\ \vdots & \cdots & \vdots & \cdots & \vdots \\ b_{N1} & \cdots & b_{Ni} & \cdots & b_{Nn} \end{bmatrix}$$

A matrix A_B is defined, having all the columns of matrix A except the i th column from matrix B . The same concept is applied on a matrix called B_A such that all its columns are from matrix B except the i th column that comes from matrix A . They are presented as:

$$A_B^{(i)} = \begin{bmatrix} a_{11} & \cdots & b_{1i} & \cdots & a_{1n} \\ \vdots & \cdots & \vdots & \cdots & \vdots \\ a_{j1} & \cdots & b_{ji} & \cdots & a_{jn} \\ \vdots & \cdots & \vdots & \cdots & \vdots \\ a_{N1} & \cdots & b_{Ni} & \cdots & a_{Nn} \end{bmatrix} \quad B_A^{(i)} = \begin{bmatrix} b_{11} & \cdots & a_{1i} & \cdots & b_{1n} \\ \vdots & \cdots & \vdots & \cdots & \vdots \\ b_{j1} & \cdots & a_{ji} & \cdots & b_{jn} \\ \vdots & \cdots & \vdots & \cdots & \vdots \\ b_{N1} & \cdots & a_{Ni} & \cdots & b_{Nn} \end{bmatrix}$$

The first order index is calculated from the matrices A with $B_A^{(i)}$ by applying the following formula:

$$V_i = \text{Var}[E[Y|X_i]] = \frac{1}{N} \sum_{j=1}^N f(A)_j f(B_A^{(i)}) - f_0^2 \quad (\text{II.16})$$

where

$$f_0 = \frac{1}{N} \sum_{j=1}^N f(A)_j \quad (\text{II.17})$$

The total order index is calculated from the matrices A and $A_B^{(i)}$ by applying the following formula:

$$\text{Var}[E[Y|X_{\sim i}]] = \frac{1}{N} \sum_{j=1}^N f(A)_j f(A_B^{(i)}) - f_0^2 \quad (\text{II.18})$$

The use of Sobol' indices acquires a quantitative classification of the impacts of each input on the variance of the output. However, Sobol' indices are relevant only when the variance is the real quantity of interest characterizing the model output. For example, when the output distribution is multi-modal or highly skewed, the variance is no longer representative. In such cases, the density-based sensitivity methods can be adopted.

II.2.5 Density-based sensitivity analysis

Density-based sensitivity methods consider the entire distribution and do not refer to a specific moment, they are also called moment independent methods. A moment independent importance measure called Chun–Han–Tak (CHT) was introduced by Chun et al. (2000), it studies the influence of parameters on the output uncertainty given a base case and a sensitivity case. Borgonovo (2007) then has defined a new moment independent importance measure that does not need previous hypothesis. It is a global sensitivity indicator which studies the influence of input uncertainty on the entire output distribution without reference to a specific moment of the output and which can be defined also in the presence of correlations among the parameters. It is given that: $f_Y(y)$ is the density function of the model Y , $f_{Y|X_i}$ is the conditional density of Y when a fixed value is given to one of the parameters X_i and $f_{X_i}(x_i)$ is the marginal density of x_i . The shaded region in figure (II.4) is the shift between the two densities $f_Y(y)$ and $f_{Y|X_i}$,

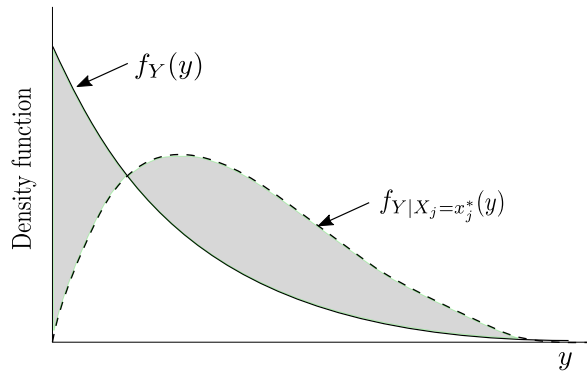

Figure II.4 – Shift between the density corresponding to Y and the conditional density.

this area is given by:

$$s(X_i) = \int |f_Y(y) - f_{Y|X_i}(y)| dy \quad (\text{II.19})$$

The expected shift is the following:

$$E_{X_i}[s(X_i)] = \int f_{X_i}(x_i) \left[\int |f_Y(y) - f_{Y|X_i}(y)| dy \right] dx_i \quad (\text{II.20})$$

The importance measure is called moment independent sensitivity indicator of parameter X_i with respect to Y . δ_i is the normalized expected shift in the distribution of Y caused by X_i , it is expressed in Equation (II.21), the signification of δ_i is given in Table (II.1).

$$\delta_i = \frac{1}{2} E_{X_i}[s(X_i)] \quad (\text{II.21})$$

Table II.1 – Properties of Borgonovo’s δ -index.

No.	Property	Description
1	$0 \leq \delta_i \leq 1$	Bounds of δ_i
2	$\delta_i = 0$	Applies if Y is independent of X_i
3	$\delta_{1,2,\dots,n} = 1$	δ for all input variables together
4	$\delta_{ij} = \delta_i$	Applies if Y is independent of X_j
5	$\delta_i \leq \delta_{i,j} \leq \delta_i + \delta_{i j}$	Bounds of δ_{ij}

The first property infers that the higher the index value the more important is the impact of the corresponding input variable. The second property states that if Y is independent from X_i , then X_i does not influence the variability of Y , then the index value is zero. If the index is computed for a group of variables consisting of all input variables of the system, then the index is equal to one. This property shall not be flawed that the sum of all individual indices always equals to one. ($\delta_1 + \delta_2 + \dots + \delta_n \neq 1$).

II.2.6 Synthesis on the sensitivity analysis methods

There exists a wide variety of sensitivity analysis model output methods. Some of them were described in the previous section. These sensitivity measures give either qualitative or quantitative information regarding the ranking of variables. They are performed based on specific assumptions and mathematical frameworks defining their computational effort, complexity and efficiency. Table (II.2) summarises the properties corresponding to the sensitivity methods. Some drawbacks of the sensitivity analysis model output are the following:

- type of Quantity of Interest (model output Y or failure probability P_f);
- goal of the study (fast screening or importance ranking);
- maximum allowable simulation budget (computational time or number of calls to the computer code);
- characteristics of the inputs (independent or not, functional input, input dimension) and of the outputs (single or multiple, functional output);
- type of the model (monotonic, linear, nonlinear);
- additional sources of uncertainties on the input probabilistic model.

Table II.2 – Properties of Sensitivity analysis methods.

Sensitivity Methods	Assumptions	Type (Qualitative or Quantitative)	Computational Effort	Complexity	Efficiency
Local measures	Analysis around a reference point	Quantitative	x	x	x
Screening Methods	Independent input variables	Qualitative	xx	xx	xx
DGSM	Independent input variables	Qualitative	xxx	xx	xxx
Variance-based	Independent input variables	Quantitative	xxxx	xxx	xxx
Density -based	No assumptions	Quantitative	xxxxx	xxx	xxxx

II.3 Reliability sensitivity analysis with respect to distribution parameters

The sensitivity of the reliability or the failure probability of a system is one of the most important concerns in the structural reliability domain. It is very important to know the impact of an input variable in a reliability problem on the failure probability. This variable can either be a distribution parameter of a random variable or a deterministic parameter of the limit state function (Papaioannou et al., 2013). In the context of this thesis, the input variables are distribution parameters. The reliability sensitivity analysis methods can be also categorised into local and global analysis.

II.3.1 Local reliability sensitivity measures

The sensitivity measures based on the partial derivative of the probability of failure with respect to the distribution parameters θ of a random input variable can be expressed as follows:

$$S_{j,i} = \frac{\partial P_f}{\partial \theta_{j,i}} \quad (\text{II.22})$$

where $S_{j,i}$ is the sensitivity measure of the i^{th} input variable and its j^{th} distribution parameter. Several works deal with the partial derivative based indices in the reliability sensitivity context. Hohenbichler and Rackwitz (1986) have presented the sensitivity measure based on the partial derivation of the reliability index (see Section (I.3.3)) with respect to a deterministic model parameter $\partial\beta/\partial\theta$. Bjerager and Krenk (1989) have proposed also a local derivative-based

index by getting the partial derivation of the unit important direction $\partial\alpha/\partial\theta$ and have showed some practical applications.

Local reliability sensitivity analysis by score functions

The local reliability-oriented sensitivity indices can be measured using the sampling-based techniques. Several techniques can be found in the literature for the derivation of the failure probability with respect to the distribution parameters, such as the score functions based technique. The sensitivity of the failure probability P_f with respect to the distributions' parameters (denoted by θ_i) is derived by using the score function. Four assumptions, known as regularity conditions are required (Rubinstein and Shapiro, 1993):

1. The probability density function $f_{\mathbf{X}}(\mathbf{x}, \theta)$ is continuous.
2. The parameter $\theta_i \in \Theta_i \subset \mathbb{R}$, $i = 1, \dots, M$ where M is the number of distribution parameter, Θ_i is an open interval on \mathbb{R} .
3. The partial derivative $\partial f_{\mathbf{X}}(\mathbf{x}, \theta)/\partial\theta_i$ exists and is finite for all \mathbf{x} and θ_i . In addition, $P_f(\theta)$ is a differentiable function of θ .
4. There exists a Lebesgue integrable dominating function $r(\mathbf{x})$ such that $\left| \mathbb{I}(\mathbf{x}) \frac{\partial f_{\mathbf{X}}(\mathbf{x}, \theta)}{\partial\theta_i} \right| \leq r(\mathbf{x})$ for all θ_i , where $r(\mathbf{x})$ is integrable in the sense of Lebesgue.

Taking the partial derivative of P_f with respect to θ_i yields :

$$\frac{\partial P_f(\theta)}{\partial\theta_i} = \frac{\partial}{\partial\theta_i} \int_{D_{\mathbf{X}}} \mathbb{I}(\mathbf{x}) f_{\mathbf{X}}(\mathbf{x}, \theta) d\mathbf{x} \quad (\text{II.23})$$

Since the joint density function is assumed continuously differentiable w.r.t. θ_i and the integration domain does not depend on θ_i , Equation (II.23) can be written as:

$$\frac{\partial P_f(\theta)}{\partial\theta_i} = \int_{D_{\mathbf{X}}} \mathbb{I}(\mathbf{x}) \cdot \frac{\partial f_{\mathbf{X}}(\mathbf{x}, \theta)}{\partial\theta_i} d\mathbf{x} \quad (\text{II.24})$$

After using an importance sampling trick, and interchanging differential and integral operators using the Lebesgue dominated convergence theorem, the partial derivative with respect to the distributions' parameters can be expressed as:

$$\begin{aligned} \frac{\partial P_f(\theta)}{\partial\theta_i} &= \int_{D_{\mathbf{X}}} \mathbb{I}(\mathbf{x}) \cdot \frac{\partial f_{\mathbf{X}}(\mathbf{x}, \theta)/\partial\theta_i}{f_{\mathbf{X}}(\mathbf{x}, \theta)} d\mathbf{x} \\ &= \int_{D_{\mathbf{X}}} \mathbb{I}(\mathbf{x}) \cdot \frac{\partial \ln f_{\mathbf{X}}(\mathbf{x}, \theta)}{\partial\theta_i} f_{\mathbf{X}}(\mathbf{x}, \theta) d\mathbf{x} \\ &= \mathbb{E}_{\theta} [\mathbb{I}(\mathbf{X}) s_{\theta_i}(\mathbf{X}, \theta)] = \mathbb{E}_{\theta} [g(\mathbf{X})] \end{aligned} \quad (\text{II.25})$$

where $s_{\theta_i}(\mathbf{x}, \boldsymbol{\theta})$ is the first order score function for the parameter θ_i :

$$s_{\theta_i}(\mathbf{x}, \boldsymbol{\theta}) = \frac{\partial \ln f_{\mathbf{X}}(\mathbf{x}, \boldsymbol{\theta})}{\partial \theta_i} \quad (\text{II.26})$$

The derivation of sensitivities in a Monte Carlo setting has been introduced by Rubinstein (1986) and then adopted by many others works such as Rahman (2009) and Millwater (2009). The Monte Carlo estimator of the quantity $\frac{\partial P_f(\boldsymbol{\theta})}{\partial \theta_i}$, for N_{MC} samples is given by:

$$\frac{\partial P_f(\boldsymbol{\theta})}{\partial \theta_i} \approx \frac{1}{N_{MC}} \sum_{i=1}^{N_{MC}} \mathbb{I}(\mathbf{X}^{(i)}) s_{\theta_i}(\mathbf{X}^{(i)}, \boldsymbol{\theta}) = \tilde{g}_N \quad (\text{II.27})$$

where \tilde{g}_N is a non-biased estimator of $\mathbb{E}[g_N]$. The use of the score-function based technique requires only one call of the MC samples, that will be reused for the estimation of P_f and its gradient with respect to the distribution parameters. The variance of \tilde{g}_N is expressed as:

$$\begin{aligned} \text{Var}[\tilde{g}_N] &= \text{Var} \left[\frac{1}{N_{MC}} \sum_{i=1}^{N_{MC}} g(\mathbf{X}^{(i)}) \right] \\ &= \int_{D_{\mathbf{X}}} g^2(\mathbf{X}) f_{\mathbf{x}}(\mathbf{X}) d\mathbf{X} - \mathbb{E}[g(X)]^2 \\ &\approx \frac{1}{N_{MC}} \sum_{i=1}^N g^2(\mathbf{X}^{(i)}) - \left(\frac{1}{N_{MC}} \sum_{i=1}^{N_{MC}} g(\mathbf{X}^{(i)}) \right)^2 = \sigma_g^2 \end{aligned} \quad (\text{II.28})$$

Considering the limit theorem, the random variable Z is defined as:

$$Z = \frac{\tilde{g}_N - \mathbb{E}[g(X)]}{\sigma_g / \sqrt{N_{MC}}} \quad (\text{II.29})$$

Considering that Z follows a standard normal distribution, the confidence interval length associated to the risk α is:

$$CI(\alpha, N_{MC}) = 2u_{1-\alpha/2} \frac{\sigma_g}{\sqrt{N_{MC}}} = \frac{2u_{1-\alpha/2}}{N_{MC}} \sqrt{\sum_{i=1}^{N_{MC}} g^2(\mathbf{X}^{(i)}) - \left(\frac{1}{N_{MC}} \sum_{i=1}^N g(\mathbf{X}^{(i)}) \right)^2} = \sigma_g^2 \quad (\text{II.30})$$

Other sensitivity indices strategies

Wu (1993) has defined a measure based on adaptive Importance Sampling and the partial derivative of the probability of failure. Another technique based on Subset sampling has been introduced by Song et al. (2009). In addition, several works have developed a reliability-sensitivity measure based on the concept of Line Sampling such as the works of Lu et al. (2008), Papaioannou et al. (2013) and Valdebenito et al. (2018). Other techniques combine the tools of approximation methods and the sampling techniques such as the method that has been proposed by Melchers and Ahammed (2004) for parameter sensitivity based on Monte Carlo Sampling and the First Order Reliability Method (FORM).

II.3.2 Screening methods for reliability sensitivity analysis

Xiao et al. (2016) proposed to adapt the modified Morris' elementary effects method proposed by Campolongo (see Section (II.2.2)) to the reliability sensitivity analysis context. The inputs are independent epistemic uncertain distribution parameters presented by the vector $\boldsymbol{\theta} = (\theta_1, \dots, \theta_{n\theta})$. The elementary effect is considered for $j \in \{1, \dots, n\theta\}$ as the following:

$$EE_j(\mathbf{x}) = \frac{P_f(\theta_1, \dots, \theta_{j-1}, \theta_j + \Delta, \theta_{j+1}, \dots, \theta_{n\theta}) - P_f(\boldsymbol{\theta})}{\Delta} \quad (\text{II.31})$$

where the failure probability P_f is estimated for each grid-point θ_j using a particular technique for rare event estimation (Zhang and Pandey, 2013). The set of two indices (μ^*, σ) can be then calculated following the formulas already given in Equations (II.5) and (II.6) .

II.3.3 DGSM for reliability sensitivity analysis

The concept of the global sensitivity measure based on the integral of local derivatives (see Section (II.2.3)) has been adapted by Wang et al. (2013) in the reliability sensitivity analysis. The formulation of this index is as follows:

$$v_i = \int_{D_{\boldsymbol{\theta}}} \left(\frac{\partial P_f(\boldsymbol{\theta})}{\partial \theta_i} \right)^2 f_{\boldsymbol{\theta}}(\boldsymbol{\theta}) d\boldsymbol{\theta} \quad (\text{II.32})$$

The partial derivative $\partial P_f / \partial \theta_k$ is found using the score function estimator described in Equation (II.27). The quasi-Monte Carlo method and double-loop point estimate method are then utilized to compute the derivative based sensitivity measure. This method allows to distinguish between highly contributing parameters and non-contributing parameters, but it cannot give an accurate ranking of the parameters.

II.3.4 Variance-based reliability sensitivity analysis

The variance-based Sobol' indices, already presented in Section (II.2.4), have been used in the reliability sensitivity context by Morio (2011). He has evaluated the sensitivity of the failure probability to the model parameters, and has proposed a methodology that is based on Sobol' indices that enables to estimate the influence of each statistical parameter on the value of the failure probability (Morio, 2011). Consider that the distribution parameters represented in $\boldsymbol{\theta}$ follow a density function $f_{\boldsymbol{\theta}}$, then the decomposition of functions already discussed in Section.(II.2.4) can be applied. The first and total order Sobol' indices can be expressed as:

$$S_i = \frac{\text{Var}[\mathbb{E}[P_f|\theta_i]]}{\text{Var}[P_f]} \quad (\text{II.33})$$

$$S_{T_i} = 1 - \frac{\text{Var}[\mathbb{E}[P_f|\boldsymbol{\theta}^{-i}]]}{\text{Var}[P_f]} \quad (\text{II.34})$$

where $\boldsymbol{\theta}^{-i}$ is the distribution parameters' vector $\boldsymbol{\theta}$ without the i^{th} component. This method can rank of the influence of the statistical parameters on the failure probability, however it needs more computational efforts DGSM or other local sensitivity measures.

II.3.5 Synthesis on reliability sensitivity measures

The reliability sensitivity measure are very common in the field of structural reliability where the sensitivity of the failure probability of a structure is of great importance. The presented reliability sensitivity measures can be adapted in the scope of this work. The difference is that the quantity of interest is the NCR or the non-functionality or non-assembly probability estimated in a tolerancing problem and based on probabilistic approaches that are described in Section (I.3).

II.4 Conclusion

This chapter reviews the sensitivity analysis methods existing in the literature. Two major poles of these methods were distinguished:

- First, the basic notions of the sensitivity analysis of model output were discussed. They represent the methods where the quantity of interest is related to the model output Y . The corresponding advantages and disadvantages of these methods are detailed.
- Then, some reliability sensitivity measures were also reviewed. They illustrate the approaches when the quantity of interest is related to a reliability measure such as the failure probability. These measures will be adapted in this thesis to the tolerancing problems.

The presented sensitivity measures will be used in later chapters in tolerancing problems for the KCs identification. The choice of the sensitivity method depends on:

- the type of the mechanical system (linear, non-linear, over-constrained).
- the dimensionality of the problem.
- the available data of the tolerancing problem.
- the requirements of the designers (classification or hierarchization of input variables).

The next chapter presents the first proposed methodology for the identification of KCs that is based on the reliability sensitivity Sobol' measure applied in a tolerance analysis framework.

Method 1: Key Characteristics Identification by Sobol' Sensitivity Indices

Contents

II.1	Introduction	32
II.2	Sensitivity analysis model output	33
II.2.1	Local sensitivity analysis	33
II.2.2	Screening methods: elementary effects and Morris method	34
II.2.3	Derivative based Global Sensitivity Measures (DGSM)	36
II.2.4	Variance-based sensitivity analysis (Sobol' Method)	37
II.2.5	Density-based sensitivity analysis	40
II.2.6	Synthesis on the sensitivity analysis methods	41
II.3	Reliability sensitivity analysis with respect to distribution parameters	42
II.3.1	Local reliability sensitivity measures	42
II.3.2	Screening methods for reliability sensitivity analysis	45
II.3.3	DGSM for reliability sensitivity analysis	45
II.3.4	Variance-based reliability sensitivity analysis	45
II.3.5	Synthesis on reliability sensitivity measures	46
II.4	Conclusion	46

III.1 Introduction

The objective of this chapter is to develop a new method for the identification of the most influencing dimensions and classify them as Key Characteristics in the same critical functional requirement during the design stage. Designers and manufacturing engineers adopt new practices, in the mechanical and industrial engineering fields, in the early phases of the design to reach a product with high quality and minimum cost. They set the nominal dimensions, the tolerance intervals and the capability requirements that need to be respected in the manufacturing process. They also indicate the dimensions that have to be considered as Key-Characteristics (KCs) on the engineering drawings. The approaches already mentioned in chapter I for the identification of KCs do not predict the uncertain impacts of each dimension in the early design stage. Further analysis is needed for this purpose. The proposed method defines the most contributing dimensions using sensitivity analysis in the context of tolerancing. It allows the classification of the dimensions with high or reduced impact on the performance of the system, they are defined as KCs or not KCs. It quantifies the impact of the variation of the statistical parameters on the variation of the failure probability. **In tolerance analysis the failure probability is called the Non Conformity Rate, which is the probability that the functional requirement is not satisfied.** In addition, this method is applicable when the system comprises more than one functional requirement. It also allows the detection of interactions between the input variables despite the linearity of the functional characteristic. This method also allows an interactive environment between the designers and manufacturing engineers by taking into account the uncertainties in tolerances in the design drawings and the manufacturing variations during the processes.

The existing works in the literature where the sensitivity analysis is used in tolerancing area are given in this chapter. The proposed approach for the KC identification and the corresponding steps are also exposed. The proposed method is applied to a stack-up example of linear function, to a linearised function, and to a system comprising two non-linear functions.

III.2 Sensitivity analysis in tolerancing area

The sensitivity methods are used to study the influence of input parameters on the output of a model. They are distinguished between the local ones and the global ones as described in previous sections in Chapter II. In tolerancing activities, it is essential to identify the contribution of input parameters corresponding to each dimension on the functionality, assemblability and the performance of any system. For this purpose, sensitivity analysis is adopted for the

categorization of low and high contributing parameters. Different works exist in the literature where the sensitivity analysis is used in the context of tolerancing.

III.2.1 Local sensitivity analysis in tolerancing

Stuppy and Meerkamm (2009) have applied “*arithmetical contributors analysis*” in tolerance management, which is a local sensitivity analysis method to quantify the influence of the tolerances of each parameter on the variation of the functional dimension. The contribution of each tolerated parameter is calculated by multiplying the corresponding absolute value of the linearity coefficient with the tolerance interval of the tolerated parameter and dividing this by the arithmetical tolerance of the functional dimension. The linearity coefficient reveals how much a geometrical change of the tolerated parameter affects the functional dimension just due to the geometrical relations in the mechanism. In addition, the arithmetical contribution takes into account the range of the tolerance intervals. The tolerance analysis in this chapter is based on arithmetical methods. Ledoux and Teissandier (2013) have proposed a method based on local sensitivities to analyse the influence of the geometric and dimensional specifications on the functional characteristic that they represent by “*c*”. The sensitivities of each deviation are calculated when considering worst-case analysis from the following equation:

$$S_{x_i} = \frac{\partial c}{\partial x_i} \quad (\text{III.1})$$

where x_i represents the small displacement torsor of each dimension involving rotation and translation deviations. There is a difficulty to interpret the sensitivity calculation since the model includes both the rotation and translation deviations. To compare these deviations, which are in different units, the elasticity is calculated. It consists of standardising each sensitivity estimated in Equation (III.1) using the nominal values of the parameter studied and that of c such as:

$$e_{x_i} = \frac{x_i}{c} \frac{\partial c}{\partial x_i} \quad (\text{III.2})$$

When a statistical model is set for c , the tolerance zone of the dimension is assumed to be six standard deviations ($\sigma_i = t_i/6$).

III.2.2 Global sensitivity analysis

Ziegler and Wartzack (2015a,b) have implemented global sensitivity analysis methods on convex hull based tolerancing techniques, such as deviation domains. The tolerancing is based on convex hull techniques. The geometrical variations are represented by the variation of the position

and orientation of geometric ideal elements with respect to their nominal position. Tolerances are expressed by norms that represent the distance measures between the deviating points and the nominal points. For sensitivity analysis the tolerance values t_i of features f_i are the input parameters of the algorithms. These input parameters then define level sets for the Small Displacement Torsors (SDT) – layers of the Deviation Domains. For performing sensitivity analysis based on X_i , for position and orientation deviations $(\mathbf{x}, \boldsymbol{\theta})$ the deviation characteristic $\lambda(\mathbf{x}, \boldsymbol{\theta})$ with respect to t_i is introduced. A Small Displacement Torsor has the deviation characteristic $0 \leq \lambda(\mathbf{x}, \boldsymbol{\theta}) \leq \infty$, $\lambda(\mathbf{x}, \boldsymbol{\theta}) = \frac{2}{t}c(\mathbf{x}, \boldsymbol{\theta})$ where $c(\mathbf{x}, \boldsymbol{\theta})$ is the tolerance constraint function. For $\lambda \leq 1$, the SDT is inside the Deviation Domain while for $\lambda = 0$ the considered SDT is $(0,0)$, so the feature is nominal. The procedure of identifying λ for a two-dimensional line is seen in Figure (III.1). The red deviating line inside the tolerance zone (upper left) is identified with a SDT $(\mathbf{y}, \boldsymbol{\theta})$ inside the associated deviation domain (upper right). Following, the deviation domain is scaled, until $(\mathbf{y}, \boldsymbol{\theta})$ is on the edge of the deviation domain (lower right). This is equivalent to the scaling of the tolerance zone until the line is just inside the tolerance zone (lower left). Finally, the deviation quality is specified (centre). Two conditions are studied, the assembly condition that ensures that the resulting clearance domain is not empty and the functionality condition, that ensures that the resulting deviation domain is inside the functional domain. The variance based sensitivity analysis was performed, this pushed the others to adopt alternative simulation outputs for both cases. In assembly condition, the output of the simulation is the Relative Clearance Domain Volume $|C_{dev}/C_{nom}|$ which measures the variation of the Clearance Domain size with respect to the nominal size. In functionality condition, the output of the simulation is the Functional Deviation Characteristic $\lambda_F(\mathbf{x}, \boldsymbol{\theta}) = (2/t_F)c_F(\mathbf{x}, \boldsymbol{\theta})$ for the resulting deviation.

III.2.3 Limitations of the methods

The local sensitivity methods introduced in Section (III.2.1) are limited to one dimensional tolerance stack-ups. Another global sensitivity analysis method adopted for more complex tolerance analysis systems that are based on deviation domains is given in Section (III.2.2). Several interrogations come to mind:

- What if the quantity of interest is not the functional requirement but the NCR?
- What if the dimensions involved in the critical functional requirement follow distributions having in their turn variable statistical parameters that need to be taken into account?
- What is the most convenient sensitivity analysis method that can be applied for this type of problems?

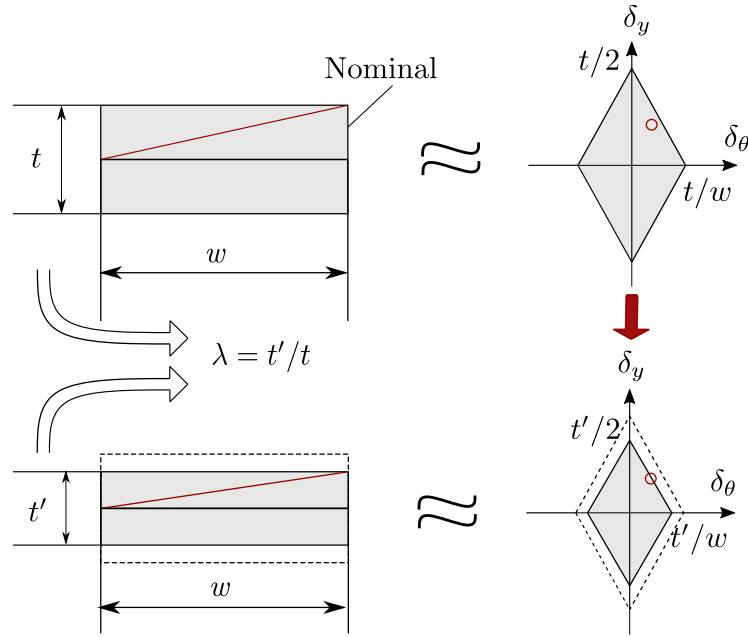

Figure III.1 – Deviating 2D line (Ziegler and Wartzack, 2015a,b).

The possible procedures to perform a sensitivity analysis in tolerancing as well as the new methodology proposed to overcome the limitations of the existing approaches are described in the following section. A comparison of these procedures is done after their application on a simple linear stack-up example.

III.3 Proposed approach based on Sobol' sensitivity index

In this section, a new methodology is proposed for the classification of the dimensions according to their influence on the performance of the system. It is inspired from previous works dealing with sensitivity analysis in tolerancing as discussed in Section (III.2). The proposed approach is based on the sensitivity analysis and more precisely on the global sensitivity analysis. It allows the classification of the dimensions with high or reduced impact on the performance of the system, these features are defined as KC or not. It quantifies the impact of the variation of the statistical parameters on the variation of the Non Conformity Rate (NCR). The main contribution of the proposed approach is that it takes into account the variability of the statistical parameters corresponding to the dimensions, which is the variability of the corresponding distributions' parameters. This aspect is not taken into account in the previous works that perform the sensitivity analysis in the context of tolerancing. In addition, this method is applicable when the system comprises more than one functional requirement. The objective of this

work is to define the most contributing dimensions using sensitivity analysis. The procedure to be followed should respect the quality measures and the different requirements given for an industrial problem. In order to perform a sensitivity analysis, it is required to select:

- the input random variables, that are also be referred as “*variables of interest*”.
- an output quantity, which is expressed in terms of a set of input random variables referred as “*quantity of interest*”.
- a suitable sensitivity metrics, as multiple definitions of the sensitivity indices are available.

A model is considered in this study with input and output parameters that need to be selected properly, such as detailed in Section (III.3.2).

III.3.1 Variation of the statistical samples

Over time, the process capability differs according to the different circumstances in which the production is executed. The manufacturing process might differ from day to another depending on these circumstances that can be the setting of the machines, the ambient temperature, the materials used in the production, etc.. As a consequence, the characteristics will deviate from the required specifications. Different types of process capability exist such as the short term and the long-term capability (Thornton, 2004). Figure (III.2) presents the capability types of the production. The short-term capability is the ideal case in the manufacturing process that respects all the requirements set such as the target value, standard deviation and the capability requirements. In the short term capability, the mean value is equal to the target value. In the long term capability the parameters of the distributions of the process may differ. The values of the mean μ of a characteristic and the standard deviation σ of the sample about the mean express the variation of a statistical sample. When the process is assumed to be in statistical control, the indices C_p and C_{pk} are used to define its capability. The process capability ratio C_p is a quantitative way to express the process capability (Montgomery, 2009). Another process capability ratio for off-centre process is C_{pk} , it takes into account the location of the process mean with respect to the specifications. The reference standard ISO 22514-1 provides definitions and mathematical expressions for the capability indices C_p and C_{pk} that are applicable for all types of distributions. When the process is in a state of statistical control, C_p is expressed as the ratio of the tolerance interval t and the reference interval. The normal distribution is usually assumed for the dimensions or the characteristics of a statistical sample, being simple to implement and close to the real cases of the production (Thornton, 2004). For

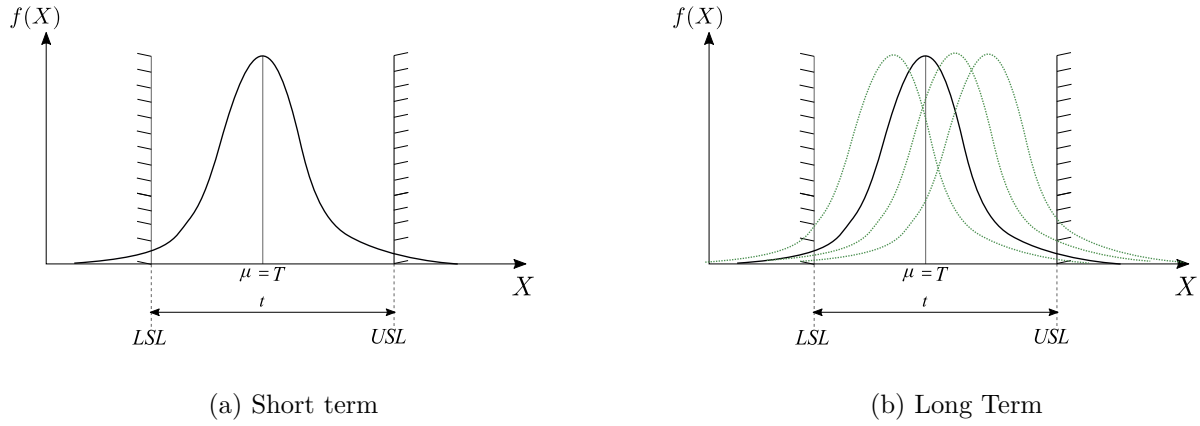

Figure III.2 – Types of process capability.

the case of a normal distribution, the capability requirements associated for each variable X_i are expressed such as Equations (III.3) and (III.4).

$$C_{pi} = \frac{t_i}{6\sigma_i} \quad (III.3)$$

$$C_{pki} = \frac{t_i/2 - |\delta_i|}{3\sigma_i} \quad (III.4)$$

δ_i and σ_i are respectively the mean shift and the standard deviation corresponding to the dimension X_i . The capability requirements to be respected for each variable X_i are $C_{pi} \geq C_{pi}^{(r)}$ and $C_{pki} \geq C_{pki}^{(r)}$. $C_{pi}^{(r)}$ and $C_{pki}^{(r)}$ are industrial requirements usually imposed by the companies. A capability domain V_D is defined for each dimension X_i as the set of acceptable (δ, σ) pairs (δ is the mean shift of the off-centred distributions). The shape of this domain differs according to the indices used and depends on the tolerancing practices of each company (Srinivasan, 1998). It is usually represented on a σ_i - δ_i diagram. Several tolerance analysis methods exist in the literature to deal with the variability of the process, such as inertial tolerancing, the process tolerancing and the capability-based tolerance :

- Inertial tolerancing has been introduced by Pillet (2004) and Adragna et al. (2006). It is used to overcome the problem of the mean shifts. For a production batch having a nominal value μ , a target value T , and a standard deviation σ the inertia is defined as:

$$I = \sqrt{\delta^2 + \sigma^2}, \text{ with } \delta = \mu - T \quad (III.5)$$

The inertial tolerancing is applicable when the mean shifts are around 1 and 2σ . For the cases where the short term standard deviations are very low and the variation of the mean around the target value can exceed $\pm 3\sigma$ or $\pm 5\sigma$, the process tolerancing is adapted. The use

of the inertial tolerancing in this case will reject acceptable processes. The zone of acceptable processes in inertial tolerancing is shown in Figure (III.3).

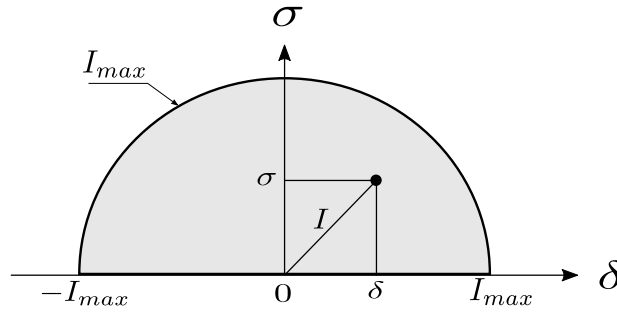

Figure III.3 – Zone of acceptable processes in Inertial Tolerancing.

- Process tolerancing consists of separating the tolerances into two parts, the dispersions and the mean shift. Mansoor (1963) has proposed an off-centring factor m to separate each tolerance interval into an off-centred component and a dispersion component, the first being cumulated in arithmetic and the second in quadratic to obtain the following formula :

$$t_i = m \sum t_i + (1 - m) \sqrt{\sum t_i^2} \tag{III.6}$$

Greenwood and Chase (1987) have given a more general formula to chains of dimensions involving components with different multiplying coefficients a_i and proposed to differentiate the factor m to each variable X to obtain :

$$t_i = \sum |a_i| m_i t_i + \frac{Z}{3} \sqrt{\sum a_i^2 (1 - m_i)^2 t_i^2} \tag{III.7}$$

where Z is the number of σ required on Y , when the X are supposed to be at 3σ . The stacking of the mean's shifts (off-centering) is done in Worst-Case, and the stacking of the dispersions is done in Statistic Root Sum Square (RSS). And then, both resulting tolerances can be cumulated. The zone of acceptable processes in tolerancing is shown in Figure (III.4).

- In the capability-based tolerance, the two capability requirements $C_{pi}^{(r)}$ and $C_{pki}^{(r)}$ should be respected. The capability domain is bounded by the equations $C_{pi}(\sigma_i) = C_{pi}^{(r)}$ and $C_{pki}(\sigma_i, \delta_i) = C_{pki}^{(r)}$. Figure (III.5) illustrates the capability domain corresponding to one dimension. The shape of the capability domain is triangular in the case where $C_{pi}^{(r)} = C_{pki}^{(r)}$ and trapezoidal in the case where $C_{pi}^{(r)} \geq C_{pki}^{(r)}$. The solid lines represent the boundary associated with $C_{pki}^{(r)}$, the dash lines represent the boundaries associated with $C_{pi}^{(r)}$ and the lower bound of the standard deviation. The hatched area at the bottom of the triangle is associated with compliant batches, but the standard deviation is too low to be achieved.

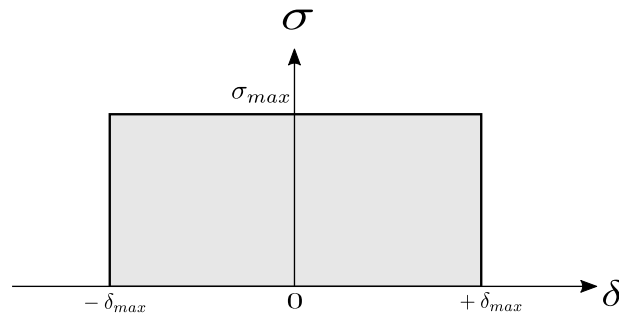

Figure III.4 – Zone of acceptable processes in Process Tolerancing.

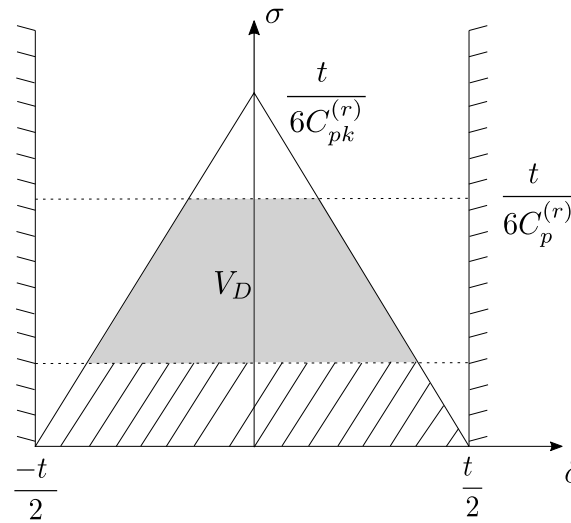

Figure III.5 – Representation of the capability domain V_D (grey area).

It can be presumed that the uncertainty of the process leads to uncertainties in the distribution parameters of the input variables. This will lead to uncertainties in the functional requirement function that will affect in its turn the NCR. The sensitivity metrics is described in Section (III.3.2).

III.3.2 Strategies for the selection of input and output parameters of the model

Several strategies can be followed to check the importance of the variables. These strategies depend on several issues such as:

- **Quantity of Interest:** The classical sensitivity analysis strategies use the functional characteristic as the quantity of interest. **The proposed method suggests the consideration of the NCR of the model instead as an output.** This choice is driven by the fact

that the NCR is used by industries as a quality measure. In addition, the method remains applicable when multiple functional requirements are involved, as the NCR can be computed using system reliability.

- **Variables of Interest:** The variables of interest can be the input variables X_i or the distributions' parameters represented by θ . **The adopted procedure herein consists of investigating the effect of the variable statistical parameters, defined by the vectors σ and δ , on the NCR.** The uncertainty in the statistical parameters is considered because the production is not perfect, therefore there is a variation in the mean shifts and standard deviation of the dimensions. This variability has non negligible impact on the NCR. In addition, their use as input parameters aggregates the effects of the capabilities and of the tolerance intervals since there is a direct relation between these parameters.
- **Single and double uncertainty levels:** The single uncertainty level stands for the supposition that there is uncertainty in the basic random variables \mathbf{X} following known distributions. The distribution parameters corresponding to the random variables can, in their turn, follow other distributions. The double uncertainty level takes into account the uncertainty in the random variables and that of the parameters' distribution. When the NCR is the quantity of interest, it is possible to work with single or with double uncertainty levels. **In the proposed approach, the choice of the distribution parameters as the variables of interest implies the consideration of double uncertainty levels.**
- **Local or global sensitivity analysis:** The local and the global sensitivity analysis can be used regardless of the choice of the quantity of interest and of the variables of interest. The selection between these two options depends on the concern on one specific value of the input domain or on the whole domain. **The proposed method adopts the global analysis.** The selection of the sensitivity method is detailed in the following section.
- **Selection of the sensitivity analysis method:** The choice of the sensitivity analysis method depends on the required criteria of each problem. First, it is essential to know the existing sensitivity analysis methods that among them, a proper one can be adapted for the identification of the KCs. To recall, Saltelli et al. (2006) have defined the Sensitivity Analysis as the study of how the uncertainty in input parameters can influence the uncertainty in the output of a model. The idea behind the sensitivity analysis is to know the importance of the input design parameters, so the performance of the system can be improved by dealing carefully with these important parameters. An overview on the existing sensitivity analysis methods is presented in Chapter II. Numerous sensitivity analysis methods exist in the literature and have been developed progressively. The challenge of this work is to choose the

appropriate approach that is suitable to the problem and that can give consistent results. As already discussed in the first chapter, sensitivity analysis methods are categorized as local methods and global methods. The local sensitivity considers the influence of the input parameters in the vicinity of a reference point. The global sensitivity approach considers the impact of an input factor by varying all other input factors (Saltelli et al., 2006). Several approaches corresponding to the global sensitivity analysis exist such as the variance-based and the density-based methods.

- The variance-based methods assume that output variance is a sensible measure of the output uncertainty. They allow the estimation of the main effects of the input variables on the variable output in addition to the total effects which are the interactions between the input variables (Saltelli et al., 2010).
- The density-based methods consider the entire distribution without being dependent to a particular moment. Their use is preferable when the variance is not an adequate proxy of uncertainty, this is applicable when the output distribution is multi-modal or highly skewed (Borgonovo et al., 2011; Pianosi and Wagener, 2015). This is not the case of our problem.

The variance-based method is considered in this chapter since the concern is to have the sensitivities by considering the variation on the whole domain and not only for a representative point (local sensitivities) and since the variance is considered as a good proxy of the uncertainty. Among the variance-based approaches, Sobol' approach is adopted in this study because of its efficient implementations that are well documented in the work of Sobol (2001) and Kucherenko and Iooss (2017). Another reason for the choice of Sobol' approach is because of the possibility to perform the sensitivity analysis with moderate numerical efforts.

III.3.3 Different steps of the proposed approach

After the selection of inputs, output and sensitivity method, the procedure to follow can be described as given in Figure (III.6). The application of the proposed method necessitates the estimation of the NCR which formulation is developed in Section (III.3.4). The sensitivity of the NCR with respect to the variable parameters is performed by applying the Sobol' approach which is one of the most used variance based methods (see Section (III.3.5)). The use of this method requires the estimation of the NCR N times, where N is the number of the Sobol' iterations which is usually a large number. If the system is linear with dimensions following normal distributions, the NCR has an explicit function, the calculation of the NCR N times

is not challenging. However, if the system is non-linear, the estimation of the NCR is done using the Monte Carlo technique and there is need to repeat the Monte Carlo simulation N times. Therefore, combining Monte Carlo with the Sobol' sensitivity analysis takes excessive numerical efforts and is time consuming. An alternative way to deal with this problem is the implementation of the re-weighting technique which is similar to the one applied in importance sampling.

Once the sensitivity indices are evaluated, the contributing and non-contributing input parameters can be known. Consequently, the KCs can be identified.

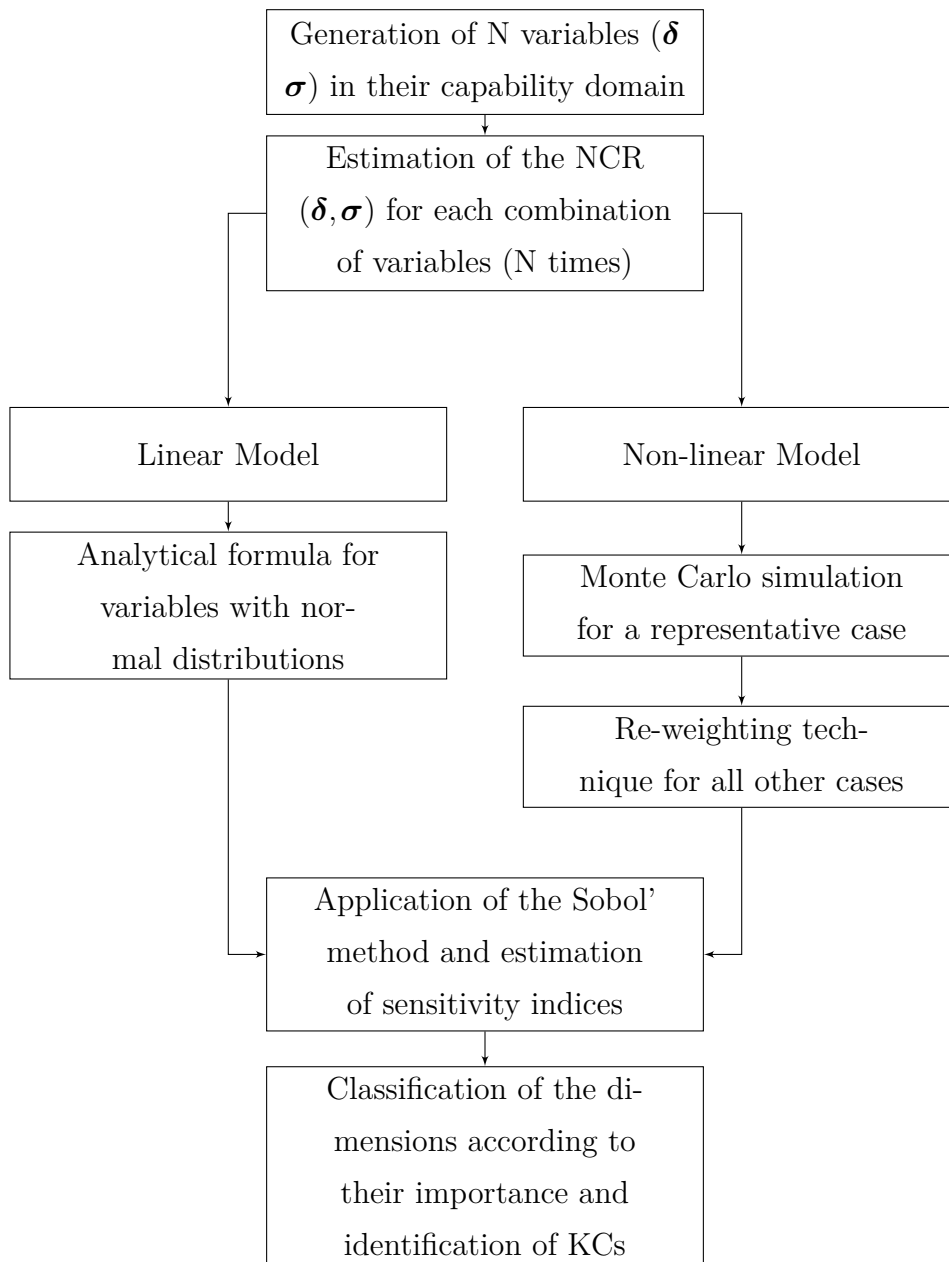

Figure III.6 – Steps of the proposed Approach.

III.3.4 Formulation of the Non-Conformity Rates

The dimensions are variables following normal distributions that in their turn have variable parameters such as the mean shifts and the standard deviations. These parameters can follow a range of distributions (uniform, normal, etc.). The random vector defining the mean shifts is noted as $\boldsymbol{\delta} = (\delta_1, \dots, \delta_n)$ and the one for the standard deviations as $\boldsymbol{\sigma} = (\sigma_1, \dots, \sigma_n)$, where n is the number of dimensions. The calculation of the NCR in this work takes into account the variability of the distributions' parameters. The statistical parameters are random variables, therefore the NCR is a random variable as well, it is expressed in terms of $\boldsymbol{\delta}$ and $\boldsymbol{\sigma}$ and can be noted as $NCR(\boldsymbol{\delta}, \boldsymbol{\sigma})$. The distribution of σ_i and δ_i is defined inside the capability domain already discussed in Section I.2.2. The points that are placed outside this area represent the cases where the capability indices are below their threshold values and such parts should not be used. In industry, the distribution may be identified using the production statistics, but since no other information is available, a uniform distribution is assumed for this study. The proposed approach can also be applied when the Inertial tolerancing (Pillet, 2004) or the Process tolerancing (Mansoor, 1963) is adopted for the estimation of the NCR and the assumption of the capability domains. They also take into account the variability of the statistical parameters.

III.3.4.1 Estimation of the NCR for a linear case with dimensions following normal distributions

When the system is linear and the dimensions follow normal distributions, the estimation of the NCR is done using the analytical formula:

$$NCR(\boldsymbol{\delta}, \boldsymbol{\sigma}) = \Phi\left(-\frac{\mu_Y(\boldsymbol{\delta}, \boldsymbol{\sigma}) - LSL_Y}{\sigma_Y(\boldsymbol{\delta}, \boldsymbol{\sigma})}\right) + \Phi\left(-\frac{USL_Y - \mu_Y(\boldsymbol{\delta}, \boldsymbol{\sigma})}{\sigma_Y(\boldsymbol{\delta}, \boldsymbol{\sigma})}\right) \quad (\text{III.8})$$

where Φ is the cumulative density function of the standard normal distribution, LSL_Y and USL_Y are respectively the lowest specification limit and the upper specification limit of t_Y . However, when the system is non-linear, the computation of the NCR is preferred to be done using Monte Carlo simulation.

III.3.4.2 Estimation of the NCR for a non-linear case using re-weighting

When the system is non-linear the NCR is defined similarly to the failure probability which is the integral of the probability density function on the failure domain. A mean shift and a standard deviation is associated to each dimension. The expression of the NCR is given by:

$$NCR(\boldsymbol{\delta}, \boldsymbol{\sigma}) = \int_{D_{\mathbf{x}}} \mathbb{I}(\mathbf{x}) f_{\mathbf{x}}(\mathbf{x} | \boldsymbol{\delta}, \boldsymbol{\sigma}) d\mathbf{x} \quad (\text{III.9})$$

where $f_{\mathbf{x}}(\mathbf{x}|\boldsymbol{\delta},\boldsymbol{\sigma})$ is the joint probability density function, and $\mathbb{I}(\mathbf{x})$ is an indicator function defined by:

$$\mathbb{I}(\mathbf{x}) = \begin{cases} 1 & \text{if } Y \notin [LSL_Y; USL_Y] \\ 0 & \text{otherwise} \end{cases} \quad (\text{III.10})$$

The Monte Carlo simulation which is one of the most common sampling technique for the estimation of the failure probability is used for the estimation of the NCR. The estimation of the NCR for a particular case is given by:

$$\text{NCR}(\boldsymbol{\delta},\boldsymbol{\sigma}) \approx \frac{1}{N_{MC}} \sum_{i=1}^{N_{MC}} \mathbb{I}(\mathbf{x}^{(i)}) \quad (\text{III.11})$$

where N_{MC} is the sample size and $\mathbf{x}^{(i)}$ are samples following a set of independent normal distributions with the mean shifts and the standard deviations. The NCR can be computed using Monte Carlo simulation, even when the problem involves multiple functional requirements. Therefore, the proposed procedure is applicable to problems involving multiple functional conditions.

Re-weighting technique

The re-weighting technique consists of considering one representative case where the mean values are assumed equal to the target value and the standard deviations are assumed to have their maximum values. A Monte Carlo simulation is conducted for the estimation of the NCR for this particular case such as given in Equation (III.12).

$$\text{NCR}(\boldsymbol{\delta}_0,\boldsymbol{\sigma}_0) = \int \mathbb{I}(\mathbf{x})f_{\mathbf{x}}(\mathbf{x}|\boldsymbol{\delta}_0,\boldsymbol{\sigma}_0)d\mathbf{x} \quad (\text{III.12})$$

The re-weighting technique is applied to estimate the NCR for the other cases of different means and standard deviations. Equation ((III.13)) is the expression of the NCR for another case of different mean shifts and standard deviations. It is then multiplied by the ratio of the density function defined for the reference case to the same density function so that it is equal to 1, this is given by Equation (III.14).

$$\text{NCR}(\boldsymbol{\delta}_1,\boldsymbol{\sigma}_1) = \int \mathbb{I}(\mathbf{x})f_{\mathbf{x}}(\mathbf{x}|\boldsymbol{\delta}_1,\boldsymbol{\sigma}_1)d\mathbf{x} \quad (\text{III.13})$$

$$\begin{aligned} \text{NCR}(\boldsymbol{\delta}_1,\boldsymbol{\sigma}_1) &= \int \mathbb{I}(\mathbf{x})f_{\mathbf{x}}(\mathbf{x}|\boldsymbol{\delta}_1,\boldsymbol{\sigma}_1) \frac{f_{\mathbf{x}}(\mathbf{x}|\boldsymbol{\delta}_0,\boldsymbol{\sigma}_0)}{f_{\mathbf{x}}(\mathbf{x}|\boldsymbol{\delta}_0,\boldsymbol{\sigma}_0)} d\mathbf{x} \\ &= \int \mathbb{I}(\mathbf{x})f_{\mathbf{x}}(\mathbf{x}|\boldsymbol{\delta}_0,\boldsymbol{\sigma}_0) \frac{f_{\mathbf{x}}(\mathbf{x}|\boldsymbol{\delta}_1,\boldsymbol{\sigma}_1)}{f_{\mathbf{x}}(\mathbf{x}|\boldsymbol{\delta}_0,\boldsymbol{\sigma}_0)} d\mathbf{x} \end{aligned} \quad (\text{III.14})$$

The estimation of the NCR can be given by:

$$\text{NCR}(\boldsymbol{\delta}_1, \boldsymbol{\sigma}_1) \approx \frac{1}{N_{MC}} \sum_{i=1}^{N_{MC}} \mathbb{I}(\mathbf{x}^{(i)}) \frac{f_{\mathbf{x}}(\mathbf{x}^{(i)} | \boldsymbol{\delta}_1, \boldsymbol{\sigma}_1)}{f_{\mathbf{x}}(\mathbf{x}^{(i)} | \boldsymbol{\delta}_0, \boldsymbol{\sigma}_0)} \quad (\text{III.15})$$

The new NCR can be deduced from the reference one that is already estimated from Equation (III.12). After the application of this approach, there is no need to generate new samples for each case where the density function parameters vary. The same sample points are kept from the failure region that provide non-zero values of the indicator function $I(\mathbf{x})$ and then multiplied by the weights.

III.3.5 Sensitivity analysis of the statistical parameters on the NCR

The Sobol' approach is described in Section (II.2.4). It has been demonstrated that a square integrable function can be decomposed into a sum of functions. Based on this idea the NCR, which is the studied quantity can be expressed as in Equation (III.16).

$$\begin{aligned} \text{NCR}(\boldsymbol{\delta}, \boldsymbol{\sigma}) &= \text{NCR}_0 \\ &+ \sum_i^n \text{NCR}_i(\delta_i, \sigma_i) \\ &+ \sum_{1 \leq i < j \leq n} \text{NCR}_{ij}(\delta_i, \sigma_i, \delta_j, \sigma_j) \\ &+ \dots \text{NCR}_{12\dots n}(\delta_1, \sigma_1, \delta_2, \sigma_2, \dots, \delta_n, \sigma_n) \end{aligned} \quad (\text{III.16})$$

where $\text{NCR}_0 = \mathbb{E}(\text{NCR})$ is a constant, $\text{NCR}_i(\delta_i, \sigma_i) = \mathbb{E}_{\sim \delta_i \sigma_i}(\text{NCR} | \delta_i, \sigma_i)$, similar relations are obtained for higher order terms of the decomposition. The variance decomposition is obtained by taking into account that the input parameters θ_i are random and independent. The variance of the model can be expressed as in Equation (III.17).

$$\text{Var}[\text{NCR}] = \sum_{i=1}^n V_i + \sum_{1 \leq i < j \leq n} V_{ij} + \dots V_{12\dots n} \quad (\text{III.17})$$

where $\text{Var}[\text{NCR}]$ is the total variance of model output which is in this study the NCR,

$$\begin{aligned} V_i &= \text{Var}(\text{NCR}_i) = \text{Var}[\mathbb{E}(\text{NCR} | \delta_i, \sigma_i)] \\ V_{ij} &= \text{Var}[\mathbb{E}(\text{NCR} | \delta_i, \sigma_i, \delta_j, \sigma_j)] \\ &\quad - \text{Var}[\mathbb{E}(\text{NCR} | \delta_i, \sigma_i)] - \text{Var}[\mathbb{E}(\text{NCR} | \delta_j, \sigma_j)] \end{aligned}$$

V_i is the first order contribution of the i^{th} model parameter, V_{ij} is the effect of the interaction of the i^{th} and j^{th} parameters. The use of this approach allows the measurement of the first-order sensitivity index, or the main effect which is the contribution to the output variance of the main

effect of one parameter, hence it measures the impact of the variation of an input parameter alone, and averaged over variations in other input parameters. The equation corresponding to the first order and the total order indices are given by Equations (III.18) and (III.19).

$$S_i^{NCR} = \frac{\text{Var}[\mathbb{E}(\text{NCR} \mid \delta_i, \sigma_i)]}{\text{Var}[\text{NCR}]} \quad (\text{III.18})$$

$$S_{T_i}^{NCR} = 1 - \frac{\text{Var}[\mathbb{E}(\text{NCR} \mid \boldsymbol{\delta}^{-1}, \boldsymbol{\sigma}^{-1})]}{\text{Var}[\text{NCR}]} \quad (\text{III.19})$$

where $\boldsymbol{\delta}^{-1}, \boldsymbol{\sigma}^{-1}$ stand for the vectors $\boldsymbol{\delta}$ and $\boldsymbol{\sigma}$ of distribution parameters without the i^{th} component. If the value of $S_{T_i}^{NCR}$ is zero, it can be deduced that the function NCR does not depend on δ_i, σ_i . In another hand if $S_{T_i}^{NCR}$ is equal to 1, it means that NCR depends only on δ_i, σ_i . The total Sensitivity measures the interaction of each variable with the other variables. There is absence of interaction between X_i and other variables, if the value of the total effects is equal to the value of the main effects. After the estimation of the NCR N times for both the linear and non-linear cases, the sensitivity analysis based on Sobol' method is performed. The Monte Carlo methods are used for the estimation of the Sobol' indices such as the work of Homma and Saltelli (1996). In this work, the first and the total order indices are estimated. These indices aggregate the contributions of the dimension to the variability of the NCR. Dimensions with high Sobol' indices need additional attention, as they can be associated with large variations of the NCR.

III.4 Applications

The application of the proposed approach is done on three different systems. The first system is a linear stack-up, the second one is an electrical plug procured by RADIALL having a linearised functional requirement, and the third one is adapted from a Gas Pedal system from Toyota having two non-linear functional requirements. The functional requirements in the three examples are functions of a chain of dimensions. Target values T_i are set to each dimension. The dimensions are subject to variations. These variations are expressed by tolerances intervals t_i which are assumed to be centred on the corresponding target values. In addition, the dimensions follow normal distributions and are subject to capability requirements $C_{pi}^{(r)} = C_{pki}^{(r)}$. The Sobol' sensitivity analysis is performed on the NCR with respect to the distribution parameters $\boldsymbol{\delta}$ and $\boldsymbol{\sigma}$ that are set as variables. The statistical parameters are expected to vary uniformly in their associated triangular capability domains.

III.4.1 Linear stack-up example

A simple linear stack-up composed of two parts is considered as shown in Figure (III.7). The functional requirement can be expressed as:

$$Y = f(\mathbf{X}) = X_1 + X_2 \in [9.5; 10.5] \quad (\text{III.20})$$

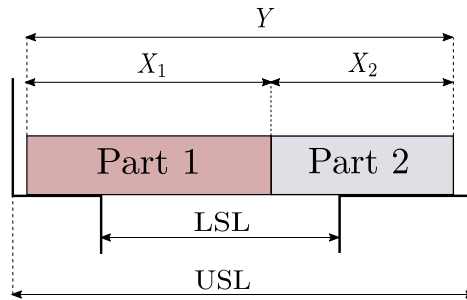

Figure III.7 – Simple two-part example.

The objective is the identification of variables with a significant influence on the performance of the system. Different cases are considered, they are presented in Table (III.1). The first case is when the parts have equal input parameters such as the capability requirements and the tolerance intervals. In the second and the third cases the tolerance intervals and capability requirements are changed respectively. The fourth case presents a change in both, the process capabilities and the tolerance intervals. The classical way to estimate the sensitivities is to apply the local analysis by deriving the functional characteristic Y with respect to the input variables X_i . When this analysis is performed, the parts have equal influence for all the different cases as shown in Figure (III.8). This way the tolerance intervals and capability requirements associated to each variable are not taken into consideration and the sensitivities are only dependent on the variables coefficients in the functional characteristic. To overcome this problem, the Sobol' sensitivity analysis method is applied. Two procedures can be followed. First the sensitivity analysis is performed on the functional requirement with respect to the dimensions (in this case the distributions' parameters are fixed, $\delta = 0$ and $\sigma = \frac{t}{6C_p}$). Then the sensitivity analysis is performed on the NCR with respect to the variable parameters characterizing the distribution of the dimensions (mean shifts and standard deviations). A comparison between the two procedures is then done to show the interest of the one adopted in this study. The results are shown in Figures (III.9) and (III.10).

Table III.1 – Four different process cases of the input data for the linear stack-up example.

Case: 1

Dimensions	T_i	t_i	$C_{pi}^{(r)} = C_{pki}^{(r)}$
X_1	6	0.5	1
X_2	4	0.5	1

Case: 2

Dimensions	T_i	t_i	$C_{pi}^{(r)} = C_{pki}^{(r)}$
X_1	6	0.5	1
X_2	4	0.5	0.8

Case: 3

Dimensions	T_i	t_i	$C_{pi}^{(r)} = C_{pki}^{(r)}$
X_1	6	0.8	1
X_2	4	0.2	1

Case: 4

Dimensions	T_i	t_i	$C_{pi}^{(r)} = C_{pki}^{(r)}$
X_1	6	0.8	1
X_2	4	0.2	0.8

In the first procedure where the sensitivity analysis is performed on the functional requirement, the two parts have equal impact on the output with no interaction. It is expected since the relation of the functional requirement is linear. In the second procedure, where the sensitivity analysis is performed on the NCR, the interactions between the parts can be measured. The sensitivities of the two parts are no longer independent. When the capability requirements are different, the most important influence is for the part having the less value which is common in the industrial practices. When the tolerance intervals have different values, the most important influence is for the part having the highest value. This example shows the interests of the method:

- it aggregates the effects of the tolerance intervals and of the capability requirements.
- it detects the interactions between input parameters regardless the linearity of the model.

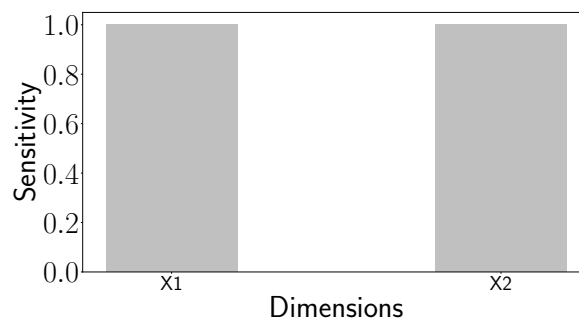

Figure III.8 – Local sensitivity indices calculated by the partial derivatives of Y with respect to X_i for the four process cases.

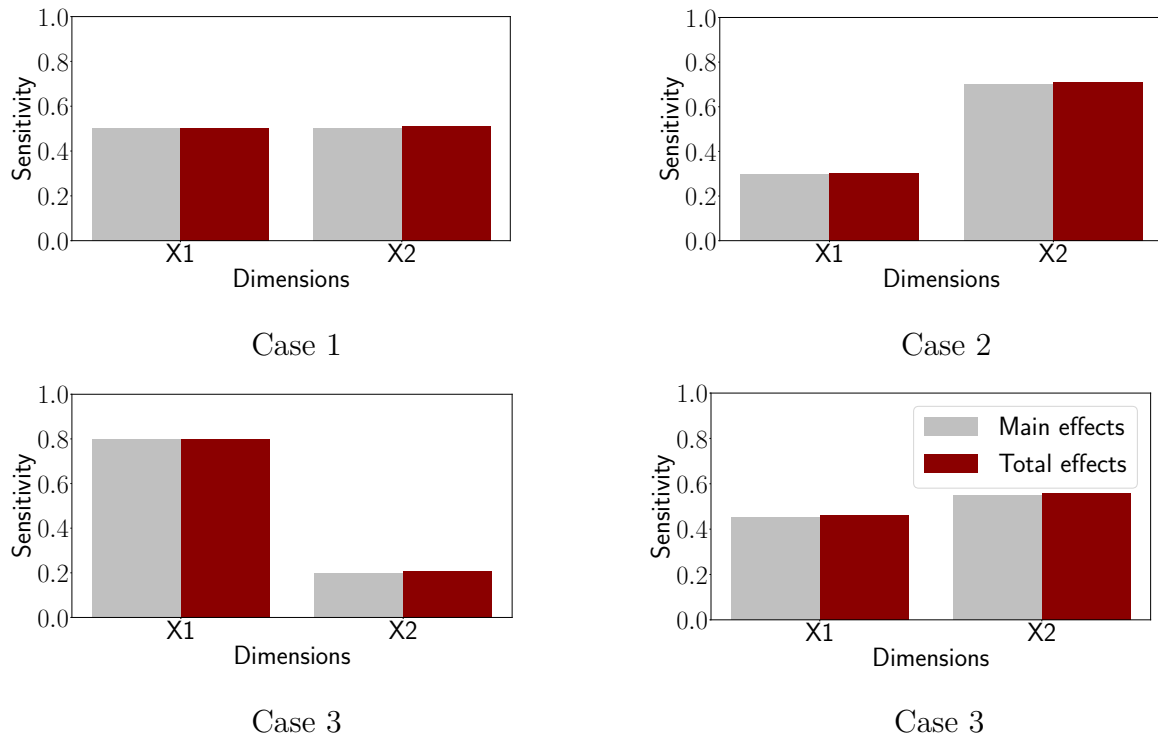

Figure III.9 – First and Total order indices based on Sobol' sensitivity analysis on the functional characteristic Y with respect to X_i .

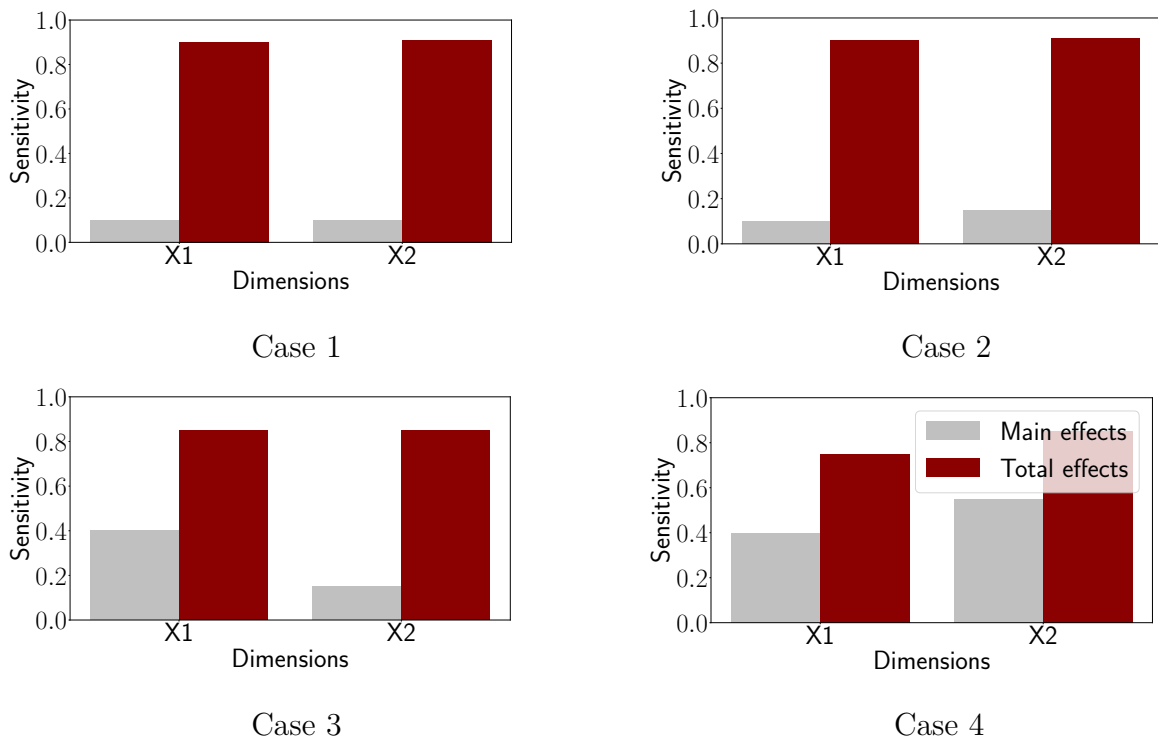

Figure III.10 – First and Total order indices based on Sobol' sensitivity analysis on the NCR with respect to the distribution parameters δ_i and σ_i corresponding to X_i .

III.4.2 Linearized system of the electrical plug from RADIALL

The method is applied on a linearised functional characteristic. The case from RADIALL is an electrical plug. Fourteen dimensions are involved in the chain of dimensions following the relation given in Equation (III.21).

$$Y = f(X) \approx a_0 + \sum_0^{14} a_i X_i \quad (\text{III.21})$$

The functional requirement is that the misalignment of the tip of the electric plug should not exceed a threshold value such as shown in Figure (III.11) (The example is provided by an industrial partner, we did not have access to the CAD model, the figure is included as an illustration only). This functional requirement is set as critical according to an analysis based on FMECA. All the dimensions involved are considered as KCs when the design procedure used at RADIALL is applied. The input data of the problem is given in Table (III.2). The purpose of this example is to be able to classify the dimensions regarding their importance on the performance of the system. The first and total sensitivity indices are estimated by the application of the Sobol' sensitivity analysis on the NCR with respect to the statistical parameters.

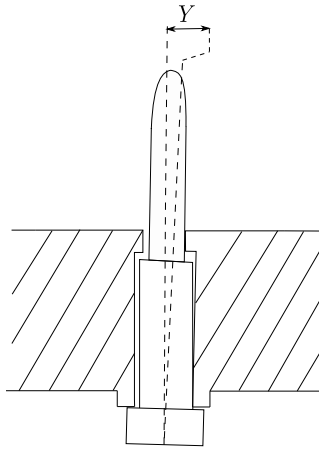

Figure III.11 – Simplified Electrical Plug.

The results are shown in Figure (III.12). It can be deduced that the variation of the statistical parameters of X_2 and X_5 has the highest contribution on the value of the NCR. Looking at the main effects, 50% of the variation of the NCR is due to the variation in the parameters corresponding to X_5 and almost 12% due to X_2 . The total effects show that there are interactions between the input parameters and most probably between X_2 , X_5 , X_{11} , X_{12} and X_{13} . Based on these results, the mentioned dimensions can be set as KCs.

Table III.2 – Coefficients, target values, tolerance intervals and capability requirements for RADIALL case input parameters.

Dimensions	a_i	T_i	t_i	$C_{pi}^{(r)} = C_{pki}^{(r)}$
X_1	-0.04	10.53	0.2	1.1
X_2	-0.5	0.1	0.2	1.1
X_3	-0.5	0	0.06	1.1
X_4	1.14	0.643	0.015	1.1
X_5	0.91	0	0.06	1.1
X_6	0.91	0.72	0.04	1.1
X_7	1.10^{-3}	1.325	0.05	1.1
X_8	0.05	0.75	0.04	1.1
X_9	1.10^{-3}	0	0.04	1.1
X_{10}	0.13	3.02	0.06	0.86
X_{11}	-1.4	0.72	0.04	0.86
X_{12}	-1.15	0	0.04	0.86
X_{13}	-0.9	0.97	0.04	0.86
X_{14}	0.13	0.4	0.06	0.86

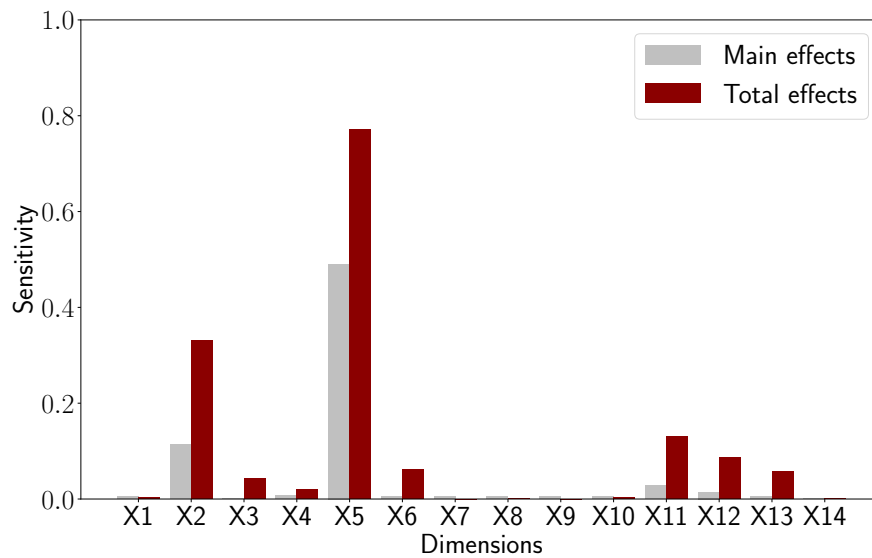

Figure III.12 – First and Total order Sobol' Sensitivity indices for RADIALL case dimensions.

Validation of the results

To validate the results of this approach, the dimensions that are set as KCs are grouped together. The problem is to check the sensitivity of the NCR to the KCs alone and to the Non-KCs. Figure (III.13) shows the percentage of the variability of the NCR caused by the variability of the KCs, of the non-KCs and their interactions. The results show that when there is a variation in the NCR, 88% of this variation is caused by the dimensions set as KCs, only 4% from the non-KCs, and the rest from their interaction. Relying on these values, it can be deduced that the choice of the KCs is relevant since they have an important contribution on the NCR (more than 80%).

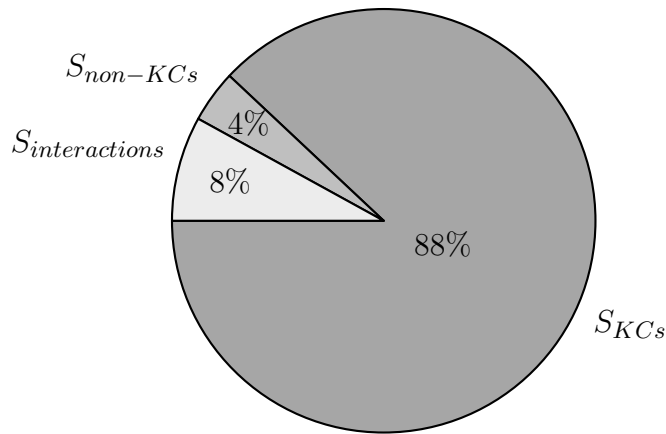

Figure III.13 – Sensitivity of the NCR to the KCs, to the non-KCs and to their interactions.

The use of this approach allows the aggregation of the coefficients a_i and the tolerance intervals and the capability requirements and allows to see the interactions between the dimensions and to take into consideration the mean shifts and the variation of the standard deviations.

III.4.3 Non-linear Toyota pedal system

Another application of the proposed method is performed on a Toyota gas Pedal system shown in Figure (III.14) and inspired from the work of Moritz Göhler et al. (2016). Two functional requirements should be satisfied in this example. The moment and the bending stress, give respectively in Equation (III.22) and Equation (III.23), have maximum values that should not be exceeded ($M_{max} = 500Nmm$ and $\sigma_{max} = 50MPa$ following a normal distribution with $\pm 5MPa$ its estimated variation). The interest of this example is to show that the choice of this method overcomes the problem faced to identify KCs when the more than one functional requirement

exist in the system. The input data are given in Table (III.3). The sensitivity of the NCR with respect to the dimensional variables is studied. A product is considered non-conform when the corresponding moment or the bending stress does not lie in the required range of values.

The Monte Carlo method is used to calculate the NCR for a reference case where the mean of each variable is equal to its target value, that the zero mean shifts, and where the standard deviations are maximum. The re-weighting technique is then used to calculate the NCR associated with other cases where the mean shifts and standard deviations are variables.

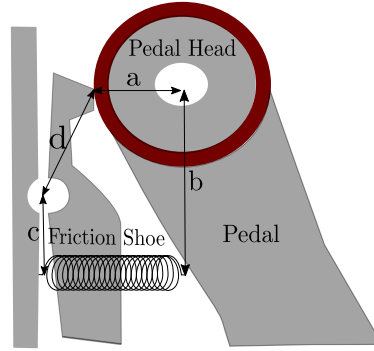

Figure III.14 – Toyota Gas Pedal System.

$$M = F_{spring} \cdot \left(b - \frac{c}{d} \cdot \mu_f \cdot a \right) \quad (III.22)$$

$$\sigma_b = \frac{6 \cdot F_{spring} \cdot c}{w \cdot h^2} \quad (III.23)$$

Where $F_{spring} = k \cdot s$

Table III.3 – Target values, tolerance intervals and capability requirements for Toyota gas pedal input parameters.

Dimensions	T_i	t_i	$C_p^{(r)} = C_{pk}^{(r)}$
a	10	0.1	1.3
b	16	0.1	1.3
c	11	0.12	1.3
d	8	0.1	1.3
s	16	0.2	1
w	4	0.08	1
h	5	0.08	1

The spring stiffness k and the coefficient of friction μ_f are also random variables following uniform distributions. k varies in the interval $[3.5;4.5]$ and μ_f varies in the interval $[0.65; 0.75]$. They are considered for the estimation of the NCR, however, they are excluded from the sensitivity analysis since they are not dimensions and the designers cannot impose any changes to these variables. The results of the analysis are shown in Figure (III.15). It is noticeable that the main effects of the dimensions are negligible unlike the total effects that have significant values for all the dimensions. It can be concluded that the variation of the NCR is caused by the interactions between the input variables. It is also probable that the studied variables have considerable interactions with the spring stiffness k and the coefficient of friction μ_f . Consequently, all the dimensions are set as KCs since they are all contributing and it is not possible to prioritize one on another .

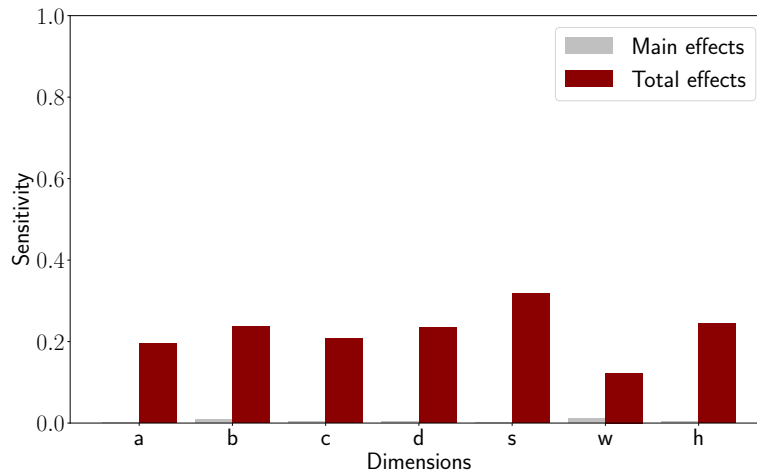

Figure III.15 – First and total order Sobol’ indices for Toyota Gas Pedal dimensions.

III.5 Conclusion

This chapter presents a new approach for the of KCs identification in the critical dimensional chains. It allows the reduction of the number of KCs with respect to the existent practices in the early design stage. Therefore, the efforts dedicated to check the KCs are reduced and consequently the manufacturing production costs. The application of this approach allows the production with a reduced cost but without losing the quality of the product. This proposed method is a numerical method that takes into account the tolerances during the design stage and the variation of the manufacturing processes. Therefore, it establishes a link between the work in the design offices from one side and the production processes from another side and enables them to work in an interactive environment. As a consequence it allows the interactivity

between the designers and the manufacturing engineers. In addition, it prevents derogations after the production (accepting the non-compliant products to be delivered). The sensitivity analysis is performed on the NCR to identify the dimensions with high importance. The Sobol' global sensitivity method is adopted in this context. For a better accuracy, the NCR is estimated by taking into consideration the variability of the input parameters associated to the dimensions such as the mean shifts and the standard deviations characterising their distributions. This is a sensitivity analysis performed on two levels of uncertainty. The application of this approach is done first on a linear stack-up case with only two parts. The results show that the proposed approach can show the interactions between parts even for a linear functional characteristic knowing that the NCR is the quantity studied. Another reason for the use of this approach is that it aggregates the input parameters, such as the tolerance intervals, the capability requirements and the multiplying coefficients. This is illustrated in an example of the electrical plug with a linearised functional characteristic. Furthermore, one other advantage of this approach is that it can be applied for the case where more than one functional requirement is needed. The application on a Toyota gas pedal illustrates this idea. It is also important to mention that it is a model free method, that is can be performed for linear and non-linear systems.

Method 2: Key Characteristics Identification based on Iso-Sensitivity Tolerance Allocation

Contents

III.1 Introduction	50
III.2 Sensitivity analysis in tolerancing area	50
III.2.1 Local sensitivity analysis in tolerancing	51
III.2.2 Global sensitivity analysis	51
III.2.3 Limitations of the methods	52
III.3 Proposed approach based on Sobol' sensitivity index	53
III.3.1 Variation of the statistical samples	54
III.3.2 Strategies for the selection of input and output parameters of the model	57
III.3.3 Different steps of the proposed approach	59
III.3.4 Formulation of the Non-Conformity Rates	61
III.3.5 Sensitivity analysis of the statistical parameters on the NCR	63
III.4 Applications	64
III.4.1 Linear stack-up example	65
III.4.2 Linearized system of the electrical plug from RADIALL	68
III.4.3 Non-linear Toyota pedal system	70
III.5 Conclusion	72

IV.1 Introduction

The proposed method based on Sobol' indices in Chapter III for the identification of the Key Characteristics is performed when the tolerance intervals, production process such as capability requirements $C_p^{(r)}$ and $C_{pk}^{(r)}$, are already known. The Sobol' based method provides engineers with the sensitivity indices corresponding to each dimension without imposing any conditions on the NCR. It is performed in a tolerance analysis framework in addition to the use of global sensitivity analysis methods. However, the following questions arise:

- what if the NCR should be less or equal than a target value?
- what if the tolerance intervals are not known and need to be allocated?
- how the KCs should be identified and what procedures should be followed in such cases?

To answer these questions, a new method is proposed in this chapter for the identification of KCs. This method should be compatible with the situations discussed above. It should be applicable when the tolerance intervals are not known in the early design stage and the quality requirement of the production should be ensured. For all these reasons, the new method is performed in a tolerance allocation framework with the use of sensitivity analysis. It allows the estimation of the tolerance intervals for the dimensions corresponding to a critical functional requirement. The proposed method is applied to a simple linear stack-up example of two parts for three different statistical models cases. It is then applied to a linearised and to a non-linear example for only one statistical model case.

IV.2 Tolerance allocation

Tolerance allocation, also known as tolerance synthesis, is the reciprocal view of the tolerance analysis. It is a very important phase in product development. The objective of tolerance allocation is setting the value of the tolerance interval corresponding to each dimension. The assembly tolerance is distributed among the component dimensions such that the assembly dimension lie within the acceptable tolerance range specified by the designer. Figure (IV.1) shows a representation of the tolerance allocation concept. The assembly tolerance is designated by t_Y and the individual dimensions tolerances are designated by the vector $\mathbf{t} = (t_1, t_2, \dots, t_n)$, where n is the number of the involved dimensions. The tolerance intervals can be associated with a probabilistic distribution. For the same value of the assembly tolerance, it is possible to deal with a large number of sets of dimensions' tolerance values. Several approaches exist

in the literature on the tolerance allocation. Some works give detailed reviews on tolerance allocation methods such as the papers of Chase (1999b,a), Singh et al. (2009), Sampath Kumar et al. (2009) and Hallmann et al. (2020). Many tolerance allocation approaches, categorised as traditional or advanced, have developed over time. In this chapter the tolerance allocation methods are described briefly. The objective of this work is not to improve the existing tolerance allocation approaches but to know their mathematical framework, since the proposed method for KC identification in this chapter will be performed in a tolerance allocation scheme.

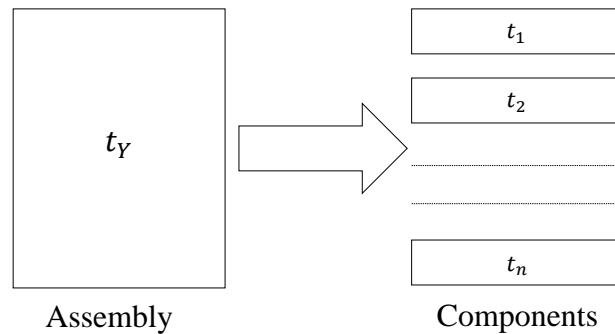

Figure IV.1 – Representation of tolerance allocation.

IV.2.1 Traditional tolerance allocation methods

The traditional methods are non-iterative tolerance allocation methods that are based on previous designs, standards, manuals, expertise and experience of the designers, and heuristics. The previous designs, standards and manuals are usually used to design the primary tolerances on each dimension, and the assembly tolerance is calculated using these tolerance values through a convenient tolerance analysis method. Several heuristic methods, which are mathematical non-iterative approaches, have been developed, e.g. the uniform scaling where equal tolerances are assigned for each dimension, proportional scaling and constant precision factor where the assignment of tolerances is with respect to weighting factors (Singh et al., 2009; Sampath Kumar et al., 2009; Dantan, 2014). These methods do not need the use of computer technologies. According to Sampath Kumar et al. (2009), the traditional methods do not take into account the manufacturing cost. Therefore, the use of the traditional methods is not suitable to characterize a tolerance design that preserves the quality of the product with an acceptable cost. Their use is limited to the preliminary design of tolerances that give the base values for the tolerance-cost optimization strategies described in the next section.

IV.2.2 Tolerance cost optimization

When setting the tolerance intervals, the balance between the quality and cost should be maintained. Peter (1970) has introduced a graphical method to distribute the tolerances between the components of an assembly to achieve the minimum cost requirement. Cheikh and McGoldrick (1987) have showed that a high production cost is caused by both:

- an increase in manufacturing cost due to tight tolerances
- an increase in assembly scrap cost due to large tolerances (see Figure (IV.2)).

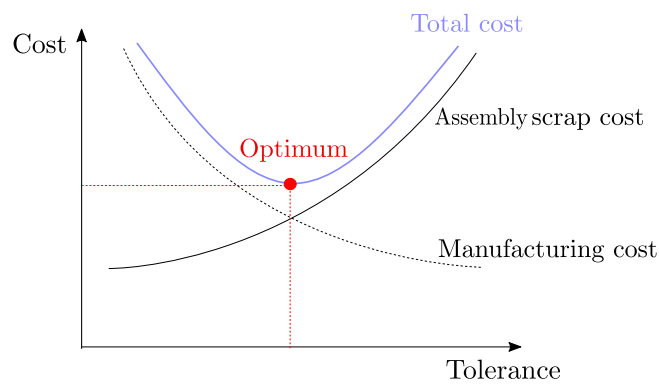

Figure IV.2 – Optimization Model.

The assignment of the optimal component tolerances can be performed by formulating a mathematical optimization problem that minimizes the sum of the production costs $C_{pr}(\mathbf{t})$ (objective) of an assembly under quality requirements Q_r (constraint) (Hong and Chang, 2002; Walter et al., 2015). Therefore, the mathematical expression of the optimization problem is the following:

$$\begin{aligned}
 \mathbf{t}^* &= \min C_{pr}(\mathbf{t}) \\
 \text{Subject to } Q_r &\leq Q_{max} \\
 t_i^{min} &\leq t_i \leq t_i^{max}
 \end{aligned}
 \tag{IV.1}$$

where Q_{max} is the upper limit of the quality requirement. According to Karmakar and Maiti (2012), the choice of the objective functions for a tolerance-cost optimization can be the following:

- cost of manufacturing;
- quality loss;

- manufacturing yield;
- process capability;
- any combination of the above.

The constraint of the tolerance-cost optimization depends on the objective of the optimization. It can be represented by the limits of the functional requirement (Walter et al., 2015) or extended to process capabilities (Mao et al., 2009).

Singh et al. (2009) have stated that tolerance cost optimization problems can be solved using deterministic and stochastic optimization algorithms. They involve evaluating machining costs of each component. The relationship between the machining costs and part tolerance is expressed through a mathematical formula, and the total machining cost is optimized to a minimum. It is subject to the constraints of the assembly function requirements. To achieve this, there is a need for cost-tolerance data for each part in the assembly. A lot of models based on the cost tolerance relationship have been proposed (Chase 1999a; Walter et al., 2015). A number of different cost minimization algorithms to allocate component tolerances have been developed. In this type of approach, a manufacturing cost is associated with each tolerance level (cost-tolerance relationship), and the problem becomes finding the component tolerance configuration that minimizes total cost without exceeding a specified assembly tolerance (Clausing, 1988). The optimization variables of the problem are the tolerance intervals. The objective of the optimization problem is therefore to determine the "best" tolerance intervals; those that will entail a minimum cost subject to compliance with a certain number of constraints.

IV.2.3 Synthesis on tolerance allocation methods

The previous section reviews the most common tolerance allocation methods that exist in the literature. They rely on various assumptions and mathematical frameworks. They are categorised as traditional and tolerance-cost optimization methods. In one hand, the traditional methods are characterized by their simplicity, they do not require complex theories or numerical work to be implemented. In another hand, the tolerance-cost optimization methods are more formalized and backed by a stronger theoretical background since they consider the manufacturing processes, therefore they give more relevant results. One drawback of the tolerance-cost methods is that the initial cost-tolerance data are hard to obtain for every part.

The proposed method in this chapter for the identification of KCs is a method that can model a tolerance allocation problem with a better respect of the target NCR. Furthermore, the willingness to identify the KCs pushes the use of sensitivity indices in the context of tolerance

allocation (recall that the sensitivity analysis methods are described in Chapter II). Therefore, the proposed method follows the same concept of the tolerance-cost optimization methods, with a difference in the choice of the objective function on sensitivities and of the constraints on the NCR. This is called the iso-sensitivity optimisation and it is presented in the following section.

IV.3 Proposed approach based on iso-sensitivity tolerance allocation

IV.3.1 Formulation of the problem

The proposed method is a step forward to be considered after the identification of the critical functional requirements. The main purpose of this method is to reduce the number of KCs in one functional requirement and by consequence decrease the manufacturing costs. As mentioned in the introduction, the most common practice for the identification of KCs is done by specifying the critical functional requirements using FMECA then set all the involved dimensions as KCs. This is very conservative method that engenders high production costs. In such situations, all the dimensions involved in the critical chains are supposed to have the same sensitivity index. In fact, the dimensions do not have the same contribution on the performance of the system. They should be classified as KCs if they have a high impact on the system or non-KCs when this impact is negligible. First, based on the idea that set all the dimensions in one critical functional requirement as KCs, the proposed method suggests to set equal sensitivities for them. Assuming that all dimensions have equal sensitivity indices is the best situation since they would be seen as all equally important, therefore they are defined either all as KCs or all non-KCs. In addition, a target NCR to be respected during the manufacturing is imposed. The constraint on the NCR guarantees that the assigned tolerances:

- will not be zero since the NCR is different from zero;
- will not be very large since the tolerated NCR would not be very large.

Finally, optimal tolerance intervals associated to each dimension are to be estimated. Therefore, an optimization problem with an objective to have equal sensitivities and equality constraints on the NCR to estimate the tolerance intervals is defined. First a design is proposed and then an optimal design is found after applying the proper optimization algorithm. The optimization

problem can be expressed as:

$$\begin{aligned} \mathbf{t}^* &= \text{Argmin} \sum_{i=1}^n (S_i(\mathbf{t}) - \bar{S}(\mathbf{t}))^2 \\ \text{Subject to } NCR(\mathbf{t}) - NCR_{target} &\leq 0 \\ t_i^{min} &\leq t_i \leq t_i^{max} \quad \text{for } i = 1 \dots n \end{aligned} \quad (\text{IV.2})$$

where \mathbf{t}^* is the vector comprising the optimal tolerance intervals associated to the dimensions, n is the total number of variables, $S_i(\mathbf{t})$ is the sensitivity index associated to each dimension and is a function of the tolerance interval \mathbf{t} , and $\bar{S}(\mathbf{t})$ is the average of the sensitivities with respect to the dimensions, it is expressed as:

$$\bar{S}(\mathbf{t}) = \frac{1}{n}(S_1(\mathbf{t}) + S_2(\mathbf{t}) + \dots + S_n(\mathbf{t})) \quad (\text{IV.3})$$

If all the dimensions have equal sensitivity indices, then their difference to the mean value is equal to zero. The sensitivity indices are estimated in this work by the local sensitivity analysis since they are easy to implement and numerically less demanding. Other sensitivity metrics could be applied, but this is not investigated in depth herein. Furthermore, it may be necessary to use Monte Carlo simulation to compute the NCR. Then if a Monte Carlo sensitivity index is used such as Morris and Sobol' indices, the problem would involve a triple loop algorithm (reliability nested within sensitivity nested within optimization).

The sensitivity of the $NCR(\mathbf{t})$ to the tolerance intervals are expressed such that:

$$S_i = \frac{\partial NCR(\mathbf{t})}{\partial t_i} \quad (\text{IV.4})$$

In an industrial context, it is expected that the estimated tolerance intervals are compared to reference values that are provided by the company. The reference values are within the CAD model, they regroup all the constraints associated with the manufacturing such as the manufacturing tools, customer requirements, etc.. For example, if the reference values are the minimum tolerances that the machine can attain (the machine cannot manufacture dimensions with tolerances below the reference values). **The dimensions having tolerances that are tighter than the reference ones are critical.** In such situations, the dimensions cannot be produced properly in such a way to have equal sensitivities. Consequently, these dimensions are critical so they are set as KCs. When the tolerance intervals are changed, the optimization problem can be repeated with the new values until the optimal intervals are reached. The method can be applied when dealing with uncertain distribution parameters of the dimensions whether the system is linear or non-linear.

IV.3.2 Statistical models' assumptions

In mass production, there exist a large number of different production batches that should respect the design capability requirements. The quality requirements of a mass produced system are needed to assure that the assembled product is robust with respect to manufacturing variability. A target NCR is assigned for each functional requirement. In order to estimate the NCR and the sensitivity indices, assumptions associated on the statistical model should be made. These assumptions are associated with the mean and the standard deviation of the dimensions knowing that the Gaussian distributions are used. Three assumptions are taken into consideration:

- Case 1: The dimensions are centred and the standard deviations have maximum values such that $\delta_i = 0$ and $\sigma_i = \frac{t}{6C_{pki}^{(r)}}$ such as shown in Figure (IV.3). This approach maximizes the total number of off-tolerance dimensions. It is pessimistic but not necessarily the worse at the level of assembly.

- Case 2: The dimensions are not centred and the standard deviation is constant such that $\sigma_i = cst$ and $\delta_i = 3C_{pki}\sigma_i - \frac{t_i}{2}$ (or $\delta_i = -3C_{pki}\sigma_i + \frac{t_i}{2}$) such as illustrated in Figure (IV.3). The mean value of the dimensions can be set to the minimum or to the maximum. The dimensions can be a mixture of minimum and maximum values. The worst case mixture need to be identified, often it is the configuration that maximizes or minimizes the average amount of matter. This approach is based on the assumption that the standard deviation is associated with the tools or the manufacturing technology. Therefore, it does not change. The mean is associated with set-ups of the tools, which change frequently after each maintenance operation, consequently it can vary over a certain range. This is a pessimistic approach where only the worst-case is considered.

- Case 3: The dimensions have variable mean shifts and the standard deviation is constant. According to the geometry shown in Figure (IV.3), the mean shift lies in the interval $[\delta_{min}; \delta_{max}] = [3C_{pki}\sigma_i - \frac{t_i}{2}; -3C_{pki}\sigma_i + \frac{t_i}{2}]$. This approach is the average over the long term.

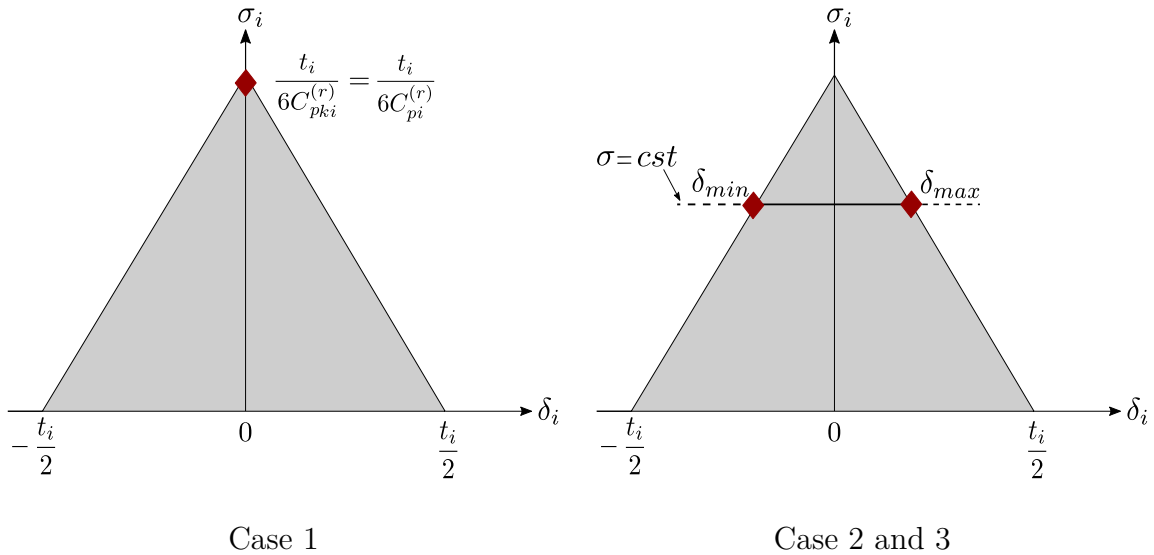

Figure IV.3 – Capability domains.

IV.3.3 NCR and Sensitivity analysis for different statistical models

The NCR is computed following the same procedure described in Section (III.3.4). In this chapter, the analytical formula is used when the system is linear, and the general formula using Monte Carlo simulations is used for the non-linear systems.

The sensitivity analysis is an important stage in the proposed method. As already mentioned in Chapter III, the application of sensitivity analysis needs the selection of the input variables, the output quantity and the proper approach to estimate the impact of input on output. The proposed method requires nesting the sensitivity indices in it, therefore, the tolerance intervals are set as the input variables and the NCR as the output of the sensitivity analysis problem. The approach to be used should be able to value the impact of the tolerance intervals on the NCR. The adopted approach in this study that estimates the sensitivity indices is the local analysis by the partial derivatives. Applying the chain rule, the sensitivities are expressed as the following:

$$S_i = \frac{\partial NCR}{\partial t_i} = \frac{\partial NCR}{\partial \sigma_i} \cdot \frac{\partial \sigma_i}{\partial t_i} + \frac{\partial NCR}{\partial \delta_i} \cdot \frac{\partial \delta_i}{\partial t_i} \quad (IV.5)$$

S_i is the sensitivity index corresponding to each tolerance. This choice is motivated by the reduction of the numerical efforts, as the sensitivity indices' estimation will be combined with an optimization problem. The estimation of the sensitivity indices differs depending on the type of the system whether it is linear or non-linear. When the system is linear, the analytical formulas are used. However, when the system is non-linear, the score functions are implemented. The use of the score functions based sensitivity indices allows the computation of the partial derivatives

without additional efforts. The sensitivity indices estimation also depends on the assumptions taken for the variations of the statistical parameters (case 1, 2 or 3). Multiple strategies can be used to define the distributions' parameters σ_i and δ_i that only affect their partial derivatives with respect to the tolerance interval. The score functions provide an efficient framework to compute the partial derivatives with respect to the parameters, and can be applied regardless of the strategy used to define the statistical model.

Sensitivity analysis for linear systems

When the functional characteristic is linear, the expression of the NCR is analytical such as given in Equation (III.8). The expression of the sensitivity index differs depending on the assumption taken on the statistical parameters. The derivatives of the NCR with respect to t are:

- Case1: $\delta_i = 0$ and $\sigma_i = \frac{t}{6C_{pki}^{(r)}}$

$$\begin{aligned} S_i &= \frac{\partial NCR(\boldsymbol{\delta}, \boldsymbol{\sigma})}{\partial t_i} \\ &= \frac{-a^2 t_i}{36(C_{pi}^{(r)})^2 \sigma_Y^3} \left[(LSLY - \mu_Y) \phi\left(\frac{LSLY - \mu_Y}{\sigma_Y}\right) \right. \\ &\quad \left. + (\mu_Y - USLY) \phi\left(\frac{\mu_Y - USLY}{\sigma_Y}\right) \right] \end{aligned} \quad (IV.6)$$

- Case 2: $\sigma_i = cst$ and $\delta_i = 3C_{pki}\sigma_i - \frac{t_i}{2}$ (or $\delta_i = -3C_{pki}\sigma_i + \frac{t_i}{2}$)

$$\begin{aligned} S_i &= \frac{\partial NCR(\boldsymbol{\delta}, \boldsymbol{\sigma})}{\partial t_i} \\ &= \frac{1}{2\sigma_Y} \left[\phi\left(\frac{LSLY - \mu_Y}{\sigma_Y}\right) - \phi\left(\frac{\mu_Y - USLY}{\sigma_Y}\right) \right] \end{aligned} \quad (IV.7)$$

- Case 3: $[\delta_{min}; \delta_{max}] = [3C_{pki}\sigma_i - \frac{t_i}{2}; -3C_{pki}\sigma_i + \frac{t_i}{2}]$

$$S_i = \frac{\partial NCR(\boldsymbol{\delta}, \boldsymbol{\sigma})}{\partial t_i} \quad (IV.8)$$

For this case the finite differences are used to estimate the sensitivities.

Sensitivity analysis by score functions for non-linear systems

When the system is non-linear, the sensitivity of the NCR with respect to the distributions' parameters (denoted by $\boldsymbol{\theta}_i = \{\delta_1, \sigma_1, \delta_2, \sigma_2, \dots, \delta_n, \sigma_n\}$) is derived by using the score function. The regularity conditions described in Chapter II are assumed to be satisfied (Rubinstein and

Shapiro, 1993; Rahman, 2009). Taking the partial derivative of $NCR(\boldsymbol{\theta})$ with respect to θ_i yields:

$$\frac{\partial NCR(\boldsymbol{\theta})}{\partial \theta_i} = \frac{\partial}{\partial \theta_i} \int_{D_{\mathbf{x}}} \mathbb{I}(\mathbf{x}) f_{\mathbf{x}}(\mathbf{x}, \boldsymbol{\theta}) d\mathbf{x} \quad (\text{IV.9})$$

The position of the integral and the partial derivative can be interchanged using the Lebesgue dominated convergence theorem, Equation (II.23) can be expressed as:

$$\begin{aligned} \frac{\partial NCR(\boldsymbol{\theta})}{\partial \theta_i} &= \int_{D_{\mathbf{x}}} \mathbb{I}(\mathbf{x}) \cdot \frac{\partial f_{\mathbf{x}}(\mathbf{x}, \boldsymbol{\theta})}{\partial \theta_i} \\ &= \int_{D_{\mathbf{x}}} \mathbb{I}(\mathbf{x}) \cdot \frac{\partial \ln f_{\mathbf{x}}(\mathbf{x}, \boldsymbol{\theta})}{\partial \theta_i} f_{\mathbf{x}}(\mathbf{x}, \boldsymbol{\theta}) d\mathbf{x} \\ &= \mathbb{E}_{\theta} [\mathbb{I}(\mathbf{X}) s_{\theta_i}(\mathbf{X}, \boldsymbol{\theta})] \end{aligned} \quad (\text{IV.10})$$

where $s_{\theta_i}(\mathbf{x}, \boldsymbol{\theta})$ is the first order score function for the parameter θ_i :

$$s_{\theta_i}(\mathbf{x}, \boldsymbol{\theta}) = \frac{\partial \ln f_{\mathbf{x}}(\mathbf{x}, \boldsymbol{\theta})}{\partial \theta_i} \quad (\text{IV.11})$$

The Monte Carlo estimator of the quantity $\frac{\partial NCR(\boldsymbol{\theta})}{\partial \theta_i}$ for N_{mc} samples is given by:

$$\frac{\partial NCR(\boldsymbol{\theta})}{\partial \theta_i} \approx \frac{1}{N_{mc}} \sum_{i=1}^{N_{mc}} \mathbb{I}(\mathbf{X}^{(i)}) s_{\theta_i}(\mathbf{X}^{(i)}, \boldsymbol{\theta}) \quad (\text{IV.12})$$

This estimator enables the use of the same samples for estimating the failure probability and its gradients with respect to distribution parameters. This method is used here as it provides local reliability-oriented sensitivity indices through the use of sampling-based techniques. In addition, it only requires one Monte Carlo iteration. Note that the first-order score function is derived from the sensitivity of the joint distribution, which can be analytically obtained. The probabilistic response $NCR(\boldsymbol{\theta})$ and its sensitivity $\frac{\partial NCR(\boldsymbol{\theta})}{\partial \theta_i}$ are formulated as the expectation of stochastic quantities with respect to the same density function. It facilitates their concurrent evaluations in a single stochastic analysis by using Monte Carlo method. In this study, the vector of distribution parameters $\boldsymbol{\theta}$ are replaced by $\boldsymbol{\mu}$ and $\boldsymbol{\sigma}$ for the sensitivity of the reliability function. Consider a random input \mathbf{X} , where the components $X_1 \dots X_N$ are independent random variables. Let X_i follow the probability density function $f_{X_i}(X_i, \mu_i, \sigma_i)$ for $i = 1, \dots, N$, with mean $\mu_i = T_i + \delta_i$ and standard deviation σ_i . The joint density of \mathbf{X} is $f_{\mathbf{X}}(\mathbf{x}, \boldsymbol{\theta}) = \prod_{i=1}^N f_{X_i}(X_i, \mu_i, \sigma_i, \boldsymbol{\theta}) = \{\mu_1, \sigma_1, \dots, \mu_N, \sigma_N\}^T$. Therefore, from Equation (II.26), the first-order score functions for μ_i and σ_i become:

$$S_{\mu_i}(\mathbf{x}, \boldsymbol{\mu}) = \frac{\partial \ln f_{\mathbf{x}}(x_i, \mu_i, \sigma_i)}{\partial \mu_i} = \frac{x_i - \mu_i}{\sigma_i^2} \quad (\text{IV.13})$$

$$S_{\sigma_i}(\mathbf{x}, \boldsymbol{\sigma}) = \frac{\partial \ln f_{\mathbf{x}}(x_i, \mu_i, \sigma_i)}{\partial \sigma_i} = \frac{1}{\sigma_i} \left[\left(\frac{x_i - \mu_i}{\sigma_i} \right)^2 - 1 \right] \quad (\text{IV.14})$$

Sensitivity analysis by Score functions under two uncertainty levels

When the dimensions have variable mean shifts and the standard deviation is constant, the variables are considered to have two uncertainty levels. The first uncertainty level is on the dimensions \mathbf{X} and the second uncertainty level is on the distributions' parameters $\boldsymbol{\theta}$. In this case the sensitivities are calculated by score functions in the augmented space. Under the bi-level input uncertainty, the NCR is defined as the following:

$$NCR(\mathbf{t}) = \int_{D_{\boldsymbol{\theta}}} NCR(\boldsymbol{\theta}) f_{\boldsymbol{\theta}|\mathbf{t}}(\boldsymbol{\theta}|\mathbf{t}) d\boldsymbol{\theta} \quad (\text{IV.15})$$

where $NCR(\boldsymbol{\theta})$ is the conditional NCR given by:

$$NCR(\boldsymbol{\theta}) = \int_{D_{\mathbf{X}}} \mathbb{I}(\mathbf{x}) f_{\mathbf{x}}(\mathbf{x}, \boldsymbol{\theta}) d\mathbf{x} \quad (\text{IV.16})$$

Referring to the work of Chabridon (2019), the NCR can be estimated by considering the augmented space. The joint PDF $f_Z = f_X f_{\boldsymbol{\theta}}$. The partial derivative of the NCR with respect to the i -th component of \mathbf{t} is given by:

$$\frac{\partial NCR(\mathbf{t})}{\partial t_i} = \frac{\partial}{\partial t_i} \left[\int_{D_{\boldsymbol{\theta}}} NCR(\boldsymbol{\theta}) f_{\boldsymbol{\theta}|\mathbf{t}}(\boldsymbol{\theta}|\mathbf{t}) d\boldsymbol{\theta} \right] = \int_{D_{\boldsymbol{\theta}}} NCR(\boldsymbol{\theta}) \frac{\partial f_{\boldsymbol{\theta}|\mathbf{t}}(\boldsymbol{\theta}|\mathbf{t})}{\partial t_i} d\boldsymbol{\theta} \quad (\text{IV.17})$$

Note that, in the previous derivations, the differential and integral operators are switched due to Lebesgue's dominated convergence theorem. Following the idea given by Rubinstein (1986), the importance sampling can be used to get an expectation with respect to the same probability measure as that used for the NCR estimation. Thus it is given as:

$$\begin{aligned} \frac{\partial NCR(\mathbf{t})}{\partial t_i} &= \int_{D_{\boldsymbol{\theta}}} NCR(\boldsymbol{\theta}) \cdot \frac{\frac{\partial}{\partial t_i} f_{\boldsymbol{\theta}|\mathbf{t}}(\boldsymbol{\theta}|\mathbf{t})}{f_{\boldsymbol{\theta}|\mathbf{t}}(\boldsymbol{\theta}|\mathbf{t})} f_{\boldsymbol{\theta}|\mathbf{t}}(\boldsymbol{\theta}|\mathbf{t}) d\boldsymbol{\theta} \\ &= \int_{D_{\boldsymbol{\theta}}} \left(\int_{D_{\mathbf{X}}} \mathbb{I}(\mathbf{x}) f_{\mathbf{x}}(\mathbf{x}) d\mathbf{x} \right) \cdot \frac{\partial \ln f_{\boldsymbol{\theta}|\mathbf{t}}(\boldsymbol{\theta}|\mathbf{t})}{\partial t_i} f_{\boldsymbol{\theta}|\mathbf{t}}(\boldsymbol{\theta}|\mathbf{t}) d\boldsymbol{\theta} \\ &= \int_{D_{\boldsymbol{\theta}}} \left(\int_{D_{\mathbf{X}}} \mathbb{I}(\mathbf{x}) s_i(\boldsymbol{\theta}, \mathbf{t}) f_{\mathbf{x}}(\mathbf{x}) d\mathbf{x} \right) f_{\boldsymbol{\theta}|\mathbf{t}}(\boldsymbol{\theta}|\mathbf{t}) d\boldsymbol{\theta} \\ &= \mathbb{E}_{\boldsymbol{\theta}} [\mathbb{I}(\mathbf{Z}) s_i(\boldsymbol{\theta}, \mathbf{t})] \end{aligned} \quad (\text{IV.18})$$

The computation of the partial derivative requires only one Monte Carlo simulation. The random variables are generated by taking into account the variability in \mathbf{X} and $\boldsymbol{\theta}$.

IV.3.4 Gradient-based optimization

Numerous optimization algorithms and strategies exist in the literature. The choice of the optimization algorithm depends on the problem to be solved. In this work, only the gradient-based strategies are presented since they are enough to solve these types of optimization problem

without a need for extensive numerical efforts. According to Stromholm (1968), the derivatives and tangents have been proposed by Fermat and Lagrange. The minimum of a function is reached using an iterative process on gradients to decrease its value. The local variations of this function are checked by the use of the tangent. The main idea of the gradient-based algorithms is that they follow a one-dimensional path in the n -dimensional design space. Consequently, only local convergence can occur with a moderate computational cost. In the first order gradient optimization, a Taylor expansion of the objective function is done such as:

$$f(x) \approx f(x^{(0)}) + (x - x^{(0)})^T \Delta f(x^{(0)}) \quad (\text{IV.19})$$

In many problems, the use of first order gradient based optimization algorithms causes the non-convergence of the solution and many objective function evaluations. Hence, the second order methods are used. The Taylor expansion would become:

$$f(x) \approx f(x^{(0)}) + (x - x^{(0)})^T \Delta f(x^{(0)}) + \frac{1}{2} x^T \Delta^2 f(x^{(0)}) \quad (\text{IV.20})$$

The Hessian matrix is composed of the second order partial derivatives of the objective function, it is in most cases expensive to compute. Therefore, it is approximated using only the first order partial derivatives. This is called the Quasi-Newton approach. The most popular Quasi-Newton method is the Broyden-Fletcher-Goldfarb-Shanno (BFGS) method (Nocedal and Wright, 2006). The optimization problem in this work is a constrained problem, therefore the Sequential Least Squares Programming (SLSQP) algorithm is adopted. The SLSQP is an extension of the BFGS algorithm and it is detailed by the following.

Sequential Least Squares Programming (SLSQP)

The non-linear programming is expressed as the following:

$$\begin{aligned} \text{NLP : } & \min f(\mathbf{x}) \\ \text{Subject to } & g_j(\mathbf{x}) = 0, \quad j = 1, \dots, m_{eq} \\ & g_j(\mathbf{x}) \geq 0, \quad j = m_{eq} + 1, \dots, m \\ & \mathbf{x}_l \leq \mathbf{x} \leq \mathbf{x}_u \end{aligned} \quad (\text{IV.21})$$

where f and g are assumed to be continuous and differentiable functions with no specific structure. The Sequential Least Squares Programming (SLSQP) is a computation method to solves non-linear programming problems. The estimation of x^{k+1} is deduced from x^k by following the the equation:

$$x^{k+1} = x^k + \alpha^k d^k \quad (\text{IV.22})$$

where d^k is the k -th search direction and α^k is the step size. The search direction is defined by a quadratic sub-problem formulated by the Lagrange function such as:

$$L(\mathbf{x}, \lambda) = f(\mathbf{x}) + \sum_{j=1}^m \lambda_j g_j(\mathbf{x}) \quad (\text{IV.23})$$

and a linear approximation of the constraints g_j . In the SLSQP, the search direction is estimated by a quadratic function. Its objective is to replace the initial problem with a sequence of quadratic problems with constraints. The quadratic function is approximated by the second-order Taylor series. The NLP is substituted by the standard quadratic programming minimizing over the difference of \mathbf{x} (Kraft, 1988). The SQP algorithm for an optimization problem composed of equations and inequalities as constraints is shown as follows:

$$\begin{aligned} QP_k = \min_{\mathbf{d} \in \mathbf{R}^n} \quad & \Delta f(\mathbf{x}^k)^T \mathbf{d} + \frac{1}{2} \mathbf{d}^T \mathbf{H}^k \mathbf{d} \\ \text{Subject to} \quad & g_j(\mathbf{x}^k) + \Delta g_j(\mathbf{x}^k)^T \mathbf{d} = 0, j = 1, \dots, m_{eq}, \\ & g_j(\mathbf{x}^k) + \Delta g_j(\mathbf{x}^k)^T \mathbf{d} \geq 0, j = m_{eq} + 1, \dots, m \end{aligned} \quad (\text{IV.24})$$

The proposed search direction is the following:

$$\mathbf{H} := \Delta^2 L(\mathbf{x}, \lambda) \quad (\text{IV.25})$$

Step size

In this thesis, the gradients are estimated by the finite difference formula:

$$\Delta f(x) = \frac{f(x + \alpha) - f(x)}{\alpha} \quad (\text{IV.26})$$

The results of the optimization depend on the value of the step size ϵ . The default value of α in the optimization algorithm is 1.10^{-7} . A very small step size would lead to inaccuracy in the calculation due to the fact that the Monte Carlo simulations are used to construct the objective and constraint functions. In this work, the step size is assumed to be 0.1 since a very small value will cause the stop of the calculation.

Fixing the seed

In this optimization, the objective and the constraint functions necessitate the evaluation of the NCR. The estimation of the NCR is performed using Monte Carlo simulations. This leads to biased expected value of the NCR and consequently the objective and constraint function of the optimization. This can be considered as noise in the optimization functions. This would make non-smooth curves for the functions, therefore the use of gradient-based methods would

be challenging. To overcome this problem, it is required to reduce the noise of the functions by reducing the variance of the estimates of NCR that correspond to different choices of \mathbf{t} . This is achieved by fixing the seed in the simulations generating different estimates of the NCR. This procedure has been proposed by Taflanidis and Beck (2008) and referred as common random numbers (CRN).

Different steps of the proposed approach

The steps of the proposed approach in this chapter are summarized in Figure (IV.4). They can be summarized as the following:

Step1. Initialization.

The Monte Carlo sampling size N_{MC} is set. The iteration counter k is initialized. The starting point $\mathbf{t}^{(0)}$ is given. The lower and upper bounds of \mathbf{t} are defined.

Step2. Set-up of sequential quadratic programming (SQP).

Let $\mathbf{t}^{(k)}$ be the tolerance interval estimated at the k^{th} iteration, $\mathbf{t}^{(k+1)} = \mathbf{t}^{(k)} + \boldsymbol{\alpha}^k$ where $\boldsymbol{\alpha}^k$ is the step size. The sub-problem in the SQP is:

$$\begin{aligned}
 \min f_{\mathbf{t}}(\mathbf{t}^{(k+1)}) &= f_{\mathbf{t}}(\mathbf{t}^{(k)} + \boldsymbol{\alpha}^k) \\
 &\cong f_{\mathbf{t}}(\mathbf{t}^{(k)}) + \mathbf{c}^T \boldsymbol{\alpha}^k + \frac{1}{2} \boldsymbol{\alpha}^{kT} \mathbf{H} \boldsymbol{\alpha}^k \\
 \text{Subject to } NCR(\mathbf{t}^{(k+1)}) &= NCR(\mathbf{t}^{(k)} + \boldsymbol{\alpha}^k) \\
 &\cong NCR(\mathbf{t}^{(k)}) + \mathbf{s}_i^T \boldsymbol{\alpha}^k
 \end{aligned} \tag{IV.27}$$

$$\begin{aligned}
 \text{where } \mathbf{c} &= \frac{\partial f_{\mathbf{t}}}{\partial \mathbf{t}}, \mathbf{H} = \frac{\partial^2 f_{\mathbf{t}}}{\partial \mathbf{t}_i \partial \mathbf{t}_m} \\
 \mathbf{s}_i &= \frac{\partial NCR(\mathbf{t})}{\partial \mathbf{t}}
 \end{aligned}$$

Step3. Stochastic sensitivity calculation.

The sensitivity of the failure probability \mathbf{S}_i is calculated by using score function such as given in Equation (IV.11) for one uncertainty level and such as given in Equation (IV.18) for double uncertainty level.

Step 4. Checking for convergence and updating.

There are several stopping criteria in SLSQP python toolbox such as the precision goal of the objective function $f_{\mathbf{t}}$ named $ftol$ and maximum number of iterations, etc.. The general convergence condition is adopted. That is, if $\|\mathbf{t}^{(k)}\| \leq ftol$ (default $ftol$ value = 1.10^{-6}), then $\mathbf{t} = \mathbf{t}^{(k)}$ and stop. If not, set $k = k + 1$, $\mathbf{t}^{(k+1)} = \mathbf{t}^{(k)} + \boldsymbol{\alpha}$ and go to Step 2.

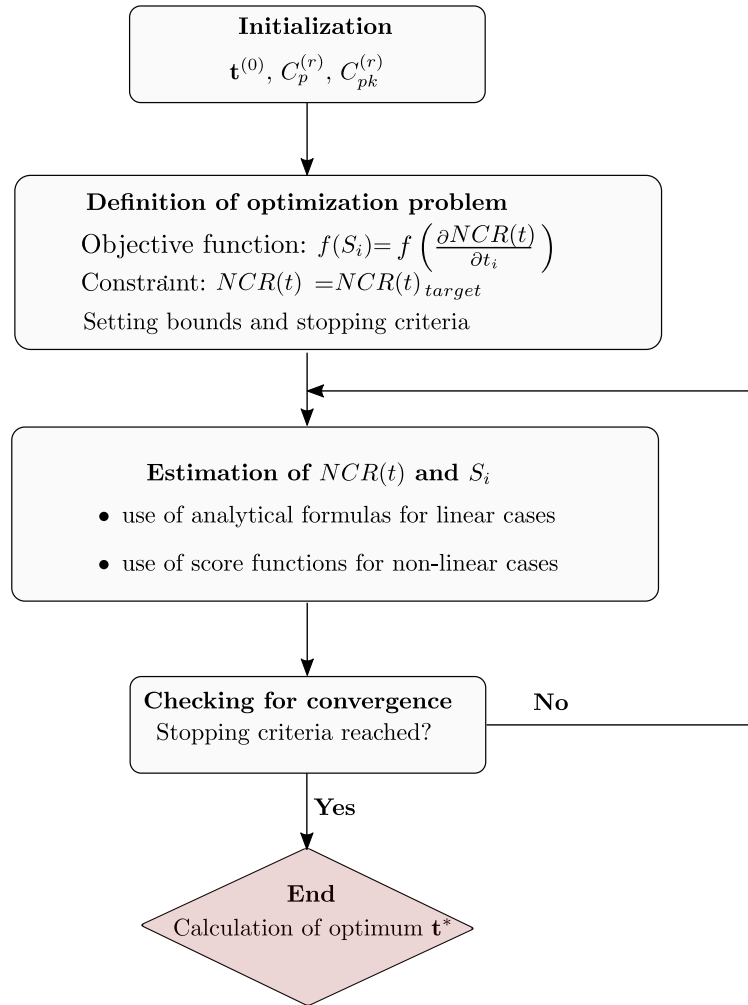

Figure IV.4 – Steps of the method with imposed gradients.

IV.4 Applications

The proposed method in this chapter is applied first on a linear stack-up example with two dimensions, i.e. two optimization variables. The numerical solutions are tested for this example in the three statistical models. Then, the method is implemented in the case of a linearised function as well as the case of a non-linear system for only one statistical model case.

IV.4.1 Linear stack-up example

A linear stack-up of two dimensions shown in Figure (III.7) is considered. The corresponding data are given in Table (IV.1).

Table IV.1 – Input parameters of the linear stack-up example.

Dimensions	T_i	t_0	$C_p^{(r)} = C_{pk}^{(r)}$	Distribution
X_1	6	1	1.33	Normal
X_2	4	1	1.33	Normal

The optimization problem involving two optimization variables can be written in the standard form as follows:

$$\begin{aligned} \mathbf{t}^* &= \text{Argmin}(S_1(t_1) - \bar{S}(\mathbf{t}))^2 + (S_2(t_2) - \bar{S}(\mathbf{t}))^2 \\ \text{Subject to } NCR(\mathbf{t}) &\leq 0.005 \end{aligned} \quad (\text{IV.28})$$

The bounds of the tolerance intervals depend on the statistical model. The sensitivities are estimated by the analytical formula and by the score functions. The sensitivities by score functions are estimated for this example to make sure that their use can give relevant results. Therefore, they can be adopted for the non-linear or over-constrained systems. The evaluation of this problem is performed for the three different statistical models already exposed in Section (IV.3.2).

- Case1: considering the first case where the dimensions follow normal distributions with fixed parameters, such that the standard deviations have maximum values and the values of the means are equal to the target values. The problem is solved following two strategies:
 1. using the analytical formulas of the NCR given in Equation (III.8) and that of the sensitivity indices given in Equation (IV.6). The results are illustrated in Figure (IV.5a). The solution is spotted by the blue circle. It represents the intersection of the constraint function with the minimum of the objective function;
 2. using the NCR estimated by Monte Carlo simulation given in Equation (III.11) and the sensitivity indices by score functions given in Equation (IV.14). The results are illustrated in Figure (IV.5b). This strategy is applied to validate the results obtained from the first strategies.

The same solution can be deduced from the two strategies. Some small perturbations are noted in the contours of the objective function when using the score functions. This is because the score functions are deduced from a Monte Carlo simulation ($N_{MC} = 1 \times 10^5$), so this is linked to the sample size. Increasing the number of samples reduces the noise, but cannot eliminate it completely. However, this does not cause excessive perturbations in the results of the optimization problem. In addition, the iso-sensitivity criteria is checked. The

number of the MC samples depends on the accuracy need for the objective and constraint functions in the optimization. Figure (IV.6) shows the accuracy of optimization functions with respect to the evolution of the number of the MC samples. Table (IV.2) shows that, for both strategies, the sensitivities deduced from the estimated tolerance intervals are equal.

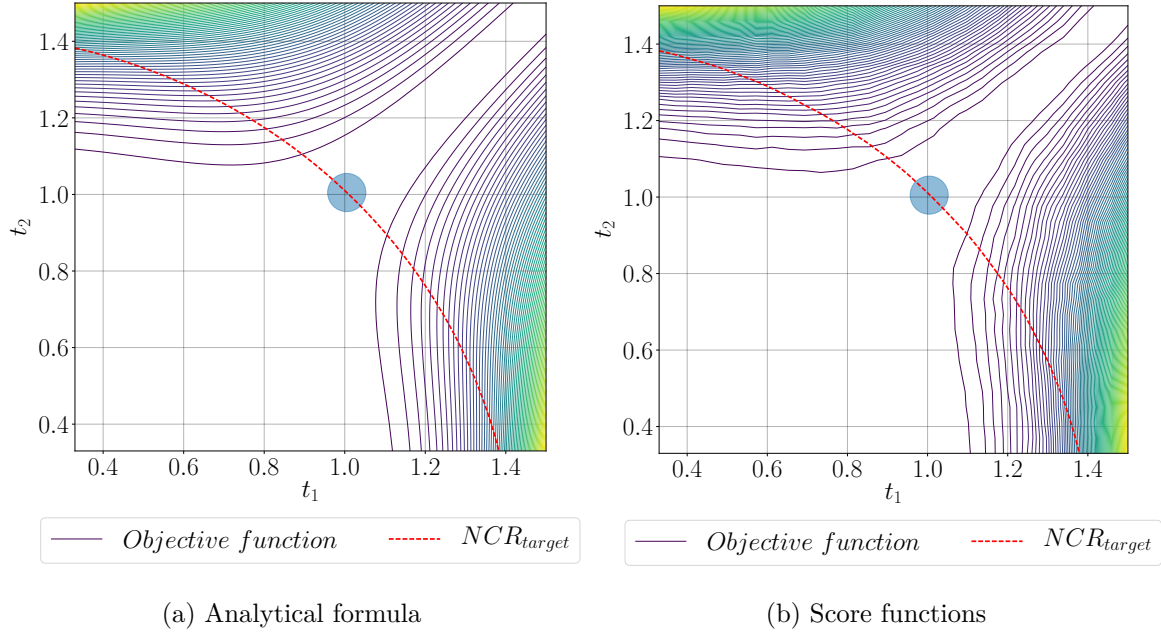

Figure IV.5 – Representation of the objective and constraint functions for case 1 as well as the optimization solution obtained from two different strategies.

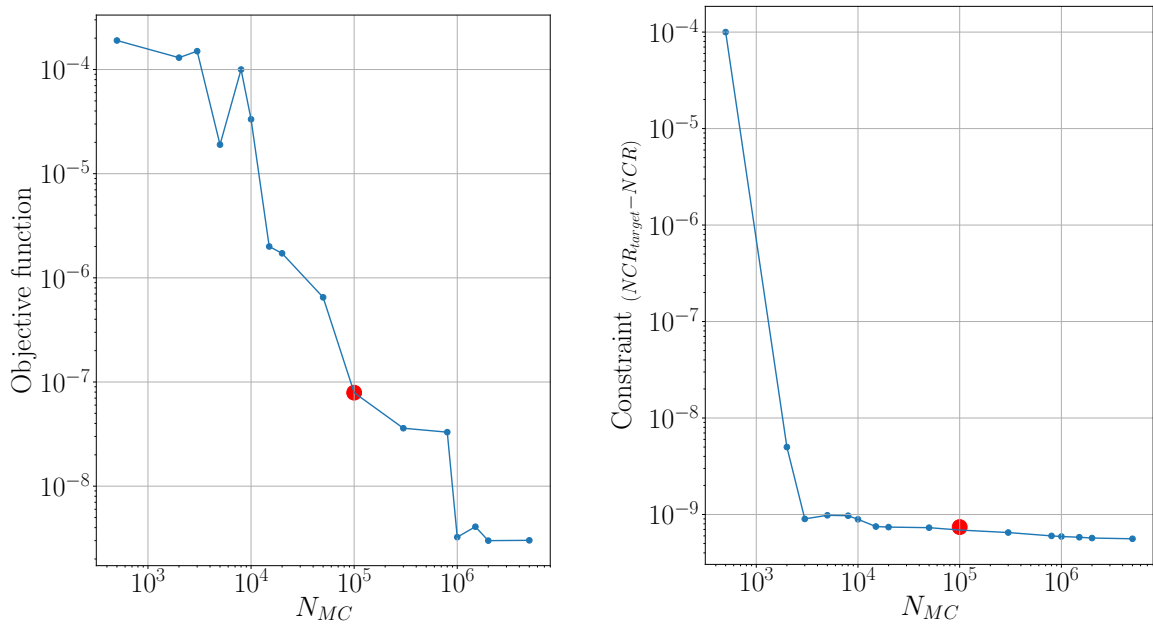

Figure IV.6 – The objective and the constraint function with respect to the number of MC samples.

Table IV.2 – Tolerance intervals and sensitivities for case 1 when analytical formulas and score functions are performed.

Dimensions	t_i^a	S_i^a	Dimensions	t_i^s	S_i^s
X_1	1.005	0.0216	X_1	1.004	0.0218
X_2	1.005	0.0216	X_2	1.005	0.0215

The NCR corresponding to the optimal tolerance values is computed for both strategies. It is equal to NCR_{target} , this proves that the constraint of the optimization is respected.

- Case 2: the second case considers a constant standard deviation (e.g. $\sigma_i = 0.1$) with the corresponding maximum of the mean shift. The NCR is estimated using the analytical formula. The NCR is quasi-linear, so the corresponding derivatives are constant. As a consequence, the expressions of the sensitivities in this case are no longer expressed in terms of tolerance intervals \mathbf{t} . Therefore the objective function is zero. So the problem in this case is to find the tolerance intervals that give the target NCR taking into consideration the sensitivities is not a function of \mathbf{t} . Therefore, the problem is no longer an optimization problem, since the objective function is always satisfied. The solution is a set of tolerances that give the target NCR. Therefore there exist an infinite number of solutions that are equally good.
- Case 3: the third case is also performed where the standard deviation is constant and the mean shift is variable. The mean shift varies uniformly in the interval $[3C_{pk}\sigma - \frac{t}{2}, -3C_{pk}\sigma + \frac{t}{2}]$. The problem is solved following two strategies:
 1. using the analytical formulas of the NCR given in Equation (III.8) and the finite differences for the estimation of the sensitivity indices. The corresponding solution is given in Figure (IV.7a).
 2. using the NCR estimated by Monte Carlo simulation given in Equation (III.11) and the sensitivity indices by score functions in the augmented space such as given in Equation (IV.18). The corresponding solution is given in Figure (IV.7b).

For this case also the same solution can be deduced from the two strategies. Similarly to case 1, some small perturbations are noted in the contours of the objective function for the same reason. In addition, the iso-sensitivity criteria is checked. Table (IV.3) shows that, for both strategies, the sensitivities deduced from the estimated tolerance intervals are equal.

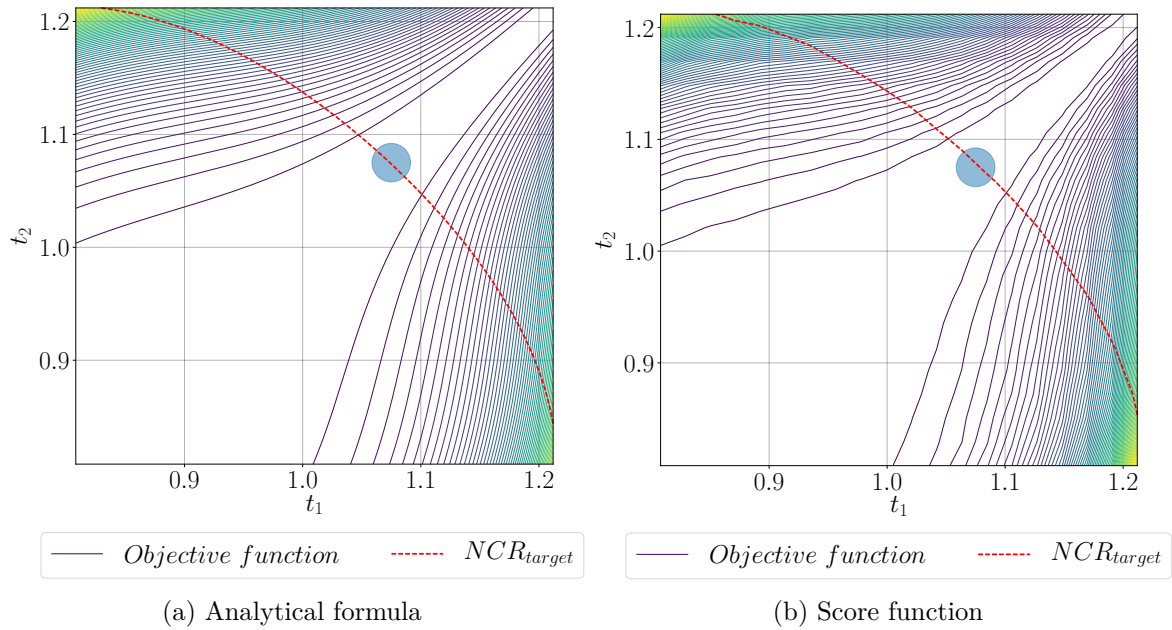

Figure IV.7 – Representation of the objective and constraint functions for case 3 as well as the optimization solution obtained from two different strategies.

Table IV.3 – Tolerance intervals and sensitivities for case 3 when analytical formulas and score functions are performed.

Dimensions	t_i^a	S_i^a	Dimensions	t_i^s	S_i^s
X_1	1.08	0.0231	X_1	1.08	0.0231
X_2	1.08	0.0231	X_2	1.075	0.0228

The tolerance intervals estimated by the use of the sensitivity indices based on the score functions are almost the same as the ones obtained by the analytical formulas. This proves that the sensitivities by the score functions give acceptable and relevant results. As a consequence they will be adapted in the more complex systems such the non-linear or the over-constrained systems.

IV.4.2 Linearised system of the Electrical plug from RADIALL

The application of the method is done also on a linearised function. The case from RADIALL is an electrical plug. Fourteen dimensions are involved in the tolerance intervals chain following the relation given in Equation (III.21). The input data already given in Table (III.2) are used. The value of the initial NCR_0 corresponding the input data is equal to 0.12. This value is considered higher than the required NCR. Therefore, there is need to reach a small NCR under

the iso-sensitivity condition. Consequently, the optimization problem involving all the tolerance intervals is written in the standard form as follows:

$$\mathbf{t}^* = \underset{\mathbf{t}}{\text{Argmin}} \sum_{i=1}^{14} (S_i(t_i) - \bar{S}(\mathbf{t}))^2 \quad (\text{IV.29})$$

Subject to $NCR(\mathbf{t}) \leq 0.0001$

The tolerances associated to every dimension are considered the initial tolerances which form the starting tolerance vector of the optimization. The statistical model assumed in this example is the model of Case 1 (centred dimensions, maximum standard deviation). The NCR and the sensitivities are estimated using the analytical formula since the functional characteristic is linearised. The results of the optimization are given in Table (IV.4).

Table IV.4 – Estimated tolerance intervals and sensitivity indices by analytical formula for RADIALL case input parameters.

Dimensions	\mathbf{t}_0	Allocated tolerances \mathbf{t}^*	$S_i(\times 10^{-5})$
X_1	0.2	3.31×10^{-2}	1.38
X_2	0.2	2.12×10^{-4}	1.38
X_3	0.06	2.12×10^{-4}	1.38
X_4	0.15	2.66×10^{-5}	1.38
X_5	0.2	6.41×10^{-5}	1.38
X_6	0.04	6.41×10^{-5}	1.38
X_7	0.05	5.31×10^1	1.38
X_8	0.04	2.12×10^{-2}	1.38
X_9	0.04	5.31×10^1	1.38
X_{10}	0.06	1.92×10^{-3}	1.38
X_{11}	0.04	1.65×10^{-5}	1.38
X_{12}	0.04	2.45×10^{-5}	1.38
X_{13}	0.04	4.00×10^{-5}	1.38
X_{14}	0.06	1.91×10^{-3}	1.38

The new sensitivities are all equal, this proves that the optimum solution is reached. It also demonstrates that the optimization problem is sufficiently well conditioned to obtain convergence, and that the method is applicable with a moderately large number of variables. It is noticed that the estimated tolerance intervals are very small with respect to the original tolerances except for the variables X_7 and X_9 . The corresponding tolerance intervals are

relatively large. It can be concluded that these two variables are not influencing the variability of the NCR, so their values can be fixed as their initial ones and then excluded from the analysis. For the rest of the variables, the low values of tolerance intervals that should give the target NCR cannot be achieved during the manufacturing process. As a consequence, they are all set as KCs.

IV.4.3 Non-linear clutch system

The one-way mechanical clutch shown in Figure (IV.8) is an example of a non-linear dimensional chain (Glancy and Chase, 1999). The main parts of the clutch are an outer ring, four rollers accompanied by four springs and a central hub. This is a device used to transmit rotary motion in only one direction. The independent manufacturing variables are the hub dimension A , the cylinder radius C , and the ring radius E . It is defined geometrically by the dimensions $X = (A, C, D, E)$. The variables C and D are equal since they both represent the radius of the ring. The angle α is expected to vary due to manufacturing variations in the clutch component dimensions. The analytical expression of the chain of dimensions is the following:

$$\alpha = \arccos\left(\frac{A+C}{E-D}\right) \quad (\text{IV.30})$$

and the functional requirement on the angle α is the following: $\alpha \in [6.4184^\circ; 7.6184^\circ]$. The input data of the clutch mechanism variables are given in Table (IV.5). The assumed statistical model is also the model of Case 1.

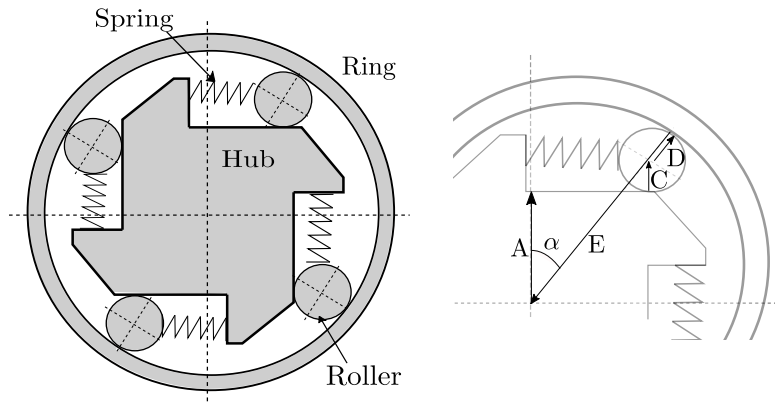

Figure IV.8 – Non-linear clutch mechanism (Glancy and Chase, 1999).

Table IV.5 – Input data for variables of the clutch mechanism.

Dimension	Mean (in mm)	\mathbf{t}_0	$\mathbf{C}_p^{(r)}$	Distribution
A	27.645	0.1	1.33	Normal
C, D	11.43	0.02	1.33	Normal
E	50.8	0.025	1.33	Normal

The value of the initial NCR_0 corresponding the input data is equal to 4×10^{-4} . This value is considered higher than the required NCR. Therefore, there is need to reach a small NCR under the iso-sensitivity condition. Therefore, the optimization problem involving all the optimization variables is written in the standard form as follows:

$$\mathbf{t}^* = \text{Argmin} \sum_{i=1}^3 (S_i(t_i) - \bar{S}(\mathbf{t}))^2 \quad (\text{IV.31})$$

Subject to $NCR(\mathbf{t}) \leq 3 \times 10^{-4}$

The variables are assumed to have a maximum standard deviation and a zero mean shift (case 1: *peak of the triangular capability domain*). The NCR is estimated using the Monte Carlo simulation and the sensitivities are estimated using the score functions formulas that is based on the NCR estimation. The results of the optimization are shown in Table (IV.6). In this case the obtained sensitivities are also all equal, proving that the optimum is reached. It is noticed that the estimated tolerance intervals are very small with respect to the original tolerances. The low values of tolerance intervals required to meet the target NCR cannot be achieved during the manufacturing process. As a consequence, they are all set as KCs.

Table IV.6 – Tolerances allocated by iso-sensitivity and the corresponding sensitivities for variables of the clutch mechanism.

Dimension	Allocated tolerances \mathbf{t}^*	Sensitivities by score functions
A	0.073	0.269
C, D	0.015	0.269
E	0.07	0.271

IV.5 Conclusion

This chapter presents a new method for the identification of the Key Characteristics in a critical functional requirement. The method is based on the tolerance allocation concept combined with sensitivity analysis. The principle tolerance allocation procedures from the literature are described in this chapter. It is shown that they do not respect a target value for the NCR. They also do not consider the capability requirements of the production process. The identification of KCs is performed by allocating the tolerance intervals in a way to respect a target value of the NCR and assuming that the sensitivities of all the involved parts are identical. This is conducted by an optimization problem that the objective function is a metrics defined as the sum of the square of the differences to the mean sensitivity index, and the condition on the NCR as a constraint. This problem is solved graphically for the systems involving only two variables for a visual validation of the method. Then it is applied on various types of systems. The application of the proposed approach is performed on the linear stack-up example with two parts for three statistical model assumptions. The results from the graphical and numerical solutions show that this approach can be applied when estimating sensitivities by analytical formulas in addition to the sensitivities based on score functions. It is also convenient to apply this approach for double level of uncertainty input. The only case where the method is not applicable is when a maximum or a minimum matter is considered. Other applications of the proposed approach were performed on an electrical plug having a linearised functional requirement and on a clutch mechanism having a non-linear functional requirement. This is only applied for one statistical model assumption. The obtained tolerance intervals are compared to reference values (e.g. as they appear on the CAD model) already specified by the designers. If the tolerance interval corresponding to one dimension cannot be achieved, the corresponding part is considered as a KC.

Key Characteristics Identification for an Over-constrained System

Contents

IV.1 Introduction	76
IV.2 Tolerance allocation	76
IV.2.1 Traditional tolerance allocation methods	77
IV.2.2 Tolerance cost optimization	78
IV.2.3 Synthesis on tolerance allocation methods	79
IV.3 Proposed approach based on iso-sensitivity tolerance allocation	80
IV.3.1 Formulation of the problem	80
IV.3.2 Statistical models' assumptions	82
IV.3.3 NCR and Sensitivity analysis for different statistical models	83
IV.3.4 Gradient-based optimization	86
IV.4 Applications	90
IV.4.1 Linear stack-up example	90
IV.4.2 Linearised system of the Electrical plug from RADIALL	94
IV.4.3 Non-linear clutch system	96
IV.5 Conclusion	98

V.1 Introduction

The objective of this chapter is to apply the already presented methods for the identification of KCs on a 3D mechanical system. Two methods are tested on this system. The first one is based on the Sobol' indices in the context of tolerancing and it was presented in Chapter III. The second one is based on tolerance allocation under iso-sensitivity conditions and was developed in Chapter IV. The mechanical system on which the methods are tested is an over-constrained system. The tolerance analysis and the geometrical modelling of over-constrained systems are already described in Section (I.2). The two methods have a common point, that they both need the estimation of the failure probability of the system. The calculation of the failure probability of an over-constrained system is not detailed because this has been already studied by Qureshi et al. (2012) and Dumas (2014). The adopted approach in this work is that of Qureshi et al. (2012) where the tolerance analysis approach is based on optimization and Monte Carlo simulation. The full description of the mechanism is in the following section.

V.2 Description of the system

The over-constrained system is an electrical plug adapted from RADIALL (see Figure (V.1)). This example has been treated by Dumas (2014) in his thesis dissertation. This mechanism consists of two parts in relative movement: part (1) is the casing and part (2) is the male contact. The casing is composed of the casing itself and a base allowing the male contact to be inserted in the casing. The casing and base plate are assumed to be fixed in relation to each other. In order for the male contact to fit into the casing without any problems, some gaps are provided between these two parts. However, in order for the electrical plug to be functional, the axes of the small cylinder of the male contact and of the outer cylinder of the casing must be aligned with each other to have maximum angular displacement. The functional requirement of this mechanism specifies that the maximum deflection of the small cylinder of the male contact with respect to the outer cylinder of the casing along \vec{x} and \vec{y} axes does not exceed a maximum value. Since form defects are neglected, this results in a requirement for the edge of the male contact (point E). The study of this mechanism implies the definition of an assembly condition and a functional requirement. Dumas (2014) has applied new tolerance approaches to get the probability of non-assembly and the probability of non-functionality. The application of the proposed methods for the identification of KCs does not require to repeat the tolerance analysis. They only require getting access to the input and to the output variables. The input variables were modelled as small displacement torsors. The output can be either

the non-assembly or the non-functionality probabilities. In this work, only the non-assembly probability is considered. The geometrical modelling and the formulation of the assembly and functionality problems are given in the following.

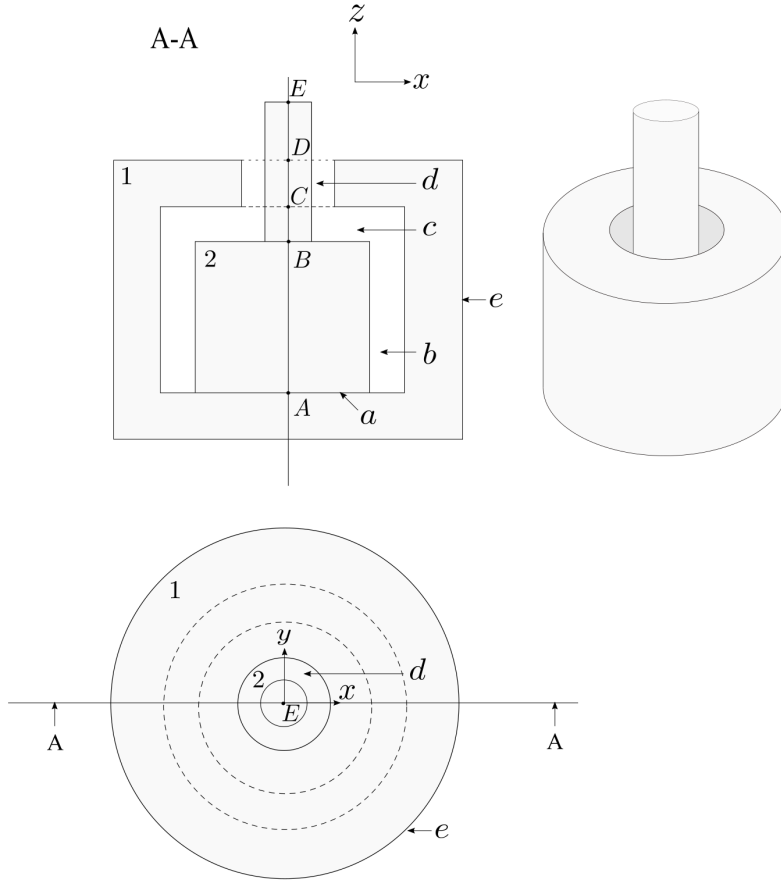

Figure V.1 – Representation of the electrical plug by RADIALL (Dumas, 2014).

V.2.1 Geometrical modelling

The point A is the origin to localise the other points (see Figure (V.1)). The corresponding coordinates are parametrised by the variables l_i , $i = \{1, 2, 3, 4\}$ in the system $R_1 = (A, \vec{x}, \vec{y}, \vec{z})$.

$$\vec{AB} = \begin{bmatrix} 0 \\ 0 \\ l_1 \end{bmatrix} \quad \vec{AC} = \begin{bmatrix} 0 \\ 0 \\ l_2 \end{bmatrix} \quad \vec{CD} = \begin{bmatrix} 0 \\ 0 \\ l_3 \end{bmatrix} \quad \vec{BE} = \begin{bmatrix} 0 \\ 0 \\ l_4 \end{bmatrix} \quad (\text{V.1})$$

Topological loop

The graph of the mechanism is presented in Figure (V.2) showing the two parts of the system. There are in total 4 joints (without that of the functional requirement), for 2 parts. The number of topological loops to write is equal to $N_{loops} = N_{joints} - N_{parts} + 1 = 4 - 2 + 1 = 3$. These loops allow to write a total of twenty compatibility equations (see Appendix (A)).

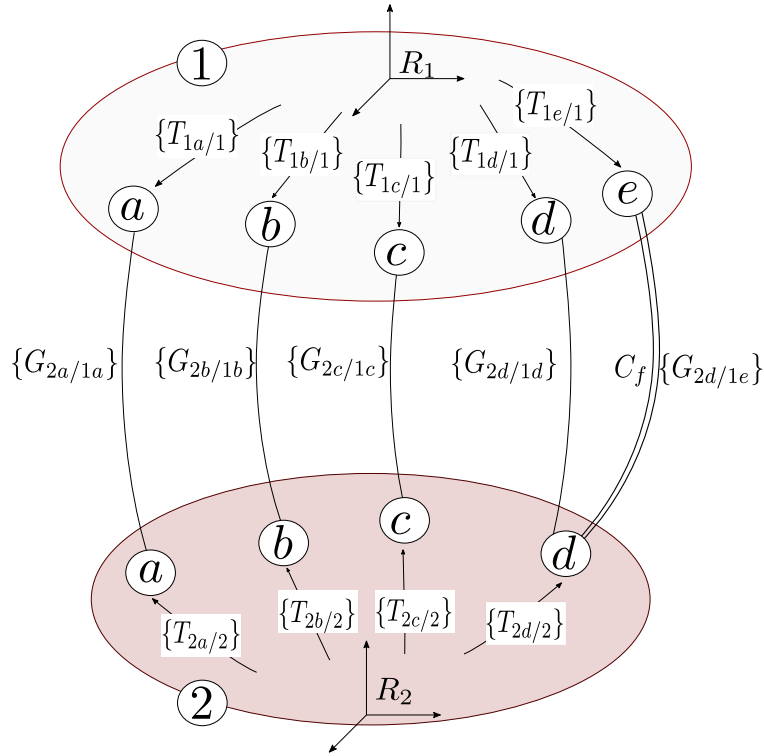

Figure V.2 – Graph of the mechanism (Dumas,2014).

Geometrical deviations

The substitution surfaces of the mechanism are the following:

- plane surfaces a and c .
- cylindrical surfaces b , d , and e .

For the cylindrical surfaces b and d , the intrinsic deviations are defined:

- d_{1b} : deviation of the diameter of the casing at the surface b .
- d_{2b} : deviation of the diameter of the male contact at the surface b .

- d_{1d} : deviation of the diameter of the casing at the surface d .
- d_{2d} : deviation of the diameter of the male contact at the surface d .

The deviation torsor is associated with each substitution surface (and for each part). The shape of the torsor depends on the type of associated surface. The torsors are expressed in the same base $(\vec{x}, \vec{y}, \vec{z})$ but with different application points:

$$\{T_{1a1}\} = \begin{Bmatrix} \alpha_{1a1} & 0 \\ \beta_{1a1} & 0 \\ 0 & w_{1a1} \end{Bmatrix}_A \quad \{T_{1b1}\} = \begin{Bmatrix} \alpha_{1b1} & u_{1b1} \\ \beta_{1b1} & v_{1b1} \\ 0 & 0 \end{Bmatrix}_A \quad \{T_{1c1}\} = \begin{Bmatrix} \alpha_{1c1} & 0 \\ \beta_{1c1} & 0 \\ 0 & w_{1c1} \end{Bmatrix}_B$$

$$\{T_{2a2}\} = \begin{Bmatrix} \alpha_{2a2} & 0 \\ \beta_{2a2} & 0 \\ 0 & w_{2a2} \end{Bmatrix}_A \quad \{T_{2b2}\} = \begin{Bmatrix} \alpha_{2b2} & u_{2b2} \\ \beta_{2b2} & v_{2b2} \\ 0 & 0 \end{Bmatrix}_A \quad \{T_{2c2}\} = \begin{Bmatrix} \alpha_{2c2} & 0 \\ \beta_{2c2} & 0 \\ 0 & w_{2c2} \end{Bmatrix}_B$$

$$\{T_{1d1}\} = \begin{Bmatrix} \alpha_{1d1} & u_{1d1} \\ \beta_{1d1} & v_{1d1} \\ 0 & 0 \end{Bmatrix}_C \quad \{T_{2d2}\} = \begin{Bmatrix} \alpha_{2d2} & u_{2d2} \\ \beta_{2d2} & v_{2d2} \\ 0 & 0 \end{Bmatrix}_C \quad \{T_{1e1}\} = \begin{Bmatrix} \alpha_{1e1} & u_{1e1} \\ \beta_{1e1} & v_{1e1} \\ 0 & 0 \end{Bmatrix}_E$$

Gaps

There are four joints in the mechanism to consider: two plane support connections at surfaces a and c and two pivot sliding connections at level surfaces b and d . All the gaps are of floating type therefore the gap torsors associated with connections are as the following:

$$\{G_{2a/1a}\} = \begin{Bmatrix} \alpha_{2a1a} & u_{2a1a} \\ \beta_{2a1a} & v_{2a1a} \\ \gamma_{2a1a} & w_{2a1a} \end{Bmatrix}_A \quad \{G_{2b/1b}\} = \begin{Bmatrix} \alpha_{3b1b} & u_{3b1b} \\ \beta_{3b1b} & v_{3b1b} \\ \gamma_{3b1b} & w_{3b1b} \end{Bmatrix}_A$$

$$\{G_{2c/1c}\} = \begin{Bmatrix} \alpha_{4c1c} & u_{4c1c} \\ \beta_{4c1c} & v_{4c1c} \\ \gamma_{4c1c} & w_{4c1c} \end{Bmatrix}_B \quad \{G_{2d/1d}\} = \begin{Bmatrix} \alpha_{4d1d} & u_{4d1d} \\ \beta_{4d1d} & v_{4d1d} \\ \gamma_{4d1d} & w_{4d1d} \end{Bmatrix}_C$$

As stated in the presentation of the mechanism, the study of the displacements of point E with respect to the outer cylinder e . The functional torsor contains the two components of

displacements along the axes \vec{x} and \vec{y} :

$$\{G_{2d/1e}\} = \left\{ \begin{array}{c} - \\ - \\ - \end{array} \begin{array}{c} u_{2d1e} \\ v_{2d1e} \\ - \end{array} \right\}_E$$

Types of surfaces

The surfaces involved in the over-constrained mechanism are plane and cylindrical surfaces. Table V.1 shows the small displacement torsors to be used and the corresponding constraints.

Table V.1 – SDT according to the type of surface and torsor according to the type of tolerance.

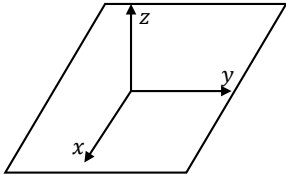
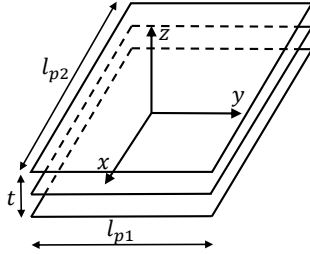
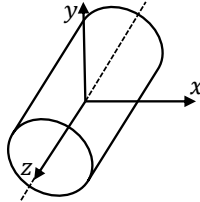
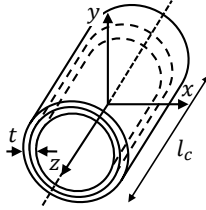
Surface	Surface Torsor	Tolerance Zone	Torsor Constraint
<p>Plane</p> 	$\{T_{S,N}\} = \left\{ \begin{array}{c} \alpha \\ \beta \\ 0 \end{array} \begin{array}{c} 0 \\ 0 \\ w \end{array} \right\}$		$\begin{aligned} -\frac{t}{2} &\leq w \leq \frac{t}{2} \\ -\frac{t}{l_{p1}} &\leq \alpha \leq \frac{t}{l_{p1}} \\ -\frac{t}{l_{p2}} &\leq \beta \leq \frac{t}{l_{p2}} \end{aligned}$
<p>Cylindrical</p> 	$\{T_{S,N}\} = \left\{ \begin{array}{c} \alpha \\ \beta \\ 0 \end{array} \begin{array}{c} u \\ v \\ 0 \end{array} \right\}$		$\begin{aligned} u^2 + v^2 &\leq \left(\frac{t}{2}\right)^2 \\ -\frac{t}{l_c} &\leq \alpha \leq \frac{t}{l_c} \\ -\frac{t}{l_c} &\leq \beta \leq \frac{t}{l_c} \end{aligned}$

V.2.2 Formulation of the assembly problem and non-assembly probability

The formulation of the assembly condition is given by Equation (I.6). By definition, a mechanism can be assembled if, for a given set of geometrical deviations \mathbf{x} given, there exist at least one gap vector \mathbf{g} such that interface constraints are respected. This means finding a position for the parts of the mechanism so that it can be assembled. It is necessary to use another

formulation based on an optimization problem. The used formulation is given by:

$$\begin{aligned}
 R_a(\mathbf{x}) &= \min_{\mathbf{g} \in \mathbb{R}^{N_t}} C_i^{(1)}(\mathbf{x}, \mathbf{g}) \\
 \text{Subject to } & C_c^{(j)}(\mathbf{x}, \mathbf{g}) = 0 \quad \forall j = \{1, \dots, N_{C_c}\} \\
 & C_i^{(l)}(\mathbf{x}, \mathbf{g}) \leq 0 \quad \forall l = \{1, \dots, N_{C_i}\}
 \end{aligned} \tag{V.2}$$

where N_T is the total number of compatibility and interface constraints, N_{C_c} is the number of the compatibility equations and N_{C_i} the number of the interface constraints. The problem consists in minimizing an interface constraint, subject to all the constraints characterizing the model behaviour including the interface constraint to minimize. A solution means that there exists a configuration of gaps so that the constraints are respected. Consider the event E_a that states:

“For a given vector \mathbf{x} , it doesn't exist a gap vector \mathbf{g} so that $R_a(\mathbf{x})$ has a solution”. The coupling of Monte Carlo and optimization techniques that allows the calculation of the non-assembly probability P_a have been proposed by Qureshi et al. (2012). This probability of non-assembly, which is an indication of the manufactured products, is estimated using the relation:

$$P_a \approx \tilde{P}_a = \frac{1}{N_{MCop}} \sum_{i=1}^{N_{MCop}} \mathbb{I}_a(\mathbf{x}^{(i)}) \tag{V.3}$$

where \mathbb{I}_a represents the indicator function defined as:

$$\mathbb{I}(\mathbf{x}) = \begin{cases} 1 & \text{if } R_a(\mathbf{x}) \text{ has not a solution} \\ 0 & \text{if } R_a(\mathbf{x}) \text{ has a solution} \end{cases} \tag{V.4}$$

V.2.3 Input random variables

The random variables follow a normal distribution $X \sim \mathcal{N}(\mu_X, \sigma_X)$. The values of the distributions' parameters corresponding to the input random variables are given in Table (V.2).

Table V.2 – Values of the random variables of the electrical plug.

$\mu_{d_{1b}}$	$\sigma_{d_{1b}}$	$\mu_{d_{2b}}$	$\sigma_{d_{2b}}$	$\mu_{d_{1d}}$	$\sigma_{d_{1d}}$	$\mu_{d_{2d}}$	$\sigma_{d_{2d}}$	μ_{X_t}	σ_{X_t}	X_r
12.1	0.03	12	0.03	6.1	0.03	6	0.03	0	0.01	0.01

The displacement geometrical deviations X_t and the rotational geometrical deviations X_r are the following:

$$X_t = \{w_{1a1}, w_{2a2}, u_{1b1}, v_{1b1}, u_{2b2}, v_{2b2}, w_{1c1}, w_{2c2}, u_{1d1}, v_{1d1}, u_{2d2}, v_{2d2}, u_{1e1}, v_{1e1}\}.$$

$$X_r = \{\alpha_{1a1}, \beta_{1a1}, \alpha_{1b1}, \beta_{1b1}, \alpha_{1c1}, \beta_{1c1}, \alpha_{1d1}, \beta_{1d1}, \alpha_{2a2}, \beta_{2a2}, \alpha_{2b2}, \beta_{2b2}, \alpha_{2c2}, \beta_{2c2}, \alpha_{2d2}, \beta_{2d2}\}$$

The rotational deviations are considered to have deterministic values, so they are not taken into account in the analysis.

In this chapter, the procedure followed by Qureshi et al. (2012) to get the non-assembly probability is considered. It uses the optimization and Monte Carlo simulation to get the results. The non-assembly probability of the electrical plug system described in this chapter was already performed using the "Tolsis" solver. This solver was developed by Phimeca and Mecamaster to solve tolerance analysis problems for over-constrained mechanisms. Both strategies tested for the KCs identification require the use of the input and the output variables. They can be extracted from the procured code.

V.3 Application of Method 1: Sobol' sensitivity indices

The application of the Sobol' based method for KC identification on the electrical plug requires the knowledge of the small displacement torsors, their distributions and the corresponding relations with manufacturing capabilities. The displacement deviations follow normal distributions. The corresponding distribution parameters are assumed to be variable and propagating from the manufacturing processes requirements such as the tolerance intervals t_i and the capabilities $C_{pi}^{(r)}$ and $C_{pki}^{(r)}$. The input generated samples are assumed to lie in the capability domain already introduced in Section (III.3.1). The reweighing technique is used for the estimation of non-assembly probability, to prevent repeated calls of the Monte Carlo simulations, thus the computational efforts are reduced.

V.3.1 Sobol' for 2D problem

For the sake of simplicity, as a first attempt of the Sobol' based strategy on over-constrained systems, the dimensionality of the problem is reduced. It is assumed that the variables associated to part (1) of the assembly has a common tolerance interval t_1 and similarly the variables associated to part (2) of the assembly has a common tolerance interval t_2 . So this is a 2D optimisation problem but the MCs still involves nineteen random variables. The torsors corresponding to part (1) and part (2) are grouped and are represented respectively by P_1 and P_2 . The results are shown in Figure (V.3). It is noted that the main effects are negligible, and the total effects are important.

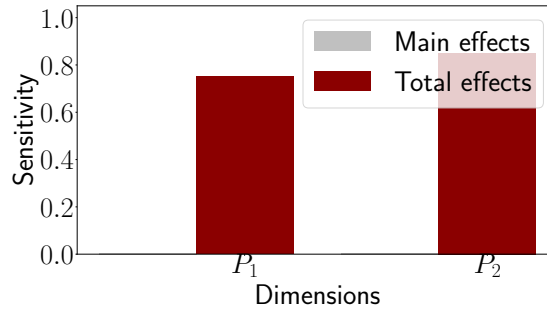

Figure V.3 – Sobol' sensitivity indices of the non-assembly probability to the geometrical displacement deviations.

V.3.2 Problem with nineteen variables

The same strategy is applied on the problem by taking into account all the random variables. The Sobol' indices corresponding to each variable are shown in Figure (V.4). The results show that the main effects of the variables are negligible, however the total effects are significant for some variables are small for others. This shows that the variation of one translational deviation does not impact alone the non-assembly probability, but the interactions of the variables have major impact on the quantity of interest. It can be also noted that the diameters d_{1b1} , d_{2b2} , d_{1d1} and d_{2d2} have an important impact on the non-assembly probability P_{na} . This is due to the higher values of the corresponding standard deviations. In addition, from the graph it is clear that the effects of the variables w_{1a1} and w_{1c1} are negligible, so they can be excluded from the analysis. The remaining variables seem to have more interaction effects, they can be set as KCs. A further step can be done by checking which variables are interacting together by estimating the higher order Sobol' indices.

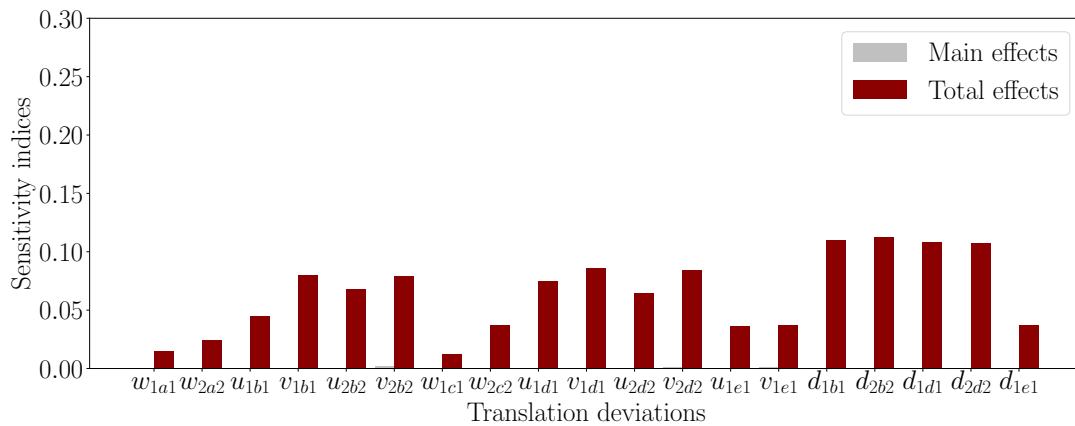

Figure V.4 – Sobol' sensitivity indices of the non-assembly probability to the geometrical displacement deviations.

V.4 Application of Method 2: Tolerance allocation by iso-sensitivity

The proposed method based on tolerance allocation by iso-sensitivity for KC identification is also applied on the electrical plug. The same procedure described in Chapter IV is followed in this example. An optimization problem is formulated and it can be written as the following:

$$\begin{aligned} \mathbf{t}^* &= \operatorname{Argmin} \sum_{i=1}^{19} (S_i(t_i) - \bar{S}(\mathbf{t}))^2 \\ \text{Subject to } & P_{na}(\mathbf{t}) \leq 0.01 \end{aligned} \tag{V.5}$$

The sensitivities are computed by the implementation of the score functions that estimate the influence of the probability of non-assembly to the distributions' parameters. So it is a reliability based optimization under uncertainty, as the constraint involves a failure probability and the objective function involves the derivatives of the failure probability. According to Schuëller and Jensen (2008), this type of problems need considerable computational efforts since the optimization and reliability analysis are both demanding. The objective function and the constraint function require the call of the coupled optimization with Monte Carlo simulation (Tolsis solver) at every iteration. In addition the number of variables is relatively high for such optimization. Two strategies to reduce the computational efforts are tested. The first strategy consists in providing the optimization with the gradients corresponding to the objective and to the constraint functions. This choice is taken since the optimization solver used is gradient based. The general strategy used in the optimization procedure that provides a gradient and using the chain rule has been adopted by Rumelhart et al. (1986) in the calibration of neural networks with the so-called back-propagation. The second strategy uses the re-weighting technique for the computation of the sensitivities based on score functions. For both strategies, the optimization algorithm chosen in Python is the Sequential Least Squares Programming (SLSQP), which is a gradient based algorithm.

V.4.1 Optimization with imposed gradient functions

Knowing that optimization algorithm used is a gradient based one, the gradients of the objective function and that of the constraints are imposed in the calculation to simplify the calculation and to reduce the computational time of the numerical simulation. The default way of the gradients' calculation in the algorithm of the program is the estimation of Finite Differences (FD). This procedure has been adopted by Jensen et al. (2009) for reliability-based optimization of stochastic systems. The different steps of this strategy are given in Figure (V.5).

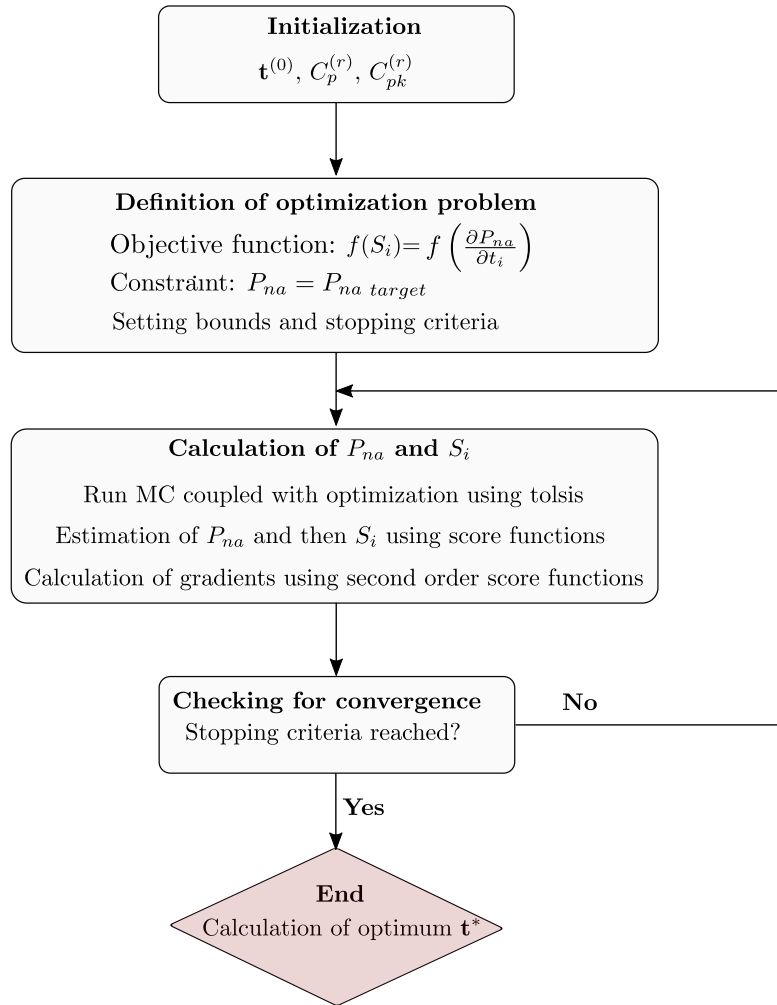

Figure V.5 – Steps of the method with imposed gradients.

The steps of the strategy are summarized as the following:

Step1. Initialization. The Monte Carlo sampling size N_{mc} is set. The iteration counter k is initialized. The starting point $\mathbf{t}^{(0)}$ is given. The lower and upper bounds of \mathbf{t} are defined.

Step2. Setup of sequential quadratic programming (SQP).

Let $\mathbf{t}^{(k)}$ be the tolerance interval estimated at the k^{th} iteration, $\mathbf{t}^{(k+1)} = \mathbf{t}^{(k)} + \boldsymbol{\alpha}^k$ where $\boldsymbol{\alpha}^k$ is

the step size. The sub-problem in the SQP is as the following:

$$\begin{aligned}
\min_{\mathbf{t}} f_{\mathbf{t}}(\mathbf{t}^{(k+1)}) &= f_{\mathbf{t}}(\mathbf{t}^{(k)} + \boldsymbol{\alpha}^k) \\
&\cong f_{\mathbf{t}}(\mathbf{t}^{(k)}) + \mathbf{c}^T \mathbf{t} + \frac{1}{2} \mathbf{t}^T \mathbf{H} \mathbf{t} \\
\text{Subject to } P_{na}(\mathbf{t}^{(k+1)}) &= P_{na}(\mathbf{t}^{(k)} + \boldsymbol{\alpha}^k) \\
&\cong P_{na}(\mathbf{t}^{(k)}) + \mathbf{s}_i^T \boldsymbol{\alpha}^k \\
\text{where } \mathbf{c} &= \frac{\partial f_{\mathbf{t}}}{\partial \mathbf{t}}, \mathbf{H} = \frac{\partial^2 f_{\mathbf{t}}}{\partial \mathbf{t}_l \partial \mathbf{t}_m} \\
\mathbf{s}_i &= \frac{\partial P_{na}(\mathbf{t})}{\partial \mathbf{t}}
\end{aligned} \tag{V.6}$$

In one hand, the gradients of the constraint function are the derivatives of the non-assembly probability with respect to the tolerance intervals $\frac{\partial P_{na}}{\partial t_i}$. They are the sensitivities used in the objective function (see Equation (IV.9)). In another hand, the gradients of the objective functions are obtained by getting the derivative of the objective function with respect to the tolerance intervals. Therefore, the derivatives of the sensitivity indices $\frac{\partial^2 P_{na}}{\partial t_i \partial t_j}$ need to be computed. By consequence, the second order score functions are calculated. The gradient of the objective function is expressed as:

$$\begin{aligned}
\frac{\partial f_{obj}}{\partial t_i} &= \frac{\partial}{\partial t_i} [(S_1 - \bar{S})^2 + \dots + (S_j - \bar{S})^2 + \dots + (S_n - \bar{S})^2] \\
&= 2(S_1 - \bar{S}) \frac{\partial}{\partial t_i} (S_1 - \bar{S}) + \dots + 2(S_j - \bar{S}) \frac{\partial}{\partial t_i} (S_j - \bar{S}) + \dots + 2(S_n - \bar{S}) \frac{\partial}{\partial t_i} (S_n - \bar{S})
\end{aligned} \tag{V.7}$$

with:

$$\begin{aligned}
\frac{\partial}{\partial t_i} (S_j - \bar{S}) &= \frac{\partial S_j}{\partial t_i} - \frac{\partial \bar{S}}{\partial t_i} \\
&= \frac{\partial S_j}{\partial t_i} - \frac{\partial}{\partial t_i} \frac{1}{n} (S_1 + \dots + S_j + \dots + S_n)
\end{aligned} \tag{V.8}$$

To recall that the sensitivity indices are defined as the influence of the tolerance intervals on P_{na} , they are computed using the first order score function. Therefore, the derivative of the sensitivity indices with respect to t_i necessitates the calculation of the second order sensitivity indices such as:

$$\begin{aligned}
\frac{\partial^2 P_{na}(\boldsymbol{\theta})}{\partial \theta_i \partial \theta_j} &= \frac{\partial}{\partial \theta_j} \int_{D_{\mathbf{X}}} \mathbb{I}(\mathbf{x}) s_{\theta_i}(\mathbf{X}, \boldsymbol{\theta}) f_{\mathbf{x}}(\mathbf{x}, \boldsymbol{\theta}) d\mathbf{x} \\
&= \int_{D_{\mathbf{X}}} \mathbb{I}(\mathbf{x}) s_{\theta_i}(\mathbf{X}, \boldsymbol{\theta}) \frac{\partial f_{\mathbf{x}}(\mathbf{x}, \boldsymbol{\theta})}{\partial \theta_j} d\mathbf{x} + \int_{D_{\mathbf{X}}} \mathbb{I}(\mathbf{x}) \frac{\partial s_{\theta_i}(\mathbf{X}, \boldsymbol{\theta})}{\partial \theta_j} f_{\mathbf{x}}(\mathbf{x}, \boldsymbol{\theta}) d\mathbf{x} \\
&= \int_{D_{\mathbf{X}}} \mathbb{I}(\mathbf{x}) s_{\theta_i}(\mathbf{X}, \boldsymbol{\theta}) s_{\theta_j}(\mathbf{X}, \boldsymbol{\theta}) d\mathbf{x} + \int_{D_{\mathbf{X}}} \mathbb{I}(\mathbf{x}) \frac{\partial s_{\theta_i}(\mathbf{X}, \boldsymbol{\theta})}{\partial \theta_j} f_{\mathbf{x}}(\mathbf{x}, \boldsymbol{\theta}) d\mathbf{x}
\end{aligned} \tag{V.9}$$

For independent variables, the expression of the second order score functions becomes:

$$\frac{\partial^2 P_{na}(\boldsymbol{\theta})}{\partial \theta_i \partial \theta_j} = \int_{D_{\mathbf{X}}} \mathbb{I}(\mathbf{x}) s_{\theta_i}(\mathbf{X}, \boldsymbol{\theta}) s_{\theta_j}(\mathbf{X}, \boldsymbol{\theta}) d\mathbf{x} \tag{V.10}$$

When the second derivation is performed with respect to the same variable the formula becomes:

$$\frac{\partial^2 P_{na}(\boldsymbol{\theta})}{\partial \theta_i \partial \theta_j} = \int_{D_{\mathbf{x}}} \mathbb{I}(\mathbf{x}) s_{\theta_i}^2(\mathbf{X}, \boldsymbol{\theta}) d\mathbf{x} + \int_{D_{\mathbf{x}}} \mathbb{I}(\mathbf{x}) \frac{\partial s_{\theta_i}(\mathbf{X}, \boldsymbol{\theta})}{\partial \theta_i} f_{\mathbf{x}}(\mathbf{x}, \boldsymbol{\theta}) d\mathbf{x} \quad (\text{V.11})$$

Step3. Stochastic sensitivity calculation.

The sensitivity of the non-assembly probability \mathbf{s}_i is calculated by using score function without re-weighting such as given in Equation (IV.11).

Step 4. Checking for convergence and updating.

There are several stopping criteria in SLSQP python toolbox such as the precision goal of the objective function $f_{\mathbf{t}}$ named *ftol* and maximum number of iterations, etc.. The general convergence condition is adopted. That is, if $\|\mathbf{t}^{(k)}\| \leq \text{ftol}$ (default *ftol* value = 1.10^{-6}), then $\mathbf{t} = \mathbf{t}^{(k)}$ and stop. If not, set $k = k + 1$, $\mathbf{t}^{(k+1)} = \mathbf{t}^{(k)} + \boldsymbol{\alpha}$ and go to Step 2. Here it is changed to 0.1, because the value of the objective function is based on MC simulation, therefore there is no need for a lot accuracy.

V.4.2 Optimization with re-weighting technique

The re-weighting technique is used to reduce the computational efforts of the problem, which circumvents the problem of repeated model simulations. It requires the call of only one optimization coupled with Monte Carlo simulation (Tolsis solver) to estimate the non-assembly probability P_{na} and the sensitivities calculated by the score functions. Therefore, there is need to give an initial guess of the tolerance intervals. The re-weighting is used to estimate P_{na} and the sensitivities by score functions giving other tolerance intervals values. The different steps of this strategy are given in Figure (V.6). By using a re-weighting scheme, the derivative of P_{na} with respect to the distributions' parameters is written as:

$$\frac{\partial P_{na}(\boldsymbol{\theta})}{\partial \theta_i} = \int \mathbb{I}(\mathbf{x}) s_{\theta_i}(\mathbf{x}, \boldsymbol{\theta}) \frac{f_{\mathbf{x}}(\mathbf{x}, \boldsymbol{\theta})}{f_{\mathbf{x}}^*(\mathbf{x}, \boldsymbol{\theta})} f_{\mathbf{x}}^*(\mathbf{x}, \boldsymbol{\theta}) d\mathbf{x} \quad (\text{V.12})$$

where $f_{\mathbf{x}}^*(\mathbf{x}, \boldsymbol{\theta})$ is the probability density function of the base distribution. Hesterberg (1995) has presented various re-weighting techniques for estimating the expected value of an output distribution without evaluating the model for the input distribution. The weight function, which is the ratio of the probability density function, is defined as:

$$w(\mathbf{x}, \boldsymbol{\theta}) = \frac{f_{\mathbf{x}}(\mathbf{x}, \boldsymbol{\theta})}{f_{\mathbf{x}}^*(\mathbf{x}, \boldsymbol{\theta})} \quad (\text{V.13})$$

The sensitivities of $P_{na}(\boldsymbol{\theta})$ are then expressed as:

$$\frac{\partial P_{na}(\boldsymbol{\theta})}{\partial \theta_i} = \int \mathbb{I}(\mathbf{x}) s_{\theta_i}(\mathbf{x}, \boldsymbol{\theta}) w(\mathbf{x}, \boldsymbol{\theta}) f_{\mathbf{x}}^*(\mathbf{x}, \boldsymbol{\theta}) d\mathbf{x} \quad (\text{V.14})$$

By using the Monte Carlo simulation, the sensitivities of $P_{na}(\theta)$ are written as:

$$\frac{\partial P_{na}(\boldsymbol{\theta})}{\partial \theta_i} \approx \frac{1}{N_{mc}} \sum_{i=1}^{N_{mc}} \mathbb{I}(\mathbf{X}^{(i)}) s_{\theta_i}(\mathbf{X}^{(i)}, \boldsymbol{\theta}) w(\mathbf{x}, \theta) \quad (\text{V.15})$$

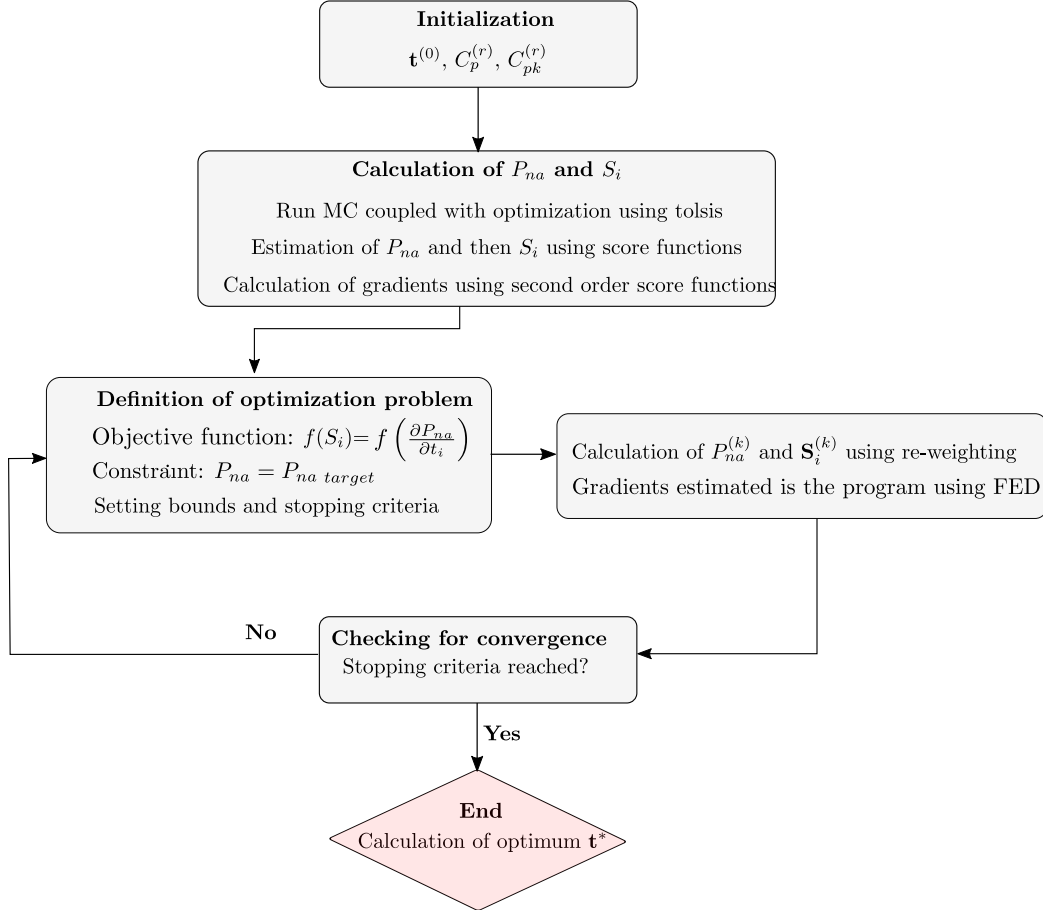

Figure V.6 – Steps of the method with re-weighting.

V.4.3 Transformation into a 2D problem

As a first attempt to apply the proposed strategies to solve the optimization based on iso-sensitivity, the problem involving nineteen variables is transformed into a 2D problem. This will serve to test the performance of the approaches in low dimensionality problems. Considering only one tolerance interval value for every part (such as done in Section (V.3.1)), the optimization problem is formulated as the following:

$$\mathbf{t}^* = \text{Argmin} \sum_{i=1}^2 (S_i(t_i) - \bar{S}(\mathbf{t}))^2 \quad (\text{V.16})$$

$$\text{Subject to } P_{na}(\mathbf{t}) \leq 0.01$$

The sensitivities of the non-assembly probability to the tolerance intervals and based on score functions are calculated using the chain rule.

$$\begin{aligned} S_1 &= \frac{\partial P_{na}}{t_1} = \sum_{i=1}^n \frac{\partial P_{na}}{\partial \sigma_i} \frac{\partial \sigma_i}{\partial t_1} \\ S_2 &= \frac{\partial P_{na}}{t_2} = \sum_{j=1}^m \frac{\partial P_{na}}{\partial \sigma_j} \frac{\partial \sigma_j}{\partial t_2} \end{aligned} \quad (\text{V.17})$$

where n and m represent the number of variables involved respectively in part (1) and part (2). The optimization with imposed gradient function and the optimization with re-weighting technique are tested for this simplified example.

Optimization with imposed gradient functions on 2D problem

To check the validity of the approach on this example, there is need to verify that the imposed gradients of the objective function and that of the constraint function are accurate. Figures (V.7b), (V.7b) show the direction of the gradients associated with the constraint and objective functions for multiple Monte Carlo simulations. The obtained directions are normal to the functions curves, this validates the accuracy of the imposed gradients. Then the optimization is tested on this problem. Figure (V.7c) shows a plot of the objective, the constraint function and the path of the optimization performed with gradients. The results show that the algorithm works well for two input variables.

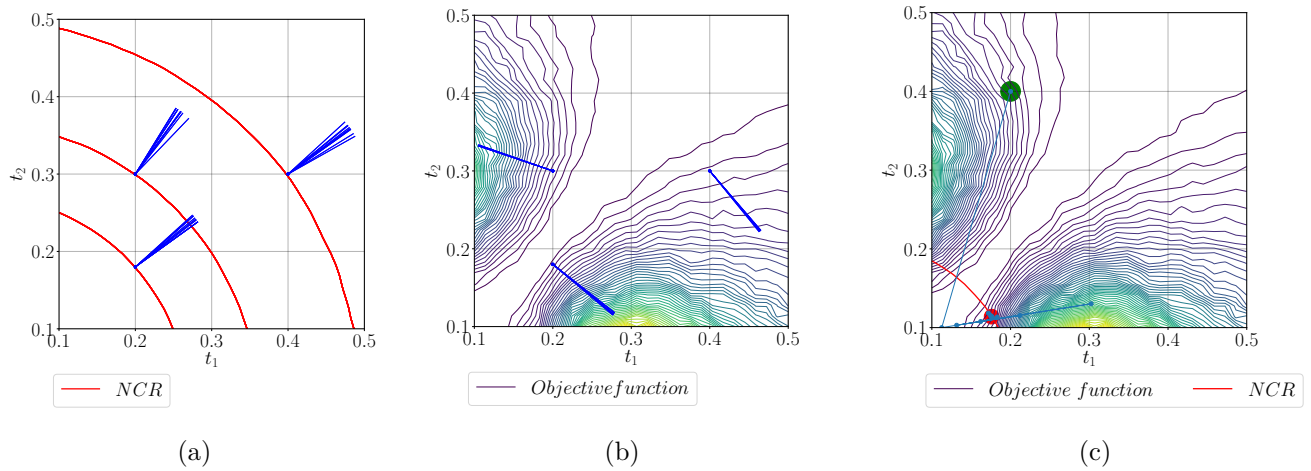

Figure V.7 – Representation of the direction of the gradients of (a) the constraint function and (b) the objective function, and (c) the optimization path.

Optimization with re-weighting on the objective and constraint functions

The optimization is repeated with the use of the re-weighting technique to estimate the constraint and objective functions. To validate the use of this approach, the constraint and objective functions estimated by the re-weighting are compared to the original functions for two different starting points such as shown in Figures (V.8) and (V.9). The illustrations show that the re-weighting technique works locally in the region surrounding the starting point (t_{ref} in the figures).

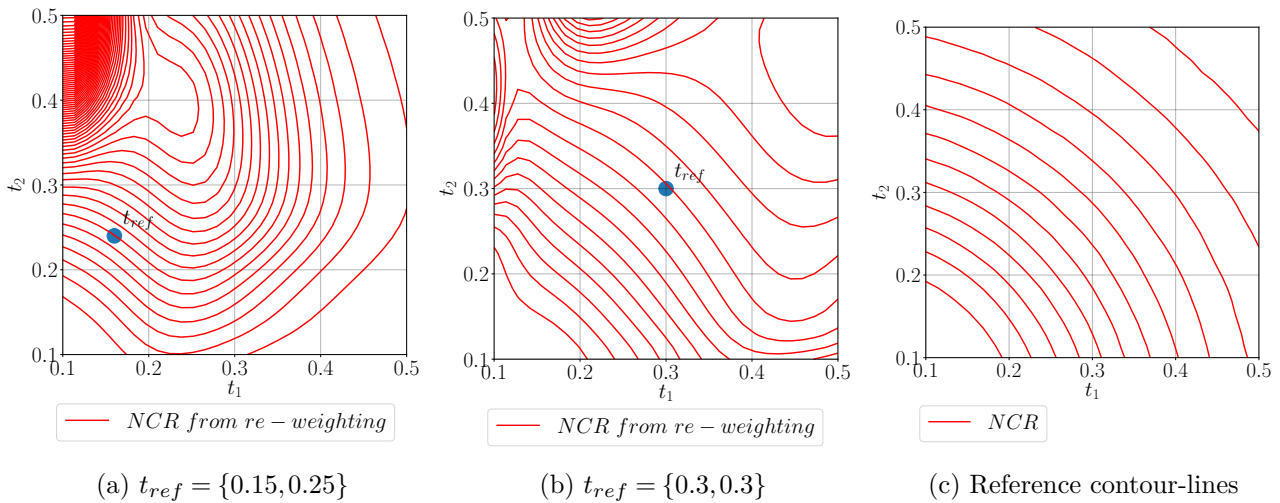

Figure V.8 – The contour-lines of the non-assembly probability estimated by the re-weighting technique for two different starting points (a) and (b) and the reference ones (c).

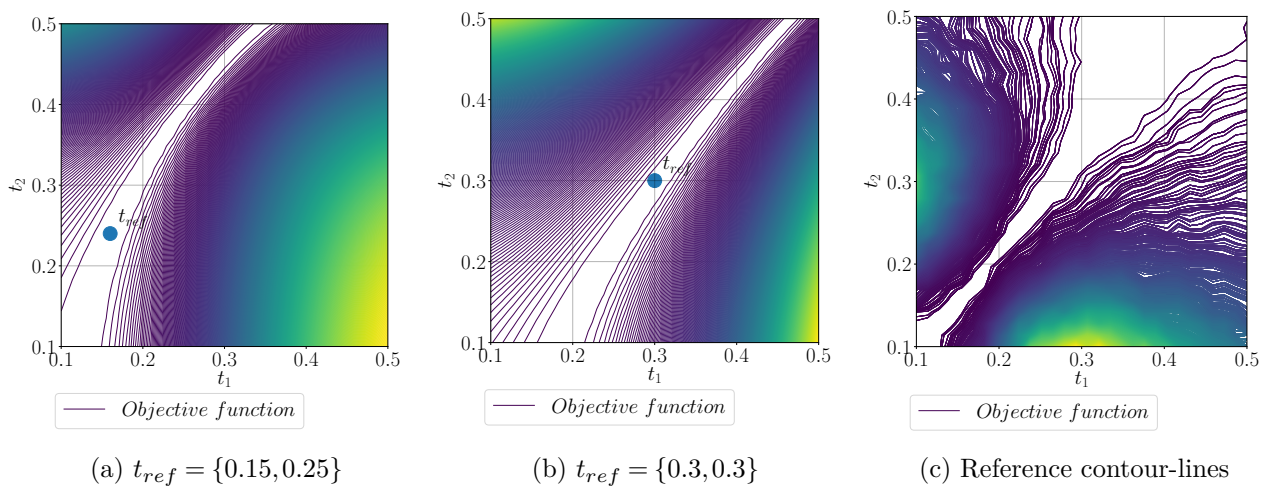

Figure V.9 – The contour-lines of the objective function estimated by the re-weighting technique for two different starting points (a) and (b) and the reference ones (c).

V.4.4 Problem with nineteen variables

After checking the optimization algorithm and the techniques on the 2D problem, it is applied on the original problem with nineteen variables. The same steps described in this section are followed. The results showing the obtained tolerance intervals from both techniques (gradients' imposition, re-weighting) are given in Table (V.3) and the deduced sensitivities calculated by score functions are shown in Figures (V.10) and (V.11). The obtained tolerance intervals are to be compared to reference tolerance intervals given by the manufacturer. The variables with tighter tolerance intervals are considered as KCs. The results show that the use of the optimization with gradients imposition works better than the re-weighting technique. A comparison between both techniques is given in Table (V.4).

Table V.3 – Tolerance intervals obtained from the reference optimization and from the one coupled with re-weighting.

Input Variables	Initial Tolerances \mathbf{t}_0	Tolerance intervals \mathbf{t}^*	\mathbf{t}_{rew}^*
w_{1a1}	0.08	0.14	0.11
w_{2a2}	0.08	0.14	0.22
u_{1b1}	0.08	0.13	0.10
v_{1b1}	0.08	0.11	0.11
u_{2b2}	0.08	0.11	0.20
v_{2b2}	0.08	0.11	0.10
w_{1c1}	0.08	0.14	0.11
w_{2c2}	0.08	0.15	0.10
u_{1d1}	0.08	0.11	0.12
v_{1d1}	0.08	0.16	0.12
u_{2d2}	0.08	0.16	0.14
v_{2d2}	0.08	0.11	0.10
u_{1e1}	0.08	0.11	0.12
v_{1e1}	0.08	0.14	0.21
d_{1b1}	0.24	0.11	0.11
d_{2b2}	0.24	0.11	0.12
d_{1d1}	0.24	0.13	0.10
d_{2d2}	0.24	0.12	0.09
d_{1e1}	0.24	0.13	0.09

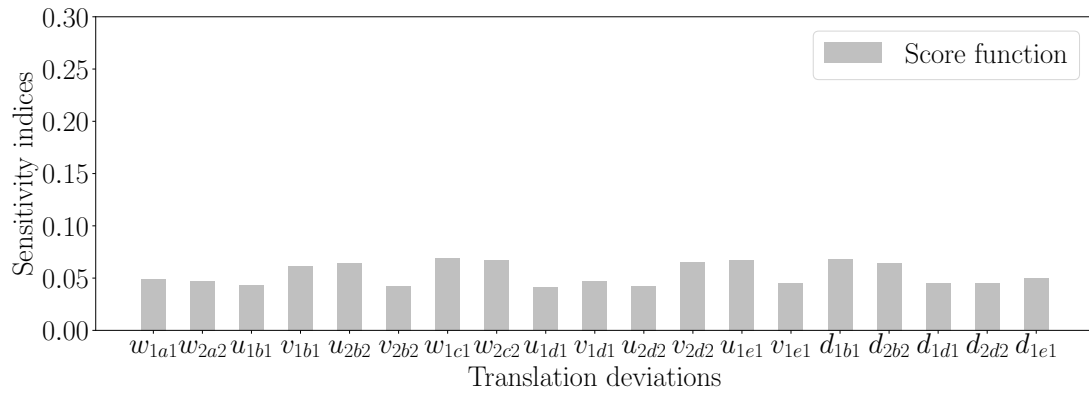

Figure V.10 – Sensitivity indices by score functions of the non-assembly probability to the geometrical displacement deviations.

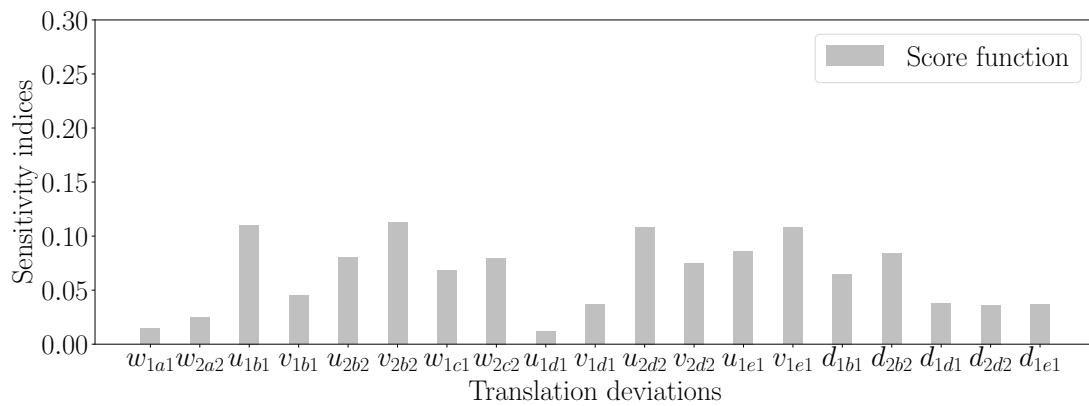

Figure V.11 – Sensitivity indices by score functions of the non-assembly probability to the geometrical displacement deviations with re-weighting.

Table V.4 – Comparison between the two strategies used for iso-sensitivity based optimization.

Gradients' imposition	Re-weighting technique
Gradients are imposed in the program	Gradients are calculated by default by the program using Finite Differences
Need to call the optimization coupled with MC simulation at every iteration	Needs only one Monte Carlo simulation
Dependent on the initial estimate	Strong dependency on the initial estimate
Slight differences between the obtained sensitivities	More important differences between the obtained sensitivities

V.5 Conclusion

In this chapter, the methodologies for KCs identification proposed in the two previous chapters have been applied on an over-constrained industrial system. A brief description of the system as well as the problem formulation are given in this chapter. The first methodology tested on this system is based on Sobol' indices, it takes into account the variability of the distributions' parameters. The method shows that the KCs can be identified for a double uncertainty levels in an over-constrained system. The second methodology is based on tolerance allocation by iso-sensitivity. It is performed as a reliability-based optimization. Two techniques were tested to reduce the computational efforts of this problem. The first one considers the calculation of the gradients and the second one is performed in a re-weighting scheme. A comparison between both techniques is also given. It can be concluded, that both KCs identification methods can be extended to an over-constrained system. Consequently, the two methods can be validated regarding such an industrial test-case. This motivates further improvements and perspectives for the proposed methodologies. These perspectives are summarized in the following concluding chapter.

Conclusion and Perspectives

Conclusion

In the scope of AHTOLAND project, the objective of this work is to develop new numerical tools for the identification of Key Characteristics (KCs) in a tolerancing framework. This is achieved by the analysis of the sensitivities of the tolerances and capabilities on the failure probabilities or Non-Conformity Rates as named in this work.

Chapter I of this manuscript reviews the basic tolerance analysis notions that will build an adequate framework for the problem of the thesis. The second part of this chapter focuses on the existing Key Characteristics practices. The industrial partners of this project apply the FMECA to get the critical chain of dimensions, then they consider all the involved dimensions as KCs. The purpose of this work is to reduce the number of KCs in the same critical chain. The sensitivity methods were used for this purpose.

Chapter II presents the existing sensitivity analysis methods that can be divided into two main categories: the model output sensitivity measures and the reliability sensitivity measures. They can be also classified as local analysis and global analysis depending on whether or not they consider the whole domain of variation of the random variable. In later chapters, these methods will serve as tools to be used in the approaches to identify KCs for tolerancing problems. The choice of the sensitivity method depends on:

- the type of the mechanical system (linear, non-linear, over-constrained).
- the dimensionality of the problem.
- the available data of the tolerancing problem
- the requirements of the designers (classification or hierarchization of input variables).

Chapter III proposes a method for KCs identification, that provides the ranking of the dimensions. It is based on the Sobol' reliability sensitivity indices applied in tolerancing context. The quantity of interest is the NCR and the input variables are the distribution parameters. The method is applied, first on a simple two-part example, on a system having a linearised functional requirement and finally on a system with two non-linear functional requirements. The results show the main effects of the dimensions in addition to total effects (interactions). Consequently, it is possible to prioritize some and neglect the effect of the others and classify them respectively as KCs or not. **The advantage of this method is that it aggregates the input parameters, such as the tolerance intervals, the capability requirements and the multiplying coefficients by integrating their influence into the analysis.** This approach is used when the process data are predefined such as the tolerance intervals and capability requirements. In addition, it does not put conditions on the value of the NCR. Other methods are needed when tolerance intervals are not known and when the NCR need to be in a specific range of values.

Chapter IV introduces iso-sensitivity tolerance allocation based method for the KCs identification. It takes into consideration the tolerance intervals, the capability requirements and the mathematical formulation of the topological loop comprising the studied dimensions. This method consists of considering that all the dimensions involved in a critical functional requirement have equal sensitivities, and then estimate the corresponding tolerance intervals to match what is called "Iso-sensitivity tolerance allocation". The tolerance intervals are re-allocated such that this procedure does not impact the quality of the manufacturing. The condition to be satisfied is that the NCR should be equal to a target value. So, this is an optimization problem with an objective to have equal sensitivities and equality constraints on the NCR to estimate the tolerance intervals. First a design is proposed and then an optimal design is found after applying the proper optimization algorithm. The estimated tolerance intervals are then compared to reference tolerance values that can be achieved by the manufacturer. So when a tolerance interval for a corresponding dimension cannot be achieved, it is considered as a KC. This approach is convenient when there is a lack of information on the manufacturing processes such as the tolerance intervals. One drawback of this approach is that it measures the sensitivities using local analysis. It is also important to mention that the results depend on the initial assumption of tolerance intervals, which reduces the accuracy of the obtained results when this assumption is not appropriate.

Finally, in **Chapter V**, the two proposed methods in this work are applied on an over-constrained system to allow the characterization of KCs. This shows their ability to be extended to industrial cases (electrical plug adapted from RADIALL). The tolerance analysis of this system has been performed previously by Dumas (2014) who applied approaches for

the estimation of the non-functionality and non-assembly probabilities of the system. In this chapter, only the non-assembly condition is considered. First, the Sobol' method is applied to this problem. This enables the KCs identification in an over-constrained system assuming the variability of the distributions' parameters of input variables. Then, the method of tolerance allocation based on iso-sensitivity is applied. This method needs significant computational time because it is an optimization coupled with MC simulation embedded in another optimization problem. To overcome this concern, two strategies are considered. The first consists in imposing the gradients to the optimization problem. The second one uses the re-weighting technique so only one call of MC simulation is needed. The first strategy used shows more relevant results in spite of a increase of the computational time.

The two proposed methods in this work are applied for two different problem statements, therefore, it is inconvenient to choose which one works better than the other. Table (V.5) provides a comparison between both methods.

Table V.5 – Comparison between the two proposed methods in this work.

	Method 1: Sobol'-based	Method 2: Iso-sensitivity tolerance allocation
Framework	Tolerance analysis	Tolerance allocation
Sensitivity method	Global analysis: Sobol' (input: statistical parameters, output: NCR)	Local analysis: Score functions (input: statistical parameters, output: NCR)
Statistical models	Variable statistical parameters	Fixed statistical parameters
Computational efforts	Moderate	Moderate for linear and non-linear mechanisms, but high for over-constrained mechanism
Advantages	Aggregates C_{pi} , t_i and a_i Detects interactions between parts	Aggregates C_{pi} , t_i and a_i NCR is controlled
Disadvantages	NCR is not controlled	Not able to check interactions

Perspectives

The proposed methods in this work, have brought many advances in order to evaluate the sensitivity of quality level of the mechanism to the involved dimensions and being consistent with the reality of manufacturing processes. However, several improvement paths can be added at all levels in order to improve the different proposals of these thesis works.

Perspective for method 1: Sobol'-based

The Sobol' based method estimates the first and the total order indices, representing the main and the interaction effects of the dimensions. This method can be extended to check the interactions between only two dimensions or more by calculating the second or higher order Sobol' indices. By doing so, selective assembly would be possible. The dimensions that have important interaction can be related to each others. If two dimensions strongly interact, it is possible to strongly compensate the deviations.

Perspectives for method 2: iso-sensitivity tolerance allocation

- The behaviour of iso-sensitivity tolerance allocation method is tested for a double uncertainty levels only on a simple 2D example. It is expected to study this situation for the non-linear and the over-constrained examples. It is manageable when the input variables are placed in an augmented space.
- The iso-sensitivity tolerance allocation method for over-constrained mechanism when applied with re-weighting did not give equal sensitivities, so the optimal tolerances were not reached. The reason behind this is most probably the choice of \mathbf{t}_0 that might be very far from the optimum value of \mathbf{t} . This would be solved by following an iterative algorithm. This means repeating the problem by considering the obtained \mathbf{t} is the new \mathbf{t}_0 until the convergence of the problem.

Perspectives for both methods

- When the proposed approaches were applied on the industrial system, only the translation deviations are taken into account in the analysis. The orientation deviations are considered to have deterministic values, so they are considered in the analysis. It is likely to consider in later works the orientation deviations. This can be achieved by assigning the variability domain of the orientation deviation based on the deviation domains. In such situation, the problem becomes computationally expensive due to the increased number of variables enclosed in the analysis.
- The two proposed methods, when applied to over-constrained mechanisms, the probability of non-assembly is taken as the quantity of interest. The probability of non-functionality could be also considered. The same steps already described for both approaches can be followed

with the only difference in the choice of the quantity of interest. The non-functionality probability formulation has been treated by Dumas (2014) and is given in Appendix A.

- Tolerance analysis is a particular case of reliability analysis. The concept of KC is specific to tolerancing, so it would be worth expanding it to reliability analysis. Therefore, the two proposed methods in this thesis adopt the reliability sensitivity measures. They evaluate the influence of the input variables on the NCR of the system. It is interesting to investigate these approaches with a new sensitivity measure that takes into account only the non-conform points of the model output and checks its sensitivity to each dimension. The main idea is to launch a Monte Carlo simulation, check the local derivatives of the points in the failure domain only. The sensitivity measure can be expressed as:

$$S_i = \int_{D_f} \left(\frac{\partial f(\mathbf{x})}{\partial x_i} \right)^2 f_{\mathbf{x}} d\mathbf{x} \quad (\text{V.18})$$

Geometrical modelling of the RADIALL electrical plug

Compatibility equations the loops used to write the compatibility equations are the following:

- Loop $1a/2a/2b/1b$ at point A :

$$\begin{aligned} \{T_{1/1}\}_A &= \{0\} \\ &= \{T_{1/1a}\} + \{G_{1a/2a}\} + \{T_{2a/2}\} + \{T_{2/2b}\} + \{G_{2b/1b}\} + \{T_{1b/1}\} \end{aligned} \quad (\text{A.1})$$

- Loop $1a/2a/2c/1c$ at point A :

$$\begin{aligned} \{T_{1/1}\}_A &= \{0\} \\ &= \{T_{1/1a}\} + \{G_{1a/2a}\} + \{T_{2a/2}\} + \{T_{2/2c}\} + \{G_{2c/1c}\} + \{T_{1c/1}\} \end{aligned} \quad (\text{A.2})$$

- Loop $1a/2a/2d/1d$ at point A :

$$\begin{aligned} \{T_{1/1}\}_A &= \{0\} \\ &= \{T_{1/1a}\} + \{G_{1a/2a}\} + \{T_{2a/2}\} + \{T_{2/2d}\} + \{G_{2d/1d}\} + \{T_{1d/1}\} \end{aligned} \quad (\text{A.3})$$

The torsors defined at a point different from A are transferred to point A via the relation from Varignon.

Interface constraints: the four joints of the mechanism lead to write the interface constraints depending on the type of joint:

- The links $2a/1a$ and $2c/1c$ are circular plan support links, the surface is so discretized in N_{da} facets in order to be able to define calculation points for constraints. The inequalities $C_i^{(k)}$, for $k = 1$ and $k = 2$, correspond to these interface constraints.

- The links $2b/1b$ and $2d/1d$ are sliding pivot links involving writing quadratic interface constraints. The linearisation procedure is applied to these constraints. They correspond interface constraints $C_i^{(k)}$, $k = 3, \dots, 6$.

The expressions of the constraints are written in the formulation of the optimization problem equation. So that the functional characteristics are related to the other geometrical parameters, it is necessary to write the equations of compatibility of a topological loop passing through the functional gap torsor. The loop $1d/2d/1e$ is written in point E :

$$\begin{aligned} \{T_{1/1}\}_E &= \{0\} \\ &= \{T_{1/1d}\} + \{G_{1d/2d}\} + \{G_{2d/1e}\} + \{T_{1e/1}\} \end{aligned} \tag{A.4}$$

Functional requirement

The functional requirement concerns the study of the angular displacement of the point E of the male contact with respect to the outer cylinder $1e$ along the \vec{x} and \vec{y} axes. The functional characteristics chosen are the two components of displacement along the \vec{x} and \vec{y} axes: u_{2d1e} and v_{2d1e} . A topological loop passing through the functional link allows to connect these functional requirement of an electrical plug parameters to the other parameters of the mechanism. This makes it possible to write two additional compatibility equations. The functionality of the mechanism is ensured if the alignment of the edge of the male contact does not exceed a tolerance t . The functional requirement relates to the maximum and minimum displacements of point E along the \vec{x} and \vec{y} axes. Each displacement must be maintained within a range to ensure the functionality of the mechanism such as:

$$u_{2d1e} \in \left[-\frac{t}{2}; \frac{t}{2}\right] \tag{A.5}$$

$$v_{2d1e} \in \left[-\frac{t}{2}; \frac{t}{2}\right] \tag{A.6}$$

Four functional requirements should be respected:

$$\begin{aligned} C_f^{(1)}(\mathbf{x}, \mathbf{g}) &= \frac{t}{2} - u_{2d1e} \geq 0 \\ C_f^{(2)}(\mathbf{x}, \mathbf{g}) &= -\frac{t}{2} + u_{2d1e} \geq 0 \\ C_f^{(3)}(\mathbf{x}, \mathbf{g}) &= \frac{t}{2} - v_{2d1e} \geq 0 \\ C_f^{(4)}(\mathbf{x}, \mathbf{g}) &= -\frac{t}{2} + v_{2d1e} \geq 0 \end{aligned} \tag{A.7}$$

Formulation of the functional problem

There are four functional requirements, so four different optimization problems need to be defined. The optimization problems are however all subject to the same constraints. They are defined as follows:

$$\begin{aligned}
 R_f^{(k)} &= \min C_f^{(k)}(\mathbf{x}, \mathbf{g}) \\
 \text{Subject to } C_c^{(j)}(\mathbf{x}, \mathbf{g}) &= 0 \quad \forall j = \{1, \dots, 20\} \\
 C_i^{(l)}(\mathbf{x}, \mathbf{g}) &\leq 0 \quad \forall l = \{1, \dots, 2 \times N_{da} + 4 \times N_d\}
 \end{aligned} \tag{A.8}$$

with $k = \{1, \dots, 4\}$ and N_{da} is the number of the discretizations of the circular surfaces a and c and N_d is the number of the linearisation of the quadratic constraints. The expression of the probability of non-functionality P_{nf} is expressed as:

$$P_{nf} = \text{Prob} \left(\bigcup_{k=1}^4 R_f^{(k)}(\mathbf{X}) \leq 0 \right) \tag{A.9}$$

$$\begin{aligned}
 R_f^{(k)}(\mathbf{x}) = \min \quad & C_f^k(\mathbf{x}, \mathbf{g}) \\
 \text{s.t.} \quad & C_c^{(1)}(\mathbf{x}, \mathbf{g}) = -\alpha_{1a1} - \alpha_{2a1a} + \alpha_{2a2} - \alpha_{2b2} + \alpha_{2b1b} + \alpha_{1b1} = 0 \\
 & C_c^{(2)}(\mathbf{x}, \mathbf{g}) = -\beta_{1a1} - \beta_{2a1a} + \beta_{2a2} - \beta_{2b2} + \beta_{2b1b} + \beta_{1b1} = 0 \\
 & C_c^{(3)}(\mathbf{x}, \mathbf{g}) = -\gamma_{2a1a} + \gamma_{2b1b} = 0 \\
 & C_c^{(4)}(\mathbf{x}, \mathbf{g}) = -u_{2a1a} - u_{2b2} + u_{2b1b} + u_{1b1} = 0 \\
 & C_c^{(5)}(\mathbf{x}, \mathbf{g}) = -v_{2a1a} - v_{2b2} + v_{2b1b} + v_{1b1} = 0 \\
 & C_c^{(6)}(\mathbf{x}, \mathbf{g}) = -w_{1a1} - w_{2a1a} + w_{2a2} + w_{2b1b} = 0 \\
 & C_c^{(7)}(\mathbf{x}, \mathbf{g}) = -\alpha_{1a1} - \alpha_{2a1a} + \alpha_{2a2} + \alpha_{2c2} + \alpha_{2c1c} + \alpha_{1c1} = 0 \\
 & C_c^{(8)}(\mathbf{x}, \mathbf{g}) = -\beta_{1a1} - \beta_{2a1a} + \beta_{2a2} + \beta_{2c2} + \beta_{2c1c} + \beta_{1c1} = 0 \\
 & C_c^{(9)}(\mathbf{x}, \mathbf{g}) = -\gamma_{2a1a} + \gamma_{2c1c} = 0 \\
 & C_c^{(10)}(\mathbf{x}, \mathbf{g}) = -u_{2a1a} + u_{2c1c} - l_1\beta_{2c1c} = 0 \\
 & C_c^{(11)}(\mathbf{x}, \mathbf{g}) = -v_{2a1a} + v_{2b1b} + l_1\alpha_{2c1c} = 0 \\
 & C_c^{(12)}(\mathbf{x}, \mathbf{g}) = -w_{1a1} - w_{2a1a} + w_{2a2} - w_{2c2} + w_{2c1c} + w_{1c1} = 0 \\
 & C_c^{(13)}(\mathbf{x}, \mathbf{g}) = -\alpha_{1a1} - \alpha_{2a1a} + \alpha_{2a2} - \alpha_{2d2} + \alpha_{2d1d} + \alpha_{1d1} = 0 \\
 & C_c^{(14)}(\mathbf{x}, \mathbf{g}) = -\beta_{1a1} - \beta_{2a1a} + \beta_{2a2} - \beta_{2d2} + \beta_{2d1d} + \beta_{1d1} = 0 \\
 & C_c^{(15)}(\mathbf{x}, \mathbf{g}) = -\gamma_{2a1a} + \gamma_{2d1d} = 0 \\
 & C_c^{(16)}(\mathbf{x}, \mathbf{g}) = -u_{2a1a} - u_{2d2} + l_2\beta_{2d2} + u_{2b1b} - l_2\beta_{2d1d} + u_{1d1} - l_2\beta_{1d1} = 0 \\
 & C_c^{(17)}(\mathbf{x}, \mathbf{g}) = v_{2a1a} - v_{2d2} + l_2\alpha_{2d2} + v_{2b1b} - l_2\alpha_{2d1d} + v_{1d1} - l_2\alpha_{1d1} = 0 \\
 & C_c^{(18)}(\mathbf{x}, \mathbf{g}) = -w_{1a1} - w_{2a1a} + w_{2a2} + w_{2d1d} = 0 \\
 & C_c^{(19)}(\mathbf{x}, \mathbf{g}) = l_4\beta_{1c1} - u_{2c1c} + l_4\beta_{2c1c} + u_{2c1e} + u_{1e1} = 0 \\
 & C_c^{(20)}(\mathbf{x}, \mathbf{g}) = -l_4\alpha_{1c1} - v_{2c1c} - l_4\alpha_{2c1c} + v_{2c1e} + v_{1e1} = 0 \\
 & C_i^{(1)}(\mathbf{x}, \mathbf{g}) = -\left(w_{2a1a} - \beta_{2a1a} \frac{d_{2b}}{2} \cos\theta_u + \alpha_{2a1a} \frac{d_{2b}}{2} \sin\theta_u\right) \leq 0 \\
 & C_i^{(2)}(\mathbf{x}, \mathbf{g}) = w_{2c1c} - \beta_{2c1c} \frac{d_{2c}}{2} \cos\theta_u + \alpha_{2c1c} \frac{d_{2c}}{2} \sin\theta_u (l_2 - l_1) \leq 0 \\
 & C_i^{(3)}(\mathbf{x}, \mathbf{g}) = u_{2b1b}^2 + v_{2b1b}^2 - \left(\frac{d_{1b} - d_{2b}}{2}\right)^2 \leq 0 \\
 & C_i^{(4)}(\mathbf{x}, \mathbf{g}) = (u_{2b1b} + l_1\beta_{2b1b})^2 + (v_{2b1b} - l_1\alpha_{2b1b})^2 - \left(\frac{d_{1b} - d_{2b}}{2}\right)^2 \leq 0 \\
 & C_i^{(5)}(\mathbf{x}, \mathbf{g}) = u_{2d1d}^2 + v_{2d1d}^2 - \left(\frac{d_{1d} - d_{2d}}{2}\right)^2 \leq 0 \\
 & C_i^{(6)}(\mathbf{x}, \mathbf{g}) = (u_{2d1d} + l_3\beta_{2d1d})^2 + (v_{2d1d} - l_3\alpha_{2d1d})^2 - \left(\frac{d_{1d} - d_{2d}}{2}\right)^2 \leq 0
 \end{aligned} \tag{A.10}$$

with $\theta_u = \frac{2u\pi}{N_{da}}$, $u = \{1, \dots, N_{da}\}$, where N_{da} is the number of discretizations of the circular plane surfaces.

Bibliography

- Adragna PA, Pillet M, Formosa F, Samper S (2006) Inertial tolerancing and capability indices in an assembly production. *Revue Internationale d'Ingénierie Numérique* 2(1-2):71–88
- Ameta G, Serge S, Giordano M (2011) Comparison of spatial math models for tolerance analysis: Tolerance-maps, deviation domain, and TTRS. *Journal of Computing and Information Science in Engineering* 11(2)
- Ballot E, Bourdet P (1997) A Computation Method for the Consequences of Geometric Errors in Mechanisms. In: *CIRP Seminar on Computer Aided Tolerancing*, Toronto, Canada
- Ballu A, Plantec JY, Mathieu L (2008) Geometrical reliability of overconstrained mechanisms with gaps. *CIRP Annals - Manufacturing Technology* 57(1):159–162
- Beaucaire P, Gayton N, Duc E, Dantan JY (2013) Statistical tolerance analysis of a mechanism with gaps based on system reliability methods. *Procedia CIRP* 10(12):2–8
- Bjerager P, Krenk S (1989) Parametric sensitivity in first order reliability theory. *Journal of Engineering Mechanics* 115(7):1577–1582
- Borgonovo E (2007) A new uncertainty importance measure. *Reliability Engineering and System Safety* 92(6):771–784
- Borgonovo E, Plischke E (2016) Sensitivity analysis: A review of recent advances. *European Journal of Operational Research* 248(3):869–887
- Borgonovo E, Castaings W, Tarantola S (2011) Moment Independent Importance Measures: New Results and Analytical Test Cases. *Risk Analysis* 31(3):404–428
- Bourdet P, Clement A (1976) Controlling a Complex Surface with a 3 Axis Measuring Machine. *Annals of CIRP* 1976 25:359–364

- Bourdet P, Mathieu L, Lartigue C, Ballu A (1996) The concept of small displacement torsor in metrology. *Advanced mathematical tool in metrology II in Series on advances in mathematics for applied sciences* 40:110–122
- Bucklew J (2004) *Intoduction to Rare Event Simulation*, springer s edn. Springer- Verlag, Ney York
- Campolongo F, Cariboni J, Saltelli A (2007) An effective screening design for sensitivity analysis of large models. *Environmental Modelling and Software* 22(10):1509–1518
- Chabridon V (2019) Reliability-oriented sensitivity analysis under probabilistic model uncertainty – Application to aerospace systems (April):76–85
- Chase KW (1999a) Minimum-Cost Tolerance Allocation. Tech. Rep. 99-5, Department of Mechanical Engineering- Brigham Young University
- Chase KW (1999b) Tolerance Allocation Methods for Designers ADCATS. Tech. Rep. 99, Mechanical Engineering Department Brigham Young University 1.0
- Chase KW, Parkinson AR (1991) A Survey of Research in the Application of Tolerance Analysis to the Design of Mechanical Assemblies. *Research in Engineering Design* 3:23–37
- Chase KW, Magleby S, Glancy CG (2004) Tolerance analysis of 2-D and 3-D mechanical assemblies with small kinematic adjustments. *Advanced Tolerancing Techniques*, Vol 218 pp 1869–1873
- Cheikh A, McGoldrick PF (1987) *The Influence of Cost, Function and Process Capability on Tolerance*, Springer US, Boston, MA, pp 42–46
- Chun MH, Han SJ, Tak NI (2000) An uncertainty importance measure using a distance metric for the change in a cumulative distribution function. *Reliability Engineering and System Safety* 70(3):313–321
- Clausing D (1988) Taguchi Methods to Improve the Development Process. In: *IEE International Conference on Communication*, pp 12–15
- Cukier RI, Fortuin CM, Shuler KE, Petschek AG, Schaibly JH (1973) Study of the sensitivity of coupled reaction systems to uncertainties in rate coefficients. I Theory. *Journal of Chemical Physics* 59(8):3873–3878
- Dantan JY (2000) *Synthèse des spécifications géométriques : modélisation par Calibre à Mobilités Internes*. PhD thesis, Université Bordeaux 1

-
- Dantan JY (2014) Tolerancing. In: CIRP Encyclopedia of Production Engineering, Springer, pp 1230–1237
- Dantan JY, Ballu A (2002) Assembly specification by gauge with internal mobilities (GIM) - A specification semantics deduced from tolerance synthesis. *Journal of Manufacturing Systems* 21(3):218–235
- Dantan JY, Mathieu L, Ballu A, Martin P (2005) Tolerance synthesis: Quantifier notion and virtual boundary. *CAD Computer Aided Design* 37(2):231–240
- Dantan JY, Hassan A, Etienne A, Siadat A, Martin P (2008) Information modeling for variation management during the product and manufacturing process design. *International Journal on Interactive Design and Manufacturing (IJIDeM)* 2(2):107–118
- Dantan JY, Gayton N, Etienne A, Qureshi AJ (2012) Mathematical issues in mechanical tolerance analysis
- De Rocquigny E, Devictor N, Tarantola S (2008) *Uncertainty in Industrial Practice: A guide to Quantitative Uncertainty Management*
- Dumas A (2014) *Developpement de methodes probabilistes pour l'analyse des tolerances des systemes mecaniques sur-contraints*. PhD thesis, Ecole nationale superieure d'arts et metiers - ENSAM
- Dumas A, Gayton N, Dantan JY, Sudret B (2015) A new system formulation for the tolerance analysis of overconstrained mechanisms. *Probabilistic Engineering Mechanics* 40:66–74
- EN16602-30-02 (2015) *Space product assurance- Failure modes, effects (and criticality) analysis (FMEA/FMECA)*. CEN-CENELEC Management Centre
- EN9100 (2018) *Quality Management Systems-Requirements for Aviation, Space and Defence Organizations*
- Evans D (1975) Statistical Tolerancing: The State of the Art. *Journal of Quality Technology* 7(1):1–12
- Giordano M, Duret D, Tichadou S, Arrieux R (1992) Clearance Space in Volumic Dimensioning. *CIRP Annals* 41(1):565–568
- Giordano M, Pairel E, Samper S (1999) Mathematical representation of Tolerance Zones pp 177–186

- Giordano M, Kataya B, Pairel E (2003) Tolerance analysis and synthesis by means of clearance and deviation spaces. In: Bourdet P, Mathieu L (eds) Geometric Product Specification and Verification: Integration of Functionality: Selected Conference Papers of the 7th CIRP International Seminar on Computer-Aided Tolerancing, Springer Netherlands, Dordrecht, pp 145–154
- Glancy CG, Chase KW (1999) A Second-Order Method for Assembly Tolerance Analysis. Proceedings of the 1999 ASME Design Engineering Technical Conferences (1):1–8
- Goka E (2019) Analyse des tolerances des systemes complexes – Modelisation des imperfections de fabrication pour une analyse realiste et robuste du comportement des systemes. PhD thesis, Ecole Nationale Supérieure d’Arts et Metiers
- Greenwood WH, Chase KW (1987) A New Tolerance Analysis Method for Designers and Manufacturers. Journal of Engineering for Industry 109(2):112
- Gupta S, Turner JU (1993) Variational Solid Modeling. IEEE Computer Graphics & Applications 13:64–74
- Hallmann M, Schleich B, Wartzack S (2020) From tolerance allocation to tolerance-cost optimization: a comprehensive literature review, vol 107. The International Journal of Advanced Manufacturing Technology
- Han X, Li R, Wang J, Qin S, Ding G (2018) Identification of key design characteristics for complex product adaptive design. International Journal of Advanced Manufacturing Technology 95(1-4):1215–1231
- Hesterberg T (1995) Weighted Average Importance Sampling and Defensive Mixture Distributions. Technometrics 37(2):185–194
- Hohenbichler M, Rackwitz R (1986) Sensitivity and importance measures in structural reliability. Civil Engineering Systems 3(4):203–209
- Homma T, Saltelli A (1996) Importance measures in global sensitivity analysis of nonlinear models. Reliability Engineering & System Safety 52:1–17
- Hong YS, Chang TC (2002) A comprehensive review of tolerancing research. International Journal of Production Research 40(11):2425–2459
- Idriss D, Beaurepaire P, Homri L, Gayton N (2018) Tolerance Analysis - Key Characteristics Identification by Sensitivity Methods. Procedia CIRP 75:33–38

-
- Idriss D, Beaurepaire P, Homri L, Gayton N (2020) Key Characteristics identification by global sensitivity analysis. *International Journal on Interactive Design and Manufacturing (IJIDeM)* 14(2):423–434
- Iooss B, Lemaître P, Iooss B, Lemaître P (2015) A review on global sensitivity analysis methods. C. Meloni and G. Dellino. In: *Uncertainty management in Simulation- Optimization of Complex Systems: Algorithms and Applications*, Springer 2015
- ISO 22514-1 (2014) *Statistical methods in process management-Capability and performance*
- Jensen HA, Valdebenito MA, Schuëller GI, Kusanovic DS (2009) Reliability-based optimization of stochastic systems using line search. *Computer Methods in Applied Mechanics and Engineering* 198(49-52):3915–3924
- Karmakar S, Maiti J (2012) A review on dimensional tolerance synthesis: Paradigm shift from product to process. *Assembly Automation* 32(4):373–388
- Kraft D (1988) A software package for sequential quadratic programming. Tech. Rep. 28
- Kucherenko S, Iooss B (2010) Derivative based global sensitivity measures. *Procedia Social and Behavioral Sciences* 2:7745–7746
- Kucherenko S, Iooss B (2017) Derivative based global sensitivity measures. In: Ghanem R, Higdon D, Owhadi H (eds) *Handbook of uncertainty quantification*, Springer
- Kucherenko S, Song S (2017) Different numerical estimators for main effect global sensitivity indices. *Reliability Engineering and System Safety* 165(February):222–238
- Ledoux Y, Teissandier D (2013) Tolerance analysis of a product coupling geometric and architectural specifications in a probabilistic approach. *Research in Engineering Design* 24(3):297–311
- Lemaire M (2009) *Structural Reliability*. John Wiley & Sons
- Lu Z, Song S, Yue Z, Wang J (2008) Reliability sensitivity method by line sampling. *Structural Safety* 30(6):517–532
- Mansoor E (1963) The application of probability to tolerances Used in Engineering Designs. *Proceeding of the institution of Mechanical Engineers* 178.1(1):p28–51
- Mansuy M (2013) Aide au tolérancement tridimensionnel : modèle des domaines

- Mao J, Cao YL, Liu SQ, Yang JX (2009) Manufacturing environment-oriented robust tolerance optimization method. *International Journal of Advanced Manufacturing Technology* 41(1-2):57–65
- Melchers RE (1990) Radial importance sampling for structural reliability. *Journal of Engineering Mechanics* 116(1):189–203
- Melchers RE, Ahammed M (2004) A fast approximate method for parameter sensitivity estimation in Monte Carlo structural reliability. *Computers and Structures* 82(1):55–61
- Military Standard (1980) Procedures for Performing a Failure Mode, Effects and Criticality Analysis
- Millwater H (2009) Universal properties of kernel functions for probabilistic sensitivity analysis. *Probabilistic Engineering Mechanics* 24(1):89–99
- Mokhtari A, Frey C (2003) Evaluation of Selected Sensitivity Analysis Methods Based Upon Applications to Two Food Safety Process Risk Models. Tech. Rep. September
- Montgomery D (2009) Introduction to statistical quality control. John Wiley & Sons
- Morio J (2011) Influence of input PDF parameters of a model on a failure probability estimation. *Simulation Modelling Practice and Theory* 19(10):2244–2255
- Moritz Göhler S, Eifler T, Howard TJ (2016) Robustness Metrics: Consolidating the Multiple Approaches to Quantify Robustness. *Journal of Mechanical Design* 138(11):111407
- Morris M (1991) Factorial Sampling Plans for Preliminary Computational Experiments. *Technometrics* 33(2):161–174
- Morse EP (2018) IMECE2004-61664. ASME International Mechanical Engineering Congress and Exposition pp 1–5
- Morse EP, You X (2013) GapSpace Multi-Dimensional Assembly Analysis, John Wiley & Sons, Ltd, chap 15, pp 273–298
- Nigam SD, Turner JU (1995) Review of statistical approaches to tolerance analysis. *Computer-Aided Design* 27(1):6–15
- Nocedal J, Wright SJ (2006) Numerical Optimization. Springer

-
- Papadopoulos I, Breitung K, Straub D (2013) Reliability sensitivity analysis with monte carlo methods. *Safety, Reliability, Risk and Life-Cycle Performance of Structures and Infrastructures - Proceedings of the 11th International Conference on Structural Safety and Reliability, ICOSSAR 2013* pp 5335–5342
- Pasanisi A, Dutfoy A (2012) An industrial viewpoint on uncertainty quantification in simulation: Stakes, methods, tools, examples. *IFIP Advances in Information and Communication Technology* 377 AICT:27–45
- Peter J (1970) Tolerancing the components of an assembly for minimum cost. *ASME Pap* 70-Prod 9
- Pianosi F, Wagener T (2015) A simple and efficient method for global sensitivity analysis based on cumulative distribution functions. *Environmental Modelling & Software* 67:1–11
- Pillet M (2004) Inertial tolerancing. *TQM Magazine* 16(3):202–209
- Qureshi AJ, Dantan JY, Sabri V, Beaucaire P, Gayton N (2012) A statistical tolerance analysis approach for over-constrained mechanism based on optimization and Monte Carlo simulation. *Computer-Aided Design* 44(2):132–142
- Rahman S (2009) Stochastic sensitivity analysis by dimensional decomposition and score functions. *Probabilistic Engineering Mechanics* 24(3):278–287
- Reliability Analysis Center (1968) Failure mode, effects, and criticality analysis. *Microelectronics Reliability* 7(3):268
- Roy U, Li B (1999) Representation and interpretation of geometric tolerances for polyhedral objects. II. Size, orientation and position tolerances. *CAD Computer Aided Design* 31(4):273–285
- Rubinstein R (1986) The score function approach for sensitivity analysis of computer simulation models. *Mathematics and Computers in Simulation* 28(5):351–379
- Rubinstein R, Shapiro A (1993) *Discrete event systems : sensitivity analysis and stochastic optimization by the score function method*. John Wiley & sons, New York
- Rumelhart DE, Hinton GE, Williams RJ (1986) Learning representations by back-propagating errors David. *Nature* 323(2):533–536
- Saltelli A, Tarantola S, Campolongo F, Ratto M (2004) *Sensitivity Analysis in Practice: A guide to Assessing Scientific Models*. John Wiley & Sons

- Saltelli A, Ratto M, Tarantola S, Campolongo F (2006) Sensitivity analysis in practice: A guide to assessing scientific models, vol 91
- Saltelli A, Ratto M, Campolongo F, Cariboni J, Gatelli D, Saisana M, Tarantola S (2008) Global Sensitivity Analysis. The Primer. John Wiley & Sons, [arXiv:1011.1669v3](https://arxiv.org/abs/1011.1669v3)
- Saltelli A, Annoni P, Azzini I, Campolongo F, Ratto M, Tarantola S (2010) Variance based sensitivity analysis of model output. Design and estimator for the total sensitivity index. *Computer Physics Communications* 181(2):259–270
- Sampath Kumar R, Soundararajan V, Alagumurthi N (2009) Review of Tolerance Analysis, Allocation and Constraints in Manufacturing. *Journal for Manufacturing Science and Production* 10(1):1–16
- Scholz F (1995) Tolerance stack analysis methods. Research and Technology Boeing Information & Support Services ISSTECH-95(030)
- Schüeller GI, Jensen HA (2008) Computational methods in optimization considering uncertainties - An overview. *Computer Methods in Applied Mechanics and Engineering* 198(1):2–13
- Sergent A, Bui MH, Favreliere H, Duret D, Samper S, Villeneuve F (2010) Identification of machining defects by Small Displacement Torsor and form parameterization method. *Recent Advances in Integrated Design and Manufacturing in Mechanical Engineering* 7:1–6
- Singh PK, Jain PK, Jain SC (2009) Important issues in tolerance design of mechanical assemblies. Part 2: Tolerance synthesis. *Proceedings of the Institution of Mechanical Engineers, Part B: Journal of Engineering Manufacture* 223(10):1249–1287
- Sobol IM (1993) Sensitivity analysis for nonlinear mathematical models. *Math Model Comput-erExp* 1(4):407–414
- Sobol IM (2001) Global sensitivity indices for nonlinear mathematical models and their Monte Carlo estimates. *Mathematics and Computers in Simulation* 55(1):271–280
- Sobol IM, Gershman A (1995) On an alternative global sensitivity estimators. *Proceedings of the Sensitivity Analysis on Model Output (SAMO) Conference 1995*
- Sobol IM, Kucherenko S (2009) Derivative based global sensitivity measures and their link with global sensitivity indices. *Mathematics and Computers in Simulation* 79(10):3009–3017
- Song S, Lu Z, Qiao H (2009) Subset simulation for structural reliability sensitivity analysis. *Reliability Engineering and System Safety* 94(2):658–665

- Srinivasan V (1998) ISO Deliberates Statistical Tolerancing, Springer US, Boston, MA, pp 77–87
- Stromholm P (1968) Fermat's methods of maxima and minima and of tangents. A reconstruction. *Archive for History of Exact Sciences* 5(1):47–69
- Stuppy J, Meerkamm H (2009) Tolerance analysis of mechanisms taking into account joints with clearance and elastic deformations. In: *Proceedings of the 17th International Conference on Engineering Design (ICED'09)*, pp 489–500
- Taflanidis AA, Beck J (2008) An efficient framework for optimal robust stochastic system design using stochastic simulation. *Computer Methods in Applied Mechanics and Engineering* 198(1):88–101
- The Boeing Group (1998) *Advance Quality Systems Tools - AQS D1-9000-1*. The Boeing Company, Seattle WA
- Thornton AC (1999) Mathematical framework for the key characteristic process. *Research in Engineering Design - Theory, Applications, and Concurrent Engineering* 11(3):145–157
- Thornton AC (2004) *Variation Risk Management*. John Wiley & Sons
- Valdebenito MA, Jensen HA, Hernández HB, Mehrez L (2018) Sensitivity estimation of failure probability applying line sampling. *Reliability Engineering and System Safety* 171(September 2017):99–111
- Van Hoecke A (2013) Hierarchization of characteristics applied to the component approval strategy. *Procedia CIRP* 10:238–250
- Walter M, Sprügel T, Wartzack S (2013) Tolerance analysis of systems in motion taking into account interactions between deviations. *Proceedings of the Institution of Mechanical Engineers, Part B: Journal of Engineering Manufacture* 227(5):709–719
- Walter MSJ, Spruegel TC, Wartzack S (2015) Least Cost Tolerance Allocation for Systems with time-variant Deviations. *Procedia CIRP* 27:1–9
- Wang P, Lu Z, Tang Z (2013) A derivative based sensitivity measure of failure probability in the presence of epistemic and aleatory uncertainties. *Computers and Mathematics with Applications* 65(1):89–101
- Whitney DE (2006) The role of key characteristics in the design of mechanical assemblies. *Assembly Automation* 26(4):315–322

- Wu YT (1993) Adaptive Importance Sampling (AIS)-Based System Reliability Sensitivity Analysis Method. *Probabilistic Structural Mechanics: Advances in Structural Reliability Methods* pp 550–564
- Xiao S, Lu Z, Xu L (2016) A new effective screening design for structural sensitivity analysis of failure probability with the epistemic uncertainty. *Reliability Engineering and System Safety* 156:1–14
- Zhang X, Pandey MD (2013) Structural reliability analysis based on the concepts of entropy, fractional moment and dimensional reduction method. *Structural Safety* 43:28–40
- Zheng LY, Chin KS (2005) QFD based optimal process quality planning. *International Journal of Advanced Manufacturing Technology* 26(7-8):831–841
- Zheng LY, McMahon CA, Li L, Ding L, Jamshidi J (2008) Key characteristics management in product lifecycle management: A survey of methodologies and practices. *Proceedings of the Institution of Mechanical Engineers, Part B: Journal of Engineering Manufacture* 222(8):989–1008
- Ziegler P, Wartzack S (2015a) A statistical method to identify main contributing tolerances in assemblability studies based on convex hull techniques. *Journal of Zhejiang University-SCIENCE A* 16(5):361–370
- Ziegler P, Wartzack S (2015b) Sensitivity Analysis of features in tolerancing based on constraint function level sets. *Reliability Engineering and System Safety* 134:324–333
- Zou Z, Morse EP (2004) A gap-based approach to capture fitting conditions for mechanical assembly. *CAD Computer Aided Design* 36(8):691–700