



HAL
open science

Knowledge model and design space exploration of sustainable refrigeration systems : Application to the integrated design of supermarket refrigeration systems

Yasmine Salehy

► To cite this version:

Yasmine Salehy. Knowledge model and design space exploration of sustainable refrigeration systems : Application to the integrated design of supermarket refrigeration systems. Eco-conception. Université Paris-Saclay, 2022. English. NNT : 2022UPAST017 . tel-03625931

HAL Id: tel-03625931

<https://theses.hal.science/tel-03625931>

Submitted on 31 Mar 2022

HAL is a multi-disciplinary open access archive for the deposit and dissemination of scientific research documents, whether they are published or not. The documents may come from teaching and research institutions in France or abroad, or from public or private research centers.

L'archive ouverte pluridisciplinaire **HAL**, est destinée au dépôt et à la diffusion de documents scientifiques de niveau recherche, publiés ou non, émanant des établissements d'enseignement et de recherche français ou étrangers, des laboratoires publics ou privés.

Knowledge model and design space exploration of sustainable refrigeration systems

*Application to the integrated design of supermarket refrigeration
systems*

Thèse de doctorat de l'université Paris-Saclay

École doctorale n° 573 : approches interdisciplinaires, fondements, applications et
innovation (Interfaces)

Spécialité de doctorat : Ingénierie des systèmes complexes

Graduate School : Sciences de l'ingénierie et des systèmes

Référent : CentraleSupélec

Thèse préparée dans l'unité de recherche **Laboratoire Génie Industriel** (Université Paris-Saclay, CentraleSupélec), sous la direction de **Bernard YANNOU**, professeur, la co-direction de **Anthony DELAHAYE**, directeur de recherche, le co-encadrement de **François CLUZEL** et **Yann LEROY**, maîtres de conférences, **Laurence FOURNAISON**, directrice de recherche, et **Hong-Minh HOANG**, chargée de recherche

Thèse soutenue à Paris-Saclay, le 25 janvier 2022, par

Yasmine SALEHY

Composition du Jury

Michael KOKKOLARAS

Professeur, McGill University

Président

Paul BYRNE

Maître de conférences, Université de Rennes 1

Rapporteur et examinateur

Patrick SEBASTIAN

Maître de conférences, Université de Bordeaux

Rapporteur et examinateur

Isabelle BLANC

Professeure, MINES ParisTech

Examinatrice

François PUEL

Professeur, CentraleSupélec, Université Paris-Saclay

Examinateur

Bernard YANNOU

Professeur, CentraleSupélec, Université Paris-Saclay

Directeur de thèse

Anthony DELAHAYE

Directeur de recherche, INRAE, Université Paris-Saclay

Co-Directeur de thèse



Titre : Modèle de connaissances et exploration de l'espace de conception des systèmes de réfrigération durables - Application à la conception intégrée des systèmes de réfrigération des supermarchés.

Mots clés : exploration d'espace de conception, réfrigération, modèle de connaissance, conception intégrée

Résumé : L'impact du changement climatique sur le secteur de la réfrigération a entraîné une augmentation du besoin en froid. L'objectif principal de cette thèse est de proposer une approche de conception intégrée et une plateforme d'exploration d'espace de conception pour aider la prise de décision dans les phases amont de conception et aller vers des systèmes de réfrigération durables.

Tout d'abord, un diagnostic de terrain est réalisé pour représenter et évaluer les opportunités de développement au sein du système socio-technique de la réfrigération. Il en résulte que les principaux points d'amélioration du système socio-technique actuel de la réfrigération sont un manque de compréhension des technologies émergentes, une faible exploration de l'espace de conception et une diversité de langage et d'outils entre les parties prenantes.

Ainsi, il est proposé d'aller vers une approche plus intégrée de la conception d'un système de réfrigération grâce à un modèle de connaissances et à une plateforme de simulation et d'exploration de l'espace de conception, cette dernière permettant d'aboutir rapidement à une architecture dimensionnée satisfaisant toutes les parties prenantes.

Une vérification de l'aptitude de la plateforme à modéliser correctement le problème, à exprimer les préférences des concepteurs et à aboutir au choix d'une architecture dimensionnée satisfaisante est effectuée au travers d'ateliers impliquant des acteurs de la conception de systèmes de réfrigération. Une validation finale des modèles est réalisée en évaluant huit critères tels que la robustesse et la facilité d'utilisation.

Title : Knowledge model and design space exploration of sustainable refrigeration systems - Application to the integrated design of supermarket refrigeration systems

Keywords : design space exploration, refrigeration, knowledge model, integrated design

Abstract: The impact of climate change on the refrigeration sector has led to an increase in the need for cooling. The main objective of this thesis is to propose an integrated design approach and a design space exploration platform to help decision making in the upstream design phases and move towards more sustainable systems.

First of all, a field diagnosis is carried out to represent and evaluate the development opportunities in the socio-technical system of refrigeration. The result is that the main shortcomings of the current socio-technical system of refrigeration are a lack of understanding of emerging technologies, poor exploration of the design space and a diversity of language and tools between stakeholders.

Thus, it is proposed to move towards a more integrated approach to the design of a refrigeration system thanks to a knowledge model and a simulation and design space exploration platform, the latter allowing to quickly arrive at a dimensioned architecture satisfying all stakeholders.

A verification of the platform's ability to correctly model the problem, to express the designers' preferences and to lead to the choice of a satisfactory dimensioned architecture is carried out through workshops involving actors in the design of refrigeration systems. A final validation of the models is carried out by evaluating eight criteria such as robustness and ease of use.



The more clearly we can focus our attention on the wonders and realities of the universe about us, the less taste we shall have for destruction.

- Rachel Carson



Résumé en français

L'impact du changement climatique sur le secteur de la réfrigération a entraîné une augmentation du besoin en froid. Près de 20 % de la consommation globale d'électricité est actuellement utilisée pour la production de froid et elle devrait atteindre 37% d'ici 2050. L'objectif principal de cette thèse est de proposer une approche de conception intégrée et une plateforme d'exploration d'espace de conception pour aider la prise de décision dans les phases amont de conception et aller vers des systèmes de réfrigération durables.

Tout d'abord, un diagnostic de terrain est réalisé pour représenter et évaluer les opportunités de développement au sein du système socio-technique de la réfrigération. Ce diagnostic se base sur des entretiens, une revue de la littérature et des observations. La méthodologie Radical Innovation Design (RID) est ensuite utilisée pour construire un livre de connaissances et évaluer les opportunités de développement. Il en résulte que les principaux points d'amélioration du système socio-technique actuel de la réfrigération sont : (1) un manque de compréhension des technologies émergentes ; (2) une faible exploration de l'espace de conception ; (3) une diversité de langage et d'outils entre les parties prenantes résultant en des systèmes de réfrigération sous-performant.

Ainsi, il est proposé d'aller vers une approche plus intégrée de la conception d'un système de réfrigération grâce à un modèle de connaissances et à une plateforme de simulation et d'exploration de l'espace de conception, cette dernière permettant d'aboutir rapidement à une architecture dimensionnée satisfaisant toutes les parties prenantes.

Afin de capitaliser les connaissances relatives à la conception des systèmes de réfrigération, quinze experts du domaine du froid ayant des rôles différents dans diverses entreprises ont été sollicités au travers d'entretiens, en plus de la revue de la littérature et des observations sur le terrain. Un modèle de connaissances a ensuite été proposé pour la conception et la simulation de systèmes de réfrigération de supermarchés. Quatre concepts sont développés en relation avec le contexte d'usage du supermarché, la structure de la solution, les propriétés et les performances du système qui incluent des modèles physiques, énergétiques, environnementaux, économiques et de maintenabilité. Une plateforme de simulation et d'exploration de l'espace de conception basée sur une énumération brute des solutions faisables est proposée, ainsi qu'un mode d'exploration de type « design by shopping ». Une vérification de l'aptitude de la plateforme à modéliser correctement le problème, à exprimer les préférences des concepteurs et à aboutir au choix d'une architecture dimensionnée satisfaisante est effectuée au travers d'ateliers impliquant des acteurs de la conception de systèmes de réfrigération. Une validation finale des modèles est réalisée en évaluant huit critères tels que la robustesse et la facilité d'utilisation et en comparant les solutions auxquelles les concepteurs ont abouti avec un cas de la littérature.



English summary

The impact of climate change on the refrigeration sector has led to an increase in cooling. Nearly 20% of the global electricity consumption is currently used for cold production, and it is expected to reach 37% by 2050. The main objective of this thesis is to propose an integrated design approach and a design space exploration platform to help decision making in the upstream design phases and move towards more sustainable systems.

First of all, a field diagnosis is carried out to represent and evaluate the development opportunities in the socio-technical system of refrigeration. This diagnosis is based on interviews, a literature review and observations. The Radical Innovation Design (RID) methodology is then used to build a knowledge book and assess development opportunities. The result is that the main shortcomings of the current socio-technical system of refrigeration are: (1) lack of understanding of emerging technologies; (2) poor exploration of the design space; (3) diversity of language and tools between stakeholders resulting in underperforming refrigeration systems.

Thus, it is proposed to move towards a more integrated approach to designing a refrigeration system thanks to a knowledge model and a simulation and design space exploration platform, the latter allowing to arrive at a dimensioned architecture satisfying all stakeholders quickly.

In order to capitalise on the knowledge around the design of refrigeration systems, fifteen experts in the field of refrigeration with different roles in various companies were solicited through interviews, in addition to the literature review and field observations. A knowledge model was then proposed to design and simulate supermarket refrigeration systems. Four concepts are developed in relation to the supermarket usage context, solution structure, system properties, and performance, including physical, energy, environmental, economic, and maintainability models. A platform for simulation and exploration of the design space based on a brute-force enumeration of feasible solutions is proposed and a "design by shopping" exploration mode. Verification of the platform's ability to correctly model the problem, express the designers' preferences, and lead to the choice of a satisfactory dimensioned architecture is carried out through workshops involving actors in the design of refrigeration systems. Final validation of the models is carried out by evaluating eight criteria such as robustness and ease of use and comparing the solutions the designers arrived at with a case from the literature.



Acknowledgement/ Remerciement

Cette thèse de doctorat, n'aurait pas vu le jour sans la participation et le soutien d'un bon nombre de personnes.

Je commence cette série de remerciement par mon équipe encadrante, du LGI et de FRISE.

A mon Directeur de thèse Pr. Bernard Yannou, je te remercie sincèrement pour tout le savoir que tu m'as transmis, et ta disponibilité constante.

A mon co-directeur de thèse, Anthony Delahaye, je te suis reconnaissante pour ta bienveillance, ton écoute et tes conseils.

A Minh Hoang et Laurence Fournaison, merci infiniment de votre soutien, vos conseils, dans les moments durs et solitaires.

A François Cluzel et Yann Leroy, je vous remercie d'avoir été là toujours à des étapes cruciales de ma thèse et de votre confiance pour les missions d'enseignement.

A tous, je vous suis reconnaissante de m'avoir fait confiance il y a 3 ans. Ce sont vos conseils, critiques et connaissances qui m'ont permis de mener à bien ce projet de thèse.

Je tiens ensuite à exprimer toute ma reconnaissance aux membres de mon jury d'avoir évalué mon travail de thèse.

A Patrick Sebastian et Paul Byrne, pour avoir accepté de rapporter ma thèse. Je vous remercie pour vos remarques et retours constructifs qui permettront de développer notre travail de recherche.

A Mickael Kokkolaras, pour avoir accepté de présider mon jury de thèse. Je vous remercie pour le bon déroulement de ma soutenance et l'expertise que vous avez apportée.

A Isabelle Blanc et François Puel, merci pour les interrogations soulevées lors de ma soutenance et les discussions qui suscitent de nouveaux champs de recherche à explorer.

Passons à tout le Laboratoire de Génie Industriel... MERCI ! Je ne saurais dire à quel point votre présence pendant ma thèse a été importante.

A tous les doctorants, particulièrement à MarcO, Marianna, Fawaz, Robin, Tjark, Emma, Emilien, Joseph, Francisco, Diego, Gui, Julien, Camille, Benoît... j'aimerais vous dire : merci pour votre énergie revitalisante ; courage pour finir et surtout profitez de cette expérience fantastique !

A tous les jeunes docteurs que j'ai eu la chance de croiser et avec qui j'ai forgé une amitié, Naouress, Bassem, Lara, ainsi que Paul-Camille et Vincent merci infiniment de votre aide, votre amitié et vos encouragements particulièrement dans des périodes compliquées !

A toute l'équipe d'IC, et particulièrement à l'équipe Support, Flore, Franck, François, Yann, Robin et Julien, merci de m'avoir permis de participer à cette aventure et merci pour votre gentillesse !

A Delphine, Carole, Corinne, Matthieu et Sylvie, l'équipe clé du labo qui fait en sorte que tout se passe pour le mieux du début à la fin, merci !

Il est souvent dit que c'est une chance de tomber sur un labo exceptionnel. Pendant cette

thèse, j'ai eu la chance d'en avoir deux avec l'unité FRISE de l'INRAE !

Depuis plus de 5 ans je fais partie de cette grande famille, pleine de vie et de bienveillance.

A tous les doctorants, jeunes docteurs, post-doc ou jeunes tout court ;) de FRISE, Nada, Dihia, Jordan, Emmanuel, Véro, Fatima, Elyamin, Walid, Tanathép, Ahmad merci pour les petits mots d'amitié qui m'ont fait chaud au cœur, pour votre grain de folie et d'énergie !

A toute l'unité FRISE qui m'a accueillie depuis mon parcours recherche, merci pour tout ! C'est grâce à vous que j'ai découvert et aimé faire de la recherche.

Une dédicasse particulière à mon ancien professeur et maintenant ami, Pascal Clain, qui a cru en moi depuis le début, qui m'a toujours poussée et à qui je suis et resterai reconnaissante !

Un grand merci à tous les Industriels, qui ont participé de près ou de loin à ce projet de thèse, particulièrement aux personnes que j'ai interviewé et aux collaborateurs de FAC SOS pour leur motivation, remarques et disponibilité.

A tous mes amis de lycée, JDA+++ , qui ont toujours été là, depuis plus de 10 ans, même sans comprendre ce que je fais depuis 3 ans. Votre amitié est une source de joie ! Merci à vous !

A Marine, qui a vécu la même expérience que moi depuis 3 ans, qui a été mon compagnon de route, mon épaule, à toute saison et toute heure, merci infiniment. Cette thèse n'aurait pas été pareil sans toi !

A Pierre, Rose et Camille, mes fidèles amis de cœur, depuis si longtemps... Je suis si reconnaissante de vous avoir dans ma vie !

A mes amis du PR, Bastien, Loup-Noé, Clément, c'est aussi grâce à vous que j'ai continué en recherche, travailler avec vous était plus qu'un plaisir !

A Estelle, ma très chère amie, tu sais l'importance de ton amitié et de ta présence dans ma vie, merci pour ton soutien tout au long de ma thèse et jusqu'au bout !

A mon très cher et tendre Rémi, j'ai eu une véritable chance de t'avoir à mes côtés pendant cette expérience si particulière, tu as toujours trouvé les mots justes, tu m'as soutenue sans faille. Merci pour ton affection, ton soutien jour et nuit et merci d'être toi !

Et finalement, à ma famille, mon père Iraj, ma mère Khadija, et mon frère Isaac, vous avez été dans mon cœur pendant toute cette période. Cette thèse a été une aventure que vous avez rendu exceptionnelle en vous ayant à mes côtés. Vous êtes formidables, votre amour et votre soutien m'ont permis d'en arriver là.

Isaac, merci d'être toujours là.

Papa, Maman, j'ai de la chance de vous avoir comme parents.

Merci à tous,

Yasmine

Table of contents

Table of contents	14
List of figures	20
List of tables.....	23
Chapter 1: General introduction.....	26
1. Context, motivation and objectives.....	28
1.1. General context.....	28
1.2. General objectives.....	28
2. Outline of the thesis	29
References.....	30
Chapter 2: Literature review on refrigeration systems design and simulation	32
1. Refrigeration systems	34
1.1. Definitions and applications.....	34
1.2. Cold production by vapour- compression refrigeration	35
1.3. System architecture	35
1.3.1. Centralized direct expansion system	35
1.3.2. Plug-in system.....	36
1.3.3. Secondary loop system.....	37
1.3.4. CO ₂ transcritical booster system	38
1.4. Refrigerants.....	39
2. Industrial engineering to support the design of refrigeration systems	41
2.1. Design science	41
2.2. Complex system definition and modelling.....	42
2.2.1. Complex systems definition	42
2.2.2. Decomposition of a complex system.....	43
2.3. Engineering design process.....	44
2.3.1. General overview of the design process	44
2.3.2. Design process methodology	47
2.3.3. Maintenance assessment.....	48
2.3.4. Eco-Design.....	51
2.3.4.1. Eco-design definition.....	51
2.3.4.2. Environmental impacts assessment.....	52
2.4. Design problem-solving methods	54

2.4.1.	Interaction representation.....	55
2.4.2.	Multi-objectives and multi-disciplinary optimisation principle.....	56
2.4.4.	Design problem resolution.....	57
2.4.4.1.	Point-based design	57
2.4.4.2.	Set-based design.....	57
2.4.4.3.	Design space exploration	57
3.	Design and simulation of refrigeration systems.....	58
3.1.	Refrigeration system design problem setting	59
3.1.1.	Design of a refrigeration system	59
3.1.2.	Design criteria and performances	59
3.2.	Comparison of different design and simulation platforms	60
3.2.1.	Inputs.....	63
3.2.2.	Outputs	63
4.	Synthesis and Research gaps	64
	References.....	66
Chapter 3:	Research gaps, research questions and general methodology	72
1.	Research gaps and questions.....	74
1.1.	Research gaps.....	74
1.2.	Research questions	74
2.	Research methodology and positioning	76
2.1.	Research framework.....	76
2.2.	Positioning of the thesis	77
	References.....	79
Chapter 4:	Socio-technical diagnosis of refrigeration systems in France	80
1.	Exploring the refrigeration socio-technical system.....	82
2.	RID methodology and process of this study.....	84
2.1.	More on the RID methodology and process	84
2.2.	Research process of this study	86
3.	Knowledge book of the socio-technical RS	88
3.1.	RS lifecycle process.....	88
3.2.	Users involved in the socio-technical RS.....	88
3.3.	Problems identified in the socio-technical RS.....	92
3.3.1.	Cost issues	97
3.3.2.	Knowledge management issues.....	97

3.3.3.	Interaction issues between stakeholders	98
3.3.4.	Tool issues	98
3.4.	Existing solutions	98
4.	Explore and decide the improvement paths of the socio-technical RS	99
4.1.	Data treatment	99
4.2.	RID Comparator	100
4.3.	RID Compass	101
5.	Discussion and conclusion	103
	References	105
Chapter 5:	Knowledge model for the design of refrigeration systems	108
1.	Introduction: Why an ontology?	110
2.	Construction process of the knowledge model	112
2.1.	Development of an ontology	112
2.2.	Methodology for the knowledge model construction	114
2.3.	Related ontologies	117
2.3.1.	General and meta-ontologies	117
2.3.2.	Domain, task and domain-task ontologies	119
2.3.3.	Application ontology: design of a system	120
3.	Knowledge model proposition	121
3.1.	Specification	121
3.2.	Knowledge acquisition	122
3.3.	Conceptualization and formalization	123
3.3.1.	Conceptual model and formalization	123
3.3.1.1.	Context related	123
3.3.1.2.	System design solution	125
3.3.1.3.	Properties	126
3.3.1.4.	Performances' assessment	127
3.3.2.	Summary	128
3.4.	Description of a supermarket refrigeration system design problem	132
3.4.1.	Context modelling	132
3.4.1.	System design solution definition classes	134
3.4.2.	Local and global performances assessment	135
3.4.2.1.	Energy consumption simulation	135
3.4.2.2.	Environmental impacts simulation	136

3.4.2.3. Other performances simulation	137
4. Discussion and conclusion.....	138
4.1. Generalisability of the knowledge model.....	138
4.1.1. Modelling other kinds of refrigeration systems	138
4.1.2. Modelling the entire supermarket energy system.....	138
4.2. Conclusion.....	138
References.....	140
Chapter 6: A simulation platform for exploring design spaces of refrigeration systems	144
1. Introduction	146
2. Design space exploration.....	146
2.1. Design Space Exploration paradigms	146
2.2. Design Space Exploration supporting techniques	147
2.3. DSE supporting tools using brute-force enumeration.....	147
2.4. Overview of our strategy	149
3. Supporting tool for developing a simulation and exploration of design space	150
3.1. Choice of simulation support tool	150
3.2. Modelling structure and language	151
4. Implementation	151
4.1. Implementation of the design problem in the tool.....	151
4.2. Dimensioning a feasible solution	155
5. Simulation and exploration tool	156
5.1. Setting the system environment for Scenarios 1 & 2.....	157
5.2. Analysis of a single point in the design space: Scenario 1	162
5.3. Exploring the design space: Scenario 2.....	166
6. Verification	169
6.1. Step-by-step verification	169
6.2. Verification by application	170
7. Discussion and limitations	173
8. Conclusion	173
References.....	175
Chapter 7: Validation of the knowledge model by scenarios and by experts	178
1. Introduction	180
2. Validation methodology	180

2.1.	Description of the methodology	180
2.2.	Target participants	185
3.	Description of the experimental protocol	186
4.	Results	187
4.1.	Participants.....	187
4.2.	Analysis of the "autonomous" testing	187
4.3.	Evaluation of the criteria	191
4.3.1.	Efficacy	191
4.3.2.	Validity.....	191
4.3.3.	Ease of use	192
4.3.4.	Completeness (technical).....	192
4.3.5.	Consistency.....	193
4.3.6.	Completeness (Decision aid support function)	193
4.3.7.	Completeness (Integrated approach)	194
4.3.8.	Robustness	194
5.	Discussion and limitations	195
	References.....	197
	Chapter 8: Discussion, limitations, and perspectives.....	198
1.	Discussion	198
2.	Limitations.....	200
3.	Perspectives	200
	General conclusion	202
	Appendices	206
	Appendix 1: Glossary	206
	Appendix 2: Modelling of the input matrices for the application of the RID methodology	207
2.1.	WW matrix.....	207
2.2.	UsEs matrix.....	209
2.3.	EsP matrix	210
2.4.	USsize.....	212
2.5.	UPsize matrix.....	214
	Appendix 3: Local and global performances assessment implemented in the Geeglee knowledge model.....	215
	Appendix 4 : Résumé étendu en Français.....	269

List of figures

Figure 2-1. Basic refrigeration system and its pressure – enthalpy (p-h) diagram.....	35
Figure 2-2. Simplified scheme of a centralized direct expansion system architecture	36
Figure 2-3. Simplified scheme of a plug-in cabinet	36
Figure 2-4. Simplified scheme of secondary loop refrigeration system.....	38
Figure 2-5. Simplified scheme of a transcritical architecture.....	39
Figure 2-6. Industrial engineering field overview inspired by Kosky et al. (2021) and Zhong and Zhou (2019)	41
Figure 2-7. Scheme of a system structure from Pahl and Beitz (2013) (left) and a simplified example for a refrigeration system structure (right).....	44
Figure 2-8. Steps of Pahl and Beitz design process (Pahl and Beitz 2013)	46
Figure 2-9. Types of Design for eXcellence (DfX) from Geometric Company	48
Figure 2-10. Eco-design tools and their use in the product development process from (Le Pochat, Bertoluci, and Froelich 2007).....	51
Figure 2-11. Steps of an LCA study from (ISO 14044 2006)	52
Figure 2-12. Example of a Design structure Matrix (DSM) to model the interactions between disciplines.....	55
Figure 2-13. Discipline interactions: sequential (left), parallel (centre), coupled (right)..	55
Figure 2-14. Two-dimensional-(2D) Pareto front (red line and dark green circles). The light green dots are feasible points, whereas the yellow ones indicate infeasible solutions with respect to the constraints.(Gollub and de Vivie-Riedle 2009).....	56
Figure 2-15. Issues identified by (Evans et al. 2014)	58
Figure 3-1. Overview of the research gaps, questions and objectives.	75
Figure 3-2. DRM framework from(Blessing and Chakrabarti 2009)	76
Figure 3-3. Positioning of our research in the industry and academic research.....	78
Figure 4-1. The three main stages of the Radical Innovation Design process	84
Figure 4-2. The Radical Innovation Design process in detail.....	85
Figure 4-3. Cognitive perspective and algorithmic workflow of the “Observe and Learn” and “Explore and Decide” stages of the Radical Innovation Design process....	86
Figure 4-4. Retail refrigeration system lifecycle process	88
Figure 4-5. Influence/Dependency graph.....	91
Figure 4-6. The 12 categories of user-profiles and their interactions	92
Figure 4-7. Causality graph for the problems occurring during the design, manufacture and installation phase.	94
Figure 4-8. Causality graph for the problems occurring during the exploitation phase.	95
Figure 4-9. Causality graph for problems occurring during the EOL treatment phase.	96
Figure 4-10. Effectiveness of the existing solutions for the problems (as percentage eradication of quantity of pains, irrespective of usage situations and user profiles). 100	
Figure 4-11. Effectiveness of the existing solutions for the user profiles or stakeholders (as percentage eradication of quantity of pains, irrespective of the usage situations and problems)	101

Figure 4-12. Results of the DSM value bucket tool with the three VBs identified.....	102
Figure 5-1. Construction of the ontology and implementation into a design platform	116
Figure 5-2. ChEBI ontology for refrigerant	118
Figure 5-3. PhysSys ontology organisation of the model library from (Borst, Akkermans, and Top 1997)	118
Figure 5-4. Existing classes in the "refrigeration device" module of DABGEO and an example of Chiller concept definition.	119
Figure 5-5. The three fields of BIM activity from (Succar 2009)	120
Figure 5-6. FBS framework from (J. S. Gero and Kannengiesser 2014)	121
Figure 5-7. UML diagram of the scenario for supermarket RS.....	124
Figure 5-8. Example of a scenario composed of a stakeholder, an objective and a system environment.	125
Figure 5-9. Decomposition of an RS design solution	125
Figure 5-10. UML diagram of some classes that can be comprise in the properties.	127
Figure 5-11. UML diagram of the global performance classes, their intra- and extra-relations with other classes.....	128
Figure 5-12. UML diagram of the knowledge model and the relations between the concepts	131
Figure 6-1. Influence Explorer visualisation tool: performances and parameters histograms	148
Figure 6-2. Our strategy for design space exploration based on a brute-force enumeration and "design by shopping" inspired by (Neema et al., 2003).....	150
Figure 6-3. Correspondence between the design problem represented in our knowledge model and the Geeglee objects.....	152
Figure 6-4. Presentation of the implementation of the scenario concept in the GEP	152
Figure 6-5. Presentation of the design space implementation in the GEP	153
Figure 6-6. Compressor characteristics implemented in the exploration platform....	154
Figure 6-7. Incompatibility table implemented in the design platform	154
Figure 6-8. Environmental impacts class implementation in the design and exploration platform.....	155
Figure 6-9. Simplified scheme of a design point computation algorithm	156
Figure 6-10. Steps to follow using the design and exploration platform	157
Figure 6-11. Reference supermarket for verification of the models	158
Figure 6-12. Platform interface	158
Figure 6-13. System environment: store characteristics interface.....	160
Figure 6-14. System environment: food conservation characteristics interface	161
Figure 6-15. Selection of the components of the existing system.....	163
Figure 6-16. Comparison of the performances evolution before and after the change of refrigerant.....	165
Figure 6-17. Pareto space displayed in the platform	166
Figure 6-18. Cost table and 1D interval visualization and selection of constraints using either the table (left) or 1D slider (right).....	167
Figure 6-19. Environmental 1D interval visualization and selection of constraints	167

Figure 6-20. Visualization of all the feasible solutions	168
Figure 6-21. Selection of non-dominated solutions	168
Figure 6-22. Workshops with INRAE experts for step-by-step verification	169
Figure 7-1. Positioning of the chapter in the thesis	180
Figure 7-2. Hierarchy of criteria for design artefact evaluation from (Prat et al., 2014).	182
Figure 7-3. Timeline of the validation session	186
Figure 7-4. Simplified script given to the testers.....	187
Figure 7-5. Environmental impacts reduction using the sliders	188
Figure 7-6. Example of 2D representation to compare design solutions	192
Figure 7. Méthodologie mise en place pour construire le livre de connaissance.....	272
Figure 8. Résumé de la méthodologie RID et des résultats obtenus pour évaluer le système socio-technique existant.....	272
Figure 9. Présentation des macro-concepts du modèle de connaissance.....	275
Figure 10. Présentation de la mise en place du concept de scénario dans le GEP.....	275
Figure 11. Présentation de la mise en place de l'espace de décision dans le GEP	276
Figure 12. Exemple d'une analyse multi-objectifs entre le coût total et les impacts environnementaux sur la plateforme de simulation et d'exploration	277
Figure 13. Exemple de l'évaluation des impacts environnementaux de toutes les alternatives possibles	277

List of tables

Table 2-1. Application, definitions and equipment of the refrigeration domain inspired by (IEA 2020).....	34
Table 2-2. Summary table of commonly used refrigerants classified by their chemical type, R-number, GWP, ODP and safety group.....	40
Table 2-3. Related work on refrigeration systems and buildings maintenance assessment.....	49
Table 2-4. Maintenance qualitative assessment table adapted from (Geng et al. 2013).	50
Table 2-5. Summary of some related works on environmental impact assessment of refrigeration systems.	54
Table 2-6. Table of the different platform specifications.	62
Table 2-7. Table of the different outputs assessed on the platforms.....	63
Table 3-1. Proposed research methodology for the present work adapted from the DRM	77
Table 4-1. Summary of the interviews (role of the interviewees and their organizations).....	86
Table 4-2. Detail questions of the interviews.....	87
Table 4-3. Table of the users and their role in the process.....	89
Table 4-4. List of problems identified in in the socio-technical RS and classified in four main categories.	97
Table 4-5. UsEs matrix: To what extent does this existing solution facilitate the usage situation? (scale from 0 = never to 5 = frequently)	99
Table 5-1. Literature review summary of the main methodologies for ontology development.....	112
Table 5-2. Summary of the knowledge acquisition (KA)	122
Table 5-3. List of concepts for the refrigeration system design level, their definitions, and their classes associated with retail refrigeration	129
Table 5-4. Scenario related classes, extended sub-classes and instances for the application to retail refrigeration systems.....	133
Table 5-5. Refrigeration system solution classes, extended sub-classes and instances for the application to retail refrigeration systems.....	134
Table 5-6. Global performance: environmental impact class, its extended sub-classes and instances for the application to retail refrigeration systems.....	136
Table 7. Verification investigation: questions and outcomes of the workshops.....	170
Table 8. Results of the total energy consumption in kWh calculated with our model and the data from the case study (last column)	172
Table 7-1. Criteria and their definition for our validation strategy	183
Table 7-2. Criteria and the associated evaluation category and tool.	184
Table 7-3. Table of target users and their activity.....	185
Table 7-4. Performances order of decision for design space reduction depending on the participants (industrial stakeholders)	190
Table 7-5. Design solutions obtained with the different uncertainty reduction.....	191

Table 7-6. Comparison of the performances implemented in our platform and in the existing refrigeration system design platforms 194

Chapter 1: General introduction

This chapter introduces the general context of this Ph.D. thesis, the motivation and challenges that drove this work around the design of refrigeration systems. This work is based on multi-field and multi-methodology research, including two research disciplines, refrigeration process engineering and design engineering. The first section of this chapter explains the context and motivation of the work. The second section describes the research objectives. The last section details the main outline of the thesis.

1. Context, motivation and objectives

1.1. *General context*

Since the beginning of the industrial revolution, around 1750, the greenhouse effect has been amplified by releasing large quantities of greenhouse gases (GHG) into the atmosphere. The massive use of fossil fuels such as oil, coal or natural gas, deforestation, certain industrial processes and agricultural practices, and the burial of waste have played a major role in increasing GHG emissions. According to data from the Intergovernmental Panel on Climate Change (IPCC), annual greenhouse gas emissions increased by 80% between 1970 and 2014 (Blanco et al. 2014). International protocols consider that these high emissions lead to global warming and ocean warming.

The responsibility to fight against climate change is shared by all spheres of society, i.e. governments, industries, academics and civil society. Education and academic research are important to move toward sustainability, but strict regulation of greenhouse gas emissions by various levels of government is essential (Panayotou 2013).

In recent decades, the world has been increasingly affected by climate change, causing economic, social and territorial disasters. Through the Montreal protocol in 1987 and Kigali amendments in 2005 and 2016 (Heath 2017; the United States. Congress. Senate. Committee on Foreign Relations 1993), the refrigeration industry has been concerned with the environmental issues, banning the use and production of refrigerants responsible for the ozone layer destruction, such as ChloroFluoroCarbons (CFCs), and with high Global Warming Potential (GWP), such as HydroFluoroCarbons (HFCs). We use more and more cooling equipment in our daily life, for food safety, for our comfort at home and workplaces, in transportation, for the conservation of medicines and vaccines, etc. Rising temperatures and extreme events such as heat waves and recent pandemics have increased the need for refrigeration. The impact of climate change on the refrigeration sector has resulted in increasing demand for cooling in the food sector, pharmaceuticals, buildings and transport (Schaeffer et al. 2012). Nearly 20% of all electricity consumption is used for cold production. This figure is expected to rise with growing demand and is predicted to reach 37% by 2050 (IEA 2018).

1.2. *General objectives*

In this context, academics and industrials have researched more sustainable and climate-friendly systems over the years. They have studied innovative and promising technologies to improve the energy efficiency of refrigeration equipment and fluid alternatives for HFCs. Improving the energy efficiency and reducing the production and use of HFCs could avoid 0.5°C of global warming by 2100 (IEA 2020).

Nevertheless, technological improvement of refrigeration equipment is an essential lever in the fight against climate change, but not sufficient. Indeed, research in the refrigeration domain

has been widely developed. New technologies are shown to be promising from an energy and efficiency point of view, but levers related to adopting these technologies in the industry persist. It is thus necessary to take the complexity of their socio-economic environment into account to implement effective new technologies.

Thus, to reduce direct and indirect effects related to the production, use and end-of-life of refrigeration systems, it becomes necessary to assess existing and new technologies and offer a global approach that will help manage the research and development (R&D) and decision making.

This Ph.D. thesis is an applied research work, which aims to respond to these challenges by finding realistic solutions to the refrigeration domain's gaps, according to two main objectives. First, this study provides a framework of understanding for the design process around refrigeration systems. The decision process is defined by identifying the various involved stakeholders, technologies, and knowledge to achieve this first goal. The second goal of this work is to develop relevant design artefacts to support research and industry in the transition toward sustainable refrigeration systems. For this purpose, a global approach based on a knowledge model (ontology) dedicated to refrigeration and a simulation and design space exploration tool is proposed.

Thus, in this thesis, research and industry issues were considered to improve the efficiency and sustainability of refrigeration systems. The scope of this study and its positioning are detailed in the next chapters.

2. Outline of the thesis

The thesis is organized into seven chapters. Chapter 1, presented here, serves as the general introduction. The context, research fields and positioning of this work are described.

In Chapter 2, a literature review of the research fields and relevant work is described. It highlights the research gaps addressed in the dissertation.

Chapter 3 details the research questions, the objectives to answer these questions and the general research methodology of the thesis.

In each contribution chapter, relevant literature was presented to position the novelty of each chapter contribution and the specific used methodology is discussed.

Chapter 4 presents the results of the refrigeration domain diagnosis. The assessment methodology is discussed, the research gaps and questions were confronted by industrial and academic experts.

Chapters 5, 6 and 7 describe the main contributions. In Chapter 5, a knowledge model was built. The relevant literature and related works are discussed, and the results are presented. Chapter 6 detailed the development of a digital platform for the exploration of design space. It is based on the knowledge model and presented through usage scenarios. Finally, Chapter

7 discusses the validity of the design exploration platform with several criteria.

Chapter 8 provides a general discussion, limitations and perspectives for future works. A general conclusion ends this dissertation.

References

- Blanco, Gabriel, Reyer Gerlagh, Sangwon Suh, John Barrett, Heleen C. de Coninck, CF Diaz Morejon, Ritu Mathur, Nebojsa Nakicenovic, Alfred Ofosu Ahenkorah, and Jiahua Pan. 2014. 'Drivers, Trends and Mitigation'.
- Heath, Eric A. 2017. 'Amendment to the Montreal Protocol on Substances That Deplete the Ozone Layer (Kigali Amendment)'. *International Legal Materials* 56 (1): 193–205. <https://doi.org/10.1017/ilm.2016.2>.
- IEA. 2018. 'The Future of Cooling'. Paris: International Energy Agency. <https://www.iea.org/reports/the-future-of-cooling>.
- IEA. 2020. 'Cooling Emissions and Policy Synthesis Report'. Paris. <https://www.iea.org/reports/cooling-emissions-and-policy-synthesis-report>.
- Panayotou, Theodore. 2013. *Instruments of Change: Motivating and Financing Sustainable Development*. Routledge.
- Schaeffer, Roberto, Alexandre Salem Szklo, André Frossard Pereira de Lucena, Bruno Soares Moreira Cesar Borba, Larissa Pinheiro Pupo Nogueira, Fernanda Pereira Fleming, Alberto Troccoli, Mike Harrison, and Mohammed Sadeck Boulahya. 2012. 'Energy Sector Vulnerability to Climate Change: A Review'. *Energy* 38 (1): 1–12. <https://doi.org/10.1016/j.energy.2011.11.056>.
- United States. Congress. Senate. Committee on Foreign Relations. 1993. *Amendment to the Montreal Protocol on Substances That Deplete the Ozone Layer: Report (to Accompany Treaty Doc. 103-9)*. [Washington, D.C.]: [U.S. G.P.O.], [1993]. <https://search.library.wisc.edu/catalog/999803377502121>.

Chapter 2: Literature review on refrigeration systems design and simulation

This chapter presents a literature review and is composed of three main sections. First, the principle, main architectures and components of refrigeration systems are detailed. In the second section, approaches and tools in industrial engineering, specifically system engineering, could be applied to refrigeration systems' design process. The literature review then focuses on the modelling of complex systems, the definition of a design process and how to solve a design problem. Finally, an overview of existing simulation-based tools to support refrigeration systems design is realized. This chapter concludes with a section highlighting the existing gaps in the literature prior to the definition in the next Chapter 3 of the emerging research questions and the associated objectives.

1. Refrigeration systems

1.1. Definitions and applications

The International Energy Agency (IEA) has defined cooling as “any human activity, design or technology that dissipates or reduces temperatures and contributes to achieving: (i) reasonable thermal comfort for people, or (ii) preservation of products and produce (medicines, food, etc.), and (iii) effective and efficient processes.” Main applications and equipment in the refrigeration domain are presented in Table 2-1.

Table 2-1. Application, definitions and equipment of the refrigeration domain inspired by (IEA 2020)

Application	Commercial and industrial cooling		Cold-chain preservation during transportation	Thermal comfort	Domestic product conservation
	Commercial refrigeration	Industrial refrigeration	Refrigerated transports	Space and mobile air conditioning	Domestic refrigeration
Definition	Small volume of storage and display chilled or frozen goods for commercial sale in stores, restaurants, supermarket, etc.	Large volume storage for the agri-food, pharmaceutical and healthcare products, floral products etc. facilities.	Critical link in the food chain to maintain the temperature integrity of perishable products from the producers to the retailers.	Removing heat and moisture from the interior of an occupied space to improve the comfort of occupants in cars, buildings, trains etc.	Short term preservation of domestic food to preserve its quality and maintain the food chain.
Equipment	Display cabinets and cold rooms, commercial equipment	Large refrigeration equipment for industrial usage	Transport refrigeration units	Heat pumps, air conditioning units (unitary or mobiles for transport AC)	Domestic refrigerators

The present Ph.D. thesis focuses on commercial refrigeration. This sector represents 3–5% of energy consumption in European countries (Evans et al. 2014) and is expanding to meet growing demand. In France, retail stores have seen their footfall increase by 10% in 5 years and their number by 8%. Refrigeration equipment (display cabinets or cold rooms) is responsible for 35–50% of the energy consumed by a retail store (Timmer, Skudritis, and Blumberga 2016).

1.2. Cold production by vapour-compression refrigeration

A cold production system is composed of 4 principal components:

- compressor
- condenser
- expansion valve
- evaporator

Refrigeration systems are used to transfer heat from cold to heat sources. A refrigerant moves inside the components and absorbs or resorbs heat by its phase changes when the fluid is condensed or evaporated. In the evaporator, the refrigerant is submitted to low pressure. The refrigerant evaporates to cool the environment by absorbing heat, and the temperature along the evaporator is almost constant. The vaporous refrigerant then enters the compressor. High pressure and high-temperature gas at the compressor exit enter the condenser, where the cumulated heat is released. The thermodynamic cycle finishes by the return of the fluid to low pressure by passing through the expansion valve (see Figure 2-1).

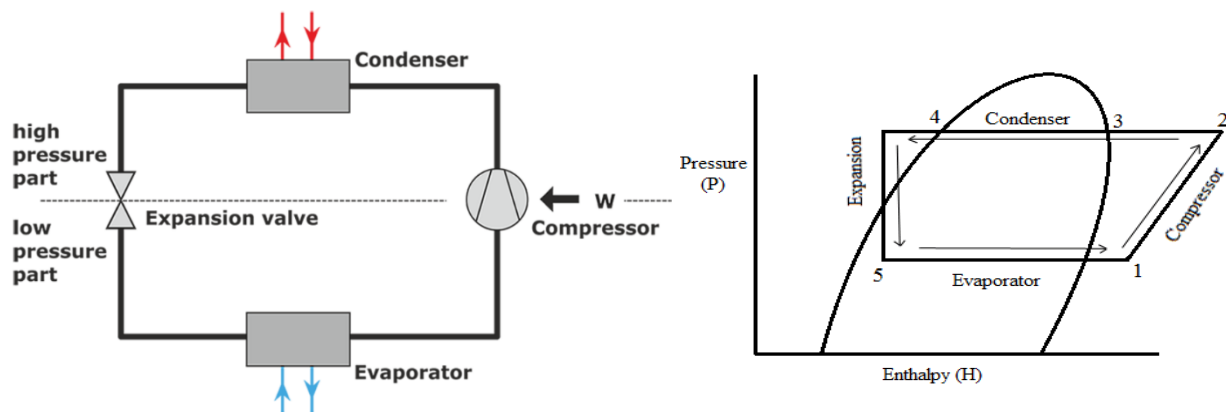

Figure 2-1. Basic refrigeration system and its pressure – enthalpy (p-h) diagram

1.3. System architecture

Different architectures exist to meet a multitude of needs. This section will describe the most frequently used refrigeration systems in retail. The layout of the main components does not vary, but the number of components may differ, and supplementary elements may be added to the system.

1.3.1. Centralized direct expansion system

Most supermarket refrigeration systems use a centralized direct expansion system where the cold production is connected to the entire store through a piping system that circulates and feeds refrigerants to all the display cabinets' evaporators. The cold production system (usually in the machine room) is separated from the display cabinets' location. For a traditional centralized system to perform adequately, a certain number of compressors must be used in order to attain the required power. This arrangement can result in unused compressor capacity and wasted energy consumption. However, this type of system is the easiest one to be installed

due to its simple architecture.

The following figure represents a simplified scheme of the system architecture in which ventilators and control components are not presented.

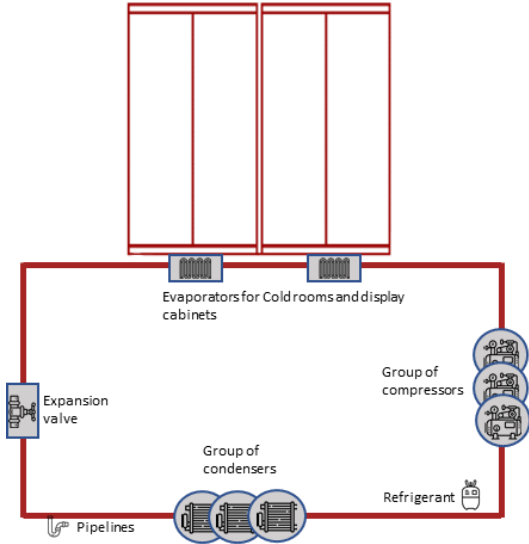

Figure 2-2. Simplified scheme of a centralized direct expansion system architecture

1.3.2. Plug-in system

Plug-in (PI) refrigeration unit is a direct expansion system with compressor, condenser, expansion valve and evaporator associated with a cabinet. For plug-in cabinets, the refrigeration unit is fitted inside the furniture. Thus, no machine room is needed.

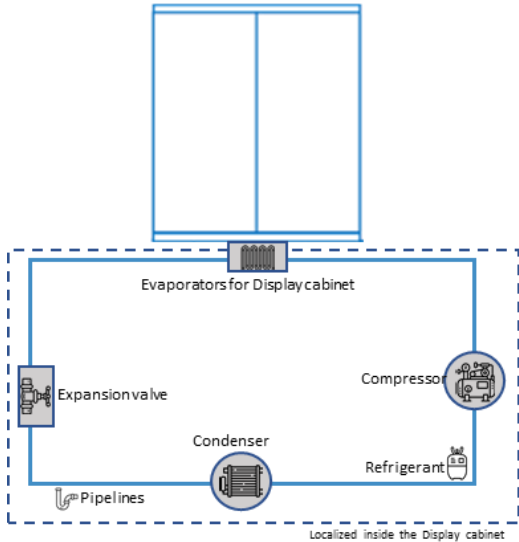

Figure 2-3. Simplified scheme of a plug-in cabinet

1.3.3. Secondary loop system

The secondary loop refrigeration systems are frequently used in industrial refrigeration and commercial comfort cooling and are also known as "Liquid-Chilling Systems" (ASHRAE 2008). This type of system architecture was first introduced to overcome several dangerous aspects of refrigerants (toxicity, flammability, high GWP...) or for system compatibility.

The baseline of this architecture (Figure 2-4) is composed of two loops. The primary loop, a direct expansion system using a traditional refrigerant (called primary refrigerant), cools the secondary fluid using a secondary fluid / primary fluid heat exchanger (Heat Exchanger in the figure) (Wang et al. 2010). This fluid provides the necessary cooling through heat exchangers in cold rooms and display cabinets that replace traditional evaporators in Figure 2-2.

The main advantages of such architecture are confining the primary loop and using environmentally friendly refrigerants to transport the cooling power by the secondary loop. It reduces the amount of primary refrigerant charge and refrigerant leakage due to shorter circuits. The system design is simpler than a distributed direct expansion system which is composed of multiple subsystems. Service and maintenance are easier than a primary centralized system (Horton 2004). The additional cost of pumps and cooler heat exchangers could be offset by combining reduced refrigerant charge and copper pipe length (by using the plastic pipe instead of copper pipe in the secondary loop SL) in supermarket application (DelVentura, Evans, and Richter 2007).

The study by Kazachi and Hinde (Kazachki and Hinde 2006) showed the comparison of a secondary loop system and a traditional direct expansion system in a supermarket. They confirmed the advantages presented above and identified the drawbacks of this system. The presence of circulating pumps and intermediate heat exchangers draws additional energy consumption. From ADEME report (ADEME 2001), it is noticed that the secondary refrigeration used approximately 10% more energy than a direct system.

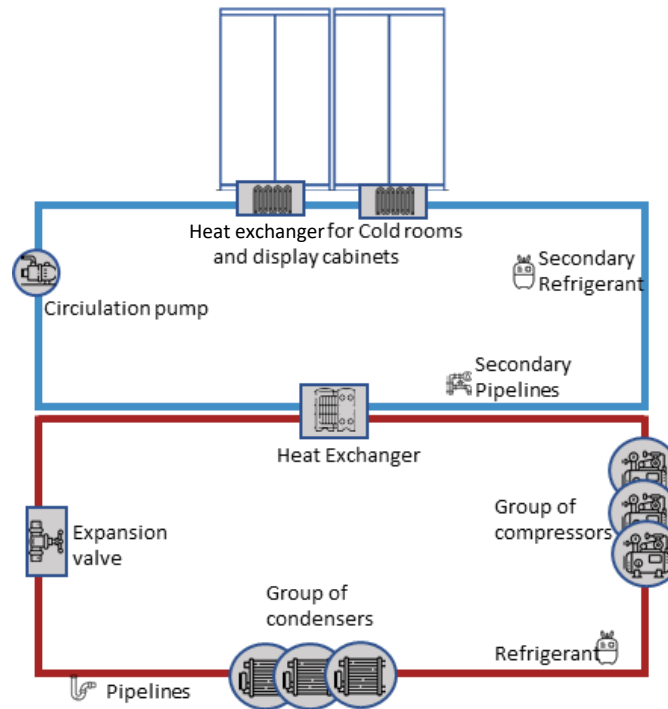

Figure 2-4. Simplified scheme of secondary loop refrigeration system

1.3.4. CO₂ transcritical booster system

Due to their lower environmental impact than conventional systems, the CO₂ or R744 as a refrigerant has been explored by many researchers (He et al. 2017). CO₂ is a natural refrigerant, non-flammable and non-toxic, it has zero ODP (Ozone Depletion Potential), and its Global Warming Potential (GWP) is equal to 1. The ODP and GWP of the most common refrigerants can be found in the next section. CO₂ is also economically attractive. As there are no limitations regarding the use of R744 as refrigerant, it is considered one of the most viable solutions for supermarket refrigeration applications (Lorentzen 1994).

Many configurations of systems using CO₂ have been tested both theoretically and experimentally. The aim was to achieve the best possible performance compared to the conventional refrigerants that are currently used.

The CO₂ booster refrigeration system or transcritical refrigeration has been applied in the modern supermarket to substitute for the conventional R404A system. One significant problem concerning the use of CO₂ is that its low critical temperature (31 °C) leads to operation in transcritical conditions when the ambient temperature is high. The operation in transcritical conditions demands higher energy consumption compared to systems using conventional refrigerants, which is an obstacle for the use of CO₂ in locations with high ambient temperatures (Mitsopoulos et al. 2019).

A typical CO₂ transcritical refrigeration system for a supermarket application is presented by Ge and Tassou (2011b). The architecture presents four pressure sections: high, intermediate,

medium and low. In the first section, the system is composed of a high stage compressor outlet, followed by the gas cooler or condenser depending on ambient conditions, the suction line heat exchanger and the high-pressure control valve. Then starts the second section, where the two-phase refrigerant flows into the receiver and immediately splits out with saturated vapour and liquid. The MT and LT expansion valves control the liquid circulating into their respective evaporators.

The refrigerant out of the LT evaporator is then sucked into the low stage compressor before mixing with the refrigerant from the MT evaporator. A simplified representation of a transcritical system is presented in Figure 2-5.

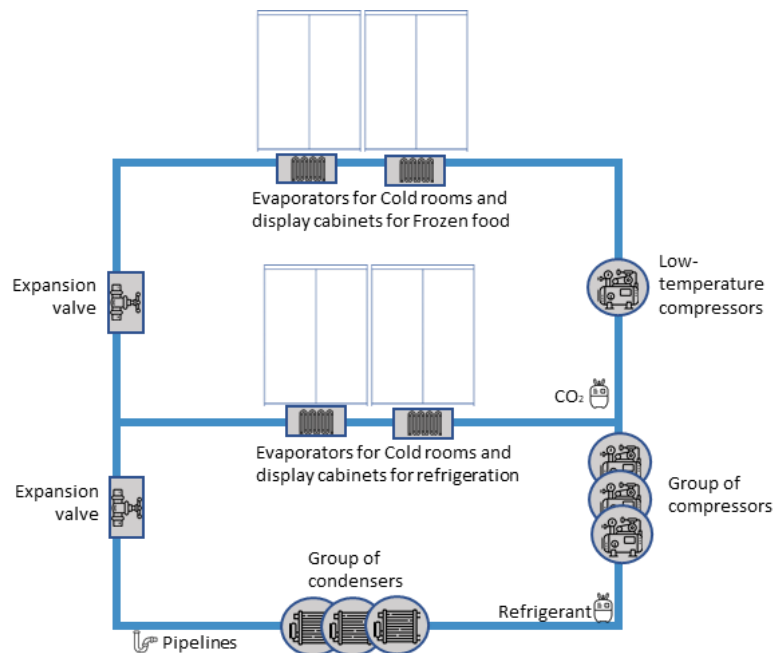

Figure 2-5. Simplified scheme of a transcritical architecture

Other configurations exist. The most commonly found are the addition of an auxiliary compressor, the integration of liquid and vapour ejectors in parallel to the high-pressure valve, and the utilization of a mechanical subcooling unit after the gas cooler.

1.4. Refrigerants

In a vapour-compression refrigeration system, refrigerants are used to ensure the compression cycle. The choice of refrigerant depends on its cost, thermodynamic and chemical properties and working conditions.

Refrigerants can be listed according to their chemical composition (see Table 2-2). Some refrigerants have a high negative impact on the environment, particularly on global warming (CFC, HCFC and HFC) and ozone depletion (CFC). In the European Union, they are subjected to specific regulations. A charge limit is applicable depending on the application (commercial refrigeration or air conditioning) (NF EN 378, 2017).

Table 2-2. Summary table of commonly used refrigerants classified by their chemical type, R-number, 100 years- Global Warming Potential (GWP), Ozone Depletion Potential (ODP) and safety group

Type	Refrigerant R-number	Refrigerant name	100 years- GWP	ODP	Safety group
CFC	12	Dichlorodifluoromethane	10900	0.82	A1
	502	CFC blend	4750	1	A1
HCFC	22	Chlorodifluoromethane	1810	0.055	A1
HFC	134a	Tetrafluoroethane	1430	0	A1
	404A	HFC blend	3922	0	A1
	407C	HFC blend	1770	0	A1
HC	290	Propane	3	0	A3
Natural	717	Ammonia	0	0	B2L
	744	Carbon dioxide	1	0	A1
HFO	1234yf	Tetrafluoropropene	4	0	A2L

2. Industrial engineering to support the design of refrigeration systems

Industrial engineering (IE) is a multidisciplinary research field that designs, studies and seeks to improve part or the entire life cycle of artefacts, i.e. all the processes, humans, systems, interactions, energy, materials, constrains and information from the design to the end of life of an artefact, with all the trades and skills involved. It can be applied to all domains such as healthcare, building, education, architecture, transport, energy.

Industrial engineering can be divided into four categories: system engineering, system and organisation management, human factor engineering and control (Kosky et al. 2021), as presented in Figure 2-6.

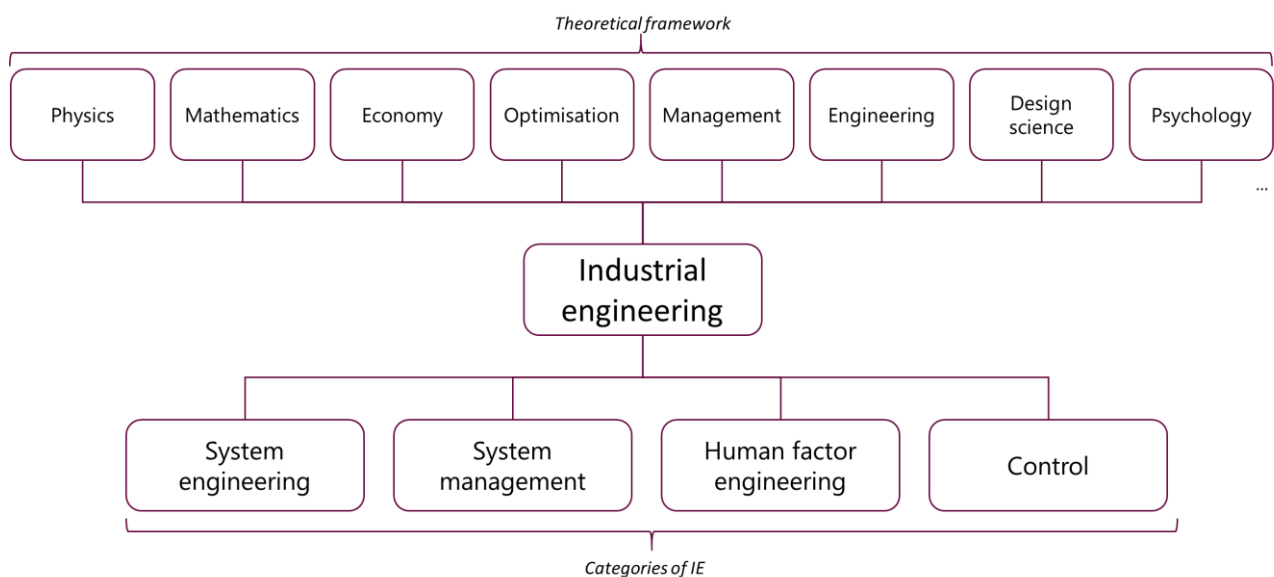

Figure 2-6. Industrial engineering field overview inspired by Kosky et al. (2021) and Zhong and Zhou (2019)

To support industrial engineering, different fields constitute the theoretical frameworks necessary to fulfil studies objectives. It includes theories, methodologies, tools from mathematics, management, physics, optimisation, design science, behaviour science, psychology.

For our research objectives, we explore in further detail system engineering artefacts, design science, system analysis and optimisation with a focus on relevant works in the refrigeration domain.

2.1. Design science

Design science as a formal research discipline appeared during the second half of the 20th century.

Design and science have many definitions in the literature. Eddington defines science as the *"attempt to set in order the facts of experience"* in (Buckminster Fuller 1946), and design is defined by (Ralph and Wand 2009) as *"a specification of an object, manifested by some agents, intended to accomplish goals, in a particular environment, using a set of primitive components, satisfying a set of requirements, subject to some constraints."*

The purpose of research in design science is based on finding models, approaches, and tools to improve the design of product or systems and their development processes (Papalambros 2015). Since 1960, many models to describe the uniformities in processes have been developed. In this section, a few design approaches that are considered in the present work are shown.

To support design science, a large literature of design philosophy (Yoshikawa 1989) or design theory and methodology (DTM) exists. Numerous authors have contributed to developing methods and diversifying applications domains of DTM.

Thus, the number of design theories is important while there is no consensus between the actors involved in the design process (industrials, researchers, designers...). The domain application, the study perimeters, and specifications... are highlighted by (Le Masson, Dorst, and Subrahmanian 2013) as the main difficulties of using design theories.

2.2. *Complex system definition and modelling*

In the design science literature, different ways exist to define and model a system in various fields as complex systems exist in many domains.

2.2.1. *Complex systems definition*

Pahl and Beitz (2013) defined dynamic systems in engineering as technical artefacts and systems consisting of sets of ordered and interrelated elements. They also characterized a system by its boundary, which cut its links with the environment. These links determine the system's external behaviour, so that it is possible to define a function expressing the relationship between inputs and outputs.

Over the past years, researchers have developed multiple definitions of complex systems adapted for each of their contexts: design research in a large company, research on eco-design of energy pathways, microbiology (Cluzel et al. 2012; Lesne 2010; White et al. 2014). Each author added elements for their definitions that apply to their field of work: biology, engineering, etc. A consensus exists for multiple common properties that define a complex system as:

- A system composed of subsystems and components that may interact with each other with different types of interaction
- A system composed of subsystems and components that may have different types, structures, life cycles and lifetimes

- A system that has close interactions and can be influenced by its environment at different levels
- A system that is hardly predictable in the long term, even by knowing the properties of its isolated elements

In the next chapter of the thesis, refrigeration systems are considered complex systems. Indeed, a refrigeration system is composed of different components and sub-systems with thermodynamic, chemical, mechanical and physical interactions (see Section 0). The components have structural and chemical specifications, have different lifetimes and do not serve the same purpose. A refrigeration system is in close interaction with its surroundings and is directly influenced by its environments, such as its location and the climate. Finally, a refrigeration system's behaviour is difficult to predict because of the close interaction with its surroundings and the high number of elements influencing the system. The subsystems are also complex systems with particular interactions. Indeed, as the technology in the refrigeration industry is developing, emerging technologies can add their share of complexity due to low maturity and high uncertainties.

2.2.2. Decomposition of a complex system

In order to have a clear and precise look at a system in a product development process, the first step is to decompose it into smaller clusters that will have the same nature.

A complex system can be decomposed in several ways: object, aspect, sequential and model-based (Pahl and Beitz 2013; Retho 2015; Wagner 1994). Object decomposition divides a system by physical components. Aspect (or discipline) decomposition divides the system according to different disciplines - or specialities. Object and aspect partitioning are "natural" partitions. Typically large companies employ both types of partitions simultaneously (mixed partition) in a matrix management organization. Sequential decomposition is applicable when partitioned sub-problems are organized by workflow or process logic and presume unidirectionality of design information.

The following figure is taken from the book Engineering Design (Pahl and Beitz 2013), and it shows the decomposition of a system: S is the system boundary, $I_{1,2,3}$ are the inputs, $O_{1,2}$ are the outputs, S_{1-5} are the subsystems, S_{21-24} are the sub-subsystems.

This kind of system decomposition can be applied to traditional machines and automates the system by having a unique presentation of the properties. The functional specifications of the model are explicit: the input and output flows are clear, and the transformation process is detailed.

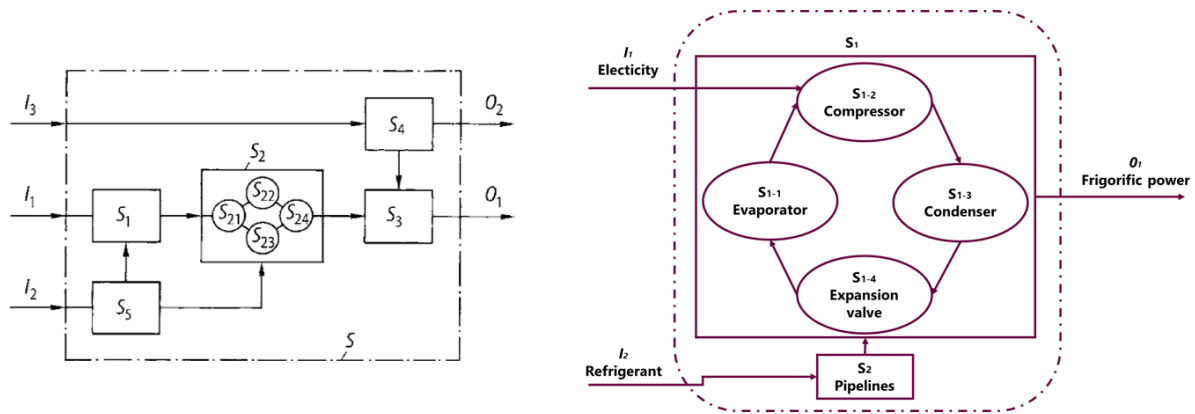

Figure 2-7. Scheme of a system structure from Pahl and Beitz (2013) (left) and a simplified example for a refrigeration system structure (right)

2.3. Engineering design process

The engineering design process is often used to create or redesign new products or systems. It is composed of design theories, methodologies and tools. We review design process frameworks and the steps to design a system in design theories. Methodologies and tools are developed in the literature to support the design process. In the following section, a general overview of a design process general methodologies to support the development of systems and engineering design tools are presented.

2.3.1. General overview of the design process

Pahl and Beitz (2013) developed the design theory of the systematic approach. The description is essentially based on (1) the fundamentals of technical systems, (2) the fundamentals of the systematic approach, and (3) the general problem-solving process. To solve a technical problem, it is necessary to have a clear and easily reproduced relationship between inputs and outputs: all relationships must be planned and thus designed to meet the specifications. Figure 2-8 details the design process steps from Pahl and Beitz. The authors have proposed a general framework to structure the design process as a sequence of four phases that can be executed iteratively:

- Task Clarification: collecting, formulating and documenting the requirements of the product to be designed.
- Conceptual Design: Identifying a design solution's basic principles and outline (or concept).
- Embodiment Design: elaborating the design into a layout that satisfies various technical and economic criteria.
- Detail Design: finalising the design and preparing production documents.

Other frameworks have been developed (Ulrich and Eppinger 2016; Tayal, n.d.; Otto and Wood 2001; Saaksvuori and Immonen 2008). The traditional steps developed in these theoretical frameworks for a product or system development are listed in the following list:

- Research or planning: A significant amount of time is spent on research or locating information
- Conceptualization, concept development or conceptual design
- Embodiment design includes:
 - Feasibility assessment: the purpose of a feasibility assessment is to determine whether the engineer's project can proceed into the design phase. This is based on two criteria: the project needs to be based on an achievable idea, and it needs to be within cost constraints.
 - Establishing design requirements: Some design requirements include hardware and software parameters, maintainability, availability, and testability.
 - Preliminary design: In this task, the overall system configuration is defined, and schematics, diagrams, and layouts of the project will provide early project configuration.
- Detailed design: the task where the engineer can completely describe a product through solid modelling and drawings.
- Decision of a solution, prototyping, production planning
- Production

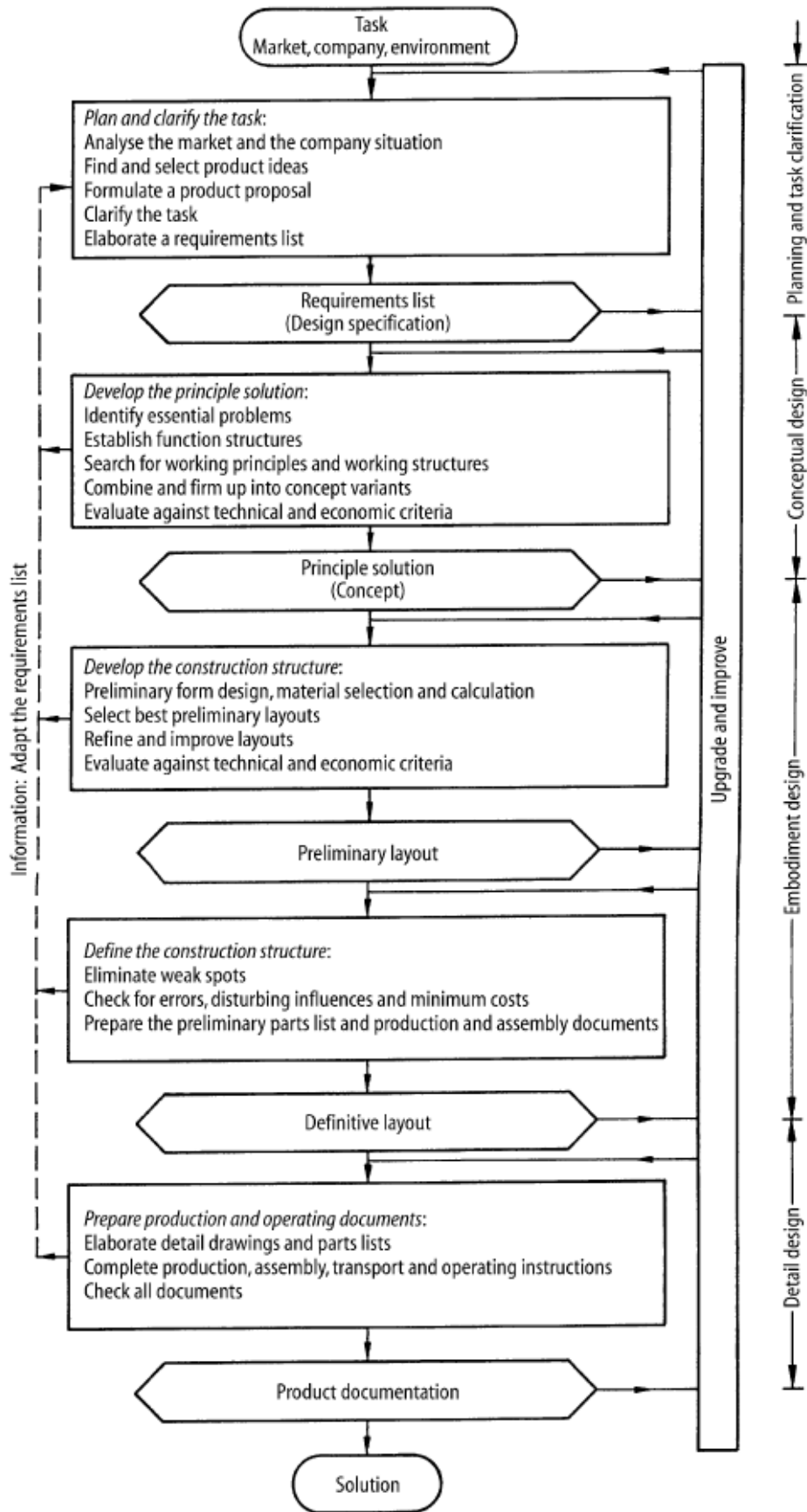

Figure 2-8. Steps of Pahl and Beitz design process (Pahl and Beitz 2013)

2.3.2. Design process methodology

The stages of product development have been described by many authors (Pahl and Beitz 2013; Wagner 1994; White et al. 2014; Mottonen et al. 2008; Tayal, n.d.; Ulrich and Eppinger 2016). They agree on the need of making choices in the early stages to reduce the risk of change at the end and reduce the total life-cycle costs. To address early involvement, design for eXcellence (DfX) is one of the most popular concepts in quality management (Jiang, Shiu, and Tu 2007). DfX is an organised way to harmonize practice. It can reduce costs and increase values. Different types of design objectives are to be addressed: Design for Manufacturing, Design for Assembly, Design for Environment, Design for Sustainability... they depend on the choice of issues that the company wants to address in the early stages of design to avoid changes afterwards. Figure 2-9 shows different types of existing DfX. To achieve the design objective, it is necessary to have a holistic representation of the targeted domain by studying the technologies and the system-human interaction (Ropohl 1999). For example, in the automotive industry, as product complexity increases and most experienced engineers retire, the development of a holistic representation and the use of DfX provides a framework for design teams to decide in the early stages of development (Fatfouta 2020).

The holistic representation of a domain includes the understanding of the socio-technical system. This term is defined in the Oxford dictionary by the infrastructure, technologies, stakeholders with their specific role in the value chain, and the performances of a system (Law 2009). In the refrigeration domain, there are practical problems related to the use of cooling technologies (breakdowns, accidents, lack of efficiency, etc.) and a heterogeneous knowledge of the domain's actors. There is no holistic representation of the refrigeration socio-technical system to our knowledge. This could help understand refrigeration systems with the diversity of technologies, stakeholders, design objects, etc. and thus better address the design problem.



Figure 2-9. Types of Design for eXcellence (DfX) from Geometric Company

In the context of the commercial refrigeration industry, many points of view can be adopted from different stakeholders: refrigerant systems' fabricants, industrial users, supermarket consumers, regulation politics, environmental activists... It exists as many design paths as designers. However, the same design process framework presented in the previous section can be considered. Traditionally, designers have focused mainly on the product's performance, features, and appearance.

In the next sections, we focus on tools and approaches to assess the performances of a system and particularly in the refrigeration domain. We focus on the maintenance that is not widely assessed in the literature and the environmental aspects of refrigeration systems.

2.3.3. Maintenance assessment

The maintenance of the refrigeration system is an important part of the exploitation phase in the life cycle. The maintenance of refrigeration systems is important to ensure the machines' longer efficiency in time and avoid breakdowns and accidents. The maintenance activities are standardized (number per year, certifications for operators according to the refrigerant, procedures, reports, etc.).

Maintenance is most often evaluated quantitatively in the literature by maintenance costs. It is a complicated activity to evaluate, due to the complexity of the systems, the organizations involved, the technologies and the standards that govern them. In the literature, methods to assess the maintenance of refrigeration systems are not widespread. The next table shows the latest studies on maintenance assessment for refrigeration systems or buildings. It highlights that's the most widespread and easy method to assess maintenance is quantitative by cost analysis.

Table 2-3. Related work on refrigeration systems and buildings maintenance assessment

Authors - date	Domain – Subject	Maintenance assessment method
(Alrwashdeh and Ammari 2019)	Refrigeration - cost analysis of two different refrigeration systems	Maintenance cost is calculated as a percentage of initial cost (ex: 10% which corresponds to 60\$/yr)
(Amrina, Kamil, and Aridharma 2020)	Buildings - Multi Criteria Approach for Sustainable Maintenance Performance Evaluation	Maintenance is assessed with 3 criteria: 1. Economic (Maintenance cost; Availability rate; Product quality; Failure rate; Ease of maintenance; Technology applied; Breakdown rate) 2. Social (Working environment; Occupational health and safety; Employee involvement; Lighting and ventilation; Training and education) 3. Environmental (Emission; Energy consumption; Material consumption; Water usage)
(Kumar Singh, Kumar, and Gupta 2020)	Refrigeration - Comparative energy, exergy and economic analysis of a cascade refrigeration system	Maintenance cost is included in the operational costs, by using a maintenance factor (ϕ) of 1.06 (rate of parts changed per year)
(Imamura, Kamiya, and Sugawa 2015)	Refrigeration - evaluation on A2L refrigerants in situations of service and maintenance	Qualitative evaluation of the maintenance: observed flammability; temperature; flame propagation

By extending our field of research to ergonomics, another field of industrial engineering, another way to assess maintenance based on a qualitative approach can be considered. For example, Geng et al. (2013) proposed a maintenance measurement framework composed of four categories of evaluating elements. For each, an illustration assesses the element into three possible ranks (see Table 2-4).

Table 2-4. Maintenance qualitative assessment table adapted from (Geng et al. 2013).

Evaluation element		Illustration of rank A	Illustration of rank B	Illustration of rank C
Accessibility design	Visibility design	System could be seen directly	Target could be seen partly because of interruption	Target could not be seen at all
	Reachability design	Maintenance could reach the system easily	Maintenance could not reach the target	Maintenance personnel may try to approach instinctively
	Operation space design	Maintenance personnel could operate freely	Maintenance personnel collides with surroundings sometimes	Maintenance personnel always collides with surroundings
Error proofing design	Error proofing design	Safety accident could be reduced effectively	Safety accident could be reduced to a certain extent	Safety accident may happen probably if maintenance personnel operates without too much experience
	Marking design	Distinct and logical marking	Confused and fragmentary marking	Few marking design could be found
Ergonomic design	RULA (rapid upper limb assessment)	Acceptable ergonomic design	Ergonomic design needs to be investigated further and change soon	Ergonomic design needs to be investigated further and change immediately
Physical hurt preventing design	Heat injury preventing design	Necessary protecting devise is set appropriately, and no contact happens between human limb and dangerous surface	Protecting devise is deficient or human limb contact with the dangerous surface sometimes	Few protecting devise could be discovered or human limb always contact with dangerous surface
	Electrical injury preventing design	Electric power is shut down in simulation and corresponding electricity cables wire away from sharp edge probably	Live working is avoided but electricity cables contact with sharp edge in several conditions	Live working is not avoided no matter electricity cables wire probably or not
	Mechanical injury preventing design	Sharp edge is chamfered comprehensively and precisely	Chamfer is missing in some necessary position	Few chamfer occurred

2.3.4. Eco-Design

2.3.4.1. Eco-design definition

Because of climate change and environmental awareness, developing new products or systems to improve the population’s life quality and comfort involves more and more environmental impacts. Moreover, the augmentation of energy consumption causes the fast decrease of fossil resources. To design a sustainable product or system, it becomes a necessity to take a new environmental dimension in the development process. The first environmental impact assessment appeared in the 1960’s and took various steps of the product lifetime into account (used resources, fabrication, use and recycling end-of-life).

In companies, the reflection of including environmental aspects in the design processes is often considered to reach certain objectives such as diminishing energy consumption, using more environmental-friendly materials and technologies or improving the product's recyclability. The purpose of eco-design is the reduction of the product (or system) environmental impacts during its life cycle. With the enrichment of emission databases, it is possible to assess all aspects of a system life cycle in the design stage from the material extraction to its disposal (or reuse, recycle...) through processing, manufacture, distribution, use, repair and maintenance.

Eco-design is defined in international norms (ISO 14062 2002) and by the European Environment Agency (EEA) as integrating environmental aspects during the system development process. Figure 2-10 shows the environmental aspect integration proposed by Le Pochat, Bertoluci, and Froelich (2007). Two main activities are included in the conceptual and detailed design phases: environmental assessment and environmental improvement. Eco-design includes theory, methods, metrics, and software to enable the assessment, improvement and decision-making during each phase.

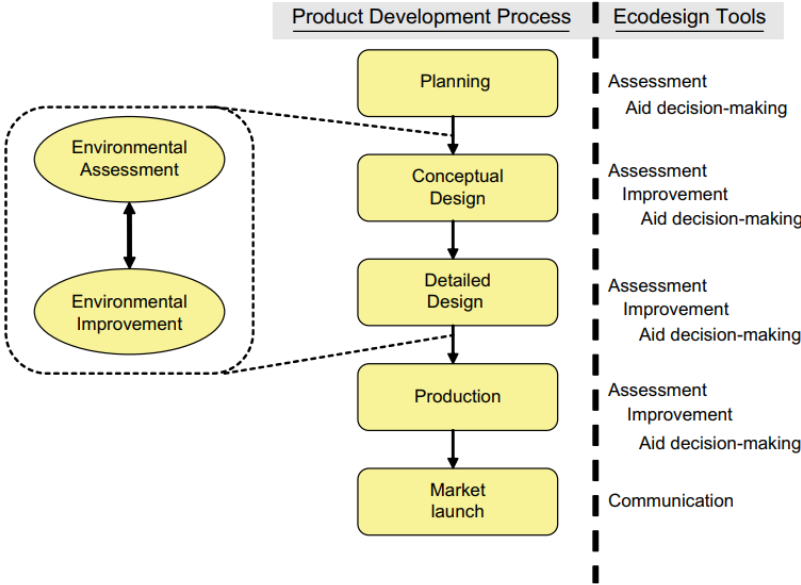

Figure 2-10. Eco-design tools and their use in the product development process from (Le Pochat,

Bertoluci, and Froelich 2007)

Vallet et al. (2013) conducted observation in groups of experienced eco-designers and highlighted the similarity between eco-design and traditional design processes in the general structure. They can be differentiated by “the environmental assessment, the solution finding and strategy definition”. The next section presents environmental impact assessment tools and how they have been used for refrigeration systems.

2.3.4.2. Environmental impacts assessment

Environmental impacts of refrigeration systems can be assessed by different indicators such as CO₂ emissions and ozone depletion potential, different metrics such as CML or EcoIndicators, and different tools such as SimaPro, OpenLCA, or GaBi. This section presents multiple methods for assessing the environmental impacts of refrigeration systems.

First, Life Cycle Assessment (LCA) is widespread in the academic and industrial worlds. LCA allows having a global and complete picture of the impacts of each process in the lifecycle of a product. In 1994, the international normalization fixed the methodology and the deontology to adopt when an LCA study is conducted. From the ISO norm (ISO 14044 2006), LCA is defined as “a compilation and assessment of inputs, outputs and potential environmental impacts of products system during its lifecycle”. An LCA study is conducted in four main steps described in ISO norms 14040 and 14044 and shown in Figure 2-11:

- Context, goal, boundaries, method and functional unit definition
- Life Cycle Inventory (LCI)
- Impacts assessment (mid-points or end-points indicators)
- Interpretation and results analysing

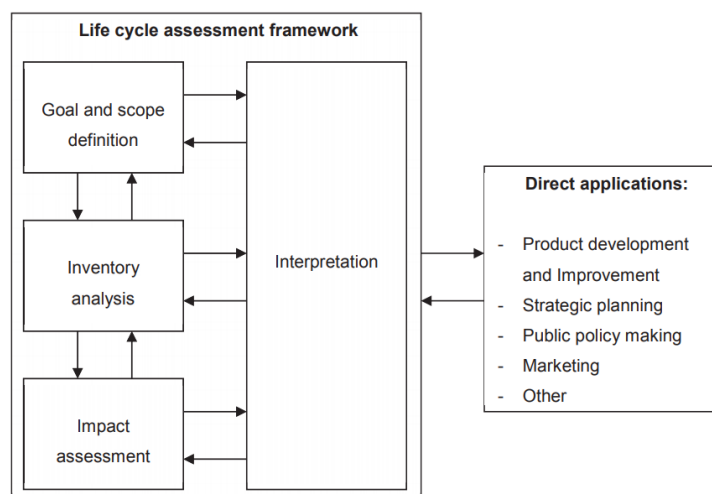

Figure 2-11. Steps of an LCA study from (ISO 14044 2006)

Secondly, the Total Equivalent Warming Impact (TEWI) is a method for evaluating refrigeration systems' Global Warming Potential (GWP) during the exploitation phase. It characterizes the CO₂ emissions of a refrigeration system on the greenhouse effect. It takes into account direct impacts, such as refrigerant leakage, and indirect impacts, such as the CO₂ emitted during the production of electricity required to operate the system.

Finally, the Life Cycle Climate Performance (LCCP) evaluates the GWP of refrigeration systems through the whole life cycle. In addition to the emissions calculated with TEWI, the LCCP method proposes to add the CO₂ emissions due to the other phases of the life cycle, i.e. manufacturing and end-of-life treatment.

The assessment of the environmental impacts of refrigeration systems is increasingly being studied. However, there is difficulty finding comprehensive data to ensure the robustness of the results.

Bovea et al. (2007) evaluated the environmental impact of different refrigerants in cooling systems in a supermarket. The study compares different scenarios with three refrigeration systems: a direct system, a system with a secondary loop and a refrigerant, and a distributed system, as well as three types of refrigerants: HCFHs, HFCs and natural refrigerant. With the lowest potential environmental impacts, it appears that the use of a natural fluid is the most suitable fluid to replace HCFHs and HFCs.

In a more recent study, Petersen et al. (2019) investigated the LCCP of different refrigerant architectures: a direct expansion system using R448A, a CO₂ transcritical booster and an R290 self-contained system. They compared the systems configurations in different cities and observed that the main impacts came from the electric mix of the region. For example, in countries that use mainly hydroelectric power, the impacts are lower than those that use mainly fossil fuel for electric production. They also highlighted that the direct expansion systems consumed around 7% less than the CO₂ transcritical booster and R290 system.

Table 2-5 summarizes a few existing papers on environmental impact assessment for cold applications. A general conclusion in these studies is the importance of the systems energy consumption towards climate change indicators. Indeed, it is the most influencing factor during the use phase of the system lifetime. The environmental impact assessment of complex systems, such as refrigeration systems, has some limits highlighted in different studies: it is time-consuming, a lack of studies and available data, and a lack of transparency.

Table 2-5. Summary of some related works on environmental impact assessment of refrigeration systems.

Authors and date	Location	Description	Environmental impact assessment method
(Maykot, Weber, and Maciel 2004)	Brazil	<i>Evaluation of typical refrigeration equipment for household and light commercial applications in North America, Europe and Asia with different refrigerant</i>	TEWI metric
(Youbi-Idrissi 2006)	France	<i>Comparative study of direct and indirect systems in France and in Germany for MT an LT</i>	SimaPro Eco-indicator 99 (E)
(Bovea, Cabello, and Querol 2007)	Spain	<i>Comparative study of environmental impacts of commonly used refrigerants (HCFCs, HFCs and natural ones), with different commercial refrigeration systems for MT and LT</i>	SimaPro 1) CML 2) Eco Indicators 95, 99 and EPS 00
(Beshr et al. 2015)	USA	<i>Analyse of the LCCP for supermarket systems with different refrigerants in six regions with climate differences</i>	LCCP metric
(Cascini et al. 2016)	Italy	<i>Evaluation of refrigeration systems under different configurations for MT</i>	SimaPro IPCC 2007 GWP 100a
(Islam et al. 2017)	Japan	<i>Environmental impact assessment of supermarket refrigerating systems using different refrigerant</i>	TEWI metric

2.4. Design problem-solving methods

In section 2.3.1, different activities in the design processes were described: definition of requirements, solutions research, detailed design, embodiment design with simulations, prototyping, dimensioning, etc. During these steps, decisions are taken toward multiple “best” solutions. In a complex system design problem, as for the design of a refrigeration system, multiple actors with different expertises and objectives collaborate. The association of different actors in the same design problem is called collaborative design. It can be centralized, or in the most frequent case, decentralized, i.e. the decision is distributed, and the design problem is divided into sub-problems (Papalambros, Michelena, and Kikuchi 1997). The design decisions are taken based on several criteria' analysis, maximisation or minimisation, sometimes conflicting (Stadler 1988). The mathematical representation of the decision objectives to fulfil is called optimisation.

Multi-disciplinary optimisation (MDO) is an engineering field composed of approaches, methods, and tools to solve design problems of systems with many domains such as automobile, building, space.

2.4.1. Interaction representation

In a multidisciplinary system, such as a refrigeration system, a discipline models a sub-part of a system with equations or simulations, and links input and output variables. For refrigeration systems, various disciplines as energy, economy, environmental impacts, lifetime, ease of installation need to be considered.

MDO can be summarized as developing strategies from current analysis tools and optimization techniques that help the engineers make the best decision during the design process to obtain optimized complex products or systems. Several types of graphs to model the interactions between disciplines could be considered to ensure relevant modelling of the system to optimise. They allow the identification of the connections between the disciplines and the optimisation of mathematical models. Design structure matrix (DSM) (see Figure 2-12) provides a clear and readable representation of the system to optimize (see (Eppinger and Browning 2012)). It is adapted to physical systems, organisations and processes. If an interaction exists between the disciplines, a cross is displayed in the table. If there is no interaction between the two disciplines, the box is blank. The black circle means that it is the same discipline. The interactions can be sequential, parallel or coupled (see Figure 2-13).

	A	B	C	D	E	F	G	H	I
A	●	X							
B		●		X				X	
C	X	X	●			X			
D			X	●			X		X
E				X	●				
F	X	X				●	X		
G		X				X	●	X	
H				X	X			●	
I				X					●

Figure 2-12. Example of a Design structure Matrix (DSM) to model the interactions between disciplines.

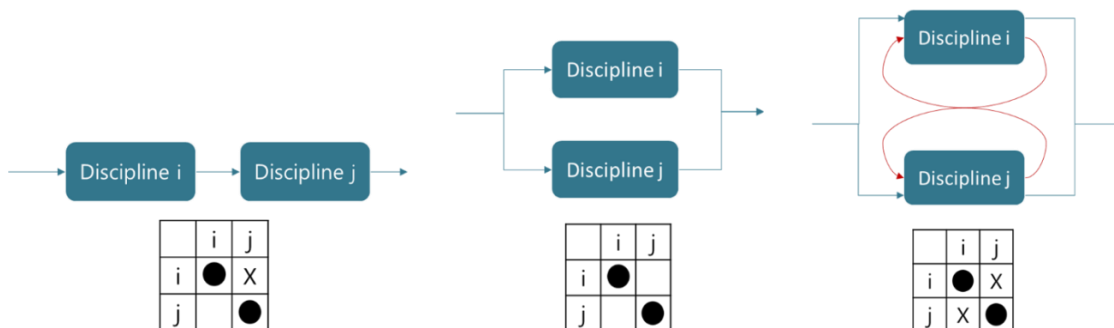

Figure 2-13. Discipline interactions: sequential (left), parallel (centre), coupled (right)

2.4.2. Multi-objectives and multi-disciplinary optimisation principle

After examining and clearly showing the interaction between disciplines or criteria, a mathematical function is established to determine the values of the unknown variables, called design variable X , that minimize or maximize the objective function f while satisfying the constraints C . The design space is composed of all the feasible solutions (points) satisfying this problem. The need for optimisation methods appears to reduce this space to optimal feasible points.

A mono-objective function can be described in Eq (1-1).

$$\begin{cases} \min_{x \in X} f(x) \text{ (or } \max f(x)) \\ \text{with} \\ x \in C \end{cases} \quad (2-1)$$

These methodologies have been extensively studied. Two classes of design optimisation can be cited: mono-objective optimisation that gives a single point as the result of the process and multi-objective optimisation. The problems are multi-disciplinary and multi-objectives (or multi-criteria) in real-life cases. Thus, the optimisation functions are multiple f_1, f_2, \dots, f_n . The multi-objective problem can be summarized in Eq (1-2).

$$\begin{cases} \min_{x \in X, i=1,2 \dots n} f_i(x) \text{ (or } \max) \\ \text{with} \\ x \in C \end{cases} \quad (2-2)$$

The development of multi-criteria optimisation has permitted the exploration of solution space and allows the decision-maker to compare several designs. When a solution cannot be decided as better than another, compromises must be made among a set of non-dominated solutions called Pareto frontier and Pareto set (See Figure 2-14). However, in this case, the design space needs to be fully explicit and understood by the users involved in the decision process.

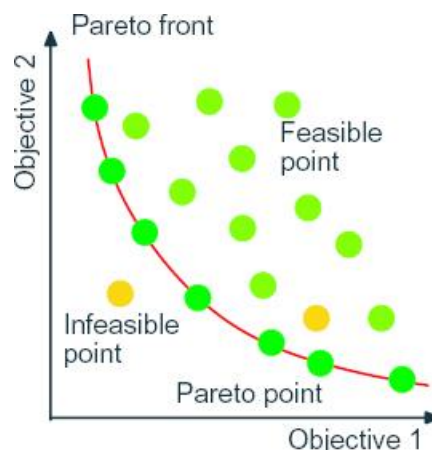

Figure 2-14. Two-dimensional-(2D) Pareto front (red line and dark green circles). The light green dots are feasible points, whereas the yellow ones indicate infeasible solutions with respect to the constraints. (Gollub and de Vivie-Riedle 2009)

2.4.4. Design problem resolution

Optimisation methods are used to resolve design problems by highlighting a set of feasible points in the design space. However, different approaches can be applied depending on the design problem and the stakeholder involved in the process. The decision-maker's preferences are taken into account in three different ways in the decision process: *a priori*, *a posteriori* or *iteratively* (Korhonen, Moskowitz, and Wallenius 1992). In an *a priori* method, the decision-maker puts his preferences before the optimisation process, for example, weighted sum, min-max, goal programming methods. In *a posteriori* and iterative methods, the preferences are considered after the optimisation process once the solutions are visualized. In this section, a quick overview of the existing methods is presented.

2.4.4.1. Point-based design

Deterministic methods are traditional processes where the solutions are particular points in the design space. In this approach, the iterative trade-off process is point-based. For example, a multi-objective optimization for supermarket refrigeration systems was conducted by (Glavan et al. 2016). They consider various discrete events: consumer interactions, defrosting schedule, and product refilling. This work aimed to optimise the supermarket total energy costs by constraining two criteria: defrosting schedule and energy optimization actions. They compare the results of different simulations to conclude on the parameters influence. It gives preliminary results before the implementation of the system. However, a limitation of this method highlighted by several works (Sobek II, Ward, and Liker 1999) is the restriction of the design space to an acceptable but not Pareto-optimal solution because of the specifications. The lack of know-how to list all the possible alternatives can result in the limitation of the tested alternatives and thus the design space.

2.4.4.2. Set-based design

Concurrent engineering (CE) and, more specifically, set-based design (SBD) can prevent the limitation of deterministic approaches by restricting the design space concurrently between the actors. All the decisions are taken in parallel to reduce the design space toward feasible points that fulfil all the objectives. Uncertainty reduction theory reduces the uncertainty through the iterative reduction of the variables range and the decision-maker knowledge gain (Canbaz, Yannou, and Yvars 2013). In the early design stages, constraint problem (CP) techniques are used to support SBD and uncertainty reduction as it places the decision-maker at the centre of the problem by formalizing the decision in the form of constraints. CP techniques help define consistent feasible design points (Yannou et al. 2005; 2013). These approaches reduce the design space progressively and converge to one or multiple feasible solutions.

2.4.4.3. Design space exploration

The common tasks of designing a product or a system based on optimization methods can

make the designers frustrated from the results (Balling 1999). Design space exploration (DSE) can be used to quickly generate and simulate a set of feasible solutions, optimise if metrics are available to compare design solutions, find the architecture, and dimension the components that satisfy the design constraints (Kang, Jackson, and Schulte 2010). DSE can help the designer explore an extended design space by gaining knowledge on the possible alternatives. He can then choose the best solution based on the visualization of all the possibilities (Abi Akle, Yannou, and Minel 2019). The thesis's proposed work is based on the design space exploration approaches. These are further developed in the contribution chapters.

Software and other digital tools have been developed in the last decades to help the simulation and design optimization of refrigeration systems. The next section provides an overview and comparison of some existing tools.

3. Design and simulation of refrigeration systems

As described previously, refrigeration systems in a supermarket are responsible for almost half of the yearly energy consumption. Therefore, they have a great potential for optimization. According to audits carried out in European countries (UK, Italy, Switzerland, Denmark, Bulgaria and Belgium) by Evans and al. (Evans et al. 2014), many issues are responsible for energy loss. Figure 2-15 presents all the issues encountered in the audit. Evans and al. identified energy savings of between 8 and 82% if appropriate changes were made.

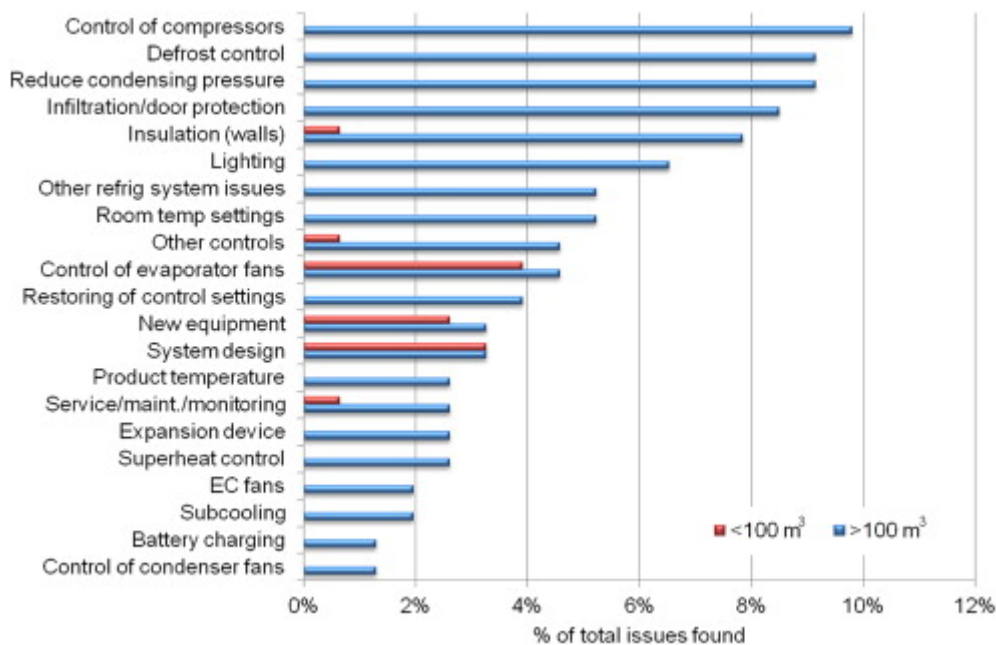

Figure 2-15. Issues identified by (Evans et al. 2014)

Many tools have been developed to support the design of optimal refrigeration systems and the understanding of existing and new refrigeration technologies. In the next section, the system performance assessment in industrial engineering is discussed, and a list of refrigeration system performances is defined based on the literature and the industry

observation. Then, a comparison of different tools is made to identify their shortcomings.

3.1. Refrigeration system design problem setting

In this section, the specifications needed to design a refrigeration system are briefly presented, and the criteria or objectives are discussed.

3.1.1. Design of a refrigeration system

To design a refrigeration system, the steps to follow are the typical steps of a design process presented in section II.3. Refrigeration systems can be sized according to cold demand, operating conditions and location (weather conditions, electricity mix...). They can be either built from scratch or can be modified from an existing system. In this case, it is important to assess the interest of this modification beforehand.

They are assessed mainly by technical, environmental and economic performances, but other performances are proposed in the next section.

Different choices are to be done on the configuration to design a refrigeration system. In addition to the dimension of the evaporators for the frigorific power need, the designers choose the architecture (see examples in section 1.) and the components associated. It mainly comprises the type and number of compressors, condensers, expansion valves, and evaporators. Depending on the client's specifications, it also counts the pipeline configuration, the electronics, recovery bottles, and other specific components.

3.1.2. Design criteria and performances

Typically, the design criteria for a system user, for example, a supermarket manager, are the system's costs and energy consumption. In the literature, the simulation and optimization of these two criteria are widely studied (Ge and Tassou 2011a; Acha, Du, and Shah 2016; Ben-Abdallah et al. 2019; Gullo, Elmegaard, and Cortella 2016; Mitsopoulos et al. 2019). For example, Ge and Tassou (2011a) assessed the total energy consumption as the sum of the energy consumption of the various subsystems. They showed that the model can carry out hourly system simulations and can be used to investigate the influence of component design and optimize with *a priori* method the overall system energy consumption. The model was validated by data collected in an instrumented supermarket.

However, for a supplier and considering the whole life cycle of a refrigeration system, costs and energy consumption are not the only performances to consider when deciding. Indeed, one can add the environmental impacts, the maintenance, the operator knowledge, the risk, etc. Shahrestani et al. (2018) provide a multi-disciplinary decision-making tool based on three main criteria: technical (energy consumption, thermal comfort and indoor air quality), economic (initial and operational cost), and environmental (CO₂ emissions).

Several criteria should be satisfied to design a refrigeration system based on quantitative and qualitative performances. In engineering design, Ulrich and Eppinger defined a product

performance as « how well a product implements its intended function. Typical performance characteristics are efficiency, life [...], energy consumption. » (Ulrich and Eppinger 2016). The definition of performances for refrigeration systems design problem is discussed in Chapter 5.

Quantitative performances are defined as outputs that can be calculated or estimated through mathematical models:

- *Energy consumption*: quantity of energy consumed by all the refrigeration system components (compressors, pumps, fans...)
- *Environmental impacts*: GWP, ODP, acidification, eutrophication, resources depletion, ecotoxicity, human toxicity...
- *Economic*: different costs of the system (components, installation, maintenance, refrigerant, energy use, etc.)
- *Space used*: space used by the refrigeration system components, the pipelines, the fans, etc.

Qualitative performances are the ones evaluated qualitatively (description and evaluation according to qualitative criteria):

- *Installation conditions*: ease of installation of the components and the system and necessary operator's knowledge
- *Maintenance condition*: conditions for the maintenance of components (necessary training of the operators, ergonomic of the machine, accessibility, etc.)
- *Technology Readiness Level (TRL)*: technology maturity, to address the reliability of the selected solution. The exploiting risk increases as the TRL of technology lowers.
- *Temperature maintenance capacity*: capacity of the system to maintain the temperature through the demand peaks.
- *Lifetime*: system physical component's lifetime (compressor, condenser, expansion valve, pump...)

The next section compares tools based on the list of criteria or performances. We try to identify the existing gaps related to these platforms.

3.2. Comparison of different design and simulation platforms

An overview of existing digital tools for the design and simulation of refrigeration systems is presented in the appendix. The tools can be used for industrial refrigeration system planning (HVACR) and research purposes. This section aims to compare the existing tools for the design of refrigeration systems and identify their main specification and scope. These tools are commonly used, in France or abroad, by refrigeration engineers, designers, consultants and researchers to assess the various possible options.

In Table 2-6, the tools compared are the following: CoolPack, CoolTool, PackCalculationPro, CoolSelector, CyberMart, Manufacturer software, EnergyPlus, SuperSmart and other types of digital tools. They are chosen based on their main purpose to support the design of refrigeration systems. It includes the support to choose components, architecture and refrigeration, simulate the system performances, optimize the system based on different criteria, and compare solutions on one or more criteria.

Six criteria are used to compare existing tools for the design and simulation of refrigeration systems:

- Language: programming language or tools used for the development of the software and the models
- Modularity: possibility of a tool to assess the user's specific system and to add a new model into the software
- Decision aid tool: different levels are specified to assess the capacity of the platform to help decision making: it can help the dimensioning of the components, it can simulate and optimize the system in operating conditions, it can compare solutions, it can help build an operational strategy.
- Required knowledge: the level of knowledge required to use the platform (* = minimum level; + = medium level; ++ = expert level)
- Type of licence: free, open-source, or the user needs to pay for its use.
- Scope of the tool: type of architectures and components modelled in the tool.

Table 2-6 presents a comparison of different platforms for the design and assessment of refrigeration systems based on the eight criteria.

Table 2-6. Table of the different platform specifications.

Software specifications								
Name	References	Release	Langage	Modularity	Decision aid tool	Required knowledge	Type of licence	Scope
CoolPack	(Jakobsen, Rasmussen, and Andersen 1999)	First release 1995	OOP: Pascal and Delphi	No	Simulation of energy consumption and comparison of refrigerant	+	Free	Vapour compression refrigeration Systems
CoolTool	(CoolTool Technology GmbH 1995)	First release 1999	Engineering Equation Solver	Not yet available (but a large database of parts)	Simulation of cooling load and comparison of plant structure	+	Paid	Refrigeration Systems
PackCalculationPro	(IPU, n.d.)	Lastest release 2021	NA	No (but a large database of compressors)	Simulation of energy consumption and operational strategy	+	Depends on the use	Refrigeration Systems
CoolSelector	(Danfoss, n.d.)	Lastest release 2021	NA	No (but large database from Danfoss)	Choice of best components for energy consumption based on an optimisation	*	Free	Refrigeration Systems components
CyberMart	(Arias 2005)	First release 2005	OOP: Delphi	No	Simulation of maximum 2 solutions and comparison between them	+	Free	Supermarket building and RS
Manufacturer software		Other	Other	No	Simulation of cooling load (mainly)	+	Free (for most)	Refrigeration sub systems
EnergyPlus	(U.S. Department of Energy's Building Technologies Office, n.d.)	Lastest release 2021	Fortran 90/95	Yes (code available)	Simulation of the energy consumption in a building	++	Free (open source)	Building energy simulation
SuperSmart	(<i>SuperSmart</i> , n.d.)	2012	NA	Possible	Simulation of the energy consumption of refrigeration system – possibility to assess the sub-systems	+	NA	Supermarket building and Ref sub systems

3.2.1. Inputs

For calculating energy consumption, certain inputs related to operating conditions are required from the user: cooling capacity, evaporation, and condensation temperature... For some tools, such as CoolPack, CyberMart, CoolSelector or Bitzer manufacturer software, the user can choose compressor, refrigerant, expansion valve from the database and iterate the simulation for the comparison of different alternatives.

3.2.2. Outputs

Table 2-7 presents the performances calculated by the different tools. The performances assessed in the design and simulation platforms previously presented are compared.

The platforms provide the user with different performances, quantitative or qualitative. The main results displayed are energy consumption and frigorific power for all of them. Moreover, installation and maintenance costs are often calculated as there is important information for the user to make a decision. The third most common performance is the environmental impact. They are mostly calculated based on the TEWI indicator, which is easy to calculate. The notions of ease of installation, technological maturity and know-how are often put aside because they are very complicated to consider in a classic optimisation approach and the early design stages, i.e. the system is not yet in place.

The interest of this type of platform is to provide users with some tools to dimension a system. However, users may lack an integrated approach to the design problem, i.e. taking into account several performances simultaneously.

Table 2-7. Table of the different outputs assessed on the platforms.

	Quantative performances				Qualitative performances			
	Energy consumption	Environmental impacts	Costs	Space used	Installation conditions	Maintenance conditions	Technology TRL	Lifetime
CoolPack	Yes	No	Yes	Yes	Through costs	Through costs	No	Yes
CoolTool	Yes	TEWI	No	No	No	No	No	No
PackCalculationPro	Yes	TEWI	Yes	No	Through costs	Through costs	No	No
CoolSelector	Yes	No	No	Yes	*	No	No	No
CyberMart	Yes	TEWI	Yes	Yes	Through costs	Through costs	No	Yes
Manufacturer software	Yes	No	No	Yes	Yes	No	No	Yes
EnergyPlus	Yes	No	No	No	No	No	No	No
SuperSmart	Yes	Yes	Yes	No	Through costs	Through costs	No	No
SuperSim	Yes	No	Yes	No	Through costs	Through costs	No	Yes

*Instructions from the manufacturer

The main gap highlighted in the presentation of these platforms for the design and simulation of refrigeration systems is the top-down simulation approach: one needs to first formulate the design problem (inputs), then execute the algorithm implemented in the tool to visualize the results. If the user is satisfied with the results, he selects the solution, and if not, he reiterates the same steps. These tools do not allow users to interact simultaneously between the performances and the system design.

4. Synthesis and Research gaps

The literature review allowed us to identify research works related to our problem and highlight the main research gaps related to the design and simulation of refrigeration systems toward optimal systems.

The review of refrigeration system design provided an overview of the refrigeration system composition, the performances studied in the literature and industry, and existing simulation tools to support the design of refrigeration systems. The review in system engineering points out the need to understand the system structure and its behaviour in its exploitation environment and the design (or decision) process.

Some limits or research gaps can be listed:

- Research gap 1: Lack of a holistic representation of the refrigeration socio-technical system.

To provide a relevant answer to improving the design process toward optimal solutions, it is necessary to represent and understand how refrigeration systems are built, who takes decisions, how and when in the process decisions are taken, i.e., understand the refrigeration socio-technical system. Very few works can be found on a holistic representation in the literature.

- Research gap 2: Lack of an integrated approach

Refrigeration systems have been widely studied in the literature. The performances of new and existing technologies are evaluated to characterize the system behaviour in use cases, i.e. mechanical and thermodynamics study of the systems; assessment of energy and environmental performances; cost assessment. These models and tools have been developed to support the design of refrigeration systems. However, the review of the tools highlights the lack of tools that could propose an integrated approach. It means that it misses to the users a complete view of the performance of a refrigeration system simultaneously and in the early design phase (detailed and embodiment design). Indeed, industrial performances are necessary to compare different technologies in real conditions. The missing performances are mainly qualitative performances such as ease of maintenance and technological maturity and quantitative performances such as cost for different architectures and environmental impacts. The performances also need to be assessed simultaneously in the same supporting tool for an optimal system design.

- Research gap 3: Lack of user integration in the design process

Digital tools such as the simulation platforms presented in section 3 have shown their usefulness to perform simple and repetitive tasks, such as choosing components from a catalogue, calculating

thermos-physical property data, and dimensioning a system based on energy consumption. However, the solution proposed is represented by a single point in the design space, as in a classical design process. If there are hundreds or thousands of possible solutions, this approach is irrelevant. Indeed, it can be a time-consuming and tiresome activity for the user, and the obtained solutions depend on the designer's expertise (Tweedie et al. 1996). Moreover, as explained in the literature review, the traditional design process can frustrate users with the results obtained. Indeed, he is not a part of the process, i.e. intervention at the beginning and the end.

Based on this literature review, it is possible to identify the different approaches and design artefacts of system engineering and industrial design that are relevant to fill the research gaps. Research questions and objectives were defined to answer each research gap, and a relevant methodology was proposed, discussed and explained in Chapter 3.

References

- Abi Akle, Audrey, Bernard Yannou, and Stéphanie Minel. 2019. 'Information Visualisation for Efficient Knowledge Discovery and Informed Decision in Design by Shopping'. *Journal of Engineering Design*.
- Acha, Salvador, Yujia Du, and Nilay Shah. 2016. 'Enhancing Energy Efficiency in Supermarket Refrigeration Systems through a Robust Energy Performance Indicator'. *International Journal of Refrigeration* 64 (April): 40–50. <https://doi.org/10.1016/j.ijrefrig.2015.12.003>.
- ADEME, and Enertech. 2001. 'Diagnostic Électrique d'un Supermarché de Moyenne Surface'.
- Alwashdeh, Saad S., and Handri Ammari. 2019. 'Life Cycle Cost Analysis of Two Different Refrigeration Systems Powered by Solar Energy'. *Case Studies in Thermal Engineering* 16 (December): 100559. <https://doi.org/10.1016/j.csite.2019.100559>.
- Amrina, Elita, Insannul Kamil, and Dhova Aridharma. 2020. 'Fuzzy Multi Criteria Approach for Sustainable Maintenance Performance Evaluation in Cement Industry'. *Sustainable Manufacturing - Hand in Hand to Sustainability on Globe: Proceedings of the 17th Global Conference on Sustainable Manufacturing* 43 (January): 674–81. <https://doi.org/10.1016/j.promfg.2020.02.125>.
- Arias, Jaime. 2005. 'Energy Usage in Supermarkets-Modelling and Field Measurements'. KTH.
- ASHRAE. 2008. *ASHRAE Handbook—HVAC Systems and Equipment*. ASHRAE Atlanta, GA.
- Baheta, Aklilu Tesfamichael, Suhaimi Hassan, Allya Radzihan B. Reduan, and Abraham D. Woldeyohannes. 2015. 'Performance Investigation of Transcritical Carbon Dioxide Refrigeration Cycle'. *Procedia Cirp* 26: 482–85.
- Balling, Richard. 1999. 'Design by Shopping: A New Paradigm'. In *Proceedings of the Third World Congress of Structural and Multidisciplinary Optimization (WCSMO-3)*, 1:295–97. University at Buffalo, Buffalo, NY.
- Ben-Abdallah, R., D. Leducq, H.M. Hoang, L. Fournaison, O. Pateau, B. Ballot-Miguët, and A. Delahaye. 2019. 'Experimental Investigation of the Use of PCM in an Open Display Cabinet for Energy Management Purposes'. *Energy Conversion and Management* 198 (October): 111909. <https://doi.org/10.1016/j.enconman.2019.111909>.
- Beshr, M., V. Aute, V. Sharma, O. Abdelaziz, B. Fricke, and R. Radermacher. 2015. 'A Comparative Study on the Environmental Impact of Supermarket Refrigeration Systems Using Low GWP Refrigerants'. *International Journal of Refrigeration* 56 (August): 154–64. <https://doi.org/10.1016/j.ijrefrig.2015.03.025>.
- Bovea, María, Ramon Cabello, and Daría Querol. 2007. 'Comparative Life Cycle Assessment of Commonly Used Refrigerants in Commercial Refrigeration Systems'. *International Journal of Life Cycle Assessment* 12 (July): 299–307. <https://doi.org/10.1065/lca2007.06.346>.
- Buckminster Fuller, Richard. 1946. 'A Comprehensive Anticipatory Design Science', *Royal Architectural Institute of Canada Journal*, Volume 1 (1924) - Volume 36 (1959), 34 (385): 357–61.
- Canbaz, Baris, Bernard Yannou, and Pierre-Alain Yvars. 2013. 'Improving Process Performance of Distributed Set-Based Design Systems by Controlling Wellbeing Indicators of Design Actors'. *Journal of Mechanical Design* 136 (2): 021005-021005–10. <https://doi.org/10.1115/1.4026034>.

- Cascini, Alessandro, Mauro Gamberi, Cristina Mora, Michele Rosano, and Marco Bortolini. 2016. 'Comparative Carbon Footprint Assessment of Commercial Walk-in Refrigeration Systems under Different Use Configurations'. *Journal of Cleaner Production* 112 (January): 3998–4011. <https://doi.org/10.1016/j.jclepro.2015.08.075>.
- Cluzel, François, Bernard Yannou, Yann Leroy, and Dominique Millet. 2012. 'Proposition for an Adapted Management Process to Evolve from Unsupervised Life Cycle Assessment of Complex Industrial Systems towards an Eco-Designing Organization'. *Concurrent Engineering Research and Applications* 20 (2): 111–26.
- CoolTool Technology GmbH. 1995. CoolTool. http://www.cooltool-software.com/index_english.htm.
- Danfoss. n.d. Coolselector®2. <https://www.danfoss.com/en/service-and-support/downloads/dcs/coolselector-2/#tab-overview>.
- DelVentura, Robert, Celena L. Evans, and Ira Richter. 2007. 'Secondary Loop Systems for the Supermarket Industry'. Bohn White Paper Setembro De.
- Eppinger, Steven D., and Tyson R. Browning. 2012. *Design Structure Matrix Methods and Applications*. MIT press.
- Evans, J.A., E.C. Hammond, A.J. Gigieli, A.M. Fostera, L. Reinholdt, K. Fikiin, and C. Zilio. 2014. 'Assessment of Methods to Reduce the Energy Consumption of Food Cold Stores'. *Applied Thermal Engineering* 62 (2): 697–705. <https://doi.org/10.1016/j.applthermaleng.2013.10.023>.
- Fatfouta, Naouress. 2020. 'Towards a Support System for Simulation Aided-Design in the Development Phase of Automotive Industry'. PhD Thesis. <http://www.theses.fr/2020UPASC025/document>.
- Ge, Y.T., and S.A. Tassou. 2011a. 'Performance Evaluation and Optimal Design of Supermarket Refrigeration Systems with Supermarket Model "SuperSim", Part I: Model Description and Validation'. *International Journal of Refrigeration* 34 (2): 527–39. <https://doi.org/10.1016/j.ijrefrig.2010.11.010>.
- Ge, Y.T., and S.A. Tassou. 2011b. 'Thermodynamic Analysis of Transcritical CO₂ Booster Refrigeration Systems in Supermarket'. *Energy Conversion and Management* 52 (4): 1868–75. <https://doi.org/10.1016/j.enconman.2010.11.015>.
- Geng, Jie, Dong Zhou, Chuan Lv, and Zili Wang. 2013. 'A Modeling Approach for Maintenance Safety Evaluation in a Virtual Maintenance Environment'. *Computer-Aided Design* 45 (5): 937–49.
- Glavan, Miha, Dejan Gradišar, Serena Invitto, Iztok Humar, Đani Juričić, Cesare Pianese, and Damir Vrančić. 2016. 'Cost Optimisation of Supermarket Refrigeration System with Hybrid Model'. *Applied Thermal Engineering* 103 (June): 56–66. <https://doi.org/10.1016/j.applthermaleng.2016.03.177>.
- Gollub, C, and R de Vivie-Riedle. 2009. 'Multi-Objective Genetic Algorithm Optimization of 2D- and 3D-Pareto Fronts for Vibrational Quantum Processes'. *New Journal of Physics* 11 (1): 013019. <https://doi.org/10.1088/1367-2630/11/1/013019>.
- Gullo, Paride, Brian Elmegaard, and Giovanni Cortella. 2016. 'Energy and Environmental Performance Assessment of R744 Booster Supermarket Refrigeration Systems Operating in Warm Climates'. *International Journal of Refrigeration* 64 (April): 61–79. <https://doi.org/10.1016/j.ijrefrig.2015.12.016>.
- He, Yang, Jianqiang Deng, Fusheng Yang, and Zaoxiao Zhang. 2017. 'An Optimal Multivariable

- Controller for Transcritical CO₂ Refrigeration Cycle with an Adjustable Ejector'. *Energy Conversion and Management* 142: 466–76.
- He, Yang, Jianqiang Deng, and Z Zhang. 2014. Thermodynamic Study on a New Transcritical CO₂ Ejector Expansion Refrigeration System with Two-Stage Evaporation and Vapor Feedback. Vol. 20. <https://doi.org/10.1080/10789669.2014.929422>.
- Horton, William Travis. 2004. 'Modeling of Secondary Loop Refrigeration Systems in Supermarket Applications.'
- IEA. 2020. 'Cooling Emissions and Policy Synthesis Report'. Paris. <https://www.iea.org/reports/cooling-emissions-and-policy-synthesis-report>.
- Imamura, Tomohiko, Kyoko Kamiya, and Osami Sugawa. 2015. 'Ignition Hazard Evaluation on A2L Refrigerants in Situations of Service and Maintenance'. *Journal of Loss Prevention in the Process Industries* 36 (July): 553–61. <https://doi.org/10.1016/j.jlpi.2014.12.018>.
- IPU. n.d. PackCalculationPro. <https://www.ipu.dk/products/pack-calculation-pro/>.
- Islam, Md. Amirul, K. Srinivasan, Kyaw Thu, and Bidyut Baran Saha. 2017. 'Assessment of Total Equivalent Warming Impact (TEWI) of Supermarket Refrigeration Systems'. *International Journal of Hydrogen Energy* 42 (43): 26973–83. <https://doi.org/10.1016/j.ijhydene.2017.07.035>.
- ISO 14044. 2006. 'Environmental Management -- Life Cycle Assessment -- Requirements and Guidelines'.
- ISO 14062. 2002. 'Management Environnemental -- Intégration Des Aspects Environnementaux Dans La Conception et Le Développement de Produit'.
- Jakobsen, Arne, Bjarne D. Rasmussen, and Simon Engedal Andersen. 1999. 'CoolPack–Simulation Tools for Refrigeration Systems'. *Scan Ref* 28 (4): 7–10.
- Jiang, J., M. Shiu, and M. Tu. 2007. 'DFX and DFSS: How QFD Integrates Them'. *Quality Progress* 40 (10): 45.
- Kang, Eunsuk, Ethan Jackson, and Wolfram Schulte. 2010. 'An Approach for Effective Design Space Exploration'. In *Monterey Workshop*, 33–54. Springer.
- Kazachki, Georgi S., and David K. Hinde. 2006. 'Secondary Coolant Systems for Supermarkets'. *ASHRAE Journal* 48 (9): 34–47.
- Korhonen, Pekka, Herbert Moskowitz, and Jyrki Wallenius. 1992. 'Multiple Criteria Decision Support - A Review'. *European Journal of Operational Research* 63 (3): 361–75. [https://doi.org/10.1016/0377-2217\(92\)90155-3](https://doi.org/10.1016/0377-2217(92)90155-3).
- Kosky, Philip, Robert Balmer, William Keat, and George Wise. 2021. 'Chapter 11 - Industrial Engineering'. In *Exploring Engineering (Fifth Edition)*, edited by Philip Kosky, Robert Balmer, William Keat, and George Wise, 229–57. Academic Press. <https://doi.org/10.1016/B978-0-12-815073-3.00011-9>.
- Kumar Singh, Kaushalendra, Rajesh Kumar, and Anjana Gupta. 2020. 'Comparative Energy, Exergy and Economic Analysis of a Cascade Refrigeration System Incorporated with Flash Tank (HTC) and a Flash Intercooler with Indirect Subcooler (LTC) Using Natural Refrigerant Couples'. *Sustainable Energy Technologies and Assessments* 39 (June): 100716. <https://doi.org/10.1016/j.seta.2020.100716>.
- Law, Jonathan. 2009. *Socio-Technical System*. Oxford University Press.

- <https://doi.org/10.1093/acref/9780199234899.013.5970>.
- Le Masson, Pascal, Kees Dorst, and Eswaran Subrahmanian. 2013. 'Design Theory: History, State of the Art and Advancements'. *Research in Engineering Design* 24 (2): 97–103. <https://doi.org/10.1007/s00163-013-0154-4>.
- Le Pochat, Stéphane, Gwenola Bertoluci, and Daniel Froelich. 2007. 'Integrating Ecodesign by Conducting Changes in SMEs'. *Journal of Cleaner Production* 15 (7): 671–80.
- Lesne, Annick. 2010. 'Modélisation Multi-Échelles Des Systèmes Vivants et de Leur Régulation.' In *Actes Du Colloque Commisco2010*. Bondy & Paris, France.
- Lorentzen, Gustav. 1994. 'Revival of Carbon Dioxide as a Refrigerant'. *International Journal of Refrigeration* 17 (5): 292–301.
- Maykot, Reinaldo, Gustavo C. Weber, and Ricard A. Maciel. 2004. 'Using the TEWI Methodology to Evaluate Alternative Refrigeration Technologies'.
- Mitsopoulos, Georgios, Evangelos Syngounas, Dimitrios Tsimpoukis, Evangelos Bellos, Christos Tzivanidis, and Stavros Anagnostatos. 2019. 'Annual Performance of a Supermarket Refrigeration System Using Different Configurations with CO2 Refrigerant'. *Energy Conversion and Management*: X 1 (January): 100006. <https://doi.org/10.1016/j.ecmx.2019.100006>.
- Mottonen, Matti, Tuukka Mustonen, Janne Harkonen, Pekka Belt, and Jarkko Hyysalo. 2008. *Design for EXcellence in High Tech Companies*.
- 'NF EN 378 - Refrigerating Systems and Heat Pumps - Safety and Environmental Requirements'. 2017. European Committee for Standardisation.
- Otto, K. N., and K. L. Wood. 2001. *Product Design: Techniques in Reverse Engineering and New Product Development*. Prentice Hall. <https://books.google.fr/books?id=up8nAQAAMAAJ>.
- Pahl, Gerhard, and Wolfgang Beitz. 2013. *Engineering Design: A Systematic Approach*. Springer Science & Business Media.
- Papalambros, Panos Y. 2015. 'Design Science: Why, What and How'. *Design Science* 1: e1. <https://doi.org/10.1017/dsj.2015.1>.
- Papalambros, Panos Y., Nestor F. Michelena, and Noboru Kikuchi. 1997. 'Distributed Cooperative Systems Design'. In *Proceedings of the 11 Th International Conference on Engineering Design*. Citeseer.
- Ralph, Paul, and Yair Wand. 2009. 'A Proposal for a Formal Definition of the Design Concept'. In *Design Requirements Engineering: A Ten-Year Perspective*, edited by Kalle Lyytinen, Pericles Loucopoulos, John Mylopoulos, and Bill Robinson, 103–36. Berlin, Heidelberg: Springer Berlin Heidelberg.
- Retho, Fabien. 2015. 'Collaborative methodology for virtual product building to support aerial vehicles with electrical propulsion design'. *Supélec*. <https://tel.archives-ouvertes.fr/tel-01323018>.
- Ropohl, Günter. 1999. 'Philosophy of Socio-Technical Systems'. *Society for Philosophy and Technology Quarterly Electronic Journal* 4 (3): 186–94.
- Saaksvuori, Antti, and Anselmi Immonen. 2008. *Product Lifecycle Management*. Springer Science & Business Media.
- Shahrestani, Mehdi, Runming Yao, Geoffrey K Cook, and Derek Clements-Croome. 2018. 'Decision-

- Making on HVAC&R Systems Selection: A Critical Review'. *Intelligent Buildings International* 10 (3): 133–53. <https://doi.org/10.1080/17508975.2017.1333948>.
- Sobek II, Durward K., Allen C. Ward, and Jeffrey K. Liker. 1999. 'Toyota's Principles of Set-Based Concurrent Engineering'. *MIT Sloan Management Review* 40 (2): 67.
- Stadler, Wolfram. 1988. *Multicriteria Optimization in Engineering and in the Sciences*. Vol. 37. Springer Science & Business Media.
- SuperSmart. n.d. <http://www.supersmart-supermarket.info/about>.
- Tahmasebzadehbaie, Mohammad, and Hoseyn Sayyaadi. 2020. 'Optimal Design of a Two-Stage Refrigeration Cycle for Natural Gas Pre-Cooling in a Gas Refinery Considering the Best Allocation of Refrigerant'. *Energy Conversion and Management* 210: 112743.
- Tayal, S. P. n.d. 'Engineering Design Process'.
- Timma, Lelde, Roberts Skudritis, and Dagnija Blumberga. 2016. 'Benchmarking Analysis of Energy Consumption in Supermarkets'. *International Scientific Conference "Environmental and Climate Technologies", CONECT 2015 95 (September): 435–38*. <https://doi.org/10.1016/j.egypro.2016.09.056>.
- Tweedie, Lisa, Robert Spence, Huw Dawkes, and Hus Su. 1996. 'Externalising Abstract Mathematical Models'. In *Proceedings of the SIGCHI Conference on Human Factors in Computing Systems*, 406–ff.
- Ulrich, Karl T., and Steven D. Eppinger. 2016. *Product Design and Development*.
- U.S. Department of Energy's Building Technologies Office. n.d. *EnergyPlus™*. <https://energyplus.net/>.
- Vallet, Flore, Benoît Eynard, Dominique Millet, Stéphanie Glatard Mahut, Benjamin Tyl, and Gwenola Bertoluci. 2013. 'Using Eco-Design Tools: An Overview of Experts' Practices'. *Design Studies* 34 (3): 345–77. <https://doi.org/10.1016/j.destud.2012.10.001>.
- Wagner, Terrance C. 1994. 'A General Decomposition Methodology for Optimal System Design.'
- Wang, Kai, Magnus Eisele, Yunho Hwang, and Reinhard Radermacher. 2010. 'Review of Secondary Loop Refrigeration Systems'. *International Journal of Refrigeration* 33 (2): 212–34. <https://doi.org/10.1016/j.ijrefrig.2009.09.018>.
- White, B.E., Alex Gorod, Vernon Ireland, Jimmy Gandhi, and Brian Sauser. 2014. *Case Studies in System of Systems, Enterprise Systems, and Complex Systems Engineering*.
- Yannou, Bernard, Faysal Moreno, Henri Thevenot, and Timothy Simpson. 2005. *Faster Generation of Feasible Design Points*. <https://doi.org/10.1115/DETC2005-85449>.
- Yannou, Bernard, Pierre-Alain Yvars, Chris Hoyle, and Wei Chen. 2013. 'Set-Based Design by Simulation of Usage Scenario Coverage'. *Journal of Engineering Design* 24 (8): 575–603.
- Yoshikawa, Hiroyuki. 1989. 'Design Philosophy: The State of the Art'. *CIRP Annals* 38 (2): 579–86. [https://doi.org/10.1016/S0007-8506\(07\)61126-3](https://doi.org/10.1016/S0007-8506(07)61126-3).
- Youbi-Idrissi, Mohammed. 2006. 'L'ACV: Un Outil d'aide à l'évaluation de l'impact Environnemental Des Systèmes Frigorifiques'. *Revue Générale Du Froid et Du Conditionnement d'air* 11063 (May): 60–67.
- Zhong, S., and W. Zhou. 2019. 'Inquiry and Experiential Mixed Teaching Method Is Effective Way to Cultivate High-Quality Innovative Talents'. *International Journal of Information and Education Technology* 9 (January): 613–17. <https://doi.org/10.18178/ijiet.2019.9.9.1276>.

Chapter 3: Research gaps, research questions and general methodology

This chapter describes the relationships between research gaps, research questions and objectives. The general methodology of the thesis is discussed. Finally, the positioning of our work between research disciplines and methodologies is presented.

1. Research gaps and questions

1.1. *Research gaps*

The literature review highlighted some following research gaps:

- Research gap 1: Lack of a holistic representation of the refrigeration socio-technical system (see Chapter 2 for the definition).
- Research gap 2: Lack of an integrated approach in the design process of refrigeration systems, i.e. some performances are missing to ensure a relevant decision process, simultaneously and in early design stages.
- Research gap 3: Lack of users' integration in the design process, i.e. a top-down approach where the solution is a single point in the solution space, and the users are not part of the process.

1.2. *Research questions*

From the research gaps, two research questions emerge:

Research question 1: How to represent and assess the refrigeration socio-technical system?

This research question is related to the first research gap previously defined. The first research question implies two objectives. The first one is to provide a structured representation of the refrigeration socio-technical system. In order to answer the first research objective, knowledge on the domain and the technical tools need to be gathered, and the stakeholders and the activities related to the lifecycle of a refrigeration system need to be identified. The second objective is to confront our hypothesis and research gaps by evaluating the current improvement opportunities in the refrigeration socio-technical system. A domain diagnosis is conducted to collect data.

This question leads to two objectives:

Objective 1.1: Establish a structured book of knowledge described as a synthetic, informative and graphically illustrated report of the existing refrigeration socio-technical system.

Objective 1.2: Assess the current improvement paths in the refrigeration socio-technical system with a suitable methodology.

A proper methodology to answer this research question is discussed in the next Chapter.

Research question 2: How to support decision-making for the design of refrigeration systems in early design stages and in the most integrated way?

We have highlighted that the supporting tools and the design process usually established are top-down (descendant) and point-based. Thus, in the present work, the lack of an integrated approach (research gap 2) and the lack of users' integration in the process (research gap 3) are addressed. It means providing all the performances simultaneously to the decision-maker in the early design phases. First, a knowledge model defines the decision problem, i.e. a formal representation to ensure that all necessary information is integrated into the problem. Then, a platform for design space

(solutions and performances) exploration is implemented to provide the users with a quick refrigeration system solution and allow the user to explore "what-if" scenarios. Appropriate verification and validation framework are constructed.

The second question leads to two objectives:

Objective 2.1: Build a knowledge model with a structured language (ontology) for the design of refrigeration systems.

Objective 2.2: Integrate this knowledge model into a multi-objective simulation and design space exploration platform for supermarket refrigeration systems.

Figure 3-1 offers an overview of the thesis outline in relation to the research gaps, questions and associated objectives.

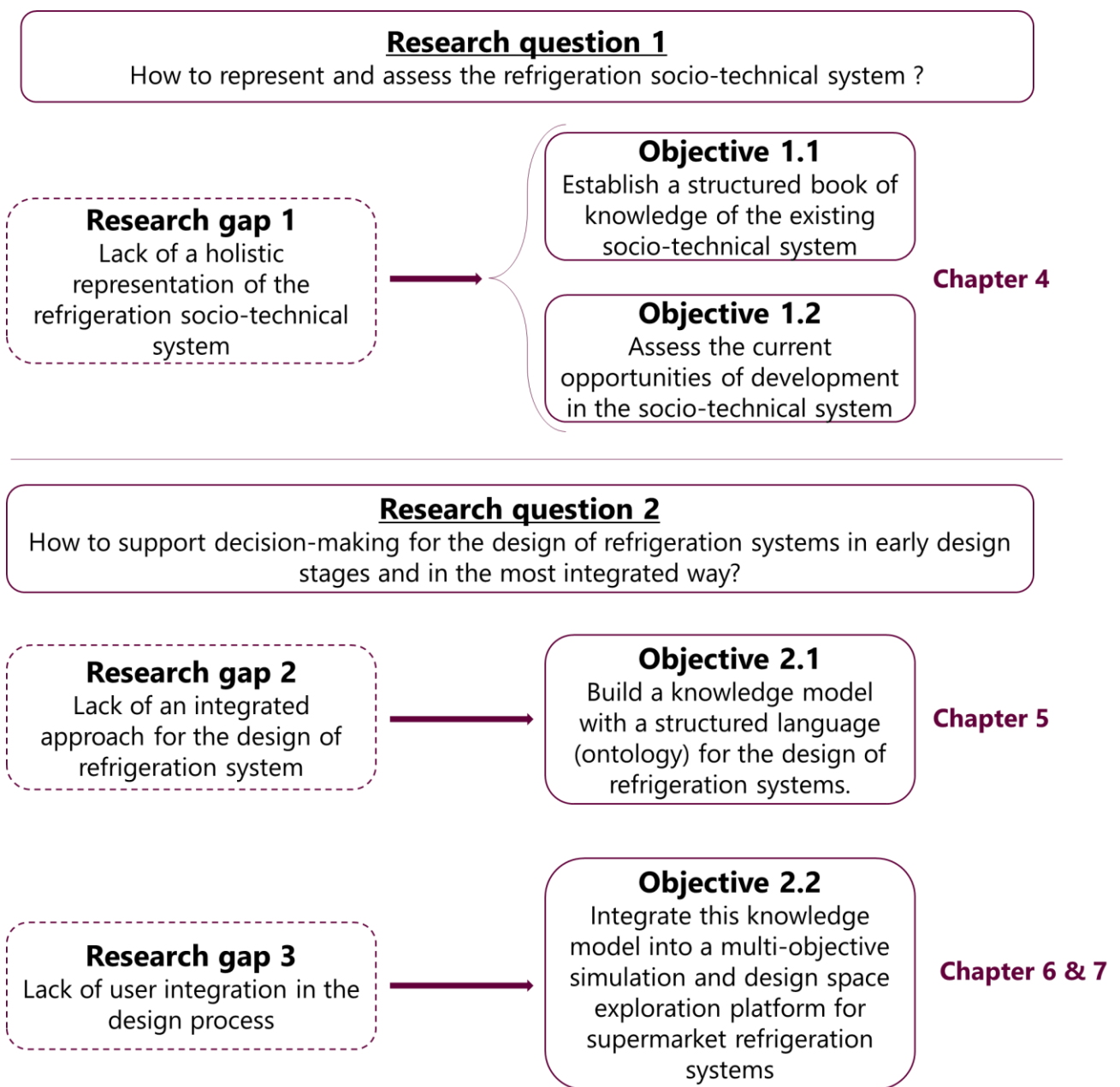

Figure 3-1. Overview of the research gaps, questions and objectives.

2. Research methodology and positioning

2.1. Research framework

In academic research, it exists different types of scientific approach: descriptive or analytical; applied or fundamental; qualitative or quantitative; conceptual or empirical; simulation or laboratory; etc. (see Kothari (2004) for more details).

This Ph.D. thesis, as applied research, uses both descriptive and analytical methodologies through the assessment of existing information in literature (analytical research) and the grounded investigation by conducting surveys and diagnosing refrigeration socio-technical system (descriptive study). The results are mainly qualitative as we are interested in investigating and improving the design process (human behaviour, steps, tools, etc.) while using quantitative measurements to describe the behaviour of a refrigeration system. Conceptual research theories are used to develop a conceptual framework, and empirical work serves to observe how the approaches are perceived in the field. We can synthesize our research framework by defining it as a multi-field research approach.

Design science has discussed different research frameworks (Blessing and Chakrabarti 2009; Chun Tie, Birks, and Francis 2019; Cross, Dorst, and Roozenburg 1992; Glaser, Strauss, and Strutzel 1968). We have adapted our research framework on the Design Research Methodology (DRM) (Blessing and Chakrabarti 2009). It consists of four main steps: (1) research clarification; (2) descriptive study; (3) prescriptive study; (4) second descriptive study as shown in Figure 3-2.

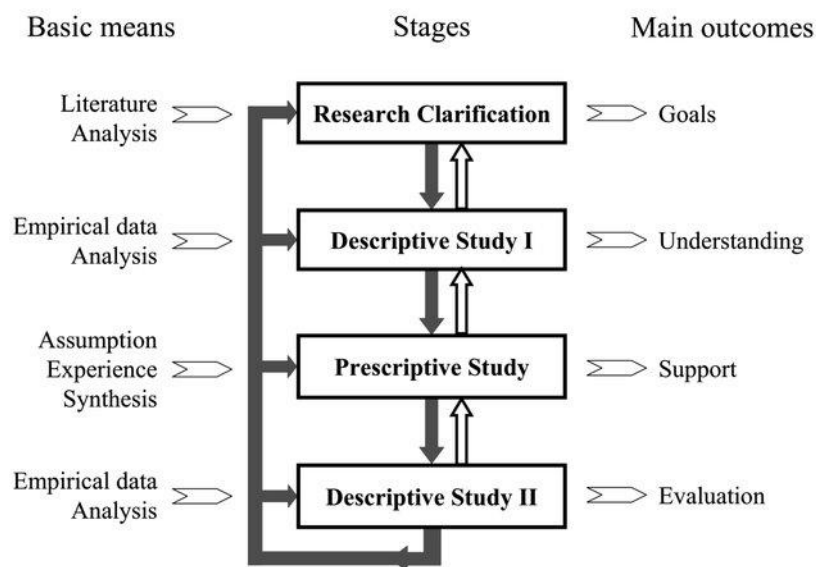

Figure 3-2. DRM framework from(Blessing and Chakrabarti 2009)

From the DRM, the chosen methodological framework for our work is presented in Table 3-1. The followed steps are iterative to adapt this process from the results obtained at each step. The first literature review allows us to define the research gaps. The first descriptive study consists of assessing the state of the existing (objective 1.1 and 1.2). The prescriptive studies are the main scientific contribution of this thesis (objective 2.1 and 2.2). Finally, the second descriptive study assesses our work with the field actors (research and industry).

Table 3-1. Proposed research methodology for the present work adapted from the DRM

DRM step	Description	Chapter n°
Research clarification	Literature review to explore the research fields in order to identify the research gaps, acquire knowledge on the domains and select the adapted design artefacts, i.e. methods, tools, models etc.	Chapter 2 & Chapter 3
Descriptive study	Industrial diagnosis, based on surveys and observation of the field to complete the literature review and confront the research gaps found in the literature to the industrial ground.	Chapter 4
Prescriptive study	Proposition and development of a knowledge model to provide a clear way of posing a problem and understanding the user's objectives	Chapter 5
	Development of a simulation and design space exploration tool and correctness verification	Chapter 6
Descriptive study II	Experimentation to assess the quality and collect feedbacks on the proposed design artefacts, i.e. model and tool	Chapter 7
	Discussion to interpret the results and provide eventually recommendations of implementation in the domain	Chapter 8

2.2. Positioning of the thesis

This Ph.D. thesis is at the crossroads of academic research and the refrigeration industry (see Figure 3-3).

The refrigeration industry, more particularly commercial refrigeration, is our field of application. Contact with the industrial and regulatory actors has allowed us to collect several qualitative and quantitative data on the field of refrigeration. This industrial knowledge is necessary to understand the design process dynamics and validate our approach.

Our work uses methods, tools, and contributions from two disciplines, refrigeration process engineering and industrial engineering within the academic research. The approach adopted is multi-disciplinary and multi-methodologies. Industrial engineering proposes tools to understand the design, installation, exploitation, lifecycle management of systems, products, humans, materials etc. A more detailed definition is given in Chapter 2. Several methodologies are combined to propose a relevant solution to our problem from industrial engineering. Design Theory and Methodology

(DTM), Model-based System engineering (MBSE), design process theory, and decision aid theory and methodology are considered

The refrigeration process engineering provided models and data. It includes multi-physics models of refrigeration systems, thermodynamic, physical and mechanical models, the physical structuration of system components and the system behaviour. Finally, a significant amount of parameters and data related to the operation of the systems were collected, in particular, to verify the obtained results.

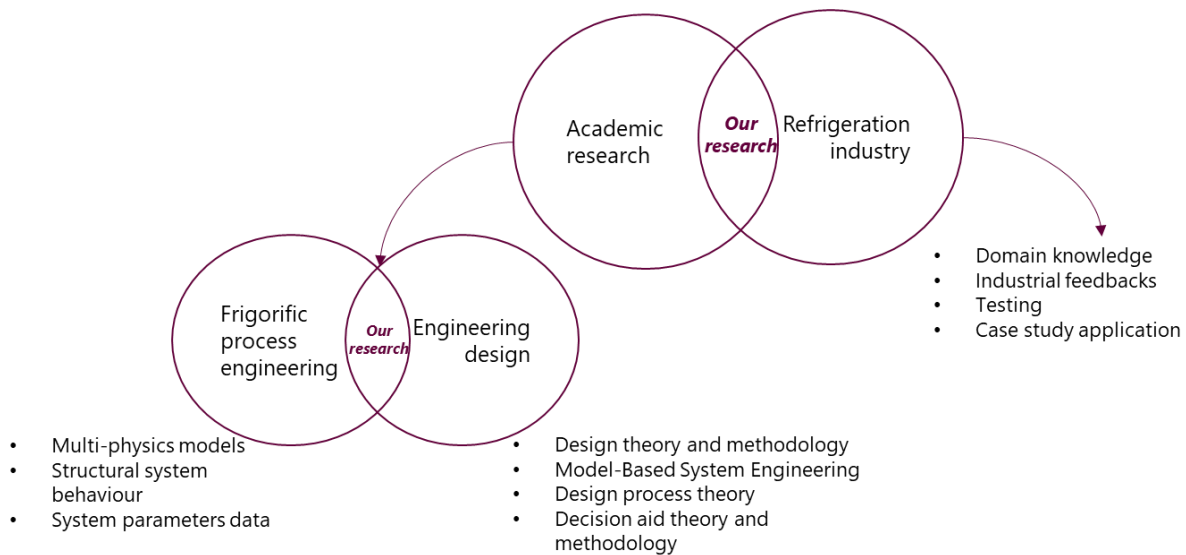

Figure 3-3. Positioning of our research in the industry and academic research

In the next chapters, the contributions of this thesis are presented.

References

- Blessing, Lucienne TM, and Amaresh Chakrabarti. 2009. *DRM: A Design Reseach Methodology*. Springer.
- Chun Tie, Ylona, Melanie Birks, and Karen Francis. 2019. 'Grounded Theory Research: A Design Framework for Novice Researchers'. *SAGE Open Medicine* 7 (January): 2050312118822927–2050312118822927. <https://doi.org/10.1177/2050312118822927>.
- Cross, Nigel, Kees Dorst, and Norbert F. M. Roozenburg. 1992. 'Research in Design Thinking'. In .
- Glaser, Barney G., Anselm L. Strauss, and Elizabeth Strutzel. 1968. 'The Discovery of Grounded Theory; Strategies for Qualitative Research'. *Nursing Research* 17 (4): 364.
- Kothari, Chakravanti Rajagopalachari. 2004. *Research Methodology: Methods and Techniques*. New Age International.
- Tweedie, Lisa, Robert Spence, Huw Dawkes, and Hus Su. 1996. 'Externalising Abstract Mathematical Models'. In *Proceedings of the SIGCHI Conference on Human Factors in Computing Systems*, 406-ff.

Chapter 4: Socio-technical diagnosis of refrigeration systems in France

This chapter resumes the field diagnosis conducted to better understand the refrigeration domain in France. The diagnosis first consisted in exploring the refrigeration socio-technical system based on: interviews with interlocutors of different roles, companies, knowledge; studies of the laws, standards, and regulations specific to the field as well as the guides of good practices; a collection of literature data on refrigeration technologies, evaluation of the performances; observation of running systems as well as in the process of design by starting from a customer need until the end of life of the machine. We then used the Radical Innovation Design (RID) methodology to organize this data collection in order to construct a knowledge book systematized in four categories which are the four dimensions of RID: stakeholders (called user profiles) who encounter issues (called problems) during their activities, themselves segmented into life cycle phases (called use situations) and finally that of existing solutions that stakeholders can apply to reduce or eliminate a problem in a given activity. Seven matrices are constructed using the 4-dimensional categories. Then, these matrices are computed to determine where to simultaneously address the creation of expected values for the stakeholders involved and address orphaned value buckets. These value buckets are defined as the main problems encountered by key stakeholders in frequent use situations. Several indicators are then calculated to allow an in-depth analysis: first, the matrices of the value pockets, and then a series of effectiveness indicators to assess the individual capacity of each solution to eradicate the identified problems. A conclusion toward a solution is finally proposed.

1. Exploring the refrigeration socio-technical system

Numerous regulations and laws govern refrigeration systems (RSs) to curb their high environmental impact (Aprea et al., 2012; Islam et al., 2017). Managing an RS from its design to its end-of-life is complex, owing to the number of disciplines, stakeholders, roles, and skills involved. The present field study chose the retail refrigeration sector because of its magnitude. This sector represents 3–5% of energy consumption in European countries and is expanding to meet growing demand. In France, retail stores have seen their footfall increase by 10% in 5 years and their number by 8%. Refrigeration equipment (display cabinets or cold rooms) is responsible for 35–50% of the energy consumed by a retail store.

Studies of RSs in retail have mainly focused on developing tools and technologies (Ben-Abdallah et al., 2019), optimizing one or multiple technical performance metrics, especially in the design stage under simplified conditions (Ge and Tassou, 2011; Kolokotroni et al., 2019), implementing performance indicators to improve energy efficiency (Acha et al., 2016), and understanding how an RS operates in a supermarket (Bahman et al., 2012). CO₂-based technologies and other energy-efficient solutions such as heat recovery are widely popular as an advantageous alternative system in the retail industry. Studies have shown that CO₂-based systems have a high potential for enhancement (Gullo et al., 2018). However, non-technical issues from the socio-technical RS generate a range of problems and lead to sub-optimal system performance. Here we define the socio-technical RS as the set of stakeholders, processes, organizations and technical solutions involved in the activities linked to the RS throughout its lifecycle. Minetto et al. (2018) have conducted interviews with food retail sector stakeholders in Europe. Despite a positive attitude toward energy-efficient solutions, the authors identify non-technical barriers to adopting low-carbon solutions such as CO₂-based systems and heat recovery: poor awareness of technological opportunities and expertise in operational optimization, and lack of social, organizational and legislative knowledge. A recently published article (Paurine et al., 2021) also highlights a lack of knowledge, skills and awareness in the industrial use of low-GWP alternative refrigerants. For this purpose, a series of surveys on available training was conducted with several actors in the field. The results showed the usefulness of these fluids and described the existing practices and the skill needs related to them. To our knowledge, no adequate description or analysis of the socio-technical aspects of an RS in France have yet been undertaken.

Law (2009) defines a socio-technical system as the infrastructure, stakeholders and their roles, technology, regulation, and performance of a system. In Hess and Sovacool, (2020), socio-technical systems are defined as “heterogeneous ensembles of people, artefacts, infrastructures, research, cultural categories, standards and laws, and natural resources”. In Sovacool et al. (2021), a socio-technical approach is used to address climate change challenges from fluorinated greenhouse gases (F-gases). These authors do not merely consider F-gases as by-products; they also address the framework of infrastructure, social institutions and the products that use the gases. In the present contribution, a socio-technical RS includes the infrastructures from the RS design through to its final disposal, the RS operating environment, stakeholders throughout its lifecycle phases (use,

maintenance, technical update, end-of-life), the technical components of the RS (e.g., compressor, condenser, refrigerant), and the laws and standards related to the RS and its performance.

Our research objective was to identify major areas for improvement of the activities related to the socio-technical RS and the stakeholders' roles. We drew up a prioritized list of improvement paths from a structural diagnosis to innovate in a more integrated design strategy and platform. The purpose of the Radical Innovation Design (RID) methodology (Yannou, 2015; Yannou et al., 2016) is to analyze a complex activity, determine its improvement paths (called "value buckets"), and use them in an innovative design or management process to increase the performance of that activity. To analyse the often low environmental performance of buildings, Lamé et al. (2017) used RID methodology to analyze the defects in the socio-technical system of specification-design-implementation-use-maintenance of a building the fragmentation in the involvement of the actors, which explained why environmental performance was poor. They were able to show difficulties in implementing lifecycle assessment (LCA), eco-design approaches, and environmental standards, together with the influence of the lack of consultation among the players in this value chain. Lamé et al. (2018) analyzed the activity system of a dental radiologist to derive value buckets from which they ideated, going on to define innovative socio-technical layout solutions. Bekhradi et al. (2017) investigated do-it-yourself activities to seek an innovative solution for a universal accent light. The utility of following a RID process is discussed by Yannou et al. (2013), and the details of the RID process are given in Yannou et al. (2016).

We used the RID methodology to build a cognitive model of the activities related to a socio-technical RS and analyze it to delineate major areas for improvement. The RID process first requires a thorough investigation of a socio-technical RS, yielding a first contribution: knowledge gathering on socio-technical RSs in France. The RID process then segments this knowledge into four dimensions, with categories of stakeholders (called "user profiles") who experience difficulties or lack of performance (called "problems") during their activities, themselves segmented into lifecycle stages (called "usage situations"). The fourth dimension consists of the existing solutions that stakeholders may apply to mitigate or remove a difficulty in a given activity. In an innovation approach, emphasis is placed on value buckets (VBs), for which existing solutions are of little or no help. The second contribution of this work is to identify and prioritize improvement areas in a socio-technical RS using two RID decision-aid tools: RID Comparator to first analyze the effectiveness of the existing solutions, and then RID Compass to decide on the improvement areas. In this light, the improvement areas are finally discussed to envisage design specifications of a more integrated model-based design platform for an RS.

Paragraph 2 of this chapter describes the RID methodology and our research process. The first contribution is presented in paragraph 3. The four dimensions are detailed and justified. The results from the two RID decision-aid tools are shown in paragraph 4. The effectiveness of the solutions from RID Comparator is first analyzed, and RID Compass then finds improvement paths. Finally, a general conclusion and perspectives are given, with a description of the proposed solution.

2. RID methodology and process of this study

2.1. More on the RID methodology and process

At a macro level, the RID process has three stages (see Figure 4-1):

- Observing the socio-technical system and learning about its current activities, shaping it into a cognitive model,
- Exploring this cognitive model and deciding on the innovation targets,
- Ideating, designing, and checking that the innovative solutions effectively enhance the activities' key performance indicators.

Here, the authors detail the two first stages for a socio-technical RS.



Figure 4-1. The three main stages of the Radical Innovation Design process

A more detailed eight-stage, X-shaped process (see Figure 4-2) represents a production process split into a problem setting part (1) and (2), defined once and for all (for building the cognitive model of current activity), a problem-solving process ("ideate and design") and an "explore and decide" step comprising two decision-making stages and tools, namely RID Comparator to visualize effectiveness ratios and shrink the market space (i.e., the user profiles, usage situations, and problems) (3), and RID Compass to visualize value buckets and decide the ambition perimeter (4) before moving on to ideation, i.e., starting creativity. The value buckets selected in the ambition perimeter are qualified questions to initiate ideation. After imagining a dreamt or ideal usage scenario (5), new innovative solutions are designed with a new product-service-organization (PSO) architecture (6) and a business model (BM) (7). Finally, a prototype is made (8), experimented with in real or virtual conditions to assess the activity's performance. RID Comparator is then used again to check the dominance of the innovative solutions within the targeted market space. The most important terms are defined in Appendix 1.

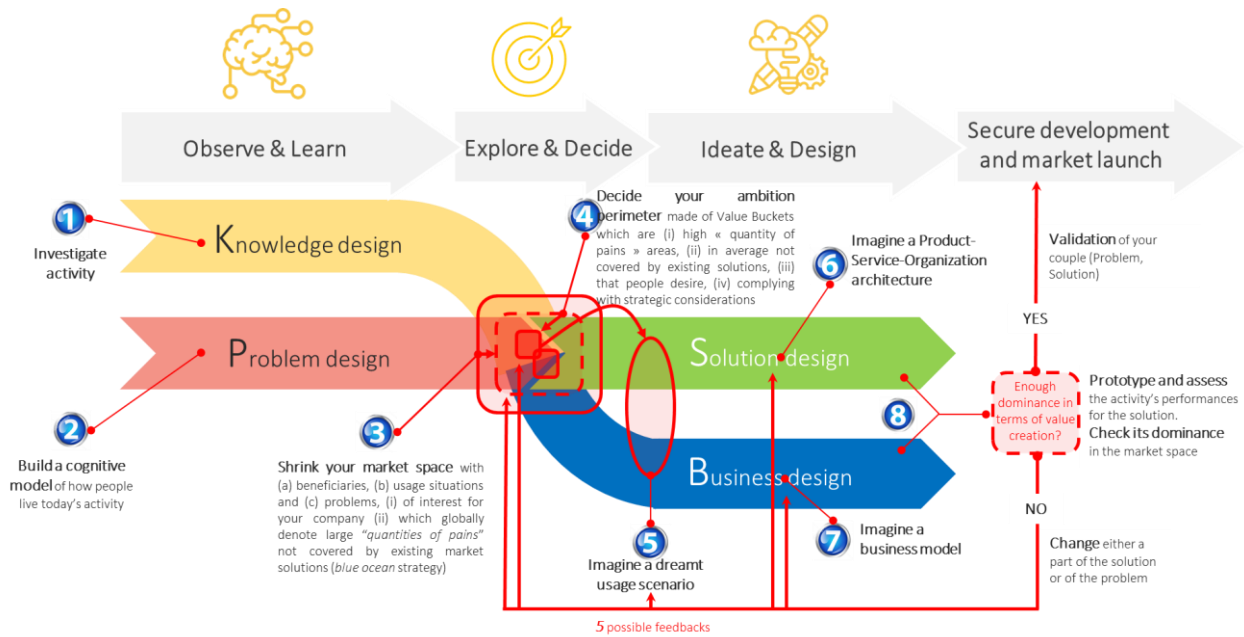

Figure 4-2. The Radical Innovation Design process in detail

A third process view (see Figure 4-3) displays the algorithmic workflow for (i) building the cognitive model of activities, (ii) interrogating this model by exploration to better understand its weakest and most desirable aspects, (iii) deciding the part of the overall problem to address (“shrink the market space”) and the precise innovations to target. Building a cognitive model of activities of the socio-technical system of interest requires segmenting four dimensions of activity, namely user profiles (Up), usage situations (Us), problems (P), and existing solutions (Es). After segmenting into meaningful categories, seven matrices (see Figure 4-3) are filled by semi-quantitative values, answering precise questions. Original algorithms were developed based on the novel metrics of “quantity of pains” to compute two derived decision-making indicators: effectiveness indicators and value buckets:

- The RID “quantity of pains” is a novel extensive semi-quantitative measurement scale factoring (a size of a user profile) × (a frequency of usage situation) × (an occurrence and gravity of a problem).
- RID Comparator answers the question, “What is the value of solutions (existing and novel) regarding the potential to improve the activity, i.e., eradicate quantities of pains?” Several types of effectiveness indicators are computed to compare the solutions.
- RID Compass answers the question, “What innovations merit development?” within the shrunk market space. Only a subset of strategic value buckets is selected in the ambition perimeter and serves as qualified ideation questions. Developing a solution from a value bucket guarantees added utility for avoiding or limiting problems during usage situations where competitors are, on average, poorly effective. It precisely orients toward “blue oceans” as described in Blue Ocean Strategy (Kim and Mauborgne, 2005).

In the present work, we do not provide the algorithmic details and formulas to compute decision-making indicators. The reader will find them in Yannou et al. (2016) and Lamé et al. (2018).

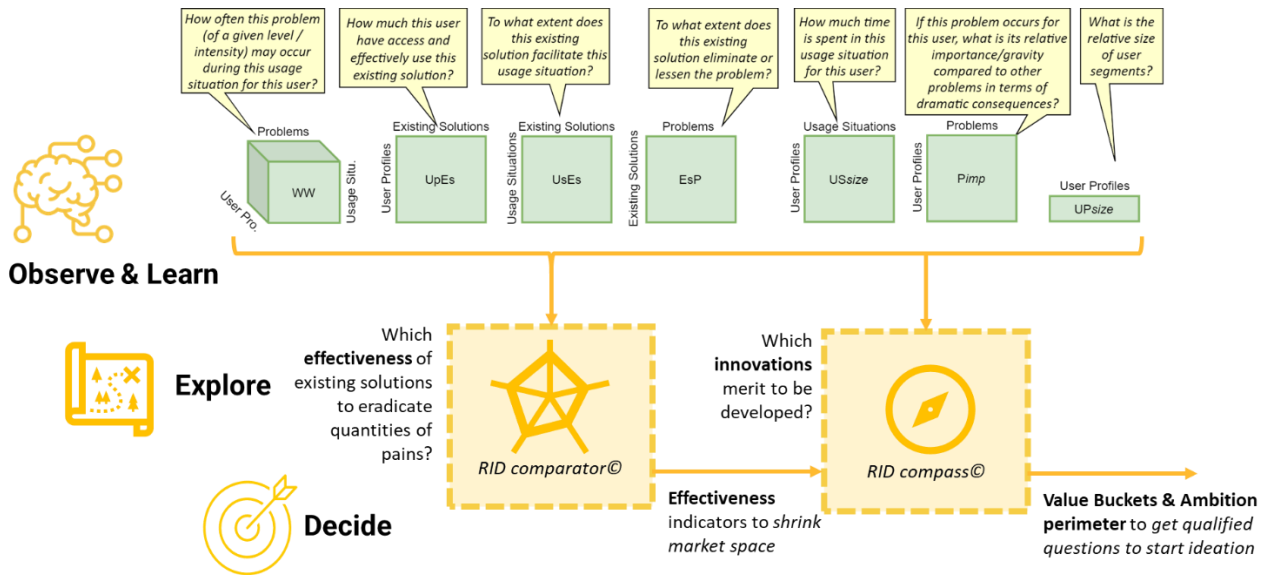

Figure 4-3. Cognitive perspective and algorithmic workflow of the “Observe and Learn” and “Explore and Decide” stages of the Radical Innovation Design process

2.2. Research process of this study

The first step in our “Observe and Learn” RID stage was an in-depth investigation of the socio-technical RS in France (Stage 1 in Figure 4-2) before building the cognitive model (Stage 2). We performed (a) a literature review and (b) a field analysis from observations, interviews and documentation. If no publications were found on commercial socio-technical RS analysis, the study's scope was extended to similar systems such as household refrigerators, buildings and energy systems (Cagno et al., 2019; Hesloin et al., 2017; Lamé et al., 2017; Mignon and Bergek, 2016).

Fifteen interviews in different companies and disciplines were conducted to collect qualitative data. The interviewees were chosen to be representative of the stakeholders of a socio-technical RS, at different levels of hierarchy, according to their activities and their availability. The list of the interviewees are presented in Table 4-1.

Table 4-1. Summary of the interviews (role of the interviewees and their organizations)

	Role	Organization
1,2,3	Research engineer, PhD	Research lab
4	Research engineer	Research lab
5	Refrigeration engineer	Research lab
6	CEO	Small company
7	Technical expert in charge of innovation	Large company
8	R&D project leader & CAD manager	Large company
9	Eco-design expert	Recycling body

10	Teacher	School specialized in refrigeration
11	Refrigeration consultant	Ministry, association
12	Research Engineer in Industrial Refrigeration	Large company
13	Business manager	Small company
14	Refrigeration expert	Association
15	Maintenance technician	Small company

Each interview lasted about one hour and was semi-guided (open questions were asked). The interviews covered six topics: (i) identity (role, background, position along the value chain), (ii) current regulation and anticipation, (iii) the technology of the systems (limits, skills, and development), (iv) the design process, (v) maintenance, and (vi) sustainability positioning (also social and economic concerns). The description of each topic is presented in Table 4-2.

Table 4-2. Detail questions of the interviews

Topic	Expected answers
Identity and Positioning of the actors on the value chain	Background/demographics - General information about the actor and company, including company name, activity, size and geographical location, background, business organization, suppliers and clients, existing collaborations
	Positioning of the actor interviewed on the value chain
	Clarification of the actors, their position and role in the refrigeration industry
Regulatory aspects, including current regulations to be complied with, and anticipation of upcoming regulations	Confirm that the regulation is the main reason for developing a new technology
	Identify potential regulation evolutions
Technology aspects, type of system developed/usually used, limits of their use, why, development of new technologies	Identify and clarify the existing technologies: maps of existing solutions → most common ones, why, by who
	Identify the ways for developing a disrupting technology
Design of a refrigeration system, what are the intermediate design objects	Maps of tools and numerical supports
	Clarify the needs of design teams for a global approach
Maintenance of refrigeration systems	Clarification of the types of maintenance and the actors involved;
	From KPIs identified, confront with experts on which are relevant and used

Sustainability issues positioning

Identify the social, economic, environmental concerns and ecological transition positioning of the actors

We obtained the two contributions to this "Observe and Learn" (Stage 1 in Figure 4-1) study. First was a knowledge design part (gathering the knowledge) on socio-technical RS in France. The knowledge was then computed during the problem design (how to build the cognitive model).

3. Knowledge book of the socio-technical RS

3.1. RS lifecycle process

Based on the data collected during the first step of interviews and a literature review, we ascertained that the main life-cycle stages of an RS were similar to any typical product life-cycle stages (Saaksvuori and Immonen, 2008; Stark, 2016): design, manufacture, installation, exploitation, and end-of-life (EOL) treatment, as depicted in Figure 4-4. In our study, we consider three main stages for the usage situations:

- **Design, manufacture and installation:** This includes the stages of the engineering design process (Pahl and Beitz, 2013), manufacturing of the RS (including raw material extraction), transport of the components to the installation site, and installation. We aggregated this first usage situation because of the difficulty in clearly distinguishing the boundaries of each stakeholder's activities in the initial stages.
- **Exploitation:** This is the longest stage. It includes the regular use of the RS and the attendant maintenance, repair and upgrades.
- **End-of-life (EOL):** This is the shortest stage of the process. It consists of the dismantling, transportation, and EOL management for recycling, reuse, or disposal of the RS.

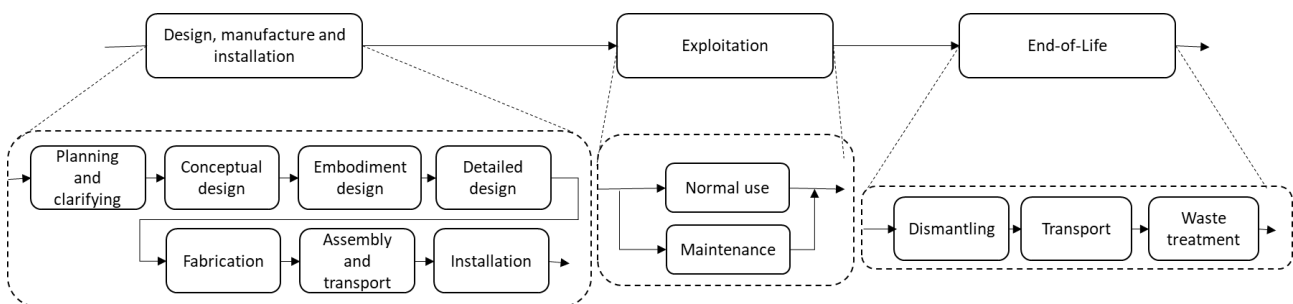

Figure 4-4. Retail refrigeration system lifecycle process

3.2. Users involved in the socio-technical RS

Since the signing of the 1987 Montreal Protocol, changing existing installations has proven difficult. In addition, from 2015, the European law on F-gases regulates refrigerants, which are to be replaced by naturally occurring gases in an industrial plant by 2030. Experience, knowledge and expertise must

thus all be rebuilt in the next decade. This evolution needs flexibility in companies to respond to the new regulation. This section provides knowledge of the current stakeholders' organizational process. The semi-guided interviews provide answers concerning the stakeholders' interactions, the timeline of the process, what their activities are, and the problems they encounter.

The interviews highlight the fragmented process of managing an RS. The interviewees had different images of the overall socio-technical system, as information is widely scattered, for example, on the tasks and activities specific to each stakeholder or available infrastructure such as EOL treatment choices. They nonetheless answered unanimously on the key roles, the constraints of adapting to the actors they interacted with (budget, deadlines, and company's mindset), and the sector's evolution.

Table 4-3 presents a summary of the different user profiles involved in the lifecycle of a refrigeration system

Table 4-3. Table of the users and their role in the process.

Actor	Role
Academic researcher	Person or group of people who keep pace with the changing regulations and anticipate them through a combination of theoretical and experimental work. (ex: researchers at INRAE)
Technological transfer centre	Person or group of people which transfers the results of research to businesses by leveraging and managing laboratories' portfolio of technologies via agreements with industrial firms; promotes the creation of innovative companies and assist them with development; supports the set-up, negotiation and management of collaborative research projects at the European and national level by bringing to bear its expertise in management project engineering; organises, leads and manages major research and development programmes; makes resources available to the environmental technologies sector by creating a porous interface between public research laboratories and the business world. (ex: INRAE transfert)
EU parliament and Council	Organization which votes EU directives on frigorific equipment
French parliament and Environmental code	Organization which votes French directives on frigorific equipment and write French regulation, standards and laws on frigorific system design
Professional organism	Organization that helps understand and implement regulation to industrial firms (ex: International Institute of Refrigeration)

R&D researcher	Person or industrial team who creates prototypes of systems to validate technical solutions. These experimental systems are intended to test and validate new components and integrate the knowledge learnt from feedback. They optimise and implement the solutions to evolve with the final user expectations (ex: Axima R&D team)
Design office	Person or industrial team that provides RS design recommendations and design the system (ex: teams in companies such as Axima, FAC SOS)
Consulting firms	Person or industrial team that provides RS design recommendations (ex: MF consulting firm)
Refrigeration engineer	Person or industrial team that installs RS, maintain, manage the EOL and build some RS components (ex: Persons working for supplying companies at FAC SOS or INRAE's refrigeration engineers)
Supplier	Person or industrial team that provides RS installation, RS maintenance and RS EOL management services (ex: FAC SOS company)
Components designer	Person or industrial team that designs RS components or system from functional specification (ex: BITZER's study officer)
Manufacturer	Person or industrial team that builds RS components or systems (ex: BITZER)
Final user	User of a RS to maintain cold for refrigeration of food in cold rooms and display cabinets or user of HVAC systems (ex: Retail stores, Commercial kitchen, cold food storage such as Carrefour, Brioche Dorée)
Building design parties	Individuals or organisations that are involved in the design, construction and life cycle management of the building (ex: Architects cabinets)
EOL treatment parties	Individuals or organisations involved in the EOL treatment of RS (ex: recycling company such as EcoSystem)

As refrigeration systems are complex systems to design, install, use, and manage, the number of stakeholders involved is important. Thus, the actors' interactions and dependencies are numerous, which can be complex because of a particular business language. We use first a Dependency Structure Matrix (DSM) to evaluate the interactions between all the stakeholders. The results are represented in an influence/dependency graph presented in Figure 4-5. Dependency structure Matrix (DSM) is a square matrix used to represent the project dependencies. The interactions are graded between 0 and 4:

- 4: actor "i" is essential to the existence of actor "j"
- 3: actor "i" can jeopardize the accomplishment of actor "j"'s missions
- 2: actor "i" can jeopardize the success of actor "j"'s projects
- 1: actor "i" can challenge the management processes of actor "j" in a limited way in time and space
- 0: actor "i" has little influence on actor "j"

The total scores of each stakeholder are visualized in the influence/dependency matrix. Insights on the dependency and influence of each stakeholder are generated, and it becomes possible to develop a specific approach and strategy for the identified stakeholders.

Figure 4-5 shows the graph generated. As expected, politics have a real impact on the evolution of refrigeration systems by defining regulation as well as technological transfer centres that help new technological clusters market-ready. They are placed as the most influencing stakeholders. We can observe that EOL parties are highly dependent stakeholders as they depend on the willingness of other actors to manage the waste of their system. Design offices and refrigeration engineers, as in charge of designing and managing the refrigeration system, are also very dependent on the other actors. Indeed, they have as much flexibility as given by the final user requirements and constraints. Relay actors are defined as stakeholders that are an active part of the general process, both influencing and dependent of the process' outcomes.

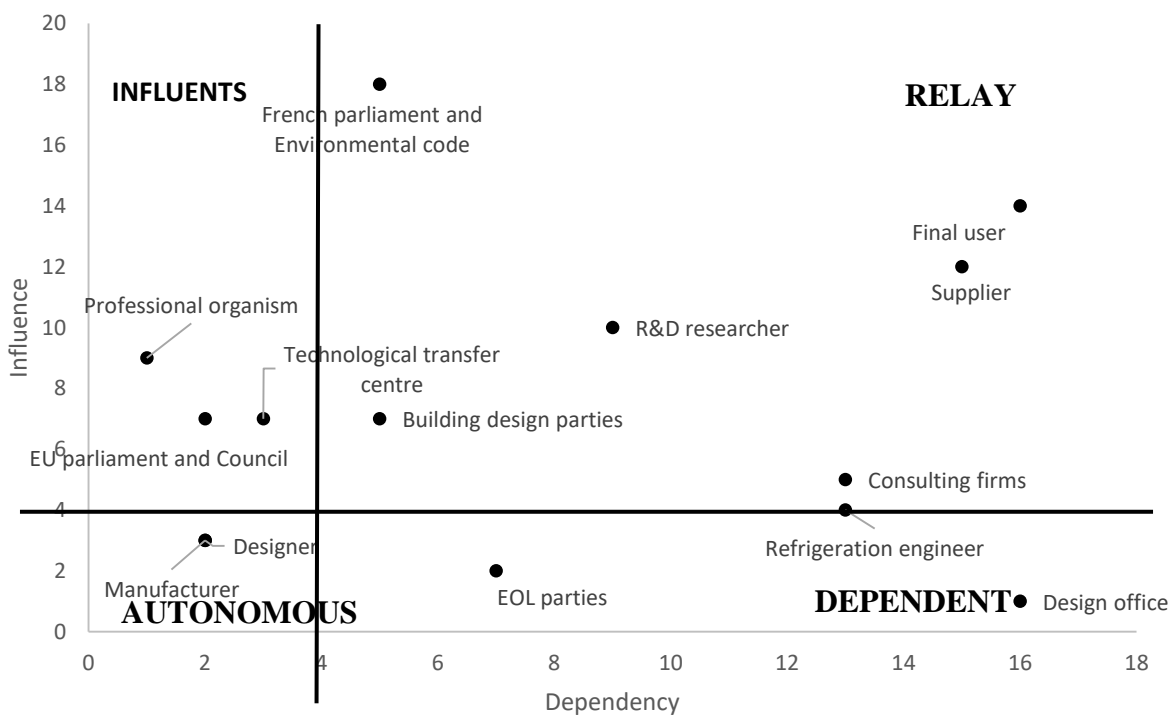

Figure 4-5. Influence/Dependency graph

The twelve identified user-profiles and their direct interactions are summarized in an interaction diagram in Figure 4-6. The users inside the dashed perimeter are the actors directly involved in designing and exploiting an RS.

During the design stage, the *final user* of the RS (e.g., a supermarket) interacts only with one actor: a *supplier*. The *supplier*, whose role is to link *manufacturing* to final use, is the most participatory stakeholder. The *supplier* also has the specific characteristic of being involved at every lifecycle stage. Once the equipment is installed and running, the only stakeholders concerned by the exploitation stage are the *final user* (as the daily user) and the refrigeration engineers via the supplier for maintenance tasks. In the final stage of the system lifecycle, the activities of *EOL treatment parties* are limited to the transport and treatment (dismantling, recycling, disposal) of the machine. The refrigeration technicians from the supply company oversee the draining of the refrigerant from the equipment. The system's *final user* is involved from time to time in the EOL of the system, but this is mostly the *supplier* company's responsibility. Around the project, a set of parties will write regulations, standards, and laws, grouped in the Environmental Code in France. The certifications, regulation watch and guidelines are provided by training facilities, unions and associations such as the International Institute of Refrigeration grouped in *professional organisms*.

Academic researchers are also external parties that anticipate new technologies through theoretical and experimental projects. They can directly relate to R&D teams or through *technology transfer centres*.

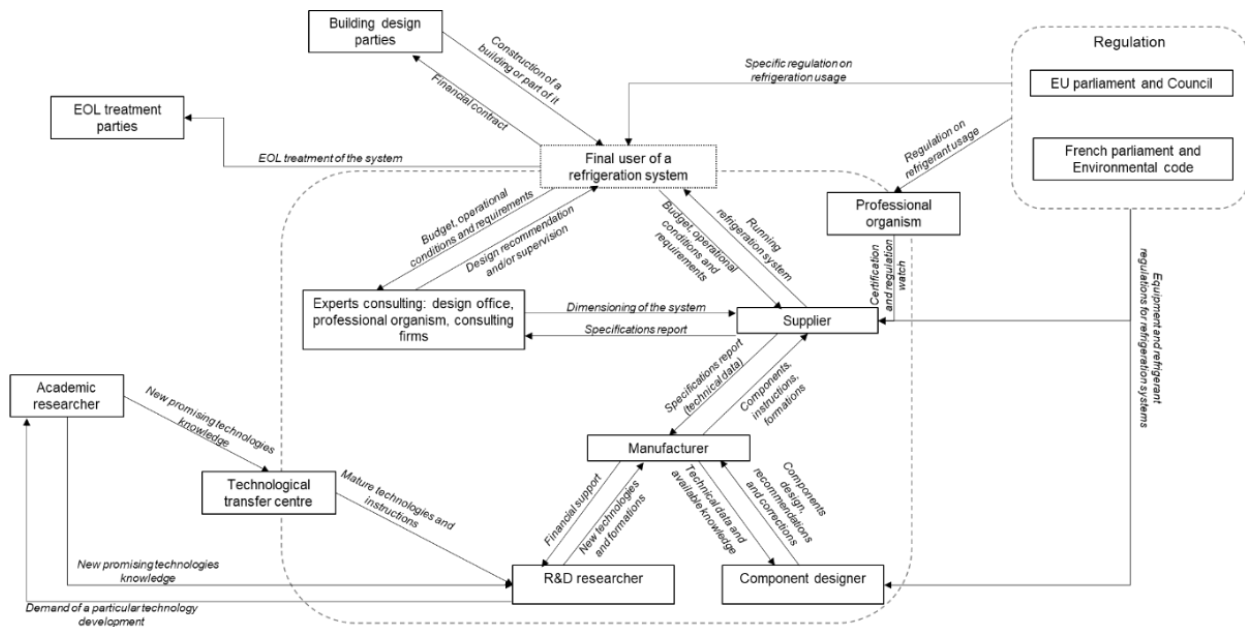

Figure 4-6. The 12 categories of user-profiles and their interactions

3.3. Problems identified in the socio-technical RS

Problems in RID are defined as “issues or lacks performance experimented by users during usage situations belonging to an activity field” (Yannou et al., 2018). The problems presented in this section

stem from the interviews, observations, and literature review. They are either specific to one or common to multiple usage situations. We collected the issues arising in the design and the exploitation phases from the interviews. The end-of-life (EOL) treatment phase gaps are documented by Ardente et al. (2015) and updated with the experts' interviews. A holistic representation of the problems is constructed during the data treatment and to better understand the underlying phenomenon. Causality graphs serve to organize the data collected into three areas: causes, consequences, and problems. Such graphical representation has been made for each of the usage situations. Figure 4-7 shows the causal graph for the design, manufacture, and installation phase. Figure 4-8 shows the causal graph for the exploitation phase. Finally, Figure 4-9 shows the causal graph for the problems occurring during the EOL treatment phase.

We then placed each of the problems into four main categories: costs (orange boxes in the figures), knowledge management (blue boxes in the figures), the interaction between stakeholders (red boxes in the figures), and tools (green boxes in the figures). This problems' categorization is adapted from Pärttö and Saariluoma (2012), and the fifteen main problems highlighted in this study are summarized in Table 4-4.

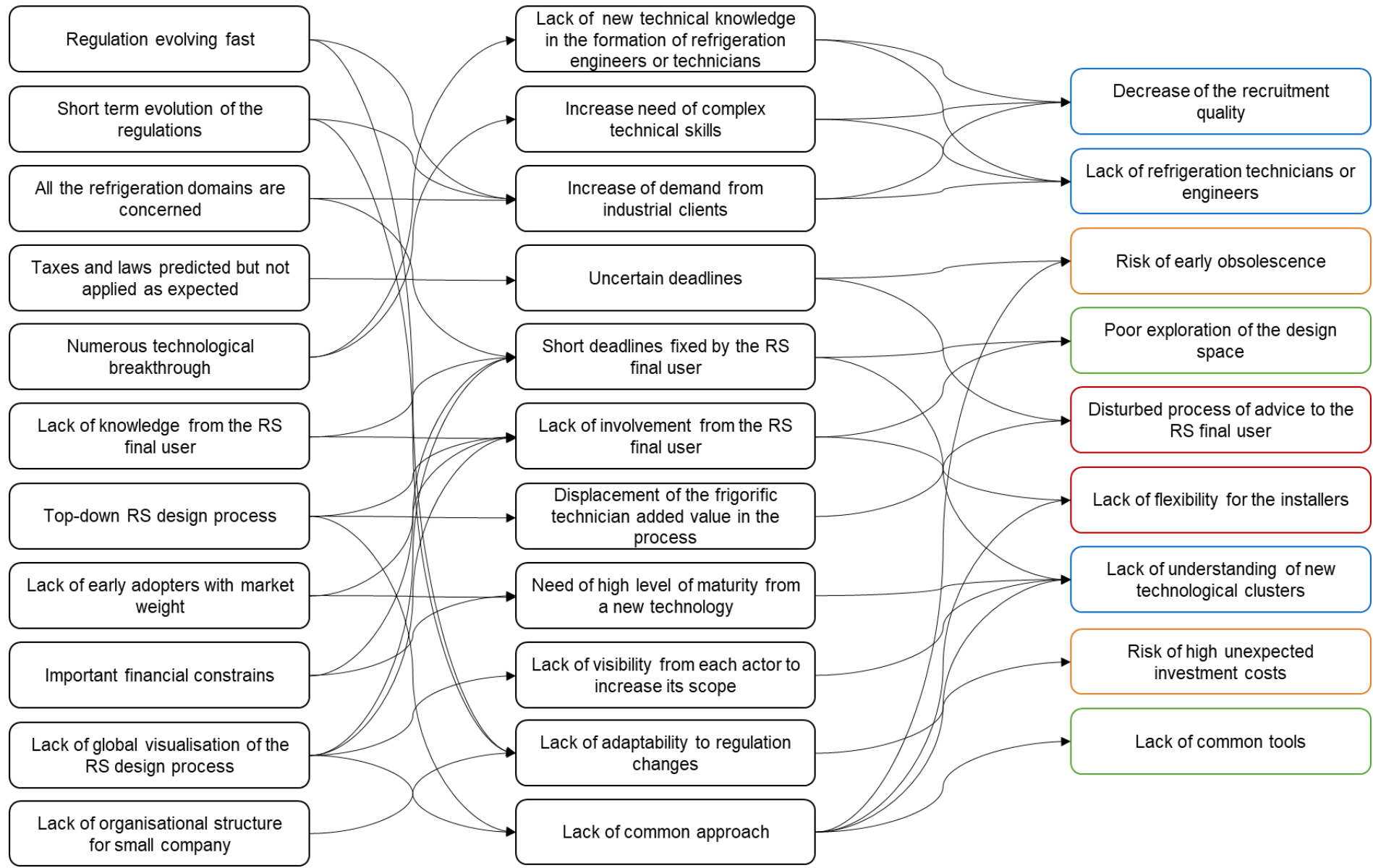

Figure 4-7. Causality graph for the problems occurring during the design, manufacture and installation phase.

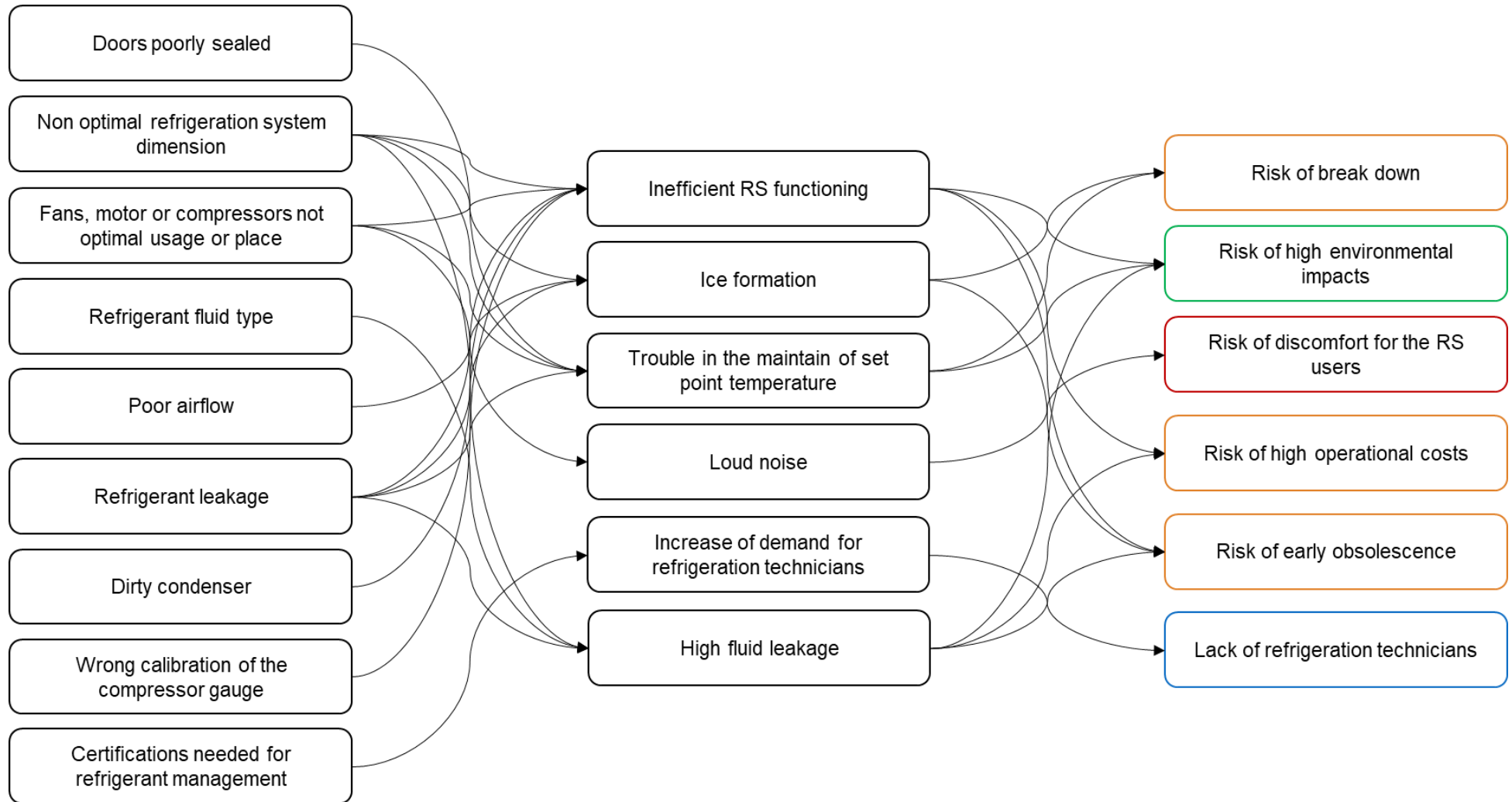

Figure 4-8. Causality graph for the problems occurring during the exploitation phase.

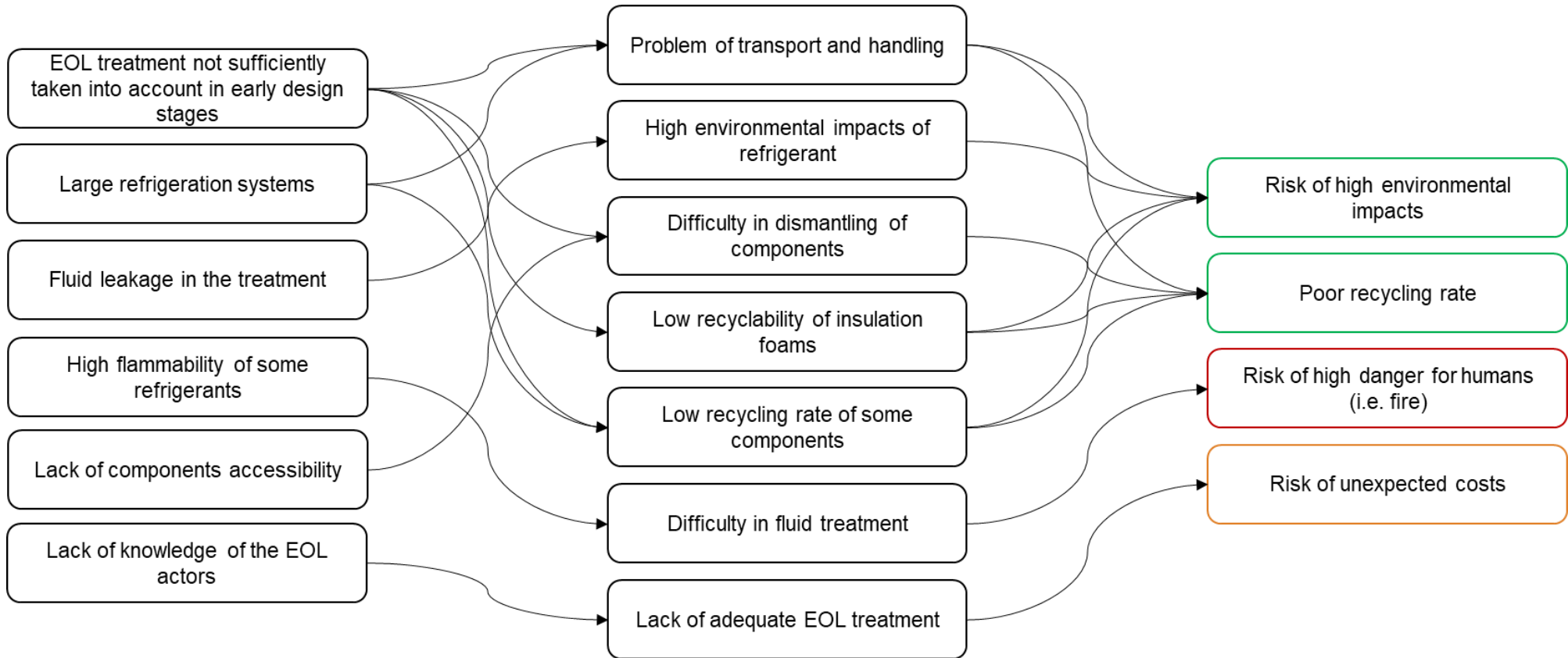

Figure 4-9. Causality graph for problems occurring during the EOL treatment phase.

Table 4-4. List of problems identified in in the socio-technical RS and classified in four main categories.

Problem category	N°	Problems identified
Cost	1	<i>Risk of early obsolescence</i>
	2	<i>Risk of unexpected investment costs</i>
	3	<i>Risk of breakdown</i>
	4	<i>Risk of high operational costs (OPEX)</i>
Knowledge management	5	<i>Decrease in the recruitment quality</i>
	6	<i>Lack of refrigeration technicians and engineers</i>
	7	<i>Lack of understanding of new technological clusters</i>
Interactions between stakeholders	8	<i>Disturbed process of advice to the final usage of the system</i>
	9	<i>Lack of flexibility for the installers</i>
	10	<i>Risk of discomfort for the final user's customers</i>
	11	<i>Risk of high danger for human health</i>
Tools	12	<i>Poor exploration of the design space</i>
	13	<i>Lack of common efficient tools</i>
	14	<i>Risk of high environmental impacts</i>
	15	<i>Poor recycling rate</i>

3.3.1. Cost issues

There is a need for rapid change in the systems to respond to the evolution of regulation. The leaders of the refrigeration market (the five largest companies represent 42% of the market) structure the technical advances. A small company will have more difficulty recruiting competent operators for these new developments and keeping up with the latest changes. The lack of structural adaptability in companies makes *the risk of high costs* inevitable. In the exploitation phase, the risk increases with the likelihood of a component's *obsolescence*, human error, and refrigerant leakage. The impact is an *increase in costs*, mostly for the final user. Moreover, the lack of knowledge about the ability of EOL parties to treat their waste sometimes leads to waste being left on-site and so means a poor recycling rate. During the exploitation, *breakdowns* are frequent but not fatal as the system functions remain robust. They can be mechanical, electrical, or design-related breakdowns and lead to *high repair costs* or *loss of frozen food*. The system's electricity consumption is the most critical operational cost mainly for maintaining systems and energy loss (Evans et al., 2014).

3.3.2. Knowledge management issues

As the sector is changing, the *training of new technicians or engineers decreases*. As industrial demand increases, the refrigeration sector in France *lacks refrigeration technicians or engineers*. SNEFFCA, a professional union, reports recruitment rate in the sector as more than 4,000 hires per year for 2,000

small or medium companies, with a falling number of applications. New technological clusters are often not fully understood in all the usage situations as there is no time to keep up with the changes (Minetto et al., 2018). For example, as CO₂-based technologies are deployed, the operators accustomed to HFC systems are faced with pressurized equipment that is new to them.

3.3.3. Interaction issues between stakeholders

Multiple problems of communication between stakeholders were found. The interviews emphasized that a change in regulation results in a *disturbance of the final user's advice process*. For example, the manufacturer is now responsible for the whole lifecycle process for air conditioning. Refrigeration engineers and operators work for the manufacturer and not a supply company. As adaptation times to new standards are not properly allowed for the final customer demands, the recommendations are not optimal. During the design phase, the frequent problem is that the final user specifications given to the supplier can *constrain the design space*. During the exploitation phase, either during regular use or maintenance, customers can hear an *uncomfortable noise*. This problem is not frequent and does not significantly damage the users but can harm the company's image. Refrigerant use can cause *human health problems* (toxic or flammable refrigerant) or require high-pressure equipment such as CO₂-based systems. Accidents, though extremely rare, can be fatal.

3.3.4. Tool issues

Most design offices are subject to a strong time constraint during the RS design phase, leading to *sub-optimal design space exploration*. More than a hundred tools exist to design an RS, but they are *not considered entirely efficient*. Most companies use LCA to calculate the environmental impacts of the systems. The exploitation and the EOL treatment phases carry a greater *risk of higher negative impacts* due to frequent refrigerant leakage and high electricity consumption, resulting in high indirect impacts, as shown in a preliminary study presented in (Salehy et al., 2019). However, it does not consider the EOL when large industrial systems components are sometimes left on-site primarily because of *higher costs of dismantling* components or *lack of knowledge* of the EOL treatment parties that can manage the EOL.

3.4. Existing solutions

For each of the usage situations defined previously (cf. Section III.1), the users have different solutions that can help them accomplish their tasks and mitigate the problems they encounter. We identified six different solution categories:

- **Software-based solutions** comprise the programs and instructions to design and monitor the RS during each usage situation, such as CoolTool (CoolTool Technology GmbH) and Excel spreadsheets.
- **Knowledge management-based solutions** comprise documents, best practices guides, certifications and techniques to guide operators, improve activities, and raise user awareness during each usage situation.
- **Methodological solutions** comprise the methods and approaches used in the design phase to palliate potential problems arising in the exploitation and EOL phases, such as Design of X

methodologies (Bralla, 1996).

- **Technical solutions** comprise the technical clusters (at all readiness levels). They can include the system architecture, the physical components, digitization, etc.
- **Tool solutions** comprise all the tangible tools used for the RS installation, maintenance, dismantling, and EOL treatment, such as a pump for refrigerant or oil draining or overband magnets for ferrous metal separation.
- **EN 378** groups the standard guidelines (*NF EN 378*, 2017).

4. Explore and decide the improvement paths of the socio-technical RS

4.1. Data treatment

To summarize, the activities of the socio-technical RS were represented in RID by twelve user profiles (Figure 4-6), three macro lifecycle stages (or usage situations), fifteen problems (*Table 4-4*) and six categories of existing solutions. Seven matrices were then filled with quantifying data on a scale from 0 = never to 5 = frequently, based on the qualitative data collected and following a precise question (see Figure 4-3).

Table 4-5 gives an example of matrix filling. From the data collected during the interviews and from observations, it quantifies the adaptation of the existing solution categories to usage situations. Actors can use a single solution during their activities or a combination of different solutions from the same category or different categories. For example, during the *design phase*, most activities use *software solutions* such as AutoCAD for the system drawings and Excel sheets for the calculation of the frigorific power, compressor needed, and sometimes by the EN378 guidelines and/or *methodological solutions*. *Technological solutions* and *tools* are only used to manufacture components or put the system in place.

Building an RID cognitive model of activity needs simultaneous answers to many precise questions but qualitatively, with the rough estimation of an order of magnitude, which is finally easy once the knowledge has accumulated.

Table 4-5. UsEs matrix: To what extent does this existing solution facilitate the usage situation? (scale from 0 = never to 5 = frequently)

	<i>Software solutions</i>	<i>KM solutions</i>	<i>EN 378 guidelines</i>	<i>Methodological solutions</i>	<i>Technological solutions</i>	<i>Tool solutions</i>
<i>Design, manufacture and installation</i>	4	4	3	3	2	2
<i>Exploitation</i>	4	5	4	4	4	5

<i>End-of-life</i>	3	4	4	3	2	5
--------------------	---	---	---	---	---	---

The other matrices filling process is explained in Appendix 2.

As explained in Section 2.1, we analyzed two sets of results: first the effectiveness indicators computed with RID Comparator, and second the overall matrix of value buckets computed with RID Compass.

4.2. RID Comparator

Figure 4-10 shows one of the effectiveness indicators: the relative effectiveness of *existing solutions* in responding to the *problems* of a socio-technical RS. It indicates the percentage of the possible quantity of pains that each existing solution removes overall in a problem. The most effective solutions are those with the broadest coverage on the radar plot.

Figure 4-10 shows that the most effective solutions are knowledge-based (training, best practices guides, skills analysis table) represented in red. *Knowledge management (KM) solutions* include understanding new technical solutions such as the use of CO₂ as a refrigerant and allow users to engage an effective transition toward regulations (Paurine et al., 2021). The diagram also highlights that the most damaging problems are mainly solved because they represent very high risks for the actors. For example, the risk of high danger for humans is 100% solved by awareness guides and risk analysis, as is the risk of high operational costs. However, interviewees emphasized that the training courses arrived only after a stakeholder was already in a critical situation (such as working with a CO₂-based system).

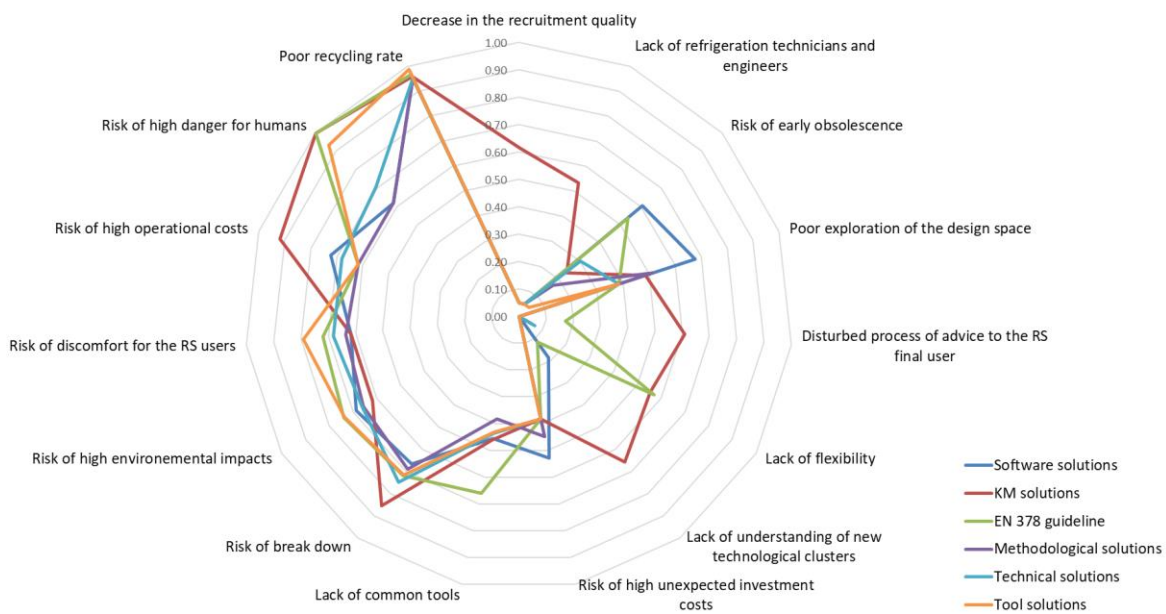

Figure 4-10. Effectiveness of the existing solutions for the problems (as percentage eradication of

quantity of pains, irrespective of usage situations and user profiles)

Figure 4-11 shows the effectiveness of *existing solutions* for each of the twelve *user profiles*. It indicates the percentage of the current quantity of pains removed for each *user profile*. This figure highlights the lack of effective solutions for each user profile. The solutions for academic researchers are underemphasized in this figure. This is because academic research represents a small market share compared to other users (manufacturers, designers, suppliers). Moreover, one of the academic research objectives in refrigeration is to develop alternative technical solutions. The diagram indicates that the stakeholders involved in the process can use a single solution during their activities or a combination of different solutions from the same category or different categories, confirming the data collected during the interviews.

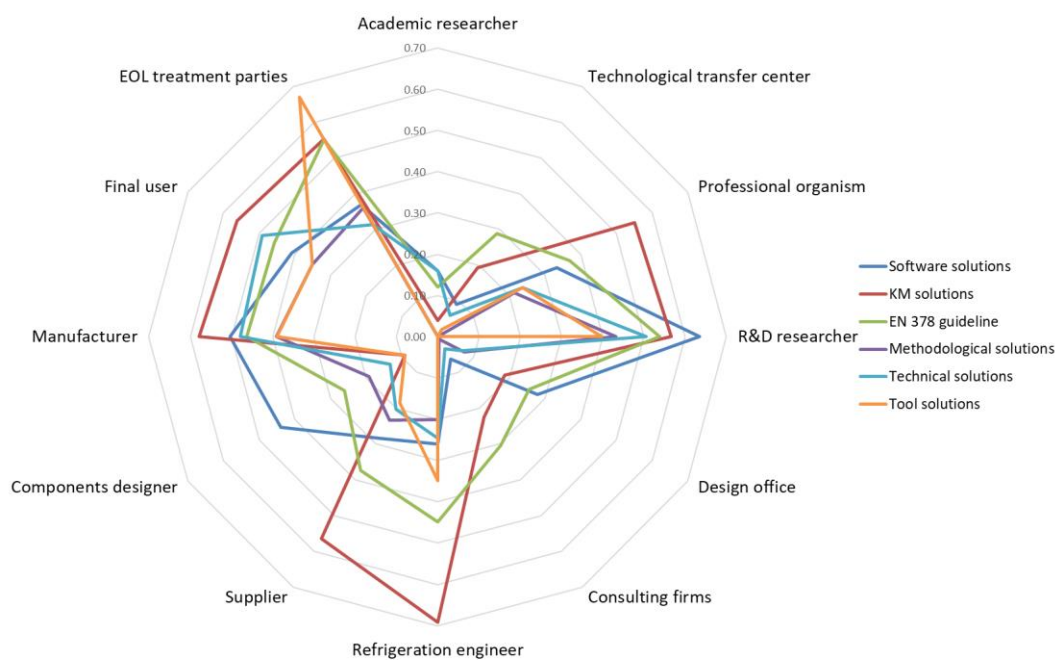

Figure 4-11. Effectiveness of the existing solutions for the user profiles or stakeholders (as percentage eradication of quantity of pains, irrespective of the usage situations and problems)

4.3. RID Compass

The analysis of effectiveness indicators lets us compare the effectiveness of the existing solutions and thus indicates where the existing solutions have already reduced the number of pains. The second decision-aid tool (RID Compass) highlights the improvement areas where solutions are not effective on average despite a high quantity of pains.

To explore the improvement paths in the socio-technical RS, we analyzed the global matrix of value buckets shown in Figure 4-12. The matrix was computed to establish where to innovate to maximise users' utility when no existing solutions were effective. The highest scores in the matrix highlight the opportunities of development for a competitive advantage, i.e., where competitors have not intensively innovated.

The three most important value buckets occur during the first usage situation, i.e., *design, manufacture and installation*. This is the most complex stage because many stakeholders are involved, each with their way of acting.

The three VBs identified by the value bucket algorithm (Figure 4-12) are:

- VB1: the *lack of understanding*, i.e., adaptation of the new technical clusters (#7).
- VB2: the *disturbed process of interaction between stakeholders*, i.e., the organizational structure in the process (#8,9).
- VB3: *lack of common tools*, i.e., the knowledge shared by all the users involved in the project (including EOL) with a technical cluster database (#13).

The most important VBs occur for knowledge management problems and interactions between stakeholders.

	Cost				Knowledge			Interactions				Tool			
	1	2	3	4	5	6	7	8	9	10	11	12	13	14	15
Design, manufacture and installation	0.06	0.05	0	0	0.14	0.28	VB1 0.35	0.34	VB2 0.26	0	0	0.07	VB3 0.35	0	0
Exploitation	0.01	0	0.08	0.02	0	0.09	0.07	0	0	0.05	0	0	0	0.06	0
End-of-life	0	0	0	0	0	0	0.02	0.01	0	0	0	0	0	0.01	0

Figure 4-12. Results of the DSM value bucket tool with the three VBs identified.

Even though the interviewees' most crucial performance metric was cost, this does not appear in the value buckets (VBs). The systematic care taken with operational conditions, i.e., regular maintenance, backup mode to prevent complete plant stoppage, and change of non-optimal components, might explain this. Moreover, a national financial incentive such as CEEs (energy saving certificates) in France to change installations encourages companies to improve their systems. The refrigeration sector is one of the first industrial fields to be impacted and made aware of environmental consequences. Accordingly, reducing the system's environmental impacts was not rated as important in the VBs, as the interviewees considered that there were solutions such as ecodesign tools and technologies such as natural refrigerants to reduce emissions.

The EOL was rated the least impactful usage situation. As an RS comes under WEEE, the solutions to manage its EOL once technicians have drained off the refrigerant are highly developed. The only marked challenge for the EOL parties is to be informed of any disruptive technological change. They need to be aware of technological developments if EOL management changes.

During the exploitation phase, the system robustness influences the problems encountered. As RSs are robust due to extensive research on system optimization, interviewees did not indicate this stage as the most challenging one. However, as summers get hotter, more and more systems run at least once in their backup degraded mode. In the years to come, refrigeration technicians and project

managers consider that they will have to face the problems of providing a system that can run at peak cold need (typically on the hottest day of the year).

More than a hundred tool solutions exist. However, the effectiveness indicators of the solutions presented in Figure 4-10 and Figure 4-11 show that they do not fully address the current industrial problems. Moreover, the problems of knowledge management and interaction between stakeholders do not have many possible solutions. This is one of the issues most difficult to manage for the interviewed user. We observed confusion among the stakeholders about the whole socio-technical system, mostly because of the large number of companies, regulations, solutions, and possibilities.

Applying the RID process revealed the importance of the design, manufacture, and installation phases. The interviewees considered this usage situation as the most challenging one: it is then that multiple actors from different companies or teams collaborate, bringing their knowledge, preferences, tools, and experience.

Knowledge management and interaction between stakeholders are two important problem categories identified by Pärttö and Saariluoma (2012) that explain failures in design. In the last decades, research in refrigeration has developed promising technologies. The stakeholders meet difficulties investing in these new technologies because of a lack of long-term visibility. RSs are robust and costly to develop. Technical change toward more sustainable systems should be more usage-driven in the future, with more systematic consideration of the users and the usage situations of the whole socio-technical RS.

Following the present study, we intend to address the gaps identified with the main value buckets by two novel solutions to improve the performance of the activities of the socio-technical RS. First, by developing first a new model-based integrated design platform and approach, and second a new organization linking all the stakeholders involved in the early stages of an RS design.

To close the loop of the RID methodology, our two solution components will be prototyped and tested in virtual and real environments. Finally, their ability to act on identified value buckets will be assessed by comparing, using RID Comparator, our solution with the existing ones.

5. Discussion and conclusion

Our objective was to improve the overall design of a refrigeration system (RS) for the food industry (as typically found in a supermarket). The areas of improvement of the socio-technical system lifecycle stages of the RS were analyzed to answer the question, "Are the causes of poor system performance due to a lack of tools, a lack of design know-how, or a whole set of organizational problems caused by a lack of consultation between the players in the value chain?"

Radical Innovation Design (RID) has proved efficient for analyzing complex socio-technical systems made of a set of activities to result in effectiveness indicators and a set of prioritized value buckets (VB), after a series of precise steps: an in-depth investigation, a segmentation in four dimensions, the

evaluation of their relationships, and finally the computation of decision-making indicators.

A field study yielded the necessary data for analysis by RID. During the interviews, the issues revealed the importance of the first step in an RS lifecycle: design, manufacture and installation. Different actors are involved in the process, and yet interactions between them are lacking. The RID algorithms advanced three main stakeholder problems during the first lifecycle stage. They concern the comprehension of new technologies (VB1), the lack of a common tool corresponding to all stakeholders' expectations (VB2), and the interaction between stakeholders (VB3),

This analysis shows us how to start from these identified value buckets to develop a twofold innovative solution. We thus propose (i) an integrated model-based design platform for modelling and simulating the refrigerant system under design and (ii) a new organization of actors over an RS lifecycle. For the integrated platform, we identified a gap related to the disturbed process of advice (VB2) that results in sub-optimal design space exploration. This is mostly due to the final user constraints (budget, mindset, company's image, deadline, and operational and installation conditions) and objectives (e.g., minimizing energy consumption and costs, maximizing performance). In the early design stage, we seek to better integrate stakeholders' constraints and objectives in a shared design platform to ensure the collaborative design and overcome the lack of interaction between stakeholders (VB3). Simplified models of RS performance not considered by existing platforms will be used to assess it earlier in the design process, including low-readiness level technologies, thus ensuring a better understanding of those technologies (VB1). Performance metrics such as maintenance costs and ease, availability performance, space used, and adaptation to the regulation's evolution are all relevant. Lastly, once our innovative solution is developed, the RID methodology will enable us to assess its overall ability to remove or lessen quantities of pains we detected in this study, to make explicit its advantages over existing solutions and prove more objectively the creation of usefulness for RS stakeholders.

References

- Acha, S., Du, Y., Shah, N., 2016. Enhancing energy efficiency in supermarket refrigeration systems through a robust energy performance indicator. *International Journal of Refrigeration* 64, 40–50. <https://doi.org/10.1016/j.ijrefrig.2015.12.003>
- Aprea, C., Greco, A., Maiorino, A., 2012. An experimental evaluation of the greenhouse effect in the substitution of R134a with CO₂. *Energy* 45, 753–761. <https://doi.org/10.1016/j.energy.2012.07.015>
- Ardente, F., Calero Pastor, M., Mathieux, F., Talens Peiró, L., 2015. Analysis of end-of-life treatments of commercial refrigerating appliances: Bridging product and waste policies. *Resources, Conservation and Recycling* 101, 42–52. <https://doi.org/10.1016/j.resconrec.2015.05.005>
- Bahman, A., Rosario, L., Rahman, M.M., 2012. Analysis of energy savings in a supermarket refrigeration/HVAC system. *Applied Energy* 98, 11–21. <https://doi.org/10.1016/j.apenergy.2012.02.043>
- Bekhradi, A., Yannou, B., Cluzel, F., Vallette, T., 2017. Categorizing user pains, usage situations and existing solutions in front end of innovation: the case of smart lighting project, in: 21st International Conference on Engineering Design (ICED 17). Vancouver, Canada.
- Ben-Abdallah, R., Leducq, D., Hoang, H.M., Fournaison, L., Pateau, O., Ballot-Miguet, B., Delahaye, A., 2019. Experimental investigation of the use of PCM in an open display cabinet for energy management purposes. *Energy Conversion and Management* 198, 111909. <https://doi.org/10.1016/j.enconman.2019.111909>
- Bralla, J.G., 1996. Design for excellence. McGraw-Hill, New York; Montreal.
- Cagno, E., Neri, A., Howard, M., Brenna, G., Trianni, A., 2019. Industrial sustainability performance measurement systems: A novel framework. *Journal of Cleaner Production* 230, 1354–1375. <https://doi.org/10.1016/j.jclepro.2019.05.021>
- CoolTool Technology GmbH, 1995. CoolTool.
- Evans, J.A., Hammond, E.C., Gigieli, A.J., Foster, A.M., Reinholdt, L., Fikiin, K., Zilio, C., 2014. Assessment of methods to reduce the energy consumption of food cold stores. *Applied Thermal Engineering* 62, 697–705. <https://doi.org/10.1016/j.applthermaleng.2013.10.023>
- Ge, Y.T., Tassou, S.A., 2011. Performance evaluation and optimal design of supermarket refrigeration systems with supermarket model “SuperSim”, Part I: Model description and validation. *International Journal of Refrigeration* 34, 527–539. <https://doi.org/10.1016/j.ijrefrig.2010.11.010>
- Gullo, P., Hafner, A., Banasiak, K., 2018. Transcritical R744 refrigeration systems for supermarket applications: Current status and future perspectives. *International Journal of Refrigeration* 93, 269–310. <https://doi.org/10.1016/j.ijrefrig.2018.07.001>
- Hesloin, C., Perry, N., Perrot-Bernardet, V., 2017. Consideration of value chain actors in the analysis of environmental performance for eco-design and incentive for sustainable behavior: case study of energy-using products road transport refrigeration units. *Ecole nationale supérieure d'arts et métiers - ENSAM*.
- Hess, D.J., Sovacool, B.K., 2020. Sociotechnical matters: Reviewing and integrating science and technology studies with energy social science. *Energy Research & Social Science* 65, 101462. <https://doi.org/10.1016/j.erss.2020.101462>

- IEA, 2018. The future of cooling. International Energy Agency, Paris.
- Islam, Md.A., Srinivasan, K., Thu, K., Saha, B.B., 2017. Assessment of total equivalent warming impact (TEWI) of supermarket refrigeration systems. *International Journal of Hydrogen Energy* 42, 26973–26983. <https://doi.org/10.1016/j.ijhydene.2017.07.035>
- Kim, W.C., Mauborgne, R., 2005. Value innovation: a leap into the blue ocean. *Journal of business strategy*.
- Kolokotroni, M., Mylona, Z., Evans, J., Foster, A., Liddiard, R., 2019. Supermarket Energy Use in the UK. *Energy Procedia* 161, 325–332. <https://doi.org/10.1016/j.egypro.2019.02.108>
- Lamé, G., Leroy, Y., Yannou, B., 2017. Ecodesign tools in the construction sector: Analyzing usage inadequacies with designers' needs. *Journal of Cleaner Production* 148, 60–72. <https://doi.org/10.1016/j.jclepro.2017.01.173>
- Lamé, G., Yannou, B., Cluzel, F., 2018. Usage-driven problem design for radical innovation in healthcare. *BMJ Innovations*.
- Law, J., 2009. socio-technical system. *A Dictionary of Business and Management*: Oxford University Press. <https://doi.org/10.1093/acref/9780199234899.013.5970>
- Mignon, I., Bergek, A., 2016. System- and actor-level challenges for diffusion of renewable electricity technologies: an international comparison. *Journal of Cleaner Production* 128, 105–115. <https://doi.org/10.1016/j.jclepro.2015.09.048>
- Minetto, S., Marinetti, S., Saglia, P., Masson, N., Rossetti, A., 2018. Non-technological barriers to the diffusion of energy-efficient HVAC&R solutions in the food retail sector. *International Journal of Refrigeration* 86, 422–434. <https://doi.org/10.1016/j.ijrefrig.2017.11.022>
- NF EN 378 - Refrigerating systems and heat pumps - Safety and environmental requirements, 2017. . European Committee for Standardisation.
- Pahl, G., Beitz, W., 2013. *Engineering design: a systematic approach*. Springer Science & Business Media.
- Pärttö, M., Saariluoma, P., 2012. Explaining failures in innovative thought processes in engineering design. *Procedia - Social and Behavioral Sciences* 41, 442–449. <https://doi.org/10.1016/j.sbspro.2012.04.053>
- Paurine, A., Maidment, G., Rodway, M., Yebiyo, M., 2021. Understanding the market need for skills in alternative refrigerants with low global warming potential in the EU region – A comprehensive survey on Refrigerant Emissions And Leakage (REAL) alternatives programme. *International Journal of Refrigeration* 122, 11–20. <https://doi.org/10.1016/j.ijrefrig.2020.11.014>
- Saaksvuori, A., Immonen, A., 2008. *Product lifecycle management*. Springer Science & Business Media.
- Salehy, Y., Leroy, Y., Cluzel, F., Hoang, H.-M., Fournaison, L., Delahaye, A., YANNOU, B., 2019. Life cycle assessment of hypermarket refrigeration system: effet of location and choice of architecture, in: AvniR Conference. Lille, France.
- Schaeffer, R., Szklo, A.S., Pereira de Lucena, A.F., Moreira Cesar Borba, B.S., Pupo Nogueira, L.P., Fleming, F.P., Troccoli, A., Harrison, M., Boulahya, M.S., 2012. Energy sector vulnerability to climate change: A review. *Energy* 38, 1–12. <https://doi.org/10.1016/j.energy.2011.11.056>
- Sovacool, B.K., Griffiths, S., Kim, J., Bazilian, M., 2021. Climate change and industrial F-gases: A critical and systematic review of developments, sociotechnical systems and policy options for

- reducing synthetic greenhouse gas emissions. *Renewable and Sustainable Energy Reviews* 141, 110759. <https://doi.org/10.1016/j.rser.2021.110759>
- Stark, J., 2016. Product lifecycle management, in: *Product Lifecycle Management (Volume 2)*. Springer, pp. 1–35.
- Yannou, B., 2015. Supporting need seeker innovation: the Radical Innovation Design methodology, in: *International Conference on Engineering Design (ICED)*. Milano, Italy.
- Yannou, B., Cluzel, F., Farel, R., 2016. Capturing the relevant problems leading to pain- and usage-driven innovations: The Dependency Structure Modeling Value Bucket algorithm. *Concurrent Engineering* 26, 131–146. <https://doi.org/10.1177/1063293X16666311>
- Yannou, B., Cluzel, F., Lamé, G., 2018. Adapting the FBS Model of Designing for Usage-Driven Innovation Processes. <https://doi.org/10.1115/DETC2018-86166>
- Yannou, B., Jankovic, M., Leroy, Y., Okudan Kremer, G.E., 2013. Observations From Radical Innovation Projects Considering the Company Context. *Journal of Mechanical Design* 135. <https://doi.org/10.1115/1.4023150>

Chapter 5: Knowledge model for the design of refrigeration systems

To capitalize knowledge around the design and multi-performances simulation of refrigeration systems, the knowledge of fifteen experts belonging to several companies with different roles was collected, in addition to the literature review (150 articles and documents) and field observations. Ontologies are used for capitalizing knowledge in different domains by defining meta-classes, relationships between them, vocabulary, instances. Thus, this chapter presents a knowledge model for the design and simulation of a refrigeration system applied to retail refrigeration. The data acquisition results allow us to establish the design process of a refrigeration system architecture in different usage scenarios. The use of ontology and a design and exploration platform in the decision-making process has many benefits. It reduces industry segmentation and helps design optimal systems. The objective of such knowledge model construction is to support the design process in the refrigeration domain for different types of actors involved in the process. Four concepts and their associated classes and relations are described as related to the context, system design solution, and performance.

1. Introduction: Why an ontology?

As shown in the diagnosis of the refrigeration domain, designing a refrigeration system (RS) is a highly collaborative process involving many actors, tools, knowledge and disciplines. Digital tools are now essential during the RS design process. They are used to calculate the cooling load, dimension the system, optimize the components, simulate the machine's efficiency, manage the installation and the End-of-Life (EOL), and calculate the environmental impacts. They use different models, which are complementary for most of them but also redundant, contradictory or too far from reality. Moreover, different actors may use different software, making communication difficult. The literature review highlights a lack of an integrated approach regarding the design of refrigeration systems (Research gap 2). We have shown from the diagnosis of the refrigeration domain that the most important value buckets (VBs) are the lack of understanding of new technologies, the lack of common tools and knowledge.

To palliate these problems, coordination of the actors for the design or development of technologies is an essential measure. This coordination is likely to happen on the condition that these actors share the same language, articulating concepts properly defined. Ontologies are systems of fundamental concepts that conceptualize the real domain concerned and provide shareable data support for wider use than a traditional knowledge database (Karray, Chebel-Morello, and Zerhouni 2012). The developed ontology provides a representation that can be used to support the design phase. It ensures the formalization and reuse of refrigeration simulation knowledge (Noy and McGuinness 2001).

The interest in developing ontologies is growing in engineering design because it involves knowledge sharing and the development of a common standard language (Ahmed, Kim, and Wallace 2006). The key use for ontology is highlighted in the literature. Yang and Zang (2006) have shown that building design object with an ontology ensures capture and sharable information. Ontologies bring many benefits highlighted in the literature and have been proven efficient in different domains such as automobile, aeronautics to support decision making in the early design process by defining in a formalized way the design problem, the constraints, structure, objectives, etc. (Munir and Sheraz Anjum 2018; L. Yang, Cormican, and Yu 2019). Indeed, understanding a complex problem by using proper models and automated knowledge, exploring more alternatives and improving prediction significantly improve human performance for the resolution of the problem (Liang 1988).

The main objective of the development of this knowledge model for designing a refrigeration system is to capitalize in a systemic representation the industrial knowledge of different experts and the theoretical knowledge from literature to define the design problem properly. The results of this data acquisition allow us to establish the modelling and multi-performances simulation process of the behaviour of a refrigeration system architecture in different usage scenarios, such as finding the best design solution or observing the impacts of a refrigerant change in the performances of a refrigeration system. The developed knowledge model is the conceptual creation of designing an energy-consuming system that meets functional requirements to fulfil the stakeholder's most crucial targets of quality – or performances -, costs, delays, and environmental impacts. The development

of technologies based on artificial intelligence and CAE/CAD (Computer Assisted Engineering/Computer-Aided Design) has facilitated access to information related to the structure and form of objects, although design know-how used in the conceptual design phase remains hidden due to its subjective nature and implicitness (Kitamura and Mizoguchi 2004). The ontology proposed would be usable by all the stakeholders of the domain listed and defined in the diagnosis chapter to ensure a shareable semantic and the usage of a common tool, a design and simulation platform, that would support the designer and researchers in their activities.

The first section of this chapter presents the construction of the ontology. Different types of ontology have been listed, depending on the knowledge and the application (Gómez-Pérez 1999; Guarino 1998; Kharbat and El-Ghalayini 2008; Van Heijst, Schreiber, and Wielinga 1997): knowledge representation, general, meta-, domain, task, domain-task, application, index, tell and ask. To understand what is included in these ontologies, the following points describe a few of the most common categories found in literature: General ontologies, also called common ontologies, are domain-neutral as it capitalizes knowledge with basic notions and concepts related to things, time, space, event. An example of such ontologies is given in (Soininen et al., 1998), in which they propose a general ontology for the configuration of any system. Meta-ontologies or generic ontologies are also general enough to be reused across domains. An example is given in (Borst, Akkermans, and Top 1997), where the authors define physical system simulation. Domain ontologies provide vocabulary about concepts, theory, the relation between concepts, principles of a particular domain, capturing "static knowledge in a problem-solving independent way" (Gómez-Pérez 1999). Task ontologies are concerned with problem-solving, not related to a particular domain but the activity. Domain-task ontologies include terms used to solve problems in a particular domain. Finally, application ontologies capitalise knowledge for modelling a particular domain. A well-known ontology in the design of a system is the Function-Structure-Behaviour (FBS) from (J. S. Gero and Kannengiesser 2014) that will be commented on in the section.

To our knowledge, no ontology-based model has been developed to support the refrigeration systems design process, more specifically, an integrated simulation for the design space exploration.

The second section presents the knowledge model for the design of refrigeration systems in an industrial context in an object-oriented representation through the definitions of classes, their properties and instances. Classes represent the domain concepts, and the association relations represent their interactions. Further, we propose that this ontology be generalized for the whole energy network systems in a store.

The ontology developed follows the classical steps of an ontology construction presented in session 2, from the specification to the implementation of the ontology directly on a simulation and design space exploration platform. These steps are presented in section 3.

The last section presents the evaluation of the ontology in two ways: from a specific case study and with expert validations.

A conclusion ends this chapter.

2. Construction process of the knowledge model

2.1. Development of an ontology

Ontology development has been studied by multiple researchers for years. Ontologies comprise definitions for objects and types of objects as well as their semantics and relations in a formal way, forcing a shared understanding of the refrigeration domain. In contrast to a mere taxonomy, which represents a hierarchically organized vocabulary of generic and specialized concepts, an ontology extends this idea by means of concept relations or constraints to enhance semantic interpretation (Gruber 1993; 1995). The main components of ontologies are a hierarchy of concepts representing types of entities, relations between concepts, restrictions on relations, and instances.

To construct an ontology, multiple methodologies have been developed in the design science domain. As constructing an ontology is a creative process, it necessarily starts with identifying the ontology's motivation, scope, and purpose. Depending on the methodology, different protocols exist, such as answering a list of questions, brainstorming. Then, the creative process needs to be iterative to refine the ontology. To build the concepts, relations, classes, one needs to first identify if a possible reuse of existing ontologies is possible. Then, workshops, brainstorming sessions, interviews, literature reviews, and observations can bring knowledge to propose a conceptualisation of the acquired knowledge. Table 5-1 gives a summary of the different methodologies.

Table 5-1. Literature review summary of the main methodologies for ontology development

Method	Authors	Steps
Enterprise	(Michael Uschold and King 1995)	Identify the purpose Build the ontology: capture, coding and integrating Evaluate how the ontology fulfils the requirements Document the ontology
TOVE- Toronto Virtual Enterprise	(Grüninger and Fox 1995)	Capture motivating scenario(s) Formulate informal competency questions Specify the terminology using first-order logic Define formally competency questions in FOL Specify axioms and definitions for the terms Evaluate competency and completeness (conditions under which the solutions to the questions are complete)
Unified methodology	(Mike Uschold 1996)	Define the purpose of the ontology Define the level of formality Find the concepts and the relations Build the ontology: choose one of four approaches (1. Skip the

		<p>previous steps and use an ontology editor to define terms and axioms; 2. Do the previous steps and then begin a formal encoding; 3. Produce an intermediate document that can be the final result, or a specification/documentation of the formal code; 4. Identify formal terms from the set of informal terms)</p> <p>Evaluate or revision cycle</p>
METHONTOLOGY	(Fernández-López, Gómez-Pérez, and Juristo 1997)	<p>Specify the requirements (purpose of the ontology, the level of formality and the scope of the ontology)</p> <p>Acquire knowledge: brainstorming, structured and unstructured interviews, formal and informal analysis of texts, and knowledge acquisition tools</p> <p>Conceptualize</p> <p>Check for reusable ontology</p> <p>Implement in a formal language</p> <p>Validate and verify</p> <p>Document</p>
Ontology Development 101 (iterative process)	(Noy and McGuinness 2001)	<p>Identify the domain and the scope</p> <p>Check for reusable ontology</p> <p>Define the classes: produce a list of all the terms, relations, and properties (attributes)</p> <p>Define value type of both the classes and the class properties (cardinality, domain and range)</p> <p>Create individual instances</p>
Methodology from Karlsruhe	(Staab et al. 2001)	<p>Study the feasibility</p> <p>Define a first draft of the ontology: ontology kickoff</p> <p>Refine/revise the first draft</p> <p>Evaluate and compare with the requirements</p> <p>Maintain and evolution phase</p>
Heuristics-based method	(Sugumaran and Storey 2002)	<p>Identify all the basic terms</p> <p>Identify the relationships</p> <p>Identify basic constraints</p> <p>Consider higher-level constraints</p>
Ontology development life cycle	(Pinto and Martins 2004)	<p>Specify the purpose and scope by answering specification questions</p> <p>Describe the conceptual model</p> <p>Formalize into formal language</p> <p>Implement</p> <p>Update and correct the implemented ontology</p> <p>Evaluate technically</p> <p>Document what was done, how and why it was done</p>

In a recent study, Yang et al. (2019) propose a review of ontology-based system engineering. They offer a roadmap to create a helpful ontology for system engineering (SE). It consists of four steps that are: (1) choose a particular knowledge area where a gap exists and has not been solved; (2) define a clear objective of use of the ontology; (3) use ontology development methodologies and tools to support the development; (4) address SE challenges into the proposed ontology.

For the development of the proposed ontology, we use a merging of different methods. The typical first steps of the METHONTOLOGY, Ontology Development 101 and the methodology from (Pinto and Martins 2004) described in Table 5-1 are used:

- Specification: Define the scope, purpose, end-users, intended use by answering the question from (Pinto and Martins 2004).
- Check for reusable ontology
- Knowledge acquisition
- Conceptualization and formalization using UML graphs

The next step corresponds to the implementation of the knowledge model on a design and simulation platform that different stakeholders can use. Finally, the last step consists of evaluating the ontology as in the METHONDOLOGY by verification and validation. The next section presents in detail the construction process of our knowledge model.

2.2. Methodology for the knowledge model construction

The construction of the knowledge model proposed in this work follows the usual steps that are presented in Section 1.1:

- Specification, during which one defines the scope, purpose, users and intended use of the knowledge model.
- Knowledge acquisition comprises all the data acquisition processes and the data acquired that provides inputs to the knowledge model.
- Conceptualization, based on the knowledge model, this step defines the concepts, classes, relations related to the specifications.
- Formalization, based on the conceptualization that defined the vocabulary, this step consists of clearly formalizing the concepts through schemes,
- Implementation, which is the development step using the formal scheme to implement the model with oriented object language, web ontology languages like OWL, or directly on a design platform, as applied in this work.
- Evaluation, which is the final step to assess the quality, i.e., the accuracy, completeness, correctness, clarity, coverage of the ontology. Different possibilities exist to assess the knowledge model and its implementation: using ontology metrics, application through scenario testing, user testing and data comparison. For more detail, see (Hlomani and Stacey,

2014). The evaluation of our ontology includes users and scenario testing. It will be detailed in Chapter 6.

Figure 5-1 shows the simplified scheme of the research methodology adopted to develop an ontology and adapted from the methods presented previously.

From the specification to the formalization of the knowledge, the first steps, with all the data acquisition and iteration, took one year of work. The specification defines the purpose of the ontology construction, the perimeter of the study, the intended use and users. The knowledge acquisition process, the number of experts, literature reviews are detailed in the following sections. The conceptualization step consists in capitalizing the data acquired based on existing knowledge models, languages, and representation. Before implementing the ontology in a platform, the final step consists of formalizing the conceptual representation through object-oriented representation to ensure that developers understand the proposed knowledge model and that no information is lost in the implementation process.

After the formalization phase, the ontology is implemented into a platform for the design and simulation of the refrigeration system. The classes, attributes and relations are used for object-oriented implementation. The ontology is then verified by two approaches: step-by-step verifications and use case verification with a supermarket refrigeration system. Five workshops were organised to challenge and verify the proposed ontology with experts (researchers, technicians, and frigorific engineers).

Then, the knowledge model and platform usage validation is made through scenario validation with experts. This scenario-based validation is detailed in the next chapter.

To position our knowledge model concerning existing works, we present related works from the literature review in the next section.

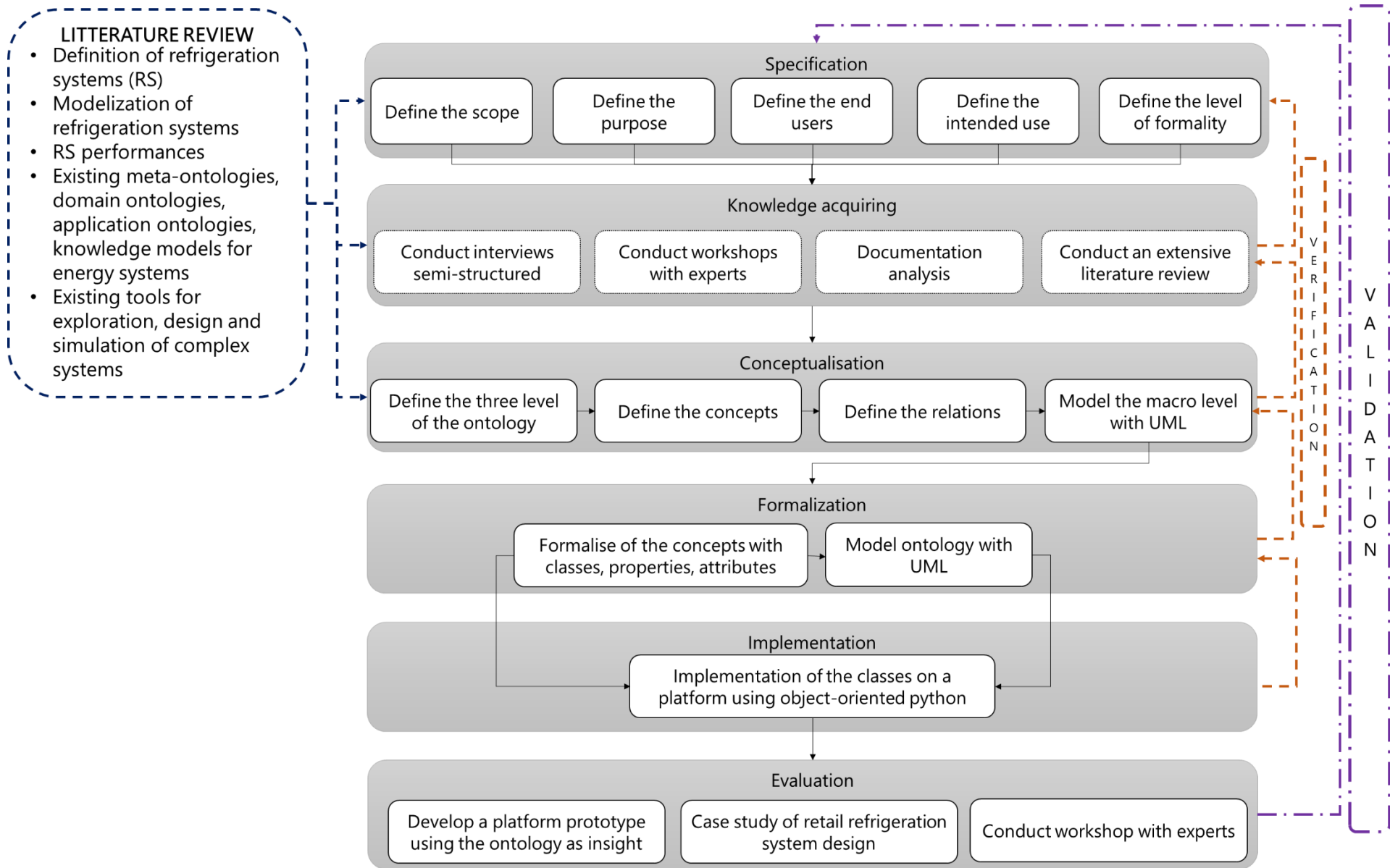

Figure 5-1. Construction of the ontology and implementation into a design platform

2.3. Related ontologies

To understand the development of an ontology in the domain of system engineering, we focus our attention on general and meta-ontologies related to physical systems, physics-based simulations, engineering design optimizations, system engineering; domain ontologies related to refrigeration domain, buildings; and application ontologies for industrial design objects. These ontologies help to support CAE/CAD. The literature review of related work justifies the different parts described in our proposed knowledge model for the design of a refrigeration system:

- A description of the context to design an RS (user, objectives, specification, constraints).
- A description of the objects and concepts useful to describe an RS solution (compressor, expansion valve, refrigerant).
- A description of the RS multi-physics simulation (performances, physical behaviour...) and a description of the decision-making process (performances, trade-offs...)

2.3.1. General and meta-ontologies

Generic and meta-ontologies help align heterogeneous knowledge in CAE/CAD (Computer Assisted Engineering/Computer-Aided Design) (Mascardi, Cordì, and Rosso 2007). Extending a general ontology to a domain-specific, in our case, the refrigeration domain can help to share terms and data.

For the design of refrigeration systems and the multi-performances simulation, we have explored existing work on a physical system, physics-based simulation, design optimization or system engineering.

General Formal Ontology (GFO) is an ontology for conceptual modelling. It is composed of multiple sub-ontologies related to the biomedical domain. One GFO sub-ontology is the Chemical Entities of Biological Interest ontology (ChEBI). Even though the first application domain of this sub-ontology is the biomedical, one concept of "refrigerant" is interesting for the refrigeration domain. They define refrigerant as "A substance used in a thermodynamic heat pump cycle or refrigeration cycle that undergoes a phase change from a gas to a liquid and back. Refrigerant is an application". It can have different instances defined in the ontology as follows "ammonia has role refrigerant". Figure 5-2 shows the different instantiations capitalised in ChEBI (<https://www.ebi.ac.uk/chebi>).

ChEBI Ontology i	
Outgoing	refrigerant (CHEBI:78433) is a application (CHEBI:33232)
Incoming	<p>ammonia (CHEBI:16134) has role refrigerant (CHEBI:78433)</p> <p>butane (CHEBI:37808) has role refrigerant (CHEBI:78433)</p> <p>carbon dioxide (CHEBI:16526) has role refrigerant (CHEBI:78433)</p> <p>chloroform (CHEBI:35255) has role refrigerant (CHEBI:78433)</p> <p>chloromethane (CHEBI:36014) has role refrigerant (CHEBI:78433)</p> <p>dichloromethane (CHEBI:15767) has role refrigerant (CHEBI:78433)</p> <p>diethyl ether (CHEBI:35702) has role refrigerant (CHEBI:78433)</p> <p>difluoromethane (CHEBI:47855) has role refrigerant (CHEBI:78433)</p> <p>dinitrogen oxide (CHEBI:17045) has role refrigerant (CHEBI:78433)</p> <p>ethane (CHEBI:42266) has role refrigerant (CHEBI:78433)</p> <p>ethene (CHEBI:18153) has role refrigerant (CHEBI:78433)</p> <p>fluoroform (CHEBI:41550) has role refrigerant (CHEBI:78433)</p> <p>fluoromethane (CHEBI:28826) has role refrigerant (CHEBI:78433)</p> <p>hexachloroethane (CHEBI:39227) has role refrigerant (CHEBI:78433)</p> <p>hexafluoroethane (CHEBI:32905) has role refrigerant (CHEBI:78433)</p> <p>isobutane (CHEBI:30363) has role refrigerant (CHEBI:78433)</p> <p>isopentane (CHEBI:30362) has role refrigerant (CHEBI:78433)</p> <p>methyl formate (CHEBI:77699) has role refrigerant (CHEBI:78433)</p> <p>pentane (CHEBI:37830) has role refrigerant (CHEBI:78433)</p> <p>propene (CHEBI:16052) has role refrigerant (CHEBI:78433)</p> <p>sulfur dioxide (CHEBI:18422) has role refrigerant (CHEBI:78433)</p> <p>tetrachloromethane (CHEBI:27385) has role refrigerant (CHEBI:78433)</p> <p>tetrafluoromethane (CHEBI:38825) has role refrigerant (CHEBI:78433)</p> <p>trichlorofluoromethane (CHEBI:48236) has role refrigerant (CHEBI:78433)</p>

Figure 5-2. ChEBI ontology for refrigerant

PhysSys ontology (Borst, Akkermans, and Top 1997) formalises concepts of physical systems. The ontology is organised with a set of model libraries for engineering design (see Figure 5-3). To do so, an investigation of diverse physical systems (heating systems, automotive components, machines) is done. To assist engineers in modelling physical events, a Physics-based Simulation Ontology called PSO has been developed recently by Cheong and Butscher (2019). The proposed ontology is based on a more formal ontology called Basic Formal Ontology (Smith et al. 2015). They propose in their work a distinction in the representation of physical phenomena versus the solver-specific interpretations of those phenomena, usable in different solvers.

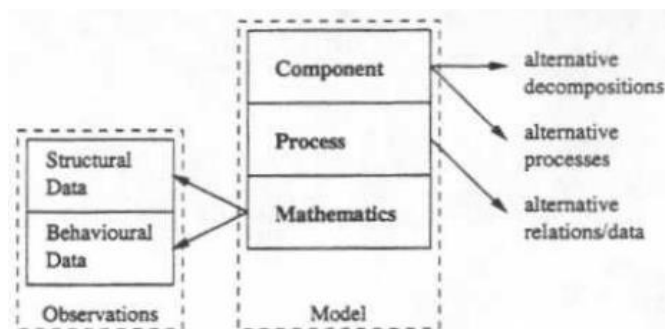

Figure 5-3. PhysSys ontology organisation of the model library from (Borst, Akkermans, and Top 1997)

To support the construction of our ontology, the optimisation domain has been investigated as a tool widely used in the engineering design process. To ensure the integrity of the optimisation

problem, the optimization process, and the resulting optimized solutions, (Witherell, Krishnamurty, and Grosse 2007) have captured this knowledge using the instantiation of an ontology its implementation into a prototype computational knowledge-based tool called ONTOP. They acquire the knowledge on compiling and organising optimisation terms in literature. They then define a formal taxonomy. The authors highlight that the knowledge problem can then be stored through a class instance, each instance specifically defined by the attributes of the design is optimized.

2.3.2. Domain, task and domain-task ontologies

After exploring general ontologies, we are interested in existing work in the specific domain. As refrigeration systems are energy-consuming devices, our investigation field is extended to energy-consuming devices in buildings. However, the topic of energy consumption devices and refrigeration systems is not much explored in the literature. Ontologies on the energy domain provide common representation and thus includes refrigeration devices as a sub-system (Cuenca, Larrinaga, and Curry 2017). 'Refrigeration Devices' module of the Domain Analysis-Based Global Energy ontology (DABGEO) (Cuenca, Larrinaga, and Curry 2020) is a formal taxonomy of refrigeration devices. It defines the different concepts of existing devices for refrigeration, their hierarchy relations, as shown in Figure 5-4.

Classes

Chiller DeepFreezer GlassdoorDisplay IceMaker OpenDisplayRefrigerator RefrigerationDevice SolidDoorRefrigerator VendingMachine WalkInRefrigerator
--

Chiller^c [back to ToC or Class ToC](#)

IRI: http://semanco02.hs-albsig.de/repository/ontology-releases/eu/semanco/ontology/SEMANCO/SEMANCO.owl#Chiller

This class represents chillers. A chiller is a machine for cooling something, especially a cold cabinet or refrigerator for keeping stored food a few degrees above freezing point.

has super-classes

[RefrigerationDevice^c](#)

Figure 5-4. Existing classes in the "refrigeration device" module of DABGEO and an example of Chiller concept definition.

Building Intelligence Modelling (BIM) ontology is an informal and semi-structured domain ontology. It includes concepts, attributes, relations and general knowledge related to the Architecture, Engineering, Construction and Operations (AECO) industry. First, BIM can be defined as a "methodology to manage the essential building design and project data in digital format throughout the building's life-cycle"(Penttilä 2006). BIM ontology is composed of four macro-level knowledge objects that include 50 concepts, 14 attributes, 160 relations, and knowledge sets which are combinations of the three previously cited objects. Succar (2009) identifies three fields of activity (see Figure 5-5). The technology field develops soft and hardware to support the building life stages

(design, construction, operation). The process field corresponds to the stakeholders involved in the building development. Finally, the policy field regroups the parties developing items to help decision making.

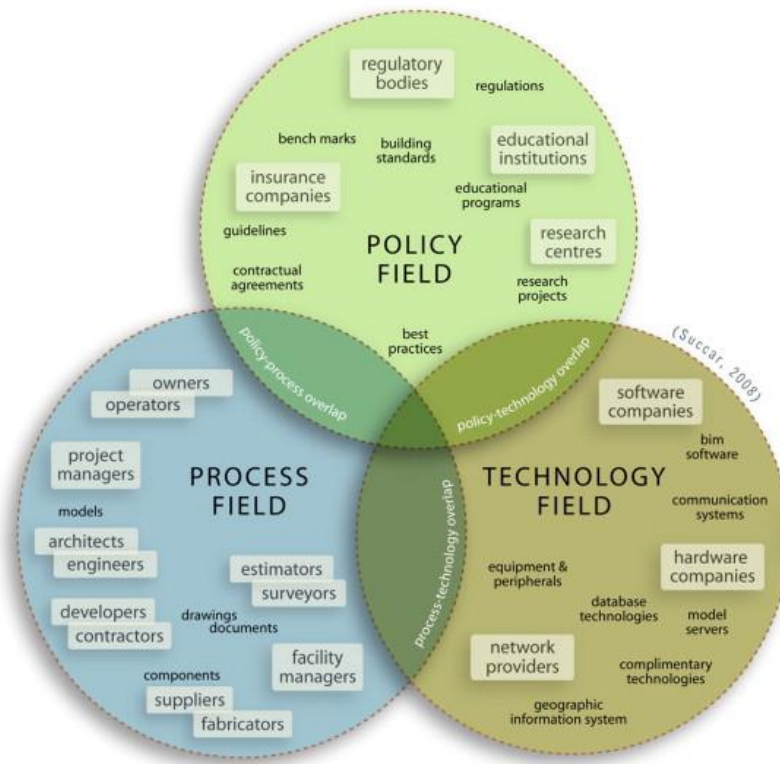

Figure 5-5. The three fields of BIM activity from (Succar 2009)

As buildings and refrigeration systems are complex systems that have been shown in the diagnosis to have similar lifecycles, the framework and concepts used in BIM can be used in our ontology.

2.3.3. Application ontology: design of a system

In the last decade, we observed a trend toward more general theories to offer abstract approaches and an ontology of the design process. Application ontologies are developed for a specific activity and need the knowledge of a particular domain. We focus our research on the design domain for the design-related activity.

One of the first theories, called General Design Theory (GDT), was explored in 1989 by Yoshikawa (Yoshikawa 1989). Based on the same idea, John Gero developed an application ontology for the design activity FBS for Function, Behaviour and Structure (J. S. Gero 1990; J. Gero and Kannengiesser 2004; J. S. Gero and Kannengiesser 2014). This ontology is now very well-known and used in the design society. The idea is that the designer creates a structure (S) that will fulfil several functions (F). Each function is expected to behave in a certain manner (Be). The real behaviour of the structure (Bs) can be different from the one expected. Figure 5-6 displays this FBS framework. The designer is supposed to compare the two behaviours to adapt and validate the structure. The structure is modelled by a set of variables selected by experts. They give important characteristics of the systems

such as dimension, materials, decision variables, geometry.

Derived from the FBS ontology, the Observation Interpretation Aggregation is a framework developed as part of two thesis projects (Collignan 2011; Quirante 2012). It integrates three models around the FBS ontology: the observation (O) model corresponding to the system behaviour; the interpretation (I) and aggregation (A) models, which formulate designers' preferences and the optimization, which allows the exploration of the design space and study different design solutions.

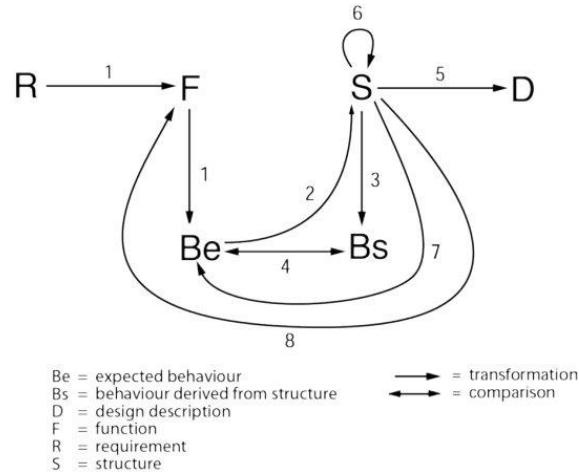

Figure 5-6. FBS framework from (J. S. Gero and Kannengiesser 2014)

3. Knowledge model proposition

3.1. Specification

What is the purpose? As described in the previous paragraphs, different ontologies exist to capitalise knowledge in a general, formal way, either generic and meta or related to a domain, task, or application. The ontology developed in this study provides a representation that can be used to support the design process in the refrigeration domain. As shown in the literature review and the industrial diagnosis, a formal representation can reduce the highlighted gaps: reduce the industry's fragmentation, improve efficiency and effectiveness of solutions, and lower the negative impacts of inadequate system design. It can be used to enable the decision-making process of designing a refrigeration system from the system specification to its final design.

What is the scope? The ontology must include information on the system's environment, stakeholders of the domain, the system's structure (components and links), resources, activity, documents, and regulation.

Who are the intended end-users? The main end-users are the stakeholders presented in the diagnosis chapter. Different scenarios of such an approach are tested on the users to validate its usefulness, reusability and relevance. Refrigeration system end-user, such as supermarkets as demonstrated in our application case study; supplier and designer of the system; researchers of the refrigeration domain are the targets of our works. Other stakeholders such as EOL parties can be considered.

What is the intended use? The ontology intends to be used with a refrigeration system simulation

and exploration platform. Four high-level scenarios can be explored: (1) observe the impacts of a change on the performances of the system; (2) help designers in the building of a new refrigeration system; (3) visualize a greater decision space by showing all the feasible solutions; (4) evaluate the potential of a low Technology Readiness Level (TRL) technology.

3.2. Knowledge acquisition

Gaining important knowledge of the refrigeration domain is necessary to develop an ontology. Two types of knowledge acquisitions have been conducted: top-down and bottom-up (Garcia and Vivacqua 2019). The first one consists of acquiring the tacit knowledge of refrigeration domain experts. The second approach focuses on acquiring knowledge thanks to specific cases. Our study's top-down approach fits well as domain knowledge and experts were available (Garcia and Vivacqua 2019). Table 5-2 summarizes the different knowledge acquisition processes. Fifteen interviews with experts in the refrigeration domain were conducted. The interviewees are six researchers, one technician and one frigorific engineer or industrial expert (suppliers and designers), two from large companies of supply and manufacture, and five from small or medium companies. Documentation, standards, various projects were also investigated and analysed. An extensive literature review of refrigeration (around 120 articles from conference proceedings and journals) systems research, and similar systems ontology such as building, electricity energy supports the knowledge acquisition. The research keywords are listed in the summary table for the data collection of case study in the literature.

Table 5-2. Summary of the knowledge acquisition (KA)

CATEGORY OF KA	KNOWLEDGE ACQUIRED	QUANTITY
INTERVIEWS	Researchers, technician, frigorific engineers, suppliers and designers expertise on <i>the process, the vocabulary, the data</i>	15 interviewees
WORKSHOPS	Researchers, technician, frigorific engineers, suppliers and designers' opinion for <i>validation and verification</i>	8 workshops
OBSERVATIONS	Documentation Regulations Standards Industrial projects	~150 articles and documents
LITERATURE REVIEW	Key words: REFRIGERATION SYSTEM ONTOLOGY; ENERGY SYSTEM ONTOLOGY; REFRIGERATION SYSTEM; REFRIGERATION SYSTEM DESIGN; ONTOLOGY OF ENERGY SYSTEM; BUILDING ONTOLOGY	

3.3. *Conceptualization and formalization*

3.3.1. Conceptual model and formalization

In the proposed ontology, we formalized a conceptual model based on the knowledge acquired and from the different existing ontologies presented in section 2. We have classified our concepts into four main categories:

- (1) *Context* related, a description of the context to design an RS (user, objectives, specification, constraints).
- (2) *System design solution* related, a description of the objects and concepts useful to describe an RS solution (compressor, expansion valve, refrigerant...).
- (3) *Properties*, which are set and unchangeable data used for the calculation of performances that are related to the physics principles, or acquired from environmental impact database, from manufacturer's catalogue or experts.
- (4) *Performances assessment*-related, a description of the RS multi-physics simulation (performances, physical behaviour...) and a description of the decision-making process (performances, trade-offs...)

We use a merging of different domain ontologies to feed ours, which means that some of the concepts are reused directly from the ontologies and framework as presented in the previous sections (example for *refrigerant*) and adapted for our intended use to be integrated into a platform.

To represent the knowledge model in a clear and understandable way, object-oriented representation is chosen. It is a way to represent ontologies through classes, class properties, and instances. Classes represent domain concepts, and association relationships represent their interactions (Gruber and Özsu, 2009). We choose to formalize the knowledge model by using Unified Modeling Language (UML). The ease of comprehension and interpretation for human beings by using this language is highlighted in Cranefield (2001) and Cranefield and Purvis (1999). Moreover, UML is a modelling language object-oriented using classes, attributes, properties, and relations that are easily modular and changeable. Thus, this modelling language is used in this study to understand the ontology better.

3.3.1.1. Context related

Context-related concepts are based on the definition of a scenario in Design Science. We have based our concept on the description proposed by McKay (2013): a scenario is composed of a particular user who wants to reach a specific objective or execute a specific activity in a specific context. Context related concept participates in the simulation of the system physical behaviour as described in (Cheong and Butscher 2019) and the components choices.

Thus, we propose that the scenario in our knowledge model is defined as follow:

The *scenario* expresses the context related to the knowledge model usage by a particular user (*stakeholder*) to respond to its *objective* in a specific *system environment*.

A *stakeholder* class is *defined by* its identity as an actor of the domain, expertise, and mindset. The list of the refrigeration domain stakeholders is the one defined in the industrial diagnosis in Chapter 2. A *stakeholder* is trying to achieve an *objective* that requires the simulation and exploration of refrigeration systems in a specific *system environment*.

A *system environment*-class can be related to requirements. It defines where the refrigeration system operates and the constraints. It is *composed of* a *location*, *conservation set-points temperatures*, and a certain *volume to be cooled*. In the case of a supermarket refrigeration system, the system environment is also defined by the *store area*, the *working and opening hours*, *number of employees*. The volume to be cooled can be a combination of *food storage* facilities (cold rooms and vertical/horizontal display cabinets), their *numbers* and the *mass of food*. In some cases, a frigorific power can replace the volume to be cooled.

Figure 5-7 shows the UML diagram of the classes composing the *scenario*. An example of the possible attributes for the *user identity* for our case study is shown in the enumeration box.

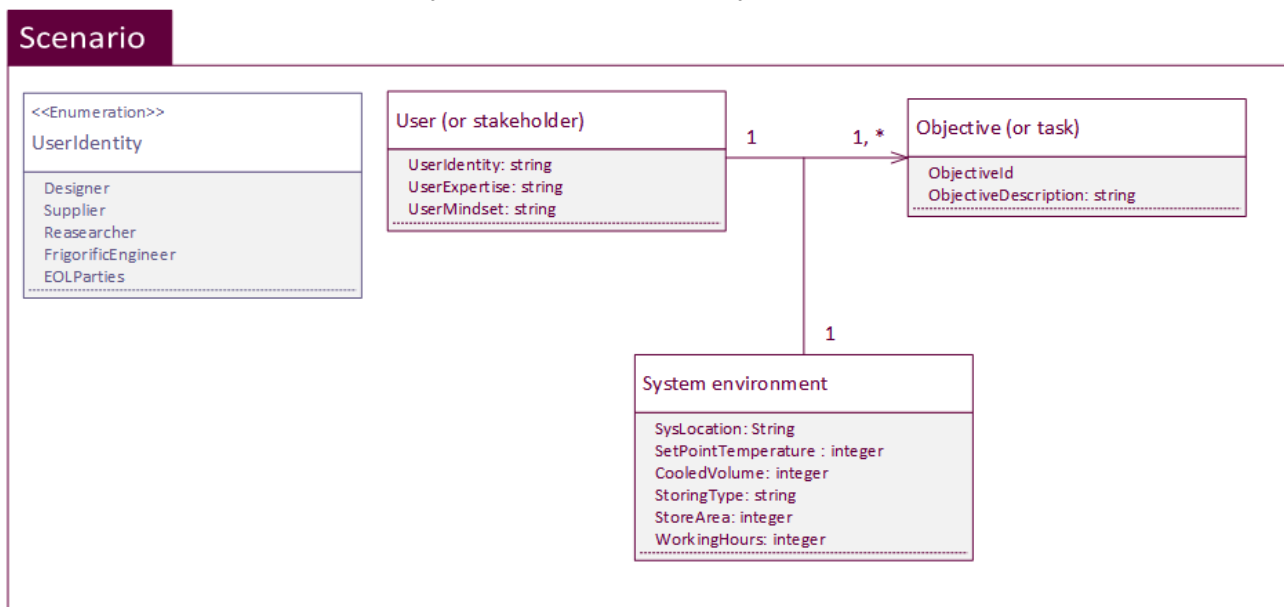

Figure 5-7. UML diagram of the scenario for supermarket RS

To better understand the scenario classes written literally, an example of a simplified scenario is shown in Figure 5-8.

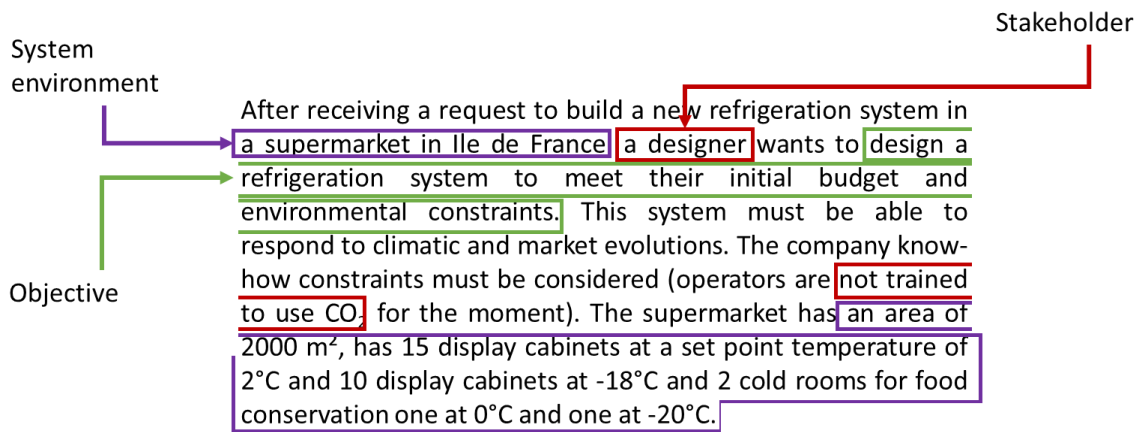

Figure 5-8. Example of a scenario composed of a stakeholder, an objective and a system environment.

3.3.1.2. System design solution

To answer a design problem for a physical system such as a car or a table, one must first define the structure of the design solution (J. Gero and Kannengiesser 2004). It comprises design variables that describe the system components and their relations. This structural description of the system constitutes the decision space. The domain experts established the choice of design variables and their ranges of variation (Rivier 2017).

An RS design solution is composed of two main classes: (1) A system architecture and (2) modules: technical components as described in Figure 5-9.

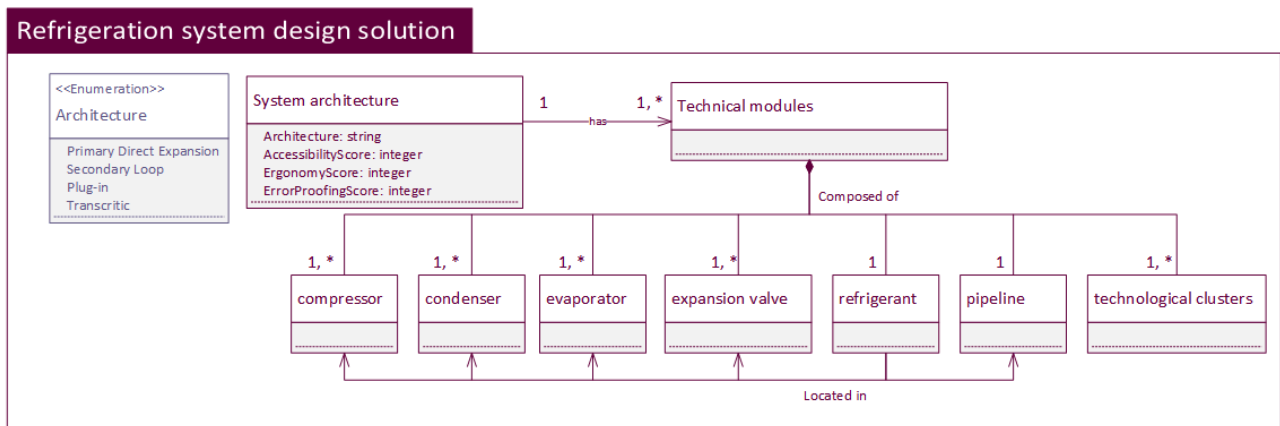

Figure 5-9. Decomposition of an RS design solution

A system or product architecture is defined in design science as:

- « the scheme by which the functional elements of the product are arranged into physical chunks and by which the chunks interact. » (Ulrich and Eppinger 2016)
- « a scheme showing the relationship between the function structure of a product and its physical consideration » (Pahl and Beitz 2013)
- « how a single product satisfies its function by being divided or not into modules » (Otto and Wood 2001)

A *system architecture* class of the refrigeration system solution defines the arrangement of the *modules* between them, directly impacting the performances to assess.

The *modules* are *Objects* as defined in the Basic Formal Ontology (BFO). In this ontology, an object is defined as a 'material entity that is spatially extended in three dimensions [and] causally unified' (Arp, Smith, and Spear 2015). The technological *modules* class are *composed of* the main physical elements of a refrigeration system: a *refrigerant fluid*, a *compressor type*, a *condenser type*, an *evaporator*, an *expansion valve*, *pipelines* and zero, one or more *technological clusters*. Two types of relations are exploited in the knowledge model to express the connexions between sub-systems:

The relation *made of* developed in the PSO is a formalized relation of the material constitution theory (Korman 2019). In the PhysSys ontology (Borst, Akkermans, and Top 1997), the same relation can be found as a system decomposition into sub-systems. As an example of a constitution relation used in our knowledge model, we can illustrate that: a *compressor* is *made of* steel, aluminium, copper.

To describe the space location of the instances, the PSO relation *located in* is used. As examples for refrigeration systems, we can describe that the *refrigerant* is *located in* the *compressor*, *condenser*, *evaporator*, *expansion valve* and *pipelines*, or that the *evaporator* is *located in* the *environment to be cooled*.

3.3.1.3. Properties

Each RS solution defines a set of *properties*. Ashby and Jones (2012) define two types of properties, intrinsic or attributive. The first one refers to the mechanic, physical data of an item, whereas the other type refers to the quality data such as cost, sustainability, ease of manufacture. We define the data as information on the items related to the system design solution stored and used to calculate performances.

Based on these definitions, we consider the *properties* as all the quantitative or qualitative data related to the *context*, the *system design solution*, which are stored in a database, unchangeable and necessary to simulate the performances of a refrigeration system.

The *properties* are thermodynamics data, material substance distribution, cost data, components' manufacturing specifications... of the system elements put into mathematical models to simulate the system performances. These data classes are *composed of*:

- *Thermodynamics and physics* data, such as the density of a refrigerant, a state change temperature, a heat exchange coefficient, etc.
- Data from *manufacturers of technical components* such as the power supply of a compressor, the inlet or outlet diameters, noise etc.
- *Cost data* set by energy suppliers such as the price of electricity, calculated from samples such as the installation price of a compressor according to the power, or capitalized from experts' knowledge such as labour cost
- *Environmental impact data* from databases such as Ecolnvent

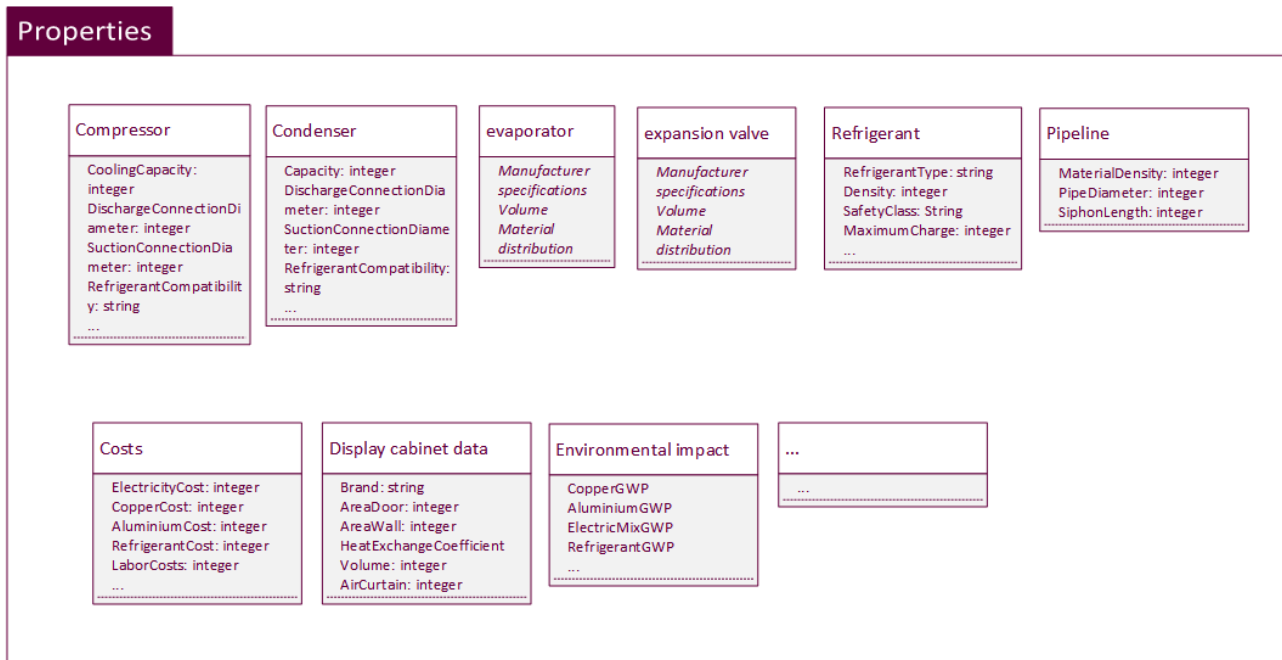

Figure 5-10. UML diagram of some classes that can be comprise in the properties

3.3.1.4. Performances' assessment

To compare design solutions in any design problem, one needs to assess how the solution responds to the scenario. To do so, we should first characterize the performances and then define how the system behaves. The system behaviour can be either defined with physical modelling, i.e. the system answers to principles of physics through mathematical models, or with empirical modelling, i.e. experimentations and observations gather information on the system behaviour (Atherton and Bates 2006).

A *performance* is defined by (Ulrich and Eppinger 2016) by "how well a product implements its intended function. Typical performance characteristics are efficiency, life [...], energy consumption." In mathematical optimization, performance is considered as a response that "describes the overall fitness of the design for its intended purpose" (Atherton and Bates 2006). In the FBS framework, the performances are described *Behaviour (B) variables* that are "attributes derived or expected to be derived from the *structure (S) variables* of the object, i.e. what it does." (J. Gero and Kannengiesser 2004), *physical things* that vary in time (quantity, flow, effort, energy and power) in the PhysSys ontology (Borst, Akkermans, and Top 1997) or as *physical behaviour* in the meta-ontology PSO (Cheong and Butscher 2019).

To formalize the performances necessary in our knowledge model and based on the listed ontologies, we distinguish two types of performance classes:

- *Global performances* class regroups the global performances involved in the design objectives. They correspond to a macro level of performance that the *stakeholder* can interpret to make decisions further. In the refrigeration domain, the global performances usually assessed are the thermal behaviour and energy consumption

(Ben-Abdallah et al. 2019; Ge and Tassou 2011), the environmental impacts (Makhnatch and Khodabandeh 2014) and total costs. In this knowledge model for the design and simulation of refrigeration systems, the *global performances* are instantiated by five main elements: the *energy consumption*, the *environmental impacts*, the *total cost*, the *maintenance*, and the *technological readiness level* of the RS solution. They can be expressed from the aggregation of *local performances*.

- *Local performances* class is composed of variables that are observed or calculated with mathematical models or empirical models (field observations and experts' knowledge). They simulate the system behaviour, called the observation model by (Quirante, Sebastian, and Ledoux 2013), in the OIA ontology or Behaviour in the FBS ontology.

Figure 5-11 shows the UML diagram of the performance classes. The *global performances* can depend on each other for the calculation. For example, the environmental impact assessment depends on the calculation of the energy consumption for the calculation of indirect emissions.

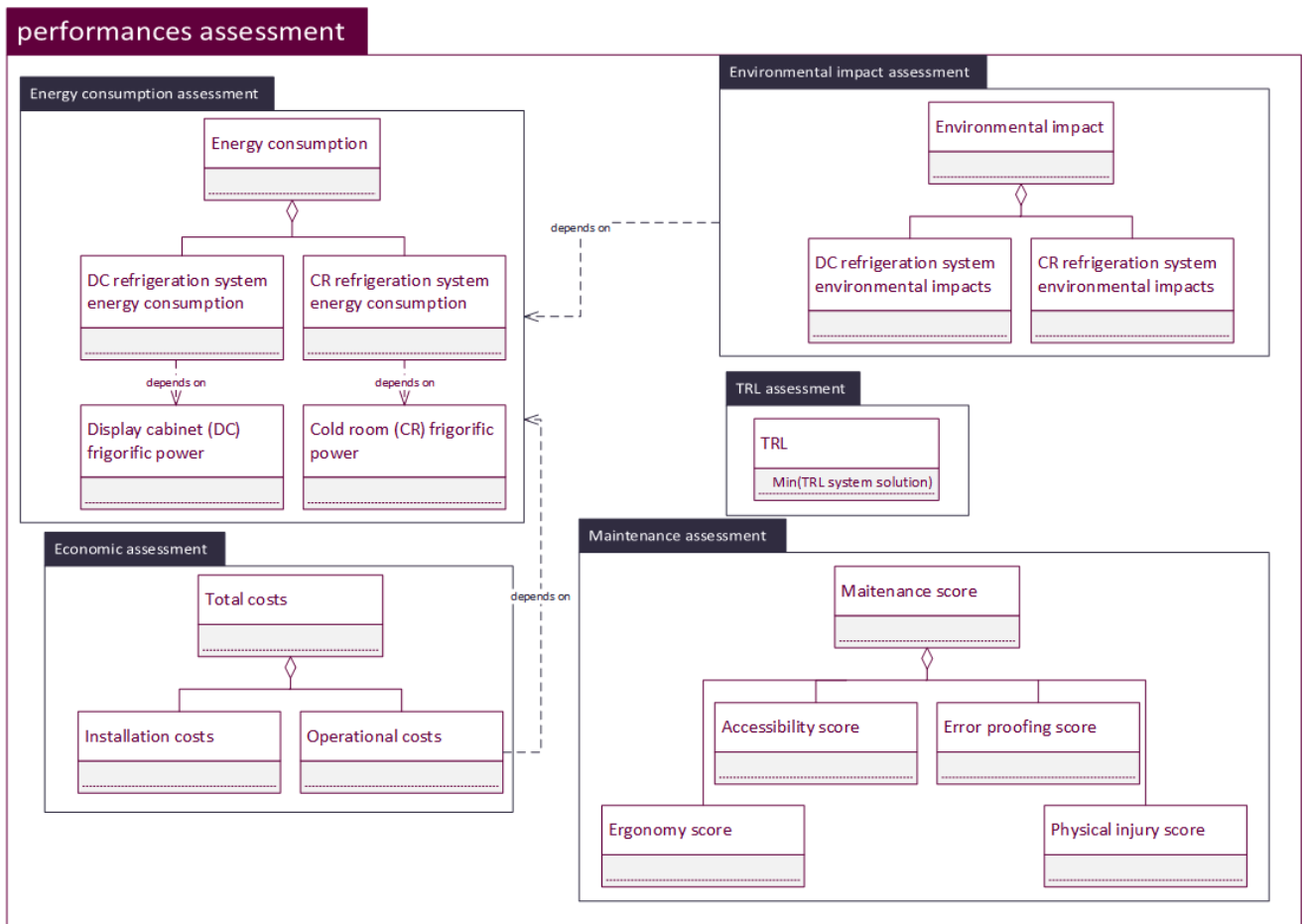

Figure 5-11. UML diagram of the global performance classes, their intra- and extra-relations with other classes

3.3.2. Summary

For a better understanding of the knowledge model, the description of a supermarket refrigeration system is shown as an example in the next section. Table 3 gives a summary of the macro concepts,

their definitions, and the classes associated. The instantiation of the system design solution, the properties and the local performance class are explained in the case study and the appendices.

Table 5-3. List of concepts for the refrigeration system design level, their definitions, and their classes associated with retail refrigeration

Concept	Definition	Class
Scenario	Expression of the context related to the knowledge model usage by a particular user to respond to its <i>objective</i> in a specific <i>system environment</i> .	Stakeholder
		Objective
		System environment
System design solution	Description of the system components, their relations.	Technological modules
		System structural architecture
Properties	Quantitative or qualitative data related to the context, the system structural solution, stored in a database, unchangeable and necessary to simulate the performances of a refrigeration system.	Physics and thermodynamics data
		Manufacturer specification
		Costs
		Environmental emissions
Local performance	Performances of the system which are observed or calculated with mathematical models or empirical models.	~300 performances (See appendix 3)
Global performance	Macro-level performances involved in the design objectives and useful for interpretation.	Total energy consumption
		Environmental impact
		Total cost
		Global maintenance
		Technological readiness level

Inter-dependence between concepts exists for the calculation of performances. Figure 5-12 shows the UML diagram of the concepts and classes related to the design and simulation of refrigeration systems for a typical supermarket. Some of the inter-relations are displayed to understand how the

classes are modelled. For example, the calculation of energy consumptions for each display cabinet or cold room depends on the *refrigeration system design solution* and the calculation of the frigorific power. The frigorific power is dependent on the *system environment* class and the *properties* class. The *maintenance score*, *technology readiness level* (TRL) and *installation costs* depend on the refrigeration system design solution, itself related to the *properties* class.

Other inter-relations not shown in Figure 5-12 include relations between *TRL* and *maintenance, costs* and *maintenance, environmental impacts* and *system design solution*, etc.

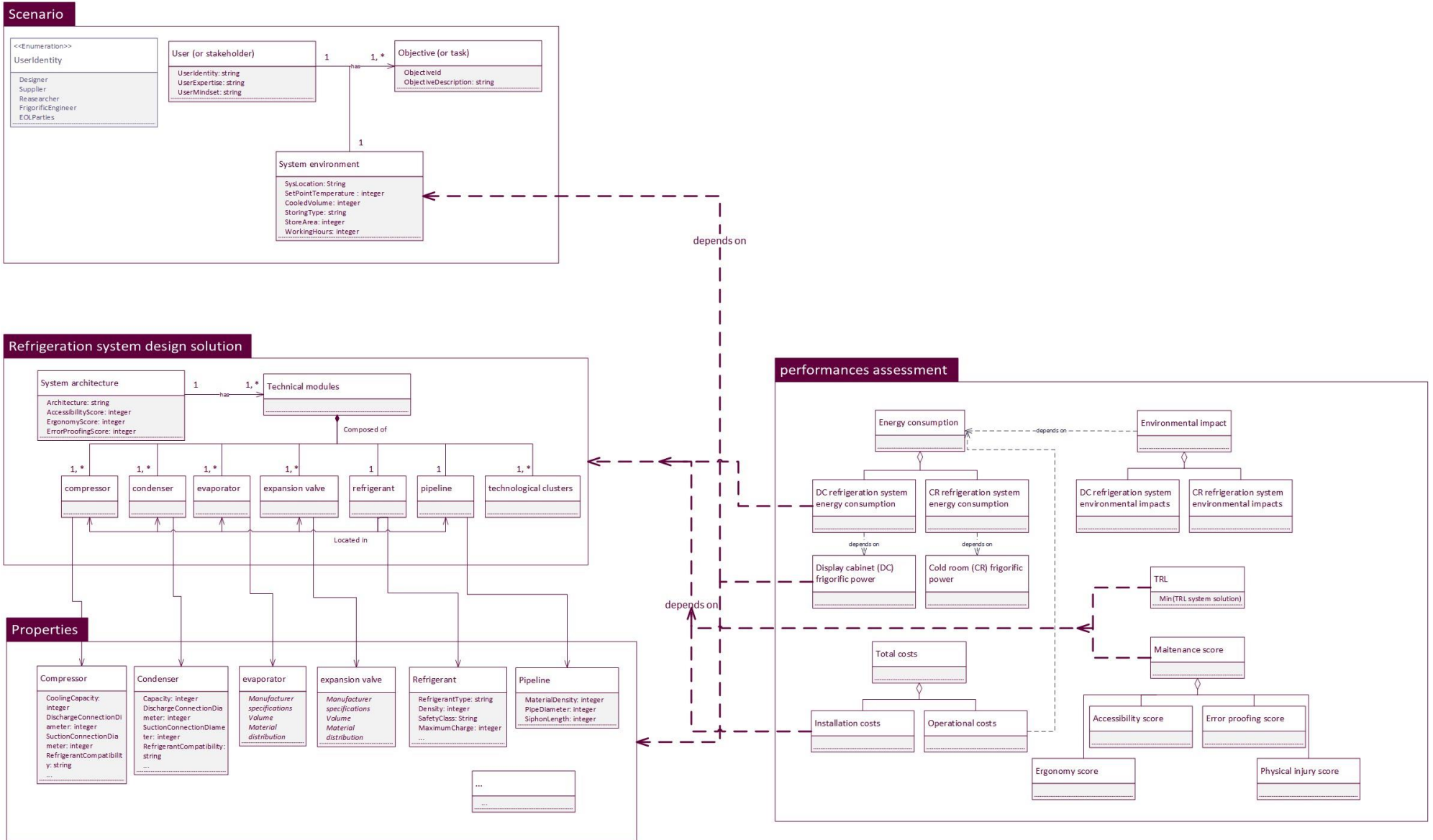

Figure 5-12. UML diagram of the knowledge model and the relations between the concepts

3.4. Description of a supermarket refrigeration system design problem

The proposed design problem focuses on the specific domain of retail refrigeration systems in which a large panel of experts, data and technologies are available. We are interested in several aspects of refrigeration systems during their life cycle to integrate them in the early design phase. They correspond to the situations of use presented in the industrial diagnosis: (1) specification, dimensioning to installation, (2) the use phase and maintenance of the systems, and (3) the end of life of the machine.

The chosen problem aims at modelling a typical retail refrigeration system to find the best solution. The first step consists of modelling the context, i.e., the user, objective and system environment. Then, a mapping between the input data and the outputs (local and global performances) is shown. Finally, a system design solution is detailed.

3.4.1. Context modelling

The context is modelled using the knowledge model. To define the design problem, one must first set the *context* or scenario. It **is composed of** three classes: *user*, *objective*, and *system environment*. The extended sub-classes (Cheong and Butscher 2019) associated to the three classes of the scenario are shown in Table 5-4.

More (or less) sub-classes for each concept can be added (or withdrawn) to fulfil a different problem modelling. As an example, if the problem consists of modelling an air conditioning system, the extended sub-classes do not include the number of display cabinets but include as system environment the sizing of the store wall, the number of clients... Extended sub-classes for objectives can also be modified to add comfort analysis.

Each extended sub-class has one or more instances. As an example, for the shown use case, Paris **is an instance of** location.

Table 5-4. Scenario related classes, extended sub-classes and instances for the application to retail refrigeration systems

Class	Extended sub-class	Description
System environment	LOC _{store}	Location of the store. It determines the external temperature during the year
	T _{ext}	External temperature. It determines the cooling power necessary to maintain a constant cold production during the year.
	A _{store}	Store surface area
	OpeningHour	Opening hour of the store
	ClosingHour	Closing hour of the store
	V _{fpos}	Volume of food stored in refrigeration (positive temperature)
	T _{pos_setpoint}	Range of positive temperature for food refrigeration storage
	PosDisplayCabinet	Number of positive temp display cabinets
	PosColdRoom	Number of refrigerated cold storage room
	V _{fpos}	Volume of frozen food stored (negative temperature)
	T _{neg_setpoint}	Range of negative temperature for food refrigeration storage
	NegDisplayCabinet	Number of negative temp display cabinets
	NegColdRoom	Number of frozen cold storage room
	Nd	Number of doors opening
Stakeholder	Researcher; designer; Refrigeration engineer; final user; EOL treatment parties	Identity of the stakeholder that uses the tool: its identity as an actor of the domain, its expertise, and its mindset
Objective	Problem or performances analysis; solution design; decision space exploration; technological change analysis	Description of the outcome of the problem analysis. Depending on the objective, the local and global performances can change, as well as the design solution, the decision or visualization of the results.

3.4.1. System design solution definition classes

The decision space is defined with the structure and the modules or technical components necessary to compose a refrigeration system. For negative and positive temperatures, the RS structure is the same for the main components (compressor, condenser, evaporator, expansion valve, refrigerant and pipelines). The class and the extended sub-classes to define a system design solution in a supermarket case study is presented in Table 5-5. Depending on the architecture, specific components may be used. As an example, transcritical architecture requires to have components that can support CO₂ as a refrigerant. Other design constraints are defined as incompatibilities (Bussemaker, Ciampa, and Nagel 2020; Arora 2012). For example, the diameter of the pipelines must fit the entry or exit of a component.

Table 5-5. Refrigeration system solution classes, extended sub-classes and instances for the application to retail refrigeration systems

Class	Extended sub-class	Instance	Description	Incompatibilities
System structure	Architecture	FMA _{pos} / FMA _{neg}	General architecture of the system for positive or negative temperature; the frigorific architecture determines the components used, the location of the machine, space used, pipelines length, etc.	No conditions
Technical modules	Compressor	PCond _{type} / NCond _{type}	Type of compressor for positive or negative temperature	Compressor type must be compatible with the refrigerant, and the architecture
	Condenser	PEvap/ NEvap	Type of condenser positive or negative temperature	Condenser must be compatible with the compressor
	Evaporator	PExpanVal/ NExpanVal	Evaporator for positive and negative temperature	Must be compatible with the type of conservation (display cabinets or cold rooms)
	Expansion valve	Refrig _{pos} / Refrig _{neg}	Expansion valve for positive and negative temperature	Depends on the number of evaporators

	Refrigerant	Circulation pump, heat exchangers, etc.	A substance used in a thermodynamic heat pump cycle or refrigeration cycle that undergoes a phase change from a gas to a liquid and back; fluid used in the system positive or negative temperature.	Depends on the set-point temperature Must respect the regulation on refrigerant use in store
	Specific components	Pipeline suction/ discharge	One or more specific components may be used for particular architecture.	
	Pipelines		Pipelines to transport the refrigerant or secondary fluid	Diameters of the pipelines must fit to the entry and exit of the technical modules.

3.4.2. Local and global performances assessment

The assessment of the *global performances* depends on the calculation of the *local performances* themselves depending on the *context*. An example of mapping the *context* to two classes of *global performances*: *energy consumption and environmental impacts*, is shown.

3.4.2.1. Energy consumption simulation

The energy consumption balance equation is defined as follow.

$$E_{total} = \sum Q \quad (5-1)$$

Where $\sum Q$ depends on the number of display cabinets, cold rooms, perimeter (yearly, monthly or daily) and the system structure. As an example, the balance equation for one day for a display cabinet at positive or negative set-point temperature is given in the following equation.

$$Q_{pos\ or\ neg} = \dot{Q}_{day} * OpeningHours + \dot{Q}_{night} * ClosingHours + \dot{Q}_{defrost} * t_{defrost} \quad (5-2)$$

Where $Q_{pos\ or\ neg}$ is in kWh/day and where

$$\dot{Q}_{day} = \dot{Q}_{wall} + \dot{Q}_{hw} + \dot{Q}_{lighting} + \dot{Q}_{infiltration_day} + \dot{Q}_{radiation_day} + \dot{Q}_{fan} \quad (5-3)$$

And

$$\dot{Q}_{night} = \dot{Q}_{wall} + \dot{Q}_{hw} + \dot{Q}_{infiltration_night} + \dot{Q}_{fan} \quad (5-4)$$

Where \dot{Q}_x are in Watt and correspond to the frigorific power.

Then, each variable answers to thermodynamics laws and models that can be found in Arias (2005) and Salehy et al. (2020).

To calculate the energy consumption, a set of properties are necessary to be defined. As an example from (ADEME and Enertech 2001), $\dot{Q}_{fan} = 150W$, $\dot{Q}_{lighting} = 288W$, $\dot{Q}_{hw} = 60W$.

3.4.2.2. Environmental impacts simulation

The environmental impact in this example consists of the calculation of the Life Cycle Climate Performance (LCCP) that characterises the global warming potential of a frigorific installation through the whole lifecycle of the system.

$$LCCP = \text{Direct emissions} + \text{Indirect emissions} + \text{Embodied emissions} \quad (5-5)$$

The direct emissions are the emissions related to the refrigerant leakage occurring during the exploitation and the end-of-life (EOL) treatment phases, respectively Eq (6) and (7), where m_{ref} is the mass of refrigerant in the whole system, n is the system lifetime, $leak_{refyear}$ is the percentage of leakage depending on the system architecture, the components' age and the life cycle phase, CO_{2eq_ref} is the global warming potential (GWP) of the refrigerant.

$$Em_{refleak} = m_{ref} * n * leak_{refyear} * CO_{2eq_ref} \quad (5-6)$$

$$Em_{refleak,EOL} = m_{ref} * leak_{refEOL} * CO_{2eq_ref} \quad (5-7)$$

The embodied and indirect emissions are the emissions related to the electric consumption of the system during the whole life cycle: manufacture, exploitation and EOL treatment, respectively shown in Eq (8) and (9), Eq (10), and (11), where m_{mat} is the mass of material substance in each technical components, except the refrigerant, R is the percentage of refrigerant recycled at the EOL, E_{recycl_mat} is the electric consumption for recycling the components, $\sum E$ is the yearly energy consumption of the whole refrigeration system, CO_{2eq_X} is the GWP for the components manufacture or EOL treatment, for the refrigerant manufacture, for the production of 1kWh of electricity, depending on the energy mix of the country.

$$Em_{sys,man} = \sum m_{mat} * CO_{2eq_manuf} \quad (5-8)$$

$$Em_{ref,man} = m_{ref} * (1 + n * leak_{refyear} - R) * CO_{2eq_ref} \quad (5-9)$$

$$Em_{sys,EOL} = \sum E_{recycl_mat} * m_{mat} * CO_{2eq_recycling} \quad (5-10)$$

$$Em_{sys,exploit} = n * \sum E * CO_{2eq_elec} \quad (5-11)$$

To obtain the different variables of the equations, i.e., m_{ref} , $leak_{refyear}$, m_{mat} , ... we need to first know the necessary frigorific power, depending on the system environment (type of conservation, opening and closing hours, and working hours, doors opening...), as shown in the energy consumption simulation section.

The properties necessary to calculate the environmental impacts of the refrigeration systems are the global warming potential of each material manufactured, the electricity..., that were found in EcoInvent database.

Table 5-6 shows how the problem modelled with the knowledge model is mapped to correspond to the elements of the equation.

Table 5-6. Global performance: environmental impact class, its extended sub-classes and instances for

the application to retail refrigeration systems

Class	Extended sub-class	Instance	Mathematical model
Environmental impacts	Embodied emissions (CO ₂ emissions)	Emissions from components manufacture	$Em_{sys,man}$ in equation 8
		Emissions from refrigerant manufacture	$Em_{ref,man}$ in equation 9
		Emissions from system recycling	$Em_{sys,EOL}$ in equation 10
	Indirect emissions (CO ₂ emissions)	Emissions from electric energy consumption during exploitation	$Em_{sys,exploit}$ in equation 11
	Direct emissions (CO ₂ emissions)	Emission from refrigerant leakage during exploitation	$Em_{refleak}$ in equation 6
		Emission from refrigerant leakage during EOL treatment	$Em_{refleak,EOL}$ in equation 7

3.4.2.3. Other performances simulation

Other global performances can be simulated for the design of a refrigeration system and depending on the users' objectives. For supermarket refrigeration systems, the total cost, the maintenance, and the technological readiness level are described.

To calculate the total cost, the capital costs (CAPEX) and the operational costs (OPEX) are summed. They include the purchase of the technical modules, the labour cost depending on the installation architecture for capital cost and the electric consumption costs, the maintenance labour costs and the refrigerant refill costs through the exploitation phase.

The maintenance is calculated as a score that depends on the architecture and the refrigerant. It is based on four sub-classes: accessibility, error proofing, ergonomic and physical injury. For example, the score of accessibility of the components in a primary direct system will be higher than for plug-in systems as the components will be less accessible for the technician.

To have a complete view of the local and global performance calculations of the design problem for a supermarket refrigeration system, all mathematical models are displayed in Appendix 3.

4. Discussion and conclusion

4.1. *Generalisability of the knowledge model*

The knowledge model implemented in a design and exploration platform can be generalized to other usages. Two generalisability possibilities are explored:

- Modelling different kinds of refrigeration systems
- Modelling the whole energy system

4.1.1. *Modelling other kinds of refrigeration systems*

It is intended to be as modular as possible, and adding different types of refrigeration systems would be possible if the classes, relationships, instances and equations are fulfilled.

The main concepts, classes and relationships would not change, but the extended sub-classes, instances and mathematical equations would. Indeed, an example for a refrigeration system in a food manufacturing plant requires the same concepts of scenario, design space, properties, local and global performances, and the associated classes. However, the extended sub-class related to the system environment will change by adding the process of food fabrication (number of fabrication machines, the volume of food, the type of food, etc.).

4.1.2. *Modelling the entire supermarket energy system*

To better represent the design problem and design an optimal system, the entire energy system of a supermarket must be modelled. It means that the heating system, air conditioning, lighting, heated water, and other energy systems should be considered for further work.

The types of the energy system in a supermarket implies to add more classes in the knowledge model. For example, in the scenario concepts, one would add classes of "heat system environment", "electrical energy network environment", etc. The systems solutions would have a different breakdown structure by adding heat system components, electrical network components, different technological modules that can allow heat recovery from the refrigeration systems, etc. Adding different technical modules in the system design solution means that the developers need to add more instances and their associated mathematical equations to ensure the correctness and completeness of the model. As shown in the knowledge acquisition section, one must follow the same steps to define the different phases of building a knowledge model, from the specification to the verification and validation shown in Chapter 5 and Chapter 6.

4.2. *Conclusion*

This chapter answers the question on how to improve the design of refrigeration systems in the early design stages (conceptual and embodiment study) by first representing the type of knowledge necessary to design refrigeration systems. Related works on the design and simulation of physical systems have been done, but to our knowledge, formal representation for refrigeration systems design has never been explored. Moreover, this work is the first step toward developing a digital platform whose goal is to. This platform ensures an optimal refrigeration design space exploration.

This first step described in this chapter proposes a knowledge model (or ontology) with a structured language for refrigeration system design based on data collected from research and industry. The

knowledge model is based on existing ontologies and the experts' know-how retrieved through interviews, observations, literature reviews. Four macro-concepts are defined (1) the **scenario**, (2) **refrigeration system design solution**, (3) the **properties**, and (4) the **performances** to be assessed. The sub-concepts, relationships and instantiations are described to represent the process of designing refrigeration systems realistically. This proposal considers the different stakeholders involved in the RS life cycle. It supports them in the design stage activities by efficiently defining and formalizing the design problem, and it improves the interaction between the different stakeholders by facilitating communication.

The knowledge model serves as a design problem representation that is then fed into a design and exploration platform to help stakeholders make aware decisions during the development phase. The choice of supporting tool to explore the design and performance space as well as the implementation of the knowledge model and the verification steps are discussed in the next chapter.

References

- ADEME, and Enertech. 2001. 'Diagnostic Électrique d'un Supermarché de Moyenne Surface'.
- Ahmed, Saeema, Sanghee Kim, and Ken M. Wallace. 2006. 'A Methodology for Creating Ontologies for Engineering Design'. *Journal of Computing and Information Science in Engineering* 7 (2): 132–40. <https://doi.org/10.1115/1.2720879>.
- Arias, Jaime. 2005. 'Energy Usage in Supermarkets-Modelling and Field Measurements'. KTH.
- Arora, Jasbir S. 2012. 'Chapter 3 - Graphical Optimization and Basic Concepts'. In *Introduction to Optimum Design (Third Edition)*, edited by Jasbir S. Arora, 65–94. Boston: Academic Press. <https://doi.org/10.1016/B978-0-12-381375-6.00003-6>.
- Arp, Robert, Barry Smith, and Andrew D. Spear. 2015. *Building Ontologies with Basic Formal Ontology*. Mit Press.
- Ashby, Michael F., and David RH Jones. 2012. *Engineering Materials 1: An Introduction to Properties, Applications and Design*. Vol. 1. Elsevier.
- Atherton, Mark, and Ron Bates. 2006. 'Searching for Improvement' 2 (October). <https://doi.org/10.2495/978-1-85312-853-0/12>.
- Ben-Abdallah, R., D. Leducq, H.M. Hoang, L. Fournaison, O. Pateau, B. Ballot-Miguet, and A. Delahaye. 2019. 'Experimental Investigation of the Use of PCM in an Open Display Cabinet for Energy Management Purposes'. *Energy Conversion and Management* 198 (October): 111909. <https://doi.org/10.1016/j.enconman.2019.111909>.
- Borst, Pim, Hans Akkermans, and Jan Top. 1997. 'Engineering Ontologies'. *International Journal of Human-Computer Studies* 46 (2): 365–406. <https://doi.org/10.1006/ijhc.1996.0096>.
- Bussemaker, Jasper H., Pier Davide Ciampa, and Bjoern Nagel. 2020. 'System Architecture Design Space Exploration: An Approach to Modeling and Optimization'. In *AIAA AVIATION 2020 FORUM*. AIAA AVIATION Forum. American Institute of Aeronautics and Astronautics. <https://doi.org/10.2514/6.2020-3172>.
- Cheong, Hyunmin, and Adrian Butscher. 2019. 'Physics-Based Simulation Ontology: An Ontology to Support Modelling and Reuse of Data for Physics-Based Simulation'. *Journal of Engineering Design* 30 (10–12): 655–87. <https://doi.org/10.1080/09544828.2019.1644301>.
- Collignan, Arnaud. 2011. 'Méthode d'optimisation et d'aide à La Décision En Conception Mécanique: Application à Une Structure Aéronautique'.
- Cranefield, Stephen. 2001. 'UML and the Semantic Web'.
- Cranefield, Stephen, and Martin K. Purvis. 1999. 'UML as an Ontology Modelling Language'. In *Intelligent Information Integration*.
- Cuenca, Javier, Felix Larrinaga, and Edward Curry. 2017. 'A Unified Semantic Ontology for Energy Management Applications.'
- Cuenca, Javier, Felix Larrinaga, and Edward Curry. 2020. 'DABGEO: A Reusable and Usable Global Energy Ontology for the Energy Domain'. *Journal of Web Semantics* 61–62 (March): 100550. <https://doi.org/10.1016/j.websem.2020.100550>.
- Fernández-López, Mariano, Asunción Gómez-Pérez, and Natalia Juristo. 1997. 'Methontology: From Ontological Art towards Ontological Engineering'.
- Garcia, Ana Cristina B., and Adriana S. Vivacqua. 2019. 'Grounding Knowledge Acquisition with

- Ontology Explanation: A Case Study'. *Journal of Web Semantics* 57 (August): 100487. <https://doi.org/10.1016/j.websem.2018.12.005>.
- Ge, Y.T., and S.A. Tassou. 2011. 'Performance Evaluation and Optimal Design of Supermarket Refrigeration Systems with Supermarket Model "SuperSim", Part I: Model Description and Validation'. *International Journal of Refrigeration* 34 (2): 527–39. <https://doi.org/10.1016/j.ijrefrig.2010.11.010>.
- Gero, John, and Udo Kannengiesser. 2004. 'The Situated Function-Behaviour-Structure Framework'. *Design Studies* 25 (July): 373–91. <https://doi.org/10.1016/j.destud.2003.10.010>.
- Gero, John S. 1990. 'Design Prototypes: A Knowledge Representation Schema for Design'. *AI Magazine* 11 (4): 26–26.
- Gero, John S., and Udo Kannengiesser. 2014. 'The Function-Behaviour-Structure Ontology of Design'. In *An Anthology of Theories and Models of Design*, 263–83. Springer.
- Gómez-Pérez, A. 1999. 'Ontological Engineering: A State of the Art'. *Expert Update: Knowledge Based Systems and Applied Artificial Intelligence* 2 (3): 33–43.
- Gruber, Thomas R. 1993. 'A Translation Approach to Portable Ontology Specifications'. *Knowledge Acquisition* 5 (2): 199–220. <https://doi.org/10.1006/knac.1993.1008>.
- Gruber, Thomas R. 1995. 'Toward Principles for the Design of Ontologies Used for Knowledge Sharing?' *International Journal of Human-Computer Studies* 43 (5–6): 907–28.
- Grüninger, Michael, and Mark S. Fox. 1995. 'Methodology for the Design and Evaluation of Ontologies'.
- Guarino, Nicola. 1998. *Formal Ontology in Information Systems: Proceedings of the First International Conference (FOIS'98), June 6-8, Trento, Italy*. Vol. 46. IOS press.
- Hlomani, Hlomani, and Deborah Stacey. 2014. 'Approaches, Methods, Metrics, Measures, and Subjectivity in Ontology Evaluation: A Survey'. *Semantic Web Journal* 1 (5): 1–11.
- Karray, Mohamed Hedi, Brigitte Chebel-Morello, and Noureddine Zerhouni. 2012. 'A Formal Ontology for Industrial Maintenance'. *Appl. Ontol.* 7 (3): 269–310.
- Kharbat, Faten, and Haya El-Ghalayini. 2008. 'Building Ontology from Knowledge Base Systems'. In . <https://doi.org/10.5772/6407>.
- Kitamura, Yoshinobu, and Riichiro Mizoguchi. 2004. 'Ontology-Based Systematization of Functional Knowledge'. *Journal of Engineering Design* 15 (4): 327–51.
- Korman, Daniel Z. 2019. 'Material Constitution'. *Oxford Bibliographies in Philosophy*. <https://www.oxfordbibliographies.com/view/document/obo-9780195396577/obo-9780195396577-0386.xml>.
- Liang, Ting-Peng. 1988. 'Development of a Knowledge-Based Model Management System: Special Focus Article'. *Operations Research* 36 (6): 849–63.
- Makhnatch, Pavel, and Rahmatollah Khodabandeh. 2014. 'The Role of Environmental Metrics (GWP, TEWI, LCCP) in the Selection of Low GWP Refrigerant'. *Energy Procedia* 61 (December): 2460–63. <https://doi.org/10.1016/j.egypro.2014.12.023>.
- Mascardi, Viviana, Valentina Cordì, and Paolo Rosso. 2007. 'A Comparison of Upper Ontologies.' In *Woa*, 2007:55–64. Citeseer.
- McKay, Everett N. 2013. 'A Communication-Driven Design Process'. In *UI Is Communication*, edited by Everett N. McKay, 241–91. Boston: Morgan Kaufmann. <https://doi.org/10.1016/B978-0-12->

396980-4.00005-6.

- Munir, Kamran, and M. Sheraz Anjum. 2018. 'The Use of Ontologies for Effective Knowledge Modelling and Information Retrieval'. *Applied Computing and Informatics* 14 (2): 116–26. <https://doi.org/10.1016/j.aci.2017.07.003>.
- Noy, Natalya F., and Deborah L. McGuinness. 2001. *Ontology Development 101: A Guide to Creating Your First Ontology*. Stanford knowledge systems laboratory technical report KSL-01-05 and
- Otto, K. N., and K. L. Wood. 2001. *Product Design: Techniques in Reverse Engineering and New Product Development*. Prentice Hall. <https://books.google.fr/books?id=up8nAQAAAMAJ>.
- Pahl, Gerhard, and Wolfgang Beitz. 2013. *Engineering Design: A Systematic Approach*. Springer Science & Business Media.
- Penttilä, H. 2006. 'Describing the Changes in Architectural Information Technology to Understand Design Complexity and Free-Form Architectural Expression'. *J. Inf. Technol. Constr.* 11: 395–408.
- Pinto, Helena Sofia, and João P. Martins. 2004. 'Ontologies: How Can They Be Built?' *Knowledge and Information Systems* 6 (4): 441–64.
- Quirante, Thomas. 2012. 'Modelling and Numerical Optimization Methods for Decision Support in Robust Embodiment Design of Products and Processes'. <http://www.theses.fr/2012BOR14676/document>.
- Quirante, Thomas, Patrick Sebastian, and Yann Ledoux. 2013. 'A Trade-off Function to Tackle Robust Design Problems in Engineering'. *Journal of Engineering Design* 24 (1): 64–81. <https://doi.org/10.1080/09544828.2012.691160>.
- Rivier, Michel. 2017. 'Analyse et Optimisation Multicritères d'un Procédé de Transfert Thermique et de Séchage Pour Une Application En Afrique de l'Ouest'. PhD Thesis. <http://www.theses.fr/2017NSAM0003/document>.
- Salehy, Yasmine, Hong Minh Hoang, François Cluzel, Yann Leroy, Anthony Delahaye, Laurence Fournaison, and Bernard Yannou. 2020. 'Energy Performances Assessment for Sustainable Design Recommendations: Case Study of a Supermarket's Refrigeration System'. *27th CIRP LCE (2020)*: 328–33. <https://doi.org/10.1016/j.procir.2020.01.102>.
- Smith, Barry, Mauricio Almeida, Jonathan Bona, Mathias Brochhausen, Werner Ceusters, Melanie Courtot, Randall Dipert, Albert Goldfain, Pierre Grenon, and Janna Hastings. 2015. 'Basic Formal Ontology 2.0: Specification and User's Guide'. *National Center for Ontological Research: Buffalo, NY, USA*.
- SOININEN, TIMO, JUHA TIIHONEN, TOMI MÄNNISTÖ, and REIJO SULONEN. 1998. 'Towards a General Ontology of Configuration'. *Artificial Intelligence for Engineering Design, Analysis and Manufacturing* 12 (4): 357–72. <https://doi.org/10.1017/S0890060498124083>.
- Staab, Steffen, Rudi Studer, H.-P. Schnurr, and York Sure. 2001. 'Knowledge Processes and Ontologies'. *IEEE Intelligent Systems* 16 (1): 26–34.
- Succar, Bilal. 2009. 'Building Information Modelling Framework: A Research and Delivery Foundation for Industry Stakeholders'. *Automation in Construction* 18 (3): 357–75.
- Sugumaran, Vijayan, and Veda C. Storey. 2002. 'Ontologies for Conceptual Modeling: Their Creation, Use, and Management'. *Data & Knowledge Engineering* 42 (3): 251–71.

- Ulrich, Karl T., and Steven D. Eppinger. 2016. *Product Design and Development*.
- Uschold, Michael, and Martin King. 1995. *Towards a Methodology for Building Ontologies*. Citeseer.
- Uschold, Mike. 1996. 'Building Ontologies: Towards a Uni Ed Methodology'. In *Proceedings of 16th Annual Conference of the British Computer Society Specialists Group on Expert Systems*. Citeseer.
- Van Heijst, Gertjan, A. Th Schreiber, and Bob J. Wielinga. 1997. 'Using Explicit Ontologies in KBS Development'. *International Journal of Human-Computer Studies* 46 (2–3): 183–292.
- Witherell, Paul, Sundar Krishnamurty, and Ian R. Grosse. 2007. 'Ontologies for Supporting Engineering Design Optimization'.
- Yang, Lan, Kathryn Cormican, and Ming Yu. 2019. 'Ontology-Based Systems Engineering: A State-of-the-Art Review'. *Computers in Industry* 111: 148–71.
- Yang, Q.Z., and Y. Zhang. 2006. 'Semantic Interoperability in Building Design: Methods and Tools'. *Computer-Aided Design* 38 (10): 1099–1112. <https://doi.org/10.1016/j.cad.2006.06.003>.
- Yoshikawa, Hiroyuki. 1989. 'Design Philosophy: The State of the Art'. *CIRP Annals* 38 (2): 579–86. [https://doi.org/10.1016/S0007-8506\(07\)61126-3](https://doi.org/10.1016/S0007-8506(07)61126-3).

Chapter 6: A simulation platform for exploring design spaces of refrigeration systems

This chapter presents the simulation and design space exploration platform. Based on the knowledge model previously shown, the design problem is implemented using the Geeglee tool. In order to find an optimal solution(s), the platform allows enumerating the set of possible solutions. Indeed, the solutions answering the design problem of supermarket refrigeration systems are first brute-force enumerated. Then, an exploration interface can be used to address different user objectives by providing an exploration of the solution and performance space. Two usage scenarios are shown in this chapter. The first example is that of a supermarket manager seeking to observe the changes of a refrigerant on the performance of his existing system. The second example is that of a designer seeking to quickly assess what the best solution for his client within budgetary and environmental constraints is. Verifications are made through workshops and a use case application to ensure completeness and correctness of the modelling process and outcomes.

1. Introduction

To improve the design activities in the early stages of the design process, as shown in the diagnosis, we propose an integrated approach, i.e. a conceptual framework and a simulation tool, to support the stakeholders in the design process. Chapter 5 proposes a knowledge model for the design of refrigeration systems and, in particular for supermarkets. Four main classes are built to represent clearly our problem: *scenario*, *refrigeration system design solution*, *properties*, and *performances assessment*. It allows us to answer our research gap 2 on the lack of integrated approach for refrigeration systems design. In this chapter, an answer to our research gap 3 is proposed. The objective is to implement the knowledge model into a multi-objective simulation and design space exploration platform for supermarket refrigeration systems.

First, design space exploration and supporting tools are introduced in section 2. Then, the supporting tool chosen to implement our model is discussed in section 3.

In section 4, the implementation of the design problem and the dimensioning steps to search for a feasible solution are presented. Section 5 presents the exploration of refrigeration systems design space through two usage examples.

Finally, section 6 presents the discussion on how we provide an answer to research gap 3 as well as the limitations. A short conclusion summarizes our study and introduces the next chapter.

2. Design space exploration

As expressed in the previous chapter, there are at least five performances (or objectives) to optimize for the design of a refrigeration system: energy consumption, environmental impacts, cost, technological maturity and maintenance. This has the consequence of increasing the number of potential optimal solutions and increasing the complexity of the trade-off needed to be addressed.

Model-Based System Engineering (MBSE) and optimization techniques are often used to find the more suitable solution for complex system development (see Chapter 2). During the diagnosis, we highlighted a top-down approach to refrigeration system design based on evaluating a very limited number of design solutions (called point-based design). The limitations of this approach are the restriction of the design solutions and the lack of user interaction in the process (research gap 3).

2.1. Design Space Exploration paradigms

Design space exploration (DSE) paradigm offers an answer to the limitations. Design space exploration is developed to improve the common tasks of designing a product or a system in the early design stages (Scaravetti and Sebastian, 2009). It can improve user-interaction in the process (Balling, 1999). DSE consists of assessing design alternatives. It can be used for quickly generating and simulating a set of feasible solutions, optimizing if metrics are available to compare design solutions, finding the architecture and dimensioning the components that satisfy the design constraints (Kang et al., 2010).

To understand how DSE can be implemented, we focus the next sections on DSE supporting techniques and tools.

2.2. *Design Space Exploration supporting techniques*

One important limitation to the use of DSE is the number of alternatives to evaluate. Indeed, as complex systems can have millions of possible alternatives, a proper representation of design space is necessary to ensure a relevant DSE. Different techniques exist to support the design space exploration.

Research in computer science has developed the Constraints Programming (CP) methods to respond to this limitation. It is used to solve optimisation problems and construct a feasible design space (Devanathan and Ramani, 2010; Rossi et al., 2006; Scaravetti et al., 2005; Yannou and Harmel, 2005). A constraint satisfaction problem (CSP) is defined by a set of variables V belonging to a set of domain D and answering to a set of constraints C . CSPs serve for enumerating feasible space, in the case of discrete variables, of all feasible combinations of parameters (which verify constraints and specifications). Solving a CSP consists of solving two steps: searching for a solution and then consistently filtering, i.e. finding the set of feasible solutions by filtering all infeasible solutions (Kumar, 1992).

The search techniques comprise backtracking methods, also said constraint propagation methods. If there are many more infeasible solutions than feasible solutions, backtracking techniques (*branch and bound*, *branch and prune*) avoid wasting time trying to enumerate these infeasible solutions as soon as possible enumeration and also allow to find an optimum for a single-objective function quickly. Filtering techniques comprise consistency-based algorithms such as path-, arc-, hull-, and box-consistency (Devanathan and Ramani, 2010; Rossi et al., 2006).

Another less sophisticated method is to enumerate all solutions – feasible and infeasible - with tree search-based techniques such as *generate-and-test*, or brute-force search. After this exhaustive enumeration, we check whether the parameter combinations verify all the design specifications and constraints, making the solution feasible. In our study, we used this simpler approach of solution brute-force enumeration followed by a feasibility check. It works well at the condition that the apparent combinatorics of the design space is not too important.

2.3. *DSE supporting tools using brute-force enumeration*

DSE needs to be integrated into a digital tool to compute the high number of possible solutions and further explore the feasible solutions by “what if” hypotheses. The digital tool needs to meet two specifications: appropriate computational costs (Kang et al., 2010) and appropriate results visualization (Ligetti et al., 2003).

There are several ways to represent the set of possible solutions depending on the type of constraints: 1D intervals, 2D polyline or polygons, 3D polyhedrons. The advantage of representing the results in 1D intervals is simplifying information visualization, especially for complex multi-disciplinary systems. 2D and 3D representations provide information transmission for constraint resolution problems on two or more objectives.

In their work on Interactive Visualization Artefacts (IVAs), Tweedie et al. (1996) developed the Influence Explorer tool, presented in Figure 6-1, where the solutions are presented in histograms and

1D intervals. The tool is based on a *generate-and-test* algorithm, where the solutions are enumerated in an exhaustive way as all the combinations of the parameters belong to a discrete set of values. The performances are then calculated, and we check if the design specification and constraints are verified for a parameter-performance tuple. When the tuples are feasible, i.e. they check all the constraints, they are coloured in red and black while the "infeasible" points are coloured in white and grey in Figure 6-1. The designer can interact simultaneously with the parameters and the performances using the sliders to reduce or extend the solutions. The designer can either find the parameters corresponding to the required performance or the performances for a particular set of parameters. This method puts the user at the centre of the decision.

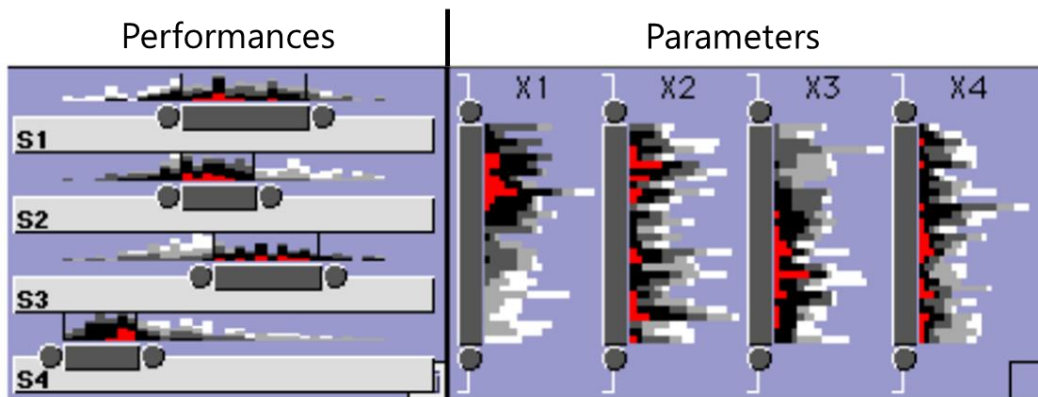

Figure 6-1. Influence Explorer visualisation tool: performances and parameters histograms

ARL Trade Space Visualizer (Stump et al., 2004) is a tool for representing all the feasible points. It is based on the same principle that was previously described. The design solutions are generated and displayed using Monte Carlo simulation or design of Experiment (DoE) (Eriksson et al., 2000). The decision process is iterative, first the user discovers solutions and investigates the problem then the design space is explored using the knowledge investigation.

HEEDS MDO (Siemens, 2014) is another DSE supporting tool, allowing the user to perform design optimization and find a set of Pareto optimal solutions using different optimization algorithms (Genetic algorithm particle swarm, SHERPA, etc.), DOE and sensitivity analysis. One interesting feature is the possibility for the tool to retrieve the data from other software, including CAD tools or Excel. Different post-processing tools are available to explore the solutions using tables, 2D plotlines, colours, point shapes...

Finally, we present the modelling and simulation tool Geeglee (Holley, 2011) for complex systems design exploration. The tool allows to first generate a design space by enumerating all the combinations of parameters. Then, an *a posteriori* exploration of the solutions is done by a user. He can thus discover relevant and sometimes non-standard design solutions, considered "blind spots", which meet his objectives (Du Manoir Geoffroy et al. 2019). The "blind spot" solutions for decision-makers are the ones that they would not have thought of or that they would have found difficult to identify, as shown in aeronautics for finding optimal architecture of Mars helicopter drone (Phan et al., 2018). Geeglee allows to easily brute-force enumerate all tuples of parameter combinations and provides a visualization interface for exploring the generated space.

2.4. *Overview of our strategy*

After studying DSE and its supporting tools, we formulate our strategy for design space exploration in this section.

The design problem has been studied, and a framework has been proposed in the knowledge model developed in Chapter 4. The design solution belongs to a certain domain, and they are linked mathematically to the global performances. To better explore the design space, Tweedie et al. (1996) encourage a pre-computation step dedicated to the generation of a design space before exploring the field of design points and selecting one or a set of best solutions. We follow this strategy to implement the design space exploration platform:

- First, a dimensioning algorithm allows us to compute all the combinations of the parameters constrained by the supermarket specification. It is based on a brute-force enumeration of the n-tuples of feasible solutions (dotted box in Figure 6-2). The solution space is in a discrete set for our study because we seek to dimension an optimal refrigeration system.
- After the first computation of design points, the design space is displayed in an exploration tool. All the solutions are presented, and the user can navigate in the design space, applying successive "what-if" hypotheses and looking to the evolution of the feasible design space. The user can reduce the design space by applying new constraints, also called decisions, on the performance space such as reduction of energy, costs, environmental impacts or on the decision space such as removing alternatives of refrigerant, compressor, architecture (see Figure 6-2). Applying these decisions crops the design space to obtain an optimal solution.

The process is iterative by allowing the users to interact simultaneously with the performance space and the decision space (Abi Akle et al., 2019), to reduce or enlarge the domains of definition of the solutions and performances to converge towards one or several "crisp solutions". This paradigm is called "Design by Shopping" (Balling, 1999).

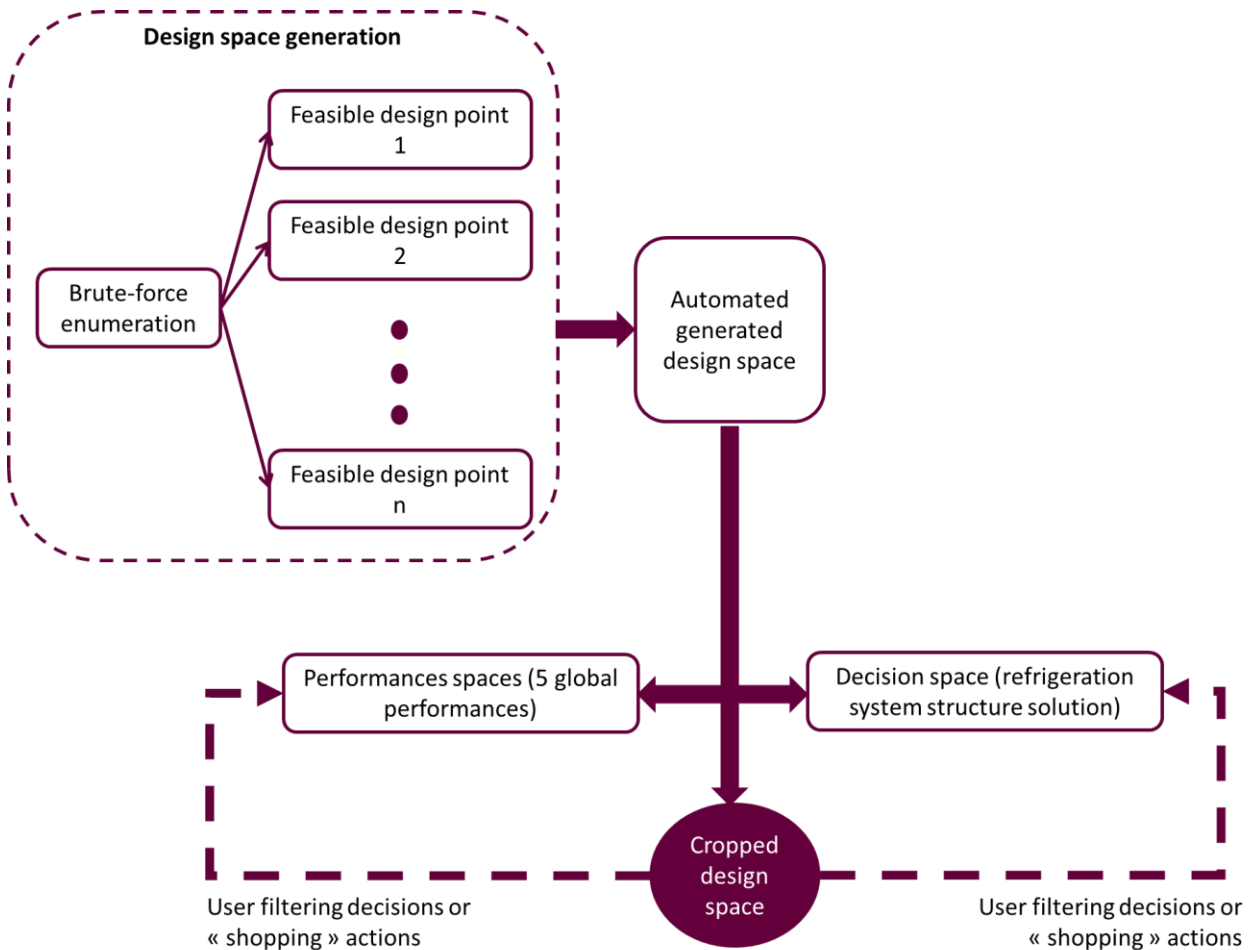

Figure 6-2. Our strategy for design space exploration based on a brute-force enumeration and "design by shopping" inspired by (Nema et al., 2003).

3. Supporting tool for developing a simulation and exploration of design space

3.1. Choice of simulation support tool

We seek to (1) simulate the behaviour of a refrigeration system and dimension it in a discrete solution space and (2) explore the design spaces under uncertainties for different stakeholders.

Different DSE tools exist, as presented in section 1.3. The choice for the simulation tool has been made based on the tool's availability, the developing interface, the capacity of the tool to support our knowledge model, the time and memory necessary for the computation of design points.

Geeglee was chosen as a DSE support tool for our model. One advantage is the visual interface of the tool that allows us to notice development errors easily. Moreover, the simplified visualization of the tool permits enumerate the system's structure and set up an incompatibility configurator in the form of a matrix. Finally, the programming language close to the common language facilitates the development. The tool can be in relation to another programming platform such as Excel and another programming language like Python. The tool framework is adapted to our knowledge model (see section 2.2.). It allows us to implement hundreds of equations and data. A collaboration with the

Geeglee developing company has provided the free use of the tool as well as a guided accompaniment. However, the computational memory for our design problem requires a difficult storage capacity to access. Moreover, the visualization of the results has some limitations that we highlight in the chapter's discussion.

3.2. Modelling structure and language

Geeglee is divided into two complementary tools: Geeglee Engineering Patterns (GEP) and Geeglee Engineering Intelligence (GEI). GEP is the tool used to model the system of interest, while GEI is used to visualize and analyse the design space data generated from the model created in GEP. GEI allows the designer to play with the design space by reducing the uncertainty to an optimal solution in a design-by-shopping manner by over-constraining the specification and making design choices (Phan et al., 2018).

The GEP tool is composed of four main sections:

- (1) High Level Requirement (HLR) where the specifications are described (inputs, constraints, objectives...).
- (2) Product Breakdown Structure (PBS) where the decision space is described (technical options for the system of interest and incompatibilities between technical solutions).
- (3) Technical Portfolio where the intermediate values related to each technical option are entered.
- (4) Engineering Patterns (EP) where the performance and physical behaviour of the system are explained by means of equations.

The knowledge model representing the design problem is implemented using Geeglee tool with Excel, Latex, and Python in the platform. Five months were dedicated to the implementation in the platform with a full-time intern for three months. Several workshops with a graphic designer were used to refine the model and the graphical interface to fit several test scenarios.

4. Implementation

4.1. Implementation of the design problem in the tool

The simplified scheme of the design problem and the relation with the four objects of Geeglee is shown in Figure 6-3. The system environment is considered the inputs of the model. Different alternatives for each technical module of the system structure are implemented. The global performances are calculated thanks to mathematical equations concerning the inputs and the system structure.

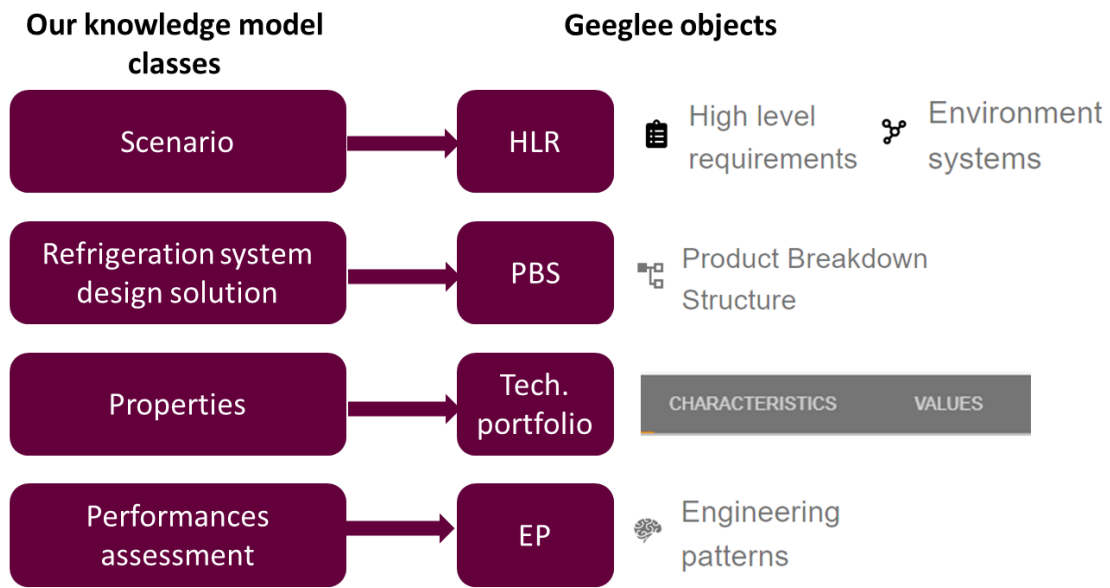

Figure 6-3. Correspondence between the design problem represented in our knowledge model and the Geeglee objects.

Figure 6-4 partially shows the definition of a scenario of the use of the refrigeration system in a supermarket (number of cold rooms, sales cabinets, the mass of food in each element, set-point temperature, location of the supermarket...) as listed in Chapter 5. The set of possible values for the variable are given in blue. This is its discrete domain of definition.

HLR INPUTS				ENVIRONMENT VARIABLES		REQUIREMENT CONSTRAINTS		HLR OUTPUTS	
HLR Inputs									
+									
Group	HLR Input		Values						
Supermarket Environment	Mass of food inside each CS [kg]	+	1000	1500					
Supermarket Environment	Mass of food inside each DC horizontal [kg]	+	30	70					
Supermarket Environment	Mass of food inside each DC vertical [kg]	+	50	100					
Supermarket Environment	Number of CS units [#]	+	1	2	3	4			
Supermarket Environment	Number of horizontal DC [#]	+	1	3	5	7			
Supermarket Environment	Number of Vertical DC [#]	+	1	3	5	7			
Supermarket Environment	System life time [yrs]	+	5	7	10	15	20		

Figure 6-4. Presentation of the implementation of the scenario concept in the GEP

The design space is composed of design points or solutions. As presented in the knowledge model, the solution is composed of architecture and the associated physical components. Four architectures presented in the state-of-the-art chapter are implemented in the platform. All refrigeration system components in a supermarket are included in the modelling with one or more alternatives. For the main components, fifteen compressors, thirteen condensers, six refrigerants, three types of pipelines

material are entered in the tool. Other components are set for specific usage, for example, CO₂ compatible technologies. In Figure 6-5, the four architectures considered are listed along with the involved components.

Product Breakdown Structure
List the PBS leaves. Each leaf will then be populated with design alternatives. (By the way, none, i.e. the absence of a component, can also be one alternative)

Module ↑	Alternatives	Plugin	Primary loop	Secondary loop	Transcritical al
Circulation Pump	4/4	<input type="checkbox"/>	<input type="checkbox"/>	<input checked="" type="checkbox"/>	<input type="checkbox"/>
Compressor	15/15	<input checked="" type="checkbox"/>	<input checked="" type="checkbox"/>	<input checked="" type="checkbox"/>	<input checked="" type="checkbox"/>
Condenser	13/13	<input checked="" type="checkbox"/>	<input checked="" type="checkbox"/>	<input checked="" type="checkbox"/>	<input checked="" type="checkbox"/>
Evaporator	1/1	<input checked="" type="checkbox"/>	<input checked="" type="checkbox"/>	<input checked="" type="checkbox"/>	<input checked="" type="checkbox"/>
Expansion Valve	1/1	<input checked="" type="checkbox"/>	<input checked="" type="checkbox"/>	<input checked="" type="checkbox"/>	<input checked="" type="checkbox"/>
Heat Exchanger	12/12	<input type="checkbox"/>	<input type="checkbox"/>	<input checked="" type="checkbox"/>	<input type="checkbox"/>
Pipeline Discharge	10/10	<input checked="" type="checkbox"/>	<input checked="" type="checkbox"/>	<input checked="" type="checkbox"/>	<input checked="" type="checkbox"/>
pipeline discharge material	3/3	<input checked="" type="checkbox"/>	<input checked="" type="checkbox"/>	<input checked="" type="checkbox"/>	<input checked="" type="checkbox"/>
Pipeline Suction	10/11	<input checked="" type="checkbox"/>	<input checked="" type="checkbox"/>	<input checked="" type="checkbox"/>	<input checked="" type="checkbox"/>
pipeline suction material	3/3	<input checked="" type="checkbox"/>	<input checked="" type="checkbox"/>	<input checked="" type="checkbox"/>	<input checked="" type="checkbox"/>
Refrigerant	6/6	<input checked="" type="checkbox"/>	<input checked="" type="checkbox"/>	<input checked="" type="checkbox"/>	<input checked="" type="checkbox"/>
secondary refrigerant	1/1	<input type="checkbox"/>	<input type="checkbox"/>	<input checked="" type="checkbox"/>	<input type="checkbox"/>
secondary refrigerant pipeline	6/6	<input type="checkbox"/>	<input type="checkbox"/>	<input checked="" type="checkbox"/>	<input type="checkbox"/>
Setpoint temperature	2/2	<input checked="" type="checkbox"/>	<input checked="" type="checkbox"/>	<input checked="" type="checkbox"/>	<input checked="" type="checkbox"/>
Transcritical compressor	3/13	<input type="checkbox"/>	<input type="checkbox"/>	<input type="checkbox"/>	<input checked="" type="checkbox"/>
Transcritical discharge pipe	2/2	<input type="checkbox"/>	<input type="checkbox"/>	<input type="checkbox"/>	<input checked="" type="checkbox"/>
Transcritical storage	3/3	<input type="checkbox"/>	<input type="checkbox"/>	<input type="checkbox"/>	<input checked="" type="checkbox"/>

Figure 6-5. Presentation of the design space implementation in the GEP

The RS modules, i.e., the technical components implemented in the platform, define several intermediary data, also called characteristics. For the modules, intermediary data are the components specifications taken from manufacturers' catalogues, experts' know-how and literature. The data can be either quantitative, such as a diameter, a power, and a capacity or qualitative such as accessibility, readiness level or compatibility. They are kept in an accessible and editable database. As an example, Figure 6-6 shows the intermediary data for a compressor.

Group ↑	Characteristic	Type
Compressor characteristics	Connection discharge line diameter (Dpipe)	Quantitative
Compressor characteristics	Connection suction line diameter (Dpipelin)	Quantitative
Compressor characteristics	Cooling capacity [kW]	Quantitative
Compressor characteristics	COP/EER [#]	Quantitative
Compressor characteristics	Current (400V) [A]	Quantitative
Compressor characteristics	Evaporator capacity [kW]	Quantitative
Compressor characteristics	Frequency compressor	Quantitative
Compressor characteristics	Max Voltage [V]	Quantitative
Compressor characteristics	Min Voltage [V]	Quantitative
Compressor characteristics	Needed Condenser capacity [kW]	Quantitative
Compressor characteristics	Power input [kW]	Quantitative
Compressor characteristics	Refrigerant compatibility	Qualitative
Compressor characteristics	Volumetric flow of refrigerant [m ³ /s]	Quantitative

Figure 6-6. Compressor characteristics implemented in the exploration platform

The incompatibilities between the values of the components are implemented as tables; an example of the incompatibilities between compressors and condensers is shown in Figure 6-7.

		Compressor									
		mp 4	2ESL-4K	2ESL-4K-40S	2OSL-3K	2KE8-05Y-40S	4DSL-10K	4FTE-20K	4HTE-15K	4PES-10Y-40P	4PES-12Y-40P
Condenser	HSK7451-70-40P										
	CRF models bitzer 109	Incomp			Incomp		Incomp	Incomp	Incomp		
	CRF models bitzer 125	Incomp			Incomp		Incomp	Incomp	Incomp		
	CRF models bitzer 142	Incomp			Incomp		Incomp	Incomp	Incomp		
	CRF models bitzer 166	Incomp			Incomp		Incomp	Incomp	Incomp		
	Condenser 1										
	Condenser 2										
	Lennox 14.1	Incomp			Incomp		Incomp	Incomp	Incomp		
	Lennox 18.6	Incomp			Incomp		Incomp	Incomp	Incomp		
	Lennox 21.1	Incomp			Incomp		Incomp	Incomp	Incomp		
	Lennox 42.5	Incomp			Incomp		Incomp	Incomp	Incomp		
	Lennox 61.6	Incomp			Incomp		Incomp	Incomp	Incomp		
	Lennox 93	Incomp			Incomp		Incomp	Incomp	Incomp		
condenser inbuilt in co...			Incomp			Incomp				Incomp	Incomp

Figure 6-7. Incompatibility table implemented in the design platform

The local and global performance classes are implemented in the design platform in the Engineering Pattern space that allows having all the equations to model the refrigeration system in usage. They are grouped under a global performance name category, and the example of the environmental impact implementation is given in Figure 6-8. As mathematical models can depend on the refrigeration system solution architecture, the tool can link a mathematical model to a different structural architecture.

In our design problem, around 300 equations are computed divided into six main groups related to

the calculation of the cooling power, the energy consumption, the environmental impacts, the maintenance score, the total costs and the system maturity. A part of the mathematical models implemented in the tool is presented in Chapter 5. The other equations defining the performances can be found in appendix 3.

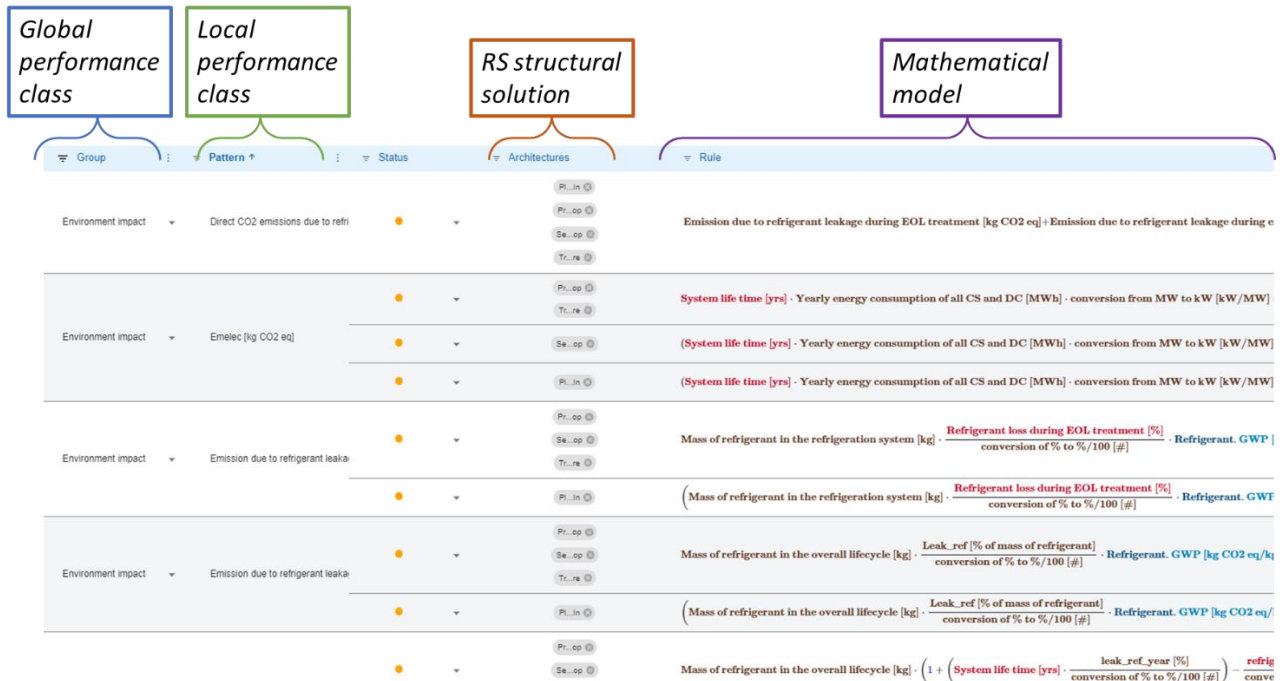

Figure 6-8. Environmental impacts class implementation in the design and exploration platform

4.2. Dimensioning a feasible solution

After implementing the variables, parameters and equations, the generation of the design problem is based on the resolution of a CSP.

Figure 6-9 shows the steps followed to dimension one solution according to the system environment constraints to search the feasible solutions. It gives a simplified example of the design steps to compute a feasible solution. It does not mean that this design point is the best solution. The algorithm repeats the steps for all the possible solutions, and the set of feasible design points generates the design space.

The system environment, i.e. location, supermarket specifications, defrost specifications, cold room (or display cabinets) specifications, allows us to calculate the frigorific power for each cold room or display cabinet. Then they are added to calculate the supermarket cold need, here only for food conservation. From this step, the required cooling capacity is calculated based on industrial experience and should be approximately 30% more than the calculated frigorific power. The required capacity can be divided between 1, 2, or more compressors (and the same for condensers). The required compressors and condensers must be discrete variables from $[1; \infty[$.

In Figure 6-9, the blue dash boxes are the parameters, and the red dash boxes are the

incompatibilities parameters. The local performances are in the plum coloured boxes. The green coloured boxes are the refrigeration system structural solution.

As shown in Figure 6-9, there is a high interdependence between the variables of the problem thus the components' selection.

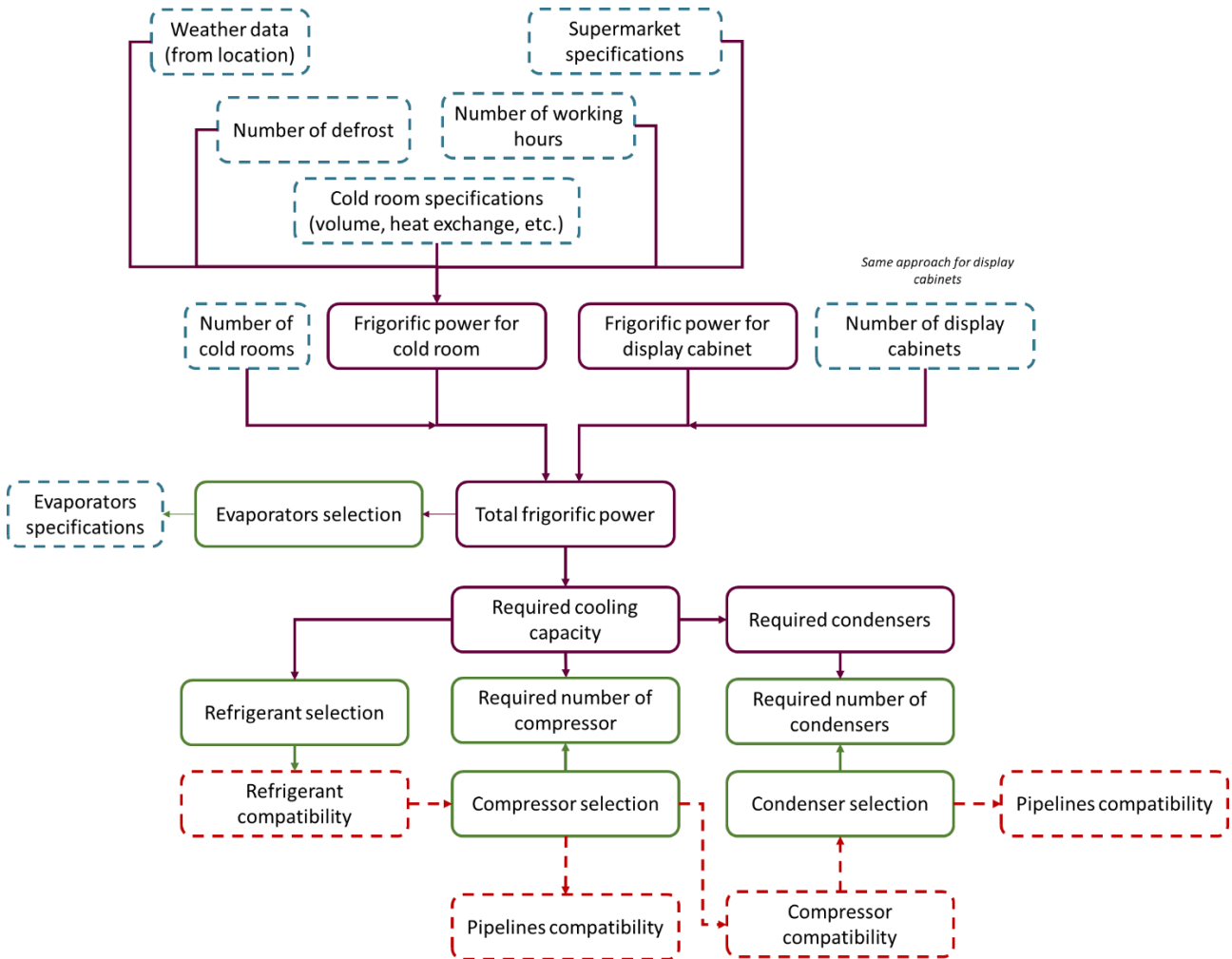

Figure 6-9. Simplified scheme of a design point computation algorithm

Once the design space is generated, all the feasible solutions are visualized in an exploration interface.

5. Simulation and exploration tool

In the previous section, we have seen how the design problem is set, how to dimension the feasible solutions based on the system environment constraints and how it is implemented using Geeglee.

In this section, we study how the visualization interface is used for design space exploration. Once the design space is generated (step 1 in Figure 6-10) as presented in the previous section, the user has access to an exploration platform. He follows two steps: setting the system environment (step 2 in Figure 6-10) and exploring, or reducing, the design space (step 3 in Figure 6-10).

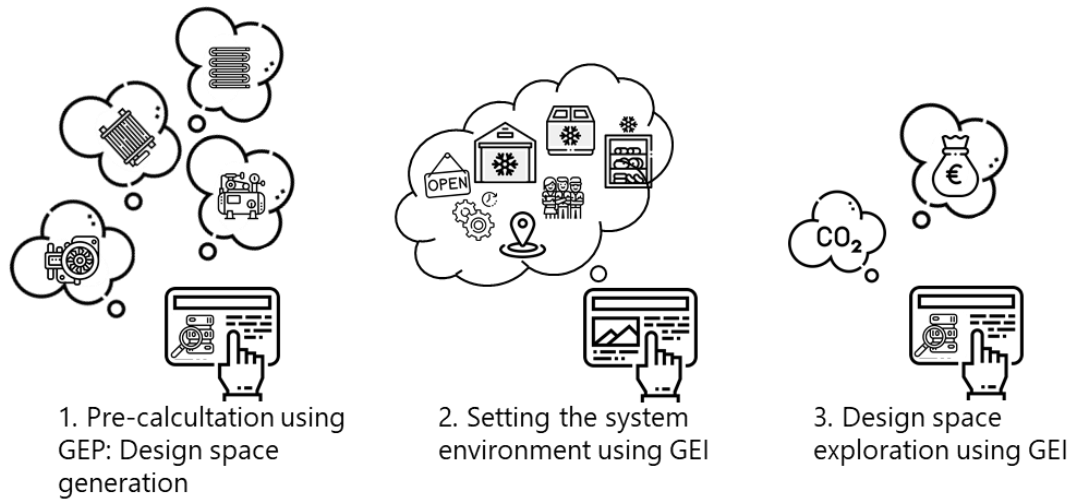

Figure 6-10. Steps to follow using the design and exploration platform

Two scenarios are provided to understand the usage in real situations based on the typical design activities highlighted in the industrial diagnosis. We focus on analysing the decision-making process to choose a refrigeration system structural solution. The scenarios are presented based on the persona method in which a target user and its objectives are presented. We consider two main scenarios:

- **Scenario 1:** A supermarket manager has been proposed to change the refrigerant of its existing system using R404 to meet the regulatory requirements F-gas II. He would like to first test the performance of a new system with the new refrigerant R1234yf, and then make a decision, "Given the changes observed in the model, would he change the refrigerant in his existing system?".
- **Scenario 2:** After receiving a request to build a refrigeration system from scratch in a supermarket in Ile de France, the designer wants to design a refrigeration system to meet their initial budget and environmental constraints. This system must be able to respond to climatic and market evolutions. The company know-how constraints must be considered (in this case, the company's operators are not trained to use CO₂ for the moment).

5.1. Setting the system environment for Scenarios 1 & 2

The same system environment is proposed based on the ADEME case study (ADEME and Enertech, 2001). We briefly present hereafter this case study. For more details, see Appendix 3. Figure 6-11 provides a simplified scheme of the case study.

The supermarket is composed of 25 display cabinets (DC) with a positive set-point temperature of 2°C, eight display cabinets and one cold room with a respective negative set-point temperature of -18°C and -20°C. The display cabinets can be vertical or horizontal with a respective mass of 50 kg and 30 kg food. To simplify the modelling, we consider that the food at positive temperatures is fruits

in bulk and ice cream at negative temperatures. The total energy consumption for a whole year measured in the report is around 291 000 kWh.

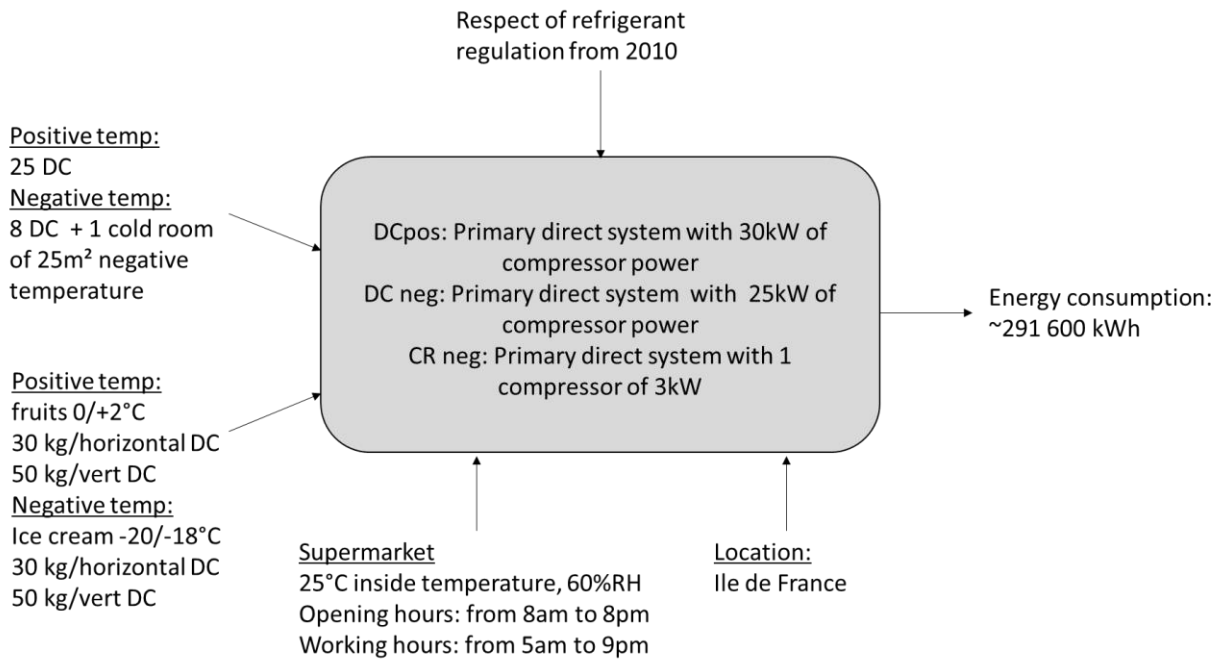

Figure 6-11. Reference supermarket for verification of the models

The first step for the supermarket manager (scenario 1) and the designer (scenario 2) is to open the interface. The user sees the interface shown in Figure 6-12 with the menu of possible actions on the left and the main window to visualize the results.

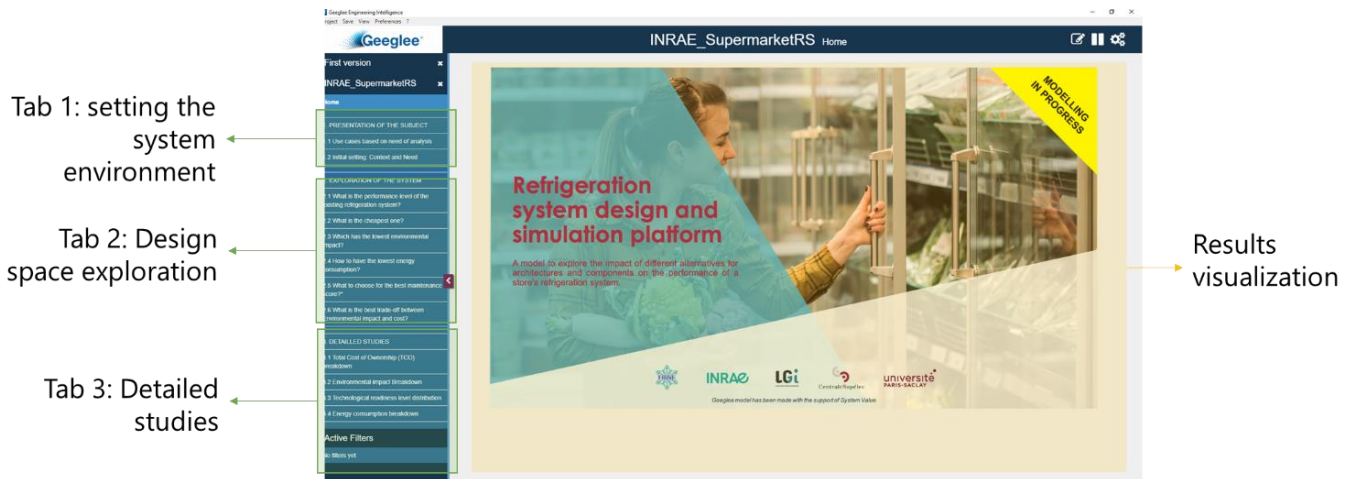

Figure 6-12. Platform interface

Then, the next step for both the supermarket manager (scenario 1) and the designer (scenario 2), is to set the system environment. Figure 6-13 and Figure 6-14 show the interface to fulfil. It comprises the store characteristics (Figure 6-13) and the food conservation characteristics (Figure 6-14).

For the store characteristics, the user selects the location Paris, the store area of 2500m², the opening hours (the store is open to customers) from 8:00 am to 8:00 pm, the working hours (the store is open for the supermarket employees) from 5:00 am to 9:00 pm and the number of employees working in the cold rooms of 10 persons.

The user selects then food conservation characteristics. First, it comprises the type of food (refrigerated or frozen) to establish the set-point temperature, i.e. 2°C for refrigerated food and -18°C for frozen food. These set-point temperatures are chosen based on the case study but could evolve. Secondly, the user selects the number of cold rooms and display cabinets. Finally, he chooses the mass of food. There is only one possible value for the mass of food for simplification purposes.

Geeglee'

- First version
- INRAE_SupermarketRS
- Home
- 1. PRESENTATION OF THE SUBJECT
 - 1.1 Use cases based on need of analysis
 - 1.2 Initial setting: Context and Need
- 2. EXPLORATION OF THE SYSTEM
 - 2.1 What is the performance level of the existing refrigeration system?
 - 2.2 What is the cheapest one?
 - 2.3 Which has the lowest environmental impact?
 - 2.4 How to have the lowest energy consumption?
 - 2.5 What to choose for the best maintenance score?*
 - 2.6 What is the best trade-off between Environmental impact and cost?
- 3. DETAILED STUDIES
 - 3.1 Total Cost of Ownership (TCO) breakdown
 - 3.2 Environmental Impact Breakdown
 - 3.3 Technological readiness level distribution
 - 3.4 Energy consumption breakdown
- Active Filters
 - No filters yet

1. Check the context

1.1 Check the general characteristics of the store

Store Location: Paris

Store dimensions (m²): Hypermarket (10000m²)

1.2 Check the specifics of the store related to the storage of frozen and refrigerated food

Store's Opening hours (hour): 12.0

Store's Working hours (hour): 16.0

Number of employees working in cold storage: 10.0



Figure 6-13. System environment: store characteristics interface

Geeglee Engineering Intelligence
Project Save View Preferences ?

Geeglee INRAE_SupermarketRS 1.2 Initial setting: Context and Need

First version
INRAE_SupermarketRS
Home

1. PRESENTATION OF THE SUBJECT
1.1 Use cases based on need of analysis
1.2 Initial setting: Context and Need
2. EXPLORATION OF THE SYSTEM
2.1 What is the performance level of the existing refrigeration system?
2.2 What is the cheapest one?
2.3 Which has the lowest environmental impact?
2.4 How to have the lowest energy consumption?
2.5 What to choose for the best maintenance score?
2.6 What is the best trade-off between Environmental impact and cost?
3. DETAILED STUDIES
3.1 Total Cost of Ownership (TCO) breakdown
3.2 Environmental Impact Breakdown
3.3 Technological readiness level distribution
3.4 Energy consumption breakdown

Active Filters
No filters yet

2. Check the need
Check the type of storage needed

Frozen food

Food in cold storage (type)
Frozen food in cold storage room
Refrigerated food in cold storage room

Food in display cabinet (type)
Frozen food in display cabinet
Refrigerated food in Display cabinet

Refrigerated food

Frozen cold storage
Frozen horizontal display cabinet
Frozen vertical display cabinet
Refrigerated cold storage
Refrigerated horizontal display cabinet
Refrigerated vertical display cabinet

Number of units
0
1

Mass of food (kg)
1000.0
30.0
50.0
1000.0
30.0
50.0

Figure 6-14. System environment: food conservation characteristics interface

Once the system environment is set, the feasible solutions are displayed in tabs 2. and 3. in the interface. Different possibilities of exploration are offered to the user:

- Evaluate an existing refrigeration system (Tab 2.1):
 - Simulate its overall performance
 - Simulate the impact of a technical component change on its performance
- Identify the best combinations of components according to a single or multi-objective analysis (From Tab 2.2 to Tab 2.6). This simulation can be used either on an existing system or for a new system. Several explorations are proposed on the platform that can allow the user to reduce the design space depending on the choices:
 - Identify the components with the lowest total cost (evaluated according to installation and operational costs over the system's lifetime)
 - Identify the components with the lowest energy consumption (evaluated per year according to the type and number of equipment, i.e. sales cabinet and cold room)
 - Identify the components with the lowest environmental impact (assessed over the entire life cycle of the system)
 - Identify the components and the most mature system (evaluated by the Technological Readiness Level (TRL) scale)
 - Identify the components with the best maintenance score (assessed by a maintenance criteria scale)
 - Identify the components with the lowest total cost and environmental impacts

5.2. Analysis of a single point in the design space: Scenario 1

In Scenario 1, the supermarket manager wants to observe the change in the performance of his existing system if he changes refrigerant (from R404 to R1234yf). The platform's goal is to provide a simulation of a single point in the design space.

On tab 2.1 of the interface, the manager must first select the components of his existing system, as shown in Figure 6-15. He chooses the type of architecture and then the compressor, condenser, refrigerant, and pipeline material. The choice of evaporator and expansion valve is by default because the model does not yet select different alternatives, and only the evaporator cooling capacity is calculated. The pipeline diameters are constraints by the type of compressor and condenser chosen.

1. Set the system architecture and the components

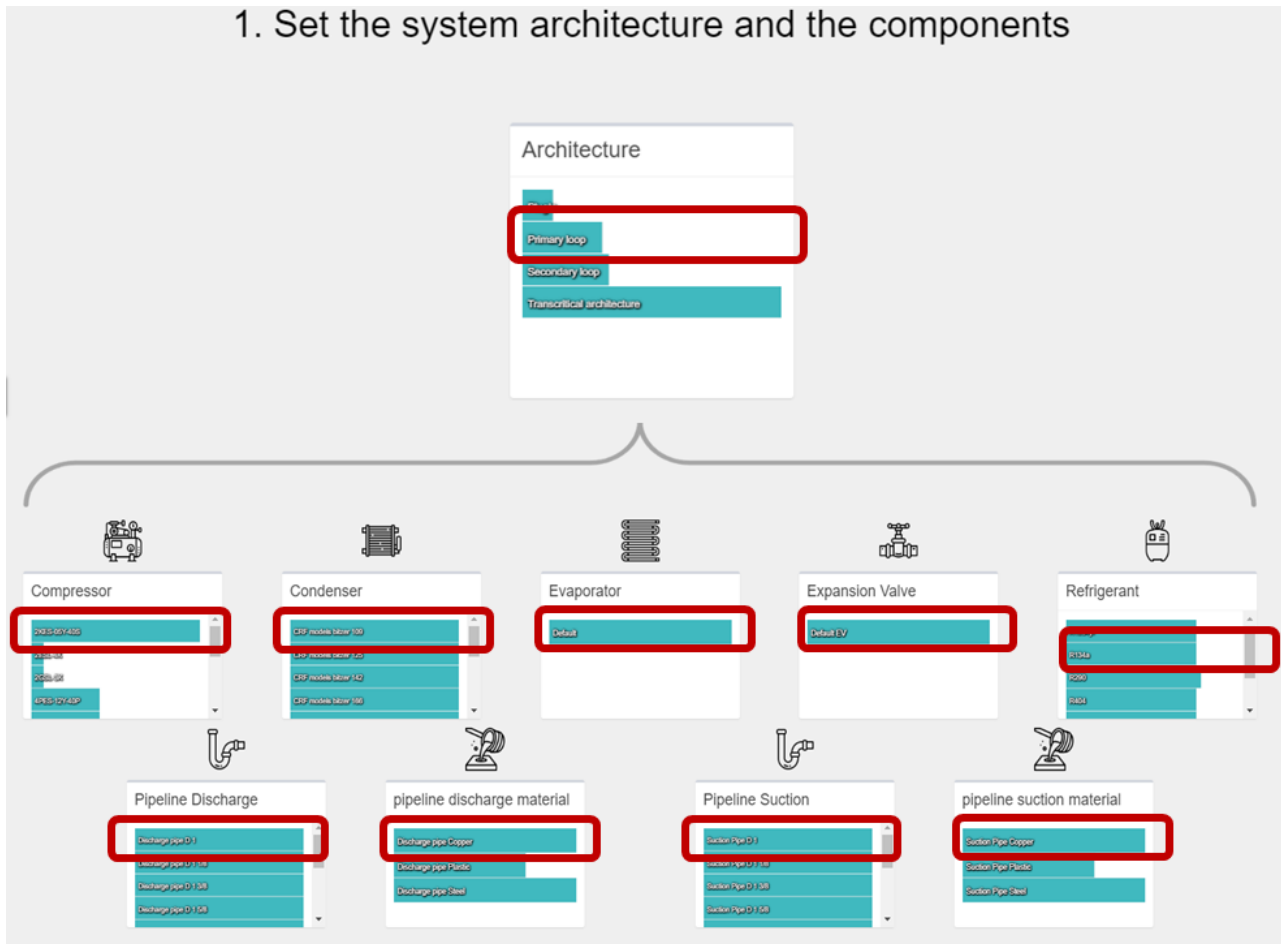

Figure 6-15. Selection of the components of the existing system

Once the components are selected, the supermarket manager has access to the performance space of his existing system. He has access to the global energy consumption, the environmental impacts, the total cost, the maintenance score and the technology maturity (obviously at maximum for an already existing system). He then selects the refrigerant change and can observe the changes in the performances. Figure 6-16 provides the comparison of the performances. It is interesting to note several points in the evolution of the global performances:

- The system's total cost increases by approximately 40% mostly due to the increase of the system energy consumption.
- The energy consumption increases by approximately 20%. This can be explained by the fact that only the type of refrigerant was changed in the simulation. The components already in place for the R404 refrigerant are not adequate for the new fluid with a different chemical composition and thus a different behaviour.
- The system's environmental impacts have a slight decrease because the R1234yf has a GWP of less than 1, compared to the R404 GWP of 3943. The difference could be greater if the system's energy consumption did not increase.
- There is a slight increase in the maintenance score because of the novelty of the R1234yf.

The significance of this difference must be discussed.

It is important to highlight the trade-off that faces the supermarket manager in this example. He can observe that the single refrigerant change can alter his system efficiency and increase the operational cost. However, the change decreases the system's environmental impacts and meets the coming regulation. To have more knowledge before making his decision, he can remove one or more constraints on one of the other components. For example, by removing the constraints on the compressor and condenser, new solutions are offered to him with better energy performances.

Before changes

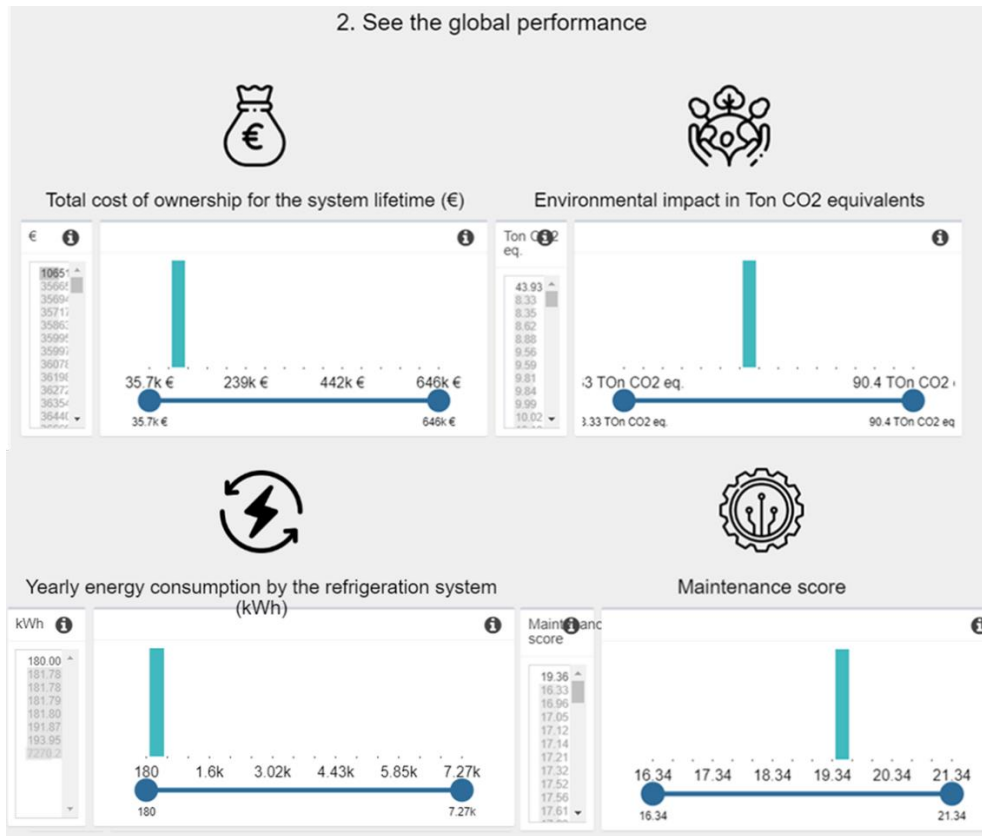

After changes

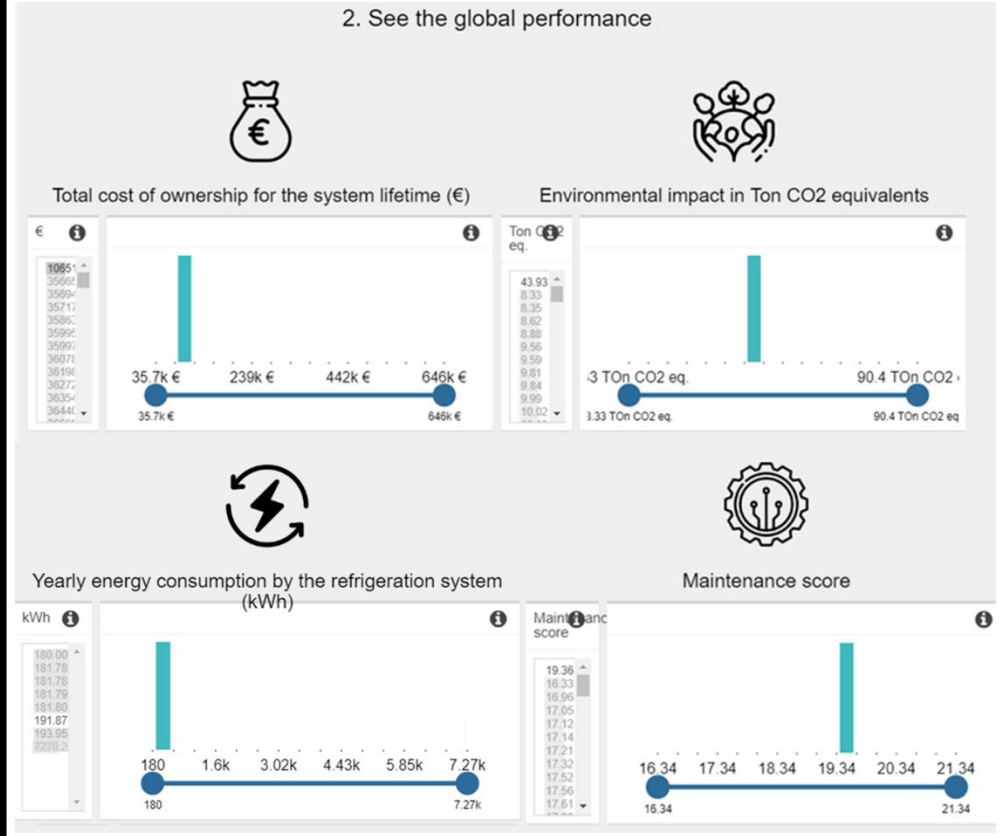

Figure 6-16. Comparison of the performances evolution before and after the change of refrigerant.

5.3. Exploring the design space: Scenario 2

For Scenario 2, the designer wants to find the best refrigeration system corresponding to his client's requirements. The client provides a constraint on the initial cost and wants to minimize the environmental impacts of his system. The goal for the platform is to provide the set of all the feasible solutions and the Pareto-optimal solutions.

To meet his objective of finding the best system composition, the designer explores the design space by interacting simultaneously with the performance space and the design space using tables, 1D intervals and 2D plots, as shown in Figure 6-17. The interval bounds are the minimum and maximum of the performance space. In these intervals, all the feasible solutions are displayed.

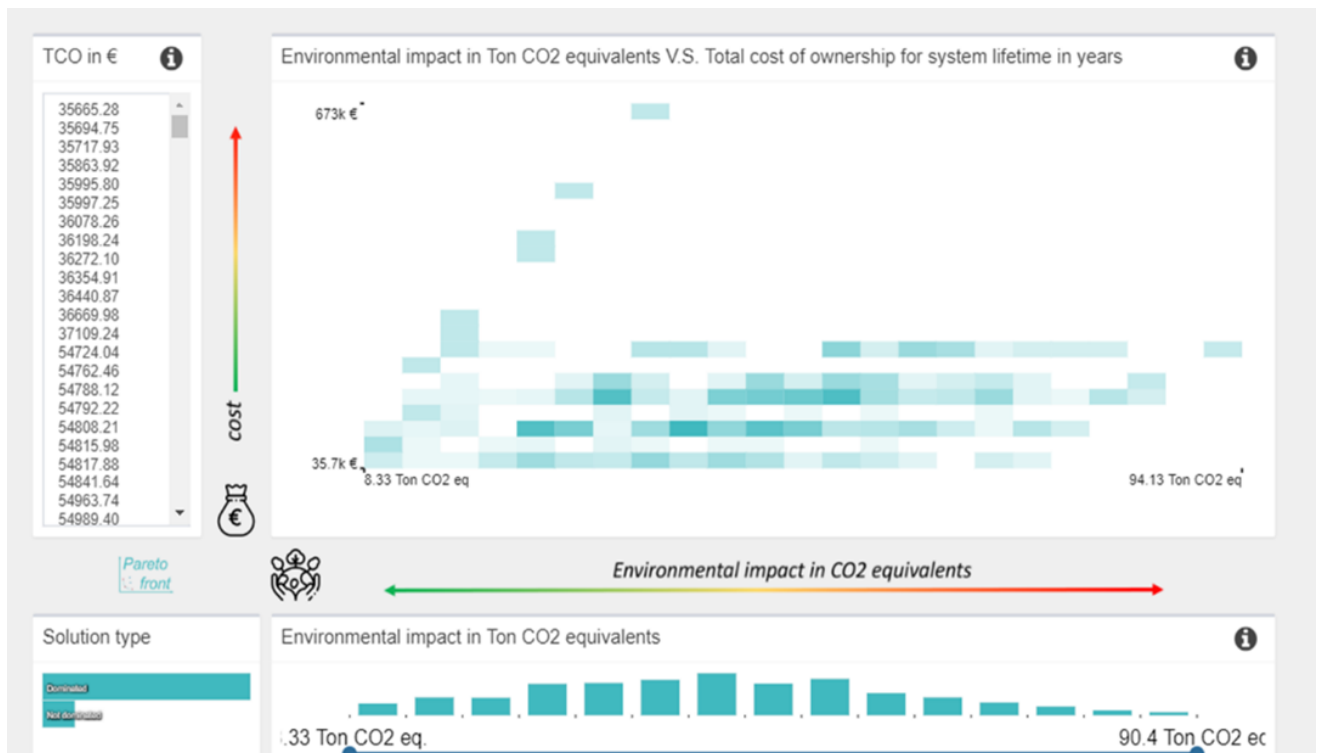

Figure 6-17. Pareto space displayed in the platform

First, the designer sets the cost constraints by selecting the maximum budget of the client in the table, or using the slider bar of the 1D interval to constraints the costs as shown in Figure 6-18.

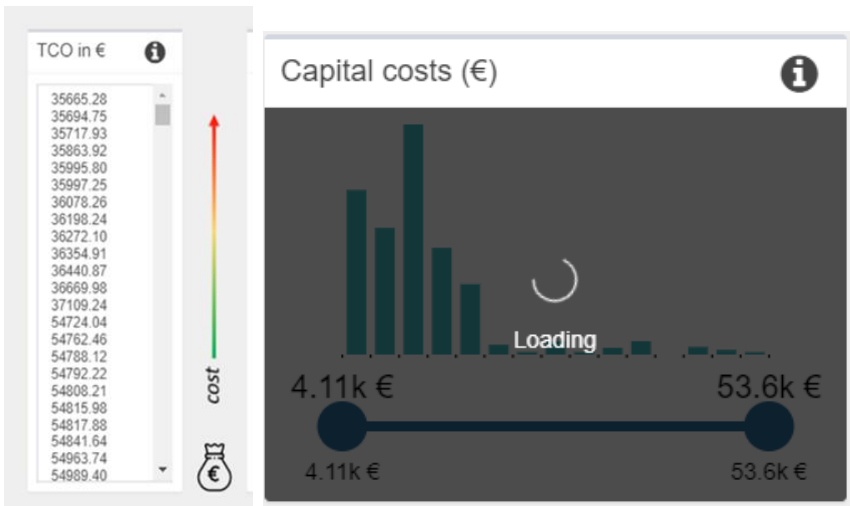

Figure 6-18. Cost table and 1D interval visualization and selection of constraints using either the table (left) or 1D slider (right)

Then, the designer can choose to minimize the environmental impacts by using the 1D interval sliders to minimize the environmental impacts as shown in Figure 6-19.

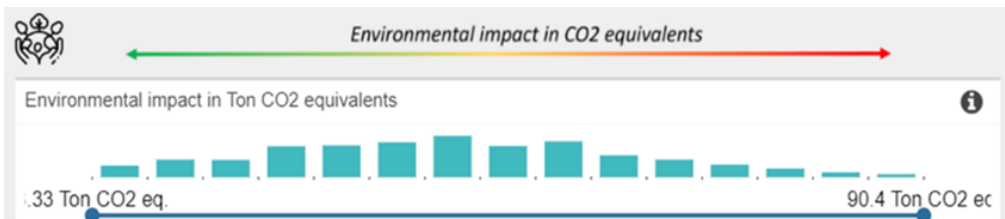

Figure 6-19. Environmental 1D interval visualization and selection of constraints

Once the performances are constrained, the designer can visualize all the feasible solutions set, as shown in Figure 6-20. He can choose to get only the Pareto-optimal solutions by selecting it on the interface, as shown in Figure 6-21.

Once the designer gets all the feasible solutions or the non-dominated solutions, he can “shop” in the design space and iterate different steps:

- He can select one architecture and observe the performances
- He can reduce the constraints to increase the space of possible solutions by playing with the sliders
- He can navigate iteratively in the performance space or the design space.
- To reduce the uncertainties, he can explore the other performances (energy performance, technological maturity, maintenance score) in Tab 3.

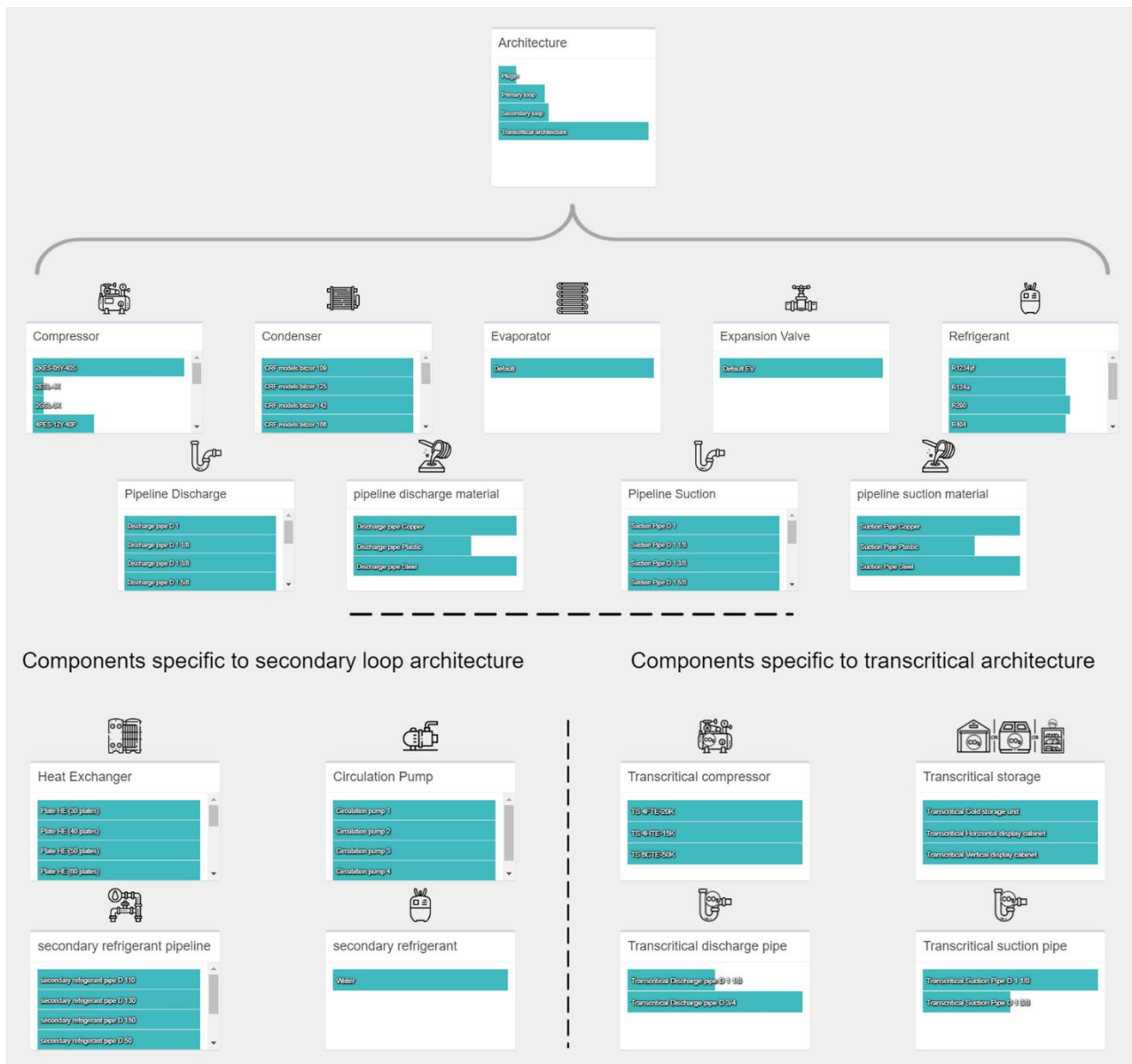

Figure 6-20. Visualization of all the feasible solutions



Figure 6-21. Selection of non-dominated solutions

6. Verification

The knowledge model described in Chapter 5 allows us to set the design problem in a clear framework. The platform's verification serves two purposes: to verify that the ontology corresponds to the domain's reality and to ensure that the proposed platform has been correctly implemented. Not to confuse with the validation of users' objectives. The verification is based on three criteria (Brank et al., 2005):

1. Minimum ontological commitment, i.e., fidelity of the domain representation to the actual knowledge of the domain: the completeness and correctness of the equations, the relevance of the architectures, the components, the data.
2. The appropriateness of the initial organization of the knowledge represented in the ontology,
3. The choice of relations.

The verification is done in two parts: (1) a step-by-step verification throughout the knowledge model construction and its implementation on the platform, (2) a global verification by comparing the results with a real case study to verify the accuracy of our mathematical models.

6.1. Step-by-step verification

A verification step-by-step was conducted throughout the whole process of knowledge model construction and its implementation with Geeglee supporting tool. Eight workshops of discussions with researchers or technicians from INRAE and the Geeglee development team were piloted to discuss:

- The definition of the concepts of the ontology, its intended use
- The platform used for the implementation of the ontology
- The content of the knowledge model, i.e., the classes, the relations, the equations, the variables, intermediary data and the implementation into the platform

The verification workshops consist of one or more hour sessions of discussions to collect feedbacks on the knowledge model and its implementation on the platform as illustrated in Figure 6-22.

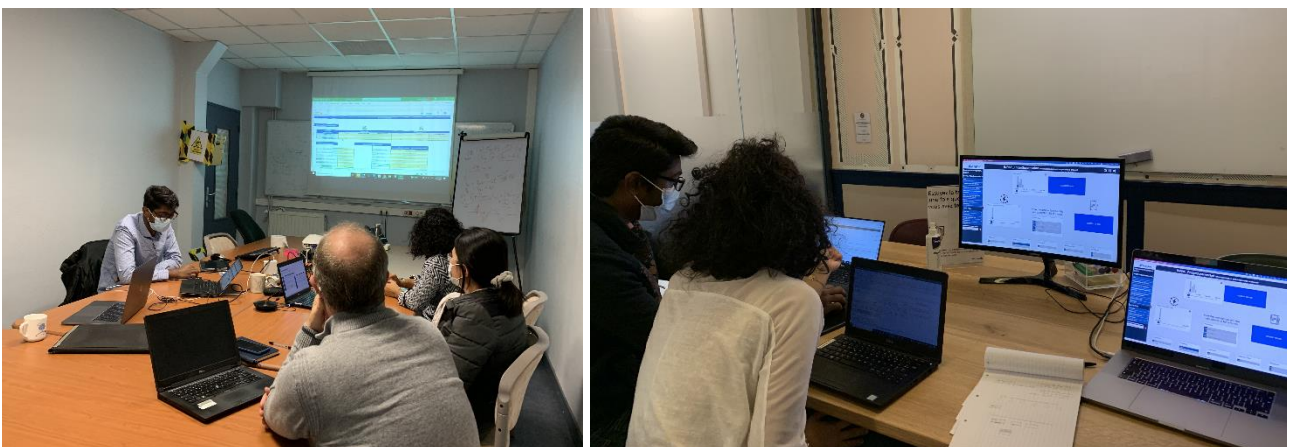

Figure 6-22. Workshops with INRAE experts for step-by-step verification

For the discussion, multiple questions were investigated, and the outcomes of the investigation are detailed in Table 7.

Table 7. Verification investigation: questions and outcomes of the workshops

What characteristics define the context of refrigeration system used?	Description of the intended use of a knowledge model, the scenario specification, the know-how of stakeholders for the design and simulation of refrigeration systems
Which components are necessary for designing a retail refrigeration system?	Description of the design process, the tools, the information exchanged, etc.
Does the proposed knowledge model satisfy the basic knowledge capitalization for the design and exploration of refrigeration systems decision space?	Discussion on the concepts, classes, relations, and the correctness of mathematical models
Does the ontology describe the reality of the domain?	Describe a refrigeration system as it is in reality Describe the real performances of a system Describe the whole life cycle of a refrigeration system

6.2. Verification by application

The objective of the first verification is to evaluate the first criteria, which is the fidelity of the knowledge model to the actual knowledge of the domain: the completeness, the correctness of the equations, the relevance of the architectures, the components, and the data.

To verify if the physics-based models, the system architecture model (components modelling and their interaction) and the problem modelling (intermediary variables) are well implemented in the platform, we simulate the *global performance: energy consumption* of a refrigeration system, for food conservation only, of a supermarket located in the Ile-de-France department. We verify the correctness of this global performance, thus ensuring that the equations, architecture, and local performance related to the energy consumption are all correct.

The data are taken from our main case study based on the ADEME report (ADEME and Enertech, 2001) presented in section 5.1 and the appendix. The energy consumption data in the report are collected thanks to different sets of sensors. As the data reported are from 2010, the refrigerant regulation from 2010 is applied, thus using R134 and 404 as *refrigerants*. The technological components of the solution are adapted from the alternatives implemented in the platform.

To verify the correctness of our model, the system structure should be the same or as close as possible to the real system in place. The *system architectures* for both temperature and the three

types of conservation (horizontal, vertical display cabinets and cold room) are *primary direct expansion* architecture. As the type of compressor were not available, we only focused on the compressor power to establish the technological modules.

The comparison of the results obtained with the model and the data from the ADEME case study are shown in Table 8. The yearly consumption calculated with the model is 252,696.3 kWh. The data from the real case study is approximately 291,600 kWh per year. The calculated yearly consumption is lower than the reference case study by 12 %, which is acceptable considering different factors impact the result. The difference in monthly consumption shown in the table can be explained mainly by the weather data in the model and that of 2010. Indeed, according to Meteo-France data, in 2010, the temperature in Paris varied between -1°C in December and 36°C in July so that the consumption data can go up to 700 kWh for the hottest months. The data taken into account in the model are average data that vary over the year between 2.7°C and 25.2°C, so the highest data is 650 kWh.

Other factors can explain the differences:

- The simplification hypothesis for the food conservation (mass, type of food, type of cold room and display cabinets);
- The technological modules chosen for the tests are newly developed technologies and the energy consumption has been well optimized in the last decade;
- The general hypothesis on the supermarket specifications (number of employees, opening hours, constant temperature in the store, the humidity level, etc.)
- The simplified parameters for the dimensioning of the evaporator and heat exchanger.

Comparing the energy consumption between the simulation and the data from the report allows us to verify the correctness of our mathematical models. The results were also shown to several people from an installation company to ensure that the difference was acceptable.

It is necessary to emphasize that we verify the accuracy of our model by calculating a single overall performance. Indeed, the environmental impacts are verified by comparing different architectures. The costs and maintenance scores attributed to the different architectures and components are discussed and the assumptions made are verified with a group of industrial actors.

Table 8. Results of the total energy consumption in kWh calculated with our model and the data from the case study (last column)

	MODEL RESULTS (KWH)				ADEME STUDY (KWH)	CASE RESULTS
	Day	Night	Daily	Monthly	Monthly	
JANUARY	24.2	22.0	554.4	18016.9	Between 400 kWh/ day in winter and 790 kWh/ day in summer	
FEBRUARY	24.8	22.0	561.4	18415.1		
MARCH	26.6	23.3	598.8	19802.7		
APRIL	28.2	24.3	629.6	20982.9		
MAY	30.0	26.0	672.3	22337.4		
JUNE	31.4	27.4	705.2	23362.8		
JULY	32.5	28.3	729.5	24174.8		
AUGUST	32.4	28.2	727.9	24110.3		
SEPTEMBER	30.7	26.9	690.6	22836.2		
OCTOBER	28.5	25.4	646.8	21222.6		
NOVEMBER	26.0	23.5	593.8	19308.8		
DECEMBER	24.4	22.3	560.4	18125.8		
TOTAL YEARLY	339.6	299.6	7670.6	252696.3	291600	

7. Discussion and limitations

The proposed design and exploration platform answers our third research gap, i.e. the lack of user integration in the design process. We propose a digital tool to support the decision process addressed to different stakeholders. Indeed, the simple visualisation of the results provides a quick understanding of the challenges.

Two scenarios corresponding to two design activities are presented to explain the design space exploration strategy implemented in the platform. The tool serves different purposes. First, it can simulate the performances of a refrigeration system for commercial refrigeration. Secondly, it can provide design solutions and allow users to interact simultaneously between performances and solutions spaces. The user can thus navigate easily to discover one optimal solution that corresponds to his expectations, as explained in the "design by shopping" paradigm.

An integrated approach is implemented in the platform, based on the knowledge model proposed in Chapter 5. Five criteria corresponding to the five global performances are modelled and can help the user reduce the design space toward one solution.

This platform has shown the feasibility and interest of developing a platform for the design space exploration of refrigeration systems. It allows users to explore different scenarios for reducing energy performances simultaneously with the environmental impacts or reducing only the costs.

Some limitations of this study can be discussed.

- First, one performance has been calculated and compared to a real use case, the modelling of the other performances was discussed with industrials to check only if the assumptions made are correct. It would be interesting to obtain other data and compare the results obtained with the simulation.
- The second possible limitation is the visualization of the results that can be too primary to make a final decision. Information can be lost with a simple 1D interval representation.
- The design space and the optimal solution is limited to our choice of components implemented in the platform. For better platform usage, the model should be extended to add more alternatives, types of components, and more precise components characteristics.

8. Conclusion

The knowledge model is implemented in a design and exploration platform supported by Geeglee computer-aided design tool. Because of the support tool structure that fits well to the structure of the proposed knowledge model, the choice to use such a support tool is justified.

The verification of the knowledge model consists of two steps:

- A part-by-part verification, i.e., verification of the implementation of the platform by testing the implementation step-by-step to verify the correctness of the chosen architecture implemented, the technical components, their specifications, the equations of each local performance. At least two different persons make this verification.

- A verification of a global performance: energy consumption, to ensure the completeness and correctness of the knowledge model implemented in the platform by an application of a case study. The verification serves to prove that the model matches the performances of a real case study. The difference in the results between the model and the reference case study are discussed with experts to assess whether the model is considered correct despite the 12% difference.

Moreover, two conference papers allowed us to present the results and to compare our models on energy consumption and the environmental impacts of the solutions.

Two scenarios are shown as usage examples of the platform. It is now necessary to validate the approach proposed. Indeed, the interest and usage of the platform must meet the objectives of the domain's actors. They each have specific knowledge, and our platform must prove its robustness when confronted with industrial activities.

In the next Chapter, the platform is validated by evaluating eight criteria through two validation sessions with two panels of actors from industry and research.

References

- Abi Akle, A., Yannou, B., Minel, S., 2019. Information visualisation for efficient knowledge discovery and informed decision in design by shopping. *Journal of Engineering Design*.
- ADEME, Enertech, 2001. Diagnostic électrique d'un supermarché de moyenne surface.
- Balling, R., 1999. Design by shopping: A new paradigm, in: *Proceedings of the Third World Congress of Structural and Multidisciplinary Optimization (WCSMO-3)*. University at Buffalo, Buffalo, NY, pp. 295–297.
- Brank, J., Grobelnik, M., Mladenic, D., 2005. A survey of ontology evaluation techniques, in: *Proceedings of the Conference on Data Mining and Data Warehouses (SiKDD 2005)*. Citeseer Ljubljana, Slovenia.
- Devanathan, S., Ramani, K., 2010. Creating Polytope Representation of Design Spaces for Visual Exploration Using Consistency Technique. *Journal of Mechanical Design - J MECH DESIGN* 132. <https://doi.org/10.1115/1.4001528>
- du Manoir Geoffroy, le C., Shruthi, S., Yan, Z., Mingze, M., 2019. Architecture and design definition processes: Return of experiment about complementary MBSE tools to model consistent architecture layers and to support design trade-offs through a set based concurrent engineering approach, in: *2019 International Symposium on Systems Engineering (ISSE)*. pp. 1–7. <https://doi.org/10.1109/ISSE46696.2019.8984581>
- Eriksson, L., Johansson, E., Kettaneh-Wold, N., Wikström, C., Wold, S., 2000. *Design of experiments. Principles and Applications*, Learn ways AB, Stockholm.
- Holley, V., 2011. A method to envision highly constrained architectural zones in the design of multi-physics systems in severe conditions. Ecole Centrale Paris.
- Kang, E., Jackson, E., Schulte, W., 2010. An approach for effective design space exploration, in: *Monterey Workshop*. Springer, pp. 33–54.
- Kumar, V., 1992. Algorithms for constraint-satisfaction problems: A survey. *AI magazine* 13, 32–32.
- Ligetti, C., Simpson, T.W., Frecker, M., Barton, R.R., Stump, G., 2003. Assessing the impact of graphical design interfaces on design efficiency and effectiveness. *J. Comput. Inf. Sci. Eng.* 3, 144–154.
- Neema, S., Sztipanovits, J., Karsai, G., Butts, K., 2003. Constraint-based design-space exploration and model synthesis, in: *International Workshop on Embedded Software*. Springer, pp. 290–305.
- Phan, L.L., Holley, V., Diez, H., 2018. Optimal architectures for a Mars helicopter drone: exploring the design space with Geeglee. Presented at the 69th International Astronautical Congress (IAC), Bremen, Germany.
- Rossi, F., Van Beek, P., Walsh, T., 2006. *Handbook of constraint programming*. Elsevier.
- Scaravetti, D., Nadeau, J.-P., Pailhes, J., Sebastian, P., 2005. Structuring of embodiment design problem based on the product lifecycle. *International Journal of Product Development* 2, 47–70. <https://doi.org/10.1504/IJPD.2005.006668>
- Scaravetti, D., Sebastian, P., 2009. Design space exploration in embodiment design: an application to the design of aircraft air conditioners. *International Journal of Product Development* 9, 292–307.
- Siemens, 2014. HEEDS MDO.
- Stump, G., Yukish, M., Martin, J., Simpson, T., 2004. The ARL Trade Space Visualizer: An Engineering Decision-Making Tool, in: *10th AIAA/ISSMO Multidisciplinary Analysis and Optimization Conference, Multidisciplinary Analysis Optimization Conferences*. American Institute of Aeronautics and Astronautics. <https://doi.org/10.2514/6.2004-4568>

- Tweedie, L., Spence, R., Dawkes, H., Su, H., 1996. Externalising abstract mathematical models, in: Proceedings of the SIGCHI Conference on Human Factors in Computing Systems. p. 406-ff.
- Yannou, B., Harmel, G., 2005. Use of Constraint Programming for Design, in: Advances in Design. ElMaraghy H. , ElMaraghy W. Editors, Springer-Verlag: London, Chapter 12, pp. 145–157. https://doi.org/10.1007/1-84628-210-1_12

Chapter 7: Validation of the knowledge model by scenarios and by experts

This chapter presents the evaluation process of our two design artefacts: the knowledge model and the design space exploration platform. First, the validation framework and the criteria are chosen based on relevant literature. Then, the experimental protocol is displayed. Scenario-based validation of the knowledge model and the proposed platform are conducted with different stakeholders. The results of the validation session are discussed, and the proposed design artefacts are evaluated.

1. Introduction

To answer our second research question on how to support the decision process for refrigeration systems in the early design stages, we proposed developing a knowledge model (Chapter 5) and a design space exploration platform (Chapter 6).

The chapter is divided into six sections. The first introduces the objective of this chapter and its position in this dissertation. Section 2 provides the validation framework, discussed with the appropriate literature review. In the third section, the experimental protocol of the validation session is detailed. The results are presented in Section 4. The validation results and the answers to our research objective are discussed in Section 5. Two main outcomes are discussed based on the work of (Silva and Winckler, 2017): (1) technical validation, (2) usefulness validation of the proposed artefacts.

The proposed research outcomes in this Ph.D. thesis need to be assessed with a proper framework (Pries-Heje et al., 2008). Thus, this chapter aims to evaluate the proposed knowledge model and design platform through analysis and empirical study using eight criteria. The final goal of the chapter is to validate the utility, quality, and originality of our design artefacts. We use a descriptive evaluation to fulfil our objective by developing appropriate scenarios that validate the criteria (Hevner et al., 2004).

Figure 7-1 shows the positioning of the chapter in relation to the others.

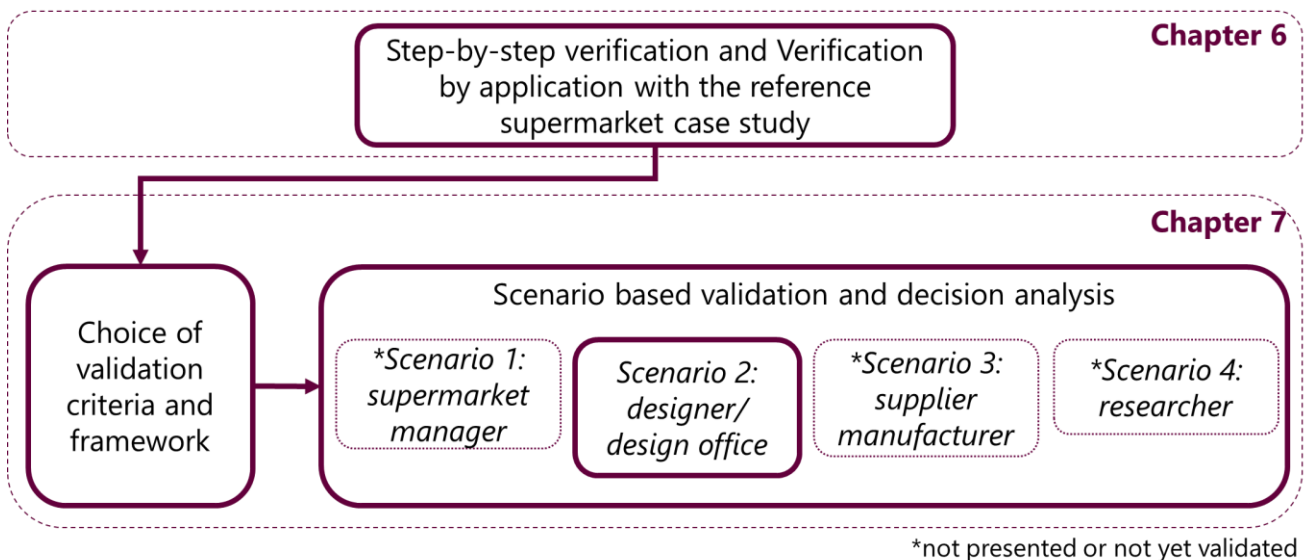

Figure 7-1. Positioning of the chapter in the thesis

2. Validation methodology

2.1. Description of the methodology

The importance of a relevant validation framework is highlighted in many works in design science (Hevner et al., 2004; Peffers et al., 2012; Rosson and Carroll, 2002; Sonnenberg and vom Brocke, 2012), where different types of design artefacts can be identified:

- Constructs are set of concepts that form a domain based on statements, other concepts... (Cleven et al., 2009)
- Models are "simplified representation of reality documented using a formal notation or language." (Peppers et al., 2012)
- Methods are logical and conceptual steps to perform an activity.
- Instantiations are concrete realisations of the other artefacts through implementing a hardware or software or part thereof.
- Frameworks are meta-models.
- Theories are cause-effect relationships observation (Cleven et al., 2009; Venable, 2006)

In the present work, two design artefacts are proposed. First, a knowledge model (or ontology) was developed and second, a design space exploration platform, i.e. an instantiation of the model, was implemented. A strategy must be developed to evaluate our design artefacts. This involves the choice of appropriate evaluation criteria. Moreover, a proper evaluation framework should be developed, with users' choice, the experimental protocol and the interpretation of the results.

To assess the relevance of a design artefact, one must assess the different artefact's dimensions. Prat et al. (2014) propose a synthesis of the system dimensions to evaluate the associated criteria and sub-criteria shown in Figure 7-2. For each of the dimensions, the criteria proposed in the literature help to answer a more general question:

- Goal: Does the artefact meet the intended purpose?
- Environment: Is the artefact consistent with its environment?
- Structure: Is the artefact's structure (technical aspect) valid (complete, clear...)?
- Activity: Is the artefact functional (activity aspect)?
- Evolution: Does the artefact adapt to its environment?

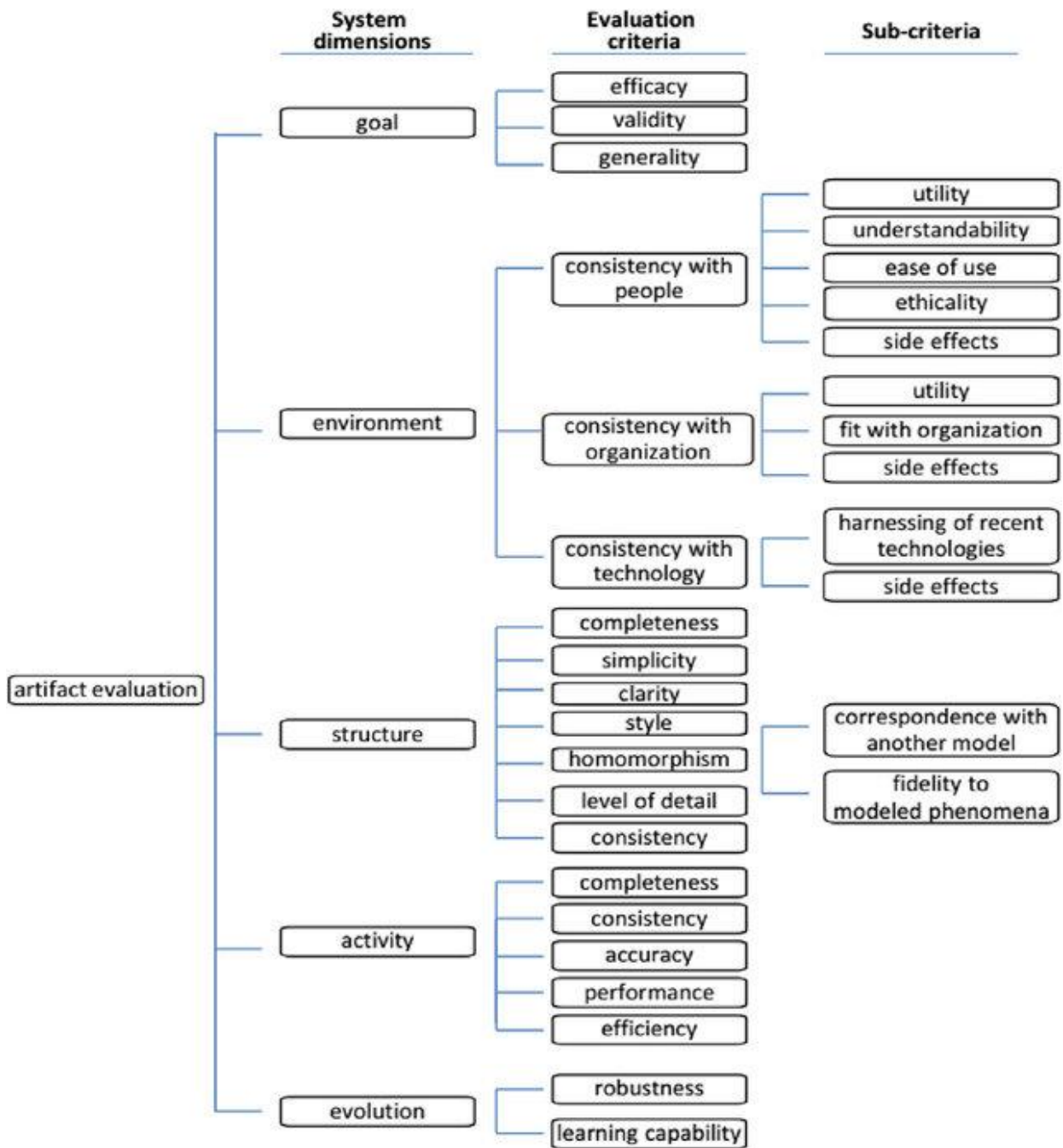

Figure 7-2. Hierarchy of criteria for design artefact evaluation from (Prat et al., 2014).

The literature presented above allowed a validation framework based on eight criteria associated with the five dimensions. Their definitions are presented in Table 7-1.

Table 7-1. Criteria and their definition for our validation strategy

Dimension	Criteria	Definition
Goal	Efficacy	The ability for the platform to produce a result: <i>Does the platform work?</i>
	Validity	The credibility of the usage: Are the usage scenarios relevant and corresponding to real design problems that the user meets?
Environment	Ease of use	The user autonomy when using the platform: <i>Is the platform comprehensible?</i>
Structure	Completeness (technical)	The degree at which the platform covers all the appropriate aspects of the problem: Is the detail level sufficient and are all the aspects of the design problem considered?
	Consistency	The repeatability of the results: Do the results vary if the inputs are the same?
Activity	Completeness (Decision aid support function)	The degree to which the platform supports the decision process: <i>To what extent does the platform support decision making?</i>
	Completeness (Integrated approach)	The degree to which the platform gives a holistic view of the problem: Does the proposed artefacts (ontology and platform) enrich the user understanding of the design process?
Evolution	Robustness	The response of the platform to changes in the environment: <i>Are the results relevant if the inputs vary?</i>

Three types of evaluation (Cleven et al., 2009; Hevner et al., 2004) are used in our validation procedure. The first category of evaluation is achieved through observations. It comprises observation of the testers' behaviour and post-session comparison of the results, i.e., design solutions obtained during the session. The second category of evaluation is quantitative measurement post-session using a questionnaire and measuring the responses on a scale from 0 (disagree entirely / absolutely not) to 5 (agree entirely / absolutely). The third category of evaluation is qualitative analysis post-session of the discussion and written feedback. For each criterion, one, two or three evaluations are proposed, as summarized in Table 7-2.

Table 7-2. Criteria and the associated evaluation category and tool.

Criteria	Evaluation category	Evaluation tool
Efficacy	Observations	Observation of the design space result. We consider the platform efficacy if a result is provided (0, 1 or more design solutions obtained)
Validity	Quantitative measurement	Response to a questionnaire and measurement on a scale of 0 to 5
Ease of use	Observation Quantitative measurement	Measurement of the frequency of solicitation through the autonomous testing and after the tutorial Response to a questionnaire and measurement on a scale of 0 to 5
Completeness (technical)	Quantitative measurement	Comparison of the performances results with a real case study
Consistency	Observation	Different users explore the same design space and the tests results are collected and compared
Completeness (Decision aid support function)	Observation Qualitative analysis of verbatim Quantitative measurement	Observation of the decision process logic Written feedbacks (verbatim) analysis and discussion Response to a questionnaire and measurement on a scale of 0 to 5
Completeness (Integrated approach)	Qualitative analysis of verbatim	Written feedbacks (verbatim) analysis and discussion Comparison with existing refrigeration systems design platform
Robustness	Observation	User explores the design space of different scenarios and the test results are collected and compared

We have proposed a set of criteria and forms of evaluation for our validation process. The participants of the validation process are now discussed.

2.2. Target participants

To target the participants, we distinguish four general baseline scenarios or user stories (Cohn, 2004) that correspond to the activity description of four different stakeholders. As described in the industrial diagnosis chapter, many actors are involved in the design process of a refrigeration system. Some of the experts interviewed during the diagnosis are the targeted testers of the proposed approach. Table 7-3 summarizes the four stakeholders with their associated tasks. Each of them has of course, its own knowledge of the domain (minimum, medium or expert knowledge). The testers involved in the validation process were not part of the ontology construction nor the design space exploration platform.

Table 7-3. Table of target users and their activity

Stakeholder	Task
Supermarket manager	Simulate a different technical module's alternative of an existing system: observe the impacts on the performances of the system and make a decision based on the results.
Designer/Design office	Design a new refrigeration system from a client's request: find the best system structure by making a trade-off between different performances and in respect of the client's requirements.
Supplier/Manufacturer	Evaluate how the addition of a new component in the design space will impact all the performances of a refrigeration system: assess the potential of a technical module.
Researcher	Evaluate the potential of a new promising technology: identify the most influential parameters on the global performances in an industrial use case.

To illustrate the approach, we present the case of a designer commissioned by the supermarket manager. The script for the experimental protocol is based on the task of a designer to find the best solution for a design problem given by a supermarket manager.

3. Description of the experimental protocol

Two validation sessions with the same scenario were held with different types of actors. The validation sessions lasted around 2:30 hours, and they are divided into three parts (Figure 7-3).

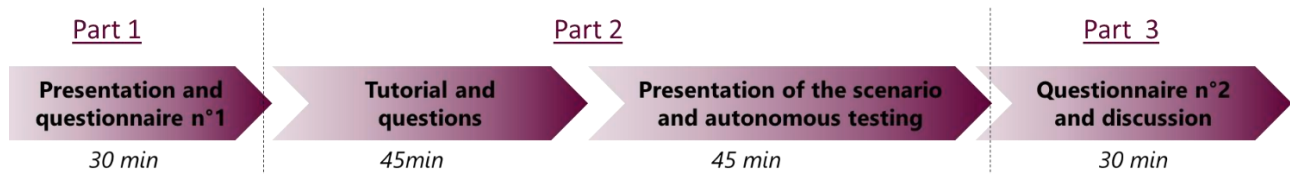

Figure 7-3. Timeline of the validation session

The first part consists in introducing the session. A presentation is made on the objectives of the validation, the concepts, and the tool. A first questionnaire is provided to evaluate the relevance of the testers. They are asked about their current position, their training, if they have ever participated in the design of a refrigeration system, their level of knowledge about computer-aided design (CAD) tools and refrigeration, and how they perceive the use of CAD tools, i.e. the usefulness of such tools.

The second part consists of a test session of the platform. Before leaving the testers in complete autonomy, a tutorial of the platform is explained with the two usage examples presented in Chapter 6, i.e. a supermarket manager wants to observe the evolution of the performance if he changes the refrigerant of his existing system and a designer wants to find the best refrigeration system solution for his client's objectives. With the demonstration of the platform, the **efficacy**, **validity** and **completeness** (technical) are discussed. Once the testers have understood how the platform works, an application is provided. The application specifications are based on our main case study presented in the verification section of Chapter 6 and reminded in Figure 7-4. The context and constraints are fictive. The testers are provided with the script of the scenario. As described in the knowledge model, a scenario is composed of a user, its objective(s) and a system environment. The testers put themselves in the shoes of a refrigeration system designer. They receive a simplified specification with the commercial refrigeration needs of a supermarket, and the regulation for refrigerant is supposed to be the same as in the report (HFCs are still available). Figure 7-4 shows the simplified scenario/script given to the testers. During the session, the testers' behaviour is observed to evaluate the **ease of use** by measuring the frequency of solicitations. Observing the decision process logic, with and without the client's constraints, serves as a form of evaluation for **completeness** (decision-aid support function). After the validation sessions, the design solutions obtained through the different tests are compared to evaluate the **consistency**.

Script

1

Context

You're a designer, the manager of a supermarket need to install a refrigeration system from scratch for his newly implented supermarket.

2

Specifications

<p><u>Supermarket specifications:</u> Area: 2000 m² Location: Ile de France Opening hours: from 8am to 8pm Working hours: from 5am to 9pm</p> <p>Rooftop accessible and secured Large space outside</p>	<p><u>Food storage need:</u> <u>Rerigerated food:</u> Set point temperature: 0°C and 2°C 25 display cabinets (vertical and horizontal)</p> <p><u>Frozen food:</u> Set point temperature: -20°C and -18°C 8 display cabinets (vertical and horizontal) 1 cold room of 25 m²</p>
---	---

3

Constraints

Initial budget: 100 k€
 Lowest environmental impacts because of the supermarket ecological mindset
 Schedule: 1 year

Figure 7-4. Simplified script given to the testers

The third part consists of filling a post-questionnaire and collecting feedback through written answers and discussion with the participants. It allows the artefacts' **completeness (integrated approach)** and **robustness** to be evaluated.

4. Results

4.1. Participants

In the validation sessions, four participants were present. They belong to the same refrigeration system design and supply company. It is a medium company specialized in the design, installation, maintenance and life cycle management of refrigeration systems. The company field of activity is commercial refrigeration, industrial refrigeration and air conditioning. The participants have different experiences in the refrigeration domain, and they all have a specific mission within the company. The four participants are a project manager more involved in client relation and design, a project manager more involved in the installation and life cycle management of the machines, a technician manager and the company CEO.

4.2. Analysis of the "autonomous" testing

After presenting the use case to the testers, they are expected to find a design solution for the supermarket manager with the support of the platform. They identified the system environment and

the client's constraints in the script. The first step for each group was to set the client's specifications in the platform, as shown in Chapter 6. Then, participants were autonomous on the whole decision process.

Once the environment is set up, participants have access to the design space comprising all feasible solutions. During the first exploration of the design space, the participants do not have access to the 2D line plot with the Pareto space (See Chapter 6). They can only crop the design space one constraint at a time in an imposed sequence.

In this first step-by-step approach, they all followed the same decision process. The first constraint applied to the decision space is the client's maximum budget. From approximately 30,000 initial solutions (without budget constraint), the design space is reduced to 8,700 solutions for all the tests (with budget constraint). Once the design space is cropped, all participants applied a second action to minimize the environmental impacts by moving the slider related to environmental impacts. However, different behaviours are observed among the participants: they can move the slider completely to the minimum, reduce the environmental impacts by half, or reduce the slider slightly as presented in Figure 7-5.

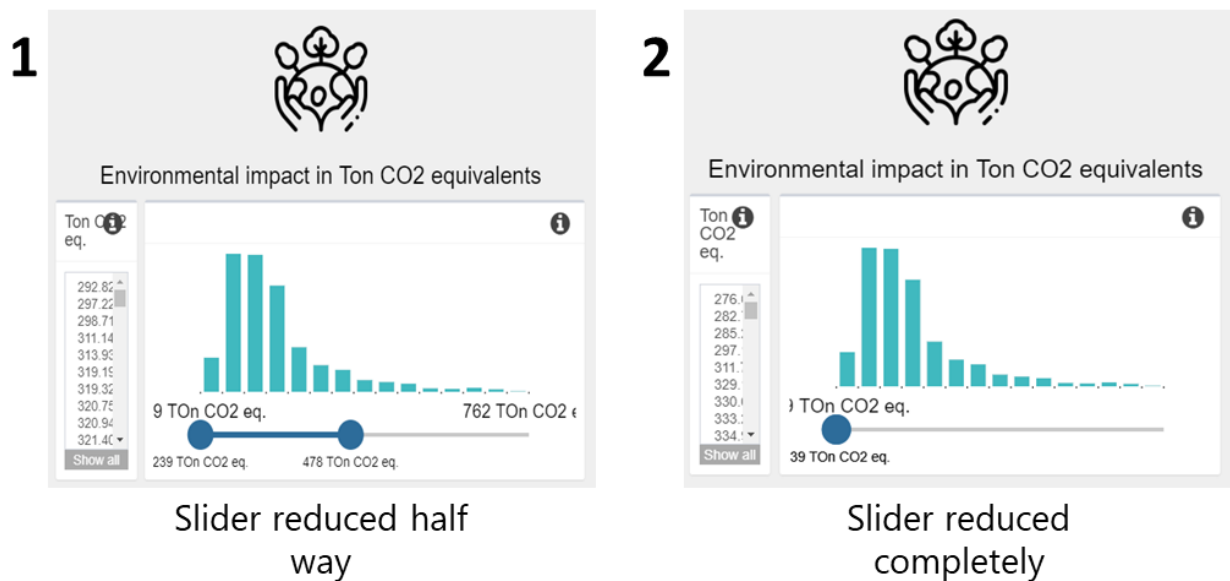

Figure 7-5. Environmental impacts reduction using the sliders

Then, a first assessment of the possible solutions is observed. Depending on the reduction of the environmental impacts' interval, the size of the design space varies between 8,700 and 2,200 solutions. A first design space is assessed in a few minutes for each participant. They can either choose a design solution based on the first results or choose to reiterate the filtering actions.

For the second part of the testing, the users have access to the Pareto space (see Chapter 6).

All of them chose to continue exploring before making a decision mostly because of the rapidity to simulate the design space and to see how other constraints on the criteria can change the solution. This action of reiteration and observation allows the participants to investigate the problem. Moreover, they have the possibility on the design space exploration platform to obtain Pareto

optimal solutions on the two criteria: economic and environmental. By selecting the filter to display only non-dominated solutions, the design space is cropped from 30,000 initial possibilities to 366 solutions. From the qualitative data collected during the sessions, the participants found the provided option "*useful*" and "*facilitating the decision*".

Once the solutions are displayed on the platform, each participant's knowledge and experience of refrigeration systems is what makes them choose a solution. For example, one participant excludes plug-in systems from the solution mostly due to a lack of knowledge of the system. One participant was interested in a particular refrigerant: he chose the alternative R290 and observed the other performances of the system; then, he decided that this refrigerant was not interesting and opted for another option.

Two solutions are found in the first approach. One participant made three filtering actions on first the cost, then two distinct ones on the environmental impacts before finding a solution: secondary architecture using R717 as a primary fluid.

The other participant found a design solution based on the Pareto space provided. No other constraints were made, and they both obtained the same design solution: a transcritical booster.

After this stage, they were asked if the found solution among the proposed alternatives satisfied them. For two of the three participants, the solution satisfies the requirement. The unsatisfied participant is the one who took the decision by constraining to the minimum the environmental impacts. Indeed, the design solutions were only two and the participant chose a solution by default among the two.

A second part during the autonomous testing was proposed to the participants. The constraints from the clients are "removed", and we observed the logic for reducing uncertainty, particularly the decision-making logic (Aspers, 2018). One important observation is the diversity of the strategies. Indeed, four different scenarios are witnessed on four participants, as presented in Table 7-4. It was asked for the participants not to communicate with each other and choose how to crop the design space. For the users with the higher responsibilities in the company, the most important criterion is the maturity of the technology developed. This is explained according to the participants by the significant risk that can be taken in developing a low TRL technology. During the discussion, participants reached a consensus on economic criteria: total cost is an important factor in decision-making. However, access to results on the environmental performance of the systems could be an additional argument in case of hesitation on a set of solutions. Another interesting point observed during the test is participant 4, who is closer to the technicians and for whom maintenance is the most important criterion for choosing the design solution. In fact, his thought process focused on the ease of operation during the installation and operation of the system.

Table 7-4. Performances order of decision for design space reduction depending on the participants (industrial stakeholders)

Reduction order	Participant 1	Participant 2	Participant 3	Participant 4
1	Technological maturity	Technological maturity	Total cost	Maintenance score
2	Total cost	Environmental impacts	Energy consumption	Total Cost
3	Environmental impacts	Total cost	Technological maturity	Energy consumption
4	Energy consumption	Energy consumption	Environmental impacts	Environmental impacts
5	Maintenance score	Maintenance score	Maintenance score	Technological maturity

The results obtained for the four scenarios of cropping the design space are presented in Table 7-5. It is interesting to observe that without particular constraints, the results depend on the user background. Our platform allows designers from different backgrounds to intuitively apply their successive filters in the order that suits them (design by shopping) to arrive at their preferred solution(s).

The first solution found by participant 1 corresponds to the system implemented in the case study system. The energy consumption is of 252,696.3 kWh. These results are in line with placing technological maturity as the first criterion. Indeed, direct expansion systems are very common and well known in the industry.

Secondly, the two proposed solutions correspond to the requirements of the participants. The energy consumption of the secondary loop system (participant 2) is of 252,696.3 kWh and the costs is approximately 10% more than the direct expansion system. However, the environmental impacts are reduced by 15%. The participant made a trade-off between cost and environmental impacts to choose this solution.

The third system (participant 3) achieves approximately the same energy consumption performance as the first participant, as it uses a direct expansion system. Moreover, in the model the installation cost depends mainly on the architecture, so the costs vary only because of the difference in the refrigerant. The two participants were offered with the same set of solutions and they did not choose the same result as they each have their own experience.

Finally, the cost of the transcritical system (participant 4) is also more expensive than the direct

expansion system, mainly because of the higher energy consumption of this system, but the environmental impacts are reduced.

Table 7-5. Design solutions obtained with the different uncertainty reduction

	Participant 1	Participant 2	Participant 3	Participant 4
Design solution	Direct expansion system using R404	Secondary loop using R717 in the primary loop	Direct expansion using R1234yf	Transcritical booster

The result of the autonomous testing allowed us to provide a recommendation of usage of the artefacts. Remember that the knowledge model provides a formal representation of the design problem. Then it is implemented in a design and simulation platform. Because of the data and the availability of the testers for commercial refrigeration, we proposed a use case on the design of a supermarket refrigeration system. We recommend using the platform as follows:

- First, the design problem should be clearly defined following the established knowledge model.
- Then, the user can enter the system environment before generating the design space, as was done in our case to facilitate the computation.
- Finally, the design space exploration can be done in several ways: either by navigating iteratively between the performance and solution spaces to reduce uncertainties or by visualizing the criteria two by two as it was done for the environmental impacts and the cost. In the latter case, the non-dominated solutions can better understand the problem, as shown in our evaluation process.

We have analysed the concrete results and the design solution obtained for the participants. In the next section, we provide the results of the evaluation criteria.

4.3. Evaluation of the criteria

In this section, the evaluation of the knowledge model and the design platform based on the eight criteria is discussed.

4.3.1. Efficacy

The efficacy is evaluated by observing if the platform provides a result at every use of the platform. The platform displayed a result at each test for all the validation sessions. Indeed, zero, one or more design solutions are provided. The participant evaluates the fluidity of the platform on the reaction time of the tool when an action is taken. They all consider that the platform is fluid enough.

4.3.2. Validity

The participants were asked to grade how they perceived the usage scenario proposed in the questionnaire. From the post-session analysis of the questionnaire, all the participants found that the

approach is relevant and corresponds to real design problems that they can meet during their activities.

4.3.3. Ease of use

Two evaluation forms serve to evaluate the criteria: observation and quantitative measure of the frequency of solicitation. During the autonomous testing, the participants asked comprehension questions about reading the graphs. Indeed, one limitation is highlighted on the interpretability of the 1D intervals. Some information is lost with the proposed visualization of results. In fact, it would be more relevant to have access to plotlines on the performance results of the different alternatives in addition to the 1D representation. Thus, for a better understanding of the design solutions, a comparison of the solutions with all the performances would help the usage of the platform. For example, using 2D plotlines, as shown in Figure 7-6, could be a simpler way to represent the solution. A presentation to the participants of this type of graph allowed us to consider an evolution of the representation of the design space. In this type of graph, the "best" solution is highlighted. The user can then explore the performance space and observe how constraining a global performance can change the "best" design solution.

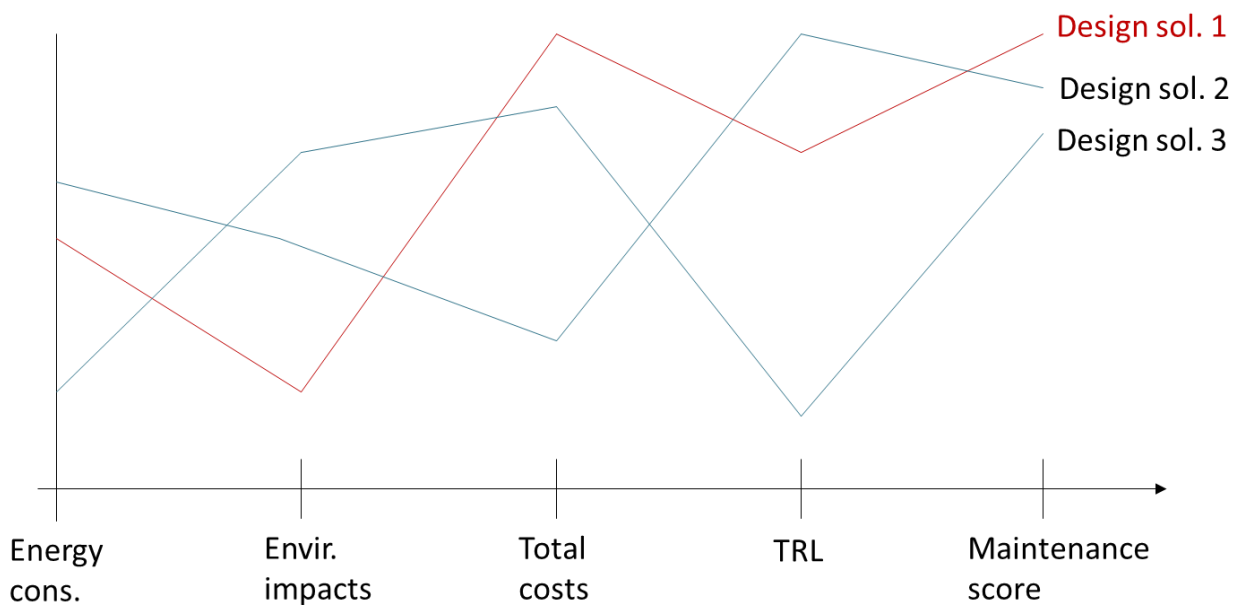

Figure 7-6. Example of 2D representation to compare design solutions

4.3.4. Completeness (technical)

For the panels of testers, the implemented global performances are relevant. The level of detail is sufficient to investigate the alternatives.

On a technical level, other aspects of the design problem can be added. For the physical aspects of the solution, it would be relevant to add the modelling of the components degradation during the system's life cycle. Moreover, for usage in an industrial use case, the level of detail for the evaporator is too macroscopic. Instead of proposing default evaporators as proposed in the platform, the

evaporator/heat exchanger sizing should also be visualized, and different choices are necessary for the designer to make decisions.

It is important to note that the completeness of the platform, i.e. the number of global performances provided, satisfies the interrogated testers. However, the correctness of all these performances has not been completely tested because of the lack of available data. Indeed, for environmental impacts, the results obtained in the platform were compared with the literature data presented in Chapter 2. The maintenance score and the costs hypothesis are discussed with industrial experts. However, it is necessary to compare the results for these three performances with a real case study for future development.

In addition, a discussion could be held with two actors of end-of-life treatment of refrigeration systems. Environmental performance is summarized in our design artefacts as the overall global warming potential of the system during its life cycle. Therefore, it would be relevant to include all categories that can be found in LCA and include an end-of-life treatment cost in the cost calculations.

4.3.5. Consistency

The comparison of the design solution obtained for each of the participants points out that the results vary depending on the mindset of the participant. However, for the same inputs, they all provided a satisfying solution.

The validation session was done with only one computer on which the platform was developed, so the users were not able to solve the problem at the same time, which may have affected the solution obtained in the end. Indeed, they could see the other testers' reduction order, which might have influenced their choice afterwards.

4.3.6. Completeness (Decision aid support function)

The preliminary analysis of the decision support functionality of the platform allowed us to conclude on the interest found by the testers. First, the accessibility in the same supporting tool is relevant. It was also highlighted that the platform could quickly evaluate a set of possible design solutions for a set of specifications. The testers can thus become aware of the diversity of the possible solutions and quickly dimension a feasible solution. Amongst the written feedback, it can be noted that participants found the exploration tool to be "time saving in the selection of the system configuration", "facilitates decision making" or "serves as a repository".

The "path" to arrive at an optimal solution depends on the user, and so the solutions can diverge (see example in Section 4.2 with the results obtained according to the path).

Finally, the visualization of the technical maturity, environmental performances and maintenance score provides originality of the platform and brings a different vision to the user. In the case of a supply company, additional arguments can be provided to the client to go towards a particular design solution. Remember that a problem identified in the diagnostic is the lack of communication between several actors involved in the decision process. The platform addresses several levels of knowledge and can thus help to improve communication. In summary, all the testers found that the platform could be used in their business.

4.3.7. Completeness (Integrated approach)

In state of the art, we have noted that design platforms do not take all the performances of a refrigeration system into account. Moreover, digital platforms do not allow designers to navigate the space of possibilities optimally because the user is not involved in the digital design process. On the contrary, in practice, the user generally poses a design problem and is provided with a single solution.

The artefacts developed in this work provide an approach for the design space exploration for commercial refrigeration systems. It could be used to implement multiple performances relevant to the design of refrigeration systems. One participant noted that: having such a tool to calculate several performances including CO₂ emissions and energy consumption according to design choices is essential.

In the literature, this approach for refrigeration systems has not been studied, as shown in

Table 7-6, which compares the performances implemented in platforms, including the present one, to support the design of the refrigeration system.

Table 7-6. Comparison of the performances implemented in our platform and in the existing refrigeration system design platforms

	Quantative performances				Qualitative performances			
	Energy consumption	Environmenta l impacts	Costs	Space used	Installation conditions	Maintenance conditions	TRL Technology	Lifetime
<i>CoolPack</i>	Yes	No	Yes	Yes	Through costs	Through costs	No	Yes
<i>CoolTool</i>	Yes	TEWI	No	No	No	No	No	No
<i>PackCalculationPro</i>	Yes	TEWI	Yes	No	Through costs	Through costs	No	No
<i>CoolSelector</i>	Yes	No	No	Yes	*	No	No	No
<i>CyberMart</i>	Yes	TEWI	Yes	Yes	Through costs	Through costs	No	Yes
<i>Manufacturer software</i>	Yes	No	No	Yes	Yes	No	No	Yes
<i>EnergyPlus</i>	Yes	No	No	No	No	No	No	No
<i>SuperSmart</i>	Yes	Yes	Yes	No	Through costs	Through costs	No	No
<i>SuperSim</i>	Yes	No	Yes	No	Through costs	Through costs	No	Yes
Proposed platform	Yes	Yes	Yes	Yes	Yes	Yes	Yes	Yes

4.3.8. Robustness

The platform has been tested with one use case. Some changes were tested by adding more or fewer display cabinets and cold rooms. The change of location, store area, were tested and the design

space was compared. For the various tests, the platform provides a result. The results obtained cannot be evaluated in a robust way due to the lack of information available during this thesis. However, we can conclude on the modularity of the proposed platform. All the participants interviewed found the platform to be of high quality. The modularity of our platform serves to ensure a possible evolution by respecting the steps followed in this study, i.e. the adaptation of the knowledge model and the implementation in the tool.

For further evaluation of the platform, the test with another industrial case study should be carried out.

5. Discussion and limitations

In this chapter, the objective is to validate our artefact based on eight criteria: efficacy, validity, ease of use, completeness (technical), consistency, the completeness for the decision support, the integrated approach and robustness.

The users have shown interest in the proposed platform during the validation sessions. Indeed, the platform is usable in industrial conditions and provides results. The testers have described the tool as powerful, enabling design problems to be solved by visualising essential performance, including CO₂ emissions and energy consumption. Our approach's essential interest is linked to the possibility of implementing different kinds of performances within the same platform necessary to solve a design problem for refrigeration systems. We were thus able to show that a certain number of trade-offs must be made to reach an optimal solution. Moreover, a top-down approach was highlighted in the literature review, excluding the user in the design or decision process. On the contrary, the present platform is based on a design space exploration paradigm that puts the user at the center of the decision process. It has been observed that each user, having his own experience of the domain and of design, can have very different results depending on his choice of criteria to lower uncertainties.

The platform was used to have a quick idea of feasible solutions through a simplified but realistic supermarket case study. To evaluate the robustness of our proposed artefacts more thoroughly, it would be relevant to consider testing the platform with another industrial case study.

Due to lack of time and available actors, some scenarios have not been tested. Indeed, we proposed four main scenarios that correspond to real activities that could be observed during the field diagnosis. In the validation process, we only focused on the design task consisting of finding a design solution for a client need. The other activities should be tested in future developments.

A demonstration of the platform with end-of-life actors for refrigeration systems revealed some possible evolutions. First, the stakeholders noted the relevance of such a tool to include waste management objectives. We recall that refrigeration systems are considered waste electrical and electronic equipment (WEEE) and subject to waste treatment standards. However, one point raised by stakeholders during the diagnosis is the lack of visibility of new technologies available and therefore degraded waste management. Several scenarios could be implemented in the platform: the reuse of components such as compressors in a solution and the possibility to see how the

components are constructed (metal composition, interlocking...)

Recommendations for the use of the platform could be proposed. On the organizational scheme that can be found in companies that use BIM, we propose a person in charge of the enrichment and the proper functioning of the artefacts, knowledge model and platform. Indeed, a Building Information Modeling (BIM) manager is a person in charge of implementing BIM within a company and ensuring the proper functioning and use of BIM tools.

References

- Aspers, P., 2018. Forms of uncertainty reduction: decision, valuation, and contest. *Theory and society* 47, 133–149.
- Cleven, A., Gubler, P., Hüner, K.M., 2009. Design Alternatives for the Evaluation of Design Science Research Artifacts, in: *Proceedings of the 4th International Conference on Design Science Research in Information Systems and Technology, DESRIST '09*. Association for Computing Machinery, New York, NY, USA. <https://doi.org/10.1145/1555619.1555645>
- Cohn, M., 2004. *User Stories Applied: For Agile Software Development*. Addison Wesley Longman Publishing Co., Inc., USA.
- Hevner, A.R., March, S.T., Park, J., Ram, S., 2004. Design science in information systems research. *MIS quarterly* 75–105.
- Peppers, K., Rothenberger, M., Tuunanen, T., Vaezi, R., 2012. Design Science Research Evaluation, in: Peppers, K., Rothenberger, M., Kuechler, B. (Eds.), *Design Science Research in Information Systems. Advances in Theory and Practice*. Springer Berlin Heidelberg, Berlin, Heidelberg, pp. 398–410.
- Prat, N., Comyn-Wattiau, I., Akoka, J., 2014. Artifact Evaluation in Information Systems Design-Science Research-a Holistic View. *PACIS 23*, 1–16.
- Pries-Heje, J., Baskerville, R., Venable, J.R., 2008. Strategies for design science research evaluation.
- Rosson, M.B., Carroll, J.M., 2002. Chapter 7 - Usability Evaluation, in: Rosson, M.B., Carroll, J.M. (Eds.), *Usability Engineering*. Morgan Kaufmann, San Francisco, pp. 227–271. <https://doi.org/10.1016/B978-155860712-5/50008-4>
- Silva, T.R., Winckler, M., 2017. A Scenario-Based Approach for Checking Consistency in User Interface Design Artifacts, in: *Proceedings of the XVI Brazilian Symposium on Human Factors in Computing Systems, IHC 2017*. Association for Computing Machinery, New York, NY, USA. <https://doi.org/10.1145/3160504.3160506>
- Sonnenberg, C., vom Brocke, J., 2012. Evaluation Patterns for Design Science Research Artefacts, in: Helfert, M., Donnellan, B. (Eds.), *Practical Aspects of Design Science*. Springer Berlin Heidelberg, Berlin, Heidelberg, pp. 71–83.
- Venable, J., 2006. The role of theory and theorising in design science research, in: *Proceedings of the 1st International Conference on Design Science in Information Systems and Technology (DESRIST 2006)*. Citeseer, pp. 1–18.

Chapter 8: Discussion, limitations, and perspectives

1. Discussion

Our research work aimed to improve the design process of refrigeration systems, with a focus on commercial refrigeration applications. Three research gaps were highlighted by a literature review, which led us to define two research questions.

Research question 1: How to represent and assess the refrigeration socio-technical system?

The first research question stems from the research gap on the lack of a holistic representation of the refrigeration socio-technical system (research gap 1).

We proposed a book of knowledge on the current refrigeration socio-technical system to address this issue. The first step was to conduct a diagnosis and knowledge investigation on the refrigeration socio-technical system. Different forms of data acquisition were implemented: interviews with interlocutors of different roles, companies, knowledge; studies of the laws, standards, and regulations specific to the field as well as the guides of good practices; a collection of literature data on refrigeration technologies, evaluation of the performances, observation.

From these data, and in order to represent the socio-technical system and assess the opportunities of development in the domain, the Radical Innovation Design (RID) methodology was used. The four RID objects allowed us to structure the knowledge in four categories: *stakeholders* (called user profiles), who encounter *issues* (called problems) during their activities, themselves segmented into *life cycle phases* (called use situations) and finally that of *existing solutions* that stakeholders can apply to reduce or eliminate a problem in a given activity. Based on the RID methodology, several categories were identified:

- Three life-cycle phases: design, manufacture and installation; exploitation and end-of-life.
- Twelve stakeholders.
- Fifteen problems classified into four categories: *cost-related*, *knowledge management (KM)-related*, *stakeholders' interaction-related* and *tool-related*.
- Six categories of existing solutions: software solutions, KM solutions, EN 378 guidelines, methodological solutions, technological solutions, tool solutions.

The main shortcomings that emerge from this analysis are: (1) a lack of understanding of the technologies, (2) a weak exploration of the design, (3) language and tool gap between the stakeholders resulting once again in an underperforming refrigeration system.

Research question 2: How to support decision-making for the design of refrigeration systems in early design stages and in the most integrated way?

The second research question arises from the lack of an integrated approach (research gap 2) and user integration (research gap 3) in the design process.

To address the lack of an integrated approach, we developed a knowledge model, or ontology, to design refrigeration systems. Four classes were defined to describe the scenario, the refrigeration system structure, the properties and the performances to assess. The knowledge model was used to set the design problem for the refrigeration system. It reuses existing ontologies found in the literature related to the design, optimization and simulation of complex systems. A standardized language was finally implemented into a design space exploration platform from this knowledge model.

We developed a platform based on the design space exploration paradigm to address the lack of user integration. The proposed strategy is based on two steps: a brute-force enumeration and an exploration of the design space composed of the decision space and the performances space. The platform allows users to find solutions to their design problems quickly. Moreover, the platform enables users to navigate between the solution space and the performance space in a quasi-simultaneous manner. Users can thus explore a multitude of "what-if" scenarios, i.e. if the user changes a parameter in the solution space, how will the performance space respond and vice versa.

The platform should be used in early design phases. Indeed, integrating several environmental, economic, maintenance and technological maturity performances within the same platform brings new knowledge to users from different trades. Therefore, it is better if the users are involved in the design process early.

The proposed solution addresses the limitations of bottom-up approaches by placing the user at the centre of the decision. Indeed, the validation step showed that the design space is explored differently for each user as the choice of an optimal system involves (i) the choice of users to restrict the performance or solution space and (ii) the users' understanding of the system.

Finally, the platform addresses several users with different levels of knowledge. It allows users from different backgrounds to intuitively apply their filters in the order that suits them (design-by-shopping) to arrive at their preferred solution(s).

Our artefacts, i.e. the knowledge model and the design space exploration platform, are evaluated through eight criteria: efficacy, validity, ease of use, technical completeness, consistency, functionality completeness for decision support and integrated approach, robustness.

According to the validation results, the users found a real interest in using the proposed design space exploration platform. The design space can be satisfactorily reduced with successive choices to come up with an optimal solution, in contrast to the traditional optimisation approaches applied in other refrigeration system design tools. Indeed, it allows the design actors to be more involved in the design process, understand the stakes of the tradeoffs, and be confronted with other points of view than their own, which cannot be done with classic optimisation.

2. Limitations

In this Ph.D. thesis, some limitations on the design artefacts can be highlighted:

- The knowledge model can be used and further developed only by a person with a high knowledge about ontologies.
- The proposed platform for the design space exploration of refrigeration systems provides different performances visualization. However, the visualization of the results on the exploration interface is too basic. Indeed, the results in 1D intervals can confuse the user and lose information.
- The verification of the energy consumption has been made based on a case study from 2010. The other global performances were either compared with literature, or the hypothesis confronted by refrigeration experts. However, to ensure the robustness of the model, comparisons with a real and actual case study should be made.
- The validation process allowed us to prove the interest of our study and the developed artefacts. However, due to lack of time and available testers, only two validation sessions were conducted with experts from the same company. Extending the validation session to other experts and other design activities would be relevant. Moreover, only one case study has been used and to improve the detail level of the model and its quality, and several other scenarios should be applied.

3. Perspectives

Several points can be considered to improve the work presented and improve the limitations of this work.

- First of all, updating the field knowledge is necessary to make the model evolve. Moreover, the proposed knowledge model can be generalized to other areas. As a first step, we recommend further modelling of the supermarket, taking into account the integrity of the supermarket energy system.
- The experts interviewed showed an interest in the platform developed. However, for use in an industrial context, especially for installers, it would be necessary to allow the designer to size the evaporators. In the same idea, the modelling of the behaviour of all components should be more developed.
- A discussion in a session with end-of-life stakeholders led to the prospect of developing the tool for end-of-life scenarios. Examples include adding reused components, integrating dismantling costs, offering a split view of the system components to prepare the treatment channels for new market technologies.

- Finally, a short-term perspective would be the addition of low maturity technologies to test a scenario with a research actor. In particular, it would be interesting to test technologies developed in the laboratory, such as Thermal Energy Storage (TES) with phase change materials (PCMs) on an industrial case and to understand what elements are missing for possible industrial development.

General conclusion

This research work is at the crossroads of two disciplines, refrigeration process engineering and industrial engineering, to propose solutions aiming to improve the design process of commercial refrigeration systems.

In the first chapter of this thesis, we presented the general context and our research objective to offer a global approach that will help manage the research and development (R&D) and decision making for refrigeration.

The second chapter offers a literature review on relevant work related to our main research objective. Three focuses are made on: refrigeration systems structure and particularly commercial refrigeration, industrial engineering tools, and refrigeration systems modelling platforms to support the design of refrigeration systems. Industrial engineering exploration allows us to identify relevant methods and tools for supporting complex systems design. Moreover, a comparison of the existing relevant tools to support refrigeration systems design is established. This allows us to identify the research gaps toward an integrated solution to design sustainable refrigeration systems.

The third chapter proposes two research questions and the associated objectives, based on the research gaps analysis. The research methodology driving this thesis is also presented. Our thesis framework is based on the design research methodology (DRM) (Bleesing and Chakrabarti, 2009) framework.

We proposed in the fourth chapter an answer to our first research question on how to represent of the refrigeration socio-technical system. For this purpose, the RID (Radical Innovation Design) (Yannou, 2015) methodology was used to build a book of knowledge divided into four categories: users, life cycle stages, problems, and existing solutions. Two RID tools were used, the RID comparator and the RID compass, to highlight development opportunities, called value buckets. The main shortcomings that emerged from this analysis are: (1) a lack of understanding of the technologies, (2) a weak exploration of the design space, (3) language and tool gap between the stakeholders resulting once again in an underperforming refrigeration system.

The diagnosis confronted our proposed research objective and confirmed our second research question on how to support decision making for the design of refrigeration systems in early design stages and in the most integrated way. A solution in two parts was proposed: the building of a knowledge model, or ontology, and the implementation of a simulation and design space exploration platform for refrigeration systems.

The fifth chapter develops the knowledge model. The knowledge model reuses other ontologies and proposes a novel framework for refrigeration systems design. Four macro-concepts were defined: the scenario, the refrigeration system structure, the properties and the performances to assess. An example for a supermarket refrigeration system is presented to explain the usage of the knowledge model. The knowledge model is used as a clear and integrated representation of the design problem to implement in a digital tool.

The sixth chapter presents how the knowledge model is implemented in a design space exploration platform. The Geeglee tool was chosen for this implementation. It is based on two main steps: a brute-force search to generate all the feasible solutions and an exploration phase based on the design by shopping paradigm. Five performances are assessed simultaneously: energy consumption, environmental impacts, total cost, maintenance score and technological maturity. A verification process has been established. First, a step-by-step verification was made throughout the implementation process using experts' workshops. Second, an application verification is made to compare the results with a real use case.

The seventh chapter presents the evaluation of the design artefacts by validating eight criteria: efficacy, validity, ease of use, technical completeness, consistency, functionality completeness for decision support and integrated approach, robustness.

Finally, the answers to our research questions have been discussed in the eighth chapter. The limitations and perspectives of our research contributions are listed.

The proposed approach showed the value of using design space exploration to size a supermarket refrigeration system. The starting point was developing a knowledge model to represent the problem correctly. This approach could be extended to other design problems, especially for designing other thermal systems, following the same steps applied in this research work.

Appendices

1. Appendix 1: Glossary

Name	Definition
Ambition perimeter	A subset of important value buckets that people also desire, complying with strategic considerations (core competencies, brand image, expected benefits, technological and market roadmaps, easiness to develop, etc.).
Business model (BM) solution	The plan for creating, delivering, and capturing the value from a PSO architecture.
Cognitive model of activity (after RID)	A simplified representation of how an activity is lived by some user profiles (here RS stakeholders), facing some problems or lack of performance during usage situations (here RS lifecycle stages), and for which existing solutions are variably effective.
Dreamt usage scenario	A usage scenario of the future desired activity where the entire solution is not represented but its desired effects are illustrated in narrative form.
Effectiveness indicators	Set of indicators given as a percentage, expressing the ability of solutions (existing ones or the innovative one) to eradicate a part of the quantities of pains for some problems or for some usage situations.
Ideation	Process of generating new ideas. In RID, a first “scenario creativity” session transforms value buckets into one or several dreamt usage scenarios, and a second “solution creativity” session transforms a dreamt usage scenario into a PSO architecture and a BM solution.
Product-service-organization (PSO) architecture	A cohesive solution of product, service and organization (the network of stakeholders that operates the product-service system)
Quantity of pains	Quantity of pains is an original extensive semi-quantitative measurement scale made of (a size of a User Profile) × (a frequency of Usage Situation) × (an occurrence and gravity of a Problem).
Radical Innovation Design (RID)	RID is a methodology to innovate on (i) an activity from the viewpoint of its beneficiaries or (ii) on a technical component’s role from the viewpoint of the system performance. It is a Design Thinking process with visual management facilities, decision-making tools, together with a project and knowledge management facilities.
Socio-technical RS	Set of stakeholders, processes, organization and technical solutions involved in the activities linked to the RS along its lifecycle phases (design, manufacture, use, maintenance, technological updates, end of life).
Value bucket (VB)	A major problem (with serious consequences) for a given user profile that arises during a frequent usage situation and for which existing solutions provide too little or no relief

2. Appendix 2: Modelling of the input matrices for the application of the RID methodology

The present thesis used RID methodology version 2. This RID version uses 6 input matrices (1D or 2D). These 6 matrices answer precise questions given in the Figure below.

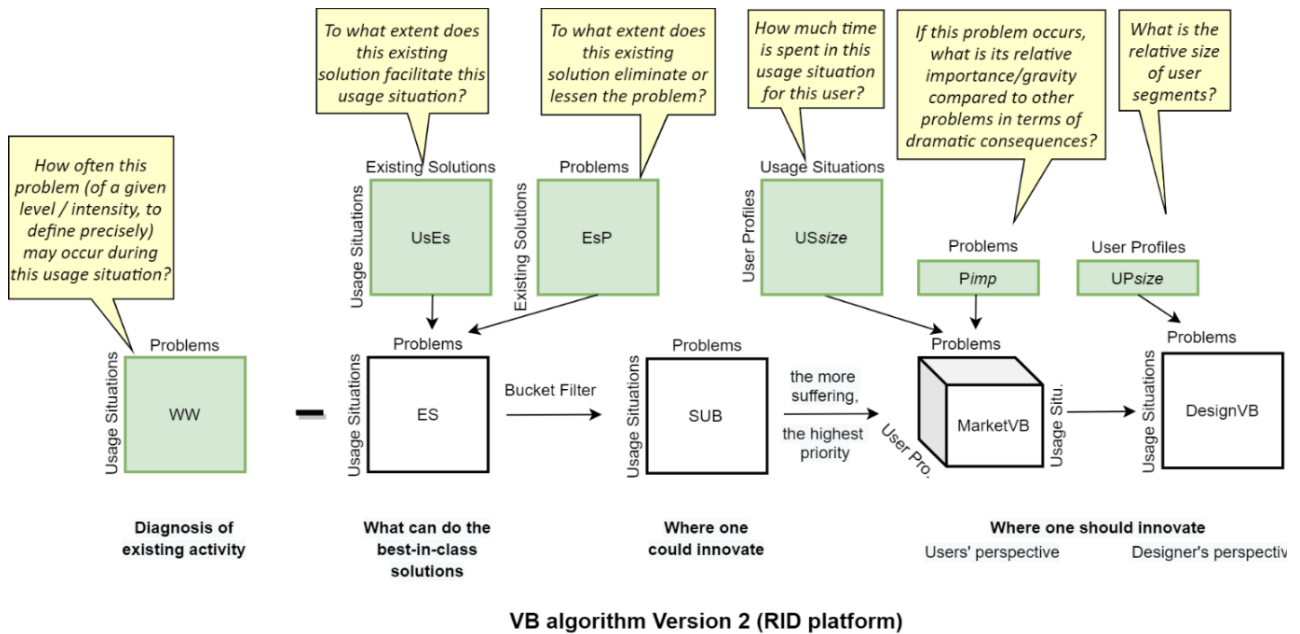

The 4 matrices *WW*, *UpEs*, *UsEs*, *EsP* have a qualitative scale spanning from 0 to 5 with: 0= No/Never; 1=Very few; 2=Rarely; 3=Some/sometimes; 4=most/a lot; 5 =frequently.

2.1. *WW* matrix

Matrix *WW* is the matrix "What's Wrong in this activity?" and crosses *Usage Situations* with *Problems*. In RID versions 1 and 2, all users have the same *Problems* when they are in a given *Usage Situation*.

The question asked to fill the matrix is: "How often this problem (of a given level / intensity, to define precisely) may occur during this usage situation?"

	Cost			Knowledge management			Interactions between stakeholders					Tool			
	Risk of early obsolescence	Risk of unexpected investment costs	Risk of break down	Risk of high operational costs (OPEX)	Decrease of the recruitment quality	Lack of refrigeration technicians and engineers	Lack of understanding of new technological clusters	Disturbed process of advice to the final usage of the system	Lack of flexibility for the suppliers	Risk of discomfort for the final user's customers	Risk of high danger for human health	Poor exploration of the design space	Lack of common efficient tools	Risk of high environmental impacts	Poor recycling rate
Design, manufacture and installation	3	2	0	0	4	4	5	5	5	0	0	3	4	0	0
Exploitation	3	0	4	3	1	3	4	2	2	3	1	0	0	4	0
End-of-life	0	0	0	1	0	0	4	3	1	1	1	0	0	4	4

Let us recall below the definition of the 15 problems considered in our RID study.

Cost	Risk of early obsolescence	The evolution of regulation and the predicted laws and taxes has proven the need of a quick change in the systems to respond to the change in regulation. In
-------------	----------------------------	--

		the exploitation phase, the risk increases with the possibility of a component's obsolescence, human error and refrigerant leakage. The impact is an increase of costs for the final user mostly.
	Risk of unexpected investment costs	In the first usage situation, a risk can occur if all the scenarios are not taken into account: If the time of respond to the new regulation from the installer is too long, a risk of high costs is inevitable and a lack of adaptability can lead to bankruptcy in the worst scenario. For academic or R&D researchers, an inconclusive research is yet rare but can occur and, in most cases, does not lead to lots of damage. In the EOL treatment, unexpected costs occur without the knowledge of the concerned actor as in most cases there is a lack of knowledge on the possibility of EOL parties to treat their waste. It can lead to waste left on site (cause of poor recycling rate).
	Risk of break down	In the exploitation phase, break down are frequent but as the system are robust, it is not fatal. It can be mechanical, electric or design related break downs. As the outside temperature increases in the summer and the maximal temperature has never occurred before, more systems are found to not be designed to support it.
	Risk of high operational costs (OPEX)	In the exploitation phase, the electric consumption of the system is the most important operational cost. The most frequent reasons are the maintenance of the systems and the energy loss. (Evans et al., 2014)
Knowledge management	Decrease of the recruitment quality	As the sector is changing, the formations of new technicians or engineer decrease. From a 2016 study by the DARES (Direction de l'Animation de la Recherche, des Etudes et des Statistiques, dépendant du ministère du Travail), more than 60% of new graduates are not qualified enough of a work.
	Lack of refrigeration technicians and engineers	As industrial demand increases, the refrigeration sector is lacking refrigeration technicians or engineer. From the professional organism called SNEFFCA, the sector is always recruiting (more than 4 000 recruitments per year for 2 000 small or medium companies) but the number of applications reduces.
	Lack of understanding of new technological clusters	In all the usage situation, new technological clusters are often not completely understood as there is no time to keep up with the changes.
Interactions between stakeholders	Disturbed process of advice to the final usage of the system	As the regulation change and the initial structure of the companies change according to the change in regulation, the process of advice for the final user is disturbed. The top down approach in the current process during the first LC phase leads often to non-optimal system recommendations.

	Lack of flexibility for the suppliers	During the first LC phase, a frequent problem is that the final user specifications given to the supplier can constrains the design space of the design office.
	Risk of discomfort for the final user’s customers	During the exploitation phase, either during normal use or maintenance, an uncomfortable noise can be heard. This problem is not frequent and has no significant damage on the users but can harm the company image.
	Risk of high danger for human health	In all the LC phases, the use of refrigerant can be source of human’s health problems. It can be toxic or inflammable and thus can start a fire or damage the health of a human in case of ingestion. Moreover, the current use of CO ₂ -based systems can be dangerous as the equipment are under high pressure. An accident is extremely rare but can be fatal.
Tool	Poor exploration of the design space	During the RS design phase, the design office is subject to a strong time constrain that prevent an optimal exploration of the design space.
	Lack of common efficient tools	During each phase of the LC, multiple tools are used by the stakeholders. Each actor can have specific tools either internally developed or tools used in multiple domains. Some of them are considered not efficient because they do not answer to an industrial need.
	Risk of high environmental impacts	The environmental impacts of the systems occurs in all the LC phases. During the exploitation and the EOI treatment, a risk of higher negative impacts is important due mostly to frequent the refrigerant leakage and high electric consumption resulting in high indirect impacts.
	Poor recycling rate	In the EOL phase of the process, it is mandatory to empty the refrigerant from the machine. However, the components of big industrial systems can be left on site, mostly because of higher costs of dismantling components or because of lack of knowledge of the EOL treatment parties that can manage the EOL.

2.2. *UsEs matrix*

Matrix *UsEs* crosses *Usage Situations* and *Existing Solutions*. The question asked to fill the matrix is: “*To what extent does this existing solution facilitate this usage situation?*”

	Software solutions	KM solutions	EN 378 guidelines	Methodological solutions	Technological solutions	Tool solutions
--	--------------------	--------------	-------------------	--------------------------	-------------------------	----------------

Design, manufacture and installation	4	4	3	3	2	2
Exploitation	4	5	4	4	4	5
End-of-life	3	4	4	3	2	5

During the design phase of a refrigeration system LC, most activities are made with software solutions and helped sometimes by the EN378 guidelines and/or by methodological solutions. Technical solutions and tools are only used for manufacture of components or to put in place the system.

During the exploitation phase, most of the solutions are necessary. Indeed, the exploitation phase of a RS is the longest period. KM and tool solutions are the frequently used, one for the formation of the refrigeration engineer on maintenance or technicians and the other are necessary for the maintenance of the machine. EN 378 guidelines are mostly used in this phase as there are norms that need to be respected (such as a frequency of maintenance, the components that need to be checked...). The break down are reported directly to the supplier by the intermediary of software that detect a break down and put the machine in a degraded state to maintain the system running. Then, at the intervention of the technicians, technological and methodological solutions are used to change the broken components of the machine or to upgrade the system.

In the last phase, the tool solutions are always used by the practionners to handle the EOL of RS. A RS is submitted to the norms for DEEE product and the norm EN 378 as a refrigerant is contained inside the system.

2.3. *EsP matrix*

Matrix *EsP* crosses *Existing Solutions* and *Problems*. The question asked to fill the matrix is: "*To what extent does this existing solution eliminate or lessen the problem?*"

	Cost				Knowledge management			Interactions between stakeholders				Tool			
	Risk of early obsolescence	Risk of unexpected investment costs	Risk of break down	Risk of high operational costs (OPEX)	Decrease of the recruitment quality	Lack of refrigeration technicians and engineers	Lack of understanding of new technological clusters	Disturbed process of advice to the final usage of the system	Lack of flexibility for the suppliers	Risk of discomfort for the final user's customers	Risk of high danger for human health	Poor exploration of the design space	Lack of common efficient tools	Risk of high environmental impacts	Poor recycling rate
Software solutions	4	1	0	2	0	0	2	0	0	0	0	3	1	2	1
KM solutions	1	0	3	3	3	3	5	4	3	0	4	1	1	0	1
EN 378 guideline	3	0	1	0	0	0	1	1	4	1	4	0	4	2	2
Methodological solutions	2	1	2	0	0	0	0	0	1	1	0	3	0	3	3
Technological solutions	4	0	4	2	0	0	0	0	1	2	1	0	2	2	3
Tool solutions	0	0	1	0	0	0	0	0	0	2	3	0	2	2	4

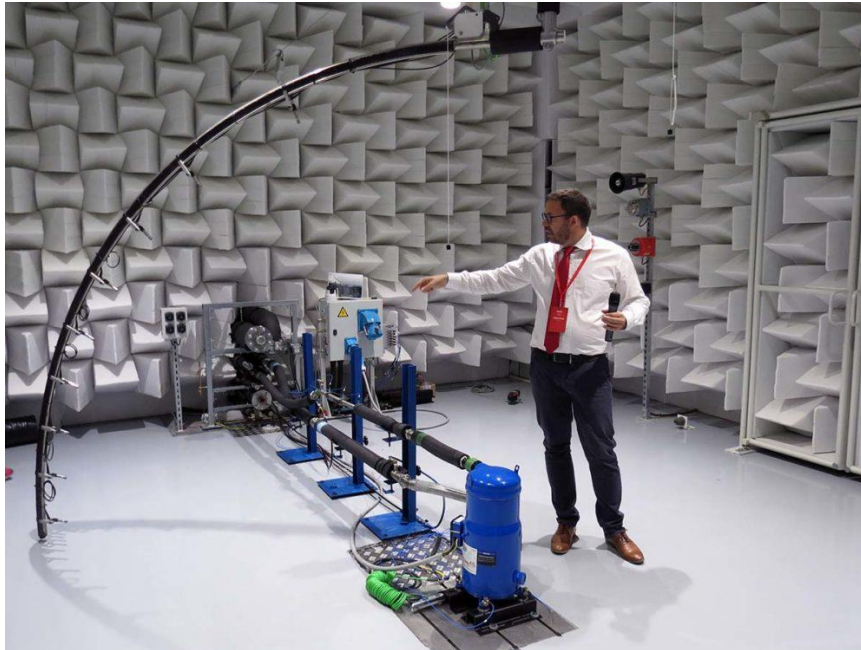

A few laboratories or companies do tests to measurement of the noise, vibration of components to reduce the discomfort of the machines.

AutoCAD is frequently used by design office to dimension the system and draw the structure during the design phase. Bitzer can help supplier to find components that meet the design office calculation of frigorific power need. It is a combination of solutions that are used by the design actors.

The software CoolTool is an example of a software that has been developed as part of a PhD project to calculate the energy consumption needed for operational conditions. It is unowned by most stakeholders and is used by very few users in France.

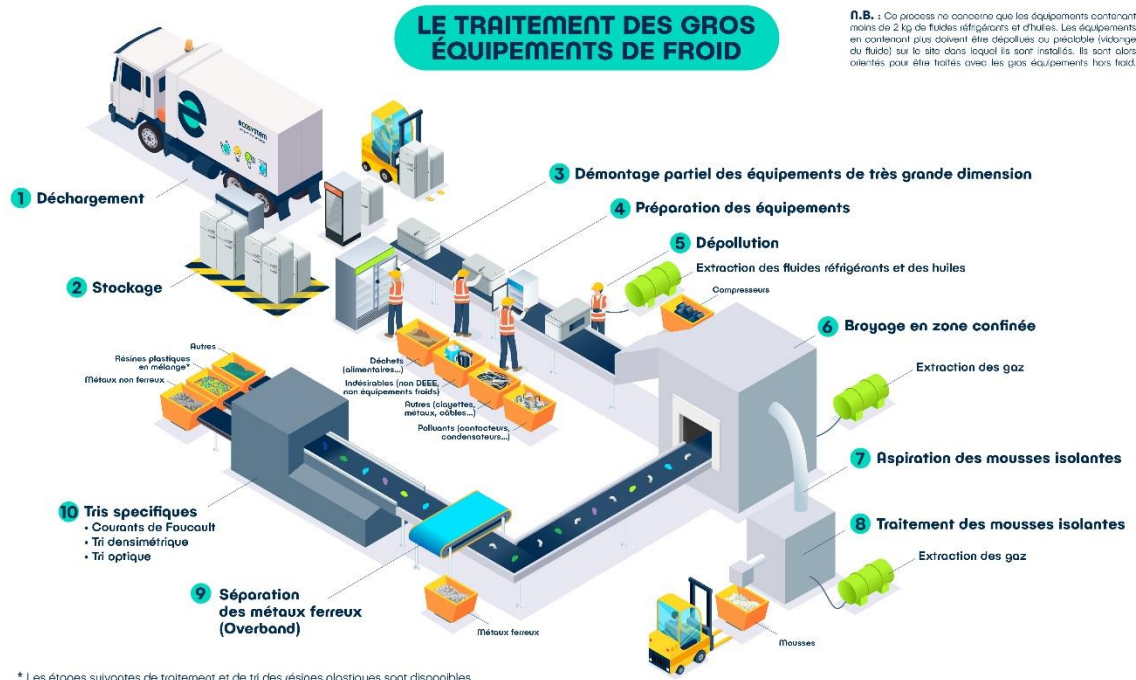

n.B. : Ce process ne concerne que les équipements contenant moins de 2 kg de fluides réfrigérants et d'huiles. Les équipements en contenant plus doivent être dépollués ou préalable (vidange ou fluide) sur le site dans lequel ils sont installés. Ils sont alors orientés pour être traités avec les gros équipements hors site.

* Les étapes suivantes de traitement et de tri des résines plastiques sont disponibles dans le schéma « Traitement spécifique des résines plastiques en mélange »

1 Déchargement

Les équipements sont déchargés avec précaution afin de ne pas endommager le circuit de refroidissement.

2 Stockage

Les équipements sont stockés dans l'attente de leur traitement. Le stockage est organisé afin d'alimenter régulièrement la ligne et d'absorber les volumes à traiter.

3 Démontage partiel des équipements de très grande dimension

Les équipements trop volumineux (en particulier équipements professionnels de froid de type armoires frigorifiques, distributeurs de boisson...) sont partiellement démontés pour récupérer diverses matières et ne pas endommager l'installation de broyage.

4 Préparation des équipements

Un tri manuel permet d'extraire différentes fractions (déchets, clayettes, câbles, indésirables...) qui bénéficieront d'un traitement spécifique ou qui ne doivent pas rentrer dans l'installation de broyage.

5 Dépollution

La dépollution consiste à extraire diverses substances réglementées (contacteurs, condensateurs, huiles et fluides réfrigérants...). Les fluides réfrigérants et les huiles sont aspirés de manière hermétique avant le retrait des compresseurs, afin d'empêcher leur relargage dans l'atmosphère. Ces fluides et huiles sont captés et éliminés.

6 Broyage en zone confinée

Les équipements passent dans un broyeur qui bénéficie d'un système permettant de contenir et d'extraire les gaz isolants. Ces gaz sont présents dans les mousses isolantes et sont en partie libérés pendant cette étape de broyage.

7 Aspiration des mousses isolantes

Les mousses isolantes contenues dans les équipements sont aspirées pour être traitées séparément.

8 Traitement des mousses isolantes

Les mousses isolantes sont traitées spécifiquement par broyage et chauffage dans une installation confinée afin d'extraire les résidus de gaz isolants pouvant être encore présents.

9 Séparation des métaux ferreux (Overband)

Un Overband, ou aimant permanent, permet d'extraire les fractions magnétiques (métaux ferreux).

10 Tris spécifiques

Différentes technologies peuvent être combinées pour séparer le reste des fractions en familles plus homogènes :
 • **Courants de Foucault** : séparation des métaux non ferreux à l'aide de champs magnétiques.
 • **Tri densimétrique** : à l'aide par exemple d'une grille vibrante qui sépare les fractions légères et les fractions lourdes ou encore par flottaison qui est une méthode de séparation en phase liquide se basant sur la densité des fractions à trier.
 • **Tri optique** : détection via des instruments d'optique (infrarouge, rayons X...) des différents types de fractions comme le plastique, les cartes, les fils...

Toutes les fractions extraites bénéficient de traitements spécifiques ultérieurs suivant trois possibilités :
 • recyclage pour produire de nouvelles matières (solution privilégiée),
 • valorisation énergétique ou valorisation matière,
 • élimination en respect des réglementations.

The figure gives the detail of EOL treatment of refrigeration systems in France once the system has been emptied.

2.4. USsize

Matrix USsize crosses User Profiles with Usage Situations. The users may spend different times in a given usage situation. The question asked to fill the matrix is: "How much time is spent in this usage situation for this user?"

	Design, manufacture and installation	Exploitation	End-of-life
Academic researcher	3	0	0

Technological transfer centre	3	0	0
Professional organism	4	3	0
R&D researcher	5	1	0
Design office	5	0	0
Consulting firms	5	0	0
Refrigeration engineer	3	5	3
Supplier	5	2	4
Components designer	5	0	0
Manufacturer	5	2	0
Final user	1	5	1
EOL treatment parties	1	0	5

Based on the expert’s interviews and the documentation, it appears that most of the user parties appear in the first phase of the LC. Indeed, once the machine is installed and running, the frequent users concerned by the exploitation phase are the final user (as the user of the machine on a daily base) and the refrigeration engineers by the intermediary of the supplier. They must frequently verify the system (directive 2002/91/CE), check of refrigerant leakage, maintain the system or repair the break downs. If the system breaks and there is no usual way of repairing the system, the manufacturer company is contacted, and the R&D team can be contacted to palliate to the issue. Professional organism such as *Bureau Veritas* sometimes inspect the running system to report the performances of the system (optimized dimensions, measurement of the energetic performance, upgrade recommendation...). The EOL of the system is the phase that require the less actors. The EOL treatment parties are frequently necessary for the transport, treatment of the machine. The refrigeration technicians oversee emptying the refrigerant in the machine. The final user of the system is involved from time to time in the EOL of the machine, but it is mostly the responsibility of the supplier company.

The process starts with an initial need from a final user, i.e., a retail store, a cuisine. A project manager from a supply company or a consulting firm under the management takes over the project. The cold need is then analyzed to give recommendations for installation. It is usually done by a design office that is an integrated team of the supply company or a consulting firm. Based on the frigorific power, designers will dimension the system (i.e., calculation of the compressor power, the dimension of condenser, needed space for the system) subjected to the operational and financial constraints. The operational constraints are brought by the building structure, for example, the size of the machine room or the available space on the roof. These companies often work with sub-contractors that are the manufacturers of components or systems. The R&D team from the manufacturing companies oversees the development of new components or systems that will meet the market needs (provided by the company marketing teams). They are composed of components designers in charge of drawing the products and providing recommendations and correction of the supplier demand.

Once the system is detailed and approved by the final user, a contract is signed to process the system's manufacture and installation. The handling of a refrigeration system, i.e., the installation, the maintenance, the dismantling, is subject to a set of regulations. Refrigeration engineers or technicians must be certified in order to put into service, maintain or dismantle the system (especially for refrigerant handling).

For the EOL treatment of the RS, EOL parties regroup all the actors that can handle commercial refrigeration systems. It can be eco-organisms (for example, Ecosystem), wastes treatment companies, public authorities in charge of waste treatment.

Around the project, a set of parties will write several regulations regrouped in France's Environmental code. Training facilities, unions, and associations such as the International Institut of Refrigeration, the RPF (Revue professionnelle du Froid) regrouped in the category of professional organisms provide the certifications, regulation watch, and guidelines.

Academic researchers are also external parties that anticipate new technologies through theoretical and experimental projects. They can directly relate with R&D teams or through a technological transfer center to make the technology market-ready.

2.5. *UPsize matrix*

Matrix *UPsize* is the vector assessing the relative size of *User Profiles* segments. The question asked to fill the matrix is: "*What is the relative size of user segments?*"

Academic researcher	1%
Technological transfer centre	1%
Professional organism	1%
R&D researcher	3%
Design office	8%
Consulting firms	5%
Refrigeration engineer	30%
Supplier	20%
Components designer (drawing)	5%
Manufacturer	20%
Final user	5%
EOL treatment parties	1%

From SNEFCCA (Syndicat National des Entreprises du Froid et des équipements en Cuisines professionnelles et Conditionnement de l'Air), 2600 companies for design and installation, maintenance activities (includes supplier, refrigeration engineers/technicians and design offices) are registered.

From RPF (Revue Professionnelle du Froid), 729 companies for manufacturing activities (including R&D, components drawing...) and 20 professional organism, organisms of research and organisms for refrigeration trainings are listed.

From (Evans et al., 2014), we consider that 4-5% of refrigeration production is for commercial use.

3. Appendix 3: Local and global performances assessment implemented in the Geeglee knowledge model

Global or local performances OR Properties	Variable name	Mathematical model
	TRL_Average [level]	("Compressor TRL"+"Condenser TRL"+"Evaporator TRL"+"Expansion valve TRL"+"Pipeline discharge TRL"+"Pipeline suction TRL"+"Refrigerant TRL"+"Material of discharge pipeline TRL"+"Material of suction pipeline TRL")/9
	TRL_Average [level]	("Compressor TRL"+"Condenser TRL"+"Evaporator TRL"+"Expansion valve TRL"+"Pipeline discharge TRL"+"Pipeline suction TRL"+"Refrigerant TRL"+"Material of discharge pipeline TRL"+"Material of suction pipeline TRL"+"Circulation pump TRL"+"Heat exchanger TRL"+"Secondary refrigerant pipeline TRL"+"Secondary refrigerant TRL")/13
	TRL_Average [level]	("Compressor TRL"+"Condenser TRL"+"Evaporator TRL"+"Expansion valve TRL"+"Pipeline discharge TRL"+"Pipeline suction TRL"+"Refrigerant TRL"+"Material of discharge pipeline TRL"+"Material of suction pipeline TRL"+"Transcritical Comperssor TRL"+"Transcritical pipeline suction TRL"+"Transcritical pipeline discharge TRL")/12
	TRL_mean [level]	floor(mean("Compressor TRL","Condenser TRL","Evaporator TRL","Expansion valve TRL","Pipeline discharge TRL","Pipeline suction TRL","Refrigerant TRL","Material of discharge pipeline TRL","Material of suction pipeline TRL"))
	TRL_mean [level]	floor(mean("Compressor TRL","Condenser TRL","Evaporator TRL","Expansion valve TRL","Pipeline discharge TRL","Pipeline suction TRL","Refrigerant TRL","Material of discharge pipeline TRL","Material of suction pipeline TRL","Circulation pump TRL","Heat exchanger TRL","Secondary refrigerant pipeline TRL","Secondary refrigerant TRL"))

	TRL_mean [level]	floor(mean("Compressor TRL","Condenser TRL","Evaporator TRL","Expansion valve TRL","Pipeline discharge TRL","Pipeline suction TRL","Refrigerant TRL","Material of discharge pipeline TRL","Material of suction pipeline TRL","Transcritical Comperssor TRL","Transcritical pipeline suction TRL","Transcritical pipeline discharge TRL"))
	TRL_min [level]	min("Compressor TRL","Condenser TRL","Evaporator TRL","Expansion valve TRL","Pipeline discharge TRL","Pipeline suction TRL","Refrigerant TRL","Material of discharge pipeline TRL","Material of suction pipeline TRL")
	TRL_min [level]	min("Compressor TRL","Condenser TRL","Evaporator TRL","Expansion valve TRL","Pipeline discharge TRL","Pipeline suction TRL","Refrigerant TRL","Material of discharge pipeline TRL","Material of suction pipeline TRL","Circulation pump TRL","Heat exchanger TRL","Secondary refrigerant pipeline TRL","Secondary refrigerant TRL")
	TRL_min [level]	min("Compressor TRL","Condenser TRL","Evaporator TRL","Expansion valve TRL","Pipeline discharge TRL","Pipeline suction TRL","Refrigerant TRL","Material of discharge pipeline TRL","Material of suction pipeline TRL","Transcritical Comperssor TRL","Transcritical pipeline suction TRL","Transcritical pipeline discharge TRL")
	Total storage unit status	"Cold storage unit"."storage unit status"+"Horizontal DC"."storage unit status"+"Vertivcal DC"."storage unit status"
	Total storage unit status	if(('Not selected'="Cold storage unit"."storage unit status") and (('Not selected'="Horizontal DC"."storage unit status" and 'Selected'="Vertivcal DC"."storage unit status") or ('Selected'="Horizontal DC"."storage unit status" and 'Not selected'="Vertivcal DC"."storage unit status"))) then 1 else 0
Circulation pump characteristic	Circulation pump TRL	"Circulation Pump"."Technology Readiness Level [#]"
Circulation pump characteristic	Energy consumption of circulation pump in a year [kWh]	"Number of circulation pumps [#]"*"Circulation Pump"."power consumption [W]"/"Conversion from kW to W [W/kW]"*"no of hours in a day [hrs/day]"*"no of days in a year [days/year]"

Circulation pump characteristic	Number of circulation pumps [#]	$\text{ceil}(\text{"mass flow of secondary refrigerant [kg/s]"/"Circulation Pump"."mass_flow provided by pump [kg/s]"})$
Circulation pump characteristic	velocity of secondary refrigerant required [m/s]	$\text{"volumetric flow of secondary refrigerant [m}^3\text{/s]"/}(\pi \cdot (\text{"secondary refrigerant pipeline"."pipe diameter [m]"/2})^2)$
Compressor characteristics	Compressor TRL	"Compressor"."Technology Readiness Level [#]"
Compressor characteristics	Compressor's available cooling capacity [kW]	"Compressor"."Cooling capacity [kW]"
Compressor characteristics	Compressor's discharge pipe diameter requirement [in]	"Compressor"."Connection discharge line diameter (Dpipeline out) [in]"
Compressor characteristics	Compressor's requirement for Condenser capacity [kW]	$\text{if}(\text{'CO2 compatible'} \neq \text{"Compressor"."Refrigerant compatibility"}) \text{ then "Compressor"."Needed Condenser capacity [kW]" else 0}$
Compressor characteristics	Compressor's suction pipe diameter requirement [in]	"Compressor"."Connection suction line diameter (Dpipeline in) [in]"
Compressor characteristics	Margin on compressor sizing (%)	$(\text{ceil}(\text{"Frigorific power for all CS and DC [kW]"/"Compressor"."Cooling capacity [kW]"})-(\text{"Frigorific power for all CS and DC [kW]"/"Compressor"."Cooling capacity [kW]})) \cdot 100$
Compressor characteristics	Number of compressors [#]	$\text{ceil}(\text{"Required compressor capacity for the refrigeration system [kW]"/"Compressor"."Cooling capacity [kW]"})$
Compressor characteristics	Required compressor capacity for the refrigeration system [kW]	"Frigorific power for all CS and DC [kW]"
Compressor characteristics	Required compressor capacity for the refrigeration system [kW]	"Frigorific power for one horizontal DC [kW]"+"Frigorific power for one vertical DC [kW]"
Condenser characteristics	Condenser TRL	"Condenser"."Technology Readiness Level [#]"
Condenser characteristics	Condenser's available capacity [kW]	"Condenser"."Condenser capacity [kW]"

Condenser characteristics	Number of condensers [#]	$\text{if}(0 = \text{"Condenser's available capacity [kW]"} \text{ then } 0 \text{ else } \text{ceil}(\frac{\text{"Compressor's requirement for Condenser capacity [kW]} * \text{"Number of compressors [#]}}{\text{"Condenser's available capacity [kW]}})$
Constants	Conversion from kW to W [W/kW]	1000
Constants	Conversion from kW to kJ [kW/kJ]	3600
Constants	Conversion from kg to Ton [Ton/kg]	1/1000
Constants	Conversion from mm to m [m/mm]	1/1000
Constants	conversion factor W to kW [kW/W]	1/1000
Constants	conversion from MW to kW [kW/MW]	1000
Constants	conversion from kW to MW [MW/kW]	1/1000
Cost	CAPEX [Euros]	"Cost of compressor component [Euros]"+"Cost of condenser component [Euros]"+"Cost of evaporator component [Euros]"+"Cost of expansion valve component [Euros]"+"Cost of entire pipeline for the refrigeration system (discharge +suction) [Euros]"
Cost	CAPEX [Euros]	"Cost of compressor component [Euros]"+"Cost of condenser component [Euros]"+"Cost of evaporator component [Euros]"+"Cost of expansion valve component [Euros]"+"Cost of entire pipeline for the refrigeration system (discharge +suction) [Euros]"+"Cost of secondary refrigerant discharge pipeline for the refrigeration system [Euros]"+"Cost of secondary refrigerant suction pipeline for the refrigeration system [Euros]"+"Cost of heat exchanger component [Euros]"+"Cost of circulation pump [Euros]"
Cost	CAPEX [Euros]	"Cost of compressor component [Euros]"+"Cost of condenser component [Euros]"+"Cost of evaporator component [Euros]"+"Cost of expansion valve component [Euros]"+"Cost of entire pipeline for the refrigeration system (discharge +suction) [Euros]"+"Cost of Transcritical compressor [Euros]"+"Cost of entire TC pipeline for the refrigeration system (discharge +suction) [Euros]"

Cost	Cost of Transcritical compressor [Euros]	"cost compressor per unit energy [Euros/kW]"*"Transcritical compressor". "Cooling capacity [kW]"*"Number of transcritical compressors [#]"
Cost	Cost of circulation pump [Euros]	"Number of circulation pumps [#]"*"Circulation Pump". "component cost [Euros]"
Cost	Cost of compressor component [Euros]	"cost compressor per unit energy [Euros/kW]"*"Compressor's available cooling capacity [kW]"*"Number of compressors [#]"
Cost	Cost of compressor component [Euros]	"cost compressor per unit energy [Euros/kW]"*"Compressor's available cooling capacity [kW]"*("Number of compressors [#]"+"Number of Vertical Display Cabinet [#]"+"Number of horizontal Display Cabinets [#]")
Cost	Cost of condenser component [Euros]	"cost condenser per unit energy [Euros/kW]"*"Condenser's available capacity [kW]"*"Number of condensers [#]"
Cost	Cost of condenser component [Euros]	"cost condenser per unit energy [Euros/kW]"*"Condenser's available capacity [kW]"*("Number of condensers [#]"+"Number of Vertical Display Cabinet [#]"+"Number of horizontal Display Cabinets [#]")
Cost	Cost of discharge pipeline for the refrigeration system [Euros]	"Mass of all discharge pipes [kg]"*"pipeline discharge material". "cost per kg [Euros/kg]"
Cost	Cost of electricity consumed per year by the refrigeration system [Euros]	"Location_data". "cost of electricity during day time [Euros/kWh]"*("Yearly energy consumption of all CS and DC [MWh]"*"conversion from MW to kW [kW/MW]")+"Location_data". "cost of electricity during night time [Euros/kWh]"*("Yearly energy consumption of all CS and DC [MWh]"*"conversion from MW to kW [kW/MW]")
Cost	Cost of electricity consumed per year by the refrigeration system [Euros]	"Location_data". "cost of electricity during day time [Euros/kWh]"*(("Yearly energy consumption of all CS and DC [MWh]"*"conversion from MW to kW [kW/MW]")+("Energy consumption of circulation pump in a year [kWh]"/2))+"Location_data". "cost of electricity during night time [Euros/kWh]"*("Yearly energy consumption of all CS and DC [MWh]"*"conversion from MW to kW [kW/MW]")+("Energy consumption of circulation pump in a year [kWh]"/2)

Cost	Cost of entire pipeline for the refrigeration system (discharge +suction) [Euros]	"Cost of discharge pipeline for the refrigeration system [Euros]"+"Cost of suction pipeline for the refrigeration system [Euros]"
Cost	Cost of entire pipeline for the refrigeration system (discharge +suction) [Euros]	("Cost of discharge pipeline for the refrigeration system [Euros]"+"Cost of suction pipeline for the refrigeration system [Euros]")*("Number of Vertical Display Cabinet [#]"+"Number of horizontal Display Cabinets [#]")
Cost	Cost of evaporator component [Euros]	"cost evaporator per unit energy [Euros/kW]"*"Compressor"."Evaporator capacity [kW]"*"Number of evaporators [#]"
Cost	Cost of expansion valve component [Euros]	"cost expansion valve per unit [Euros]"*"Number of expansion valves [#]"
Cost	Cost of heat exchanger component [Euros]	"cooling capacity of Heat exchanger in secondary loop required by the evaporator [kW]"*"cost heat exchanger per unit energy [Euros/kW]"
Cost	Cost of refrigerant for the entire system lifetime [Euros]	"Mass of refrigerant in the overall lifecycle [kg]"*"Refrigerant"."cost per kg [Euros/kg]"
Cost	Cost of refrigerant for the entire system lifetime [Euros]	("Mass of refrigerant in the overall lifecycle [kg]"*"Refrigerant"."cost per kg [Euros/kg]")*("Number of Vertical Display Cabinet [#]"+"Number of horizontal Display Cabinets [#]")
Cost	Cost of secondary refrigerant [Euros]	"Total mass of secondary refrigerant"*"secondary refrigerant"."cost per kg [Euros/kg]"
Cost	Cost of secondary refrigerant discharge pipeline for the refrigeration system [Euros]	"mass of secondary refrigerant discharge pipe [kg]"*"pipeline discharge material"."cost per kg [Euros/kg]"
Cost	Cost of secondary refrigerant suction pipeline for the refrigeration system [Euros]	"mass of secondary refrigerant suction pipe [kg]"*"pipeline suction material"."cost per kg [Euros/kg]"
Cost	Cost of suction pipeline for the refrigeration system [Euros]	"Mass of all suction pipe [kg]"*"pipeline suction material"."cost per kg [Euros/kg]"
Cost	OPEX [Euros]	"Cost of refrigerant for the entire system lifetime [Euros]"+"Cost of electricity consumed per year by the refrigeration system [Euros]"*"System life time [yrs]"*((1-(1+("inflation rate [%]"/100)-("Profit rate [%]"/100)))^(-"System life time [yrs]"))/((("inflation rate [%]"/100)-("Profit rate [%]"/100)))

Cost	OPEX [Euros]	"Cost of refrigerant for the entire system lifetime [Euros]"+"Cost of secondary refrigerant [Euros]"+"Cost of electricity consumed per year by the refrigeration system [Euros]"*"System life time [yrs]"*((1-(1+((("inflation rate [%]"/100)-("Profit rate [%]"/100))))^(-"System life time [yrs]"))/((("inflation rate [%]"/100)-("Profit rate [%]"/100)))
Cost	Total cost of refrigeration system for entire lifetime [Euros]	"CAPEX [Euros]"/"no of years of investment [#]"+"OPEX [Euros]"
Cost	cost of total secondary refrigerant pipeline [Euros]	"Cost of secondary refrigerant discharge pipeline for the refrigeration system [Euros]"+"Cost of secondary refrigerant suction pipeline for the refrigeration system [Euros]"
CS Characteristics	Nb of doors opening per day for CS [#]	(if("T_set [°C]">0) then 0.0311 else 0.0303)*("Cold storage unit"."V_room [m^3]"^2)-(if("T_set [°C]">0) then 1.9426 else 1.8178)*("Cold storage unit"."V_room [m^3]")+ (if("T_set [°C]">0) then 46.441 else 40.124)
CS Characteristics	Number of Cold Storage units [#]	if('NO Cold Storage Unit'="Cold storage unit"."name") then 0 else "Number of CS units [#]"
CS Energy Consumption	Frigorific power for CS [kW]	max("Frigorific power for CS during closed time [kW]","Frigorific power for one CS during working time [kW]")
CS Energy Consumption	Frigorific power for CS during closed time [kW]	frigorific_power("Hourly Q_dot_ColdStorage [kW]","pinch_h [°C]","eta [#]","T_c [°C]","Location_data"."01 Jan_Min_temp [°C]","Location_data"."02 Feb_Min_temp [°C]","Location_data"."03 Mar_Min_temp [°C]","Location_data"."04 April_Min_temp [°C]","Location_data"."05 May_Min_temp [°C]","Location_data"."06 Jun_Min_temp [°C]","Location_data"."07 Jul_Min_temp [°C]","Location_data"."08 Aug_Min_temp [°C]","Location_data"."09 Sep_Min_temp [°C]","Location_data"."10 Oct_Min_temp [°C]","Location_data"."11 Nov_Min_temp [°C]","Location_data"."12 Dec_Min_temp [°C]")

CS Energy Consumption	Frigorific power for CS during closed time [kW]	frigorific_power("Hourly Q_dot_ColdStorage [kW]", "pinch_h [°C]", "eta [#]", "T_c [°C]", "Location_data"."01 Jan_Min_temp [°C]", "Location_data"."02 Feb_Min_temp [°C]", "Location_data"."03 Mar_Min_temp [°C]", "Location_data"."04 April_Min_temp [°C]", "Location_data"."05 May_Min_temp [°C]", "Location_data"."06 Jun_Min_temp [°C]", "Location_data"."07 Jul_Min_temp [°C]", "Location_data"."08 Aug_Min_temp [°C]", "Location_data"."09 Sep_Min_temp [°C]", "Location_data"."10 Oct_Min_temp [°C]", "Location_data"."11 Nov_Min_temp [°C]", "Location_data"."12 Dec_Min_temp [°C]")
CS Energy Consumption	Frigorific power for all CS [kW]	"Frigorific power for CS [kW]"*"Number of CS units [#]"
CS Energy Consumption	Frigorific power for all CS and DC [kW]	"Frigorific power for all CS [kW]"+"Frigorific power for all horizontal DC [kW]"+"Frigorific power for all vertical DC [kW]"
CS Energy Consumption	Frigorific power for one CS during working time [kW]	frigorific_power("Hourly Q_dot_ColdStorage [kW]", "pinch_h [°C]", "eta [#]", "T_c [°C]", "Location_data"."01 Jan_Max_temp [°C]", "Location_data"."02 Feb_Max_temp [°C]", "Location_data"."03 Mar_Max_temp [°C]", "Location_data"."04 April_Max_temp [°C]", "Location_data"."05 May_Max_temp [°C]", "Location_data"."06 Jun_Max_temp [°C]", "Location_data"."07 Jul_Max_temp [°C]", "Location_data"."08 Aug_Max_temp [°C]", "Location_data"."09 Sep_Max_temp [°C]", "Location_data"."10 Oct_Max_temp [°C]", "Location_data"."11 Nov_Max_temp [°C]", "Location_data"."12 Dec_Max_temp [°C]")
CS Energy Consumption	Hourly Q_dot_Airex [kW]	"V_airex [m ³ /hrs]"*"delta_h x phi [Wh/m ³]" / "Conversion from kW to W [W/kW]"
CS Energy Consumption	Hourly Q_dot_ColdStorage [kW]	"Hourly Q_dot_Airex [kW]"+"Hourly Q_dot_light [kW]"+"Hourly Q_dot_people [kW]"+"Hourly Q_dot_food for CS [kW]"+"Hourly Q_dot_trans [kW]"
CS Energy Consumption	Hourly Q_dot_ColdStorage [kW]	0

CS Energy Consumption	Hourly Q_dot_food for CS [kW]	if('NO Cold Storage Unit'="Cold storage unit"."name") then 0 else "Stored food in cold storage"."mass flow [kg/m ³]/"Stored food in cold storage"."rho_pr [kg/m ³]"*("Stored food in cold storage"."Delta_H [kJ/kg]"/"Conversion from kW to kJ [kW/kJ]")*"Mass of food inside each CS [kg]"*(1/"no of hours in a day [hrs/day]")
CS Energy Consumption	Hourly Q_dot_light [kW]	("Cold storage unit"."Heat_light [W/m ²]/"Conversion from kW to W [W/kW]")*("Cold storage unit"."A_floor [m ² "])
CS Energy Consumption	Hourly Q_dot_people [kW]	"Hourly Q_dot_people during working time [kW]"+"Hourly Q_dot_people during opening time [kW]"
CS Energy Consumption	Hourly Q_dot_people during opening time [kW]	if('NO Cold Storage Unit'="Cold storage unit"."name") then 0 else "Nb of people coming during opening time [#]"*("People heat during opening time [W]"/"Conversion from kW to W [W/kW]"
CS Energy Consumption	Hourly Q_dot_people during working time [kW]	if('NO Cold Storage Unit'="Cold storage unit"."name") then 0 else "Nb of people coming during working time [#]"*("People heat during working time [W]"/"Conversion from kW to W [W/kW]"
CS Energy Consumption	Hourly Q_dot_trans [kW]	((("Cold storage unit"."U_sidewall [W/m ² .K]"/"Conversion from kW to W [W/kW]""Cold storage unit"."A_sidewall [m ² "])+("Cold storage unit"."U_floor [W/m ² .K]"/"Conversion from kW to W [W/kW]""Cold storage unit"."A_floor [m ² "]))*("Supermarket"."Ambient temperature [°C]"-"T_set [°C]")
CS Energy Consumption	T_c [°C]	"T_set [°C]"-"pinch_c [°C]"
CS Energy Consumption	T_set [°C]	"Setpoint temperature"."setpoint temperature [°C]"
CS Energy Consumption	Total energy consumption by the refrigeration system [MWh]	"Yearly energy consumption of all CS and DC [MWh]"
CS Energy Consumption	Total energy consumption by the refrigeration system [MWh]	"Yearly energy consumption of all CS and DC [MWh]"+"Energy consumption of circulation pump in a year [kWh]"*conversion from kW to MW [MW/kW]"

CS Energy Consumption	Total energy consumption by the refrigeration system [MWh]	"Yearly energy consumption of all CS and DC [MWh]"+"TC_Yearly energy consumption of all CS and DC [MWh]"
CS Energy Consumption	V_airex [m ³ /hrs]	"Nb of doors opening per day for CS [#]"*"Cold storage unit"."V_room [m ³]/("no of hours in a day [hrs/day]")
CS Energy Consumption	Yearly energy consumption of CS in closed time [kWh]	Energy_consumption_CS("Hourly Q_dot_ColdStorage [kW]", "pinch_h [°C]", "eta [#]", "T_c [°C]", "No of days used in a month (31) [days]", "No of days used in a month (28) [days]", "No of days used in a month (30) [days]", "Supermarket's Closed time [hrs]", "Location_data"."01 Jan_Min_temp [°C]", "Location_data"."02 Feb_Min_temp [°C]", "Location_data"."03 Mar_Min_temp [°C]", "Location_data"."04 April_Min_temp [°C]", "Location_data"."05 May_Min_temp [°C]", "Location_data"."06 Jun_Min_temp [°C]", "Location_data"."07 Jul_Min_temp [°C]", "Location_data"."08 Aug_Min_temp [°C]", "Location_data"."09 Sep_Min_temp [°C]", "Location_data"."10 Oct_Min_temp [°C]", "Location_data"."11 Nov_Min_temp [°C]", "Location_data"."12 Dec_Min_temp [°C]")
CS Energy Consumption	Yearly energy consumption of CS in working time [kWh]	Energy_consumption_CS("Hourly Q_dot_ColdStorage [kW]", "pinch_h [°C]", "eta [#]", "T_c [°C]", "No of days used in a month (31) [days]", "No of days used in a month (28) [days]", "No of days used in a month (30) [days]", "Supermarket's Working time [hrs]", "Location_data"."01 Jan_Max_temp [°C]", "Location_data"."02 Feb_Max_temp [°C]", "Location_data"."03 Mar_Max_temp [°C]", "Location_data"."04 April_Max_temp [°C]", "Location_data"."05 May_Max_temp [°C]", "Location_data"."06 Jun_Max_temp [°C]", "Location_data"."07 Jul_Max_temp [°C]", "Location_data"."08 Aug_Max_temp [°C]", "Location_data"."09 Sep_Max_temp [°C]", "Location_data"."10 Oct_Max_temp [°C]", "Location_data"."11 Nov_Max_temp [°C]", "Location_data"."12 Dec_Max_temp [°C]")

CS Energy Consumption	Yearly energy consumption of all CS and DC [MWh]	"Yearly energy consumption of all CS and DC in closed time [MWh]"+"Yearly energy consumption of all CS and DC in working time [MWh]"
CS Energy Consumption	Yearly energy consumption of all CS and DC in closed time [MWh]	("Yearly energy consumption of CS in closed time [kWh]"*"Number of CS units [#]"+"Yearly energy consumption of defrost in closed time [kWh]"*("Number of Vertical DC [#]"+"Number of horizontal DC [#]")+ "Yearly energy consumption of horizontal DC in closed time [kWh]"*"Number of horizontal DC [#]"+"Yearly energy consumption of vertical DC in closed time [kWh]"*"Number of Vertical DC [#]*)"conversion from kW to MW [MW/kW]"
CS Energy Consumption	Yearly energy consumption of all CS and DC in working time [MWh]	("Yearly energy consumption of CS in working time [kWh]"*"Number of CS units [#]"+"Yearly energy consumption of defrost in working time [kWh]"*("Number of Vertical DC [#]"+"Number of horizontal DC [#]")+ "Yearly energy consumption of horizontal DC in working time [kWh]"*"Number of horizontal DC [#]"+"Yearly energy consumption of vertical DC in working time [kWh]"*"Number of Vertical DC [#]*)"conversion from kW to MW [MW/kW]"
CS Energy Consumption	$\Delta T \times \phi$ [Wh/m ³]	$(-0.0011) * (T_{set} [^{\circ}C])^2 - (0.6231) * (T_{set} [^{\circ}C]) + (17.245)$
DC Characteristics	Number of Vertical Display Cabinet [#]	if('NO Vertical Display Cabinet'="Vertical DC"."name") then 0 else "Number of Vertical DC [#]"
DC Characteristics	Number of horizontal Display Cabinets [#]	if('NO Horizontal Display Cabinet'="Horizontal DC"."name") then 0 else "Number of horizontal DC [#]"
DC Energy consumption	Frigorific power for all horizontal DC [kW]	"Frigorific power for one horizontal DC [kW]"*"Number of horizontal DC [#]"
DC Energy consumption	Frigorific power for all vertical DC [kW]	"Frigorific power for one vertical DC [kW]"*"Number of Vertical DC [#]"
DC Energy consumption	Frigorific power for one horizontal DC [kW]	max("Frigorific power for one horizontal DC during closed time [kW]", "Frigorific power for one horizontal DC during working time [kW]")

DC Energy consumption	Frigorific power for one horizontal DC during closed time [kW]	frigorific_power("Hourly Q_night_hor [kW]","pinch_h [°C]","eta [#]","T_c [°C]","Location_data"."01 Jan_Min_temp [°C]","Location_data"."02 Feb_Min_temp [°C]","Location_data"."03 Mar_Min_temp [°C]","Location_data"."04 April_Min_temp [°C]","Location_data"."05 May_Min_temp [°C]","Location_data"."06 Jun_Min_temp [°C]","Location_data"."07 Jul_Min_temp [°C]","Location_data"."08 Aug_Min_temp [°C]","Location_data"."09 Sep_Min_temp [°C]","Location_data"."10 Oct_Min_temp [°C]","Location_data"."11 Nov_Min_temp [°C]","Location_data"."12 Dec_Min_temp [°C]")
DC Energy consumption	Frigorific power for one horizontal DC during closed time [kW]	frigorific_power("Hourly Q_night_hor [kW]","pinch_h [°C]","eta [#]","T_c [°C]","Supermarket"."Ambient temperature [°C]",0,0,0,0,0,0,0,0,0,0)
DC Energy consumption	Frigorific power for one horizontal DC during working time [kW]	frigorific_power("Hourly Q_day_hor [kW]","pinch_h [°C]","eta [#]","T_c [°C]","Location_data"."01Jan_Max_temp [°C]","Location_data"."02 Feb_Max_temp [°C]","Location_data"."03 Mar_Max_temp [°C]","Location_data"."04 April_Max_temp [°C]","Location_data"."05 May_Max_temp [°C]","Location_data"."06 Jun_Max_temp [°C]","Location_data"."07 Jul_Max_temp [°C]","Location_data"."08 Aug_Max_temp [°C]","Location_data"."09 Sep_Max_temp [°C]","Location_data"."10 Oct_Max_temp [°C]","Location_data"."11 Nov_Max_temp [°C]","Location_data"."12 Dec_Max_temp [°C]")
DC Energy consumption	Frigorific power for one horizontal DC during working time [kW]	frigorific_power("Hourly Q_day_hor [kW]","pinch_h [°C]","eta [#]","T_c [°C]","Supermarket"."Ambient temperature [°C]",0,0,0,0,0,0,0,0,0,0)
DC Energy consumption	Frigorific power for one vertical DC [kW]	max("Frigorific power for one vertical DC during closed time [kW]","Frigorific power for one vertical DC during working time [kW]")

DC Energy consumption	Frigorific power for one vertical DC during closed time [kW]	frigorific_power("Hourly Q_night_ver [kW]","pinch_h [°C]","eta [#]","T_c [°C]","Location_data"."01 Jan_Min_temp [°C]","Location_data"."02 Feb_Min_temp [°C]","Location_data"."03 Mar_Min_temp [°C]","Location_data"."04 April_Min_temp [°C]","Location_data"."05 May_Min_temp [°C]","Location_data"."06 Jun_Min_temp [°C]","Location_data"."07 Jul_Min_temp [°C]","Location_data"."08 Aug_Min_temp [°C]","Location_data"."09 Sep_Min_temp [°C]","Location_data"."10 Oct_Min_temp [°C]","Location_data"."11 Nov_Min_temp [°C]","Location_data"."12 Dec_Min_temp [°C]")
DC Energy consumption	Frigorific power for one vertical DC during closed time [kW]	frigorific_power("Hourly Q_night_ver [kW]","pinch_h [°C]","eta [#]","T_c [°C]","Supermarket"."Ambient temperature [°C]",0,0,0,0,0,0,0,0,0,0)
DC Energy consumption	Frigorific power for one vertical DC during working time [kW]	frigorific_power("Hourly Q_day_ver [kW]","pinch_h [°C]","eta [#]","T_c [°C]","Location_data"."01Jan_Max_temp [°C]","Location_data"."02 Feb_Max_temp [°C]","Location_data"."03 Mar_Max_temp [°C]","Location_data"."04 April_Max_temp [°C]","Location_data"."05 May_Max_temp [°C]","Location_data"."06 Jun_Max_temp [°C]","Location_data"."07 Jul_Max_temp [°C]","Location_data"."08 Aug_Max_temp [°C]","Location_data"."09 Sep_Max_temp [°C]","Location_data"."10 Oct_Max_temp [°C]","Location_data"."11 Nov_Max_temp [°C]","Location_data"."12 Dec_Max_temp [°C]")
DC Energy consumption	Frigorific power for one vertical DC during working time [kW]	frigorific_power("Hourly Q_day_ver [kW]","pinch_h [°C]","eta [#]","T_c [°C]","Supermarket"."Ambient temperature [°C]",0,0,0,0,0,0,0,0,0,0)
DC Energy consumption	Hourly Q_day_hor [kW]	"Hourly Q_wall_hor [kW]"+"Horizontal DC"."Q_hw [w]"*conversion factor W to kW [kW/W]"+"Horizontal DC"."Q_lighting [W]"*conversion factor W to kW [kW/W]"+"Hourly Q_infiltration_day_hor [kW]"+"Hourly Q_radiation_day_hor [kW]"+"Horizontal DC"."Q_fan [W]"*conversion factor W to kW [kW/W]"+"Hourly Q_dot_food for DC_hor [kW]"

DC Energy consumption	Hourly Q_day_ver [kW]	"Hourly Q_wall_ver [kW]"+"Vertivcal DC"."Q_hw [w]"*"conversion factor W to kW [kW/W]"+"Vertivcal DC"."Q_lighting [W]"*"conversion factor W to kW [kW/W]"+"Hourly Q_infiltration_day_ver [kW]"+"Hourly Q_radiation_day_ver[kW]"+"Vertivcal DC"."Q_fan [W]"*"conversion factor W to kW [kW/W]"+"Hourly Q_dot_food for Dc_ver [kW]"
DC Energy consumption	Hourly Q_dot_food for DC_hor [kW]	if('NO Horizontal Display Cabinet'="Horizontal DC"."name") then 0 else "Stored food in display cabinet"."mass flow [kg/m^3]"/"Stored food in display cabinet"."rho_pr [kg/m^3]"*(("Stored food in display cabinet"."Delta_H [kJ/kg]"/"Conversion from kW to kJ [kW/kJ]"*)"Mass of food inside each DC horizontal [kg]"*(1/"no of hours in a day [hrs/day]"
DC Energy consumption	Hourly Q_dot_food for Dc_ver [kW]	if('NO Vertical Display Cabinet'="Vertivcal DC"."name") then 0 else "Stored food in cold storage"."mass flow [kg/m^3]"/"Stored food in cold storage"."rho_pr [kg/m^3]"*(("Stored food in cold storage"."Delta_H [kJ/kg]"/"Conversion from kW to kJ [kW/kJ]"*)"Mass of food inside each DC vertical [kg]"*(1/"no of hours in a day [hrs/day]"
DC Energy consumption	Hourly Q_infiltration_day_hor [kW]	"Horizontal DC"."X_(air_curtain) [#]"*"Horizontal DC"."V_(air_curtain) [kg/s]"*(("Supermarket"."h_ambience [kJ/kg]"-"Setpoint temperature"."h_inside [kJ/kg]")
DC Energy consumption	Hourly Q_infiltration_day_ver [kW]	"Vertivcal DC"."X_(air_curtain) [#]"*"Vertivcal DC"."V_(air_curtain) [kg/s]"*(("Supermarket"."h_ambience [kJ/kg]"-"Setpoint temperature"."h_inside [kJ/kg]")
DC Energy consumption	Hourly Q_infiltration_night_hor [kW]	"Horizontal DC"."U_air_curtainDC [W/m^2.K]"*"conversion factor W to kW [kW/W]"*"Horizontal DC"."A_air curtainDC [m^2]"*(("Supermarket"."Ambient temperature [°C]"-"Setpoint temperature"."setpoint temperature [°C]"
DC Energy consumption	Hourly Q_infiltration_night_ver [kW]	"Vertivcal DC"."U_air_curtainDC [W/m^2.K]"*"conversion factor W to kW [kW/W]"*"Vertivcal DC"."A_air curtainDC [m^2]"*(("Supermarket"."Ambient temperature [°C]"-"Setpoint temperature"."setpoint temperature [°C]"

DC Energy consumption	Hourly Q_night_hor [kW]	"Hourly Q_wall_hor [kW]"+"Horizontal DC"."Q_hw [w]"*"conversion factor W to kW [kW/W]"+"Hourly Q_infiltration_night_hor [kW]"+"Horizontal DC"."Q_fan [W]"*"conversion factor W to kW [kW/W]"+"Hourly Q_dot_food for DC_hor [kW]"
DC Energy consumption	Hourly Q_night_ver [kW]	"Hourly Q_wall_ver [kW]"+"Vertical DC"."Q_hw [w]"*"conversion factor W to kW [kW/W]"+"Hourly Q_infiltration_night_ver [kW]"+"Vertical DC"."Q_fan [W]"*"conversion factor W to kW [kW/W]"+"Hourly Q_dot_food for Dc_ver [kW]"
DC Energy consumption	Hourly Q_radiation_day_hor [kW]	"Horizontal DC"."hro [W/m ² K]"*"conversion factor W to kW [kW/W]"*"Horizontal DC"."A_door [m ²]"*("Horizontal DC"."T_wall [°C]"-"Setpoint temperature"."setpoint temperature [°C]")*"Horizontal DC"."phi_1 [#]"*"Horizontal DC"."phi_2 [#]"
DC Energy consumption	Hourly Q_radiation_day_ver[kW]	"Vertical DC"."hro [W/m ² K]"*"conversion factor W to kW [kW/W]"*"Vertical DC"."A_door [m ²]"*("Vertical DC"."T_wall [°C]"-"Setpoint temperature"."setpoint temperature [°C]")*"Vertical DC"."phi_1 [#]"*"Vertical DC"."phi_2 [#]"
DC Energy consumption	Hourly Q_wall_hor [kW]	"Horizontal DC"."U_wallDC [W/m ² .K]"*"conversion factor W to kW [kW/W]"*"Horizontal DC"."A_wallDC [m ²]"*("Supermarket"."Ambient temperature [°C]"-"Setpoint temperature"."setpoint temperature [°C]")
DC Energy consumption	Hourly Q_wall_ver [kW]	"Vertical DC"."U_wallDC [W/m ² .K]"*"conversion factor W to kW [kW/W]"*"Vertical DC"."A_wallDC [m ²]"*("Supermarket"."Ambient temperature [°C]"-"Setpoint temperature"."setpoint temperature [°C]")

DC Energy consumption	Yearly energy consumption of defrost in closed time [kWh]	<pre> if("Number of Vertical Display Cabinet [#]"=0 and "Number of horizontal Display Cabinets [#]"=0) then 0 else Energy_consumption_DC_defrost("Q_dot_defrost for one time [kW]","pinch_h [°C]","eta [#]","T_c [°C]","No of days used in a month (31) [days]","No of days used in a month (28) [days]","No of days used in a month (30) [days]","time for each defrost [hrs]","number of defrosts in closed time [#]","Location_data"."01 Jan_Min_temp [°C]","Location_data"."02 Feb_Min_temp [°C]","Location_data"."03 Mar_Min_temp [°C]","Location_data"."04 April_Min_temp [°C]","Location_data"."05 May_Min_temp [°C]","Location_data"."06 Jun_Min_temp [°C]","Location_data"."07 Jul_Min_temp [°C]","Location_data"."08 Aug_Min_temp [°C]","Location_data"."09 Sep_Min_temp [°C]","Location_data"."10 Oct_Min_temp [°C]","Location_data"."11 Nov_Min_temp [°C]","Location_data"."12 Dec_Min_temp [°C]") </pre>
-----------------------	---	---

DC Energy consumption	Yearly energy consumption of defrost in working time [kWh]	<pre> if("Number of Vertical Display Cabinet [#]"=0 and "Number of horizontal Display Cabinets [#]"=0) then 0 else Energy_consumption_DC_defrost("Q_dot_defrost for one time [kW]","pinch_h [°C]","eta [#]","T_c [°C]","No of days used in a month (31) [days]","No of days used in a month (28) [days]","No of days used in a month (30) [days]","time for each defrost [hrs]","number of defrosts in working time [#]","Location_data"."01Jan_Max_temp [°C]","Location_data"."02 Feb_Max_temp [°C]","Location_data"."03 Mar_Max_temp [°C]","Location_data"."04 April_Max_temp [°C]","Location_data"."05 May_Max_temp [°C]","Location_data"."06 Jun_Max_temp [°C]","Location_data"."07 Jul_Max_temp [°C]","Location_data"."08 Aug_Max_temp [°C]","Location_data"."09 Sep_Max_temp [°C]","Location_data"."10 Oct_Max_temp [°C]","Location_data"."11 Nov_Max_temp [°C]","Location_data"."12 Dec_Max_temp [°C]") </pre>
-----------------------	--	---

DC Energy consumption	Yearly energy consumption of horizontal DC in closed time [kWh]	<p>Energy_consumption_DC("Hourly Q_night_hor [kW]","pinch_h [°C]","eta [#]","T_c [°C]","No of days used in a month (31) [days]","No of days used in a month (28) [days]","No of days used in a month (30) [days]","Supermarket's Closed time [hrs]","time for each defrost [hrs]","number of defrosts in closed time [#]","Location_data"."01 Jan_Min_temp [°C]","Location_data"."02 Feb_Min_temp [°C]","Location_data"."03 Mar_Min_temp [°C]","Location_data"."04 April_Min_temp [°C]","Location_data"."05 May_Min_temp [°C]","Location_data"."06 Jun_Min_temp [°C]","Location_data"."07 Jul_Min_temp [°C]","Location_data"."08 Aug_Min_temp [°C]","Location_data"."09 Sep_Min_temp [°C]","Location_data"."10 Oct_Min_temp [°C]","Location_data"."11 Nov_Min_temp [°C]","Location_data"."12 Dec_Min_temp [°C]")</p>
DC Energy consumption	Yearly energy consumption of horizontal DC in closed time [kWh]	<p>Energy_consumption_DC("Hourly Q_night_hor [kW]","pinch_h [°C]","eta [#]","T_c [°C]","No of days used in a month (31) [days]","No of days used in a month (28) [days]","No of days used in a month (30) [days]","Supermarket's Closed time [hrs]","time for each defrost [hrs]","number of defrosts in closed time [#]","Supermarket"."Ambient temperature [°C]",0,0,0,0,0,0,0,0,0,0)</p>

DC Energy consumption	Yearly energy consumption of horizontal DC in working time [kWh]	<p>Energy_consumption_DC("Hourly Q_day_hor [kW]","pinch_h [°C]","eta [#]","T_c [°C]","No of days used in a month (31) [days]","No of days used in a month (28) [days]","No of days used in a month (30) [days]","Supermarket's Working time [hrs]","time for each defrost [hrs]","number of defrosts in working time [#]","Location_data"."01Jan_Max_temp [°C]","Location_data"."02 Feb_Max_temp [°C]","Location_data"."03 Mar_Max_temp [°C]","Location_data"."04 April_Max_temp [°C]","Location_data"."05 May_Max_temp [°C]","Location_data"."06 Jun_Max_temp [°C]","Location_data"."07 Jul_Max_temp [°C]","Location_data"."08 Aug_Max_temp [°C]","Location_data"."09 Sep_Max_temp [°C]","Location_data"."10 Oct_Max_temp [°C]","Location_data"."11 Nov_Max_temp [°C]","Location_data"."12 Dec_Max_temp [°C]")</p>
DC Energy consumption	Yearly energy consumption of horizontal DC in working time [kWh]	<p>Energy_consumption_DC("Hourly Q_day_hor [kW]","pinch_h [°C]","eta [#]","T_c [°C]","No of days used in a month (31) [days]","No of days used in a month (28) [days]","No of days used in a month (30) [days]","Supermarket's Working time [hrs]","time for each defrost [hrs]","number of defrosts in working time [#]","Supermarket"."Ambient temperature [°C]",0,0,0,0,0,0,0,0,0,0)</p>

DC Energy consumption	Yearly energy consumption of vertical DC in closed time [kWh]	<p>Energy_consumption_DC("Hourly Q_night_ver [kW]","pinch_h [°C]","eta [#]","T_c [°C]","No of days used in a month (31) [days]","No of days used in a month (28) [days]","No of days used in a month (30) [days]","Supermarket's Closed time [hrs]","time for each defrost [hrs]","number of defrosts in closed time [#]","Location_data"."01 Jan_Min_temp [°C]","Location_data"."02 Feb_Min_temp [°C]","Location_data"."03 Mar_Min_temp [°C]","Location_data"."04 April_Min_temp [°C]","Location_data"."05 May_Min_temp [°C]","Location_data"."06 Jun_Min_temp [°C]","Location_data"."07 Jul_Min_temp [°C]","Location_data"."08 Aug_Min_temp [°C]","Location_data"."09 Sep_Min_temp [°C]","Location_data"."10 Oct_Min_temp [°C]","Location_data"."11 Nov_Min_temp [°C]","Location_data"."12 Dec_Min_temp [°C]")</p>
DC Energy consumption	Yearly energy consumption of vertical DC in closed time [kWh]	<p>Energy_consumption_DC("Hourly Q_night_ver [kW]","pinch_h [°C]","eta [#]","T_c [°C]","No of days used in a month (31) [days]","No of days used in a month (28) [days]","No of days used in a month (30) [days]","Supermarket's Closed time [hrs]","time for each defrost [hrs]","number of defrosts in closed time [#]","Supermarket"."Ambient temperature [°C]",0,0,0,0,0,0,0,0,0,0)</p>

DC Energy consumption	Yearly energy consumption of vertical DC in working time [kWh]	Energy_consumption_DC("Hourly Q_day_ver [kW]","pinch_h [°C]","eta [#]","T_c [°C]","No of days used in a month (31) [days]","No of days used in a month (28) [days]","No of days used in a month (30) [days]","Supermarket's Working time [hrs]","time for each defrost [hrs]","number of defrosts in working time [#]","Location_data"."01Jan_Max_temp [°C]","Location_data"."02 Feb_Max_temp [°C]","Location_data"."03 Mar_Max_temp [°C]","Location_data"."04 April_Max_temp [°C]","Location_data"."05 May_Max_temp [°C]","Location_data"."06 Jun_Max_temp [°C]","Location_data"."07 Jul_Max_temp [°C]","Location_data"."08 Aug_Max_temp [°C]","Location_data"."09 Sep_Max_temp [°C]","Location_data"."10 Oct_Max_temp [°C]","Location_data"."11 Nov_Max_temp [°C]","Location_data"."12 Dec_Max_temp [°C]")
DC Energy consumption	Yearly energy consumption of vertical DC in working time [kWh]	Energy_consumption_DC("Hourly Q_day_ver [kW]","pinch_h [°C]","eta [#]","T_c [°C]","No of days used in a month (31) [days]","No of days used in a month (28) [days]","No of days used in a month (30) [days]","Supermarket's Working time [hrs]","time for each defrost [hrs]","number of defrosts in working time [#]","Supermarket"."Ambient temperature [°C]",0,0,0,0,0,0,0,0,0,0)
Environment impact	Direct CO2 emissions due to refrigerant leakage [kg CO2 eq]	"Emission due to refrigerant leakage during EOL treatment [kg CO2 eq]"+"Emission due to refrigerant leakage during exploitation phase [kg CO2 eq]"
Environment impact	Emelec [kg CO2 eq]	"System life time [yrs]"*"Yearly energy consumption of all CS and DC [MWh]"*"conversion from MW to kW [kW/MW]"*"Location_data"."GWP Electricity [kgCO2 eq/kWh]"
Environment impact	Emelec [kg CO2 eq]	("System life time [yrs]"*"Yearly energy consumption of all CS and DC [MWh]"*"conversion from MW to kW [kW/MW]"+"Energy consumption of circulation pump in a year [kWh]")*"Location_data"."GWP Electricity [kgCO2 eq/kWh]"

Environment impact	Emelec [kg CO2 eq]	("System life time [yrs]"*("Yearly energy consumption of all CS and DC [MWh]"*("conversion from MW to kW [kW/MW]"*("Location_data"."GWP Electricity [kgCO2 eq/kWh]")+("Number of Vertical Display Cabinet [#]"+"Number of horizontal Display Cabinets [#]"))
Environment impact	Emission due to refrigerant leakage during EOL treatment [kg CO2 eq]	"Mass of refrigerant in the refrigeration system [kg]"*("Refrigerant loss during EOL treatment [%]"/"conversion of % to %/100 [#]"*("Refrigerant"."GWP [kg CO2 eq/kg]"
Environment impact	Emission due to refrigerant leakage during EOL treatment [kg CO2 eq]	("Mass of refrigerant in the refrigeration system [kg]"*("Refrigerant loss during EOL treatment [%]"/"conversion of % to %/100 [#]"*("Refrigerant"."GWP [kg CO2 eq/kg]"))*("Number of Vertical Display Cabinet [#]"+"Number of horizontal Display Cabinets [#]"))
Environment impact	Emission due to refrigerant leakage during exploitation phase [kg CO2 eq]	"Mass of refrigerant in the overall lifecycle [kg]"*("Leak_ref [% of mass of refrigerant]"/"conversion of % to %/100 [#]"*("Refrigerant"."GWP [kg CO2 eq/kg]"
Environment impact	Emission due to refrigerant leakage during exploitation phase [kg CO2 eq]	("Mass of refrigerant in the overall lifecycle [kg]"*("Leak_ref [% of mass of refrigerant]"/"conversion of % to %/100 [#]"*("Refrigerant"."GWP [kg CO2 eq/kg]"))*("Number of Vertical Display Cabinet [#]"+"Number of horizontal Display Cabinets [#]"))
Environment impact	Emref_man [kg CO2 eq]	"Mass of refrigerant in the overall lifecycle [kg]"*(1+("System life time [yrs]"*("leak_ref_year [%]"/"conversion of % to %/100 [#]"))-"refrigerant_reused_EOL [%]"/"conversion of % to %/100 [#]"))*("Refrigerant"."GWP [kg CO2 eq/kg]"
Environment impact	Emref_man [kg CO2 eq]	("Mass of refrigerant in the overall lifecycle [kg]"*(1+("System life time [yrs]"*("leak_ref_year [%]"/"conversion of % to %/100 [#]"))-"refrigerant_reused_EOL [%]"/"conversion of % to %/100 [#]"))*("Refrigerant"."GWP [kg CO2 eq/kg]"))*("Number of Vertical Display Cabinet [#]"+"Number of horizontal Display Cabinets [#]"))

Environment impact	Emsys_EOL [kg CO2 eq]	<pre> (("GWP Recycling steel [kg CO2 eq/kg]"*"mass of steel in the components except pipelines [kg]")+("GWP Recycling copper [kg CO2 eq/kg]"*"mass of copper in the components except pipelines [kg]")+("GWP Recycling aluminium [kg CO2 eq/kg]"*"mass of Aluminium in the components except pipelines [kg]"))+(if('Copper'="pipeline discharge material"."name") then ("GWP Recycling copper [kg CO2 eq/kg]") elseif('Plastic'="pipeline discharge material"."name") then ("GWP Recycling plastic [kg CO2 eq/kg]") else ("GWP Recycling steel [kg CO2 eq/kg]"))*"Mass of all discharge pipes [kg]"+(if('Copper'="pipeline suction material"."name") then ("GWP Recycling copper [kg CO2 eq/kg]") elseif('Plastic'="pipeline suction material"."name") then ("GWP Recycling plastic [kg CO2 eq/kg]") else ("GWP Recycling steel [kg CO2 eq/kg]"))*"Mass of all suction pipe [kg]" </pre>
--------------------	-----------------------	--

Environment impact	Emsys_EOL [kg CO2 eq]	<pre> (("GWP Recycling steel [kg CO2 eq/kg]"*"mass of steel in the components except pipelines [kg]")+("GWP Recycling copper [kg CO2 eq/kg]"*"mass of copper in the components except pipelines [kg]")+("GWP Recycling aluminium [kg CO2 eq/kg]"*"mass of Aluminium in the components except pipelines [kg]"))+(if('Copper'="pipeline discharge material"."name") then ("GWP Recycling copper [kg CO2 eq/kg]") elseif('Plastic'="pipeline discharge material"."name") then ("GWP Recycling plastic [kg CO2 eq/kg]") else ("GWP Recycling steel [kg CO2 eq/kg]"))*("Mass of all discharge pipes [kg]"+"mass of secondary refrigerant discharge pipe [kg]")+((if('Copper'="pipeline suction material"."name") then ("GWP Recycling copper [kg CO2 eq/kg]") elseif('Plastic'="pipeline suction material"."name") then ("GWP Recycling plastic [kg CO2 eq/kg]") else ("GWP Recycling steel [kg CO2 eq/kg]"))*("Mass of all suction pipe [kg]"+"mass of secondary refrigerant suction pipe [kg]")) </pre>
--------------------	-----------------------	--

Environment impact	Emsys_EOL [kg CO2 eq]	<pre> (((("GWP Recycling steel [kg CO2 eq/kg]"*mass of steel in the components except pipelines [kg])+"GWP Recycling copper [kg CO2 eq/kg]"*mass of copper in the components except pipelines [kg])+"GWP Recycling aluminium [kg CO2 eq/kg]"*mass of Aluminium in the components except pipelines [kg]))+(if('Copper'="pipeline discharge material"."name") then ("GWP Recycling copper [kg CO2 eq/kg]") elseif('Plastic'="pipeline discharge material"."name") then ("GWP Recycling plastic [kg CO2 eq/kg]") else ("GWP Recycling steel [kg CO2 eq/kg]"))*("Mass of all discharge pipes [kg]"))+(if('Copper'="pipeline suction material"."name") then ("GWP Recycling copper [kg CO2 eq/kg]") elseif('Plastic'="pipeline suction material"."name") then ("GWP Recycling plastic [kg CO2 eq/kg]") else ("GWP Recycling steel [kg CO2 eq/kg]"))*("Mass of all suction pipe [kg]"))*("Number of Vertical Display Cabinet [#]"+"Number of horizontal Display Cabinets [#]") </pre>
--------------------	-----------------------	---

Environment impact	Emsys_EOL [kg CO2 eq]	<pre> (("GWP Recycling steel [kg CO2 eq/kg]"*mass of steel in the components except pipelines [kg])+"GWP Recycling copper [kg CO2 eq/kg]"*mass of copper in the components except pipelines [kg])+"GWP Recycling aluminium [kg CO2 eq/kg]"*mass of Aluminium in the components except pipelines [kg]))+(if('Copper'="pipeline discharge material"."name") then ("GWP Recycling copper [kg CO2 eq/kg]") elseif('Plastic'="pipeline discharge material"."name") then ("GWP Recycling plastic [kg CO2 eq/kg]") else ("GWP Recycling steel [kg CO2 eq/kg]"))*("Mass of all discharge pipes [kg]"+"Mass of all TC discharge pipes [kg]"))+(if('Copper'="pipeline suction material"."name") then ("GWP Recycling copper [kg CO2 eq/kg]") elseif('Plastic'="pipeline suction material"."name") then ("GWP Recycling plastic [kg CO2 eq/kg]") else ("GWP Recycling steel [kg CO2 eq/kg]"))*("Mass of all suction pipe [kg]"+"Mass of all TC suction pipe [kg])) </pre>
--------------------	-----------------------	--

Environment impact	Emsys_man [kg CO2 eq]	"Emsys_man_compressor [kg CO2 eq]"+"Emsys_man_condenser [kg CO2 eq]"+"Emsys_man_evaporator [kg CO2 eq]"+"Emsys_man_expansion valve [kg CO2 eq]"+"Emsys_man_pipeline [kg CO2 eq]"
Environment impact	Emsys_man [kg CO2 eq]	"Emsys_man_compressor [kg CO2 eq]"+"Emsys_man_condenser [kg CO2 eq]"+"Emsys_man_evaporator [kg CO2 eq]"+"Emsys_man_expansion valve [kg CO2 eq]"+"Emsys_man_pipeline [kg CO2 eq]"+"Emsys_man_secondary refrigerant pipeline [kg CO2 eq]"+"Emsys_man_circulation pump [kg CO2 eq]"+"Emsys_man_Heat exchanger [kg CO2 eq]"
Environment impact	Emsys_man [kg CO2 eq]	("Emsys_man_compressor [kg CO2 eq]"+"Emsys_man_condenser [kg CO2 eq]"+"Emsys_man_evaporator [kg CO2 eq]"+"Emsys_man_expansion valve [kg CO2 eq]"+"Emsys_man_pipeline [kg CO2 eq]")+("Number of Vertical Display Cabinet [#]"+"Number of horizontal Display Cabinets [#]")
Environment impact	Emsys_man [kg CO2 eq]	"Emsys_man_compressor [kg CO2 eq]"+"Emsys_man_condenser [kg CO2 eq]"+"Emsys_man_evaporator [kg CO2 eq]"+"Emsys_man_expansion valve [kg CO2 eq]"+"Emsys_man_pipeline [kg CO2 eq]"+"Emsys_man_Transcritical compressor [kg CO2 eq]"+"Emsys_man_TC pipeline [kg CO2 eq]"

Environment impact	Emsys_man_Heat exchanger [kg CO2 eq]	<pre>"mass of entire heat exchanger [kg]"*(("Heat Exchanger"."Steel in component [%]"*GWP steel [kg CO2 eq/kg])+"Heat Exchanger"."Copper in component [%]"*GWP copper [kg CO2 eq/kg])+"Heat Exchanger"."Aluminium in component [%]"*GWP aluminium [kg CO2 eq/kg])+"Heat Exchanger"."Lubricating oil in component [%]"*GWP lubricating oil [kg CO2 eq/kg])+"Heat Exchanger"."Casting/Forging [%]"*GWP Casting/Forging [kg CO2 eq/kg])+"Heat Exchanger"."Termoforming/Injection moulding [%]"*GWP Termoforming/Injection moulding [kg CO2 eq/kg])+"Heat Exchanger"."Cut/bending/deep drawing [%]"*GWP Cut/bending/deep drawing [kg CO2 eq/kg])+"Heat Exchanger"."Wire drawing/extrusion/lamination [%]"*GWP Wire drawing/extrusion/lamination [kg CO2 eq/kg])+"Heat Exchanger"."Welding/soldering [%]"*GWP Welding/soldering [kg CO2 eq/kg])+"Heat Exchanger"."Powder coating/Zinc coating/cataphoresis/anodizing [%]"*GWP Powder coating/Zinc coating/cataphoresis/anodizing [kg CO2 eq/kg])+"Heat Exchanger"."Other machining [%]"*GWP other machining [kg CO2 eq/kg]))</pre>
--------------------	--------------------------------------	---

Environment impact Emsys_man_circulation pump [kg CO2 eq]

"Number of circulation pumps [#]"*"Circulation Pump".Mass [kg]"*("Circulation Pump".Steel in component [%]"*"GWP steel [kg CO2 eq/kg]")+("Circulation Pump".Copper in component [%]"*"GWP copper [kg CO2 eq/kg]")+("Circulation Pump".Aluminium in component [%]"*"GWP aluminium [kg CO2 eq/kg]")+("Circulation Pump".Lubricating oil in component [%]"*"GWP lubricating oil [kg CO2 eq/kg]")+("Circulation Pump".Casting/Forging [%]"*"GWP Casting/Forging [kg CO2 eq/kg]")+("Circulation Pump".Termoforming/Injection moulding [%]"*"GWP Termoforming/Injection moulding [kg CO2 eq/kg]")+("Circulation Pump".Cut/bending/deep drawing [%]"*"GWP Cut/bending/deep drawing [kg CO2 eq/kg]")+("Circulation Pump".Wire drawing/extrusion/lamination [%]"*"GWP Wire drawing/extrusion/lamination [kg CO2 eq/kg]")+("Circulation Pump".Welding/soldering [%]"*"GWP Welding/soldering [kg CO2 eq/kg]")+("Circulation Pump".Powder coating/Zinc coating/cataphoresis/anodizing [%]"*"GWP Powder coating/Zinc coating/cataphoresis/anodizing [kg CO2 eq/kg]")+("Circulation Pump".Other machining [%]"*"GWP other machining [kg CO2 eq/kg])

Environment impact Emsys_man_compressor [kg CO2 eq]

```
"Number of compressors [#]"*"Compressor"."Mass [kg]"*(("Compressor"."Steel in component [%]"*"GWP steel [kg CO2 eq/kg]")+("Compressor"."Copper in component [%]"*"GWP copper [kg CO2 eq/kg]")+("Compressor"."Aluminium in component [%]"*"GWP aluminium [kg CO2 eq/kg]")+("Compressor"."Lubricating oil in component [%]"*"GWP lubricating oil [kg CO2 eq/kg]")+("Compressor"."Casting/Forging [%]"*"GWP Casting/Forging [kg CO2 eq/kg]")+("Compressor"."Termoforming/Injection moulding [%]"*"GWP Termoforming/Injection moulding [kg CO2 eq/kg]")+("Compressor"."Cut/bending/deep drawing [%]"*"GWP Cut/bending/deep drawing [kg CO2 eq/kg]")+("Compressor"."Wire drawing/extrusion/lamination [%]"*"GWP Wire drawing/extrusion/lamination [kg CO2 eq/kg]")+("Compressor"."Welding/soldering [%]"*"GWP Welding/soldering [kg CO2 eq/kg]")+("Compressor"."Powder coating/Zinc coating/cataphoresis/anodizing [%]"*"GWP Powder coating/Zinc coating/cataphoresis/anodizing [kg CO2 eq/kg]")+("Compressor"."Other machining [%]"*"GWP other machining [kg CO2 eq/kg]"))
```

Environment impact Emsys_man_condenser [kg CO2 eq]

"Number of condensers [#]"*("Condenser"."Mass [kg]"*(("Condenser"."Steel in component [%]"*("GWP steel [kg CO2 eq/kg]")+("Condenser"."Copper in component [%]"*("GWP copper [kg CO2 eq/kg]")+("Condenser"."Aluminium in component [%]"*("GWP aluminium [kg CO2 eq/kg]")+("Condenser"."Lubricating oil in component [%]"*("GWP lubricating oil [kg CO2 eq/kg]")+("Condenser"."Casting/Forging [%]"*("GWP Casting/Forging [kg CO2 eq/kg]")+("Condenser"."Termoforming/Injection moulding [%]"*("GWP Termoforming/Injection moulding [kg CO2 eq/kg]")+("Condenser"."Cut/bending/deep drawing [%]"*("GWP Cut/bending/deep drawing [kg CO2 eq/kg]")+("Condenser"."Wire drawing/extrusion/lamination [%]"*("GWP Wire drawing/extrusion/lamination [kg CO2 eq/kg]")+("Condenser"."Welding/soldering [%]"*("GWP Welding/soldering [kg CO2 eq/kg]")+("Condenser"."Powder coating/Zinc coating/cataphoresis/anodizing [%]"*("GWP Powder coating/Zinc coating/cataphoresis/anodizing [kg CO2 eq/kg]")+("Condenser"."Other machining [%]"*("GWP other machining [kg CO2 eq/kg]"))

Environment impact Emsys_man_evaporator [kg CO2 eq]

"Number of evaporators [#]"*("Evaporator"."Mass [kg]"*(("Evaporator"."Steel in component [%]"*("GWP steel [kg CO2 eq/kg]")+("Evaporator"."Copper in component [%]"*("GWP copper [kg CO2 eq/kg]")+("Evaporator"."Aluminium in component [%]"*("GWP aluminium [kg CO2 eq/kg]")+("Evaporator"."Lubricating oil in component [%]"*("GWP lubricating oil [kg CO2 eq/kg]")+("Evaporator"."Casting/Forging [%]"*("GWP Casting/Forging [kg CO2 eq/kg]")+("Evaporator"."Termoforming/Injection moulding [%]"*("GWP Termoforming/Injection moulding [kg CO2 eq/kg]")+("Evaporator"."Cut/bending/deep drawing [%]"*("GWP Cut/bending/deep drawing [kg CO2 eq/kg]")+("Evaporator"."Wire drawing/extrusion/lamination [%]"*("GWP Wire drawing/extrusion/lamination [kg CO2 eq/kg]")+("Evaporator"."Welding/soldering [%]"*("GWP Welding/soldering [kg CO2 eq/kg]")+("Evaporator"."Powder coating/Zinc coating/cataphoresis/anodizing [%]"*("GWP Powder coating/Zinc coating/cataphoresis/anodizing [kg CO2 eq/kg]")+("Evaporator"."Other machining [%]"*("GWP other machining [kg CO2 eq/kg]"))

Environment impact	Emsys_man_expansion valve [kg CO2 eq]	<pre>"Number of expansion valves [#]"*"Expansion Valve"."Mass [kg]"*(("Expansion Valve"."Steel in component [%]"*"GWP steel [kg CO2 eq/kg]")+("Expansion Valve"."Copper in component [%]"*"GWP copper [kg CO2 eq/kg]")+("Expansion Valve"."Aluminium in component [%]"*"GWP aluminium [kg CO2 eq/kg]")+("Expansion Valve"."Lubricating oil in component [%]"*"GWP lubricating oil [kg CO2 eq/kg]")+("Expansion Valve"."Casting/Forging [%]"*"GWP Casting/Forging [kg CO2 eq/kg]")+("Expansion Valve"."Termoforming/Injection moulding [%]"*"GWP Termoforming/Injection moulding [kg CO2 eq/kg]")+("Expansion Valve"."Cut/bending/deep drawing [%]"*"GWP Cut/bending/deep drawing [kg CO2 eq/kg]")+("Expansion Valve"."Wire drawing/extrusion/lamination [%]"*"GWP Wire drawing/extrusion/lamination [kg CO2 eq/kg]")+("Expansion Valve"."Welding/soldering [%]"*"GWP Welding/soldering [kg CO2 eq/kg]")+("Expansion Valve"."Powder coating/Zinc coating/cataphoresis/anodizing [%]"*"GWP Powder coating/Zinc coating/cataphoresis/anodizing [kg CO2 eq/kg]")+("Expansion Valve"."Other machining [%]"*"GWP other machining [kg CO2 eq/kg]"))</pre>
--------------------	---------------------------------------	--

Environment impact	Emsys_man_pipeline [kg CO2 eq]	<pre>((if('Copper'="pipeline discharge material"."name") then ("GWP copper [kg CO2 eq/kg]")) elseif('Plastic'="pipeline discharge material"."name") then ("GWP plastic [kg CO2 eq/kg]")) else ("GWP steel [kg CO2 eq/kg]"))*"Mass of all discharge pipes [kg]")+((if('Copper'="pipeline suction material"."name") then ("GWP copper [kg CO2 eq/kg]")) elseif('Plastic'="pipeline suction material"."name") then ("GWP plastic [kg CO2 eq/kg]")) else ("GWP steel [kg CO2 eq/kg]"))*"Mass of all suction pipe [kg]"</pre>
--------------------	--------------------------------	--

Environment impact	Emsys_man_secondary refrigerant pipeline [kg CO2 eq]	((if('Copper'="pipeline discharge material"."name") then ("GWP copper [kg CO2 eq/kg]")) elseif('Plastic'="pipeline discharge material"."name") then ("GWP plastic [kg CO2 eq/kg]")) else ("GWP steel [kg CO2 eq/kg]"))*"mass of secondary refrigerant suction pipe [kg]")+((if('Copper'="pipeline suction material"."name") then ("GWP copper [kg CO2 eq/kg]")) elseif('Plastic'="pipeline suction material"."name") then ("GWP plastic [kg CO2 eq/kg]")) else ("GWP steel [kg CO2 eq/kg]"))*"mass of secondary refrigerant suction pipe [kg]"
Environment impact	Indirect CO2 emissions [kg CO2 eq]	"Emsys_man [kg CO2 eq]"+"Emref_man [kg CO2 eq]"+"Emsys_EOL [kg CO2 eq]"+"Emelec [kg CO2 eq]"
Environment impact	Leak_ref [% of mass of refrigerant]	"ref_leak_primary_BOL [%]"+"(("ref_leak_primary_EOL [%]"-"ref_leak_primary_BOL [%]"/10)*"System life time [yrs]"
Environment impact	Leak_ref [% of mass of refrigerant]	"ref_leak_secondary_BOL [%]"+"(("ref_leak_secondary_EOL [%]"-"ref_leak_secondary_BOL [%]"/10)*"System life time [yrs]"
Environment impact	Leak_ref [% of mass of refrigerant]	"ref_leak_plugin_BOL [%]"+"(("ref_leak_plugin_EOL [%]"-"ref_leak_plugin_BOL [%]"/10)*"System life time [yrs]"
Environment impact	Total CO2 emissions of refrigeration system for entire lifetime [Ton CO2 eq]	"Total CO2 emissions of refrigeration system for entire lifetime [kg CO2 eq]"*"Conversion from kg to Ton [Ton/kg]"
Environment impact	Total CO2 emissions of refrigeration system for entire lifetime [kg CO2 eq]	"Indirect CO2 emissions [kg CO2 eq]"+"Direct CO2 emissions due to refrigerant leakage [kg CO2 eq]"
Environment impact	leak_ref_year [%]	"Leak_ref [% of mass of refrigerant]"/"conversion of % to %/100 [#]"/"System life time [yrs]"
Evaporator characteristics	Evaporator TRL	"Evaporator"."Technology Readiness Level [#]"
Evaporator characteristics	Number of evaporators [#]	"Number of Vertical Display Cabinet [#]"+"Number of horizontal Display Cabinets [#]"+"Number of Cold Storage units [#]"

Evaporator characteristics	Number of evaporators [#]	"Number of Vertical Display Cabinet [#]"+"Number of horizontal Display Cabinets [#]"+"Number of Cold Storage units [#]" +(if('Transcritical Horizontal display cabinet'="Transcritical storage"."name") then "Number of Transcritical Horizontal Display cabinet [#]" elseif('Transcritical Vertical display cabinet'="Transcritical storage"."name") then "Number of Transcritical Vertical display cabinets [#]" else "Number of Transcritical CS units [#]")
Expansion valve characteristics	Expansion valve TRL	"Expansion Valve"."Technology Readiness Level [#]"
Expansion valve characteristics	Number of expansion valves [#]	"Number of evaporators [#]"
Heat exchanger characteristics	Area of heat transfer required [m ²]	"cooling capacity of Heat exchanger in primary loop required by the evaporator [kW]" / ("overall heat transfer coefficient for Heat exchanger [kJ/kg.°C]" * "pinch_h [°C]")
Heat exchanger characteristics	Heat exchanger TRL	"Heat Exchanger"."Technology Readiness Level [#]"
Heat exchanger characteristics	Length of the heat exchanger [m]	if("Heat Exchanger"."nb of plates [#]"=0) then ("Area of heat transfer required [m ²]" / (2 * pi * "Heat Exchanger"."Diameter of heat exchanger [m]" / 2)) else ("Heat Exchanger"."nb of plates [#]" * ("Heat Exchanger"."Separation distance between plate [m]" + "Heat Exchanger"."Width of each plate [m]" + 2 * "heat exchanger plate/pipe thickness [m]"))
Heat exchanger characteristics	cooling capacity of Heat exchanger in primary loop required by the evaporator [kW]	"Frigorific power for all CS and DC [kW]"
Heat exchanger characteristics	cooling capacity of Heat exchanger in secondary loop required by the evaporator [kW]	"Frigorific power for all CS and DC [kW]"
Heat exchanger characteristics	e (thickness of heat exchanger) [m]	if("Heat Exchanger"."e [m]" <> 0) then ("Heat Exchanger"."e [m]") else (("Pipeline Discharge"."pipe diameter [m]" - "heat exchanger plate/pipe thickness [m]") * (ln("Pipeline Discharge"."pipe diameter [m]") - ln("Pipeline Discharge"."pipe diameter [m]" - "heat exchanger plate/pipe thickness [m]"))))

Heat exchanger characteristics	mass flow of secondary refrigerant [kg/s]	"cooling capacity of Heat exchanger in secondary loop required by the evaporator [kW]/("secondary refrigerant"."specific heat of secondary refrigerant [kJ/kg.°C]"*pinch_c [°C])"
Heat exchanger characteristics	mass of entire heat exchanger [kg]	"mass of primary refrigerant pipe in heat exchanger [kg]"+"mass of secondary refrigerant pipe in heat exchanger [kg]"
Heat exchanger characteristics	mass of primary refrigerant pipe in heat exchanger [kg]	if("Heat Exchanger"."nb of plates [#]"<>0) then (("Area of heat transfer required [m^2]/2)*2*"heat exchanger plate/pipe thickness [m]"*density of HE material [kg/m^3]" else (((pi*(((Pipeline Discharge"."pipe diameter [m])/2)^2)-((Pipeline Discharge"."pipe diameter [m])/2)-("pipe thickness [mm]"*Conversion from mm to m [m/mm]))^2))*Length of the heat exchanger [m]))*"pipeline discharge material"."Density of pipe material [kg/m^3]"
Heat exchanger characteristics	mass of secondary refrigerant pipe in heat exchanger [kg]	(if("Heat Exchanger"."nb of plates [#]"<>0) then (("Area of heat transfer required [m^2]/2)*2*"heat exchanger plate/pipe thickness [m]"") else (((pi*(((Heat Exchanger"."Diameter of heat exchanger [m])/2)^2)-((Heat Exchanger"."Diameter of heat exchanger [m])/2)-("heat exchanger plate/pipe thickness [m]"^2))*Length of the heat exchanger [m]))*"density of HE material [kg/m^3]"
Heat exchanger characteristics	overall heat transfer coefficient for Heat exchanger [kJ/kg.°C]	("Pipeline Discharge"."pipe diameter [m]"/("Refrigerant"."h_refrigerant [kW/m^2.K]"*(Pipeline Discharge"."pipe diameter [m]"+"heat exchanger plate/pipe thickness [m]")))+("e (thickness of heat exchanger) [m]"/"conductivity of HE material [kW/m.K]"")+1/"secondary refrigerant"."h_secondary refrigerant [kW/m^2.K]"
Heat exchanger characteristics	volume of primary refrigerant in primary refrigerant pipe heat exchanger [m^3]	if("Heat Exchanger"."nb of plates [#]"<>0) then (("Area of heat transfer required [m^2]/2)*Heat Exchanger"."Width of each plate [m]"") else (pi*("Pipeline Discharge"."pipe diameter [m])/2)^2*Length of the heat exchanger [m]"

Heat exchanger characteristics	volume of secondary refrigerant in secondary refrigerant pipe heat exchanger [m ³]	if("Heat Exchanger"."nb of plates [#]"<>0) then (("Area of heat transfer required [m ²]/2)*"Heat Exchanger"."Width of each plate [m]") else (pi*("Heat Exchanger"."Diameter of heat exchanger [m]"/2) ²)*"Length of the heat exchanger [m]"
Heat exchanger characteristics	volumetric flow of secondary refrigerant [m ³ /s]	"mass flow of secondary refrigerant [kg/s]/("secondary refrigerant"."density of refrigerant in pipe [kg/m ³])"
Maintenance	Accessibility design	"Visibility design"+"Reachability design"+"Operation space design"
Maintenance	Architecture - Ergonomic design	
Maintenance	Architecture - Error proofing design	
Maintenance	Architecture - Marking design	
Maintenance	Architecture - Operation space design	
Maintenance	Architecture - Reachability design	
Maintenance	Architecture - Visibility design	
Maintenance	Electrical injury preventing design	sum("Electrical injury preventing design")/2
Maintenance	Ergonomic design	(sum("Ergonomic design"+"Architecture - Ergonomic design")/5
Maintenance	Error proofing design	(sum("Error proofing design"+"Architecture - Error proofing design")/5
Maintenance	Heat injury preventing design	sum("Heat injury preventing design")/4
Maintenance	Heat injury preventing design	sum("Heat injury preventing design")/6
Maintenance	Marking design	(sum("Marking design"+"Architecture - Marking design")/3
Maintenance	Mechanical injury preventing design	sum("Heat injury preventing design")/3
Maintenance	Operation space design	(sum("Operation space design"+"Architecture - Operation space design")/8
Maintenance	Operation space design	(sum("Operation space design"+"Architecture - Operation space design")/10
Maintenance	Physical hurt preventing design	"Mechanical injury preventing design"+"Heat injury preventing design"+"Electrical injury preventing design"
Maintenance	Reachability design	(sum("Reachability design"+"Architecture - Reachability design")/11
Maintenance	Reachability design	(sum("Reachability design"+"Architecture - Reachability design")/13
Maintenance	Total maintenance score [#]	"Accessibility design"+"Physical hurt preventing design"+"Ergonomic design"+"Error proofing design"+"Marking design"
Maintenance	Visibility design	(sum("Visibility design"+"Architecture - Visibility design")/6

Material Distribution	mass of Aluminium in the components except pipelines [kg]	$ \begin{aligned} &(\text{"Number of compressors [\#]"*"\Compressor"."Mass [kg]"*"\Compressor"."Alu-} \\ &\text{minium in component [\%]})+(\text{"Number of condensers [\#]"*"\Condenser"."Mass} \\ &[\text{kg}"*"\Condenser"."Aluminium in component [\%]})+(\text{"Number of evaporators} \\ &[\text{\#}"*"\Evaporator"."Mass [kg]"*"\Evaporator"."Aluminium in component} \\ &[\%]})+(\text{"Number of expansion valves [\#]"*"\Expansion Valve"."Mass [kg]"*"\Ex-} \\ &\text{pansion Valve"."Aluminium in component [\%]}) \end{aligned} $
Material Distribution	mass of Aluminium in the components except pipelines [kg]	$ \begin{aligned} &(\text{"Number of compressors [\#]"*"\Compressor"."Mass [kg]"*"\Compressor"."Alu-} \\ &\text{minium in component [\%]})+(\text{"Number of condensers [\#]"*"\Condenser"."Mass} \\ &[\text{kg}"*"\Condenser"."Aluminium in component [\%]})+(\text{"Number of evaporators} \\ &[\text{\#}"*"\Evaporator"."Mass [kg]"*"\Evaporator"."Aluminium in component} \\ &[\%]})+(\text{"Number of expansion valves [\#]"*"\Expansion Valve"."Mass [kg]"*"\Ex-} \\ &\text{pansion Valve"."Aluminium in component [\%]})+(\text{"Number of circulation} \\ &\text{pumps [\#]"*"\Circulation Pump"."Mass [kg]"*"\Circulation Pump"."Aluminium in} \\ &\text{component [\%]})+(\text{"mass of entire heat exchanger [kg]"*"\Heat Exchanger"."Alu-} \\ &\text{minium in component [\%]}) \end{aligned} $
Material Distribution	mass of Aluminium in the components except pipelines [kg]	$ \begin{aligned} &(\text{"Number of compressors [\#]"*"\Compressor"."Mass [kg]"*"\Compressor"."Alu-} \\ &\text{minium in component [\%]})+(\text{"Number of condensers [\#]"*"\Condenser"."Mass} \\ &[\text{kg}"*"\Condenser"."Aluminium in component [\%]})+(\text{"Number of evaporators} \\ &[\text{\#}"*"\Evaporator"."Mass [kg]"*"\Evaporator"."Aluminium in component} \\ &[\%]})+(\text{"Number of expansion valves [\#]"*"\Expansion Valve"."Mass [kg]"*"\Ex-} \\ &\text{pansion Valve"."Aluminium in component [\%]})+(\text{"Number of transcritical} \\ &\text{compressors [\#]"*"\Transcritical compressor"."Mass [kg]"*"\Transcritical com-} \\ &\text{pressor"."Aluminium in component [\%]}) \end{aligned} $

Material Distribution	mass of copper in the components except pipelines [kg]	$(\text{"Number of compressors [\#]" * "Compressor"."Mass [kg]" * "Compressor"."Copper in component [\%]"} + \text{"Number of condensers [\#]" * "Condenser"."Mass [kg]" * "Condenser"."Copper in component [\%]"} + \text{"Number of evaporators [\#]" * "Evaporator"."Mass [kg]" * "Evaporator"."Copper in component [\%]"} + \text{"Number of expansion valves [\#]" * "Expansion Valve"."Mass [kg]" * "Expansion Valve"."Copper in component [\%]"})$
Material Distribution	mass of copper in the components except pipelines [kg]	$(\text{"Number of compressors [\#]" * "Compressor"."Mass [kg]" * "Compressor"."Copper in component [\%]"} + \text{"Number of condensers [\#]" * "Condenser"."Mass [kg]" * "Condenser"."Copper in component [\%]"} + \text{"Number of evaporators [\#]" * "Evaporator"."Mass [kg]" * "Evaporator"."Copper in component [\%]"} + \text{"Number of expansion valves [\#]" * "Expansion Valve"."Mass [kg]" * "Expansion Valve"."Copper in component [\%]"} + \text{"Number of circulation pumps [\#]" * "Circulation Pump"."Mass [kg]" * "Circulation Pump"."Copper in component [\%]"} + \text{"mass of entire heat exchanger [kg]" * "Heat Exchanger"."Copper in component [\%]"})$
Material Distribution	mass of copper in the components except pipelines [kg]	$(\text{"Number of compressors [\#]" * "Compressor"."Mass [kg]" * "Compressor"."Copper in component [\%]"} + \text{"Number of condensers [\#]" * "Condenser"."Mass [kg]" * "Condenser"."Copper in component [\%]"} + \text{"Number of evaporators [\#]" * "Evaporator"."Mass [kg]" * "Evaporator"."Copper in component [\%]"} + \text{"Number of expansion valves [\#]" * "Expansion Valve"."Mass [kg]" * "Expansion Valve"."Copper in component [\%]"} + \text{"Number of transcritical compressors [\#]" * "Transcritical compressor"."Mass [kg]" * "Transcritical compressor"."Copper in component [\%]"})$

Material Distribution	mass of steel in the components except pipe-lines [kg]	$(\text{"Compressor"."Mass [kg]"*"}\text{"Compressor"."Steel in component [%]"*"}\text{"Number of compressors [#"]})+(\text{"Number of condensers [#]"*"}\text{"Condenser"."Mass [kg]"*"}\text{"Condenser"."Steel in component [%"]})+(\text{"Number of evaporators [#]"*"}\text{"Evaporator"."Mass [kg]"*"}\text{"Evaporator"."Steel in component [%"]})+(\text{"Number of expansion valves [#]"*"}\text{"Expansion Valve"."Mass [kg]"*"}\text{"Expansion Valve"."Steel in component [%"]})$
Material Distribution	mass of steel in the components except pipe-lines [kg]	$(\text{"Compressor"."Mass [kg]"*"}\text{"Compressor"."Steel in component [%]"*"}\text{"Number of compressors [#"]})+(\text{"Number of condensers [#]"*"}\text{"Condenser"."Mass [kg]"*"}\text{"Condenser"."Steel in component [%"]})+(\text{"Number of evaporators [#]"*"}\text{"Evaporator"."Mass [kg]"*"}\text{"Evaporator"."Steel in component [%"]})+(\text{"Number of expansion valves [#]"*"}\text{"Expansion Valve"."Mass [kg]"*"}\text{"Expansion Valve"."Steel in component [%"]})+(\text{"Number of circulation pumps [#]"*"}\text{"Circulation Pump"."Mass [kg]"*"}\text{"Circulation Pump"."Steel in component [%"]})+(\text{"mass of entire heat exchanger [kg]"*"}\text{"Heat Exchanger"."Steel in component [%"]})$
Material Distribution	mass of steel in the components except pipe-lines [kg]	$(\text{"Compressor"."Mass [kg]"*"}\text{"Compressor"."Steel in component [%]"*"}\text{"Number of compressors [#"]})+(\text{"Number of condensers [#]"*"}\text{"Condenser"."Mass [kg]"*"}\text{"Condenser"."Steel in component [%"]})+(\text{"Number of evaporators [#]"*"}\text{"Evaporator"."Mass [kg]"*"}\text{"Evaporator"."Steel in component [%"]})+(\text{"Number of expansion valves [#]"*"}\text{"Expansion Valve"."Mass [kg]"*"}\text{"Expansion Valve"."Steel in component [%"]})+(\text{"Number of transcritical compressors [#]"*"}\text{"Transcritical compressor"."Mass [kg]"*"}\text{"Transcritical compressor"."Steel in component [%"]})$
Outputs	Conversion from Celsius to Kelvin [K]	273
Outputs	Maximum outside temperature system can handle [°C]	$(\text{"Compressor's available cooling capacity [kW]"*"}\text{"Number of compressors [#]"*"}\text{"eta [#"]})/\text{"Hourly Q_dot_ColdStorage [kW]}*(\text{"T_c [°C]"}+\text{"Conversion from Celsius to Kelvin [K]"})+\text{"T_c [°C]"}$
Primary pipe characteristics	Diameter of the discharge pipeline [in]	"Pipeline Discharge"."pipe diameter [in]"

Primary pipe characteristics	Diameter of the suction pipeline [in]	"Pipeline Suction"."pipe diameter [in]"
Primary pipe characteristics	Length of pipe in supermarket roof [m]	$\sqrt{\text{"Supermarket"."Area of roof available [m}^2\text{]}}$
Primary pipe characteristics	Length of pipe inside the supermarket [m]	"Supermarket"."Distance between machine room and CS [m]"
Primary pipe characteristics	Length of pipe running vertical to the roof [m]	"Supermarket"."Height of supermarket [m]"
Primary pipe characteristics	Length of total pipe in siphons [m]	$(\text{"Number of siphons required [\#]"} * \text{"Pipeline Discharge"."Siphon length [m]"})$
Primary pipe characteristics	Mass of all discharge pipes [kg]	$\text{"Volume of material in discharge pipe [m}^3\text{]} * \text{"pipeline discharge material"."Density of pipe material [kg/m}^3\text{]"}$
Primary pipe characteristics	Mass of all suction pipe [kg]	$\text{"Volume of material in suction pipe [m}^3\text{]} * \text{"pipeline suction material"."Density of pipe material [kg/m}^3\text{]"}$
Primary pipe characteristics	Mass of entire piping (discharge +suction) for the refrigeration system	$\text{"Mass of all discharge pipes [kg]} + \text{"Mass of all suction pipe [kg]"}$
Primary pipe characteristics	Material of discharge pipeline TRL	"pipeline discharge material"."Technology Readiness Level [\#]"
Primary pipe characteristics	Material of suction pipeline TRL	"pipeline suction material"."Technology Readiness Level [\#]"
Primary pipe characteristics	Number of siphons required [\#]	$\text{floor}(\text{"Length of pipe running vertical to the roof [m]"} / (\text{"number of pipes [\#]} * 3))$
Primary pipe characteristics	Pipeline discharge TRL	"Pipeline Discharge"."Technology Readiness Level [\#]"
Primary pipe characteristics	Pipeline suction TRL	"Pipeline Suction"."Technology Readiness Level [\#]"
Primary pipe characteristics	Volume of material in discharge pipe [m ³]	$\pi * ((\text{"Pipeline Discharge"."pipe diameter [m]"} / 2)^2 - ((\text{"Pipeline Discharge"."pipe diameter [m]"} / 2) - (\text{"pipe thickness [mm]} * \text{"Conversion from mm to m [m/mm]}))^2) * \text{"length of discharge pipe [m]"}$

Primary pipe characteristics	Volume of material in suction pipe [m ³]	$\pi * ((\text{"Pipeline Suction"."pipe diameter [m]"} / 2) - (\text{"Pipeline Suction"."pipe diameter [m]"} / 2) - (\text{"pipe thickness [mm]"} * \text{"Conversion from mm to m [m/mm]"}))^2 * \text{"length of suction pipe [m]"}$
Primary pipe characteristics	length of discharge pipe [m]	$(\text{"Length of total pipe in siphons [m]"} + \text{"Length of pipe running vertical to the roof [m]"} + \text{"Length of pipe in supermarket roof [m]"}) * \text{"number of pipes [#]"} + \text{"Length of pipe inside the supermarket [m]"}$
Primary pipe characteristics	length of discharge pipe [m]	0.5
Primary pipe characteristics	length of suction pipe [m]	$\text{"Length of pipe inside the supermarket [m]"}$
Primary pipe characteristics	length of suction pipe [m]	0
Primary pipe characteristics	length of suction pipe [m]	0.5
Primary pipe characteristics	number of pipes [#]	2
Primary pipe characteristics	v_ref_pipeline_discharge [m ³]	$\pi * ((\text{"Pipeline Discharge"."pipe diameter [m]"} / 2) - (\text{"pipe thickness [mm]"} * \text{"Conversion from mm to m [m/mm]"}))^2 * \text{"length of discharge pipe [m]"}$
Primary pipe characteristics	v_ref_pipeline_suction [m ³]	$\pi * ((\text{"Pipeline Suction"."pipe diameter [m]"} / 2) - (\text{"pipe thickness [mm]"} * \text{"Conversion from mm to m [m/mm]"}))^2 * \text{"length of suction pipe [m]"}$
Primary pipe characteristics	v_ref_pipeline_total [m ³]	$\text{"v_ref_pipeline_discharge [m^3]"} + \text{"v_ref_pipeline_suction [m^3]"}$
Refrigerant characteristics	Mass of refrigerant in all evaporators [kg]	$\text{"density of refrigerant in evaporator [kg/m^3]"} * \text{"Evaporator"."V_ref [m^3]"} * \text{"Number of evaporators [#]"}$
Refrigerant characteristics	Mass of refrigerant in the overall lifecycle [kg]	$(1 + \text{"Leak_ref [% of mass of refrigerant]"} / \text{"conversion of \% to \% / 100 [#]"})) * \text{"Mass of refrigerant in the refrigeration system [kg]"}$

Refrigerant characteristics	Mass of refrigerant in the overall lifecycle [kg]	$((1 + \text{Leak_ref} [\% \text{ of mass of refrigerant}]) / \text{conversion of \% to \% / 100} [\#]) * \text{Mass of refrigerant in the refrigeration system [kg]} * (\text{Number of Vertical Display Cabinet} [\#] + \text{Number of horizontal Display Cabinets} [\#])$
Refrigerant characteristics	Mass of refrigerant in the refrigeration system [kg]	$(\text{Mass of refrigerant in all evaporators [kg]} + \text{Mass of refrigerants in all condensers [kg]} + \text{Mass of refrigerants in the entire pipeline [kg]})$
Refrigerant characteristics	Mass of refrigerant in the refrigeration system [kg]	$(\text{Mass of refrigerants in all condensers [kg]} + \text{Mass of refrigerants in the entire pipeline [kg]}) + \text{mass of refrigerant in heat exchanger [kg]}$
Refrigerant characteristics	Mass of refrigerants in all condensers [kg]	$\text{density of refrigerant in condenser [kg/m}^3] * (\text{if}(\text{'CO2 compatible'} = \text{'Compressor'}, \text{'Refrigerant compatibility'}) \text{ then } (\text{'Compressor'}. \text{'V_ref [m3]} * \text{Number of compressors} [\#]) \text{ else } \text{'Condenser'}. \text{'V_ref [m3]} * \text{Number of condensers} [\#]))$
Refrigerant characteristics	Mass of refrigerants in the entire pipeline [kg]	$(\text{'Refrigerant'}. \text{density of refrigerant in pipe [kg/m}^3]) * \text{v_ref_pipeline_total [m}^3]$
Refrigerant characteristics	Mass of refrigerants in the entire pipeline [kg]	$(\text{'Refrigerant'}. \text{density of refrigerant in pipe [kg/m}^3]) * (\text{v_ref_pipeline_total [m}^3] + \text{v_ref_TC_pipeline_total [m}^3])$
Refrigerant characteristics	Max T _h [°C]	$\text{pinch_h [}^\circ\text{C]} + (\text{max}(\text{'Location_data'}. \text{'01Jan_Max_temp [}^\circ\text{C]}', \text{'Location_data'}. \text{'02 Feb_Max_temp [}^\circ\text{C]}', \text{'Location_data'}. \text{'03 Mar_Max_temp [}^\circ\text{C]}', \text{'Location_data'}. \text{'04 April_Max_temp [}^\circ\text{C]}', \text{'Location_data'}. \text{'05 May_Max_temp [}^\circ\text{C]}', \text{'Location_data'}. \text{'06 Jun_Max_temp [}^\circ\text{C]}', \text{'Location_data'}. \text{'07 Jul_Max_temp [}^\circ\text{C]}', \text{'Location_data'}. \text{'08 Aug_Max_temp [}^\circ\text{C]}', \text{'Location_data'}. \text{'09 Sep_Max_temp [}^\circ\text{C]}', \text{'Location_data'}. \text{'10 Oct_Max_temp [}^\circ\text{C]}', \text{'Location_data'}. \text{'11 Nov_Max_temp [}^\circ\text{C]}', \text{'Location_data'}. \text{'12 Dec_Max_temp [}^\circ\text{C]}'))$
Refrigerant characteristics	Refrigerant TRL	$\text{'Refrigerant'}. \text{Technology Readiness Level} [\#]$
Refrigerant characteristics	Refrigerant safety satisfaction	$\text{if}(\text{'Refrigerant'}. \text{Maximum refrigerant charge [kg]} < 0) \text{ then } (\text{if}(\text{'Mass of refrigerant in the refrigeration system [kg]} < \text{'Refrigerant'}. \text{Maximum refrigerant charge [kg]}) \text{ then } 1 \text{ else } 0) \text{ else } 1$

Refrigerant characteristics	Secondary refrigerant TRL	"secondary refrigerant"."Technology Readiness Level [#]"
Refrigerant characteristics	Total mass of secondary refrigerant	"mass of secondary refrigerant in pipe [kg]"+"mass of secondary refrigerant in heat exchanger [kg]"+"mass of secondary refrigerant in evaporator [kg]"
Refrigerant characteristics	conversion of % to %/100 [#]	100
Refrigerant characteristics	density of refrigerant in condenser [kg/m ³]	("Refrigerant"."coefficient 1 of refrigerant density in condenser [kg/m ³ .°C ²]"*(("Max T_h [°C]"^2)+"Refrigerant"."coefficient 2 of refrigerant density in condenser [kg/m ³ .°C]"*(("Max T_h [°C]"))+"Refrigerant"."coefficient 3 of refrigerant density in condenser [kg/m ³ "])
Refrigerant characteristics	density of refrigerant in evaporator [kg/m ³]	("Refrigerant"."coefficient 1 of refrigerant density in evaporator [kg/m ³ .°C ³]"*(("T_c [°C]"^3)+"Refrigerant"."coefficient 2 of refrigerant density in evaporator [kg/m ³ .°C ²]"*(("T_c [°C]"^2)+"Refrigerant"."coefficient 3 of refrigerant density in evaporator [kg/m ³ .°C]"*(("T_c [°C]"))+"Refrigerant"."coefficient 4 of refrigerant density in evaporator [kg/m ³ "])
Refrigerant characteristics	mass of refrigerant in heat exchanger [kg]	"volume of primary refrigerant in primary refrigerant pipe heat exchanger [m ³]"*"density of refrigerant in evaporator [kg/m ³]"
Refrigerant characteristics	mass of secondary refrigerant in evaporator [kg]	"Evaporator"."V_ref [m ³]"*"secondary refrigerant"."density of refrigerant in pipe [kg/m ³]"
Refrigerant characteristics	mass of secondary refrigerant in heat exchanger [kg]	"volume of secondary refrigerant in secondary refrigerant pipe heat exchanger [m ³]"*"secondary refrigerant"."density of refrigerant in pipe [kg/m ³]"
Refrigerant characteristics	mass of secondary refrigerant in pipe [kg]	"v_secondary ref_pipeline_total [m ³]"*"secondary refrigerant"."density of refrigerant in pipe [kg/m ³]"
Secondary pipe characteristics	Secondary refrigerant pipeline TRL	"secondary refrigerant pipeline"."Technology Readiness Level [#]"
Secondary pipe characteristics	Volume of material in entire secondary refrigerant pipeline [m ³]	"Volume of material in secondary refrigerant discharge pipe [m ³]"+"Volume of material in secondary refrigerant suction pipe [m ³]"

Secondary pipe characteristics	Volume of material in secondary refrigerant discharge pipe [m ³]	$\pi * (\text{"secondary refrigerant pipeline"."pipe diameter [m]"/2})^2 - (\text{"secondary refrigerant pipeline"."pipe diameter [m]"/2} - \text{"pipe thickness [mm]" * "Conversion from mm to m [m/mm]"})^2 * \text{"length of secondary refrigerant discharge pipe [m]"}$
Secondary pipe characteristics	Volume of material in secondary refrigerant suction pipe [m ³]	$\pi * (\text{"secondary refrigerant pipeline"."pipe diameter [m]"/2})^2 - (\text{"secondary refrigerant pipeline"."pipe diameter [m]"/2} - \text{"pipe thickness [mm]" * "Conversion from mm to m [m/mm]"})^2 * \text{"length of secondary refrigerant suction pipe [m]"}$
Secondary pipe characteristics	length of secondary refrigerant discharge pipe [m]	"Length of pipe inside the supermarket [m]"
Secondary pipe characteristics	length of secondary refrigerant suction pipe [m]	"Length of pipe inside the supermarket [m]"
Secondary pipe characteristics	mass of all secondary refrigerant pipe [kg]	"mass of secondary refrigerant discharge pipe [kg]" + "mass of secondary refrigerant suction pipe [kg]"
Secondary pipe characteristics	mass of secondary refrigerant discharge pipe [kg]	"Volume of material in secondary refrigerant discharge pipe [m ³]" * "pipeline discharge material"."Density of pipe material [kg/m ³]"
Secondary pipe characteristics	mass of secondary refrigerant suction pipe [kg]	"Volume of material in secondary refrigerant suction pipe [m ³]" * "pipeline suction material"."Density of pipe material [kg/m ³]"
Secondary pipe characteristics	v_secondary ref_pipeline_discharge [m ³]	$\pi * (\text{"secondary refrigerant pipeline"."pipe diameter [m]"/2})^2 - (\text{"pipe thickness [mm]" * "Conversion from mm to m [m/mm]"})^2 * \text{"length of secondary refrigerant discharge pipe [m]"}$
Secondary pipe characteristics	v_secondary ref_pipeline_suction [m ³]	$\pi * (\text{"secondary refrigerant pipeline"."pipe diameter [m]"/2})^2 - (\text{"pipe thickness [mm]" * "Conversion from mm to m [m/mm]"})^2 * \text{"length of secondary refrigerant suction pipe [m]"}$
Secondary pipe characteristics	v_secondary ref_pipeline_total [m ³]	"v_secondary ref_pipeline_discharge [m ³]" + "v_secondary ref_pipeline_suction [m ³]"
Supermarket Environment	Daily nb of people coming into CS [#]	ceil("Nb of people allocated to CS activities per unit area of supermarket [# / m ²]" * "Supermarket"."Supermarket area [m ²]")

Supermarket Environment	Nb of people allocated to CS activities per unit area of supermarket [#/ m^2]	$\text{if}(\text{"Supermarket"."Supermarket area [m}^2\text{"}=10000) \text{ then } 10/10000 \text{ elseif}(\text{"Supermarket"."Supermarket area [m}^2\text{"}=4000) \text{ then } 5/4000 \text{ else } 2/250$
Supermarket Environment	Nb of people coming during opening time [#]	$(1/3)*\text{"Daily nb of people coming into CS [#]"/"Supermarket"."Public Open hours [hrs]"}$
Supermarket Environment	Nb of people coming during working time [#]	$(2/3)*\text{"Daily nb of people coming into CS [#]"/("Supermarket"."Working hours [hrs]"-"Supermarket"."Public Open hours [hrs])"}$
Supermarket Environment	Super market area [m^2]	$\text{"Supermarket"."Supermarket area [m}^2\text{"}$
Supermarket Environment	Supermarket's Closed time [hrs]	$\text{"no of hours in a day [hrs/day]"-"Supermarket's Working time [hrs]"}$
Supermarket Environment	Supermarket's Working time [hrs]	$\text{"Supermarket"."Working hours [hrs]"}$
Supermarket Environment	Supermarket's public opening time	$\text{"Supermarket"."Public Open hours [hrs]"}$
Transcritical	Cost of TC discharge pipeline for the refrigeration system [Euros]	$\text{"Mass of all TC discharge pipes [kg]"*"}\text{"pipeline discharge material"."cost per kg [Euros/kg]"}$
Transcritical	Cost of TC suction pipeline for the refrigeration system [Euros]	$\text{"Mass of all TC suction pipe [kg]"*"}\text{"pipeline suction material"."cost per kg [Euros/kg]"}$
Transcritical	Cost of entire TC pipeline for the refrigeration system (discharge +suction) [Euros]	$\text{"Cost of TC discharge pipeline for the refrigeration system [Euros]"+"Cost of TC suction pipeline for the refrigeration system [Euros]"}$
Transcritical	Diameter of the Transcritical discharge pipeline [in]	$\text{"Transcritical discharge pipe"."pipe diameter [in]"}$
Transcritical	Diameter of the Transcritical suction pipeline [in]	$\text{"Transcritical suction pipe"."pipe diameter [in]"}$

Transcritical	Emsys_man_TC pipeline [kg CO2 eq]	((if('Copper'="pipeline discharge material"."name") then ("GWP copper [kg CO2 eq/kg]")) elseif('Plastic'="pipeline discharge material"."name") then ("GWP plastic [kg CO2 eq/kg]")) else ("GWP steel [kg CO2 eq/kg]"))*"Mass of all TC discharge pipes [kg]")+((if('Copper'="pipeline suction material"."name") then ("GWP copper [kg CO2 eq/kg]")) elseif('Plastic'="pipeline suction material"."name") then ("GWP plastic [kg CO2 eq/kg]")) else ("GWP steel [kg CO2 eq/kg]"))*"Mass of all TC suction pipe [kg]"
Transcritical	Emsys_man_Transcritical compressor [kg CO2 eq]	"Number of transcritical compressors [#]"*"Transcritical compressor"."Mass [kg]"*(("Transcritical compressor"."Steel in component [%]"*GWP steel [kg CO2 eq/kg]")+("Transcritical compressor"."Copper in component [%]"*GWP copper [kg CO2 eq/kg]")+("Transcritical compressor"."Aluminium in component [%]"*GWP aluminium [kg CO2 eq/kg]")+("Transcritical compressor"."Lubricating oil in component [%]"*GWP lubricating oil [kg CO2 eq/kg]")+("Transcritical compressor"."Casting/Forging [%]"*GWP Casting/Forging [kg CO2 eq/kg]")+("Transcritical compressor"."Termoforming/Injection moulding [%]"*GWP Termoforming/Injection moulding [kg CO2 eq/kg]")+("Transcritical compressor"."Cut/bending/deep drawing [%]"*GWP Cut/bending/deep drawing [kg CO2 eq/kg]")+("Transcritical compressor"."Wire drawing/extrusion/lamination [%]"*GWP Wire drawing/extrusion/lamination [kg CO2 eq/kg]")+("Transcritical compressor"."Welding/soldering [%]"*GWP Welding/soldering [kg CO2 eq/kg]")+("Transcritical compressor"."Powder coating/Zinc coating/cataphoresis/anodizing [%]"*GWP Powder coating/Zinc coating/cataphoresis/anodizing [kg CO2 eq/kg]")+("Transcritical compressor"."Other machining [%]"*GWP other machining [kg CO2 eq/kg]))
Transcritical	Mass of all TC discharge pipes [kg]	"Volume of material in TC discharge pipe [m ³]"*"pipeline discharge material"."Density of pipe material [kg/m ³]"
Transcritical	Mass of all TC suction pipe [kg]	"Volume of material in TC suction pipe [m ³]"*"pipeline suction material"."Density of pipe material [kg/m ³]"

Transcritical	Mass of entire TC piping (discharge +suction) for the refrigeration system	"Mass of all TC discharge pipes [kg]"+"Mass of all TC suction pipe [kg]"
Transcritical	Number of transcritical compressors [#]	ceil("TC_Frigorific power for all CS and DC [kW]"/"Transcritical compressor"."Cooling capacity [kW]")
Transcritical	TC_Frigorific power for CS [kW]	"TC_Frigorific power for CS during closed time [kW]"+"TC_Frigorific power for one CS during working time [kW]"
Transcritical	TC_Frigorific power for CS during closed time [kW]	frigorific_power("TC_Hourly Q_dot_ColdStorage [kW]","pinch_h [°C]","eta [#]","TC_T_c [°C]","Location_data"."01 Jan_Min_temp [°C]","Location_data"."02 Feb_Min_temp [°C]","Location_data"."03 Mar_Min_temp [°C]","Location_data"."04 April_Min_temp [°C]","Location_data"."05 May_Min_temp [°C]","Location_data"."06 Jun_Min_temp [°C]","Location_data"."07 Jul_Min_temp [°C]","Location_data"."08 Aug_Min_temp [°C]","Location_data"."09 Sep_Min_temp [°C]","Location_data"."10 Oct_Min_temp [°C]","Location_data"."11 Nov_Min_temp [°C]","Location_data"."12 Dec_Min_temp [°C]")
Transcritical	TC_Frigorific power for all CS [kW]	if('Transcritical Cold storage unit'="Transcritical storage"."name") then "TC_Frigorific power for CS [kW]"*"Number of Transcritical CS units [#]" else 0
Transcritical	TC_Frigorific power for all CS and DC [kW]	"TC_Frigorific power for all CS [kW]"+"TC_Frigorific power for all DC [kW]"
Transcritical	TC_Frigorific power for all DC [kW]	if('Transcritical Cold storage unit'<>"Transcritical storage"."name") then "TC_Frigorific power for one DC [kW]"*(if('Transcritical Horizontal display cabinet'="Transcritical storage"."name") then "Number of Transcritical Horizontal Display cabinet [#]" else "Number of Transcritical Vertical display cabinets [#]") else 0

Transcritical	TC_Frigorific power for one CS during working time [kW]	<pre>frigorific_power("TC_Hourly Q_dot_ColdStorage [kW]","pinch_h [°C]","eta [#]","TC_T_c [°C]","Location_data"."01Jan_Max_temp [°C]","Location_data"."02 Feb_Max_temp [°C]","Location_data"."03 Mar_Max_temp [°C]","Location_data"."04 April_Max_temp [°C]","Location_data"."05 May_Max_temp [°C]","Location_data"."06 Jun_Max_temp [°C]","Location_data"."07 Jul_Max_temp [°C]","Location_data"."08 Aug_Max_temp [°C]","Location_data"."09 Sep_Max_temp [°C]","Location_data"."10 Oct_Max_temp [°C]","Location_data"."11 Nov_Max_temp [°C]","Location_data"."12 Dec_Max_temp [°C]")</pre>
Transcritical	TC_Frigorific power for one DC [kW]	<pre>"TC_Frigorific power for one DC during closed time [kW]"+"TC_Frigorific power for one DC during working time [kW]"</pre>
Transcritical	TC_Frigorific power for one DC during closed time [kW]	<pre>frigorific_power("TC_Hourly Q_night [kW]","pinch_h [°C]","eta [#]","TC_T_c [°C]","Location_data"."01 Jan_Min_temp [°C]","Location_data"."02 Feb_Min_temp [°C]","Location_data"."03 Mar_Min_temp [°C]","Location_data"."04 April_Min_temp [°C]","Location_data"."05 May_Min_temp [°C]","Location_data"."06 Jun_Min_temp [°C]","Location_data"."07 Jul_Min_temp [°C]","Location_data"."08 Aug_Min_temp [°C]","Location_data"."09 Sep_Min_temp [°C]","Location_data"."10 Oct_Min_temp [°C]","Location_data"."11 Nov_Min_temp [°C]","Location_data"."12 Dec_Min_temp [°C]")</pre>

Transcritical	TC_Frigorific power for one DC during working time [kW]	$\text{frigorific_power}(\text{"TC_Hourly Q_day [kW]"}, \text{"pinch_h [°C]"}, \text{"eta [\#]"}, \text{"TC_T_c [°C]"}, \text{"Location_data"."01Jan_Max_temp [°C]"}, \text{"Location_data"."02 Feb_Max_temp [°C]"}, \text{"Location_data"."03 Mar_Max_temp [°C]"}, \text{"Location_data"."04 April_Max_temp [°C]"}, \text{"Location_data"."05 May_Max_temp [°C]"}, \text{"Location_data"."06 Jun_Max_temp [°C]"}, \text{"Location_data"."07 Jul_Max_temp [°C]"}, \text{"Location_data"."08 Aug_Max_temp [°C]"}, \text{"Location_data"."09 Sep_Max_temp [°C]"}, \text{"Location_data"."10 Oct_Max_temp [°C]"}, \text{"Location_data"."11 Nov_Max_temp [°C]"}, \text{"Location_data"."12 Dec_Max_temp [°C]"})$
Transcritical	TC_Hourly Q_day [kW]	$\text{"TC_Hourly Q_wall [kW]} + \text{"Transcritical storage"."Q_hw [w]} * \text{"conversion factor W to kW [kW/W]} + \text{"Transcritical storage"."Q_lighting [W]} * \text{"conversion factor W to kW [kW/W]} + \text{"TC_Hourly Q_infiltration_day [kW]} + \text{"TC_Hourly Q_radiation_day [kW]} + \text{"Transcritical storage"."Q_fan [W]} * \text{"conversion factor W to kW [kW/W]} + (\text{if}(\text{"Transcritical Horizontal display cabinet"} = \text{"Transcritical storage"."name"}) \text{ then "Hourly Q_dot_food for DC_hor [kW]} \text{ else "TC_Hourly Q_dot_food for Dc_ver [kW]"}$
Transcritical	TC_Hourly Q_dot_Airex [kW]	$\text{"TC_V_airex [m}^3\text{/hrs]} * \text{"TC_delta_h x phi [Wh/m}^3\text{]} / \text{"Conversion from kW to W [W/kW]"}$
Transcritical	TC_Hourly Q_dot_ColdStorage [kW]	$\text{"TC_Hourly Q_dot_Airex [kW]} + \text{"TC_Hourly Q_dot_light [kW]} + \text{"TC_Hourly Q_dot_people [kW]} + \text{"TC_Hourly Q_dot_food for CS [kW]} + \text{"TC_Hourly Q_dot_trans [kW]"}$
Transcritical	TC_Hourly Q_dot_food for CS [kW]	$\text{"TC_mass flow [kg/m}^3\text{]} / \text{"TC_rho_pr [kg/m}^3\text{]} * (\text{"TC_Delta_H [kJ/kg]} / \text{"Conversion from kW to kJ [kW/kJ]}) * \text{"Mass of food inside each CS [kg]} * (1 / \text{"no of hours in a day [hrs/day]"})$
Transcritical	TC_Hourly Q_dot_food for DC_hor [kW]	$\text{"TC_mass flow [kg/m}^3\text{]} / \text{"TC_rho_pr [kg/m}^3\text{]} * (\text{"TC_Delta_H [kJ/kg]} / \text{"Conversion from kW to kJ [kW/kJ]}) * \text{"Mass of food inside each DC horizontal [kg]} * (1 / \text{"no of hours in a day [hrs/day]"})$

Transcritical	TC_Hourly Q_dot_food for Dc_ver [kW]	"TC_mass flow [kg/m^3]"/"TC_rho_pr [kg/m^3]"*("TC_Delta_H [kJ/kg]"/"Conversion from kW to kJ [kW/kJ]")*"Mass of food inside each DC vertical [kg]"*(1/"no of hours in a day [hrs/day]")
Transcritical	TC_Hourly Q_dot_light [kW]	("Transcritical storage"."Heat_light [W/m^2]"/"Conversion from kW to W [W/kW]"*("Transcritical storage"."A_floor [m^2]")
Transcritical	TC_Hourly Q_dot_people [kW]	"TC_Hourly Q_dot_people during working time [kW]"+"TC_Hourly Q_dot_people during opening time [kW]"
Transcritical	TC_Hourly Q_dot_people during opening time [kW]	"Nb of people coming during opening time [#]"*("People heat during opening time [W]"/"Conversion from kW to W [W/kW]")
Transcritical	TC_Hourly Q_dot_people during working time [kW]	"Nb of people coming during working time [#]"*("People heat during working time [W]"/"Conversion from kW to W [W/kW]")
Transcritical	TC_Hourly Q_dot_trans [kW]	((("Transcritical storage"."U_sidewall [W/m^2.K]"/"Conversion from kW to W [W/kW]"*("Transcritical storage"."A_sidewall [m^2]")+("Transcritical storage"."U_floor [W/m^2.K]"/"Conversion from kW to W [W/kW]"*("Transcritical storage"."A_floor [m^2]"))*("Supermarket"."Ambient temperature [°C]"-"TC_setpoint temp [°C]")
Transcritical	TC_Hourly Q_infiltration_day [kW]	"Transcritical storage"."X_(air_curtain) [#]"*("Transcritical storage"."V_(air_curtain) [kg/s]"*("Supermarket"."h_ambience [kJ/kg]"-"TC_h_inside [kJ/kg]")
Transcritical	TC_Hourly Q_infiltration_night [kW]	"Transcritical storage"."U_air_curtainDC [W/m^2.K]"*("conversion factor W to kW [kW/W]"*("Transcritical storage"."A_air_curtainDC [m^2]"*("Supermarket"."Ambient temperature [°C]"-"TC_setpoint temp [°C]")
Transcritical	TC_Hourly Q_night [kW]	"TC_Hourly Q_wall [kW]"+"Transcritical storage"."Q_hw [w]"*("conversion factor W to kW [kW/W]"+"TC_Hourly Q_infiltration_night [kW]"+"Transcritical storage"."Q_fan [W]"*("conversion factor W to kW [kW/W]" +(if("Transcritical Horizontal display cabinet"="Transcritical storage"."name") then ("TC_Hourly Q_dot_food for DC_hor [kW]") else ("TC_Hourly Q_dot_food for Dc_ver [kW]"))

Transcritical	TC_Hourly Q_radiation_day [kW]	"Transcritical storage"."hro [W/m ² K]"*"conversion factor W to kW [kW/W]"*"Transcritical storage"."A_door [m ²]"*("Transcritical storage"."T_wall [°C]"-"TC_setpoint temp [°C]")*"Transcritical storage"."phi_1 [#]"*"Transcritical storage"."phi_2 [#]"
Transcritical	TC_Hourly Q_wall [kW]	"Transcritical storage"."U_wallDC [W/m ² .K]"*"conversion factor W to kW [kW/W]"*"Transcritical storage"."A_wallDC [m ²]"*("Supermarket"."Ambient temperature [°C]"-"TC_setpoint temp [°C]")
Transcritical	TC_Margin on compressor sizing (%)	(ceil("TC_Frigorific power for all CS and DC [kW]"/"Transcritical compressor"."Cooling capacity [kW]")-("TC_Frigorific power for all CS and DC [kW]"/"Transcritical compressor"."Cooling capacity [kW]"))*100
Transcritical	TC_T_c [°C]	"TC_setpoint temp [°C]"-"pinch_c [°C]"
Transcritical	TC_V_airex [m ³ /hrs]	"Nb of doors opening per day for CS [#]"*"Transcritical storage"."V_room [m ³]"/(("no of hours in a day [hrs/day]"))
Transcritical	TC_Yearly energy consumption of CS in closed time [kWh]	if('Transcritical Cold storage unit'="Transcritical storage"."name") then (Energy_consumption_CS("TC_Hourly Q_dot_ColdStorage [kW]","pinch_h [°C]","eta [#]","TC_T_c [°C]","No of days used in a month (31) [days]","No of days used in a month (28) [days]","No of days used in a month (30) [days]","Supermarket's Closed time [hrs]","Location_data"."01 Jan_Min_temp [°C]","Location_data"."02 Feb_Min_temp [°C]","Location_data"."03 Mar_Min_temp [°C]","Location_data"."04 April_Min_temp [°C]","Location_data"."05 May_Min_temp [°C]","Location_data"."06 Jun_Min_temp [°C]","Location_data"."07 Jul_Min_temp [°C]","Location_data"."08 Aug_Min_temp [°C]","Location_data"."09 Sep_Min_temp [°C]","Location_data"."10 Oct_Min_temp [°C]","Location_data"."11 Nov_Min_temp [°C]","Location_data"."12 Dec_Min_temp [°C]")) else 0

Transcritical	TC_Yearly energy consumption of CS in working time [kWh]	<pre> if('Transcritical Cold storage unit'="Transcritical storage"."name") then (Energy_consumption_CS("TC_Hourly Q_dot_ColdStorage [kW]","pinch_h [°C]","eta [#]","TC_T_c [°C]","No of days used in a month (31) [days]","No of days used in a month (28) [days]","No of days used in a month (30) [days]","Supermarket's Working time [hrs]","Location_data"."01Jan_Max_temp [°C]","Location_data"."02 Feb_Max_temp [°C]","Location_data"."03 Mar_Max_temp [°C]","Location_data"."04 April_Max_temp [°C]","Location_data"."05 May_Max_temp [°C]","Location_data"."06 Jun_Max_temp [°C]","Location_data"."07 Jul_Max_temp [°C]","Location_data"."08 Aug_Max_temp [°C]","Location_data"."09 Sep_Max_temp [°C]","Location_data"."10 Oct_Max_temp [°C]","Location_data"."11 Nov_Max_temp [°C]","Location_data"."12 Dec_Max_temp [°C]")) else 0 </pre>
Transcritical	TC_Yearly energy consumption of DC in closed time [kWh]	<pre> if('Transcritical Cold storage unit'<>"Transcritical storage"."name") then (Energy_consumption_DC("TC_Hourly Q_night [kW]","pinch_h [°C]","eta [#]","TC_T_c [°C]","No of days used in a month (31) [days]","No of days used in a month (28) [days]","No of days used in a month (30) [days]","Supermarket's Closed time [hrs]","time for each defrost [hrs]","number of defrosts in closed time [#]","Location_data"."01 Jan_Min_temp [°C]","Location_data"."02 Feb_Min_temp [°C]","Location_data"."03 Mar_Min_temp [°C]","Location_data"."04 April_Min_temp [°C]","Location_data"."05 May_Min_temp [°C]","Location_data"."06 Jun_Min_temp [°C]","Location_data"."07 Jul_Min_temp [°C]","Location_data"."08 Aug_Min_temp [°C]","Location_data"."09 Sep_Min_temp [°C]","Location_data"."10 Oct_Min_temp [°C]","Location_data"."11 Nov_Min_temp [°C]","Location_data"."12 Dec_Min_temp [°C]")) else 0 </pre>

Transcritical	TC_Yearly energy consumption of DC in working time [kWh]	<pre> if('Transcritical Cold storage unit'<>"Transcritical storage"."name") then (Energy_consumption_DC("TC_Hourly Q_day [kW]","pinch_h [°C]","eta [#]","TC_T_c [°C]","No of days used in a month (31) [days]","No of days used in a month (28) [days]","No of days used in a month (30) [days]","Supermarket's Working time [hrs]","time for each defrost [hrs]","number of defrosts in working time [#]","Location_data"."01Jan_Max_temp [°C]","Location_data"."02 Feb_Max_temp [°C]","Location_data"."03 Mar_Max_temp [°C]","Location_data"."04 April_Max_temp [°C]","Location_data"."05 May_Max_temp [°C]","Location_data"."06 Jun_Max_temp [°C]","Location_data"."07 Jul_Max_temp [°C]","Location_data"."08 Aug_Max_temp [°C]","Location_data"."09 Sep_Max_temp [°C]","Location_data"."10 Oct_Max_temp [°C]","Location_data"."11 Nov_Max_temp [°C]","Location_data"."12 Dec_Max_temp [°C]")) else 0 </pre>
Transcritical	TC_Yearly energy consumption of all CS and DC [MWh]	<pre> "TC_Yearly energy consumption of all CS and DC in closed time [MWh]"+"TC_Yearly energy consumption of all CS and DC in working time [MWh]" </pre>
Transcritical	TC_Yearly energy consumption of all CS and DC in closed time [MWh]	<pre> ("TC_Yearly energy consumption of CS in closed time [kWh]"*"Number of Transcritical CS units [#]")+("TC_Yearly energy consumption of DC in closed time [kWh]"*(if('Transcritical Horizontal display cabinet'="Transcritical storage"."name") then "Number of Transcritical Horizontal Display cabinet [#]" else "Number of Transcritical Vertical display cabinets [#]"))*"conversion from kW to MW [MW/kW]" </pre>
Transcritical	TC_Yearly energy consumption of all CS and DC in working time [MWh]	<pre> ("TC_Yearly energy consumption of CS in working time [kWh]"*"Number of Transcritical CS units [#]")+("TC_Yearly energy consumption of DC in working time [kWh]"*(if('Transcritical Horizontal display cabinet'="Transcritical storage"."name") then "Number of Transcritical Horizontal Display cabinet [#]" else "Number of Transcritical Vertical display cabinets [#]"))*"conversion from kW to MW [MW/kW]" </pre>

Transcritical

TC_Yearly energy consumption of defrost in closed time [kWh]

```

if('Transcritical Cold storage unit'<>"Transcritical storage"."name") then
(if("Number of Transcritical Vertical display cabinets [#]"=0 and "Number of
Transcritical Horizontal Display cabinet [#]"=0) then 0 else Energy_consump-
tion_DC_defrost("Q_dot_defrost for one time [kW]","pinch_h [°C]","eta
[#]","TC_T_c [°C]","No of days used in a month (31) [days]","No of days used in
a month (28) [days]","No of days used in a month (30) [days]","time for each
defrost [hrs]","number of defrosts in closed time [#]","Location_data"."01
Jan_Min_temp [°C]","Location_data"."02 Feb_Min_temp [°C]","Loca-
tion_data"."03 Mar_Min_temp [°C]","Location_data"."04 April_Min_temp
[°C]","Location_data"."05 May_Min_temp [°C]","Location_data"."06
Jun_Min_temp [°C]","Location_data"."07 Jul_Min_temp [°C]","Loca-
tion_data"."08 Aug_Min_temp [°C]","Location_data"."09 Sep_Min_temp
[°C]","Location_data"."10 Oct_Min_temp [°C]","Location_data"."11
Nov_Min_temp [°C]","Location_data"."12 Dec_Min_temp [°C]")) else 0
    
```

Transcritical	TC_Yearly energy consumption of defrost in working time [kWh]	if("Transcritical Cold storage unit"<>"Transcritical storage"."name") then (if("Number of Transcritical Vertical display cabinets [#]"=0 and "Number of Transcritical Horizontal Display cabinet [#]"=0) then 0 else Energy_consumption_DC_defrost("Q_dot_defrost for one time [kW]","pinch_h [°C]","eta [#]","TC_T_c [°C]","No of days used in a month (31) [days]","No of days used in a month (28) [days]","No of days used in a month (30) [days]","time for each defrost [hrs]","number of defrosts in working time [#]","Location_data"."01Jan_Max_temp [°C]","Location_data"."02 Feb_Max_temp [°C]","Location_data"."03 Mar_Max_temp [°C]","Location_data"."04 April_Max_temp [°C]","Location_data"."05 May_Max_temp [°C]","Location_data"."06 Jun_Max_temp [°C]","Location_data"."07 Jul_Max_temp [°C]","Location_data"."08 Aug_Max_temp [°C]","Location_data"."09 Sep_Max_temp [°C]","Location_data"."10 Oct_Max_temp [°C]","Location_data"."11 Nov_Max_temp [°C]","Location_data"."12 Dec_Max_temp [°C]")) else 0
Transcritical	TC_delta_h x phi [Wh/m^3]	(-0.0011)*("TC_setpoint temp [°C"]^2)-(0.6231)*("TC_setpoint temp [°C"])+(17.245)
Transcritical	Transcritical Comperssor TRL	"Transcritical compressor"."Technology Readiness Level [#]"
Transcritical	Transcritical Compressor's discharge pipe diameter requirement [in]	"Transcritical compressor"."Connection discharge line diameter (Dpipeline out) [in]"
Transcritical	Transcritical Compressor's suction pipe diameter requirement [in]	"Transcritical compressor"."Connection suction line diameter (Dpipeline in) [in]"
Transcritical	Transcritical compressor and pipe connection	if(("Transcritical compressor"."Connection discharge line diameter (Dpipeline out) [in]"="Transcritical discharge pipe"."pipe diameter [in]") and ("Transcritical compressor"."Connection suction line diameter (Dpipeline in) [in]"="Transcritical suction pipe"."pipe diameter [in]")) then 1 else 0
Transcritical	Transcritical compressor and pipe connection	1
Transcritical	Transcritical pipeline suction TRL	"Transcritical suction pipe"."Technology Readiness Level [#]"
Transcritical	Transcritical pipeline discharge TRL	"Transcritical discharge pipe"."Technology Readiness Level [#]"

Transcritical	Volume of material in TC discharge pipe [m ³]	$\pi * ((\text{"Transcritical discharge pipe"."pipe diameter [m]"} / 2) ^ 2 - (\text{"Transcritical discharge pipe"."pipe diameter [m]"} / 2) - (\text{"pipe thickness [mm]"} * \text{"Conversion from mm to m [m/mm]"})) ^ 2 * \text{"length of TC discharge pipe [m]"}$
Transcritical	Volume of material in TC suction pipe [m ³]	$\pi * ((\text{"Transcritical suction pipe"."pipe diameter [m]"} / 2) ^ 2 - (\text{"Transcritical suction pipe"."pipe diameter [m]"} / 2) - (\text{"pipe thickness [mm]"} * \text{"Conversion from mm to m [m/mm]"})) ^ 2 * \text{"length of TC suction pipe [m]"}$
Transcritical	length of TC discharge pipe [m]	"Distance between the transcritical storage and main storage [m]"
Transcritical	length of TC suction pipe [m]	"Distance between the transcritical storage and main storage [m]"
Transcritical	v_ref_TC_pipeline_total [m ³]	"v_ref_pipeline_TC_discharge [m ³]" + "v_ref_pipeline_TC_suction [m ³]"
Transcritical	v_ref_pipeline_TC_discharge [m ³]	$\pi * ((\text{"Transcritical discharge pipe"."pipe diameter [m]"} / 2) - (\text{"pipe thickness [mm]"} * \text{"Conversion from mm to m [m/mm]"})) ^ 2 * \text{"length of TC discharge pipe [m]"}$
Transcritical	v_ref_pipeline_TC_suction [m ³]	$\pi * ((\text{"Transcritical suction pipe"."pipe diameter [m]"} / 2) - (\text{"pipe thickness [mm]"} * \text{"Conversion from mm to m [m/mm]"})) ^ 2 * \text{"length of TC suction pipe [m]"}$

4. Appendix 4 : Résumé étendu en Français

1. Contexte

L'impact du changement climatique sur le secteur de la réfrigération a entraîné une augmentation de la demande de froid dans le secteur alimentaire, les produits pharmaceutiques, les bâtiments et les transports. Près de 20 % de la consommation totale d'électricité est utilisée pour la production de froid. Ce chiffre devrait augmenter avec la demande croissante et devrait atteindre 37 % d'ici 2050 [1]. Les systèmes de réfrigération (SR) sont régis par de nombreuses réglementations et lois afin de limiter leur impact environnemental élevé. La gestion d'un SR, de sa conception à sa fin de vie, est complexe en raison du nombre de disciplines, d'intervenants, de rôles et de compétences impliqués. Le secteur de la réfrigération de détail a été choisi dans la présente étude de terrain en raison de son ampleur. Ce secteur représente 3 à 5% de la consommation d'énergie dans les pays européens et se développe pour répondre à une demande croissante. En France, les magasins de détail ont vu leur fréquentation augmenter de 10% en 5 ans et leur nombre de 8%. Les équipements frigorifiques (vitrines ou chambres froides) sont responsables de 35 à 50% de l'énergie consommée par un magasin de détail.

Un système frigorifique peut être décrit par son architecture, ses composants (compresseur, condenseur, évaporateur, ...) et le fluide frigorigène. Le système peut être dimensionné en fonction de la demande de froid et de puissance, des conditions d'exploitation, du lieu (conditions climatiques, mixité électrique...). Il est évalué principalement en fonction des performances techniques, environnementales et économiques. Un système peut être construit à partir de zéro ou être modifié à partir d'un système existant pour être optimisé. Dans ce cas, il est important d'évaluer au préalable l'intérêt de cette modification dans le système. Les enjeux techniques liés au système physique, c'est-à-dire le système frigorifique décrit précédemment, et non techniques liés au système socio-technique d'un système de réfrigération, c'est-à-dire l'ensemble des acteurs, processus, organisations et solutions techniques impliqués dans les activités liées au système de réfrigération tout au long de son cycle de vie, génèrent une série de problèmes et peuvent conduire à des performances sous-optimales du système physique. Dans le processus de conception d'un système, les phases amont sont primordiales [2]. Il convient donc de favoriser l'exploration de la phase amont en développant les méthodes, les outils et les pratiques liés à cette phase [3].

L'objectif de cette thèse est de répondre à la question de recherche principale suivante :

Comment améliorer le processus de conception grâce à un outil d'exploration en phase amont de conception ?

De cette question, deux sous questions de recherche émergent :

- **Question de recherche 1 :** Comment représenter et évaluer le système socio-technique des systèmes de réfrigération ?

Cette question amène à deux objectifs :

- **Objectif 1.1 :** Mettre en place un livre de connaissance structuré du système socio-technique existant
- **Objectif 1.2 :** Evaluer les manques actuels du système socio-technique grâce à la méthodologie Radical Innovation Design (RID) [2,3]

- **Question de recherche 2 :** Comment aider à la prise de décision pour la conception de système de réfrigération le plus en amont du processus et de manière la plus intégrée ?

Cette deuxième question de recherche amène à deux sous objectifs :

- **Objectif 2.1 :** Construire un modèle de connaissance avec un langage structuré (ontologie) pour la conception de système de réfrigération de supermarché
- **Objectif 2.2 :** Intégrer ce modèle de connaissance dans une plateforme de simulation et d'exploration multi-objectifs pour concevoir un système de réfrigération de supermarché

Dans le deuxième chapitre, nous répondons au premier objectif en diagnostiquant le système socio-technique des systèmes de réfrigération en France grâce à la méthodologie Radical Innovation Design (RID) [2,3].

Dans le troisième chapitre, un état de l'art sur les différents travaux de développement de plateforme de modélisation et de simulation sont explorés afin de définir une approche de recherche répondant aux lacunes mises en avant dans le diagnostic.

Le chapitre quatre présente le modèle de connaissance développé pour concevoir un système de réfrigération de supermarché en phase amont de conception. Le chapitre conclut par une phase de validation de ce modèle auprès d'experts.

Le dernier chapitre montre la mise en place du modèle de connaissance dans la plateforme de simulation, l'exploration de scénario d'utilisation de la plateforme et la validation par des experts du domaine.

Enfin, une conclusion générale finalise ce mémoire.

2. Diagnostic du système socio-technique de réfrigération

Afin de répondre à notre première question de recherche, nous avons cherché à diagnostiquer le système socio-technique de la réfrigération en représentant et évaluant l'état de l'existant.

La recherche vise à développer des innovations pour répondre à la réglementation croissante et aux impacts environnementaux critiques des systèmes de réfrigération. Un système de réfrigération sociotechnique est un système complexe faisant intervenir de multiples disciplines, environnements et parties prenantes tout au long de son cycle de vie (utilisation, maintenance, mise à jour technique et fin de vie). Sa complexité peut soulever des problèmes et provoquer des malentendus lors des premières étapes de la conception. Cela peut conduire à des performances sous-optimales. La méthodologie Radical Innovation Design (RID) est bien adaptée à l'identification des principaux domaines d'amélioration des activités des systèmes complexes. À cette fin, des données provenant d'entretiens et de pratiques existantes fournies par différentes entreprises ayant une expérience et des connaissances variées ont été recueillies pour alimenter la méthodologie RID. Notre champ d'investigation est la réfrigération dans le secteur de la vente au détail.

Deux séries de résultats sont présentées répondant aux deux objectifs de recherche (1.1 et 1.2)

2.1. Objectif 1.1 : Livre de connaissance

Premièrement, un livre de connaissances du système socio-technique est décrit. La Figure 7 présente la méthodologie suivie pour construire le livre de connaissance et classer les données collectées. Une quinzaine d'acteurs du domaine de la réfrigération en France ont été interviewés. Les personnes interrogées ont été choisies pour être représentatives des acteurs impliqués dans le cycle de vie des systèmes de réfrigération. Les données collectées sont divisées en quatre catégories correspondant aux quatre dimensions ontologiques de RID (situations d'usage, profils des utilisateurs, problèmes actuels et solutions existantes) :

- Trois situations d'usages sont identifiées : *Conception, fabrication et installation ; Exploitation ; Fin de vie.*
- Douze profils d'utilisateurs sont identifiés : *Chercheur académique ; Centre de transfert technologique ; Organisme professionnel ; Chercheur en R&D ; Bureau d'études ; Cabinet de conseil ; Ingénieur frigoriste ; Fournisseur ; Concepteur de composants ; Fabricant ; Utilisateur final ; Parties de traitement de la fin de vie*
- Quinze problèmes sont mis en avant : *Risque d'obsolescence précoce; Risque de coûts d'investissement imprévus ; Risque de panne; Risque de coûts opérationnels élevés (OPEX); Diminution de la qualité du recrutement; Manque de techniciens et d'ingénieurs en réfrigération; Manque de compréhension des nouvelles grappes technologiques; Perturbation du processus de conseil à l'utilisation finale du système; Manque de flexibilité pour les installateurs; Risque d'inconfort pour les clients de l'utilisateur final; Risque de danger élevé pour la santé humaine; Mauvaise exploration de l'espace de conception; Manque d'outils communs efficaces; Risque d'impacts environnementaux élevés; Faible taux de recyclage*
- Six catégories de solutions existantes sont présentées : *Solutions basées sur les logiciels ; Solutions basées sur la gestion des connaissances ; Solutions méthodologiques ; Solutions techniques ; Solutions outils ; Directives EN 378.*

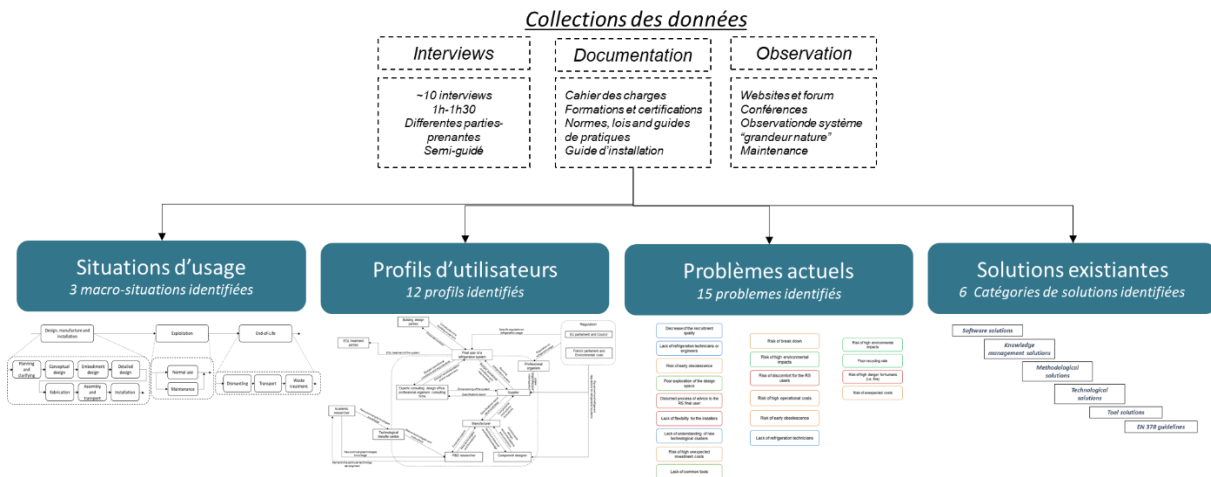

Figure 7. Méthodologie mise en place pour construire le livre de connaissance

2.2. Objectif 1.2 : Evaluation des pistes d'amélioration

La deuxième série de résultats a été obtenue avec deux outils d'aide à la décision de RID. Le premier outil, « RID Comparator », a calculé l'efficacité des solutions existantes et a montré que les solutions de gestion des connaissances étaient les plus efficaces. Le second outil, « RID Compass », a mis en évidence trois domaines d'amélioration (poches de valeur) : (i) une mauvaise adaptation aux nouvelles briques technologiques innovantes, (ii) des processus d'interaction perturbés entre les parties prenantes, et (iii) un manque d'outils communs. La Figure 8 résume les étapes suivies et les résultats obtenus grâce à la méthodologie RID. Les résultats ont été validés par itération avec les experts interrogés.

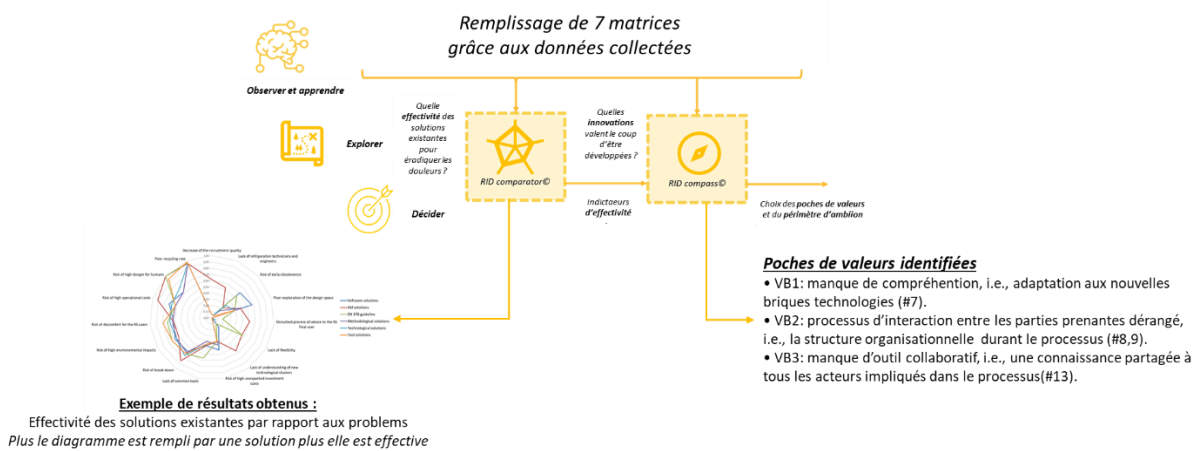

Figure 8. Résumé de la méthodologie RID et des résultats obtenus pour évaluer le système socio-technique existant

Une revue de littérature approfondie est menée afin de trouver une solution innovante qui permettra de pallier les poches de valeurs identifiées dans ce diagnostic. Une solution développant une plateforme intégrée basée sur des modèles est préconisée pour combler ces poches de valeurs.

3. Revue de littérature vers une solution innovante

En partant du résultat du diagnostic, et pour pallier les poches de valeurs identifiées, nous cherchons à construire la connaissance autour des systèmes de réfrigération pour la mettre en place dans une plateforme de conception intégrée qui servira à modéliser et simuler puis optimiser une architecture de système réfrigérant et, plus généralement, celle d'un système énergétique thermique.

Nous avons mené une revue de la littérature avec une centaines d'articles, nous amenant à classer les travaux

antérieurs sur la modélisation et la simulation/optimisation de systèmes frigorifiques et énergétiques en plusieurs catégories d'études :

- Les études ayant pour objectif la modélisation et simulation de composants (ex : compresseur, condenseur...) individuels avec des modèles mathématiques très détaillés et spécifiques pour l'objectif de l'étude (améliorer une efficacité ou montrer une performance intéressante à un niveau local)[4–6].
- Les études ayant pour objectif la modélisation et simulation de systèmes entiers avec plusieurs composants et configurations par des séries d'équations mathématiques pour montrer la faisabilité de la solution technique. Selon l'objectif de l'étude, les modèles développés vont être plus ou moins complexes et juste par rapport à la réalité (évaluation de performances uniquement thermodynamiques par exemple). Les études utilisent soit des logiciels existants (comme SuperSim, Dymola), soit des modèles basés sur des équations plus ou moins complexes/détaillées et nécessaires à l'étude mais qui ne rentrent pas dans un processus de conception (c'est-à-dire qu'on évalue une performance à un instant t avec des hypothèses particulières) [7–11]. Ce sont les articles les plus fréquemment trouvés dans la littérature.
- Les études ayant pour objectif la définition d'un langage avec des composants, des connexions, des variables comme des bibliothèques de langages à intégrer dans une étude (ex : Modelica) [12–14]
- Les études ayant pour objectif le développement d'une ontologie d'une partie des systèmes de réfrigération, ou incluse dans une ontologie plus générale, comme *CheBi* [17], une ontologie définissant les entités chimiques avec un sous-concept dédié aux réfrigérants.

Dans toutes ces études, il manque certaines notions industrielles pour la simulation et la modélisation de performances réelles en usage comme la maintenance, la sécurité, la facilité d'installation, le confort sonore... Ces manques sont un frein à une évolution optimale des systèmes afin de répondre aux nouvelles réglementations. En effet, les plateformes de simulation et modélisation existantes pour les systèmes de réfrigération ne traduisent pas toute la complexité des systèmes au niveau de la diversité des performances obtenues ou la diversité des architectures possibles. Elles ne permettent donc pas une exploration optimale de l'espace de conception. De plus, le diagnostic souligne une approche de conception de système de réfrigération descendante et basée sur l'évaluation d'un nombre très limité de solutions dimensionnées (on parle de *point-based design*). En effet, une limitation mise en avant par plusieurs travaux [18] est la restriction de l'espace de conception à une solution acceptable mais pas optimale au vue des spécifications sans tester l'ensemble des alternatives possibles, faute du savoir-faire pour les énumérer. La conception basée sur des ensembles (*set-based design*) [19, 20] commence par l'analyse d'un ensemble de solutions possibles puis réduit progressivement l'ensemble des possibilités pour tendre vers le meilleur compromis. Nous retrouvons dans les travaux de A. Abi Akle [20] une notion similaire appelé le « *Design by Shopping* ». Dans cette approche, le processus est itératif en permettant aux acteurs de la conception d'interagir en simultané avec l'espace de performance et l'espace de décision.

Dans ses travaux de recherche, V.Holley développe une approche [21] basée sur les concepts listés précédemment et développe l'outil de modélisation et de simulation Geeglee. En générant un espace de conception avec toutes les alternatives possibles, l'approche permet de découvrir des conceptions pertinentes et parfois hors normes répondant aux objectifs des acteurs impliqués. En se basant sur des critères de performances du système, les acteurs peuvent ainsi trouver des solutions intéressantes auxquelles ils n'auraient pas pensé ou qu'ils auraient difficilement identifiées. Geeglee est divisé en deux outils complémentaires : *Geeglee Engineering Patterns* (GEP) et *Geeglee Engineering Intelligence* (GEI). GEP est l'outil utilisé pour modéliser le système d'intérêt (*system of interest*), tandis que GEI est celui utilisé pour visualiser et analyser les données de l'espace de conception qui sont générées à partir du modèle créé sous GEP, puis pour permettre au concepteur de jouer avec l'espace de conception en réduisant l'incertitude jusqu'à une solution optimale, ceci de manière opportuniste (*design by shopping*) en sur-contraignant le cahier des charges et en effectuant des choix de conception particuliers.

Afin de répondre aux limites identifiées, nous avons cherché à développer une plateforme d'exploration d'espace de conception basée sur ces approches avec les outils Geeglee. Dans la plateforme, le comportement

du système est implanté puis simulé pour estimer des valeurs de performances qui permettent de visualiser tout l'espace de conception possible. Le modèle doit être détaillé et précis c'est-à-dire que tous les composants, les architectures, l'évolution du système sont décrits avec des modèles quantitatifs (modèles physiques, thermiques, coûts, impacts sur l'environnement) et qualitatifs (pour les performances liées à la maintenance du système, à la sécurité des opérateurs, l'installation...), en utilisant la connaissance du domaine de la réfrigération, pour évaluer des architectures et des technologies. Nous désirons également ne pas nous contenter d'explorer une seule architecture paramétrée mais bien un ensemble d'architectures différentes qui sont des assemblages de composants du commerce. Pour ce faire, on propose un langage de description non ambigu et complet des objets et des relations qui les lient. Des performances réelles, explicitées dans ce modèle de connaissance, sont évaluées à l'aide d'équations mathématiques. Ces performances sont visualisées dans une plateforme d'exploration d'espace de conception qui permet de résoudre des problèmes mono- ou multi-objectifs.

4. Modèle de connaissance structuré

Afin de capitaliser toute la connaissance autour de la conception des systèmes de réfrigération, les connaissances de 15 experts appartenant à plusieurs entreprises ayant des rôles différents sont collectées, en plus de la revue de littérature (150 articles). Le processus de conception est défini dans un langage commun à tous les acteurs du domaine pour assurer un usage pertinent de la plateforme. Les résultats de cette acquisition de données nous permettent d'établir le processus de modélisation et simulation du comportement d'une architecture d'un système de réfrigération dans un scénario d'usage. Ce modèle de connaissance est nécessaire pour modéliser le système d'intérêt et permet d'alimenter le GEP.

Le processus suivi pour la construction du modèle de connaissance est le suivant :

- Spécification vérifiée par des experts par itération
- Acquisition des connaissances : explicitation du langage choisi et pourquoi
- Conceptualisation du domaine avec la définition de chaque macro-concept, des instances et des relations et vérification des critères de qualité de l'ontologie par itération avec experts.
- Formalisation des concepts dans des classes et modélisation dans un format UML

La figure 3 présente la logique de construction du modèle et des macro-concepts pour la conception de systèmes de réfrigération. La classe de *scénario* exprime les situations d'utilisation du client. Elle est définie comme la combinaison d'un *environnement système* et d'une partie prenante. L'environnement du système est l'endroit où le système de réfrigération fonctionne. Il est défini par une localisation, une température de conservation, et un certain volume à refroidir. Une partie prenante est définie par son identité en tant qu'acteur du domaine et par son expertise. Il peut s'agir d'un chercheur, d'un fournisseur de froid, de l'utilisateur final du système de réfrigération et d'un acteur de fin de vie.

Ensuite, la conception du système physique suit.

Le *scénario* influence l'*espace de décision* globale du système de réfrigération. Par exemple, si le *scénario* est défini avec des meubles de vente avec une température de consigne positive à 3°C, le réfrigérant R717 (du CO₂) ne pourra pas être dans l'*espace de décision*. En effet, les conditions d'utilisation du CO₂ impliquent une température de consigne négative. La *décision globale* est définie par les paramètres (éléments physiques du système) qui auront un impact important sur les performances du système. Elle est composée d'une architecture de système, d'un fluide frigorigène, d'un type de compresseur, d'un type de condenseur, d'un évaporateur, d'un détendeur et de zéro, un ou plusieurs briques technologiques.

Les classes de *décision globale et locale* définissent un ensemble de *données intermédiaires*. Il s'agit de données thermodynamiques, physiques, météorologiques, économiques... des éléments du système qui sont mises dans des modèles mathématiques. Le calcul aboutit aux *performances locales* du système. Celles-ci sont définies comme étant observées ou calculées avec des modèles mathématiques nécessaires à la prise de décision de l'acteur impliqué dans la conception du système.

L'agrégation des *performances locales* définit les *performances globales* du système. Les *performances globales* du système sont les performances de chaque objectif de conception. Elles correspondent à un niveau macro de performance que la partie prenante peut interpréter. Il est composé de 5 éléments principaux : la consommation d'énergie, le coût total, la maintenance, les impacts environnementaux, et le niveau de maturité.

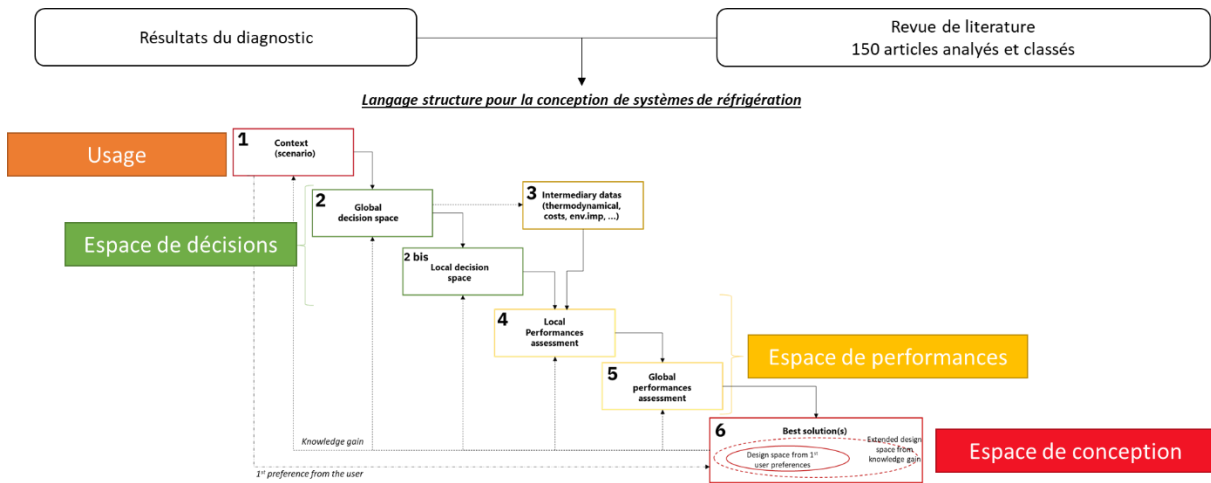

Figure 9. Présentation des macro-concepts du modèle de connaissance

L'outil GEP est composé de quatre sections principales :

- *High Level Requirement* (HLR) où sont décrits les spécifications (entrées, contraintes, objectifs...).
- *Product Breakdown Structure* (PBS) où est décrit l'espace de décision (les options techniques pour le système d'intérêt et les incompatibilités entre solutions techniques).
- *Technical Portfolio* où sont entrées les valeurs intermédiaires liées à chaque option technique.
- *Engineering Patterns* où sont explicités les performances et le comportement physique du système au moyen d'équations.

Deux exemples de la mise en œuvre du modèle sur GEP sont montrés sur les figures 4 et 5.

Sur la Figure 10, on retrouve en partie la définition d'un scénario d'usage du système frigorifique dans un supermarché (nombre de chambres froide, de meubles de vente, la masse de nourriture dans chaque élément, la température de consigne, la localisation du supermarché...).

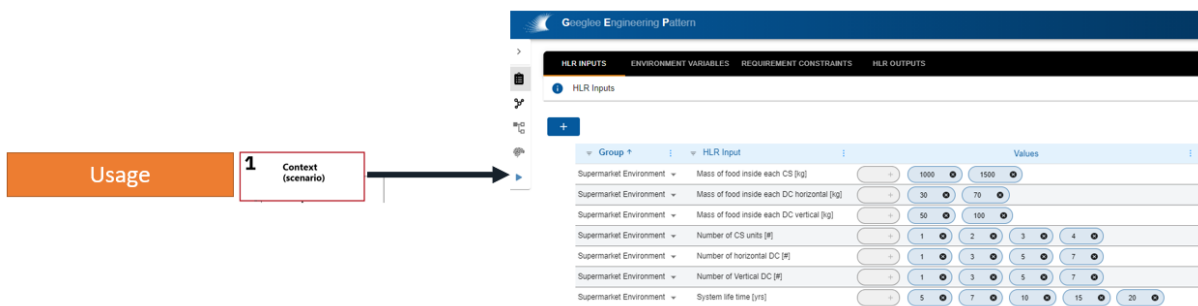

Figure 10. Présentation de la mise en place du concept de scénario dans le GEP

Sur la Figure 11, l'exemple de l'espace de décision est montré sur le GEP. Plusieurs architectures de systèmes de réfrigération sont mises en place (primaire, secondaire, logé, transcritique) dans l'espace de décision. Tous les composants d'un système de réfrigération dans un supermarché sont inclus dans la modélisation avec une ou plusieurs alternatives.

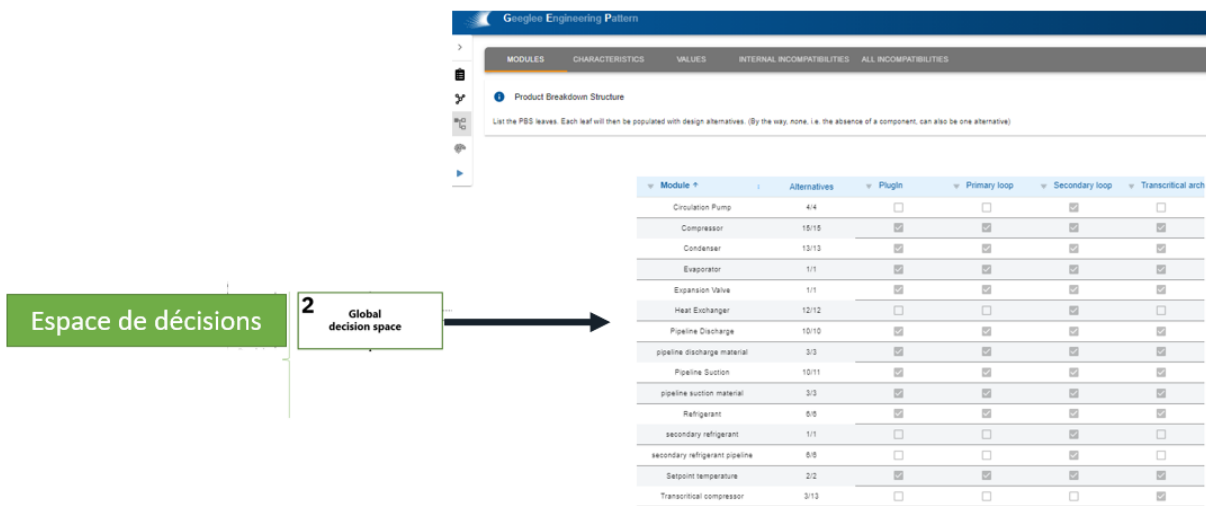

Figure 11. Présentation de la mise en place de l'espace de décision dans le GEP

La qualité de notre modèle de connaissance est évaluée sur plusieurs points : la pertinence du vocabulaire employé, sa clarté, le choix des relations, la cohérence et l'extensibilité, la fidélité par rapport au domaine et l'usage de l'ontologie. Une vérification ligne par ligne du modèle est faite afin d'assurer la cohérence et la fidélité du modèle.

5. Mise en place d'une plateforme de simulation et d'exploration

Dans cette dernière partie et afin de répondre au dernier objectif, le modèle de connaissance validé est ensuite exploité à l'aide de l'outil GEI configuré pour permettre de retrouver le modèle de connaissance et d'explorer l'ensemble de l'espace de conception selon les objectifs et les besoins des utilisateurs. Des performances qualitatives et quantitatives sont analysées et évaluées. Les objectifs de cette plateforme sont non seulement de tester plusieurs alternatives de composants ou d'architecture possible en phase amont de conception et d'explorer en temps réel l'espace de conception mais aussi d'apporter un outil d'aide à la décision pour les industriels et pour aider à explorer des champs de recherche. Il est intéressant de noter que les études de cas proposées sont représentatives de la complexité industrielle liée à la conception et exploitation de système de réfrigération dans un supermarché [19, 20].

En reprenant le modèle de connaissance pour la conception de système de réfrigération, la simulation commence par la définition du scénario d'utilisation du système de réfrigération. Ensuite, plusieurs possibilités d'exploitation de la plateforme d'exploration sont proposées à l'utilisateur. Elles sont regroupées en deux catégories :

- Évaluer un système de réfrigération existant :
 - o Simuler ses performances globales
 - o Simuler l'impact d'un changement de composant technique sur ses performances
- Identifier les meilleures combinaisons de composants selon une analyse mono- ou multi-objectifs. Cette simulation peut être utilisée soit sur un système existant, soit pour un nouveau système. Les objectifs correspondent à une combinaison de performances globales. Plusieurs scénarios d'analyse sont proposés sur la plateforme :
 - o Identifier les composants avec le plus faible coût total (évalué selon les coûts d'installation et opérationnels sur toute la durée de vie du système)
 - o Identifier les composants avec le moins de consommation énergétique (évalué par année selon le type et le nombre d'équipement, i.e. meuble de vente et chambre froide)
 - o Identifier les composants avec le plus faible impact environnemental (évalué sur tout le cycle de vie du système)

- Identifier les composants et le système le plus mature (évalué par l'échelle de Technological Readiness Level (TRL))
- Identifier les composants avec le meilleur score de maintenance (évalué par une échelle de critère de maintenance)
- Identifier les composants ayant le coût total et les impacts environnementaux les plus faibles

Ce dernier exemple d'utilisation listé précédemment est montré dans la Figure 12. On cherche à connaître l'ensemble des meilleurs compromis de combinaisons au sens de Pareto.

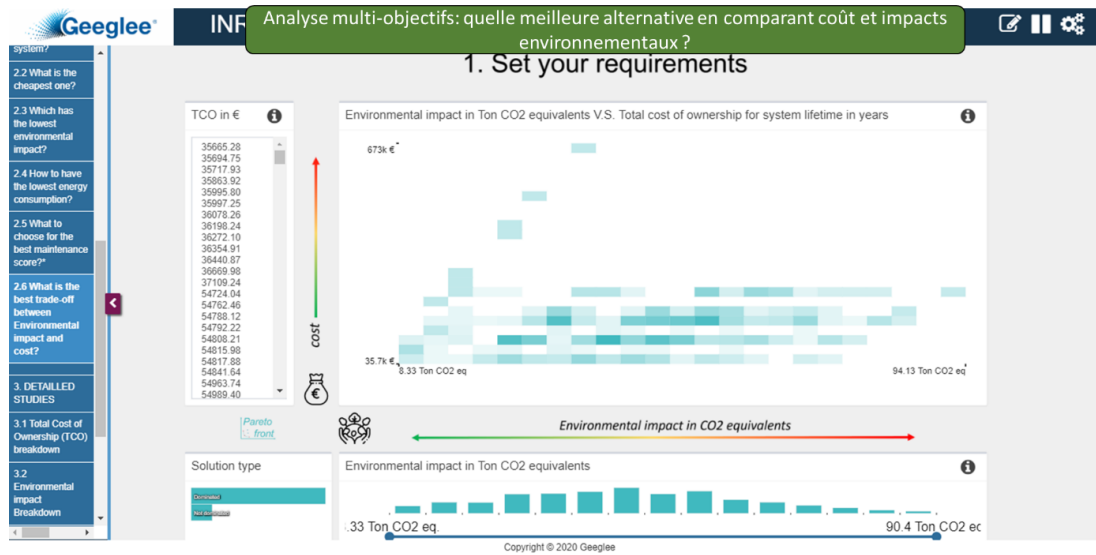

Figure 12. Exemple d'une analyse multi-objectifs entre le coût total et les impacts environnementaux sur la plateforme de simulation et d'exploration

Pour chaque scénario d'usage, les performances locales et globales présentées dans le modèle de connaissance sont évaluées et peuvent être explorées plus en détail afin de répondre aux spécifications de l'utilisateur. Un exemple de l'étude détaillé exploré avec l'impact environnemental est présenté dans la Figure 13. La performance globale d'impacts environnementaux est présentée en premier puis une répartition des impacts directs (liés aux fuites de réfrigérant) et indirects (liés à la consommation d'électricité) est définie.

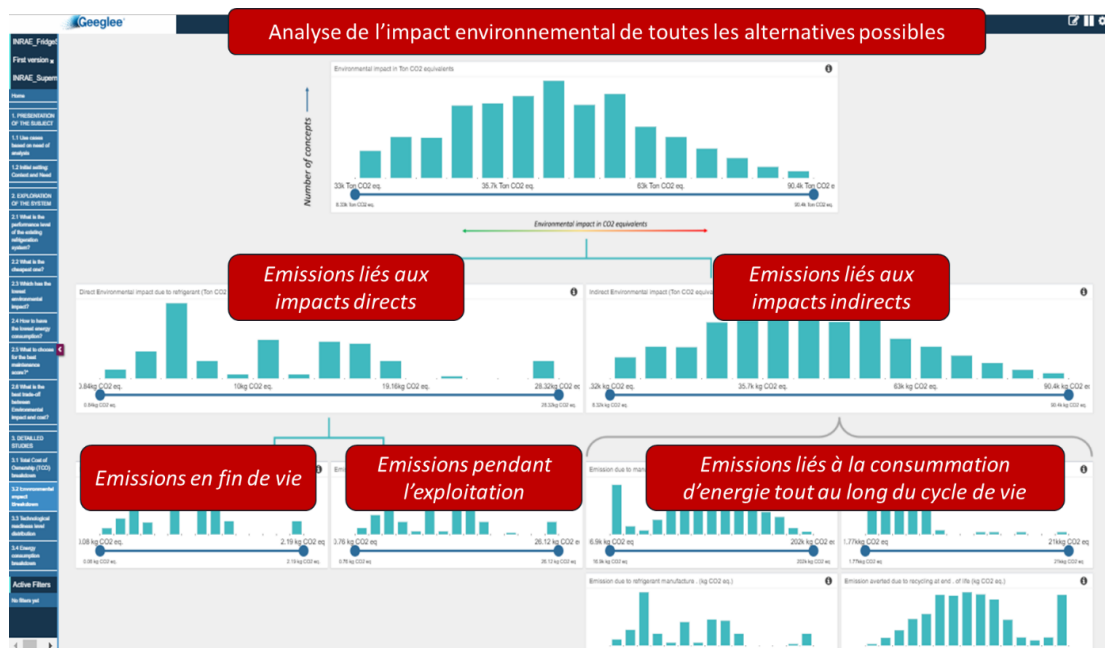

Figure 13. Exemple de l'évaluation des impacts environnementaux de toutes les alternatives possibles

Ces scénarios d'usage de la plateforme sont présentés en détail dans le rapport et sont validés par expérimentation avec des experts (test de la plateforme). La qualité de la plateforme est évaluée selon les mêmes critères de qualité cités dans le paragraphe précédent : la pertinence du vocabulaire employé, sa clarté, le choix des relations, la cohérence et l'extensibilité, la fidélité et l'usage. En s'appuyant sur les limites des plateformes digitales actuelles pour évaluer les performances de systèmes de réfrigération et les concevoir, un nouvel outil est développé. Cette plateforme offre pour la première fois la possibilité aux acteurs du domaine d'explorer un large espace de conception et de décision (plus de 10 000 alternatives considérées). Quatre apports majeurs obtenus avec cette nouvelle plateforme peuvent être considérés : (1) intégration de plusieurs performances dont des performances « industrielles » (maintenance, coûts totaux, maturité technologique) ; (2) modularité des composants techniques, c'est-à-dire la possibilité pour tous les acteurs du processus de pouvoir ajouter un ou plusieurs composants qui leur sont propres ; (3) modularité pour l'intégration de nouvelles briques technologiques et leur évaluation dans un cas industriel ; (4) accessibilité de la plateforme à tous les acteurs impliqués dans le processus afin de permettre une conception itérative entre utilisation finale et conception. Plusieurs expérimentations de la plateforme sont mises en place pour valider les critères listés. Six experts venant du domaine académique ou industriel de la réfrigération sont désignés pour tester et évaluer la pertinence de la plateforme et les résultats obtenus. Des scénarios provenant de cas d'études réel sont testés. Il est montré comment l'espace de conception est différent selon les spécifications de l'utilisateur. Par exemple, un concepteur en charge de concevoir un système de réfrigération avec des composants matures et le plus efficace énergétiquement n'aura pas les mêmes résultats qu'un concepteur voulant concevoir un système avec le moindre coût d'investissement. Une réévaluation par la méthode RID permet de valider que cette plateforme répond aux poches de valeurs identifiées pendant le diagnostic.

Des recommandations d'utilisation de la plateforme et du modèle de connaissances sont proposées afin de permettre aux acteurs académiques et industriels de tendre vers le développement de nouvelles briques technologiques et de systèmes optimaux.

6. Conclusion

L'objectif principal de cette thèse est d'améliorer la conception globale d'un système de réfrigération (RS) pour l'industrie alimentaire (tel qu'on le trouve généralement dans un supermarché). Les domaines d'amélioration des étapes du cycle de vie du système sociotechnique de la réfrigération ont été analysés pour répondre à la question suivante : "Les causes des mauvaises performances du système sont-elles dues à un manque d'outils, à un manque de savoir-faire en matière de conception, ou à tout un ensemble de problèmes organisationnels causés par un manque de concertation entre les acteurs de la chaîne de valeur ?". Une étude de terrain a permis de recueillir les données nécessaires à une analyse par le RID. Lors des entretiens, les questions ont révélé l'importance de la première étape du cycle de vie d'un système de réfrigération : la conception, la fabrication et l'installation. Cette analyse nous montre comment partir de ces valeurs identifiées pour développer une solution innovante.

Une revue de littérature extensive et la collection de données auprès d'experts a permis de mettre en place un modèle de connaissance structurée pour la conception de système de réfrigération. Ensuite nous avons mis en place ce modèle de connaissance dans une plateforme de simulation et d'exploration basée sur des modèles pour modéliser et simuler le système réfrigérant en cours de conception. L'utilisateur peut trouver la meilleure combinaison de solutions pour un scénario de système de réfrigération en supermarché ou explorer en temps réel les effets d'un changement de composants physiques sur les performances du système.

Cette plateforme de simulation et d'exploration répond à une lacune liée au processus de conception perturbé qui entraîne une exploration sous-optimale de l'espace de conception. Cela est principalement dû à un processus de conception descendant et l'évaluation d'un nombre très limité de solutions dimensionnées pour répondre aux contraintes de l'utilisateur final (budget, état d'esprit, image de l'entreprise, délai et conditions d'exploitation et d'installation) et à son objectif (par exemple, minimiser la consommation d'énergie et les coûts, maximiser les performances). Au début de la phase de conception, nous avons cherché à mieux intégrer les contraintes et les objectifs des parties prenantes dans une plateforme de conception partagée afin d'assurer une conception collaborative et de surmonter le manque d'interaction entre les parties prenantes. Des modèles simplifiés de la performance du système de réfrigération non pris en compte par les plateformes existantes sont utilisés pour l'évaluer plus tôt dans le processus de conception, assurant ainsi une meilleure appréhension

de ces technologies. Les mesures de performance telles que les coûts et la facilité de maintenance, les performances en matière de disponibilité, l'espace utilisé et l'adaptation à l'évolution de la réglementation sont intégrés.

7. Références

- [1] IEA, 'The future of cooling', International Energy Agency, Paris, 2018. [Online]. Available: <https://www.iea.org/reports/the-future-of-cooling>
- [2] A. Chakrabarti, T. P. Bligh, and T. Holden, 'Towards a decision-support framework for the embodiment phase of mechanical design', *Artificial Intelligence in Engineering*, vol. 7, no. 1, pp. 21–36, Jan. 1992, doi: 10.1016/0954-1810(92)80004-A.
- [3] Y. Benabid, 'Contribution à l'amélioration du processus de conception des produits innovants: Développement d'outils d'aide au choix des processus', Ecole nationale supérieure d'arts et métiers-ENSAM; École Militaire ..., 2014.
- [4] B. Yannou, 'Supporting need seeker innovation: the Radical Innovation Design methodology', in *International Conference on Engineering Design (ICED)*, Milano, Italy, Jul. 2015, vol. 8. [Online]. Available: <https://hal.archives-ouvertes.fr/hal-01340338>
- [5] B. Yannou, F. Cluzel, and R. Farel, 'Capturing the relevant problems leading to pain- and usage-driven innovations: The Dependency Structure Modeling Value Bucket algorithm', *Concurrent Engineering*, vol. 26, no. 2, pp. 131–146, Oct. 2016, doi: 10.1177/1063293X16666311.
- [6] D. Keppler, 'Absorption chillers as a contribution to a climate-friendly refrigeration supply regime: Factors of influence on their further diffusion', *Journal of Cleaner Production*, vol. 172, pp. 1535–1544, Jan. 2018, doi: 10.1016/j.jclepro.2017.10.276.
- [7] S. Sun, Z. Xing, Y. Li, P. C. Su, and W. Chen, 'Experimental investigation on twin screw refrigeration compressor with different capacity control methods', *International Journal of Refrigeration*, vol. 130, pp. 370–381, Oct. 2021, doi: 10.1016/j.ijrefrig.2021.04.027.
- [8] R. Ben-Abdallah *et al.*, 'Experimental investigation of the use of PCM in an open display cabinet for energy management purposes', *Energy Conversion and Management*, vol. 198, p. 111909, Oct. 2019, doi: 10.1016/j.enconman.2019.111909.
- [9] P. Gullo, B. Elmegaard, and G. Cortella, 'Energy and environmental performance assessment of R744 booster supermarket refrigeration systems operating in warm climates', *International Journal of Refrigeration*, vol. 64, pp. 61–79, Apr. 2016, doi: 10.1016/j.ijrefrig.2015.12.016.
- [10] R. DelVentura, C. L. Evans, and I. Richter, 'Secondary loop systems for the supermarket industry', *Bohn White paper setembro de*, 2007.
- [11] M. Kolokotroni, Z. Mylona, J. Evans, A. Foster, and R. Liddiard, 'Supermarket Energy Use in the UK', *Energy Procedia*, vol. 161, pp. 325–332, Mar. 2019, doi: 10.1016/j.egypro.2019.02.108.
- [12] G. Mitsopoulos, E. Syngounas, D. Tsimpoukis, E. Bellos, C. Tzivanidis, and S. Anagnostatos, 'Annual performance of a supermarket refrigeration system using different configurations with CO2 refrigerant', *Energy Conversion and Management: X*, vol. 1, p. 100006, Jan. 2019, doi: 10.1016/j.ecmx.2019.100006.
- [13] Y. T. Ge and S. A. Tassou, 'Performance evaluation and optimal design of supermarket refrigeration systems with supermarket model "SuperSim", Part I: Model description and validation', *International Journal of Refrigeration*, vol. 34, no. 2, pp. 527–539, Mar. 2011, doi: 10.1016/j.ijrefrig.2010.11.010.
- [14] M. Wetter, 'Modelica-based modelling and simulation to support research and development in building energy and control systems', *null*, vol. 2, no. 2, pp. 143–161, Jun. 2009, doi: 10.1080/19401490902818259.
- [15] M. Wetter, 'Modelica Library for Building Heating, Ventilation and Air-Conditioning Systems', Oct. 2009, doi: 10.3384/ecp09430042.
- [16] V. Sanz, A. Urquia, F. E. Cellier, and S. Dormido, 'Modeling of hybrid control systems using the DEVSLib Modelica library', *Control Engineering Practice*, vol. 20, no. 1, pp. 24–34, Jan. 2012, doi: 10.1016/j.conengprac.2010.11.014.
- [17] J. Hastings *et al.*, 'The ChEBI reference database and ontology for biologically relevant chemistry: enhancements for 2013', *Nucleic Acids Res*, vol. 41, no. Database issue, pp. D456–D463, Jan. 2013, doi: 10.1093/nar/gks1146.

- [18] D. K. Sobek II, A. C. Ward, and J. K. Liker, 'Toyota's principles of set-based concurrent engineering', *MIT Sloan Management Review*, vol. 40, no. 2, p. 67, 1999.
- [19] B. Canbaz, B. Yannou, and P.-A. Yvars, 'Improving Process Performance of Distributed Set-Based Design Systems by Controlling Wellbeing Indicators of Design Actors', *Journal of Mechanical Design*, vol. 136, no. 2, pp. 021005-021005-10, Dec. 2013, doi: 10.1115/1.4026034.
- [20] A. Abi Akle, 'Visualisation d'information pour une décision informée en exploration d'espace de conception par shopping', 2015. [Online]. Available: <http://www.theses.fr/2015ECAP0039/document>
- [21] V. Holley, 'A method to envision highly constrained architectural zones in the design of multi-physics systems in severe conditions.', Ecole Centrale Paris, 2011.
- [22] ADEME and Enertech, 'Diagnostic électrique d'un supermarché de moyenne surface', 2001.
- [23] Valérie Moreux et Olivier Gerin (EDF - Division Recherche et Développement), Hubert Despretz (ADEME), 'Le froid alimentaire dans les grandes et moyennes surfaces', 2000.