



HAL
open science

Mobility and traffic models for VANETs

Oumaima El Joubari

► **To cite this version:**

Oumaima El Joubari. Mobility and traffic models for VANETs. Networking and Internet Architecture [cs.NI]. Université Paris-Saclay, 2022. English. NNT : 2022UPASG018 . tel-03627931

HAL Id: tel-03627931

<https://theses.hal.science/tel-03627931>

Submitted on 1 Apr 2022

HAL is a multi-disciplinary open access archive for the deposit and dissemination of scientific research documents, whether they are published or not. The documents may come from teaching and research institutions in France or abroad, or from public or private research centers.

L'archive ouverte pluridisciplinaire **HAL**, est destinée au dépôt et à la diffusion de documents scientifiques de niveau recherche, publiés ou non, émanant des établissements d'enseignement et de recherche français ou étrangers, des laboratoires publics ou privés.

Mobility and traffic models for VANETs

Modèles de mobilité et de trafic dans les VANETs

Thèse de doctorat de l'université Paris-Saclay

École doctorale n° 580, sciences et technologies de l'information et de la communication (STIC)
Spécialité de doctorat: Réseaux, Information et Communication
Graduate School : Informatique et sciences du numérique, Référent :
Faculté des sciences d'Orsay

Thèse préparée dans l'unité de recherche L2S (Université Paris-Saclay, CNRS, CentraleSupélec) sous la direction de Jalel BEN OTHMAN, Professeur et le co-encadrement de Véronique VEQUE, Professeur

Thèse soutenue à Paris-Saclay, le 01 Mars 2022, par

Oumaima EL JOUBARI

Composition du jury

Marco DI RENZO Directeur de recherche, CNRS, France	Président
Hacène FOUCHAL Professeur, Université de Reims, France	Rapporteur, Examineur
Pascal LORENZ Professeur, Université de Haute-Alsace, France	Rapporteur, Examineur
Boubaker DAACHI Professeur, Université Paris 8, France	Examineur
Abdellatif KOBANE Professeur, ENSIAS, Maroc	Examineur
Lynda MOKDAD Professeur, UPEC, France	Examinatrice
Jalel BEN OTHMAN Professeur, Université Sorbonne Paris, France	Directeur de thèse

Titre: Modèles de mobilité et de trafic dans les VANETs

Mots clés: STI, VANET, Modèles de mobilité, Chaînes de Markov, TDMA, Méthodes d'accès.

Résumé:

La gestion routière devient de plus en plus un problème auquel il faut s'attaquer rapidement. Parmi les conséquences néfastes de la congestion figure les accidents de la route, l'empreinte environnementale, la vitesse commerciale des transports publics et les embouteillages. Il est donc nécessaire de développer un système de transport capable d'assurer la sécurité des usagers de la route et d'améliorer l'infrastructure de transport. Les systèmes de transport intelligents ont gagné d'importance comme une solution prometteuse pour réduire la congestion. Ces systèmes intègrent des technologies avancées pour fournir des services intelligents et robustes qui visent à prévenir les incidents routiers susceptibles de menacer la vie des passagers. L'une des exigences les plus rigoureuses de ces applications est la transmission fiable et sans risque des paquets de données. VANET est conçu spécifiquement pour fournir une infrastructure de communication sans fil pour que les véhicules et les équipements routiers puissent échanger des données de trafic. La caractéristique particulière de ce réseau est la forte mobilité des noeuds du réseau qui entraîne des changements fréquents dans la topologie et la densité. Ceci peut impacter les réseaux et par conséquent ne pas répondre aux exigences des applications de sécurité.

Dans cette thèse, nous traitons spécifiquement les méthodes d'accès pour les VANET qui sont basées sur la méthode TDMA. TDMA s'est avérée être la technique d'accès la plus appropriée pour VANET car elle permet à un seul nœud d'accéder au canal à tout moment. Cependant, les protocoles classiques basés sur la méthode TDMA ne sont pas adaptés aux réseaux fortement dynamiques et leur utilisation dans un environnement véhiculaire peut engendrer des collisions d'accès et une utilisation inéquitable des ressources. Par conséquent, une bonne compréhension de la mobilité

permettra de concevoir et d'évaluer des méthodes d'accès qui soient efficaces même dans un environnement mobile. Bien que l'on trouve des modèles de mobilité fidèles dans la littérature, ils ne parviennent pas à reproduire avec précision certains aspects de la mobilité des véhicules. Le comportement du trafic est influencé par plusieurs facteurs tels que l'architecture de la route, les limitations de vitesse, les règles de circulation et le comportement individuel des véhicules. Ceux-ci doivent être inclus dans un modèle de mobilité afin d'obtenir des résultats fidèles. Dans ce contexte, nous développons dans cette thèse des modèles stochastiques à base de chaînes de Markov basés sur des traces réelles de véhicules collectées par les RSUs en utilisant la communication V2X pour émuler le comportement des véhicules sur des routes urbaines et autoroutières. Les modèles proposés présentent le double avantage de modéliser et de prévoir le trafic. En utilisant une technique de résolution numérique, la densité du trafic, la longueur des files d'attente, le temps du trajet et le temps d'attente sont estimés. La densité de trafic estimée est ensuite exploitée pour développer une méthode d'accès basé sur TDMA appelée TA-TDMA qui a pour but principal de réduire les collisions d'accès et améliorer l'utilisation des ressources à travers la prédiction de mobilité et le clustering. Pour évaluer la performance de la méthode proposée, un outil de simulation de trafic basé sur les files d'attente a été développé à l'aide du logiciel SimEvents. Ce modèle de simulation permet de générer des mesures synthétiques importantes pour l'évaluation des performances des réseaux routiers. Le protocole TA-TDMA a ensuite été implémenté et comparé avec le protocole VeMAC, en considérant différents scénarios et environnements. La solution proposée a montré de meilleurs résultats par rapport au protocole VeMAC en termes d'efficacité et de robustesse face aux changements topologiques.

Title: Mobility and traffic models for VANETs

Keywords: ITS, VANET, Mobility models, Markov chains, TDMA, Channel access methods.

Abstract:

The ever-growing traffic congestion is becoming a serious issue that needs to be urgently addressed. The growing number of traffic accidents, the environmental footprint of transport, commercial speed of public transportation and traffic jams are few examples of the adverse consequences of congestion. This calls for an upgrade of the transport system in order to ensure road users safety and effectively enhance the transportation infrastructure. ITS have grown in importance as a promising solution to the congestion issue. These systems rely on the most advanced technologies to provide intelligent and robust safety services that seek to prevent road incident that may threaten the life of passengers. One of the most stringent requirements of these applications is an error-free and reliable transmission of data packets. VANET were designed specifically to provide a wireless communication infrastructure to allow vehicles and road equipment to exchange traffic data. The particular feature of this network is the highly dynamic mobility which results in frequent changes in the topology and density of the network. This has negative effects on the network performance which does not allow to cater safety applications requirements. In this thesis, we address specifically channel access methods for VANET that are based on TDMA method. TDMA has been proven the most suitable access technique for VANET as it allows a single node to access the channel at any time slot. However, conventional TDMA-based protocols might encounter difficulties in a dynamic networks such as access collision and unfair use of resources. Hence, a good understanding of mobil-

ity will allow the design and evaluation of channel access methods that are efficient and robust even in a mobile environment. Although faithful mobility models are found in the literature, they fail to accurately capture some aspects of vehicular mobility. The traffic behaviour is influenced by several factors such as road layout, speed limits, traffic rules and individual vehicle's behaviour. Consequently, it is compulsory to include all these features in a mobility model for accurate results. In this context, we develop in this thesis stochastic Markov chain models based on real vehicle traces collected by RSUs using V2X communication to emulate vehicular behaviour in both urban and highway roads. The proposed models have the twofold benefit of modelling and predicting traffic. Using a direct numerical resolution technique, traffic density, waiting queue lengths, travel times and delays are predicted. The predicted traffic density is then exploited to design a Traffic-aware TDMA channel access method that aims to reduce access collisions and enhance resource utilization through mobility prediction and clustering. To evaluate the performance of the proposed method, a queue-based mobility simulation framework was developed using the SimEvents toolbox. The simulation framework allows the generation of synthetic measures relevant to the assessment of road network performance. The TA-TDMA MAC protocol was then implemented and compared with an existing MAC protocol called VeMAC, under different scenarios and environments. The proposed solution has shown better results than the VeMAC protocol in terms of efficiency and robustness against topological changes.

Acknowledgements

The path towards this dissertation have been circuitous. Its completion is thanks in large part to the special people who challenged, supported, and helped me along the way. have the honor and the pleasure to express my gratitude and appreciation to all those who have guided, assisted and supervised me during the development of this thesis.

I sincerely thank my thesis supervisor, Professor Jalel BEN OTHMAN , for his continuous support, patience and guidance throughout the realization of this project. I have benefited greatly from his wealth of knowledge and his invaluable assistance and insights leading to the writing of this dissertation. His availability and constant encouragement have also been a great help in facing up every challenge. Big thanks to him once again for giving me this opportunity and for putting his trust in me.

I would also like to thank my co-supervisor Professor Véronique VEQUE who offered on-going guidance and support throughout this project. A pleasure it has been working closely with you, and heeding your valuable advice.

I am tremendously fortunate to have my defense jury members Dr. Marco DI RENZO, Dr. Hacène FOUCHAL, Dr. Pascal LOREZ, Dr. Abdellatif KOBANE, Dr. Boubaker DAACHI and Dr. Lynda MOKDAD review my dissertation and bring a depth of knowledge that could improve my work.

Thanks to the University of Paris Saclay for awarding me this PhD and providing me with the financial means to complete this project. I also thank all my colleagues at L2S laboratory, specially Dr. Violeta , Dr. Florent, Dr. Stefano, Dr. Trun, Dr. Incha, future Dr. Meriem and future Dr. Mourad for always offering support and for making the Lab life more awesome.

Thank you to my friends, Dr. Elhadja, Kaoutar, Mouna, Mona, Dr. Maissa, Ichrak, and Mossaab who endured this long process with me, always offering love and support. I am so glad to have you in my life.

Lastly, my family deserves endless gratitude: my father for teaching me to appreciate science and be ambitious, my mother for teaching me to believe in myself and that patience is the key to relief, and my sister who continuously inspires in me a love for learning and for always telling me that I am awesome even when I didn't feel that way. To my family, I give everything, including this.

Dedications

This thesis is dedicated to the people who have supported me throughout my education.
Thanks for making me see this adventure through to the end.

Contents

1	Introduction	17
1.1	Context of the thesis	17
1.2	Opportunities and Challenges	19
1.3	Motivation	22
1.4	Outline	23
2	Literature Review	27
2.1	Mobility models	27
2.1.1	Trace based models	28
2.1.2	Survey-based models	28
2.1.3	Simulator-based models	29
2.1.4	Synthetic models	30
2.2	Medium access control protocols in VANETs	34
2.2.1	Centralized TDMA-based MAC protocols	35
2.2.2	Cluster-based TDMA-based MAC protocols	36
2.2.3	Distributed TDMA-based MAC protocols	38
2.3	Contributions	39
3	Queuing theory based simulation model for vehicular mobility	43
3.1	Introduction	43
3.2	Proposed model	44
3.2.1	Traffic generation module:	45
3.2.2	Road section module:	47
3.2.3	Intersection module:	48
3.2.4	Control module:	50
3.3	Simulation results	53
3.4	Conclusion	57
4	Markov Chain Mobility Model for Multi-lane Highways	61
4.1	Introduction	61
4.2	Proposed model	62
4.3	Numerical results	66
4.3.1	Performance indicators	66
4.3.2	Numerical results	66
4.4	Conclusion	71

5	A Stochastic Mobility Model for Urban Environments	73
5.1	Introduction	73
5.2	Proposed Model	74
5.2.1	Markov chain for road traffic	76
5.2.2	Markov chain for intersection traffic	79
5.2.3	Numerical resolution and performance measures	80
5.3	Numerical results and Simulation	82
5.4	Conclusion	91
6	Traffic-aware channel access technique for collision avoidance in VANET	93
6.1	Introduction	93
6.2	System model	94
6.3	Simulation results	98
6.4	Conclusion	102
7	Conclusion	105
7.1	Summary of the Contributions	105
7.2	Future Research Directions	107
A	Appendix of chapter 4:	111
B	Appendix of chapter 5:	113
C	Appendix of chapter 6:	115

List of Figures

1.1	Outline Diagram	24
2.1	Slot allocation in ACFM protocol [109]	36
3.1	Modules of the simulation framework	45
3.2	Steps to define the traffic generation module	46
3.3	Traffic generation model	46
3.4	Steps to define the road section module	47
3.5	Road section model	48
3.6	Steps to define the intersection module	49
3.7	Signal-controlled intersection model	50
3.8	Yield signed intersection model	50
3.9	Toll station model	51
3.10	Steps to define the lane change module	51
3.11	Lane changing model	52
3.12	Steps to define the routing module	53
3.13	Routing block model	53
3.14	Urban environment scenario	54
3.15	Average waiting time vs congestion rate for each intersection	55
3.16	Average waiting time of an actuated and a pretimed traffic light vs congestion rate	56
3.17	Average waiting time vs congestion rate at each lane	56
3.18	Highway environment scenario	57
3.19	Average travel delay of a normal highway segment and a highway merge area	58
3.20	Comparison of the average travel delay of three highway lanes	58
4.1	An example of a highway road	63
4.2	Transition graph of the Markov chain describing traffic over a three-lane highway.	65
4.3	Average number of vehicles vs. Arrival rate	67
4.4	Congestion rate vs. Arrival rate	68
4.5	Average travel time vs. Arrival rate	68
4.6	Average number of vehicles vs. Average speed	69
4.7	Congestion rate vs. Average speed	70
4.8	Average travel time vs. Average speed	70
4.9	Average number of vehicles generated by the Markov model vs Realistic traces	71
4.10	Average travel time generated by the Markov model vs Realistic traces	71
4.11	Accuracy plotted for the estimated number of vehicles and travel time	72
5.1	A diagram of a road layout in an urban area	75
5.2	Traffic scenario represented as a queue system	76

5.3	Transition graph of the Markov chain describing traffic in a double-lane road.	78
5.4	Transition graph of the Markov chain describing traffic in three intersections	80
5.5	Per road average number of vehicle against density	83
5.6	Per road average travel time against density	85
5.7	Per lane average travel time against density	85
5.8	Per intersection average number of vehicles vs density	86
5.9	Per intersection congestion rate vs density	86
5.10	Per intersection average queue lengths vs density	87
5.11	Per intersection average waiting time vs density	87
5.12	Comparison of the average number of vehicles	88
5.13	Comparison of the average queue lengths	89
5.14	Percent accuracy of the average number of vehicles	89
5.15	Percent accuracy of the average queue lengths	90
5.16	Average waiting time: Pre-timed traffic light vs Actuated traffic light	90
5.17	Average travel delay: Random travel speed vs Actuated speed controller	91
6.1	System model for highway environments	95
6.2	Frame partitioning example for a highway scenario	97
6.3	System model for urban environments	98
6.4	Frame partitioning example for an urban scenario	98
6.5	cluster-based time slot allocation process	99
6.6	Access collision rate for a highway scenario	100
6.7	Utilization rate for a highway scenario	101
6.8	Access collision rate for an urban scenario	102
6.9	Utilization rate for an urban scenario	103

List of Tables

1.1	Motivation summary	23
2.1	Comparison of mobility models	40
2.2	Comparison of TDMA-based MAC protocols for VANET	41
2.3	Contributions summary	42
3.1	Configuration used in the urban simulation	55
3.2	Configuration used in the highway simulation	57
4.1	Values used for numerical resolution	67
5.1	Road configuration	82
5.2	Intersection configuration	83
5.3	Set-up configuration	84
6.1	Simulation set-up for the highway scenario	100
6.2	Simulation set-up for the urban scenario	101
A.1	Notations used in chapter 4	111
B.1	Notations used in chapter 5	113
C.1	Notations used in chapter 6	115

Acronyms

- A-VeMAC** Adaptive vehicular MAC protocol. 38, 39, 41
- ACFM** Adaptive Collision-Free MAC. 9, 35, 36, 41, 93
- ATIS** Advanced Travellers Information Systems. 18
- ATSA** Adaptive TDMA slot assignment. 39, 41
- CALM** Communication Air-Interface for Long and Medium-Range Communication. 18
- CBMAC** Cluster Based Medium Access Control Protocol. 37, 41, 93
- CBMCS** A clustering-Based multi-channel V2V communication system. 37, 41
- CCH** control channel. 96
- CDMA** Code division multiple access. 37
- CFR MAC** Near Collision Free Reservation Based MAC. 39, 41
- CH** Cluster head. 37, 41, 93, 95, 97
- CSMA/CA** Carrier Sense Multiple Access with Collision Avoidance. 35, 37
- CTMC** Continuous time Markov chains. 22, 23, 25, 26, 62, 64, 72, 74, 79, 88, 91, 94, 95, 106, 107
- DSRC** Dedicated short-range communication. 18, 19, 94, 95
- FCC** Federal Communications Commission. 19
- GPS** Global Positioning System. 40
- GTH** Grassmann-Taksar-Heyman. 66
- I2I** Infrastructure-to-Infrastructure. 18, 94
- IR** Infrared. 18
- ITS** Intelligent Transport System. 17, 19, 21, 57, 105
- LWR** Lighthill-Whitham-Richards. 30, 31, 40
- MAC** Media Access Control. 7, 11, 22, 23, 25, 34–39, 41, 42, 94, 106, 107

MANET Mobile Adhoc Network. 17, 19

MEC Mobile Edge Computing. 20

ML machine learning. 30, 33, 40

MMWAVE Millimeter waves. 18

NN Nearest Neighbor. 33

OBU Onboard Unit. 94

OBUs Onboard Units. 93

OFDMA Orthogonal Frequency Division Multiple Access. 38

QoS Quality of Service. 43

R-MAC Risk-Aware Dynamic MAC. 35, 41, 93

RL Reinforcement Learning. 40

RSU Roadside Unit. 18, 35, 36, 41, 62, 75, 79, 94, 95, 97

RSUs Roadside Units. 3, 18, 35, 36, 61, 62, 74, 75, 77, 93, 94, 96, 105, 115

RWALK Random walk. 40

RWP Random Way-Point. 30, 40

SCH service channels. 96

SDMA Space-division multiple access. 38

SOFT MAC Space-Orthogonal Frequency-Time Medium Access Control. 38, 41, 93

SPaT Signal Phase and Timing. 31

TA Traffic aware. 26

TA-TDMA Traffic Aware TDMA. 2, 3, 93, 94, 98–102, 107, 110

TC-MAC TDMA Cluster-based MAC. 37, 41, 93

TDMA Time division multiple access. 2, 3, 7, 11, 22–26, 34–39, 41, 93, 95, 106, 109, 110

UTSP Unified TDMA-based Scheduling Protocol. 35, 41

V2I Vehicle-to-Infrastructure. 17, 18, 61, 62, 94

V2P Vehicle-to-pedestrian. 17, 18

V2V Vehicle-to-Vehicle. 17, 18, 62, 94

V2X Vehicle-to-anything. 2, 3, 18, 24, 25, 61, 62, 72, 106, 110

VANET Vehicular Adhoc Network. 2, 3, 7, 11, 17–25, 27, 34, 35, 37–39, 41–44, 62, 91, 93, 102, 105–107, 109

VAT-MAC Adaptive TDMA MAC Protocol. 36, 41

VCTs Vehicular Communication Technologies. 18

VeMAC Vehicular Ad Hoc Networks MAC. 2, 3, 25, 26, 38, 39, 41, 93, 94, 98–102, 106, 107, 110

VFC Vehicular Fog Computing. 19

VRUs Vulnerable Road Users. 17, 18

WAVE Wireless access in the vehicular environment. 18

WiFi Wireless Fidelity. 18

Wimax Worldwide Interoperability for Microwave Access. 18

WLAN Wireless Local Area Network. 18

1 - Introduction

1.1 . Context of the thesis

The steadily growing population and traffic flows worldwide have led to a significant pressure on transport infrastructure in the recent years. This congestion on roads is expected to grow worse as the number of cars and transportation needs are increasing. According to The Future of Urban Mobility 2.0 study, 53% of the world's population was concentrated in urban centers in 2014 and, by 2050, a growth of 14% is expected. Besides hindering passengers' mobility and increasing the number of road accidents [1], congestion may have harmful effects on the human health and the environment [2, 3] due to the excessive gas emission produced by idling or slow vehicles. It also adversely impacts the economic growth, the efficiency of the transport system [4] and the livability of cities overall. The fact that these issues affect the life quality is a rallying call for the development of an improved transportation system in order to increase public safety and mitigate the congestion issue and its underlying causes. Intelligent Transport System (ITS) gained high attention from the research community and automotive industry as a long-lasting solution to the congestion issue [5]. ITS are new systems that take advantage of advanced communication, information, computing, and control technologies to improve the transportation system. It places its central focus on relieving traffic congestion, enhancing public safety, reducing atmospheric emissions, and increasing the road network efficiency. But it will provide more services such as multimedia and infotainment applications.

Ubiquitous connectivity has a significant importance in the development of these systems. It will offer an unmatched opportunity to collect massive amounts of data allowing the design of robust monitoring methods and control mechanisms able to directly estimate, control and monitor traffic flows, hence improving driving condition and maintaining safety [6]. Vehicular Adhoc Network (VANET) has been an active research topic in the area of wireless communication. VANET is known as an instantiation of Mobile Adhoc Network (MANET) designed to provide ubiquitous connectivity to all road network equipment, in which vehicles use wireless transceivers to communicate with vehicles within their radio communication range. Thus, this technology enables real-time information exchange between vehicles and nearby road-side infrastructure through wireless devices embedded in the vehicles. VANET allows five possible ways of communication architectures [7]. Vehicle-to-Vehicle (V2V) [8] allows direct or multi-hop communication between moving vehicles, without the support of a fixed infrastructure equipment. Vehicle-to-Infrastructure (V2I) [9] allows communication between vehicles and roadside infrastructure such as cellular base stations, relays and access points. Vehicle-to-pedestrian (V2P) [10] include communication between vehicles and Vulnerable

Road Users (VRUs) such as pedestrians, cyclists, and motorised two-wheeler users. The hybrid architecture Vehicle-to-everything (V2X) [11] that relies on both V2V and V2I to ensure a multi-hop communication between a vehicle and a distant roadside unit and to extend the infrastructure coverage. Finally, Infrastructure-to-Infrastructure (I2I) technology [12] represents communication between Roadside Units (RSUs) or between a RSU and a backbone network.

To increase the scope of applications and facilitate access to information, VANET deployment combine different wireless communication technologies that can be divided into two categories: traditional information and communication technologies and Vehicular Communication Technologies (VCTs) [13]. Traditional communication technologies are either infrastructure-based or infrastructureless. Infrastructure-based communication technologies such as cellular networks, Wireless Fidelity (WiFi) [14], and Worldwide Interoperability for Microwave Access (Wimax) [15] are used for long and medium range communication that support location based services, Access to internet, V2V, V2I and V2P. Infrastructure-less technologies encompass Wireless Local Area Network (WLAN) [16], Zigbee [17], Infrared (IR) [18], Bluetooth [19], and Millimeter waves (MMWAVE) [20] that can be used to support V2V, V2I and I2I communications. VCTs are state of the art technologies that came into existence to specifically fulfill the requirements of ITS. Dedicated short-range communication (DSRC) [21], Wireless access in the vehicular environment (WAVE) [22] and Communication Air-Interface for Long and Medium-Range Communication (CALM) [23] are technologies designed to provide a communication architecture for vehicular applications. These technologies are still under development and can support V2V, V2I, V2P and I2I.

Through VANET, vehicles are able to sense and interact with their surroundings using onboard devices and sensors. In this setting, researchers have established a wide range of applications for enhanced road safety, environmental protection, efficiency, driving comfort and infotainment [24, 25]. Driving efficiency applications such as ATIS [26] will provide real-time assistance to drivers which will help them decide on the most advantageous travel mode to reach their destination, while allowing reduced road congestion and gas emissions. Another application is the Safe Distance application which aims to dynamically adjust the head-away distance between vehicles and their speeds based on the actual traffic condition [13]. This application came to existence to reduce the risk of rear-end collisions, specially in congested areas. Each of these applications have a different set of requirements that affect its performance. For instance, safety-related applications are time-critical and require a delay-free transmission of data. However, entertainment applications are delay-tolerant and can withstand latency of several seconds. Despite the known benefits and opportunities that VANET might offer, its particular properties are not meeting certain requirements of these applications. In the next section the numerous opportunities provided by VANET are identified and its scope of application is explored. After understanding the communication

requirements of these applications, we define the challenges, gaps and issues faced by VANET in the move towards achieving timely, seamless efficient and reliable connectivity.

1.2 . Opportunities and Challenges

The advancement of wireless communication will play a critical role in the deployment of innovative solutions for safety, mobility management and reducing the environmental footprint of congestion, and towards an intelligent transport system, where vehicles will travel within intelligent and connected road infrastructure. In order to improve transport network connectivity, VANET was developed as a wireless communication infrastructure dedicated to the domain of vehicles. This Adhoc network has some unique characteristics that distinguishes it from other MANET that are defined in the following:

- **Broad bandwidth:** VANET uses a number of different wireless technologies as mentioned in the previous section. However, their use is limited to certain circumstances and applications because they were not initially designed to respond to the requirements of vehicular communications. Future communication technologies such as DSRC [21] are expected to meet the requirements of both safety-related and comfort applications when fully deployed. DSRC provides a dedicated bandwidth of 75 MHz in the 5.9 GHz band allocated by the US Federal Communications Commission (FCC) to support seamless communication among vehicles and infrastructure units [5].
- **Constrained and predictable mobility:** one of the most distinctive features of VANET is the mobility of nodes. Vehicles are generally moving at random and high speeds and their behavior is controlled by the choices of the driver. But they usually show signs of regularities in their patterns as they are constrained by the street layout and traffic regulations like speed limits and intersection rules. Therefore, these features can be exploited by modelling and prediction techniques to reproduce and forecast vehicular mobility.
- **Power constraint:** Compared to mobile nodes forming MANET, vehicles have no significant power constraints. They can be provided with unlimited energy sources from fuel to solar energy [27] that can support the energy requirements of the network nodes.
- **High computational and storage capacities:** ITS applications such as contextual applications, traffic monitoring and autonomous driving will require robust data processing and storing systems. Vehicles are therefore going to be embedded with high level computers and storage resources to handle megabytes of data. Vehicular Fog Computing (VFC) is a novel paradigm

[28] that was proposed to ensure real-time accessibility and distributed processing of mobility data. VANET will also integrate Mobile Edge Computing (MEC) [29] where the cloud service is pushed to the network edge in order to reduce latency and energy consumption.

All the above mentioned features bring new opportunities to support a wide range of applications that are classified into three categories: Safety applications, efficiency applications and comfort applications. Safety applications are designed to improve public safety and avoid collisions. These applications may include collision warning systems [30], safe distance warning [31], road obstacle warning [32], cooperative driving [33], intersection collision warning [34], and lane change assistance [35]. Safety applications are delay-intolerant and require a real-time and reliable communication. Any delays or intermittency during the transmission of critical data may threaten the safety of road users. Efficiency applications aim to manage and control traffic in order to improve driving conditions and reduce congestion. Some of the applications are smart traffic lights [36], variable speed limits [37], parking management [38], traveler information systems [39]. Traffic efficiency-related applications rely heavily on data collection, traffic condition prediction and accessibility to traffic data. Comfort applications introduce services to drivers in order to make their trip more comfortable and enjoyable. Examples of these applications include contextual services [40] such as restaurants or attractions recommendations, internet access [41], multimedia downloading [42] and infotainment applications [43]. Comfort applications have a stringent requirement when it comes to availability and reliability. Information needs to be provided to the users when it is needed and access to internet has to be granted.

Each category of these applications seeks a different set of requirements to ensure its effectiveness. Despite the potential offered by VANET to support the actual deployment of these applications, the design of communication protocols faces particular challenges which act as a stumbling block to the full realisation of a safe, efficient, and sustainable transport system. The highly dynamic nature of vehicular traffic and the different transportation environments result in some drawbacks that are listed in the following:

- Highly dynamic topology [44]: A vehicular network is highly dynamic due to two reasons: speed of the vehicles and characteristics of radio propagation. Vehicles have high relative velocities in both urban environments and highways. They may also move at different directions. Thus, vehicles can quickly join or leave the network in a very short period of time, leading to frequent and fast topology changes.
- Frequently disconnection [45] : The highly dynamic topology results in frequent changes in its connectivity, thus the link between two vehicles can quickly disappear while they are transmitting information.

- Fragmentation [46]: VANET is subject to frequent fragmentation. Although this issue has been broadly studied in MANET, the proposed solutions are not suitable for VANET. It is mostly because VANET's connectivity depends on the scenario.
- Variable Network density [47]: the network's density depends on vehicular density which is highly variable. In traffic jam situations the network can be categorized in very dense networks whilst in suburban traffics it could be a sparse network.
- Propagation model : Typically, VANET operates in three environments: highway, rural, and urban. In a highway, the propagation model is usually assumed to be free-space [48], but the signal can suffer interference by the reflection with the wall panels around the roads. In a city, its surroundings make the communication complex due to the variable vehicle density and the presence of buildings, trees, and other objects, acting as obstacles to the signal propagation [49]. Such obstacles cause shadowing, multi-path, and fading effects. In rural environments, due to the complex topographic forms, it is important to consider the signal reflection and the attenuation of the signal propagation. Therefore, in this scenario, the free-space model is not appropriate. As in any other network, the propagation model in a VANET must consider the effects of potential interference of wireless communication from other vehicles and the existence of largely deployed access points.
- Large-scale network [50]: In a city environment or highways at the entrance of big cities the network could be quite large scale.
- Driver reaction [51]: The topology of the network could be affected by driver's behavior due to his/her reaction to incident warnings or threats. In other words the content of messages can change the network's topology.

Despite the advances brought by VANET technologies, a lack of adaptation to the characteristics of the vehicular environment does not allow achieving the communication requirements for ITS applications, notably safety applications since any faulty transmission of safety-related messages can pose a serious threat to human life. From the above analysis, it can be inferred that most of these challenges are primarily connected to mobility. Hence, taking into account vehicle's mobility in the design of VANET protocols is of prime importance. This in turn will allow mitigating the shortcomings of VANET, thus resulting in a fast, reliable, error-free, and efficient communication. This thesis focuses mainly on the study and development of mobility-aware communication protocols, more particularly resource allocation methods in a vehicular communication system. In the next section, the main motivations behind the solutions proposed in this study are exposed.

1.3 . Motivation

This section focuses on highlighting the motivations behind the work presented in this thesis. Our research is hoping to contribute to the design of resource allocation methods for safety-related applications. In a highly mobile network, communication between transport nodes may face difficulties such as access collision resulting in reliability, throughput and channel utilization degradation. Safety applications are delay-sensitive and require an error-free transmission and a high packet data throughput. Hence, it is particularly important for VANET to deliver the low-latency and high reliability of data transmission to comply with the requirements of these applications. The understanding and prediction of mobility in vehicular environments is a turn-key solution to design effective communication protocols for VANET. Mobility-aware channel access mechanisms can be called the main focus of this thesis. Our research process consists of three steps. The first step aims at developing a flexible mobility simulation tool to test the performance of our proposed channel access method. The simulator is suitable for both urban and highway environments and includes blocks to simulate traffic control algorithms. The next step is to implement prediction models to accurately predict the vehicular traffic in different scenarios and environments through some mobility parameters such as road capacity, vehicles arrivals, intersection rules, and density. Finally, using the proposed traffic prediction models, a traffic-aware channel access method is proposed and evaluated using the simulation model. The method is based on Time division multiple access (TDMA) and focuses on fairly assigning time slots to vehicles by considering traffic density and travel direction. In what follows, our research objectives are summarized:

- Design a simulation tool for use in the context of vehicular mobility: A novel simulation framework for vehicular mobility that functions in the Simulink/Matlab environment is developed. Such tool allows to test different scenarios and to generate synthetic measures relevant to the assessment of ITS applications and network performance.
- Design mobility forecasting models to study the evolution of vehicular traffic: The purpose of mobility forecasting is to anticipate traffic flow and take that into account in planning solutions in different areas. Two stochastic models based on Markov chains were developed for mobility prediction each adapted to a different environment (highway or urban). As there is a strong link between modeling and predicting mobility, the first step was modelling vehicular traffic behaviors as a queue system. Then its evolution is studied using Continuous time Markov chains (CTMC).
- Develop a traffic-aware Media Access Control (MAC) protocol for VANET: The prime aim of our research is to contribute in the direction of improving

TDMA-based MAC protocol in some aspects such as efficient channel utilization and negotiation overhead through mobility prediction and clustering. Based on the developed CTMC models, traffic density forecasts are used to assign time slots for vehicles. The SimEvents traffic simulator is used as a test bed to analyze the performance of the proposed MAC protocol.

Table 1.1 summarizes the motivation and the adopted approaches for all works presented in this thesis.

Table 1.1: Motivation summary

Chapter	Target direction	Requirement	Approach	Motivation
Chapter 3	Simulation model for vehicular mobility	Adaptability to different scenarios and environments	Computer simulation	A simulation tool with a special emphasis on mobility is needed for the design of solutions and strategies impacted by the dynamic nature of vehicular traffic
Chapter 4	Traffic forecasting model for highway environments	Integrate mobility aspects of multi-lane highways such density of lanes, lane changing, high speeds...	CTMC	Traffic forecasting allows to build a knowledge of the distribution of traffic along the lanes of a highway for traffic management purposes or to design traffic-aware strategies
Chapter 5	Traffic forecasting model for urban environments	Reproduce mobility aspects characterizing urban traffic such as the stop-and-go, queuing, intersection policies...	CTMC	Traffic forecasting allows to build a knowledge of the distribution of traffic along the lanes of urban roads and intersections for traffic management purposes or to design traffic-aware strategies
Chapter 6	MAC protocol for collision avoidance in VANET	Fair and efficient resource allocation	Traffic prediction and clustering	MAC protocols for VANET need to take into consideration mobility patterns to avoid collisions and efficiently utilize the radio resources

1.4 . Outline

The rest of this dissertation is organized as illustrated in figure 1.1. Chapter 2 reviews the existing mobility models and medium access control protocols. Chapter 3 describes a queue-based mobility simulator for vehicular environments. Chapter 4 addresses mobility modelling and prediction in highway environments using Markov chains and a numerical solution method. Chapter 5 extends the model proposed in chapter 4 to adapt it to urban environments. In chapter 6, a traffic aware TDMA-based protocol for medium access is proposed to mitigate the data collision issue

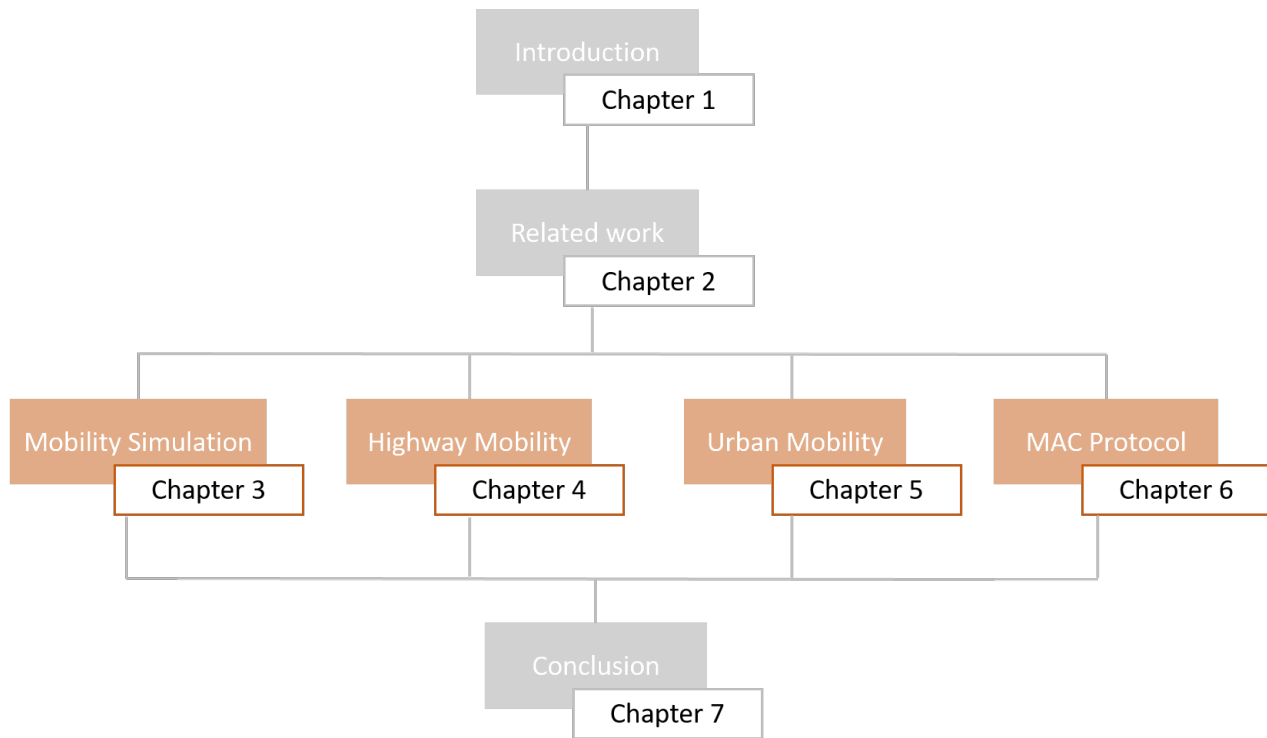

Figure 1.1: Outline Diagram

and improve the channel utilization and allocation process. Conclusions and future directions of the research are presented in chapter 7. More details and contributions of each chapter are given in the following:

- **Chapter 2:**

Chapter 2 surveys the most prominent literature related to mobility models and TDMA-based MAC protocols for VANET. This step is very crucial to formulate the problem this thesis intends to address and to highlight the contributions to be made to improve existing works. Throughout this chapter, a classification of mobility models is first provided and the advantages and drawbacks of each category are underlined. We continue by presenting and comparing models that address the mobility modelling issue in vehicular environments. An overview of different TDMA-based protocols designed to handle the data collision issue in V2X communication is also given. At the end of the chapter, it is explained how the work proposed in this thesis contributes to the existing literature.

- **Chapter 3:**

In this chapter, a queue-based simulation model is proposed. The tool is able to emulate vehicular mobility in both highway and urban environments in order to

understand and monitor traffic behavior or to evaluate the performance of systems impacted by mobility. The proposed tool functions in the Simulink/Matlab environment, and uses SimEvents toolbox to create different modules each representing a section of the road map or a mobility operation such as lane change, queuing at intersections or routing. The proposed tool allows to generate synthetic measures relevant to the assessment of the road network performance. Different simulation results will be presented for a defined scenario to validate the proposed simulator. The simulation tool was used to carry out simulations of different scenarios and use cases in the next chapters.

- **Chapter 4:**

In this chapter, a traffic prediction model for highway environments is introduced. The model is based on Markov chain and is designed to tackle the congestion issue in multi-lane highways. Based on traffic data collected from vehicles through V2X technology, the model studies the evolution of traffic flow along a multiple lane divided highway. By calculating the steady-state probabilities using a resolution algorithm, the expected number of vehicles traveling on a highway segment is estimated. Performance measures are then inferred to detect possible congestion and then prevent it from happening. The numerical results are presented and compared with realistic traces to validate the model accuracy, and to show its ability to reproduce the fundamental mobility aspects in a highway environment.

- **Chapter 5:**

Chapter 5 proposes an extension of the model presented in chapter 4 to adapt it to urban environments. The behavior of vehicles along multi-lane roads and intersections is modeled as a stochastic process using queuing theory. Particularly, the queue system is analysed as a CTMC and different performance measures are derived and analyzed under various scenarios. To validate the model, the obtained forecasts are compared with a queue model and the realistic traces. The results show that the model is capable of reproducing the realistic behavior of traffic in urban roads without incurring heavy costs and time-consuming computing. The estimates obtained were then used to design an actuated traffic light and a vehicle speed adaptor. From the simulation results, it is clear that using the proposed traffic forecasting model helps reduce vehicles idling and travel times.

- **Chapter 6:**

In the previous chapters, several mobility models were proposed to predict and simulate vehicular traffic in different environments. In chapter 6, a new TDMA-based MAC protocol for VANET is developed to mitigate access collision and fairness issues. Based on mobility models proposed in the previous chapters are exploited to bring improvements to the VeMAC protocol [118] in order to meet the real-time requirements by reducing data collisions and improving resource utilization efficiency.

The CTMC mobility models are used to predict traffic densities and then appropriate resources are assigned to each area of the road network. The protocol is also cluster-based and confers to cluster heads the task of managing access within their clusters. The validity of TA-TDMA protocol is confirmed through simulation where the proposed protocol and VeMAC [118] protocol are compared.

In order to determine the key problems that needs to be remedied by the proposed work, the first step was to review the existing solutions present in the literature. The next section aims to present an overview of literature that relates to the work proposed in this thesis.

2 - Literature Review

In this chapter, a review of works that relate to the solutions proposed in this dissertation is presented. Then the main contributions of the thesis that advance the state-of-the-art are also highlighted. First, a detailed classification of mobility models is provided based on the level of description and mobility aspects. Second, the vast body of works on mobility models present in the literature is surveyed and compared. Then, works that have been developed for channel access control in VANET are analyzed and compared. Finally, the limitations that are addressed by the proposed solutions are discussed.

2.1 . Mobility models

In this section, the goal is to provide an overview of mobility models. First, the models are classified based on their approach in constructing the model and the motion constraints features considered. Then, a large range of works is studied for each category. Finally, a comparative analysis is conducted to easily figure out the differences between the models and eventually identify the application requirements satisfied by each model.

In general, mobility models are divided into three categories depending on the level of description. The first category of the microscopic description focuses on more details by considering the individual behavior of each vehicle and its interaction with the road infrastructure or the surrounding vehicles such as the safety distance between vehicles, acceleration, braking, and overtaking. This type of modeling is more precise, but computationally more expensive. The macroscopic models consider macroscopic quantities of vehicle dynamics such as traffic density, traffic flow, mean velocity, and road configuration, while treating vehicular traffic according to fluid dynamics. These models are generally very simplistic and computationally inexpensive but at the cost of the realism and accuracy of the results. The last category is the mesoscopic models. This category aggregates both the microscopic and macroscopic characteristics to express the movements of different vehicles. The behavior of vehicles is modelled by taking into consideration the external factors such as density, traffic lights, queues, etc. These models generally combine the advantages of both macroscopic and microscopic descriptions.

Yet, classifying models based on their level of description may be seen more as a broad classification. A more precise classification scheme based on the models' functionalities is proposed in [52, 106]. Mobility models can be divided into four main classes: trace based models, survey-based models, simulator-based models and synthetic models. In the following, the principles of each category are discussed and some of the prominent works are reviewed.

2.1.1 . Trace based models

These models infer vehicular mobility patterns from statistics extracted from real user traces collected by a variety of computer vision based tracking approaches and location-aware services. These types of models are highly applied in human mobility modelling and have gained attention as a promising technique to accurately model vehicular mobility. Authors in [54] proposed a mobility model called TRAILS that allows salable and flexible simulation scenarios by extracting the mobility graph from realistic traces. In [55], authors developed a human mobility model that generates user trip paths from large scale picture datasets extracted from Flickr in order to enhance prediction accuracy. Although these mobility models are faithful they are not suitable for vehicular mobility because its features are different from those of human mobility. Some works were proposed to specifically study mobility patterns in a vehicular environment. In [56], a region-aware mobility pattern mining framework was developed by considering both pattern extraction and origin-destination region partitions. The problem was formulated as an optimization problem of maximizing the origin-destination correlations with spatial constraints. These models have the advantage of giving accurate spatial and temporal descriptions and are more adequate for modelling large scale and complex scenarios. However, they are inflexible and require accessibility to large datasets of vehicular traces that are not highly available to the public. A number of projects were initiated to gather mobility trajectories and driving patterns such as OpenStreetMap [57], MIT Reality Mining [58], CRAWDAD [59], USC MobiLib [60], Cabspotting [61], InD [62], highD [63] and naturalistic driving patterns [64]. But for relevant results, they still require the involvement of more participants. In the next sub-section, the survey-based models are reviewed. These models are based on the same concept as trace-based models as they rely on realistic data. But they use statistical characterization of mobility instead of mobility traces.

2.1.2 . Survey-based models

Survey-based models seek to model mobility features using extensive statistical data collected through surveys. Udel[65] is a mobility model that falls within this category. It relies on activity survey data provided by U.S department of Labor to emulate vehicular and pedestrian dynamics in an urban environment in order to demonstrate the impact of mobility on the performance of mesh networks. However, the model only reflects pedestrians mobility which doesn't allow simulating vehicles behaviors. The Agenda-based mobility model [66] can also be cited as it falls within this category. This model combines both social activities and geographic movements to model a node's movements. These movement are based on an individual agenda, which includes all kinds of activities in a specific day. Data from the US National Household Travel Survey has been used to obtain activity distributions, occupation distributions and dwell time distributions. The model is only able to reproduce human's motion behavior, hence it requires considering

more factors to model vehicular mobility. The ETH [67] has addressed specifically vehicular mobility and proposed a model that generates public and private vehicular traffic over real regional road maps of Switzerland with a high level of realism. The model is calibrated using data from mobility surveys or statistics. Similarly to trace-based models, this category offers the advantage of accurate modelling of mobility characteristics that would be too complex to model using mathematical approaches. However, one major limitation of the survey-based approach is that it only provides large scale mobility characterization such as density and traffic flow but can not produce accurate movement patterns. Computer simulation of mobility is another technique used to generate vehicular patterns. In the next sub-section, several softwares that allow vehicular traffic simulation are studied.

2.1.3 . Simulator-based models

Traffic simulator-based models extract mobility patterns from traffic simulators. These simulations models are computer-based and provide valuable solutions by giving a clear insight of complex scenarios such as dense urban areas. There exist several simulation software dedicated to vehicular mobility, either freely available for use or commercial products that require the purchase of a license. PARAMICS[68][69], CORSIM[70], AIMSUN[71] and PTV VISSIM[72][73] are one of the earliest microscopic mobility models proposed to simulate ITS. PARMICS and VISSIM were designed for urban networks while CORSIM is for traffic simulation of freeway networks. AIMSUN allows simulation of both urban and non-urban networks. The models mentioned above are commercial softwares that require the purchase of a licence. Among the freely available micro-simulation programs, we find SUMO [74][75] which is designed for traffic management and vehicular communications simulation. MOVE[76] is developed on the top layer of SUMO to generate realistic mobility traces. VanetMobiSim [77][78] is a traffic simulator that allows to model features such as road topology, traffic signs and signals and interests point. The models of this category has the drawback of requiring complex configurations and slow simulation speed of large scale scenarios. MEZZO [79] and DynaMIT [80] are meso-simulation based traffic models. MEZZO is able to capture all important aspects of vehicular movements on roads and junctions, and travel behavior such as the route choice. DynaMIT allows the estimation and prediction of current and future state of traffic, and also provides travel information and assistance. AnyLogic simulation model [81, 82] is a tool that offers a road traffic library allowing urban traffic simulation for road traffic planning and engineering. Nevertheless, the simulator can not be used to evaluate VANET as it does not include a wireless communication library. Despite allowing detailed analysis of road traffic, these simulators are inflexible because their extension to incorporate more characteristic is costly. Synthetic models are another class of models that is flexible and scalable, these models are defined and reviewed in the next sub-section.

2.1.4 . Synthetic models

Synthetic models depict vehicles mobility by applying mathematical approaches, and can be further classified into six classes: Stochastic models, traffic stream models, car following models, behavioural models, queue models and ML models.

Stochastic models

describe the mobility patterns of moving nodes as a random process, where velocity and trajectories are usually arbitrarily chosen. City Section mobility model was proposed in [52] by Davies. In this model bi-directional single-lane roads are considered. The vehicles path computation is based on the Random Way-Point (RWP) model [83]. Vehicles select a random destination over a grid layout and travel with a constant speed. Once the destination is reached, the same process is repeated again. This model does not support speed variation, intersection rules or multi-lane traffic which are important characteristics of urban traffic. Freeway [84] is a stochastic mobility model, in which the simulation area, is a multiple lane freeway. Nodes travel randomly from an origin point to a destination while keeping security distance from the preceding vehicle on the same lane. The lane change behavior is not considered in this model. The vehicle keeps the same lane until reaching the area limit, then it is placed again randomly in another position and repeats the process. This scenario is definitely unrealistic. Manhattan [84] is another stochastic model, introduced to simulate an urban environment. A map of vertical and horizontal roads that represent double-lane bidirectional roads is considered. Vehicles are randomly put in a road and then move along the road following the same process as the freeway model. When reaching an intersection, the vehicle randomly chooses a new destination using a probabilistic approach. Headway distance between vehicles and lane changing are both modelled. Nonetheless, behaviors such as queuing at intersections and traffic signs were not included in the model, which is unrealistic. The model of Nagel and Schreckenberg [85] was designed to emulate traffic in single lane-freeways. In [86], the authors extended the previous model to incorporate drivers' reaction to the preceding vehicle's speed and safety distance. Authors in [87] have proposed a hot road mobility model to generate synthetic traces that can improve vehicular services. These models are extensively used in application for their limited data demands and easy deployment. However, they only reflect a basic level of details. Hence, further improvements need to be made to realistically mimic driving behaviors such as lane changing, queuing and the stop-and-go phenomenon.

Traffic stream models

describe vehicular traffic as a hydrodynamic phenomena while considering the three main macroscopic characteristics of traffic flow which are speed, density and flow. The most broadly used traffic stream model was presented by Lighthill-Whitham-

Richards (LWR) [88, 89]. The authors used kinematic waves to model traffic flow as a continuous function of density. The model allows to predict the evolution of traffic bottlenecks along urban roads and near junctions combining both macroscopic and microscopic traffic descriptions. Many other works [90, 91] used the LWR model as a bedrock to study the dynamics of queues at intersections. Authors in [90] apply LWR shockwave theory to identify traffic states changes by exploiting the queue discharge process in the previous signal cycle which allows distinguishing the queue discharge from the upstream arrival. The model proposed in [91] aims for enhancing fuel efficiency by designing a cooperative adaptive cruise control system that applies LWR model to predict the length of queues and their release time based on Signal Phase and Timing (SPaT) information received from signalized intersections. Models within this category allow to describe the global traffic behavior with a minimal level of details. However, finding their solution when inflow continuously varies over time is a cumbersome and time consuming process.

Car following models

consider measures like the headway distance and the velocity of surrounding vehicles in order to describe the behavior of each vehicle. The model introduced in [92] by Krauß takes into account parameters such as velocity, acceleration, deceleration and the safety distance that needs to be maintained from the vehicle ahead in single-lane roads. The model describes how a vehicle sets a velocity to reach a new position in the next time step. The model was defined at a simple level thus makes its implementation easy. But, vehicular behavior in multi-lane roads is not considered. Lane changing is not modelled, which does not allow capturing the influence of traffic in a lane in on its neighboring lanes. In another study [93], a mobility model was developed to describe the lane change behavior in multi-lane roads while considering V2V communication to explore its neighborhood when a road incident occurs. This model can be considered an extension of the Krauß model [92] as it incorporates the same parameters but it additionally models the lane changing behavior in two-lane traffic. Similar work was introduced in [94] to emulate traffic in multiple-lane roads and lane change behavior. The model relies on previous traffic data to estimate the probability of lane changing using Bayesian reasoning. The model shows better results in terms of prediction accuracy compared to classic car-following model. However, the proposed model is not inclusive as it does not model all vehicular behaviors. The benefit of car-following models is their preciseness and accuracy in describing traffic. However, this entails an increase in the computational complexity and overhead, especially when studying large scale scenarios. Moreover, they fail to capture the overall behavior of the roadway system. A vehicle's lane change behavior is predicted based on the probability computed using previous traffic data.

Behavioural models

are drawn from biological physics and artificial intelligence. They are based on behavioral rules conducted by social influences, rational decisions or actions following a stimulus-reaction process. Legendre *et al.* [95] introduced the first behavioral model to study human mobility. Later on, the model was adapted in several works to describe vehicular traffic. Authors in [96] proposed a model that involves the driving behaviours such as the reaction to the sudden braking of the vehicle ahead. An advanced behavioural model was presented in [97] to mimic various mobility characteristics that can't be derived from recorded traces. Although these models successfully provide a realistic description of traffic, their application to large-scale scenarios requires complex calculations.

Queue models

are developed to study queues formed at intersections by waiting vehicles and consequent delays by applying probabilistic distributions. Gawron [98] introduced the first queuing model suitable for vehicular traffic called the "Fast lane". The model represents roads as a FIFO (First In First Out) queue and a server while vehicles are represented as clients. The vehicles enter a queue and stay there for an amount of time until it is their turn to be served. After service completion the vehicles are released. It was stated that the queues can model signalized intersections, but no further specifications were given. The idea was extended by authors in [99] to develop a stochastic queuing model for signal control optimization at isolated intersections. In this model, the arrival is modeled as a Poisson process and intersections as an M/G/1 system. When the served queues vanish, the signal is switched to the other phase, and after the queues next served are freed, it switches back to the current phase. Using this queue model, the authors then developed a numerical method to compute the steady-state distribution of delays, queues, etc. Another queue-based approach was introduced in the work of Cremer and Landefeld [100] to study traffic at signalized intersections while considering the effects of spill-back phenomenon. The principle is similar to the "Fast lane" model but further improvements were suggested. The model specifies the vehicle movements on all parts of the link between two junctions, and models the behavior of vehicles at unprotected left-turns. For more accuracy, the model needs to consider lane change behavior. The model presented in [101] takes into account spatial characteristics such as the road network topology to describe mobility in a city area. The model considers two different scenarios. In a sparse scenario, the street layout and vehicles behavior is modelled as an M/G/ ∞ system. In dense scenarios, the proposed queuing network is modelled as an M/G(n)/ ∞ system to include the effect of the number of vehicles on the service rate. Contrarily to queue models defined above, the overtaking laws were defined in this model to capture its effect on the traffic flow. However, the intersection rules considered are unrealistic. It

was assumed that vehicles go to one of three possible streets with equal probabilities. The major benefit of models of this type is their ability to simplistically model complex scenarios and their easy and rapid deployment as they contain restrictive assumptions. They can also simulate large scale traffic in a small computing time, even on moderate hardware. Nevertheless, the downside of the aforementioned models is that they overlook the importance of considering the coordination of vehicles crossing the intersection at the same time and lane change behavior.

ML-based models

ML-based approaches have received considerable attention from researchers as an alternative for vehicular traffic prediction. These models generate a traffic prediction function through learning from realistic examples. The learning process is based on optimisation algorithms that aim at reducing the gap between the estimated and expected values for a more accurate prediction. Authors in [102] proposed a deep learning-based forecasting model that relies on 40 day traffic data collected by 58 cameras located at different locations around London. The primary advantage of the proposed model is its ability to reduce forecasting errors. However, only two features could be captured which are time and traffic density. Another drawback is the extra costs associated with the deployment of cameras all over the road network. In [103] a Nearest Neighbor (NN) based classification model is used for traffic flow prediction using Correlation analysis. This model aims at reducing storage and computation costs of large training samples by considering off-line distributed training and online parallel prediction. A multitask learning-based artificial neural network was proposed in [104] to predict traffic flows. The data used in the model is the vehicle flow rates of discrete time series which were recorded every 15 min. The model proves its efficiency to provide estimates closer to the true values. A deep reinforcement learning algorithm was used in [105] to plan a human-like autonomous car-following model. The purpose was to improve the accuracy of traditional car-following models by using historical driving data of the driver in the learning process, which can enable the vehicle to move in accordance with the behavioral features of its regular driver. ML-based models are able to provide fast and low error rate predictions. However, they require tremendous offline training which limits their usage in the real world. Traffic flow patterns have different features depending on the locations, speed, time, etc. Therefore, it is important to train the predictor multiple times to reflect different scenarios. Accordingly, the running time of the learning process needs to be reduced to effectively apply ML-based traffic prediction approaches in the real world. Another drawback of these models is their reliance on real-life examples in the training process. The datasets used by ML-based models need to be large enough to obtain a well-trained model. In less traveled or sparse areas where historical traces are less readily available, ML-based models are unable to ensure low prediction error rates.

After reviewing the available literature on vehicular mobility modelling, works related to medium access control are also reviewed since this thesis has made contributions in this area.

2.2 . Medium access control protocols in VANETs

A Media Access Control (MAC) protocol is designed to disseminate safety messages reliably and rapidly to improve the safety and efficiency of vehicles on the road in VANET. Due to the high mobility in the vehicular environment, MAC protocols should be designed to adapt to the changing topology in order to guarantee a bounded transmission delay of safety applications and an increased throughput for non-safety applications. In this section, the different MAC protocols proposed to adapt themselves to different vehicle densities are studied. There exists different classification framework for MAC protocols. Authors in [106] proposed a classification that distinguishes three types of protocols depending on the channel access methods used: contention-based method, contention-free method and the hybrid category that combines the two previous methods.

- Contention-based protocols [107]: in this category, protocols use the carrier sensing mechanism. Vehicles sense the channel before transmission. If a carrier signal from another node is detected, the vehicle attempting to transmit waits and tries again after a short time period. These protocols prove not to be effective in VANET due to the hidden terminal problem.
- Contention-free protocols [108]: these protocols allow a single node to have access to the channel at any given time in order to avoid collisions during transmission. Contention-free protocols for VANET are typically based on TDMA and better meet the requirements of safety/traffic messages dissemination as it allows a reduced possibility of transmission collisions. However, given the bidirectional traffic flow and the high travel speeds of vehicles, the likelihood that the hidden terminal or merging collision would happen is not as low as it should be. Moreover, highly dense traffic might lead to unfair allocation of time slots.
- Hybrid protocols: these protocols combine both contention-free and contention-based mechanisms with the aim of improving their ability to avoid messages colliding during transmission.

In this thesis, we solely focus on TDMA. In [106], TDMA-based MAC protocols are classified into three categories depending on the network topology: centralized, cluster-based and distributed topology. In the following, an overview of works proposed for each category is presented. Table 2.2 provides a comparative analysis of the reviewed protocols.

2.2.1 . Centralized TDMA-based MAC protocols

These protocols assume that there are central controllers (RSUs) which are used to manage channel access of the vehicles within their coverage area and make allocation decisions. In recent years, some centralized TDMA-based MAC protocols were adapted for communications in VANETs while avoiding access collision caused by simultaneous access to the same time slot. Each protocol was proposed to address a particular problem in a specific mobility scenario.

Adaptive Collision-Free MAC (ACFM) [109] is a protocol of the centralized category. In this protocol, the RSU dynamically schedules the assignment of time slots to vehicles in its coverage area. Time is divided into a frames, each is then subdivided to sub-frames. As shown in figure 2.1, a set of slots is used by the RSU to broadcast to the vehicles control messages, and the rest of slots is used by vehicles to broadcast beacon messages. When too many slots are unassigned, the RSU reduces the size of the frame by one sub-frame. In contrast, if the number of slots doesn't satisfy the access demand the RSU increases the frame size by one sub-frame. To avoid interference between adjacent segments, two orthogonal frequencies are used to ensure the same frequency is not used by two hops neighbors. This protocol has the advantage of improving throughput and reducing coordination overhead, but the set of slots is not fully utilized since the size of the sub-frames is fixed. Moreover, the protocol solely focuses on safety-related applications and doesn't support non-safety applications. The traffic scenario considered in this study is unrealistic, since it assumes that all vehicles are moving in the same direction. In cases where the traffic is bidirectional, it is likely that merging collision will occur.

Risk-Aware Dynamic MAC (R-MAC) [110] was proposed as an extension of ACFM to support real-time dissemination of warning messages. Similarly to ACFM, the frame is divided into two sets, namely the RSUs set and the vehicles set. The vehicle set is further divided into two sets, the first one is contention-based and uses Carrier Sense Multiple Access with Collision Avoidance (CSMA/CA) to transmit warning messages in safety hazard situations, while the second set is contention-free and uses TDMA to broadcast non-safety beacon messages. The protocol is based on a stochastic prediction model that computes the expected collision risk and accordingly adjust the size of the contention-based set. The downside of this protocol is that it is only applicable to safety applications and does not consider bidirectional traffic same as the ACFM protocol.

Unified TDMA-based Scheduling Protocol (UTSP) [111, 112] is a TDMA-based protocol proposed to increase the throughput for non-safety applications in VANET. In UTSP, the RSUs are central nodes that collect information such as channel state, velocity and access priorities and then assign time slots to vehicles using a weight function. Although the allocation process guarantees fairness between vehicles and increases throughput, it is doubtful that the protocol can satisfy the requirements of delay-sensitive applications. Moreover, collision may

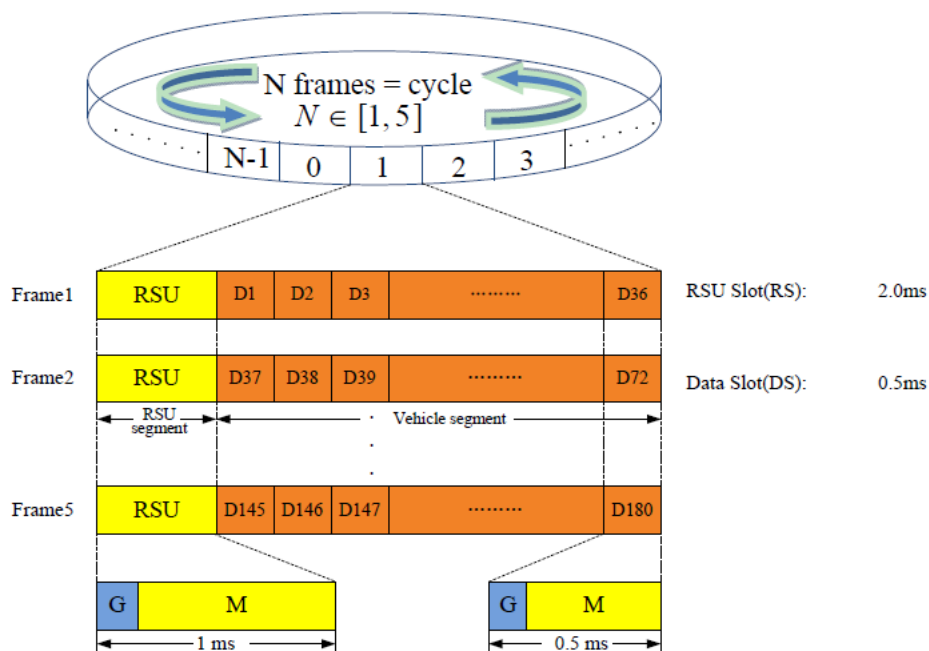

Figure 2.1: Slot allocation in ACFM protocol [109]

occur between vehicles due to the hidden terminal problem.

Adaptive TDMA MAC Protocol (VAT-MAC) [113] was proposed with the aim of maximizing time slot utilization. The protocol predicts the number of vehicles within the communication range of a RSU and collision risk. Then, it accordingly adjusts the frame length. This solution jointly increases throughput and channel utilization, however transmission rate may go down in case of long frame lengths.

The key advantage of centralized MAC protocol lies in the capability of RSUs to collect traffic information from nodes, access channel quality, and assign the appropriate time slots to each vehicle. Nonetheless, relying solely on RSUs may not be practical due to their limited coverage. Moreover, a high cost would be required to deploy a large number of RSUs in dense areas where high traffic needs to be accommodated. An alternative solution is to use clustering to locally manage time slot allocation. This type of protocols are reviewed in the next sub-section.

2.2.2 . Cluster-based TDMA-based MAC protocols

This category of protocols assumes that vehicles form groups named as clusters. In each cluster, one vehicle called the cluster head is elected as the leader to manage the channel access of vehicles affiliated to its cluster. These protocols have the advantage of avoiding inter-cluster and intra-cluster access collisions. Moreover, locally managing access by the cluster-head helps reduce the negotiation overhead between vehicles. Nevertheless, the main challenge in cluster-based

TDMA protocols is maintaining the cluster stability in a highly dynamic topology. Several cluster-based MAC protocols have been proposed in the literature for vehicular communications in order to provide a fair channel access and utilization while reducing transmission collisions.

Cluster Based Medium Access Control Protocol (CBMAC) [114] is a cluster-based access control protocol in which vehicles form a cluster and elects a cluster-head who is responsible for assigning bandwidth to the members of its cluster. The time frame is divided into slots where the first one is assigned to the cluster head to broadcast a hello messages to its members, while the second slot is also reserved to the cluster head to broadcast control messages. In order to reduce inter-cluster interference, this protocol introduces a spatial reuse algorithm in order to allow vehicles of neighboring clusters to use the same channel in the same time slots. The key advantage of CBMAC is that it mitigates the hidden node problem and access fairness issue. However, its drawback is that it doesn't address the merging collision problem, which can occur in scenarios where traffic flows in opposite directions.

A clustering-Based multi-channel V2V communication system (CBMCS) [115] was proposed in focus towards accident avoidance. In CBMCS, all vehicles form clusters using the control channel, then one cluster head is elected to manage medium access and reserve resources to the cluster members. The control channel employs the CSMA/CA scheme, while the data channel uses both TDMA and Code division multiple access (CDMA) schemes to guarantee a reliable and rapid transmission within clusters. Firstly, Each cluster member periodically broadcast information such as its position and speed during its assigned TDMA time slot on the data channel. Then, to avoid inter-cluster interference, the CDMA scheme is used and each cluster head selects a different orthogonal code from its neighboring cluster heads.

TDMA Cluster-based MAC (TC-MAC) [116] is a dynamic multi-channel MAC protocol designed for VANET. The authors addressed three important aspects which are cluster formation, TDMA slot reservation and intra-cluster communication. The protocol uses a stable clustering method to ensure longer cluster head lifetimes. The slot allocation is based on TDMA mechanism and managed by the cluster heads. While TC-MAC protocol proves its efficiency regarding efficient time slot utilization, it has some drawbacks. First, the protocol was designed for unidirectional highway scenarios only, and thus will perform poorly in bidirectional roads due to high collision risk. Moreover, the inter-cluster interference problem which can cause access collisions was not addressed.

Some of the challenges facing this type of protocol is the design of stable algorithm for cluster formation, selection of the CH and cluster management. Cluster instability and short CH duration may affect the performance of the protocol. These challenges can be overcome if no controllers are involved in the allocation process. Such protocols are called distributed MAC protocols and are reviewed in

the next sub-section.

2.2.3 . Distributed TDMA-based MAC protocols

These protocols coordinate channel access in a distributed way. They assume that no central nodes are needed to manage the access to the channel, but each vehicle communicates with its one-hop neighbors to negotiate their access to the channel. In the literature, various distributed TDMA-based MAC protocols have been proposed for VANET that are reviewed below.

Space-Orthogonal Frequency-Time Medium Access Control (SOFT MAC) [117] is a hybrid MAC protocol for VANET that uses TDMA scheme for channel access, while Orthogonal Frequency Division Multiple Access (OFDMA) and Space-division multiple access (SDMA) are used for simultaneous transmissions. In this protocol, roads are divided into cells and to each a set of available sub-carrier is assigned. SOFT MAC frames contain information about the status of each time slot in the frame, the number of slots and the ID of the vehicle currently reserving the slot. These information is accessed by each vehicle before sending a reservation request to check the available slots. Although this protocol is efficient in terms of increased throughput and reduced collision since vehicles in adjacent cells don't transmit on the same sub-carrier, it doesn't solve the merging collision as bidirectional traffic is not considered. Besides, the protocol assign a fixed size slot set to each cell without considering the density and access demand. This entails a considerable loss of resources in low density cells, and unsatisfied access demand in high density cell. The use of multiple access mechanisms also makes its implementation very expensive and complex.

Vehicular Ad Hoc Networks MAC (VeMAC) [118] is multi-channel MAC protocol proposed for VANET. Unlike SOFT MAC protocol, VeMAC is completely contention-free and only uses TDMA access method. To reduce merging collision caused by vehicles travelling on opposite directions, this protocol assign disjoint sets of time slots to each directions. In VeMAC, the hidden terminal problem is solved by including information about the time slots used by the one-hop neighborhood to the header of all transmitted messages, so each vehicle can determine the set of time slots used by its two-hop neighborhood and request reservation of a free slot from accessible time slots set. This protocol is able to be effective in regards to reducing the merging and access collisions rates. However, due to a lot of information included in the control frame header, the protocol generates more overhead. Moreover, VeMAC shares the same disadvantage as SOFT MAC when it comes to channel utilization efficiency. The size of the slots set assigned to each direction is not decided according to the traffic volume on each direction. In case no slots in the accessible set are free, the vehicle will reserve a free slot from the set assigned to the opposite direction. This will likely lead to increasing merging collisions.

Adaptive vehicular MAC protocol (A-VeMAC) [119] was proposed as an extension to VeMAC. Similarly to VeMAC, this protocol employs a TDMA mechanism

to ensure a contention-free access and is suitable for bidirectional traffic. The improvement that A-VeMAC has brought is that the length of the two different slot sets assigned to opposite directions is adapted based on the current traffic conditions on each direction. The access mechanism used in A-VeMAC is the same as VeMAC.

In [120], another adaptive TDMA slot assignment named Adaptive TDMA slot assignment (ATSA) was proposed to improve the utilization efficiency issue in VeMAC protocol. ATSA takes into account the unbalanced traffic in the opposite directions and proposes a slot management mechanism based on a binary tree. Despite that these solutions outperform VeMAC in terms of resource utilization, no further improvement was observed as regards to overhead and merging collisions.

Near Collision Free Reservation Based MAC (CFR MAC) [121] was proposed to mitigate the merging collision problem in VeMAC. On top of dividing the time slots to two disjoint sets each reserved for a different direction, CFR MAC further divides each slots set into three subsets associated to three velocity intervals: high, medium and low. The CFR MAC protocol dynamically adjusts the number of time slots assigned to each direction and velocity interval. In comparison to VeMAC, CFR MAC protocol considerably reduces the access delay and the collision rates. However, the overhead issue still needs to be tackled.

There is a large number of solutions present in the literature that targets the mobility and channel access in VANET. After reviewing the most prominent works it becomes possible to highlight the issues that needs to be tackled in this dissertation. In the next section, the key challenges relative to each targeted direction are summarized as well as the improvement brought by the proposed solution to level these challenges.

2.3 . Contributions

After reviewing the existing literature, a summary of the leading challenges related to the issues targeted in this dissertation is highlighted in table 2.3. Also, the contributions of each of the proposed solutions designed to overcome these challenges are presented.

This chapter examines prior work that supports our own method for traffic-aware TDMA-based multiple channel access for VANET. In a first step, the focus was placed on mobility models for vehicular traffic simulation and prediction. These models were classified and examined in order to highlight what lay behind our motivation to design new traffic simulation and prediction models. Following that, TDMA-based MAC protocol designed for VANET were reviewed and their limitations were presented. Based on the conducted study, the motivation that shaped the contribution of this study is discussed. In this next chapter, a simulation framework that allows emulating vehicular traffic is presented.

Table 2.1: Comparison of mobility models

Model	Target environment	Map generation	Trip generation	Path computation	Lane change	Velocity	Intersection behaviour
TRAILS [54]	Urban	Extracted from traces	Random	RWP	No	Uniform	-
M. Beiró [55]	Human mobility	Real map	Traces	Traces	No	Traces	-
Mining regional mobility [56]	Urban	Real map	Taxi traces	Traces	No	Traces	-
Udel [65]	Urban human mobility	Undirected graph	Traces	Traces	No	Traces	-
Agenda-based [66]	Urban	Grid layout	Traces	Traces	No	Traces	-
ETH [67]	Urban	Real map	Traces	Traces	No	Traces	-
City section [52]	Urban	Grid layout	Random	RWP	No	Uniform	Random
Freeway [84]	Freeway	Undirected graph	Random	RWP	No	Non-uniform	-
Manhattan [84]	Urban	Grid layout	Random	RWP	No	Non-uniform	Probabilistic
Nagel & Schreckenberg [85]	Freeway	User-defined	Random	RWP	No	Non-uniform	-
Cellular automaton [86]	Freeway	User-defined	Random	RWP	No	Non-uniform	-
Hot road [87]	Urban	Real map	Taxi traces	Traces	No	Traces	-
LWR [88, 89]	Urban and freeway	Real map	Random	Kinematic waves	No	Non-uniform	Traffic signal
Henry et al. [90]	Urban	User-defined	-	Kinematic waves	No	Non-uniform	Traffic signal
Yang et al. [91]	Urban	User-defined	-	Kinematic waves	No	Non-uniform	Traffic signal
Krauß [92]	Urban and freeway	User-defined	Random	Uniform	Yes	Non-uniform	-
2-lane car-following [93]	Freeway	User-defined	Uniform	Uniform	Yes	Uniform	-
Bayesian [94]	Urban and freeway	User-defined	User-defined	Random	Yes	Non-uniform	-
Legendre [95]	Human mobility	Map file	Random	Brownian motion, RWALK, Group Walk	No	Normal or uniform distribution	-
Gipps [96]	Highway	Random	Random	Random	Yes	Non-uniform	-
Driving cycles [97]	Urban, rural, highway	Real map	GPS traces	Traces	No	Non-uniform	-
Fast lane [98]	Urban and highway	User-defined	Random	-	No	Uniform	Traffic signal
Mirchandani et al. [99]	Urban intersections	User-defined	-	-	No	-	Traffic signal
Cremer & Landenfeld [100]	Urban	User-defined	Random	RWP	No	Uniform	Traffic signal
Mohimani et al. [101]	Urban	Grid layout	Random	Random	No	Non-uniform	Deterministic
Spatio-temporal ML [102]	Urban	Real map	Prediction	Prediction	No	-	-
NN-based model [103]	Urban	Real map	Prediction	Prediction	No	Prediction	-
F. Jin [104]	Urban	Real map	Prediction	Prediction	No	-	-
Deep RL model [105]	Highway	Real map	-	Prediction	No	Prediction	-

Table 2.2: Comparison of TDMA-based MAC protocols for VANET

Protocol	Access management	Access mechanism	Traffic aware	Application	Use case	Advantage	Drawback
ACFM [109]	RSU	TDMA	No	Safety	Highways	<ul style="list-style-type: none"> Increases throughput Reduces overhead 	<ul style="list-style-type: none"> Inefficient channel utilisation Bidirectional traffic is not considered
R-MAC [110]	RSU	TDMA CSMA/CA	No	Safety	Highways	<ul style="list-style-type: none"> Predicts collision risk and adjusts the size of the sub-frames accordingly 	<ul style="list-style-type: none"> Inefficient channel utilisation Bidirectional traffic is not considered
UTSP [111, 112]	RSU	TDMA	No	Non-safety	Highways	<ul style="list-style-type: none"> Increases throughput and fairness 	<ul style="list-style-type: none"> The hidden terminal problem is not solved Can't support delay-sensitive applications
VAT-MAC [113]	RSU	TDMA	Yes	Safety	Urban & highways	<ul style="list-style-type: none"> Increases throughput Maximizes channel utilization 	<ul style="list-style-type: none"> Low transmission rate
CBMAC [114]	CH	TDMA	No	Non-safety	Highways	<ul style="list-style-type: none"> Reduces hidden terminal problem 	<ul style="list-style-type: none"> Does not target merging collision issue
CBMCS [115]	CH	TDMA CDMA CSMA/CA	No	Safety	Highways	<ul style="list-style-type: none"> Reduces inter-cluster interference 	<ul style="list-style-type: none"> Merging collision is not addressed Limited to safety applications
TC-MAC [116]	CH	TDMA	No	Safety	Highways	<ul style="list-style-type: none"> Efficient channel access 	<ul style="list-style-type: none"> Inter-cluster interference and bidirectional traffic were not considered
SOFT MAC [117]	Vehicles	TDMA SDMA OFDMA	No	Safety & non-safety	Highways	<ul style="list-style-type: none"> Increases throughput Reduces collision rates 	<ul style="list-style-type: none"> Complex and expensive implementation Merging collision not solved Inefficient channel utilization
VeMAC [118]	Vehicles	TDMA	No	Safety & non-safety	Urban & highways	<ul style="list-style-type: none"> Reduces access collision 	<ul style="list-style-type: none"> Increased overhead Merging collision not solved Inefficient channel utilization
A-VeMAC [119]	Vehicles	TDMA	Yes	Safety & non-safety	Urban & highways	<ul style="list-style-type: none"> Reduces access collision Improves channel utilization 	<ul style="list-style-type: none"> Increased overhead Merging collision not solved
ATSA [120]	Vehicles	TDMA	Yes	Safety & non-safety	Urban & highways	<ul style="list-style-type: none"> Reduces access collision Improves channel utilization 	<ul style="list-style-type: none"> Increased overhead Merging collision not solved
CFR MAC [121]	Vehicles	TDMA	Yes	Safety & non-safety	Urban & highways	<ul style="list-style-type: none"> Reduces access and merging collision Improves channel utilization 	<ul style="list-style-type: none"> Increased overhead

Table 2.3: Contributions summary

Target direction	Key challenges	Proposed improvements
Mobility simulation	<ul style="list-style-type: none"> • Long simulation runtime • Time-consuming configuration efforts • Non reusable or scalable model components 	<ul style="list-style-type: none"> • SimEvents environment is used to allow fast simulations even of complex and large scale scenarios; • SimEvents offers drag-and-drop blocks for easy simulation set up; • The developed tool consists of several scalable module blocks that can be configured and reused to meet the requirements of each application scenario.
Highway mobility modelling	<ul style="list-style-type: none"> • Exhaustive modelling with high complexity; • Simplistic modelling with low accuracy; • Some behaviors are disregarded such as lane change; • Forecasting ability is important to provide decision support. 	<ul style="list-style-type: none"> • The most important mobility aspects are incorporated to preserve the accuracy of the results; • A mesoscopic modelling is used to avoid combinatorial explosion and expensive computations; • Continuous-time Markov chains and a direct numerical method are used to generate traffic forecasts.
Urban mobility modelling	<ul style="list-style-type: none"> • Exhaustive modelling with high complexity; • Simplistic modelling with low accuracy; • Some behaviors are disregarded such as queuing, crossing intersections; • Forecasting ability is important to provide decision support. 	<ul style="list-style-type: none"> • The most important mobility aspects are incorporated to preserve the accuracy of the results; • A mesoscopic modelling is used to avoid combinatorial explosion and expensive computations; • Continuous-time Markov chains and a direct numerical method are used to generate traffic forecasts.
VANET MAC protocol	<ul style="list-style-type: none"> • High collisions • Unfair allocation • Poor channel utilization • Negotiation overhead 	<ul style="list-style-type: none"> • Hidden terminal and merging collision problems are solved; • Clustering is used to reduce negotiation overhead; • Cluster heads fairly reserve slots to the members; • Traffic prediction is used to estimate traffic density and accordingly assign slot sets to the different areas of the road system; • The solution is adaptive to both highway and urban roads.

3 - Queuing theory based simulation model for vehicular mobility

3.1 . Introduction

Despite the patent advantages of VANET, its implementation is, however, still facing major challenges related to transmission reliability and efficiency [123]. These hamper any progress towards a real vision of an intelligent transport infrastructure able to provide safety services. In fact, safety-related applications have stringent requirements in terms of QoS that VANET is unable to meet due to its particular features. The defining features of VANET include the highly variable network topology and the network nodes mobility. It is therefore very important to analyse the robustness of these networks to the vehicles movement. One of the solutions considered was using analytical mobility models in computer simulations in order to test their performance before their implementation in real-world. Computer simulation tools have been commonly used in many fields, including transport systems, traffic engineering, healthcare and facility design [124, 125, 126]. They provide a cost-efficient and risk-free way to study the performance of traffic control applications or communication protocols and their ability to cope with vehicle motion dynamics.

NS2 [127, 128], SUMO [74, 75] and VanetMobisim [77, 78] are the most commonly used simulation tools to evaluate and compare the performance of VANET. NS2 [127, 128] is an event-driven simulation tool designed especially for studying the dynamic nature of communication networks. It can support the simulation of information transmission between moving vehicles but it fails to capture important mobility aspects that can impact driving behaviour such as crossing signalized intersections, lane change and queuing. SUMO [74, 75] is an open source tool dedicated to vehicular traffic simulation. It provides large packages of applications to simulate several features around traffic, however there are some limitations. Even if SUMO includes real-world scenario example, preparing complex and large scale scenarios is time consuming. Another limitation is that it does not allow modelling communication between vehicles. Hence, it is necessary to couple SUMO with other simulation tool such as NS2 to simulation vehicular communication. Similarly, VanetMobisim [77, 78] generates traffic patterns but does not allow network simulation. The trace file generated by VanetMobisim can be integrated in NS2 to evaluate the performance of vehicular networks under different traffic scenarios. The unavailability of a single simulator that comprises both traffic and network simulation was the driving motivation to build a new simulation framework.

The proposed framework offers a test bed for analysing vehicular traffic under various scenarios and integrates peculiar mobility aspects such as lane changing,

speed limits, stopping before a red light, route generation, queuing, vehicles behaviour at intersections, and the impact of traffic jams on the behaviour of the network as a whole. The strength of the model lies in its flexibility and possible extension to include control algorithms or communication technologies for an accurate testing and evaluation of the effectiveness of an ITS. The framework was built using various elements of the Matlab, Simulink and SimEvents interfaces. These platforms are widely used in diverse areas including automotive industry and offer both graphical and textual modelling tools for rapid prototyping of systems. The SimEvents toolbox also provides a set of template components and custom blocks such as entity generators, queues, servers, sinks, and discrete-event system blocks that allows building event-driven entity-flow systems. Hence, the event-driven aspects of transportation systems can be reproduced to generate accurate mobility traces for both highway and urban environments. In addition, large scale and complex simulations can be implemented and carried out swiftly using the simulation framework proposed.

In this chapter, the different components of the framework allowing the simulation of driving behaviours are explained. The framework is later extended in chapter 5 by integrating time-critical control algorithms and in chapter 6 by integrating clustering and vehicular wireless communications for the purpose of evaluating and comparing mobility-aware resource allocation methods in VANET. Several simulation results will be presented for defined scenarios to elaborate on the capability of the framework to operate under different traffic scenarios and to show how it can be used for accurate and reliable simulations.

3.2 . Proposed model

An important feature of the proposed framework is that it considers both the microscopic and mesoscopic parameters that influence the performance of VANET. The simulator runs in SimEvents, a discrete-event simulation environment provided by the MathWorks, Inc that runs under Simulink. It is a highly attractive platform for vehicular traffic because it offers a library of predefined graphical blocks for modelling queuing systems such as FIFO queues, servers, entity generators and sinks. It also allows graphical displays and statistical analysis and leaves room for possible extension and enhancement of the simulator. The proposed simulator consists of implementing several custom-built blocks covering the main aspects of vehicular mobility including the road characteristics (number of lanes, capacity, speed limit), intersection policies (traffic signals, stop sign, roundabout), individual vehicle characteristics (type, desired speed, destination) and mobility operations (lane changing, queuing). The building blocks can be divided into two types of components, infrastructure components and event components. The infrastructure components are the elements that allow defining the road infrastructure such as the road/lane configuration, signalized or unsignalized intersections, merging

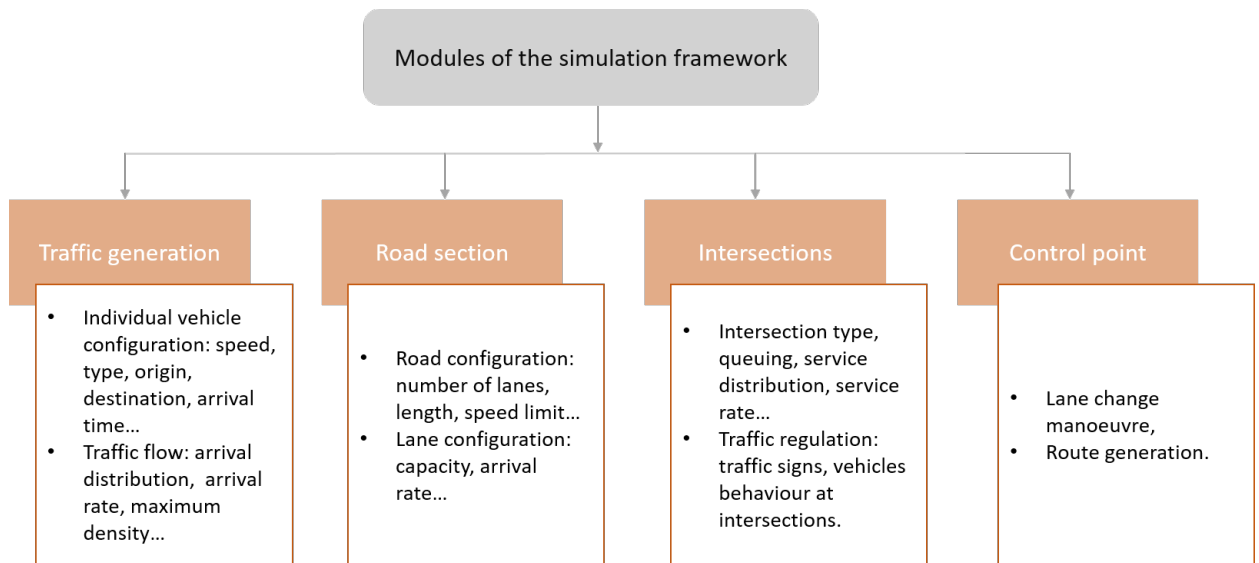

Figure 3.1: Modules of the simulation framework

intersections, etc. The event components are events that can change the network topology such as lane change, arrival/departure of a vehicle, crossing an intersection, etc. The custom-built blocks can be organized into four modules, representing either a road section, an intersection, a traffic generator or a control zone, as depicted in figure 3.1. In the following, the design and implementation of each module is described and explained.

3.2.1 . Traffic generation module:

The traffic generation module represents the starting point of a road where vehicles arrival occurs. This module allows defining the basic information about individual vehicles such as the trip route, vehicle type, desired travel speed and arrival time. The module should also allow modelling vehicles arrival with probability distributions. The steps followed to define the module are depicted in figure 3.2. The first step is the definition of the probability distribution used to model the arrival of vehicles. Then, the parameters that define the shape of the distribution need to be specified. The next step is the generation of vehicles following the defined distribution and setting a configuration for each vehicle. A vehicle is defined by its type (car, motorcycle, bus, truck, etc), the source and destination of its trip, its arrival time, and finally its speed which needs to be specified according to the road speed limit and its type.

The module is constructed using five different block types as shown in figure 3.3. The "Vehicles generator" block has a function of generating a number of vehicles per unit of time following a probability distribution defined by the block "Arrivals distribution". Each entity is then assigned by the "Set attribute" block a type and a destination generated randomly using event-based random number

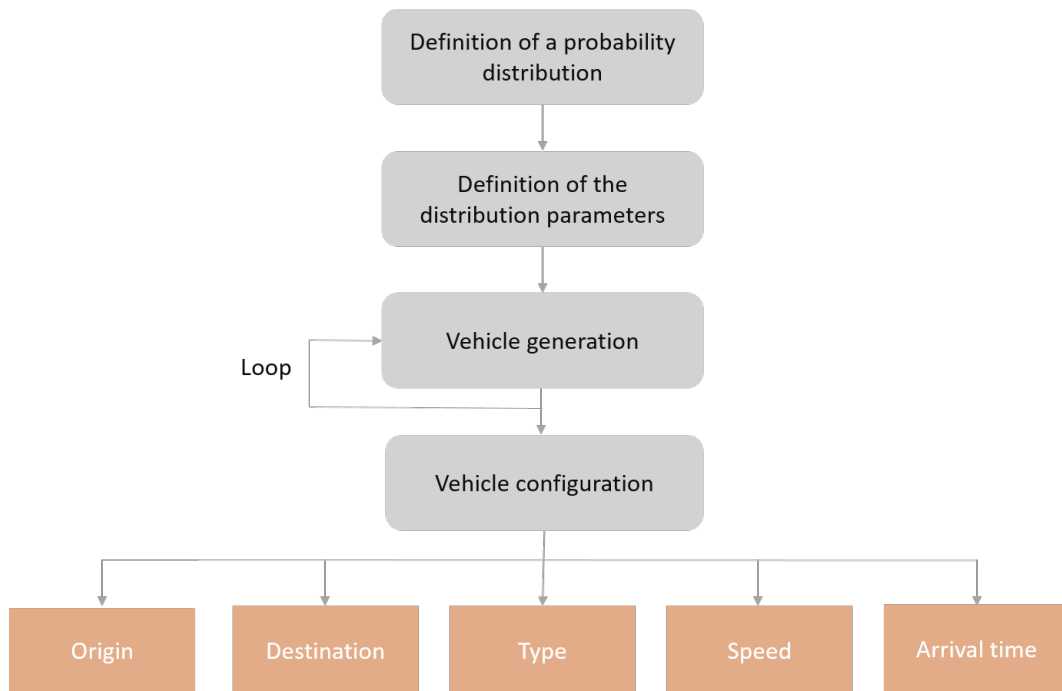

Figure 3.2: Steps to define the traffic generation module

blocks. The origin of the vehicle is set to be the intersection where the vehicle is generated. The "start timer" block records the arrival time of each entity and associates to it a time stamp to record the exact time it spends in a road section. A path combiner block is used to merge into a single entity output port the flow of vehicles coming from other roads with the flow of vehicles generated at the start point. The last block is a Matlab function that sets a desired velocity for each vehicle as a function of its type and the speed limit on the road section.

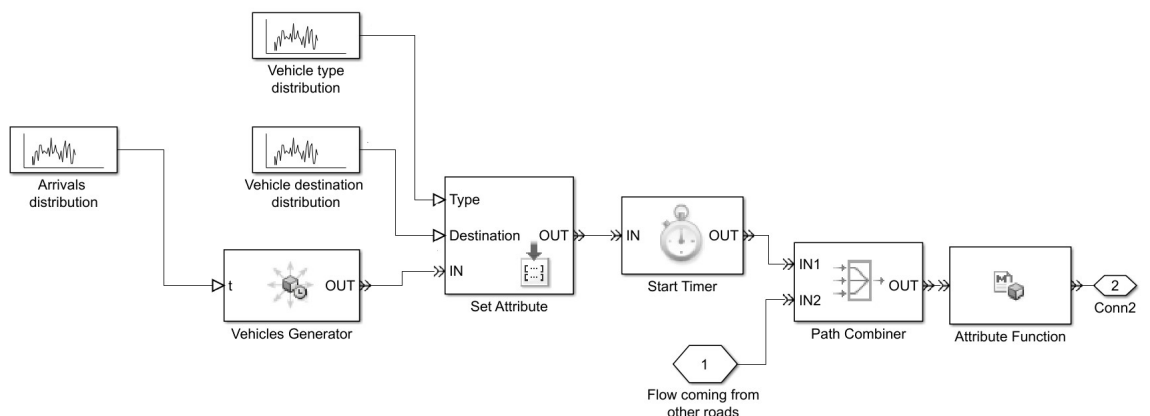

Figure 3.3: Traffic generation model

3.2.2 . Road section module:

The road section module allows modelling a section of the road and its lanes. This module describes the various items and characteristics that define a roadway such as the number of lanes, the speed limit, and the capacity. Figure 3.4 explains the different steps to follow in order to implement these properties. As a first step, the number of lanes is determined in order to split traffic flow among the different lanes. The next step consists in representing each lane by a queue and then defining its properties. Each lane is defined by its length, its capacity, speed limit, arrival rate and the service rate. The arrival rate represents the amount of traffic coming through each lane, while the service rate represents the time required to travel through the lane.

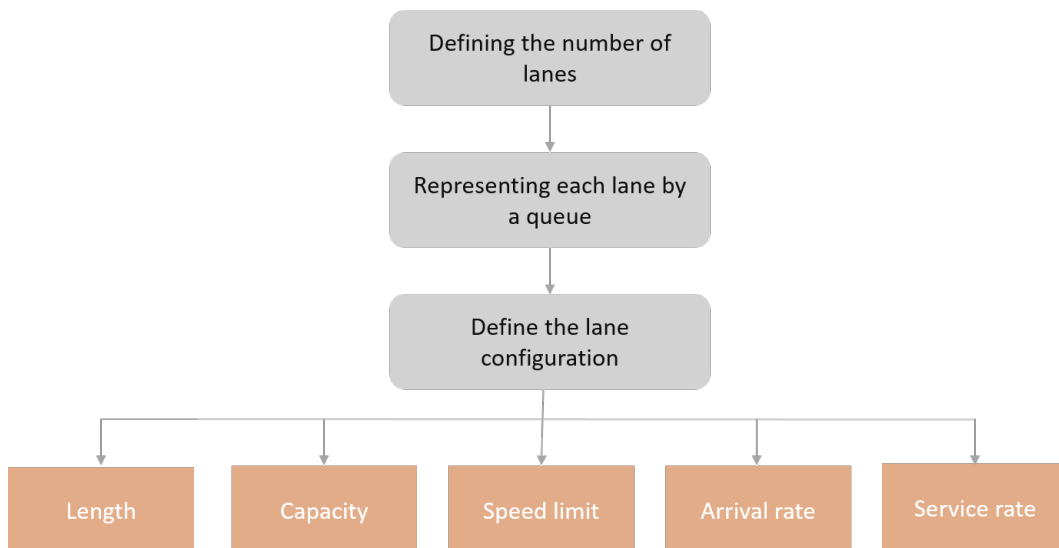

Figure 3.4: Steps to define the road section module

Figure 3.5 shows how the road section module is constructed in SimEvents. Its first block "output lane" allows to direct the arriving vehicles to one of the lanes and allows to choose different switching distributions using the random number generator block "lane distribution". The number of output ports can be specified according to the number of lanes in the road. In the example depicted in figure 3.5, a double lane road is considered. Each lane is represented by a FIFO queue with a fixed capacity relative to its length. The vehicles stored in the queue are released one by one from the queue to be serviced. The block "get velocity attribute" retrieves the desired velocity attribute of each entity in order for it to be used by the function block "vehicle service time" to compute the actual travel speed taking into account the density on the lane and the speed limit, and then to determine the travel time. The last block "Lane server" represents an infinite set of single servers where each holds a vehicle for a period of time previously calculated by the function block "vehicle service time".

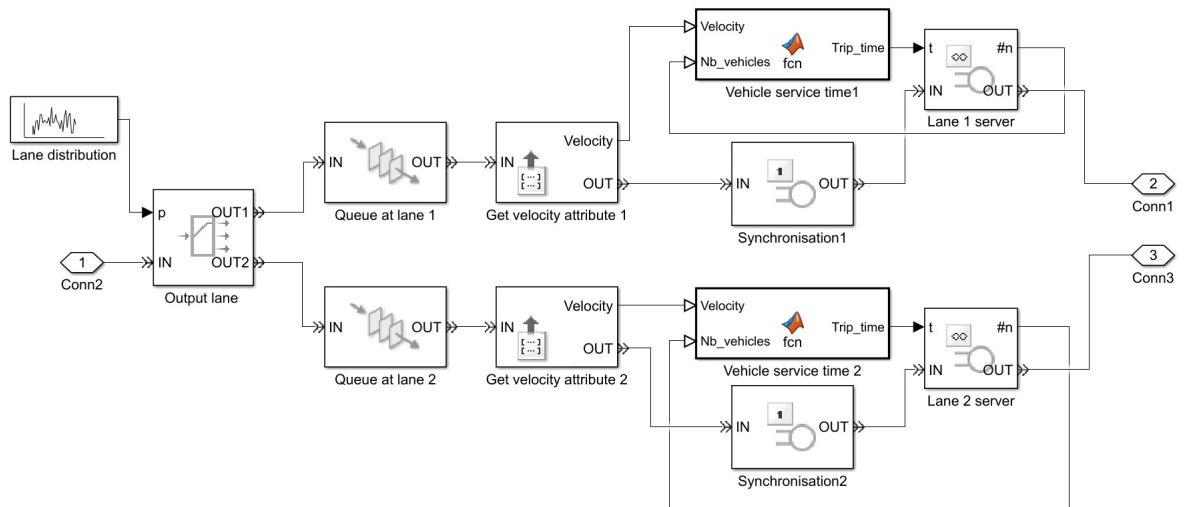

Figure 3.5: Road section model

3.2.3 . Intersection module:

The modelling of intersections will be realized through the intersection module. The blocks of this module will allow defining the type of the intersection, crossing rules, waiting lines and the service rate. Figure 3.6 describes how traffic at intersections is modelled. First, the type of the intersection needs to be specified. We distinguish four types of intersection: Signalized, unsignalized, merge zones, and toll gates. The signalized junctions are controlled by traffic lights, while unsignalized are controlled by traffic signs (stop-and-go, yield signed, roundabout). A merge zone is an area where two traffic flows from multiple roads of the same travel direction merge into a single road. Toll gates are stations at the entry and exit of highways where drivers pay the toll fees. After defining the intersection type, the waiting lines where vehicles have to wait before crossing the intersection are modelled by queues. The service discipline is then defined according to the type of the intersection to describe the priority order in which vehicles are serviced. The last step is modelling the service using a probability distribution to define the amount of time until a vehicle finishes crossing the intersection.

The intersection module provides four different blocks to model signal-controlled, unsignalized, merge intersections or toll stations. The framework provides two types of signalized intersections: pretimed and actuated. The pretimed traffic lights have a fixed cycle, while the actuated traffic lights are dynamics and adjust the cycle length according to the number of vehicles queuing at the intersection. The actuated signal-controlled intersection is constructed as represented in figure 3.7. As vehicles arrive to the signalized intersection, they are stored in a FIFO queue representing the waiting line. For multiple lane roads, a queue is assigned to each lane. The number of vehicles present in the block #n is used by the "Ac-

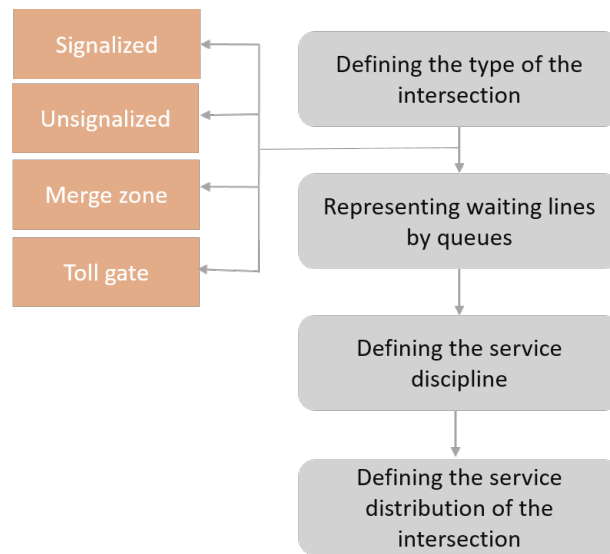

Figure 3.6: Steps to define the intersection module

tuated traffic light" block to calculate the traffic signal cycle length. This block can be replaced by a "pre-timed traffic signals" block to simulate fixed cycle length traffic lights. The "traffic controller" block receives the light signal from the previous block to manage the service of vehicles. In the red light phase, the vehicles are forced to wait in the queue block, then when the light switches to green, the vehicles are released one by one to get through the "intersection server" block that implements the service time of each entity. The service time is defined as the time needed for a vehicle to cross the intersection and move to another one.

To model a stop sign intersection, the "traffic signals" and "traffic controller" blocks are not used. This also applies to modeling roundabouts, the single server block, though, has to be replaced by an N-server block to allow multiple vehicles to enter the roundabout at the same time. The yield signed intersection is developed as shown in figure 3.8. The "control decision" block retrieves the length of the opposite waiting queue and generates a signal for the "traffic controller" block. If the opposite queue is empty, the "traffic controller" allows the vehicle to be serviced, else it forces the vehicle to stop and yield the right of way to other vehicles. The merge signed intersection is implemented in the same way as the yield signed intersection. The "traffic controller" block allows vehicles entering from the side road to merge with traffic on the main road when no vehicle is occupying the server. Figure 3.9 represents the toll station model. The traffic flows from different lanes represented by queues is evenly distributed over the toll booths using the "Toll booth switch" block. The vehicles allocated to a toll booth are stored in a FIFO queue and are serviced one by one by the "Toll server" block.

3.2.4 . Control module:

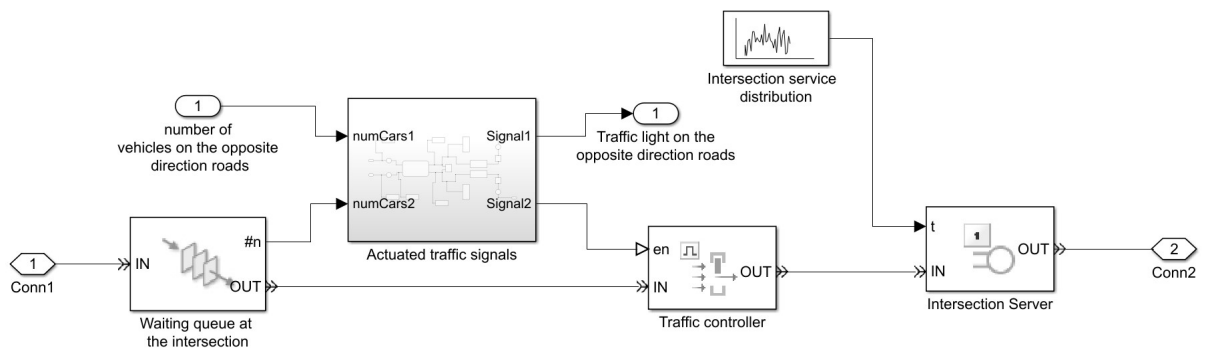

Figure 3.7: Signal-controlled intersection model

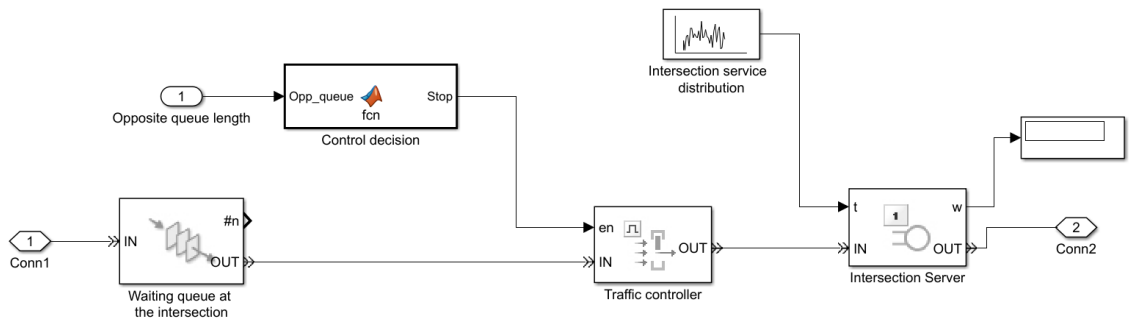

Figure 3.8: Yield signed intersection model

The control module provides customized blocks to model mobility operations such as lane changes or travel routes generation. The lane change module allows modelling the lane change manoeuvre in multi-lane roads. The steps followed to describe this behaviour are explained in figure 3.10. First, a parameter representing the congestion threshold is set for each lane. Then, the number of vehicles travelling on each lane is retrieved in order to calculate the corresponding congestion rate. The lane change decision is then defined for each vehicle passing through the lane change block. If the congestion rate on the current lane exceeds the congestion threshold set for the lane, the vehicle switches to the left lane. If the lane is not in a congested state, the vehicle continues its trip on the same lane.

The figure 3.11 shows how the lane change block is constructed. For a double-lane road, the flow from both queues representing the lanes is merged using the "path combiner" block. Then, based on the number of entities in each queue the next lane is estimated using the Matlab function defined by the block "Lane

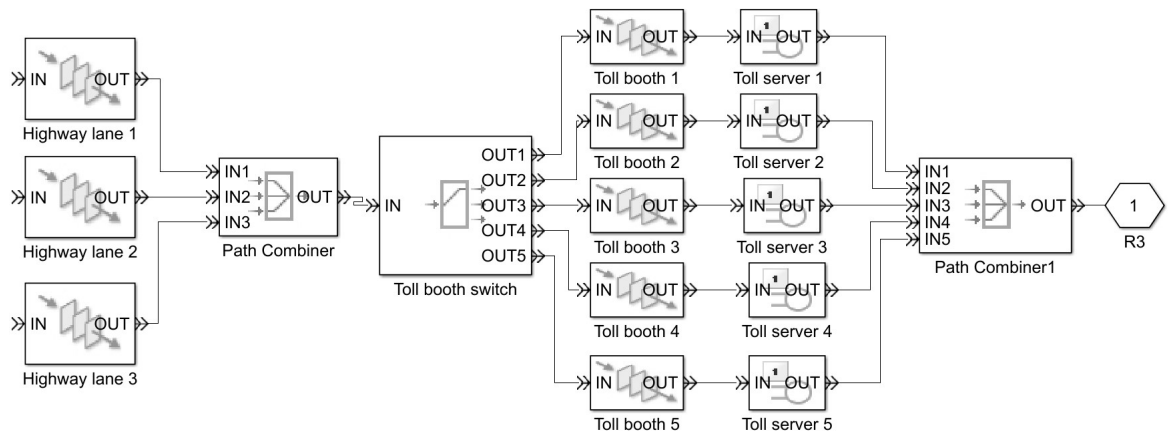

Figure 3.9: Toll station model

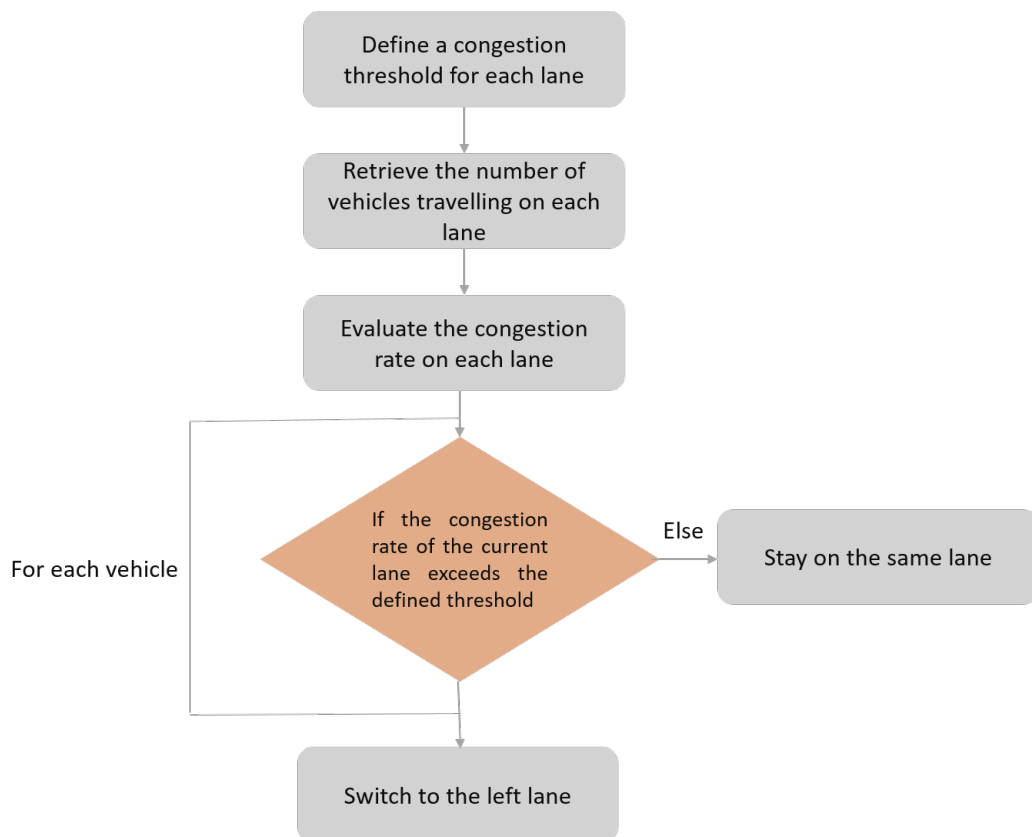

Figure 3.10: Steps to define the lane change module

change rate function". The later is the block where the value of the congestion threshold is defined. The next block named "lane switch" directs the vehicle to its

next lane according to the value returned by the Matlab function.

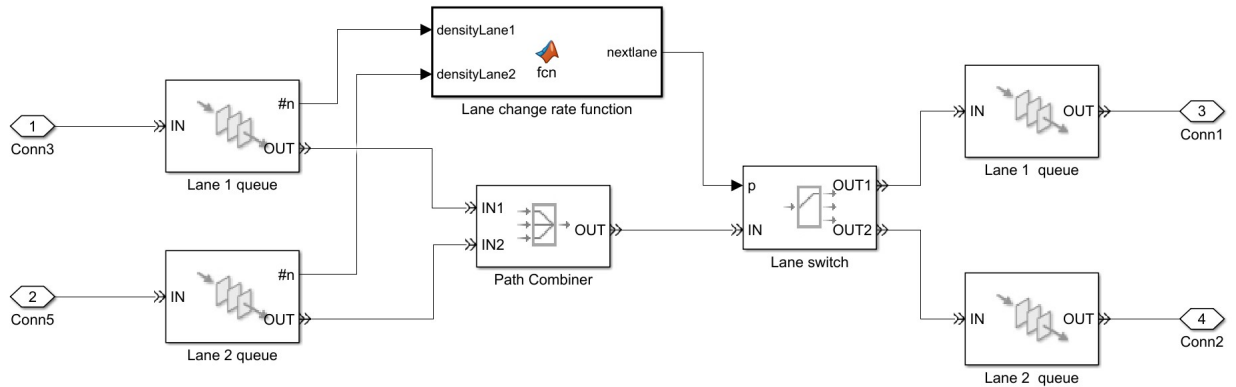

Figure 3.11: Lane changing model

The routing module serves as a route generator that finds the optimal route from the current intersection to the destination intersection. We start from the premise that drivers have a rational behaviour and always choose the most optimal route to their destination. The topology of the road network is represented by a weighted digraph, where each node represents an intersection and each edge represents a road. The weight of each branch corresponds to the distance between two neighbor intersections. A path finding method is then used to find the optimal route from the current to the destination node. The A* algorithm [128] is the method used in this model. It is a heuristic search algorithm in artificial intelligence algorithms that takes into consideration the cost and always finds the solution with the lowest total cost. Figure 3.12 illustrates the steps considered to define the routing module.

The routing block depicted in figure 3.13 is placed after the intersection block and has a function of routing vehicles to their next intersection. The first block "Get destination" outputs the value of the destination attribute which is then used as an input to the function block "Next intersection port". The function has access to the adjacency matrix of the graph representing the road topology and the distance between each two connected intersections. Based on these data, the function applies the A* graph search method [128] to find the most optimal route to the destination and returns the entity's output port which represent the next intersection. The "next intersection routing" block releases the entity to its next intersection port. If the current intersection corresponds to its destination, the "read timer" block reads the value of the time stamp associated by the start timer block and reports the time elapsed. After, the entity is routed to the "sink" block which terminates the entity path.

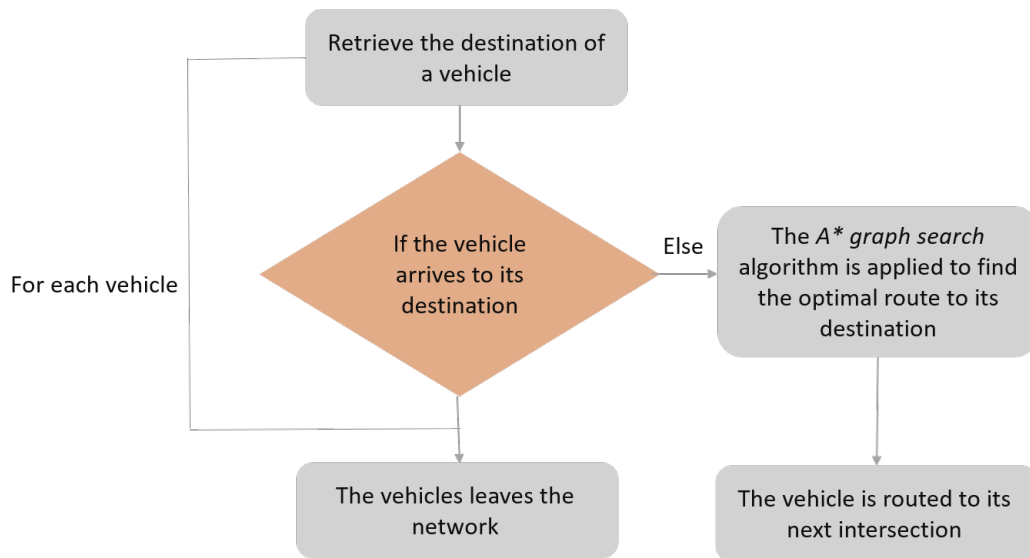

Figure 3.12: Steps to define the routing module

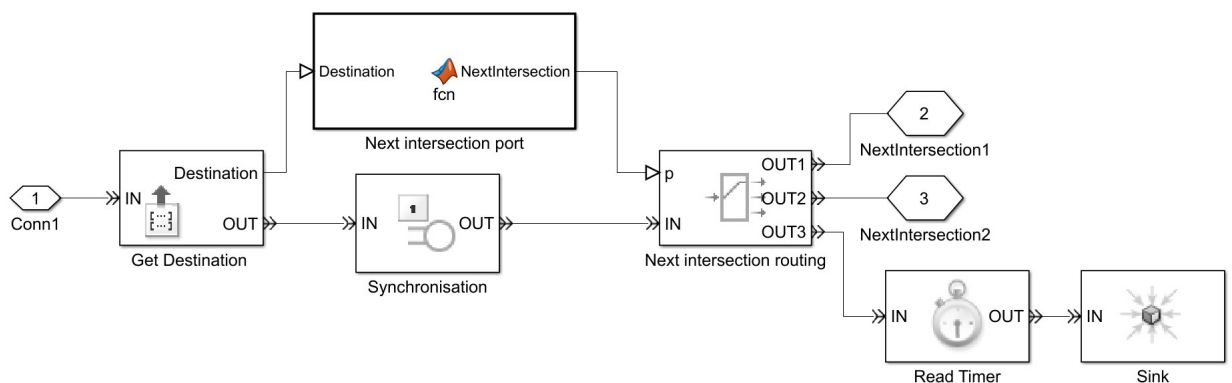

Figure 3.13: Routing block model

3.3 . Simulation results

In this section, the potential of the proposed simulation framework is demonstrated through simulation results. The first step was defining the simulation scenarios and then setting the configuration for the simulation framework. Two different environments are considered in the test: urban traffic and highway traffic. In the urban traffic scenario, a simple network of three intersections and six double-lane bidirectional links is considered. Figure 3.14 depicts the road architecture considered in the first test and table 3.1 summarizes the configuration used in the urban scenario.

The scenario considered was implemented in SimEvents using the proposed

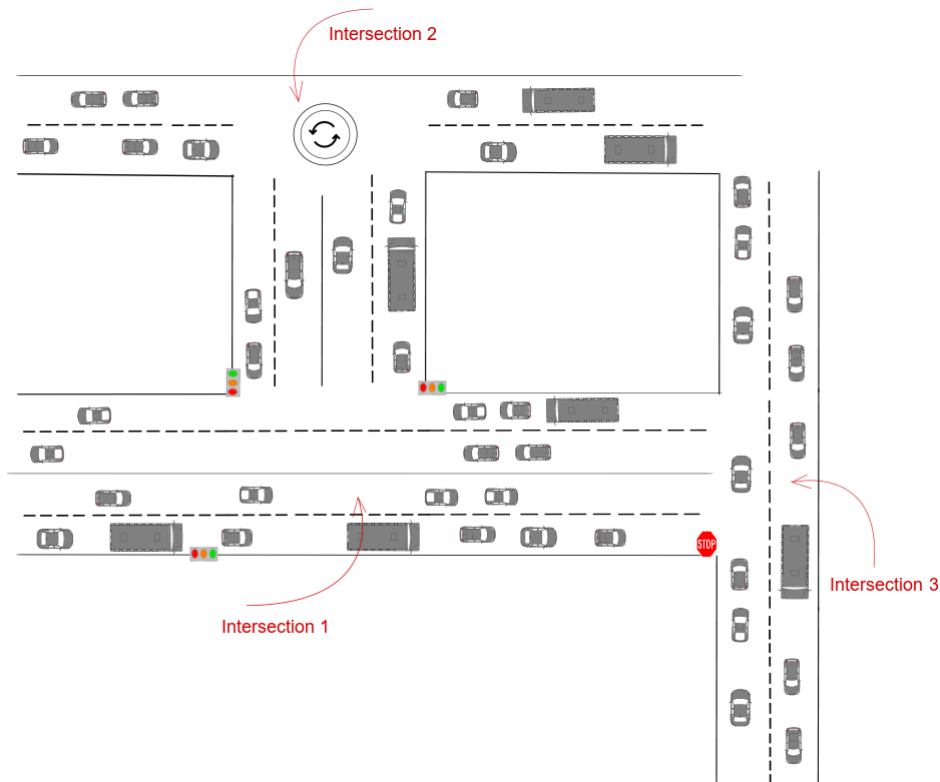

Figure 3.14: Urban environment scenario

framework and various results were generated. The simulation model allows generating several statistics to monitor averaged measures such as queue lengths, service times, inter-generation times, server utilization, etc. The following are some example results. The average waiting time per intersection is plotted in regards to the congestion rate as shown in figure 3.15. It can be observed that the different intersection policies perform differently, while the roundabout intersection generates more waiting times. It is worth mentioning that the waiting time curves follow an increasing trend due to the increase of the number of vehicles.

In figure 3.16, the curves illustrate the average waiting time at an actuated traffic light and a pretimed traffic light. Under less congested conditions, it can be seen that the actuated traffic signal performs similarly to the fixed cycle traffic light. However, in a congested state, the actuated traffic light shows a significant outperformance compared to the static traffic light. The chart in figure 3.17 represents the average waiting time at two lanes of the road linking intersection 1 to intersection 2. It can be noticed that an increased traffic density can lead to higher waiting times. More specifically, the right lane shows a higher waiting time compared to the left lane because drivers mostly keep in the right lane.

In a second test, a highway environment as illustrated in figure 3.18 is consid-

Table 3.1: Configuration used in the urban simulation

Intersection	Policy	Arrival distribution	Service distribution
Intersection 1 Intersection 2 Intersection 3	Traffic light Roundabout Stop sign	Poisson, 15 vehicles/min Poisson, 30 vehicles/min Poisson, 50 vehicles/min	Exponential, 18 vehicles/min Exponential, 12 vehicles/min Exponential, 18 vehicles/min
Road	Length	Speed limit	Number of lanes
Road from I1 to I2 Road from I2 to I1 Road from I1 to I3 Road from I3 to I1	400m 400m 500m 500m	50 km/h 50 km/h 30 km/h 30 km/h	2 2 2 2

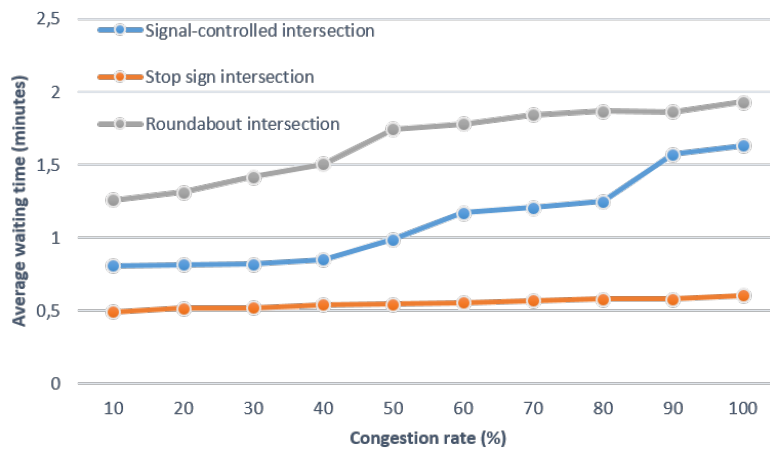

Figure 3.15: Average waiting time vs congestion rate for each intersection

ered. A highway road is divided into two sections, where the first section represents a normal highway segment and the second one represents a merge area where a side road merges onto the main highway road. Table 3.2 summarizes the parameters used to configure the simulation framework.

This scenario was implemented in the SimEvents environment using the adequate simulation modules. Following that, performance measures are derived and plotted. The average delay is calculated for both sections, then the performance of the three lanes of the first section in terms of delay is compared. The average delay is plotted against congestion rate to analyze the impact of congestion on the highway traffic flow.

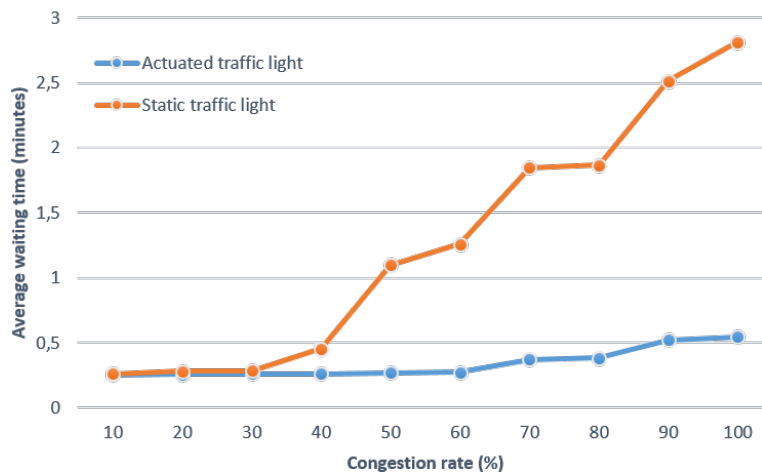

Figure 3.16: Average waiting time of an actuated and a pretimed traffic light vs congestion rate

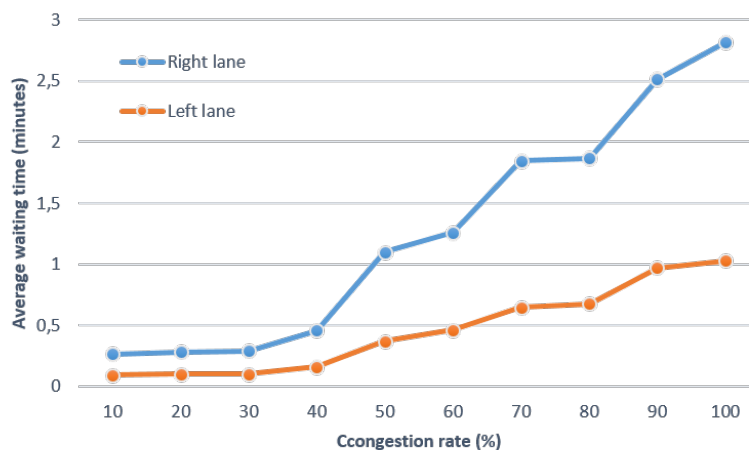

Figure 3.17: Average waiting time vs congestion rate at each lane

The chart in figure 3.19 shows the average travel delay of the two highway sections. It can be noticed that higher delays occur at the merge area as traffic density increases when more traffic flow originates from the side road. Furthermore, when vehicles on the main highway road approach the merge area, they might slow down their speed to let in vehicles that are trying to merge.

The performance of the three lanes of the first highway section in terms of the average travel delay is compared in figure 3.20. It can be observed that more delays are occurring at each highway lane when traffic congestion increases. Moreover, the right most lane shows more delays as vehicles with the highest travel velocities

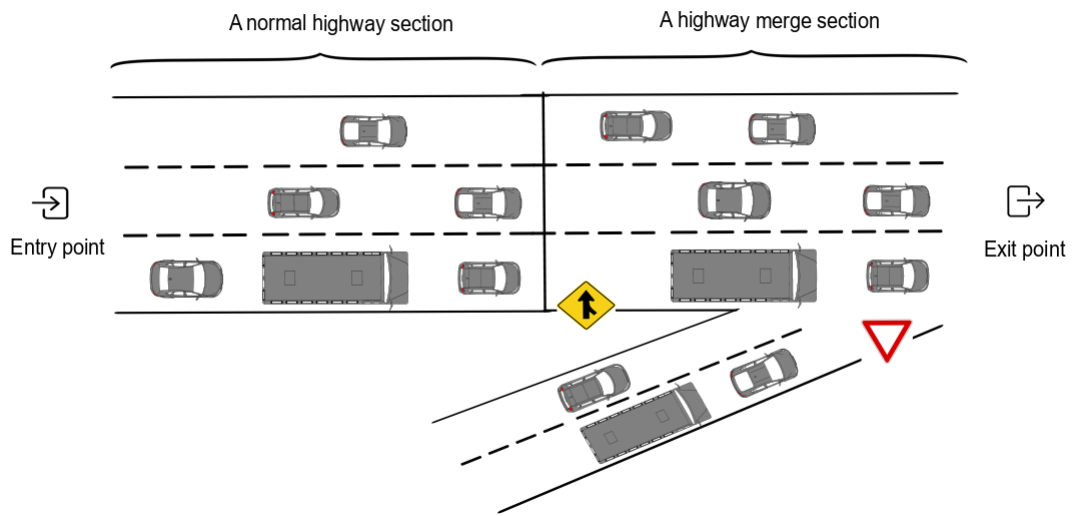

Figure 3.18: Highway environment scenario

Table 3.2: Configuration used in the highway simulation

Highway section	Number of lanes	Length	Speed limit	Arrival rate
Normal section	3 lanes	120 km/h	400 m	Poisson, 45 vehicles/min
Merge section	3 lanes	120 km/h	400 m	Poisson, 30 vehicles/min

tend to shift to the left fast lanes. Based on the different results presented in this section, the simulation framework has proven its potential to accurately emulate the realistic traffic behaviour in both highways and urban areas.

3.4 . Conclusion

In this chapter, a simulation framework was developed using the SimEvent library. The framework serves as an efficient simulation tool for testing and evaluating the performance of ITS applications and protocols before they are implemented in real world. The model takes into account some fundamental properties of mobility, such as lane changing, reaction to road signs, and route generation. Moreover, it reports significant aggregate measures to analyse the performance of the system, for instance the average waiting time, the queue lengths, the utilization time, etc. Through simulation results, the model has shown its effectiveness in generating accurate traffic traces that reflect the realistic behavior of vehicular

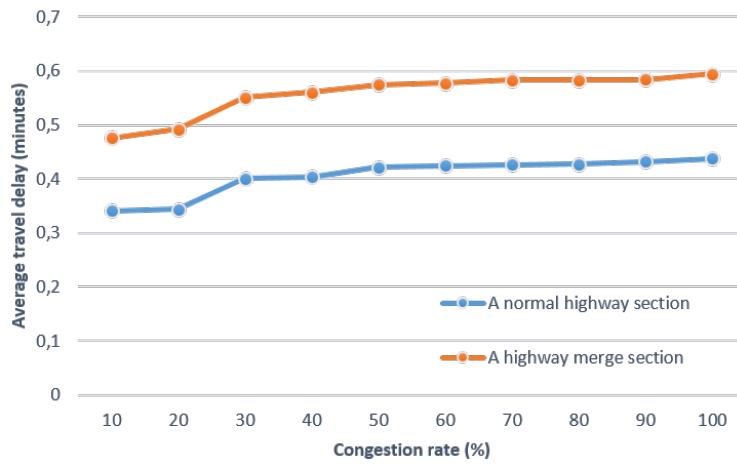

Figure 3.19: Average travel delay of a normal highway segment and a highway merge area

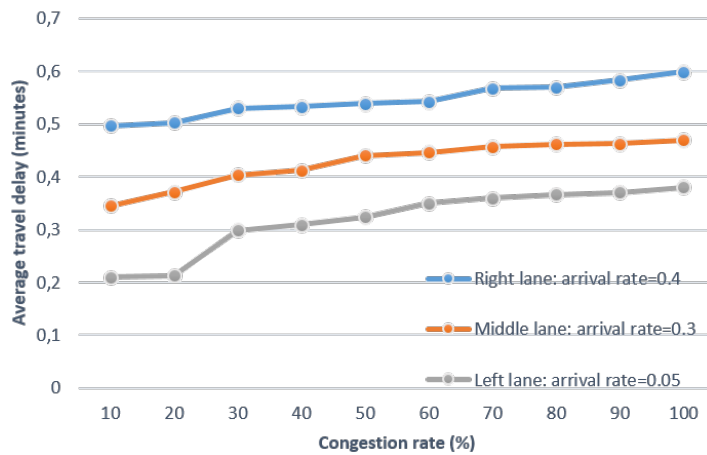

Figure 3.20: Comparison of the average travel delay of three highway lanes

traffic in both urban and highway environments. Furthermore, the proposed tool is powerful enough in terms of quick simulation response and scenario configuration even for complex and large scale scenarios. Future improvements will focus on enriching the proposed library with more modules and graphical interfaces to facilitate the use of the tool. In chapter 5, the framework is extended by integrating traffic control applications such as traffic-prediction based traffic lights and speed control in order to test and evaluate the accuracy of a mobility prediction model proposed for urban environments. Vehicular communication and clustering will be

integrated in chapter 6 for the purpose of evaluation and comparing the performance of the proposed mobility-aware resource allocation technique. The next chapter will focus on mobility prediction using stochastic methods. While mobility simulation is used to understand the behaviour of vehicular traffic and evaluate the efficiency of the proposed resource allocation protocol against the highly dynamic environment, mobility prediction allows to forecast future traffic condition in order to provide efficient resource management.

4 - Markov Chain Mobility Model for Multi-lane Highways

4.1 . Introduction

In the previous chapter, a simulation model was constructed to reproduce an almost real situation of traffic in different scenarios and environments. This tool can be used for different purposes that require testing the robustness of a solution against the highly dynamic traffic. However, to anticipate the changes in the road system, a mobility prediction model is required. The next stage of our approach focuses on building a mobility model to estimate the future state of traffic based on data collected using V2X communications. The predicted mobility is necessary to design mobility proactive approaches and therefore will be used to design a mobility-aware MAC protocol in chapter 6.

This chapter aims at introducing a fully-distributed model for traffic prediction dedicated to multiple-lane highway environments. The next chapter, will extend the model to cover mobility prediction in urban environments. Several models that target highway traffic modelling were discussed in chapter 2. Freeway [84] and Manhattan [84] are simplistic models that emulate highway traffic where routes, paths and speeds are randomly generated. This is the greatest shortcoming of these models because they don't consider the correlation between the past and future traffic states. Moreover, lane change behavior is not reflected. Krauß [92] and Gipps [96] proposed highway traffic models that take into account multi-lane traffic and lane changing, however they are based on unrealistic configurations. Moreover, historical traces or real-time collected traffic data are not considered. The simplicity of these models is what conferred them success, however, the mobility patterns predicted are not as realistic as they should be. Machine learning based mobility models [102, 103] have attracted a growing attention in recent years and this attention is expected to further increase in the near future. The strength of these models is their ability to train and generate a prediction model based on realistic datasets. On the downside, using these models would produce completely useless results if large datasets are not available.

To address these issues, the model proposed in this chapter takes into consideration all mobility features characterizing highway traffic. These features include high speeds, two or more lanes and the absence of traffic signals and intersections. It is also assumed that vehicles are equipped with V2X capability and collect traffic data from RSUs to estimate future traffic conditions along highway roads. RSUs use V2I communications to exchange packets with vehicles within their coverage area. However, it is quite likely that some nodes in the network will be isolated due to the limited communication range of RSUs. Moreover, placing RSUs at

regular intervals could not be guaranteed for their cost of deployment. To improve the efficiency of V2I infrastructure, V2V communications can be used to extend the connectivity of RSUs and to ensure service continuity in the VANET. Several cooperation schemes were developed to combine both V2I and V2V to mitigate the service disruption problem in uncovered areas [136, 137, 138].

The work can be broadly separated into two parts. The first one was focused on describing traffic flow along multi-lane roads using queuing theory features. Principles of queuing theory have been widely used in traffic engineering [139, 140], because it allows to study waiting lines and queues, and to cover problems of optimization involving waiting and delays in servicing vehicles. So the use of this approach is not only inexpensive in terms of deployment but also allows to predict queue lengths and waiting times. The second part involves modeling changes in the system as a CTMC which allows to reflect the stochastic and variable nature of the transportation network and to predict future traffic states.

The key advantage of this approach is that it arises from simplistic assumptions that make modelling traffic a less complex problem without a loss of realism. A direct method is used to calculate the steady state distribution, which gives the exact solution to a system of linear equations. This approach is much more tractable and allows to derive interesting explicit results. Using an iterative and direct numerical method for solving the stationary probabilities of the Markov chain, long-term estimates of traffic distribution and measures such as average traffic volume, average travel time and congestion rate are computed. It was very important to test the model for different scenarios before proving the accuracy of the forecasts. Using historical mobility traces, the parameters for each scenario are firstly set and then the network performance is evaluated for different metrics. To validate the accuracy of the estimates, the obtained results are compared with realistic traces extracted using drones. The model has been proven to be very accurate and reliable.

4.2 . Proposed model

In this section, a new traffic model that utilizes traffic information collected through V2X communication is introduced in order to predict traffic along a highway road. First, the main assumptions used are presented and the model formulation is provided afterwards. The notations used hereinafter are summarized in table A.1.

In the proposed architecture, a multi-lane highway road divided into a number of segments of equal lengths is considered. A RSU is assumed to be placed in each segment of the highway and that vehicles are provided with local storage, computing capacity and V2X technology. All RSUs collect traffic data from vehicles within their coverage area and update driving conditions in real time. Based on recorded data, RSUs continuously compute the number of vehicles simultaneously

traveling on each segment, arrival rates and average speeds and share them with every vehicle arriving to the start point of the highway segment. Given the current state of traffic, vehicles can obtain estimates of future traffic condition by applying the model presented here. Figure 4.1 depicts the highway architecture considered in this study.

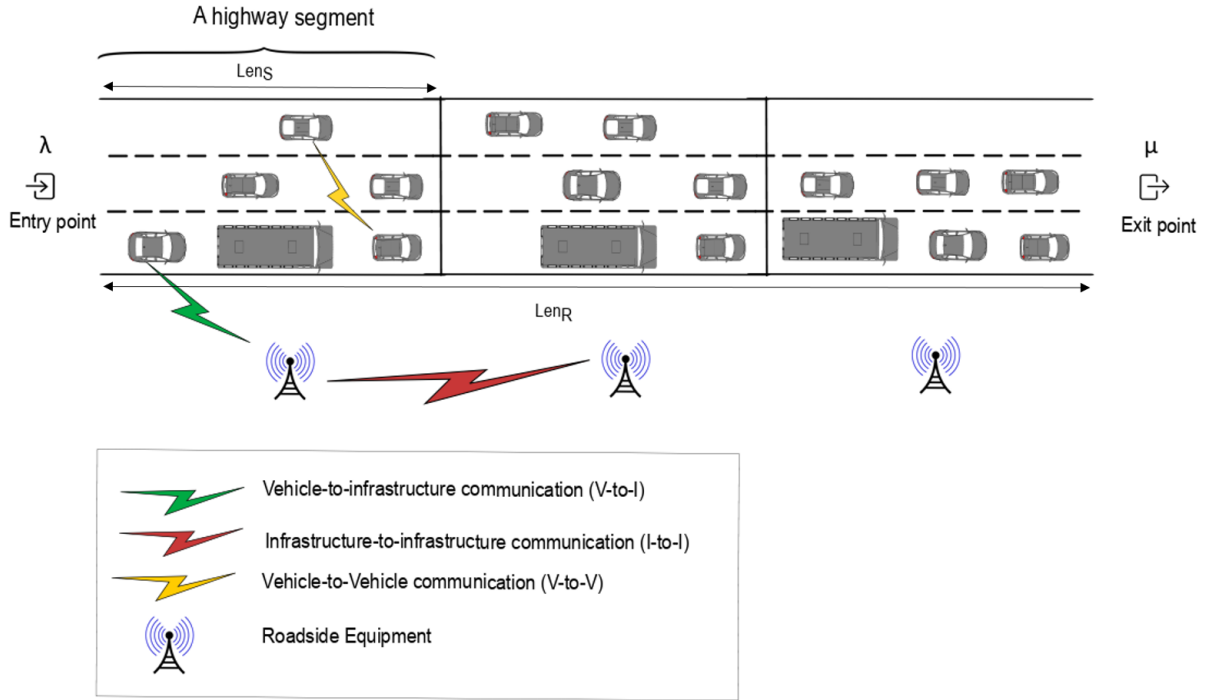

Figure 4.1: An example of a highway road

Let M be the number of lanes and S the number of segments. We assume that all lanes are of equal capacity C_{lane} and that segments are of length $Len_S = \frac{Len_R}{S}$, where Len_R is the length of the highway road. The set of lanes will be denoted \mathcal{M} and the set of segments \mathcal{S} . Each lane m is assigned a weight α_m relative to its density, such as $\sum_{m \in \mathcal{M}} \alpha_m = 1$. The weight of a lane m is computed based on recorded data and is defined by the following formula:

$$\alpha_m = \frac{\text{Number of vehicles on lane } m}{\text{Total number of vehicles}} \quad (4.1)$$

The number of occurrences of arrival and service processes occur independently and randomly at a given time interval. Thus, similarly to works in [141, 142, 143],

vehicles arrivals can be modelled following a Poisson process with rate λ and service following an exponential distribution of rate $\mu = \frac{Sp}{Len_R}$, where Sp is the average travel speed. The ratio of arrival-to-service completion is denoted $\rho = \frac{\lambda}{\mu}$. To ensure the stability of the system, ρ is assumed to satisfy the following constraint: $\rho < 1$. It needs to be emphasized that this condition must be satisfied by the lanes too. Hence, we consider scenarios where :

$$\lambda_m < \mu_m, \forall m \in \mathcal{M} \quad (4.2)$$

Arrival rates at each lane are defined by their position on the road, such that the right lane has a higher arrival rate than the left lane. This could be expressed as the following formula:

$$\lambda_m = \lambda \times \alpha_m \quad (4.3)$$

Similarly to the arrival rates, the service rates are defined in a way that the right lane has a lower service rate than the one on the left of the road. This condition can be expressed as:

$$\mu_m = \mu \times \frac{1}{\alpha_m} \quad (4.4)$$

Let $\{X(t), t \geq 0\}$ be a CTMC with a finite set of states Ω and transition matrix P . A state $X(t)$ is a vector of multiple random variables corresponding to the number of vehicles on each lane as below:

$$X(t) = \{X_1(t), X_2(t), \dots, X_M(t)\} \quad (4.5)$$

A random variable $X_m(t)$ corresponding to lane m must satisfy the following constraint:

$$\forall m \in \mathcal{M}, 0 \leq X_m(t) \leq C_{lane} \quad (4.6)$$

In order to express transition between states, we first define three types of possible events happening in the system:

- A vehicle arriving to the highway segment ;
- A vehicle completing service;
- A lane change occurrence.

Given D_m the actual traffic volume at lane m , which represents the total number of vehicles simultaneously travelling on lane m , the lane change probability from lane m to a lane n is defined as follow:

$$LC_{mn} = \begin{cases} 1 - \frac{D_n}{\sum_{k \in \mathcal{M}} D_k \cdot 1_{(|m-k|=1)}} & \text{if } m \text{ and } n \text{ are adjacent lanes} \\ 0 & \text{otherwise} \end{cases} \quad (4.7)$$

Thus, the probability of moving from state x to state y , $(x, y) \in \Omega^2$ and $x \neq y$, is given by:

$$p_{xy} = \begin{cases} \lambda_m & \text{if a vehicle arrives at lane } m \\ \mu_m & \text{if a vehicle departs from lane } m \\ LC_{mn} & \text{if a vehicle changes from lane } m \text{ to lane } n \\ - \sum_{z \in \Omega \setminus \{x\}} p_{xz} & \text{if } x = y \\ 0 & \text{otherwise} \end{cases} \quad (4.8)$$

Figure 4.2 represents the transition graph of the Markov chain corresponding to a highway section composed of three lanes.

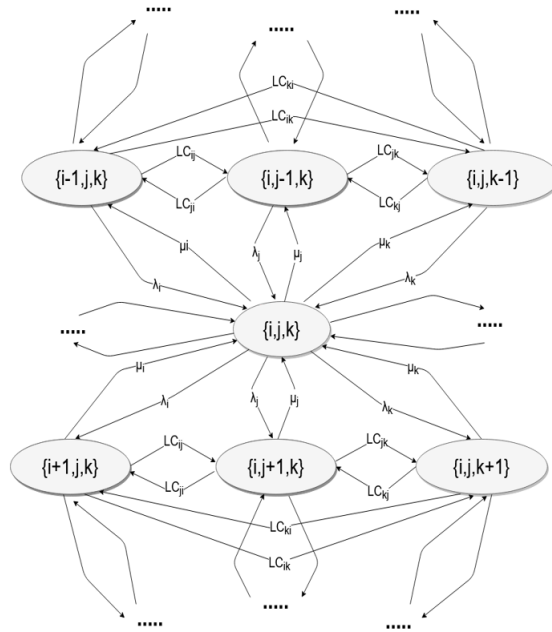

Figure 4.2: Transition graph of the Markov chain describing traffic over a three-lane highway.

The steady-state probabilities π can be obtained by solving the linear system defined by the following balance equation for each $x \in \Omega$:

$$\begin{aligned} & \pi_x \cdot \sum_{y \in \Omega \setminus \{x\}} \left(\sum_{m \in \mathcal{M}} \lambda_m \cdot 1_{(p_{xy}=\lambda_m)} + \sum_{m \in \mathcal{M}} \mu_m \cdot 1_{(p_{xy}=\mu_m)} + \sum_{m \in \mathcal{M}} \sum_{n \in \mathcal{M} \setminus \{m\}} LC_{mn} \cdot 1_{(p_{xy}=LC_{mn})} \right) = \\ & \sum_{y \in \Omega \setminus \{x\}} \pi_y \left(\sum_{m \in \mathcal{M}} \lambda_m \cdot 1_{(p_{yx}=\lambda_m)} + \sum_{m \in \mathcal{M}} \mu_m \cdot 1_{(p_{yx}=\mu_m)} + \sum_{m \in \mathcal{M}} \sum_{n \in \mathcal{M} \setminus \{m\}} LC_{mn} \cdot 1_{(p_{yx}=LC_{mn})} \right) \end{aligned}$$

A numerical method based on the Grassmann-Taksar-Heyman (GTH) algorithm [144] is applied to compute the stationary vector of the transition rate matrix P .

4.3 . Numerical results

This section summarizes and discusses the main findings of this study. In subsection 4.3.1, the key indicators that measure the performance of highway roads are expressed. Subsection 4.3.2 outlines the numerical results calculated for different test samples and scenarios.

4.3.1 . Performance indicators

From the obtained vector π , L_m the long-run average number of vehicles on lane m is first computed using the following formula:

$$L_m = \sum_{x \in \Omega} \pi_x \cdot x_m \quad (4.9)$$

The average volume-to-capacity ratio VC_m of lane m can be inferred from L_m as below:

$$VC_m = L_m / C \quad (4.10)$$

Based on Little's law formula [145, 146], S_m which denotes the average travel time on lane m is calculated as follow:

$$S_m = \frac{1}{\lambda_m} \cdot \sum_{x \in \Omega} \pi_x \cdot x_m \quad (4.11)$$

4.3.2 . Numerical results

For test scenarios, traffic data from German highways provided by highD dataset [147] is integrated. The obtained estimates are analyzed and compared with realistic traces for accurate validation. Table 4.1 summarizes the different tests carried out.

In the first set-up, a three-lane highway road of 400 meters long is considered. The road can handle up to 30 vehicles with the distance headway being taken into account. The average travel speed measured is 100 km/h. We study the performance of the road for different traffic patterns i.e. low density, average density and high density by varying the value of arrival rate.

Table 4.1: Values used for numerical resolution

Parameter	Scenario 1	Scenario 2
Highway section length	400 m	400 m
Number of lanes	3	2 - 3
Per-lane capacity	10	10
Average speed	100 km/h	40-120 km/h
Time unit	1 minute	1 minute
Arrival rate	varies from 0 to 10	10 vehicles/minute

In figure 4.3, the average number of vehicles travelling on each lane is illustrated. By analyzing the curves, we find that traffic density decreases from the right lane to the left lane. In real traffic conditions, fast lanes are generally used to overtake slow preceding cars or when the right lanes get saturated. The model can properly reflect this behavior.

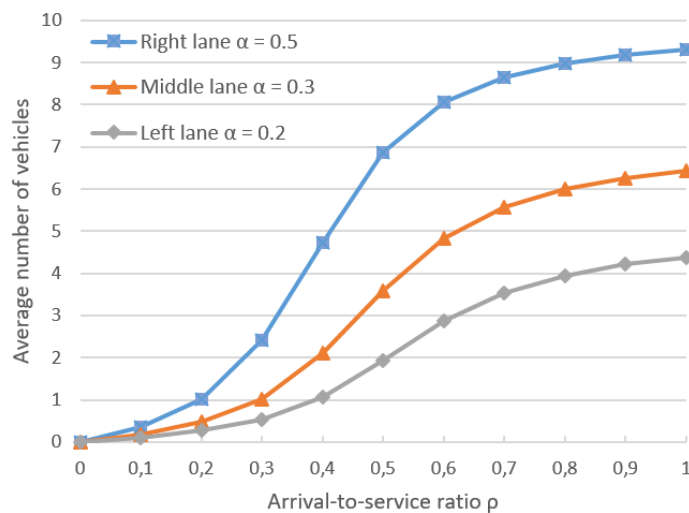

Figure 4.3: Average number of vehicles vs. Arrival rate

Figure 4.4 shows results for the congestion rate corresponding to each lane. The curves demonstrate similar behaviour as the previous chart. It can be seen that the congestion rate of the right most lane is higher compared to the middle and left one. The average travel time is represented in figure 4.5. It can be observed that the average driven time increases rashly as more vehicles arrive on the road. Moreover, the travel speed is much more slower on the right lane due to its higher

congestion rate.

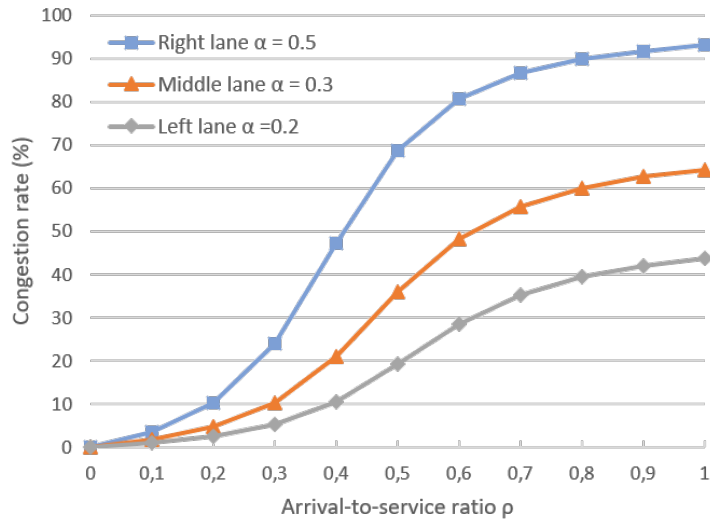

Figure 4.4: Congestion rate vs. Arrival rate

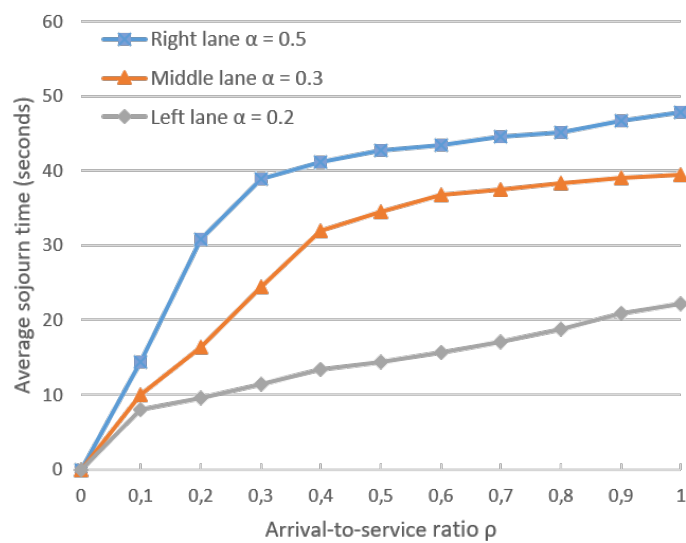

Figure 4.5: Average travel time vs. Arrival rate

For the second case study, the performance of a double-lane road and a three-lane road is compared with respect to the average velocity. It is assumed that 10 vehicles arrive to each road per unit of time. The estimated average number of vehicles as a function of average speed is presented in figure 4.6. It can be noticed that the total number of vehicles is greater on the three-lane road as it can

handle approximately 30% more traffic than the double-lane road. Furthermore, the plots show a significant drop in traffic density when the average velocity of vehicles increases.

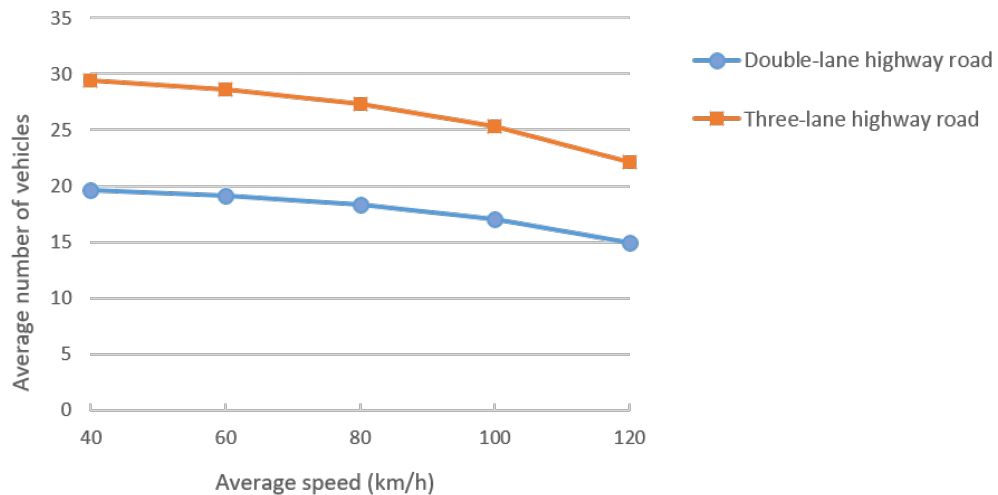

Figure 4.6: Average number of vehicles vs. Average speed

The curves in figure 4.7 show the congestion rate of both freeways. Despite that the three-lane road has a higher density, it can be observed that its congestion rate is lower than the two-lane road. Adding more lanes allows to handle more traffic but helps decrease traffic congestion. In addition, it can be observed that higher speeds contribute in alleviating congestion. Up to 11% of congestion can be dropped by slightly increasing the traffic speed for both highways. In figure 4.8, the average trip time versus average speed is depicted. Numerical results demonstrate that having additional lanes on the road can drastically reduce the average trip duration on the road. It can also be noted that the model is able to reflect the large time delays resulting from slow vehicles travelling on the highway.

The numerical results presented above demonstrate that the model proposed can realistically reproduce the traffic behaviour in a highway environment. In order to validate the accuracy of the forecasting model, a comparison is carried out between the estimates of the average number of vehicles and trip duration and the realistic traces recorded on a double-lane road with a frame rate equal to 25Hz. The estimates are calculated every 100 frames for a duration of one minute.

In figure 4.9, the realistic values of the average number of vehicles are compared with the estimated values. While in figure 4.10, a comparison of the actual value and the estimated value of the average trip time is represented. The two curves appear closely identical in both charts. To evaluate the forecasting results for precision, the percent accuracy is expressed as follow:

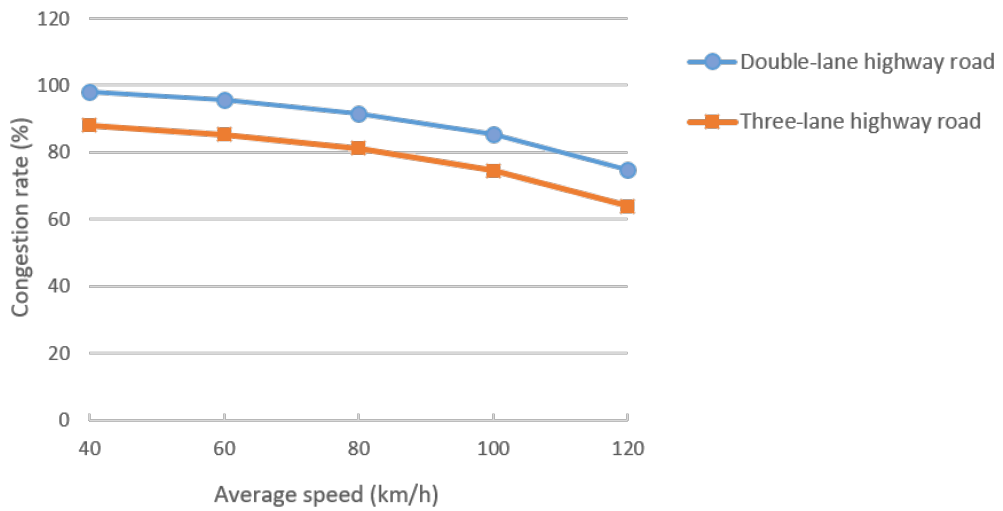

Figure 4.7: Congestion rate vs. Average speed

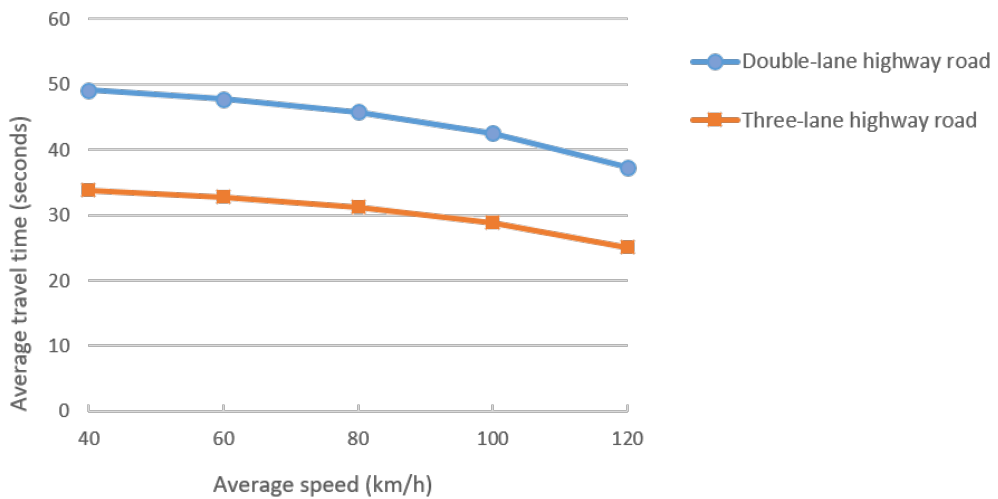

Figure 4.8: Average travel time vs. Average speed

$$Accuracy = \left(1 - \frac{|Actual\ value - Estimated\ value|}{Actual\ value}\right) \times 100$$

Figure 4.11 shows the accuracy of both the estimated traffic volume and the estimated travel time. The curves determine how close the estimation is to the realistic value. For this case study, the average accuracy is close to 92% for the number of vehicles and close to 90% for the travel time.

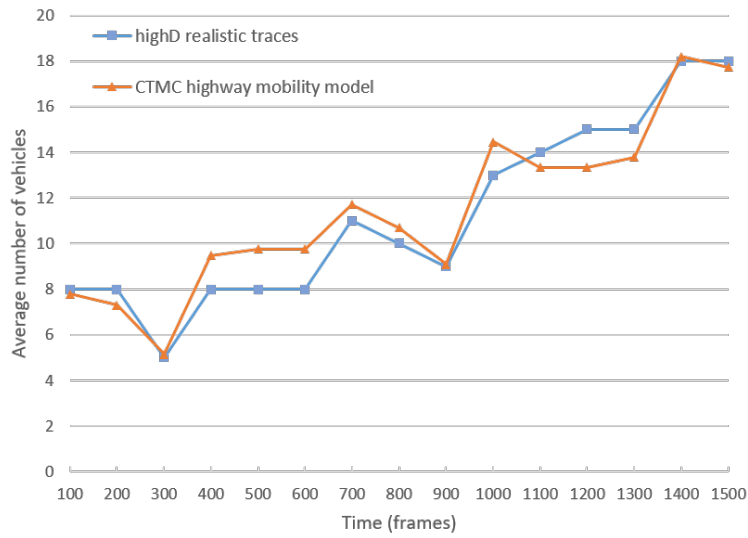

Figure 4.9: Average number of vehicles generated by the Markov model vs Realistic traces

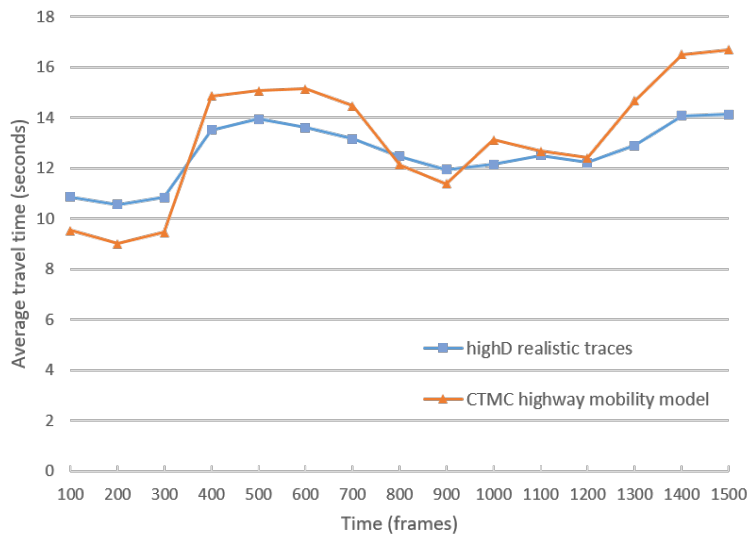

Figure 4.10: Average travel time generated by the Markov model vs Realistic traces

4.4 . Conclusion

Despite the large attention given to mobility prediction in vehicular networks, much less attention has been directed to highway traffic prediction. Most mod-

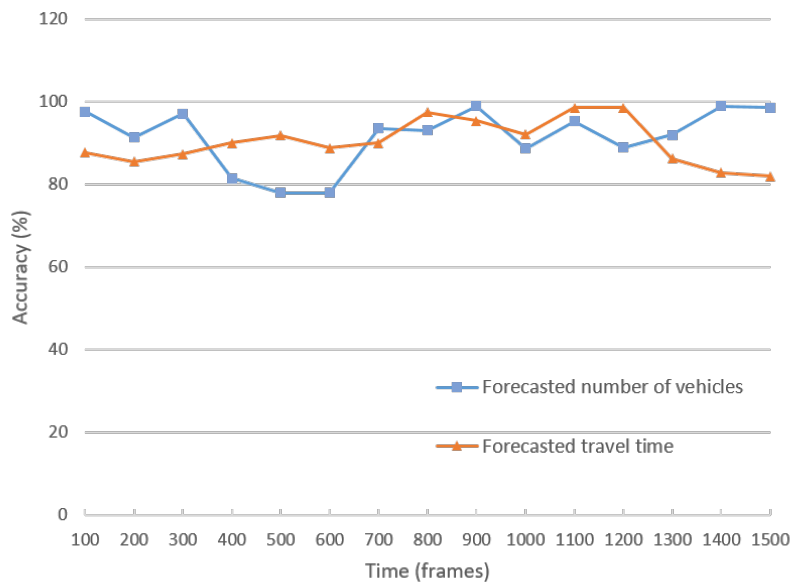

Figure 4.11: Accuracy plotted for the estimated number of vehicles and travel time

els introduced in the literature fail to reflect the most crucial aspect of highway traffic which is the lane changing behavior in multi-lane roads. Moreover, they are either based on very simplistic approaches at the cost of less accuracy, or based on complex machine learning models that are judged inefficient when a large enough training dataset is not available. This study focuses on exploiting V2X technology to predict highway traffic in the purpose of improving resource allocation management in vehicular networks. But generally, mobility models can be used to design any approach where a knowledge of traffic is vital. The approach proposed extrapolate arrival and service distribution from timely collected traffic data. Then, a Markov chain method is applied to describe vehicular dynamics in a highway environment and to predict future traffic state. The model was tested for different scenarios generated from realistic historical traces. The numerical results were compared with real traces to validate the accuracy of the prediction model. The results have shown the ability of the CTMC to describe with high accuracy traffic behavior in a highway environment. The model can therefore be exploited by connected vehicles for a more effective autonomous traffic control or network design. The applicability of this model in urban environment will not be adequate as both environments have different mobility aspects. The work presented in the next chapter aims to extend the CTMC model to study and predict mobility in urban environments.

5 - A Stochastic Mobility Model for Urban Environments

5.1 . Introduction

In the previous chapter, a stochastic mobility model was designed to emulate traffic in a highway environment. The proposed model shows great potential to predict traffic along multi-lane highway roads without any loss of precision. However, this model can not successfully mimic traffic in an urban environment due to its particular characteristics. Highway and urban roads not only differ with regard to their roadway geometry, but major differences in mobility characteristics could be observed.

First, highways are main public roads connecting major population centers, while urban roads are located within the boundaries of a built-up area. Hence, a highway road network is usually modelled as a bidirectional link, while an urban road network is modelled as a graph with frequent exit/entry points. Moreover, traffic patterns in each vehicular environment have distinct features. Urban roads have a higher traffic demand compared to highway roads. This discrepancy is caused by the fact that urban networks are used for daily mobility needs while highways are used for long commutes. It is reported in [148] that urban mobility accounts for 64% of overall mobility and is expected to triple by 2050. This increase is driven by the continuous growth in the number of city residents and workers. Consequently, the urban mobility system is facing breakdown as congestion is increasing and travel speeds declining. Another contributor to the slow urban roadway traffic is the presence of traffic control signals at intersections which can cause intermittent disruption of traffic flow and abrupt speed changes. Highway roads are not signal-controlled, which improves the flow and prevents long-standing traffic at intersections. Heavy pedestrian traffic is also a factor that slows down traffic flow in urban areas. All these differences call for an extension of the mobility model proposed in the previous chapter in order to include the factors that influence mobility in urban areas.

There exist several mobility models designed to model urban traffic. City section [83] and Manhattan [84] are mobility models that are highly used in research to model urban traffic. These models simplistically model road maps and vehicles' behavior which is their greatest drawback. The configurations used are incomplete and based on unrealistic assumptions that would lead to inaccurate results. Lane change and intersection policies are two crucial features that need to be taken into consideration while modelling urban mobility, however, the aforementioned models don't describe them. The models proposed in [99] and [100] study the behavior of queues at signalized intersections using queuing theory, but these models are

not comprehensive as the impact of queuing on the overall behavior of the studied section is not captured. The goal of the work proposed in this chapter is to present a stochastic mobility model suitable for urban environments. The traffic behavior in multi-lane roads and near intersections is modelled using queuing theory features, then a Markov chains in continuous time is constructed to study the evolution of queues. This approach allows to get long-term estimates of traffic distribution using a numerical method for solving the stationary distribution. The work can be broadly separated into two parts. The first part was focused on describing traffic flow along multi-lane roads while taking into consideration lane change operations. The second part involved modeling the queuing behavior of vehicles at intersections.

The resulting model is expressed as a state transition matrix that concisely summarizes traffic dynamics over different time steps. This approach differs from the work introduced in chapter 4 as we were keen on integrating crucial behaviors related to urban traffic such as vehicles behaviour at intersections, queuing and the coordination between vehicles crossing an intersection at the same time. The updated traffic information exchanged in real time between vehicles and RSUs such as the current traffic condition, travel speeds, itineraries etc, is used to predict the future condition of traffic and manage traffic in a distributed manner. This can help to detect possible congestion areas and influence traffic flows onto less congested roads, synchronize traffic lights and other road signals to deal with future traffic demands, and adjust driving velocity to ensure vehicles arriving to the stop bar when the traffic light is green which helps in reducing vehicular queuing. A comparison of the proposed model with Gawron's queue-based model [98] and realistic traces is conducted to investigate the accuracy of our model. Results indicate that the CTMC model is able to realistically mimic urban mobility aspects. These findings are valid for both low and high traffic densities. Dynamic traffic light and speed control policies were designed using traffic estimates obtained with the proposed model. Matlab SimEvent framework proposed in chapter 3 was used to test and compare the performance of the proposed approach with a conventional road system. The simulation results show that using a traffic model to forecast future traffic states can help reduce the average waiting time at intersections and travel delays while guaranteeing better road infrastructure utilization.

5.2 . Proposed Model

The main goal of the proposed mobility model is to describe traffic dynamics in an urban environment and predict the future traffic condition along arterial roads and at controlled and uncontrolled intersections. The proposed approach can be seen as a two-stage process. First, a queue system is built to describe the traffic dynamics in an urban area. Therein after, Markov chains in continuous time are built to study the evolution of the queues. In addition to notations summarized in table A.1, notations in table C.1 are used herein after.

To model urban traffic, a city section that contains a set \mathcal{N} of N road intersections linked by double-way and multi-lane roads is considered. \mathcal{R} denotes the set of single-way roads composing the network. Three types of intersections are modelled: roundabouts, stop-and-go and signal-controlled intersections. It is supposed that vehicles arrive to an intersection from roads outside the network or from adjacent intersections within the studied area. Vehicles arriving to the intersection are either served immediately or queued until the intersection is available. Once a vehicle is served, it is then routed to its next intersection, or leaves the network. In this model, it is assumed that each vehicle is equipped with a communication unit, and exchanges traffic information with roadside units deployed along the road and at each intersection. The RSUs are able to collect information about arrival and departure times, travel speeds and next destination intersection. Then, the RSU periodically computes average quantities such as arrival rates, average speeds and density and then broadcast the information to vehicles. These information are used by vehicles to forecast future traffic states using the approach presented here. Figure 5.1 depicts an example of the street layout considered in this study. The road network can be thereby modelled using queuing theory principles as depicted in figure 5.2.

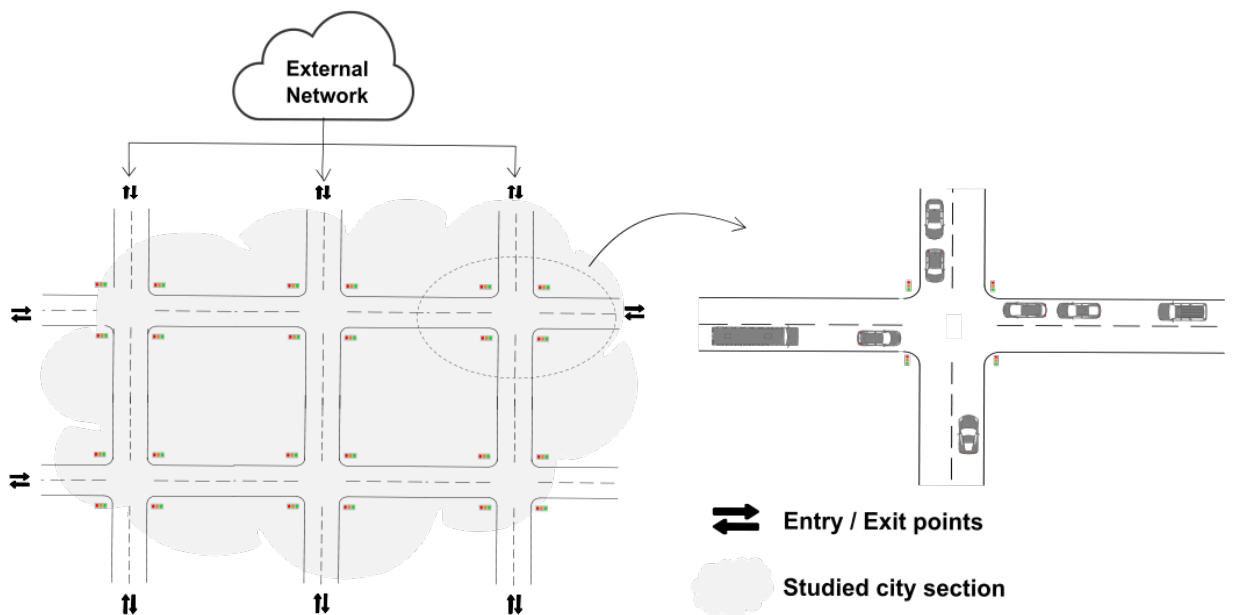

Figure 5.1: A diagram of a road layout in an urban area

Each lane of a road is modelled as a fixed-capacity queue and multiple servers each holding a vehicle for a specific service time representing the time needed to travel from the start intersection to the end intersection. The probability distribution used to model the arrival and departure of vehicles is similar to work in chapter 4. The vehicles arrive from the outside network to an intersection within

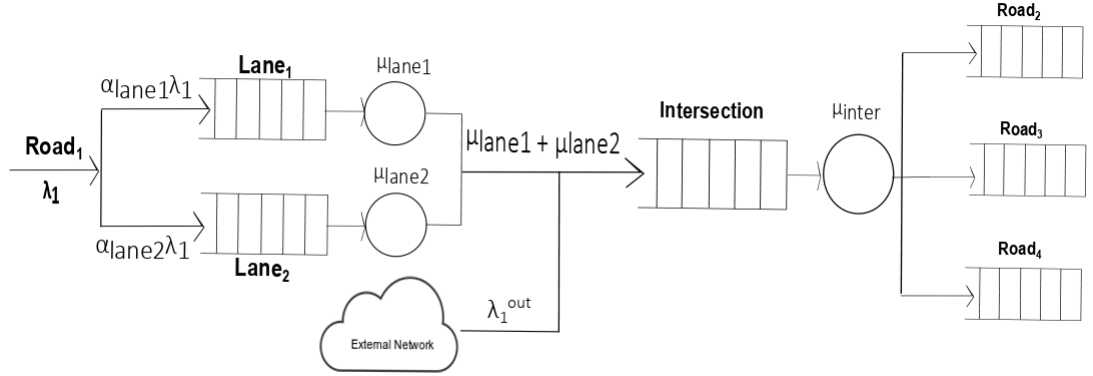

Figure 5.2: Traffic scenario represented as a queue system

the studied city section following a Poisson process. The Poisson distribution is most suitable as vehicles arrive independently and in a random manner within a given time interval. Vehicles originating from adjacent intersections arrive to the intersection with a rate calculated as a function of the average service time of all roads meeting at the considered intersection. The vehicles are stored in the queue and released following a FIFO service discipline. Vehicles can undergo the service process simultaneously as vehicles can travel along a road section at the same time. We also assume the amount of time between two successive service completions is random and independent from one another. Hence, the service time is modelled following an exponential distribution.

As in the case of roads and lanes, it is assumed that the arrival and service rates of intersections satisfy the stability constraint:

$$\lambda_i < \mu_i, \forall i \in \mathcal{N} \quad (5.1)$$

When vehicles arrive at the stop bar of a road, they are queued up and released following FIFO policy. They are then held by a single server for a certain time and then released. The vehicle can then travel to its next destination or leave the network.

5.2.1 . Markov chain for road traffic

In order to build our model, we construct as a first step a Markov Chain in continuous time to model the behavior of queues representing a multi-lane road. We consider an urban road of M lanes and let C_{lane} be its capacity, which represents the number of vehicles that can be handled by a single lane. The arrival rate and service rate of a road are denoted λ_r and μ_r respectively. The arrival rate λ_r of a road r linking intersection i to intersection j is defined as follows:

$$\lambda_r = \mu_i \cdot p_{ij}, \forall r \in \mathcal{R} \quad (5.2)$$

μ_i is the service rate of the start intersection i that is extracted from historical traces collected by RSUs and p_{ij} the probability that a vehicle travels from intersection i to intersection j .

We denote by α_m the probability that a vehicle chooses to travel on lane m , with $\sum_{m \in \mathcal{M}} \alpha_m = 1$. The arrival rate of a lane m can therefore be calculated as follows:

$$\lambda_m = \alpha_m \cdot \lambda_r \quad (5.3)$$

The service rate of a lane is calculated as a function of the lane length Len_R and the average speed V_m^{avg} :

$$\mu_m = \frac{V_m^{avg}}{Len_R} \quad (5.4)$$

The service rate of the road is defined as the sum of service rates of its lanes as follows:

$$\mu_r = \sum_{m \in \mathcal{M}} \mu_m \quad (5.5)$$

Let $X(t) = (X_1(t), \dots, X_M(t))$ be a vector of random variables representing the traffic state of a road, where each element $X_m(t)$ represents the number of vehicles travelling on lane m , such as, for each $m \in \mathcal{M}$ and $t \in [0, +\infty)$, $0 \leq X_m(t) \leq C_s$. Therefore, the open network allows to study a population set \mathcal{Q} of size $0 \leq |\mathcal{Q}| \leq M \times C_{lane}$. The collection of possible values of $X(t)$ is called a state space. Let Ω be the state space of the random variable $X(t)$. Given a state $x \in \Omega$, the value of each element $X_m(t)$ of the random vector is denoted x_m .

The Markov chain modeling a road section is defined as the random process $\{X(t), t \geq 0\}$, defined by a finite state space Ω , and a state transition matrix P , where its element p_{xy} reflects the likelihood of the system transitioning from state x to state y . Given P the transition rate matrix and π the equilibrium distribution, the balance equations can be expressed mathematically as:

$$\pi_x \cdot P_{xy} = \pi_y \cdot P_{yx} \quad (5.6)$$

Then the global balance equations are obtained by summing over y :

$$\pi_x \cdot \sum_{y \in \Omega \setminus \{x\}} P_{xy} = \sum_{y \in \Omega \setminus \{x\}} \pi_y \cdot P_{yx} \quad (5.7)$$

Thus, to establish the transition probability matrix P , we first denote the lane change probability from lane n to lane m by LC_{nm} . If a vehicle is traveling on a lane n , the probability it changes to an adjacent lane m is defined as a function of density. If m is more congested, there is a low probability the vehicle will change to lane m . However, if the current lane n is more dense than the destination lane m , the lane change probability is increased. Given D_n and D_m the density of lane n and lane m respectively, the lane change probability can be expressed by the following:

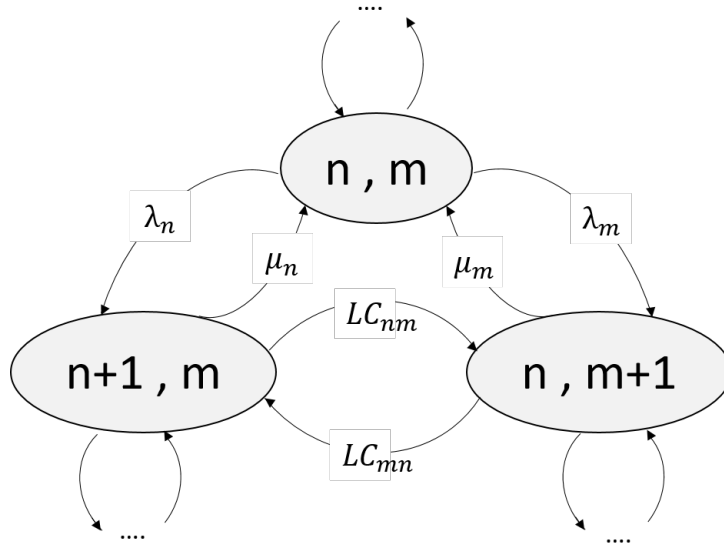

Figure 5.3: Transition graph of the Markov chain describing traffic in a double-lane road.

$$LC_{nm} = \begin{cases} 1 - \frac{D_m}{D_n + D_m} & \text{if } n \text{ and } m \\ & \text{are adjacent lanes;} \\ 0 & \text{otherwise.} \end{cases} \quad (5.8)$$

Another characteristic of matrix P is that the row sum is 0, such as for each $(x, y) \in \Omega^2$:

$$p_{xy} = \begin{cases} Pr\{X(t+1) = y | X(t) = x\} \geq 0, & \text{if } x \neq y; \\ - \sum_{z \in \Omega \setminus \{x\}} p_{xz} & \text{if } x = y. \end{cases} \quad (5.9)$$

The transition matrix P is formed by the collection of transition probabilities p_{xy} that describes the probability a system will evolve from state x to state y . Figure 5.3 represents the corresponding Markov graph.

$$p_{xy} = \begin{cases} \lambda_m, & \text{if a vehicle arrives at lane } m; \\ \mu_m, & \text{if a vehicle leaves lane } m; \\ LC_{nm}, & \text{if a vehicle changes from lane } n \text{ to lane } m; \\ - \sum_{z \in \Omega \setminus \{x\}} p_{xz} & \text{if } x = y; \\ 0 & \text{otherwise.} \end{cases} \quad (5.10)$$

Given the transition probability matrix P defined previously and the equilibrium vector π , the balance equation is expressed as follows:

$$\begin{aligned} \pi_x \cdot \sum_{y \in \Omega \setminus \{x\}} \left(\sum_{m \in \mathcal{M}} \lambda_m \cdot 1_{(p_{xy}=\lambda_m)} + \sum_{m \in \mathcal{M}} \mu_m \cdot 1_{(p_{xy}=\mu_m)} + \sum_{n \in \mathcal{M}} \sum_{m \in \mathcal{M} \setminus \{n\}} LC_{nm} \cdot 1_{(p_{xy}=LC_{nm})} \right) = \\ \sum_{y \in \Omega \setminus \{x\}} \pi_y \left(\sum_{l \in \mathcal{M}} \lambda_l \cdot 1_{(p_{yx}=\lambda_l)} + \sum_{m \in \mathcal{M}} \mu_m \cdot 1_{(p_{yx}=\mu_m)} + \sum_{n \in \mathcal{M}} \sum_{m \in \mathcal{M} \setminus \{n\}} LC_{nm} \cdot 1_{(p_{yx}=LC_{nm})} \right) \end{aligned}$$

5.2.2 . Markov chain for intersection traffic

The next step is to construct a CTMC to model traffic at intersections. We consider that the road network contains a set \mathcal{N} of road intersection. It is assumed that \mathcal{N} is composed of N intersections ($\mathcal{N} = \{1..N\}$). Each intersection $i \in \mathcal{N}$ is assigned a corresponding value C_i in $\mathcal{C} = \{C_1, C_2, \dots, C_N\}$ which represents the sum of capacities of roads that meet at the intersection.

As stated before, the arrivals from the outside network to one of the studied intersection are random and independent and can therefore be modelled using a Poisson distribution of rate λ_i^{out} . The arrivals from neighboring intersection depends on the service rate of roads leading to the intersection. Let i be the set of incident roads to an intersection. The arrival rate of an intersection i is then calculated by the following formula:

$$\lambda_i = \lambda_i^{out} + \sum_{r \in i} \mu_r, \forall i \in \mathcal{N} \quad (5.11)$$

For simplicity, the service time is modelled using an exponential distribution with μ_i . The service rate can be extracted from traces collected by vehicles and it represents the number of vehicles crossing the intersection in a period of time. For signal-controlled intersections, the service rate can represent the average number of vehicles crossing the intersection during a traffic signal cycle.

The Markov chain is defined as the random process $\{Y(t), t \geq 0\}$ where $Y(t) = (Y_1(t), \dots, Y_N(t))$ is a vector of multiple random variables. Each element $Y_i(t)$ represents the number of vehicles queuing or crossing an intersection i . As waiting lines at intersection are of a limited capacity that is relative to the lengths of roads leading to the intersection, we assume that the random variable verify the following constraint: $\forall i \in \mathcal{N}$ and $\forall t \in [0, +\infty[$, $0 \leq Y_i(t) \leq C_i$. A population set \mathcal{A} of size $0 < |\mathcal{A}| < \sum_{i \in \mathcal{N}} C_i$ can be studied by the Markov chain.

The state space Θ is defined as the collection of possible values of $Y_i(t)$, and T the transition matrix such as, given $(u, v) \in \Theta^2$, T_{uv} is the transition probability from state u to state v . We first define the routing matrix $R = (r_{i,j})_{1 \leq i \leq N, 1 \leq j \leq N}$ where each element $r_{ij}, \forall (i, j) \in \mathcal{N}^2$ is the probability that a vehicle travels from intersection i to intersection j . The diagonal elements $r_{ii}, \forall i \in \mathcal{N}$ is the probability that a vehicle leaves the network from intersection i . The routing probability matrix is supposed to be computed periodically by RSU using collected data.

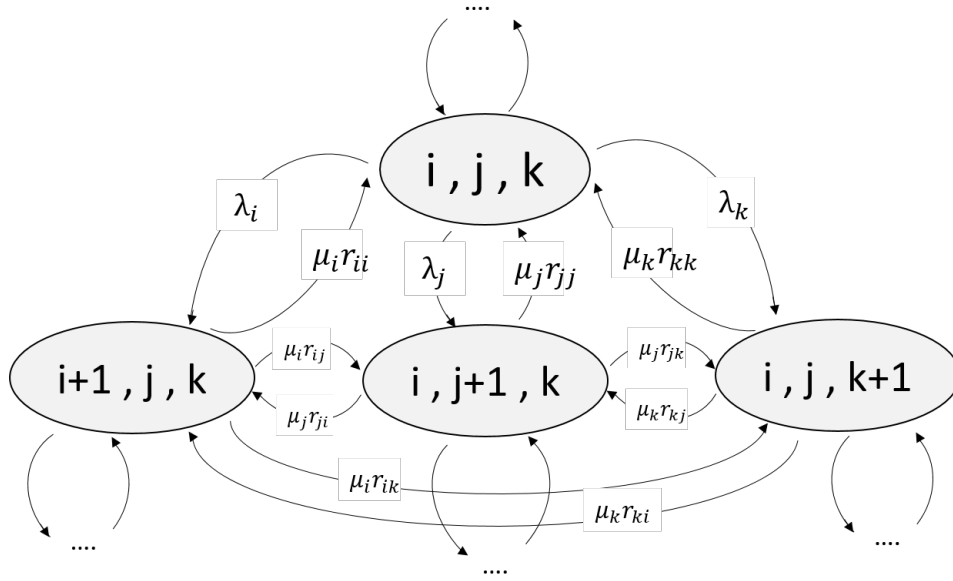

Figure 5.4: Transition graph of the Markov chain describing traffic in three intersections

The transition matrix T can then be established as follows:

$$T_{uv} = \begin{cases} \lambda_i, & \text{if a vehicle joins the network from intersection } i; \\ \mu_i \cdot r_{ii}, & \text{if a vehicle leaves the network from intersection } i; \\ \mu_i \cdot r_{ij}, & \text{if a vehicle travels from intersection } i \text{ to intersection } j; \\ -\sum_{w \in \Theta \setminus \{u\}} T_{uw} & \text{if } u = v; \\ 0 & \text{otherwise.} \end{cases} \quad (5.12)$$

The transition diagram of the proposed Markov chain is depicted in figure 5.4.

The stationary distribution Ψ of the Markov Chain $T(t)$, is expressed by:

$$\begin{aligned} \Psi_u \cdot \sum_{v \in \Theta \setminus \{u\}} \left(\sum_{i \in \mathcal{N}} \lambda_i \cdot 1_{(T_{uv}=\lambda_i)} + \sum_{i \in \mathcal{N}} \mu_i \cdot r_{ii} \cdot 1_{(T_{uv}=\mu_i \cdot r_{ii})} + \sum_{i \in \mathcal{N}} \sum_{j \in \mathcal{N} \setminus \{i\}} \mu_i \cdot r_{ij} \cdot 1_{(T_{uv}=\mu_i \cdot r_{ij})} \right) = \\ \sum_{v \in \Theta \setminus \{u\}} \Psi_v \left(\sum_{i \in \mathcal{N}} \lambda_i \cdot 1_{(T_{vu}=\lambda_i)} + \sum_{i \in \mathcal{N}} \mu_i \cdot r_{ii} \cdot 1_{(T_{vu}=\mu_i \cdot r_{ii})} + \sum_{i \in \mathcal{N}} \sum_{j \in \mathcal{N} \setminus \{i\}} \mu_i \cdot r_{ij} \cdot 1_{(T_{vu}=\mu_i \cdot r_{ij})} \right) \end{aligned}$$

5.2.3 . Numerical resolution and performance measures

The numerical resolution and performance measurement used in this chapter follow the same method introduced in [144]. First, three different metrics are derived to study the performance of roads which are the average number of vehicles,

the congestion rate and the average travel time. Then, intersection performance measures are computed.

Let L_m denote the average number of vehicles traveling on lane m :

$$L_m = \sum_{x \in \Omega} \pi_x \cdot x_m, \forall m \in \mathcal{M} \quad (5.13)$$

The estimated volume-to-capacity ratio VC which represents the congestion rate is deduced:

$$VC_m = L_m / C_{lane}, \forall m \in \mathcal{M} \quad (5.14)$$

By applying Little law formula, the average sojourn time S_m of lane m can be expressed:

$$S_m = \frac{1}{\lambda_m} \cdot \sum_{x \in \Omega} \pi_x \cdot x_m, \forall m \in \mathcal{M} \quad (5.15)$$

For intersections, the average queue lengths and average waiting time are used as performance metrics to evaluate the system. The average waiting time of an intersection i is denoted W_i and defines the average time a vehicle spends queuing at the intersection. W_i is calculated as the difference between the sojourn time S_i and the service time $\frac{1}{\mu_i}$:

$$W_i = S_i - \frac{1}{\mu_i}, \forall i \in \mathcal{N} \quad (5.16)$$

The average sojourn time of an intersection S_i can be calculated using Little's law as below:

$$S_i = \frac{1}{\lambda_i} \cdot \sum_{u \in \Theta} \Psi_u \cdot u_i, \forall i \in \mathcal{N} \quad (5.17)$$

From equations 5.16 and 5.17, W_i can be deduced:

$$W_i = \frac{1}{\lambda_i} \cdot \sum_{u \in \Theta} \Psi_u \cdot u_i - \frac{1}{\mu_i}, \forall i \in \mathcal{N} \quad (5.18)$$

And finally, the average length of a queue Q_i at an intersection i can be computed as below:

$$Q_i = \lambda_i \cdot W_i, \forall i \in \mathcal{N} \quad (5.19)$$

By replacing W_i by its value, we obtain the following formula:

$$Q_i = \sum_{u \in \Theta} \Psi_u \cdot u_i - \frac{\lambda_i}{\mu_i} \quad (5.20)$$

Table 5.1: Road configuration

	Road configuration			
Road id	Road length	Start intersection	End intersection	Number of lanes
Road 1	300 m	1	2	2
Road 2	300 m	2	1	2
Road 3	500 m	1	3	3
Road 4	500 m	3	1	3
Road 5	300 m	2	3	2
Road 6	300 m	3	2	2

5.3 . Numerical results and Simulation

This section reports the results of the analysis that have been computed. The numerical results of the different performance measures are first presented. Then, we compared the proposed model with realistic traces and Gawron’s queue model [98]. Finally, the estimates obtained are used in two different smart mobility applications and a comparison between the performance of a conventional and intelligent road systems is conducted on the SimEvents model proposed in chapter 3.

To study the performance of the proposed model, a realistic road map is considered. A city section composed of three intersections of different policies are linked by bidirectional multi-lane roads. In tables 5.1 and 5.2, the spatial configuration of the city section is given. Parameters used in this study are extracted from inD [148] and roundD [149] datasets [148, 149] that offer naturalistic vehicle trajectories recorded at German intersections and multi-lane roads using a drone with a frame rate equal to 25Hz.

In a first set up, we study the performance of the city section under different density scenarios to investigate to which extent our model is able to reflect the impact of density on the performance of the road system. Values of the intersection service rate, lane average speed, and lane arrival probability α are extracted from traces recorded over 15 minutes. Table 5.3 summarizes the values of the parameters considered in this set-up.

First, we evaluate and compare results of the average number of vehicles and average travel time for the different roads.

Figure 5.5 refers to the average number of vehicles traveling on the different roads as a function of density. The curves show clearly that as arrivals increase, all roads show an increase in traffic volume. It’s also worth noting that higher traffic is noticed on longer roads with more lanes as they are able to handle more vehicles.

Table 5.2: Intersection configuration

Intersection configuration		
Intersection id	Policy	Queue capacity
Intersection 1	Traffic light	30
Intersection 2	Stop-and-go	45
Intersection 3	Roundabout	30
Routing matrix	$\begin{pmatrix} 0.3 & 0.2 & 0.5 \\ 0.2 & 0.2 & 0.6 \\ 0.4 & 0.3 & 0.3 \end{pmatrix}$	

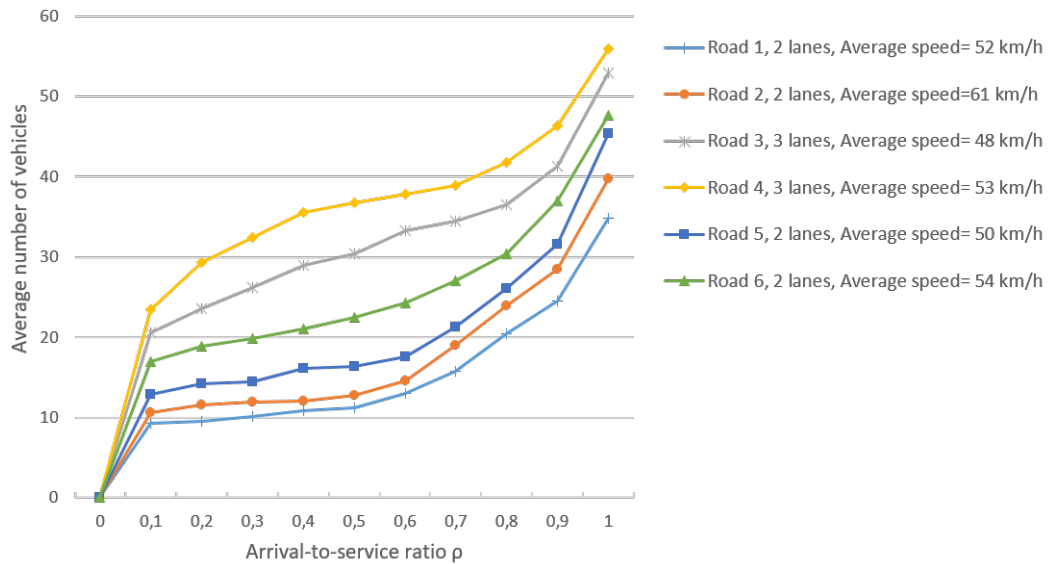

Figure 5.5: Per road average number of vehicle against density

Moreover, roads of the same length can have different performances. This may be explained by the disproportionate traffic volume that can be drawn into opposite directions of the road, the average speed on each road and the waiting time at the end intersection.

Figure 5.6 shows the relationship between arrival rates and the average travel time. It can be seen that the roads that encounter the lowest traffic volume and higher average speed are also the ones to ensure rapid traffic of vehicles. It is also apparent that a lot of time is required for vehicles to cross long distance roads than short distance roads.

Table 5.3: Set-up configuration

	Road parameters		
Road id	Lane id	Average speed (m/s)	Arrival probability
Road 1	Lane 1	25,607	0,535
	Lane 2	33,291	0,465
Road 2	Lane 1	27,673	0,407
	Lane 2	40,407	0,593
Road 3	Lane 1	23,643	0,74
	Lane 2	28,522	0,452
	Lane 3	29,731	0,808
Road 4	Lane 1	24,875	0,472
	Lane 2	30,877	0,707
	Lane 3	32,841	0,821
Road 5	Lane 1	24,208	0,603
	Lane 2	30,992	0,397
Road 6	Lane 1	27,482	0,319
	Lane 2	32,134	0,681
	Intersection parameters		
Intersection id	Intersection 1	Intersection 2	Intersection 3
Service rate	14,25	17	14

Figure 5.7 shows the graphs of the congestion rate in the right lane, middle lane and left lane respectively of a road 4. As expected, there is significantly a higher congestion rate on the right lane than the left ones. This is due to more traffic being drawn onto the right lane. Moreover, vehicles traveling with low velocities tend to use the right lane, while when traveling at high-speeds drivers shift to left lanes for smoother flow of traffic.

The performance of the three intersections is also analyzed. The metrics selected to evaluate the intersection performance are the average number of vehicles, congestion rate, average waiting time and average queue lengths. The estimates of the performance metrics are calculated using data extracted from traces. The results are calculated for different density values to investigate the evolution of queues as a function of density.

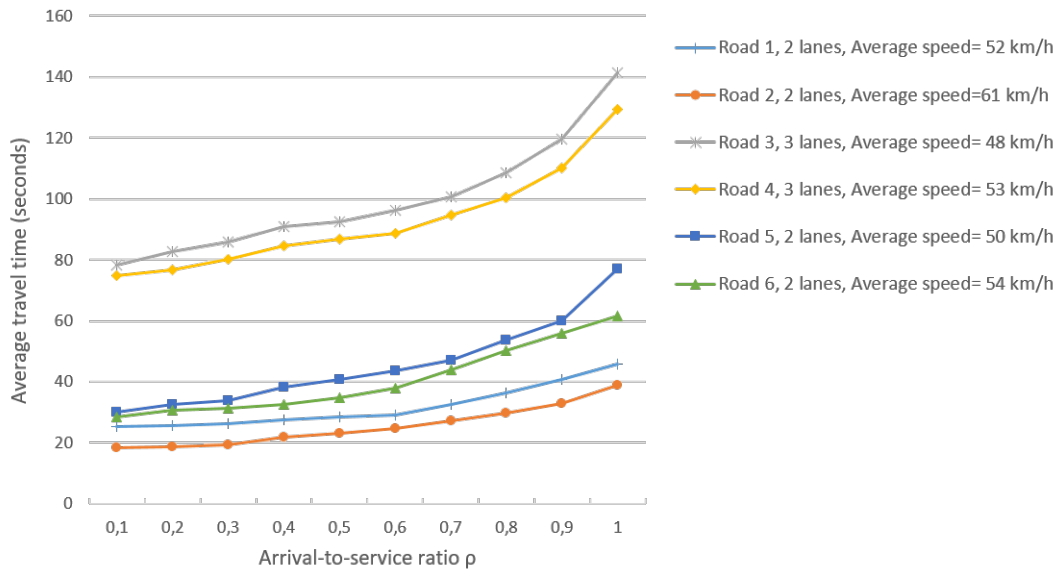

Figure 5.6: Per road average travel time against density

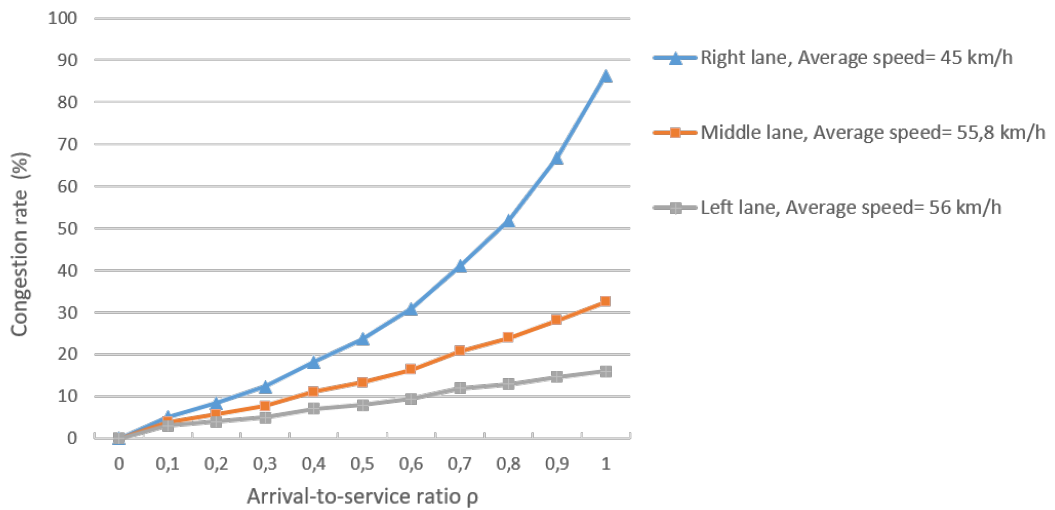

Figure 5.7: Per lane average travel time against density

The predicted average number of vehicles are given in figure 5.8. It can be seen that the results are different from one policy to another, and that the average traffic volume on all intersections grows according to the increase of the arrival rate of vehicles to the network. On figure 5.9, the average congestion rate is displayed for the three intersection where measures are calculated for different values of the arrival rate. The signal controlled intersection shows the highest

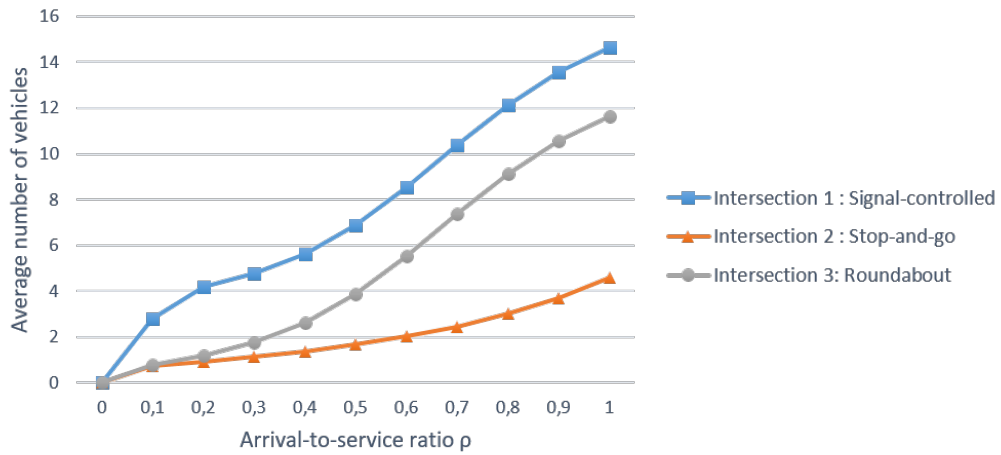

Figure 5.8: Per intersection average number of vehicles vs density

congestion rate as vehicles queue for a considerable period of time on the stopover of a signal controlled intersection before crossing the intersection at the green light. Roundabouts are the second highest road junctions because it's where several roads meet. The lowest congestion rate is seen in the stop-and-go junction where two roads intersect. Upon arriving to this type of intersections, vehicles stop briefly before crossing while respecting the 4-way stop rule.

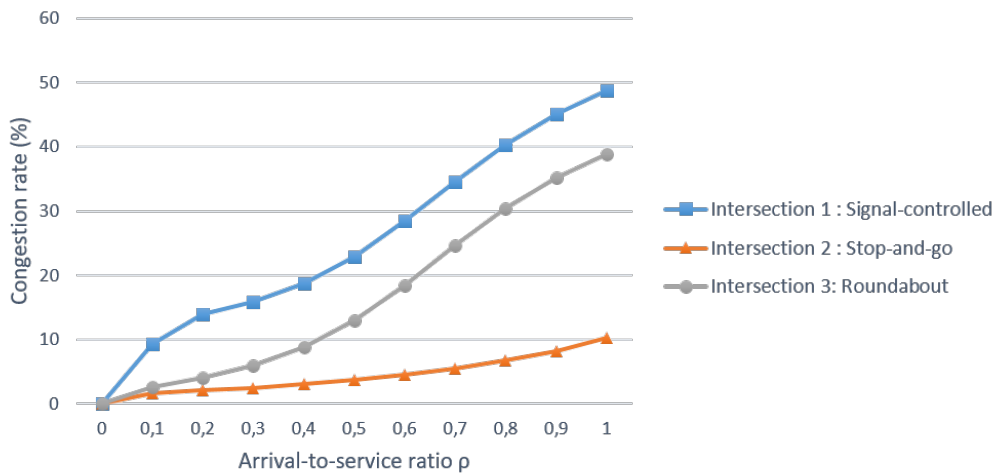

Figure 5.9: Per intersection congestion rate vs density

Figure 5.10 depicts the average queue length as a function of arrival rate. It can be observed that congested intersection is where longer queues are formed. Consequently, as displayed in figure 5.11, the results of the average waiting time indicate that long queues at a traffic light controlled intersection gives rise to delays. The

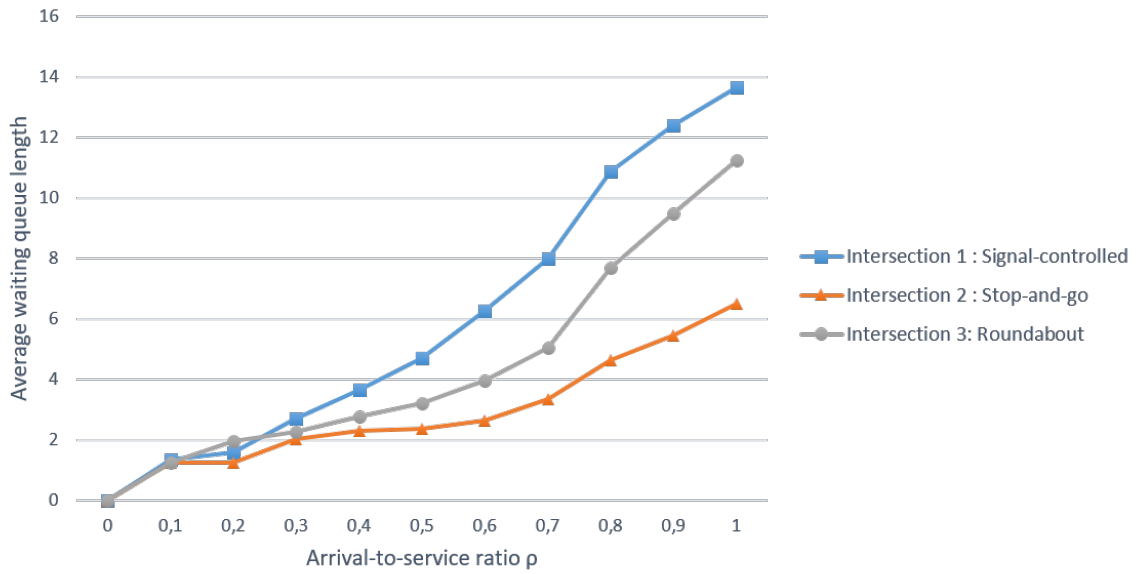

Figure 5.10: Per intersection average queue lengths vs density

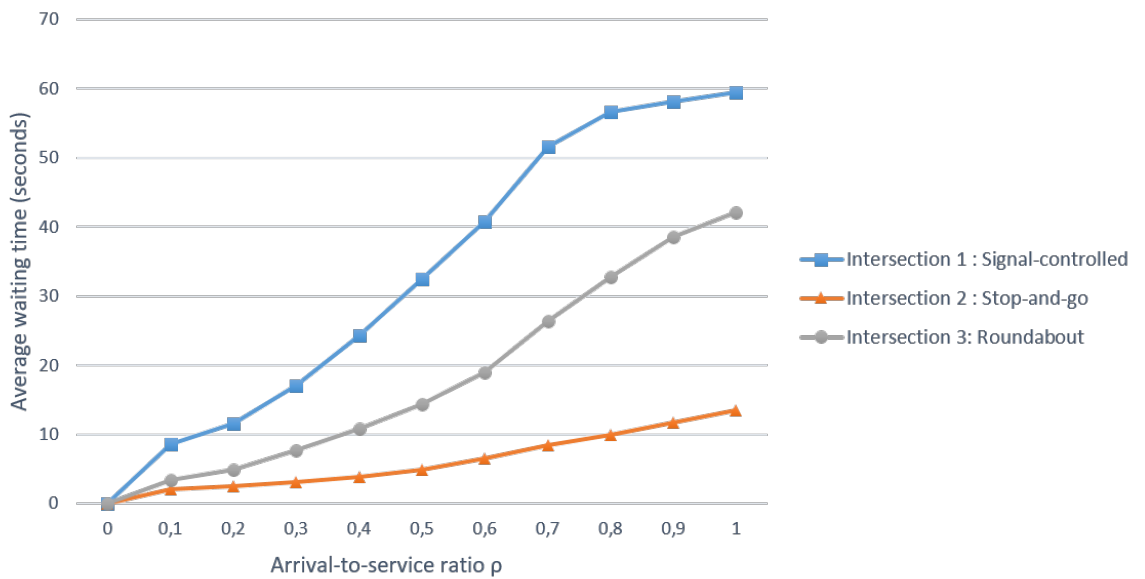

Figure 5.11: Per intersection average waiting time vs density

signal-controlled intersection generate more delays. In highly congested scenarios, the signal cycle length may not be enough to clear the intersection in more delays. Contrary, the roundabout intersection has a lower waiting time because vehicles are only required to yield when there is traffic. In stop sign intersections, the waiting time is very low due to the frequent stop-and-go driving.

In order to test the predictive ability of the proposed model, average waiting time results at intersections are compared with realistic traces and the results of Gawron's queue model [98]. The percent accuracy of both the CTMC model and Gawron queue model is calculated and plotted. Accuracy is computed using the same formula as used in chapter 4.

The average number of vehicles is compared with the estimated values as illustrated in figure 5.12. While in figure 5.13, the actual values of the average queue lengths are compared with the obtained results using the CTMC model, the realistic traces and Gawron's queue model [98]. The results of the proposed model follow the same trend as the realistic traces. However, the obtained results using the Gawron model [98] don't follow the same evolution as the curve representing the traces and don't show a realistic behavior as the waiting time and queue length don't increase accordingly with the density of the network.

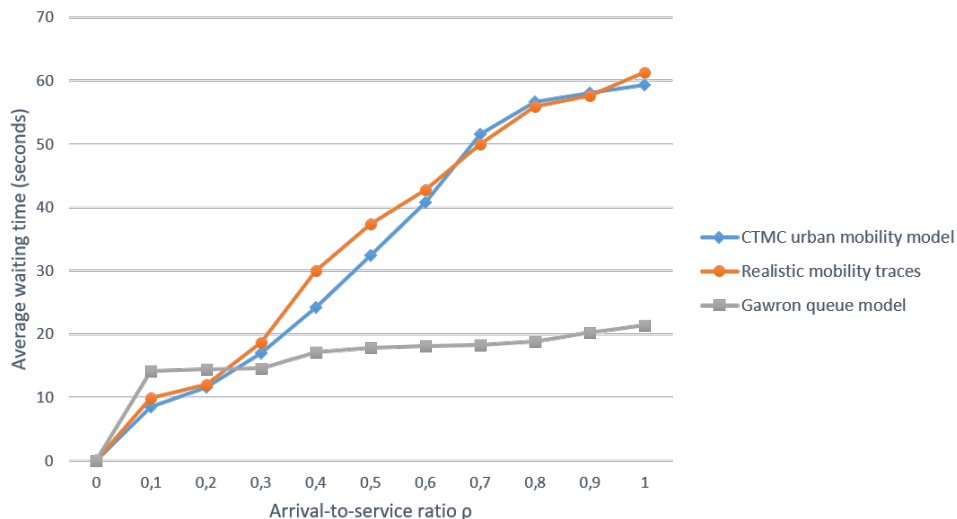

Figure 5.12: Comparison of the average number of vehicles

A first look at the chart in figure 5.13 shows that the CTMC outperforms the Gawron model [98] in terms of forecasting accuracy. For this case study, the proposed model allows to obtain an average of 93% accuracy for the expected number of vehicles, against 31% accuracy obtained with Gawron model. For the expected queue lengths, the average accuracy of the CTMC model is 80% and 24% for the Gawron model. One can notice the wide disparity between the accuracy of the CTMC-based model proposed in this study and the queue-based model proposed in [98].

Finally, to underline the importance of using the traffic prediction models to improve the performance of the transport system efficiency using smart mobility applications, an actuated traffic light and an automatic speed control strategies were designed and simulated using the SimEvent simulation tool introduced in

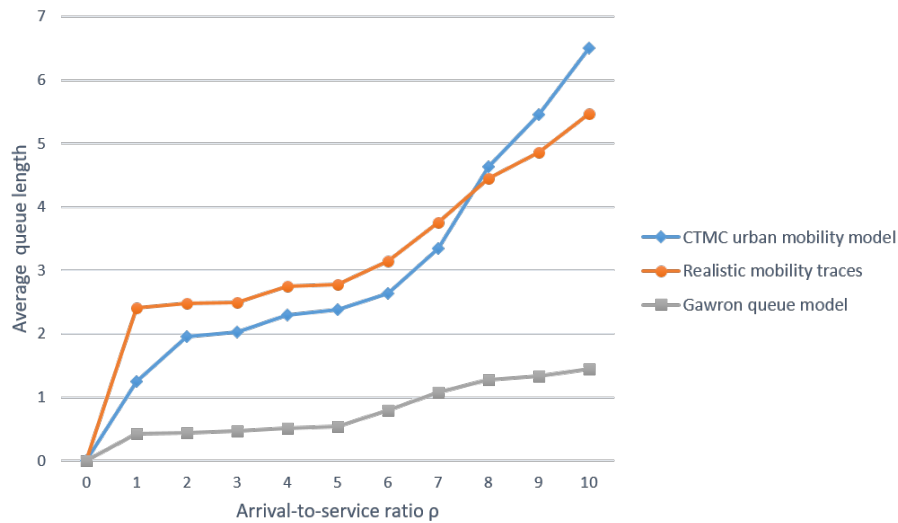

Figure 5.13: Comparison of the average queue lengths

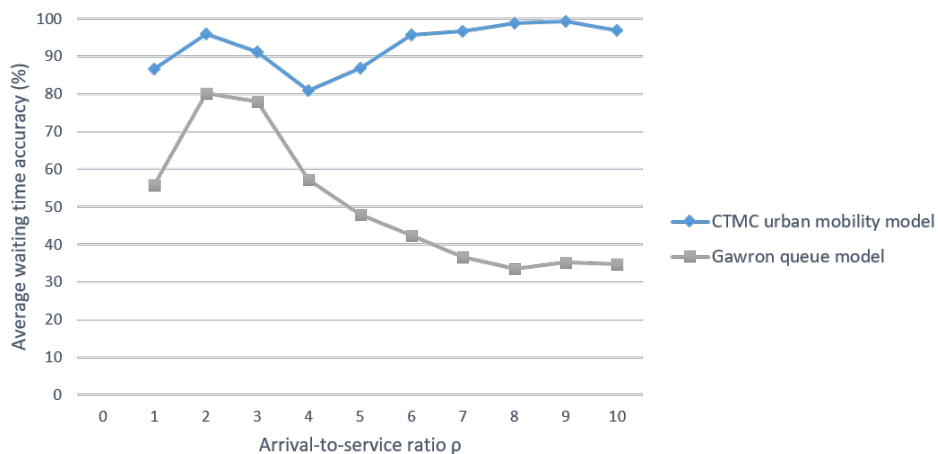

Figure 5.14: Percent accuracy of the average number of vehicles

chapter 3. The traffic signal block predict future congestion rate based on the actual traffic condition. If the estimated congestion rate is above a pre-defined threshold, the traffic controller requests the green light after the minimum red light delay is reached. However, if the intersection is not congested, the red light runs until the maximum red delay is out, then switches to green light. The simulation was performed for a run-time of 200 seconds for each value of the density. The comparison results are reported in figure 5.16. We can observe that the two curves follow similar trends. However, the average waiting time is significantly low for the dynamic traffic model.

The speed control policy is implemented in SimEvents environment so that

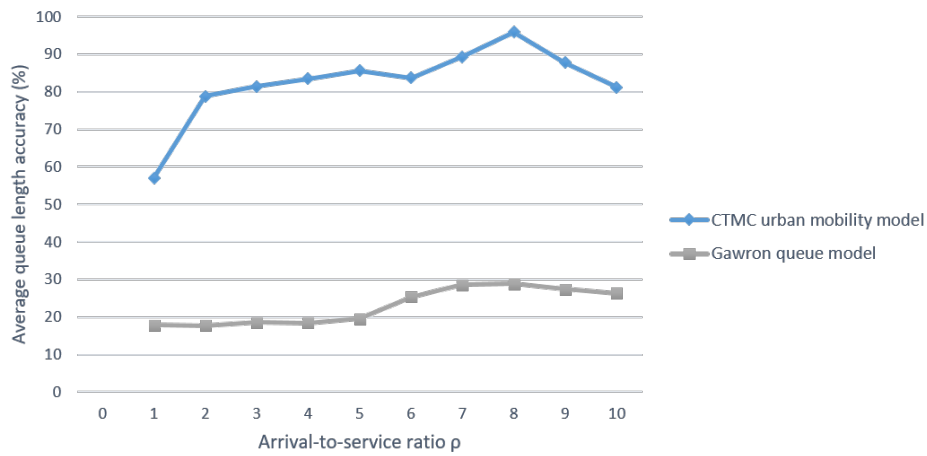

Figure 5.15: Percent accuracy of the average queue lengths

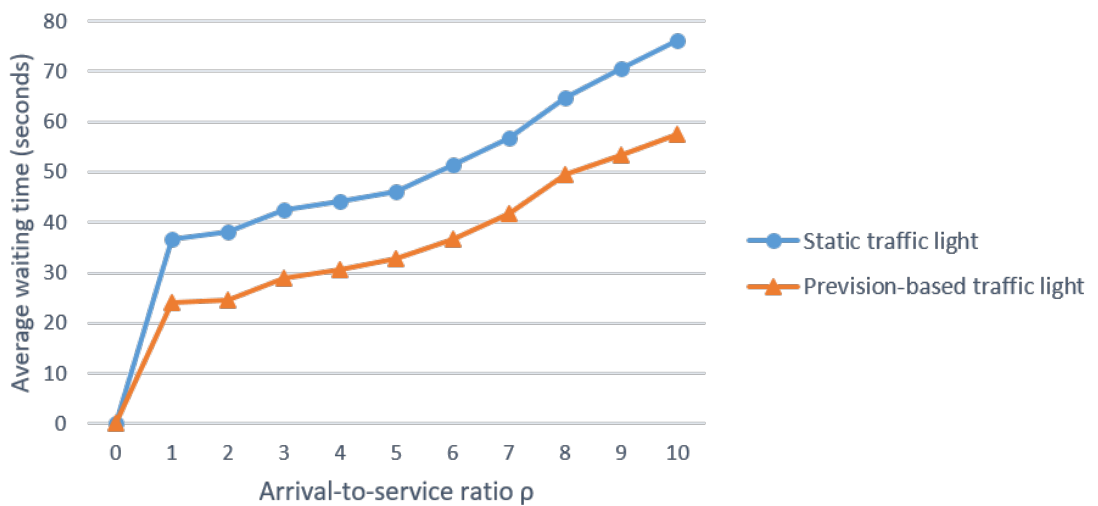

Figure 5.16: Average waiting time: Pre-timed traffic light vs Actuated traffic light

the attribute function automatically controls the travel velocity of vehicles. If the estimated congestion rate exceeds the threshold, the minimum allowed speed is continuously increased until the congestion rate falls below the threshold. The simulation was run for 200 seconds and results are shown in figure 5.17. The graphs demonstrates that a prediction based speed controller can help substantially reduce delays, particularly when more vehicles are generated.

5.4 . Conclusion

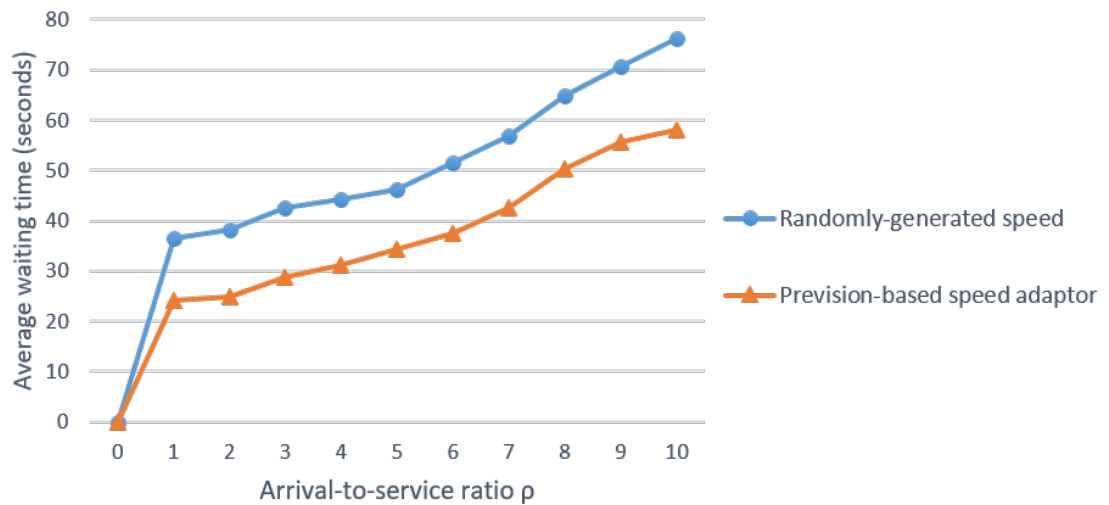

Figure 5.17: Average travel delay: Random travel speed vs Actuated speed controller

In this chapter a stochastic mobility model for urban environments was developed by extending the model presented in chapter 4. By applying queuing theory principles, the traffic scenario in multiple-lane roads and junctions is represented. The system behavior is then modelled as Markov chain to forecast the long-run average quantities such as congestion rates and average waiting times in order to predict future traffic states and to analyse the performance of the system. Numerical results were derived for a set of configurations by varying parameters that affect the performance of the system. In order to prove the validity of the model, the inferred results were compared with a queue-based model proposed by Gawron and realistic traces collected using drones. The results show that the model accurately reflects the real world traffic behaviour when historical traffic information are used in the prediction process. Moreover, despite the low complexity of the model, it still proves to be successful in providing relevant traffic prediction, with low error rates. The importance of the CTMC mobility prediction model is showcased by designing a congestion-aware traffic light system and a vehicle speed controller. Exploiting the potential of traffic prediction will allow developing value-added traffic management systems. Given the short-term traffic prediction, these systems can adjust their decision-making procedures to adapt to a certain traffic scenario. The findings provide evidence that traffic prediction is effective at improving traffic efficiency and reducing delays brought on by congestion. The next chapter aims at highlighting the relevance of using traffic prediction models to improve the performance of VANETs. The models proposed in chapter 4 and chapter 5 are exploited to mitigate the data access collision and the fairness issue in radio resources allocation in IEEE 802.11p-based vehicular networks.

6 - Traffic-aware channel access technique for collision avoidance in VANET

6.1 . Introduction

In the previous chapters, the main goal was to design mobility simulation and forecasting models suitable for different scenarios and multiple usage. This chapter will focus on investigating the importance of these models in designing communication protocols for VANET. Due to the significance of road safety, one of the stringent requirements of VANET performance is low latency and reliable communication between transport equipment (OBUs or RSUs). The frequent changes in the topology, bidirectional mobility, and the continuously varying density can lead to medium access collisions and thus affect the network performance. In a VANET, collisions occur when multiple nodes choose a common physical channel to transmit signals simultaneously.

Contention-based protocols where vehicles perform a carrier sensing operation to search for an available channel perform less well than TDMA protocols. This is mainly due to the hidden terminal problem and merging collisions that cannot be detected by channel sensing [150]. The hidden terminal problem occurs when two vehicles cannot hear each other due to the distance and try to transmit a signal to a common neighbor through the same radio channel. While the merging collision occurs when two vehicles using the same channel draw near because they are moving at high speed or on opposite directions. Several TDMA-based contention free protocols were proposed in the literature to reduce data collision rate. These protocols are reviewed and compared in chapter 2. These protocols can be classified into three categories: centralized, cluster-based and distributed. Centralized protocols such as ACFM [109] and R-MAC [110] use central controllers like RSUs to manage access to the channel. Cluster-based protocols like CBMAC [114] and TC-MAC [115] rely on the CHs to organise the slot allocation. From the third category of distributed protocols, SOFT MAC [117] and VeMAC [118] can be cited. These protocols don't require a centralized management of the channel access. Vehicles synchronise among them their transmissions to avoid overlapping.

Although these protocols are specifically designed to avoid the hidden terminal problem, the merging collision, or both, they still have many weaknesses, notably regarding negotiation overhead and the effective and fair utilization of time resources. In vehicular networks, resources are limited and must be shared fairly in order to allow access to the widest set of vehicles. Thus, those resources must be allocated depending on traffic density. The knowledge of evolution of traffic may be very useful in order to allow an efficient resource management. To address the above limitations, a novel channel access mechanism called Traffic Aware TDMA

(TA-TDMA) is introduced in this chapter to avoid collision issues while minimizing access delays. The protocol is based on VeMAC [118] and tries to mitigate the unfairness in time resources allocation by utilizing the CTMC mobility models proposed in chapters 4 and 5. Traffic conditions on opposite directions, different lanes, and road segments are forecasted and then each frame is partitioned accordingly. Each direction, lane, and segment is allocated a different set of time slots while considering the vehicle traffic conditions. The protocol is also cluster-based and access time among participating nodes is managed by the cluster head (CH). To evaluate the performance of the proposed approach, the TA-TDMA protocol was implemented in the SimEvents framework proposed in chapter 3. More than that, The VeMAC protocol [118] was also implemented in order to compare their performances. In the next section, a more concrete overview of the approach proposed in this chapter is given.

6.2 . System model

In this section, the framework of the TA-TDMA MAC protocol is detailed. First, the assumptions and scenarios considered in this study are discussed. Following that, the clustering procedural flow is introduced, and finally details of the protocol design are explained.

In the proposed approach, two real-world traffic scenarios are considered:

- Highway scenario where a number of vehicles are traveling in two opposite directions of a multiple lane road;
- Urban scenario where a number of vehicles driving in a city section composed of several controlled and uncontrolled intersections linked by bi-directional roads of multiple lanes.

For simplicity reasons, it is assumed that RSUs have equal transmission range R_{RSU} and are able to directly communicate with vehicles traveling within their service area through V2I communication and to adjacent RSUs through I2I communication. To extend the range of RSUs, the V2I communication can be supported by cooperative V2V communication or vehicles clustering. It is also assumed that each vehicle is equipped with an OBU that allows DSRC communications with other vehicles and RSUs and a GPS receiver that provides time reference and location information. All vehicles have the same transmission range R_{OBU} and can communicate with RSUs through direct or cooperative V2I communication.

As illustrated in figure 6.1, the highway road is assumed to be divided into multiple segments of equal lengths, each serviced by a RSU. Let \mathcal{S} denote the set of segments. The length of each segment $s \in \mathcal{S}$ is denoted L and depends on the transmission range R_{RSU} of the RSUs and is calculated as follow:

$$L = 2 * R_{RSU} \tag{6.1}$$

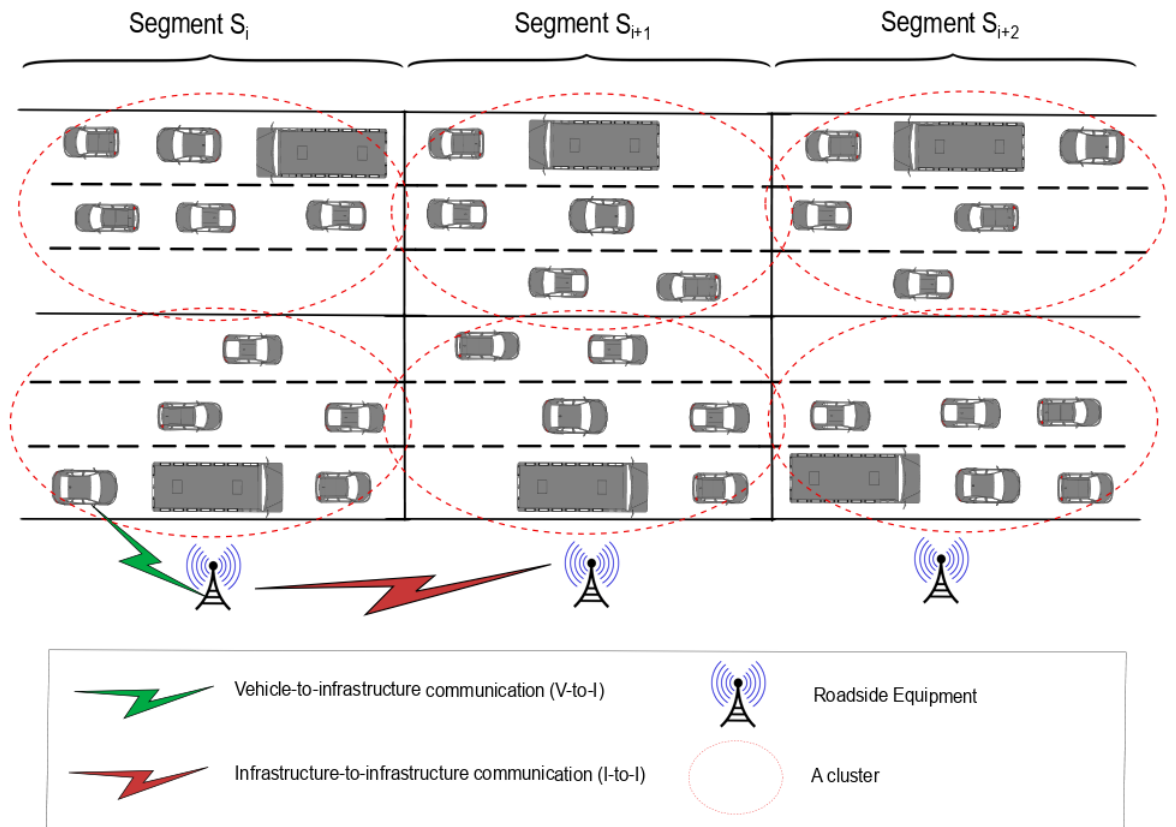

Figure 6.1: System model for highway environments

Vehicles will arrive to the start point of a segment according to a Poisson process and then measure vehicular information such as the moving direction, speed and position. This information is transmitted to the RSU servicing the segment and used to forecast traffic condition in the next time frame using the CTMC traffic model for multi-lane highways proposed in chapter 4.

At first, when a vehicle joins the network, it starts by sensing to the channel to receive the affiliation poll from the CH. Then it sends an affiliation request to join the cluster. If multiple CHs exist within its range, it selects its preferred CH based on the signal quality and relative velocity. Upon receiving an affiliation request from a vehicle, the CH updates the cluster table. If the vehicle doesn't receive any affiliation polls within a time period dt , it forms a cluster and invites vehicles within its range to join its cluster. It is assumed that neighboring clusters can communicate through their CHs or via a gateway nodes.

The TDMA-based mechanism proposed in this thesis supports DSRC wireless

communication technology composed of one control channel (CCH) and several service channels (SCH). However, we restrict our focus on the CCH as it serves safety applications. Time frames are divided into a fixed number of time slots of equal duration τ . The allocation process is performed in two steps. First, each area is allocated a set of time resources then the CH manage the access of its member to these resources.

Initially, the RSUs divide the available time slots into S sets each allocated to a different segment. This will help to reduce the hidden terminal problem as vehicles traveling on neighboring segments do not have access to the same time slots. The size of each set is adaptively adjusted based on the estimated traffic density on each directions. Let V_i denote the estimated traffic volume of segment i , and D_i its density ratio. D_i is calculated as the fraction of V_i and the total estimated density of the network and is defined as follows:

$$D_i = \frac{V_i}{\sum_{j \in S} V_j} \quad (6.2)$$

Given N the total number of time slots, the number of slots assigned to segment i is calculated as:

$$N_i = N \times D_i \quad (6.3)$$

To reduce merging collision probability, the vehicles moving in the left and right directions are given access to different time slots. Hence, the set N_i is further divided into two sub-sets N_i^L and N_i^R used in the left and right direction respectively. To compute N_i^L and N_i^R , the density ratio of each travel direction is first calculated. Given V_i^L the estimated traffic volume on the left direction of segment i , the density ratio DL_i is computed using the following formula:

$$DL_i = \frac{V_i^L}{V_i} \quad (6.4)$$

Similarly, the density ratio of the right direction DR_i is computed as follow:

$$DR_i = \frac{V_i^R}{V_i} \quad (6.5)$$

From equations 6.4 and 6.5, N_i^L and N_i^R can be obtained as follow:

$$N_i^L = N_i \times DL_i \text{ and } N_i^R = N_i \times DR_i \quad (6.6)$$

To further overcome packet collisions, each lane is assigned a different set of time slots. It is assumed that each direction has the same number of lanes M . $D_i^L(m)$ and $D_i^R(m)$ denote the density ratio of the m^{th} lane of the left and right direction of segment i respectively and are calculated by the following formulas:

$$DL_i(m) = \frac{V_i^L(m)}{\sum_{n \in \mathcal{M}} V_i^L(n)} \text{ and } DR_i(m) = \frac{V_i^R(m)}{\sum_{n \in \mathcal{M}} V_i^R(n)} \quad (6.7)$$

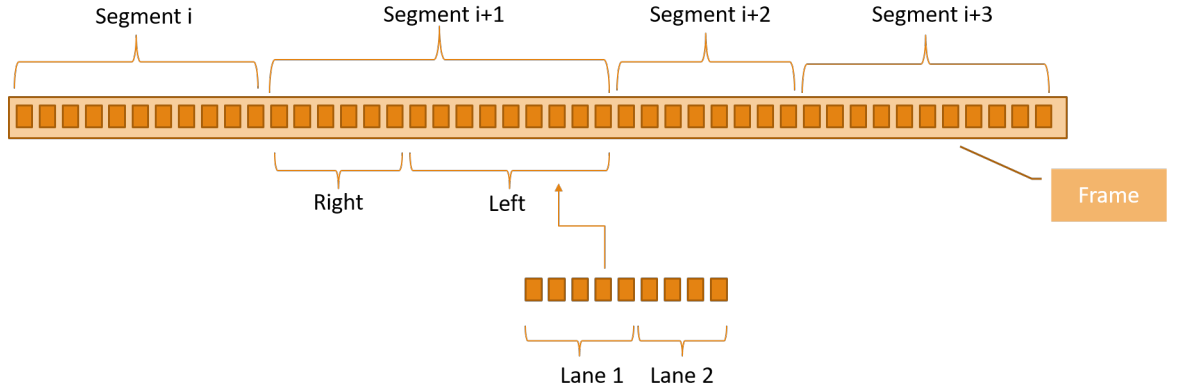

Figure 6.2: Frame partitioning example for a highway scenario

Finally the number of time slots assigned to lane m of both left and right directions is calculated as follow:

$$N_i^L(m) = N_i^L \times DL_i(m) \text{ and } N_i^R(m) = N_i^R \times DR_i(m) \quad (6.8)$$

Figure 6.2 illustrates an example of the frame partitioning into distinct timeslot sets each used by vehicles traveling on a different area.

The urban scenario is illustrated by figure 6.3. The roads are divided into segments of equal lengths in the same way as the highway scenario. The only difference is that an additional segment is added to represent the intersection area. A RSU is assumed to be deployed at the junction to collect traffic data of vehicles crossing the intersection. The frame is divided as shown in figure 6.4.

To get a time slot, vehicles send an access request to the CH. It is supposed that requests to a CH follow the Poisson model with rate $\lambda_{request}$ and are stored in queue and are served one by one following FIFO policy. The CH keeps a time slot information table that keeps trace of status of the time slots assigned to its area (direction and segment). Once a request is received, it forwards a list of available slots to the vehicle who chooses one slot randomly and then informs the CH of its choice. Upon receiving a response from the vehicle, the CH updates its slots table and forwards it to the other CHs managing clusters within the same direction and segment. In the case of a collision where the CH receives multiple allocation requests for the same time slot, the CH assigns the time slot to the vehicle who first requested access. After updating the time slot table, it sends an updated list of available time slots to the other vehicles to choose again. Once the vehicle has access to a time slot it starts transmitting its packet. After completed transmission it then releases the time slot and informs the CH. The allocation process is illustrated in figure 6.5.

6.3 . Simulation results

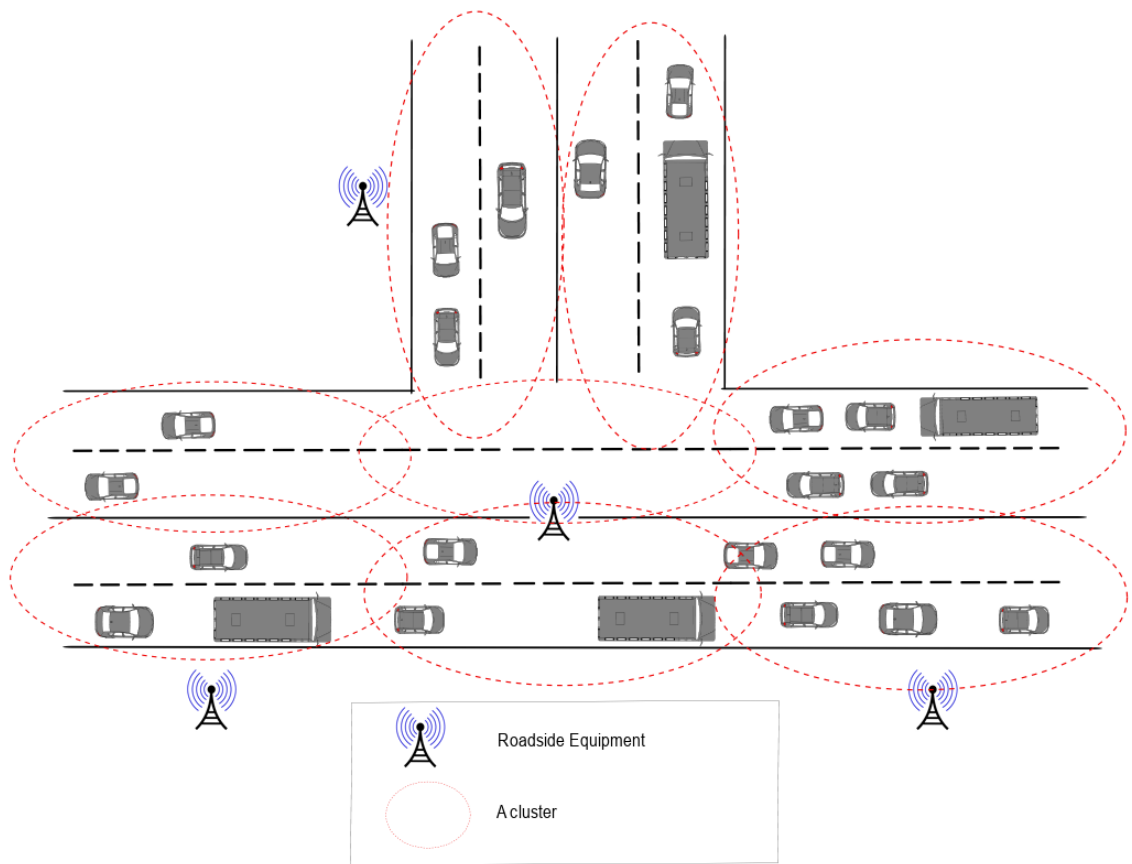

Figure 6.3: System model for urban environments

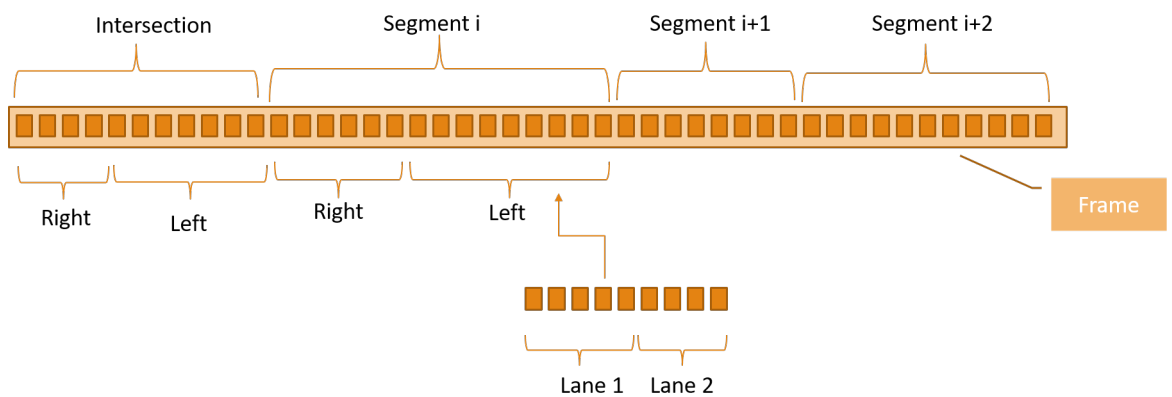

Figure 6.4: Frame partitioning example for an urban scenario

In this section, the performance of TA-TDMA protocol for different road topologies is assessed and the results are compared to the performance of the VeMAC protocol [118]. In this evaluation, the access collision rate and channel

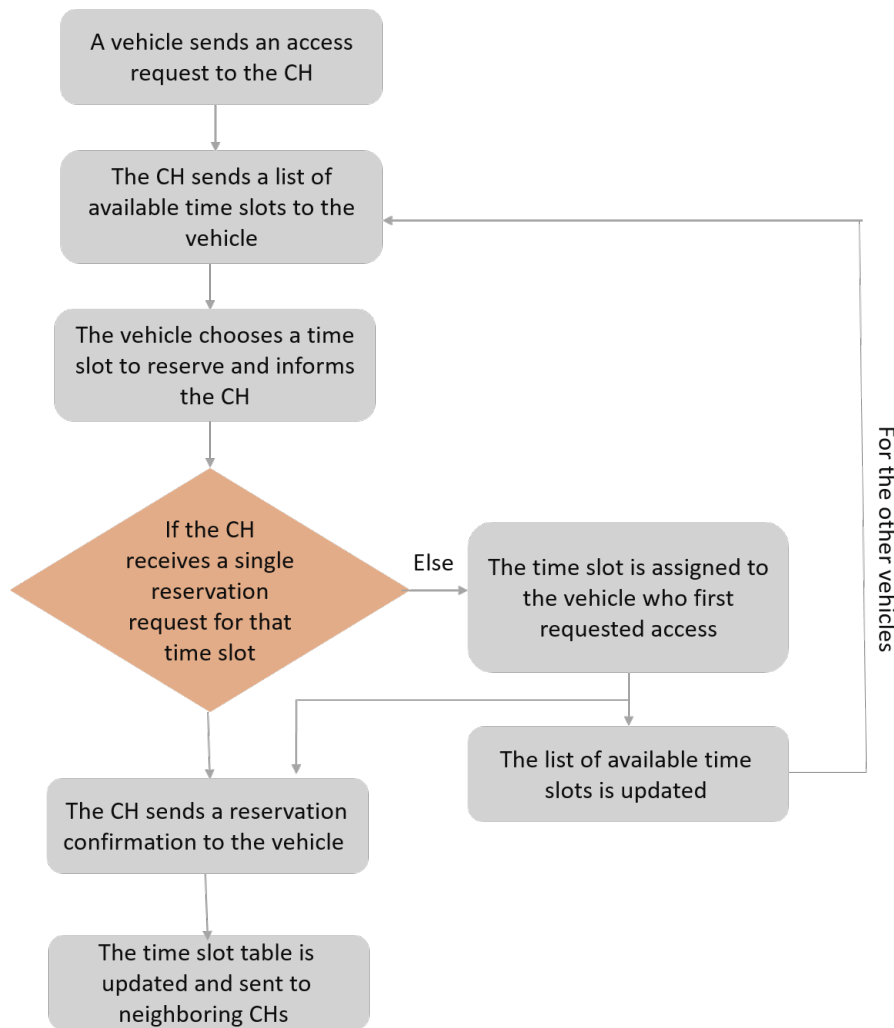

Figure 6.5: cluster-based time slot allocation process

utilization rate are considered as performance metrics. The simulation was carried out using the SimEvents model proposed in chapter 3.

At first, the performance of both TA-TDMA and VeMAC in a highway environment where traffic flows in opposite directions is studied. The set-up considered in the analysis is summarized in table 6.1.

Figure 6.6 shows the relationship between the access collision rate and road congestion. It is obvious from the results that using TA-TDMA ensures lower collision rates compared to VeMAC [118]. The fact that TA-TDMA assigns disjoint slots to each segment and each lane also reduces the hidden terminal problem which will likely to occur by utilizing VeMAC protocol [118]. The channel utilization rate is computed and plotted for both TA-TDMA and VeMAC [118]. The two curves in figure 6.7 show the performance of both studied protocols in terms of resource

Table 6.1: Simulation set-up for the highway scenario

Simulation parameter	Value
Road length	4km
Number of lanes	3
Average speed	100km/h
Vehicle transmission range	200m
RSU transmission range	500m

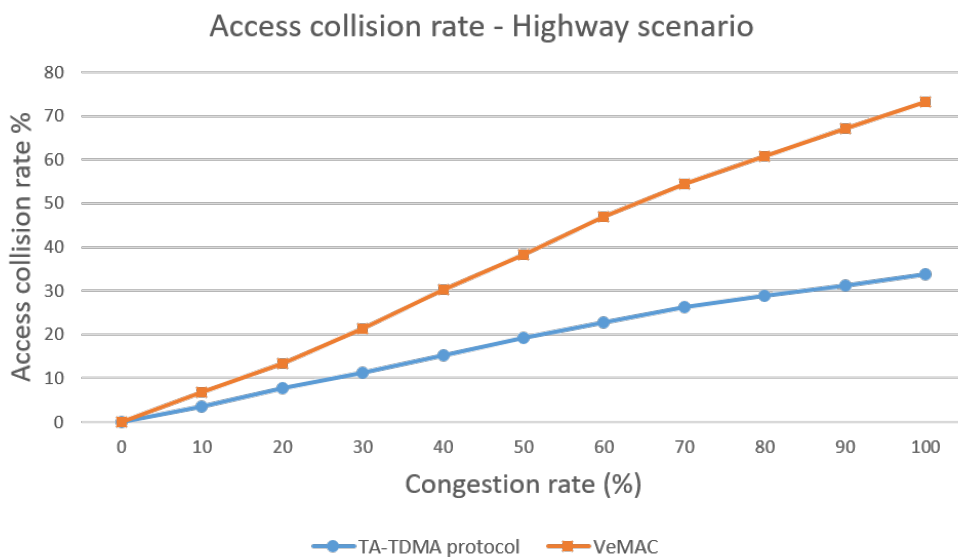

Figure 6.6: Access collision rate for a highway scenario

utilization. It can be observed that TA-TDMA protocol allows better channel utilization compared to VeMAC[118]. TA-TDMA assigns adaptive sub-frames to each area of the highway in order to satisfy the high access demand of dense area and to avoid wasting available resources in low demand areas. However, VeMAC [118] assigns equal sets to both directions regardless of the traffic density and access demand on each directions. This can lead to unfair time slot allocation and low channel utilization. It can also be observed that the proposed protocol outperforms VeMAC [118] even in a congested scenario. When road congestion increases, TA-TDMA can reduce collision rate and improve utilization by as much as 40 per cent.

To evaluate the efficiency of the protocol in an urban environment, the set-up

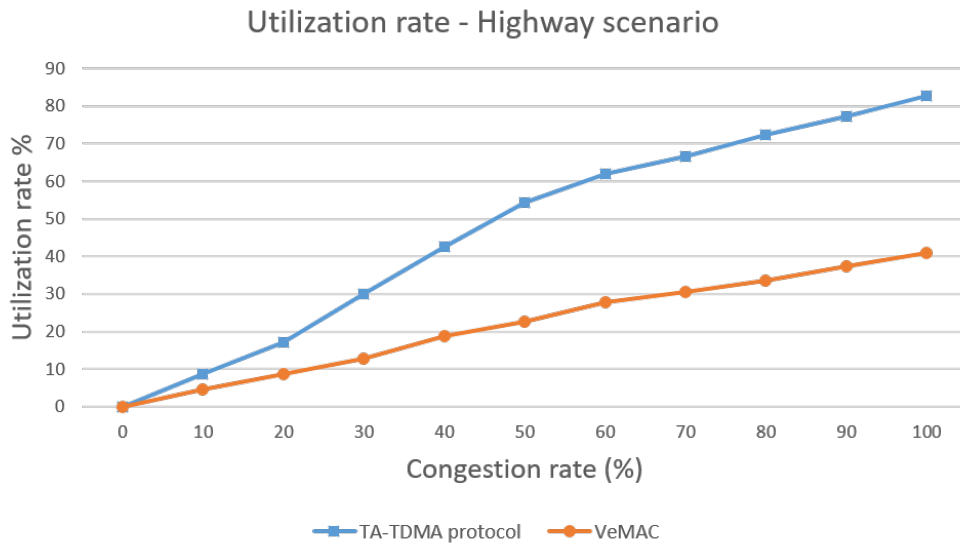

Figure 6.7: Utilization rate for a highway scenario

in table 6.2 is considered. The road layout studied is similar to the one presented in figure 6.3.

Table 6.2: Simulation set-up for the urban scenario

Simulation parameter	Value
Number of roads	3
Number of intersections	1
Intersection policy	Traffic lights
Road length	300m
Number of lanes	2
Average speed	60km/h
Vehicle transmission range	200m
RSU transmission range	300m

The performance of TA-TDMA and VeMAC [118] in an urban environment in terms of collision rate is shown in figure 6.8. The results proves that TA-TDMA outperforms the baseline protocol VeMAC [118] in reducing channel access collision even in urban environments which are characterized by high traffic density. It can be observed that the more dense is the network, the more the gap between the two models widens. In a completely congested urban area, TA-TDMA can reduce access collision by 41 per cent. Figure 6.9 illustrates the channel utilization rate of

the analyzed protocols. It can clearly be seen that TA-TDMA raises time resource utilization efficiency compared to VeMAC [118]. In dense urban environments, it is highly required to utilize a fair access method since the demand for time resources grows as much as traffic volume grows. TA-TDMA has proven its efficiency to cope with unbalanced traffic condition and different topology. This is achieved principally through mobility modelling and prediction in the design of the MAC protocols. In a completely highly dense urban area, TA-TDMA improves the performance of VeMAC in terms of utilization by 33 per cent.

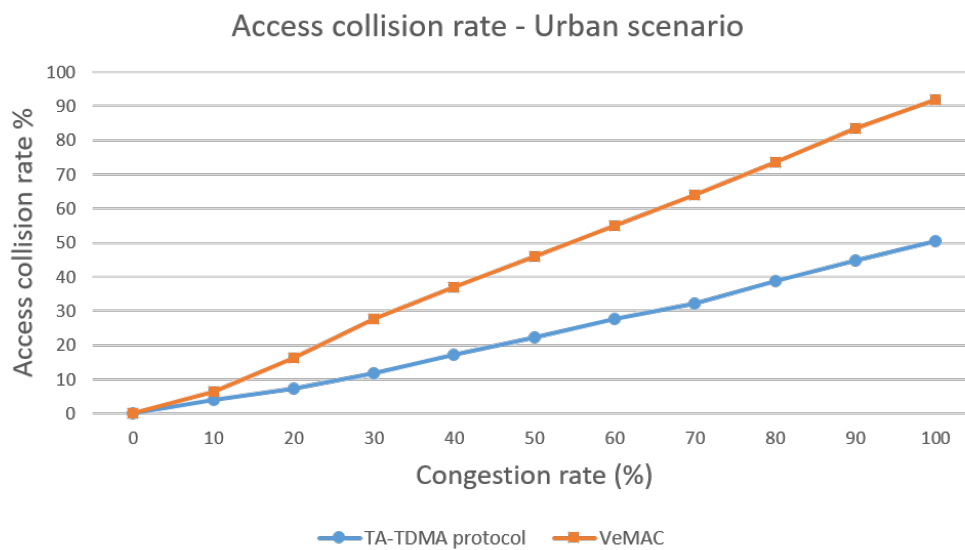

Figure 6.8: Access collision rate for an urban scenario

6.4 . Conclusion

In this chapter, the importance of traffic prediction in solving the resource allocation fairness in VANET is investigated. Markov mobility models proposed in chapters 4 and 5 were used to predict traffic volume in different areas of highways and urban roads, then a TA-TDMA MAC protocol is proposed to extend the VeMAC protocol. The proposed solution aims to assign a set of time slots to vehicles according to their travel direction, lane and road section. The protocol is also cluster-based and confers to cluster heads the task of managing access within their clusters. The simulation tool proposed in chapter 3 is used to validate the proposed protocol that is compared with VeMAC protocol. The results exhibit the efficiency of TA-TDMA as it outperforms VeMAC in terms of collision and channel utilization rate. Future directions will focus on studying the applicability of the proposed protocol to increase throughput for non-safety applications.

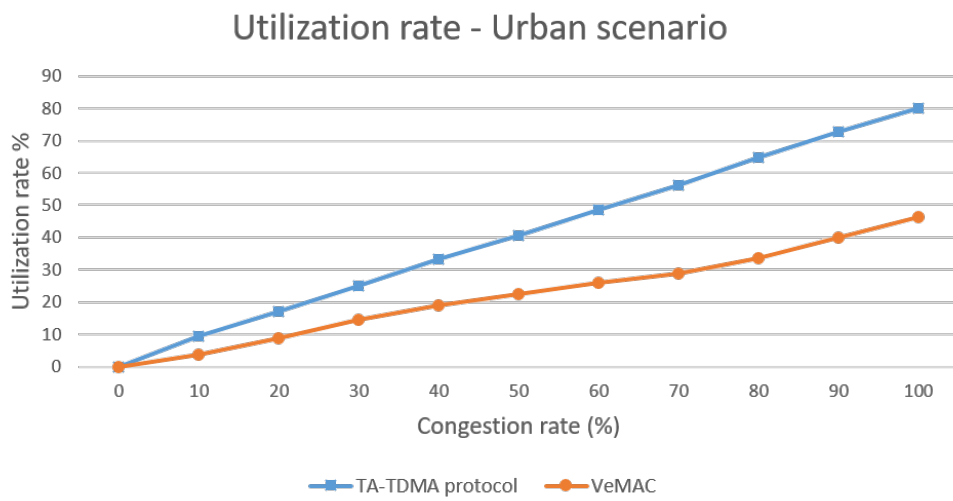

Figure 6.9: Utilization rate for an urban scenario

7 - Conclusion

7.1 . Summary of the Contributions

The growing population, witnessed in the recent decades, came with a significant increase in demand for transport. The current transportation infrastructure is now deemed inadequate and inefficient to meet the needs of the future traffic demands. The pressure put of the infrastructure spawns many issues such as larger proportion of gas emissions, traffic congestion, and road accidents. This calls for the development of more efficient, safe and sustainable transportation systems. ITS have gained tremendous interest from research and industry as a key lever to cope with the heavy load of traffic and all the disadvantages that it entails. ITS rely on different advanced technologies to improve transportation such as wireless communication, sensors, IoT, vehicle control, and many more. VANET is one of the technologies developed to support ITS by providing a vehicular communication infrastructure that enables data exchange between the entities of the network (vehicles and RSUs) through wireless devices embedded in the vehicles and road equipment. Inter-Vehicular connectivity is a promising way to improve traffic safety. Real-time data exchange between vehicles will allow the design of new safety-related applications such as automatic accident notification, pre-crash warning, autonomous driving, etc. These applications have high requirements regarding communication reliability and latency. They are highly sensitive to delays and require an error-free, low-latency and reliable communication. Nonetheless, the nature of vehicular mobility has a potent influence on the performance of VANET to fulfill the communication requirements of these applications. Vehicles are generally moving at high speeds causing frequent changes in the network topology, partition and disconnections. This is a significant motivation for the study of mobility modelling and prediction techniques in the field of vehicular communications. This thesis addresses particularly the channel access management issue in VANET. In a highly dynamic and dense environment, the network can be exposed to an access collision risk due the hidden terminal or merging collision. Therefore, it is important to use mobility prediction techniques to design MAC protocols able to cope with the highly dynamic nature of transportation network and to comply with the requirements of safety applications. Considering mobility in the evaluation of communication protocols is also of great importance. Using a mobility model to reflect the realistic behaviour of traffic in simulation will help to accurately analyse the robustness of the proposed protocols against mobility. The contributions made in this thesis are briefly concluded in what follows:

- **Queue-based mobility simulation framework:** A simulation model was introduced to emulate vehicular mobility. The proposed simulator performs

based on queuing theory and was implemented using the SimEvent/Matlab toolbox. The benefit from using this tool is its flexibility that allows to integrate control systems or communication protocols. Moreover, it can also ensure rapid prototyping and simulation of large scale scenarios. Different simulation results were presented for different scenarios to ensure that the model is operating accurately. Throughout the thesis, this framework was used to evaluate the performance of traffic-aware control algorithms and MAC protocols.

- **CTMC mobility forecasting model for highway environments:** The aim was to design a stochastic mobility model tailored to vehicular environments. The proposed model is based on Markov chain and aims to tackle traffic prediction in a highway environment. Based on traffic data collected from vehicles through V2X technology, the model studies the evolution of traffic flow along a multiple lane divided highway and locally estimates the expected number of vehicles traveling on a highway segment or lane. The predicted traffic density was compared with real world traces in order to validate its accuracy. The results show that the model is able to accurately reproduce the fundamental mobility aspects in a highway environment.
- **CTMC mobility forecasting model for urban environments:** Given the differences between the highway and urban environment, it was important to extend the previously proposed mobility model in order to reflect the vehicular activities in an urban environment such as intersection rules and queuing. To validate the model, the obtained forecasts were compared with the fast lane queue model and real world traces. The obtained results showed that the proposed model is capable of realistically reproducing urban traffic behavior without incurring heavy costs and time-consuming computing. Furthermore, to highlight the importance of mobility prediction in the design of ITS applications, the obtained forecasts were used to design an actuated traffic light and a vehicle speed adaptor. The simulation results make clear that using a traffic forecasting model helps to reduce vehicles idling and travel times.
- **Traffic-aware TDMA MAC protocol for safety-applications:** The CTMC prediction models that were proposed were exploited to develop a traffic-aware TDMA-based protocol tailored to VANET. Our aim was to improve the VeMAC protocol in order to meet the reliability and low-latency requirements of safety applications. The proposed solution relies on predicted traffic density to assign appropriate resources to each area of the road network. This solution guarantees a reduced access collision rates since vehicles traveling on opposite directions or different lanes will have access to different sets of time slots. Moreover, the protocol adaptively computes the size of the time slots set assign to each area in order to increase channel access

fairness. Vehicles cluster was considered in this scenario to locally manage channel access of vehicles. The cluster heads are conferred the task of assigning time slots to vehicles affiliated to their clusters and also manage inter-cluster interference. The validity of TA-TDMA protocol is confirmed through simulation where its performance with VeMAC is compared according to access collision and channel utilization.

The work presented in this thesis is open to possible improvements and extensions in order to tackle more challenges. Therefore, the possible enhancements considered in shaping our future directions are enumerated in the next section.

7.2 . Future Research Directions

Regardless of the presented contributions provided during this thesis in the area of mobility modelling and channel access management in VANET, several interesting aspects can be further explored and extended. Therefore, we devote this section to identify and study some perspectives and possible future research directions.

The main focus for further development is the improvement of the TA-TDMA MAC protocol. First, we would like to take a closer look at the clustering methods used in vehicular communications in order to identify the requirements that need to be targeted to enhance the stability of the clustering. We would also like to study the idea of spatial reuse of time slots as a solution to provide more available slots when access demand is high due to a mass of vehicles on the roads. Therefore, an algorithm needs to be introduced to define which vehicles are allowed to use the same time slots at the same time without causing an access collision. Another potential idea that we wish to consider is to incorporate a machine learning technique that will predict the number of slots to assign to each area based on previous predictions. This technique can be used as backup to ensure accurate results when real-time traffic data are not available. Further study should also be devoted to identifying the requirements of non-safety applications and extend the proposed protocol to fulfill them.

It was explained in the thesis that the advantage of using Markov chains is their memory-less property. In other words, using a Markov model allows predicting the future traffic based only on the current state of traffic. The proposed CTMC traffic model was developed under a number of assumptions but we tried to incorporate the most important mobility aspects that affect the performance of the road systems. The results prove that these assumptions allow a faster execution of the model but also preserve the accuracy of the estimations even for large scale scenarios. Adding more details into the model can lead to exponential growth of the number of states of the Markov chain and therefore a risk of combinatory explosion, which makes the model unusable. Machine learning techniques can deal with complex patterns, however they require large historical traces in order to

predict results in a reliable manner. Thus, using a machine learning-based prediction model in less traveled or sparse areas is inefficient. Nevertheless, it would be interesting to address traffic prediction using machine learning in scenarios where large enough learning datasets are available. On another note, the simulation environment proposed in this thesis can be further improved. In the future, we will try to introduce more traffic control systems such as lane change assistance and travel route recommendation. Network simulation can also be improved by developing modules that can emulate routing and cooperative data dissemination.

Synthèse:

La croissance démographique et l'expansion urbaine ont profondément changé la façon dont les humains se déplacent. Ceux sont les principales difficultés à laquelle est confronté le transport routier vu le déséquilibre entre les besoins de déplacement et les moyens de transport mis à disposition. Parmi les conséquences néfastes de la congestion routière figure les accidents de la route, l'empreinte environnementale, la vitesse commerciale des transports publics et les embouteillages. Cela devient de plus en plus un problème auquel il faut s'attaquer rapidement. Il est donc nécessaire de développer un système de transport capable d'assurer la sécurité des usagers de la route et d'améliorer l'infrastructure de transport. Les systèmes de transport intelligents ont gagné d'importance comme une solution prometteuse pour réduire la congestion. Ces systèmes vont offrir d'immenses possibilités pour remédier à des problèmes tels que la congestion, la sécurité routière et de l'émission de gaz en intégrant des technologies avancées pour fournir des services intelligents et robustes qui visent à prévenir les incidents routiers susceptibles de menacer la vie des passagers et fluidifier le trafic pour une utilisation efficace du carburant. L'une des exigences les plus rigoureuses de ces applications est la transmission fiable et sans risque des paquets de données. VANET est conçu spécifiquement pour fournir une infrastructure de communication sans fil pour que les véhicules et les équipements routiers puissent échanger des données de trafic. La caractéristique particulière de ce réseau est la forte mobilité des noeuds du réseau qui entraîne des changements fréquents dans la topologie et la densité. Ceci peut impacter les réseaux et par conséquent ne pas répondre aux exigences des applications de sécurité.

Dans cette thèse, nous traitons spécifiquement les méthodes d'accès pour les VANET qui sont basées sur la méthode TDMA. TDMA s'est avérée être la technique d'accès la plus appropriée pour VANET car elle permet à un seul nœud d'accéder au canal à tout moment. Cependant, les protocoles classiques basés sur la méthode TDMA ne sont pas adaptés aux réseaux fortement dynamiques et leur utilisation dans un environnement véhiculaire peut engendrer des collisions d'accès et une utilisation inéquitable des ressources. Par conséquent, une bonne compréhension de la mobilité permettra de concevoir et d'évaluer des méthodes d'accès qui soient efficaces même dans un environnement mobile. Bien que l'on trouve des modèles de mobilité fidèles dans la littérature, ils ne parviennent pas à reproduire avec précision certains aspects de la mobilité des véhicules. Le comportement du trafic est influencé par plusieurs facteurs tels que l'architecture de la route, les limitations de vitesse, les règles de circulation et le comportement individuel des véhicules. Ceux-ci doivent être inclus dans un modèle de mobilité afin d'obtenir des résultats fidèles. Dans ce contexte, nous développons dans cette thèse des

modèles stochastiques à base de chaînes de Markov basés sur des traces réelles de véhicules collectées par les RSUs en utilisant la communication V2X pour émuler le comportement des véhicules sur des routes urbaines et autoroutières. Les modèles proposés présentent le double avantage de modéliser et de prévoir le trafic. En utilisant une technique de résolution numérique, la densité du trafic, la longueur des files d'attente, le temps du trajet et le temps d'attente sont estimés. La densité de trafic estimée est ensuite exploitée pour développer une méthode d'accès basé sur TDMA appelée TA-TDMA qui a pour but principal de réduire les collisions d'accès et améliorer l'utilisation des ressources à travers la prédiction de mobilité et le clustering. Pour évaluer la performance de la méthode proposée, un outil de simulation de trafic basé sur les files d'attente a été développé à l'aide du logiciel SimEvents. Ce modèle de simulation permet de générer des mesures synthétiques importantes pour l'évaluation des performances des réseaux routiers. Le protocole TA-TDMA a ensuite été implémenté et comparé avec le protocole VeMAC, en considérant différents scénarios et environnements. La solution proposée a montré de meilleurs résultats par rapport au protocole VeMAC en termes d'efficacité et de robustesse face aux changements topologiques.

A - Appendix of chapter 4:

Table A.1: Notations used in chapter 4

Notation	Description
\mathcal{M}	Set of road lanes
M	Total number of lanes
S	Number of sections
\mathcal{S}	Set of sections
Len_R	Length of a highway road
Len_S	Length of a highway section
Sp	Average speed on a highway section
m	Index value for lane m
C_{lane}	Lane capacity
α_m	Probability to travel on lane m
D_m	Density of lane m
LC_{nm}	Lane change probability from lane n to lane m
λ	Arrival rate of vehicles
λ_m	Arrival rate of vehicles at lane m
μ	Service/Departure rate of vehicles
μ_m	Service/Departure rate of vehicles at lane m
ρ	Arrival-to-service ratio
t	Temporal variable
$X(t)$	Vector representing traffic over a road at time t
$X_m(t)$	Random variable representing the traffic condition of lane m at time t
Ω	State space
x,y,z	Values of $X(t)$
P	Transition probability matrix
p_{xy}	Transition probability from state x to state y
π	Steady-state probability distribution
L_m	Average number of vehicles traveling on lane m
S_m	Average sojourn time of lane m
VC_m	Average volume-to-traffic ratio of lane m

B - Appendix of chapter 5:

Table B.1: Notations used in chapter 5

Notation	Description
\mathcal{N}	Set of intersections
N	Number of intersections
λ_i, μ_i	Arrival and departure rates at intersection i
λ_i^{out}	Arrival rate at intersection i from the external network
R	Routing probability matrix
r_{ij}	Routing probability from intersection i to intersection j
C_i	Queue capacity of intersection i
S_i	Average sojourn time of intersection i
W_i	Average waiting time of intersection i
Q_i	Average queue length of intersection i
λ_r, μ_r	Arrival and service rates of a road r
V_m^{avg}	Average speed of lane m
$Y(t)$	Vector representing traffic at intersections at time t
$Y_i(t)$	Random variable representing traffic at intersection i at time t
Θ	State space
T	Transition probability matrix
Ψ	Steady-state probability distribution

C - Appendix of chapter 6:

Table C.1: Notations used in chapter 6

Notation	Description
R_{OBU}	Transmission range of vehicles
R_{RSU}	Transmission range of RSUs
\mathcal{S}	The set of segments
L	The length of a road segment
τ	Duration of time slots
V_i	The estimated traffic volume of segment i
D_i	Density ratio of segment i
N	Total number of time slots
N_i	Number of time slots assigned to segment i
N_i^L, N_i^R	Time slot set of the left and right direction respectively
V_i^L, V_i^R	Traffic volume of the left and right direction respectively
DL_i	Density ratio of the left direction
DR_i	Density ratio of the right direction
$DL_i(m)$	Density ratio of the m^{th} lane on the left direction
$DR_i(m)$	Density ratio of the m^{th} lane on the right direction

Bibliography

- [1] Ghosh, B. (2019). Predicting the Duration and Impact of the Nonrecurring Road Incidents on the Transportation Network (Doctoral dissertation, Ph. D. Thesis, Nanyang Technological University, Singapore).
- [2] Simeonova, E., Currie, J., Nilsson, P., & Walker, R. (2021). Congestion pricing, air pollution, and children's health. *Journal of Human Resources*, 56(4), 971-996.
- [3] Requia, W. J., Higgins, C. D., Adams, M. D., Mohamed, M., & Koutrakis, P. (2018). The health impacts of weekday traffic: A health risk assessment of PM_{2.5} emissions during congested periods. *Environment international*, 111, 164-176.
- [4] Jin, J., & Rafferty, P. (2017). Does congestion negatively affect income growth and employment growth? Empirical evidence from US metropolitan regions. *Transport Policy*, 55, 1-8.
- [5] Dimitrakopoulos, G., & Demestichas, P. (2010). Intelligent transportation systems. *IEEE Vehicular Technology Magazine*, 5(1), 77-84.
- [6] Alam, M., Ferreira, J., & Fonseca, J. (2016). Introduction to intelligent transportation systems. In *Intelligent transportation systems* (pp. 1-17). Springer, Cham.
- [7] Cunha, F., Villas, L., Boukerche, A., Maia, G., Viana, A., Mini, R. A., & Loureiro, A. A. (2016). Data communication in VANETs: Protocols, applications and challenges. *Ad Hoc Networks*, 44, 90-103.
- [8] Harding, J., Powell, G., Yoon, R., Fikentscher, J., Doyle, C., Sade, D., ... & Wang, J. (2014). Vehicle-to-vehicle communications: readiness of V2V technology for application (No. DOT HS 812 014). United States. National Highway Traffic Safety Administration.
- [9] Chou, C. M., Li, C. Y., Chien, W. M., & Lan, K. C. (2009, May). A feasibility study on vehicle-to-infrastructure communication: WiFi vs. WiMAX. In *2009 tenth international conference on mobile data management: systems, services and middleware* (pp. 397-398). IEEE.
- [10] Sewalkar, P., & Seitz, J. (2019). Vehicle-to-pedestrian communication for vulnerable road users: Survey, design considerations, and challenges. *Sensors*, 19(2), 358.
- [11] Fallgren, M., Dillinger, M., Alonso-Zarate, J., Boban, M., Abbas, T., Manolakis, K., ... & Vilalta, R. (2018). Fifth-generation technologies for the

- connected car: Capable systems for vehicle-to-anything communications. *IEEE vehicular technology magazine*, 13(3), 28-38.
- [12] Huang, L., Jiang, H., Zhang, Z., Yan, Z., & Guo, H. (2017). Efficient data traffic forwarding for infrastructure-to-infrastructure communications in VANETs. *IEEE Transactions on Intelligent Transportation Systems*, 19(3), 839-853.
- [13] Dar, K., Bakhouya, M., Gaber, J., Wack, M., & Lorenz, P. (2010). Wireless communication technologies for ITS applications [Topics in Automotive Networking]. *IEEE Communications Magazine*, 48(5), 156-162.
- [14] Jansons, J., Petersons, E., & Bogdanovs, N. (2013, March). WiFi for Vehicular Communication Systems. In 2013 27th International Conference on Advanced Information Networking and Applications Workshops (pp. 425-430). IEEE.
- [15] Fernández-Caramés, T. M., González-López, M., & Castedo, L. (2011). Mobile WiMAX for vehicular applications: Performance evaluation and comparison against IEEE 802.11 p/a. *Computer Networks*, 55(16), 3784-3795.
- [16] Choi, J., Va, V., Gonzalez-Prelcic, N., Daniels, R., Bhat, C. R., & Heath, R. W. (2016). Millimeter-wave vehicular communication to support massive automotive sensing. *IEEE Communications Magazine*, 54(12), 160-167.
- [17] Shinde, N., Bhor, S., Wable, T., & Dubule, S. (2015). Zigbee based vehicular adhoc networking. *International Journal of Infinite Innovations in Technology*.
- [18] Lu, P. W., & Chen, R. (2014). Infrared-based vehicular positioning with the automatic radiation-strength control. *IET Intelligent Transport Systems*, 8(3), 273-285.
- [19] Bronzi, W., Frank, R., Castignani, G., & Engel, T. (2016). Bluetooth low energy performance and robustness analysis for inter-vehicular communications. *Ad Hoc Networks*, 37, 76-86.
- [20] Choi, J., Va, V., Gonzalez-Prelcic, N., Daniels, R., Bhat, C. R., & Heath, R. W. (2016). Millimeter-wave vehicular communication to support massive automotive sensing. *IEEE Communications Magazine*, 54(12), 160-167.
- [21] Kenney, J. B. (2011). Dedicated short-range communications (DSRC) standards in the United States. *Proceedings of the IEEE*, 99(7), 1162-1182.
- [22] Hamato, S., Ariffin, S. H. S., & Fisal, N. (2013). Overview of wireless access in vehicular environment (WAVE) protocols and standards. *Indian Journal of Science and Technology*, 7, 07.

- [23] Kasik, J. P. (2006). Keep Calm: The Communications Air Interface Long and Medium Range (CALM) Effort is Designed to Create a Standard for Vehicle-to-Vehicle and Vehicle-to-Infrastructure Communication requirements-A Vital Project for VII. Traffic Technology International.
- [24] Kumar, V., Mishra, S., & Chand, N. (2013). Applications of VANETs: present & future. *Communications and Network*, 5(01), 12.
- [25] Englund, C., Chen, L., Vinel, A., & Lin, S. Y. (2015). Future applications of VANETs. In *Vehicular ad hoc Networks* (pp. 525-544). Springer, Cham.
- [26] Figueiredo, L., Jesus, I., Machado, J. T., Ferreira, J. R., & De Carvalho, J. M. (2001, August). Towards the development of intelligent transportation systems. In *ITSC 2001. 2001 IEEE Intelligent Transportation Systems. Proceedings* (Cat. No. 01TH8585) (pp. 1206-1211). IEEE.
- [27] Shigeta, N., & Hosseini, S. E. (2021). Sustainable Development of the Automobile Industry in the United States, Europe, and Japan with Special Focus on the Vehicles' Power Sources. *Energies*, 14(1), 78.
- [28] Hou, X., Li, Y., Chen, M., Wu, D., Jin, D., & Chen, S. (2016). Vehicular fog computing: A viewpoint of vehicles as the infrastructures. *IEEE Transactions on Vehicular Technology*, 65(6), 3860-3873.
- [29] Liu, L., Chen, C., Pei, Q., Maharjan, S., & Zhang, Y. (2021). Vehicular edge computing and networking: A survey. *Mobile Networks and Applications*, 26(3), 1145-1168.
- [30] Bella, F., & Russo, R. (2011). A collision warning system for rear-end collision: a driving simulator study. *Procedia-social and behavioral sciences*, 20, 676-686.
- [31] Xiaofei, P. E. I., Zhaodu, L. I. U., Guocheng, M. A., & Yang, Y. E. (2012). Safe distance model and obstacle detection algorithms for a collision warning and collision avoidance system. *Journal of Automotive Safety and Energy*, 3(1), 26.
- [32] Godha, S. (2017). On-road obstacle detection system for driver assistance. *Asia Pacific Journal of Engineering Science and Technology*, 3(1), 16-21.
- [33] Kianfar, R., Augusto, B., Ebadighajari, A., Hakeem, U., Nilsson, J., Raza, A., ... & Wymeersch, H. (2012). Design and experimental validation of a cooperative driving system in the grand cooperative driving challenge. *IEEE transactions on intelligent transportation systems*, 13(3), 994-1007.
- [34] Tu, L., & Huang, C. M. (2010). Forwards: A map-free intersection collision-warning system for all road patterns. *IEEE Transactions on Vehicular Technology*, 59(7), 3233-3248.

- [35] Dang, R., Ding, J., Su, B., Yao, Q., Tian, Y., & Li, K. (2014, October). A lane change warning system based on V2V communication. In 17th International IEEE Conference on Intelligent Transportation Systems (ITSC) (pp. 1923-1928). IEEE.
- [36] Al-qutwani, M., & Wang, X. (2019). Smart traffic lights over vehicular named data networking. *Information*, 10(3), 83.
- [37] Grumert, E. F., Tapani, A., & Ma, X. (2018). Characteristics of variable speed limit systems. *European transport research review*, 10(2), 1-12.
- [38] Elsonbaty, A. A. (2020). The smart parking management system. *International Journal of Computer Science & Information Technology (IJCSIT)* Vol, 12.
- [39] Levinson, D. (2003). The value of advanced traveler information systems for route choice. *Transportation Research Part C: Emerging Technologies*, 11(1), 75-87.
- [40] Gena, C., & Torre, I. (2004). The importance of adaptivity to provide onboard services: A preliminary evaluation of an adaptive tourist information service onboard vehicles. *Applied Artificial Intelligence*, 18(6), 549-580.
- [41] Aslam, B., Wang, P., & Zou, C. C. (2013). Extension of internet access to VANET via satellite receive-only terminals. *International Journal of Ad Hoc and Ubiquitous Computing*, 14(3), 172-190.
- [42] Lalitha, E., & Jayachandran, D. (2014). Multimedia Content Downloading In VANET with Density Estimation. *International Journal of Engineering Research and General Science*, 2(2).
- [43] Rene, S., Alins, J., Mata-Diaz, J., Ganan, C., Muñoz, J. L., & Esparza, O. (2014). Vespa: Emulating infotainment applications in vehicular networks. *IEEE pervasive computing*, 13(3), 58-66.
- [44] Fiore, M., & Härri, J. (2008, May). The networking shape of vehicular mobility. In *Proceedings of the 9th ACM international symposium on Mobile ad hoc networking and computing* (pp. 261-272).
- [45] Peng, H., Liang, L., Shen, X., & Li, G. Y. (2018). Vehicular communications: A network layer perspective. *IEEE Transactions on Vehicular Technology*, 68(2), 1064-1078.
- [46] Dias, J. A., Rodrigues, J. J., Isento, J. N., Pereira, P. R., & Lloret, J. (2011). Performance assessment of fragmentation mechanisms for vehicular delay-tolerant networks. *EURASIP Journal on Wireless Communications and Networking*, 2011(1), 1-14.

- [47] Reyes, A., Barrado, C., López, M., & Excelente, C. (2014). Vehicle density in VANET applications. *Journal of Ambient Intelligence and Smart Environments*, 6(4), 469-481.
- [48] Reis, A. B., Sargento, S., Neves, F., & Tonguz, O. K. (2013). Deploying roadside units in sparse vehicular networks: What really works and what does not. *IEEE transactions on vehicular technology*, 63(6), 2794-2806.
- [49] Mir, Z. H., & Filali, F. (2016, January). Simulation and performance evaluation of vehicle-to-vehicle (V2V) propagation model in urban environment. In *2016 7th International Conference on Intelligent Systems, Modelling and Simulation (ISMS)* (pp. 394-399). IEEE.
- [50] Grzybek, A., Danoy, G., Seredynski, M., & Bouvry, P. (2013, November). Evaluation of dynamic communities in large-scale vehicular networks. In *Proceedings of the third ACM international symposium on Design and analysis of intelligent vehicular networks and applications* (pp. 93-100).
- [51] Malta, L., Miyajima, C., & Takeda, K. (2009). A study of driver behavior under potential threats in vehicle traffic. *IEEE Transactions on Intelligent Transportation Systems*, 10(2), 201-210.
- [52] Davies, V. A. (2000). Evaluating mobility models within an ad hoc network (Master's thesis, advisor: Tracy Camp, Dept. of Mathematical and Computer Sciences. Colorado School of Mines).
- [53] Harri, J., Filali, F., & Bonnet, C. (2009). Mobility models for vehicular ad hoc networks: a survey and taxonomy. *IEEE Communications Surveys & Tutorials*, 11(4), 19-41.
- [54] Förster, A., Bin Muslim, A., & Udugama, A. (2018, October). "TRAILS-A Trace-Based Probabilistic Mobility Model." In *Proceedings of the 21st ACM International Conference on Modeling, Analysis and Simulation of Wireless and Mobile Systems* (pp. 295-302).
- [55] Beiró, M. G., Panisson, A., Tizzoni, M., & Cattuto, C. (2016). "Predicting human mobility through the assimilation of social media traces into mobility models." *EPJ Data Science*, 5(1), 30.
- [56] Lian, J., Li, Y., Gu, W., Huang, S. L., & Zhang, L. (2020). Mining regional mobility patterns for urban dynamic analytics. *Mobile Networks and Applications*, 25(2), 459-473.
- [57] Haklay, M., & Weber, P. (2008). Openstreetmap: User-generated street maps. *IEEE Pervasive computing*, 7(4), 12-18.

- [58] Pentland, A. (2009). Reality mining of mobile communications: Toward a new deal on data. The global information technology report 2008–2009, 1981.
- [59] Yeo, J., Kotz, D., & Henderson, T. (2006). CRAWDAD: a community resource for archiving wireless data at Dartmouth. ACM SIGCOMM Computer Communication Review, 36(2), 21-22.
- [60] MobiLib USC WLAN traces <http://nile.cise.ufl.edu/MobiLib/>
- [61] <http://www.cabspotting.org>
- [62] Bock, J., Krajewski, R., Moers, T., Runde, S., Vater, L., & Eckstein, L. (2020, October). The ind dataset: A drone dataset of naturalistic road user trajectories at german intersections. In 2020 IEEE Intelligent Vehicles Symposium (IV) (pp. 1929-1934). IEEE.
- [63] Krajewski, R., Bock, J., Kloeker, L., & Eckstein, L. (2018, November). The highd dataset: A drone dataset of naturalistic vehicle trajectories on german highways for validation of highly automated driving systems. In 2018 21st International Conference on Intelligent Transportation Systems (ITSC) (pp. 2118-2125). IEEE.
- [64] Balsa-Barreiro, J., Valero-Mora, P. M., Menéndez, M., & Mehmood, R. (2020). Extraction of Naturalistic Driving Patterns with Geographic Information Systems. Mobile Networks and Applications, 1-17.
- [65] Kim, J., & Bohacek, S. (2005). A survey-based mobility model of people for simulation of urban mesh networks. Proc. MeshNets, 1-11.
- [66] Zheng, Q., Hong, X., & Liu, J. (2006, April). An agenda based mobility model. In 39th Annual Simulation Symposium (ANSS'06) (pp. 8-pp). IEEE.
- [67] Realistic Vehicular Traces <http://lst.inf.ethz.ch/ad-hoc/car-traces>
- [68] Cameron, G. D., & Duncan, G. I. (1996). PARAMICS—Parallel microscopic simulation of road traffic. The Journal of Supercomputing, 10(1), 25-53.
- [69] Q.P. Ltd., Paramics, <https://www.paramics.co.uk/en/>
- [70] M.M. Technology, Traffic software integrated system - corridor simulation, <https://mctrans.ce.ufl.edu/featured/TSIS/>
- [71] Tss—transport simulation systems, aimsun, tss, <https://www.aimsun.com/>
- [72] Fellendorf, M. (1994, October). VISSIM: A microscopic simulation tool to evaluate actuated signal control including bus priority. In 64th Institute of Transportation Engineers Annual Meeting (Vol. 32, pp. 1-9). Springer.
- [73] Vissim America, <https://www.ptvgroup.com/>

- [74] Lopez, P. A., Behrisch, M., Bieker-Walz, L., Erdmann, J., Flötteröd, Y. P., Hilbrich, R., ... & Wießner, E. (2018, November). Microscopic traffic simulation using sumo. In 2018 21st International Conference on Intelligent Transportation Systems (ITSC) (pp. 2575-2582). IEEE.
- [75] SUMO Homepage <https://www.eclipse.org/sumo/>
- [76] Karnadi, F., Mo, Z., & Lan, K. C. (2005). MOVE: A MObility model generator for VEhicular network. In Elev. Annu. Int. Conf. Mob. Comput. Netw (p. 5).
- [77] Fiore, M., Harri, J., Filali, F., & Bonnet, C. (2007, March). Vehicular mobility simulation for VANETs. In 40th Annual Simulation Symposium (ANSS'07) (pp. 301-309). IEEE.
- [78] VanetMobiSim 1.1, <http://vanet.eurecom.fr/>
- [79] Burghout, W., Koutsopoulos, H. N., & Andreasson, I. (2006, September). A discrete-event mesoscopic traffic simulation model for hybrid traffic simulation. In 2006 IEEE Intelligent Transportation Systems Conference (pp. 1102-1107). IEEE.
- [80] Wen, Y., & Ben-Akiva, M. E. (2008). Scalability of dynamic traffic assignment (Doctoral dissertation, Massachusetts Institute of Technology, Department of Civil and Environmental Engineering).
- [81] Anylogic road traffic simulation software <https://www.anylogic.fr/road-traffic/>
- [82] Merkurjeva, G., & Bolshakovs, V. (2010, March). Vehicle schedule simulation with AnyLogic. In 2010 12th International Conference on Computer Modelling and Simulation (pp. 169-174). IEEE.
- [83] Yoon, J., Liu, M., & Noble, B. (2003, March). Random waypoint considered harmful. In IEEE INFOCOM 2003. Twenty-second Annual Joint Conference of the IEEE Computer and Communications Societies (IEEE Cat. No. 03CH37428) (Vol. 2, pp. 1312-1321). IEEE.
- [84] Bai, F., Sadagopan, N., & Helmy, A. (2003). The IMPORTANT framework for analyzing the Impact of Mobility on Performance Of Routing protocols for Adhoc NeTworks. *Ad hoc networks*, 1(4), 383-403.
- [85] Nagel, K., & Schreckenberg, M. (1992). A cellular automaton model for freeway traffic. *Journal de physique I*, 2(12), 2221-2229.
- [86] Zhang, G., & Xu, W. (2018, July). Cellular automaton traffic model considering driver's reaction to velocity and headway distance with variable possibility of randomization. In IOP Conference Series: Materials Science and Engineering (Vol. 392, No. 6, p. 062024). IOP Publishing.

- [87] Zhang, D., Huang, H., Zhou, J., Xia, F., & Chen, Z. (2013). Detecting hot road mobility of vehicular ad hoc networks. *Mobile Networks and Applications*, 18(6), 803-813.
- [88] Lighthill, M. J., & Whitham, G. B. (1964). On kinematic waves: II. A theory of traffic flow on long crowded roads. *Special Report*, 79, 7-35.
- [89] Richards, P. I. (1956). Shock waves on the highway. *Operations research*, 4(1), 42-51.
- [90] Liu, H. X., Wu, X., Ma, W., & Hu, H. (2009). Real-time queue length estimation for congested signalized intersections. *Transportation research part C: emerging technologies*, 17(4), 412-427.
- [91] Yang, H., Rakha, H., & Ala, M. V. (2016). Eco-cooperative adaptive cruise control at signalized intersections considering queue effects. *IEEE Transactions on Intelligent Transportation Systems*, 18(6), 1575-1585.
- [92] Krauß, S. (1998). *Microscopic modeling of traffic flow: Investigation of collision free vehicle dynamics*.
- [93] Ou, H., & Tang, T. Q. (2018). An extended two-lane car-following model accounting for inter-vehicle communication. *Physica A: Statistical Mechanics and Its Applications*, 495, 260-268.
- [94] Pop, M. D., Proştean, O., & Proştean, G. (2019, July). Multiple Lane Road Car-Following model using bayesian reasoning for lane change behavior estimation: A smart approach for smart mobility. In *Proceedings of the 3rd International Conference on Future Networks and Distributed Systems* (pp. 1-8).
- [95] Legendre, F., Borrel, V., De Amorim, M. D., & Fdida, S. (2006, November). Modeling mobility with behavioral rules: The case of incident and emergency situations. In *Asian Internet Engineering Conference* (pp. 186-205). Springer, Berlin, Heidelberg.
- [96] Gipps, P. G. (1981). A behavioural car-following model for computer simulation. *Transportation Research Part B: Methodological*, 15(2), 105-111.
- [97] Kharrazi, S., Almen, M., Frisk, E., & Nielsen, L. (2018). Extending behavioral models to generate mission-based driving cycles for data-driven vehicle development. *IEEE Transactions on Vehicular Technology*, 68(2), 1222-1230.
- [98] Gawron, C. (1998). An iterative algorithm to determine the dynamic user equilibrium in a traffic simulation model. *International Journal of Modern Physics C*, 9(03), 393-407.

- [99] Mirchandani, P. B., & Zou, N. (2007). Queuing models for analysis of traffic adaptive signal control. *IEEE Transactions on Intelligent Transportation Systems*, 8(1), 50-59.
- [100] Cremer, M., & Landenfeld, M. (1998). A mesoscopic model for saturated urban road networks. In *Traffic and Granular Flow* (Vol. 97, pp. 169-180).
- [101] Mohimani, G. H., Ashtiani, F., Javanmard, A., & Hamdi, M. (2008). Mobility modeling, spatial traffic distribution, and probability of connectivity for sparse and dense vehicular ad hoc networks. *IEEE Transactions on Vehicular Technology*, 58(4), 1998-2007.
- [102] Ketabi, R., Al-Qathrady, M., Alipour, B., & Helmy, A. (2019, November). Vehicular traffic density forecasting through the eyes of traffic cameras; a spatio-temporal machine learning study. In *Proceedings of the 9th ACM Symposium on Design and Analysis of Intelligent Vehicular Networks and Applications* (pp. 81-88).
- [103] Xia, D., Li, H., Wang, B., Li, Y., & Zhang, Z. (2016). A map reduce-based nearest neighbor approach for big-data-driven traffic flow prediction. *IEEE access*, 4, 2920-2934.
- [104] Jin, F., & Sun, S. (2008, June). Neural network multitask learning for traffic flow forecasting. In *2008 IEEE International Joint Conference on Neural Networks (IEEE World Congress on Computational Intelligence)* (pp. 1897-1901). IEEE.
- [105] Zhu, M., Wang, X., & Wang, Y. (2018). Human-like autonomous car-following model with deep reinforcement learning. *Transportation research part C: emerging technologies*, 97, 348-368.
- [106] Hadded, M., Muhlethaler, P., Laouiti, A., Zagrouba, R., & Saidane, L. A. (2015). TDMA-based MAC protocols for vehicular ad hoc networks: a survey, qualitative analysis, and open research issues. *IEEE Communications Surveys & Tutorials*, 17(4), 2461-2492.
- [107] Sharma, G., Ganesh, A., & Key, P. (2009). Performance analysis of contention based medium access control protocols. *IEEE Transactions on Information Theory*, 55(4), 1665-1682.
- [108] Busch, C., Magdon-Ismael, M., Sivrikaya, F., & Yener, B. (2004, October). Contention-free MAC protocols for wireless sensor networks. In *International Symposium on Distributed Computing* (pp. 245-259). Springer, Berlin, Heidelberg.

- [109] Guo, W., Huang, L., Chen, L., Xu, H., & Xie, J. (2012, October). An adaptive collision-free MAC protocol based on TDMA for inter-vehicular communication. In 2012 International Conference on Wireless Communications and Signal Processing (WCSP) (pp. 1-6). IEEE.
- [110] Guo, W., Huang, L., Chen, L., Xu, H., & Miao, C. (2013). R-mac: Risk-aware dynamic mac protocol for vehicular cooperative collision avoidance system. *International Journal of Distributed Sensor Networks*, 9(5), 686713.
- [111] Zhang, R., Lee, J., Shen, X., Cheng, X., Yang, L., and Jiao, B., "A unified tdma-based scheduling protocol for vehicle-to-infrastructure communications," in *International Conference Wireless Communications and Signal Processing (WCSP)*, Oct. 2013, pp. 1–6 (2013).
- [112] Zhang, R., Cheng, X., Yang, L., Shen, X., and Jiao, B., "A novel centralized TDMA-based scheduling protocol for vehicular networks," in *IEEE Transactions on Intelligent Transportation Systems*, Vol. 16, Feb. 2015, pp. 411–416 (2015).
- [113] Cao, S., & Lee, V. C. (2017). A novel adaptive TDMA-based MAC protocol for VANETs. *IEEE Communications Letters*, 22(3), 614-617.
- [114] Gunter, Y., Wiegel, B., & Grossmann, H. P. (2007, October). Cluster-based medium access scheme for VANETs. In 2007 IEEE intelligent transportation systems conference (pp. 343-348). IEEE.
- [115] Ding, R., & Zeng, Q. A. (2009, June). A clustering-based multi-channel vehicle-to-vehicle (V2V) communication system. In 2009 First International Conference on Ubiquitous and Future Networks (pp. 83-88). IEEE.
- [116] Almalag, M. S., Olariu, S., & Weigle, M. C. (2012, June). Tdma cluster-based mac for vanets (tc-mac). In 2012 IEEE international symposium on a world of wireless, mobile and multimedia networks (WoWMoM) (pp. 1-6). IEEE.
- [117] Abdalla, G. M., Abu-Rgheff, M. A., & Senouci, S. M. (2009, June). Space-orthogonal frequency-time medium access control (SOFT MAC) for VANET. In 2009 Global Information Infrastructure Symposium (pp. 1-8). IEEE.
- [118] Omar, H. A., Zhuang, W., & Li, L. (2012). VeMAC: A TDMA-based MAC protocol for reliable broadcast in VANETs. *IEEE transactions on mobile computing*, 12(9), 1724-1736.
- [119] Chen, P., Zheng, J., & Wu, Y. (2017, May). A-VeMAC: An adaptive vehicular MAC protocol for vehicular ad hoc networks. In 2017 IEEE International Conference on Communications (ICC) (pp. 1-6). IEEE.
- [120] YANG, W. D., Pan, L. I., & ZHU, H. S. (2013). Adaptive TDMA slot assignment protocol for vehicular ad-hoc networks. *The Journal of China Universities of Posts and Telecommunications*, 20(1), 11-25.

- [121] Zou, R., Liu, Z., Zhang, L., & Kamil, M. (2014, April). A near collision free reservation based MAC protocol for VANETs. In 2014 IEEE Wireless Communications and Networking Conference (WCNC) (pp. 1538-1543). IEEE.
- [122] Gomides, T. S., Robson, E., de Souza, A. M., Souza, F. S., Villas, L. A., & Guidoni, D. L. (2020). An adaptive and distributed traffic management system using vehicular ad-hoc networks. *Computer Communications*, 159, 317-330.
- [123] Cunha, F., Villas, L., Boukerche, A., Maia, G., Viana, A., Mini, R. A., & Loureiro, A. A. (2016). Data communication in VANETs: Protocols, applications and challenges. *Ad Hoc Networks*, 44, 90-103.
- [124] Pursula, M. (1999). Simulation of traffic systems-an overview. *Journal of geographic information and decision analysis*, 3(1), 1-8.
- [125] Fomundam, S., & Herrmann, J. W. (2007). A survey of queuing theory applications in healthcare.
- [126] Xiao, H., & Zhang, G. (2010, January). The queuing theory application in bank service optimization. In 2010 International Conference on Logistics Systems and Intelligent Management (ICLSIM) (Vol. 2, pp. 1097-1100). IEEE.
- [127] Issariyakul, T., & Hossain, E. (2009). Introduction to network simulator 2 (NS2). In *Introduction to network simulator NS2* (pp. 1-18). Springer, Boston, MA.
- [128] NS2, DARPA Project, Available: http://nslam.isi.edu/nslam/index.php/User_Information
- [129] Ertel, W. (2018). *Introduction to artificial intelligence*. Springer.
- [130] Mejri, M. N., Ben-Othman, J., & Hamdi, M. (2014). Survey on VANET security challenges and possible cryptographic solutions. *Vehicular Communications*, 1(2), 53-66.
- [131] Hahn, D. A., Munir, A., & Behzadan, V. (2019). Security and Privacy Issues in Intelligent Transportation Systems: Classification and Challenges. *IEEE Intell. Transp. Syst.*
- [132] Cunha, F., Villas, L., Boukerche, A., Maia, G., Viana, A., Mini, R. A., & Loureiro, A. A. (2016). Data communication in VANETs: Protocols, applications and challenges. *Ad Hoc Networks*, 44, 90-103.
- [133] Lin, Y., Wang, P., & Ma, M. (2017, May). Intelligent transportation system (its): Concept, challenge and opportunity. In 2017 IEEE 3rd International Conference on Big Data Security on Cloud (BigDataSecurity), IEEE International Conference on High Performance and Smart Computing (Hpsc), and IEEE International Conference on Intelligent Data and Security (IDS) (pp. 167-172). IEEE.

- [134] Javed, M. A., Zeadally, S., & Hamida, E. B. (2019). Data analytics for cooperative intelligent transport systems. *Vehicular communications*, 15, 63-72.
- [135] Kuutti, S., Fallah, S., Katsaros, K., Dianati, M., Mccullough, F., & Mouzakitis, A. (2018). A survey of the state-of-the-art localization techniques and their potentials for autonomous vehicle applications. *IEEE Internet of Things Journal*, 5(2), 829-846.
- [136] Barrachina, J., Sanguesa, J. A., Fogue, M., Garrido, P., Martinez, F. J., Cano, J. C., ... & Manzoni, P. (2013, November). V2X-d: A vehicular density estimation system that combines V2V and V2I communications. In *2013 IFIP Wireless Days (WD)* (pp. 1-6). IEEE.
- [137] Nguyen, B. L., Ngo, D. T., Tran, N. H., & Vu, H. L. (2019, October). Combining V2I with V2V communications for service continuity in vehicular networks. In *2019 IEEE Intelligent Transportation Systems Conference (ITSC)* (pp. 201-206). IEEE.
- [138] Sukuvaara, T., & Nurmi, P. (2009). Wireless traffic service platform for combined vehicle-to-vehicle and vehicle-to-infrastructure communications. *IEEE Wireless Communications*, 16(6), 54-61.
- [139] Wang, P., Zhao, J., Gao, Y., Sotelo, M. A., & Li, Z. (2020). Lane work-schedule of toll station based on queuing theory and PSO-LSTM model. *IEEE Access*, 8, 84434-84443.
- [140] Guerouahane, N., Aissani, D., Farhi, N., & Bouallouche-Medjkoune, L. (2017). M/G/c/c state dependent queuing model for a road traffic system of two sections in tandem. *Computers & Operations Research*, 87, 98-106.
- [141] Kafi, M. A., Ben-Othman, J., Mokdad, L., & Badache, N. (2017). "Performance analysis and evaluation of REFIACC using queuing networks." *Simulation Modelling Practice and Theory*, 71, 15-26.
- [142] Mokdad, L., Ben-Othman, J., & Nguyen, A. T. (2015). "DJAVAN: Detecting jamming attacks in Vehicle Ad hoc Networks." *Performance Evaluation*, 87, 47-59.
- [143] Mokdad, L., Ben-Othman, J., Yahya, B., & Niagne, S. (2014). "Performance evaluation tools for QoS MAC protocol for wireless sensor networks." *Ad Hoc Networks*, 12, 86-99.
- [144] Grassmann, W. K., Taksar, M. I., & Heyman, D. P. (1985). "Regenerative analysis and steady state distributions for Markov chains." *Operations Research*, 33(5), 1107-1116.

- [145] Kleinrock, Leonard. 1975. Queueing Systems Volume I: Theory. Canada: John Wiley & Sons, Inc.
- [146] Stewart, W. J. (2009). Probability, Markov chains, queues, and simulation. Princeton university press.
- [147] R. Krajewski, J. Bock, L. Kloeker and L. Eckstein, "The highD Dataset: A Drone Dataset of Naturalistic Vehicle Trajectories on German Highways for Validation of Highly Automated Driving Systems," 2018 21st International Conference on Intelligent Transportation Systems (ITSC), Maui, HI, 2018, pp. 2118-2125, doi: 10.1109/ITSC.2018.8569552.
- [148] Bock, J., Krajewski, R., Moers, T., Runde, S., Vater, L., & Eckstein, L. (2020, October). The ind dataset: A drone dataset of naturalistic road user trajectories at german intersections. In 2020 IEEE Intelligent Vehicles Symposium (IV) (pp. 1929-1934). IEEE.
- [149] Krajewski, R., Moers, T., Bock, J., Vater, L., & Eckstein, L. (2020, September). The round dataset: A drone dataset of road user trajectories at roundabouts in germany. In 2020 IEEE 23rd International Conference on Intelligent Transportation Systems (ITSC) (pp. 1-6). IEEE.
- [150] K. Sjoberg, E. Uhlemann and E. G. Strom, "How Severe Is the Hidden Terminal Problem in VANETs When Using CSMA and STDMA?," 2011 IEEE Vehicular Technology Conference (VTC Fall), 2011, pp. 1-5, doi: 10.1109/VETECONF.2011.6093256.